



**@server**

xSeries 380

## **User's Reference**





xSeries 380



# User's Reference

**Note:** Before using this information and the product it supports, be sure to read the general information in Appendix A, "Product warranties and notices," on page 79.

**First Edition (July 2001)**

**© Copyright International Business Machines Corporation 2001. All rights reserved.**

US Government Users Restricted Rights – Use, duplication or disclosure restricted by GSA ADP Schedule Contract with IBM Corp.

# Safety

Before installing this product, read the Safety Information.

مج، يجب قراءة دات السلامة

Antes de instalar este produto, leia as Informações de Segurança.

在安装本产品之前，请仔细阅读 **Safety Information** (安全信息)。

安裝本產品之前，請先閱讀「安全資訊」。

Prije instalacije ovog produkta obavezno pročitajte Sigurnosne Upute.

Před instalací tohoto produktu si přečtěte příručku bezpečnostních instrukcí.

Læs sikkerhedsforskrifterne, før du installerer dette produkt.

Lees voordat u dit product installeert eerst de veiligheidsvoorschriften.

Ennen kuin asennat tämän tuotteen, lue turvaohjeet kohdasta Safety Information.

Avant d'installer ce produit, lisez les consignes de sécurité.

Vor der Installation dieses Produkts die Sicherheitshinweise lesen.

Πριν εγκαταστήσετε το προϊόν αυτό, διαβάστε τις πληροφορίες ασφάλειας (safety information).

לפני שתתקינו מוצר זה, קראו את הוראות הבטיחות.

A termék telepítése előtt olvassa el a Biztonsági előírásokat!

Prima di installare questo prodotto, leggere le Informazioni sulla Sicurezza

製品の設置の前に、安全情報をお読みください。

본 제품을 설치하기 전에 안전 정보를 읽으십시오.

Пред да се инсталира овој продукт, прочитајте информацијата за безбедност.

Les sikkerhetsinformasjonen (Safety Information) før du installerer dette produktet.

Przed zainstalowaniem tego produktu, należy zapoznać się z książką "Informacje dotyczące bezpieczeństwa" (Safety Information).

Antes de instalar este produto, leia as Informações sobre Segurança.

Перед установкой продукта прочтите инструкции по технике безопасности.

Pred inštaláciou tohto zariadenia si pečítajte Bezpečnostné predpisy.

Pred namestitvijo tega proizvoda preberite Varnostne informacije.

Antes de instalar este producto lea la información de seguridad.

Läs säkerhetsinformationen innan du installerar den här produkten.

#### Statement 1



#### DANGER

**Electrical current from power, telephone, and communication cables is hazardous.**

**To avoid a shock hazard:**

- **Do not connect or disconnect any cables or perform installation, maintenance, or reconfiguration of this product during an electrical storm.**
- **Connect all power cords to a properly wired and grounded electrical outlet.**
- **Connect to properly wired outlets any equipment that will be attached to this product.**
- **When possible, use one hand only to connect or disconnect signal cables.**
- **Never turn on any equipment when there is evidence of fire, water, or structural damage.**
- **Disconnect the attached power cords, telecommunications systems, networks, and modems before you open the device covers, unless instructed otherwise in the installation and configuration procedures.**
- **Connect and disconnect cables as described in the following table when installing, moving, or opening covers on this product or attached devices.**

#### To Connect:

1. Turn everything OFF.
2. First, attach all cables to devices.
3. Attach signal cables to connectors.
4. Attach power cords to outlet.
5. Turn device ON.

#### To Disconnect:

1. Turn everything OFF.
2. First, remove power cords from outlet.
3. Remove signal cables from connectors.
4. Remove all cables from devices.

Statement 3



**CAUTION:**

When laser products (such as CD-ROMs, DVD drives, fiber optic devices, or transmitters) are installed, note the following:

- Do not remove the covers. Removing the covers of the laser product could result in exposure to hazardous laser radiation. There are no serviceable parts inside the device.
- Use of controls or adjustments or performance of procedures other than those specified herein might result in hazardous radiation exposure.



**DANGER**

Some laser products contain an embedded Class 3A or Class 3B laser diode. Note the following.

Laser radiation when open. Do not stare into the beam, do not view directly with optical instruments, and avoid direct exposure to the beam.

Class 1 Laser Product  
Laser Klasse 1  
Laser Klass 1  
Luokan 1 Laserlaite  
Appareil À Laser de Classe 1

**Statement 4**

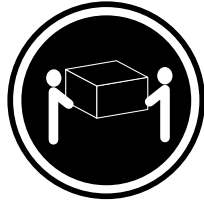

≥18 kg (37 lbs)

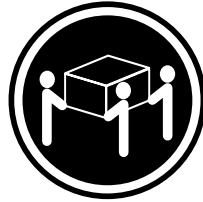

≥32 kg (70.5 lbs)

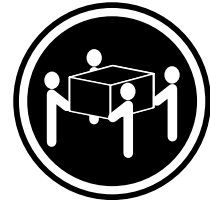

≥55 kg (121.2 lbs)

**CAUTION:**

**Use safe practices when lifting.**

**Statement 5**

**CAUTION:**



The power control button on the device and the power switch on the power supply do not turn off the electrical current supplied to the device. The device also might have more than one power cord. To remove all electrical current from the device, ensure that all power cords are disconnected from the power source.





**Statement 8**



**CAUTION:**

Never remove the cover on a power supply or any part that has the following label attached.



Hazardous voltage, current, and energy levels are present inside any component that has this label attached. There are no serviceable parts inside these components. If you suspect a problem with one of these parts, contact a service technician.

**Statement 10**



**CAUTION:**

Do not place any object weighing more than 82 kg (180 lbs.) on top of rack-mounted devices.



**Statement 13**

**CAUTION:**



Overloading a branch circuit is potentially a fire hazard and a shock hazard under certain conditions. To avoid these hazards, ensure that your system electrical requirements do not exceed branch circuit protection requirements. Refer to the information that is provided with your IBM device for electrical specifications.

Statement 14



**CAUTION:**  
Hazardous voltage, current, and energy levels might be present. Only a qualified service technician is authorized to remove the covers where the following label is attached.

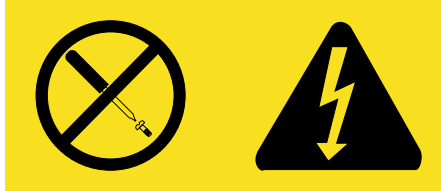

Statement 15



**CAUTION:**

Make sure that the rack is secured properly to avoid tipping when the server unit is extended.

Statement 16



**CAUTION:**

Some accessory or option board outputs exceed Class 2 or limited power source limits and must be installed with appropriate interconnecting cabling in accordance with the national electric code.

# Contents

<b>Safety</b> .....	iii
<b>Chapter 1. Introducing the IBM xSeries 380 server</b> .....	1
Features and specifications .....	2
Notices and statements used in this book .....	3
What your IBM xSeries 380 offers .....	5
Reliability, availability, and serviceability features .....	6
Server controls and indicators .....	7
Front view .....	7
Rear view .....	9
<b>Chapter 2. Turning on the server</b> .....	11
Turning on the server for the first time .....	11
Turning on the server .....	12
Turning off the server .....	12
Standby mode .....	13
<b>Chapter 3. Arranging your workspace</b> .....	15
Comfort .....	15
Glare and lighting .....	15
Air circulation .....	16
Electrical outlets and cable lengths .....	16
<b>Chapter 4. Configuring your server</b> .....	17
Using the BIOS Setup Utility program .....	18
Starting the BIOS Setup Utility program .....	18
Choices available from the BIOS Setup main menu .....	18
Using the Extensible Firmware Interface (EFI) boot manager .....	24
Using the Extensible Firmware Interface (EFI) shell .....	25
Using the QLogic SCSI Utility .....	26
Using the Firmware Update Utility .....	26
Using the SELView Utility .....	26
Using the Server Management Configuration Utility .....	27
<b>Chapter 5. Installing options</b> .....	31
Before you begin .....	32
System reliability considerations .....	32
Working inside the server with the power on .....	33
Handling static-sensitive devices .....	33
Safety information .....	34
Installing hot-swap options .....	41
Replacing a hot-swap 172-mm fan .....	41
Replacing a hot-swap 120-mm fan .....	42
Installing a hot-swap hard disk drive .....	43
Replacing a hot-swap power supply .....	44
Replacing a hot-plug PCI adapter .....	46
Input/output ports .....	49
Video port .....	49
Keyboard port .....	50
Auxiliary-device (pointing device) port .....	50
Parallel port .....	51
Serial ports .....	52
Universal Serial Bus (USB) ports .....	52
SCSI port .....	53

<b>Chapter 6. Solving Problems</b> .....	55
Diagnostic tools overview .....	55
POST .....	57
AMIDiagnostic program .....	57
Running AMIDiag in batch mode .....	57
AMIDiag Menus .....	58
AMIDiag Shortcuts .....	59
Selecting AMIDiag tests .....	60
AMIDiag error codes .....	62
System error codes .....	62
Memory error codes .....	63
IDE CD error codes .....	65
IDE DVD error codes .....	65
ATAPI removables error codes .....	65
SCSI error codes .....	66
Keyboard error codes .....	66
Video error codes .....	67
USB error codes .....	67
Parallel error codes .....	68
Serial port error codes .....	68
PS/2 mouse error codes .....	69
ACPI error codes .....	69
Troubleshooting charts .....	70
Troubleshooting an Ethernet controller .....	73
Network connection problems .....	73
Ethernet controller troubleshooting chart .....	74
Replacing the battery .....	75
Getting information, help, and service .....	76
Getting information .....	76
Using the World Wide Web .....	76
Getting information by fax .....	76
Getting help and service .....	76
Using the documentation and diagnostic programs .....	76
Calling for service .....	77
Purchasing additional services .....	78
<b>Appendix A. Product warranties and notices</b> .....	79
Warranty Information .....	79
Warranty Period .....	79
IBM Statement of Limited Warranty .....	79
Part 1 - General Terms .....	79
Part 2 - Country-unique Terms .....	81
Notices .....	87
Edition notice .....	88
Processing date data .....	88
Trademarks .....	88
Important notes .....	89
Electronic emission notices .....	89
Federal Communications Commission (FCC) Statement .....	89
Industry Canada Class A emission compliance statement .....	89
Australia and New Zealand Class A statement .....	90
United Kingdom telecommunications safety requirement .....	90
European Union EMC Directive conformance statement .....	90
Taiwan electrical emission statement .....	90
Japanese Voluntary Control Council for Interference (VCCI) statement .....	90
Power cords .....	91

**Index** ..... 93



---

## Chapter 1. Introducing the IBM xSeries 380 server

Your IBM® eServer xSeries 380 delivers processing for 64-bit applications. It is a four-way symmetric multiprocessing (SMP) server that is ideally suited for 64-bit application development environments that require an industry standard reference platform, efficient memory management, and 64-bit processing performance.

Your IBM xSeries 380 server comes with a three-year limited warranty. With access to the World Wide Web, you can obtain up-to-date information about your server model and other IBM products at <http://www.ibm.com/pc/eserver/xseries>.

For service, assistance, or additional information on the World Wide Web, see “Getting information, help, and service” on page 76.

You will find the server serial number and model number on labels on the rear and the front of the server. You will need these numbers when you register your server with IBM.

## Features and specifications

The following table provides a summary of the features and specifications for your xSeries 380.

<p><b>Microprocessor:</b></p> <ul style="list-style-type: none"> <li>• Intel® Itanium® microprocessor</li> <li>• 2 or 4 MB* of level-3 cache 133 MHz front-side bus (FSB)</li> <li>• Support for up to four microprocessors</li> </ul> <p><b>Memory:</b></p> <ul style="list-style-type: none"> <li>• Standard: 1 GB*(4-256 MB DIMMs)</li> <li>• Maximum: 64 GB (64-1 GB DIMMs)</li> <li>• Type: PC100, version 1.2 buffered, ECC, SDRAM</li> <li>• Slots: 64 dual inline</li> </ul> <p><b>Standard drives:</b></p> <ul style="list-style-type: none"> <li>• Diskette: IDE 120 MB (LS120)</li> <li>• CD-ROM: IDE</li> <li>• Hard disk drives: Two 36 GB hot-swap low voltage differential SCSI (LVDS) drives</li> </ul> <p><b>Redundant cooling:</b></p> <p>Six hot-swap fan assemblies</p>	<p><b>PCI expansion slots:</b></p> <ul style="list-style-type: none"> <li>• Eight hot-plug 66 MHz 64-bit</li> <li>• Two non-hot-plug 33 MHz 64-bit (reserved)</li> </ul> <p><b>Hot-swap power supplies:</b></p> <ul style="list-style-type: none"> <li>• Four 800-watt (110 -208 V ac)</li> </ul> <p><b>Video:</b></p> <ul style="list-style-type: none"> <li>• ATI RAGE controller</li> <li>• Compatible with SVGA and VGA</li> <li>• 8 MB video memory</li> </ul> <p><b>Size:</b></p> <ul style="list-style-type: none"> <li>• Height: 31.12 cm (12.25 inches, 7U)</li> <li>• Depth: 44.45 cm (17.5 inches)</li> <li>• Width: 71.12 cm (28.0 inches)</li> <li>• Maximum weight: 68.1 kg (150 lb) depending on configuration</li> </ul>	<p><b>Environment:</b></p> <p>Air temperature: 10° to 35°C (50° to 95°F)</p> <p><b>Heat output</b></p> <p>Approximate heat output in British thermal units (Btu) per hour: 6174 Btu</p> <p><b>Installation requirements:</b></p> <ul style="list-style-type: none"> <li>• Front clearance: 3 in.</li> <li>• Rear clearance: 8 in.</li> </ul> <p><b>Integrated functions:</b></p> <ul style="list-style-type: none"> <li>• QLogic ISP12160 low voltage directive SCSI (LVDS) controller</li> <li>• Integrated service processor</li> <li>• Video port</li> <li>• Mouse port</li> <li>• Keyboard</li> <li>• Parallel port</li> <li>• Two serial ports</li> <li>• Two Universal Serial Bus (USB) ports</li> <li>• System controls and indicators</li> <li>• Basic input/output system (BIOS), power-on self-test (POST), and Setup utility stored in a flash memory device.</li> </ul>
---	--	---

\*KB equals approximately 1000 bytes. MB equals approximately 1 000 000 bytes. GB equals approximately 1 000 000 000 bytes.



---

## Notices and statements used in this book

The Caution statements and Danger statements also appear in the multilingual safety information book provided on the *IBM xSeries Documentation* CD. Each statement is numbered for easy reference to the corresponding statement in the safety book.

Descriptions of the notices and statements that appear in this book are as follows:

- **Notes:** These notices provide important tips, guidance, or advice.
- **Important:** These notices provide information or advice that might help you avoid inconvenient or problem situations.
- **Attention:** These notices indicate possible damage to programs, devices, or data. An attention notice is placed just before the instruction or situation in which damage could occur.
- **Caution:** These statements indicate situations that can be potentially hazardous to you. A caution statement is placed just before the description of a potentially hazardous procedure step or situation.
- **Danger:** These statements indicate situations that can be potentially lethal or extremely hazardous to you. A danger statement is placed just before the description of a potentially lethal or extremely hazardous procedure step or situation.



---

## What your IBM xSeries 380 offers

The unique design of your server combines the following features:

- Multiprocessing performance

Your system supports one to four Itanium microprocessors with either 2 or 4 MB each of level-2 cache. It is a four-way symmetric multiprocessing (SMP) server.

- Large system memory

The xSeries 380 can support up to 64 GB of system memory. Memory resides on two memory boards. Each memory board contains slots for 32 dual inline memory modules (DIMMs). The memory controller supports PC100-registered version 1.2 buffered synchronous dynamic random access memory (SDRAM) DIMMs.

Supported DIMM sizes are 256 MB, 512 MB, and 1 GB. Each memory board can support from 1 GB to 32 GB.

- System-management capabilities

Three controllers provide the system-management capabilities of your server: the Baseboard Management Controller (BMC), Intelligent Chassis Management Bus Controller (ICMBC), and the Hot-Swap Controller (HSC). The BMC monitors for system platform management events and logs their occurrence in the System Event Log (SEL). System platform management events include over-temperature and over-voltage conditions as well as fan failures.

The HSC performs the SAF-TE command set, controls the fault lights, and provides a path for management information from the SCSI interface. It retrieves drive fault status, backplane temperature, and fan failure information from the Intelligent Platform Management Bus (IPMB). Then, it queries the status of the power distribution board from the BMC and controls drive power-on and power-down. This facilitates the hot-swapping capabilities of the PCI adapters, fans, and hard disk drives.

The Chassis Bridge Controller (CBC) serves as a bridge between the internal Intelligent Platform Management Bus (IPMB) and the external Intelligent Chassis Management Bus Controller (ICMBC). The internal IPMB transports management information within a system, and the external ICMBC transports server management information between the servers.

---

## Reliability, availability, and serviceability features

Three of the most important considerations in server design are reliability, availability, and serviceability (RAS). The RAS features help you to ensure the integrity of the data that is stored on your server, the availability of the server when you need it, and the ease with which you can diagnose and repair problems.

The following is an abbreviated list of the RAS features that your server supports:

- Power-on self-test (POST)
- Automatic restart after a power failure
- Low-voltage protection
- Dual hot-swap LVDS SCSI hard disk drives
- Error checking and correcting (ECC) memory
- Error codes and messages
- Menu driven setup, system configuration, and diagnostic programs
- System-management capabilities
- Redundant and hot-swap fans
- Redundant and hot-swap power supplies
- Diagnostic LEDs

---

## Server controls and indicators

The following section identifies the controls and indicators on the front and rear of your server.

### Front view

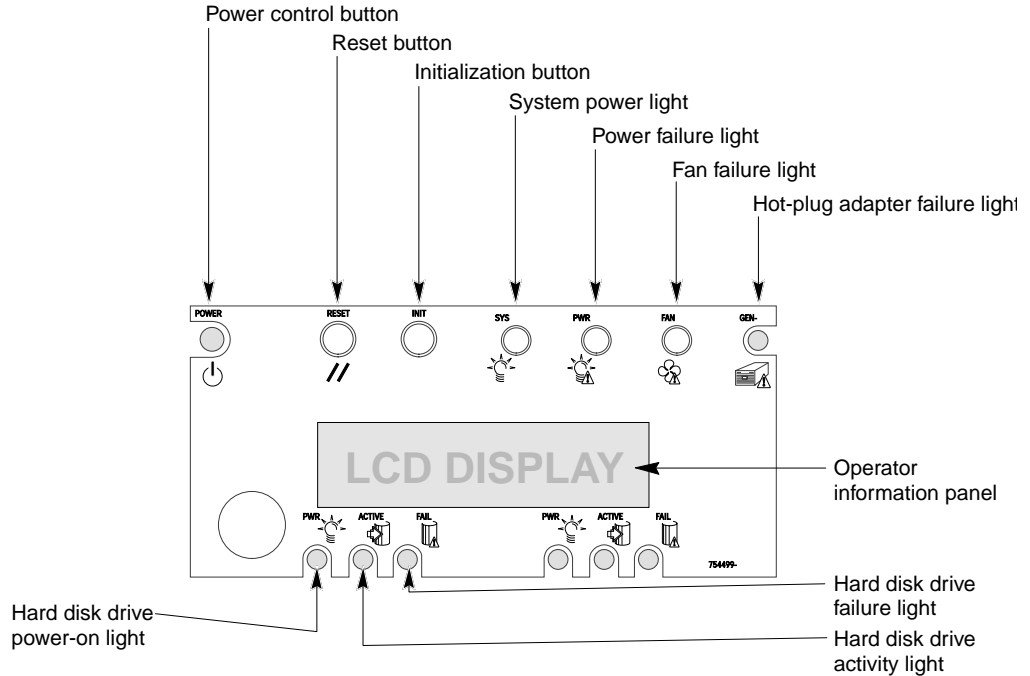

**Power control button:** Press this button to turn the server on or off.

**Reset button:** Press this button to reset the server and run the power-on self-test (POST).

**Initialization button:** Press this button to move register information into a file or output device, provided the operating system supports copying or moving of the register information.

**System power light:** When this light is on, power is present in the server. When this light is off, it indicates that power is turned off or the power source is disrupted.

**Power failure light:** When this light is flashing, it indicates that the power source failed. When this light is on, it indicates that the power source experienced a catastrophic failure.

**Fan failure light:** When this light is flashing, it indicates that a fan has failed.

**Hot-plug adapter failure light:** When this light is on, it indicates that a hot-plug adapter has failed.

**Operator information panel:** System monitor information appears on this display.

**Hard disk drive failure light:** When this light is on, a hard disk drive has failed. When flashing, this light indicates that a drive reset is in progress.

**Hard disk drive activity light:** When this light is on, the server is accessing the hard disk drive.

**Hard disk drive power-on light:** When this light is on, power to the hard disk drive is present.

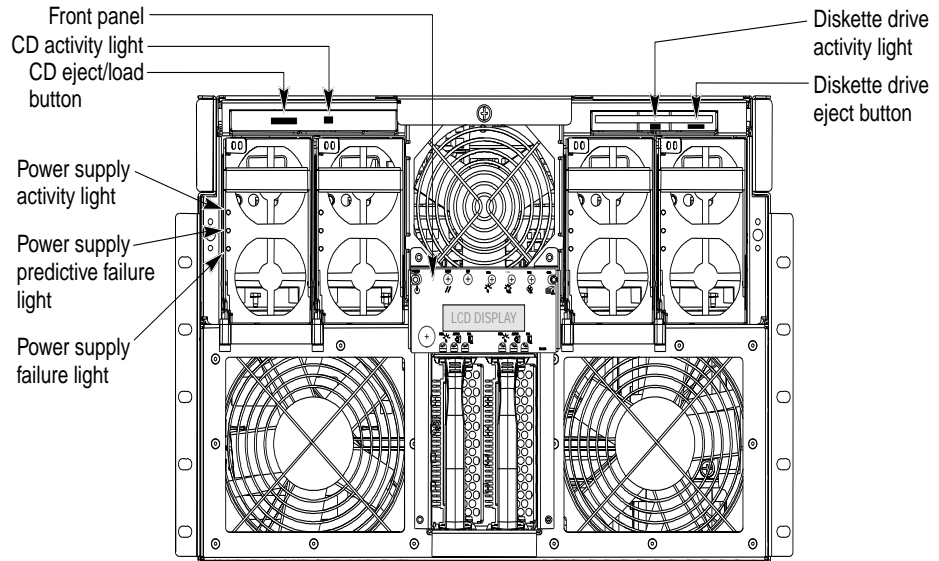

**CD eject/load button:** Press this button to eject or retract the CD tray so that you can insert or remove a CD.

**CD activity light:** When this light is on, the CD drive is being accessed.

**Front panel:** The front panel contains status lights.

**Diskette drive activity light:** When this light is on, the diskette drive is being accessed.

**Diskette eject button:** Press this button to eject a diskette from the drive.

**Power supply failure light** When this light is on, the power supply has failed. When this light is blinking, the power supply has reached its current limit of power output

**Power supply predictive failure light:** When this light is blinking, the power supply is about to fail.

**Power supply activity light:** When this light is on, the power supply is functioning properly. When this light is blinking, the power supply is in standby mode.

## Rear view

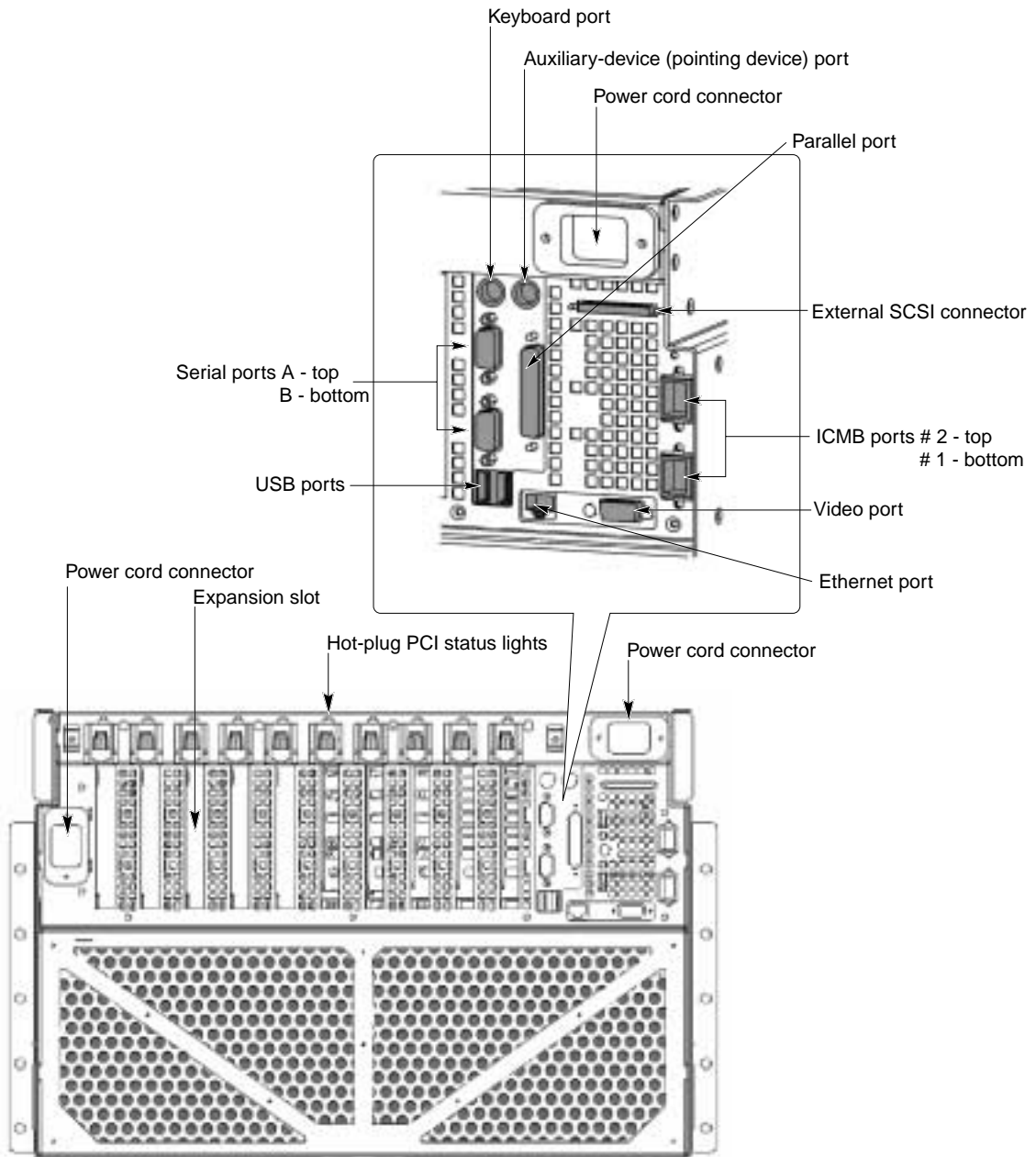

**USB ports:** Use this port to connect Universal Serial Bus devices to the server.

**Serial ports:** Use this port to connect modems or other serial devices to the server.

**Keyboard port:** Use this port to connect the keyboard to the server.

**Auxiliary-device (pointing device) port:** Use this port to connect a mouse or pointing device to the server.

**Power cord connector:** There are two power cord connectors. These connectors connect the two power cords to the server.

**Parallel port:** Use this port to connect parallel devices to the server.

**External SCSI connector:** Use this connector to attach external SCSI devices to the server.

**ICMB ports:** Use these ports to connect the Intelligent Chassis Management Bus and external bus for passing management information between servers.

**Video port:** Use this port to connect the monitor to the server.

**Ethernet port:** Use this port to connect the server to an Ethernet network.

**Hot-plug PCI status lights:** These lights display the status of the PCI adapter installed in the expansion slot.

**Expansion slots:** These expansion slots are for PCI adapters. These slots are numbered 1 through 10 from right to left as you are facing the rear of the server.



---

## Chapter 2. Turning on the server

This chapter provides instructions on how to start your server for the first time, starting the server after turning it off, and how to turn off the server.

---

### Turning on the server for the first time

Starting the server for the first time involves plugging the two power cables of your server into a power distribution unit (PDU) and configuring the system before installing and starting the operating system. Packaged with your server are two power cables to connect your server to a PDU. You can use one of the following PDU options:

- NetBAY Front-end Power Distribution Unit
- NetBAY Server Dual-cord Power Distribution Unit
- NetBAY Rack Power Distribution Unit

If you choose to plug your server into outlets, refer to “Power cords” on page 91 for information.

The first time you start the server, you will need to run the BIOS Setup utility, set the correct date and time, and then let the server run its power-on self-test (POST) and pass control to the boot manager. For more information, refer to “Using the Extensible Firmware Interface (EFI) boot manager” on page 24.

Complete the following steps to start your server for the first time:

1. Make sure that all external devices, such as the monitor, keyboard, and mouse are connected to the server.
2. Remove the drive protection card from the LS120 diskette drive.
3. Plug one end of the two power cables into the server. You must plug a power cable into each power supply.
4. Plug the opposite end of the two power cables into a PDU. Alternatively, use optional power cords (see “Power cords” on page 91) to plug the server directly into the power source.
5. Turn on the monitor by pressing the monitor power-on button.
6. Press the power-control button on the front of the server.
7. Insert the installation CD for your operating system.

**Notes:**

- a. Before you can use your computer, you must obtain and install an operating system. Refer to the information provided with your operating system for installation instructions.
  - b. If you do not insert the CD in time, the system will not recognize the CD and you will need to restart the server.
8. When the startup process is complete, refer to the documentation that comes with your operating system for instructions on how to complete the installation.

---

## Turning on the server

This section provides information about how to turn on the server again after the initial startup has been completed.

Complete the following steps to start the server:

1. Verify that the power cords are plugged into a PDU.
2. Turn on the monitor by pressing the monitor power-on button.
3. Press the power-control button on the front panel of the server. See “Server controls and indicators” on page 7 for the location of this button.

**Attention:** If the following message displays during POST, press Reset before continuing system startup:

ERRORS FOUND IN MEMORY SUBSYSTEM, FAILING ROWS WILL BE MAPPED OUT ON THE NEXT RESET. IT IS STRONGLY SUGGESTED THAT YOU RESET THE SYSTEM NOW.

ALLOWING THE SYSTEM TO CONTINUE TO BOOT MAY RESULT IN UNSTABLE SYSTEM BEHAVIOR AND/OR HARD DISK CORRUPTION

Hit F1 to load defaults or F2 to run setup or ESC to continue

---

## Turning off the server

Statement 5

CAUTION:



The power control button on the device and the power switch on the power supply do not turn off the electrical current supplied to the device. The device also might have more than one power cord. To remove all electrical current from the device, ensure that all power cords are disconnected from the power source.

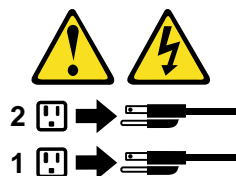

Complete the following steps to turn off the server:

**Note:** Turning off the server refers to the act of disconnecting the server from the power source.

1. Refer to your operating system documentation for the proper procedure to shut down the operating system.

**Note:** Each operating system is different. Some will allow an immediate shutdown; others require an orderly shutdown procedure.

2. Press and hold the power-control button on the front of the server for several seconds. This will put the server into standby mode.
3. Disconnect the server from the power source.

**Note:** After you turn off the server, wait at least 5 seconds before you turn on the server again.

---

## Standby mode

Standby puts the server into a wait state. When in a wait state, the server is not running the operating system, and all core logic is shut down except for the service processor.

Complete the following steps to put the server into the standby mode:

1. Refer to your operating system documentation for the proper procedure to shut-down the operating system.

**Note:** Each operating system is different. Read all the documentation about shutting down the operating system before continuing.

2. Press the power-control button on the front of the server.



---

## Chapter 3. Arranging your workspace

To get the most from your server, arrange both the equipment you use and your work area to suit your needs and the kind of work you do. Your comfort is of foremost importance, but light sources, air circulation, and the location of electrical outlets also can affect the way you arrange your workspace.

---

### Comfort

Although no single working position is ideal for everyone, here are a few guidelines to help you find a position that suits you best. Sitting in the same position for a long time can cause fatigue. A good chair can make a big difference. The backrest and seat should adjust independently and provide good support. The seat should have a curved front to relieve pressure on the thighs. Adjust the seat so that your thighs are parallel to the floor and your feet are either flat on the floor or on a footrest.

When using the keyboard, keep your forearms parallel to the floor and your wrists in a neutral, comfortable position. Try to keep a light touch on the keyboard and your hands and fingers relaxed. You can change the angle of the keyboard for maximum comfort by adjusting the position of the keyboard feet. Adjust the monitor so the top of the screen is at, or slightly below, eye level. Place the monitor at a comfortable viewing distance, usually 51 to 61 cm (20 to 24 in.), and position it so you can view it without having to twist your body. Also position other equipment you use regularly, such as the telephone or a mouse, within easy reach.

---

### Glare and lighting

Position the monitor to minimize glare and reflections from overhead lights, windows, and other light sources. Even reflected light from shiny surfaces can cause annoying reflections on your monitor screen. Place the monitor at right angles to windows and other light sources, when possible. Reduce overhead lighting, if necessary, by turning off lights or using lower wattage bulbs. If you install the monitor near a window, use curtains or blinds to block the sunlight. You might have to adjust the Brightness and Contrast controls on the monitor as the room lighting changes throughout the day. Where it is impossible to avoid reflections or to adjust the lighting, an antiglare filter placed over the screen might be helpful. However, these filters might affect the clarity of the image on the screen; try them only after you have tried all other methods of reducing glare.

Dust buildup compounds problems that are associated with glare. Remember to clean your monitor screen periodically using a soft cloth that is moistened with a nonabrasive liquid glass cleaner.

---

## Air circulation

Your server and monitor produce heat. Your server has one or more fans that pull in fresh air and force out hot air. The monitor lets hot air escape through vents. Blocking the air vents can cause overheating, which might result in a malfunction or damage. Place the server and monitor so that nothing blocks the air vents; usually, 15 cm (6 inches) of air space is sufficient. Also, make sure that the vented air is not blowing on someone else.

---

## Electrical outlets and cable lengths

The location of electrical outlets and the length of power cords and cables that connect to the monitor, printer, and other devices might determine the final placement of your server.

When arranging your workspace:

- Avoid the use of extension cords. When possible, plug the PDU power cords directly into electrical outlets.

- Keep power cords and cables neatly routed away from walkways and other areas where they might get kicked accidentally.

- For more information about power cords, see “Power cords” on page 91.

---

## Chapter 4. Configuring your server

The following configuration utilities are provided with your server.

- **BIOS Setup Utility**

This program is part of the basic input/output system (BIOS) that comes with your server. Use this program to configure the serial and parallel ports, change the drive startup sequence, set the date and time, and set passwords.

- **Extensible Firmware Interface (EFI) boot manager**

This program controls the startup environment. After you turn on the server, this program offers you a choice of startup options. For example, you can start to the EFI shell, to an operating system located on the network or on media, or to the Boot Maintenance Menu.

- **QLogic SCSI Utility**

You can use this utility to configure the devices that are attached to the integrated SCSI controller. Use this program to change default values, resolve configuration conflicts, and perform a low-level format on a SCSI hard disk.

- **Firmware Update Utility**

You can use this utility to upgrade the firmware that controls the Baseboard Management Controller (BMC), the Hot-Swap Controller (HSC), the Chassis Bus Controller (CBC), and the system BIOS.

- **System Event Log Viewer Utility**

You can use this utility to view the System Event Log. The BMC logs system platform management events and logs the events in the System Event Log (SEL). System platform management events include over-temperature conditions, over-voltage conditions, and fan failure.

- **Server Management Configuration Utility**

You can use this utility to view or modify the server management firmware configuration data. The firmware configuration data is maintained on the BMC.

---

## Using the BIOS Setup Utility program

This section provides the instructions needed to start the BIOS Setup Utility program and descriptions of the available menu choices.

### Starting the BIOS Setup Utility program

To start the BIOS Setup Utility program:

1. Turn on the server.
2. Press F2 to start the BIOS Setup Utility program.

**Note:** If you have set both levels of passwords (user and supervisor), you must type the supervisor password to access the full BIOS Setup menu.

Follow the instructions that appear on the screen.

### Choices available from the BIOS Setup main menu

From the BIOS Setup Utility Main menu, you can select settings that you want to change.

**Note:** The choices on some menus might differ slightly, depending on the BIOS version in your server.

The following table describes the choices available from the Main menu:

Menu item	Default value	Description
BIOS Version	[ <i>bios_version_number</i> ]	The currently installed version of BIOS. You cannot change this value. It appears for informational purposes only.
Processor Type	[Intel Itanium processor]	The processor type. You cannot change this value. It appears for informational purposes only.
Processor Retest	[Disabled] Enabled	The system will activate and retest all processors on the next system start, if <b>Enabled</b> . This option will be automatically set to <b>Disabled</b> on the next system start.
Language	[English (US)] Francais (FR) Deutsch (DR) Italiano (IT) Espanol (SP)	The default language used by the BIOS.
System Time	[ <i>hh:mm:ss</i> ]	The time in <i>hour:minute:second</i> format.
System Date	[ <i>day mm/dd/yyyy</i> ]	The day and date in <i>month/day/year</i> format.



The following table describes the choices available from the Advanced menu.

Primary menu	Item submenu	Item value	Description
Boot Configuration	Plug & Play O/S	[No] Yes	Configures boot settings. If the operating system supports Plug and Play operation, set this value to <b>Yes</b> .
	Reset Config Data	[No] Yes	Resets the configuration data after a restart operation.
	Numlock	[Off] On	Locks the number keypad.
	ADM Graphics Mode	[Disabled] Enabled	Enables or disables the ADM graphics mode.
Peripheral Configuration	Serial Port A	[Auto] Enable Disable	Determines serial port A configuration at startup.  <b>Auto</b> Automatically determine the base I/O address and interrupt to use for the port.  <b>Enable</b> Requires you to supply the base I/O address and the interrupt value.  <b>Disable</b> Causes the server to disable the port.
	Serial Port B	[Auto] Enable Disable	Determines serial port B configuration at startup.  <b>Auto</b> Automatically determine the base I/O address and interrupt to use for the port.  <b>Enable</b> Requires you to supply the base I/O address and the interrupt value.  <b>Disable</b> Causes the server to disable the port.
	Parallel Port	[Auto] Enable Disable	Determines parallel port configuration at boot time.  <b>Auto</b> Causes the server to determine the base I/O address and interrupt to use for the port.  <b>Enable</b> Requires you to supply the base I/O address and the interrupt value.  <b>Disable</b> Causes the server to disable the port.

Primary menu	Item submenu	Item value	Description
Peripheral Configuration	Mode	[Bi-directional] Output Only EPP ECP	Defines the transfer mode for the parallel port.  <b>Bi-directional</b> Enables data transfer to and from the server.  <b>Output</b> Enables data transfer from the server only.  <b>EPP</b> Specifies Enhanced Parallel Port mode.  <b>ECP</b> Specifies Enhanced Port mode.
	Onboard SCSI	[Enabled] Disabled	Enables or disables the onboard SCSI.
	Onboard NIC	[Enabled] Disabled	Enables or disables the onboard network interface controller (NIC) during the operation of the EFI shell. This value has no effect on the operating system.

Primary menu	Item submenu	Item value	Description
IDE Configuration	IDE Controller	[Both] Disabled Primary Secondary	<p>Selects the IDE controller and hard disk drive type installed in your system.</p> <p><b>Both</b> Enables both IDE controllers.</p> <p><b>Disabled</b> Disables the integrated IDE controller.</p> <p><b>Primary</b> Enables only the primary controller.</p> <p><b>Secondary</b> Enables only the secondary controller.</p>
	Hard Disk Pre-Delay [Disabled] Enabled	[Disabled] Enabled	<p>Configures the hard disk pre-delay.</p> <p><b>Enabled</b> Causes the BIOS to insert a delay before attempting to detect IDE drives in the system.</p> <p><b>Disabled</b> Disables the pre-delay.</p>
	Primary IDE Master	[drive_id] Not Installed	<p>A drive-specific identifier for the primary IDE master device currently installed in the system. Click on the value to display sub-menu items:</p> <p><b>Type</b> Specifies how the server identifies the device (automatically or as an ATPI device).</p> <p><b>Use ARMD Drive As</b> Specifies how to use the device (diskette drive or hard disk drive)</p>
	Secondary IDE Master	[drive_id] Not Installed	<p>A drive-specific identifier for the secondary IDE master device currently installed in the system. Click on the value to display a sub-menu item:</p> <p><b>Type</b> Specifies how the server identifies the device (automatically or as an ATPI device).</p>

Primary menu	Item submenu	Item value	Description
Chipset Configuration	Request Bus Parking	[Disabled] Enabled	Defines whether to park on the system bus.
	BINIT Input	[Disabled] Enabled	Enables all host bus agents to enable bus initialization (BINIT) observation logic.
	In-Order Queue Depth	[08]	Defines the in-order queue depth. When set to 1, all agents on the host bus limit their in-order queue depth to 1.
	BSP Jumper Selected	[Disabled] Enabled	
	CPU Work Arouds	[Auto] Manual	Defines Processor Dispersal, DET stalls, and other processor settings.
	Memory Related Items	[Disabled] Enabled	Defines System ECC, Base Memory Test Interval, Defective DIMM Mapout, and Clear Bad Memory Row.
Event Log Configuration	Event Logging	[Enabled] Disabled	Enables or disables logging of system events.
	Enable BERR	[Enabled] Disabled	Enables or disables bus error (BERR) event generation.
	Enable SERR	[Enabled] Disabled	Enables or disables PCI system error (SERR) event generation.
	Enable PERR	[Enabled] Disabled	Enables or disables PCI parity error (PERR) event generation.
	Enable BINIT	[Enabled] Disabled	Enables or disables BINIT event generation.
	Enable HostBus DATA ERROR	[Enabled] Disabled	Enables or disables processor data error checking.
	Enable HostBus ADDR PARITY	[Enabled] Disabled	Enables or disables processor Address Parity checking
	Clear All MCA Records	[Disabled] Enabled	Enables or disables the logging of MCA records on NVRAM.

The following table describes the choices available from the Security menu.

Menu item	Default value	Description
Administrator Password Is	[Not Installed] administrator_password	The current administrator password. To set the administrator password, use the <b>Set Administrator Password</b> menu item.
User Password Is	[Not Installed] user_password	The current user password. To set the user password, use the <b>Set User Password</b> menu item.

Menu item	Default value	Description
Set Administrator Password	Not applicable	Define the administrator password.
Set User Password	Not applicable	Define the User password

**Setting the administrator password.** You can set the administrator password so that only authorized personnel can change configuration information from within the BIOS Setup Utility. The keyboard and mouse remain locked until you type the correct password. You can use any combination of up to seven characters (A-Z, a-z, 0-9, and blanks) for your administrator password. Keep a record of your password in a secure place.

**Note:** Only a qualified service technician can delete the administrator password.

**Setting the user password.** This password is set for each user, so that the administrator can control permissions and configuration options for each user. You can use any combination of up to seven characters (A-Z, a-z, 0-9, and blanks) for your user password.

The following describes the choices available from the System Management menu.

Menu item	Default value	Description
Console Redirection	Not applicable	Configures the server for console redirection.
Service Boot	[Disabled] Enabled	Starts the server in Service Partition Boot mode. This item will be automatically reset to <b>Disabled</b> on the next system start.

The following describes the choices available from the Exit menu.

Menu item	Description
Exit Saving Changes	Exit from Setup with or without saving your changes in CMOS. <b>Yes</b> Saves your changes and exits from the utility <b>No</b> Discards your changes and exits from the utility
Exit Discarding Changes	Exit from Setup with or without discarding your changes. <b>Yes</b> Discards your changes and exits from the utility. <b>No</b> Saves your changes and exits from the utility.
Load Setup Defaults	Load Setup with factory defaults. <b>Yes</b> Loads Setup values from a file previously saved through the Save Custom Defaults menu item. You must specify the file name. <b>No</b> No action.

Menu item	Description
Load Custom Defaults	Load Setup with custom defaults. <b>Yes</b> Loads Setup values from a file previously saved through the Save Custom Defaults menu item. You must specify the file name. <b>No</b> No action.
Save Custom Defaults.	Save the current set of values into a file that you can later load using the Load Custom Defaults menu item. <b>Yes</b> Writes setup values to a file you specify. <b>No</b> No action.
Discard Changes	Discard the changed values you have accumulated during this Setup session. <b>Yes</b> Discards the Setup values for the current Setup Utility session <b>No</b> No action.

## Using the Extensible Firmware Interface (EFI) boot manager

You can use the EFI boot manager to configure a variety of boot options including booting to an external device as well as to a specific file. The following table provides a summary of the actions available from the EFI boot manager:

Action	Description
Boot from a File	Automatically adds EFI applications as boot options or enables you to boot from a specific file.
Add a Boot Option	Adds a boot option to the EFI boot manager. You specify the option by providing the name of the EFI application. Along with the name, you can also provide either ASCII or UNICODE arguments the file might use.
Delete Boot Options	Enables you to delete a specific boot option or all boot options.
Change Boot Order	Enables you to control the relative order in which the EFI boot manager attempts boot options. For help on the control key sequences you need for this option, refer to the help menu. Enables you to select a boot option to use one time (the next boot operation).
Manage Boot Next Setting	Enables you to select a boot option to use one time (the next boot operation).
Set Automatic Boot Timeout Value	Enables you to define the value in seconds that pass before the system automatically boots without user intervention. Setting this value to zero disables the timeout feature.

Action	Description
Select Active Console Output Devices	Enables you to display the list of available console output devices, as contained in the ConOutDev list. You can select or deselect additional output consoles from this menu. Note: The Boot Maintenance Manager performs logic checking to ensure that you choose a legal ensemble of devices. For example, the manager does not allow you to choose two different messaging devices, such as PC-ANSI and VT-100, to be active consoles on a given UART.
Select Active Console Input Devices	Enables you to display the list of available console input devices, as contained in the ConInDev list and the subset detailed in the ConIn variable.
Select Active Error Devices	Enables you to display the list of available error devices as contained in the ErrOutDev list and the subset detailed in the ErrOut variable. <b>Note:</b> The active error devices are essentially a type of console output device whose only traffic includes error messaging.
Cold Reset	Enables you to perform a platform-specific cold reset of the system. <b>Note:</b> A cold reset typically means a full platform reset.
Exit	Returns control to the EFI boot manager main menu. This will display the active boot devices, including a possible integrated EFI shell (if the implementation is so constructed).

## Using the Extensible Firmware Interface (EFI) shell

Use the EFI shell to load device drivers, start EFI applications, and start (boot) the network operating system. In addition, the EFI shell also provides a set of basic commands to manage files and system environment variables.

In addition, with the EFI shell, you can create your own EFI shell commands and EFI applications. For detailed information about the EFI shell, its commands, and the ability to develop applications, refer to the *EFI Developer's Guide*. Find the guide at the following World Wide Web address:  
<http://developer.intel.com/technology/efi/downsource.htm>.

Click **EFI sample implementation source code** and select the Microsoft® Word file Efi\_dg.doc in the Notes folder.

---

## Using the QLogic SCSI Utility

Use the QLogic SCSI Utility to configure the SCSI capabilities of the xSeries 380 server. You run this utility during the restart operation before the BIOS Setup Utility. To enter the QLogic SCSI Utility, perform the following procedure:

During the system reset performed after you exit from the BIOS Setup Utility, watch the monitor for the prompt to start the QLogic Setup Utility. When you see the prompt for the QLogic Setup Utility, press Alt+Q.

---

## Using the Firmware Update Utility

The Firmware Upgrade Utility is an EFI program that updates the following server code:

- Baseboard Management Controller (BMC)
- Hot-Swap Controller (HSC)
- Chassis Bridge Controller (CBC)
- BIOS

For the most recent firmware downloads, update utilities, and instructions, go to the IBM Personal Computing Web page at <http://www.ibm.com/pc/support>, and download the latest level of BIOS and firmware code. The README.TXT file in the download package contains the instructions for using the utility.

---

## Using the SELView Utility

Use the SELView Utility to perform the following tasks:

- Examine all System Event Log (SEL) entries
- Examine previously stored System Event Log entries from a file
- Save the System Event Log entries to a file
- Clear the System Event Log entries from the nonvolatile storage area
- Sort the SEL records by various fields such as Timestamp, Sensor Type Number, Event Description, and Generator ID

**Note:** For the latest version of the utility, go to the IBM Personal Computing Web page at <http://www.ibm.com/pc/support>.

If you suspect a problem with your server, run this utility and save the log file. Call for service and refer the service to the log file for information. To use the SELView Utility, do the following:

1. Insert the System Utilities CD into the CD-ROM drive.

**Note:** You can run the utility directly from the System Utilities CD or from a diskette you create from the CD. If you choose to run the utility from a diskette, follow the instructions in the READ.TXT file on the CD.

2. Type the following command from the EFI shell prompt:  
issue: map -r
3. Locate the FSx where x is the CD-ROM drive (FF).
4. Issue FSx: where x is the CD-ROM drive.



5. Type the following: `CD selview`
6. Run the utility by typing the following command:  
`Selview`

You can select the following actions:

- File** Open and save System Event Log files. You can also exit from the utility from this menu.
- SEL** Manage System Event Log files by reloading data, displaying properties, clearing log entries, and sorting files by various fields.
- Help** Provides information on the utility.

## Using the Server Management Configuration Utility

Use the Server Management Configuration Utility to perform the following tasks:

- Configure power restoration policies when the system loses AC power
- Set the accelerated cool-down timeout
- Set the Fault Resilient Boot (FRB) time-out
- Enable or disable Platform Event Filtering (PEF) and Platform Event Paging (PEP)
- Configure the Advanced Configuration and Power Interface (ACPI) features

**Note:** For the latest version of the utility, go to the IBM Personal Computing Web page at <http://www.ibm.com/pc/support>.

To use the Server Management Configuration Utility, do the following:

1. Insert the System Utilities CD into the CD-ROM drive.
  - Note:** You can run the utility directly from the System Utilities CD or from a diskette you create from the CD. If you choose to run the utility from a diskette, follow the instructions in the READ.TXT file on the CD.
2. Type the following command from the EFI shell prompt:  
`issue: map -r`
3. Locate the FSx where x is the CD-ROM drive (FF).
4. Issue FSx: for the CD-ROM drive.
5. Type the following: `CD SMConfig`
6. Run the utility by typing the following command:  
`SMConfig`

The following table provides a summary of the actions available from the utility main menu.

Menu item	Description
File open	Opens a different .ini file of configuration data.
Config	Select from a dynamic list of options for the configuration classes in the current .ini file.

Menu item	Description
Platform setup	Configures the platform-specific feature. <b>Accelerated cool down</b> Enables the system to cool down more rapidly when the system is powered off.
Power setup	Configures power features. <b>Power restore policy</b> Defines activity when the system loses and then regains AC power. <b>Power restore delay</b> The delay in seconds before the power restore policy is activated. <b>Power cycle delay</b> The amount of time the system will not respond to the front power-on button.
Fault resilient booting setup	Enables or disables a multiprocessing system to startup the system, if the bootstrap processor (BSP) fails. <b>FRB3</b> The level of fault resilient booting in which a timer is started at system startup or system hard reset.
ACPI	Configures ACPI features. <b>Button model</b> Defines the model of power-on button. <b>State notify</b> Determines if other server management controllers installed in the server will be notified of ACPI changes. <b>Fan control</b> Defines the operation of the fans when the system enters standby mode.
Platform event filtering setup	Configures the actions to take during a platform event. <b>PEF enable</b> Enables or disables the platform event filter (PEF). <b>PEP actions</b> Enables or disables platform event paging actions when an event filter is triggered. <b>Logging enabled</b> Enables or disabled system event logging when an event filter is triggered. <b>Power down</b> Enable or disable system power off during an event. <b>Reset</b> Enables or disables a system reset when an event is triggered. <b>Power cycle</b> Enables or disables sending a LAN alert message when an event is triggered. <b>Filter entries</b> Enables or disables pre-configured event filters.

Menu item	Description
Platform event paging setup	<p>Configures platform event paging features.</p> <p><b>Blackout period</b> The amount of time between telephone pages.</p> <p><b>Modem page string</b> The paging service number and the message character string.</p>
Emergency management port (EMP) setup	<p>Enables remote server management over a modem or a direct serial connection.</p> <p><b>Access mode</b> Defines EMP port access.</p> <p><b>Restricted access mode</b> Enables or disables restricted access mode.</p> <p><b>Connection mode</b> Configures the method of connection to the port.</p> <p><b>Data carrier detect mode</b> Enables or disables monitoring of the data carrier detect signal.</p> <p><b>Baud rate</b> Configures the maximum rate that data is transmitted through the EMP port.</p> <p><b>Flow control</b> Enables or disables the flow control.</p> <p><b>Modem Init string</b> Defines the modem initialization string.</p> <p><b>Modem hangup string</b> This string is sent to the modem when the EMP ends the session.</p> <p><b>Modem ESC sequence</b> The value sent to the modem before sending a command string to the modem.</p> <p><b>Modem phone number</b> The telephone number of the modem connected to the server.</p> <p><b>Set password</b> Defines the password to restrict EMP access through the direct serial connection or modem.</p>

Menu item	Description
Direct platform control/LAN setup	<p>Configure direct platform control/LAN features.</p> <p><b>LAN access mode</b> Defines the remote access mode.</p> <p><b>Host IP address</b> The logical or Web address of the server.</p> <p><b>Subnet mask</b> The logical or Web address of the server subnet. The mask determines if the alert destination is the local subnet or another subnet relative to the server.</p> <p><b>Gateway IP address</b> The IP address of the gateway, or router system for the subnet.</p> <p><b>Alert IP address</b> The logical or Web address of the systems to which an alert message will be sent.</p> <p><b>SNMP community string</b> Defines the community field in the header of the SNMP trap sent for a LAN alert.</p>

## Chapter 5. Installing options

This chapter provides the basic information that is needed to install hardware options and components in your server.

For a list of supported options for your server, see the ServerProven<sup>®</sup> list at the following World Wide Web address: <http://www.ibm.com/pc/compat/>.

Some options and components must be installed or replaced only by trained service personnel.

You can install or replace the following options and components:

- 172-mm fan
- 120-mm fan
- Hard disk drive
- PCI adapters in slots 3 through 10
- Power supply

Trained service personnel only can install or replace the following components:

- Microprocessor
- Memory
- Legacy I/O board

### Statement 14



### CAUTION:

Hazardous voltage, current, and energy levels might be present. Only a qualified service technician is authorized to remove the covers where the following label is attached.



---

## Before you begin

Before you begin to install options in your server, read the following information:

- Become familiar with the safety and handling guidelines provided in the Safety Information book, the requirements specified in “Safety information” on page 34, and the information in “Handling static-sensitive devices” on page 33. These guidelines will help you work safely while working with your server or options.
- Make sure that you have an adequate number of properly grounded electrical outlets for your server, monitor, and any other options that you intend to install.
- You do not need to turn off the server to install or replace hot-swap power supplies, hot-swap drives, hot-swap fans, or hot-plug PCI adapters.
- Back up all important data before you make changes to disk drives.

For a list of supported options for the xSeries 380, refer to <http://www.ibm.com/pc/us/compat> on the World Wide Web.

## System reliability considerations

**Attention:** The operating temperature of the server, when installed in an equipment rack, must not go below 10° C (50° F) or rise above 35° C (95° F). Extreme fluctuations in temperature can cause a variety of problems in your server.

The equipment rack must provide sufficient airflow to the front of the server to maintain proper cooling. It must also include ventilation sufficient to exhaust a maximum of 6174 Btu per hour for the server. The rack that is selected and the ventilation that is provided must be suitable to the environment in which the server will be used.

To help maintain proper cooling and system reliability, ensure that:

- Each of the drive bays has a drive installed.
- Each of the power supply bays has a power supply installed.
- A removed hot-swap drive is replaced within 10 minutes of removal.
- Cables for optional adapters are routed according to the instructions that are provided with the adapters.
- A failed fan is replaced within 48 hours.

## Working inside the server with the power on

Your server supports hot-plug devices and is designed to operate safely while turned on with the cover removed. Follow these guidelines when you work inside a server that is turned on:

- Avoid loose-fitting clothing on your forearms. Button long-sleeved shirts before working inside the server; do not wear cufflinks while you are working inside the server.
- Do not allow your necktie or scarf to hang inside the server.
- Remove jewelry, such as bracelets, necklaces, rings, and loose-fitting wrist watches.
- Remove items from your shirt pocket (such as pens or pencils) that could fall into the server as you lean over it.
- Take care to avoid dropping any metallic objects, such as paper clips, hair pins, or screws, into the server.

## Handling static-sensitive devices

**Attention:** Static electricity can damage electronic devices and your system. To avoid damage, keep static-sensitive devices in their static-protective package until you are ready to install them.

To reduce the possibility of electrostatic discharge, observe the following precautions:

- Limit your movement. Movement can cause static electricity to build up around you.
- Handle the device carefully, holding it by its edges or its frame.
- Do not touch solder joints, pins, or exposed printed circuitry.
- Do not leave the device where others can handle and possibly damage the device.
- While the device is still in its static-protective package, touch it to an unpainted metal part of the system unit for at least two seconds. (This drains static electricity from the package and from your body.)
- Remove the device from its package and install it directly into your system unit without setting it down. If it is necessary to set the device down, place it in its static-protective package. Do not place the device on your system unit cover or on a metal table.
- Take additional care when handling devices during cold weather because heating reduces indoor humidity and increases static electricity.

## Safety information

Before installing this product, read the Safety Information.

مح، يجب قراءة دات السلامة

Antes de instalar este produto, leia as Informações de Segurança.

在安装本产品之前，请仔细阅读 **Safety Information** (安全信息)。

安裝本產品之前，請先閱讀「安全資訊」。

Prije instalacije ovog produkta obavezno pročitajte Sigurnosne Upute.

Před instalací tohoto produktu si přečtěte příručku bezpečnostních instrukcí.

Læs sikkerhedsforskrifterne, før du installerer dette produkt.

Lees voordat u dit product installeert eerst de veiligheidsvoorschriften.

Ennen kuin asennat tämän tuotteen, lue turvaohjeet kohdasta Safety Information.

Avant d'installer ce produit, lisez les consignes de sécurité.

Vor der Installation dieses Produkts die Sicherheitshinweise lesen.

Πριν εγκαταστήσετε το προϊόν αυτό, διαβάστε τις πληροφορίες ασφάλειας (safety information).

לפני שתתקינו מוצר זה, קראו את הוראות הבטיחות.

A termék telepítése előtt olvassa el a Biztonsági előírásokat!

Prima di installare questo prodotto, leggere le Informazioni sulla Sicurezza

製品の設置の前に、安全情報をお読みください。

본 제품을 설치하기 전에 안전 정보를 읽으십시오.

Пред да се инсталира овој продукт, прочитајте информацијата за безбедност.

Les sikkerhetsinformasjonen (Safety Information) før du installerer dette produktet.

Przed zainstalowaniem tego produktu, należy zapoznać się z książką "Informacje dotyczące bezpieczeństwa" (Safety Information).

Antes de instalar este produto, leia as Informações sobre Segurança.



Перед установкой продукта прочтите инструкции по технике безопасности.

Pred inštaláciou tohto zariadenia si pečítajte Bezpečnostné predpisy.

Pred namestitvijo tega proizvoda preberite Varnostne informacije.

Antes de instalar este producto lea la información de seguridad.

Läs säkerhetsinformationen innan du installerar den här produkten.

Statement 1



**DANGER**

**Electrical current from power, telephone, and communication cables is hazardous.**

**To avoid a shock hazard:**

- **Do not connect or disconnect any cables or perform installation, maintenance, or reconfiguration of this product during an electrical storm.**
- **Connect all power cords to a properly wired and grounded electrical outlet.**
- **Connect to properly wired outlets any equipment that will be attached to this product.**
- **When possible, use one hand only to connect or disconnect signal cables.**
- **Never turn on any equipment when there is evidence of fire, water, or structural damage.**
- **Disconnect the attached power cords, telecommunications systems, networks, and modems before you open the device covers, unless instructed otherwise in the installation and configuration procedures.**

To connect:

1. Turn everything OFF.
2. First, attach all cables to devices.
3. Attach signal cables to connectors.
4. Attach power cords to outlet.
5. Turn device ON.

To disconnect:

1. Turn everything OFF.
2. First, remove power cords from outlet.
3. Remove signal cables from connectors.
4. Remove all cables from devices.

**Statement 3**



**CAUTION:**

**When laser products (such as CD-ROMs, DVD drives, fiber optic devices, or transmitters) are installed, note the following:**

- **Do not remove the covers. Removing the covers of the laser product could result in exposure to hazardous laser radiation. There are no serviceable parts inside the device.**
- **Use of controls or adjustments or performance of procedures other than those specified herein might result in hazardous radiation exposure.**



**Class 1 Laser Product  
Laser Klasse 1  
Laser Klass 1  
Luokan 1 Laserlaite  
Appareil À Laser de Classe 1**

**Statement 4**

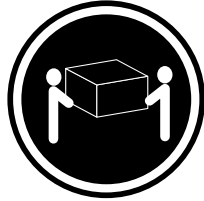

≥18 kg (37 lbs)

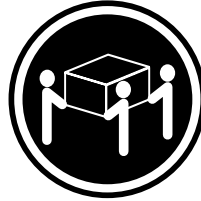

≥32 kg (70.5 lbs)

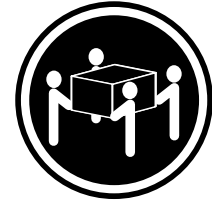

≥55 kg (121.2 lbs)

**CAUTION:**

**Use safe practices when lifting.**

**Statement 5**

**CAUTION:**



The power control button on the device and the power switch on the power supply do not turn off the electrical current supplied to the device. The device also might have more than one power cord. To remove all electrical current from the device, ensure that all power cords are disconnected from the power source.



**Statement 8**



**CAUTION:**

Never remove the cover on a power supply or any part that has the following label attached.



Hazardous voltage, current, and energy levels are present inside any component that has this label attached. There are no serviceable parts inside these components. If you suspect a problem with one of these parts, contact a service technician.

**Statement 13**

**CAUTION:**



Overloading a branch circuit is potentially a fire hazard and a shock hazard under certain conditions. To avoid these hazards, ensure that your system electrical requirements do not exceed branch circuit protection requirements. Refer to the information that is provided with your IBM device for electrical specifications.

**Statement 15**



**CAUTION:**

**Make sure that the rack is secured properly to avoid tipping when the server unit is extended.**

**Statement 16**



**CAUTION:**

**Some accessory or option board outputs exceed Class 2 or limited power source limits and must be installed with appropriate interconnecting cabling in accordance with the national electric code.**

---

## Installing hot-swap options

This section contains the information necessary to install, remove, and replace the hot-swap options and components in your server. The options and components in the following list are the only options and components that you can install, remove, or replace. A qualified technician must service all other options and components.

User-replaceable options and components include the following:

- 172-mm fan
- 120-mm fan
- Hard disk drive
- PCI adapters in slots 3 through 10
- Power supply

## Replacing a hot-swap 172-mm fan

Your server contains four 172-mm fans, two on each side of the server. The fans are accessed from the fan-access doors on either side of the server. Each fan contains a fan-failure light that identifies a failed fan.

**Note:** The illustrations in this document might differ slightly from your hardware.

Complete the following steps to replace a 172-mm fan:

1. Review the information in “Safety information” on page 34.

### Statement 15



### CAUTION:

**Make sure that the rack is secured properly to avoid tipping when the server unit is extended.**

2. Slide the server out of the rack.

3. Slide the latch on the fan-access door upward, and open the door.

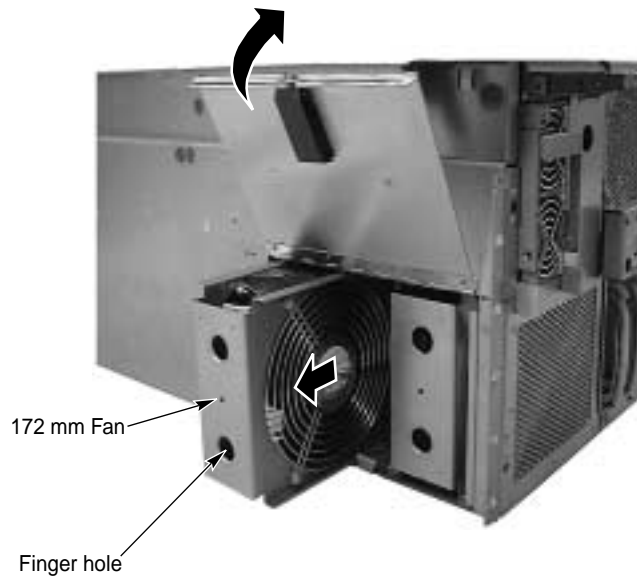

4. Grasp the fan assembly with the finger holes, and pull the fan assembly out of the server.  
**Attention:** To maintain proper cooling, do not leave the door open for an extended time.
5. Slide the new fan assembly into place.
6. Close and lock the fan-access door.
7. Slide the chassis back into the rack.

## Replacing a hot-swap 120-mm fan

Your server contains two 120-mm fans, which are accessed from the fan-access door on the top of the server. Each fan contains a fan-failure light that identifies a failed fan.

**Note:** The illustrations in this document might differ slightly from your hardware.

Complete the following steps to replace a 120-mm fan:

1. Review the information in "Safety information" on page 34.

### Statement 15



### CAUTION:

**Make sure that the rack is secured properly to avoid tipping when the server unit is extended.**

2. Slide the server out of the rack.
3. Loosen the thumbscrew on the fan-access door, and open the door.



4. Grasp the fan assembly with the finger holes, and pull the fan assembly out of the server.

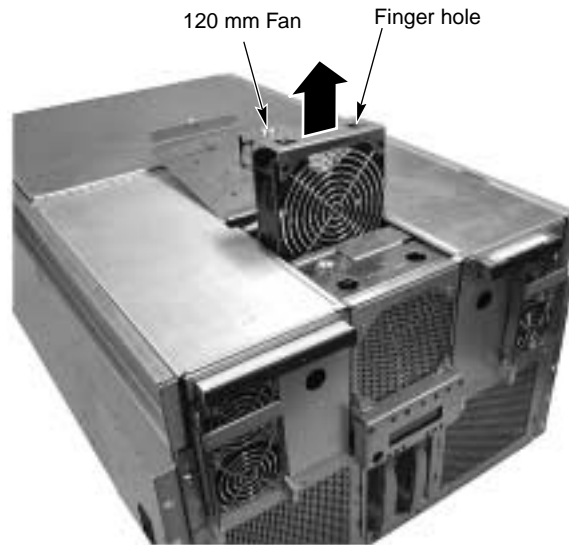

**Attention:** Do not leave the door open for an extended time. Cooling of the system could be reduced.

5. Slide the new fan-assembly into place.
6. Close the fan-access door, and tighten the thumbscrew.
7. Slide the chassis back into the rack.

## Installing a hot-swap hard disk drive

Your server supports two 1-inch (26 mm) slim, 3.5-inch hot-swap SCSI hard disk drives in the hard disk drive bays.

Each hot-swap hard disk drive has three indicator lights: the power-on light, activity light, and status light. The hard disk drive lights are illustrated and described in “Server controls and indicators” on page 7. If the amber hard disk drive status light is lit continuously, that individual drive is faulty and requires replacement. You can replace a hot-swap drive without turning off the server.

**Note:** The illustrations in this document might differ slightly from your hardware.

**Attention:** When you handle static-sensitive devices, take precautions to avoid damage from static electricity. For details on handling these devices, see “Handling static-sensitive devices” on page 33.

**Note:** To maintain proper system cooling, do not operate the server for more than 10 minutes without either a drive or a filler panel installed in each bay.

Complete the following steps to install a drive in a hot-swap bay:

1. Review “Before you begin” on page 32.

**Note:** You do not have to turn off the server to install hot-swap hard disk drives.



2. Align the drive assembly with the guide rails in the bay, and slide the drive into the bay.
3. Check the hard disk drive indicator lights to verify that the drive is functioning properly. See “Server controls and indicators” on page 7 for more information.

**Attention:** Do not press on the perforated metal bracket of the tray when you push the assembly into the bay.

## Replacing a hot-swap power supply

Before you continue with the power-supply replacement procedure, review the following information.

**Attention:** To maintain proper system cooling, do not operate the server for more than 5 minutes without either a power supply or filler panel installed.

**Notes:**

1. The power-supply bays are, from left to right, 1, 3, 4, and 2.
2. The illustrations in this document might differ slightly from your hardware.

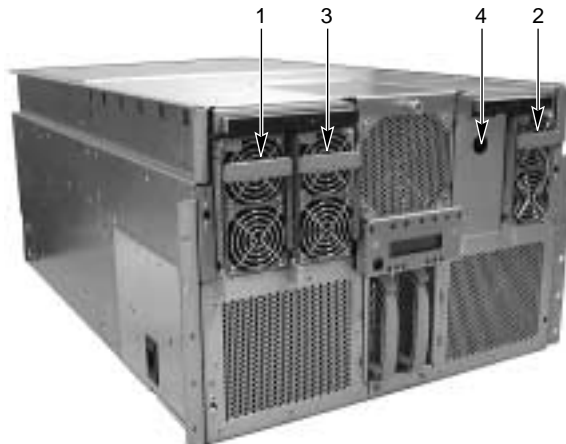

**Statement 8**



**CAUTION:**

**Never remove the cover on a power supply or any part that has the following label attached.**



**Hazardous voltage, current, and energy levels are present inside any component that has this label attached. There are no serviceable parts inside these components. If you suspect a problem with one of these parts, contact a service technician.**

The power-supply status indicators provide the following information:

<b>Power on</b>	<b>Predictive failure</b>	<b>Failure</b>	<b>Power-supply status</b>
Off	Off	Off	No power to any power supplies
Off	Off	On	Power-supply failure
Blinking	Off	Off	AC power present/standby output on
On	Off	Off	DC outputs on and working
On	Off	Blinking	Current limit
On	Blinking	Off	Predictive failure

Complete the following steps to replace a power supply:

1. Review the information in “Before you begin” on page 32.

2. Press the handle-locking tab to the left, and pull the power-supply handle down.

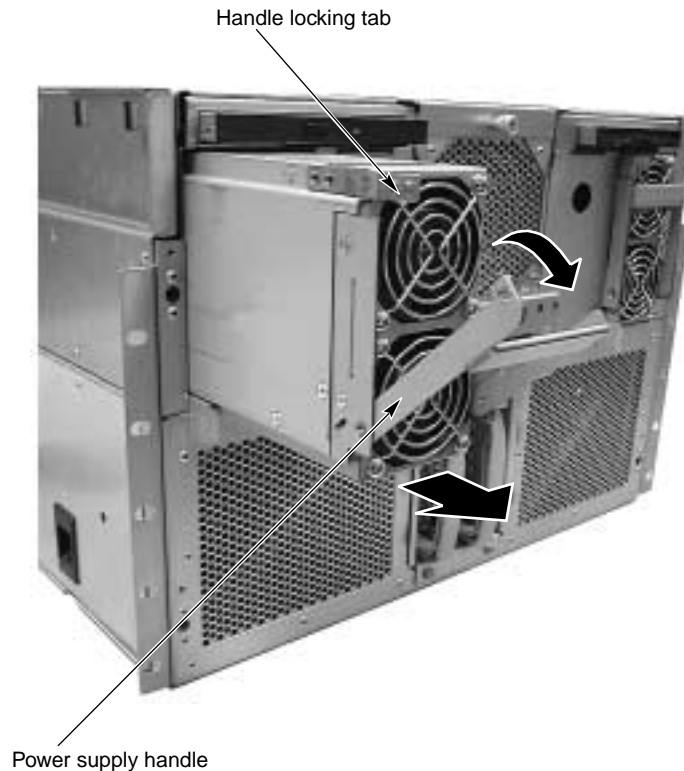

3. Slide the power-supply out of the server.
4. Remove the new power-supply from the protective packaging, and place it on a static-protective surface.
5. With the handle in the open position (pulled down), slide the new power supply into the power-supply bay.
6. Push the handle up and into the locked position.
7. Check the power-supply status indicators to verify the power supply is functioning properly.

## Replacing a hot-plug PCI adapter

This section provides instructions on replacing a hot-plug PCI adapter.

### Notes:

1. You can install hot-plug adapters in slots 3 through 10 only, counting from right to left while facing the back of the server.
2. Hot-plug operations require operating system support and installation of the required device drivers. You can determine if IBM has validated an adapter for hot-plug operation at: <http://www.ibm.com/pc/us/compat/hotplug/index.shtml>. For unsupported adapters, refer to the documentation provided with the adapter for information and support.

Complete the following steps to replace a hot-plug PCI adapter:

1. Review the information in “Before you begin” on page 32.

**Statement 15**



**CAUTION:**

**Make sure that the rack is secured properly to avoid tipping when the server unit is extended.**

**Statement 16**



**CAUTION:**

**Some accessory or option board outputs exceed Class 2 or limited power source limits and must be installed with appropriate interconnecting cabling in accordance with the national electric code.**

2. Slide the server out of the rack.
3. Loosen the thumbscrews on the rear cover, and open the cover.

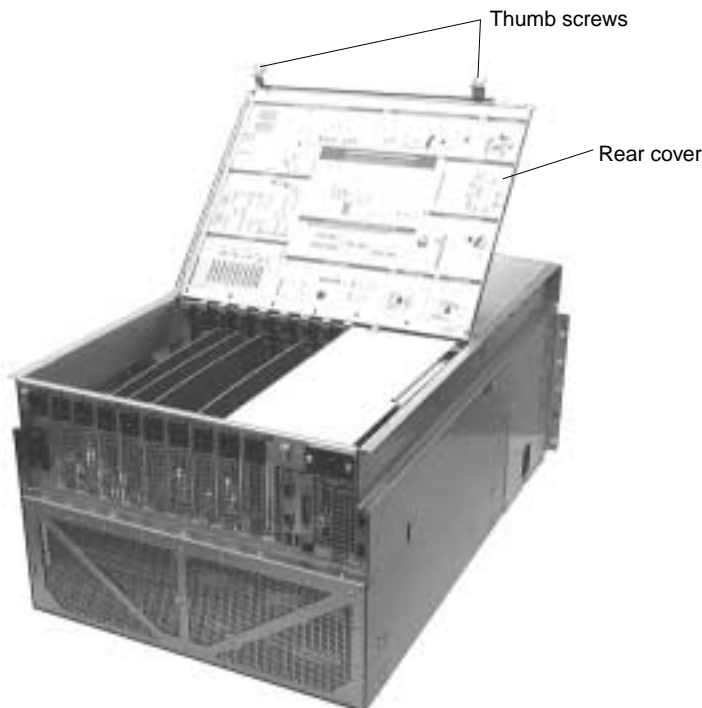

4. Press on the retention mechanism locking tab, and rotate the mechanism out toward the rear of the server.

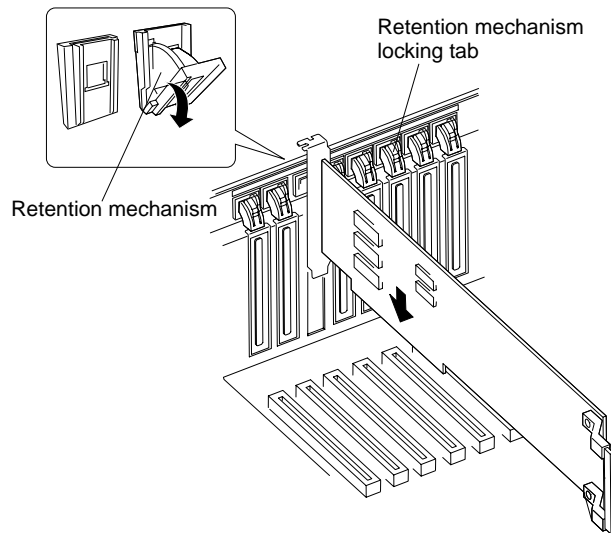

5. Remove the adapter from the expansion slot.
6. Insert the new PCI adapter into the expansion slot, and press it firmly into place.
7. Push the retention mechanism locking tab in from the rear of the server until it locks into place.

**Note:** Refer to the upper-left corner of the illustration above.

8. Rotate the retention mechanism locking tab on the rear of the expansion slot into place.

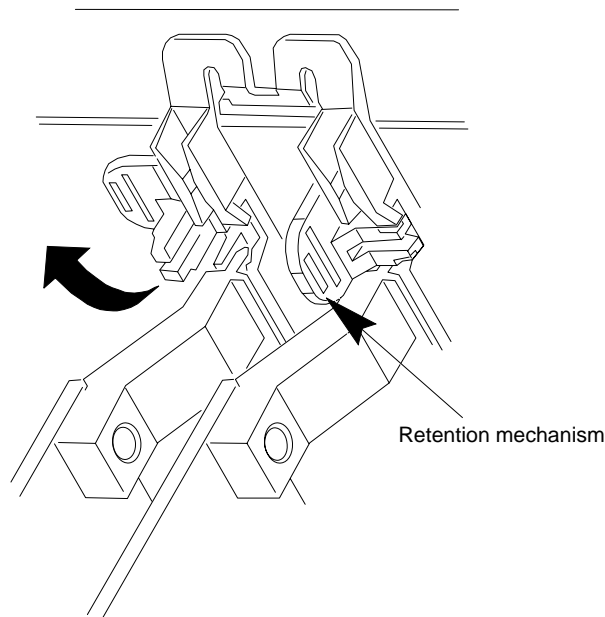

9. Check the status lights above the PCI adapter after it is installed.

**Note:** If the green status light is lit, power is applied to the adapter, and it is ready for use. If the amber status light is lit, the adapter might be defective or not installed properly.

10. Configure the adapter, according to the instructions that come with the adapter.

---

## Input/output ports

This section provides information about the following input/output (I/O) ports on the rear of your server:

- One video port
- One auxiliary pointing-device (mouse) port
- One keyboard port
- One parallel port
- Two serial ports
- Two Universal Serial Bus (USB) ports
- One external SCSI port

## Video port

The integrated ATI RAGE 128VR 64-bit SVGA chip contains an SVGA controller that is fully compatible with industry video standards. The standard system configuration comes with 16 MB of video memory. You cannot add video memory to this system.

There is one video port connector on the system board.

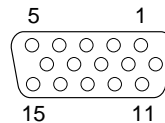

The following table shows the pin-number assignments for the video connector on the system board.

Pin	Signal	Pin	Signal
1	Red	9	Not connected
2	Green	10	Ground
3	Blue	11	Not connected
4	Not connected	12	Display data channel data
5	Ground	13	Horizontal synchronization
6	Ground	14	Vertical synchronization
7	Ground	15	Display data channel clock
8	Ground		

## Keyboard port

There is one keyboard port on the system board.

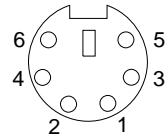

The following table shows the pin-number assignments for the keyboard connector on the system board.

Pin	Signal	Description
1	I/O	Data
2	N/A	Not connected
3	N/A	Ground
4	N/A	+5 V dc
5	I/O	Keyboard clock
6	N/A	Not connected

## Auxiliary-device (pointing device) port

There is one auxiliary-device (pointing device) port on the system board.

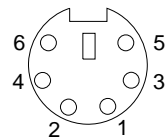

The following table shows the pin-number assignments for the auxiliary-device connector on the system board.

Pin	Signal	Description
1	I/O	Data
2	N/A	Not connected
3	N/A	Ground
4	N/A	+5 V dc
5	I/O	Keyboard clock
6	N/A	Not connected



## Parallel port

Your server has one parallel port. The 25-pin connector of the parallel port provides one IEEE 1284-compatible 25-pin bi-directional EPP. BIOS programming of the Super I/O registers enables the parallel port and determines the port address and interrupt. When disabled, the interrupt is available to add-on boards.

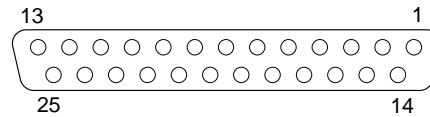

The following table shows the pin-number assignments for the parallel-port connector on the system board.

Pin	Signal	Pin	Signal
1	STROBE_L	10	-Acknowledge
2	Data bit 0	11	Busy
3	Data bit 1	12	Paper end
4	Data bit 2	13	Select
5	Data bit 3	14	-Auto feed
6	Data bit 4	15	-Error
7	Data bit 5	16	-Initial
8	Data bit 6	17	-SLCTIN_L
9	Data bit 7	18-25	Ground

## Serial ports

Your server has two standard serial (communication) ports: serial port A and serial port B.

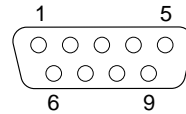

The following table shows the pin-number assignments for the serial-port connectors on the system board. These pin-number assignments conform to the industry standard.

Pin	Signal	Description
1	DCD	Data carrier detected
2	RXD	Receive data
3	TXD	Transmit data
4	DTR	Data terminal ready
5	GND	Ground
6	DSR	Data set ready
7	RTS	Request to send
8	CTS	Clear to send
9	RIA	Ring indication active

## Universal Serial Bus (USB) ports

Your server has two Universal Serial Bus (USB) ports, which are configured automatically.

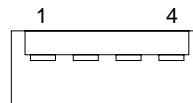

Pin	Signal	Description
1	VCC	Over current monitor (port 0 or 1)
2	DataL (0 or 1)	Differential data line paired with DATAH0
3	DataH (0 or 1)	Differential data line paired with DATAL0
4	GND	Ground

## SCSI port

Your server has one external small computer system interface (SCSI) port.

The QLogic ISP 12160 LVDS SCSI controller supports two LVDS channels. One channel is used internally to provide support for the internal SCSI drives (connected to the SCSI backplane). The second LVDS channel is routed to the rear of the chassis to support external devices.

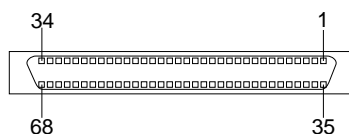

Pin	Signal	Pin	Signal	Pin	Signal	Pin	Signal
1	+Data 12	18	Term power	35	-Data 12	52	Term power
2	+Data 13	19	S19 (Reserved)	36	-Data 13	53	Reserved
3	+Data 14	20	Ground	37	-Data 14	54	Ground
4	+Data 15	21	+Attention	38	-Data 15	55	-Attention
5	+Data P1	22	Ground	39	-Data P1	56	Ground
6	+Data 0	23	+Busy	40	-Data 0	57	-Busy
7	+Data 1	24	+Acknowledge	41	-Data 1	58	-Acknowledge
8	+Data 2	25	+Reset	42	-Data 2	59	-Reset
9	+Data 3	26	+Message	43	-Data 3	60	-Message
10	+Data 4	27	+Select	44	-Data 4	61	-Select
11	+Data 5	28	+Control/Data	45	-Data 5	62	-Control/Data
12	+Data 6	29	+Request	46	-Data 6	63	-Request
13	+Data 7	30	+Input/Output	47	-Data 7	64	-Input/Output
14	+Data P	31	+Data 8	48	-Data P	65	-Data 8
15	Ground	32	+Data 9	49	Ground	66	-Data 9
16	S16 (DIFFSENS)	33	+Data 10	50	Ground	67	-Data 10
17	Term power	34	+Data 11	51	Term power	68	-Data 11



---

## Chapter 6. Solving Problems

This section provides basic troubleshooting information to help you resolve some common problems that might occur with your server.

If you cannot locate and correct the problem using the information in this section, refer to “Getting information, help, and service” on page 76 for more information.

---

### Diagnostic tools overview

The following tools are available to help you identify and resolve hardware-related problems:

- **AMIDiagnostic program**

This program is an EFI-based diagnostic program for IBM 64-bit computers with Intel microprocessors. The AMIDiag has test routines that examine the systems and subsystems in the server, including all PCI Plug and Play features. AMIDiag detects, diagnoses, and provides system information about PCI Plug and Play adapters and devices.

Detailed information about the network environment, CD-ROM drives, SCSI devices, power-management features, and other system data can be displayed. The diagnostic program tests the existing system memory and cache memory; it does not simply report information found in the system BIOS.

**Note:** The AMIDiag can test up to 64 GB of memory

- **Troubleshooting charts**

These charts list problem symptoms, along with suggested steps to correct the problems. See the “Troubleshooting charts” on page 70 for more information.

# Server Support

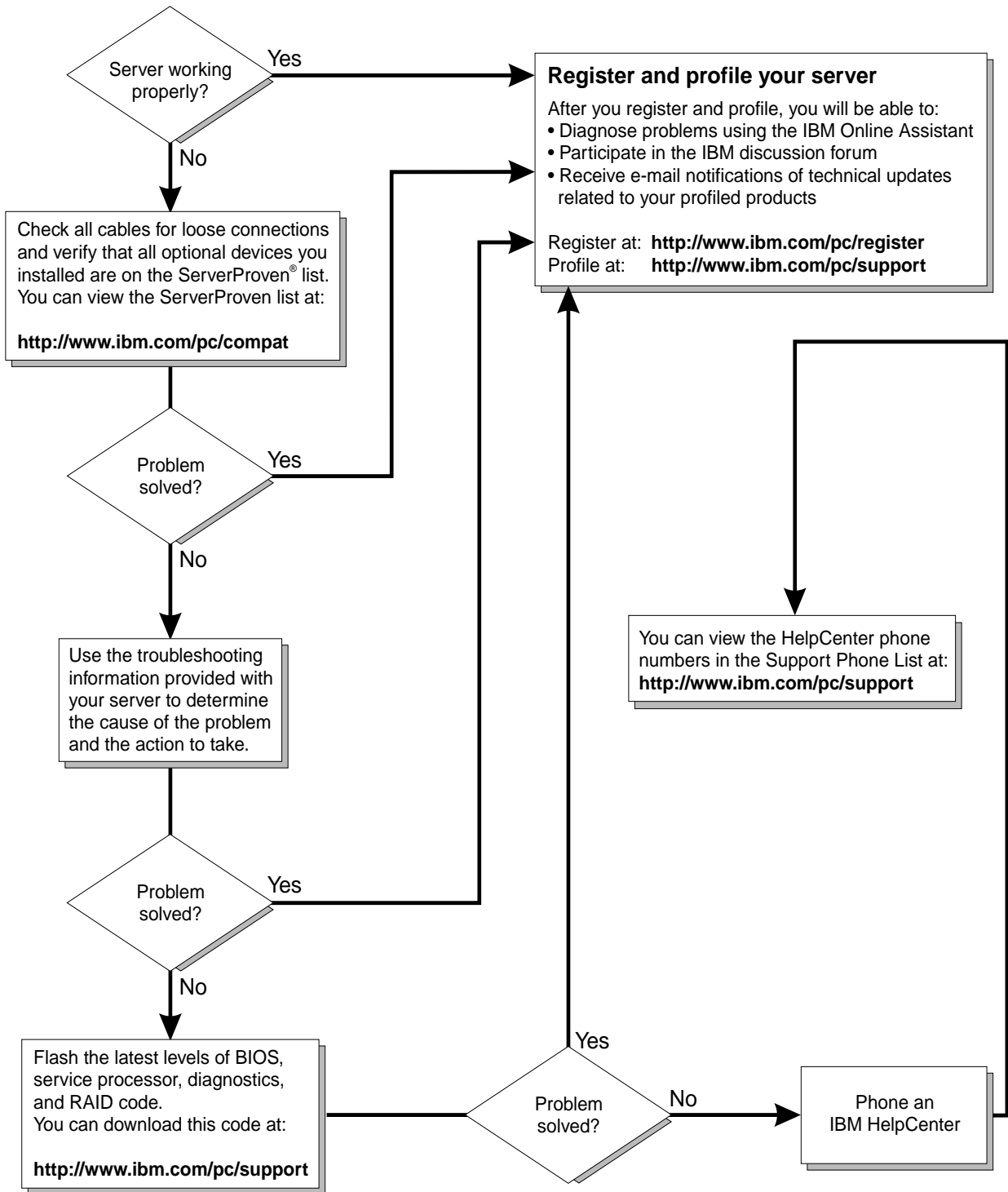

---

## POST

When you turn on your server, it performs a series of tests to check the operation of server components and some of the options installed in the server. This series of tests is called the power-on self-test (POST). The System Abstraction Layer (SAL), BIOS, and Extensible Firmware Interface (EFI) each perform a segment of the POST.

**Note:** If you have a power-on password set, you must type the password and press Enter, when prompted, before POST will continue.

---

## AMIDiagnostic program

Complete the following steps to run the AMIDiagnostic program:

1. Insert the LS120 diskette containing the diagnostic program into the diskette drive.
2. Boot the system to the EFI shell.
3. Type FS0: and press Enter to select FS0 as the default drive.
4. Type AMIDiag and press Enter to start the diagnostic program.
5. Use the arrow keys or keyboard shortcuts to select the test. See “AMIDiag Shortcuts” on page 59 for the keyboard shortcuts.
6. Press Enter to run the test.

## Running AMIDiag in batch mode

When your computer is experiencing an intermittent problem that no diagnostic software test has been able to identify, run the AMIDiag test over an extended period of time. Many computer problems (especially memory problems) are not evident when a test is run only once. AMIDiag enables you to run diagnostics on only a certain part of the computer, a specific part of memory, or a specific part of a disk drive. AMIDiag also enables you to build script (INI) files that contain test configuration information. After you have created an AMIDiag.ini file, you can run the AMIDiag diagnostic routines listed in the INI file automatically.

### Batch mode steps

Complete the following steps to run the diagnostic program in the batch mode:

1. Select the AMIDiag tests to be run.
2. Select the test parameters, such as the drives, the I/O ports, and other parameters for each selected test.

**Note:** These parameters differ for each test.

3. After selecting the test and its parameters, press F10 to run the test and check that it is configured properly.
4. Save the selected test parameters and tests in an AMIDiag.ini file.

**Note:** You can run this set of tests at any time.

## Error log viewer

AMIDiag enables you to display the error log while still running AMIDiag. The AMIDiag error log contains all diagnostic errors that AMIDiag has found during the current AMIDiag session. The error log viewer offers some text search capabilities.

To display the error log, complete the following:

1. Click **display error log file** on the AMIDiag options menu.
2. Type the name of the error log file.

**Note:** The default error log name is AMIDIAG.LOG

## AMIDiag Menus

The following is a list the available menu choices from the AMIDiag program:

- System
- Memory
- IDE Devices
- Diskette drive (FDD)
- SCSI
- Keyboard (KBD)
- Video
- USB
- Miscellaneous (Misc.)
- User
- Options

The following illustration is a screen shot of the AMIDiag menu choices.

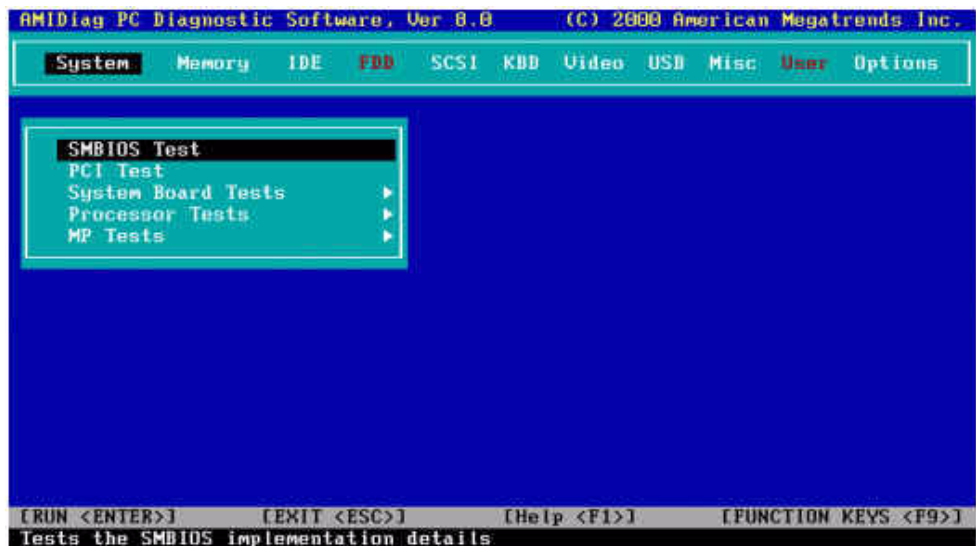



## AMIDiag Shortcuts

The following illustration shows the keyboard shortcuts for the AMIDiag program.

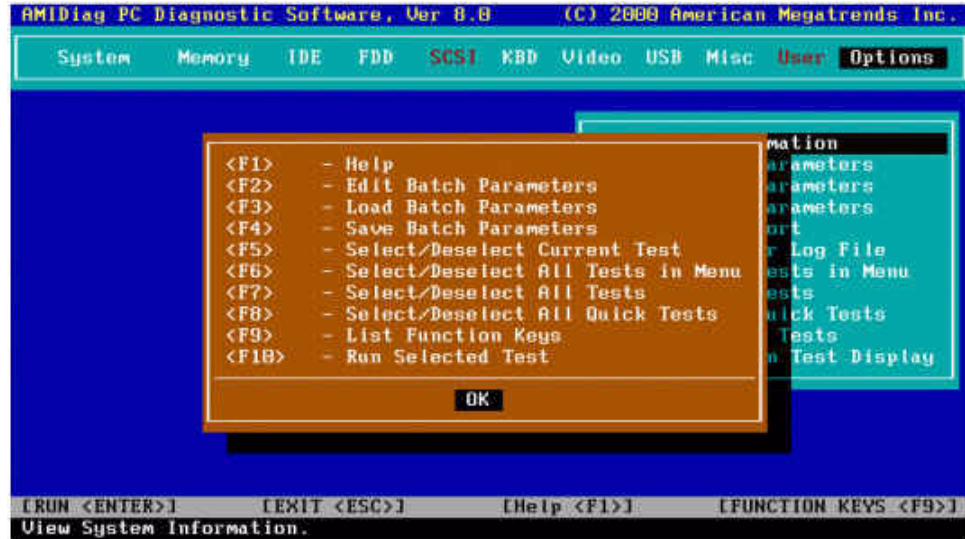

The following table contains the various keyboard shortcut combinations to run certain AMIDiag tests:

To run the test or test group...	Do this
Run all AMIDiag tests.	Press F7, then F10.
Run a complete overall system quick test	Press F8, then F10.
Run all system board diagnostic tests.	Select the System menu. Press F6, then F10.
Run all memory diagnostic routines.	Select the Memory menu. Press F6, then F10.
Run all IDE drive diagnostic routines.	Select the IDE menu. Press F6, then F10.
Run all diskette diagnostic routines.	Select the Floppy menu. Press F6, then F10.
Run all keyboard diagnostic routines.	Select the Keyboard menu. Press F6. Press F10.
Run all video diagnostic routines.	Select the Video menu. Press F6. Press F10.
Run all serial, parallel, and mouse diagnostic routines.	Select the Misc. menu. Press F6. Press F10.
Print a report about system configuration and test errors.	Select the Options menu. Select Generate Reports. Select the print device.
Exit AMIDiag.	Press Esc. Select <b>Yes</b> at the prompt.

## Selecting AMIDiag tests

<b>Processor problems</b>	
Make sure the computer has the proper CPU and it is operating properly.	Run the Basic Functionality test and the CPU Protected Mode on the System menu.
Check the CPU speed.	Run the Processor speed test on the System menu.
Make sure the computer clock is running properly.	Run the Timer test and the Real Time Clock test on the System menu.
Make sure the system configuration is not corrupted.	Run the CMOS Validity test on the System menu.
Make sure Plug and Play devices are functioning.	Run the Plug and Play test on the System menu.
Make sure the PCI adapter slots are functioning correctly.	Run the PCI system test on the System menu.
<b>Memory problems</b>	
Random memory (or performance) problems occur but BIOS POST did not find any memory problems.	Run the Pattern test, the Random Pattern Test and the Cache Memory test on the Memory menu.
The BIOS finds memory errors or memory problems occur constantly.	Run the Walking 1s test on the Memory menu.
Intermittent cache memory problems.	Run the Cache Memory test on the Memory menu.
Identify and report data corruption because of hardware parity problems.	Run the Parity test on the Memory menu.
Identify shorts on data lines and data bits stuck at 0.	Run the Walking 0s test on the Memory menu.
<b>IDE device problems</b>	
Find the data transfer rate and track to track seek time for the hard disk drive.	Run the Performance test on the DISK IDE menu.
Determine the drive Seek capability.	Run the Seek test on the DISK IDE menu.
Verify the hard drive read function.	Run the Read/Verify test on the DISK IDE menu.
<b>Diskette drive problems</b>	
Verify that the floppy drive formats disks correctly.	Run the Diskette Format test on the FDD menu.
Verify the floppy drive speed.	Run the Drive Speed test on the FDD menu.
Make sure the floppy drive is reading and writing correctly.	Run the Random R/W test and the Sequential R/W test on the FDD menu.
Make sure the drive seeks correctly.	Run the Elevator Seek test on the FDD menu.
<b>Keyboard problems</b>	
Make sure the keyboard interface works	Run the Keyboard Controller test on the Keyboard Menu.

Make sure each keyboard key sends the correct signal to the computer.	Run the Scan/ASCII Code test on the Keyboard Menu.
Make sure the keyboard LEDs work.	Run the Keyboard LED test on the Keyboard Menu.
<b>SCSI drive problems</b>	
Make sure that the SCSI drive is reading correctly.	Run the SCSI Disk Read test on the SCSI menu.
Make sure that the SCSI drive is writing correctly.	Run the SCSI Disk Write test on the SCSI menu.
Make sure that the SCSI tape drive is reading correctly.	Run the SCSI Tape Read test on the SCSI menu.
Make sure that the SCSI tape drive is writing correctly.	Run the SCSI Tape Write test on the SCSI menu.
Rewind the tape cartridge in the SCSI tape drive.	Run the SCSI Tape Rewind test on the SCSI menu.
<b>CD-ROM drive problems</b>	
Make sure that the CD-ROM drive is reading correctly.	If the computer has a SCSI CD-ROM drive, run the SCSI CD-ROM Read test on the SCSI menu. If the computer has an ATAPI or IDE CD-ROM drive, run the CD Data test on the IDE menu.
To test the CD-ROM drive tray,	Choose the CD Tray Test on the IDE or SCSI group menu.
Make sure that the CD-ROM drive can play audio CDs correctly.	If the computer has a SCSI CD-ROM drive, choose the SCSI CD-ROM Play test on the SCSI menu. If the computer has an ATAPI or IDE CD-ROM drive, choose the CD Audio Test on the IDE menu.
<b>Video problems</b>	
Video display problems.	Run the Video Memory test on the Video menu.
Make sure the video display attributes (blinking, bold, and reverse video) memory are operating correctly.	Run the Attribute test on the Video menu.
Make sure text displays correctly.	Run the 40x25 and 80x25 Display tests on the Video menu.
Make sure graphics display correctly.	Make sure the correct video drivers are loaded. Run the Video 320x200, 640x200, 640x350, 640x480, and Color tests on the Video menu.
Make sure Super VGA graphics display correctly.	Run the VESA Video Mode and VESA Video Memory test on the Video menu.
<b>Serial port problems</b>	
A mouse attached to a serial port does not work. A device attached to a serial port does not work.	Run the Serial port test on the Misc. menu.

<b>Parallel port problems</b>	
A printer connected to the parallel port does not work.	Run the Parallel port test on the Misc. menu.
<b>Audio problems</b>	
Make sure the speaker attached to your computer is working correctly.	Run the PC speaker test on the System menu.
Make sure the Sound Blaster adapter in your computer is working.	Run the Sound Blaster test on the Misc. menu.

---

## AMIDdiag error codes

This section contains tables showing the error codes that can be generated by some of the AMIDdiag program tests. Locate the test name in the headings to find the correct list of error codes.

### System error codes

Code	Explanation	Action
3000h	Register Bank Switch Failed	Call for service.
3001h	Register Read/Write Failed	
3002h	CPU Basic Instruction Operation Failed	
3006h	FPU Comparison Error	
3010h	CPU Speed does not match expected value	
3011h	CPU Mode Switching Failed	
3020h	CPU Basic Compatibility Test Failed	
3022h	CPU Protected Mode Compatibility Test failed	Call for service.
3100h	Read/Write test on DMA controller 1 failed	
3101h	Read/Write test on DMA controller 2 failed	
3102h	Read/Write test on page registers failed	
3111h	Enable/Disable of the interrupt controller failed	
3120h	The Timer Periodic Interrupt is not being generated	
3121h	The Timer is counting at a slower rate	

Code	Explanation	Action
3140h	The battery backup unit that powers CMOS RAM has no power	Call for service.
00A0h	PCI Device Enumeration Failed	
00A1h	PCI Device Access Failed	
00A2h	PCI Configuration Space could not be verified	
1000h	MP table failed or Load MP driver failed	
1009h	Cache coherency test failed	
100Ah	Memory consistency test failed	
100Bh	I/O access test failed on processor X at port xxxh	
100Eh	CPU speed error	
1020h	CPU functionality test failed	Call for service.
00B2h	SMBIOS Table Checksum Invalid	

## Memory error codes

Code	Explanation	Action
0100h	ROM read error.The diagnostic program could not read from a ROM location.	Call for service.
0120h	Parity error at absolute memory location xxxxxxxh. The diagnostic program found a parity error at xxxxxxxh.	
0130h	The pattern written at xxxxxxxh was qqqqh. The pattern read back from that address was ppph. AMIDdiag wrote a pattern to address xxxxxxxh. A different value was read back.	

Code	Explanation	Action
0131h	Parity failure at xxxxxxxh during pattern test. While performing the pattern test to the specified address, AMIDiag received a parity error.	Call for service.
0132h	Faulty memory chip on SIMMM xxxx1. Reseat Memory DIMMs 2. Replace Memory Board.	
0135h	ECC correctable error in SIMM sockets xxxx/yyyy	
0136h	ECC uncorrectable error in SIMM sockets xxxx/yyyy	
0137h	Error occurred on bank xxxx interleave yyyy	
0140h	Failure at address xxxxxxxh, bit position bbh. A failure occurred at the specified address.	
0150h	Failure at xxxxxxxh, bit position bbh. A failure occurred at the specified address.	
0170h	RAM Refresh is not working. The system RAM refresh signal is either not being generated or the signal is being generated sporadically.	
0180h	The pattern written at address xxxxxxxh was qqqqh. The pattern read back from that address was pppph. The diagnostic program wrote a pattern to address xxxxxxxh. When reading it back, AMIDiag read a different value from that same address.	
0184h	Data bus short found1	
0190h	Test failed at address xxxxxxxh. An unknown memory error occurred at xxxxxxxh.	

## IDE CD error codes

Code	Explanation	Action
0A01h	Eject fails on drive x	1. Manually eject media. 2. Retry tray function. 3. Call for service.
0A02h	Close failed on drive x	
0A03h	Sequential data test failed, Drive x, Sector Y	1. Replace media. 2. Call for service.
0A04h	Sequential data test failed, No data CD in Drive x	
0A05h	Random data test failed, Drive x, Sector Y	
0A06h	Random data test failed, No data CD in Drive x	
0A07h	Sequential Play test failed, Drive x, Sector y	

## IDE DVD error codes

Code	Explanation	Action
1900h	Critical/Command Error	1. Replace media. 2. Call for service.

## ATAPI removables error codes

Code	Explanation	Action
0F01h	No ATAPI Removable drives present	Call for service.
0F02h	Write failed	1. Replace media. 2. Call for service.
0F03h	Read failed	
0F04h	Seek operation failed	
0F05h	Eject fails on drive x	
0F06h	Sequential Read Verify failed	
0F08h	Random Read Verify failed	

## SCSI error codes

Code	Explanation	Action
0500h	SCSI device not ready	1. Confirm that drive is configured. 2. Replace drive. 3. Call for service.
0502h	SCSI device read error	
0504h	SCSI device write error	
0505h	SCSI disk format failed	
0506h	SCSI disk self test failed	
0507h	SCSI disk buffer error	
0508h	SCSI disk random read error	
0509h	SCSI disk random write error	
050Ah	SCSI disk block repair failed	
050Bh	SCSI spin down test failed	

## Keyboard error codes

Code	Explanation	Action
0400h	The diagnostic program found a keyboard controller interface error	1. Replace the keyboard. 2. Call for service.
0401h	The diagnostic program issued commands to the keyboard controller and received improper responses	
0410h - 0411h	Keyboard clock line is stuck low/high. The clock line to the keyboard is stuck either low or high.	
0412h - 0413h	Keyboard data line is stuck low/high. The data line to the keyboard is stuck either low or high.	



## Video error codes

Code	Explanation	Action
0900h	Vertical Synchronization Test failed	Call for service.
0901h	Horizontal Synchronization Test failed	
0902h	Graphics controller test failed	
0904h	DAC register test failed	
0905h	Video adapter memory R/W test failed	
0921h	AGP test failed	
2100h	Video adapter attribute test failed	<ol style="list-style-type: none"> <li>1. Replace the video monitor.</li> <li>2. Call for service.</li> </ol>
2102h	Video adapter color test failed	

## USB error codes

Error Code	Description	Action
0B00h	USB mouse set protocol failed	<ol style="list-style-type: none"> <li>1. Check the USB mouse connection.</li> <li>2. Replace the USB mouse.</li> <li>3. Call for service.</li> </ol>
0B01h	USB mouse remove and attach tests failed	
0B02h	USB mouse not present	
0B30h1	USB keyboard control test failed	<ol style="list-style-type: none"> <li>1. Check the USB keyboard connection.</li> <li>2. Replace the USB keyboard.</li> <li>3. Call for service.</li> </ol>
0B40h	USB keyboard LED test failed	
0B50h	USB keyboard remove and attach test failed	
0B60h	USB keyboard not present	
0B70h	USB Hub communication test failed	<ol style="list-style-type: none"> <li>1. Check the USB Hub connection.</li> <li>2. Replace the USB Hub.</li> <li>3. Replace the Legacy I/O board.</li> </ol>
0B80h	USB Hub port status test failed	
0B90h	USB Hub not present	

## Parallel error codes

Code	Explanation	Action
0701h	Data written to port xxxh was yyh. Data read back was zzh.	<ol style="list-style-type: none"> <li>1. Check connection of loopback if used during test.</li> <li>2. Call for service.</li> </ol>
0702h	The IRQ activation test failed at xxxh	Call for service.
0703h	No response from printer	<ol style="list-style-type: none"> <li>1. Check connection and condition of printer cable.</li> <li>2. Replace printer.</li> <li>3. Call for service.</li> </ol>
0704h	ECP register W/R failed at port xxxh	Call for service.
0705h	ECP FIFO test failed at port xxxh	
0706h	Loopback test failed at port xxxh	<ol style="list-style-type: none"> <li>1. Check connection of loopback if used during test.</li> <li>2. Call for service.</li> </ol>
0709h	EPP register R/W test failed at port xxxh	Call for service.

## Serial port error codes

Code	Description	Action
0601h	Data written to port xxxh was yyyy. Data read back from the port was zzzh.	<ol style="list-style-type: none"> <li>1. Check connection of loopback if used during test.</li> <li>2. Call for service.</li> </ol>
0602h	Interrupt identification register test failed	Call for service.
0603h	Data written to port xxxh was yyyy. Data read back from the port was zzzh.	<ol style="list-style-type: none"> <li>1. Check connection of loopback if used during test.</li> <li>2. Call for service.</li> </ol>
604	Line register test failed at port xxxh	Call for service.
0605h	Interrupt activation test failed at port xxxh	

Code	Description	Action
0606h	Data transfer test failed at port xxxh	<ol style="list-style-type: none"> <li>1. Check connection of loopback if used during test.</li> <li>2. Call for service.</li> </ol>
0607h	Loop back test failed at port xxxh	

## PS/2 mouse error codes

Code	Explanation	Action
1B00h	PS/2 Mouse Self Test Failed	<ol style="list-style-type: none"> <li>1. Check PS/2 mouse connection.</li> <li>2. Replace the mouse.</li> <li>3. Call for service.</li> </ol>
1B01h	PS/2 Mouse Echo Test Failed	
1B02h	PS/2 Mouse Remote mode Test Failed	
1B03h	PS/2 Mouse failed to respond to the self test	

## ACPI error codes

Code	Explanation	Action
1702h	Invalid ACPI tables	<ol style="list-style-type: none"> <li>1. Replace the System BIOS.</li> <li>2. Call for service.</li> </ol>

## Troubleshooting charts

You can use the troubleshooting charts in this section to find solutions to problems that have definite symptoms.

**Attention:** If diagnostic error messages appear that are not listed in the following tables, make sure that your server has the latest levels of BIOS and firmware installed.

See “AMIDiagnostic program” on page 57 to test the server. If you have run the diagnostic test programs or if running the tests does not reveal the problem, call for service.

Look for the symptom in the left column of the chart. Instructions and probable solutions to the problem are in the right column. If you have just added new software or a new option and your server is not working, do the following before using the troubleshooting charts:

- Remove the software or device that you just added.
- Run the diagnostic tests to determine if your server is running correctly.
- Reinstall the new software or new device.

Device	Suggested action
<b>CD-ROM drive</b>	Verify that:
CD-ROM drive is not recognized.	<ol style="list-style-type: none"> <li>1. The primary IDE channel is enabled in the BIOS Setup Utility program.</li> <li>2. The correct device driver is installed for the CD-ROM drive.</li> </ol> <p>If the problem remains, call for service.</p>
<b>Diskette drive</b>	If there is a diskette in the drive, verify that the diskette is good and not damaged. (Try another diskette if you have one.)
Diskette drive in-use light stays on, or the system bypasses the diskette drive.	If the diskette drive in-use light stays on, or the system continues to bypass the diskette drive, call for service.
<b>Expansion enclosure problems</b>	Verify that:
The SCSI expansion enclosure used to work, but does not work now.	<ol style="list-style-type: none"> <li>1. The cables for all external SCSI options are connected correctly.</li> <li>2. The last option in each SCSI chain, or the end of the SCSI cable, is terminated correctly.</li> <li>3. Any external SCSI option is turned on. You must turn on an external SCSI option before turning on the server.</li> </ol> <p>For more information, see your expansion enclosure documentation.</p>
<b>General problems</b>	Call for service.
Problems such as broken cover locks or indicator lights not working.	
<b>Intermittent problems</b>	Verify that:
A problem occurs only occasionally and is difficult to detect.	<ol style="list-style-type: none"> <li>1. All cables and cords are connected securely to the rear of the server and attached options.</li> <li>2. When the server is turned on, verify that the power supply and fan indicator lights are off.</li> <li>3. Ensure that the SCSI bus and devices are configured correctly and that the last external device in each SCSI chain is terminated correctly.</li> </ol> <p>If the items above are correct and the problem remains, call for service.</p>

Device	Suggested action
<b>Keyboard, mouse, or pointing-device problems.</b>	<ol style="list-style-type: none"> <li>1. Make sure that the keyboard cable is properly connected to the server.</li> <li>2. Make sure that the server and the monitor are turned on.</li> </ol>
All or some keys on the keyboard do not work.	<ol style="list-style-type: none"> <li>3. Try using another keyboard.</li> </ol> <p>If the items above are correct and the problem remains, call for service.</p>
The mouse or pointing device does not work.	<ol style="list-style-type: none"> <li>1. Verify that the mouse or pointing-device cable is securely connected and the device drivers are installed correctly.</li> <li>2. Try using another mouse or pointing device.</li> </ol> <p>If the problem remains, call for service.</p>
<b>Monitor problems</b>	<p>Some IBM monitors have their own self-tests. If you suspect a problem with your monitor, refer to the information that comes with the monitor for adjusting and testing instructions.</p> <p>If you still cannot find the problem, call for service.</p>
Testing the monitor.	
The screen is blank.	<p>Verify that:</p> <ol style="list-style-type: none"> <li>1. The server power cord is plugged into the server and a working electrical outlet.</li> <li>2. The monitor cables are connected properly.</li> <li>3. The monitor is turned on, and the Brightness and Contrast controls are adjusted correctly.</li> </ol> <p>If the items above are correct and the screen remains blank, call for service.</p>
Only the cursor appears.	Call for service.
The monitor works when you turn on the server, but goes blank when you start some application programs.	<p>Verify that:</p> <ol style="list-style-type: none"> <li>1. The primary monitor cable is connected to the server.</li> <li>2. You installed the necessary device drivers for the applications.</li> </ol> <p>If the items above are correct and the screen remains blank, call for service.</p>
Wavy, unreadable, rolling, distorted screen, or screen jitter.	<p>If the monitor self-tests show the monitor is working properly, consider the location of the monitor. Magnetic fields around other devices (such as transformers, appliances, fluorescent lights, and other monitors) can cause screen jitter or wavy, unreadable, rolling, or distorted screen images. If this happens, turn off the monitor. (Moving a color monitor while it is turned on might cause screen discoloration.) Then move the device and the monitor at least 305 mm (12 in.) apart. Turn on the monitor.</p> <p><b>Notes:</b></p> <ol style="list-style-type: none"> <li>1. To prevent diskette drive read/write errors, be sure the distance between monitors and diskette drives is at least 76 mm (3 in.).</li> <li>2. Non-IBM monitor cables might cause unpredictable problems.</li> <li>3. An enhanced monitor cable with additional shielding is available for the 9521 and 9527 monitors. For information about the enhanced monitor cable, see your IBM reseller or IBM marketing representative.</li> </ol> <p>If the problem remains, call for service.</p>
Wrong characters appear on the screen.	<p>If the wrong language is displayed, update the BIOS with the correct language.</p> <p>If the problem remains, call for service.</p>

Device	Suggested action
<b>Option problems</b>	Verify that:
An IBM option that was just installed does not work.	<ol style="list-style-type: none"> <li>1. The option is designed for the server. Refer to the "Server Support" flowchart for information about obtaining ServerProven™ compatibility information from the World Wide Web.</li> <li>2. You followed the installation instructions that came with the option.</li> <li>3. The option is installed correctly.</li> <li>4. You have not loosened any other installed options or cables.</li> <li>5. You updated the configuration information in the BIOS Setup Utility program. Whenever memory or an option is changed, you must update the configuration.</li> </ol> <p>If the problem remains, call for service.</p>
An IBM option that used to work does not work now.	<p>Verify that all of the option hardware and cable connections are secure.</p> <p>If the option comes with its own test instructions, use those instructions to test the option.</p> <p>If the failing option is a SCSI option, verify that:</p> <ol style="list-style-type: none"> <li>1. The cables for all external SCSI options are connected correctly.</li> <li>2. The last option in each SCSI chain, or the end of the SCSI cable, is terminated correctly.</li> <li>3. Any external SCSI option is turned on. You must turn on an external SCSI option before turning on the server.</li> </ol> <p>If the problem remains, call for service.</p>
<b>Power problems</b>	Verify that:
The server does not power on.	<ol style="list-style-type: none"> <li>1. The power cables are properly connected to the server.</li> <li>2. The electrical outlet functions properly.</li> <li>3. The type of memory installed is correct.</li> <li>4. If you just installed an option, remove it, and restart the server. If the server now powers on, you might have installed more options than the power supply supports.</li> </ol> <p>If the problem remains, call for service.</p>
<b>Serial port problems</b>	Verify that:
The number of serial ports identified by the operating system is less than the number of serial ports installed.	<ol style="list-style-type: none"> <li>1. Each port is assigned a unique address by the BIOS Setup Utility program, and none of the serial ports are disabled.</li> <li>2. The serial-port adapter, if you installed one, is seated properly.</li> </ol> <p>If the problem remains, call for service.</p>
A serial device does not work. For more information about the serial port see "Serial ports" on page 52.	<p>Verify that:</p> <ol style="list-style-type: none"> <li>1. The device is compatible with the server.</li> <li>2. The serial port is enabled and is assigned a unique address.</li> </ol> <p>If the problem remains, call for service.</p>

Device	Suggested action
<b>Software problem</b>	To determine if problems are caused by the software, verify that:
Suspected software problem.	<ol style="list-style-type: none"> <li>1. Your server has the minimum memory requirements needed to use the software. For memory requirements, refer to the information that comes with the software. <b>Note:</b> If you have just installed an adapter or memory, you might have a memory address conflict.</li> <li>2. The software is designed to operate on your server.</li> <li>3. Other software works on your server.</li> <li>4. The software that you are using works on another system.</li> </ol> <p>If you received any error messages when using the software program, refer to the information that comes with the software for a description of the messages and solutions to the problem.</p> <p>If the items above are correct and the problem remains, contact your place of purchase.</p>
<b>Universal Serial Bus (USB) port problems</b>	Verify that:
A USB device does not work.	<ol style="list-style-type: none"> <li>1. You are not trying to use an USB device during POST if you have a standard (non-USB) keyboard attached to the keyboard port. <b>Note:</b> If a standard (non-USB) keyboard is attached to the keyboard port, then the USB is disabled and no USB device will work during POST.</li> <li>2. The correct USB device driver is installed.</li> <li>3. Your operating system supports USB devices.</li> </ol> <p>If the problem still exists, call for service.</p>

## Troubleshooting an Ethernet controller

This section provides troubleshooting information for problems that might occur with an 10/100 Mbps Ethernet controller.

### Network connection problems

If an Ethernet controller cannot connect to the network, check the following:

- Make sure that the cable is installed correctly.  
The network cable must be securely attached at all connections. If the cable is attached but the problem persists, try a different cable.  
If you set the Ethernet controller to operate at 100 Mbps, you must use Category 5 cabling.  
If you directly connect two workstations (without a hub), or if you are not using a hub with X ports, use a crossover cable.  
**Note:** To determine whether a hub has an X port, check the port label. If the label contains an X, the hub has an X port.
- Determine if the hub supports auto-negotiation. If not, try configuring the integrated Ethernet controller manually to match the speed and duplex mode of the hub.
- Make sure that you are using the correct device drivers, supplied with your server.
- Check for operating system-specific causes for the problem.
- Make sure that the device drivers on the client and server are using the same protocol.
- Test the Ethernet controller.

How you test the Ethernet controller depends on which operating system you are using (see the Ethernet controller device driver README file).

## Ethernet controller troubleshooting chart

You can use the following troubleshooting chart to find solutions to 10/100 Mbps Ethernet controller problems that have definite symptoms.

Ethernet controller problem	Suggested action
The server stops running when loading device drivers.	<p>The PCI BIOS interrupt settings are incorrect.</p> <p>Check the following:</p> <ul style="list-style-type: none"> <li>• Determine if the interrupt (IRQ) setting assigned to the Ethernet controller is also assigned to another device in the BIOS Setup Utility program.</li> </ul> <p>Although interrupt sharing is allowed for PCI devices, some devices do not function well when they share an interrupt with a dissimilar PCI device. Try changing the IRQ assigned to the Ethernet controller or the other device.</p> <ul style="list-style-type: none"> <li>• Make sure that you are using the most recent device driver available from the World Wide Web.</li> <li>• Run the network diagnostic program.</li> </ul> <p>If the problem remains, call for service.</p>
Data is incorrect or sporadic.	<p>Check the following:</p> <ul style="list-style-type: none"> <li>• Make sure that you are using Category 5 cabling when operating the server at 100 Mbps.</li> <li>• Make sure that the cables do not run close to noise-inducing sources like fluorescent lights.</li> </ul>
The Ethernet controller stopped working when another adapter was added to the server.	<p>Check the following:</p> <ul style="list-style-type: none"> <li>• Make sure that the cable is connected to the Ethernet controller.</li> <li>• Make sure that your PCI system BIOS is current.</li> <li>• Reseat the adapter.</li> <li>• Determine if the interrupt (IRQ) setting assigned to the Ethernet adapter is also assigned to another device in the BIOS Setup Utility program.</li> </ul> <p>Although interrupt sharing is allowed for PCI devices, some devices do not function well when they share an interrupt with a dissimilar PCI device. Try changing the IRQ assigned to the Ethernet adapter or the other device.</p> <p>If the problem remains, call for service.</p>
The Ethernet controller stopped working without apparent cause.	<p>Check the following:</p> <ul style="list-style-type: none"> <li>• Run diagnostics for the Ethernet controller.</li> <li>• Try a different connector on the hub.</li> <li>• Reinstall the device drivers. Refer to your operating-system documentation and to the ServerGuide information.</li> </ul> <p>If the problem remains, call for service.</p>



---

## Replacing the battery

Call for service.

Statement 14



**CAUTION:**

Hazardous voltage, current, and energy levels might be present. Only a qualified service technician is authorized to remove the covers where the following label is attached.



---

## Getting information, help, and service

If you need help, service, or technical assistance or just want more information about IBM products, you will find a wide variety of sources available from IBM to assist you. This section contains information about where to go for additional information about IBM and IBM products, what to do if you experience a problem with your computer, and whom to call for service should it be necessary.

### Getting information

Information about your IBM server product and preinstalled software, if any, is available in the documentation that comes with your server. That documentation includes printed books, online books, README files, and help files. In addition, information about IBM products is available on the World Wide Web and through the IBM Automated Fax System.

#### Using the World Wide Web

On the World Wide Web, the IBM Web site has up-to-date information about IBM products and support. The address for the IBM Personal Computing home page is <http://www.ibm.com/pc/>.

You can find support information for your IBM products at <http://www.ibm.com/pc/support/>.

If you click **Profile** from the support page, you can create a customized support page that is specific to your hardware, complete with Frequently Asked Questions, Parts Information, Technical Hints and Tips, and Downloadable Files. In addition, you can choose to receive e-mail notifications whenever new information becomes available about your registered products.

You also can order publications through the IBM Publications Ordering System at <http://www.elink.ibm.com/public/applications/publications/cgibin/pbi.cgi>.

#### Getting information by fax

If you have a touch-tone telephone and access to a fax machine, in the U.S. and Canada, you can receive, by fax, marketing and technical information on many topics, including hardware, operating systems, and local area networks (LANs).

You can call the IBM Automated Fax System 24 hours a day, 7 days a week. Follow the recorded instructions, and the requested information will be sent to your fax machine. In the U.S. and Canada, to access the IBM Automated Fax System, call 1-800-426-3395.

### Getting help and service

If you have a problem with your server product you will find a wide variety of sources available to help you.

#### Using the documentation and diagnostic programs

Many problems can be solved without outside assistance. If you experience a problem with your server product, the first place to start is the troubleshooting information in your IBM documentation. If you suspect a software problem, see the documentation, including README files and online help, that comes with the operating system or application program.

Most IBM server products come with a set of diagnostic programs that you can use to help you identify hardware problems. See the troubleshooting information in your IBM documentation for instructions on using the diagnostic programs.

The troubleshooting information or the diagnostic programs might tell you that you need additional or updated device drivers or other software. IBM maintains pages on the World Wide Web where you can get the latest technical information and download device drivers and updates. To access these pages, go to <http://www.ibm.com/pc/support/> and follow the instructions.

## Calling for service

If you have tried to correct the problem yourself and still need help, during the warranty period, you can get help and information by telephone through the IBM HelpCenter<sup>®</sup>. The following services are available during the warranty period:

- **Problem determination** - Trained personnel are available to assist you with determining if you have a hardware problem and deciding what action is necessary to fix the problem.
- **IBM hardware repair** - If the problem is determined to be caused by IBM hardware under warranty, trained service personnel are available to provide the applicable level of service.
- **Engineering Change management** - Occasionally, there might be changes that are required after a product has been sold. IBM or your reseller, if authorized by IBM, will make selected Engineering Changes (ECs) available that apply to your hardware.

The following items are not covered:

- Replacement or use of non-IBM parts or nonwarranted IBM parts. All warranted parts contain a 7-character identification in the format IBM FRU XXXXXXX.
- Identification of software problem sources.
- Configuration of BIOS as part of an installation or upgrade.
- Changes, modifications, or upgrades to device drivers.
- Installation and maintenance of network operating systems (NOS).
- Installation and maintenance of application programs.

Refer to your IBM hardware warranty for a full explanation of IBM warranty terms. Be sure to retain your proof of purchase to obtain warranty service.

In the U.S. and Canada, these services are available 24 hours a day, 7 days a week. In the U.K., these services are available Monday through Friday, from 9:00 a.m. to 6:00 p.m.

**Note:** Response time will vary depending on the number and complexity of incoming calls.

Please have the following information ready when you call:

- Machine type and model
- Serial numbers of your IBM hardware products
- Description of the problem
- Exact wording of any error messages
- Hardware and software configuration information

Phone numbers are subject to change without notice. For the most up-to-date phone numbers, go to <http://www.ibm.com/pc/support/> and click **Support Phone List**.

Country		Telephone number
Austria	Österreich	01-24 592 5901
Belgium - Dutch	Belgie	02-210 9820
Belgium - French	Belgique	02-210 9800
Canada	Toronto only	416-383-3344
Canada	Canada - all other	1-800-565-3344
Denmark	Danmark	45 20 82 00
Finland	Suomi	09-22 931 840
France	France	02 38 55 74 50
Germany	Deutschland	07032-1549 201
Ireland	Ireland	01-815 9202
Italy	Italia	02-482 9202
Luxembourg	Luxembourg	298-977 5063
Netherlands	Nederland	020-514 5770
Norway	Norge	23 05 32 40
Portugal	Portugal	21-791 51 47
Spain	España	91-662 49 16
Sweden	Sverige	08-477 4420
Switzerland	Schweiz/Suisse/Svizzera	0848-80 52 52
United Kingdom	United Kingdom	01475-555 055
U.S.A. and Puerto Rico	U.S.A. and Puerto Rico	1-800-772-2227

In all other countries, contact your IBM reseller or IBM marketing representative.

## Purchasing additional services

During and after the warranty period, you can purchase additional services, such as support for IBM and non-IBM hardware, operating systems, and application programs; network setup and configuration; upgraded or extended hardware repair services; and custom installations. Service availability and service name might vary by country.

For more information about these services, contact your IBM marketing representative.

---

## Appendix A. Product warranties and notices

This chapter contains warranty and emission notices. It also contains trademarks and general-information notices.

---

### Warranty Information

This section contains the warranty period for your product and the IBM Statement of Limited Warranty.

### Warranty Period

Contact your place of purchase for warranty service information. Some IBM Machines are eligible for on-site warranty service depending on the country where service is performed.

<b>Machine</b> - IBM eServer xSeries 380
--

<b>Warranty Period</b> - Three Years
--------------------------------------

### IBM Statement of Limited Warranty

Z125-4753-06 8/2000

#### Part 1 - General Terms

This Statement of Limited Warranty includes Part 1 - General Terms and Part 2 - Country-unique Terms. The terms of Part 2 replace or modify those of Part 1. The warranties provided by IBM in this Statement of Limited Warranty apply only to Machines you purchase for your use, and not for resale, from IBM or your reseller. The term "Machine" means an IBM machine, its features, conversions, upgrades, elements, or accessories, or any combination of them. The term "Machine" does not include any software programs, whether pre-loaded with the Machine, installed subsequently or otherwise. Unless IBM specifies otherwise, the following warranties apply only in the country where you acquire the Machine. Nothing in this Statement of Limited Warranty affects any statutory rights of consumers that cannot be waived or limited by contract. If you have any questions, contact IBM or your reseller.

#### The IBM Warranty for Machines

IBM warrants that each Machine 1) is free from defects in materials and workmanship and 2) conforms to IBM's Official Published Specifications ("Specifications"). The warranty period for a Machine is a specified, fixed period commencing on its Date of Installation. The date on your sales receipt is the Date of Installation unless IBM or your reseller informs you otherwise. If a Machine does not function as warranted during the warranty period, and IBM or your reseller are unable to either 1) make it do so or 2) replace it with one that is at least functionally equivalent, you may return it to your place of purchase and your money will be refunded.

**Extent of Warranty** The warranty does not cover the repair or exchange of a Machine resulting from misuse, accident, modification, unsuitable physical or operating environment, improper maintenance by you, or failure caused by a product for which IBM is not responsible. The warranty is voided by removal or alteration of Machine or parts identification labels.

**THESE WARRANTIES ARE YOUR EXCLUSIVE WARRANTIES AND REPLACE ALL OTHER WARRANTIES OR CONDITIONS, EXPRESS OR IMPLIED, INCLUDING, BUT NOT LIMITED TO, THE IMPLIED WARRANTIES OR CONDITIONS OF MERCHANTABILITY AND FITNESS FOR A PARTICULAR PURPOSE. THESE WARRANTIES GIVE YOU SPECIFIC LEGAL RIGHTS AND YOU MAY ALSO HAVE OTHER RIGHTS WHICH VARY FROM JURISDICTION TO JURISDICTION. SOME JURISDICTIONS DO NOT ALLOW THE EXCLUSION OR LIMITATION OF EXPRESS OR IMPLIED WARRANTIES, SO THE ABOVE EXCLUSION OR LIMITATION MAY NOT APPLY TO YOU. IN THAT EVENT, SUCH WARRANTIES ARE LIMITED IN DURATION TO THE WARRANTY PERIOD. NO WARRANTIES APPLY AFTER THAT PERIOD.**

### **Items Not Covered by Warranty**

IBM does not warrant uninterrupted or error-free operation of a Machine.

Any technical or other support provided for a Machine under warranty, such as assistance via telephone with "how-to" questions and those regarding Machine set-up and installation, will be provided **WITHOUT WARRANTIES OF ANY KIND.**

### **Warranty Service**

To obtain warranty service for a Machine, contact IBM or your reseller. If you do not register your Machine with IBM, you may be required to present proof of purchase.

During the warranty period, IBM or your reseller, if approved by IBM to provide warranty service, provides without charge certain types of repair and exchange service to keep Machines in, or restore them to, conformance with their Specifications. IBM or your reseller will inform you of the available types of service for a Machine based on its country of installation. At its discretion, IBM or your reseller will 1) either repair or exchange the failing Machine and 2) provide the service either at your location or a service center. IBM or your reseller will also manage and install selected engineering changes that apply to the Machine.

Some parts of IBM Machines are designated as Customer Replaceable Units (called "CRUs"), e.g., keyboards, memory, or hard disk drives. IBM ships CRUs to you for replacement by you. You must return all defective CRUs to IBM within 30 days of your receipt of the replacement CRU. You are responsible for downloading designated Machine Code and Licensed Internal Code updates from an IBM Internet Web site or from other electronic media, and following the instructions that IBM provides.

When warranty service involves the exchange of a Machine or part, the item IBM or your reseller replaces becomes its property and the replacement becomes yours. You represent that all removed items are genuine and unaltered. The replacement may not be new, but will be in good working order and at least functionally equivalent to the item replaced. The replacement assumes the warranty service status of the replaced item. Many features, conversions, or upgrades involve the removal of parts and their return to IBM. A part that replaces a removed part will assume the warranty service status of the removed part.

Before IBM or your reseller exchanges a Machine or part, you agree to remove all features, parts, options, alterations, and attachments not under warranty service.

You also agree to

1. ensure that the Machine is free of any legal obligations or restrictions that prevent its exchange;
2. obtain authorization from the owner to have IBM or your reseller service a Machine that you do not own; and

3. where applicable, before service is provided:
  - a. follow the problem determination, problem analysis, and service request procedures that IBM or your reseller provides;
  - b. secure all programs, data, and funds contained in a Machine;
  - c. provide IBM or your reseller with sufficient, free, and safe access to your facilities to permit them to fulfill their obligations; and
  - d. inform IBM or your reseller of changes in a Machine's location.

IBM is responsible for loss of, or damage to, your Machine while it is 1) in IBM's possession or 2) in transit in those cases where IBM is responsible for the transportation charges.

Neither IBM nor your reseller is responsible for any of your confidential, proprietary or personal information contained in a Machine which you return to IBM or your reseller for any reason. You should remove all such information from the Machine prior to its return.

### **Limitation of Liability**

Circumstances may arise where, because of a default on IBM's part or other liability, you are entitled to recover damages from IBM. In each such instance, regardless of the basis on which you are entitled to claim damages from IBM (including fundamental breach, negligence, misrepresentation, or other contract or tort claim), except for any liability that cannot be waived or limited by applicable laws, IBM is liable for no more than

1. damages for bodily injury (including death) and damage to real property and tangible personal property; and
2. the amount of any other actual direct damages, up to the charges (if recurring, 12 months' charges apply) for the Machine that is subject of the claim. For purposes of this item, the term "Machine" includes Machine Code and Licensed Internal Code.

This limit also applies to IBM's suppliers and your reseller. It is the maximum for which IBM, its suppliers, and your reseller are collectively responsible.

**UNDER NO CIRCUMSTANCES IS IBM LIABLE FOR ANY OF THE FOLLOWING: 1) THIRD-PARTY CLAIMS AGAINST YOU FOR DAMAGES (OTHER THAN THOSE UNDER THE FIRST ITEM LISTED ABOVE); 2) LOSS OF, OR DAMAGE TO, YOUR RECORDS OR DATA; OR 3) SPECIAL, INCIDENTAL, OR INDIRECT DAMAGES OR FOR ANY ECONOMIC CONSEQUENTIAL DAMAGES, LOST PROFITS OR LOST SAVINGS, EVEN IF IBM, ITS SUPPLIERS OR YOUR RESELLER IS INFORMED OF THEIR POSSIBILITY. SOME JURISDICTIONS DO NOT ALLOW THE EXCLUSION OR LIMITATION OF INCIDENTAL OR CONSEQUENTIAL DAMAGES, SO THE ABOVE LIMITATION OR EXCLUSION MAY NOT APPLY TO YOU.**

### **Governing Law**

Both you and IBM consent to the application of the laws of the country in which you acquired the Machine to govern, interpret, and enforce all of your and IBM's rights, duties, and obligations arising from, or relating in any manner to, the subject matter of this Agreement, without regard to conflict of law principles.

## **Part 2 - Country-unique Terms**

### **AMERICAS**

#### **BRAZIL**

**Governing Law:** *The following is added after the first sentence:*

Any litigation arising from this Agreement will be settled exclusively by the court of Rio de Janeiro.

## **NORTH AMERICA**

**Warranty Service:** *The following is added to this Section:*

To obtain warranty service from IBM in Canada or the United States, call 1-800-IBM-SERV (426-7378).

### **CANADA**

**Governing Law:** *The following replaces "laws of the country in which you acquired the Machine" in the first sentence:*

laws in the Province of Ontario.

### **UNITED STATES**

**Governing Law:** *The following replaces "laws of the country in which you acquired the Machine" in the first sentence:*

laws of the State of New York.

## **ASIA PACIFIC**

### **AUSTRALIA**

**The IBM Warranty for Machines:** *The following paragraph is added to this Section:*

The warranties specified in this Section are in addition to any rights you may have under the Trade Practices Act 1974 or other similar legislation and are only limited to the extent permitted by the applicable legislation.

**Limitation of Liability:** *The following is added to this Section:*

Where IBM is in breach of a condition or warranty implied by the Trade Practices Act 1974 or other similar legislation, IBM's liability is limited to the repair or replacement of the goods or the supply of equivalent goods. Where that condition or warranty relates to right to sell, quiet possession or clear title, or the goods are of a kind ordinarily acquired for personal, domestic or household use or consumption, then none of the limitations in this paragraph apply.

**Governing Law:** *The following replaces "laws of the country in which you acquired the Machine" in the first sentence:*

laws of the State or Territory.

### **CAMBODIA, LAOS, AND VIETNAM**

**Governing Law:** *The following replaces "laws of the country in which you acquired the Machine" in the first sentence:*

laws of the State of New York.

*The following is added to this Section:*

Disputes and differences arising out of or in connection with this Agreement shall be finally settled by arbitration which shall be held in Singapore in accordance with the rules of the International Chamber of Commerce (ICC). The arbitrator or arbitrators designated in conformity with those rules shall have the power to rule on their own competence and on the validity of the Agreement to submit to arbitration. The arbitration award shall be final and binding for the parties without appeal and the arbitral award shall be in writing and set forth the findings of fact and the conclusions of law.



All proceedings shall be conducted, including all documents presented in such proceedings, in the English language. The number of arbitrators shall be three, with each side to the dispute being entitled to appoint one arbitrator.

The two arbitrators appointed by the parties shall appoint a third arbitrator before proceeding upon the reference. The third arbitrator shall act as chairman of the proceedings. Vacancies in the post of chairman shall be filled by the president of the ICC. Other vacancies shall be filled by the respective nominating party. Proceedings shall continue from the stage they were at when the vacancy occurred.

If one of the parties refuses or otherwise fails to appoint an arbitrator within 30 days of the date the other party appoints its, the first appointed arbitrator shall be the sole arbitrator, provided that the arbitrator was validly and properly appointed.

The English language version of this Agreement prevails over any other language version.

## **HONG KONG AND MACAU**

**Governing Law:** *The following replaces "laws of the country in which you acquired the Machine" in the first sentence:*  
laws of Hong Kong Special Administrative Region.

## **INDIA**

**Limitation of Liability:** *The following replaces items 1 and 2 of this Section:*

1. liability for bodily injury (including death) or damage to real property and tangible personal property will be limited to that caused by IBM's negligence;
2. as to any other actual damage arising in any situation involving nonperformance by IBM pursuant to, or in any way related to the subject of this Statement of Limited Warranty, IBM's liability will be limited to the charge paid by you for the individual Machine that is the subject of the claim.

## **JAPAN**

**Governing Law:** *The following sentence is added to this Section:*  
Any doubts concerning this Agreement will be initially resolved between us in good faith and in accordance with the principle of mutual trust.

## **NEW ZEALAND**

**The IBM Warranty for Machines:** *The following paragraph is added to this Section:*  
The warranties specified in this Section are in addition to any rights you may have under the Consumer Guarantees Act 1993 or other legislation which cannot be excluded or limited. The Consumer Guarantees Act 1993 will not apply in respect of any goods which IBM provides, if you require the goods for the purposes of a business as defined in that Act.

**Limitation of Liability:** *The following is added to this Section:*

Where Machines are not acquired for the purposes of a business as defined in the Consumer Guarantees Act 1993, the limitations in this Section are subject to the limitations in that Act.

## **PEOPLE'S REPUBLIC OF CHINA (PRC)**

**Governing Law:** *The following replaces this Section:*  
Both you and IBM consent to the application of the laws of the State of New York

(except when local law requires otherwise) to govern, interpret, and enforce all your and IBM's rights, duties, and obligations arising from, or relating in any manner to, the subject matter of this Agreement, without regard to conflict of law principles.

Any disputes arising from or in connection with this Agreement will first be resolved by friendly negotiations, failing which either of us has the right to submit the dispute to the China International Economic and Trade Arbitration Commission in Beijing, the PRC, for arbitration in accordance with its arbitration rules in force at the time. The arbitration tribunal will consist of three arbitrators. The language to be used therein will be English and Chinese. An arbitral award will be final and binding on all the parties, and will be enforceable under the Convention on the Recognition and Enforcement of Foreign Arbitral Awards (1958).

The arbitration fee will be borne by the losing party unless otherwise determined by the arbitral award.

During the course of arbitration, this Agreement will continue to be performed except for the part which the parties are disputing and which is undergoing arbitration.

### **EUROPE, MIDDLE EAST, AFRICA (EMEA)**

#### ***THE FOLLOWING TERMS APPLY TO ALL EMEA COUNTRIES:***

The terms of this Statement of Limited Warranty apply to Machines purchased from IBM or an IBM reseller.

#### **Warranty Service:**

If you purchase an IBM Machine in Austria, Belgium, Denmark, Estonia, Finland, France, Germany, Greece, Iceland, Ireland, Italy, Latvia, Lithuania, Luxembourg, Netherlands, Norway, Portugal, Spain, Sweden, Switzerland or United Kingdom, you may obtain warranty service for that Machine in any of those countries from either (1) an IBM reseller approved to perform warranty service or (2) from IBM. If you purchase an IBM Personal Computer Machine in Albania, Armenia, Belarus, Bosnia and Herzegovina, Bulgaria, Croatia, Czech Republic, Georgia, Hungary, Kazakhstan, Kirghizia, Federal Republic of Yugoslavia, Former Yugoslav Republic of Macedonia (FYROM), Moldova, Poland, Romania, Russia, Slovak Republic, Slovenia, or Ukraine, you may obtain warranty service for that Machine in any of those countries from either (1) an IBM reseller approved to perform warranty service or (2) from IBM.

If you purchase an IBM Machine in a Middle Eastern or African country, you may obtain warranty service for that Machine from the IBM entity within the country of purchase, if that IBM entity provides warranty service in that country, or from an IBM reseller, approved by IBM to perform warranty service on that Machine in that country. Warranty service in Africa is available within 50 kilometers of an IBM authorized service provider. You are responsible for transportation costs for Machines located outside 50 kilometers of an IBM authorized service provider.

#### **Governing Law:**

The applicable laws that govern, interpret and enforce rights, duties, and obligations of each of us arising from, or relating in any manner to, the subject matter of this Statement, without regard to conflict of laws principles, as well as Country-unique terms and competent court for this Statement are those of the country in which the warranty service is being provided, except that in 1) Albania, Bosnia-Herzegovina, Bulgaria, Croatia, Hungary, Former Yugoslav Republic of Macedonia, Romania, Slovakia, Slovenia, Armenia, Azerbaijan, Belarus, Georgia, Kazakhstan, Kyrgyzstan, Moldova, Russia, Tajikistan, Turkmenistan, Ukraine, and Uzbekistan, the laws of Austria apply; 2) Estonia, Latvia, and Lithuania, the laws of Finland apply; 3) Algeria, Benin, Burkina Faso, Cameroon, Cape Verde, Central African Republic, Chad, Congo,

Djibouti, Democratic Republic of Congo, Equatorial Guinea, France, Gabon, Gambia, Guinea, Guinea-Bissau, Ivory Coast, Lebanon, Mali, Mauritania, Morocco, Niger, Senegal, Togo, and Tunisia, this Agreement will be construed and the legal relations between the parties will be determined in accordance with the French laws and all disputes arising out of this Agreement or related to its violation or execution, including summary proceedings, will be settled exclusively by the Commercial Court of Paris; 4) Angola, Bahrain, Botswana, Burundi, Egypt, Eritrea, Ethiopia, Ghana, Jordan, Kenya, Kuwait, Liberia, Malawi, Malta, Mozambique, Nigeria, Oman, Pakistan, Qatar, Rwanda, Sao Tome, Saudi Arabia, Sierra Leone, Somalia, Tanzania, Uganda, United Arab Emirates, United Kingdom, West Bank/Gaza, Yemen, Zambia, and Zimbabwe, this Agreement will be governed by English Law and disputes relating to it will be submitted to the exclusive jurisdiction of the English courts; and 5) in Greece, Israel, Italy, Portugal, and Spain any legal claim arising out of this Statement will be brought before, and finally settled by, the competent court of Athens, Tel Aviv, Milan, Lisbon, and Madrid, respectively.

**THE FOLLOWING TERMS APPLY TO THE COUNTRY SPECIFIED:**

**AUSTRIA AND GERMANY**

**The IBM Warranty for Machines:** *The following replaces the first sentence of the first paragraph of this Section:*

The warranty for an IBM Machine covers the functionality of the Machine for its normal use and the Machine's conformity to its Specifications.

*The following paragraphs are added to this Section:*

The minimum warranty period for Machines is six months. In case IBM or your reseller is unable to repair an IBM Machine, you can alternatively ask for a partial refund as far as justified by the reduced value of the unrepaired Machine or ask for a cancellation of the respective agreement for such Machine and get your money refunded.

**Extent of Warranty:** *The second paragraph does not apply.*

**Warranty Service:** *The following is added to this Section:*

During the warranty period, transportation for delivery of the failing Machine to IBM will be at IBM's expense.

**Limitation of Liability:** *The following paragraph is added to this Section:*

The limitations and exclusions specified in the Statement of Limited Warranty will not apply to damages caused by IBM with fraud or gross negligence and for express warranty.

*The following sentence is added to the end of item 2:*

IBM's liability under this item is limited to the violation of essential contractual terms in cases of ordinary negligence.

**EGYPT**

**Limitation of Liability:** *The following replaces item 2 in this Section:*

as to any other actual direct damages, IBM's liability will be limited to the total amount you paid for the Machine that is the subject of the claim. For purposes of this item, the term "Machine" includes Machine Code and Licensed Internal Code.

*Applicability of suppliers and resellers (unchanged).*

**FRANCE**

**Limitation of Liability:** *The following replaces the second sentence of the first paragraph of this Section:*

In such instances, regardless of the basis on which you are entitled to claim damages from IBM, IBM is liable for no more than: *(items 1 and 2 unchanged)*.

## IRELAND

**Extent of Warranty:** *The following is added to this Section:*

Except as expressly provided in these terms and conditions, all statutory conditions, including all warranties implied, but without prejudice to the generality of the foregoing all warranties implied by the Sale of Goods Act 1893 or the Sale of Goods and Supply of Services Act 1980 are hereby excluded.

**Limitation of Liability:** *The following replaces items one and two of the first paragraph of this Section:*

1. death or personal injury or physical damage to your real property solely caused by IBM's negligence; and
2. the amount of any other actual direct damages, up to 125 percent of the charges (if recurring, the 12 months' charges apply) for the Machine that is the subject of the claim or which otherwise gives rise to the claim.

*Applicability of suppliers and resellers (unchanged).*

*The following paragraph is added at the end of this Section:*

IBM's entire liability and your sole remedy, whether in contract or in tort, in respect of any default shall be limited to damages.

## ITALY

**Limitation of Liability:** *The following replaces the second sentence in the first paragraph:*

In each such instance unless otherwise provided by mandatory law, IBM is liable for no more than:

1. *(unchanged)*
2. as to any other actual damage arising in all situations involving nonperformance by IBM pursuant to, or in any way related to the subject matter of this Statement of Warranty, IBM's liability, will be limited to the total amount you paid for the Machine that is the subject of the claim.

*Applicability of suppliers and resellers (unchanged).*

*The following replaces the third paragraph of this Section:*

Unless otherwise provided by mandatory law, IBM and your reseller are not liable for any of the following: *(items 1 and 2 unchanged)* 3) indirect damages, even if IBM or your reseller is informed of their possibility.

## SOUTH AFRICA, NAMIBIA, BOTSWANA, LESOTHO AND SWAZILAND

**Limitation of Liability:** *The following is added to this Section:*

IBM's entire liability to you for actual damages arising in all situations involving nonperformance by IBM in respect of the subject matter of this Statement of Warranty will be limited to the charge paid by you for the individual Machine that is the subject of your claim from IBM.

## UNITED KINGDOM

**Limitation of Liability:** *The following replaces items 1 and 2 of the first paragraph of this Section:*

1. death or personal injury or physical damage to your real property solely caused by IBM's negligence;
2. the amount of any other actual direct damages or loss, up to 125 percent of the charges (if recurring, the 12 months' charges apply) for the Machine that is the subject of the claim or which otherwise gives rise to the claim;

*The following item is added to this paragraph:*

3. breach of IBM's obligations implied by Section 12 of the Sale of Goods Act 1979 or Section 2 of the Supply of Goods and Services Act 1982.

*Applicability of suppliers and resellers (unchanged).*

*The following is added to the end of this Section:*

IBM's entire liability and your sole remedy, whether in contract or in tort, in respect of any default shall be limited to damages.

---

## Notices

This publication was developed for products and services offered in the U.S.A.

IBM may not offer the products, services, or features discussed in this document in other countries. Consult your local IBM representative for information on the products and services currently available in your area. Any reference to an IBM product, program, or service is not intended to state or imply that only that IBM product, program, or service may be used. Any functionally equivalent product, program, or service that does not infringe any IBM intellectual property right may be used instead. However, it is the user's responsibility to evaluate and verify the operation of any non-IBM product, program, or service.

IBM may have patents or pending patent applications covering subject matter described in this document. The furnishing of this document does not give you any license to these patents. You can send license inquiries, in writing, to:

*IBM Director of Licensing  
IBM Corporation  
North Castle Drive  
Armonk, NY 10504-1785  
U.S.A.*

INTERNATIONAL BUSINESS MACHINES CORPORATION PROVIDES THIS PUBLICATION "AS IS" WITHOUT WARRANTY OF ANY KIND, EITHER EXPRESS OR IMPLIED, INCLUDING, BUT NOT LIMITED TO, THE IMPLIED WARRANTIES OF NON-INFRINGEMENT, MERCHANTABILITY OR FITNESS FOR A PARTICULAR PURPOSE. Some states do not allow disclaimer of express or implied warranties in certain transactions, therefore, this statement may not apply to you.

This information could include technical inaccuracies or typographical errors. Changes are periodically made to the information herein; these changes will be incorporated in new editions of the publication. IBM may make improvements and/or changes in the product(s) and/or the program(s) described in this publication at any time without notice.

Any references in this publication to non-IBM Web sites are provided for convenience only and do not in any manner serve as an endorsement of those Web sites. The materials at those Web sites are not part of the materials for this IBM product, and use of those Web sites is at your own risk.

IBM may use or distribute any of the information you supply in any way it believes appropriate without incurring any obligation to you.

## Edition notice

© COPYRIGHT INTERNATIONAL BUSINESS MACHINES CORPORATION, 2001.  
All rights reserved.

Note to U.S. Government Users — Documentation related to restricted rights — Use, duplication or disclosure is subject to restrictions set forth in GSA ADP Schedule Contract with IBM Corp.

## Processing date data

This IBM hardware product and IBM software products that might be packaged with it have been designed, when used in accordance with their associated documentation, to process date data correctly within and between the 20th and 21st centuries, provided all other products (for example, software, hardware, and firmware) used with these products properly exchange accurate date data with them.

IBM cannot take responsibility for the date data processing capabilities of non-IBM products, even if those products are preinstalled or otherwise distributed by IBM. You should contact the vendors responsible for those products directly to determine the capabilities of their products and update them if needed. This IBM hardware product cannot prevent errors that might occur if software, upgrades, or peripheral devices you use or exchange data with do not process date data correctly.

The foregoing is a Year 2000 Readiness Disclosure.

## Trademarks

The following terms are trademarks of the IBM Corporation in the United States, other countries, or both:

xSeries	Predictive Failure Analysis
EtherJet	ServerProven
HelpCenter	TechConnect
HelpWare	IBM
the e-business logo	

Lotus and Domino are trademarks of Lotus Development Corporation in the United States, other countries, or both.

Tivoli and NetView are trademarks of Tivoli Systems Inc. in the United States, other countries, or both. Intel, MMX, LANDesk, Pentium, Pentium II Xeon, and Pentium III Xeon are trademarks of Intel Corporation in the United States, other countries, or both.

Microsoft, Windows, and Windows NT are trademarks of Microsoft Corporation in the United States, other countries, or both. UNIX is a registered trademark of The Open Group in the United States and other countries.

Intel, MMX, LANDesk, Itanium, Pentium, Pentium II Xeon, and Pentium III Xeon are trademarks of Intel Corporation in the United States, other countries, or both.

Java and all Java-based trademarks and logos are trademarks or registered trademarks of Sun Microsystems, Inc. in the United States, other countries, or both. Other company, product, and service names may be trademarks or service marks of others.

## Important notes

Processor speeds indicate the internal clock speed of the microprocessor; other factors also affect application performance.

When referring to hard disk drive capacity, MB stands for 1 000 000 bytes and GB stands for 1 000 000 000 bytes. Total user-accessible capacity may vary depending on operating environments.

Maximum internal hard disk drive capacities assume the replacement of any standard hard disk drives and population of all hard disk drive bays with the largest currently supported drives available from IBM.

Unless otherwise stated, IBM makes no representations or warranties with respect to non-IBM products. Support (if any) for the non-IBM products is provided by the third party, not IBM.

Some software may differ from its retail version (if available), and may not include user manuals or all program functionality.

---

## Electronic emission notices

### Federal Communications Commission (FCC) Statement

**Note:** This equipment has been tested and found to comply with the limits for a Class A digital device, pursuant to Part 15 of the FCC Rules. These limits are designed to provide reasonable protection against harmful interference when the equipment is operated in a commercial environment. This equipment generates, uses, and can radiate radio frequency energy and, if not installed and used in accordance with the instruction manual, may cause harmful interference to radio communications. Operation of this equipment in a residential area is likely to cause harmful interference, in which case the user will be required to correct the interference at his own expense.

Properly shielded and grounded cables and connectors must be used in order to meet FCC emission limits. IBM is not responsible for any radio or television interference caused by using other than recommended cables and connectors or by unauthorized changes or modifications to this equipment. Unauthorized changes or modifications could void the user's authority to operate the equipment.

This device complies with Part 15 of the FCC Rules. Operation is subject to the following two conditions: (1) this device may not cause harmful interference, and (2) this device must accept any interference received, including interference that may cause undesired operation.

### Industry Canada Class A emission compliance statement

This Class A digital apparatus complies with Canadian ICES-003.

### Avis de conformité à la réglementation d'Industrie Canada

Cet appareil numérique de classe A est conforme à la norme NMB-003 du Canada.

## Australia and New Zealand Class A statement

Attention: This is a Class A product. In a domestic environment this product may cause radio interference in which case the user may be required to take adequate measures.

## United Kingdom telecommunications safety requirement

### Notice to Customers

This apparatus is approved under approval number NS/G/1234/J/100003 for indirect connection to public telecommunication systems in the United Kingdom.

## European Union EMC Directive conformance statement

This product is in conformity with the protection requirements of EU Council Directive 89/336/EEC on the approximation of the laws of the Member States relating to electromagnetic compatibility. IBM cannot accept responsibility for any failure to satisfy the protection requirements resulting from a nonrecommended modification of the product, including the fitting of non-IBM option cards.

This product has been tested and found to comply with the limits for Class A Information Technology Equipment according to CISPR 22/European Standard EN 55022. The Limits for Class A equipment were derived for commercial and industrial environments to provide reasonable protection against interference with licensed communication equipment.

**Attention:** This is a Class A product. In a domestic environment this product may cause radio interference in which case the user may be required to take adequate measures.

## Taiwan electrical emission statement

警告使用者：  
這是甲類的資訊產品，在  
居住的環境中使用時，可  
能會造成射頻干擾，在這  
種情況下，使用者會被要  
求採取某些適當的對策。

## Japanese Voluntary Control Council for Interference (VCCI) statement

この装置は、情報処理装置等電波障害自主規制協議会（VCCI）の基準に基づくクラスA情報技術装置です。この装置を家庭環境で使用すると電波妨害を引き起こすことがあります。この場合には使用者が適切な対策を講ずるよう要求されることがあります。



## Power cords

For your safety, IBM provides a power cord with a grounded attachment plug to use with this IBM product. To avoid electrical shock, always use the power cord and plug with a properly grounded outlet. IBM power cords used in the United States and Canada are listed by Underwriter's Laboratories (UL) and certified by the Canadian Standards Association (CSA).

For units intended to be operated at 115 volts: Use a UL-listed and CSA-certified cord set consisting of a minimum 14 AWG, Type SJT, three-conductor cord, a maximum of 15 feet in length and a parallel blade, grounding-type attachment plug rated 20 amperes, 125 volts. For units intended to be operated at 230 volts (U.S. use): Use a UL-listed and CSA-certified cord set consisting of a minimum 14 AWG, Type SJT, three-conductor cord, a maximum of 15 feet in length and a tandem blade, grounding-type attachment plug rated 15 amperes, 250 volts.

For units intended to be operated at 230 volts (outside the U.S.): Use a cord set with a grounding-type attachment plug. The cord set should have the appropriate safety approvals for the country in which the equipment will be installed.

IBM power cord part number	Used in these countries and regions
24P6887	Antigua, Aruba, Bahamas, Barbados, Belize, Bermuda, Bolivia, Brazil, Caicos Island, Canada, Cayman Islands, Costa Rica, Columbia, Dominican Republic, Guam, Ecuador, El Salvador, Guatemala, Haiti, Honduras, Jamaica, Japan, Mexico, Netherlands Antilliles, Nicaragua, Panama, Peru, Phillipines, Saudi Arabia, Thailand, Taiwan, United States, Venezuela
12J5120	Antigua, Aruba, Bahamas, Barbados, Belize, Bermuda, Bolivia, Brazil, Caicos Island, Canada, Cayman Islands, Costa Rica, Columbia, Dominican Republic, Guam, Ecuador, El Salvador, Guatemala, Haiti, Honduras, Jamaica, Japan, Mexico, Netherlands Antilliles, Nicaragua, Panama, Peru, Phillipines, Taiwan, United States, Venezuela
55H6643	Afghanistan, Albania, Algeria, Andorra, Angola, Armenia, Austria, Azerbaidjan, Belarus, Benin, Belgium, Bosnia, Burkina Faso, Burundi, Cameroon, Cambodia, Cape Verde, Central African Republic, Chad, Congo (Republic of), Comoros, Congo (Democratic Republic of), Cote D'Ivoire (Ivory Coast), Croatia, Czech Rep, Dahomey, Djibouti, Equatorial Guinea, Eqypt, Eritrea, Estonia, Ethiopia, Finland, France, French Guyana, French Polynesia, Gabon, Georgia, Germany, Greece, Guadeloupe, Guinea, Guinea Bissau, Hungary, Iceland, Indonesia, Iran, Kazakhstan, Korea (South), Kyrgyzstan, Laos, Latvia, Lebanaon, Lithuania, Luxemborg, Macedonia, Madagascar, Mali, Martinique, Mauritania, Mauritius, Mayotte, Moldavia, Monaco, Mongolia, Morocco, Mozambique, Netherlands, New Caledonia, Niger, Nigeria, Norway, Poland, Portugal, Reunion, Romania, Russia, Rwanda, Sao Tome, Saudi Arabia, Senegal, Serbia, Slovakia, Solvenia, Somalia, Spain, Suriname, Sweden, Syria, Tajikistan, Togo, Tunisia, Turkey, Turkmenistan, Ukraine, Upper Volta, USSR (C.I.S.), Uzbekistan, Vanuatu, Vietnam, Wallia and Futuna, Yugoslavia, Zaire
36L8822	Denmark, Lichtenstein, Switzerland
12J5122	Israel
12J5126	Chile, Italy, Libya

<b>IBM power cord part number</b>	<b>Used in these countries and regions</b>
12J5124	Bangladesh, India, Lesotho, Maldives, Namibia, Nepal, Pakistan, Samoa, South Africa, Sri Lanka, Swaziland, Uganda
12J5987	Bahrain, Brunei, Botswana, Channel Islands, Cyprus, Dominica, Gambia, Ghana, Grenada, Guyana, Hong Kong, Iraq, Ireland, Jordan, Kenya, Kuwait, Liberia, Malawi, Malaysia, Malta, Myanmar (Burma), Nigeria, Oman, Qatar, Seychelles, Saint Kitts & Nevis, Saint Lucia, Saint Vincent and the Grenadines, Sierra Leone, Singapore, Sudan, Tanzania, Trinidad & Tobago, United Arab Emirate (Dubai), United Kingdom, Yemen, Zambia, Zimbabwe
12J5128	Australia, Fiji, New Zealand, Papua New Guinea
01K9851	China
36L8884	Argentina, Paraguay, Uruguay

# Index

## A

- adapter
  - compatibility 46
  - installing 46
- administrator password 22
- advanced setup 19
- AMIDiagnostic program 57
- assistance, technical 76
- auxiliary-device (pointing device) port 50

## B

- baseboard management controller (BMC) 5
- battery replacement 75
- BIOS Setup Utility
  - main menu 18
- boot manager 24

## C

- CD-ROM
  - drive specifications 2
  - problems 70
- chassis bridge controller (CBC) 5
- Class A electronic emission notice 89
- configuring
  - your server 17
- connector and port locations 49
- connectors
  - auxiliary-device (pointing device) 50
  - keyboard 50
  - mouse 50
  - parallel 51
  - SCSI 53
  - serial 52
  - universal serial bus (USB) 52
  - video 49
- cords, power 91
- customer support and service 76

## D

- diagnostic
  - codes 62
  - programs, starting 57
  - tools 55
- DIMMs
  - specifications 2
  - supported 2
- diskette drive
  - problem 70
  - specifications 2
- display
  - problem 71

## E

- electrical input 2
- electronic emission Class A notice 89
- emission requirements
  - electronic emission Class A notice 89
  - FCC Class A notice 89
- environment 2
- error codes, diagnostic
  - ACPI errors 69
  - ATAPI removables errors 65
  - IDE CD errors 65
  - IDE DVD errors 65
  - keyboard errors 66
  - memory errors 63
  - parallel port errors 68
  - PS/2 mouse errors 69
  - SCSI errors 66
  - SCSI port errors 68
  - system errors 62
  - USB errors 67
  - video errors 67
- Ethernet
  - troubleshooting information 73
- expansion enclosure
  - problem 70
- Extensible Firmware Interface (EFI)
  - boot manager 24
  - shell 25

## F

- fan failure light 7
- fans, replacing 41
- FCC Class A notice 89
- features
  - server 2
- features and specifications 2
- firmware update utility 26

## H

- handling static-sensitive devices 33
- hard disk drive failure light 7
- hard disk drive, installing 43
- hardware
  - problems 55
- hardware problems 55
- heat output 2
- help by telephone 77
- help information 76
- hot-plug PCI status lights 9
- hot-swap controller (HSC) 5
- hot-swap power supply, replacing 44

## I

- I/O connectors 49
- important notes 89
- indicator lights 7
- initialization button 7
- installing
  - adapters 46
  - battery 75
  - options 31
- integrated functions 2
- intelligent chassis management bus (ICMBC) 5

## K

- keyboard
  - connector 50
  - problem 71
- keyboard port 50

## L

- LEDs
  - front view 7
  - rear view 9

## M

- memory
  - error message 12
  - specifications 2
- microprocessor
  - specifications 2
- monitor
  - problem 71
- mouse
  - port 50
  - problem 71

## N

- network connection
  - problems 73
- notices
  - electronic emission, Class A 89
  - FCC, Class A 89
  - miscellaneous 89
  - product 89
  - trademarks 88

## O

- operator information panel 7
- option
  - installing 31

- problem 72

## P

- parrallel port 51
- PCI adapter, replacing 46
- pointing device
  - connector 50
  - problem 71
- port
  - auxiliary-device 50
  - keyboard 50
  - parallel 51
  - SCSI 53
  - serial 52
  - USB 52
  - video 49
- POST (power-on self-test) 57
- power
  - cords 91
  - problem 72
  - supply specifications 2
- power control button 7
- power distribution unit (PDU) 11
- power failure light 7
- power supply, replacing 44
- problem
  - CD-ROM 70
  - diskette drive 70
  - hardware 55
  - intermittent 70
  - keyboard or mouse 71
  - monitor 71
  - network connection 73
  - option 72
  - power 72
  - serial port 72
  - software 73
  - USB port 73
- problem solving 55
- product
  - notices 89

## Q

- QLogic SCSI utility 26

## R

- RAS features 6
- reset button 7

## S

- Safety iii, 34
- Safety information 34
- SCSI port 53

- SELview Utility 26
- serial
  - devices, problems 72
  - port or connector 52
- serial port 52
- server management configuration utility (SMConfig) 27
- service summary 76
- software
  - problem 73
- standby mode 13
- support services 76
- system
  - management 5
- system power light 7

## T

- trademarks 88
- troubleshooting 55
  - Ethernet 73
- troubleshooting charts 70

## U

- United States electronic emission Class A notice 89
- United States FCC Class A notice 89
- universal serial bus (USB) ports 52
- USB port
  - problem 73
- user password 22
- utilities
  - BIOS Setup 18
  - EFI boot manager 24
  - EFI shell 25
  - firmware update 26
  - SELview 26
  - server management configuration 27

## V

- video port 49





# IBM

Part Number: 06P4913

Printed in the United States of America.

06P4913

