

**Note**

Before using this information and the product it supports, be sure to read the general information under "Notice" on page H-5.

## **Fifth Edition (October 1996)**

**The following paragraph does not apply to the United Kingdom or any country where such provisions are inconsistent with local law:** INTERNATIONAL BUSINESS MACHINES CORPORATION PROVIDES THIS PUBLICATION "AS IS" WITHOUT WARRANTY OF ANY KIND, EITHER EXPRESS OR IMPLIED, INCLUDING, BUT NOT LIMITED TO, THE IMPLIED WARRANTIES OF MERCHANTABILITY OR FITNESS FOR A PARTICULAR PURPOSE. Some states do not allow disclaimer of express or implied warranties in certain transactions, therefore, this statement may not apply to you.

This publication could include technical inaccuracies or typographical errors. Changes are periodically made to the information herein; these changes will be incorporated in new editions of the publication. IBM may make improvements and/or changes in the product(s) and/or the program(s) described in this publication at any time.

It is possible that this publication may contain reference to, or information about, IBM products (machines and programs), programming, or services that are not announced in your country. Such references or information must not be construed to mean that IBM intends to announce such IBM products, programming, or services in your country.

Requests for technical information about IBM products should be made to your IBM Authorized Dealer or your IBM Marketing Representative.

A form for readers' comments appears at the back of this publication. If the form has been removed, address your comments to:

Department CCF  
Design & Information Development  
IBM Corporation  
P.O. Box 12195  
RESEARCH TRIANGLE PARK, NC 27709-9990  
USA

When you send information to IBM, you grant IBM a nonexclusive right to use or distribute the information in any way it believes appropriate without incurring any obligation to you.

**© Copyright International Business Machines Corporation 1992,1996. All rights reserved.**

Note to U.S. Government Users — Documentation related to restricted rights — Use, duplication or disclosure is subject to restrictions set forth in GSA ADP Schedule Contract with IBM Corp.

# Contents

IBM License Agreement for Productivity Aids . . . . .	iv
NetWare Network Computing Products from IBM . . . . .	vii
PROTECTION AND SECURITY . . . . .	viii
<b>Safety Information . . . . .</b>	<b>xi</b>
<b>Chapter 1. Introduction . . . . .</b>	<b>1-1</b>
<b>Chapter 2. Installation Procedure . . . . .</b>	<b>2-1</b>
<b>Chapter 3. Overview of the PC Card Environment . . . . .</b>	<b>3-1</b>
Overview of Point Enablers, Socket Services, Card Services, and Super Client Drivers . . . . .	3-1
<b>Chapter 4. Package Contents and System Requirements . . . . .</b>	<b>4-1</b>
Cabling Requirements . . . . .	4-1
Hardware Requirements for the EtherJet PC Card . . . . .	4-3
Hardware Requirements for IBM LAN Client . . . . .	4-4
Software Requirements for the EtherJet PC Card . . . . .	4-4
Software Requirements for IBM LAN Client . . . . .	4-4
<b>Chapter 5. Inserting and Removing the PC Card . . . . .</b>	<b>5-1</b>
<b>Chapter 6. Installing the Software—LANAID and IBM LAN Client . . . . .</b>	<b>6-1</b>
About LANAID . . . . .	6-1
About IBM LAN Client . . . . .	6-2
<b>Chapter 7. Installing the Device Drivers for Your Network Environment . . . . .</b>	<b>7-1</b>
<b>Appendix A. EtherJet Point Enabler (POINTJET.EXE) . . . . .</b>	<b>A-1</b>
Point Enabler Messages . . . . .	A-2
<b>Appendix B. EtherJet Card Services Enabler . . . . .</b>	<b>B-1</b>
Card Services Enabler Messages . . . . .	B-2



<b>Appendix C. Problem Determination</b> . . . . .	C-1
Common Errors . . . . .	C-2
The LEDs . . . . .	C-4
NDIS Error Codes . . . . .	C-6
ODI Messages . . . . .	C-14
Point Enabler Messages . . . . .	C-22
<b>Appendix D. Using a Memory Manager in DOS</b> . . . . .	D-1
Memory Managers with a Point Enabler . . . . .	D-1
Memory Managers with Card and Socket Services . . . . .	D-2
Expanded Memory Specification . . . . .	D-4
<b>Appendix E. Desktop Management Interface</b> . . . . .	E-1
<b>Appendix F. Help and Service Information</b> . . . . .	F-1
Step 1: Preparing for the Call . . . . .	F-1
Step 2: Placing the Call to IBM . . . . .	F-1
<b>Appendix G. Parts Information</b> . . . . .	G-1
<b>Appendix H. Product Warranty and Notices</b> . . . . .	H-1
Product Warranty . . . . .	H-1
Notice . . . . .	H-5
Notice to Users in the United Kingdom . . . . .	H-5
Electronic Emission Notices . . . . .	H-5
Trademarks . . . . .	H-8
<b>Appendix I. List of Abbreviations</b> . . . . .	I-1
<b>Index</b> . . . . .	X-1

---

## IBM License Agreement for Productivity Aids

IF YOU DOWNLOAD OR USE THIS PROGRAM YOU AGREE TO THESE TERMS.

International Business Machines Corporation grants you a license to use the Program only in the country where you acquired it and only for use with IBM Networking Products (IBM networking interface cards made Generally Available by IBM). The Program is copyrighted

and licensed (not sold). We do not transfer title to the Program to you. You obtain no rights other than those granted you under this license.

Under this license, you may:

1. use the Program on one or more machines at a time;
2. make copies of the Program for use or backup purposes within your Enterprise;
3. modify the Program and merge it into another program; and make copies of the original file you downloaded and distribute it, provided that you transfer a copy of this license to the other party. The other party agrees to these terms by its first use of the Program.

You must reproduce the copyright notice and any other legend of ownership on each copy or partial copy, of the Program.

You may NOT:

1. distribute the Program over electronic networks (except internally), or by means of electronic "bulletin boards".
2. sublicense, rent, lease, or assign the Program.
3. reverse assemble, reverse compile, or otherwise translate the Program.

We do not warrant that the Program is free from claims by a third party of copyright, patent, trademark, trade secret, or any other intellectual property infringement.

Under no circumstances are we liable for any of the following:

1. third-party claims against you for losses or damages;
2. loss of, or damage to, your records or data;
3. economic consequential damages (including lost profits or savings) or incidental damages, even if we are informed of their possibility.



Some jurisdictions do not allow these limitations or exclusions, so they may not apply to you.

We do not warrant uninterrupted or error free operation of the Program. We have no obligation to provide service, defect correction, or any maintenance for the Program. We have no obligation to supply any Program updates or enhancements to you even if such are or later become available.

**IF YOU DOWNLOAD OR USE THIS PROGRAM YOU AGREE TO THESE TERMS.**

THERE ARE NO WARRANTIES, EXPRESS OR IMPLIED, INCLUDING THE IMPLIED WARRANTIES OF MERCHANTABILITY AND FITNESS FOR A PARTICULAR PURPOSE.

Some jurisdictions do not allow the exclusion of implied warranties, so the above exclusion may not apply to you.

You may terminate this license at any time. We may terminate this license if you fail to comply with any of its terms. In either event, you must destroy all your copies of the Program.

You are responsible for the payment of any taxes resulting from this license.

You may not sell, transfer, assign, or subcontract any of your rights or obligations under this license. Any attempt to do so is void.

Neither of us may bring a legal action more than two years after the cause of action arose.

If you acquired the Program in the United States, this license is governed by the laws of the State of New York. If you acquired the Program in Canada, this license is governed by the laws of the Province of Ontario. Otherwise, this license is governed by the laws of the country in which you acquired the Program.



---

## **NetWare Network Computing Products from IBM**

The following additional license terms apply to the Novell NetWare Client 32 for DOS/Windows 3.1 code, included with IBM's LAN Client program. In the event of any inconsistency between the following terms and the terms of the IBM License Agreement for Productivity Aids, the following terms shall prevail.

**IF YOU DOWNLOAD OR USE THIS PROGRAM YOU AGREE TO THESE TERMS.**

The IBM program you have licensed may be designed to run in a single computer system only, or it may contain modules designed to run in multiple computer system environments. The type of environment that applies is limited by the definitions that follow:

**SINGLE USER PROGRAM** means a program which operates on an intelligent single-user device by which the device acts as a standalone system or a peer system on a Communications Network

**COMMUNICATIONS NETWORK** means a computer system which allows a number of independent computing devices to communicate with each other

**NETWORK HOST OR NETWORK SERVER** means a single machine on which a Host program or NLM or VAP operates to provide the host or server resources to the other machines in a network

**HOST PROGRAM** means that portion of the NetWare network operating system that executes on the Network Host or Network Server

**CLIENT PROGRAM** means that portion of the NetWare network operating system that executes on the personal workstation

**NLM PROGRAM OR VAP PROGRAM** means an application program that executes under control of the NetWare network operating system on the Network Host or Network Server



DOCUMENTATION means the manual(s) and other printed material packaged by IBM with the Program

If you have licensed a Host Program, an NLM Program or a VAP Program, and/or Client Program, you are authorized to 1) use one copy of the Host Program on a single Network Host or Network Server; 2) use a single copy of an NLM Program or a VAP Program on a single Network Host or Network Server; and 3) use the Client Program, and to, without additional charge, reproduce and use copies, subject to the limitation identified in the Program Documentation, of the Client Program, in support of the Host Program

---

## **PROTECTION AND SECURITY**

You must label, when recorded on portable media, Additional License Copies, Client Program Copies, copies made from them, and their documentation with the Program number, the copyright wording, and the copyright year as shown on the Program or documentation. The label of an Additional License Copy, a Client Program Copy, or a copy made from it must also include the words:

Licensed Material - Property of IBM

IBM retains title to this copy and to any copy made from it.

You may not transfer possession of this copy to any third party.

The label on documentation must also include the words:

Reprinted by permission of IBM.











## Safety Information

 **Danger:** Before you begin to install this product, read the safety information in *Caution: Safety Information—Read This First*, SD21-0030-02. This booklet describes safe procedures for cabling and plugging in electrical equipment.

 **Varning — livsfara:** Innan du börjar installera den här produkten bör du läsa säkerhetsinformationen i dokumentet *Varning: Säkerhetsföreskrifter—Läs detta först*, SD21-0030-02. Där beskrivs hur du på ett säkert sätt ansluter elektrisk utrustning.

 **Fare:** Før du begynner å installere dette produktet, må du lese sikkerhetsinformasjonen i *Advarsel: Sikkerhetsinformasjon — Les dette først*, SD21-0030-02 som beskriver sikkerhetsrutinene for kabling og tilkobling av elektrisk utstyr.

 **Fare!** Før du installerer dette produkt, skal du læse sikkerhedsforskrifterne i *NB: Sikkerhedsforskrifter—Læs dette først* SD21-0030-02. Vejledningen beskriver den fremgangsmåde, du skal bruge ved tilslutning af kabler og udstyr.

 **Gevaar:** Voordat u begint met de installatie van dit product, moet u eerst de veiligheidsinstructies lezen in de brochure *PAS OP! Veiligheidsinstructies—Lees dit eerst*, SD21-0030-02. Hierin wordt beschreven hoe u elektrische apparatuur op een veilige manier moet bekabelen en aansluiten.

 **Gevaar** Voordat u begint met het installeren van dit product, dient u eerst de veiligheidsrichtlijnen te lezen die zijn vermeld in de publicatie *Caution: Safety Information - Read This First*, SD21-0030-02. In dit boekje vindt u veilige procedures voor het aansluiten van elektrische apparatuur.



**Vorsicht:** Bevor mit der Installation des Produktes begonnen wird, die Sicherheitshinweise in *Achtung:*

*Sicherheitsinformationen—Bitte zuerst lesen*, IBM Form SD21-0030-02. Diese Veröffentlichung beschreibt die Sicherheitsvorkehrungen für das Verkabeln und Anschließen elektrischer Geräte.



危険： 導入作業を開始する前に、安全に関する小冊子SD21-0030 の「最初にお読みください」(Read This First)の項をお読みください。この小冊子は、電気機器の安全な配線と接続の手順について説明しています。



**Danger :** Avant d'installer le présent produit, consultez le livret *Attention : Informations pour la sécurité — Lisez-moi d'abord*, SD21-0030-02, qui décrit les procédures à respecter pour effectuer les opérations de câblage et brancher les équipements électriques en toute sécurité.



**Danger:** Avant de procéder à l'installation de ce produit, lisez d'abord les consignes de sécurité dans la brochure *ATTENTION: Consignes de sécurité—A lire au préalable*, SD21-0030-02. Cette brochure décrit les procédures pour câbler et connecter les appareils électriques en toute sécurité.



**Pericolo:** prima di iniziare l'installazione di questo prodotto, leggere le informazioni relative alla sicurezza riportate nell'opuscolo *Attenzione: Informazioni di sicurezza — Prime informazioni da leggere* in cui sono descritte le procedure per il cablaggio ed il collegamento di apparecchiature elettriche.





**Perigo:** Antes de iniciar a instalação deste produto, leia as informações de segurança *Cuidado: Informações de Segurança — Leia Primeiro*, SD21-0030-02. Este documento descreve como efectuar, de um modo seguro, as ligações eléctricas dos equipamentos.



**Peligro:** Antes de empezar a instalar este producto, lea la información de seguridad en *Atención: Información de Seguridad — Lea Esto Primero*, SD21-0030-02. Este documento describe los procedimientos de seguridad para cablear y enchufar equipos eléctricos.



**Perigo:** Antes de começar a instalar este produto, leia as informações de segurança contidas em *Cuidado: Informações Sobre Segurança—Leia Isto Primeiro*, SD21-0030-02. Esse folheto descreve procedimentos de segurança para a instalação de cabos e conexões em equipamentos eléctricos.



**VAARA:** Ennen kuin aloitat tämän tuotteen asennuksen, lue julkaisussa *Varoitus: Turvaohjeet—Lue tämä ensin*, SD21-0030-02, olevat turvaohjeet. Tässä kirjasessa on ohjeet siitä, miten sähkölaitteet kaapeloidaan ja kytketään turvallisesti.



위험: 이 제품을 설치하기 전에 반드시 "주의: 안전 정보-시작하기 전에" (SD21-0030-02)에 있는 안전 정보를 읽으십시오.



危險：安裝本產品之前，請先閱讀  
"Caution: Safety Information--Read  
This First" SD21-0030 手冊中所提  
供的安全注意事項。這本手冊將會說明  
使用電器設備的纜線及電源的安全程序。



Uwaga:  
Przed rozpoczęciem instalacji produktu należy zapoznać się z instrukcją:  
"Caution: Safety Information - Read This First", SD21-0030.  
Zawiera ona warunki bezpieczeństwa przy podłączeniu do sieci elektrycznej  
i eksploatacji.



**Upozornění:** než zahájíte instalaci tohoto produktu, přečtete si  
nejprve bezpečnostní informace v pokynech „Bezpečnostní  
informace“ č. 21-0030. Tato brožurka popisuje bezpečnostní  
opatření pro kabeláž a zapojení elektrického zařízení.



**Vigyázat:** Mielőtt megkezdi a berendezés üzembe helyezését,  
olvassa el a "Caution: Safety Information— Read This First,  
SD21-0030-02 könyvecskében leírt biztonsági információkat. Ez a  
könyv leírja, milyen biztonsági intézkedéseket kell megtenni az  
elektromos berendezés huzalozásakor illetve csatlakoztatásakor.



Pozor: Preden začnete z instalacijo tega produkta  
preberite poglavje: "Opozorilo: Informacije  
o varnem rokovanju-preberi pred uporabo,"  
SD21-0030. To poglavje opisuje pravilne  
postopke za kabliranje,



---

## Chapter 1. Introduction

The EtherJet PC Card is a credit-card-size adapter that allows users to connect to an Ethernet network via their computers. The EtherJet PC Card is designed to operate in computers that comply with the Personal Computer Memory Card International Association (PCMCIA) Release 2.1 or higher standard (including PC Card 95) and contains Type II slots.

Special features include:

- Compliance with PCMCIA Release 2.1 or higher and PC Card 95 standards
- Compliance with IEEE 802.3 standards
- PC Card speed of 10 Mbps
- Full-duplex operation
- Auto-Negotiation of full- and half-duplex modes
- Card powers down when cable is removed
- IBM LAN AID for easy installation

LAN AID is an installation tool used to configure your PC Card and install IBM LAN Client. LAN AID automatically detects a previously installed network environment and configures the card to work in that environment. If needed, LAN AID will also install one or more client systems and protocols supported by IBM LAN Client.

- IBM LAN Client to significantly reduce DOS memory use

IBM LAN Client provides programming interfaces to support network applications. It allows a client workstation to communicate with an IBM LAN Server or Novell\*\* NetWare\*\* Server. It also allows the use of TCP/IP applications and provides for NetBIOS and IEEE 802.2 application programming interfaces. IBM LAN Client has the ability to operate in 32-bit protect mode and requires as little as 2 KB of conventional memory.



- Support for a variety of network operating systems and network applications
- Compatibility with PCMCIA Card and Socket Services Release 2.0 and higher



---

## Chapter 2. Installation Procedure

Perform the following steps to prepare for and install your new EtherJet PC Card.

- **1** Read the README.1ST file on Diskette 1, Device Drivers for the most current information about the EtherJet PC Card.
- **2** Read Chapter 3, "Overview of the PC Card Environment" for information about software support for PC Cards.
- **3** Verify that you have the package contents, cables, hardware, and software listed in Chapter 4, "Package Contents and System Requirements."
- **4** If you plan to use Card and Socket Services software, Version 2.0 or higher, and it is not already installed, install it and reboot your computer. The software may be provided with your computer or operating system. See page 3-3 for a description of this software.
- **5** Install the PC Card, following the instructions under "Inserting the PC Card" on page 5-1.
- **6** Install the software.

If you want to install or are using IBM LAN Client, perform the steps in "Installing LAN AID" on page 6-3 and continue to the end of "Using LAN AID to Install IBM LAN Client."

If you want to install or are using any other network operating system, go to Chapter 7, "Installing the Device Drivers for Your Network Environment" and follow the instructions for your environment.





For future reference, store this manual with the instruction manual supplied with your computer.



---

## **Chapter 3. Overview of the PC Card Environment**

This chapter provides an overview of the hardware and software unique to the PC Card environment.

---

### **Overview of Point Enablers, Socket Services, Card Services, and Super Client Drivers**

The PC Card (formerly PCMCIA) standard defines the physical, electrical, mechanical, and software specifications for the PC Card environment.

The EtherJet PC Card slots meet PC Card 95, Type II standards. The EtherJet PC Card software operates with PCMCIA Card and Socket Services Release 2.0 or higher.

### **The PC Card and PC Card Sockets**

The PC Card environment in your computer consists of one or more PC Card sockets controlled by a socket controller.

The socket controller is the interface between the PC Card and your computer. Many computers use the Intel 82365SL socket controller or an Intel-compatible socket controller. In general, Intel-compatible socket controllers respond to software and hardware the same as the Intel 82365SL, although some incompatibilities might exist. Some computers use other types of socket controllers.

Unlike other types of adapter card sockets (ISA, Micro Channel, PCI) PC Card sockets do not automatically receive power when the computer is powered on. Instead, software running in your computer directs power to be applied to the PC Card socket at the appropriate time, usually when the PC Card is about to be used. By not continuously supplying power to the PC Card sockets, the computer conserves energy.

## Enabling PC Card Sockets

Power can be applied to the sockets through various interfaces, each having advantages and disadvantages. The main types of software that supply power or enable the socket are Card and Socket Services, point connectivity enablers, and super client drivers.

Many of the EtherJet device drivers are designed to work with Card and Socket Services. A point connectivity enabler, POINTJET.EXE, is also provided to be used with the EtherJet device drivers. See the figure at the end of this chapter.

### Super Client Drivers

Super client drivers are typically used to enable PC Card modems or storage devices and would not normally be able to support the EtherJet PC Card. Super client drivers will not normally interfere with the EtherJet PC Card or its device drivers, but if you experience problems you might try disabling any super client drivers currently active in the computer.

### Point Connectivity Enablers

These are small programs that provide an interface directly to the PC Card controller; therefore, they must be written to support a particular type of controller. A point enabler for the Intel 82365SL or Intel-compatible socket controllers is provided.

In the DOS environment only, you have the option of using this point connectivity enabler *instead* of Card and Socket Services.

The point enabler supplied with this PC Card is POINTJET.EXE. It can be used with computers that contain Intel-compatible controllers. These include the IBM ThinkPad, Toshiba 4500 and later, and many others.

**Note:** When using the point connectivity enabler, it is vitally important that you make certain that the system resources used by the PC Card are different from and do not conflict with resources in use by the system and any other PC Cards installed in your computer. See Appendix A, "EtherJet Point Enabler (POINTJET.EXE)" for more information about POINTJET.EXE.

### **Advantage**

- Enablers consume no memory — they remove themselves after configuring the PC Card.

### **Disadvantages**

- The point enabler enables only one socket. Therefore, the PC Card must always be in the specified or default socket.
- In some computers, the socket might not be switched off when the computer is in suspend mode, so the PC Card will continue to consume power.
- You must allocate memory and interrupt resources manually to ensure that no resource conflicts exist in the computer.

### **Card and Socket Services**

This is a software management interface that allows system resources (such as memory, interrupts, slots, and I/O ports) to be automatically allocated and deallocated as PC Cards are inserted and removed from the computer.

Card and Socket Services notifies client device drivers when a PC Card has been inserted or removed from the computer. If the client driver wants to use the PC Card, it can request system resources from Card and Socket Services so that the PC Card will be configured with the assigned resources.

Card Services is a software interface normally provided with your operating system. Socket Services interfaces with hardware in your computer and is normally provided with your computer. Refer to your operating system manual for information about installing Card and Socket Services. Some operating systems will require installation of a separate resource manager as well.

### **Advantages**

- Ability to insert and remove PC Cards without manual computer reconfiguration.
- Automatic allocation and deallocation of system resources.

### ***Disadvantage***

Stay-resident program that uses system memory. The amount varies according to the type of PC Card support and the drivers used.

### **Card and Socket Services versus Point Enablers**

In principle, Card and Socket Services is the better method of connection because it allows you to insert or remove PC Cards from any socket, even while the computer is switched on; it automatically allocates resources like I/O ports, interrupt levels, and sockets. Because Card and Socket Services must always be present to detect PC Card changes and adjust system resources, 30 to 40 KB of system memory is required by Card and Socket Services.

Point Enablers are popular because they remove themselves from memory after having been loaded, but the user is responsible for assigning system resources and ensuring that the system resources used do not conflict with other system settings. The PC Card can be used only in the specified slot that is point-enabled.

Card and Socket Services provides for the most flexible use of system resources, and its use is recommended if system memory is available. Note that use of Card and Socket Services is required in computers that have non-Intel-compatible socket controllers. If your applications require a lot of system memory and you do not require the flexibility that Card and Socket Services provides, then use the point enabler.

***Relationship between the Interfaces:*** The following diagram shows how the interfaces relate to each other:

### **What to do next?**

Step 2 of the Installation Procedure is now complete. Go to Chapter 4, "Package Contents and System Requirements" to continue with the next step.

## PC Card Software Configurations

---

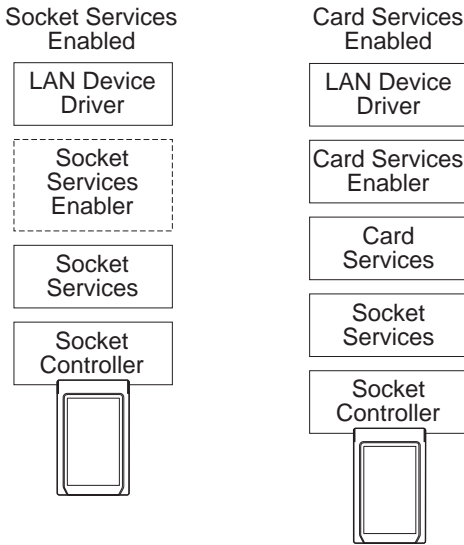
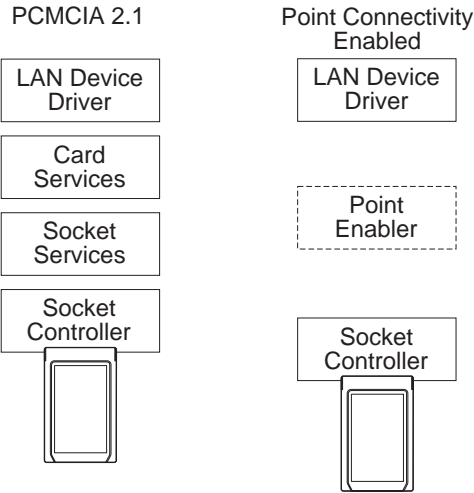



---

## Chapter 4. Package Contents and System Requirements

The PC Card kit consists of :

- An EtherJet PC Card
- A 10BASE-T cable or 10BASE-T/10BASE2 combo cable to connect to the network (see "Cabling Requirements")
- Four diskettes containing NDIS device drivers, DOS and OS/2 ODI device drivers, Novell NetWare server device drivers, the IBM LAN AID installation tool, IBM LAN Client device drivers, and a TCP/IP packet driver.
- This manual (EtherJet PC Card Installation and User's Guide)
- *Safety Information - Read This First* booklet

If any item is missing or damaged, contact your place of purchase.

---

### Cabling Requirements

In order to connect the EtherJet PC Card to your network, you will need one of the following cables (supplied in this package).

- A 10BASE-T cable

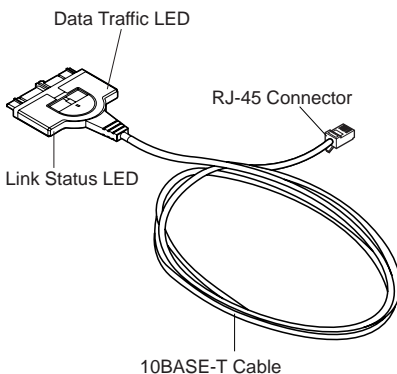



The 10BASE-T cable allows connection to 10BASE-T networks with no additional cables required. It is 3 meters (10 feet) in length and contains a friction locking mechanism.

- A 10BASE-T/10BASE2 Combo Cable

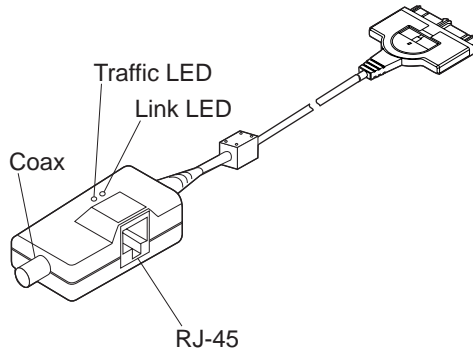

The 10BASE-T/10BASE2 combo cable allows connection to either 10BASE-T or 10BASE2 networks, is approximately 305 millimeters (12 inches) in length, and contains a friction locking mechanism.

Each network requires one of the following additional cables (not supplied in this package).

- A category 3, 4, or 5 cable with RJ-45 connectors, for use with twisted-pair (10BASE-T) cabling in your Ethernet network.

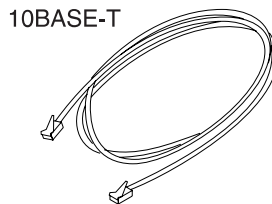

- An RG-58, standard, coaxial cable (10BASE2) with bayonet connectors (BNCs) and a BNC T-type connector with a terminator.

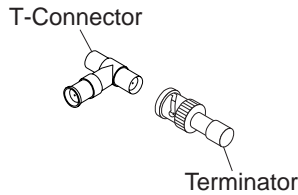
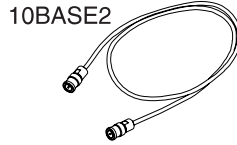

Table 4-1 provides the physical specifications for each type of network cabling. These specifications conform to the IEEE 802.3 standards.

*Table 4-1. Cable Specifications*

	<b>Cable Type</b>	<b>Segment Length (maximum)</b>	<b>Total Nodes/Segment</b>	<b>Tap Spacing</b>
Ethernet 10BASE2	Coax (50 ohm)	185 m (607 ft)	30	0.5 m (1.6 ft)
Ethernet 10BASE-T	Unshielded twisted-pair (EIA/TIA category 3)	100 m (328 ft)	256	N/A

### **Hardware Requirements for the EtherJet PC Card**

An IBM or IBM-compatible personal computer with an 80386 or higher processor and a PCMCIA Type II slot is required.

---

## Hardware Requirements for IBM LAN Client

**Note:** IBM LAN Client is described in Chapter 6, "Installing the Software—LANAID and IBM LAN Client."

- 80386 or higher processor
- Hard-disk drive with at least 3 MB of free storage
- At least 4 MB of RAM
- Connection to the network

---

## Software Requirements for the EtherJet PC Card

The EtherJet PC Card can be used in a computer equipped with a network operating system or network application that uses the Network Driver Interface (NDIS), NetWare Open Data-Link Interface (ODI), or Packet Driver Specification (PDS).

The following list shows the network environments that are compatible with the PC Cards. Verify that you have the required software for your computer's network environment.

- Novell NetWare Versions 3.12 and 4.1
- IBM LAN Server
- IBM LAN Client
- Banyan\*\* VINES\*\* (client only)
- Microsoft Windows for Workgroups, Version 3.1 and higher
- Microsoft Windows NT, Versions up through 3.51
- Microsoft Windows 95
- Microsoft LAN Manager
- Packet Driver software

---

## Software Requirements for IBM LAN Client

- A supported operating system from the following list
  - DOS 5.0 or higher
  - Windows 3.1 (enhanced mode only) with DOS 5.0 or higher
  - Windows for Workgroups 3.11 with DOS 5.0 or higher
- HIMEM.SYS memory manager

**Note:** If EMM386.EXE is in use it must be Version 4.49 or higher. EMM386.EXE is provided with your DOS operating system. To determine what level you are using, type **EMM386** at a DOS prompt. For more information about EMM386.EXE, refer to your DOS manual.

### **What to do next?**

Step 3 of the Installation Procedure is now complete. Go to Chapter 2, "Installation Procedure" on page 2-1 and continue with the next step.



---

## Chapter 5. Inserting and Removing the PC Card

### Inserting the PC Card

- 1** Insert the PC Card into the PC Card slot. If you are using a point enabler, you must place the PC Card in the slot identified by the point enabler. If you are using Card and Socket Services, any open slot is sufficient.

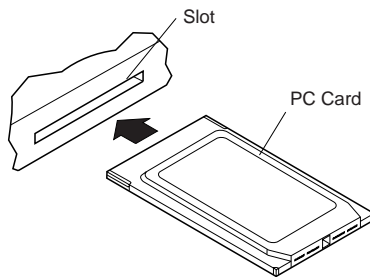

The PC Card is keyed to go in one way only. If you feel any resistance before the PC Card is fully inserted, remove the PC Card, turn it over, and reinsert it.

- 2** Connect the cable to the network as described in the following steps.

- 3** If this package contains the 10BASE-T cable and your network uses unshielded twisted-pair (UTP) cabling, attach the RJ-45 connector on the PC Card cable to the telecommunications outlet.

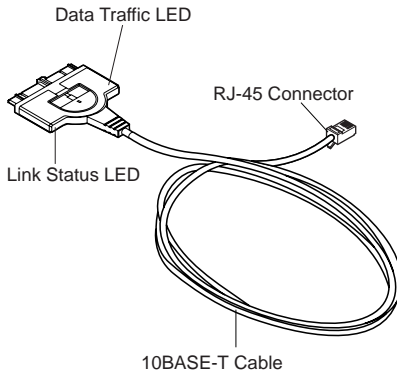

If this package contains the 10BASE-T/10BASE2 combo cable, and your network uses UTP cabling, you will need an additional Category 3, 4, or 5 cable with two RJ-45 connectors. The cable is not included in this package. Attach the end of the cable to the RJ-45 connector on the 10BASE-T/10BASE2 combo cable. Attach the other end of the cable to the RJ-45 telecommunications outlet.

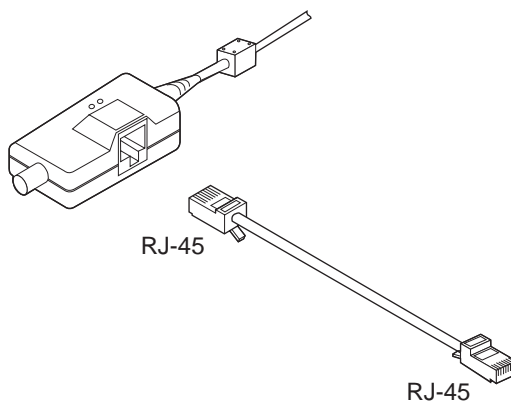

- 4** If this package contains the 10BASE-T/10BASE2 combo cable, and your network uses standard coaxial cable, you might need the following attachments: RG-58 coaxial cable with two BNCs, a terminator, and a BNC T-type connector. These are not included in this package. Attach the coaxial network cable to the BNC T-type connector. Then, attach the BNC T-type connector to the coaxial portion of the combo cable.

If this is not the end of the network segment, attach the additional RG-58 coaxial cable to the open end of the T-type connector. This is now the open end of the network.

If this is the end of the network segment, attach a 50-ohm terminator to the open end of the coaxial T-type connector.

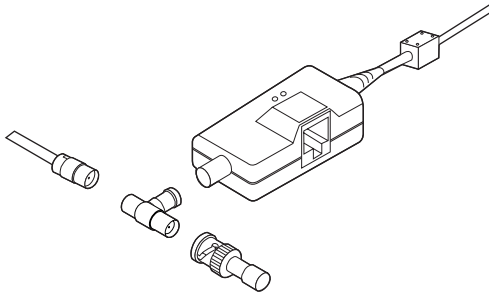

- 5** To attach the PC Card cable to the PC Card, move the latching button (the half-circle in the center of the connector) toward the cable. The cable cannot be connected or disconnected unless the latch is retracted. Attach the cable to the PC Card. The connector is keyed to attach one way only. If you feel any resistance, remove the connector, turn it over, and reattach it.



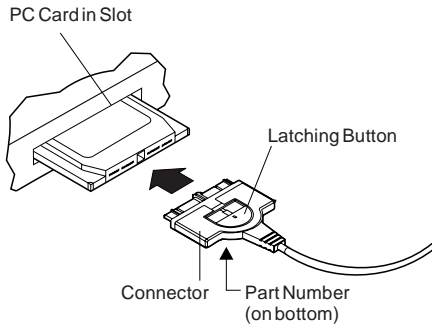

- 6** To lock the PC Card assembly securely, move the latching button toward the PC Card. In some cases, you may want to leave the PC Card cable latch retracted. If the cable is pulled, it will disconnect from the PC Card, possibly saving your computer from being pulled off a table.

**Notes:**

- a. The PC Card and the cable must be plugged into the computer as well as into the network for the drivers to successfully initialize.
- b. If you are using Card and Socket Services, the PC Card can be removed and reinserted at any time. This could affect your network operating system. Also, the cable can be removed from the PC Card while the card is still installed in the computer. This will serve the same purpose as removing the PC Card from the computer. Without the cable attached, the PC Card can be stored in the slot indefinitely without consuming power. If the cable is reattached, the card will be reinitialized by Card and Socket Services.
- c. If you are using a point enabler, and the PC Card or cable is removed after the point enabler is loaded, the PC Card should not be reinserted until the computer is switched OFF. Failure to switch OFF the computer might result in damage to your computer or your PC Card or both.

## What to do next?

Step 5 of the Installation Procedure is now complete. Return to Chapter 2, "Installation Procedure" on page 2-1 and continue with step 6.

## Removing the PC Card

- 1** Detach the cable from the PC Card.

Retract the latching button (the half-circle in the center of the connector) by moving it toward the cable.

Unplug the cable from the PC Card. The cable is still connected to the network cable.

- 2** Remove the PC Card and store it. See your computer manual.

**Note:** Without the cable attached, the PC Card can be stored in the slot indefinitely without consuming power.



---

## Chapter 6. Installing the Software—LANAID and IBM LAN Client

After you have inserted the PC Card, you must configure the PC Card software to operate with your computer and network operating system. You will need the manuals that were shipped with your network operating system.

If your computer does not have a hard disk, contact your network administrator.

---

### About LANAID

LANAID is a software tool shipped on the EtherJet PC Card diskettes. Use LANAID to configure the EtherJet PC Card to work with any of the network operating systems listed below. It will also install the IBM LAN Client network operating system.

LANAID detects the following network operating systems and configures the PC Card to work with them:

- IBM LAN Client
- DOS Novell NetWare Client-16
- OS/2 Novell NetWare Client
- Banyan VINES 6.x
- Microsoft LAN Manager
- Windows for Workgroups
- Other DOS NDIS environments
- OS/2 NDIS environments

For all other environments, you will use your network operating system to change parameters in the PC Card configuration.

## The Net Address

LANAID identifies the PC Card to be configured by its universally administered address, which was assigned at the factory. The universally administered address, or net address, of the EtherJet PC Card is shown on the back of the card. Ensure that the address shown by LANAID is the same as the address on the PC Card. It may be necessary to remove one or more PC Cards to allow LANAID to find the PC Card to be configured.

---

## About IBM LAN Client

IBM LAN Client prevents excessive consumption of DOS conventional memory in DOS-based computers by drivers and protocol stacks. The LAN drivers and protocol stacks no longer require large amounts of DOS memory below 1 MB.

In addition, IBM LAN Client provides support using one PC Card-specific LAN device driver instead of two different kinds of drivers for your clients and servers. You select the appropriate device drivers and protocol stacks for your computer. The correct modules are automatically loaded based on the options you select.

## Protocols and Clients Supported by IBM LAN Client

IBM LAN Client provides support for the following protocols and clients:

- For DOS 5.0 or higher:
  - NetWare Client-32 (IPX\*\*/SPX)
  - IEEE 802.2
  - NetBIOS
  - DOS LAN Services
- For Windows 3.1:
  - NetWare Client-32 (IPX/SPX)
  - IEEE 802.2
  - NetBIOS
  - TCP/IP
  - DOS LAN Services
- For Windows for Workgroups 3.11:

NetWare Client-32 (IPX/SPX)  
IEEE 802.2  
NetBIOS  
TCP/IP  
DOS LAN Services

## IBM LAN Client Features

- As little as 2 KB conventional memory required.
- Protocol NetWare Loadable Modules (NLM)s: these are dynamically loadable and unloadable modules that operate in 32-bit protect mode and implement the various protocol functions. Supported protocols include 802.2, IPX/SPX, TCP/IP, and NetBIOS.
- New Novell NetWare Client-32 for DOS/Windows
  - 32-bit, protect-mode client
  - Automatically reconnects an entire network environment, including open files
  - Enhanced cache (large, configurable network cache)
  - Enhanced native installation and configuration utilities.
- Provides backwards compatibility for existing DOS 802.2 and NetBIOS applications.
- Uses NET.CFG file, consistent with other products.
- Concurrent multiple frame types and protocols.
- Winsock 1.1 support for TCP/IP.

**Note:** DOS conventional memory consumption does not increase when you combine multiple protocols. The DOS LAN Services (DLS) Client can require significant amounts of DOS memory.

## Installing LANAIID

The LANAIID graphical user interface operates under DOS or in a **full-screen** DOS session of OS/2. (A DOS *window* of OS/2 will not work correctly.) You need at least 1.5 MB of free, extended memory and 300 KB of conventional memory to run the program. At a DOS prompt, enter **mem** to find out about the memory availability on your system.

LANAID options can be selected several ways. You can click with a mouse or other pointing device, or you can make selections by tabbing to your selection and pressing Enter. (If you will be using a mouse with LANAID, make sure that you have a mouse driver installed.) Push buttons can also be selected with *hot keys*. The hot keys are the letters that correspond to the underlined characters on the push button. Press **Alt** plus the hot-key letter.

You can get help on each LANAID panel by selecting the Help button at the bottom of the panel. You can get context-sensitive help by placing your mouse pointer on any part of the panel and pressing **F1**.

**1** Install LANAID on your hard disk:

At the DOS prompt, insert Diskette 2, LANAID in drive A and enter **a:install**.

**2** Type the drive, path, and directory you want to use for LANAID.

You can let it default to C: for the drive and \LANAID for the directory or you can enter new values. Press **Enter** for each entry.

The files are automatically decompressed and copied to the target directory. When this is completed, the LANAID program is automatically invoked.

## Using LANAID to Install IBM LAN Client

**1** Start LANAID from the directory where you installed it. If it has not been installed, install LANAID from Diskette 2, LANAID by entering **a:install**.

LANAID should be run from DOS.

**2** Select the **Network Software** push button.

Follow the instructions on the panels to specify how your CONFIG.SYS is to be upgraded.

**3** If you are using an operating system that works with IBM LAN Client, a list of software options is presented in the center of the Network Operating System Choices panel. Select **Install IBM LAN Client**. You can choose Express Install to have the LANAIID program install IBM LAN Client using the default protocols provided for your PC Card type and operating system. NetWare Client-32 and 802.2 will be loaded. Continue with the instructions in step 5.

**4** If you want to customize parameters for your IBM LAN Client installation, first select **Install IBM LAN Client**. Then, choose **Custom Install** and select from the following clients and protocols:

- **NetWare Client-32 (IPX/SPX)**

NetWare Client is Novell's version of client software.

You cannot select both NetWare Client and DOS LAN Services.

- **DOS LAN Services (DLS)**

DLS is the DOS client software for LAN servers. When you select DLS, you are asked for the following information:

- User Name
- Machine ID
- Domain Name

When you select DLS, NetBIOS is automatically selected as well.

You cannot select both DLS and NetWare Client.

- **NetBIOS**

When you select NetBIOS, parameters cannot be set in LANAIID.

You can find up-to-date information about the NetBIOS device driver parameters in LNCLIENT.TXT in the \LNCLIENT subdirectory.

- **802.2**



Choose 802.2 when you are using the IEEE 802.2 protocol on your LAN.

When you select 802.2, parameters cannot be set in LANAID.

- **TCP/IP**

This option is presented under Windows or Windows for Workgroups only.

Choose **TCP/IP** when you are using the TCP/IP protocol on your network.

When you select TCP/IP, you are required to select a Local IP Address and Default Gateway. The Local Subnet Mask is set to 255.255.240.0 by default. You can change it by typing in a new value and selecting **OK**.

You cannot select *both* DLS and NetWare Client; however, all other combinations are accepted. Some options are selected automatically, based on your other choice. If you choose DLS, then NetBIOS is selected automatically.

**5** On the IBM LAN Client Configuration panel, there are two or more folders. The Install Options folder allows you to specify directory names and backup parameters. The Adapter Options folder allows you to set parameters for this PC Card. Other folders, such as NWCL32, TCP/IP, or DLS allow you to set parameters for each chosen network operating system or protocol.

**6** When you have finished, press the **Install** push button. You will be prompted to insert diskettes. The options that you have selected will be installed automatically.

On the View Adapter Configuration panel, there are two folders. The Configurable folder shows all the parameters you can set along with their current values. Parameters that are in conflict with other settings are noted. Use the **Suggest** push button to have LANAID suggest nonconflicting values. Use the **Change** push button to select from the allowable values yourself. The Hardware folder shows parameters of the computer system that you cannot set, but that might be useful.

Select the **Store** push button to save the settings. You will be prompted to insert diskettes at the proper time, and the values that you have chosen will be configured automatically.

When you finish with the panels, press the **Done** button and you will be returned to the main panel. Installation is then complete.

## 7 Reboot your computer.

### Using LANAID to Configure the PC Card

This section explains how to run LANAID to configure the PC Card for operation with a previously installed network operating system and device driver. See Chapter 7, "Installing the Device Drivers for Your Network Environment" on page 7-1 for information on installing network operating systems and device drivers.

If you are using Card and Socket Services, LANAID will default to Autoset mode, which allows the LAN driver to negotiate with Card and Socket Services for available resources. If you don't use Autoset mode, LANAID will allow you to select values for resources to be used by your PC Card such as Interrupt and I/O Address.

If you are not using Card and Socket Services in Autoset mode, you must ensure that the values that you select for Interrupt and I/O address do not conflict with those for other PC Cards installed in your computer.

- 1 From the LANAID main panel, select **Network Software**. On the Network Operating System Choices panel, select **Identify Existing Network Operating System**.
- 2 On the Network Operating System Selection panel, LANAID identifies a network operating system and the directory in which the network operating system is installed. It is important to confirm these choices or manually identify the actual installed operating system and directory. When the information is correct, press the **Continue** push button.
- 3 From the LANAID main panel, select **View Adapter Configuration**. On the next panel, there are two folders. The

Configurable folder shows all the parameters you can set along with their current values. Parameters that are in conflict with other settings are noted. Use the **Suggest** push button to have LANAIID suggest nonconflicting values. Use the **Change** push button to select from the allowable values yourself. The Hardware folder shows parameters of the computer system that you cannot set, but that might be useful.

Select the **Store** push button. You will be prompted to insert diskettes at the correct time, and the values that you have chosen will be configured automatically.

When you finish with the panels, press the **Done** button and you will be returned to the main panel. Installation is then complete. See "PC Card Diagnostics" on page C-5 if you want to use the diagnostics.

#### 4 Reboot your computer.

## Chapter 7. Installing the Device Drivers for Your Network Environment

LANAID configures the EtherJet PC Card to work with certain DOS/Windows and OS/2 network operating systems. It is necessary for the network operating system to be installed before LANAID is run. This chapter tells how to install each of the network operating systems and, when needed, how to run LANAID.

### Where to Find the Installation Instructions for Your Environment

*Table 7-1. Installation Instructions*

Banyan VINES	page 7-2
Microsoft LAN Manager	page 7-5
Windows for Workgroups	page 7-7
Novell NetWare lower than 4.0	page 7-9
Novell NetWare 4.0	page 7-11
Novell NetWare 4.01 and higher	page 7-13
OS/2 Novell NetWare Client	page 7-15
OS/2 NDIS 2 Device Driver Using LAPS	page 7-17
OS/2 NDIS 2 Device Driver Using MPTS	page 7-19
OS/2 NDIS 2 Device Driver Using Other Installation Programs	page 7-22
Packet Driver	page 7-22
Warp Connect	page 7-23
Windows NT	page 7-24
Windows 95	page 7-26
Novell NetWare Server	page 7-27

## Banyan VINES—Installation

Perform the following installation steps for the PC Card when using DOS and a Banyan VINES environment with NDIS drivers:

- 1** If there is already one computer attached to your Banyan server, follow the instructions below. Otherwise, go to step 1a to install your PC Card.
  - Format a high-density diskette.
  - From the computer already logged in to the server, type **PCCOPY**.
  - On successive panels, select:
    - **Copy PC Configuration Software** or **LAN Driver** or both
    - **NDIS Ethernet** and **PCCONFIG**
    - **REDIRALL**
    - **A:**
  - Insert the formatted diskette in drive A and press **Enter**.
  - This will make one installation diskette with all the required Banyan files on it.
  - Back at your computer, make a \VINES subdirectory on your hard disk.
  - Copy the contents of the new diskette into your \VINES subdirectory.
  - Go to step 2 on page 7-3.
- a** Make a \VINES subdirectory on your hard disk.
- b** Copy the contents of the Banyan installation diskette to your \VINES subdirectory.
- c** If you used a directory name other than \VINES, make a note of it. You will need the directory name when you perform the installation procedures in step 2 on page 7-3.

- d** Locate the subdirectory \NDIS on one of the two Banyan VINES LAN software diskettes and copy the contents of this subdirectory to the subdirectory on your hard disk containing the other Banyan software.

## **2** Configure the PC Card.

- a** If LAN Aid is not already installed, install it as described in "Installing LAN Aid" on page 6-3.
- b** After LAN Aid is installed, continue with "Using LAN Aid to Install IBM LAN Client" on page 6-4. When you get to the panel that asks for the existing network operating system, select **Banyan VINES**.

## **3** Run the PCCONFIG program that was supplied with the Banyan software.

- a** Type **CD VINES**.
- b** Type **PCCONFIG** to run the configuration program.
- c** Select **Login Environment Settings**.
- d** Select **Default Communications Driver**.
- e** Select **NDIS Ethernet**.
- f** Press **Enter**.
- g** Press **Esc** to return to the main menu.
- h** Select **Network Card Settings**.
- i** Select **NDIS Ethernet**.
- j** Type **IBMEXNDI\_NIF** in the PROTOCOL.INI bindings blank.

**k** Make sure that the other settings are the same as those chosen when you ran the installation program (those specified in your PROTOCOL.INI).

**l** Press **F10**, **Esc**, and **F10** to save your changes.

**4** If you installed the PC Card in a VINES system that was already configured for other adapters, it might be necessary to merge the two PROTOCOL.INI files. Compare PROTOCOL.INI with the most recent PROTOCOL.00x and copy any necessary information back into PROTOCOL.INI.

**5** Installation is now complete.

**Note:** After you install the PC Card and reboot your computer, type **CD VINES**, and then **BAN** to get to the Banyan login panel.

## Microsoft LAN Manager—Installation

If you have already installed Microsoft LAN Manager, use the instructions that came with it to install the device drivers. Then, to configure the PC Card, begin with step 3 on page 7-6 here.

- 1** Refer to the *Microsoft LAN Manager Installation and Configuration Guide* and follow these instructions to install the program.
- 2** Make a note of the directory in which you are installing your LAN Manager software because you will be asked for it in step 3 on page 7-6. The default name is LANMAN.DOS.
  - a** Insert the LAN Manager SETUP diskette and type **a:setup**.
  - b** Insert the LAN Manager DOS Driver 1 diskette (not an EtherJet PC Card diskette) when prompted.
  - c** On the bottom of the Network Adapter Drivers window, select **Other Driver**.
  - d** When prompted, insert EtherJet PC Card Diskette 1, Device Drivers in the diskette drive. Do *not* enter a path name on the prompt window.
  - e** Press **Enter** when **EtherJet PC Card** is displayed.
  - f** On the Network Protocols window, select the NetBEUI driver by pressing the space bar and press **Enter**.
  - g** Follow the instructions on the panels to complete the configuration. However, *do not reboot* your computer at this time. Throughout the rest of the installation, pressing **Enter** will advance the panels.

**Note:** You will get a note saying *Setup has detected extended memory in your system. Do you want setup to maximize application memory?* Answer no.



### 3 Configure the PC Card.

- a** If LANAIID is not already installed, install it as described in “Installing LANAIID” on page 6-3.
- b** After LANAIID is installed, continue with “Using LANAIID to Install IBM LAN Client” on page 6-4. When you get to the panel that asks for the existing network operating system, select **Microsoft LAN Manager**.

### 4 Installation is now complete.

## Microsoft Windows for Workgroups—Installation

**1** Refer to Microsoft *Windows for Workgroups System Guide* for the general procedure regarding installation of network drivers for Windows for Workgroups. The following instructions should apply in most circumstances.

- Make sure that Windows for Workgroups is up and running.
- From the Program Manager window, double-click **Network**.
- Double-click **Network Setup**.
- Select the **Drivers** push button at the bottom of the Network Setup window.
- Select **Add Adapter**.
- Select **Unlisted or Updated Network Adapter** from the top of the list box and then select **OK**.
- Insert Diskette 1, Device Drivers in drive A. Verify that the selected path is A:\ and then select **OK**.
- Select **IBM EtherJet PC Card, NDIS2 and NDIS3** from the Network Adapter list and select **OK**. The device driver files will be copied at this point.
- Select **Close** when you have finished with the Network Drivers window.
- Select **OK** in the Network Setup window.
- You will be prompted to reinstall specific network-related files; reinstall them as needed.
- If prompted, insert the Windows for Workgroups program application diskettes or CD-ROM and follow the instructions.
- Select **OK** for messages regarding updates to the SYSTEM.INI and PROTOCOL.INI files.
- Exit the Windows for Workgroups setup. Do not reboot your computer at this time. Exit to the DOS prompt.

**2** Configure the PC Card.



- a** If LANAIID is not already installed, install it as described in “Installing LANAIID” on page 6-3.
- b** After LANAIID is installed, continue with “Using LANAIID to Install IBM LAN Client” on page 6-4. When you get to the panel that asks for the existing network operating system, select **Windows for Workgroups**.



## DOS Novell NetWare Client (Versions lower than 4.0)—Installation

If you have already installed Novell NetWare Client, use the instructions that came with it to install the device drivers. Then, to configure the PC Card, begin with step 4 here.

**1** Create a directory that will hold the NetWare files. The default directory name is NWCLIENT.

**2** In your AUTOEXEC.BAT:

- Add the directory to the PATH= command. For example,  
PATH=C:\;C:\DOS;yourdirectory;
- Add the following commands to the end:

```
LSL
NESL
IBMEXNWC
IPXODI
NETX
```

These represent:

NetWare Link Support Layer program  
IBM EtherJet PC Card driver  
NetWare ODI Network driver  
NetWare workstation shell for NetWare 3.11.

**3** Insert your NetWare diskette in drive A.

**4** Copy LSL.COM, IPXODI.COM, NESL.COM, and NETX.EXE to your NetWare directory.

**Note:** Make a note of the directory name to which the NetWare files are copied.

**5** Configure the PC Card.

- a** If LANAIID is not already installed, install it as described in "Installing LANAIID" on page 6-3.

- b** After LANAIID is installed, continue with “Using LANAIID to Install IBM LAN Client” on page 6-4. When you get to the panel that asks for the existing network operating system, select **Novell NetWare Client-16**.

**Note:** You need to change the default adapter address that is supplied by the PC Card installation program to a locally administered address or to the universally administered address.

- 6** Installation is now complete.

## DOS Novell NetWare Client (Version 4.0)—Installation

If you have already installed Novell NetWare Client, use the instructions that came with it to install the device drivers. Then, to configure the PC Card, begin with step 4 here.

- 1** Create a directory that will hold the NetWare files. The default directory name is NWCLIENT.
- 2** In your AUTOEXEC.BAT:
  - Add the directory to the PATH= command. For example,  
PATH=C:\;C:\DOS;yourdirectory;
  - Add the following commands to the end:  
LSL  
NESL  
IBMEXNWC  
IPXODI  
VLM

These represent:

  - NetWare Link Support Layer program
  - IBM EtherJet PC Card driver
  - NetWare ODI Network driver
  - NetWare workstation shell for NetWare 4.0x.
- 3** Insert your NetWare diskette in drive A.
- 4** Copy LSL.COM, IPXODI.COM, and NESL.COM to your NetWare directory.
- 5** Copy all files with the extension .VLM to your NetWare directory.
- 6** Copy VLM.EXE to your NetWare directory.
- 7** Add LASTDRIVE=Z to the end of your CONFIG.SYS.
- 8** Configure the PC Card.

- a** If LANAIID is not already installed, install it as described in “Installing LANAIID” on page 6-3.
- b** After LANAIID is installed, continue with “Using LANAIID to Install IBM LAN Client” on page 6-4. When you get to the panel that asks for the existing network operating system, select **Novell NetWare Client-16**.

**Note:** You need to change the default adapter address that is supplied by the PC Card installation program to a locally administered address or to the universally administered address.

**9** Installation is now complete.

## DOS Novell NetWare Client (Versions 4.01 and higher)—Installation

If you have already installed Novell NetWare Client, use the instructions that came with it to install the device drivers. Then, to configure the PC Card, begin with step 9 on page 7-14 here.

- 1** Insert the NetWare Client for DOS and Windows diskette 1 in drive A, and type **a:**, press **Enter**, and then type **install** and press **Enter**.
- 2** Specify the target directory for the NetWare Client installation and answer any questions.
- 3** To install the DOS Client device driver, choose to select the driver for your network board. During this procedure you will need to choose **Other Drivers** to install the EtherJet PC Card DOS client driver, IBMEXNWC.COM.
- 4** When prompted, insert the EtherJet PC Card Diskette 1, Device Drivers. The device driver, IBMEXNWC.COM, and installation file, IBMEXNWC.INS, are located in the \DOS directory.
- 5** Choose **IBM EtherJet PC Card**.
- 6** Choose any settings as desired. All settings are optional. The PC Card environment setting will be determined automatically.
- 7** Select to continue with the installation and press **Enter** to finish installing NetWare.
- 8** When the installation is complete exit the installation program.



## 9 Configure the PC Card.

- a** If LANAIID is not already installed, install it as described in “Installing LANAIID” on page 6-3.
- b** After LANAIID is installed, continue with “Using LANAIID to Install IBM LAN Client” on page 6-4. When you get to the panel that asks for the existing network operating system, select **Novell NetWare Client-16**.

**Note:** You need to change the default adapter address that is supplied by the PC Card installation program to a locally administered address or to the universally administered address.

## 10 Installation is now complete.

## OS/2 Novell NetWare Client—Installation

If you have already installed Novell NetWare Client, use the instructions that came with it to install the device drivers. Then, to configure the PC Card, begin with step 6 on page 7-16 here.

- 1** Before performing the installation procedures, determine which adapter address (local or universal) you will be using.
  - If you are using the locally administered adapter address (an adapter address that you can assign that overrides the universally administered address), continue with the procedures in step 2.
  - If you are using the universally administered adapter address (an adapter address that is permanently encoded in the adapter at the time of manufacture and that is unique to the adapter) the address is printed on the label located on the back of the EtherJet PC Card. The universal address may also be obtained by using LANAIID if necessary. To see the adapter universal address go to “PC Card Diagnostics” on page C-5 and follow the sequence to step f. Select the Hardware page of the Adapter Configuration. The universal address is listed as the MAC address. The address will also be displayed on the main panel at step 1.

Record the universal address here. \_\_\_\_\_

- 2** Use the Novell NetWare instructions (shipped with your Novell software) to install the NetWare files on your computer’s hard disk.

**Attention** *Do not reboot* your computer during the NetWare installation. Your specific environment variables will not be set until you perform the PC Card installation procedures (in step 6 on page 7-16).
- 3** Verify that you are installing the NetWare Requester for OS/2. From the installation menu, select **Requester on workstation**.
- 4** When requested to select the ODI LAN driver, type **IBMEXNWC.OS2**.

**5** When prompted, insert the EtherJet PC Card Diskette 1, Device Drivers. The OS/2 client driver, IBMEXNWC.OS2, is located in the \OS2 directory.

**6** Configure the PC Card.

**a** If LANAIID is not already installed, install it as described in "Installing LANAIID" on page 6-3.

**b** After LANAIID is installed, continue with "Using LANAIID to Install IBM LAN Client" on page 6-4. When you get to the panel that asks for the existing network operating system, select **Novell NetWare**.

**Note:** You need to change the default adapter address that is supplied by the PC Card installation program to a locally administered address or to the universally administered address you recorded in step 1 on page 7-15.

## OS/2 NDIS 2 Device Driver Using LAPS

If your OS/2 network operating system has not yet been installed on your computer, install it now and follow its instructions for installing device drivers. If an OS/2 network operating system has previously been installed, follow the instructions here for using LAPS to install device drivers.

- 1** Insert Diskette 1, Device Drivers in drive A.
- 2** Enter **laps** at the OS/2 prompt. LAPS is usually located in the \IBMCOM subdirectory on the boot drive.
- 3** Select **Install**. You will be prompted for the source of the .NIF file. Enter **a:**. Select **OK** when the Installation Complete message appears. You will return to the main menu.
- 4** Select **Configure** and then, on the Select a Configuration option menu, make sure that **Configure LAN Transport** is highlighted. Select **Continue**. You will now be in the Configuration Workstation panel.
- 5** From the Network Adapters group box, select **IBM EtherJet PC Card Ethernet Adapter**. Then, select **Add**.

**Note:** You can edit parameter settings for this adapter. Select this adapter in the Current Configuration box and select **Edit**.

- 6** In the Protocols list box, select the protocols used by your network application. Highlight each protocol and select **ADD**. If you are not sure which ones to use, select **IBM IEEE 802.2** and **IBM OS/2 NetBIOS** protocol drivers or ask your network administrator.

The protocol drivers you have selected will appear under the adapter driver name in the Current Configuration list box.

**Note:** You can edit parameter settings for the protocols. Highlight a protocol and select **Edit**.

- 7** Select **OK** when you have completed your selections for the adapter. You will now return to the main menu. Select **Exit** for the changes to take effect.

- 8** Select **Exit** on the IBM logo panel.
- 9** You will see messages regarding updates to the CONFIG.SYS file. Make sure that the correct drive and directory for the CONFIG.SYS file are specified, and click **Continue**.
- 10** Exit the program. Select **OK** when asked if you want CONFIG.SYS, STARTUP.CMD, and PROTOCOL.INI updated.
- 11** Select **Exit** on the Exiting LAPS window.
- 12** Configure the PC Card.
  - a** If LANAIID is not already installed, install it as described in "Installing LANAIID" on page 6-3.
  - b** After LANAIID is installed, continue with "Using LANAIID to Install IBM LAN Client" on page 6-4. When you get to the panel that asks for the existing network operating system, select **OS/2 NDIS Environment**.
- 13** Installation is now complete. Shut down and restart your computer for all changes to take effect.
- 14** Check for the following conditions to determine whether the adapter is working correctly and whether installation has been completed successfully:
  - The device driver files are loading successfully. There are no error messages.
  - You are able to log on and communicate with the network.If you experience problems, go to Appendix C, "Problem Determination" on page C-1.

## OS/2 NDIS 2 Device Driver Using MPTS

MPTS is the new *Multiple Protocol Transport Services*, which replaces LAPS for use under OS/2 Warp Connect and Warp Server.

If your OS/2 network operating system (DLS, Warp) has not yet been installed on your computer, install it now and follow its instructions for installing device drivers. If an OS/2 network operating system has previously been installed, follow the instructions here for using LAPS to install device drivers.

- 1** Start MPTS by performing either of the following actions:
  - From the OS/2 desktop, double-click the MPTS icon.
  - From an OS/2 window, go into the IBMCOM subdirectory and enter **mpts** at the OS/2 prompt.
- 2** Select **OK** on the MPTS logo panel.
- 3** Select **Install**. You will be prompted for the source of the .NIF file. Insert Diskette 1, Device Drivers in drive a and enter **a:**. Select **OK** once the Installation Complete message appears. You will return to the main menu.
- 4** Select **Configure** in the MPTS dialog box.
- 5** On the Configure panel, make sure that **LAN adapters and protocols** is preselected and then select **Configure** at the bottom of the panel.
- 6** In the Configuration panel, in the Network Adapters group box, select **IBM EtherJet PC Card** and select **ADD**.

**Note:** You can edit parameter settings for this adapter. Highlight this adapter in the Current Configuration list box and select **Edit**.
- 7** In the Protocols list box, select the protocols used by your network application. Highlight each protocol and select **ADD**. If you are not sure which ones to use, select **IBM IEEE 802.2** and **IBM OS/2 NetBIOS** protocol drivers or ask your network administrator.

The protocol drivers you have selected will appear under the adapter driver name in the Current Configuration list box.

**Note:** You can edit parameter settings for the protocols. Highlight a protocol and select **Edit**.

- 8** Select **OK** when you have finished selecting and editing protocols in the LAPS Configuration panel.
- 9** Select **Close** on the Configure panel.
- 10** Select **Exit** in the MPTS dialog box.
- 11** Select **Exit** on the Update CONFIG.SYS panel to update the CONFIG.SYS file.
- 12** Select **OK** when you get the message that the CONFIG.SYS has been successfully updated.
- 13** Select **Exit** on the Exiting MPTS panel.
- 14** Configure the PC Card.
  - a** If LANAIID is not already installed, install it as described in "Installing LANAIID" on page 6-3.
  - b** After LANAIID is installed, continue with "Using LANAIID to Install IBM LAN Client" on page 6-4. When you get to the panel that asks for the existing network operating system, select **OS/2 NDIS Environment**.
- 15** Shut down OS/2 and restart your computer to let the changes take effect. Installation is now complete.
- 16** At system startup, check for the following conditions to determine whether the adapter is working correctly and whether installation has been completed successfully:
  - The device driver files loaded successfully. There are no error messages.
  - You are able to log on and communicate with the network.



If you experience problems go to Appendix C, “Problem Determination.”





## **OS/2 NDIS 2 Device Driver Using Other Installation Programs**

- 1** Insert Diskette 1, Device Drivers in drive A.
- 2** Use your product documentation to install the driver (IBMEXNDI.OS2).
- 3** Modify the parameters if needed.
- 4** Installation is now complete. Shut down and restart your computer for all changes to take effect.
- 5** Check for the following conditions to determine whether the adapter is working correctly and whether installation has been completed successfully:
  - The device driver files load successfully. There are no error messages.

If you experience problems go to Appendix C, "Problem Determination" on page C-1.

### **Packet Driver**

The Packet Driver is installed without using LANAIID. See the README.1ST file on Diskette 1, Device Drivers for instructions on installing the Packet Driver.

## Warp Connect—Installation

- 1** After the system reboots and you are presented with the System Configuration panel, be sure that you have PCMCIA Support installed. To install support, double-click the icon and follow the instructions.
- 2** Continue with Warp Connect install.
- 3** On the Networking Support panel, answer **Yes** and click **OK**.
- 4** On the Product Selection panel, choose the products for your networking environment and click **OK**.
- 5** On the Set up selected products panel, on the Adapter tab, click **Other adapter....**
- 6** Insert Diskette 1, Device Drivers in drive A. Click **OK** on the Network Adapter Driver Disk panel.
- 7** On the Drivers Found panel, choose **Ethernet** as the type of LAN. Click **OK** to return to the Set up selected products panel.
- 8** Click **Settings** to view the Verify Network Adapter Parameters panel. Click **OK** when complete and return to the Set up selected products panel.
- 9** Click **Install** when the other products have been customized.
- 10** Continue with the Warp Connect install.

## Windows NT—Installation

For Windows NT, the EtherJet PC Card device driver is installed without using LANAID.

Diskette 1, Device Drivers contains the latest device driver for Windows NT (IBMEXWNT.SYS).

IBMEXWNT.SYS is an NDIS 3.0 device driver for Windows NT 3.51 or higher. This driver requires that Service Pack 2 or higher has been applied to your Windows NT system. It will only function in a computer with an Intel 82365SL or compatible socket controller. Windows NT does not support the Databook socket controllers at this time.

Perform the following installation steps for the PC Card when using Windows NT 3.51.

- 1** Make sure that Windows NT is up and running.
- 2** From the Program Manager window, double-click **Control Panel**.
- 3** Double-click **Network**.
- 4** Select **Add Adapter**. Select **<Other> Requires disk from manufacturer** from the bottom of the list box, and then select **Continue**.
- 5** Insert Diskette 1, Device Drivers in drive A. Verify that the selected path is A:\ and select **OK**.
- 6** Select **OK** on the Select OEM option window.
- 7** From the IBM EtherJet PC Card Setup window, accept the default settings or modify each parameter to the correct value and then select **OK**.

**Note:** If values shown in this window are incorrect or are in conflict with other devices in your system, the EtherJet PC Card will not operate correctly.

- 8** The next EtherJet PC Card Setup window prompts you for a value for NetAddr. If you are using the universally administered address leave the field blank and select **Continue**. If you are using a locally administered address, enter its value and select **Continue**.

**Note:** Unless your network administrator has instructed you to enter a value for this field, you should leave it blank and select **Continue**.

- 9** Windows NT might prompt you to reinstall network-related files; reinstall them as needed.
- 10** After the EtherJet PC Card has been added to the list of Installed Adapter Cards in the Network Settings window, select **OK**.
- 11** Remove the diskette from the drive and select **Restart now** when prompted from the Network Settings Change window.
- 12** Installation is now complete.

If you experience problems, verify that you have performed the installation procedure correctly. See Appendix C, "Problem Determination" on page C-1.

## Windows 95—Installation

For Windows 95, the EtherJet PC Card device driver is installed without using LANAID.

You will need your Windows 95 diskettes or CD-ROM during installation.

Diskette 1, Device Drivers contains the latest device driver for Windows 95 (IBMEXW95.VXD). It is recommended that you use the Windows 95 PC Card support software.

Perform the following installation steps for the PC Card when using Windows 95.

- 1** Reboot Windows 95 without the PC Card inserted.
- 2** Be sure that PC Card support is enabled. To check this, double-click **PC Card** in the Control Panel. If you are shown PC Card properties, then support is enabled. Otherwise, complete the questions and reboot.
- 3** Reinstall the PC Card and cable. The system will recognize your PC Card. On the New Hardware Found panel, select **Driver from disk provided by hardware manufacturer**. The system will prompt you for a diskette. Insert EtherJet PC Card Diskette 1, Device Drivers in drive A, type **a:\win95** and press **Enter**. Follow the instructions on the screen.
- 4** Select **Control Panel** and select **Network**. In the Network window, verify that EtherJet PC Card and the correct protocols have been added.  
  
To add a protocol, select **Protocol**, then **Add**. In the next window, select the manufacturer of your network protocol, and the protocol itself.
- 5** Installation is now complete.

## Novell NetWare Server

The EtherJet PC Card NetWare Server LAN driver is called IBMEXNWS.LAN and is located in the \NETWARE directory on the EtherJet PC Card Diskette 1, Device Drivers.

IBMEXNWS.LAN is not a card service-aware device driver. This means that you must enable the PC Card with other software before it can be used by the device driver.

If you do not have card and socket services installed on your computer, you must use the point enabler, POINTJET.EXE, to enable the PC Card. Refer to Appendix A, "EtherJet Point Enabler (POINTJET.EXE)" on page A-1 for information about using POINTJET.EXE.

If you have card and socket services installed on your computer, you should use the card services enabler, CS20JET.EXE, to enable the PC Card. Refer to Appendix B, "EtherJet Card Services Enabler" on page B-1 for information about using CS20JET.EXE.

If you are using 10BASE-T cabling and your PC Card cable is connected to the network, the link active LED should be on and the transmit LED should be off once the PC Card has been correctly enabled.

Before you begin the server driver installation the PC Card must be installed in the computer and enabled as described above or the EtherJet PC Card will not be detected by the device driver.

Refer to your NetWare Server documentation for complete instructions on installing the server and other device drivers. The following information describes the general procedure for installing the EtherJet PC Card NetWare Server driver, IBMEXNWS.LAN.

If NetWare Server 4.x is not currently installed, you should install it now. During the NetWare Server installation process you will be able to install the IBMEXNWS.LAN device driver. Choose **other** or **unlisted** device driver during the installation process and you will be prompted for the EtherJet PC Card Diskette 1, Device Drivers. You

will also be able to configure the input parameters for the IBMEXNWS.LAN device driver.

If NetWare Server 4.x is already installed, you can use the NetWare 4.x INSTALL.NLM to install the device driver. From the NetWare Server console, type LOAD INSTALL. Choose **other** or **unlisted** device driver during the installation process and you will be prompted for the EtherJet PC Card Diskette 1, Device Drivers. You will also be able to configure the input parameters for the IBMEXNWS.LAN device driver.

Installation is now complete.

---

## Appendix A. EtherJet Point Enabler (POINTJET.EXE)

POINTJET.EXE is the point enabler for the EtherJet PC Card, supporting Intel 82365SL and compatible socket controllers. It can be loaded as a device driver from CONFIG.SYS, or run as a DOS executable. The syntax is:

```
device=d:\pointjet.exe SA|SB|SC|SD|RA|RB|RC|RD
                    IOBASE=xxx IRQ=x SRAM=xxxx
```

(where device=d: specifies the correct drive and path).

The first parameter specifies the socket. Generally a laptop with two sockets uses SA for the top (IBM ThinkPad) and SB for the bottom. Sockets in a docking station or port replicator may be specified with RA and RB. The default socket is SA.

IOBASE is the I/O base address of the card. Although the enabler allows any valid I/O address, the device drivers require this address to be on a 16-byte boundary in the hexadecimal range of 200 to 360 (inclusive).

The IRQ default is 3 and the range is 2-F.

SRAM is the segment used to open the attribute memory window. The default address is the d000 segment, and you must ensure that whatever 4-KB segment is used is available. The enabler unloads after the card is enabled, and the 4-KB memory area is then free for other use. If configuring manually, try to load the point enabler first in your CONFIG.SYS to avoid memory conflicts with programs loaded later. If you must load the enabler later in CONFIG.SYS, be sure to read Appendix D, "Using a Memory Manager in DOS" to understand how to avoid memory conflicts.

The following line shows the enabler default parameters as well as the required format:

```
device=d:\pointjet SA IOBASE=300 IRQ=3 SRAM=d000
```



The IOBASE, IRQ, and SRAM parameters are entered as hexadecimal values in the form shown.

---

## Point Enabler Messages

Error Code	Explanation and Action
JET0001I	<p>IBM EtherJet PC Card Point Enabler Version x.xx</p> <p>This message is the sign-on banner. x.xx is the level of the driver.</p>
JET0002E	<p>The PCMCIA Socket Controller is NOT Intel-compatible.</p> <p>This message is displayed if the socket controller on your machine is not Intel 82365SL-compatible, or if the specified socket does not exist.</p>
JET0003E	<p>There is no PC card in the specified slot.</p> <p>This message is displayed if the specified slot exists but does not contain a card or an EtherJet cable is not attached to the card. Make sure the PC Card is fully inserted.</p>
JET0004E	<p>Card in specified slot is not an IBM EtherJet PC Card.</p> <p>There can be several reasons for this message:</p> <ol style="list-style-type: none"><li>1. The PC Card in the slot you specified is not an EtherJet PC Card.</li><li>2. Phantom slot. Socket controllers generally support up to 4 slots each, but laptops may have only 2 physical slots (for example, you specify SD on a laptop with 2 slots). The enabler is unable to detect and report this situation.</li><li>3. Possible memory conflict. Try changing the SRAM parameter of POINTJET to a different value.</li><li>4. The card is defective (CIS unreadable or damaged).</li></ol>
JET0005E	<p>Unrecognized parameter entered on the command line.</p> <p>An unrecognized parameter was entered on the command line. This should be followed by a short help on the syntax.</p>

<b>Error Code</b>	<b>Explanation and Action</b>
JET0006I	POINTJET.EXE command format: This is the help message, giving the command line syntax.
JET0007E	Invalid parameter value specified for SRAM=xxxx SRAM parameter was entered incorrectly. Enter it in the form SRAM=xxxx using your chosen value. Enter the value in hexadecimal without spaces.
JET0008E	Invalid parameter value specified for IOBASE=xxx The IOBASE parameter was entered incorrectly. Enter it in the form IOBASE=300 without spaces or other characters.
JET0009E	Invalid parameter value specified for IRQ=x The IRQ parameter was entered incorrectly. Enter it in the form IRQ=A for interrupt ten (in hexadecimal format).
JET0011E	Error - Unable to communicate with the EtherJet controller. The Ethernet controller on the card is not responding. There could be an I/O conflict, or the card could be bad.
JET0015I	Card enabled successfully. Card enabled and ready for use by device drivers.



---

## Appendix B. EtherJet Card Services Enabler

CS20JET.EXE is the Card Services enabler for the EtherJet PC Card. CS20JET.EXE is used with IBM EtherJet device drivers that are not card services enabled. It can be loaded as a device driver from CONFIG.SYS, or can run as a DOS executable.

Card and Socket Services for your adapter must be loaded in order to use the Card Services enabler. If you do not have Card and Socket Services installed on your computer you should use the point enabler, POINTJET.EXE. See Appendix A, "EtherJet Point Enabler (POINTJET.EXE)" on page A-1 for information on using the point enabler.

The syntax of the command is

```
device=d:\cs20jet IO=xxx IR=x SL=x
```

where all parameters are optional.

IO defines the I/O base address of the PC Card. IO is specified as three hexadecimal digits. Although the Card Services enabler allows any valid I/O address, the device drivers require the address to be on a sixteen-byte boundary in the hexadecimal range of 200 to 360 (inclusive).

IR defines the interrupt for the PC Card. IR is specified as a single hexadecimal digit.

SL defines the socket of the PC Card. SL is specified as a single hexadecimal digit. Computer manufacturers and Card Services levels specify socket ordering in various ways, but the parameter SL=1 refers to the first logical socket, SL=2 refers to the second logical socket, and so on.

If no parameters are specified, the PC Card can be enabled in any socket and the I/O base address and interrupt are determined by Card Services. In general, it is recommended that you not specify the IO or IR parameters unless you want to use a specific resource.

The following are examples of proper formatting of the CS20JET.EXE command:

```
device=d:\cs20jet                (recommended format)
device=d:\cs20jet I0=300 IR=A SL=1
device=d:\cs20jet I0=210 SL=2
device=d:\cs20jet IR=5
```

If the Card Services enabler encounters problems such as not being able to acquire a resource, 3 alternating tones will sound and an appropriate message will be displayed.

The CS20JET.EXE should be loaded only once and it will enable one EtherJet PC Card.

---

## Card Services Enabler Messages

*Table B-1 (Page 1 of 4). Problem Descriptions and Recommended Actions*

<b>Error Code</b>	<b>Explanation and Action</b>
JETCS0011	<p>IBM EtherJet PC Card Card Services Enabler Version x.x, (xxxxxx)</p> <p>This message is the sign-on banner. The enabler version, x.x, and date, (xxxxxx), are included in the banner.</p>
JETCS002E	<p>Card Services is not loaded.</p> <p>Card Services has not been loaded. Refer to your operating system or Card Services documentation for information on loading Card Services.</p>
JETCS003E	<p>Card Services signature is incorrect.</p> <p>Card Services is loaded, but it is not a standard release of Card Services. Refer to your operating system or Card Services documentation for information on loading a standard release of Card Services. Card Services release PCMCIA 2.0 or higher is required.</p>

*Table B-1 (Page 2 of 4). Problem Descriptions and Recommended Actions*

<b>Error Code</b>	<b>Explanation and Action</b>
JETCS004E	<p>Invalid Card Services version.</p> <p>Card Services is loaded, but it is not a release supported by this enabler. Refer to your operating system or Card Services documentation for information on loading a current release of Card Services. Card Services release PCMCIA 2.0 or higher is required.</p>
JETCS005E	<p>Get first tuple call failed.</p> <p>Could not read information from the PC Card. Ensure that you are not using the point enabler, POINTJET.EXE, to enable the PC Card and ensure that the EtherJet PC Card is inserted in the slot.</p>
JETCS006E	<p>Get tuple data call failed.</p> <p>Could not read information from the PC Card. Ensure that you are not using the point enabler, POINTJET.EXE to enable the PC Card and ensure that the EtherJet PC Card is inserted in the slot.</p>
JETCS007E	<p>Preserve IRQ call failed.</p> <p>Could not save the configured IRQ on the PC Card. Ensure that you are not using the point enabler, POINTJET.EXE, to enable the PC Card and ensure that the EtherJet PC Card is inserted in the slot.</p>
JETCS008E	Release configuration call failed.
JETCS009E	Release IO call failed.
JETCS010E	<p>Release IRQ call failed.</p> <p>The Card Services enabler could not release the resource specified in messages 8 through 11. Ensure that you are loading CS20JET.EXE only once.</p>
JETCS012E	Request IO call failed.

*Table B-1 (Page 3 of 4). Problem Descriptions and Recommended Actions*

<b>Error Code</b>	<b>Explanation and Action</b>
JETCS013E	Request IRQ call failed.
JETCS018E	Request configuration failed. The Card Services enabler could not acquire the resource specified in messages 12, 13, and 18. Ensure that you are loading CS20JET.EXE only once.
JETCS019E	Request exclusive failed. The PC Card is already being exclusively used by another device driver. The PC Card is already being exclusively used by another device driver. Ensure that no other device drivers, like IBMEXNWC.COM or IBMEXNDI.DOS, are using the PC Card. Ensure that you are loading CS20JET.EXE only once.
JETCS020I	Invalid parameter name. An incorrect parameter was entered on the command line. Verify the command line parameters. This message will be followed by message JETCS021I.
JETCS021I	Parameter ignored. An invalid parameter was entered on the command line. Verify the command line parameters. This message will be preceded by message JETCS020I.
JETCS022I	Invalid parameter value. An incorrect parameter value was entered on the command line. Verify the command line parameters. This message will be followed by message JETCS023I.

*Table B-1 (Page 4 of 4). Problem Descriptions and Recommended Actions*

<b>Error Code</b>	<b>Explanation and Action</b>
JETCS023I	<p>Bad value. Parameter value set to zero.</p> <p>An incorrect parameter value was entered on the command line. Verify the command line parameters ensuring that all values are entered in hexadecimal. This message will be preceded by message JETCS022I.</p>





## Appendix C. Problem Determination

This chapter contains procedures that help you troubleshoot problems with the EtherJet PC Card.

**1** In Table C-1, locate the symptom that best describes the problem.

**2** Follow the recommended actions for resolving the problem.

*Table C-1 (Page 1 of 2). Problem Descriptions and Recommended Actions*

Symptom	Recommended Action
You hear a series of 3 or 4 alternating tones when the EtherJet PC Card is inserted into a socket.	This series of tones indicates that there was a problem while initializing one of the device drivers. Ensure that the EtherJet PC Card with a cable attached is inserted into a socket before running the device driver. You might still hear the tones, but an error message should also be displayed.
Error message when running drivers.	See the following sections of this manual for error message explanations. <ul style="list-style-type: none"> <li>• JETnnnnl; see "Point Enabler Messages" on page A-2, or "Point Enabler Messages" on page C-22.</li> <li>• JETCSnnn; see "Card Services Enabler Messages" on page B-2.</li> <li>• IBMEXNWx-yy-nnn; see "ODI Messages" on page C-14.</li> <li>• OS/2 pop-up message containing the EtherJet PC Card name; see "OS/2 Client NetWare Driver Pop Up Messages" on page C-21.</li> <li>• If you are using the OS/2 NDIS driver, IBMEXNDI.OS2 messages are logged to LANTRAN.LOG instead of the display.</li> </ul>

*Table C-1 (Page 2 of 2). Problem Descriptions and Recommended Actions*

<b>Symptom</b>	<b>Recommended Action</b>
PC Card is in the socket but is not recognized by device drivers.	Ensure that the PC Card is firmly in the socket and that the cable that came with the PC Card is attached to the PC Card.
Problem with the PC Card's operation	Go to "PC Card Diagnostics" on page C-5.
Graphics are not appearing correctly	Use a VGA or higher resolution display monitor.
Other problems not described in this table	Go to "Common Errors" on page C-2 and review the README.1ST file on Diskette 1, Device Drivers.

**Note:** If you are still having problems after trying the suggested actions in Table C-1 on page C-1, see Appendix F, "Help and Service Information" on page F-1 for information on obtaining service for your PC Card.

## Common Errors

This section describes some of the common errors that can occur with the EtherJet PC Card. The errors in this section are usually the result of a configuration or setup discrepancy, and can usually be corrected by changing a configuration parameter or changing your computer setup.

1. You are using EMM386.EXE or another memory manager.

EMM386 is the source of many problems with PC Cards. The problem occurs when EMM386.EXE, the PC Card, or Card Services are using the same memory. This is called *memory contention*. The PC Card will not function correctly if this contention occurs. If you are using Card Services, check to be sure that the memory that Card Services controls is excluded by the memory manager. If you are using a point enabler, be sure that the memory that is used is excluded by the memory manager or that the point enabler is located before the memory manager in CONFIG.SYS. As a quick test, comment out

EMM386.EXE in your CONFIG.SYS, reboot, and try the PC Card again.

If the PC Card functions, you will have to edit the EMM386.EXE command to exclude some memory. The EtherJet PC Card point enabler uses 4 KB of memory. See Appendix D, "Using a Memory Manager in DOS" for more information.

## 2. You are using Card Services.

During reboot, you hear four alternating tones. This indicates that Card Services was unable to give you one or more resources that your program requested. Resources are I/O ports, interrupt level, and memory locations.

**Note:** The items in the following paragraph are performed by the installation program.

If you are using the NDIS driver (IBMEXNDI.DOS), edit the PROTOCOL.INI file and see whether you have specified a particular value for the interrupt level or I/O port. This would be indicated by the keywords `IRQ=0xX` and `IOADDRESS=0xXXX`. If you are using the ODI driver (IBMEXNWC.COM), edit the NET.CFG file and see whether you have specified a particular value for the interrupt level or I/O port. This would be indicated by the keywords `INT X` and `PORT XXX`.

These keywords specify a particular value for these parameters. If you find one or more of these keywords, comment them out by placing a semicolon in front of the keyword. Save the file and reboot your computer. If both are commented out or are not in PROTOCOL.INI or NET.CFG, the driver is in Autoset mode and lets Card Services determine what values are used by the driver. If you reboot and still receive the alternating beep alarm, there is a problem with Card Services.

Check your level of Card Services and ensure that it is the latest available. To get the latest level, call the IBM BBS (see "Getting Help" on page F-2).

## 3. You are using a point enabler.

When you use a point enabler, it is essential that the I/O port and interrupt level do not conflict with resources used by the

computer or other PC Cards. Edit the CONFIG.SYS file for the line containing the point enabler. Example line:

```
C:\POINTJET.EXE SA SRAM=D000 IRQ=9 IOBASE=300
```

. The example parameter values are Socket A, Memory 0xD000 through 0xD3FF, interrupt level 9, and I/O ports 0x300 through 0x30F. Verify that they are not being used by the computer or other PC Cards.

4. If you believe that you have a hardware problem with the PC Card, run the PC Card diagnostics. See "PC Card Diagnostics" on page C-5.
5. Check your level of BIOS and ensure that it is the latest available.

---

## The LEDs

Two LEDs are visible on the EtherJet cable.



Symbol for data traffic LED



Symbol for link status LED

The LINK LED signifies two issues:

- You are using 10BASE-T and you are linked to an Ethernet hub or switch. If you are not using 10BASE-T, this LED does not apply.
- Your PC Card has power. If it does not have power, the LINK LED will not be on.

If the LINK LED does not light up check the following:

- Your computer is connected to a 10BASE-T Ethernet network.
- Your cable is not broken or damaged.
- Your computer has a good connection to the hub or switch.
- The hub or switch is switched on.

- You are using a crossover cable with a hub set up to use crossover cables.
- Your computer is enabled by the point enabler or the Card and Socket Services driver.
- Your PC Card is securely plugged in to the socket.

The ACTIVITY LED represents the transmission and reception of data across the network. The ACTIVITY LED is used for both 10BASE-T and 10BASE2 networks. If the ACTIVITY LED is not lit it does not necessarily signify a problem. The ACTIVITY LED is only used when data is being transmitted and received on the network.

If the ACTIVITY LED does not light up, and you are using 10BASE-T cabling, check to see if the LINK LED is lit. If not, follow the checks under the LINK LED section.

If the LINK LED is lit and the ACTIVITY LED is not or you are using 10BASE2 cabling, check the following:

- There is a good physical connection at the hub and at the PC Card.
- Check for a broken or damaged cable.
- Make sure that there is data being transmitted on the network.
- Make sure that the hub is switched on.
- Make sure that the point enabler or Card and Socket Services enabled the PC Card correctly.

If you are not successful in identifying these symptoms or the real problem, see Appendix F, "Help and Service Information" on page F-1.

## PC Card Diagnostics

Diagnostics for the EtherJet PC Card are contained in LANAIID on Diskette 2, LANAIID.

1. Begin on a DOS full screen or a DOS full-screen session of Windows or OS/2. Go to the directory where LANAIID is installed, and then enter **lanaid**.

2. When the main options panel is presented, perform the following steps to get to the diagnostics.
  - a. Select **Network Software**.
  - b. Select **Continue**.
  - c. Select **Continue** again.
  - d. Select **Identify Existing Network Operating System**, then select **Continue**.
  - e. Verify the network operating system and select **Continue**.
  - f. The current PC Card configuration can be viewed now.
  - g. Continue by selecting **Cancel**.
  - h. Select **Yes**.
  - i. Select **Diagnostics**.

3. The diagnostic procedure is performed automatically.

If all of the tests pass then the PC Card point enabler or Card Services is working correctly, the PC Card is functional, and the network cable is attached to the card. If the PC Card is not located, the I/O Register Test fails, or the Interrupt Test fails, the PC Card probably has a configuration conflict. Check the socket, I/O address, and interrupt selected for conflicts with the computer and other PC Cards. The other three tests are internal PC Card tests and are a good indication of a PC Card failure.

---

## NDIS Error Codes

The following sections provide messages that can be received from the NDIS driver function. If you are using OS/2, the messages are logged to a file. The NDIS driver signals the user when a Card Services call fails; the error signal is an alternating beep. If you hear this sound, a problem is occurring during configuration of the PC Card. If you are using OS/2, you must review the LANTRAN.LOG file in your \IBMCOM subdirectory to determine what is wrong. Depending on the error, you may see one or more of the following error codes. They are listed in numerical order.

## NDIS Error Codes

Error Code	Explanation and Action
XND0005	<p>No media cable found.</p> <p>The driver could not find an active media cable.</p> <p>Actions</p> <ol style="list-style-type: none"><li>1. Be sure that your EtherJet PC Card is completely inserted into the slot.</li><li>2. Be sure that your cable is attached to the EtherJet PC Card.</li><li>3. Be sure that the media end of the cable is attached to active media.</li></ol>
XND0009	<p>EtherJet Device Driver did not load.</p> <p>The EtherJet PC Card and driver did not successfully load. There should be other messages before this one explaining the failure. Check the screen, or if you are running OS/2, check the LANTRAN.LOG (usually in the \IBMCOM subdirectory) for messages.</p>
XND0022	<p>EEPROM not found, scanning BIOS for configuration.</p> <p>The driver was unable to find the EtherJet PC Card EEPROM.</p> <p>Actions</p> <ul style="list-style-type: none"><li>• Be sure that there are no I/O conflicts if the IOBaseAddress value in PROTOCOL.INI is manually set.</li><li>• If you are using the point enabler (POINTJET.EXE), be sure that each card has a unique IOBASE value assigned for each card.</li><li>• Be sure that the IOBaseAddress value assigned to the EtherJet card does not conflict with other I/O assignments on your system.</li><li>• Try a different PC Card and slot, if possible.</li></ul>
XND0025	<p>EEPROM read failure.</p> <p>See XND0022.</p>
XND0027	<p>EEPROM failed checksum validation.</p> <p>See XND0022.</p>



---

Error Code	Explanation and Action
------------	------------------------

---

XND0028

EtherJet PC Card not found.

The EtherJet driver was unable to find the EtherJet card.

Actions

1. Be sure that the EtherJet card is inserted.
  2. If a specific slot is specified in PROTOCOL.INI, be sure that it matches the slot used.
  3. Be sure that the EtherJet cable is attached to the card (the card is designed to appear inserted only if the cable is attached to it).
  4. Attach the cable to active media.
  5. If the card is point enabled, be sure that the I/O address assigned by POINTJET is the same as that specified in PROTOCOL.INI.
  6. If you specify an I/O address for your card, be sure that there are no conflicts.
- 

XND0029

An EtherJet PC Card failed to initialize.

The EtherJet PC Card and driver did not successfully load. There should be other messages before this one explaining the failure. Check the screen, or if you are running OS/2, check the LANTRAN.LOG (usually in the \IBMCOM subdirectory) for messages.

<b>Error Code</b>	<b>Explanation and Action</b>
XND0030	<p>There was no EtherJet PC Card found.</p> <p>No card was inserted at protocol bind (netbind) time. If you are using the point enabler, the card must be inserted when the enabler is run. If you use Card and Socket Services, the EtherJet PC Card does not need to be inserted until protocol bind time. This message indicated that no card was inserted at protocol bind time.</p> <p>Actions.</p> <ol style="list-style-type: none"><li>1. If using an enabler, the card must be inserted before the enabler is run, and remain inserted (hot-plugging is not possible using an enabler).</li><li>2. If using Card and Socket Services be sure to insert the card before the protocols try to bind to the EtherJet PC Card (try inserting the card at initialization time).</li><li>3. See actions for XND0028.</li></ol>
XND0032	<p>***** No Card Found *****</p> <p>The driver has initialized but a card must be inserted before a protocol attempts to use the EtherJet PC Card.</p> <p>Actions</p> <ol style="list-style-type: none"><li>1. Insert a card before starting a protocol.</li><li>2. If your network software has already started, you may need to restart your system with the card inserted.</li></ol>

Error Code	Explanation and Action
------------	------------------------

XND0080	<p data-bbox="413 272 849 301">Unrecognized PROTOCOL.INI keyword.</p> <p data-bbox="413 318 1013 462">There is an unrecognized value in the EtherJet section of PROTOCOL.INI. A keyword is the lefthand side of an assignment statement. DuplexValue is a keyword and might appear in PROTOCOL.INI as DuplexValue = HDX.</p> <p data-bbox="413 480 1013 537">Action: Review PROTOCOL.INI statements. The only keywords that are valid for the EtherJet section are:</p> <p data-bbox="413 555 1101 749">           NETWORKADDRESS            IOBASEADDRESS            IRQ            SLOT (only if using Card and Socket Services)            DUPLEXMODE            PCMCIA (not valid for OS/2 driver)            NOPCMCIA (not valid for OS/2 driver)         </p>
XND0081	<p data-bbox="413 766 791 795">Invalid PROTOCOL.INI Parameter.</p> <p data-bbox="413 813 1013 956">There is an unrecognized value in the EtherJet section of PROTOCOL.INI. A value is the righthand side of an assignment statement. HDX is a parameter value that might appear in PROTOCOL.INI as DuplexValue = HDX.</p>
XND0082	<p data-bbox="413 974 1013 999">EtherJet DRIVERNAME Not Found in PROTOCOL.INI.</p> <p data-bbox="413 1017 980 1071">The PROTOCOL.INI file does not have a section for EtherJet.</p> <p data-bbox="413 1089 496 1114">Actions</p> <ol data-bbox="428 1132 992 1288" style="list-style-type: none"> <li data-bbox="428 1132 992 1186">1. If you set PROTOCOL.INI up manually, verify the settings.</li> <li data-bbox="428 1204 992 1288">2. If this is not a manual installation, your network install software should initialize PROTOCOL.INI. Try running the installation program again.</li> </ol>

<b>Error Code</b>	<b>Explanation and Action</b>
XND0083	<p>Could not open PROTMAN\$</p> <p>The driver could not open the protocol manager.</p> <p>Actions</p> <ol style="list-style-type: none"><li>1. Be sure the protocol manager is loaded in CONFIG.SYS. For OS/2, the protocol manager driver name is PROTMAN.OS2, for DOS it is normally PROTMAN.DOS.</li><li>2. Be sure that the EtherJet driver is loaded AFTER protocol manager.</li></ol>
XND0084	<p>Could Not Get Info From PROTMAN\$</p> <p>Error retrieving PROTOCOL.INI information from protocol manager.</p>
XND0086	<p>You are loading more than the maximum number of EtherJet drivers.</p> <p>EtherJet supports a maximum of three adapters and drivers. Check your CONFIG.SYS for extra driver statements.</p>
XND0088	<p>Please specify IOBaseAddress in PROTOCOL.INI for each card loaded.</p> <p>If you are using multiple cards, each one is associated with a particular protocol stack via the IOBaseAddress value of PROTOCOL.INI. Be sure to specify an IOBaseAddress for each card used.</p>
XND008F	<p>IOBaseAddress in PROTOCOL.INI does not match any card.</p> <p>The EtherJet device driver cannot find a card with the specified I/O address. If you are using an enabler, be sure that the value you specify in PROTOCOL.INI matches the value specified for the enabler. If you are using Card and Socket Services, be sure that there are no I/O conflicts with other cards.</p>
XND00C1	<p>IBMEXND\$ Not Found in PROTOCOL.INI.</p> <p>Could not find the driver section in PROTOCOL.INI. See XND0082.</p>

<b>Error Code</b>	<b>Explanation and Action</b>
XND00E0	<p>Unable to read EtherJet CIS via Card Services.</p> <p>Error initializing the card via Card and Socket Services.</p> <p>Actions</p> <ol style="list-style-type: none"><li>1. Be sure you have the correct and latest version of Card and Socket Services.</li><li>2. Be sure that there is at least 4 KB of memory available for Card and Socket Services to use for card CIS validation.</li></ol>
XND00E1	<p>Unable to obtain EtherJet I/O assignment via Card Services.</p> <p>There are no I/O resources available for the card.</p> <p>Actions</p> <ol style="list-style-type: none"><li>1. If you specified an IOBaseAddress value in PROTOCOL.INI, there might be a conflict. Try a different value.</li><li>2. There might be no I/O resources available for the EtherJet PC Card. The EtherJet PC Card requires eight, sixteen-bit I/O port values, somewhere in the range of 0200h to 0360h (the default value is 0300h to 030Fh).</li></ol>
XND00E2	<p>Unable to obtain EtherJet IRQ assignment via Card Services.</p> <p>There are no IRQ (interrupt) resources available.</p> <p>Actions</p> <ol style="list-style-type: none"><li>1. If you specified an IRQ value in PROTOCOL.INI, it might not be available.</li><li>2. All available interrupts on your system might be in use. Try freeing up an interrupt and then try again.</li></ol>

<b>Error Code</b>	<b>Explanation and Action</b>
XND00E3	<p>Unable to obtain EtherJet configuration from Card Services.</p> <p>There is an error obtaining resources from Card and Socket Services.</p> <p>Actions</p> <ol style="list-style-type: none"><li>1. Be sure that your Card and Socket Services are set up correctly.</li><li>2. Be sure that you have enough resources available to Card and Socket Services for the EtherJet PC Card.</li></ol>
XND00E4	<p>Unable to communicate with EtherJet PC Card.</p> <p>There is an error communicating with the Ethernet controller on the EtherJet card.</p> <p>Actions</p> <ol style="list-style-type: none"><li>1. This could be caused by an I/O conflict, or having two EtherJet cards mapped to the same I/O space.</li><li>2. Replace the card.</li></ol>
XND00E5	<p>Unknown failure initializing EtherJet PC Card.</p> <p>Actions</p> <ol style="list-style-type: none"><li>1. Try another card.</li><li>2. Get help from your network administrator.</li></ol>

---

## ODI Messages

The following messages can occur during ODI driver installation.

The messages follow this form::

IBMEXNWx-yy-nn

where

x = C refers to Client

x = S refers to Server

yy = DOS refers to the DOS Client, IBMEXNWC.COM

yy = OS/2 refers to the OS/2 Client, IBMEXNWC.OS2

yy = NW refers to the NetWare Server, IBMEXNWS.LAN

IBMEXNWx-yy-1 through IBMEXNWx-yy-36 are standard NetWare client error messages and are self-explanatory.

The following messages are unique to the EtherJet PC Card.

**IBMEINWx-yy-100** The IBM EtherJet PC Card cannot be found

The device driver was unable to locate the PC Card in the system.

If yy=DOS, check the NET.CFG file to see if ENABLE NOPCMCIA is present. If this parameter is present or if yy=NW then either the point enabler, POINTJET.EXE, or the Card Services enabler, CS20JET.EXE, must be used to enable the PC Card.

If you are using the point enabler, ensure that there are no conflicts with the resources, especially the I/O base address, assigned by the point enabler and resources already in use in the system.

Ensure that any I/O addresses specified on the driver command line, in the AUTOEXEC.NCF, or in the NET.CFG files match the I/O address enabled by the point enabler or Card Services enabler.

Ensure that the EtherJet PC Card is firmly seated in its socket and that the cable supplied with the PC Card is attached to it.

**IBMEXNWx-yy-101** The IBM EtherJet PC Card was unable to initialize.

Hardware error. Perform diagnostics.

**IBMEXNWx-yy-102** The IBM EtherJet PC Card could not be reset.

Hardware error. Perform diagnostics.

**IBMEXNWx-yy-103** There are multiple EtherJet PC Cards in the system. Please specify the correct port in NET.CFG.

Multiple EtherJet PC Cards have been detected in the system. You must specify the PORT parameter in the NET.CFG file. This message will be seen only if ENABLE NOPCMCIA is specified in the NET.CFG file.

**IBMEXNWx-yy-104** The EEPROM on the EtherJet PC Card is faulty or not present.

Hardware error. Perform diagnostics.

**IBMEXNWx-yy-105** The EtherJet PC Card failed the loopback test.

The PC Card was unable to transmit and receive a frame during initial testing. Ensure that there are no interrupt conflicts and reload the device driver. Possible hardware error, perform diagnostics.

**IBMEXNWx-yy-107** The EtherJet PC Card failed the media test; please check cable.

The cable was not correctly detected by the device driver. Ensure that the cable is plugged in and you have attached the appropriate accessory cable if you are using the combo cable. Reload the device driver.

**IBMEXNWx-yy-109** Invalid DUPLEXMODE value, HDX (half duplex) will be used.

An incorrect DUPLEXMODE value was entered in NET.CFG. Valid values of duplexmode are FDX (full duplex), HDX (half duplex), and AUTO (auto-negotiation). HDX will be used.



**IBMEXNWx-yy-110** The EtherJet PC Card RAM failed the memory test.

Hardware error. Reload the device driver. If you continue to receive this message contact IBM Support.

**IBMEXNWx-yy-111** The DUPLEXMODE parameter value was invalid or was not entered in uppercase.

This message applies only to the NetWare server driver, IBMEXNWS.LAN.

Each letter of parameter DUPLEXMODE must be in uppercase. Valid values of DUPLEXMODE are FDX (full duplex), HDX (half duplex), and AUTO (auto-negotiation).

**IBMEXNWx-yy-152** EtherJet PC Card MLID will not load because no card services were found.

Card Services was not found. Ensure that Card Services is installed in the computer. If you are using the point enabler, POINTJET.EXE, put ENABLE NOPCMCIA in the NET.CFG.

**IBMEXNWx-yy-153** EtherJet PC Card MLID will not load because Card Services release level is not PCMCIA 2.0 and higher.

Card Services was found but it was an old release. Card Services must be at PCMCIA Release 2.0 or higher.

**IBMEXNWx-yy-154** A Node Address is required to complete startup.

The EtherJet PC Card NetWare OS/2 client requires that a node address be specified in the NET.CFG. The IEEE or burned-in address can be found on the back of the EtherJet PC Card and can be used as the node address. Since the node address is a locally administered address, the device driver will automatically turn the IEEE address into a locally administered address.

**IBMEXNWx-yy-155** Initialization Failure.

A problem was detected during initialization of the device driver. The device driver was unable to initialize. Check other error messages for possible causes.

**IBMEXNWx-yy-156** The Node Address specified matches a multicast address.

The node address specified in NET.CFG is a multicast address. The node address parameter is required for the EtherJet PC Card. Since the node address must be a locally administered address, the device driver will automatically change the multicast address to a locally administered address.

**IBMEXNWx-yy-200** Looking for Card Services.

Information message to show progress of device driver initialization.

**IBMEXNWx-yy-201** Card Services found.

Information message to show progress of device driver initialization.

**IBMEXNWx-yy-203** Registering the EtherJet PC Card MLID with Card Services.

Information message to show progress of device driver initialization.

**IBMEXNWx-yy-204** EtherJet PC Card MLID loaded, but no EtherJet PC Card was found or the EtherJet PC Card was not in the slot specified in NET.CFG.

If there is no EtherJet PC Card in the computer then this is an informational message.

If there is an EtherJet PC Card in the computer and you expected it to be found, check the following:

- Ensure that the EtherJet PC Card is firmly seated in its socket and that the cable supplied with the PC Card is attached to it.
- If you specified a SLOT parameter in the NET.CFG, make sure that the PC Card is inserted in that slot. The first logical socket in the computer has a SLOT value of 1, the second logical socket in the computer has a SLOT value of 2, and so on.

- If you also received message IBMEXNWC-DOS-206, a card was found but it was not available for use by this driver. Try specifying the SLOT parameter in NET.CFG. Ensure that you are not using CS20JET.EXE. CS20JET.EXE is not required for this device driver.

**IBMEXNWx-yy-206** EtherJet PC Card in requested socket is not available.

The EtherJet PC Card is being exclusively used by another device driver or another instance of IBMEXNWC.COM. If you are using multiple EtherJet PC Cards in a card services environment make sure that you specify the SLOT parameter in each LINK DRIVER IBMEXNWC section in the NET.CFG file.

**IBMEXNWx-yy-207** No IO ports available or PORT specified in NET.CFG not available.

The PORT value specified in the NET.CFG file is not available. Try another PORT value or do not specify a port value and Card Services will assign an available I/O base address.

This message is not valid if ENABLE NOPCMCIA is specified in the NET.CFG for this driver. No message will be displayed if there is an I/O conflict.

**IBMEXNWx-yy-208** No interrupts available or INT specified in NET.CFG not available.

The INT value specified in the NET.CFG is not available, try another INT value or do not specify an interrupt and Card Services will assign an available interrupt. If you did not specify an INT in the NET.CFG then there are no interrupts available for use by the EtherJet PC Card.

This message is not valid if ENABLE NOPCMCIA is specified in the NET.CFG for this driver. No message will be displayed if there is an interrupt conflict.

**IBMEXNWx-yy-209** Error requesting configuration from Card Services.

Card Services could not configure the PC Card. Check other error messages for possible causes.

**IBMEXNWx-yy-210** Unable to establish communication with the Ethernet controller on the PC Card.

Possible hardware error. Perform diagnostics. If you continue to get this error, update your Card and Socket Services to the latest version.

**IBMEXNWx-yy-211** There are multiple EtherJet PC Cards in the system. Specify slot in NET.CFG.

In order to use multiple EtherJet PC Cards you must specify the slot number for each card in NET.CFG.

This message applies to the DOS client, yy=DOS, device driver.

**IBMEXNWx-yy-212** EtherJet PC Card MLID will not load because the EtherJet PC Card failed initialization.

Possible hardware error. Perform diagnostics. If you continue to get this error, update your Card and Socket Services to the latest version.

**IBMEXNWx-yy-213** INT value set in NET.CFG ignored. The interrupt supplied on the point enabler command line will be used.

The interrupt allocated by the point enabler will be used automatically, the INT value specified in NET.CFG is ignored.

**IBMEXNWx-yy-214** More than one EtherJet PC Card defined in NET.CFG. You must specify SLOT for each in NET.CFG.

More than one instance of IBMEXNWC was specified in the NET.CFG. You must specify the SLOT parameter for each instance of the LINK DRIVER IBMEXNWC in NET.CFG. None of the PC Cards will remain operational.

This message applies on to the OS/2 client, yy=OS/2, device driver.

**IBMEXNWx-yy-215** More than two LINK DRIVER IBMEXNWC sections in NET.CFG. Entry not used.

Only two EtherJet PC Cards are supported with the OS/2 client driver, IBMEXNWC, but more than two PC Cards were defined in the NET.CFG.

This message applies to the OS/2 client, yy=OS/2, device driver.

**IBMEXNWx-yy-220** The driver is unable to initialize.

The device driver was unable to initialize. Check other error messages for possible causes.

**IBMEXNWx-yy-229** Incorrect BUSID detected. BUSID must be 3 for PCMCIA.

The EtherJet PC Card must be installed in a PCMCIA or PC Card socket.

**IBMEXNWx-yy-251** Response to registration request not received from Card Services.

The device driver did not receive a response to the registration request. Check other error messages for possible causes.

**IBMEXNWx-yy-252** Registration with Card Services successful.

Information message to show progress of device driver initialization.

**IBMEXNWC-yy-253** Could not read card identification information.

A PC Card was inserted, but the device driver could not read card identification information from the PC Card. If the EtherJet PC Card was inserted, the device driver will not be able to find the EtherJet PC Card. Refer to your card and socket services documentation to verify that card and socket services is installed correctly.

## OS/2 Client NetWare Driver Pop Up Messages

***EtherJet PC Card AttachDD to Card Services failed:*** Could not attach to Card Services. Check other error messages. Verify that Card and Socket Services and the resource manager are installed correctly. Refer to your OS/2 documentation for information on installing Card and Socket Services.

***EtherJet PC Card Device Driver cannot find Card Services:*** Card Services was not found. Ensure that Card Services is installed in the computer. Refer to your OS/2 documentation for information on installing Card and Socket Services.

***EtherJet PC Card RegisterClient failed:*** Could not register client with Card Services. Check other error messages for possible causes.

***EtherJet PC Card GetFirstTuple failed:*** Could not read information from the card. Check other error messages.

***EtherJet PC Card GetTupleData failed:*** Could not read information from the card. Check other error messages.

***EtherJet PC Card RequestIRQ failed:*** The INT value specified in the NET.CFG is not available, try another INT value or do not specify an interrupt and Card Services will assign an available interrupt. If you did not specify an INT in the NET.CFG then there are no interrupts available for use by the EtherJet PC Card.

This message is not valid if ENABLE NOPCMCIA is specified in the NET.CFG for this driver. No message will be displayed if there is an interrupt conflict.

***EtherJet PC Card RequestIO for Ethernet failed:*** The PORT value specified in the NET.CFG is not available, try another PORT value or do not specify a port value and Card Services will assign an available I/O base address.

This message is not valid if ENABLE NOPCMCIA is specified in the NET.CFG for this driver. No message will be displayed if there is an I/O conflict.

***EtherJet PC Card RequestConfiguration failed:*** Card Services could not configure the PC Card. Check other error messages for possible causes.

---

## Point Enabler Messages

Error Code	Explanation and Action
JET0001I	<p>IBM EtherJet PC Card Point Enabler Version x.xx</p> <p>This message is the sign-on banner. x.xx is the level of the driver.</p>
JET0002E	<p>The PCMCIA Socket Controller is NOT Intel-compatible.</p> <p>This message is displayed if the socket controller on your machine is not Intel 82365SL-compatible, or if the specified socket does not exist.</p>
JET0003E	<p>There is no PC card in the specified slot.</p> <p>This message is displayed if the specified slot exists but does not contain a card or an EtherJet cable is not attached to the card. Make sure the PC Card is fully inserted.</p>
JET0004E	<p>Card in specified slot is not an IBM EtherJet PC Card.</p> <p>There can be several reasons for this message:</p> <ol style="list-style-type: none"> <li>1. The PC Card in the slot you specified is not an EtherJet PC Card.</li> <li>2. Phantom slot. Socket controllers generally support up to 4 slots each, but laptops may have only 2 physical slots (for example, you specify SD on a laptop with 2 slots). The enabler is unable to detect and report this situation.</li> <li>3. Possible memory conflict. Try changing the SRAM parameter of POINTJET to a different value.</li> <li>4. The card is defective (CIS unreadable or damaged).</li> </ol>
JET0005E	<p>Unrecognized parameter entered on the command line.</p> <p>An unrecognized parameter was entered on the command line. This should be followed by a short help on the syntax.</p>

<b>Error Code</b>	<b>Explanation and Action</b>
JET0006I	POINTJET.EXE command format: This is the help message, giving the command line syntax.
JET0007E	Invalid parameter value specified for SRAM=xxxx SRAM parameter was entered incorrectly. Enter it in the form SRAM=xxxx using your chosen value. Enter the value in hexadecimal without spaces.
JET0008E	Invalid parameter value specified for IOBASE=xxx The IOBASE parameter was entered incorrectly. Enter it in the form IOBASE=300 without spaces or other characters.
JET0009E	Invalid parameter value specified for IRQ=x The IRQ parameter was entered incorrectly. Enter it in the form IRQ=A for interrupt ten (in hexadecimal format).
JET0011E	Error - Unable to communicate with the EtherJet controller. The Ethernet controller on the card is not responding. There could be an I/O conflict, or the card could be bad.
JET0015I	Card enabled successfully. Card enabled and ready for use by device drivers.





---

## Appendix D. Using a Memory Manager in DOS

If your computer comes with a memory manager preinstalled, or if you would like to use one, you must ensure that the memory manager does not use memory used by the point enabler or Card and Socket Services (depending on which you use).

To determine whether your computer uses a memory manager, edit your CONFIG.SYS file and look for the memory manager driver name. For example, when using EMM386, look for the line:

```
DEVICE=C:\DOS\EMM386.EXE...
```

The following sections describe what to do for a point enabler environment and for a Card and Socket Services environment. You may also need to reference documentation for your particular memory manager and your computer's operating manual.

---

### Memory Managers with a Point Enabler

The EtherJet point enabler (POINTJET.EXE) uses a 4-KB memory area to initialize the PC Card. Although this memory is returned after the PC Card is initialized, there must be no conflicts during execution of the point enabler.

Since the EtherJet point enabler needs memory for only a brief period to enable the PC Card, one way to avoid conflict is to run the enabler early in CONFIG.SYS before loading memory managers (or other programs that might cause conflicts). The advantage to this approach is that the memory area is used briefly by the enabler, and then is available for normal system use (instead of remaining reserved during system operation).

Another way to avoid memory conflicts is to tell the memory manager not to use the memory area used by the enabler, as in the following CONFIG.SYS example (using emm386 as the memory manager).

```
DEVICE=C:\POINTJET.EXE SA SRAM=D000 IRQ=9 IOBASE=300
```

```
.
```

```
DEVICE=C:\DOS\HIMEM.SYS
```

```
.
```

```
DEVICE=C:\DOS\EMM386.EXE 1024 RAM X=D000-D0FF
```

Notice that the EMM386 line excludes the ranges that the POINTJET.EXE enabler uses with the X= parameter.

---

## Memory Managers with Card and Socket Services

1. To prevent duplicate use of a memory location, the area used by your PC Card must be excluded from the memory manager. To do this, you must edit your CONFIG.SYS file. In certain environments, the installation program will add the exclude statement automatically.

The EtherJet PC Card does not use memory during operation, but Card Services normally needs 4 KB excluded for its use.

2. Card Services and memory managers typically do not talk to each other. You must tell them what areas can be used. For example, with IBM Card Services the /MA option is used to tell Card Services what memory range it can use for PC Cards. It also uses some of this area for itself. That same /MA range must be excluded from the memory manager line. This will prohibit the memory manager from also using that same space.

When using IBM Card Services, the /MA is used to specify the range of memory the PC Cards and Card Services use. The parameter is added to the Resource Map Utility line in your CONFIG.SYS. For example:

- Using IBM Card Services:

On a 720 computer using memory range C0000–CFFFF

```
DEVICE=C:\DOS\EMM386.EXE NOEMS X=C000-CFFF
```

```
.
```

```
DEVICE=C:\DOS\DICRMU02.SYS /MA=C000-CFFF
```

The Resource Map Utility driver name may be slightly different for the various computers. Consult your operating manual.

- Using Phoenix Card Services with the /ADDR option:

For some versions of Phoenix Card Services, the /ADDR parameter is used to specify the 4-KB memory range used by Card Services. The memory range chosen for the PC Cards must not conflict with this range. The /ADDR parameter is placed on the Phoenix device driver line in the CONFIG.SYS file. Consult your operation manual as to the version you have and whether the /ADDR option is needed.

**Note:** The /ADDR needs only the starting address of the Card Services memory area.

On a 350 computer using memory range D0000–DFFFF

```
DEVICE=C:\DOS\EMM386.EXE NOEMS X=D000-DFFF
```

```
.
```

```
DEVICE=C:\PCPLUS\PCMCS.EXE /WAIT=12 /ADDR=D0 /IRQ=9
```

### 3. General Rules:

#### IBM Card Services

- a. The memory area used by PC Cards must fall within the range specified by /MA.
- b. The memory area used by Card Services itself (4 KB) must be included in the /MA range.
- c. All of the /MA range must be excluded from your memory manager line.

## Phoenix\*\* Card Services

- a. The memory used by Card Services starting at the /ADDR address and the memory used by the PC Card should be excluded from the memory manager line.
- b. If the /ADDR line is not used, the driver will use the first available address on a 4-KB boundary for Card Services. The memory manager line must exclude this area and the PC Card memory area.

---

## Expanded Memory Specification

Expanded memory specification (EMS) requires 64 KB (one page frame) of contiguous memory. This may cause you to move your PC Card memory range. With EMM386 you set the page frame base address using the FRAME= option on the memory manager line in the CONFIG.SYS. If the FRAME= option is not used, EMM386 will find the first 64-KB block of contiguous memory. For example:

1. Using a point enabler with the PC Card at D0000–D0FFF, the C0000–CFFFF range is free for the EMS page. A sample memory manager line in your CONFIG.SYS is:

```
DEVICE=C:\DOS\EMM386.EXE RAM 1024 X=D000-D0FF FRAME=C000
```

**Note:** The FRAME= parameter sets the base address of the EMS page frame (the page frame uses C0000–CFFFF). So, no PC Cards should be set to use memory in the range C0000–CFFFF.

2. Using IBM Card Services, you can set the /MA option such that a 64-KB block is free for the EMS page frame. A sample memory manager line in your CONFIG.SYS is:

```
DEVICE=C:\DOS\EMM386.EXE RAM 1024 X=D000-D0FF FRAME=C000
```

```
·  
·
```

```
DEVICE=C:\DICRMU01.SYS /MA=D000-D0FF
```

**Note:** Because of the /MA option, IBM CS will use memory in the range D0000–D0FFF only. The FRAME= parameter sets the base address of the EMS page frame (the page frame uses



C0000–CFFFF). So, no PC Cards should be set to use memory in the range C0000–CFFFF.





## Appendix E. Desktop Management Interface

The Desktop Management Interface (DMI) is a standard framework for managing the information provided by the components of PC systems. DMI was created by the Desktop Management Task Force (DMTF). The DMTF is a cooperative, industry-wide effort formed to bring management, ease of use, and control to PC systems.

The DMI architecture utilizes a service layer, a local program that collects information from the components of the PC system and passes the information to management applications. The IBM LAN adapter instrumentation couples the adapter's device driver to the service layer.

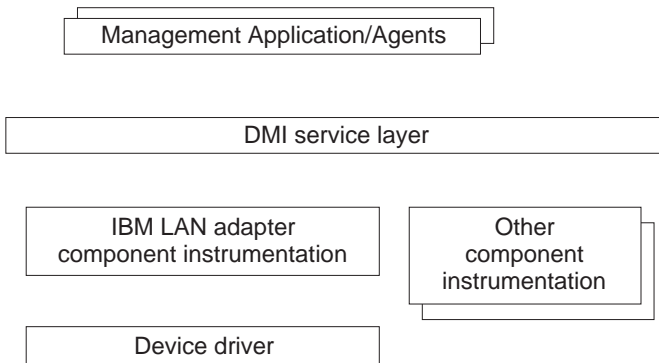

For additional information about the DMTF or DMI, refer to URL <http://www.dmtf.org>.

### LAN Adapter Instrumentation for OS/2

The IBM LAN adapter instrumentation is implemented as a protocol stack in OS/2. Currently, the protocol stack supports NDIS 2 device drivers. The protocol stack implementation allows the instrumentation to get and set attributes for any IBM NDIS 2 device driver without requiring changes to the device driver.

Information about acquiring the OS/2 DMI service layer and management applications can be found at URL



**<http://www.software.ibm.com/sysman/download>**. The IBM LAN adapter instrumentation for OS/2 is on Diskette 1, Device Drivers in the \DMI\OS2 directory.

### **Automatic Installation**

The IBM LAN adapter instrumentation can be installed like any other protocol stack by using MPTS. Follow these steps.

1. Start MPTS (double-click the MPTS icon).
2. Select **Configure**.
3. Select **Configure** again.
4. Select **Other protocols....**
5. When prompted for an installation diskette, insert Diskette 1, Device Drivers. Change from the default directory of A:\ to A:\DMI\OS2, and then press **Enter**. The files will be copied to the system.
6. Bind the IBM LAN adapter instrumentation protocol for the adapters you want managed via DMI, by selecting **Add**. Select **OK** when you have finished.
7. Exit the MPTS installation process.

**Note:** The installation procedure copies MACDMI2.EXE and MACDMI.MIF to the \IBMCOM\PROTOCOL directory, which is not usually in the PATH statement. You must ensure that these files reside in a directory that is in your PATH.

### **Manual Installation**

The IBM LAN adapter instrumentation can be also be installed manually by following these steps.

1. Install the executable (MACDMI2.EXE) and its files: Copy MACDMI2.EXE and MACDMI.MIF to a directory included in your PATH statement.
2. Install the protocol driver (MACDMI.OS2) and its files. The following example uses <dmipath> to represent the install directory.
  - a. Copy MACDMI.OS2, MACDMI.NIF, MDM.MSG and MDMH.MSG to <dmipath>.

- b. Ensure that <dmipath> is in your DPATH statement.
- c. Update your CONFIG.SYS file to contain the entry:  

```
DEVICE=C:<dmipath>\MACDMI.OS2
```
- d. Add a section to your system's PROTOCOL.INI file for the IBM LAN adapter instrumentation  

```
[MACDMI]  
DRIVERNAME = MACDMI$
```
- e. Add a bindings entry to the system's PROTOCOL.INI file to indicate which NDIS 2 drivers you want to be managed by DMI. An example of a complete PROTOCOL.INI entry would be:

```
[MACDMI]  
DRIVERNAME = MACDMI$  
Bindings = IBMEXNDI_nif
```

### Starting the IBM LAN Adapter Instrumentation

The IBM LAN adapter instrumentation, MACDMI2.EXE, can be started at an OS/2 command prompt, with the RUN command in CONFIG.SYS or with the START command. The OS/2 DMI service layer must be started before the instrumentation.

The first time the instrumentation runs, it will install the IBM LAN adapter components into the OS/2 service layer's database. The instrumentation displays messages indicating the status of the procedure.

If you want to change the LAN adapter that is to be managed, just go into MPTS and bind the IBM LAN adapter instrumentation protocol to the adapters you want managed. The next time the instrumentation is started, it will install (if necessary) additional LAN adapter components into the OS/2 service layer's database.

## **IBM LAN Adapter Instrumentation Messages**

Look in LANTRAN.LOG for error messages from MACDMI.OS2. Use the OS/2 Help Facility to get additional information on any MDMxxxxx error messages reported by MACDMI2.EXE or MACDMI.OS2. For example: enter **help MDM0041**.

## **Managing IBM LAN Adapters Locally**

Once the OS/2 DMI service layer and the IBM LAN adapter instrumentation have been started, the management information file (MIF) browser can be used to view and set LAN adapter attributes.

## **LAN Adapter Instrumentation for NT**

The IBM LAN adapter instrumentation is implemented as a ring-3 executable program in NT. The executable program supports NDIS 3 device drivers. The instrumentation allows users to retrieve attributes for any IBM NDIS 3 device driver without requiring changes to the device driver.

Information about acquiring the Win32 DMI service layer and management applications can be found at URL

**<http://www.software.ibm.com/sysman/download>**. The IBM LAN adapter instrumentation for NT is on &drvrdisk. in the \DMI\NT directory.

## **Installation**

Copy all the files from A:\DMI\NT to the desired directory on your system.

## **Starting the IBM LAN Adapter Instrumentation**

The IBM LAN adapter instrumentation for NT, MACDMINT.EXE, can be started like any other executable file. The NT DMI service layer must be started before the instrumentation.

The first time the instrumentation runs it will install the IBM LAN adapter components into the NT service layer's database. The instrumentation displays messages indicating the status of the procedure.

The instrumentation will manage all the LAN adapters in the system.

## **IBM LAN Adapter Instrumentation Messages**

The IBM LAN adapter instrumentation will display messages on the screen.

### **Managing IBM LAN Adapters Locally**

Once the Win32 DMI service layer and the IBM LAN adapter instrumentation have been started, the management information file (MIF) browser can be used to view LAN adapter attributes.

## **SNMP Management of IBM LAN Adapters**

The IBM LAN adapter instrumentation can be managed by an SNMP agent, using the DMI subagent in the system. The DMI subagent translates a MIB variable into the corresponding DMI MIF attribute. In order to manage the IBM LAN adapters using SNMP, follow the steps outlined below for the end station and the manager's station.

These are the files necessary to use SNMP to manage IBM LAN adapters. The files are all located on the diskette in the \DMISNMPMGRS directory.

- MACDMI.MAP—mapping file fragment, correlates SNMP object identifier (OID) to DMI component.
- MACDMI.MIB—SNMP MIB file that describes the manageable attributes of the IBM LAN adapters.
- MACDMI.DEF—MIB definition file that describes attributes of IBM LAN adapters. Used in NetView for Windows.

### **End Station Setup**

- OS/2 End Station

Copy the contents of the MACDMI.MAP file to the DMISA.MAP mapping file. The mapping file provides the correlation between the SNMP OID and the DMI component. The mapping file is located in the directory <netview\_path>\BINAGENT, where <netview\_path> is an environment variable defined during installation.

Start these programs: SNMP agent (SNMPD.EXE), DMI subagent (DMISA.EXE), and the LAN adapter instrumentation (MACDMI2.EXE).

- NT End Station

Copy the contents of the MACDMI.MAP file to the DMISA.MAP mapping file. The mapping file provides the correlation between the SNMP OID and the DMI component. The mapping file is located in the directory <netview\_path>\BIN\AGENT, where <netview\_path> is an environment variable defined during installation.

Start these programs: SNMP agent (SNMPD.EXE), DMI subagent (DMISA32.EXE), and the LAN adapter instrumentation (MACDMINT.EXE).

### Manager's Station Setup

- NetView for Windows

The MIB Browser operates on the MIB definition file (MACDMI.DEF) that defines the structure of the MIB. The default path for this file is the <install\_dir>\BIN\DEF\_FILE directory. The default <install\_dir> is NVWIN.

Copy MACDMI.DEF to the <install\_dir>\BIN\DEF\_FILE directory and copy MACDMI.MIB to the <install\_dir>\BIN\MIBS directory.

To view the LAN adapter attributes, use the MIB Browser function and the **Load MIB Tree** option to load the MIB definition file (MACDMI.DEF). This will display the tree of MIB attributes that represent the LAN adapter. Double-click any MIB attribute to obtain its value. Double-click a second time to graph the value; this would be useful for an attribute such as Ring Utilization.

- NetView for AIX

The MIB Browser operates directly on the MIB file (MACDMI.MIB). Copy MACDMI.MIB to the \usr\OV\snmp\_mibs directory. To load the MIB: start NetView for AIX, select **OPTIONS** and then the **LOAD/UNLOAD MIB** option.

To view the LAN adapter attributes, select **TOOLS** and then the **MIB Browser** option. Use the **Down Tree** option to traverse the MIB tree and locate the LAN adapter attributes. The path through the MIB tree is:

```
internet->private->enterprises->ibm->  
  ibmArchitecture->ibmDmi->mibsFromMifs->  
    ibmLanAdapter->dmtfGroups
```

Click on **Start Query** to obtain the value of a MIB attribute.



---

## **Appendix F. Help and Service Information**

If you need warranty service, return or exchange is available. In addition, if your IBM option is installed in an IBM computer, you might be entitled to service at your location. Your technical support representative can help you determine the best alternative.

Before calling, please prepare for your call by following these steps.

---

### **Step 1: Preparing for the Call**

To assist the technical support representative, have available as much of the following information as possible:

1. Option name, description, and serial number (if any)
2. Proof of purchase
3. Computer manufacturer, model, serial number (if IBM), and manual
4. Exact wording of the error message (if any)
5. Description of the problem
6. Hardware and software configuration information for your system

If possible, be at your computer. Your technical support representative might want to walk you through the problem during the call.

---

### **Step 2: Placing the Call to IBM**

Use one of the following numbers:

- Within the United States, call the PC HelpCenter at 1-800-426-7299.
- Within Canada
  - For support, call HelpPC at 1-800-565-3344.
  - For more information or to place an order, call 1-800-465-7999.





- Outside the United States and Canada, contact IBM, your place of purchase, or your local branch office.

## Getting Help

If you have run tests and are still having trouble with the PC Card, contact IBM:

### IBM Product Support

**1-800-426-7299** Options by IBM HelpCenter

**1-800-237-5511** IBM Support Services

**1-800-772-2227** IBM PC Help Center

**1-800-565-3344** HelpPC (Canada)

### IBM PC Company BBS

For new or updated version of the installation code or the drivers:

**United States** (919) 517-0001 (directory 32)

**Vancouver** (604) 664-6464

**Toronto** (416) 956-7877

**Montreal** (514) 938-3022

**Winnipeg** (204) 934-2735

**Markham** (905) 316-4255

**Halifax** (902) 420-0300

You can download the code from the BBS or the Internet. If you are outside the United States or Canada, contact your IBM marketing representative.

### World Wide Web

Anonymous ftp to [lansupport.raleigh.ibm.com](ftp://lansupport.raleigh.ibm.com)

On a web browser:

**The IBM Networking Home Page** <http://www.raleigh.ibm.com/>

**The IBM PC Company Home Page** <http://www.pcco.ibm.com/>





## Appendix G. Parts Information

To order PC Card parts, contact your IBM marketing representative or your place of purchase.

Table G-1. Part Numbers

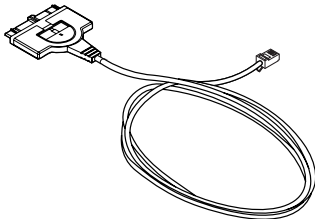
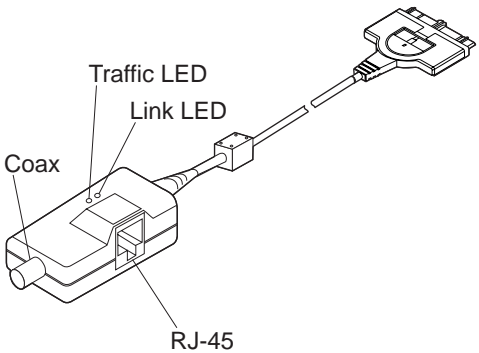
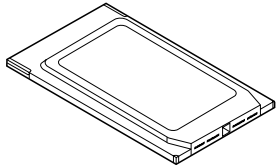
Part Number	Description	Diagram
72H5165	10BASE-T PC Card Cable	
72H5166	10BASE-T/10BASE2 Combo Cable	
72H5163	PC Card	





---

## Appendix H. Product Warranty and Notices

This appendix contains the product warranty, notices, and trademarks.

---

### Product Warranty



International Business Machines Corporation Armonk, NY 10504

---

#### Statement of Limited Warranty

*The warranties provided by IBM in this Statement of Limited Warranty apply only to Machines you originally purchase for your use, and not for resale, from IBM or an IBM authorized reseller. The term "Machine" means an IBM machine, its features, conversions, upgrades, elements, or accessories, or any combination of them. Machines are subject to these terms only if purchased in the United States or Puerto Rico, or Canada, and located in the country of purchase. If you have any questions, contact IBM or your reseller.*

**Machine** EtherJet PC Card

**Warranty Period\*** Lifetime

*\*Elements and accessories are warranted for three months. Contact your place of purchase for warranty service information.*

#### Production Status

Each Machine is manufactured from new parts, or new and serviceable used parts (which perform like new parts). In some cases, the Machine may not be new and may have been previously installed. Regardless of the Machine's production status, IBM's warranty terms apply.

## The IBM Warranty

IBM warrants that each Machine 1) is free from defects in materials and workmanship and 2) conforms to IBM's Official Published Specifications. IBM calculates the expiration of the warranty period from the Machine's Date of Installation. The date on your receipt is the Date of Installation, unless IBM or your reseller informs you otherwise.

During the warranty period, IBM or your reseller will provide warranty service under the type of service designated for the Machine and will manage and install engineering changes that apply to the Machine. IBM or your reseller will specify the type of service.

For a feature, conversion, or upgrade, IBM or your reseller may require that the Machine on which it is installed be 1) the designated, serial-numbered Machine and 2) at an engineering-change level compatible with the feature, conversion, or upgrade. Some of these transactions (called "Net-Priced" transactions) may include additional parts and associated replacement parts that are provided on an exchange basis. All removed parts become the property of IBM and must be returned to IBM.

Replacement parts assume the remaining warranty of the parts they replace.

If a Machine does not function as warranted during the warranty period, IBM or your reseller will repair or replace it (with a Machine that is at least functionally equivalent) without charge. If IBM or your reseller is unable to do so, you may return it to your place of purchase and your money will be refunded.

If you transfer a Machine to another user, warranty service is available to that user for the remainder of the warranty period. You should give your proof of purchase and this Statement to that user.

## Warranty Service

To obtain warranty service for the Machine, you should contact your reseller or call IBM. In the United States, call IBM at **1-800-426-7299**. In Canada, call IBM at **1-800-565-3344**. You may be required to present proof of purchase.

Depending on the Machine, the service may be 1) a "Repair" service at your location (called "On-site") or at one of IBM's or a reseller's service locations (called "Carry-in") or 2) an "Exchange" service, either On-site or Carry-in.

When a type of service involves the exchange of a Machine or part, the item IBM or your reseller replaces becomes its property and the replacement becomes yours. The replacement may not be new, but will be in good working order and at least functionally equivalent to the item replaced.

It is your responsibility to:

1. obtain authorization from the owner (for example, your lessor) to have IBM or your reseller service a Machine that you do not own;
2. where applicable, before service is provided —
  - a. follow the problem determination, problem analysis, and service request procedures that IBM or your reseller provide,
  - b. secure all programs, data, and funds contained in a Machine,
  - c. inform IBM or your reseller of changes in a Machine's location, and
  - d. for a Machine with exchange service, remove all features, parts, options, alterations, and attachments not under warranty service. Also, the Machine must be free of any legal obligations or restrictions that prevent its exchange; and
3. be responsible for loss of, or damage to, a Machine in transit when you are responsible for the transportation charges.

## Extent of Warranty

IBM does not warrant uninterrupted or error-free operation of a Machine.

Misuse, accident, modification, unsuitable physical or operating environment, improper maintenance by you, or failure caused by a product for which IBM is not responsible may void the warranties.

THESE WARRANTIES REPLACE ALL OTHER WARRANTIES, EXPRESS OR IMPLIED, INCLUDING, BUT NOT LIMITED TO, THE IMPLIED WARRANTIES OF MERCHANTABILITY AND FITNESS FOR A PARTICULAR PURPOSE. HOWEVER, SOME LAWS DO NOT ALLOW THE EXCLUSION OF IMPLIED WARRANTIES. IF THESE LAWS APPLY, THEN ALL EXPRESS AND IMPLIED WARRANTIES ARE LIMITED IN DURATION TO THE WARRANTY PERIOD. NO WARRANTIES APPLY AFTER THAT PERIOD.

In Canada, warranties include both warranties and conditions.

Some jurisdictions do not allow limitations on how long an implied warranty lasts, so the above limitation may not apply to you.

## Limitation of Liability

Circumstances may arise where, because of a default on IBM's part (including fundamental breach) or other liability (including negligence and misrepresentation), you are entitled to recover damages from IBM. In each such instance, regardless of the basis on which you are entitled to claim damages, IBM is liable only for:

1. bodily injury (including death), and damage to real property and tangible personal property; and
2. the amount of any other actual loss or damage, up to the greater of \$100,000 or the charge for the Machine that is the subject of the claim.

Under no circumstances is IBM liable for any of the following:

1. third-party claims against you for losses or damages (other than those under the first item listed above);
2. loss of, or damage to, your records or data; or
3. economic consequential damages (including lost profits or savings) or incidental damages, even if IBM is informed of their possibility.

Some jurisdictions do not allow the exclusion or limitation of incidental or consequential damages, so the above limitation or exclusion may not apply to you.

This warranty gives you specific legal rights and you may also have other rights which vary from jurisdiction to jurisdiction.

---

## Notice

References in this publication to IBM products, programs, or services do not imply that IBM intends to make these available in all countries in which IBM operates. Any reference to an IBM product, program, or service is not intended to state or imply that only IBM's product, program, or service may be used. Any functionally equivalent product, program, or service that does not infringe any of IBM's intellectual property rights may be used instead of the IBM product, program, or service. Evaluation and verification of operation in conjunction with other products, programs, or services, except those expressly designated by IBM, are the user's responsibility.

IBM may have patents or pending patent applications covering subject matter in this document. The furnishing of this document does not give you any license to these patents. You can send license inquiries, in writing, to the IBM Director of Licensing, IBM Corporation, 500 Columbus Avenue, THORNWOOD NY 10594 USA.

---

## Notice to Users in the United Kingdom

The United Kingdom Telecommunications Act 1984. This apparatus is approved under General Approval number NS/G/1234/J/100003 for indirect connections to public telecommunications systems in the United Kingdom.

---

## Electronic Emission Notices

### Federal Communications Commission (FCC) Statement

**Note:** This equipment has been tested and found to comply with the limits for a Class B digital device, pursuant to Part 15 of the FCC Rules. These limits are designed to provide reasonable protection against harmful interference in a residential installation. This equipment generates, uses, and can radiate radio frequency energy and, if not installed and used in accordance with the instructions, may cause harmful interference to radio communications. However, there is no guarantee that interference will not occur in a particular installation. If this equipment does cause harmful interference to





radio or television reception, which can be determined by turning the equipment off and on, the user is encouraged to try to correct the interference by one or more of the following measures:

- Reorient or relocate the receiving antenna.
- Increase the separation between the equipment and receiver.
- Connect the equipment into an outlet on a circuit different from that to which the receiver is connected.
- Consult an IBM authorized dealer or service representative for help.

Properly shielded and grounded cables and connectors must be used in order to meet FCC emission limits. Proper cables and connectors are available from IBM authorized dealers. IBM is not responsible for any radio or television interference caused by using other than recommended cables and connectors or by unauthorized changes or modifications to this equipment. Unauthorized changes or modifications could void the user's authority to operate the equipment.

This device complies with Part 15 of the FCC Rules. Operation is subject to the following two conditions: (1) this device may not cause harmful interference, and (2) this device must accept any interference received, including interference that may cause undesired operation.

### **Industry Canada Class B Emission Compliance Statement**

This Class B digital apparatus meets the requirements of the Canadian Interference-Causing Equipment Regulations.

### **Avis de conformité aux normes d'Industrie Canada**

Cet appareil numérique de la classe B respecte toutes les exigences du Règlement sur le matériel brouilleur du Canada.



## **European Community (EC) Mark of Conformity Statement**

This product is in conformity with the protection requirements of EC Council Directive 89/336/EEC on the approximation of the laws of the Member States relating to electromagnetic compatibility. IBM cannot accept responsibility for any failure to satisfy the protection requirements resulting from a non-recommended modification of the product, including the fitting of non-IBM option cards.

This product has been tested and found to comply with the limits for Class B Information Technology Equipment according to CISPR 22 / European Standard EN 55022. The limits for Class B equipment were derived for typical residential environments to provide reasonable protection against interference with licensed communication devices.

Dieses Gerät ist berechtigt in Übereinstimmung mit dem deutschen EMVG vom 9.Nov.92 das EG-Konformitätszeichen zu führen. Der Außsteller der Konformitätserklärung ist die IBM UK Ltd., PO Box 30, Spango Valley, Greenock, Scotland PA16 OAH.

Dieses Gerät erfüllt die Bedingungen der EN 55022 Klasse B.

## **Japanese Voluntary Control Council for Interference (VCCI) Statement**

This equipment is in the 2nd Class category (information equipment to be used in a residential area or an adjacent area thereto) and conforms to the standards set by the Voluntary Control Council for Interference by Information Technology Equipment aimed at preventing radio interference in such residential areas.

When used near a radio or TV receiver, it may become the cause of radio interference.

Read the instructions for correct handling.



## 情報処理装置等電波障害自主規制協議会 (VCCI) 表示

この装置は、第二種情報装置(住宅地域又はその隣接した地域において使用されるべき情報装置)で住宅地域での電波障害防止を目的とした情報処理装置等電波障害自主規制協議会 (VCCI) 基準に適合しております。

しかし、本装置をラジオ、テレビジョン受信機に近接してご使用になると、受信障害の原因となることがあります。

取扱説明書に従って正しい取り扱いをして下さい。

---

## Trademarks

The following terms are trademarks of IBM Corporation in the United States or other countries or both:

EtherJet	HelpCenter
HelpWare	IBM
Micro Channel	Operating System/2
OS/2	ThinkPad

Windows is a trademark or registered trademark of Microsoft Corporation.

Other company, product, and service names, which may be denoted by a double asterisk (\*\*), may be trademarks or service marks of others.



---

## Appendix I. List of Abbreviations

<b>BBS</b>	Bulletin Board System
<b>BNC</b>	Bayonet Niell-Concelman
<b>DLC</b>	Data link control
<b>DLS</b>	DOS LAN Services
<b>DMA</b>	Direct memory access
<b>DMI</b>	Desktop Management Interface
<b>DMTF</b>	Desktop Management Task Force
<b>DOS</b>	Disk Operating System
<b>GUI</b>	Graphical user interface
<b>IEEE</b>	Institute of Electrical and Electronics Engineers
<b>IPX</b>	Internetwork Packet eXchange
<b>IRQ</b>	Interrupt Request
<b>KB</b>	Kilobytes
<b>LAN</b>	Local area network
<b>LAPS</b>	LAN Adapter and Protocol Support
<b>LED</b>	Light-emitting diode
<b>LLC</b>	Logical Link Control
<b>LSP</b>	LAN Support Program
<b>MAC</b>	Media access control
<b>MB</b>	Megabyte
<b>Mbps</b>	Million bits per second
<b>MMIO</b>	Memory Mapped Input Output
<b>MPS</b>	Multiple Protocol Support for DOS and Windows
<b>MPTS</b>	Multiple Protocol Transport Services
<b>MSB</b>	Most Significant Bit



<b>NDIS</b>	Network Definition Interface Specification
<b>NetBIOS</b>	Network Basic I/O System
<b>NLM</b>	NetWare loadable module
<b>NIOS</b>	NetWare I/O Subsystem
<b>ODI</b>	Open Data-link Interface
<b>OS/2</b>	Operating System/2
<b>PCMCIA</b>	Personal Computer Memory Card International Association
<b>PROM</b>	Programmable Read Only Memory
<b>RAM</b>	Random Access Memory
<b>ROM</b>	Read Only Memory
<b>SNAP</b>	Subnetwork Access Protocol
<b>SPX</b>	Sequenced Packet eXchange
<b>SRAM</b>	Static Random Access Memory
<b>TCP/IP</b>	Transmission Control Protocol Internet Protocol
<b>URL</b>	Uniform Resource Locator
<b>UTP</b>	Unshielded Twisted Pair



# Index

## A

abbreviations list 1-1

## B

Banyan VINES 7-2

## C

Cables 4-1

card services

    advantages 3-3

    description 3-3

    disadvantages 3-4

    problems during reboot C-3

    versus point enablers 3-4

configuring the PC Card 6-1, 6-2

## D

Desktop Management Interface E-1

device driver, NDIS 2 7-17, 7-19,  
7-22

diagnostics C-5

DMI E-1

DMTF E-1

## E

EMM386.EXE C-2

Enabler Error Codes A-2, C-22

error codes, ndis

    enabler C-22

    listing C-6

    NDIS C-7

EtherJet PC Card 1-1

expanded memory  
    specification D-4

## H

hardware problem C-4

help

help with PC Card C-5

## I

IBM LAN Client features 6-3

IBM LAN Client installation 6-4

IBM service F-2

IBM support F-2

IBMXNDI.DOS C-3

indicators, LED C-4

installing device drivers 7-1

installing the software 6-1

instrumentation, LAN adapter, for  
NT E-4

instrumentation, LAN adapter, for  
OS/2 E-1

Intel 3-1

interface software

    DOS 3-1

    OS/2 3-1

## L

LAN Adapter and Protocol Support  
(LAPS) 7-17

LAN Client 6-2

LANAID 6-1

LANAID, installing with 6-1

LAPS 7-17

LED indicators C-4



license agreement iv  
Light Emitting Diodes C-4

## M

memory manager C-2, D-1  
    expanded memory  
    specification D-4  
    with a point enabler D-1  
    with card and socket  
    services D-2  
memory managers with a point  
    enabler D-1  
memory managers with card and  
    socket services D-2  
messages  
    LAN Adapter  
        Instrumentation E-4, E-5  
Microsoft LAN Manager 7-5  
Microsoft Windows for  
    Workgroups 7-7  
MPTS 7-19  
Multiple Protocol Transport Services  
    (MPTS) 7-19

## N

NDIS device driver  
    NDIS device driver 7-19  
    with LAPS 7-17  
    with MPTS 7-19  
    with other programs 7-22  
NDIS Error Codes C-7  
NetBIOS device driver parms 6-5  
Novell NetWare for DOS 7-9  
Novell NetWare for OS/2 7-15  
Novell NetWare Server 7-27

## O

OS/2 7-15, 7-17, 7-19  
OS/2 NDIS 2 device driver 7-17,  
    7-19  
OS/2 Novell NetWare Client 7-15

## P

Package Contents 4-1  
part numbers G-1  
PC Card 1-1  
    getting help F-2  
    support F-2  
PCMCIA 1-1, 2-1  
Phoenix Card Services D-3, D-4  
point connectivity enablers 3-2  
    advantages 3-3  
    disadvantages 3-3  
    versus Card and Socket  
    Services 3-4  
point enabler A-1, C-3  
problem determination C-1  
productivity aids license  
    agreement iv

## R

RJ-45 connector 5-2

## S

service F-2  
SNMP Management E-5  
software 4-4  
software configuration 3-4  
support F-2

## T

testing PC Card C-5



troubleshooting PC Card C-5

## **U**

unshielded twisted-pair cabling 5-2

URL for DMI information E-1

URL NT service layer  
information E-4

URL OS/2 service layer  
information E-1

UTP 5-2

## **W**

Warp Connect 7-23

warranty H-1

Windows 95 7-26

Windows NT 7-24







# Tell Us What You Think!

## EtherJet PC Card Installation and User's Guide Part Number 72H4539

We hope you find this publication useful, readable, and technically accurate, but only you can tell us! Your comments and suggestions will help us improve our technical publications. Please take a few minutes to let us know what you think by completing this form. If you are in the U.S.A., you can mail this form postage free or fax it to us at 1-800-253-3520. Elsewhere, your local IBM branch office or representative will forward your comments or you may mail them directly to us.

**Overall, how satisfied are you with the information in this book?**

Satisfied

Dissatisfied

**How satisfied are you that the information in this book is:**

Satisfied

Dissatisfied

Accurate

Complete

Easy to find

Easy to understand

Well organized

Applicable to your task

Specific comments or problems:

---



---



---

Please tell us how we can improve this book:

---



---



---

Thank you for your comments. If you would like a reply, provide the necessary information below.

Name

Address

Company or Organization

Phone No.



NO POSTAGE  
NECESSARY  
IF MAILED IN THE  
UNITED STATES



# BUSINESS REPLY MAIL

FIRST-CLASS MAIL PERMIT NO. 40 ARMONK, NEW YORK

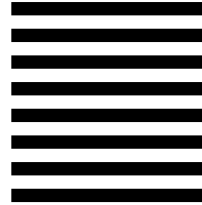

POSTAGE WILL BE PAID BY ADDRESSEE

Design & Information Development  
Dept. CGF/Bldg. 656  
International Business Machines Corporation  
PO BOX 12195  
RESEARCH TRIANGLE PARK NC 27709-9990



Fold and Tape

Please do not staple

Fold and Tape

**Tell Us What You Think!**







**IBM**



Part Number: 72H4539

Printed in USA

