



IntelliStation E Pro

Types 6836 and 6846

User's Guide

Welcome...

Thank you for buying an IBM IntelliStation E Pro computer.

This *User's Guide* contains information for setting up and configuring your computer. This book also contains information for every day use, and solving problems.

You can find the most current information about your computer on the IBM Web site at: <http://www.ibm.com/pc/support>

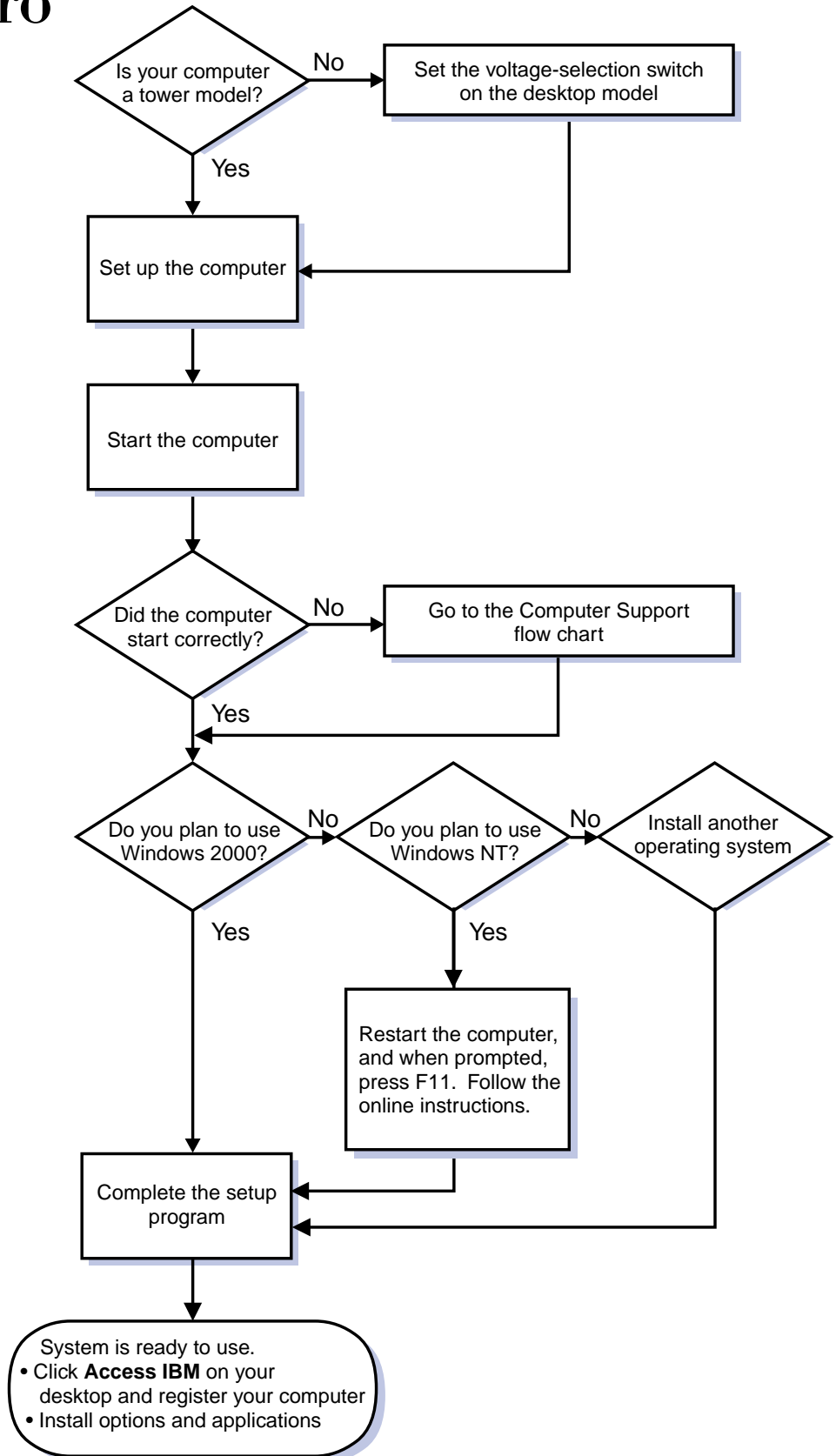

Computer Support

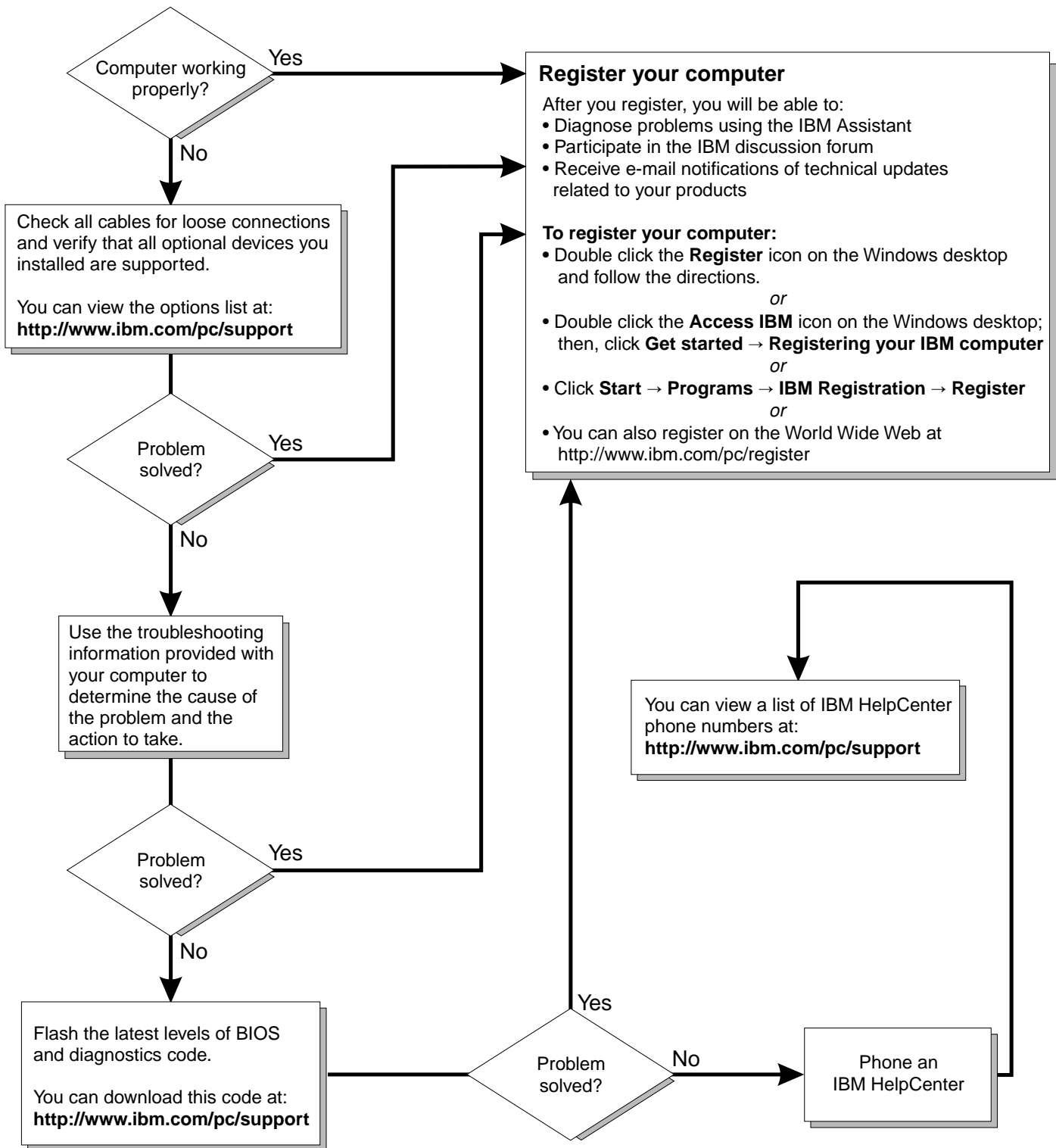

IBM® IntelliStation® E Pro



User's Guide

NOTE

Before using this information and the product it supports, be sure to read the general information in Appendix E, “Product warranties and notices” on page E-115.

First Edition (October 2000)

© Copyright International Business Machines Corporation 2000. All rights reserved.

US Government Users Restricted Rights – Use, duplication or disclosure restricted by GSA ADP Schedule Contract with IBM Corp.

Contents

Safety	vii
Preface	xv
Chapter 1. Introducing the IntelliStation E Pro models	1
Features and specifications for the tower model	2
Features and specifications for the desktop model	3
Software	4
Preinstalled software	4
Software Selections CD	5
Other software CDs	6
What your IntelliStation E Pro offers	6
Computer controls and indicators	7
Chapter 2. Setting up your computer	9
Selecting a location for your computer	9
Arranging your workspace	9
Comfort	9
Glare and lighting	10
Air circulation	10
Electrical outlets and cable lengths	10
Connecting computer cables	10
Starting your computer for the first time	12
Running the setup program	13
Registering your computer	14
Using Access IBM	14
Viewing documentation on the World Wide Web	15
Installing other operating systems	15
Product recovery program	16
Additional setup tasks	16
Setting up Internet Explorer	16
Creating emergency repair diskettes	16
Finishing the installation	16
Chapter 3. Operating your computer	17
Turning on your computer	17
Using video features	17
Video device drivers	18
Changing monitor settings	18
Using audio features	18
Line out	18
Line in	19
Mic	19
MIDI	19
Managing your computer	19
Wake on LAN	19
Remote Program Load or Dynamic Host Configuration Protocol	19
Remote Administration	20
LANClient Control Manager	20
System Migration Assistant	20
Desktop Management Interface	20
Using security features	20
Anti-intrusion features	20
Component protection	21

Data protection	21
Virus protection	21
Shutting down your operating system	21
Turning off your computer	21
Chapter 4. Configuring your computer	23
Using the Configuration/Setup Utility program	23
Starting the Configuration/Setup Utility program	23
Choices available from the Configuration/Setup Utility main menu	23
Using passwords	25
Using the SCSISelect Utility program (some models)	26
Starting the SCSISelect Utility program	26
Choices available from the SCSISelect menu	26
Chapter 5. Installing options	29
Major components of the tower model	29
Major components of the desktop model	30
System and PCI extender boards	31
System and PCI extender board option connectors	31
System board internal cable connectors	32
System board external connectors	32
System board jumpers	33
Before you begin	33
System reliability considerations	34
Handling static-sensitive devices	34
Safety information	35
Power and signal cables for internal drives	39
Installing options in a tower model	40
Moving the stabilizing feet	40
Removing the side cover	41
Removing the support bracket assembly	42
Working with adapters	43
Adapter considerations	43
Installing an adapter	44
Installing a SCSI adapter (some models)	45
Installing internal drives	46
Internal drive bays	47
Preinstallation steps (all bays)	48
Installing a drive in bay 2 or 4	48
Installing a hard disk drive in bay 5, 6, or 7	50
Installing memory modules	51
Installing a security U-bolt	53
Installing the cover	54
Installing options in the desktop model	55
Removing the computer cover	55
Working with adapters	56
Adapter considerations	57
Installing an adapter	58
Installing a SCSI adapter (some models)	59
Installing internal drives	60
Internal drive bays	60
Preinstallation steps (all bays)	61
Installing a drive in bay 2	61
Installing memory modules	63
Installing a security U-bolt	65
Installing the cover	65

Connecting external options	66
I/O connector locations	67
Input/Output connectors	67
Mouse connector	68
Keyboard connector	68
Parallel connector	68
Serial connectors	69
Ethernet connector	69
Universal Serial Bus connectors	70
Audio connectors	70
MIDI connector	71
Video connector	71
Ultra160 SCSI connector (some models)	71
Chapter 6. Solving problems	73
Diagnostic tools overview	73
POST	74
POST beep code descriptions	74
Small computer system interface messages (some models)	74
Diagnostic programs and error messages	75
Text messages	76
Starting the diagnostic programs	76
Using the diagnostics CD	77
Downloading the diagnostics program	77
Using the diagnostic diskette	77
Viewing the test log	78
Diagnostic error message tables	78
Troubleshooting charts	83
Software-generated error messages	88
Troubleshooting the Ethernet controller	88
Network connection problems	88
Ethernet controller troubleshooting chart	89
Ethernet controller messages	90
Novell NetWare or IntraNetWare system ODI driver teaming messages	90
NDIS 4.0 (Windows NT) driver messages	91
Ethernet teaming messages	92
Recovering your operating system and preinstalled software	94
Recovering BIOS	94
Recovering or installing device drivers	96
Recovering your operating system	96
Performing a full or partial recovery	96
Using Norton AntiVirus for IBM	97
Using the ConfigSafe program	97
Clearing CMOS	98
Replacing the battery	98
Getting information, help, and service	99
Getting information	100
Using the World Wide Web	100
Getting information by fax	100
Getting help and service	100
Using the documentation and diagnostic programs	100
Calling for service	101
Other services	102
Purchasing additional services	103

Appendix A. Using the Software Selections CD	105
Features of the Software Selections CD	105
Starting the Software Selections CD	105
Installing software using the Software Selections CD	106
Appendix B. Maintaining your computer	107
Taking care of your computer	107
Basics	107
Cleaning your computer	107
Computer and keyboard	107
Monitor screen	107
Mouse	107
Moving your computer	109
Appendix C. Computer records	111
Serial numbers and keys	111
Appendix D. Viewing the International License Agreement for Non-Warranted Programs	113
Appendix E. Product warranties and notices	115
Warranty Statements	115
IBM Statement of Limited Warranty for United States, Puerto Rico, and Canada (Part 1 - General Terms)	115
IBM Statement of Warranty Worldwide except Canada, Puerto Rico, Turkey, United States (Part 1 – General Terms)	118
Part 2 - Worldwide Country-Unique Terms	120
Notices	124
Edition notice	124
Processing date data	125
Trademarks	125
Important notes	125
Electronic emission notices	126
Federal Communications Commission (FCC) Statement	126
Industry Canada Class A emission compliance statement	126
Australia and New Zealand Class A statement	126
United Kingdom telecommunications safety requirement	126
European Union EMC Directive conformance statement	127
Taiwan electrical emission statement	127
Japanese Voluntary Control Council for Interference (VCCI) statement	127
Power cords	127
Index	129

Safety

Before installing this product, read the Safety Information book.

مج، يجب قراءة دات السلامة

Antes de instalar este produto, leia o Manual de Informações sobre Segurança.

安装本产品前请先阅读《安全信息》手册。

Prije instalacije ovog proizvoda pročitajte priručnik sa sigurnosnim uputama.

Před instalací tohoto produktu si přečtete příručku bezpečnostních instrukcí.

Læs hæftet med sikkerhedsforskrifter, før du installerer dette produkt.

Lue Safety Information -kirjanen, ennen kuin asennat tämän tuotteen.

Avant de procéder à l'installation de ce produit, lisez le manuel Safety Information.

Vor Beginn der Installation die Broschüre mit Sicherheitshinweisen lesen.

Πριν εγκαταστήσετε αυτό το προϊόν, διαβάστε το εγχειρίδιο Safety Information.

לפני שתתקינו מוצר זה, קראו את הוראות הבטיחות.

Przed zainstalowaniem tego produktu należy przeczytać broszurę Informacje Dotyczące Bezpieczeństwa.

Prima di installare questo prodotto, leggere l'opuscolo contenente le informazioni sulla sicurezza.

本製品を導入する前に、安全情報資料を御読みください。

이 제품을 설치하기 전에, 안전 정보 책자를 읽어보십시오.

Пред да го инсталирате овој производ прочитајте ја книгата со безбедносни информации.

Lees voordat u dit product installeert eerst het boekje met veiligheidsvoorschriften.

Les heftet om sikkerhetsinformasjon (Safety Information) før du installerer dette produktet.

Prije instalacije ovog proizvoda pročitajte priručnik sa sigurnosnim uputama.

Antes de instalar este produto, leia o folheto Informações sobre Segurança.

Перед установкой продукта прочтите брошюру по технике безопасности (Safety Information).

Pred inštaláciou tohto produktu si prečítajte Informáciu brožúrku o bezpečosti.

Preden namestite ta izdelek, preberite knjižico Varnostne informacije.

Antes de instalar este producto, lea la Información de Seguridad.

Läs säkerhetsinformationen innan du installerar den här produkten.

在安裝本產品之前，也請先閱讀「安全性資訊」小冊子。

Installálás el tt olvassa el a Biztonsági el írások kézikönyvét !

Statement 1



Danger

Electrical current from power, telephone, and communication cables is hazardous.

To avoid a shock hazard:

- **Do not connect or disconnect any cables or perform installation, maintenance, or reconfiguration of this product during an electrical storm.**
- **Connect all power cords to a properly wired and grounded electrical outlet.**
- **Connect to properly wired outlets any equipment that will be attached to this product.**
- **When possible, use one hand only to connect or disconnect signal cables.**
- **Never turn on any equipment when there is evidence of fire, water, or structural damage.**
- **Disconnect the attached power cords, telecommunications systems, networks, and modems before you open the device covers, unless instructed otherwise in the installation and configuration procedures.**
- **Connect and disconnect cables as described in the following table when installing, moving, or opening covers on this product or attached devices.**

<p>To connect:</p> <ol style="list-style-type: none">1. Turn everything OFF.2. First, attach all cables to devices.3. Attach signal cables to connectors.4. Attach power cords to outlet.5. Turn device ON.	<p>To disconnect:</p> <ol style="list-style-type: none">1. Turn everything OFF.2. First, remove power cords from outlet.3. Remove signal cables from connectors.4. Remove all cables from devices.
---	---

DANGER

Le courant électrique provenant de l'alimentation, du téléphone et des câbles de transmission peut présenter un danger.

Pour éviter tout risque de choc électrique :

- Ne manipulez aucun câble et n'effectuez aucune opération d'installation, d'entretien ou de reconfiguration de ce produit au cours d'un orage.
- Branchez tous les cordons d'alimentation sur un socle de prise de courant correctement câblé et mis à la terre.
- Branchez sur des socles de prise de courant correctement câblés tout équipement connecté à ce produit.
- Lorsque cela est possible, n'utilisez qu'une seule main pour connecter ou déconnecter les câbles d'interface.;
- Ne mettez jamais un équipement sous tension en cas d'incendie ou d'inondation, ou en présence de dommages matériels.
- Avant de retirer les carters de l'unité, mettez celle-ci hors tension et déconnectez ses cordons d'alimentation, ainsi que les câbles qui la relie aux réseaux, aux systèmes de télécommunication et aux modems (sauf instruction contraire mentionnée dans les procédures d'installation et de configuration).
- Lorsque vous installez, que vous déplacez, ou que vous manipulez le présent produit ou des périphériques qui lui sont raccordés, reportez-vous aux instructions ci-dessous pour connecter et déconnecter les différents cordons.

Connexion:	Déconnexion:
1. Mettez les unités hors tension.	1. Mettez les unités hors tension.
2. Commencez par brancher tous les cordons sur les unités.	2. Débranchez les cordons d'alimentation des prises.
3. Branchez les câbles d'interface sur des connecteurs.	3. Débranchez les câbles d'interface des connecteurs.
4. Branchez les cordons d'alimentation sur des prises.	4. Débranchez tous les câbles des unités.
5. Mettez les unités sous tension.	

Statement 2

CAUTION:



When replacing the lithium battery, use only IBM Part Number 33F8354 or an equivalent type battery recommended by the manufacturer. If your system has a module containing a lithium battery, replace it only with the same module type made by the same manufacturer. The battery contains lithium and can explode if not properly used, handled, or disposed of.

Do not:

- Throw or immerse into water.
- Heat to more than 100 C (212 F)
- Repair or disassemble

Dispose of the battery as required by local ordinances or regulations.

DANGER

Danger d'explosion en cas de remplacement incorrect de la batterie.

Remplacer uniquement par une batterie IBM de type ou d'un type équivalent recommandé par le fabricant. La batterie contient du lithium et peut exploser en cas de mauvaise utilisation, de mauvaise manipulation ou de mise au rebut inappropriée.

Ne pas :

- Lancer ou plonger dans l'eau
- Chauffer à plus de 100°C (212°F)
- Réparer ou désassembler

Mettre au rebut les batteries usagées conformément aux règlements locaux.

Statement 3



CAUTION:

When laser products (such as CD-ROMs, DVD drives, fiber optic devices, or transmitters) are installed, note the following:

- Do not remove the covers. Removing the covers of the laser product could result in exposure to hazardous laser radiation. There are no serviceable parts inside the device.
- Use of controls or adjustments or performance of procedures other than those specified herein might result in hazardous radiation exposure.



Danger

Some laser products contain an embedded Class 3A or Class 3B laser diode. Note the following. Laser radiation when open. Do not stare into the beam, do not view directly with optical instruments, and avoid direct exposure to the beam.

DANGER

Certains modèles d'ordinateurs personnels sont équipés d'origine d'une unité de CD-ROM ou de DVD-ROM. Mais ces unités sont également vendues séparément en tant qu'options. L'unité de CD-ROM/DVD-ROM est un appareil à laser. Aux États-Unis, l'unité de CD-ROM/DVD-ROM est certifiée conforme aux normes indiquées dans le sous-chapitre J du DHHS 21 CFR relatif aux produits à laser de classe 1. Dans les autres pays, elle est certifiée être un produit à laser de classe 1 conforme aux normes CEI 825 et CENELEC EN 60 825.

Lorsqu'une unité de CD-ROM/DVD-ROM est installée, tenez compte des remarques suivantes:

ATTENTION: Pour éviter tout risque d'exposition au rayon laser, respectez les consignes de réglage et d'utilisation des commandes, ainsi que les procédures décrites.

L'ouverture de l'unité de CD-ROM/DVD-ROM peut entraîner un risque d'exposition au rayon laser. Pour toute intervention, faites appel à du personnel qualifié.

Certaines unités de CD-ROM/DVD-ROM peuvent contenir une diode à laser de classe 3A ou 3B. Tenez compte de la consigne qui suit:

DANGER

Rayonnement laser lorsque le carter est ouvert. Évitez toute exposition directe des yeux au rayon laser. Évitez de regarder fixement le faisceau ou de l'observer à l'aide d'instruments optiques.

Statement 4

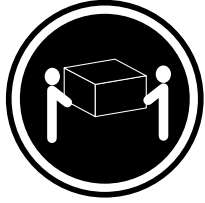

≥18 kg (39.7 lbs)



≥32 kg (70.5 lbs)

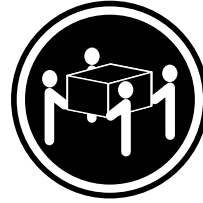

≥55 kg (121.2 lbs)

CAUTION:
Use safe practices when lifting.

Statement 5



CAUTION:
The power control button on the device and the power switch on the power supply do not turn off the electrical current supplied to the device. The device also might have more than one power cord. To remove all electrical current from the device, ensure that all power cords are disconnected from the power source.

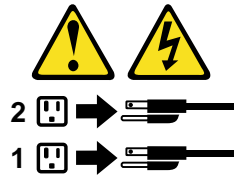

Modem safety information

To reduce the risk of fire, electrical shock, or injury when using telephone equipment, always follow basic safety precautions, such as:

- Never install telephone wiring during a lightning storm.
- Never install telephone jacks in wet locations unless the jack is specifically designed for wet locations.
- Never touch uninsulated telephone wires or terminals unless the telephone line has been disconnected at the network interface.
- Use caution when installing or modifying telephone lines.
- Avoid using a telephone (other than a cordless type) during an electrical storm. There may be a remote risk of electric shock from lightning.
- Do not use the telephone to report a gas leak in the vicinity of the leak.

Consignes de sécurité relatives au modem

Lors de l'utilisation de votre matériel téléphonique, il est important de respecter les consignes ci-après afin de réduire les risques d'incendie, d'électrocution et d'autres blessures :

- N'installez jamais de cordons téléphoniques durant un orage.
- Les prises téléphoniques ne doivent pas être installées dans des endroits humides, excepté si le modèle a été conçu à cet effet.
- Ne touchez jamais un cordon téléphonique ou un terminal non isolé avant que la ligne ait été déconnectée du réseau téléphonique.
- Soyez toujours prudent lorsque vous procédez à l'installation ou à la modification de lignes téléphoniques.
- Si vous devez téléphoner pendant un orage, pour éviter tout risque de choc électrique, utilisez toujours un téléphone sans fil.
- En cas de fuite de gaz, n'utilisez jamais un téléphone situé à proximité de la fuite.

Preface

This book will help you become familiar with your IBM IntelliStation E Pro computer and its many features. It describes how to set up, configure, operate, maintain, and install options in your computer. Information about software, problem solving, and getting help is also included in this book.

Related information

The following documentation contains additional information about your computer. If your computer comes with IBM-preinstalled software, you might be able to view these documents using Access IBM. See “Using Access IBM” on page 14 for information about how to use Access IBM. The IBM documents listed below can also be found at <http://www.ibm.com/pc/support> on the World Wide Web.

- *Hardware Maintenance Manual*

This publication contains information for trained service technicians. It can be found at <http://www.ibm.com/pc/support> on the World Wide Web.

- README files on the *Device Drivers and IBM Enhanced Diagnostics* CD

Several README files on this CD contain information about the various adapters and devices that might be attached to your computer.

- Adaptec SCSI documentation

This publication, accessible through Access IBM, contains information and instructions for installing and configuring small computer systems interface (SCSI) device drivers and devices.

- *Safety Information*

This publication, accessible through Access IBM, contains multilingual Caution and Danger notices.

Notices used in this book

This information product contains notices that relate to specific topics. The Caution and Danger notices also appear in the multilingual *Safety Information* book that is accessible through Access IBM. Each notice is numbered for easy reference to the corresponding notices in the safety book.

The notice definitions are as follows:

- **Notes:** These notices provide important tips, guidance, or advice.
- **Important:** These notices provide information or advice that might help you avoid inconvenient or problem situations.
- **Attention:** These notices indicate possible damage to programs, devices, or data. An attention notice is placed just before the instruction or situation in which damage could occur.
- **Caution:** These notices indicate situations that can be potentially hazardous to you. A caution notice is placed just before descriptions of potentially hazardous procedure steps or situations.
- **Danger:** These notices indicate situations that can be potentially lethal or extremely hazardous to you. A danger notice is placed just before descriptions of potentially lethal or extremely hazardous procedures or situations.

Chapter 1. Introducing the IntelliStation E Pro models

Thank you for selecting an IBM® IntelliStation® Professional Workstation. Your computer incorporates many of the latest advances in computing technology and is easy to expand and upgrade as your needs change.

If you have access to the World Wide Web, you can obtain up-to-date information about your IntelliStation E Pro model and other IBM computer products at the following World Wide Web address:

<http://www.ibm.com/pc/us/intellistation/>

Your computer model and serial numbers are located on labels on the bottom of the computer and on the lower right side of the bezel on the tower model. These labels are located on the bottom of the computer and on the lower right front of the bezel on the desktop model. You will need these numbers when you register your computer with IBM.

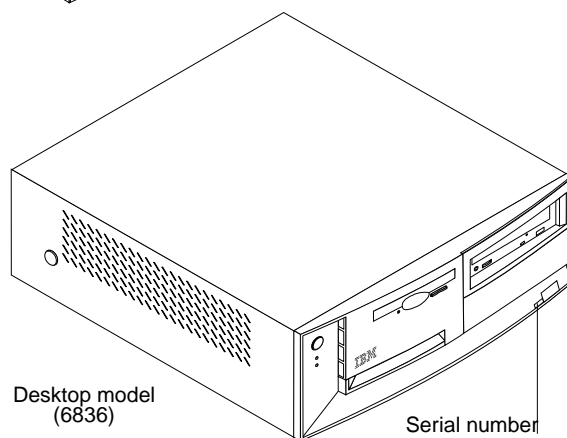
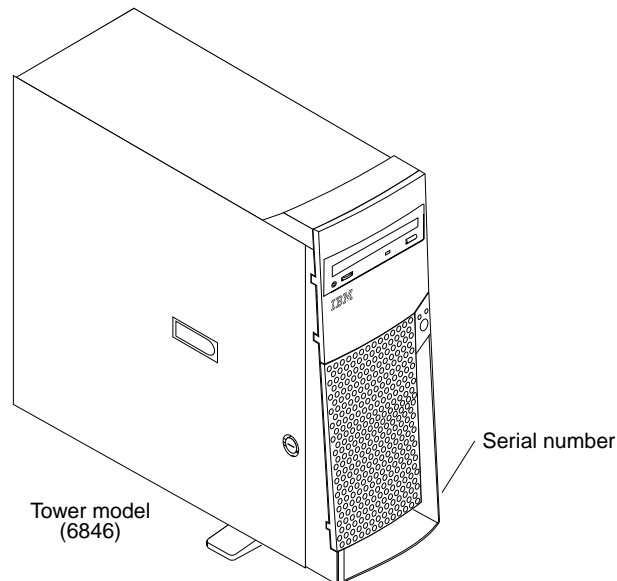

Features and specifications for the tower model

The following table provides a summary of the features and specifications of the tower model. Some features and specifications are not available on all models.

Table 1. Tower Model Features and Specifications

<p>Microprocessor:</p> <ul style="list-style-type: none"> • Supports one microprocessor • Intel™ Pentium™ III with 256 KB Level-2 cache and MMX (MMX2) technology <p>Memory:</p> <ul style="list-style-type: none"> • Minimum: 64 MB • Maximum: 1.5 GB • Type: PC133 MHz, ECC SDRAM, unregistered DIMMs only • Slots: Three dual inline <p>Drives: (depending on your model)</p> <ul style="list-style-type: none"> • Diskette: 1.44 MB • CD-ROM: IDE • Hard disk drive <p>Expansion bays:</p> <ul style="list-style-type: none"> • Two 5.25-in. bays (One CD-ROM drive installed) • Two 3.5-in. bays (One diskette drive installed) • Three 3.5-in. slim-high bays available (One hard disk drive installed) <p>PCI expansion slots:</p> <ul style="list-style-type: none"> • Three 33 MHz/32-bit on the system board (some models come with a SCSI adapter installed) • Two 33 MHz/32-bit on the PCI Bus extender board <p>AGP slot:</p> <ul style="list-style-type: none"> • Accelerated graphics port (AGP) • Video adapter installed in the AGP slot on the system board <p>Power supply:</p> <p>One 330 watt (90-240 V ac)</p>	<p>Video: (depending on your model)</p> <ul style="list-style-type: none"> • Matrox or NVidia AGP video adapter • Compatible with SVGA and VGA • Matrox has 16 MB SDRAM video memory • NVidia has 32 MB SDRAM video memory <p>Size:</p> <ul style="list-style-type: none"> • Height: 470 mm (18.5 in.) • Depth: 508 mm (19.9 in.) • Width: 165 mm (6.5 in.) • Weight: approximately 19.5 Kg (43 lb.) when fully configured or 15.9 Kg (35 lb.) minimum <p>Integrated functions:</p> <ul style="list-style-type: none"> • 10BASE-T/100BASE-TX Ethernet controller on the system board with an RJ-45 Ethernet port • Two serial ports • Parallel port • Two USB ports • Keyboard port • Mouse port • MIDI port • Audio ports <ul style="list-style-type: none"> — Line out — Line in — Mic • Dual-channel bus mastering IDE controller <p>Acoustical noise emissions:</p> <ul style="list-style-type: none"> • Sound power, idling: 6.6 bel maximum • Sound power, operating: 6.8 bel maximum 	<p>Environment:</p> <ul style="list-style-type: none"> • Air temperature: <ul style="list-style-type: none"> — Computer on: 10° to 35° C (50.0° to 95.0° F). Altitude: 0 to 914 m (2998.7 ft.) — Computer on: 10° to 32° C (50.0° to 89.6° F). Altitude: 914 m (2998.7 ft.) to 2133 m (6998.0 ft.) — Computer off: 10° to 43° C (50.0° to 109.4° F). Maximum altitude: 2133 m (6998.0 ft.) • Humidity: <ul style="list-style-type: none"> — Computer on: 8% to 80% — Computer off: 8% to 80% <p>Heat output:</p> <p>Approximate heat output in British Thermal Units (Btu) per hour</p> <ul style="list-style-type: none"> • Minimum configuration: 341 Btu (100 watts) • Maximum configuration: 1604 Btu (470 watts) <p>Electrical input:</p> <ul style="list-style-type: none"> • Sine-wave input (50-60 Hz) required • Input voltage low range: <ul style="list-style-type: none"> — Minimum: 90 V ac — Maximum: 137 V ac • Input voltage high range: <ul style="list-style-type: none"> — Minimum: 180 V ac — Maximum: 265 V ac • Input kilovolt-amperes (kVA) approximately: <ul style="list-style-type: none"> — Minimum: 0.095 kVA — Maximum: 0.213 kVA
---	--	---

Features and specifications for the desktop model

The following table provides a summary of the features and specifications of the desktop model. Some features and specifications are not available on all models.

Table 2. Desktop Model Features and Specifications

<p>Microprocessor:</p> <ul style="list-style-type: none"> • Supports one microprocessor • Intel™ Pentium™ III with 256 KB Level-2 cache and MMX (MMX2) technology <p>Memory:</p> <ul style="list-style-type: none"> • Minimum: 64 MB • Maximum: 1.5 GB • Type: PC133 MHz, ECC SDRAM, unregistered DIMMs only • Slots: Three dual inline <p>Drives: (depending on your model)</p> <ul style="list-style-type: none"> • Diskette: 1.44 MB • CD-ROM: IDE • Hard disk drive <p>Expansion bays</p> <ul style="list-style-type: none"> • Two 5.25-in. bays (One CD-ROM drive installed) • Two 3.5-in. bays (One diskette drive and one hard disk drive installed) <p>PCI expansion slots:</p> <ul style="list-style-type: none"> • Three 33 MHz/32-bit on the system board (some models come with a SCSI adapter installed) <p>AGP slot:</p> <ul style="list-style-type: none"> • Accelerated graphics port (AGP) • Video adapter installed in the AGP slot on the system board <p>Power supply:</p> <p>One 155 watt (90-240 V ac)</p>	<p>Video: (depending on your model)</p> <ul style="list-style-type: none"> • Matrox or NVidia AGP video adapter • Compatible with SVGA and VGA • Matrox has 16 MB SDRAM video memory • NVidia has 32 MB SDRAM video memory <p>Size:</p> <ul style="list-style-type: none"> • Height: 140 mm (5.5 in.) • Depth: 425 mm (16.7 in.) • Width: 425 mm (16.7 in.) • Weight: approximately 11.3 Kg (25 lb.) when fully configured <p>Integrated functions:</p> <ul style="list-style-type: none"> • 10BASE-T/100BASE-TX Ethernet controller on the system board with an RJ-45 Ethernet port • Two serial ports • Parallel port • Two USB ports • Keyboard port • Mouse port • MIDI port • Audio ports <ul style="list-style-type: none"> — Line out — Line in — Mic • Dual-channel bus mastering IDE controller <p>Acoustical noise emissions:</p> <ul style="list-style-type: none"> • Sound power, idling: 6.6 bel maximum • Sound power, operating: 6.8 bel maximum 	<p>Environment:</p> <ul style="list-style-type: none"> • Air temperature: <ul style="list-style-type: none"> — Computer on: 10° to 35° C (50.0° to 95.0° F). Altitude: 0 to 914 m (2998.7 ft.) — Computer on: 10° to 32° C (50.0° to 89.6° F). Altitude: 914 m (2998.7 ft.) to 2133 m (6998.0 ft.) — Computer off: 10° to 43° C (50.0° to 109.4° F). Maximum altitude: 2133 m (6998.0 ft.) • Humidity: <ul style="list-style-type: none"> — Computer on: 8% to 80% — Computer off: 8% to 80% <p>Heat output:</p> <p>Approximate heat output in British Thermal Units (Btu) per hour</p> <ul style="list-style-type: none"> • Minimum configuration: 272 Btu (80 watts) • Maximum configuration: 767 Btu (225 watts) <p>Electrical input:</p> <ul style="list-style-type: none"> • Sine-wave input (50-60 Hz) required • Input voltage low range: <ul style="list-style-type: none"> — Minimum: 90 V ac — Maximum: 137 V ac • Input voltage high range: <ul style="list-style-type: none"> — Minimum: 180 V ac — Maximum: 265 V ac • Input kilovolt-amperes (kVA) approximately: <ul style="list-style-type: none"> — Minimum: 0.08 kVA — Maximum: 0.52 kVA
---	--	---

Software

Your IBM computer comes with Microsoft® Windows 2000® Professional¹ preinstalled with the option of changing your operating system to Windows NT® Workstation.

In addition to your operating system, a variety of other software programs comes with your computer, such as application programs, diagnostic tools, and device drivers. Some of the software is *preinstalled* on your computer, and some software is on the CDs that comes with your computer.

Important:

The software, other than the Microsoft operating system, is licensed under the terms of the *IBM International License Agreement for Non-Warranted Programs*. Use of your computer signifies acceptance of this license agreement. For detailed instructions about viewing the license agreement, see Appendix D, "Viewing the International License Agreement for Non-Warranted Programs," on page 113.

Preinstalled software

In addition to the Microsoft operating system, your preinstalled software includes the following programs:

- **Access IBM** provides links to selected IBM Web sites and the IBM Assistant, a help system for many end-user tasks. Access IBM also provides shortcuts to help accomplish many of these tasks.
- **Adobe Acrobat Reader** is used to read portable document format (PDF) files. You can download the most current versions of Adobe Acrobat Reader for other languages and operating systems from the Adobe Web site at <http://www.adobe.com> on the World Wide Web.
- **ConfigSafe** is a comprehensive configuration tracking and recovery tool. It provides features that you can use to restore your system if your desktop becomes damaged, unusable, or unstartable.
- **IBM Backup and Restore** program creates and stores a backup image of the primary partition (drive C) of your hard disk drive. You can recover this backup image, in the event that drive C becomes damaged or unusable.
- **IBM Registration** program can be used to register your computer with IBM. When you register your computer with IBM, information is entered into an IBM database, which enables IBM to contact you in case of a recall or other severe problem. In addition, some locations offer extended privileges and services to registered users.
- **Online Books** enable you to access documentation that contains detailed information about your computer.
- **PC-Doctor for Windows** is a program to help you locate and resolve some problems that might occur with your computer.
- **Product Recovery Program** enables you to recover the Windows 2000 or Windows NT operating systems and other software programs.

You must have Internet access to use some of these programs. For more information about connecting to the Internet, refer to the operating system documentation that comes with your computer.

1. The Microsoft Certificate of Authenticity is your assurance that the Windows software in your computer is legally licensed from Microsoft Corporation.

See Chapter 2, "Setting up your computer," on page 9 for additional information about your preinstalled software. For more information about using the recovery programs and solving problems, see Chapter 6, "Solving problems," on page 73.

Important:

1. No backup diskettes for your preinstalled software come with your computer. However, you can reinstall the device drivers and applications that come preinstalled on your computer from the directories on your hard disk drive. For more information on recovering your computer software, see "Recovering your operating system and preinstalled software" on page 94.
2. The device drivers and some programs are also available at <http://www.ibm.com/pc/support> on the World Wide Web and on the *Device Drivers and IBM Enhanced Diagnostics* CD.

Software Selections CD

The *Software Selections* CD contains application programs and support software for use with your computer, such as:

IBM Universal Manageability Services	UM Services streamline and automate personal computer (PC) systems management and support tasks, such as asset deployment and tracking.
IBM Update Connector™	You can use IBM Update Connector to download software programs, software updates, data, and data updates from IBM via the Internet. Update Connector automatically determines whether your computer needs available updates and, if so, it downloads and installs them at your option.
Netscape Communicator	You can use Netscape Communicator to navigate your company intranet or the World Wide Web. Netscape Communicator provides a full suite of Internet functions, including e-mail, threaded discussion groups (newsgroups), and support for the latest features on the World Wide Web.
Norton AntiVirus for IBM	You can use Norton AntiVirus for IBM to detect and remove viruses from your computer.

For more information about installing software using the *Software Selections* CD, see Appendix A, "Using the Software Selections CD," on page 105.

Other software CDs

Some IntelliStation models come with additional CDs. These CDs include software that you can install and programs that you can run to test hardware components of your computer.

Lotus® SmartSuite

Lotus SmartSuite, a package of award-winning productivity applications, contains powerful applications and everything you need to access the Internet. Your computer comes with either a Lotus *SmartSuite* CD or a proof of entitlement to receive one free CD-ROM version of Lotus SmartSuite. To install your SmartSuite package, insert the Lotus *SmartSuite* CD into your CD-ROM drive, or contact your network administrator for assistance.

Device Drivers and IBM Enhanced Diagnostics CD

The diagnostic test programs are stored on the *Device Drivers and IBM Enhanced Diagnostics* CD that comes with your computer. These programs provide the primary methods of testing system components. Some of the preinstalled device drivers are also stored on this CD.

What your IntelliStation E Pro offers

The design of your computer takes advantage of advancements in graphics, memory, systems-management, and network environments. Your computer includes:

- High-performance accelerated graphics port (AGP) graphics

Your computer comes with an AGP graphics adapter installed. This high-performance adapter supports high resolutions and includes many performance-enhancing features for your operating-system environment.

- Large system memory

The memory bus in your computer supports up to 1.5 gigabytes (GB)² of system memory. The memory controller provides error code correction (ECC) support for up to three industry standard PC133, 3.3 V, 168-pin, 133 megahertz (MHz), unregistered, synchronous dynamic random access memory (SDRAM) dual in-line memory modules (DIMMs).

- Systems-management capabilities

Your computer comes with features that a network administrator or file server can use to remotely manage and control your computer. Some of the features include: Wake on LAN, Remote Administration, and System Migration Assistant.

- Integrated network environment support

Your computer comes with an Ethernet controller on the system board. This Ethernet controller has an interface for connecting to 10-Mbps or 100-Mbps networks. The computer automatically selects between 10BASE-T and 100BASE-TX environments. This controller provides full-duplex (FDX) capability, which allows simultaneous transmission and reception of data on the Ethernet local area network (LAN).

2. One Gigabyte is equal to 1,000,000,000 bytes.

Computer controls and indicators

This section identifies the controls and indicators on your tower and desktop models.

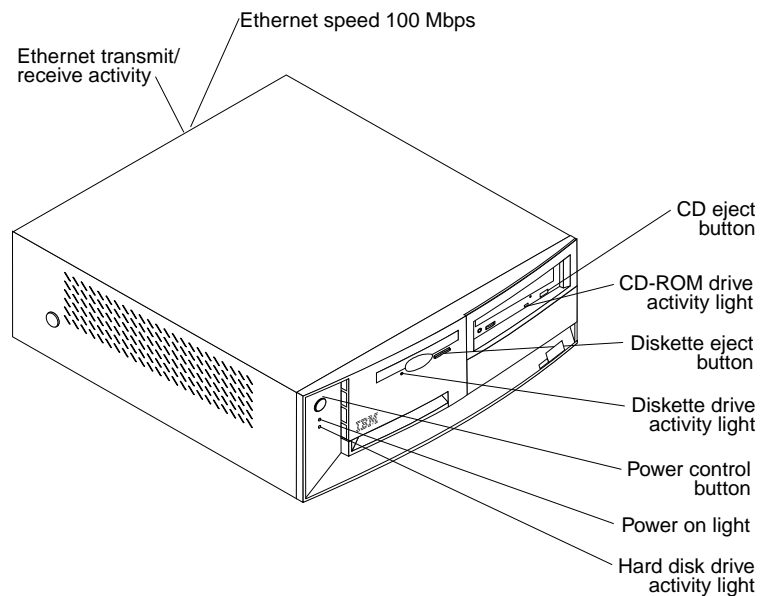
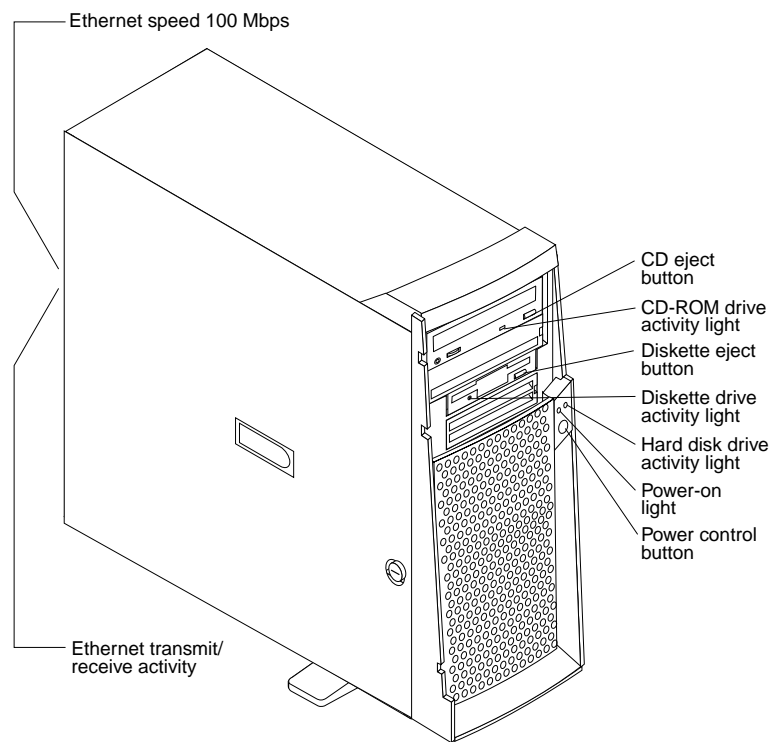

CD eject button: Push this button to open the CD tray to remove a CD from the drive.

CD-ROM drive activity light: When this light is on, the CD-ROM drive is in use.

Diskette eject button: Push this button to release a diskette from the drive.

Ethernet speed 100 Mbps: When this light is on, the Ethernet speed is 100 Mbps. When this light is off, the Ethernet speed is 10 Mbps.

Ethernet transmit/receive activity: When this light is on, there is activity between the server and the network.

Diskette drive activity light: When this light is on, the diskette drive is in use.

Hard disk drive activity light: When this light is on, the hard disk drive is in use.

Power-on light: This status indicator lights when you turn on your computer.

Power control button: Press this button to manually turn the computer on or off.

Chapter 2. Setting up your computer

This chapter provides information about setting up your computer and preparing it to run your applications.

Before you begin to set up your computer, read the information in “Safety” on page vii.

You will need the following items:

- Computer
- Computer power cord
- Keyboard
- Mouse
- Monitor (sold separately with signal cable and power cord)

If you are missing an item, contact your place of purchase.

Selecting a location for your computer

Make sure you have an adequate number of properly grounded electrical outlets for the computer, monitor, and any other devices. Select a location for the computer where it will remain dry. Leave about 127 mm (5 in.) of space around the computer for proper air circulation.

For information about arranging your computer for comfort and ease-of-use, refer to “Arranging your workspace”.

Arranging your workspace

To get the most from your computer, arrange both the equipment you use and your work area to suit your needs and the kind of work you do. Your comfort is of foremost importance, but light sources, air circulation, and the location of electrical outlets also can affect the way you arrange your workspace.

Comfort

Although no single working position is ideal for everyone, the following guidelines will help you find a position that suits you best.

Sitting in the same position for a long time can cause fatigue. A good chair can make a big difference. The backrest and seat should adjust independently and provide good support. The seat should have a curved front to relieve pressure on the thighs. Adjust the seat so that your thighs are parallel to the floor and your feet are either flat on the floor or on a footrest.

When using the keyboard, keep your forearms parallel to the floor and your wrists in a neutral, comfortable position. Try to keep a light touch on the keyboard and your hands and fingers relaxed. You can change the angle of the keyboard for maximum comfort by adjusting the position of the keyboard feet.

Adjust the monitor so that the top of the screen is at, or slightly below, eye level. Place the monitor at a comfortable viewing distance, usually 51 to 61 cm (20 to 24 in.), and position it so that you can view it without having to twist your body. Also position other equipment you use regularly, such as the telephone or a mouse, within easy reach.

Glare and lighting

Position the monitor to minimize glare and reflections from overhead lights, windows, and other light sources. Even reflected light from shiny surfaces can cause annoying reflections on your monitor screen. Place the monitor at right angles to windows and other light sources when possible. Reduce overhead lighting, if necessary, by turning off lights or using lower wattage bulbs. If you install the monitor near a window, use curtains or blinds to block the sunlight. You might have to adjust the brightness and contrast controls on the monitor as the room lighting changes throughout the day.

Where it is impossible to avoid reflections or to adjust the lighting, an antiglare filter placed over the screen might be helpful. However, these filters might affect the clarity of the image on the screen; try them only after you have exhausted other methods of reducing glare.

Dust buildup compounds problems that are associated with glare. Remember to clean your monitor screen periodically using a soft cloth that is moistened with a nonabrasive liquid glass cleaner.

Air circulation

Your computer and monitor produce heat. Your computer has one or more fans that pull in fresh air and forces out hot air. The monitor lets hot air escape through vents. Blocking the air vents can cause overheating, which might result in a malfunction or damage. Place the computer and monitor so that nothing blocks the air vents; usually, 51 mm (2 in.) of air space is sufficient. Also, make sure the vented air is not blowing on someone else.

Electrical outlets and cable lengths

The location of electrical outlets and the length of power cords and cables that connect to the monitor, printer, and other devices might determine the final placement of your computer.

When arranging your workspace:

- Avoid the use of extension cords. Whenever possible, plug the computer power cords directly into electrical outlets.
- Keep power cords and cables neatly routed away from walkways and other areas where they might be kicked accidentally.

For more information about power cords, see “Power cords” on page 127.

Connecting computer cables

Use the following steps to set up your computer. Look for the small icons on the following pages, and on the back of your computer.

If your computer cables and connector panel have color-coded connectors, match the color of the cable end with the color of the connector. For example, match a blue cable end with a blue panel connector, a red cable end with a red panel connector, and so on.

1. Connect the monitor cable to the monitor connector. Tighten the screws; then, connect the keyboard cable to the keyboard connector, and connect the mouse cable to the mouse connector.

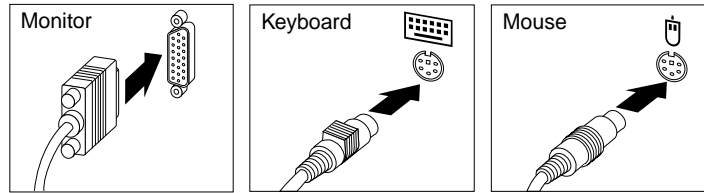

Note: If your computer comes with Windows NT and a ScrollPoint[®] mouse, your mouse will function the first time you start up your computer, but your mouse will not have its ScrollPoint function. You must shut down and restart the computer to enable the ScrollPoint function.

2. Connect any additional devices you have.
 - Connect a printer or parallel device to the parallel connector.

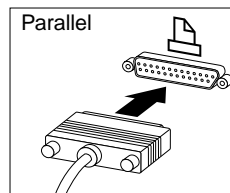

- Connect a serial device or external modem to the serial connector.

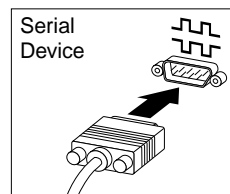

- Connect Universal Serial Bus (USB) devices to either of the USB connectors.

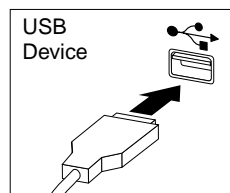

- Connect optional devices, such as speakers, microphones, or headphones, for models with an audio device.

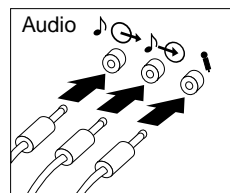

- Connect the Ethernet cable to the RJ-45 Ethernet connector.

Important:

To operate the computer within FCC Class A limits, use a category 5 Ethernet cable.

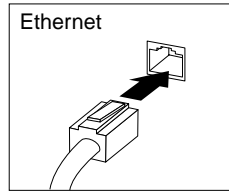

3. Connect the power cord to the power connector located on the rear of the computer. If there is a label covering the power connector, remove it.

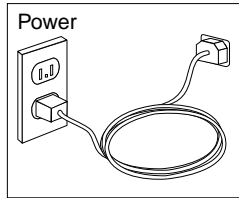

Attention: If you have a desktop model, check the position of the voltage-selection switch. Use a ball point pen to slide the switch, if necessary.

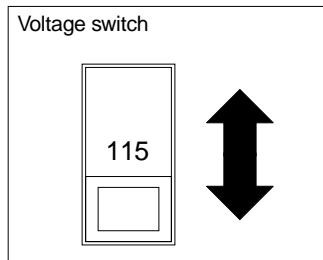

- If the voltage supply range in your location is 90-137 V ac, set the voltage switch to 115 V.
 - If the voltage supply range in your location is 180-265 V ac, set the voltage switch to 230-265 V.
4. Connect the power cords into properly grounded electrical outlets.

Note: When the power cord is first plugged in, the computer might turn on for a few seconds, then turn off. This is normal.

Starting your computer for the first time

This section contains the information that you will need to start operating your computer.

1. Review the safety precautions listed in Statement 1 and Statement 5 in “Safety” on page vii.
2. If your computer is a desktop model, set the voltage-selection switch located next to the power cord connector on the rear of the computer.

- If the voltage supply range in your location is 90-137 V ac, set the voltage-selection switch to 115 V.
 - If the voltage supply range in your location is 180-265 V ac, set voltage selection switch to 230 V.
3. Turn on all devices connected to the computer.
 4. Press the power control button on your computer. For the location of the power control button, see “Computer controls and indicators” on page 7.

Attention: After you have turned on your computer for the first time, you must complete the setup procedure before you turn off your computer; otherwise, unexpected results might occur.

When you start your computer, you can select one of the following messages to use the configuration program or the recovery program. If you do not select the following messages, your computer completes POST and the Windows desktop appears.

- Press F1 for Configuration/Setup

You can use this program to configure serial- and parallel-connector assignments, change the drive startup sequence, set the date and time, and set passwords. See Chapter 4, “Configuring your computer,” on page 23 for more information about using the Configuration and Setup Utility.

- To Start the Product Recovery Program, Press F11

The Product Recovery Program is provided on your computer to assist you with some recovery operations. This program enables you to recover Windows 2000, Windows NT, and other software programs. For more information about recovering your preinstalled software, see “Recovering your operating system and preinstalled software” on page 94.

- <<<Press <CTRL><A> for SCSISelect Utility!>>>

The SCSISelect Utility program is a built-in, menu-driven configuration utility program that you can use to view the default SCSI IDs and locate and correct configuration conflicts. You will only see this message if your computer contains a SCSI adapter. For more information about using this program, see “Using the SCSISelect Utility program (some models)” on page 26.

If you experience any problems during startup, see “Troubleshooting charts” on page 83.

Running the setup program

The setup program starts when you turn on the computer for the first time, or after you have recovered your operating system. The program will prompt you to make choices or type information as required.

Notes:

1. The setup program is slightly different from the one that is described in your operating system documentation. Some choices that are described in your operating system documentation do not appear because they are preset.
2. During the setup procedure, you must indicate that you accept the license agreement, before you can complete the procedure.
3. In some instances, the registration information will already be entered into the registration fields. If the Product ID number is not already entered, you must type the Product ID number from your Microsoft Certificate of Authenticity. The product ID number is located on the label attached to the bottom of your computer.
4. If the setup program has already been run once, it will not start when you turn on your computer.

To complete the setup procedure, you will need the following items and information:

- The Microsoft operating system documentation that comes with your computer.
- Network information (if applicable) from your network administrator.
- The printer model and port that is used by the printer, if the printer is attached directly to your computer.

After the setup procedure finishes and the computer restarts, the Windows desktop appears and your computer is ready for use.

Registering your computer

Registering your computer helps IBM provide better service to you. When your registration information is received, it is placed into a central database accessible by IBM technical-support representatives. If you need technical assistance, the support representative will already have information about your computer, saving you time on the phone.

The registration program gathers your name, address, voice and fax telephone numbers, e-mail address, machine type, and machine serial number. If you do not register your computer during the initial setup, you can still do so at a later time.

To register your computer, use one of the following methods to access the registration program; then, follow the on-screen instructions.

- Double click the **Register** icon on the Windows desktop and follow the directions
- Double click the **Access IBM** icon on the Windows desktop; then, click **Get started** → **Registering your IBM computer**
- Click **Start** → **Programs** → **IBM Registration** → **Register**
- You can also register on the World Wide Web at <http://www.ibm.com/pc/register>

Note: The registration program, which starts through Access IBM or the **Register** icon, also has the capability of printing the registration information and supplying you with a mailing address, in the event no modem or Internet access is available.

Using Access IBM

Access IBM provides links to selected IBM Web sites and to the IBM Assistant, a help system for many end-user tasks. Access IBM also provides shortcuts to help accomplish many of these tasks.

Descriptions of the choices available from the Access IBM main menu are as follows:

- **Get Started**
Select this choice to display information about tasks that are typically performed immediately after installing a new computer.
- **Customize**
Select this choice to display information about personalizing your computer to fit your needs.
- **Upgrade**
Select this choice to display information about upgrading your computer hardware, finding IBM services, and purchasing IBM options (accessories).
- **Maintain**

Select this choice to display information about tasks, programs, and tools to protect data.

- **Solve problems**

Select this choice to display information about troubleshooting procedures, diagnostic tools, recovery procedures, and getting assistance from IBM.

Complete the following steps to use Access IBM.

1. Double click the **Access IBM** icon on the Windows desktop. If the **Access IBM** icon is not available on your desktop, click **Start**→ **Programs**→ **Access IBM**.
2. Click one of the categories listed on the menu (for example, Get Started).
3. Click a topic.

Viewing documentation on the World Wide Web

Documentation about your computer hardware and software is provided in portable document format (PDF) files that are read with Adobe Acrobat Reader. If Adobe Acrobat Reader is not installed on your computer, a message will appear when you attempt to view the PDF file. If you want to install a version of Adobe Acrobat Reader, you can download it from the Adobe Web site at <http://www.adobe.com> on the World Wide Web.

Complete the following steps to view online documentation.

1. Click **Start** → **Programs** → **Online Books** → **Online Books**. If no online books are installed, go to step 2.
2. You can search for online documentation files at <http://www.ibm.com/pc/support> on the World Wide Web.

Installing other operating systems

Your IBM computer comes with Microsoft Windows 2000 Professional preinstalled with the option of changing your operating system to Windows NT Workstation. For complete details about installing Windows NT Workstation, see “Recovering your operating system” on page 96.

To install another operating system, follow the instructions in the documentation provided with the operating system and any updates. Then, follow the instructions in Appendix A, “Using the Software Selections CD,” on page 105 to install the support software.

Note: If you install another operating system, you might need additional software or device drivers. Hardware-specific support software is available on the *Device Drivers and IBM Enhanced Diagnostics* CD. If you experience problems with the device drivers installed from this CD, you can obtain the latest device drivers at <http://www.ibm.com/pc/support> on the World Wide Web.

Before installing any operating system, be sure you obtain the latest updates. Contact the operating system manufacturer or, if applicable, check the manufacturer’s World Wide Web site to obtain the updates.

Additional information about operating systems is posted periodically on the World Wide Web at <http://www.ibm.com/pc/support>

Product recovery program

The Product Recovery Program is preinstalled on the hard disk drive that comes with your IBM computer. This program enables you to recover the Windows 2000 or Windows NT operating systems.

This program is designed to be hidden from view to protect the program from accidental damage. If you are using fdisk, NT Disk Administrator, or another utility to reformat your hard disk drive, you might be able to see the partition where the Product Recovery Program is stored. Do not delete this information, or your Product Recovery Program will be lost.

Backup diskettes for your preinstalled software are not provided with your computer. However, most of your IBM-preinstalled programs are located on the C:\IBMTTOOLS directory on your hard disk drive. For complete instructions on recovering some of the preinstalled software, see "Recovering your operating system and preinstalled software" on page 94.

Additional setup tasks

This section includes information about several tasks that you might want to perform while setting up your computer. These optional tasks are helpful if performed when setting up your computer for the first time.

- Setting up Internet Explorer
- Creating an IBM Enhanced Diagnostics diskette
- Creating an emergency repair diskette

Setting up Internet Explorer

Internet Explorer is a tool that you can use to navigate your company intranet or the World Wide Web.

Note: You must be connected to your company intranet or to the World Wide Web (or both) to be able to use Internet Explorer. For information about connecting to the Internet, as well as further information about Internet Explorer, see the Microsoft operating system documentation that comes with your computer.

Creating emergency repair diskettes

At your earliest opportunity, create emergency repair diskettes. It is important to create these diskettes, such as, a diagnostics diskette, Norton AntiVirus Rescue Disks, and the Repair Recovery diskette to use for recovery purposes.

If you add options to your computer, create a new emergency repair diskette to ensure that it reflects your current system configuration. For complete details on creating repair diskettes, click on the **Access IBM** → **Maintain**.

Finishing the installation

Locate the serial and model numbers, and then record this information in Appendix C, "Computer records," on page 111. For the location of the serial and model numbers, see Chapter 1, "Introducing the IntelliStation E Pro models," on page 1.

Chapter 3. Operating your computer

This chapter provides information to help you in the day-to-day use of your computer.

Turning on your computer

If you are starting your computer for the first time, see “Starting your computer for the first time” on page 12.

Attention: If you have a desktop model, check the position of the voltage-selection switch located beside the power cord connector. Use a ballpoint pen to slide the switch, if necessary.

- If the voltage supply range in your location is 90-137 V ac, set the voltage switch to 115 V.
- If the voltage supply range in your location is 180-265 V ac, set the voltage switch to 230-265 V.

After you plug one end of the computer into the power supply connector on the rear of the computer, and the other end of the power cord into an electrical outlet, the computer can start as follows:

- You can press the power control button on the front of the computer to start the computer.
- If the computer is turned on and a power failure occurs, the computer will start automatically when the power is restored.

If the POST detects a problem when you turn on your computer, you will hear repeating beeps. If this occurs, see Chapter 6, “Solving problems,” on page 73 for more information.

During POST, the following messages appear:

- Press F1 for Configuration/Setup
- To Start the Product Recovery Program, Press F11
- <<< Press <CTRL><A> for SCSISelect Utility! >>>

Note: The SCSI message only appears if a SCSI adapter is installed in your computer.

If your computer is properly connected and configured to load a startup image from the network, a request is sent and a startup image is loaded into your computer. If the request is unsuccessful or there is no network connection, the operating system and application programs are loaded from the hard disk drive.

Your computer can “wake up” and be started remotely over a network, if it has a properly configured network connection. For more information, see “Wake on LAN” on page 19 and “Remote Administration” on page 20.

Using video features

Your computer has an AGP graphics adapter that uses a standard video protocol for displaying text and graphic images on a monitor screen. The adapter supports a variety of video modes. Video modes are different combinations of resolution, refresh rate, and color defined by a video standard for displaying text or graphics.

Video device drivers

To take full advantage of the graphics adapter in your computer, some operating systems and application programs require custom software, known as video device drivers. These preinstalled device drivers provide support for greater speed, higher resolution, more available colors, and flicker-free images.

Device drivers for the graphics adapter and a README file with instructions for installing the device drivers are provided on the *Device Drivers and IBM Enhanced Diagnostics* CD and on the hard disk drive C:\IBMTOOLS\DRIVERS directory that comes with your computer. You can use the device driver installation instructions if you ever need to reinstall the device drivers or if you need information on obtaining and installing updated device drivers. For more information about installing device drivers, see “Recovering or installing device drivers” on page 96.

Changing monitor settings

To get the best possible image on your screen and to reduce flicker, you might need to reset the resolution and refresh rate of your monitor. You can view and change monitor settings through your operating system using the instructions provided in the README files on the *Device Drivers and IBM Enhanced Diagnostics* CD or on the C:\IBMTOOLS\DRIVERS directory on your hard disk drive.

Attention: Before you change any monitor settings, be sure to review the information that comes with your monitor. Using a resolution or refresh rate that is not supported by your monitor might cause the screen to become unreadable and could damage the monitor. The information that comes with your monitor usually includes the resolutions and refresh rates that the monitor supports. If you need additional information, contact the manufacturer of the monitor.

To minimize screen flicker and jitter, set your monitor for the highest noninterlaced refresh rate that the monitor supports. If your monitor complies with the VESA display data channel (DDC) standard, it is probably already set to the highest refresh rate that the monitor and video controller can support. If you are not sure if your monitor is DDC-compliant, see the documentation provided with the monitor.

If you have a dual-monitor video adapter and you connect both monitors but don't see the second monitor, go to **Start** → **Settings** → **Control Panel** → **Display Properties** → **Settings** → **Display Type** and enable the **Multi-head** option.

Using audio features

Your computer has an integrated audio controller that supports Sound Blaster applications and is compatible with the Microsoft Windows Sound System. Your computer has three audio connectors. Using the audio controller, you can record sound and music. If you connect external speakers to the Line out connector, you can play sound with multimedia applications.

The audio connectors in your computer are 3.5 mm (1/8-in.) mini-jacks. A description of the connectors follows. See “I/O connector locations” on page 67 for the locations of these connectors on both the tower and desktop models.

Line out

This connector is used to send audio signals from the computer to external devices, such as powered speakers with built-in amplifiers, headphones, multimedia keyboards, or the audio Line in jack on a stereo system.

Line in

This connector is used to accept audio signals from external devices, such as line output from a stereo, television, or a musical instrument, into the computer sound system.

Mic

This connector is used to connect a microphone to your computer when you want to record voice or other sounds on the hard disk. This connector and a microphone can also be used by speech recognition software.

Note: If you experience interference or speaker feedback while recording, try reducing the microphone recording volume (gain).

MIDI

The musical instrument digital interface (MIDI) connector allows your computer to interact with musical instruments and other musical equipment.

Managing your computer

Your computer comes with features that a network administrator or file server can use to remotely manage and control your computer.

IBM Universal Manageability Services (UM Services) streamline and automate personal computer (PC) systems management and support tasks, such as asset deployment and tracking. These utilities are available for IBM PCs at no additional charge, helping to reduce total cost of ownership of your networked computers so that you can focus vital company resources on essential business activities.

Go to <http://www.ibm.com/pc/us/software/sysmgmt/> on the World Wide Web and select **Products/downloads** for more information about available system management programs.

Wake on LAN

A network administrator can use Wake on LAN to turn on your computer from a remote location. When Wake on LAN is used with network management software, many functions, such as data transfers, software updates, and POST or BIOS updates to your computer, can be initiated remotely.

Note: If the computer power cord is plugged into a surge protector or power strip, make sure that when you turn off power, you turn off the computer power button and not the surge protector or power strip switch. Otherwise, the Wake on LAN feature will not work.

Remote Program Load or Dynamic Host Configuration Protocol

A network administrator can use Remote Program Load (RPL) or Dynamic Host Configuration Protocol (DHCP) to control your computer. If you use RPL with software, such as IBM LANClient Control Manager, you can use a feature called *Hybrid RPL*, which installs hybrid images (or files) on the hard disk. If your computer is a Hybrid RPL client, each time the computer starts from the network, LANClient Control Manager downloads a small *bootstrap* program to your computer hard disk drive and avoids the network traffic associated with a standard RPL.

DHCP is a protocol that lets network administrators centrally manage and automate the assignment of Internet Protocol (IP) addresses on a network.

Remote Administration

A network administrator can use the Remote Administration feature to remotely update the POST and BIOS code in your computer.

Network-management software, such as LANClient Control Manager (LCCM), is required to take advantage of this feature.

LANClient Control Manager

LANClient Control Manager is a graphical, server-based program that aids in system deployment by allowing mass unattended installations of operating systems, complete software images, device drivers, and BIOS code updates to remote systems. Used with Wake on LAN, LCCM can remotely turn on your computer, which means that installation can be done while the computer is not being used.

For more information or to download this software, visit <http://www.ibm.com/pc/us/desktop/lccm> on the World Wide Web.

System Migration Assistant

System Migration Assistant (SMA) helps administrators remotely transfer configurations, profile settings, printer drivers, and files from an IBM or non-IBM PC to supported IBM systems.

For more information or to download this software, visit <http://www.pc.ibm.com/us/software/sysmgmt/products/sma> on the World Wide Web.

Desktop Management Interface

DMI is a method for gathering information about the hardware and software in your computer. In a network environment, network administrators can use DMI to remotely monitor and control your computer.

Using security features

To deter unauthorized use of your computer, you can use anti-intrusion features and other security features that are provided with your computer.

Anti-intrusion features

IBM anti-intrusion features help protect against the theft of computer components, such as the microprocessor, system memory modules, or hard disk drives.

A cover lock is built into your computer to prevent the cover from being removed. Two identical keys for the cover lock are also supplied. A tag attached to the keys has the key serial number and the address of the key manufacturer.

Important:

Record the "key code" number along with the manufacturer address and phone number in the space provided in Appendix C, "Computer records," on page 111. Because locksmiths are not authorized to duplicate the cover lock keys, you must order replacement keys from the key manufacturer. When ordering replacement keys, you will need the key code number.

You can also set a chassis-intrusion detector inside your computer to alert the system administrator each time the computer cover is removed. For more information about

setting the chassis-intrusion alert, see Chapter 4, “Configuring your computer,” on page 23.

Component protection

Your computer has components with serial numbers that can be registered with a third-party security company. (You can also register the entire system.) By registering computer components, you can improve the chances of identifying the components if they are ever stolen and recovered. For more information about component registration, see the IBM support page at <http://www.ibm.com/pc/us/desktop/assetid/> on the World Wide Web.

Data protection

You can lose data from the hard disk drive for a variety of reasons. Security violations, viruses, or hard disk drive failures can all contribute to data loss. To help protect against the loss of valuable information, IBM has incorporated a data-saving feature in your computer.

Virus protection

Your computer has built-in virus protection that can be enabled through the Configuration/Setup Utility program. This built-in protection only checks for viruses in the boot record. Also, Norton AntiVirus for IBM is available on the IBM *Software Selections* CD. For more information on how to use the *Software Selections* CD, see Appendix A, “Using the Software Selections CD,” on page 105.

Shutting down your operating system

When you are ready to shut down your operating system, follow these instructions to prevent the loss of unsaved data or damage to your software programs. For more information about shutting down your operating system, refer the operating system documentation that comes with your computer.

Complete the following steps to shut down your operating system.

1. Save any files you are working on.
2. Close all open applications.
3. Click the Windows **Start** button.
4. Click **Shut Down**.
5. Click **Shut Down**; then, click **OK** to confirm the request.

Turning off your computer

You can turn off your computer as follows:

Statement 5



CAUTION:

The power control button on the device and the power switch on the power supply do not turn off the electrical current supplied to the device. The device also might have more than one power cord. To remove all electrical current from the device, ensure that all power cords are disconnected from the power source.

Statement 5

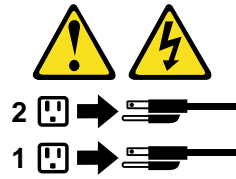

- You can press the power control button on the front of the computer. This starts an orderly shutdown of the operating system, if this feature is supported by your operating system, and places the computer in standby mode.
Note: After turning off the computer, wait at least five seconds before you press the power control button to turn on the computer again.
- You can press and hold the power control button for more than four seconds to cause an immediate shutdown of the computer and place the computer in standby mode. You can use this feature if the operating system stops functioning.
- If you cannot use the power control button to turn off your computer, disconnect the computer power cords from the electrical outlets.
Note: After disconnecting the power cords, wait approximately 15 seconds for your computer to stop running.

Chapter 4. Configuring your computer

The following configuration programs are provided with your computer:

- **Configuration/Setup Utility program**

This program is part of the BIOS code that comes with your computer. You can use this program to configure serial- and parallel-connector assignments, change the drive startup sequence, set the date and time, set passwords, and set the chassis-intrusion alert. See “Using the Configuration/Setup Utility program” for more information.

- **SCSISelect Utility program (some models)**

With the built-in SCSISelect Utility program, you can configure the devices that are attached to the SCSI adapter. See “Using the SCSISelect Utility program (some models)” on page 26 for more information.

Using the Configuration/Setup Utility program

This section provides the instructions for starting the Configuration/Setup Utility program and descriptions of the menu choices that are available.

Starting the Configuration/Setup Utility program

Complete the following steps to start the Configuration/Setup Utility program.

1. Turn on the computer and watch the monitor screen.
2. When the message Press F1 for Configuration/Setup appears, press F1.
3. Follow the instructions that appear on the screen.

Choices available from the Configuration/Setup Utility main menu

From the Configuration/Setup Utility main menu, you can select settings that you want to change. The Configuration/Setup Utility main menu is similar to the following:

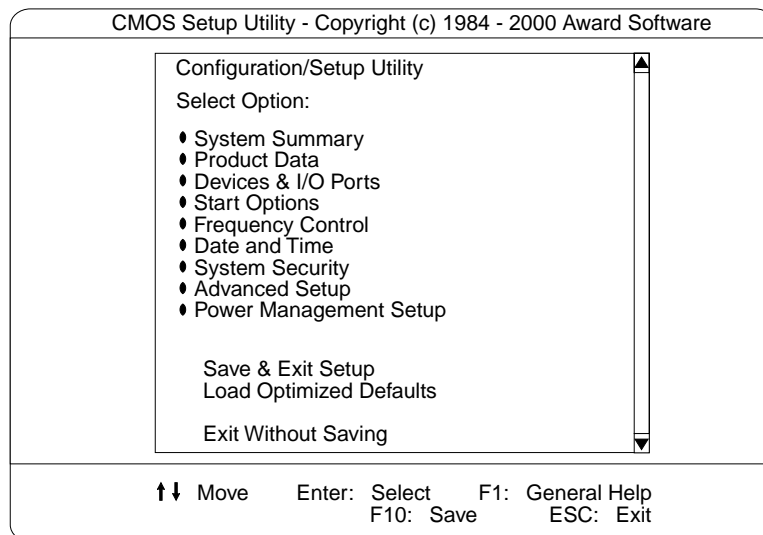

Notes:

1. You can press F1 to display help information for a selected menu item.
2. The choices on some menus might differ slightly from the ones that are described in this book, depending on the version of BIOS code in your computer.

3. If both a power-on and administrator password are set, you can type either password at the password prompt that appears as you start your computer. However, if you want to change the settings in the Configuration/Setup, you must type the administrator password to access the full configuration menus. If you type the power-on password, you can only view limited information in the Configuration/Setup program. For more information about setting passwords, see “Using passwords” on page 25.

Descriptions of the choices available from the main menu are as follows:

- **System Summary**

Select this choice to display configuration information. This includes the type and speed of the microprocessor and the amount of memory that is installed.

Changes that you make to configuration settings appear on this summary screen. You cannot edit the fields.

This choice appears on both the full and limited Configuration/Setup Utility menus.

- **Product Data**

Select this choice to view system information, such as the machine type and model, the computer serial number, and the revision level or issue date of the BIOS code that is stored in the flash EEPROM.

- **Devices & I/O Ports**

Select this choice to view or change the assignments for devices and input/output ports. This choice appears only on the full Configuration/Setup Utility main menu.

- **Start Options**

Select this choice to view or change the start options. Start options take effect when you start your computer.

You can select keyboard operating characteristics, such as the keyboard speed. You also can specify whether the computer starts with the keyboard number lock on or off.

The computer uses a startup sequence to determine the device from which the operating system starts. For example, you can define a startup sequence that checks for a startable diskette in the diskette drive; then, checks the hard disk drive, and then checks a network adapter.

You can enable a virus-warning test that checks for changes in the master boot record at startup. You also can choose to run POST in the quick mode, and read the microprocessor serial number.

- **Frequency Control**

Select this choice to enable or disable the auto-detect DIMM/PCI clock.

- **Date and Time**

Select this choice to set the system date and time.

The system time is in a 24-hour format: hour:minute:second.

- **System Security**

Select this choice to set a power-on or an administrator password. See “Using passwords” on page 25 for more information. You also can enable the chassis-intrusion detector to alert you each time the computer cover is removed.

- **Advanced Setup**

Select this choice to change values for advanced hardware features, such as Cache Control and PCI configuration.

A message appears above the choices on this menu to alert you that the system might malfunction if these options are configured incorrectly. Follow the instructions on the screen carefully.

— **Cache Control**

Select this choice to enable or disable the microprocessor cache.

Attention: Do not make changes to the Cache Control unless directed to do so by an IBM authorized service representative.

— **ROM Shadowing**

Select this choice to enable or disable the state of ROM shadowing.

— **Chipset Feature**

Select this choice to modify settings that control features of the core chip set on the system board.

Attention: Do not make changes to the Chipset Feature unless directed to do so by IBM.

— **Memory Settings**

Select this choice to manually enable or disable a bank of memory.

If a memory error is detected during POST or memory configuration, the computer can automatically disable the failing memory bank and continue operating with reduced memory capacity. If this occurs, you must manually enable the memory bank after the problem is corrected. Select **Memory Settings** from the Advanced Setup menu, use the arrow keys to highlight the bank that you want to enable; then, use the arrow keys to select **Enable**.

- **Power Management Setup**

Select this choice to enable or disable system power settings.

- **Save and Exit Setup**

Select this choice to save your customized settings.

- **Load Optimized Defaults**

Select this choice to discard your changes and restore the factory settings.

- **Exit Without Saving**

Select this choice if you want to exit without saving changes, or if no changes have been made.

Using passwords

You can use any combination of up to seven characters (A–Z, a–z, and 0–9) for the power-on password or the administrator password. When you have set one or both of the passwords, record them and keep them in a secure place.

If both a power-on and administrator password are set, you can type either password at the password prompt that appears as you start your computer. However, if you want to change the settings in the Configuration/Setup, you must type the administrator password to access the full configuration menus. If you type the power-on password, you can only view limited information in the Configuration/Setup program.

If you forget the power-on password, you can regain access to the computer through either of the following methods:

- Start the Configuration/Setup Utility program and change the power-on password.
- Change the jumper position on the complimentary metal oxide semiconductor (CMOS) jumper as described in “Clearing CMOS” on page 98.

Using the SCSISelect Utility program (some models)

SCSISelect is a built-in, menu-driven configuration utility program that you can use to:

- View the default SCSI IDs
- Locate and correct configuration conflicts

The following sections provide the instructions for starting the SCSISelect Utility program and descriptions of the menu choices that are available.

Starting the SCSISelect Utility program

Complete the following steps to start the SCSISelect Utility program:

1. Turn on the computer.
2. When the <<< Press <CTRL><A> for SCSISelect™ Utility! >>> prompt appears, press Ctrl+A.
3. When the Would you like to configure the host adapter or run the SCSI disk utility? question appears, make your selection and press Enter.
4. Use the arrow keys to select a choice from the menu.
 - Press Esc to exit the SCSISelect Utility program.
 - Press the F5 key to switch between color and monochrome modes (if your monitor permits).
5. Follow the instructions on the screen to change the settings of the selected items; then, press Enter.

Choices available from the SCSISelect menu

The following choices appear on the SCSISelect Utility menu:

- **Configure/View Host Adapter Settings**

Select this choice to view or change the SCSI controller settings. To reset the SCSI controller to its default values, press F6; then, follow the on-screen instructions.

You can view or change the following controller settings:

- **Host Adapter SCSI ID**

Select this choice to view the SCSI controller identification (ID), which is usually 7.

- **SCSI Parity Checking**

Select this choice to view the assigned value of *Enabled*.

- **Host Adapter SCSI Termination**

Select this choice to view the assigned value of *Automatic*.

- **Boot Device Options**

Select this choice to configure startable-device parameters. Before you can make updates, you must know the ID of the device whose parameters you want to configure.

- **SCSI Device Configuration**

Select this choice to configure SCSI-device parameters. Before you can make updates, you must know the ID of the device whose parameters you want to configure.

Note: The Maximum Sync Transfer Rate represents the transfer rate for Ultra SCSI devices.

- The transfer rate for Ultra160 low voltage differential (LVD) devices is 160.0 Mbps.
- The transfer rate for Ultra2 SCSI LVD devices is 80.0 Mbps.
- The transfer rate for Fast SCSI devices is 20.0 Mbps.

- **Advanced Configuration Options**

Select this choice to view or change the settings for advanced configuration options. These options include enabling support for large hard disk drives and support for drives with Ultra SCSI speeds.

- **SCSI Disk Utilities**

Select this choice to view the SCSI IDs that are assigned to each device or to format a SCSI device.

To use the utility program, select a drive from the list. Read the on-screen instructions carefully before making a selection.

Note: If you press Ctrl+A before the selected drives are ready, an Unexpected SCSI Command Failure screen might appear. Restart the computer and watch the SCSISelect messages as each drive starts. After the drive that you want to view or format starts, press Ctrl+A.

Chapter 5. Installing options

This chapter provides instructions to help you add options to your computer. Some option-removal instructions are provided, in case you need to remove one option to install another. For a list of supported options for your computer, go to <http://www.ibm.com/pc/support> on the World Wide Web.

Major components of the tower model

The following illustration shows the locations of major components in the tower model.

Note: The illustrations in this document might differ slightly from your hardware.

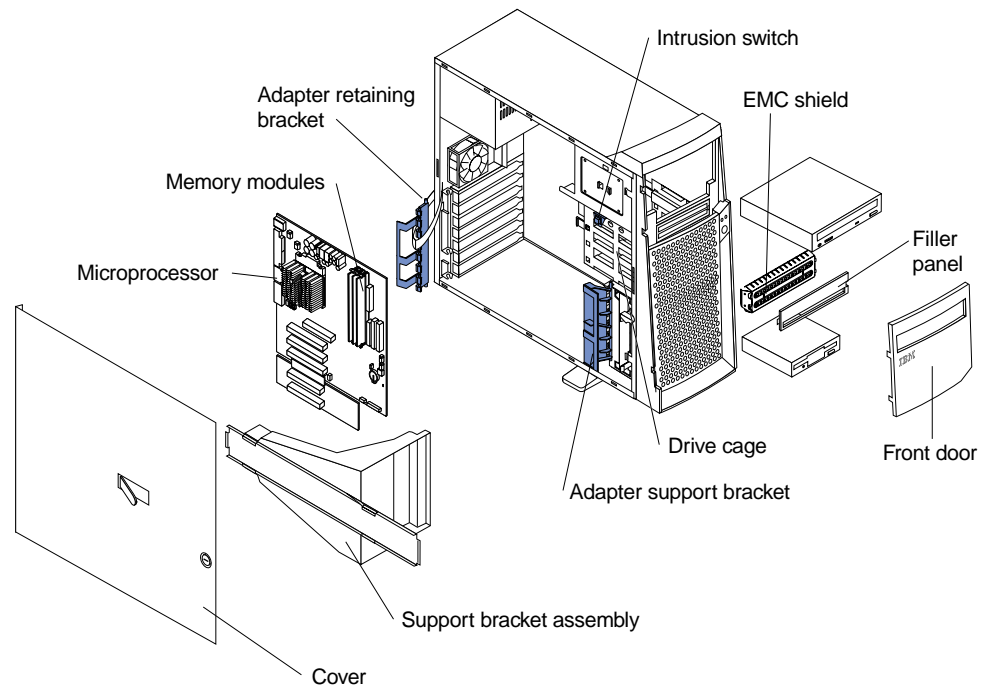

Major components of the desktop model

The following illustration shows the locations of major components in the desktop model.

Note: The illustrations in this document might differ slightly from your hardware.

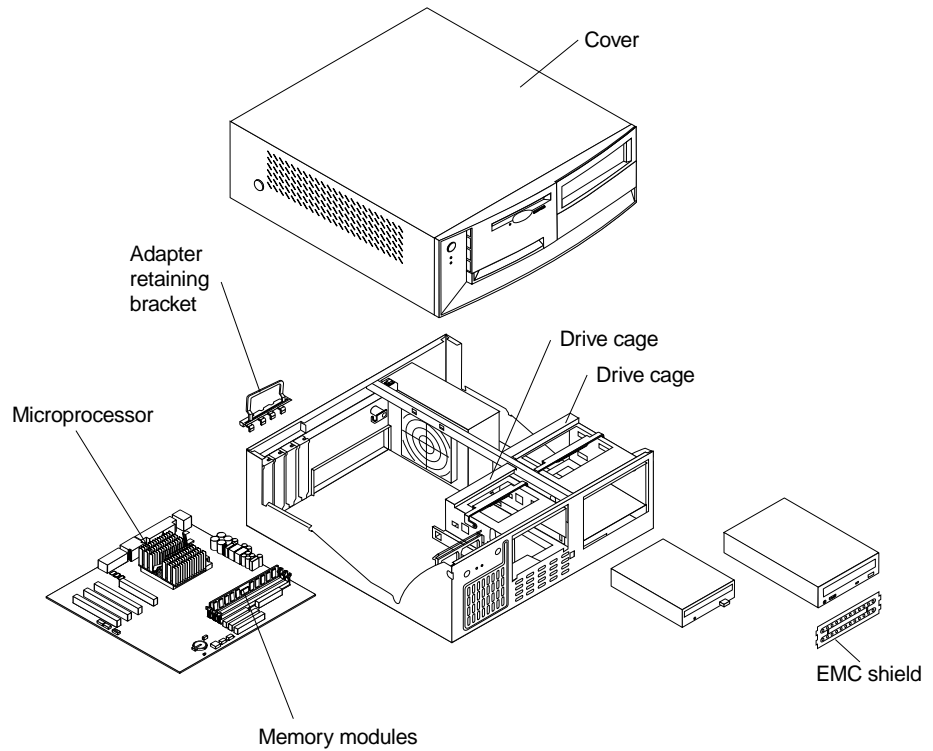

System and PCI extender boards

The illustrations in the following sections show the components on the system and PCI extender boards.

Note: The PCI extender board is only available in the tower model.

System and PCI extender board option connectors

The following illustration identifies the system and PCI extender board connectors for options you can install.

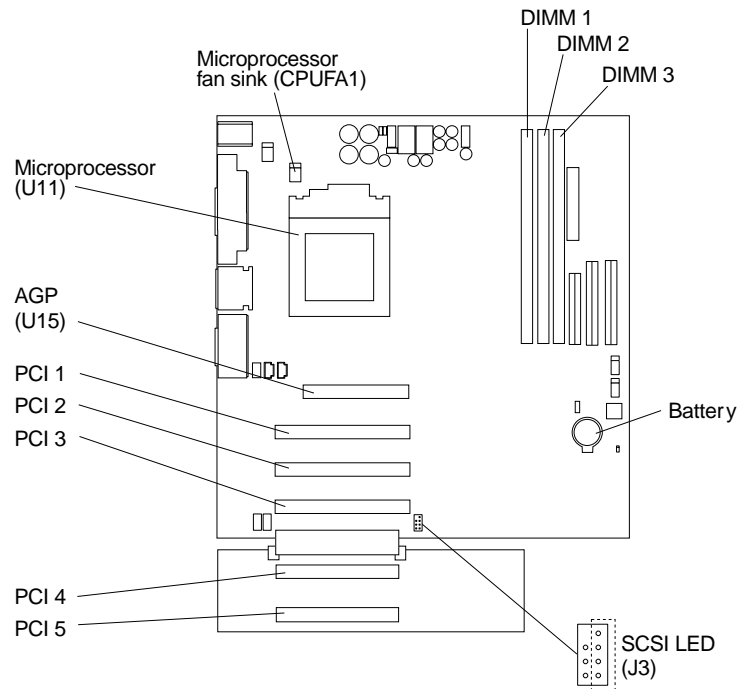

System board internal cable connectors

The following illustration identifies system board connectors for internal cables.

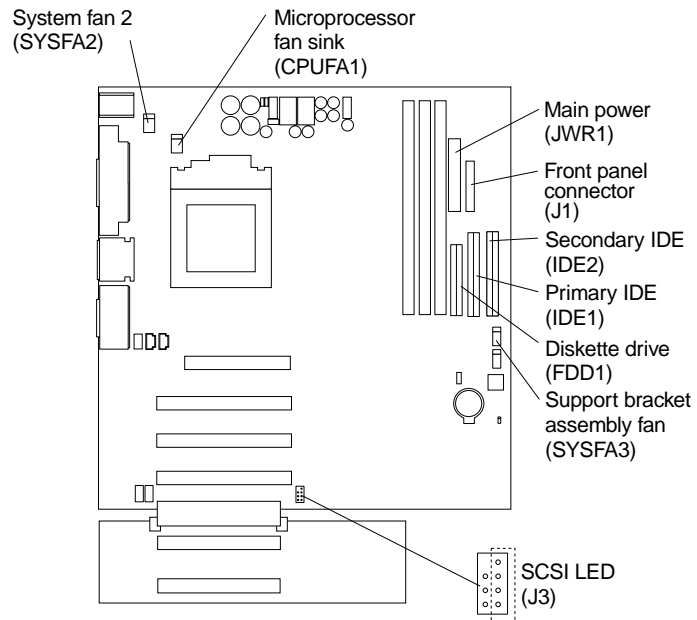

System board external connectors

The following illustration identifies system board connectors for external devices.

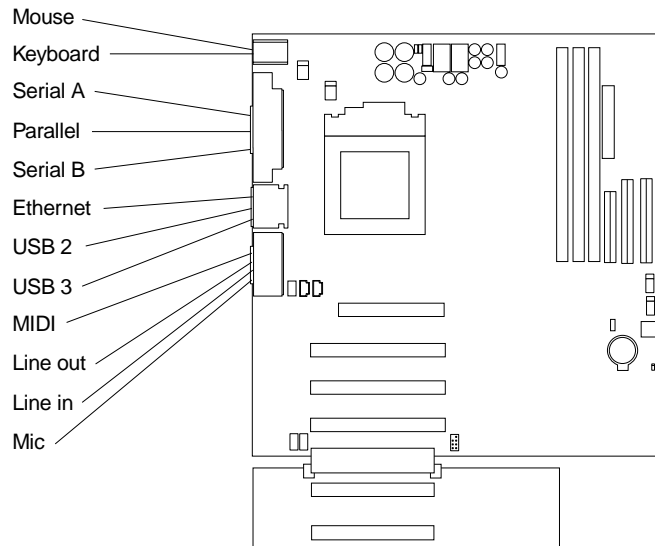

System board jumpers

The following illustration identifies the jumpers on the system board.

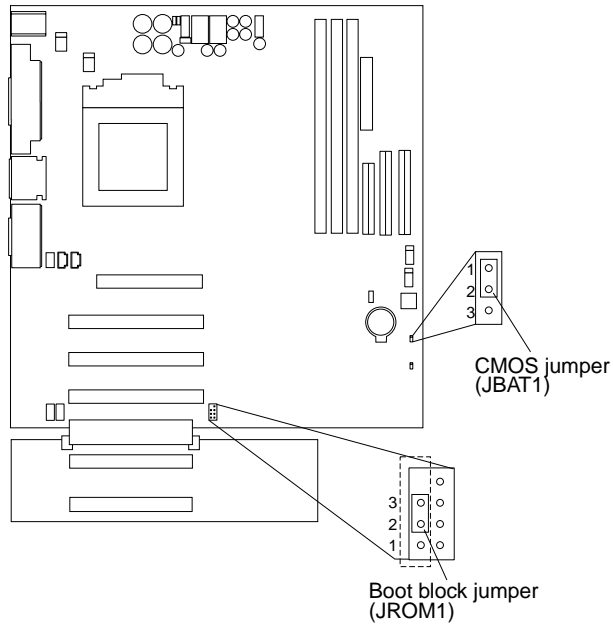

Boot block jumper

For normal operations of the system, a jumper is installed on pins 2 and 3 of the boot block jumper. See “Recovering BIOS” on page 94 for information about the boot block jumper.

CMOS jumper

For normal operation of the system, a jumper is installed on pins 1 and 2 of the CMOS jumper. See “Clearing CMOS” on page 98 for information about the CMOS jumper.

Before you begin

Before you begin to install options in your computer, read the following information.

- Become familiar with the safety and handling guidelines specified under “Handling static-sensitive devices” on page 34, and read the safety statements in “Safety information” on page 35. These guidelines will help you work safely with your computer or options.
- Make sure that you have an adequate number of properly grounded electrical outlets for your computer, monitor, and any other options that you intend to install.
- When you need to access the inside of the computer to install options, you might find it easier to lay the computer on its side. If you do so, rotate the two front feet in towards the computer, so they do not break off due to the weight of the computer.

Before you place the computer in an upright position, rotate the two front feet a quarter turn away from the computer, see “Installing options in a tower model” on page 40 for details.

- Back up all important data before you make changes to hard disk drives.
- Have a small, flat-blade screwdriver available.

- For a list of supported options for your computer, refer to <http://www.ibm.com/pc/support> on the World Wide Web.

System reliability considerations

To help ensure proper cooling and system reliability, make sure that:

- Each of the drive bays has a drive or a filler panel and electromagnetic compatibility (EMC) shield installed.
- There is space around the computer to allow the computer cooling system to work properly. Leave about 127 mm (5 in.) of space around the front and rear of the computer.
- Cables for optional adapters are routed according to the instructions that are provided with the adapters.
- A failed fan is replaced within 1 hour.

Handling static-sensitive devices

Attention: Static electricity can damage electronic devices and your system. To avoid damage, keep static-sensitive devices in their static-protective bag until you are ready to install them.

To reduce the possibility of electrostatic discharge, observe the following precautions.

- Limit your movement. Movement can cause static electricity to build up around you.
- Handle the device carefully, holding it by its edges or its frame.
- Do not touch solder joints, pins, or exposed printed circuitry.
- Do not leave the device where others can handle and possibly damage the device.
- While the device is still in its anti-static package, touch it to an unpainted metal part of the system unit for at least two seconds. (This drains static electricity from the package and from your body.)
- Remove the device from its package and install it directly into your system unit without setting it down. If it is necessary to set the device down, place it on its static-protective package. (If your device is an adapter, place it component side up.) Do not place the device on your system unit cover or on a metal table.
- Take additional care when handling devices during cold weather as heating reduces indoor humidity and increases static electricity.

Safety information

Before installing this product, read the Safety Information book.

مج، يجب قراءة دات السلامة

Antes de instalar este produto, leia o Manual de Informações sobre Segurança.

安装本产品前请先阅读《安全信息》手册。

Prije instalacije ovog proizvoda pročitajte priručnik sa sigurnosnim uputama.

Před instalací tohoto produktu si přečtěte příručku bezpečnostních instrukcí.

Læs hæftet med sikkerhedsforskrifter, før du installerer dette produkt.

Lue Safety Information -kirjanen, ennen kuin asennat tämän tuotteen.

Avant de procéder à l'installation de ce produit, lisez le manuel Safety Information.

Vor Beginn der Installation die Broschüre mit Sicherheitshinweisen lesen.

Πριν εγκαταστήσετε αυτό το προϊόν, διαβάστε το εγχειρίδιο Safety Information.

לפני שתתקינו מוצר זה, קראו את הוראות הבטיחות.

Przed zainstalowaniem tego produktu należy przeczytać broszurę Informacje Dotyczące Bezpieczeństwa.

Prima di installare questo prodotto, leggere l'opuscolo contenente le informazioni sulla sicurezza.

本製品を導入する前に、安全情報資料を御読みください。

이 제품을 설치하기 전에, 안전 정보 책자를 읽어보십시오.

Пред да го инсталирате овој производ прочитајте ја книгата со безбедносни информации.

Lees voordat u dit product installeert eerst het boekje met veiligheidsvoorschriften.

Les heftet om sikkerhetsinformasjon (Safety Information) før du installerer dette produktet.

Prije instalacije ovog proizvoda pročitajte priručnik sa sigurnosnim uputama.

Antes de instalar este produto, leia o folheto Informações sobre Segurança.

Перед установкой продукта прочтите брошюру по технике безопасности (Safety Information).

Pred inštaláciou tohto produktu si pre ítajte Informa nú brožúrku o bezpe nosti.

Preden namestite ta izdelek, preberite knjižico Varnostne informacije.

Antes de instalar este producto, lea la Información de Seguridad.

Läs säkerhetsinformationen innan du installerar den här produkten.

在安裝本產品之前，也請先閱讀「安全性資訊」小冊子。

Installálás el tt olvassa el a Biztonsági el írások kézikönyvét !

Statement 1



<p>Danger</p> <p>Electrical current from power, telephone, and communication cables is hazardous.</p> <p>To avoid a shock hazard:</p> <ul style="list-style-type: none">• Do not connect or disconnect any cables or perform installation, maintenance, or reconfiguration of this product during an electrical storm.• Connect all power cords to a properly wired and grounded electrical outlet.• Connect to properly wired outlets any equipment that will be attached to this product.• When possible, use one hand only to connect or disconnect signal cables.• Never turn on any equipment when there is evidence of fire, water, or structural damage.• Disconnect the attached power cords, telecommunications systems, networks, and modems before you open the device covers, unless instructed otherwise in the installation and configuration procedures.• Connect and disconnect cables as described in the following table when installing, moving, or opening covers on this product or attached devices.
--

<p>To connect:</p> <ol style="list-style-type: none">1. Turn everything OFF.2. First, attach all cables to devices.3. Attach signal cables to connectors.4. Attach power cords to outlet.5. Turn device ON.	<p>To disconnect:</p> <ol style="list-style-type: none">1. Turn everything OFF.2. First, remove power cords from outlet.3. Remove signal cables from connectors.4. Remove all cables from devices.
---	---

Statement 2

CAUTION:



When replacing the lithium battery, use only IBM Part Number 33F8354 or an equivalent type battery recommended by the manufacturer. If your system has a module containing a lithium battery, replace it only with the same module type made by the same manufacturer. The battery contains lithium and can explode if not properly used, handled, or disposed of.

Do not:

- Throw or immerse into water
- Heat to more than 100 C (212 F)
- Repair or disassemble

Dispose of the battery as required by local ordinances or regulations.

Statement 3



CAUTION:

When laser products (such as CD-ROMs, DVD drives, fiber optic devices, or transmitters) are installed, note the following:

- Do not remove the covers. Removing the covers of the laser product could result in exposure to hazardous laser radiation. There are no serviceable parts inside the device.
- Use of controls or adjustments or performance of procedures other than those specified herein might result in hazardous radiation exposure.



Danger

Some laser products contain an embedded Class 3A or Class 3B laser diode. Note the following. Laser radiation when open. Do not stare into the beam, do not view directly with optical instruments, and avoid direct exposure to the beam.

Statement 4

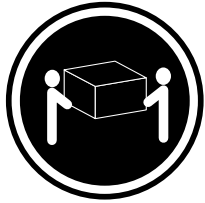

≥18 kg (39.7 lbs)



≥32 kg (70.5 lbs)

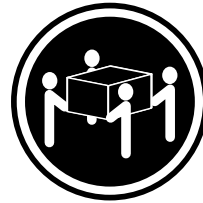

≥55 kg (121.2 lbs)

CAUTION:
Use safe practices when lifting.

Statement 5



CAUTION:
The power control button on the device and the power switch on the power supply do not turn off the electrical current supplied to the device. The device also might have more than one power cord. To remove all electrical current from the device, ensure that all power cords are disconnected from the power source.

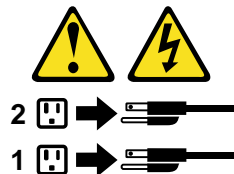

Power and signal cables for internal drives

Your computer uses cables to connect IDE and SCSI drives to the power supply and to the system board. The following cables are provided:

- Four-wire power cables connect the drives to the power supply. At the end of these cables are plastic connectors that attach to different drives; these connectors vary in size. Also, certain power cables attach to the system board.
- Flat signal cables, also called ribbon cables, connect IDE, SCSI, and diskette drives to the system board. There are two sizes of ribbon signal cables that come with your computer.
 - The wider IDE signal cable has two or three connectors.
 - If the cable has three connectors, one of these connectors is attached to the drive, one is a spare, and the third attaches to the primary or secondary IDE connector on the system board.

- If the cable has two connectors, one of these connectors is attached to the hard disk drive, and the other attaches to the primary or secondary IDE connector on the system board.

Note: If you want to add another device, and your computer does not come with a CD-ROM drive preinstalled, you will need a second signal cable with three connectors. You will need an 80-conductor ATA 66 signal cable if you are replacing the existing signal cable or adding a second hard disk drive. ATA 66 signal cables are color-coded. The blue connector attaches to the system board, the black connector attaches to the master device, and the gray middle connector attaches to the subordinate device.

If your computer comes with a CD-ROM drive, it will have an ATA 66 signal cable. However, if you are installing a hard disk drive, you must change the switch setting on the CD-ROM drive to secondary and change the connector used for the CD-ROM drive to the gray middle connector.

- The narrower signal cable has two connectors, one to attach to the diskette drive and the other to attach to the connector (FDD1) on the system board.

Note: To locate connectors on the system board, see “System board internal cable connectors” on page 32.

The following are some important points to remember when connecting power and signal cables to internal drives:

- The drives that are preinstalled in your computer come with power and signal cables attached. If you replace any drives, it is important to remember which cable is attached to which drive.
- When you install a drive, ensure that the drive connector at the *end* of the signal cable is always connected to a drive; also, ensure that the drive connector at the other end is connected to the system board. This reduces electronic noise from the computer.
- If two IDE devices are used on a single cable, one must be designated as the primary or master device and the other as the secondary or subordinate device; otherwise, some of the IDE devices might not be recognized by the system. The primary and secondary designation is determined by switch or jumper settings on each IDE device.
- If two IDE devices are on a single cable, and only one is a hard disk drive, the hard disk drive must be set as the master device.
- If you have only one IDE device on a cable, it must be set as master.

Installing options in a tower model

This section provides instructions for installing various options in a tower model.

Moving the stabilizing feet

The two front feet on the bottom of the tower model rotate 90 degrees to provide additional stability.

When you need to access the inside of the computer to install options, you might find it easier to lay the computer on its side. If you do so, rotate the feet in towards the computer, so they do not break off due to the weight of the computer.

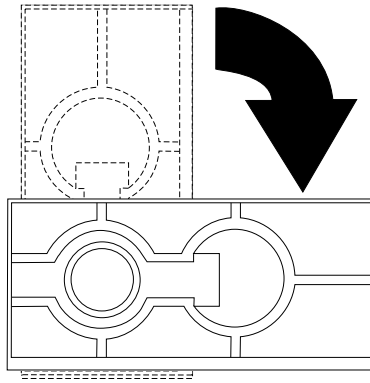

When you are finished installing options and have reinstalled the side cover, turn the two front stabilizing feet a quarter turn out from the computer and set it carefully back on its feet.

Removing the side cover

The following information describes how to remove the side cover.

Note: The illustrations in this document might differ slightly from your hardware.

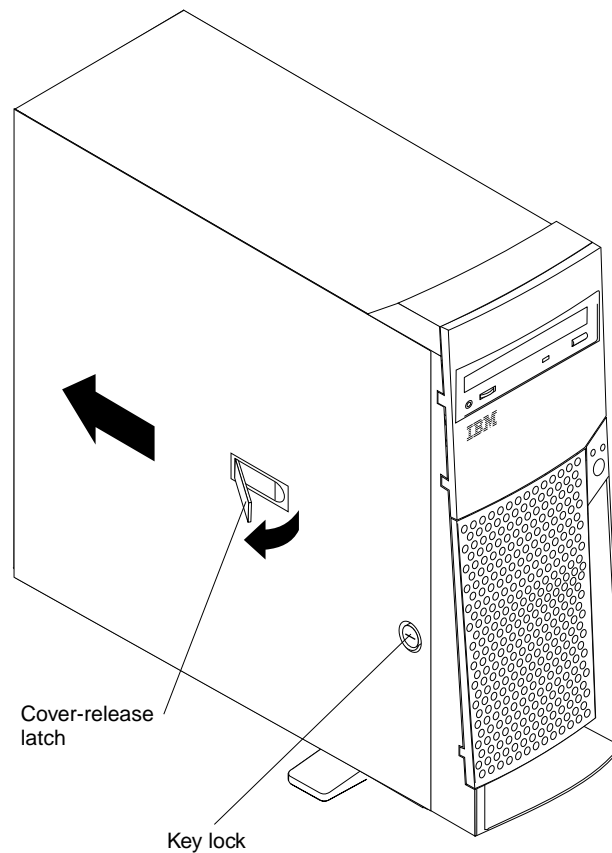

Complete the following steps to remove the side cover of the computer.

1. Review the information in “Before you begin” on page 33 and the safety precautions listed in Statement 1 and Statement 5 in “Safety information” on page 35.
2. Remove any media (diskettes, CDs, or tapes) from the drives and shut down your operating system.

3. Turn off the computer and all attached devices and disconnect all external cables and power cords.
4. If necessary, unlock the computer cover.
5. Pull out on the cover-release latch, which will slide the cover toward the rear of the computer about 12.7 mm (1/2 in.). Then, remove the cover from the computer and set it aside.

To replace the side cover, see “Installing the cover” on page 54.

Attention: For proper cooling and airflow, replace the cover before turning on the computer. Operating the computer with the cover removed might damage the computer components.

Removing the support bracket assembly

When working with some options, such as hard disk drives and memory modules, you must first remove the support bracket assembly to access the option.

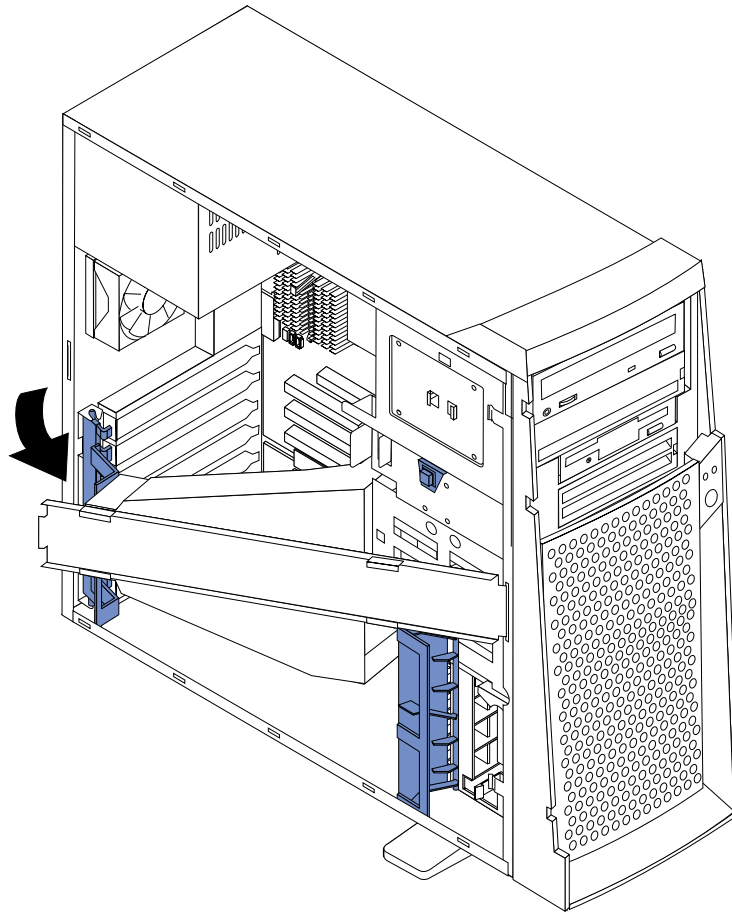

Complete the following steps to remove the support bracket assembly.

1. Review the safety precautions listed in “Safety information” on page 35.
2. Remove any media (diskettes, CDs, or tapes) from the drives and shut down your operating system.
3. Turn off the computer and attached devices and disconnect all external cables and power cords; then, remove the side cover. For more information about removing the side cover, see “Removing the side cover” on page 41.

4. Disconnect the support bracket assembly fan cable from the connector (SYSFA3) on the system board. For the location of the fan cable connector, see “System board internal cable connectors” on page 32.
5. Locate the end of the support bracket near the rear of the computer. Pull it out approximately 152 mm (6 in.).
6. Pull the front end of the support bracket assembly away from the computer and place the assembly aside.

To reinstall the support bracket assembly, reverse the previous steps.

Working with adapters

Your computer comes with adapter connectors, call *slots*. The AGP video adapter is installed in the AGP slot. You can install up to five PCI adapters in PCI expansion slots 1 through 5. All PCI expansion slots are 32-bit, 33 MHz slots.

The following illustration shows the location of the AGP and PCI expansion slots on the system board and the PCI extender board.

Note: The illustrations in this document might differ slightly from your hardware.

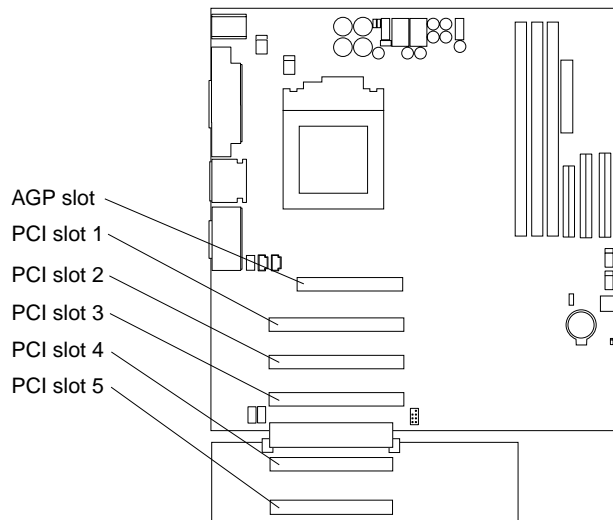

Adapter considerations

Before you install adapters, review the following:

- Locate the documentation that comes with the adapter and follow those instructions in addition to the instructions given in this chapter. If you need to change switch settings or jumper settings on your adapter, follow the instructions that come with the adapter.
- You can install full-length adapters in all five PCI expansion slots.
- Your computer supports 5.0V and universal PCI adapters; it does not support 3.3V adapters.
- Your computer uses a rotational interrupt technique to configure PCI adapters. Because of this technique, you can install a variety of PCI adapters that currently do not support sharing of PCI interrupts.
- PCI slots 1 through 5 are on PCI bus 0.

The system scans the AGP slot and PCI slots 1 through 5 to assign system resources; then, the system starts (boots) the PCI devices in the following order, if you have not changed the default boot sequence: PCI slots 1 and 2, system

board integrated drive electronics (IDE) or SCSI devices, and then PCI slots 3 through 5.

Note: To change the boot sequence for PCI devices, start the Configuration/Setup Utility program, select **Start Options** from the main menu, select **Startup Sequence**; then, select **Second device (SCSI)** to designate the adapter boot sequence. See Chapter 4, “Configuring your computer,” on page 23 for details on using the Configuration/Setup Utility program.

- For a list of supported options for your computer, refer to <http://www.ibm.com/pc/support> on the World Wide Web.

Installing an adapter

Complete the following steps to install an adapter.

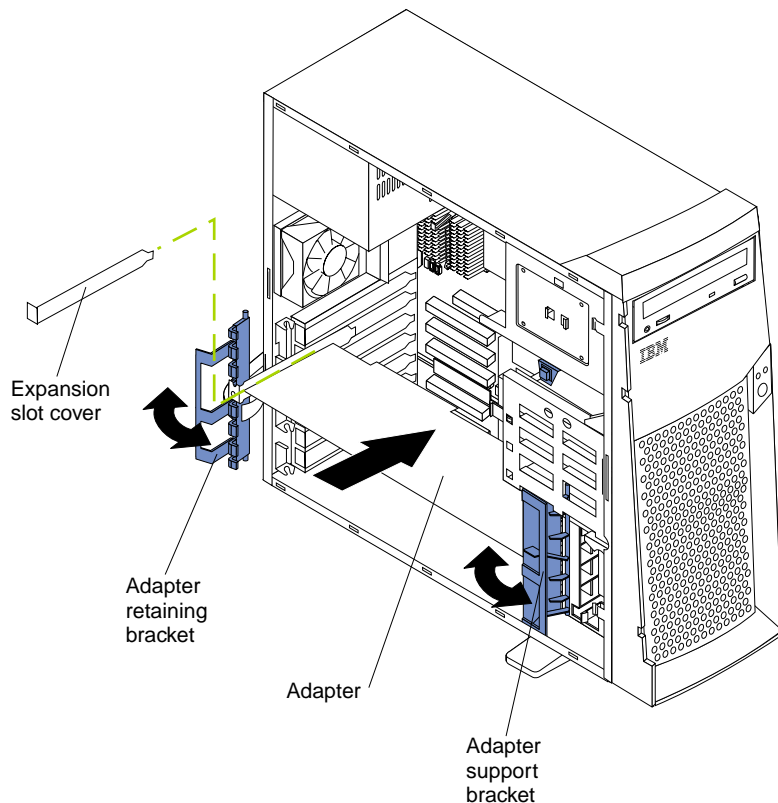

Attention: When you handle ESD-sensitive devices, take precautions to avoid damage from static electricity. For details on handling these devices, see “Handling static-sensitive devices” on page 34.

1. Review the safety precautions listed in “Safety information” on page 35.
2. Remove any media (diskettes, CDs, or tapes) from the drives and shut down your operating system.
3. Turn off the computer and attached devices and disconnect all external cables and power cords; then, remove the side cover. For more information about removing the side cover, see “Removing the side cover” on page 41.
4. Determine which PCI expansion slot you will use for the adapter.

Note: Check the instructions that come with the adapter for any requirements, restrictions, or cabling instructions. It might be easier for you to route cables before you install the adapter.

5. If you are installing a full-length adapter, rotate the front adapter support bracket to the open (unlocked) position.
6. Rotate the rear adapter retaining bracket to the open (unlocked) position; then, place it over the rear of the computer.
7. Remove the PCI expansion-slot cover. From the rear of the computer, press in on the slot cover. Grasp it and pull it out of the slot. Store it in a safe place for future use.
Attention: PCI expansion-slot covers must be installed on all vacant slots. This maintains the electromagnetic emissions characteristics of the computer and ensures proper cooling of system components.
8. Touch the static-protective bag containing the adapter to any unpainted metal surface on the computer; then, remove the drive from the bag and place it on a static-protective surface.
9. Remove the adapter from the static-protective package. Avoid touching the components and gold-edge connectors on the adapter.
10. Place the adapter, component-side up, on a flat, static-protective surface.
11. Set any jumpers or switches as described by the adapter manufacturer.
12. To install the adapter, carefully grasp the adapter by the top edge or upper corners, and align it with the slot guides; then, press the adapter *firmly* into the expansion slot.
Attention: When you install an adapter in the computer, be sure that it is completely and correctly seated in the PCI expansion slot before you turn on the computer. Incomplete insertion might cause damage to the system board, PCI extender board, or the adapter.
13. Connect required cables to the adapter.
Attention: Route cables so that they do not block the flow of air from the fans.
14. If you have another adapter or other options to install, do so now.
15. If you have installed a full-length adapter, rotate the front adapter support bracket to the closed (locked) position.
16. Reinstall the rear adapter retaining bracket; then, rotate the bracket to the closed (locked) position.
17. Reinstall the side cover (see “Installing the cover” on page 54 for details).
18. Reconnect the external cables and power cords; then, turn on the attached devices and the computer.

Installing a SCSI adapter (some models)

Complete the following steps to install a SCSI adapter.

1. If you have not already installed the SCSI adapter, complete steps 1 through 11 of “Installing an adapter” on page 44. Then, return here to complete the installation.

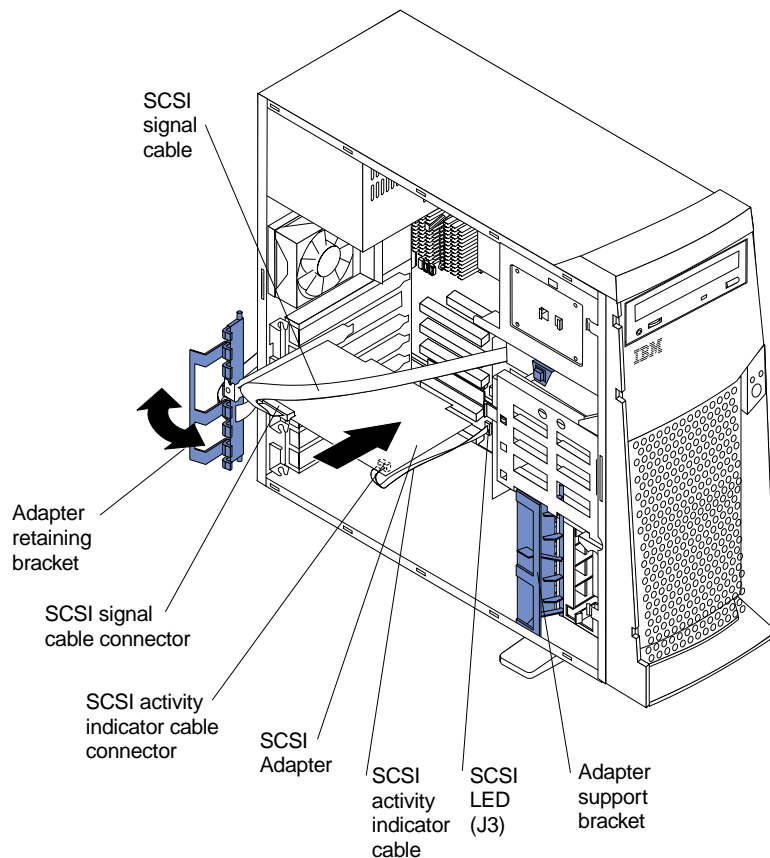

2. Connect one end of the SCSI signal cable (purchased separately) to the adapter; then, connect one or more of the signal cable connectors to the rear of the SCSI devices.
3. Connect the SCSI activity indicator cable (purchased separately) to the adapter and to the SCSI LED connector (J3) on the system board. See "System and PCI extender board option connectors" on page 31 for the location of the SCSI LED connector.
4. If you have other adapters to install or remove, do so now.
5. Rotate the front adapter support bracket to the closed (locked) position.
6. Reinstall the rear adapter retaining bracket; then, rotate the bracket to the closed (locked) position.
7. Install the side cover. See "Installing the cover" on page 54 for details.
8. Reconnect the external cables and power cords; then, turn on the attached devices and the computer.

Installing internal drives

Different types of drives enable your computer to read multiple types of media and store data in different formats. Depending on your computer model, you might have one or more of the following drives installed.

- Diskette
- Hard disk
- CD-ROM
- Tape

Internal drive bays

Your IntelliStation E Pro comes with an IDE CD-ROM drive installed in bay 1, a 3.5-in., 1.44 MB diskette drive installed in bay 3, and a hard disk drive installed in bay 5 in some models.

Note: The illustrations in this document might differ slightly from your hardware.

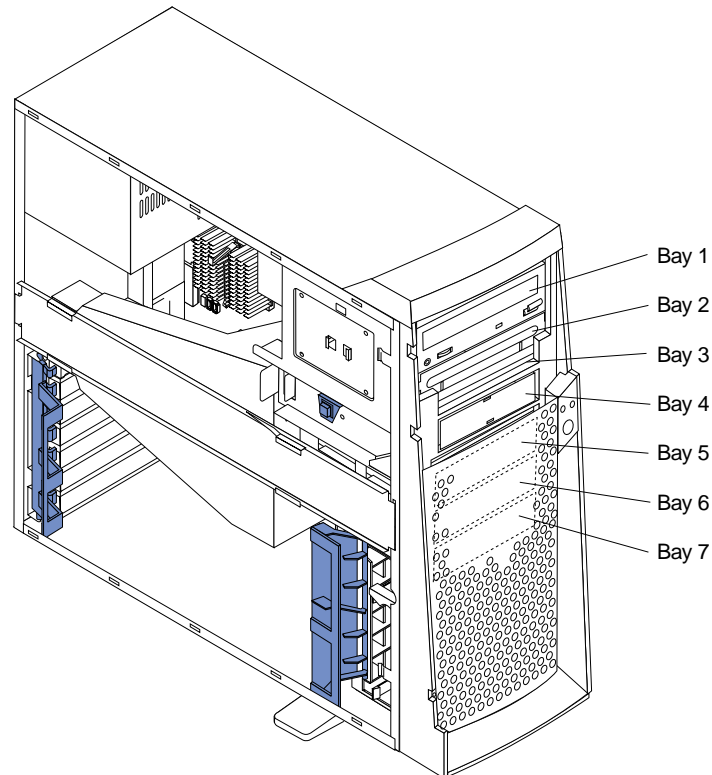

Notes:

1. Diskette drives, tape drives, and CD-ROM drives are removable media drives. You can install removable-media drives in bays 1, 2, 3, and 4.
2. You can install a 3.5-in, slim-high or a 5.25-in., half-high, removable-media drive, such as a tape backup drive, in bay 2.
3. You can only install a 3.5-in., slim-high, removable-media drive in bay 4.
4. The IntelliStation E Pro computer supports only one diskette drive, which uses 1 MB and 2 MB diskettes.
5. Before you install a 3.5-in. drive in a 5.25-in. bay, you must attach the 5.25 in. conversion kit, supplied with your option, to the 3.5-in drive. Refer to the documentation that comes with the option for the conversion kit installation instructions.

Note: Only 3.5-in. options that ship with proper mounting hardware can be supported in the 5.25-in. bays.

6. If you have a tape backup drive in your server, use a dry process cleaning cartridge to clean the tape head two hours after you first use a new data cartridge. Then, clean the tape head once a month, or after each eight hours of continuous read/write operations, whichever occurs first. For complete details about the tape backup drive, refer to the documentation that comes with your computer or your backup option.
7. The electromagnetic interference (EMI) integrity and cooling of the computer are both protected by having bays 1 through 4 covered or occupied. When you install

a drive, save the EMC shield and filler panel from the bay, in case you later remove the drive and do not replace it with another.

8. For a list of supported options for your computer, refer to <http://www.ibm.com/pc/support> on the World Wide Web.

Preinstallation steps (all bays)

Before you install drives in your computer, verify that you have all the cables and other equipment specified in the documentation that comes with the drive. You might also need to perform certain preinstallation activities. Some of the steps are required only during the initial installation of an option.

1. Read “Safety” on page vii, “Handling static-sensitive devices” on page 34, and the documentation that comes with your drive.
2. Choose the bay in which you want to install the drive.
3. Check the instructions that come with the drive to see if you need to set any switches or jumpers on the drive. If you are installing a SCSI device, be sure to set the SCSI ID for that device.

Installing a drive in bay 2 or 4

Complete the following steps to install a drive in bay 2 or 4.

Attention: When you handle ESD-sensitive devices, take precautions to avoid damage from static electricity. For more details on handling these devices, see “Handling static-sensitive devices” on page 34.

1. Review the safety precautions listed in “Safety information” on page 35.
2. Remove any media (diskettes, CDs, or tapes) from the drives and shut down your operating system.
3. Turn off the computer and attached devices and disconnect all external cables and power cords; then, remove the side cover. See “Removing the side cover” on page 41 for details.
4. Remove the support bracket assembly and disconnect the fan cable from the connector (SYSFA3) on the system board. See “Removing the support bracket assembly” on page 42 for removal instructions.
5. Use a screwdriver to gently pry the filler panel and EMC shield away from the computer.

Note: If you are installing a drive that is a laser product, observe the following safety precaution:

Statement 3



CAUTION:

When laser products (such as CD-ROMs, DVD drives, fiber optic devices, or transmitters) are installed, note the following:

- Do not remove the covers. Removing the covers of the laser product could result in exposure to hazardous laser radiation. There are no serviceable parts inside the device.
- Use of controls or adjustments or performance of procedures other than those specified herein might result in hazardous radiation exposure.



Danger

Some laser products contain an embedded Class 3A or Class 3B laser diode. Note the following. Laser radiation when open. Do not stare into the beam, do not view directly with optical instruments, and avoid direct exposure to the beam.

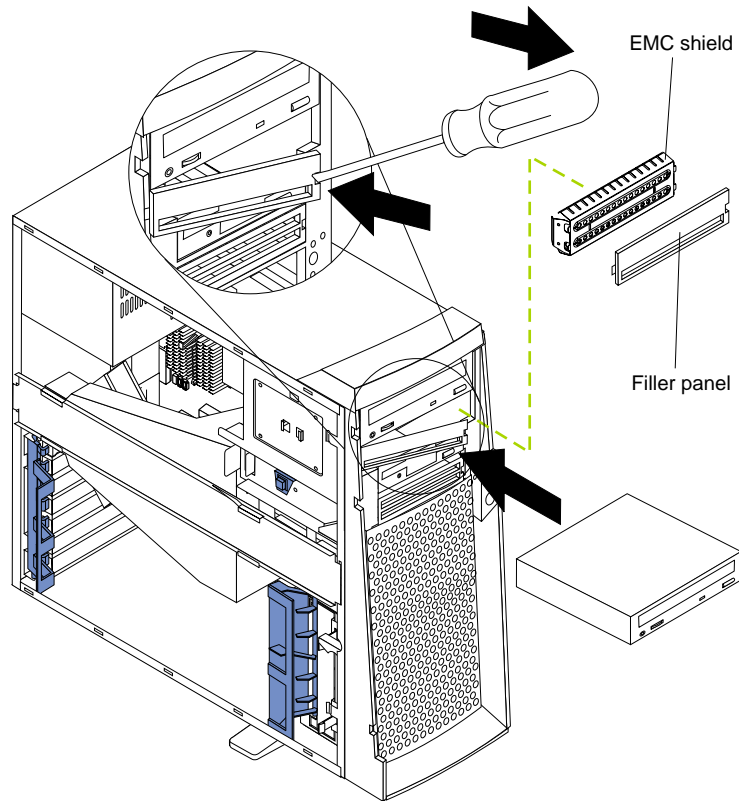

6. Touch the static-protective bag containing the drive to any unpainted metal surface on the computer; then, remove the drive from the bag and place it on a static-protective surface.
7. Set any jumpers or switches on the drive according to the documentation that comes with the drive.
8. Install the drive:
 - If you are installing a 5.25-in drive in bay 2, push the drive into the bay. Then, use the two screws that come with your option to attach the drive to the drive cage.
 - If you are installing a 3.5-in drive in bay 2, you must attach the 5.25-in conversion kit, supplied with your option, to the 3.5-in drive.

Note: You can install only a 3.5-in device in bay 4.
9. Cable the drive:
 - If the drive is an IDE device, plug one connector of the IDE signal cable into the back of the drive and the other end of the cable into the IDE connector (IDE1) on the system board. For the location of the IDE connectors, see “System board internal cable connectors” on page 32.
 - If the drive is a SCSI device, plug one connector of the SCSI signal cable into the back of the drive and the other end of the cable into the SCSI adapter. See “Installing a SCSI adapter (some models)” on page 45 for details.

Note: Make sure to route the signal cable so that it does not block the air flow to the rear of the drives or over the microprocessor.

10. Plug one of the power cables from the power supply into the back of the drive. The connectors are keyed and can be inserted only one way.
11. If you have other options to install or remove, do so now.
12. Replace the support bracket assembly and reconnect the fan cable to the connector (SYSFA3) on the system board. See “Removing the support bracket assembly” on page 42 for installation instructions.
13. Reinstall the side cover. See “Installing the cover” on page 54 for details.
14. Reconnect the external cables and power cords; then, turn on the attached devices and the computer.

Installing a hard disk drive in bay 5, 6, or 7

Complete the following steps to install a hard disk drive in bay 5, 6, or 7.

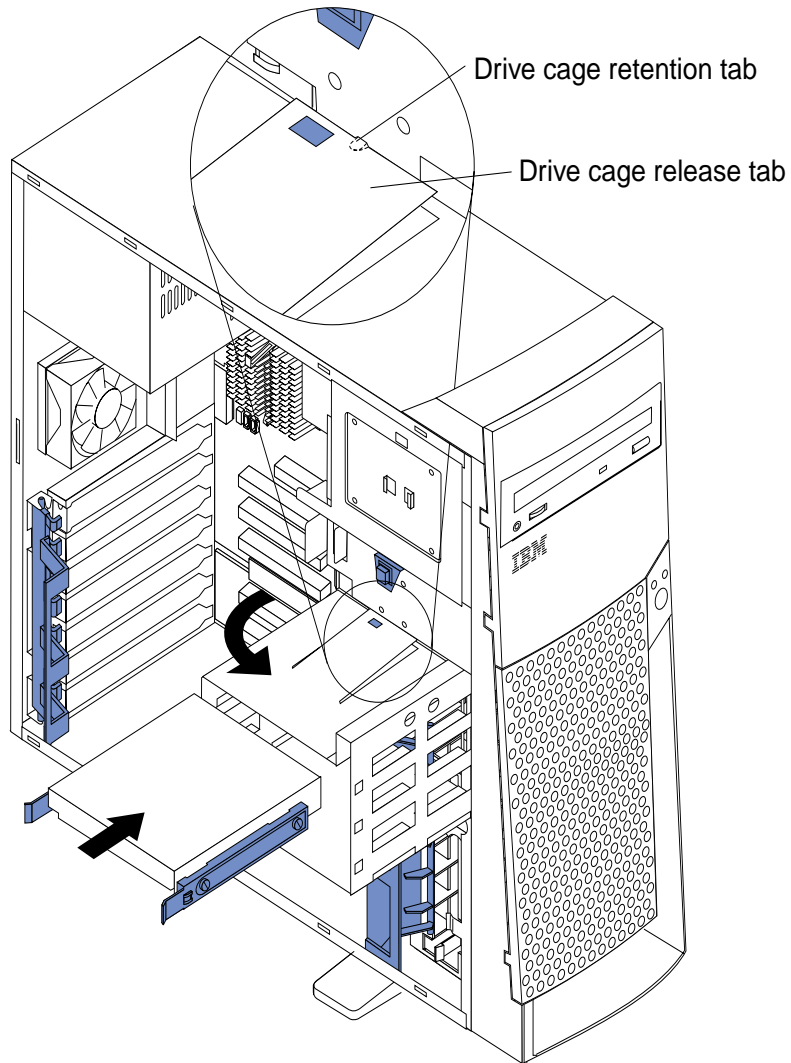

Attention: When you handle ESD-sensitive devices, take precautions to avoid damage from static electricity. For details on handling these devices, see “Handling static-sensitive devices” on page 34.

1. Review the safety precautions listed in “Safety information” on page 35.

2. Remove any media (diskettes, CDs, or tapes) from the drives and shut down your operating system.
3. Turn off the computer and attached devices and disconnect all external cables and power cords; then, remove the cover. See “Removing the side cover” on page 41 for details.
4. Remove the support bracket assembly and disconnect the fan cable from the connector (SYSFA3) on the system board. See “Removing the support bracket assembly” on page 42 for removal instructions.
5. Access the drive cage.
 - a. If your computer has hard disk drives installed in the drive cage, disconnect the power and signal cables from the rear of the drives.
 - b. Rotate the drive cage out of the computer until it locks into place over the drive cage retention tab.

Note: Before you install a hard disk drive, ensure that the drive cage locks into place over the drive cage retention tab by pressing on the side of the drive cage.
6. Attach the blue, plastic guide rails to the sides of the drive using the screws and guide rails provided in the drive cage.
7. Slide the drive into the drive cage until the plastic tabs on the guide rails lock into place in the drive cage.
8. Lift the drive cage up and press in on the drive cage release tab; then, rotate the cage back into the computer.

Note: Clear any cables that might impede the replacement of the drive cage.
9. Connect the power and signal cables to the rear of each drive.

Note: Make sure to route the signal cable so that it does not block the air flow to the rear of the drives or over the microprocessor.
10. If you have other options to install or remove, do so now.
11. Reinstall the support bracket assembly and reconnect the fan cable to the connector (SYSFA3) on the system board. See “Removing the support bracket assembly” on page 42 for removal instructions.
12. Reinstall the side cover. See “Installing the cover” on page 54 for details.
13. Reconnect the external cables and power cords; then, turn on the attached devices and the computer.

Installing memory modules

Adding memory to your computer is an easy way to make programs run faster. You can increase the amount of memory in your computer by installing options called memory modules. Your computer uses a noninterleaved memory configuration.

Your computer comes with a DIMM installed on the system board in DIMM connector 1.

Notes:

1. When installing additional memory modules, install the second memory module in DIMM connector 2, and the third in DIMM connector 3. (See the illustration in this section for memory connector locations.)
2. Your IntelliStation E Pro computer supports 64 MB, 128 MB, 256 MB, and 512 MB DIMMs. Your computer supports a minimum of 64 MB and a maximum of 1.5 GB of system memory. Refer to <http://www.ibm.com/pc/support> for a list of memory modules for use with your computer.

3. Installing or removing DIMMs changes the configuration information in the computer. Therefore, after installing or removing a DIMM, you must change and save the new configuration information by using the Configuration/Setup Utility program. When you restart the computer, the system displays a message indicating that the memory configuration has changed. Start the Configuration/Setup Utility program and select **Save Settings**. See Chapter 4, "Configuring your computer," on page 23 for more information.
4. The illustrations in this document might differ slightly from your hardware.

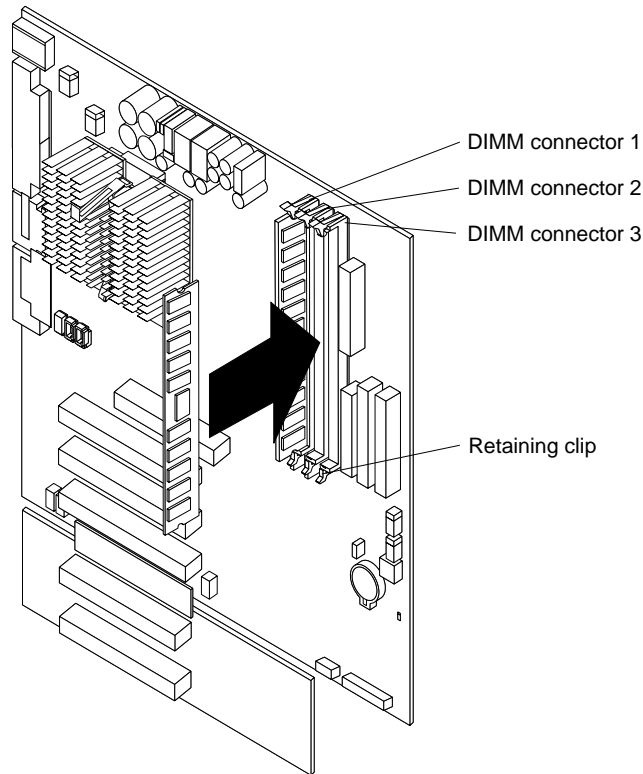

Complete the following steps to install a DIMM.

Attention: When you handle ESD-sensitive devices, take precautions to avoid damage from static electricity. For details on handling these devices, see "Handling static-sensitive devices" on page 34.

1. Review the safety precautions listed in "Safety information" on page 35.
2. Remove any media (diskettes, CDs, or tapes) from the drives and shut down your operating system.
3. Turn off the computer and attached devices and disconnect all external cables and power cords; then, remove the cover (see "Removing the side cover" on page 41 for details).
4. Remove the support bracket assembly and disconnect the fan cable from the connector (SYSFA3) on the system board. See "Removing the support bracket assembly" on page 42 for removal instructions.
5. Touch the static-protective package containing the DIMM to any unpainted metal surface on the computer. Then, remove the DIMM from the package.
6. Install the DIMM:
 - a. If you are installing a DIMM in connector 1, remove the AGP adapter.
Remove the AGP adapter only if you are replacing the DIMM in connector 1. See "System and PCI extender board option connectors" on page 31 for the

location of the AGP slot. See “Installing an adapter” on page 44 for details about removing the AGP adapter.

- b. Open the retaining clip on each end of the DIMM slot. Turn the DIMM so that the pins align correctly with the connector.

Note: To avoid breaking the retaining clips or damaging the DIMM connectors, open and close the clips gently.

- c. Insert the DIMM into the connector by aligning the DIMM edges with the slots at each end of the DIMM connector. Firmly press the DIMM straight down into the connector by applying pressure on both ends of the DIMM simultaneously. Be sure that the retaining clips snap into the locked position when the DIMM is firmly seated in the connector.
 - d. If a gap exists between the DIMM and the retaining clips, the DIMM has not been correctly installed. In this case, open the retaining clips and remove the DIMM; then, reinsert the DIMM.
 - e. If you removed the AGP adapter, reinstall it now. See “Installing an adapter” on page 44 for details.
7. If you have other options to install or remove, do so now.
 8. Replace the support bracket assembly and reconnect the fan cable to the connector (SYSFA3) on the system board. See “Removing the support bracket assembly” on page 42 for installation instructions.
 9. Reinstall the side cover. See “Installing the cover” on page 54 for details.
 10. Reconnect the external cables and power cords; then, turn on the attached devices and the computer.

If you want to remove a DIMM, reverse the previous steps.

Installing a security U-bolt

To help prevent hardware theft, you can add a security U-bolt and cable to your computer. After you add the security cable, make sure that it does not interfere with other cables that are connected to the computer.

Before you begin:

- Obtain the following items:
 - A flat-blade screwdriver
 - An adjustable wrench
 - A 199 mm (3/4 in.) U-bolt or wire rope (similar to National Manufacturing No. 3230, Stock No. 176-735)
 - Threaded nuts that fit the U-Bolt
 - A security cable
 - A lock, such as a combination lock or padlock.
- Read the information in “Handling static-sensitive devices” on page 34, and “Safety information” on page 35.

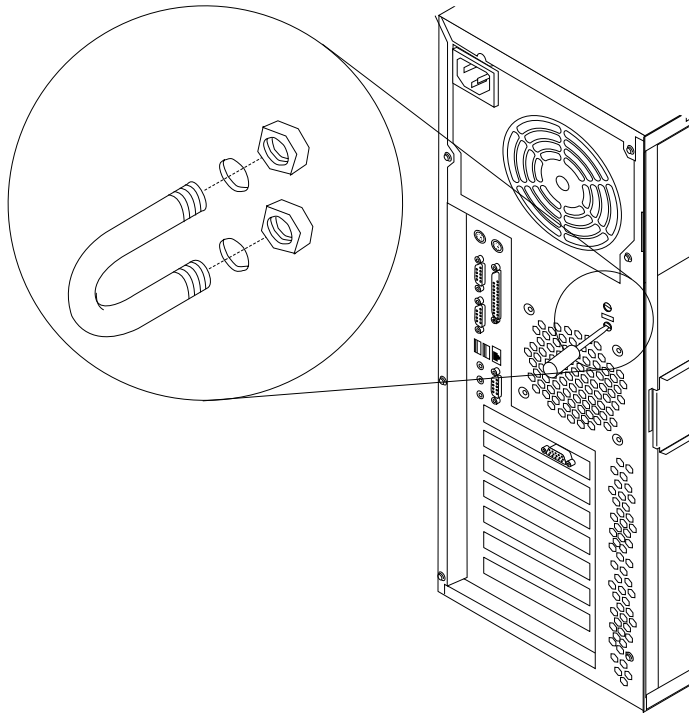

Complete the following steps to install the U-bolt.

1. Review the safety precautions listed in “Safety information” on page 35.
2. Remove any media (diskettes, CDs, or tapes) from the drives and shut down your operating system.
3. Turn off the computer and attached devices and disconnect all external cables and power cords; then, remove the cover (see “Removing the side cover” on page 41 for details).
4. Use a screwdriver to remove the two metal knockouts.
5. Insert the U-bolt through the rear panel; then, attach and tighten the nuts.
6. Replace the side cover. See “Installing the cover” for details.
7. Thread the cable through the U-bolt and around an object that is a part of or permanently secured to the building structure or foundation, and from which it cannot be removed; then, fasten the cable ends together with a lock.
8. Reconnect the external cables and power cords; then, turn on the attached devices and the computer.

Installing the cover

The following information describes the cover installation procedure.

Note: The illustrations in this document might differ slightly from your hardware.

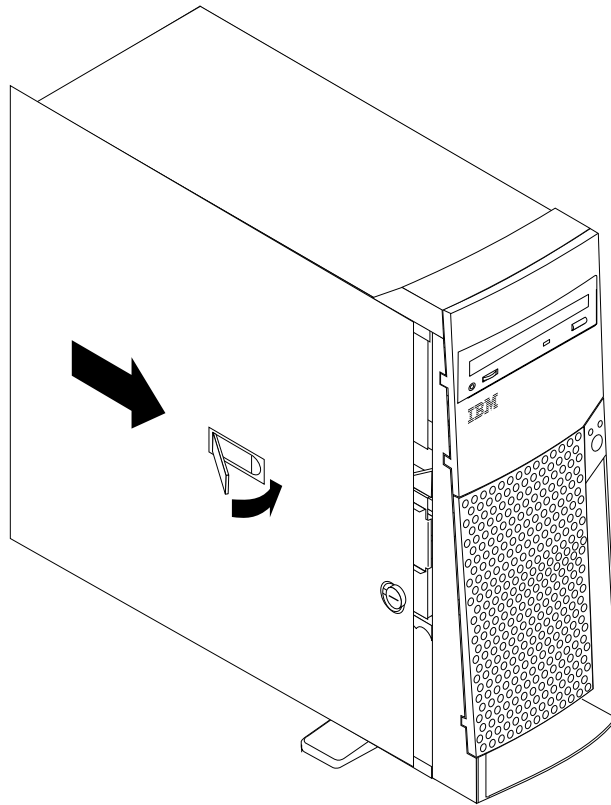

Note: If you removed the support bracket assembly after you removed the cover, reinstall it before you install the cover. For support bracket installation instructions, see “Removing the support bracket assembly” on page 42.

Complete the following steps to install the computer cover.

1. Clear any cables that might impede the replacement of the cover.
2. Install the side cover by placing it into position on the computer. Close the cover release latch to secure the cover in place.
3. Lock the cover, if required.
4. If you have not done so already, make sure that the two front stabilizing feet are rotated outward so that they properly support the computer. Rotate each individual foot outward 90 degrees.
5. Reconnect the external cables and power cords to the computer; then, plug the power cords into electrical outlets.
6. Turn on the attached devices; then, turn on the computer.

Installing options in the desktop model

This section provides instructions to help you add options to your desktop computer. Some option-removal instructions are provided, in case you need to remove one option to install another. For a list of supported options for your computer, go to <http://www.ibm.com/pc/support> on the World Wide Web.

Removing the computer cover

The following information describes how to remove the computer cover.

Note: The illustrations in this document might differ slightly from your hardware.

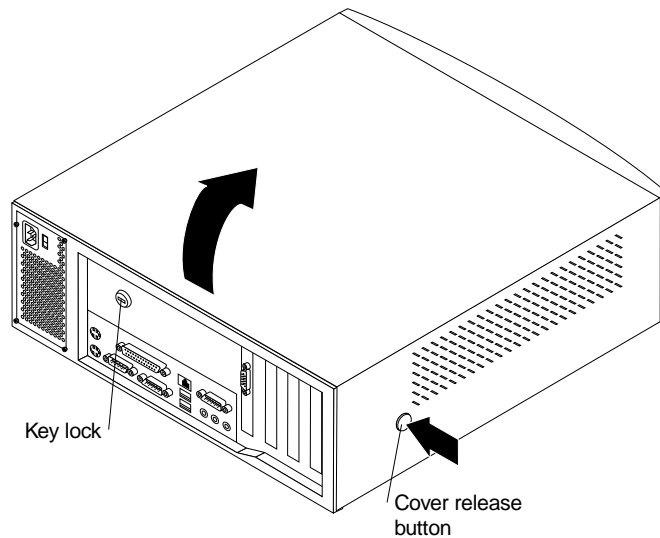

Complete the following steps to remove the cover of the computer.

1. Review the information in “Before you begin” on page 33 and the safety precautions listed in Statement 1 and Statement 5 in “Safety information” on page 35.
2. Remove any media (diskettes, CDs, or tapes) from the drives and shut down your operating system.
3. Turn off the computer and all attached devices; then, disconnect all external cables and power cords.
4. If necessary, unlock the computer cover.
5. Press the buttons on the sides of the computer and pivot the rear of the cover up toward the front of the computer.

Attention: For proper cooling and airflow, replace the cover before turning on the computer. Operating the computer with the cover removed might damage the computer components.

To reinstall the cover, see “Installing the cover” on page 65.

Working with adapters

Your computer comes with adapter connectors, called *slots*. The AGP video adapter is installed in the AGP slot. You can install up to three PCI adapters in expansion slots 1 through 3. All PCI expansion slots are 32-bit, 33 MHz slots.

Note: The illustrations in this document might differ slightly from your hardware.

The following illustration shows the location of the PCI expansion slots on the system board.

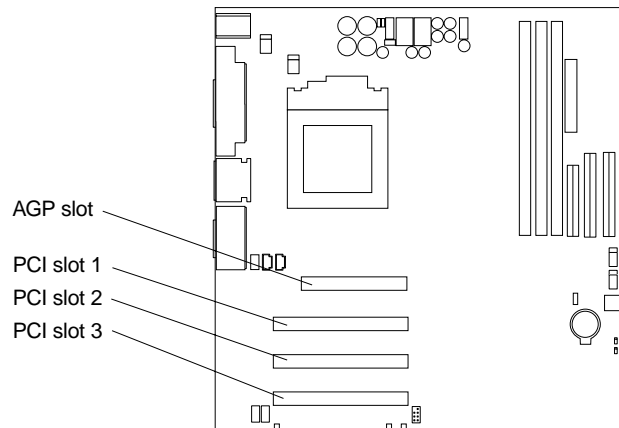

Adapter considerations

Before you install adapters, review the following:

- Locate the documentation that comes with the adapter and follow those instructions in addition to the instructions given in this chapter. If you need to change the switch or jumper settings on your adapter, follow the instructions that come with the adapter.
- You can install full-length adapters in all three PCI expansion slots.
- Your computer supports 5.0V and universal PCI adapters; it does not support 3.3V adapters.
- Your computer uses a rotational interrupt technique to configure PCI adapters. Because of this technique, you can install a variety of PCI adapters that currently do not support sharing of PCI interrupts.
- PCI slots 1 through 3 are on PCI bus 0.

The system scans the AGP slot and PCI expansion slots 1 through 3 to assign system resources; then, the system starts (boots) the PCI devices in the following order, if you have not changed the default boot sequence: PCI expansion slots 1 and 2, system board integrated drive electronics (IDE) or SCSI devices, and then PCI expansion slot 3.

Note: To change the boot sequence for PCI devices, start the Configuration/Setup Utility program, select **Start Options** from the main menu, select **Startup Sequence**; then, select **Second device (SCSI)** to designate the adapter boot sequence. See Chapter 4, “Configuring your computer,” on page 23 for details on using the Configuration/Setup Utility program.

- For a list of supported options for your computer, refer to <http://www.ibm.com/pc/support> on the World Wide Web.

Installing an adapter

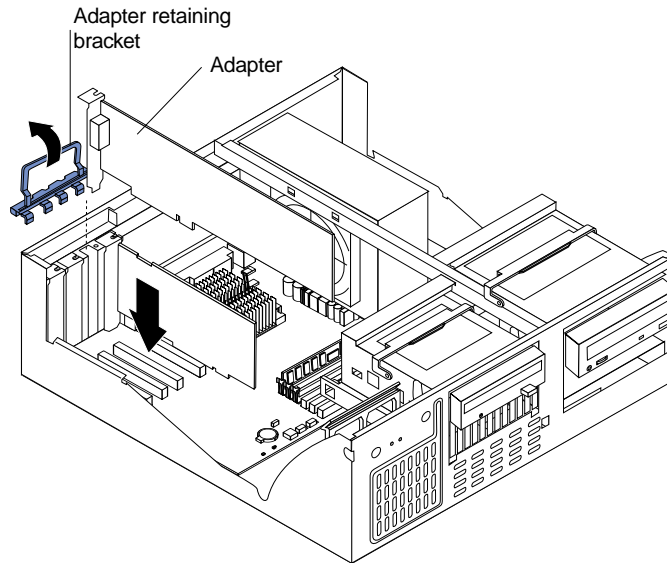

Complete the following steps to install an adapter.

Attention: When you handle ESD-sensitive devices, take precautions to avoid damage from static electricity. For details on handling these devices, see “Handling static-sensitive devices” on page 34.

1. Review the safety precautions listed in “Safety information” on page 35.
2. Remove any media (diskettes, CDs, or tapes) from the drives and shut down your operating system.
3. Turn off the computer and all attached devices and disconnect all external cables and power cords; then, remove the cover. See “Removing the computer cover” on page 55 for details.

4. Determine which PCI expansion slot you will use for the adapter.

Note: Check the instructions that come with the adapter for any requirements, restrictions, or cabling instructions. It might be easier for you to route any device cables before you install the adapter.

5. Rotate the rear adapter retaining bracket to the open (unlocked) position and remove it from the computer. Keep it in a safe place.
6. Remove the PCI expansion-slot cover. From the rear of the computer, press in on the slot cover. Grasp it and pull it out of the slot. Store it in a safe place for future use.

Attention: PCI expansion-slot covers must be installed on all vacant slots. This maintains the electromagnetic emissions characteristics of the computer and ensures proper cooling of system components.

7. Touch the static-protective package containing the adapter to any unpainted metal surface on the server. Then, remove the adapter from the static-protective package. Avoid touching the components and gold-edge connectors on the adapter.
8. Place the adapter, component-side up, on a flat, static-protective surface.
9. Set any jumpers or switches as described by the adapter manufacturer.
10. To install the adapter, carefully grasp the adapter by its top edge or upper corners, and align it with the PCI slot guides; then, press the adapter *firmly* into the PCI expansion slot.

Attention: When you install an adapter in the computer, be sure that it is completely and correctly seated in the PCI expansion slot before you turn on the computer. Incomplete insertion might cause damage to the system board or the adapter.

11. Connect required cables to the adapter.

Attention: Route cables so that they do not block the flow of air from the fans.

12. If you have another adapter to install, do so now.
13. Reinstall the rear adapter retaining bracket; then, rotate the bracket to the closed (locked) position.
14. If you have other options to install or remove, do so now.
15. Reinstall the cover. See “Installing the cover” on page 65 for details.
16. Reconnect the external cables and power cords; then, turn on the attached devices and the computer.

Installing a SCSI adapter (some models)

Complete the following steps to install a SCSI adapter.

1. If you have not already installed the SCSI adapter, complete steps 1 through 10 of “Installing an adapter” on page 58. Then, return here to complete the installation.

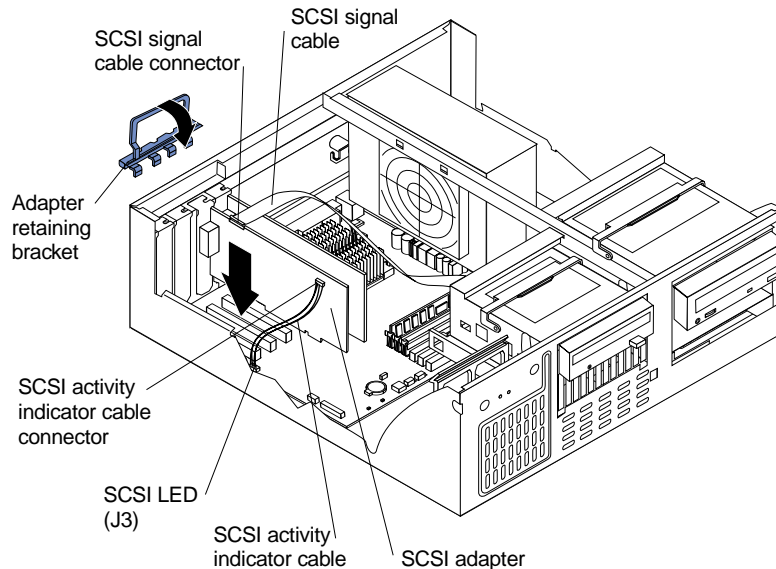

2. Connect one end of the SCSI signal cable (purchased separately) to the adapter; then, connect one or more of the signal cable connectors to the rear of the SCSI devices.
3. Connect the SCSI activity indicator cable (purchased separately) to the adapter and to the SCSI LED connector (J3) on the system board. See “System and PCI extender board option connectors” on page 31 for the location of the SCSI LED connector.
4. If you have other adapters or options to install or remove, do so now.
5. Rotate the rear adapter retaining bracket to the closed (locked) position.
6. Reinstall the cover. See “Installing the cover” on page 65 for details.
7. Reconnect the external cables and power cords; then, turn on the attached devices and the computer.

Installing internal drives

Different types of drives enable your computer to read various types of media and store data in different formats. Depending on your computer model, you might have one or more of the following drives installed.

- Diskette
- Hard disk
- CD-ROM
- Tape

Internal drive bays

Your computer comes with an IDE CD-ROM drive installed in bay 1, a hard disk drive installed in bay 3, and a 3.5-in., 1.44 MB diskette drive installed in bay 4.

Note: The illustrations in this document might differ slightly from your hardware.

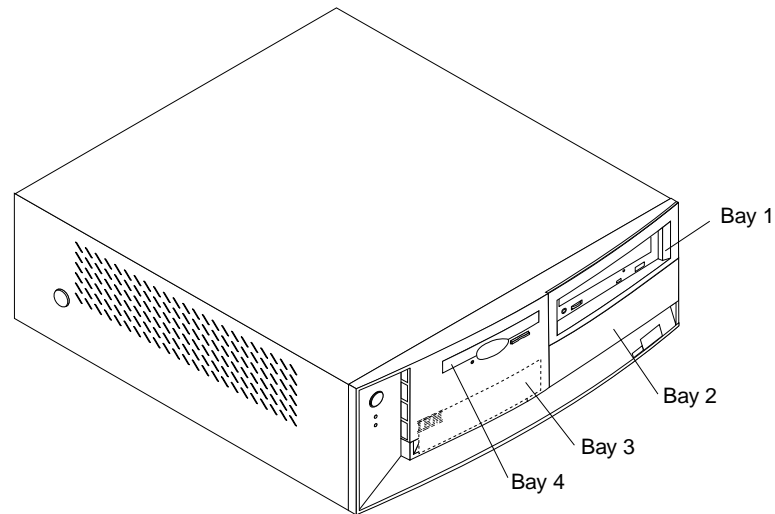

Notes:

1. Diskette drives, tape drives, and CD-ROM drives are removable-media drives. You can install removable-media drives in bays 1, 2, and 4.
2. You can install a 3.5-in slim-high or a 5.25-in., half-high, removable-media drive in bay 2.
3. The IntelliStation E Pro computer supports only one diskette drive, which uses 1 MB and 2 MB diskettes.
4. Before you install a 3.5-in. drive in a 5.25-in. bay, you must attach the 5.25 in. conversion kit, supplied with your option, to the 3.5-in. drive. Refer to the documentation that comes with the option for the conversion kit installation instructions.

Note: Only 3.5-in. options that ship with proper mounting hardware can be supported in the 5.25-in. bay.

5. If you have a tape backup drive in your server, use a dry process cleaning cartridge to clean the tape head two hours after you first use a new data cartridge. Then, clean the tape head once a month or after each eight hours of continuous read/write operations, whichever occurs first. For complete details about the tape backup drive, refer to the documentation that comes with your computer or your backup option.
6. The electromagnetic interference (EMI) integrity and cooling of the computer are both protected by having bays 1 through 4 covered or occupied. When you install a drive, save the EMC shield and filler panel from the bay, in case you later remove the drive and do not replace it with another.

7. For a list of supported options for your computer, refer to <http://www.ibm.com/pc/support> on the World Wide Web.

Preinstallation steps (all bays)

Before you install drives in your computer, verify that you have all the cables and other equipment specified in the documentation that comes with the drive. You might also need to perform certain preinstallation activities. Some of the steps are required only during the initial installation of an option.

1. Read “Safety” on page vii, “Handling static-sensitive devices” on page 34, and the documentation that comes with your drive.
2. Choose the bay in which you want to install the drive.
3. Check the instructions that come with the drive to see if you need to set any switches or jumpers on the drive. If you are installing a SCSI device, be sure to set the SCSI ID for that device.

Installing a drive in bay 2

Complete the following steps to install a drive in bay 2.

Attention: When you handle ESD-sensitive devices, take precautions to avoid damage from static electricity. For details on handling these devices, see “Handling static-sensitive devices” on page 34.

1. Read the safety precautions listed in “Safety information” on page 35.
2. Remove any media (diskettes, CDs, or tapes) from the drives and shut down your operating system.
3. Turn off the computer and all attached devices and disconnect all external cables and power cords; then, remove the cover. See “Removing the computer cover” on page 55 for details.
4. Use a screwdriver to gently pry the EMC shield away from the computer.

Note: If you are installing a drive that is a laser product, observe the following safety precaution:

Statement 3



CAUTION:

When laser products (such as CD-ROMs, DVD drives, fiber optic devices, or transmitters) are installed, note the following:

- Do not remove the covers. Removing the covers of the laser product could result in exposure to hazardous laser radiation. There are no serviceable parts inside the device.
- Use of controls or adjustments or performance of procedures other than those specified herein might result in hazardous radiation exposure.



Danger

Some laser products contain an embedded Class 3A or Class 3B laser diode. Note the following. Laser radiation when open. Do not stare into the beam, do not view directly with optical instruments, and avoid direct exposure to the beam.

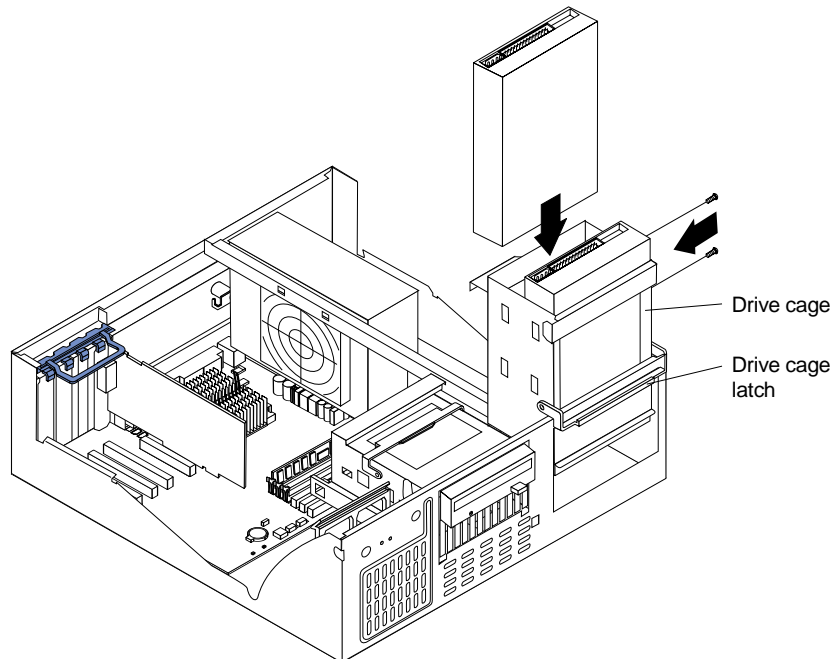

Note: If your computer has a CD-ROM drive installed in bay 1, remove the signal and power cables from the CD-ROM drive before rotating the drive cage out of the computer.

5. Rotate the drive cage toward the front of the computer until the drive cage latch locks on the chassis.

Attention: Do not use the drive cage latch to rotate either drive cage out of the computer.

6. Touch the static-protective bag containing the drive to any unpainted metal surface on the computer; then, remove the drive from the bag and place it on a static-protective surface.
7. Set any jumpers or switches on the drive according to the documentation that comes with the drive.
8. Install the drive:
 - If you are installing a 5.25-in drive in bay 2, push the drive in to the bay; then, use the two screws to attach the drive to the drive cage.
 - If you are installing a 3.5-in drive in bay 2, you must attach the 5.25-in. conversion kit, supplied with your option, to the 3.5-in drive.
9. Cable the drive:
 - If the drive is an IDE device, plug one connector of the IDE signal cable into the back of the drive and the other end of the cable into the IDE connector (IDE1) on the system board. For the location of the IDE connectors, see "System board internal cable connectors" on page 32.
 - If the drive is a SCSI device, plug one connector of the SCSI signal cable into the back of the drive and the other end of the cable into the SCSI adapter.

Note: Make sure to route the cable so that it does not block the air flow to the rear of the drives or over the microprocessor.

10. If you have another drive to install or remove, do so now.
11. Connect the power cable from the power supply into the back of the drive. The connectors are keyed and can be inserted only one way.
Attention: To prevent damaging your computer, hold onto the drive cage when you release it from the chassis.
12. Lift up on the drive cage and rotate the release latch to the unlocked position.
Attention: Ensure that all cables have been moved from under the drive cage so that the power or signal cables are not damaged.
13. Pivot the drive cage back into the computer and press down on the cage until it locks in place.
14. If you have other options to install or remove, do so now.
15. Reinstall the cover (see “Installing the cover” on page 65 for details).
16. Reconnect the external cables and power cords; then, turn on the attached devices and the computer.

Installing memory modules

Adding memory to your computer is an easy way to make programs run faster. You can increase the amount of memory in your computer by installing options called memory modules. Your computer uses a noninterleaved memory configuration.

Your computer comes with a DIMM installed on the system board in DIMM connector 1.

Notes:

1. When installing additional memory modules, install the second memory module in DIMM connector 2, and the third in DIMM connector 3. (See the illustration in this section for memory connector locations.)
2. Your IntelliStation E Pro computer supports 64 MB, 128 MB, 256 MB, and 512 MB DIMMs. Your computer supports a minimum of 64 MB and a maximum of 1.5 GB of system memory. Go to <http://www.ibm.com/pc/support> for a list of memory modules for use with your computer.
3. The illustrations in this document might differ slightly from your hardware.

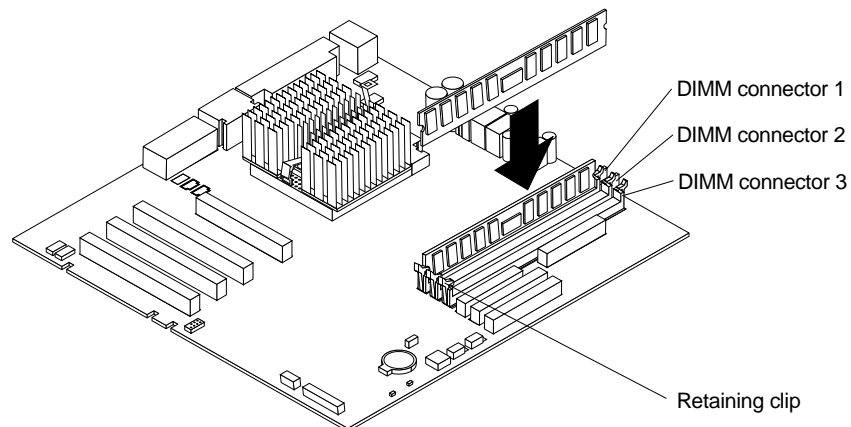

Complete the following steps to install a DIMM.

Attention: When you handle ESD-sensitive devices, take precautions to avoid damage from static electricity. For details on handling these devices, see “Handling static-sensitive devices” on page 34.

1. Review the safety precautions listed in “Safety information” on page 35.
2. Remove any media (diskettes, CDs, or tapes) from the drives and shut down your operating system.
3. Turn off the computer and all attached devices and disconnect all external cables and power cords; then, remove the cover. See “Removing the computer cover” on page 55 for details.
4. Touch the static-protective package containing the DIMM to any unpainted metal surface on the computer. Then, remove the DIMM from the package.
5. Install the DIMM:
 - a. If you are installing a DIMM in connector 1 or 2, remove the AGP adapter.
See “System and PCI extender board option connectors” on page 31 for the location of the AGP slot. See “Installing an adapter” on page 58 for details about removing the AGP adapter.
 - b. Open the retaining clip on each end of the DIMM connector. Turn the DIMM so that the pins align correctly with the connector.
Note: To avoid breaking the retaining clips or damaging the DIMM connectors, open and close the clips gently.
 - c. Insert the DIMM into the connector by aligning the DIMM edges with the slots at each end of the DIMM connector. Firmly press the DIMM straight down into the connector by applying pressure on both ends of the DIMM simultaneously. Be sure that the retaining clips snap into the locked position when the DIMM is firmly seated in the connector.
 - d. If a gap exists between the DIMM and the retaining clips, the DIMM has not been properly installed. In this case, open the retaining clips and remove the DIMM; then, reinsert the DIMM.
 - e. If you removed the AGP adapter, reinstall it now. See “Installing an adapter” on page 58 for details on reinstalling the AGP adapter.
6. If you have other options to install or remove, do so now.
7. Replace the cover. See “Installing the cover” on page 65 for more details.
8. Reconnect the external cables and power cords; then, turn on the attached devices and the computer.

Note: Installing or removing DIMMs changes the configuration information in the computer. Therefore, after installing or removing a DIMM, you must change and save the new configuration information by using the Configuration/Setup Utility program. When you restart the computer, the system displays a message indicating that the memory configuration has changed. Start the Configuration/Setup Utility program and select **Save & Exit Setup**. See Chapter 4, “Configuring your computer,” on page 23 for more information.

If you want to remove a DIMM, reverse the previous steps.

Installing a security U-bolt

To help prevent hardware theft, you can add a security U-bolt and cable to your computer. After you add the security cable, make sure that it does not interfere with other cables that are connected to the computer.

Before you begin:

- Obtain the following:
 - A flat-blade screwdriver
 - An adjustable wrench
 - A 199 mm (3/4 in.) U-bolt or wire rope (similar to National Manufacturing No. 3230, Stock No. 176-735)
 - Threaded nuts that fit the U-Bolt
 - A security cable
 - A lock, such as a combination lock or padlock.
- Read the information in “Handling static-sensitive devices” on page 34, and “Safety information” on page 35.

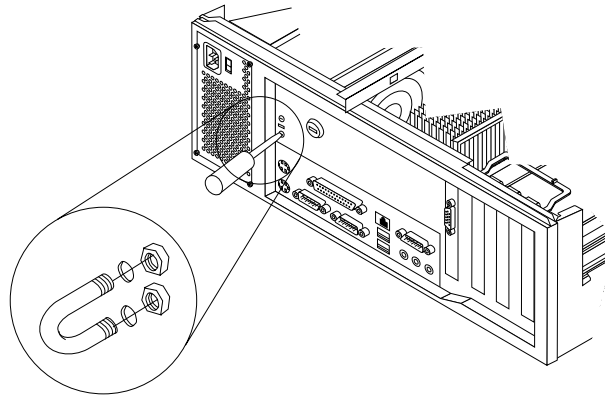

Complete the following steps to install a U-bolt.

1. Review the safety precautions listed in “Safety information” on page 35.
2. Remove any media (diskettes, CDs, or tapes) from the drives and shut down your operating system.
3. Turn off the computer and all attached devices and disconnect all external cables and power cords; then, remove the cover. See “Removing the computer cover” on page 55 for details.
4. Use a screwdriver to remove the two metal knockouts.
5. Insert the U-bolt through the rear panel; then, attach and tighten the nuts.
6. If you have other options to install or remove, do so now.
7. Replace the computer cover. See “Installing the cover” for more details.
8. Thread the cable through the U-bolt and around an object that is a part of or permanently secured to the building structure or foundation, and from which it cannot be removed; then, fasten the cable ends together with a lock.
9. Reconnect the external cables and power cords; then, turn on the attached devices and the computer.

Installing the cover

The following information describes the cover installation procedure.

Note: The illustrations in this document might differ slightly from your hardware.

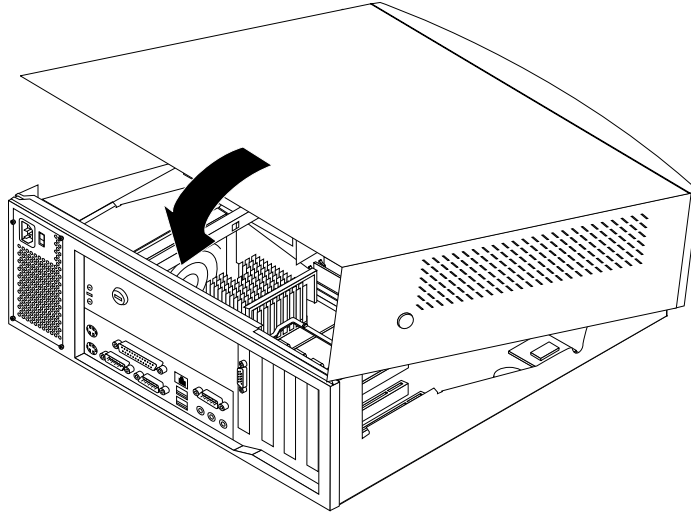

Complete the following steps to install the computer cover.

1. Clear any cables that might impede the replacement of the cover.
2. Position the cover over the computer and pivot the cover down until the cover snaps into place.
3. Lock the cover, if required.
4. Reconnect the external cables and power cords to the computer; then, plug the power cords into electrical outlets.
5. Turn on all attached devices; then, turn on the computer.

Connecting external options

You can attach a SCSI storage expansion enclosure to your computer.

To attach an external device:

1. Read “Before you begin” on page 33, review the safety precautions listed in Statement 1 and Statement 5 in “Safety information” on page 35, and read the documentation that comes with your options.
2. Be sure your computer and all attached devices are turned off.
3. Follow the instructions that come with the option to prepare it for installation and to connect it to the computer.

Note: If you are attaching a SCSI device, see “Ultra160 SCSI connector (some models)” on page 71 for SCSI ID and cabling information.

I/O connector locations

The following illustration shows the input/output connectors and the expansion slots on the rear of the computer.

The following illustration shows the I/O connectors on the rear of the tower model.

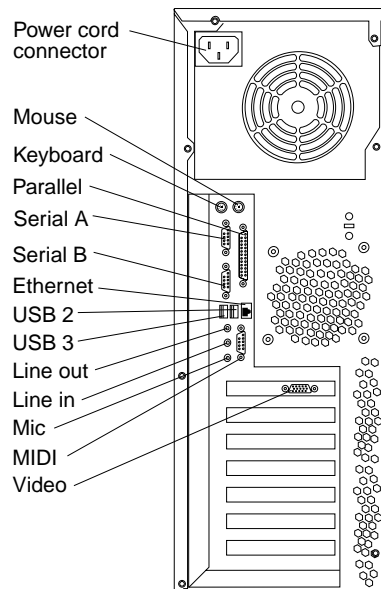

The following illustration shows the I/O connectors on the rear of the desktop model.

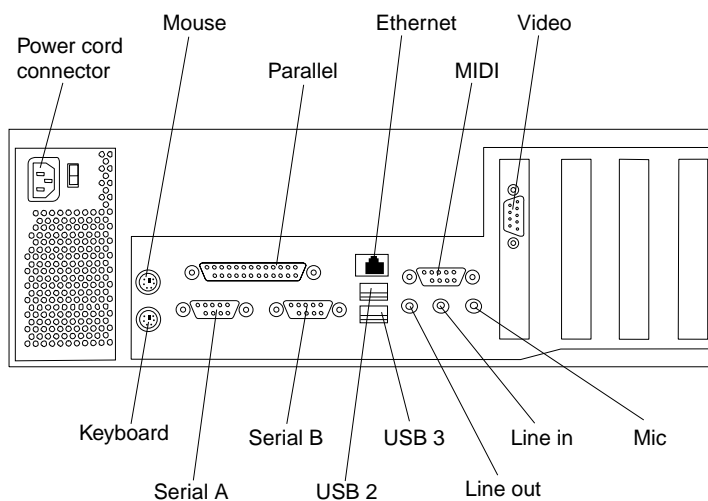

Note: If your computer is a SCSI model, the SCSI adapter will be located in PCI slot 1; the external connector will be located in the slot below the video connector on the tower model and to the right of the video connector on the desktop model. See “System and PCI extender board option connectors” on page 31 for the location of the PCI slots.

Input/Output connectors

This section provides information about the I/O connectors on the rear of your computer. These connectors include the following:

- One mouse
- One keyboard

- One parallel
- Two serial
- One Ethernet
- Two USB
- Line out
- Line in
- Mic
- MIDI
- One video
- One Ultra160 SCSI (some models)

Mouse connector

The system board has one mouse connector that supports a mouse or other pointing device. The mouse connector is located on the rear of your computer. See “I/O connector locations” on page 67 for its location.

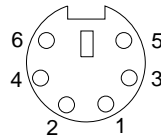

Keyboard connector

There is one keyboard connector on the rear of your computer. See “I/O connector locations” on page 67 for its location.

Note: If you attach a standard (non-USB) keyboard to the keyboard connector, the USB connectors and devices will be disabled during the power-on self-test.

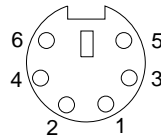

Parallel connector

Your computer has one parallel connector. This connector supports three standard Institute of Electrical and Electronics Engineers (IEEE) 1284 modes of operation: standard parallel port (SPP), enhanced parallel port (EPP), and extended capability port (ECP).

Viewing or changing the connector assignments: You can use the built-in Configuration/Setup Utility program to configure the parallel connector as bidirectional; that is, so that data can be both read from and written to a device. In bidirectional mode, the computer supports the ECP and EPP modes.

Complete the following steps to view or change the parallel-connector assignment.

1. Restart the computer and watch the monitor screen.
2. When the message Press F1 for Configuration/Setup appears, press F1.
3. When the Configuration/Setup Utility menu appears, select **Devices & I/O Ports;** then, press Enter.
4. Select the parallel connector; then, use the arrow keys to advance through the settings available.

Note: When you configure the parallel connector as bidirectional, use an IEEE 1284-compliant cable. The cable must not exceed 3 meters (9.8 feet).

5. Press Esc twice to return to the Configuration/Setup main menu; then, select **Save & Exit Setup** to exit from the Configuration/Setup Utility program.

Parallel connector: There is a 25-pin, female D-shell parallel connector on the rear of your computer. See “I/O connector locations” on page 67 for the location of this connector.

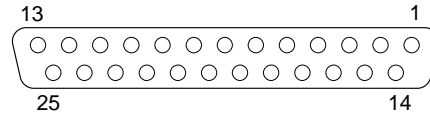

Serial connectors

Your computer has two standard serial connectors: serial connector A and serial connector B.

Some application programs require specific connectors, and some modems function properly only at certain communication connector addresses. You might need to use the Configuration/Setup Utility program to change communication connector address assignments to prevent or resolve address conflicts.

Viewing or changing the serial-connector assignments: Complete the following steps to view or change the serial-connector assignments.

1. Restart the computer and watch the monitor screen.
2. When the message Press F1 for Configuration/Setup appears, press F1.
3. When the Configuration/Setup Utility menu appears, select **Devices & I/O Ports**; then, press Enter.
4. Select the serial connector; then, use the arrow keys to advance through the available settings.
5. Press Esc twice to return to the Configuration/Setup Utility main menu; then, select **Save & Exit Setup** to exit from the Configuration/Setup Utility program.

Serial connectors: There are two 9-pin, male D-shell serial connectors located on the rear of your computer. See “I/O connector locations” on page 67 for their locations.

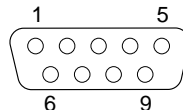

Ethernet connector

Your computer comes with an integrated Ethernet controller. This controller provides an interface for connecting to 10-Mbps or 100-Mbps networks and provides full-duplex capability, which enables simultaneous transmission and reception of data on the Ethernet LAN.

To access the Ethernet connector, attach a Category 3, 4 or 5 unshielded twisted-pair (UTP) cable to the RJ-45 connector on the rear of your computer. See “I/O connector locations” on page 67 for its location.

Note: The 100BASE-TX Fast Ethernet standard requires that the cabling in the network be Category 5.

Configuring the Ethernet controller: When you connect your computer to the network, the Ethernet controller automatically detects the data-transfer rate (10Mbps

or 100Mbps) on the network and then sets the controller to operate at the appropriate rate. In addition, if the Ethernet connector that your computer is connected to supports auto-negotiation, the Ethernet controller will set the appropriate duplex state. That is, the Ethernet controller will adjust to the network data rate, whether the data rate is standard Ethernet (10BASE-T), Fast Ethernet (100BASE-TX), half duplex (HDX), or full duplex (FDX). The controller supports HDX and FDX modes at both speeds.

The Ethernet controller is integrated on the system board. You do not need to set any jumpers or configure the controller for your operating system before you use the Ethernet controller. However, you must install a device driver to enable your operating system to address the Ethernet controller. The device drivers are provided on the preinstalled software and the *Device Drivers and IBM Enhanced Diagnostics CD*.

Ethernet connector: There is an RJ-45 connector on the rear of the computer, see “I/O connector locations” on page 67 for the location of this connector.

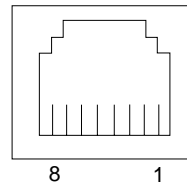

Universal Serial Bus connectors

Your computer has two Universal Serial Bus (USB) connectors, which are configured automatically. USB is a serial interface standard for telephony and multimedia devices. It uses Plug and Play technology to determine the type of device that is attached to the connector.

Notes:

1. If you attach a standard (non-USB) keyboard to the keyboard connector, the USB connectors and devices will be disabled during the power-on self-test.
2. If you install a USB keyboard that has a mouse connector, the USB keyboard emulates a mouse, and you will not be able to disable the mouse settings in the Configuration/Setup Utility program.

USB cables and hubs: You need a 4-pin cable to connect devices to USB 2 or USB 3. If you plan to attach more than two USB devices, you must use a hub to connect the devices. The hub provides multiple connectors for attaching additional external USB devices.

USB technology transfers data at up to 12 megabits-per-second (Mbps) with a maximum of 127 external devices and a maximum signal distance of five meters (16 ft.) per segment.

USB connectors: There are two USB connectors on the rear of the computer for attaching USB compatible devices, see “I/O connector locations” on page 67 for the location of the USB connectors.

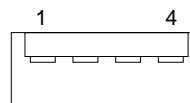

Audio connectors

The audio connectors are used to connect external audio equipment to your computer, see “I/O connector locations” on page 67 for the location of these connectors.

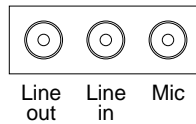

Line out: This connector is used to send audio signals from the computer to external devices, such as powered speakers with built-in amplifiers, headphones, multimedia keyboards, or the audio Line in connector on a stereo system.

Line in: This connector is used to accept audio signals from external devices, such as line output from a stereo, television, or musical instrument into the computer sound system.

Mic: This connector is used to connect a microphone to your computer when you want to record voice or other sounds on the hard disk drive. It can also be used by speech recognition software.

MIDI connector

The musical instrument digital interface (MIDI) connector allows your computer to interact with musical instruments and other musical equipment. You might use the MIDI connector as an interface between your computer and a synthesizer to edit and store sound information for the synthesizer on the computer. See “I/O connector locations” on page 67 for the location of the MIDI connector.

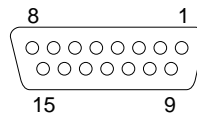

Video connector

Your computer uses an AGP adapter located in the AGP slot on the system board. There is a 15-pin analog video connector located on the rear of your computer. See “I/O connector locations” on page 67 for the location of this connector.

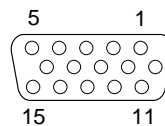

Ultra160 SCSI connector (some models)

Some IntelliStation E Pro computer models come with a SCSI adapter, which supports an Ultra160/MB SCSI internal channel in a full-featured PCI 2.1-/2.2-compliant bus master package. This configuration supports a zero wait state, 32-bit memory transfers at 160 Mbytes/second, when LVD SCSI peripherals are attached. This channel supports up to 15 SCSI devices. In addition, the SCSI adapter uses:

- Double-transition clocking to achieve high transfer rates
- Domain name validation to negotiate compatible data transfer speeds with each device
- Cyclic-redundancy checking, instead of the usual parity checking, to significantly improve data reliability

SCSI cabling requirements: You can install two internal SCSI devices using the SCSI signal cable that comes with your computer. If you plan to attach external SCSI devices, you must order additional SCSI cables. To select and order the correct cables for use with external devices, contact your IBM reseller or IBM marketing representative. To receive indication of SCSI hard-disk drive activity, you must also connect the SCSI adapter to the SCSI LED (J3) connector on the system board. See

“System and PCI extender board option connectors” on page 31 for the location of the SCSI connector.

For information about the maximum length of a SCSI cable between the terminated ends of the cable, refer to the American National Standards Institute (ANSI) SCSI standards. Adhering to these standards will help ensure that your computer operates correctly.

Setting SCSI IDs: Each SCSI device connected to a SCSI controller must have a unique SCSI ID. This ID enables the SCSI controller to identify the device and ensure that different devices on the same SCSI channel do not attempt to transfer data simultaneously. SCSI devices that are connected to different SCSI channels can have duplicate SCSI IDs.

To install external SCSI devices, you must first install an optional SCSI PCI adapter. Refer to the information that is provided with the device for instructions to set its SCSI ID.

If a SCSI adapter is installed in your computer, you can use its 68-pin SCSI connector to connect different types of SCSI devices.

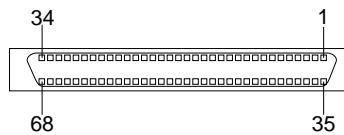

Chapter 6. Solving problems

This section provides basic troubleshooting information to help you resolve some problems that might occur with your system.

If you cannot locate and correct the problem using the information in this section, refer to “Getting information, help, and service” on page 99 for more information.

Diagnostic tools overview

The following tools are available to help you identify and resolve hardware-related problems:

- **POST beep codes**

The power-on self-test beep codes indicate the detection of a problem. See “POST” on page 74 for more information.

- **Diagnostic programs and error messages**

The system diagnostic programs are stored on the *Device Drivers and IBM Enhanced Diagnostics* CD. These programs are the primary methods of testing the major components of your computer. See “Diagnostic programs and error messages” on page 75 for more information.

- **Troubleshooting charts**

These charts list problem symptoms and steps to correct the problems. See the “Troubleshooting charts” on page 83 for more information.

- **Customized support page**

You can create a customized support page on the World Wide Web that is specific to your hardware, including frequently asked questions, parts information, technical hints and tips, and downloadable files. In addition, you can choose to receive e-mail notifications whenever new information becomes available about your registered products.

After you register your IntelliStation products, you can diagnose problems using the IBM Assistant, and you can participate in the IBM discussion forum. For more detailed information about registration for your IBM products, visit the following addresses on the Web:

- <http://www.ibm.com/pc/register>
- <http://www.ibm.com/pc/support>

POST

When you turn on the computer, it performs a series of tests to check the operation of system components and some of the options that are installed in the computer. This series of tests is called the power-on self-test or POST.

If POST finishes without detecting any problems, the first window of your operating system or application program appears.

Notes:

1. If you have a power-on password set, you must type the password and press Enter, when prompted, before POST will continue.
2. A single problem might cause several error messages. When this occurs, work to correct the cause of the first error message. After you correct the cause of the first error message, the other error messages usually will not occur the next time you run the test.

POST beep code descriptions

The possible types of beep codes that your system might emit are:

Repeating long beeps

Indicates that a memory error has occurred. Ensure that all DIMMs are correctly installed.

One long beep and two short beeps

Indicates that a video error has occurred and the BIOS code cannot initialize the video screen to display any additional information. Ensure that the video adapter is correctly installed.

Small computer system interface messages (some models)

The following table lists actions to take if you receive any SCSI error message.

Note: If your system does not have a hard disk drive, ignore any message that indicates that the BIOS code is not installed.

You will get these messages only when running the SCSISelect Utility.

Table 3. SCSI messages

SCSI Messages	Description
All	<p>One or more of the following might be causing the problem.</p> <ul style="list-style-type: none"> • A failing SCSI device (adapter or drive) • An improper SCSI configuration • Duplicate SCSI IDs in the same SCSI chain • An improperly installed SCSI terminator • A defective SCSI terminator • An improperly installed cable • A defective cable <p>Action:</p> <p>Verify that:</p> <ul style="list-style-type: none"> • The external SCSI devices are turned on. External SCSI devices must be turned on <i>before</i> the computer. • The cables for all external SCSI devices are connected correctly. • The last device in each SCSI chain is terminated properly. • The SCSI devices are configured correctly. <p>If the above items are correct, run the diagnostic programs to obtain additional information about the failing device. If the error remains or recurs, call for service.</p>

Diagnostic programs and error messages

The system diagnostic programs are stored on the *Device Drivers and IBM Enhanced Diagnostics* CD. These programs are the primary method of testing the major components of your computer.

Diagnostic error messages indicate that a problem exists; they are not intended to be used to identify a failing part. Troubleshooting and servicing of complex problems that are indicated by error messages should be performed by trained service personnel.

Sometimes the first error to occur causes additional errors. In this case, the computer displays more than one error message. Always follow the suggested action instructions for the *first* error message that appears.

The following sections contain the error codes that might appear in the detailed test log and summary log, when running the diagnostic programs.

The error code format is as follows:

fff-ttt-iii-date-cc-text message

where:

fff is the three-digit function code that indicates the function being tested when the error occurred. For example, function code 089 is for the microprocessor.

ttt is the three-digit failure code that indicates the exact test failure that was encountered. (These codes are for trained service

	personnel and are described in the <i>Hardware Maintenance Manual</i> .)
iii	is the three-digit device ID. (These codes are for trained service personnel and are described in the <i>Hardware Maintenance Manual</i> .)
date	is the date that the diagnostic test was run and the error recorded.
cc	are the check digits that are used to verify the validity of the information.
text message	is the diagnostic message that indicates the reason for the problem.

Text messages

The diagnostic text message format is as follows:

Function Name: Result (test specific string)

where:

Function Name	is the name of the function being tested when the error occurred. This corresponds to the function code (fff) given in the previous list.	
Result	can be one of the following:	
	Passed	This result occurs when the diagnostic test completes without any errors.
	Failed	This result occurs when the diagnostic test discovers an error.
	User Aborted	This result occurs when you stop the diagnostic test before it is complete.
	Not Applicable	This result occurs when you specify a diagnostic test for a device that is not present.
	Aborted	This result occurs when the test could not proceed because of the system configuration.
	Warning	This result occurs when a possible problem is reported during the diagnostic test, such as when a device that is to be tested is not installed.

Test Specific String is additional information that is used to analyze the problem.

Starting the diagnostic programs

The IBM Enhanced Diagnostics programs will isolate your computer hardware from software that you have installed on your hard disk drive. The programs run independently of the operating system, and *must be run either from a CD or diskette*. This method of testing is generally used when other methods are not accessible or have not been successful in isolating a problem suspected to be hardware related.

A Device Drivers and IBM Enhanced Diagnostics CD comes with your computer. You can also download the latest image of the diagnostics from <http://www.ibm.com/pc/support> on the World Wide Web.

Using the diagnostics CD

Complete the following steps to start the IBM Enhanced Diagnostics using the CD.

1. Turn off your computer and any attached devices.
2. Turn on all attached devices; then, turn on your computer.
3. When you see *Press F1 for Configuration/Setup*, press the F1 key.
4. When the Configuration/Setup Utility menu appears, select **Start Options**.
5. From the Start Options menu, select **Startup Sequence**.
6. Note the device selected as the First Startup Device. Later, you must restore this setting.
7. Select **CD-ROM** as the First Startup Device.
8. Press Esc two times to return to the Configuration/Setup Utility menu.
9. Place the *Device Drivers and IBM Enhanced Diagnostics* CD in the CD-ROM drive.
10. Select **Save & Exit Setup** and follow the prompts. The diagnostics will load. Follow the instructions on the screen to run the diagnostics.

Important:

When you finish running the diagnostics and utilities, remove the CD from the CD-ROM drive and turn off the computer. You must restore the First Startup Device to the original settings. Use steps 2 through 7 of this procedure to do this.

Downloading the diagnostics program

Complete the following steps to download the latest image of the IBM Enhanced Diagnostics from the World Wide Web and create a startable Enhanced Diagnostics diskette:

1. Go to the following World Wide Web site: <http://www.ibm.com/pc/support/>
2. Download the diagnostics file for your computer to a hard disk drive directory (not to a diskette).
3. Go to a DOS prompt and change to the directory where the file was downloaded.
4. Insert a blank high-density diskette in diskette drive A.
5. Type in the following, and then press Enter: *filename a:* where *filename* is the name of the file you downloaded from the Web.

The downloaded file is self-extracting and will be copied to the diskette. When the copy completes, you have a startable IBM Enhanced Diagnostics diskette.

Using the diagnostic diskette

Complete the following steps to start the IBM Enhanced Diagnostics using the diagnostics diskette:

1. Turn off your computer and any attached devices.
2. Insert the IBM Enhanced Diagnostics diskette into the diskette drive.
3. Turn on all attached devices; then, turn on your computer.
4. Follow the instructions on the screen.

When the tests have completed, you can view the Test Log by selecting **Utility** from the top of the screen.

If the hardware checks out OK, but the problem persists during normal computer operations, a software error might be the cause. If you suspect a software problem, refer to the information that comes with the software package.

Viewing the test log

The test log records data about system failures and other pertinent information. The test log will not contain any information until after the diagnostic program has run.

Note: If you already are running the diagnostic programs, begin with step 4.

Complete the following steps to view the test log:

1. Insert the *Device Drivers and IBM Enhanced Diagnostics* CD.
2. Turn on the computer and watch the screen.
If the system is on, shut down your operating system and restart the system.
3. If a power-on password is set, the system prompts you for it. Type in the appropriate password; then, press Enter.
4. Run the diagnostic programs and when the Diagnostic Programs screen appears, select **Utility**.
5. Select **View Test Log** from the list that appears; then, follow the instructions on the screen.
6. You can save the test log to a file on a diskette or to your hard disk drive.

Note: The system maintains the test-log data while the system is powered on. When you turn off the power to the computer, the test log is cleared.

Diagnostic error message tables

The following tables provide descriptions of the error messages that might be listed in the test log after you run the diagnostic programs.

Attention: If diagnostic error messages appear that are not listed in the following tables, make sure that your system has the latest levels of BIOS and diagnostics installed.

Code	Function	Result	Text message	Action
001	Core system	Failed	Processor board, ECC Test	Call for service.
			System board	
005	Video port		Processor and system boards	
011	Serial port		Integrated serial port	
014	Parallel port		Integrated parallel port	
015	USB interface	Aborted	Can NOT test USB interface while it is in use. Note: If you have a USB keyboard or mouse attached, you cannot run the diagnostic program for the USB interface.	<ol style="list-style-type: none"> 1. Turn off the system. 2. Replace the USB keyboard and mouse with a standard keyboard and mouse. 3. Turn on the system. 4. Run the diagnostic test again.
		Failed	System board	Call for service.
020	PCI interface	Failed	System board	Call for service.

Code	Function	Result	Text message	Action
030	SCSI interface	Failed	SCSI adapter in slot <i>n</i> failed register/counter/ power test (where <i>n</i> is the slot number of the failing adapter)	Refer to the information provided with the adapter for instructions. If the problem persists, call for service.
			SCSI controller on system board failed register/counter/power test	Call for service.
035	ServeRAID	Aborted	Test setup error: No ServeRAID adapter found on system board or PCI bus	Make sure the ServeRAID adapter is properly installed. If the problem remains, replace the ServeRAID adapter. If the problem persists, call for service.
		Failed	Adapter in slot <i>n</i> ; adapter/drive configuration error (where <i>n</i> is the slot number of the failing adapter)	Run the ServeRAID Configuration Utility. If the problem remains, replace the ServeRAID adapter in slot <i>n</i> .
			Adapter in slot <i>n</i> ; internal error (where <i>n</i> is the slot number of the failing adapter)	
			Logical drive <i>m</i> on adapter in slot <i>n</i> (where <i>m</i> is the number of the failing logical drive and <i>n</i> is the slot number of the adapter)	If the problem persists, call for service.
			On system board; internal error	Run the ServeRAID Configuration Utility.
			On system board; adapter/drive configuration error	
			Logical drive on system board adapter	If the problem persists, call for service.
			Adapter in slot <i>n</i> ; memory allocation error (where <i>n</i> is the slot number of the failing adapter)	Call for service.
			On system board; memory allocation error	
			On system board; PCI configuration error	
			On system board; POST error	
			Adapter in slot <i>n</i> ; POST error (where <i>n</i> is the slot number of the failing adapter)	Replace the ServeRAID adapter in slot <i>n</i> . If the problem persists, call for service.
			Adapter in slot <i>n</i> ; PCI configuration error (where <i>n</i> is the slot number of the failing adapter)	
SCSI drive on adapter in slot <i>n</i> , SCSI ID <i>m</i> (where <i>n</i> is the slot number of the adapter and <i>m</i> is the SCSI ID of the drive)	Check the cable and power connections on the drive. If the problem persists, call for service.			
075	Power supply	Failed	Voltage sensed by the system is out of range	Call for service.

Code	Function	Result	Text message	Action
089	Microprocessor	Failed	Invalid microprocessor in slot xyz or BIOS setup problem (where xyz identifies the microprocessor that is causing the error message)	<ol style="list-style-type: none"> 1. Check the system error log for the related error messages. 2. If your system does not have the latest level BIOS installed, update the BIOS. 3. If the problem remains, replace the xyz microprocessor and run the test again. <p>If the problem persists, call for service.</p>
			Processor in socket id xyz is installed but not functioning (where xyz identifies the microprocessor that is causing the error message)	
			Microprocessor in socket id xyz (where xyz identifies the microprocessor that is causing the error message)	<ol style="list-style-type: none"> 1. Reseat the microprocessor. 2. If the problem remains, replace the microprocessor. <p>If the problem persists, call for service.</p>
			Processor in socket id xyz is defective (where xyz identifies the microprocessor that is causing the error message)	<p>Replace the microprocessor.</p> <p>If the problem persists, call for service.</p>
			Test setup error: Application microprocessor not installed or BIOS setup problem	<ol style="list-style-type: none"> 1. Verify that the Application microprocessor is installed and seated correctly. 2. If your system does not have the latest level BIOS installed, update the BIOS. 3. If the problem remains, replace the Application microprocessor and run the test again. <p>If the problem persists, call for service.</p>
	Microprocessor	Failed	VRM corresponding to microprocessor in socket xyz is defective (where xyz identifies the microprocessor whose VRM is causing the error message)	<p>Replace the VRM.</p> <p>If the problem remains, call for service.</p>
			VRM corresponding to microprocessor in socket id xyz is not installed (where xyz identifies the microprocessor whose VRM is causing the error message)	<p>Install a VRM.</p> <p>If the problem persists, call for service.</p>

Code	Function	Result	Text message	Action
175	System thermal	Failed	Fan # <i>n</i> (where <i>n</i> is the number of the failing fan)	Replace the indicated fan.
			Temperature sensed on processor board is out of range	Call for service.
180	Status display	Failed	Any failure message	Call for service.
201	System memory	Failed	DIMMs in location DIMM <i>n</i> (where <i>n</i> is the number of the socket that contains the failing DIMM)	<ol style="list-style-type: none"> 1. Reseat the failing DIMM. 2. If the problem remains, replace the DIMM. <p>If the problem persists, call for service.</p>
			Test setup error: Corrupt BIOS in ROM	<p>If your system does not have the latest level BIOS installed, update the BIOS to the latest level.</p> <p>If the problem persists, call for service.</p>
			Test setup error: Corrupt DMI BIOS, information in BIOS is not as expected	
202	System cache	Aborted	Test setup error: BIOS cannot access VPD information	<p>If your system does not have the latest level BIOS installed, update the BIOS to the latest level and run the diagnostic program again.</p> <p>If the problem persists, call for service.</p>
			Test setup error: Corrupt DMI BIOS, information in BIOS is not as expected	
			Test setup error: No L2 cache detected on microprocessor socket id <i>xyz</i> or BIOS setup problem (where <i>xyz</i> identifies the microprocessor that is causing the error message)	<ol style="list-style-type: none"> 1. If your system does not have the latest level BIOS installed, update the BIOS to the latest level 2. Run the diagnostic program again. 3. If the problem remains, replace the failing processor. <p>If the problem persists, call for service.</p>
		Test setup error: Unknown hardware problem associated with microprocessor in socket id <i>xyz</i> . (where <i>xyz</i> identifies the microprocessor that is causing the error message)		
		Failed	Microprocessor in socket ID <i>xyz</i> (where <i>xyz</i> identifies the microprocessor that is causing the error message)	<ol style="list-style-type: none"> 1. Reseat the identified microprocessor. 2. If the problem remains, replace the microprocessor. <p>If the problem persists, call for service.</p>
Warning	Test setup error: Cache is disabled. Use system setup to enable before retrying the test	<p>Use the Cache Control choice from the Advanced Setup menu to enable the cache.</p> <p>If the problem persists, call for service.</p>		

Code	Function	Result	Text message	Action
206	Diskette drive	Failed	Internal diskette drive bay	Call for service.
215	CD-ROM	Failed	On system board.	Call for service.
		Aborted	The CD-ROM drive is not present.	Verify that the cables are properly connected to the CD-ROM drive. If the problem persists, call for service.
217	Hard disk drive	Failed	BIOS drive # <i>n</i> (where <i>n</i> is the drive bay number)	Call for service.
264	Magnetic tape drive	Aborted	Test setup error: No tape drive found	Check the cable and power connections to the drive. Refer to the information that is provided with the tape drive. If the problem persists, call for service.
			Failed	The load/mount test failed for device <i>n</i> on adapter <i>m</i> (where <i>n</i> is the number of the device and <i>m</i> is the adapter number)
		Failed	The self-diagnostic failed for device <i>n</i> on adapter <i>m</i> . (where <i>n</i> is the number of the device and <i>m</i> is the adapter number)	
		Failed	The unload/eject test failed for device <i>n</i> on adapter <i>m</i> (where <i>n</i> is the number of the device and <i>m</i> is the adapter number)	
		Failed	The unload/eject push button test failed for device <i>n</i> on adapter <i>m</i> (where <i>n</i> is the number of the device and <i>m</i> is the adapter number)	
		Failed	The Read/Write Self-diagnostic failed for device <i>n</i> on adapter <i>m</i> (where <i>n</i> is the number of the device and <i>m</i> is the adapter number)	Insert a new tape cartridge; then, run the diagnostic test again. Refer to the information that is provided with the tape drive. If the problem persists, call for service.
301	Keyboard	Failed	On system-board keyboard test failed	1. Verify that the keyboard cable is connected. 2. If the problem remains, replace the keyboard cable. If the problem persists, call for service.
302	Mouse	Failed	On system-board pointing device test failed.	Replace the pointing device. If the problem persists, call for service.
305	Video monitor		Any message	Refer to the information that came with the monitor.

Code	Function	Result	Text message	Action
405	Ethernet	Failed	In PCI slot <i>n</i> (where <i>n</i> is the PCI slot number in which the failing Ethernet adapter is installed)	Replace the Ethernet adapter in slot <i>n</i> . If the problem persists, call for service.
			On system board	Call for service.
415	Analog/digital modem	Not applicable	No modem was detected	<ol style="list-style-type: none"> 1. Verify that the modem is properly attached to the system. 2. If the problem remains, replace the modem. <p>If the problem persists, call for service.</p>
			PCI modem detected, but not enabled	<ol style="list-style-type: none"> 1. Change the configuration to enable the modem. 2. If the problem remains, replace the modem. <p>If the problem persists, call for service.</p>
		Failed	Modem reset failed	<p>Replace the modem.</p> <p>If the problem persists, call for service.</p>
			No dial tone detected	<ol style="list-style-type: none"> 1. Make sure that the phone line attached to the modem has a dial tone. (Connect a phone to the line and listen, if necessary.) If there is no tone, have the phone line serviced. 2. If the problem remains, replace the modem. <p>If the problem persists, call for service.</p>

Troubleshooting charts

You can use the troubleshooting charts in this section to find solutions to problems that have definite symptoms.

Attention: If diagnostic error messages appear that are not listed in the following tables, make sure that your computer has the latest levels of BIOS code and diagnostics installed.

See “Starting the diagnostic programs” on page 76 to test the system. If you have run the diagnostic test programs or if running the tests does not reveal the problem, call for service.

Look for the symptom in the left column of the chart. Instructions and probable solutions to the problem are in the right column. If you have just added new software or a new option and your system is not working, do the following before using the troubleshooting charts:

- Remove the software or device that you just added.
- Run the diagnostic tests to determine if your system is running correctly.
- Reinstall the new software or new device.

Table 4. Troubleshooting charts

Device	Suggested action
CD-ROM drive	Verify that:
CD-ROM drive is not recognized.	<ol style="list-style-type: none"> 1. The primary IDE channel is enabled in the Configuration/Setup Utility program. 2. All cables and jumpers are installed correctly. 3. The correct device driver is installed for the CD-ROM drive.
Diskette drive	If there is a diskette in the drive, verify that:
Diskette drive in-use light stays on, or the system bypasses the diskette drive.	<ol style="list-style-type: none"> 1. The diskette drive is enabled in the Configuration/Setup Utility program. 2. The diskette is good and not damaged. (Try another diskette if you have one.) 3. The diskette contains the necessary files to start the system. 4. Your software program is OK. <p>If the diskette drive in-use light stays on, or the system continues to bypass the diskette drive, call for service.</p>
Expansion enclosure	Verify that:
The SCSI expansion enclosure used to work, but does not work now.	<ol style="list-style-type: none"> 1. The cables for all external SCSI options are connected correctly. 2. The last option in each SCSI chain, or the end of the SCSI cable, is terminated correctly. 3. Any external SCSI option is turned on. You must turn on an external SCSI option before turning on the system. <p>For more information, see your SCSI and expansion enclosure documentation.</p>
Other devices	Call for service.
Problems such as broken cover locks or indicator lights not working.	
Intermittent problems	Verify that:
A problem occurs only occasionally and is difficult to detect.	<ol style="list-style-type: none"> 1. All cables and cords are connected securely to the rear of the system and attached options. 2. When the system is turned on, air is flowing from the rear of the system at the fan grille. If there is no air flow, the fan is not working. This causes the system to overheat and shut down. 3. Ensure that the SCSI bus and devices are configured correctly and that the last external device in each SCSI chain is terminated correctly. <p>If the items above are correct, call for service.</p>
Keyboard, mouse, or pointing-device	<ol style="list-style-type: none"> 1. Make sure that the keyboard cable is properly connected to the system. 2. Make sure that the system and the monitor are turned on.
All or some keys on the keyboard do not work.	<ol style="list-style-type: none"> 3. Try using another keyboard. <p>If the items above are correct, call for service.</p>

Table 4. Troubleshooting charts

Device	Suggested action
The mouse or pointing device does not work.	<ol style="list-style-type: none"> 1. Verify that the mouse or pointing-device cable is securely connected and the device drivers are installed correctly. 2. Try using another mouse or pointing device. <p>If the problem remains, call for service.</p>
Memory	Verify that:
The amount of memory displayed is less than the amount of memory installed.	<ol style="list-style-type: none"> 1. The memory modules are seated properly. 2. You have installed the correct type of memory. 3. If you changed the memory, you updated the memory configuration with the Configuration/Setup Utility program. 4. All banks of memory on the DIMMs are enabled. The system might have automatically disabled a DIMM bank when it detected a problem, or a DIMM bank could have been manually disabled. <p>If the problem persists, call for service.</p>
Microprocessor	The startup (boot) microprocessor is not working properly.
The system emits a continuous tone during the POST.	<p>Verify that the startup microprocessor is seated properly. If it is, replace the startup microprocessor.</p> <p>If the problem remains, call for service.</p>
Monitor	Some IBM monitors have their own self-tests. If you suspect a problem with your monitor, refer to the information that comes with the monitor for adjusting and testing instructions.
Testing the monitor.	<p>If you still cannot find the problem, call for service.</p>
The screen is blank.	<p>Verify that:</p> <ol style="list-style-type: none"> 1. The system power cord is plugged into the computer and a working electrical outlet. 2. The monitor cables are connected properly. 3. The monitor is turned on and the brightness and contrast controls are adjusted correctly. <p>If the items above are correct and the screen remains blank, call for service.</p>
Only the cursor appears.	Call for service.
The monitor works when you turn on the system, but goes blank when you start some application programs.	<p>Verify that:</p> <ol style="list-style-type: none"> 1. The primary monitor cable is connected to the video port. 2. You installed the necessary device drivers for the applications. <p>If the items above are correct and the screen remains blank, call for service.</p>
The monitor works, but give an Out of Range error	Go to the VGA node and change the refresh rate to match the optimal setting of the monitor.

Table 4. Troubleshooting charts

Device	Suggested action
Wavy, unreadable, rolling, distorted screen, or screen jitter.	<p>If the monitor self-tests show the monitor is OK, consider the location of the monitor. Magnetic fields around other devices (such as transformers, appliances, fluorescent lights, and other monitors) can cause screen jitter or wavy, unreadable, rolling, or distorted screen images. If this happens, turn off the monitor. (Moving a color monitor while it is turned on might cause screen discoloration.) Then move the device and the monitor at least 305 mm. (12 in.) apart. Turn on the monitor.</p> <p>Notes:</p> <ol style="list-style-type: none"> 1. To prevent diskette drive read/write errors, be sure the distance between monitors and diskette drives is at least 76 mm (3 in.). 2. Non-IBM monitor cables might cause unpredictable problems. 3. An enhanced monitor cable with additional shielding is available for the 9521 and 9527 monitors. For information about the enhanced monitor cable, see your IBM reseller or IBM marketing representative. <p>If the problem remains, call for service.</p>
Wrong characters appear on the screen.	<p>If the wrong language is displayed, update the BIOS with the correct language.</p> <p>If the problem remains, call for service.</p>
Option	Verify that:
An IBM option that was just installed does not work.	<ol style="list-style-type: none"> 1. The option is designed for the computer. Refer to the "Computer Support" flowchart for information about obtaining options compatibility information from the World Wide Web. 2. You followed the installation instructions that came with the option. 3. The option is installed correctly. 4. You have not loosened any other installed options or cables. 5. You updated the configuration information in the Configuration/Setup Utility program. Whenever memory or an option is changed, you must update the configuration. <p>If the problem remains, call for service.</p>
An IBM option that used to work does not work now.	<p>Verify that all of the option hardware and cable connections are secure.</p> <p>If the option comes with its own test instructions, use those instructions to test the option.</p> <p>If the failing option is a SCSI option, verify that:</p> <ol style="list-style-type: none"> 1. The cables for all external SCSI options are connected correctly. 2. The last option in each SCSI chain, or the end of the SCSI cable, is terminated correctly. 3. Any external SCSI option is turned on. You must turn on an external SCSI option before turning on the system. <p>If the problem remains, call for service.</p>
Parallel port	Verify that:
The number of parallel ports displayed is less than the number of parallel ports installed.	<ol style="list-style-type: none"> 1. Each port is assigned a unique address. 2. The parallel-port adapter, if you installed one, is seated properly. <p>If the problem remains, call for service.</p>

Table 4. Troubleshooting charts

Device	Suggested action
<p>Power</p> <p>The system does not power on.</p>	<p>Verify that:</p> <ol style="list-style-type: none"> 1. The power cables are properly connected to the system. 2. The electrical outlet functions properly. 3. The type of memory installed is correct. 4. If you just installed an option, remove it, and restart the system. If the system now powers on, you might have installed more options than the power supply supports. <p>If the problem remains, call for service.</p>
<p>Printer</p> <p>The printer does not work.</p>	<p>Verify that:</p> <ol style="list-style-type: none"> 1. The printer is turned on and is online. 2. The printer signal cable is connected to the correct serial or parallel port on the computer. Note: Non-IBM printer cables might cause unpredictable problems. 3. You have assigned the printer port correctly in your operating system or application program. 4. You have assigned the printer port correctly using the Configuration/Setup Utility program. <p>If the items above are correct and the printer still does not work, run the tests described in the documentation that comes with your printer. If the tests show that the printer is OK, call for service.</p>
<p>Serial port</p> <p>The number of serial ports identified by the operating system is less than the number of serial ports installed.</p>	<p>Verify that:</p> <ol style="list-style-type: none"> 1. Each port is assigned a unique address by the Configuration/Setup Utility program and none of the serial ports are disabled. Note: The management C connector is the same as a serial port connector, but it is used only by the integrated ASM Processor, and is not available for use by the operating system. This port does not appear in the Configuration/Setup Utility program menus; it can be configured using your system-management software. 2. The serial-port adapter, if you installed one, is seated properly. <p>If the problem still exists, call for service.</p>
<p>A serial device does not work.</p>	<p>Verify that:</p> <ol style="list-style-type: none"> 1. The device is compatible with the computer. 2. The serial port is enabled and is assigned a unique address. 3. Make sure that the device is not connected to the management port C. Note: The management C connector is the same as a serial port connector, but it is used only by the integrated ASM Processor and is not available for use by the operating system. This port does not appear in the Configuration/Setup Utility program menus; it can be configured using your system-management software. <p>If the problem still exists, call for service.</p>

Table 4. Troubleshooting charts

Device	Suggested action
Universal Serial Bus (USB) ports	Verify that: <ol style="list-style-type: none"> <li data-bbox="565 296 1406 352">1. You are not trying to use a USB device during POST, if you have a standard (non-USB) keyboard attached to the keyboard port. <p data-bbox="602 363 1446 417">Note: If a standard (non-USB) keyboard is attached to the keyboard port. then the USB is disabled and no USB device will work during POST.</p> <ol style="list-style-type: none"> <li data-bbox="565 428 1045 455">2. The correct USB device driver is installed. <li data-bbox="565 466 1089 493">3. Your operating system supports USB devices. <p data-bbox="602 504 1154 531">Note: Windows NT does not support USB devices.</p> <p data-bbox="553 558 984 585">If the problem still exists, call for service.</p>
A USB device does not work.	

Software-generated error messages

These messages appear if a problem or conflict is detected by the application program, the operating system, or both. Error messages for operating system and other software problems are generally text messages, but they also can be numeric codes. For information about these software error messages, see the information supplied with the operating system and application program.

Device	Suggested action
Software problem	To determine if problems are caused by the software, verify that: <ol style="list-style-type: none"> <li data-bbox="589 984 1438 1062">1. Your computer has the minimum memory requirements needed to use the software. For memory requirements, refer to the information that comes with the software. <p data-bbox="626 1073 1401 1129">Note: If you have just installed an adapter or memory, you might have a memory address conflict.</p> <ol style="list-style-type: none"> <li data-bbox="589 1140 1183 1167">2. The software is designed to operate on your system. <li data-bbox="589 1178 1029 1205">3. Other software works on your system. <li data-bbox="589 1215 1243 1243">4. The software that you are using works on another system. <p data-bbox="581 1270 1446 1348">If you received any error messages when using the software program, refer to the information that comes with the software for a description of the messages and solutions to the problem.</p> <p data-bbox="581 1375 1398 1432">If the items above are correct and the problem remains, contact your place of purchase.</p>
Suspected software problem.	

Troubleshooting the Ethernet controller

This section provides troubleshooting information for problems that might occur with the 10/100 Mbps Ethernet controller.

Network connection problems

If the Ethernet controller cannot connect to the network, check the following:

- Make sure that the cable is installed correctly.

The network cable must be securely attached at all connections. If the cable is attached but the problem persists, try a different cable.

If you set the Ethernet controller to operate at 100 Mbps, you must use Category 5 cabling.

If you directly connect two workstations (without a hub), or if you are not using a hub with X ports, use a crossover cable.

Note: To determine whether a hub has an X port, check the port label. If the label contains an X, the hub has an X port.

- Determine if the hub supports auto-negotiation. If not, try configuring the integrated Ethernet controller manually to match the speed and duplex mode of the hub.
- Check the LAN activity light on the rear of the computer. The LAN activity light illuminates when the Ethernet controller sends or receives data over the Ethernet network. If the LAN activity light is off, make sure that the hub and network are operating and that the correct device drivers are loaded.
- Make sure that you are using the correct device drivers, supplied with your system.
- Check for operating system-specific causes for the problem.
- Make sure that the device drivers on the client and system are using the same protocol.
- Test the Ethernet controller.

The way you test the Ethernet controller depends on which operating system you are using (see the Ethernet controller device driver README file).

Ethernet controller troubleshooting chart

You can use the following troubleshooting chart to find solutions to 10/100 Mbps Ethernet controller problems that have definite symptoms.

Table 5. Ethernet troubleshooting chart

Ethernet controller problem	Suggested Action
The system stops running when loading device drivers.	<p>The PCI BIOS interrupt settings are incorrect.</p> <p>Check the following:</p> <ul style="list-style-type: none"> • Determine if the IRQ setting assigned to the Ethernet controller is also assigned to another device in the Configuration/Setup Utility program. <p>Although interrupt sharing is allowed for PCI devices, some devices do not function well when they share an interrupt with a dissimilar PCI device. Try changing the IRQ assigned to the Ethernet controller or the other device. For example, for NetWare Versions 3 and 4 it is recommended that disk controllers not share interrupts with LAN controllers.</p> <ul style="list-style-type: none"> • Make sure that you are using the most recent device driver available from the World Wide Web. • Run the network diagnostic program. <p>If the problem remains, call for service.</p>
The LAN activity light (some models) does not light.	<p>Check the following:</p> <ul style="list-style-type: none"> • Make sure that you have loaded the network device drivers. • The network might be idle. Try sending data from this workstation. • Run diagnostics on the LEDs. • The function of this LED can be changed by device driver load parameters. If necessary, remove any LED parameter settings when you load the device drivers.
Data is incorrect or sporadic.	<p>Check the following:</p> <ul style="list-style-type: none"> • Make sure that you are using Category 5 cabling when operating the system at 100 Mbps. • Make sure that the cables do not run close to noise-inducing sources like fluorescent lights.

Table 5. Ethernet troubleshooting chart

Ethernet controller problem	Suggested Action
<p>The Ethernet controller stopped working when another adapter was added to the system.</p>	<p>Check the following:</p> <ul style="list-style-type: none"> • Make sure that the cable is connected to the Ethernet controller. • Make sure that your PCI system BIOS is current. • Reseat the adapter. • Determine if the IRQ setting assigned to the Ethernet adapter is also assigned to another device in the Configuration/Setup Utility program. <p>Although interrupt sharing is allowed for PCI devices, some devices do not function well when they share an interrupt with a dissimilar PCI device. Try changing the IRQ assigned to the Ethernet adapter or the other device.</p> <p>If the problem remains, call for service.</p>
<p>The Ethernet controller stopped working without apparent cause.</p>	<p>Check the following:</p> <ul style="list-style-type: none"> • Run diagnostics for the Ethernet controller. • Try a different connector on the hub. • Reinstall the device drivers. Refer to your operating system documentation. <p>If the problem remains, call for service.</p>

Ethernet controller messages

The integrated Ethernet controller might display messages from the following device drivers:

- Novell NetWare or IntraNetWare system open data-link interface (ODI)
- Network driver interface specification (NDIS) adapter for level 4.0 (Windows NT)

Novell NetWare or IntraNetWare system ODI driver teaming messages

This section provides explanations of the error messages for the Novell NetWare or IntraNetWare system ODI driver, and suggested actions to resolve each problem.

Table 6. NetWare driver messages for the Ethernet controller

Message	Description
<p>Couldn't allocate resources.</p>	<p>Explanation: An unknown error has occurred when trying to allocate needed resources for the AFT Module. Action:</p> <ul style="list-style-type: none"> • Check the system configuration. If the problem persists, contact your network supplier. • Verify that the Ethernet controller is enabled. If the Ethernet controller is enabled, run the diagnostic programs.
<p>AFT group for primary adapter in slot <i>nnn</i> already exists.</p>	<p>Explanation: An attempt was made to rebind an adapter already in an AFT group. Action: Check the AFT slot numbers for existing AFT teams. If the problem persists, contact your network supplier.</p>
<p>Error locating device control table (DCT) addresses in internal table. Make sure that you have loaded LAN drivers after loading AFT.NLM.</p>	<p>Explanation: The bind command was entered prior to loading the device driver. The device driver must be loaded after loading AFT.NLM, but before any bind command can be issued. Action: Load the driver for the supported adapter and try loading the AFT module again. If the problem persists, contact your network supplier.</p>
<p>Insufficient number of arguments specified.</p>	<p>Explanation: The appropriate or expected number of parameters was not entered in a command. Action: Check the parameters required for the given command. If the problem persists, contact your network supplier.</p>

Table 6. NetWare driver messages for the Ethernet controller

Message	Description
Duplicate slot numbers detected.	Explanation: An attempt has been made to bind the same slot number more than once. Action: Check the slot numbers entered during the bind. Adapter slot numbers must be valid and unique. If the problem persists, contact your network supplier.
'xxx' is not supported for AFT team.	Explanation: A bind command has been issued for adapters not supported by AFT.NLM. Action: Make sure that you attempt to bind only adapters supported by AFT.NLM.
Primary and Secondary adapters do not match. AFT group is not created.	Explanation: A bind command was entered for an adapter team that is a combination of system and client adapters. An AFT team must be a grouping of the same classification of adapter. Action: Verify that all the adapters bound in a team are of the same classification.
Requested number of Secondary cards are not found.	Explanation: The number of adapters specified in the bind command could not be located. Action: Verify the numbers and slot locations of the adapters to be bound. If the problem persists, contact your network supplier.
Failed to create AFT group. Make sure that the drivers for supported adapters are loaded, primary adapter is bound to protocols, and secondary adapter is not bound to any protocols.	Explanation: Binding of protocol failed. Protocol is either not bound to any adapter or is bound to more than one adapter in the group. Action: Ensure that the protocol is bound to only adapter in an AFT team.
Error identifying slot numbers for the specified board names.	Explanation: The mapping between the board name entered and the slot number for an adapter could not be established. Action: Check the board name for the adapter before issuing the bind command. If the problem persists, contact your network supplier.
Can't unbind specified slot from AFT group. Make sure that the slot you specified is for the primary adapter in an AFT group.	Explanation: The number entered in the unbind command was not the primary adapter in an AFT group. Action: Reissue the unbind command and specify the slot number for the primary adapter.
LAN adapter at slot <i>nnnn</i> (Port 0xaa) failed to reset. Check the state of the adapter.	Explanation: The adapter that you specified could not be initialized. Action: <ol style="list-style-type: none"> 1. Load the driver for the supported adapter. 2. Check that the adapter is seated properly in the slot and try loading the AFT module again. <p>If the problem persists, contact your network supplier.</p>
AFT is not supported on this version of NetWare.	Explanation: The NetWare on your system is not a version supported by AFT. Action: Load and bind AFT only on supported versions of NetWare (currently version 4.11 and above).
Failed to allocate resources tags.	Explanation: An unknown error has occurred when trying to allocate needed resources for the AFT module. Action: Check system configuration. If the problem persists, contact your network supplier.
Please unload all LAN drivers before unloading AFT.NLM.	Explanation: An attempt was made to unload the AFT.NLM module before unloading the adapter driver. Action: Unload the adapter driver before unloading the AFT module.

NDIS 4.0 (Windows NT) driver messages

This section contains the error messages for the NDIS 4.0 drivers. The explanation and recommended action are included with each message.

Table 7. NDIS (Windows NT) driver messages for the Ethernet controller

Error code (hex)	Description
0x00	Explanation: The driver could not register the specified interrupt. Action: Using the Configuration/Setup Utility program, make sure that a PCI interrupt is assigned to your Ethernet card, and that Ethernet is enabled.
0x01	Explanation: One of the PCI cards did not get the required resources. Action: Using the Configuration/Setup Utility program, make sure that a PCI interrupt is assigned to your Ethernet card, and that Ethernet is enabled.
0x02	Explanation: Bad node address (multicast address). Action: Make sure the locally administered address is valid, if one is specified. The address can not be a multicast address.
0x03	Explanation: Failed self-test. Action: Make sure a cable is attached to the Ethernet connector. If the problem persists, call for service.
0x0D	Explanation: Could not allocate enough memory for transmit queues. Action: <ol style="list-style-type: none"> 1. From the Windows NT desktop, select Start --> Control Panel --> Networks --> Adapters. 2. Select your IBM Ethernet adapter from the list. 3. Select Properties --> Advanced. 4. Lower the resource values that apply to the transmit queue.
0x0E	Explanation: Could not allocate enough memory for receive queue. Action: <ol style="list-style-type: none"> 1. From the Windows NT desktop, select Start --> Control Panel --> Networks --> Adapters. 2. Select your IBM Ethernet adapter from the list. 3. Select Properties --> Advanced. 4. Lower the resource values that apply to the receive queue.
0x0F	Explanation: Could not allocate enough memory for other structures. Action: <ol style="list-style-type: none"> 1. From the Windows NT desktop, select Start --> Control Panel --> Networks --> Adapters. 2. Select your IBM Ethernet adapter from the list. 3. Select Properties --> Advanced. 4. Lower the value for the resource named in the message.
0x10	Explanation: Did not find any Ethernet controllers. Action: Using the Configuration/Setup Utility program, make sure that Ethernet is enabled.
0x11	Explanation: Multiple Ethernet controllers found, but none matched the required ID. Action: Using the Configuration/Setup Utility program, make sure that Ethernet is enabled.
0x13	Explanation: Did not find any Ethernet controllers that matched the required subven/subdev. Action: Using the Configuration/Setup Utility program, make sure that Ethernet is enabled.
0x16	Explanation: Single adapter found, but multiple instances tried to load. Action: Using the Configuration/Setup Utility program, make sure that Ethernet is enabled, and that the slot containing the IBM IntelliStation 10/100 Ethernet Adapter or the IBM 10/100 Etherjet PCI adapter is enabled.
0x17	Explanation: Slot parameter not specified in the registry. Action: Remove the adapter driver and reinstall it. If the problem persists, call for service.
All other 4-character hexadecimal codes	Action: Call for service.

Ethernet teaming messages

This section displays the messages associated with Ethernet teaming.

Table 8. NDIS (Windows NT) driver teaming messages for the Ethernet controller

Event ID	Type	Description
01	Error	Explanation: Team Name and physical adapter name are the same. This is an invalid configuration. Action: Reconfigure the adapter team by double-clicking the PROSet icon in the control panel.
02	Error	Explanation: Unable to allocate required resources. Action: Free some memory resources and restart.
03	Error	Explanation: Unable to read required registry parameters. Action: Reconfigure the adapter team by double-clicking the PROSet icon in the control panel.
04	Error	Explanation: Unable to bind to physical adapter. Action: Reconfigure the adapter team by double-clicking the PROSet icon in the control panel.
05	Error	Explanation: Unable to initialize an adapter team. Action: Reconfigure the adapter team by double-clicking the PROSet icon in the control panel.
06	Informational	Explanation: Team <i>nn</i> . Primary adapter is initialized. Action: None.
07	Informational	Explanation: Team <i>nn</i> . Secondary adapter is initialized. Action: None.
08	Informational	Explanation: Team <i>nn</i> . Virtual adapter or Team is initialized. Action: None.
09	Informational	Explanation: Team <i>nn</i> . Primary adapter is switching over. Action: None.
10	Warning	Explanation: Team <i>nn</i> . Adapter link down. Action: Make sure the adapter is functioning properly.
11	Informational	Explanation: Team <i>nn</i> . Secondary adapter took over. Action: None.
12	Warning	Explanation: Team <i>nn</i> . Secondary adapter is deactivated from the Team. Action: Make sure the secondary adapter is functioning properly and that the adapter cable is securely connected to the LAN.
13	Informational	Explanation: Team <i>nn</i> . Secondary adapter has rejoined the Team. Action: None.
14	Informational	Explanation: Team <i>nn</i> . Secondary adapter link is working. Action: None.
15	Error	Explanation: Team <i>nn</i> . The last adapter has lost its link. Network connection has been lost. Action: Shut down the computer and replace the adapters; then, restart the system to reestablish the connection.
16	Informational	Explanation: Team <i>nn</i> . An adapter has reestablished the link. Network connection has been restored. Action: None.
17	Informational	Explanation: Team <i>nn</i> . Preferred primary adapter has been detected. Action: None.
18	Informational	Explanation: Team <i>nn</i> . Preferred secondary adapter has been detected. Action: None.
19	Informational	Explanation: Team <i>nn</i> . Preferred primary adapter took over. Action: None.
20	Informational	Explanation: Team <i>nn</i> . Preferred secondary adapter took over. Action: None.
21	Warning	Explanation: Team <i>nn</i> . Primary adapter does not sense any Probes. Possible reason: partitioned Team. Action: Make sure the cables of the adapter team are connected to the same LAN segment. Reconfigure the team if necessary.

Recovering your operating system and preinstalled software

This section contains instructions for recovering BIOS code, device drivers, operating system, and other support software.

Notes:

1. The Product Recovery program is provided on your computer to assist you with recovery operations.
2. The Product Recovery program is preinstalled on the hard disk drive that comes with your IBM computer and is designed to be hidden from view to protect the program from accidental damage.

If you are using fdisk, NT Disk Administrator, or another utility to reformat your hard disk drive, you might be able to see the partition where the Product Recovery program is stored. Do not delete this information, or your Product Recovery program will be lost.

3. Some recovery processes delete all information stored on the primary partition (drive C). If possible, back up your data files before starting the process.

Recovering BIOS

If the BIOS code has become corrupted, such as from a power failure during a flash update, you can recover the BIOS code using the boot block jumper and a BIOS flash diskette.

The boot block jumper selects between normal BIOS mode and flash recovery mode. In the normal position, the jumper will be installed on pins 2 and 3. In the recovery mode, the jumper will be installed on pins 1 and 2.

Note: You can obtain a BIOS flash diskette from one of the following sources:

- Download files to make a BIOS flash diskette from the World Wide Web. Go to <http://www.pc.ibm.com/support/> and make the selections for your computer.
- Contact your IBM service representative.

Complete the following steps to recover the BIOS code.

1. Remove any media (diskettes, CDs, or tapes) from the drives and shut down your operating system.
2. Turn off the computer and all attached devices and disconnect all external cables and power cords.
3. If necessary, unlock the computer cover; then, remove the cover. For the tower model, see "Removing the side cover" on page 41 and for the desktop model, see "Removing the computer cover" on page 55.

4. Locate jumper JROM1 on the system board.

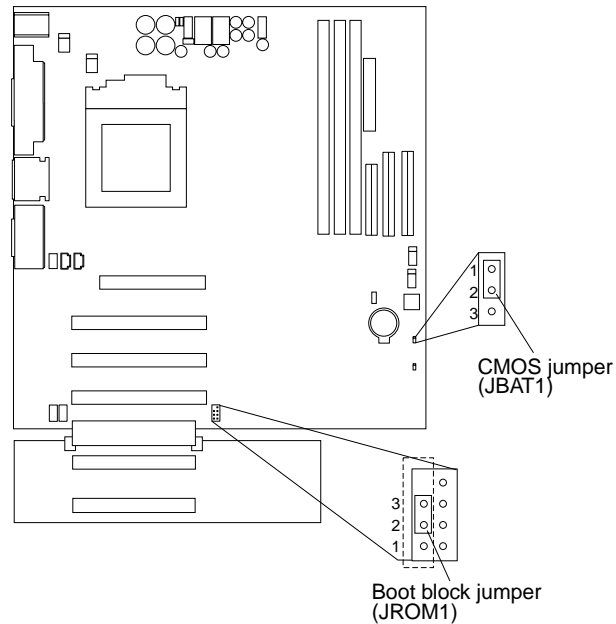

Note: The PCI extender board is only available in the tower model.

5. Move the JROM1 jumper to the alternate position (pins 1 and 2) to enable BIOS recovery mode.
6. Reinstall the computer cover, see “Installing the cover” on page 54 for the tower model and “Installing the cover” on page 65 for the desktop model.
7. Reconnect all external cables and power cords and turn on the attached devices.
8. Insert the BIOS flash diskette in the diskette drive.
9. Restart the computer. The BIOS begins the power-on self-test; then, the BIOS Flash Utility starts.
10. When prompted as to whether you want to save the current code to a diskette, select **N**.
11. When prompted enter **Y** to continue the flash process. The system automatically starts the Flash Utility a second time.
12. When prompted as to whether you want to save the current BIOS, stop the process by removing the BIOS flash diskette from the diskette drive.
13. Remove any media (diskettes, CDs, or tapes) from the drives; then, shut down your operating system.
14. Turn off the computer and all attached devices and disconnect all external cables and power cords.
15. Remove the cover. See “Removing the side cover” on page 41 for the tower model and “Removing the computer cover” on page 55 for the desktop model.
16. Move the JROM1 jumper to the normal position (pins 2 and 3) to return to normal startup mode.
17. Reinstall the computer cover. See “Installing the cover” on page 54 for the tower model and “Installing the cover” on page 54 for the desktop model.
18. Reconnect the external cables and power cords; then, turn on the attached devices and the computer. They should start up normally.

Recovering or installing device drivers

Use the following steps to recover or install device drivers.

Notes:

1. Before you can recover or install device drivers, your operating system must be installed on your computer.
2. Before you start recovering or installing device drivers, make sure you have the documentation and software media for the device.
3. Device drivers for IBM devices and the instructions to install them (README.TXT) are located on the *Device Drivers and IBM Diagnostics* CD and on the hard disk drive C:\IBMTOOLS\DRIVERS directory.
4. The latest device drivers are also available on the World Wide Web at <http://www.ibm.com/pc/support>

Complete the following steps to recover or install device drivers from the hard disk drive.

1. Start your computer and operating system, if you have not already done so.
2. Display the directory structure of the hard disk drive. (You can also display the directory structure by using the DOS Command Prompt window.)
3. Click to open the IBMTOOLS directory; then, click to open the DRIVERS directory.
4. Click to open the directory of the device driver that you want to install.
5. In the directory of the device driver, double-click the README file to view it.
6. Follow the device-driver installation instructions in the README file.
7. When the installation completes, restart the computer.

Recovering your operating system

Use the following steps to recover or install the operating system that comes with your computer. To install other operating systems, see "Installing alternate operating systems" on page 97.

Performing a full or partial recovery

Attention: The Product Recovery Program will overwrite all files on the C:\ drive. A **full recovery** will restore the operating system, device drivers, and applications. A **partial recovery** will restore your operating system and device drivers without restoring applications.

1. If you can shut down your operating system normally, do so. If you cannot shut down normally, turn your computer off.

Note: If the computer will not turn off after you hold down the power button for at least four seconds, unplug the power cord and wait a few seconds before reconnecting it.

2. Turn on your computer
3. When the To Start the Product Recovery Program, Press F11 message appears, quickly press F11. The prompt displays for only a few seconds.
4. You might have a choice of operating systems to recover. Select the operating system you want to recover. Otherwise, select the option given.
5. Select the recovery options you want and follow the instructions on the screen.
6. When recovery is complete, restart your computer.

7. If you have installed Windows NT, you must create an extended partition and logical drives. For information about creating partitions and logical drives, click on the **Access IBM** icon on your desktop, and click **Changing your operating system**.

Note: After the operating system is recovered or installed, the setup program starts the first time the operating system starts up. For information about setup, see “Running the setup program” on page 13.

Installing alternate operating systems: To install an operating system, follow the instructions in the documentation provided with the operating system and any updates.

Note: Before installing any operating system, be sure to obtain the latest updates. Contact the operating system manufacturer or, check the manufacturer’s World Wide Web site to obtain any updates available.

After installing your operating system, you can install additional support software. See Appendix A, “Using the Software Selections CD,” on page 105 for more detailed information.

Using Norton AntiVirus for IBM

The Norton AntiVirus for IBM program is comprehensive antivirus product that detects and removes viruses from your computer. To install the Norton AntiVirus for IBM program, complete the following steps.

1. Click on the **Software Selections** icon on your desktop.
2. When prompted, insert the *Software Selections* CD into the CD-ROM drive; then, click **OK**.
3. When the Software Selection menu appears, click **Install Software**. Then, when the software menu appears, select the Norton AntiVirus for IBM check box.
4. After selecting the software, click **Install**. A window opens showing the software programs that are selected for installation. Click **OK** to continue with the installation process, or click **Cancel** to clear your selections.

Using the ConfigSafe program

ConfigSafe can be used as a troubleshooting tool, especially if problems develop after you install a new application or option. Before you make any changes to your computer configuration, use ConfigSafe to take a snapshot of your current, working operating system configuration. If you have preinstalled software, ConfigSafe automatically takes a snapshot of your initial operating system configuration settings when you first start up your computer. Then, you can easily return to that configuration if your computer becomes disabled by changes in the configuration files.

If you are unable to solve a problem yourself and you need assistance from an IBM technical support representative, use ConfigSafe to generate a report about recent changes in your configuration before you call the PC HelpCenter[®]. The IBM technical support representative will be able to use the information in this report to help you solve the problem.

Complete the following steps to access the ConfigSafe program.

Click **Start**→ **Programs**→ **ConfigSafe**

Clearing CMOS

If you need to *erase* configuration information, you must move the CMOS jumper. See the illustration in “Recovering BIOS” on page 94 for the location of the CMOS jumper.

The default position is a jumper installed on pins 1 and 2. Before you change the position of this jumper, you *must* turn off the computer and attached devices, and disconnect all external cables and power cords. Remove the cover and then move the jumper to pins 2 and 3.

Note: If possible, record your computer configuration information *before* moving the CMOS jumper.

After moving the jumper, wait at least 5 minutes for the CMOS information to clear.

Changing the position of this jumper erases all configuration and setup information, including the power-on and administrator passwords. Therefore, you must reconfigure the computer after clearing CMOS memory (see Chapter 4, “Configuring your computer,” on page 23).

After you clear the CMOS information, move the jumper back to its normal position (pins 1 and 2). Reconnect the external cables and power cords; then, turn on the attached devices and the computer.

Replacing the battery

When replacing the battery, you must replace it with a lithium battery of the same type from the same manufacturer. To avoid possible danger, read and follow the safety statement below.

To order replacement batteries, call 1-800-772-2227 within the United States, and 1-800-465-7999 or 1-800-465-6666 within Canada. Outside the U.S. and Canada, call your IBM reseller or IBM marketing representative.

Note: After you replace the battery, you must reconfigure your system and reset the system date and time.

Statement 2



CAUTION:

When replacing the lithium battery, use only IBM Part Number 33F8354 or an equivalent type battery recommended by the manufacturer. If your system has a module containing a lithium battery, replace it only with the same module type made by the same manufacturer. The battery contains lithium and can explode if not properly used, handled, or disposed of.

Do not:

- **Throw or immerse into water.**
- **Heat to more than 100 C (212 F)**
- **Repair or disassemble**

Dispose of the battery as required by local ordinances or regulations.

Complete the following steps to replace the battery.

1. Read “Before you begin” on page 33, and follow any special handling and installation instructions supplied with the replacement battery.
2. Remove any media (diskettes, CDs, or tape) from the drives and shut down your operating system.
3. Turn off the computer and attached devices and disconnect all external cables and power cords.
4. If necessary, unlock the computer cover; then, remove the computer cover. See “Removing the side cover” on page 41 for the tower model and see “Installing the cover” on page 54 for the desktop model.
5. Do the following to remove the battery:
 - a. Press the battery release tab to release the battery from the socket.
 - b. Lift the battery out of the socket.

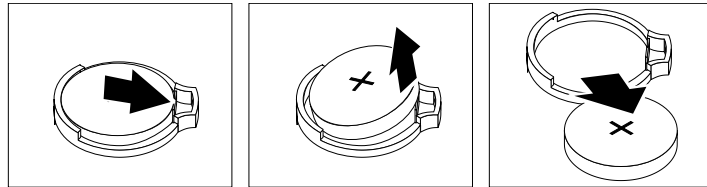

6. Do the following to insert the new battery:
 - a. Tilt the battery so that you can insert it into the socket.
 - b. Press down on the battery after you insert it into the socket.

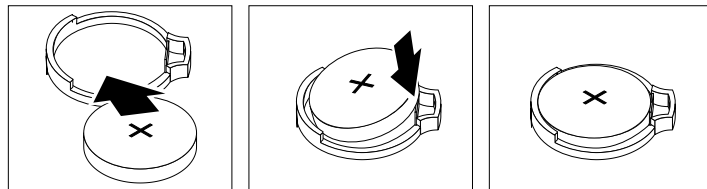

7. Reinstall the cover, see “Installing the cover” on page 54 for the tower model. See “Installing the cover” on page 65 for the desktop model.
8. Reconnect the external cables and power cords; then turn on the attached devices and the computer.
9. Start the Configuration/Setup Utility program and set configuration parameters.
 - Set the system date and time.
 - Set the power-on password.
 - Reconfigure your system.

Getting information, help, and service

If you need help, service, technical assistance, or just want more information about IBM products, you will find a wide variety of sources available from IBM to assist you.

This section contains information about where to go for additional information about IBM and IBM products, what to do if you experience a problem with your computer, and whom to call for service should it be necessary.

Getting information

Information about your IBM computer and preinstalled software, if any, is available in the documentation that comes with your computer. That documentation includes printed books, online books, README files, and help files. In addition, information about IBM products is available on the World Wide Web and through the IBM Automated Fax System.

Using the World Wide Web

On the World Wide Web, the IBM Web site has up-to-date information about IBM Personal Computer products and support. The address for the IBM Personal Computing home page is <http://www.ibm.com/pc>

You can find support information for your IBM products, including supported options, at <http://www.ibm.com/pc/support>

If you select Profile from the support page, you can create a customized support page that is specific to your hardware, complete with Frequently Asked Questions, Parts Information, Technical Hints and Tips, and Downloadable Files. In addition, you can choose to receive e-mail notifications whenever new information becomes available about your registered products.

You also can order publications through the IBM Publications Ordering System at <http://www.elink.ibm.com/public/applications/publications/cgi-bin/pbi.cgi>

Getting information by fax

If you have a touch-tone telephone and access to a fax machine, in the U.S. and Canada you can receive by fax marketing and technical information on many topics, including hardware, operating systems, and local area networks (LANs).

You can call the IBM Automated Fax System 24 hours a day, 7 days a week. Follow the recorded instructions, and the requested information will be sent to your fax machine. In the U.S. and Canada, to access the IBM Automated Fax System, call 1-800-426-3395.

Getting help and service

If you have a problem with your computer, you will find a wide variety of sources available to help you.

Using the documentation and diagnostic programs

Many computer problems can be solved without outside assistance. If you experience a problem with your computer, the first place to start is the troubleshooting information of your computer documentation. If you suspect a software problem, see the documentation, including README files and online help, that comes with the operating system or application program.

Most IBM computers and servers come with a set of diagnostic programs that you can use to help you identify hardware problems. See the troubleshooting information of your computer documentation for instructions on using the diagnostic programs.

The troubleshooting information or the diagnostic programs might tell you that you need additional or updated device drivers or other software. IBM maintains pages on the World Wide Web where you can get the latest technical information and download device drivers and updates. To access these pages, go to <http://www.ibm.com/pc/support> and follow the instructions.

Calling for service

If you have tried to correct the problem yourself and still need help, during the warranty period, you can get help and information by telephone through the IBM PC HelpCenter. The following services are available during the warranty period:

- Problem determination - Trained personnel are available to assist you with determining if you have a hardware problem and deciding what action is necessary to fix the problem.
- IBM hardware repair - If the problem is determined to be caused by IBM hardware under warranty, trained service personnel are available to provide the applicable level of service.
- Engineering change management - Occasionally, there might be changes that are required after a product has been sold. IBM or your reseller, if authorized by IBM, will make selected Engineering Changes (ECs) available that apply to your hardware.

The following items are not covered:

- Replacement or use of non-IBM parts or nonwarranted IBM parts
Note: All warranted parts contain a 7-character identification in the format IBM FRU XXXXXXX.
- Identification of software problem sources
- Configuration of BIOS as part of an installation or upgrade
- Changes, modifications, or upgrades to device drivers
- Installation and maintenance of network operating systems (NOS)
- Installation and maintenance of application programs

Refer to your IBM hardware warranty for a full explanation of IBM warranty terms. Be sure to retain your proof of purchase to obtain warranty service.

In the U.S. and Canada, these services are available 24 hours a day, 7 days a week. In the U.K., these services are available Monday through Friday, from 9:00 a.m. to 6:00 p.m.

Note: Response time will vary depending on the number and complexity of incoming calls.

If possible, be at your computer when you call. Please have the following information ready:

- Machine Type and Model
- Serial numbers of your IBM hardware products
- Description of the problem
- Exact wording of any error messages
- Hardware and software configuration information

Phone numbers are subject to change without notice. For the most up-to-date phone numbers, go to <http://www.ibm.com/pc/support> and click **HelpCenter phone list**.

Country		Telephone number
Austria	Österreich	01-24 692 5901
Belgium - Dutch	Belgie	02-210 9820
Belgium - French	Belgique	02-210 9800
Canada	Toronto only	416-383-3344
Canada	Canada - all other	1-800-565-3344
Denmark	Danmark	35 25 02 91
Finland	Suomi	09-22 931 840
France	France	01 69 32 40 40
Germany	Deutschland	069-6654 9040
Ireland	Ireland	01-815 9200
Italy	Italia	02-4827 5040
Luxembourg	Luxembourg	298-977 5063
Netherlands	Nederland	020-504 0501
Norway	Norge	23 05 32 40
Portugal	Portugal	21-791 51 47
Spain	España	91-662 49 16
Sweden	Sverige	08-751 52 27
Switzerland	Schweiz/Suisse/Svizzera	0848-80-52-52
United Kingdom	United Kingdom	01475-555 055
U.S.A. and Puerto Rico	U.S.A. and Puerto Rico	1-800-772-2227

In all other countries, contact your IBM reseller or IBM marketing representative.

Other services

IBM Update Connector is a remote communication tool that you can use with some IBM computers to communicate with the HelpCenter. Update Connector enables you to receive and download updates for some of the software that might come with your computer.

With some computer models, you can register for International Warranty Service. If you travel with your computer or need to move it to another country, you might be able to receive an International Warranty Service Certificate that is honored virtually worldwide, wherever IBM or IBM resellers sell and service IBM products.

For more information or to register for International Warranty Service:

- In the U.S. or Canada, call 1-800-497-7426.
- In Europe, call 44-1475-893638 (Greenock, U.K.).
- In Australia and New Zealand, call 61-2-9354-4171.
- In all other countries, contact your IBM reseller or IBM marketing representative.

IBM Integrated Technology Services offers a broad range of information technology support, implementation, and management services. For more information about these services, refer to the Integrated Technology Services Web site at <http://www.ibm.com/services/its>

For technical assistance with the installation of, or questions related to, Service Packs for your preinstalled Microsoft Windows product, refer to the Microsoft Product Support Services Web site at <http://support.microsoft.com/directory/>, or you can contact the IBM HelpCenter. Some fees might apply.

Purchasing additional services

During and after the warranty period, you can purchase additional services, such as support for IBM and non-IBM hardware, operating systems, and application programs; network setup and configuration; upgraded or extended hardware repair services; and custom installations. Service availability and service name might vary by country.

For more information about these services, see the online information.

Appendix A. Using the Software Selections CD

Use the information in this chapter if you want to install or reinstall software from the *Software Selections* CD.

Important:

You must have Microsoft Internet Explorer 4.0 or later installed to run the IBM *Software Selections* CD.

Notes:

1. The *Software Selections* CD does not contain operating systems. Before you can use the CD, your operating system must be installed.
2. Not all software is available for all operating systems. See the *Software Selections* CD to find out which programs are available for your operating system.

Features of the Software Selections CD

The *Software Selections* CD contains application programs and support software for use with your computer.

You can use the CD to:

- Install software products directly from the CD on models equipped with a CD-ROM drive.
- Create an image of the *Software Selections* CD on your hard disk drive or on a LAN disk and install the software products from that image.

The *Software Selections* CD is easy to use and automates installation procedures for most programs. It also has a help system that describes the features of the CD.

The programs on the *Software Selections* CD are licensed according to the terms and conditions of the *IBM International License Agreement for Non-Warranted Programs*, which is available through Access IBM. For more information about how to view this license agreement, see Appendix D, "Viewing the International License Agreement for Non-Warranted Programs," on page 113.

Starting the Software Selections CD

To use the *Software Selections* CD, insert the CD into your CD-ROM drive. The Software Selections program starts automatically if the auto-run feature is enabled.

If the auto-run feature is disabled in your computer, you can use the *Software Selections* CD by using any of the following options:

- Complete the following steps to start from the desktop:
 1. Place the *Software Selections* CD in the CD-ROM drive.
 2. Click on the **Software Selections** icon on the Windows desktop.
 3. The Software Selections menu appears.
- Complete the following steps to start from Access IBM:
 1. Double click on the **Access IBM** icon; then, click **Customize** → **Installing additional software**.
 2. You will be prompted to insert the *Software Selections* CD in the CD-ROM drive. The Software Selections main menu appears after you insert the CD into the CD-ROM drive and close the drive tray.

After a program is installed, you can access it by clicking **Start** → **Programs** and selecting it from the menu. For most programs, support documentation is built into the online Help system; for some, online documentation is also provided.

Installing software using the Software Selections CD

Complete the following steps to use the *Software Selections* CD to install software programs:

1. In the Software Selections menu, click to select the check box next to each software program you want to install.
2. After selecting the programs, click **Install**. A window opens showing the software programs that will be installed. Click **OK** to continue with the installation process, or click **Cancel** to clear your selections.
3. To complete the installation, follow the instructions on the screen.

After a program is installed, you can access it by clicking **Start** → **Programs** and selecting it from the menu. For most programs, support documentation is included in the online help system; for some, online documentation (such as a README file) is also provided.

Appendix B. Maintaining your computer

This chapter provides information to help maintain your computer on a day-to-day basis to ensure proper computer operation.

Taking care of your computer

This section provides guidelines for the proper handling and care of your computer.

Basics

Here are some basic points about keeping your computer functioning properly:

- Keep your computer in a clean, dry environment. Make sure it rests on a flat, sturdy surface.
- Do not place items on top of the monitor or cover any of the vents in the monitor or computer. These vents provide air flow to keep your computer from overheating.
- Keep food and drinks away from all parts of your computer. Food particles and spills might make the keyboard and mouse sticky and unusable.
- Do not get the power switches or other controls wet. Moisture can damage these parts and cause an electrical hazard.
- Always disconnect a power cord by grasping the plug, not the cord.

Cleaning your computer

It is a good practice to clean your computer periodically to protect the surfaces and ensure trouble-free operation.

Attention: Be sure to turn off the computer and monitor power switches before cleaning the computer and monitor screen.

Computer and keyboard

Use only mild cleaning solutions and a damp cloth to clean the painted surfaces of the computer.

Monitor screen

Do not use abrasive cleaners when cleaning the surface of the monitor screen. The screen surface is easily scratched, so avoid touching it with pens, pencil points, and erasers.

To clean the screen surface, wipe it gently with a soft, dry cloth, or blow on the screen to remove grit and other loose particles. Then, use a soft cloth moistened with a nonabrasive liquid glass cleaner.

Mouse

If the pointer on the screen does not move smoothly with the mouse, you might need to clean the mouse.

Complete the following steps to clean your mouse:

1. Turn off the computer.
2. Disconnect the mouse cable from the computer.
3. Turn the mouse upside down. Unlock the retainer on the bottom of the mouse by moving it in the direction indicated by the arrow on the retainer.

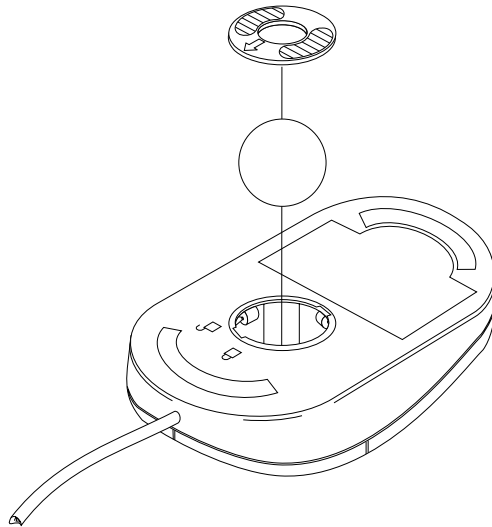

4. Turn the mouse right-side up, and the retainer and ball will drop out.
5. Wash the ball in warm, soapy water and dry it well.
6. Using a damp cloth, wipe the outside of the mouse and the retainer. Be sure to wipe the rollers inside the mouse.
7. Insert the ball and retainer. Lock the retainer by moving it in the opposite direction of the arrow.
8. Reconnect the mouse cable to the computer.

Moving your computer

Take the following precautions before moving your computer.

Statement 4

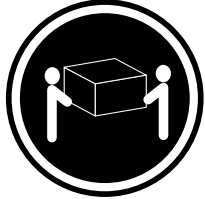

≥18 kg (39.7 lbs)

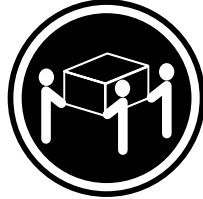

≥32 kg (70.5 lbs)

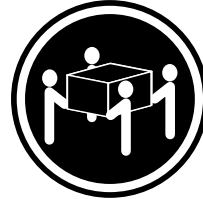

≥55 kg (121.2 lbs)

CAUTION:

Use safe practices when lifting.

1. Back up all files and data from the hard disk.
Operating systems can vary in the way they perform backup procedures. Refer to your operating system documentation for information about software backup.
2. Remove all media (diskettes, CDs, tapes, and so on) from the drives.
3. Turn off the computer and all attached devices. Your hard disk drive automatically parks the read/write heads in a nondata area. This process prevents damage to the hard disk.
4. Unplug the power cords from electrical outlets.
5. Note where you have attached your cables to the rear of the computer; then, remove them.
6. If you saved the original shipping cartons and packing materials, use them to pack the units. If you are using different cartons, cushion the units to avoid damage.

Appendix C. Computer records

This appendix contains a form for recording information about your computer, which can be helpful if you ever need to have your computer serviced.

Serial numbers and keys

Record and retain the following information.

Product Name	IntelliStation E Pro
Model/Type (M/T)	
Serial Number (S/N)	
Key manufacturer address, phone number and key code number	

The model and type (M/T) numbers and the serial number (S/N) are located on labels on the bottom of the computer and on the lower right side of the bezel on the tower model. These labels are located on the bottom of the computer and on the lower right front of the bezel on the desktop model.

Appendix D. Viewing the International License Agreement for Non-Warranted Programs

The IBM International License Agreement for Non-Warranted Programs is viewable through Access IBM. Use of your computer signifies acceptance of this agreement. Complete the following steps to view the license agreement:

1. Click the Windows **Start** button.
2. Scroll to and click **Access IBM**.
3. In the Access IBM window, click **Solve problems**.
4. Click **IBM International License Agreement**.

If your preinstalled software is no longer installed in your computer, you can view the license agreement on the *Software Selections* CD by clicking **Read the license agreement** in the Software Selections program. For more information about the *Software Selections* CD, see Appendix A, "Using the Software Selections CD," on page 105.

Appendix E. Product warranties and notices

This chapter contains warranty and emission notices. It also contains trademarks and general-information notices.

Warranty Statements

The warranty statements consist of two parts: Part 1 and Part 2. Part 1 varies by country. Part 2 is the same for all countries. Be sure to read both the Part 1 that applies to your country and Part 2.

- **United States, Puerto Rico, and Canada (Z125-4753-05 11/97)**
(page 115, Part 1 - General Terms)
- **Worldwide except Canada, Puerto Rico, Turkey, and United States (Z125-5697-01 11/97)**
("Part 1 - General Terms," on page 118)
- **Worldwide Country-Unique Terms**
("Part 2 - Worldwide Country-Unique Terms" on page 120)

IBM Statement of Limited Warranty for United States, Puerto Rico, and Canada (Part 1 - General Terms)

This Statement of Limited Warranty includes Part 1 - General Terms and Part 2 - Country-unique Terms. **The terms of Part 2 may replace or modify those of Part 1.** The warranties provided by IBM in this Statement of Limited Warranty apply only to Machines you purchase for your use, and not for resale, from IBM or your reseller. The term "Machine" means an IBM machine, its features, conversions, upgrades, elements, or accessories, or any combination of them. The term "Machine" does not include any software programs, whether pre-loaded with the Machine, installed subsequently or otherwise. Unless IBM specifies otherwise, the following warranties apply only in the country where you acquire the Machine. Nothing in this Statement of Warranty affects any statutory rights of consumers that cannot be waived or limited by contract. If you have any questions, contact IBM or your reseller.

Machine - IntelliStation E Pro Types 6836 and 6846

Warranty Period* - Parts: Three (3) years Labor: Three (3) years

** Contact your place of purchase for warranty service information. Some IBM Machines are eligible for On-site warranty service depending on the country where service is performed.*

The IBM Warranty for Machines

IBM warrants that each Machine 1) is free from defects in materials and workmanship and 2) conforms to IBM's Official Published Specifications. The warranty period for a Machine is a specified, fixed period commencing on its Date of Installation. The date on your sales receipt is the Date of Installation, unless IBM or your reseller informs you otherwise.

During the warranty period IBM or your reseller, if approved by IBM to provide warranty service, will provide repair and exchange service for the Machine, without charge, under the type of service designated for the Machine and will manage and install engineering changes that apply to the Machine.

If a Machine does not function as warranted during the warranty period, and IBM or your reseller are unable to either 1) make it do so or 2) replace it with one that is at least functionally equivalent, you may return it to your place of purchase and your money will be refunded. The replacement may not be new, but will be in good working order.

Extent of Warranty

The warranty does not cover the repair or exchange of a Machine resulting from misuse, accident, modification, unsuitable physical or operating environment, improper maintenance by you, or failure caused by a product for which IBM is not responsible. The warranty is voided by removal or alteration of Machine or parts identification labels.

THESE WARRANTIES ARE YOUR EXCLUSIVE WARRANTIES AND REPLACE ALL OTHER WARRANTIES OR CONDITIONS, EXPRESS OR IMPLIED, INCLUDING, BUT NOT LIMITED TO, THE IMPLIED WARRANTIES OR CONDITIONS OF MERCHANTABILITY AND FITNESS FOR A PARTICULAR PURPOSE. THESE WARRANTIES GIVE YOU SPECIFIC LEGAL RIGHTS AND YOU MAY ALSO HAVE OTHER RIGHTS WHICH VARY FROM JURISDICTION TO JURISDICTION. SOME JURISDICTIONS DO NOT ALLOW THE EXCLUSION OR LIMITATION OF EXPRESS OR IMPLIED WARRANTIES, SO THE ABOVE EXCLUSION OR LIMITATION MAY NOT APPLY TO YOU. IN THAT EVENT, SUCH WARRANTIES ARE LIMITED IN DURATION TO THE WARRANTY PERIOD. NO WARRANTIES APPLY AFTER THAT PERIOD.

Items Not Covered by Warranty

IBM does not warrant uninterrupted or error-free operation of a Machine.

Unless specified otherwise, IBM provides non-IBM machines **WITHOUT WARRANTIES OF ANY KIND.**

Any technical or other support provided for a Machine under warranty, such as assistance via telephone with "how-to" questions and those regarding Machine set-up and installation, will be provided **WITHOUT WARRANTIES OF ANY KIND.**

Warranty Service

To obtain warranty service for the Machine, contact your reseller or IBM. In the United States, call IBM at 1-800-772-2227. In Canada, call IBM at 1-800-565-3344. (In Toronto, call 416-383-3344.) You may be required to present proof of purchase.

IBM or your reseller provides certain types of repair and exchange service, either at your location or at a service center, to keep Machines in, or restore them to, conformance with their Specifications. IBM or your reseller will inform you of the available types of service for a Machine based on its country of installation. IBM may repair the failing Machine or exchange it at its discretion.

When warranty service involves the exchange of a Machine or part, the item IBM or your reseller replaces becomes its property and the replacement becomes yours. You represent that all removed items are genuine and unaltered. The replacement may not be new, but will be in good working order and at least functionally equivalent to the item replaced. The replacement assumes the warranty service status of the replaced item.

Any feature, conversion, or upgrade IBM or your reseller services must be installed on a Machine which is 1) for certain Machines, the designated, serial-numbered Machine and 2) at an engineering-change level compatible with the feature, conversion, or upgrade. Many features, conversions, or upgrades involve the removal of parts and their return to IBM. A part that replaces a removed part will assume the warranty service status of the removed part.

Before IBM or your reseller exchanges a Machine or part, you agree to remove all features, parts, options, alterations, and attachments not under warranty service.

You also agree to

1. ensure that the Machine is free of any legal obligations or restrictions that prevent its exchange;
2. obtain authorization from the owner to have IBM or your reseller service a Machine that you do not own; and
3. where applicable, before service is provided
 - a. follow the problem determination, problem analysis, and service request procedures that IBM or your reseller provides,
 - b. secure all programs, data, and funds contained in a Machine,
 - c. provide IBM or your reseller with sufficient, free, and safe access to your facilities to permit them to fulfill their obligations, and
 - d. inform IBM or your reseller of changes in a Machine's location.

IBM is responsible for loss of, or damage to, your Machine while it is 1) in IBM's possession or 2) in transit in those cases where IBM is responsible for the transportation charges.

Neither IBM nor your reseller is responsible for any of your confidential, proprietary or personal information contained in a Machine which you return to IBM or your reseller for any reason. You should remove all such information from the Machine prior to its return.

Production Status

Each IBM Machine is manufactured from new parts, or new and used parts. In some cases, the Machine may not be new and may have been previously installed. Regardless of the Machine's production status, IBM's appropriate warranty terms apply.

Limitation of Liability

Circumstances may arise where, because of a default on IBM's part or other liability, you are entitled to recover damages from IBM. In each such instance, regardless of the basis on which you are entitled to claim damages from IBM (including fundamental breach, negligence, misrepresentation, or other contract or tort claim), IBM is liable for no more than

1. damages for bodily injury (including death) and damage to real property and tangible personal property; and
2. the amount of any other actual direct damages, up to the greater of U.S. \$100,000 (or equivalent in local currency) or the charges (if recurring, 12 months' charges apply) for the Machine that is the subject of the claim.

This limit also applies to IBM's suppliers and your reseller. It is the maximum for which IBM, its suppliers, and your reseller are collectively responsible.

UNDER NO CIRCUMSTANCES IS IBM LIABLE FOR ANY OF THE FOLLOWING: 1) THIRD-PARTY CLAIMS AGAINST YOU FOR DAMAGES (OTHER THAN THOSE UNDER THE FIRST ITEM LISTED ABOVE); 2) LOSS OF, OR DAMAGE TO, YOUR RECORDS OR DATA; OR 3) SPECIAL, INCIDENTAL, OR INDIRECT DAMAGES OR FOR ANY ECONOMIC CONSEQUENTIAL DAMAGES (INCLUDING LOST PROFITS OR SAVINGS), EVEN IF IBM, ITS SUPPLIERS OR YOUR RESELLER IS INFORMED OF THEIR POSSIBILITY. SOME JURISDICTIONS DO NOT ALLOW THE EXCLUSION OR LIMITATION OF INCIDENTAL OR CONSEQUENTIAL DAMAGES, SO THE ABOVE LIMITATION OR EXCLUSION MAY NOT APPLY TO YOU.

IBM Statement of Warranty Worldwide except Canada, Puerto Rico, Turkey, United States (Part 1 – General Terms)

This Statement of Warranty includes Part 1 - General Terms and Part 2 - Country-unique Terms. **The terms of Part 2 may replace or modify those of Part 1.** The warranties provided by IBM in this Statement of Warranty apply only to Machines you purchase for your use, and not for resale, from IBM or your reseller. The term "Machine" means an IBM machine, its features, conversions, upgrades, elements, or accessories, or any combination of them. The term "Machine" does not include any software programs, whether pre-loaded with the Machine, installed subsequently or otherwise. Unless IBM specifies otherwise, the following warranties apply only in the country where you acquire the Machine. Nothing in this Statement of Warranty affects any statutory rights of consumers that cannot be waived or limited by contract. If you have any questions, contact IBM or your reseller.

Machine - IntelliStation E Pro Types 6936 and 6846

Warranty Period* - Parts: Three (3) years Labor: (3) years

** Contact your place of purchase for warranty service information. Some IBM Machines are eligible for On-site warranty service depending on the country where service is performed.*

The IBM Warranty for Machines

IBM warrants that each Machine 1) is free from defects in materials and workmanship and 2) conforms to IBM's Official Published Specifications. The warranty period for a Machine is a specified, fixed period commencing on its Date of Installation. The date on your sales receipt is the Date of Installation, unless IBM or your reseller informs you otherwise.

During the warranty period IBM or your reseller, if approved by IBM to provide warranty service, will provide repair and exchange service for the Machine, without charge, under the type of service designated for the Machine and will manage and install engineering changes that apply to the Machine.

If a Machine does not function as warranted during the warranty period, and IBM or your reseller are unable to either 1) make it do so or 2) replace it with one that is at least functionally equivalent, you may return it to your place of purchase and your money will be refunded. The replacement may not be new, but will be in good working order.

Extent of Warranty

The warranty does not cover the repair or exchange of a Machine resulting from misuse, accident, modification, unsuitable physical or operating environment, improper maintenance by you, or failure caused by a product for which IBM is not responsible. The warranty is voided by removal or alteration of Machine or parts identification labels.

THESE WARRANTIES ARE YOUR EXCLUSIVE WARRANTIES AND REPLACE ALL OTHER WARRANTIES OR CONDITIONS, EXPRESS OR IMPLIED, INCLUDING, BUT NOT LIMITED TO, THE IMPLIED WARRANTIES OR CONDITIONS OF MERCHANTABILITY AND FITNESS FOR A PARTICULAR PURPOSE. THESE WARRANTIES GIVE YOU SPECIFIC LEGAL RIGHTS AND YOU MAY ALSO HAVE OTHER RIGHTS WHICH VARY FROM JURISDICTION TO JURISDICTION. SOME JURISDICTIONS DO NOT ALLOW THE EXCLUSION OR LIMITATION OF EXPRESS OR IMPLIED WARRANTIES, SO THE ABOVE EXCLUSION OR LIMITATION MAY NOT APPLY TO YOU. IN THAT EVENT, SUCH WARRANTIES ARE LIMITED IN DURATION TO THE WARRANTY PERIOD. NO WARRANTIES APPLY AFTER THAT PERIOD.

Items Not Covered by Warranty

IBM does not warrant uninterrupted or error-free operation of a Machine.

Unless specified otherwise, IBM provides non-IBM machines **WITHOUT WARRANTIES OF ANY KIND.**

Any technical or other support provided for a Machine under warranty, such as assistance via telephone with "how-to" questions and those regarding Machine set-up and installation, will be provided **WITHOUT WARRANTIES OF ANY KIND.**

Warranty Service

To obtain warranty service for the Machine, contact your reseller or IBM. You may be required to present proof of purchase.

IBM or your reseller provides certain types of repair and exchange service, either at your location or at a service center, to keep Machines in, or restore them to, conformance with their Specifications. IBM or your reseller will inform you of the available types of service for a Machine based on its country of installation. IBM may repair the failing Machine or exchange it at its discretion.

When warranty service involves the exchange of a Machine or part, the item IBM or your reseller replaces becomes its property and the replacement becomes yours. You represent that all removed items are genuine and unaltered. The replacement may not be new, but will be in good working order and at least functionally equivalent to the item replaced. The replacement assumes the warranty service status of the replaced item.

Any feature, conversion, or upgrade IBM or your reseller services must be installed on a Machine which is 1) for certain Machines, the designated, serial-numbered Machine and 2) at an engineering-change level compatible with the feature, conversion, or upgrade. Many features, conversions, or upgrades involve the removal of parts and their return to IBM. A part that replaces a removed part will assume the warranty service status of the removed part.

Before IBM or your reseller exchanges a Machine or part, you agree to remove all features, parts, options, alterations, and attachments not under warranty service.

You also agree to

1. ensure that the Machine is free of any legal obligations or restrictions that prevent its exchange;
2. obtain authorization from the owner to have IBM or your reseller service a Machine that you do not own; and
3. where applicable, before service is provided
 - a. follow the problem determination, problem analysis, and service request procedures that IBM or your reseller provides,
 - b. secure all programs, data, and funds contained in a Machine,
 - c. provide IBM or your reseller with sufficient, free, and safe access to your facilities to permit them to fulfill their obligations, and
 - d. inform IBM or your reseller of changes in a Machine's location.

IBM is responsible for loss of, or damage to, your Machine while it is 1) in IBM's possession or 2) in transit in those cases where IBM is responsible for the transportation charges.

Neither IBM nor your reseller is responsible for any of your confidential, proprietary or personal information contained in a Machine which you return to IBM or your reseller

for any reason. You should remove all such information from the Machine prior to its return.

Production Status

Each IBM Machine is manufactured from new parts, or new and used parts. In some cases, the Machine may not be new and may have been previously installed. Regardless of the Machine's production status, IBM's appropriate warranty terms apply.

Limitation of Liability

Circumstances may arise where, because of a default on IBM's part or other liability, you are entitled to recover damages from IBM. In each such instance, regardless of the basis on which you are entitled to claim damages from IBM (including fundamental breach, negligence, misrepresentation, or other contract or tort claim), IBM is liable for no more than

1. damages for bodily injury (including death) and damage to real property and tangible personal property; and
2. the amount of any other actual direct damages, up to the greater of U.S. \$100,000 (or equivalent in local currency) or the charges (if recurring, 12 months' charges apply) for the Machine that is the subject of the claim.

This limit also applies to IBM's suppliers and your reseller. It is the maximum for which IBM, its suppliers, and your reseller are collectively responsible.

UNDER NO CIRCUMSTANCES IS IBM LIABLE FOR ANY OF THE FOLLOWING: 1) THIRD-PARTY CLAIMS AGAINST YOU FOR DAMAGES (OTHER THAN THOSE UNDER THE FIRST ITEM LISTED ABOVE); 2) LOSS OF, OR DAMAGE TO, YOUR RECORDS OR DATA; OR 3) SPECIAL, INCIDENTAL, OR INDIRECT DAMAGES OR FOR ANY ECONOMIC CONSEQUENTIAL DAMAGES (INCLUDING LOST PROFITS OR SAVINGS), EVEN IF IBM, ITS SUPPLIERS OR YOUR RESELLER IS INFORMED OF THEIR POSSIBILITY. SOME JURISDICTIONS DO NOT ALLOW THE EXCLUSION OR LIMITATION OF INCIDENTAL OR CONSEQUENTIAL DAMAGES, SO THE ABOVE LIMITATION OR EXCLUSION MAY NOT APPLY TO YOU.

Part 2 - Worldwide Country-Unique Terms

ASIA PACIFIC

AUSTRALIA: The IBM Warranty for Machines: The following paragraph is added to this Section:

The warranties specified in this Section are in addition to any rights you may have under the Trade Practices Act 1974 or other legislation and are only limited to the extent permitted by the applicable legislation.

Extent of Warranty: The following replaces the first and second sentences of this Section:

The warranty does not cover the repair or exchange of a Machine resulting from misuse, accident, modification, unsuitable physical or operating environment, operation in other than the Specified Operating Environment, improper maintenance by you, or failure caused by a product for which IBM is not responsible.

Limitation of Liability: The following is added to this Section:

Where IBM is in breach of a condition or warranty implied by the Trade Practices Act 1974, IBM's liability is limited to the repair or replacement of the goods or the supply of equivalent goods. Where that condition or warranty relates to right to sell, quiet possession or clear title, or the goods are of a kind ordinarily acquired for personal, domestic or household use or consumption, then none of the limitations in this paragraph apply.

PEOPLE'S REPUBLIC OF CHINA: Governing Law: The following is added to this Statement:

The laws of the State of New York govern this Statement.

INDIA: Limitation of Liability: The following replaces items 1 and 2 of this Section:

1. liability for bodily injury (including death) or damage to real property and tangible personal property will be limited to that caused by IBM's negligence;
2. as to any other actual damage arising in any situation involving nonperformance by IBM pursuant to, or in any way related to the subject of this Statement of Warranty, IBM's liability will be limited to the charge paid by you for the individual Machine that is the subject of the claim.

NEW ZEALAND: The IBM Warranty for Machines: The following paragraph is added to this Section:

The warranties specified in this Section are in addition to any rights you may have under the Consumer Guarantees Act 1993 or other legislation which cannot be excluded or limited. The Consumer Guarantees Act 1993 will not apply in respect of any goods which IBM provides, if you require the goods for the purposes of a business as defined in that Act.

Limitation of Liability: The following is added to this Section:

Where Machines are not acquired for the purposes of a business as defined in the Consumer Guarantees Act 1993, the limitations in this Section are subject to the limitations in that Act.

EUROPE, MIDDLE EAST, AFRICA (EMEA)

The following terms apply to all EMEA countries.

The terms of this Statement of Warranty apply to Machines purchased from an IBM reseller. If you purchased this Machine from IBM, the terms and conditions of the applicable IBM agreement prevail over this warranty statement.

Warranty Service

If you purchased an IBM Machine in Austria, Belgium, Denmark, Estonia, Finland, France, Germany, Greece, Iceland, Ireland, Italy, Latvia, Lithuania, Luxembourg, Netherlands, Norway, Portugal, Spain, Sweden, Switzerland or United Kingdom, you may obtain warranty service for that Machine in any of those countries from either (1) an IBM reseller approved to perform warranty service or (2) from IBM.

If you purchased an IBM Personal Computer Machine in Albania, Armenia, Belarus, Bosnia and Herzegovina, Bulgaria, Croatia, Czech Republic, Georgia, Hungary, Kazakhstan, Kirghizia, Federal Republic of Yugoslavia, Former Yugoslav Republic of Macedonia (FYROM), Moldova, Poland, Romania, Russia, Slovak Republic, Slovenia, or Ukraine, you may obtain warranty service for that Machine in any of those countries from either (1) an IBM reseller approved to perform warranty service or (2) from IBM.

The applicable laws, Country-unique terms and competent court for this Statement are those of the country in which the warranty service is being provided. However, the laws of Austria govern this Statement if the warranty service is provided in Albania, Armenia, Belarus, Bosnia and Herzegovina, Bulgaria, Croatia, Czech Republic, Federal Republic of Yugoslavia, Georgia, Hungary, Kazakhstan, Kirghizia, Former Yugoslav Republic of Macedonia (FYROM), Moldova, Poland, Romania, Russia, Slovak Republic, Slovenia, and Ukraine.

The following terms apply to the country specified:

EGYPT: Limitation of Liability: The following replaces item 2 in this Section:
2. as to any other actual direct damages, IBM's liability will be limited to the total amount you paid for the Machine that is the subject of the claim.

Applicability of suppliers and resellers (unchanged).

FRANCE: Limitation of Liability: The following replaces the second sentence of the first paragraph of this Section:

In such instances, regardless of the basis on which you are entitled to claim damages from IBM, IBM is liable for no more than: (items 1 and 2 unchanged).

GERMANY: The IBM Warranty for Machines: The following replaces the first sentence of the first paragraph of this Section:

The warranty for an IBM Machine covers the functionality of the Machine for its normal use and the Machine's conformity to its Specifications.

The following paragraphs are added to this Section:

The minimum warranty period for Machines is six months.

In case IBM or your reseller are unable to repair an IBM Machine, you can alternatively ask for a partial refund as far as justified by the reduced value of the unrepaired Machine or ask for a cancellation of the respective agreement for such Machine and get your money refunded.

Extent of Warranty: The second paragraph does not apply.

Warranty Service: The following is added to this Section:

During the warranty period, transportation for delivery of the failing Machine to IBM will be at IBM's expense.

Production Status: The following paragraph replaces this Section:

Each Machine is newly manufactured. It may incorporate in addition to new parts, re-used parts as well.

Limitation of Liability: The following is added to this Section:

The limitations and exclusions specified in the Statement of Warranty will not apply to damages caused by IBM with fraud or gross negligence and for express warranty.

In item 2, replace "U.S. \$100,000" with "1.000.000 DEM."

The following sentence is added to the end of the first paragraph of item 2:

IBM's liability under this item is limited to the violation of essential contractual terms in cases of ordinary negligence.

IRELAND: Extent of Warranty: The following is added to this Section:

Except as expressly provided in these terms and conditions, all statutory conditions, including all warranties implied, but without prejudice to the generality of the foregoing all warranties implied by the Sale of Goods Act 1893 or the Sale of Goods and Supply of Services Act 1980 are hereby excluded.

Limitation of Liability: The following replaces items one and two of the first paragraph of this Section:

1. death or personal injury or physical damage to your real property solely caused by IBM's negligence; and 2. the amount of any other actual direct damages, up to the greater of Irish Pounds 75,000 or 125 percent of the charges (if recurring, the 12 months' charges apply) for the Machine that is the subject of the claim or which otherwise gives rise to the claim.

Applicability of suppliers and resellers (unchanged).

The following paragraph is added at the end of this Section:

IBM's entire liability and your sole remedy, whether in contract or in tort, in respect of any default shall be limited to damages.

ITALY: Limitation of Liability: The following replaces the second sentence in the first paragraph:

In each such instance unless otherwise provided by mandatory law, IBM is liable for no more than: (item 1 unchanged) 2) as to any other actual damage arising in all situations involving non-performance by IBM pursuant to, or in any way related to the subject matter of this Statement of Warranty, IBM's liability, will be limited to the total amount you paid for the Machine that is the subject of the claim.

Applicability of suppliers and resellers (unchanged).

The following replaces the second paragraph of this Section:

Unless otherwise provided by mandatory law, IBM and your reseller are not liable for any of the following: (items 1 and 2 unchanged) 3) indirect damages, even if IBM or your reseller is informed of their possibility.

SOUTH AFRICA, NAMIBIA, BOTSWANA, LESOTHO AND SWAZILAND:

Limitation of Liability: The following is added to this Section:

IBM's entire liability to you for actual damages arising in all situations involving nonperformance by IBM in respect of the subject matter of this Statement of Warranty will be limited to the charge paid by you for the individual Machine that is the subject of your claim from IBM.

TURKIYE: Production Status: The following replaces this Section:

IBM fulfills customer orders for IBM Machines as newly manufactured in accordance with IBM's production standards.

UNITED KINGDOM: Limitation of Liability: The following replaces items 1 and 2 of the first paragraph of this Section:

1. death or personal injury or physical damage to your real property solely caused by IBM's negligence; 2. the amount of any other actual direct damages or loss, up to the greater of Pounds Sterling 150,000 or 125 percent of the charges (if recurring, the 12 months' charges apply) for the Machine that is the subject of the claim or which otherwise gives rise to the claim.

The following item is added to this paragraph:

3. breach of IBM's obligations implied by Section 12 of the Sale of Goods Act 1979 or Section 2 of the Supply of Goods and Services Act 1982.

Applicability of suppliers and resellers (unchanged).

The following is added to the end of this Section:

IBM's entire liability and your sole remedy, whether in contract or in tort, in respect of any default will be limited to damages.

NORTH AMERICA

CANADA: Warranty Service: The following is added to this section:

To obtain warranty service from IBM, call **1-800-565-3344**. In Toronto, call **416-383-3344**.

UNITED STATES OF AMERICA: Warranty Service: The following is added to this section:

To obtain warranty service from IBM, call **1-800-772-2227**.

Notices

This section contains trademarks, electronic emission notices, and other important information.

This publication was developed for products and services offered in the U.S.A.

IBM may not offer the products, services, or features discussed in this document in other countries. Consult your local IBM representative for information on the products and services currently available in your area. Any reference to an IBM product, program, or service is not intended to state or imply that only that IBM product, program, or service may be used. Any functionally equivalent product, program, or service that does not infringe any IBM intellectual property right may be used instead. However, it is the user's responsibility to evaluate and verify the operation of any non-IBM product, program, or service.

IBM may have patents or pending patent applications covering subject matter described in this document. The furnishing of this document does not give you any license to these patents. You can send license inquiries, in writing, to:

*IBM Director of Licensing
IBM Corporation
North Castle Drive
Armonk, NY 10504-1785
U.S.A.*

Edition notice

INTERNATIONAL BUSINESS MACHINES CORPORATION PROVIDES THIS PUBLICATION "AS IS" WITHOUT WARRANTY OF ANY KIND, EITHER EXPRESS OR IMPLIED, INCLUDING, BUT NOT LIMITED TO, THE IMPLIED WARRANTIES OF NON-INFRINGEMENT, MERCHANTABILITY OR FITNESS FOR A PARTICULAR PURPOSE. Some states do not allow disclaimer of express or implied warranties in certain transactions, therefore, this statement may not apply to you.

This information could include technical inaccuracies or typographical errors. Changes are periodically made to the information herein; these changes will be incorporated in new editions of the publication. IBM may make improvements and/or changes in the product(s) and/or the program(s) described in this publication at any time without notice.

Any references in this publication to non-IBM Web sites are provided for convenience only and do not in any manner serve as an endorsement of those Web sites. The materials at those Web sites are not part of the materials for this IBM product, and use of those Web sites is at your own risk.

IBM may use or distribute any of the information you supply in any way it believes appropriate without incurring any obligation to you.

**© COPYRIGHT INTERNATIONAL BUSINESS MACHINES CORPORATION, 2000.
All rights reserved.**

Note to U.S. Government Users — Documentation related to restricted rights — Use, duplication or disclosure is subject to restrictions set forth in GSA ADP Schedule Contract with IBM Corp.

Processing date data

This IBM hardware product and IBM software products that might be packaged with it have been designed, when used in accordance with their associated documentation, to process date data correctly within and between the 20th and 21st centuries, provided all other products (for example, software, hardware, and firmware) used with these products properly exchange accurate date data with them.

IBM cannot take responsibility for the date data processing capabilities of non-IBM products, even if those products are preinstalled or otherwise distributed by IBM. You should contact the vendors responsible for those products directly to determine the capabilities of their products and update them if needed. This IBM hardware product cannot prevent errors that might occur if software, upgrades, or peripheral devices you use or exchange data with do not process date data correctly.

The foregoing is a Year 2000 Readiness Disclosure.

Trademarks

The following terms are trademarks of the IBM Corporation in the United States, other countries, or both:

HelpCenter	SmartSuite
IBM	ServeRAID
IntelliStation	Update Connector
LANClient Control Manager	Wake on Lan
ScrollPoint	

Lotus and Domino are trademarks of Lotus Development Corporation in the United States, other countries, or both.

Tivoli and NetView are trademarks of Tivoli Systems Inc. in the United States, other countries, or both.

Intel, MMX, LANDesk, Pentium, Pentium II Xeon, and Pentium III Xeon are trademarks or registered trademarks of Intel Corporation in the United States, other countries, or both.

Microsoft, Windows, and Windows NT are trademarks or registered trademarks of Microsoft Corporation.

UNIX is a registered trademark of The Open Group in the United States and other countries.

Java and all Java-based trademarks and logos are trademarks or registered trademarks of Sun Microsystems, Inc. in the United States, other countries, or both.

Other company, product, and service names may be trademarks or service marks of others.

Important notes

Processor speeds indicate the internal clock speed of the microprocessor; other factors also affect application performance.

When referring to hard disk drive capacity, MB stands for 1 000 000 bytes and GB stands for 1 000 000 000 bytes. Total user-accessible capacity may vary depending on operating environments.

Maximum internal hard disk drive capacities assume the replacement of any standard hard disk drives and population of all hard disk drive bays with the largest currently supported drives available from IBM.

Unless otherwise stated, IBM makes no representations or warranties with respect to non-IBM products. Support (if any) for the non-IBM products is provided by the third party, not IBM.

Some software may differ from its retail version (if available), and may not include user manuals or all program functionality.

Electronic emission notices

Federal Communications Commission (FCC) Statement

Note: This equipment has been tested and found to comply with the limits for a Class A digital device, pursuant to Part 15 of the FCC Rules. These limits are designed to provide reasonable protection against harmful interference when the equipment is operated in a commercial environment. This equipment generates, uses, and can radiate radio frequency energy and, if not installed and used in accordance with the instruction manual, may cause harmful interference to radio communications. Operation of this equipment in a residential area is likely to cause harmful interference, in which case the user will be required to correct the interference at his own expense.

Properly shielded and grounded cables and connectors must be used in order to meet FCC emission limits. IBM is not responsible for any radio or television interference caused by using other than recommended cables and connectors or by unauthorized changes or modifications to this equipment. Unauthorized changes or modifications could void the user's authority to operate the equipment.

This device complies with Part 15 of the FCC Rules. Operation is subject to the following two conditions: (1) this device may not cause harmful interference, and (2) this device must accept any interference received, including interference that may cause undesired operation.

Industry Canada Class A emission compliance statement

This Class A digital apparatus complies with Canadian ICES-003.

Avis de conformité à la réglementation d'Industrie Canada

Cet appareil numérique de classe A est conforme à la norme NMB-003 du Canada.

Australia and New Zealand Class A statement

Attention: This is a Class A product. In a domestic environment this product may cause radio interference in which case the user may be required to take adequate measures.

United Kingdom telecommunications safety requirement

Notice to Customers

This apparatus is approved under approval number NS/G/1234/J/100003 for indirect connection to public telecommunication systems in the United Kingdom.

European Union EMC Directive conformance statement

This product is in conformity with the protection requirements of EU Council Directive 89/336/EEC on the approximation of the laws of the Member States relating to electromagnetic compatibility. IBM cannot accept responsibility for any failure to satisfy the protection requirements resulting from a nonrecommended modification of the product, including the fitting of non-IBM option cards.

This product has been tested and found to comply with the limits for Class A Information Technology Equipment according to CISPR 22/European Standard EN 55022. The Limits for Class A equipment were derived for commercial and industrial environments to provide reasonable protection against interference with licensed communication equipment.

Attention: This is a Class A product. In a domestic environment this product may cause radio interference in which case the user may be required to take adequate measures.

Taiwan electrical emission statement

警告使用者：
這是甲類的資訊產品，在
居住的環境中使用時，可
能會造成射頻干擾，在這
種情況下，使用者會被要
求採取某些適當的對策。

Japanese Voluntary Control Council for Interference (VCCI) statement

この装置は、情報処理装置等電波障害自主規制協議会（VCCI）の基準に基づきクラスA情報技術装置です。この装置を家庭環境で使用すると電波妨害を引き起こすことがあります。この場合には使用者が適切な対策を講ずるよう要求されることがあります。

Power cords

For your safety, IBM provides a power cord with a grounded attachment plug to use with this IBM product. To avoid electrical shock, always use the power cord and plug with a properly grounded outlet.

IBM power cords used in the United States and Canada are listed by Underwriter's Laboratories (UL) and certified by the Canadian Standards Association (CSA).

For units intended to be operated at 115 volts: Use a UL-listed and CSA-certified cord set consisting of a minimum 18 AWG, Type SVT or SJT, three-conductor cord, a maximum of 15 feet in length and a parallel blade, grounding-type attachment plug rated 15 amperes, 125 volts.

For units intended to be operated at 230 volts (U.S. use): Use a UL-listed and CSA-certified cord set consisting of a minimum 18 AWG, Type SVT or SJT, three-conductor cord, a maximum of 15 feet in length and a tandem blade, grounding-type attachment plug rated 15 amperes, 250 volts.

For units intended to be operated at 230 volts (outside the U.S.): Use a cord set with a grounding-type attachment plug. The cord set should have the appropriate safety approvals for the country in which the equipment will be installed.

IBM power cords for a specific country or region are usually available only in that country or region.

IBM power cord part number	Used in these countries and regions
13F9940	Argentina, Australia, China (PRC), New Zealand, Papua New Guinea, Paraguay, Uruguay, Western Samoa
13F9979	Afghanistan, Algeria, Andorra, Angola, Austria, Belgium, Benin, Bulgaria, Burkina Faso, Burundi, Cameroon, Central African Rep., Chad, China (Macau S.A.R.), Czech Republic, Egypt, Finland, France, French Guiana, Germany, Greece, Guinea, Hungary, Iceland, Indonesia, Iran, Ivory Coast, Jordan, Lebanon, Luxembourg, Malagasy, Mali, Martinique, Mauritania, Mauritius, Monaco, Morocco, Mozambique, Netherlands, New Caledonia, Niger, Norway, Poland, Portugal, Romania, Senegal, Slovakia, Spain, Sudan, Sweden, Syria, Togo, Tunisia, Turkey, former USSR, Vietnam, former Yugoslavia, Zaire, Zimbabwe
13F9997	Denmark
14F0015	Bangladesh, Burma, Pakistan, South Africa, Sri Lanka
14F0033	Antigua, Bahrain, Brunei, Channel Islands, China (Hong Kong S.A.R.), Cyprus, Dubai, Fiji, Ghana, India, Iraq, Ireland, Kenya, Kuwait, Malawi, Malaysia, Malta, Nepal, Nigeria, Polynesia, Qatar, Sierra Leone, Singapore, Tanzania, Uganda, United Kingdom, Yemen, Zambia
14F0051	Liechtenstein, Switzerland
14F0069	Chile, Ethiopia, Italy, Libya, Somalia
14F0087	Israel
1838574	Thailand
62X1045	Bahamas, Barbados, Bermuda, Bolivia, Brazil, Canada, Cayman Islands, Colombia, Costa Rica, Dominican Republic, Ecuador, El Salvador, Guatemala, Guyana, Haiti, Honduras, Jamaica, Japan, Korea (South), Liberia, Mexico, Netherlands Antilles, Nicaragua, Panama, Peru, Philippines, Saudi Arabia, Suriname, Taiwan, Trinidad (West Indies), United States of America, Venezuela

Index

A

- acoustical noise emissions 2, 3
- adapter
 - boot option 44, 57
 - considerations 43, 57
 - installing 44, 58
 - PCI 43, 56
 - PCI bus 43, 57
- adapters
 - full length 43, 57
- advanced configuration options 27
- advanced setup 24
- audio
 - connectors 18
 - controller 18
 - features 18

B

- battery replacement 98
- bay
 - drive 47, 60
 - filler panel 48
- bays 1, 2, 3, or 4 48, 61
- bays 5, 6, or 7 50
- beep codes
 - POST 74
- bidirectional
 - parallel port configuration 68
- BIOS
 - restoring 94

C

- cables
 - connecting 10
 - length 10
 - USB 70
- cabling
 - Ethernet 69
 - SCSI device 49, 51, 62
 - SCSI requirements 71
- cache control 24, 25
- CD-ROM drive 2, 3
 - activity light 7
 - eject button 7
 - installing 46, 60
- CD-ROM problems 84
- channels
 - SCSI 72
- Class A electronic emission notice 126
- components, hardware 29
- computer
 - cleaning 107
 - moving 109

- shutting down 21
- taking care 107
- Configuration/Setup Utility 23
 - main menu 23
- configure host adapter settings 26
- configuring
 - Ethernet 69
- configuring your server 23
- connector
 - USB 70
- connectors
 - external 67
 - input/output 67
- controls and indicators 7
- cooling 34
- core chipset control 25
- cover
 - installing 54, 65
 - removing 41, 55

D

- data protection
 - virus protection 21
- data rate
 - Ethernet 70
- date and time 24
- depth 2, 3
- Desktop Management Interface 20
- diagnostic
 - error code format 75
 - error message tables 78
 - programs and error messages 75
 - programs, starting 76
 - test log, viewing 77, 78
 - text messages 76
- diagnostic tools 73
- DIMM 51, 63
 - installing 52, 63
 - retaining clips 53, 64
- DIMM connector
 - locations 52, 63
- diskette
 - eject button 7
- diskette drive 2, 3
 - activity light 7
 - installing 46, 60
 - problem 84
- display
 - problem 85
- drive
 - bay filler panel 48
 - preinstallation 48, 61
- drives
 - installing 46, 60
- drives, standard 2, 3
- Dynamic Host Configuration Protocol 19

E

- electrical input 2, 3
- electronic emission Class A notice 126
- environment
 - air temperature 2, 3
 - humidity 2, 3
- error
 - diagnostic code format 75
- error messages
 - diagnostic 75, 78
 - SCSI 74
- Ethernet
 - cabling 69
 - configuring 69
 - error messages 90
 - IntraNetWare error messages 90
 - NetWare error messages 90
 - troubleshooting information 88
 - Windows NT error messages 91
- Ethernet controller 6
- Ethernet port 69
- expansion bays 2, 3
 - location 47, 60
 - type 47, 60
- expansion enclosure
 - problem 84
- expansion slots 2, 3
- external options
 - connecting 66
- external port connectors 32

F

- FCC Class A notice 126
- filler panel 48

H

- hard disk drive
 - installing 46, 60
 - light 8
- hardware
 - problems 73
- hardware, major 29
- heat output 2, 3
- height 2, 3
- host adapter settings, configure 26

I

- I/O ports 67
- IDs
 - setting SCSI 72
- important notes 125
- input/output connectors 67
- installing
 - adapters 44, 58

- battery 98
- internal drives 46, 60
- memory modules 51, 63
- options 29
- integrated
 - Ethernet 69
 - SCSI 71
- integrated functions 2, 3
- internal cable connectors 32
- internal drives
 - installing 46, 60
- introduction 1

J

- jumpers and switches 33

K

- keyboard
 - problem 84
 - speed 24
- keyboard port 68

L

- LANClient Control Manager (LCCM) 20
- Lights See LEDs 7
- local area network
 - Ethernet 69

M

- maximum sync transfer rate 26
- memory
 - configuration changes 52, 64
 - problem 85
 - settings 25
 - specifications 2, 3
- memory module
 - installing 51, 63
 - order of installation 51, 63
 - specifications 2, 3, 6
 - supported 51, 63
- messages
 - diagnostic error 75, 78
 - diagnostic text 76
 - Ethernet controller 90
 - SCSI error 74
- microprocessor
 - cache 25
 - problem 85
- model number 1
- monitor
 - problem 85
- mouse
 - cleaning 107

problem 85

N

network connection

problems 88

networks 69

notices

electronic emission, Class A 126

FCC, Class A 126

miscellaneous 125

product 126

trademarks 125

number

model 1

serial 1

O

option

problem 86

options

installing 29

P

parallel port 68

pin-number assignments 69

problem 86

parity checking, SCSI 26

password

forgotten power-on 25

PCI

adapters 43, 56

bus B 43, 57

expansion slots 43, 57

PCI configuration 24

pin-number assignments

parallel port 69

pointing device

problem 85

ports

Ethernet 69

input/output 67

keyboard 68

universal serial bus (USB) 70

POST

beep codes 74

POST (power-on self-test) 74

power

problem 87

power control button 8

power cords 127

power supply

specifications 2, 3

power-on light 8

printer

problem 87

problem

CD-ROM 84

diskette drive 84

hardware 73

intermittent 84

keyboard or mouse 84

memory 85

microprocessor 85

monitor 85

network connection 88

option 86

parallel port 86

power 87

printer 87

serial port 87

software 88

USB port 88

problem solving 73

processor serial number access 25

product

notices 126

R

recovering

BIOS 94

device drivers 96

operating system 96

reliability, system 34

Remote Administration 20

Remote Program Load 19

removable media drives

installing 46, 60

removing

side cover 41, 55

support bracket 42

retaining clips

DIMM 53, 64

S

safety information

book vii, 35

electrical ix, 37

laser xi, 38

lifting xiii, 39, 109

safety requirements

electronic emission Class A notice 126

FCC Class A notice 126

SCSI

adapter boot option 43, 57

cabling requirements 71

device 49, 62

disk utilities 27

error messages 74

setting IDs 72

SCSI device configuration 26

SCSI parity checking 26

SCSI port 71

SCSISelect

boot device options 26

- menu 26
- parity checking 26
- starting 26
- SCSISelect Utility 23, 26
- security
 - anti-intrusion 20
 - chassis-intrusion detector 20
 - component protection 21
 - data protection 21
 - features 20
 - virus protection 21
- serial number 1
- serial port
 - problem 87
- serial ports 69
- service summary 100
- setup
 - advanced 24
- side cover
 - removing 41, 55
- size, server 2, 3
- software
 - problem 88
 - system management 19
- start options 24
- startup sequence 24
- static-sensitive devices, handling 34
- support bracket
 - removing 42
- switches and jumpers 33
- system board
 - connectors
 - internal cables 32
 - options 31
 - external port connectors 32
 - switches and jumpers 33
- system management
 - Desktop Management Interface 20
 - Dynamic Host Configuration Protocol 19
 - LANClient Control Manager (LCCM) 20
 - Remote Administration 20
 - Remote Program Load 19
 - software 19
 - System Migration Assistant (SMA) 20
 - Wake on LAN 19
- System Migration Assistant (SMA) 20
- system reliability 34
- system summary 24

T

- tape drive
 - installing 46, 60
- temperature
 - air 2, 3
- test log
 - viewing diagnostic 77, 78
- time and date 24
- trademarks 125
- troubleshooting 73
 - Ethernet 88

troubleshooting charts 83

U

- United States electronic emission Class A notice 126
- United States FCC Class A notice 126
- universal serial bus ports 70
- USB port
 - problem 88
- USB ports 70
- utility
 - Configuration/Setup 23
 - SCSI disk 27
 - SCSISelect 26

V

- video
 - controller 17
 - features 17
 - modes 17
 - monitor settings 18
- video controller
 - specifications 2, 3
- virus detection test 24

W

- Wake on LAN 19
- Web site
 - compatible options 51, 63
- weight 2, 3
- width 2, 3



Part Number: 06P4566

Printed in the United States of America.

06P4566

