

IBM™ T120 Monitor



T120

User's Guide

English

First Edition (October/2005)

@ Copyright International Business Machines Corporation 2005. All rights reserved. US Government Users Restricted Rights – Use, duplication or disclosure restricted by GSA ADP Schedule Contract with IBM Corp.

Note: For important information, refer to the Monitor Safety and Warranty manual that comes with this monitor.

Contents

Safety (Read first)	2
Setting up the monitor	3
Product Description.....	3
Handling Instructions.....	3
Workplace Preparation.....	4
Adjusting the Monitor Position.....	4
Working Practices	4
Caring for your Monitor	5
Connecting your Monitor for Analog.....	6
Connecting your Monitor for Digital.....	7
Switching on your Monitor.....	8
Device Driver Installation	9
Windows 2003/Me.....	9
Windows XP	10
Auto Setup	11
Auto Setup	11
Auto Setup for DOS	12
Auto Setup for Windows 2003, Windows Me or Windows XP	13
Manual Setup	14
Adjusting Your LCD Monitor	15
User controls	15
On-screen display (OSD) controls	17
General Information	19
Display modes.....	19
Power Management.....	21
Product Disposal.....	21
Troubleshooting	22
Further Help	25
Specifications	25
Product recycling and disposal	26



Safety: Read first

Before installing this product, read the Safety Information.

Avant d'installer ce produit, lisez les consignes de sécurité.

Vor der Installation dieses Produkts die Sicherheitshinweise lesen.

Πριν εγκαταστήσετε το προϊόν αυτό, διαβάστε τις πληροφορίες ασφαλείας (safety information).

לפני יצירתו מוצר זה, קראו את הודאות הבטיחות.

A termék telepítése előtt olvassa el a Biztonsági előírásokat!

Prima di installare questo prodotto, leggere le Informazioni sulla Sicurezza

Antes de instalar este produto, leia as Informações de Segurança.

Läs säkerhetsinformationen innan du installerar den här produkten.

Prije instalacije ovog produkta obavezno pročitajte Sigurnosne Upute.

Les sikkerhetsinformasjonen (Safety Information) før du installerer dette produktet.

Przed zainstalowaniem tego produktu, należy zapoznać się z książką "Informacje dotyczące bezpieczeństwa" (Safety Information).

Пред да се инсталира овој продукт, прочитајте информацијата за безбедност.

Před inštaláciou tohto zariadenia si prečítajte Bezpečnostné predpisy.

Pred namestitvijo tega proizvoda preberite Varnostne informacije.

Ennen kuin asennat tämän tuotteen, lue turvaohjeet kohdasta Safety Information.

Před instalací tohoto produktu si přečtěte příručku bezpečnostních instrukcí.

在安裝本產品之前，請仔細閱讀 Safety Information (安全信息)。

安裝本產品之前，請先閱讀「安全資訊」。

مع، يجب قراءة دات السلامة

Les sikkerhedsforskrifterne, før du installerer dette produkt.

製品を設置する前に、安全情報をお読みください。

본 제품을 설치하기 전에 안전 정보를 읽으십시오.

Antes de instalar este producto lea la información de seguridad.

Antes de instalar este produto, leia as Informações de Segurança.

Перед установкой продукта прочтите инструкции по технике безопасности.

Lees voordat u dit product installeert eerst de veiligheidsvoorschriften.

Setting up the monitor

Product Description

The IBM TFT LCD T120 Monitor works with a computer with a suitable on-board sub-system or Video Adapter card that can support UXGA 1600 x 1200, SXGA 1280 x 1024, XGA 1024 x 768, SVGA 800 x 600, or VGA 640 x 480 at 60 Hz.

The product package should include the following items:

- *User's Guide and Installation Files CD*
- *Monitor Safety and Warranty Guide*
- *Quick Installation Guide*
- *Power Cord For Model 4945-20U*
- *IBM T120 Monitor*
- *Analog & Digital Interface Cables*

Handling Instructions

Do not support the monitor within the screen area. The Liquid Crystal Display is glass and can be damaged by rough handling or excessive pressure.

1. Lift the monitor by placing your hands where indicated below.

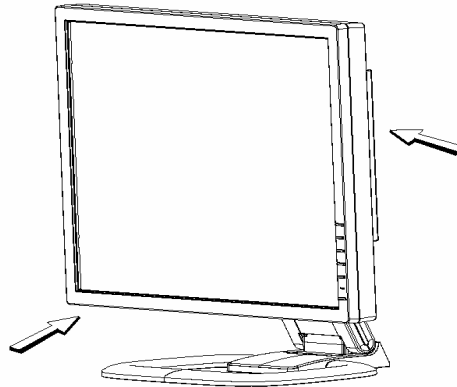

2. Before using your monitor for the first time, remove the clear protective film from the front of the screen.

Workplace Preparation



This section gives advice on what you should consider before you set up your monitor.

Height

Position the monitor so that the top of the screen is slightly below your eye level when you sit at your workstation.

Orientation

Choose a position that gives the least reflection from lights and windows, usually at a right angle to any windows. Position the monitor directly in front of you so that you do not have to twist your body to use it. Tilt the monitor to a comfortable viewing angle.

Adjusting the Monitor Position

The monitor offers the adjusting height, rake, and rotation possibility that enable the monitor to be optimally adjusted for the respective user and the respective situation.

T120

You can tilt the screen backward and forward, as well as lift up and down as shown below:

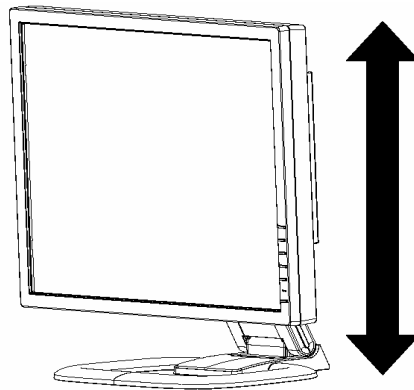

Working Practices



This section gives advice on how you can work comfortably and reduce fatigue.

Rest

Take regular breaks. Vary your posture, stand up and stretch occasionally as prolonged use of computer workstations can be tiring.

Back

Sit back in your chair and use the backrest.

Hands

Adjust the seat height so that your forearms are approximately horizontal and your wrists are straight when using the keyboard. Your upper arms should be relaxed with your elbows near your body.

Use a light touch on the keyboard, keeping your hands and fingers relaxed. Allow a space in front of the keyboard to rest your wrists when not typing. Consider using a wrist pad.

Eyesight

Working with monitors, in common with any prolonged close work, can be visually demanding. Look away from the screen periodically and have your eyesight checked regularly.

Screen settings

Set the screen brightness and contrast to a comfortable level. You may have to adjust this as the lighting changes during the day. Many application programs let you select color combinations which can help you to view in comfort. See the *User controls* section on page 15 for more information.

Caring for your Monitor

Be sure to turn off the power before you perform any maintenance on the monitor. Clean your monitor as follows:

- Gently wipe the device covers and the screen with a soft cloth.
- Remove finger marks and grease with a damp cloth and mild detergent; do not use solvents or abrasives.
- Never use flammable cleaning material to clean your IBM monitor or any other electrical apparatus.

Connecting your Monitor for Analog

Be sure to read the 'Safety' Information located in the Monitor Safety and Warranty Guide before carrying out this procedure.

1. Turn off your computer and all attached devices.
2. Tilt the monitor all the way forward.
3. Connect the analog signal cable to the VGA video port on the back of your computer.

This port might be directly attached to your computer (figure A), or it might be part of a video adapter card (figure B). The analog video port on your computer or video adapter card is normally blue to match the blue connector on your monitor's analog video cable.

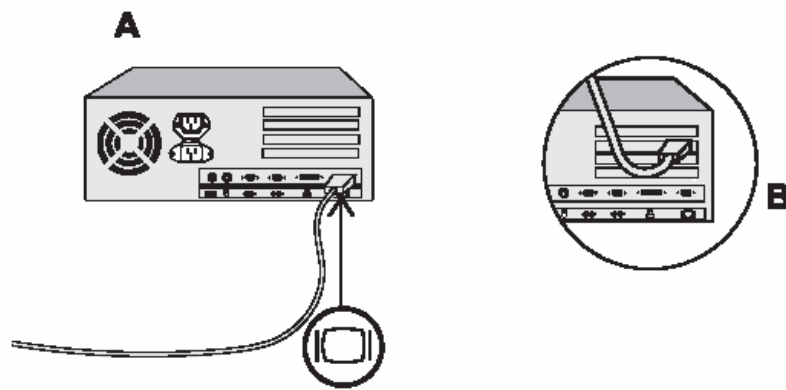

4. Attach the power cord at the back of the monitor where it says "AC IN". The arrow in the drawing below indicates the approximate area:

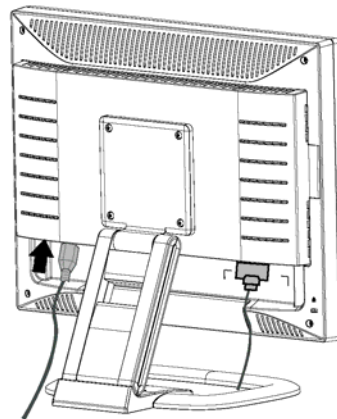

5. Insert the power plug into a properly grounded electrical outlet.

Connecting your Monitor for Digital

1. Turn off your computer and all attached devices
2. Tilt the monitor all the way forward.
3. Connect the DVI connector to the DVI port located on the back of the Monitor. See picture below.

Connecting DVI Cable

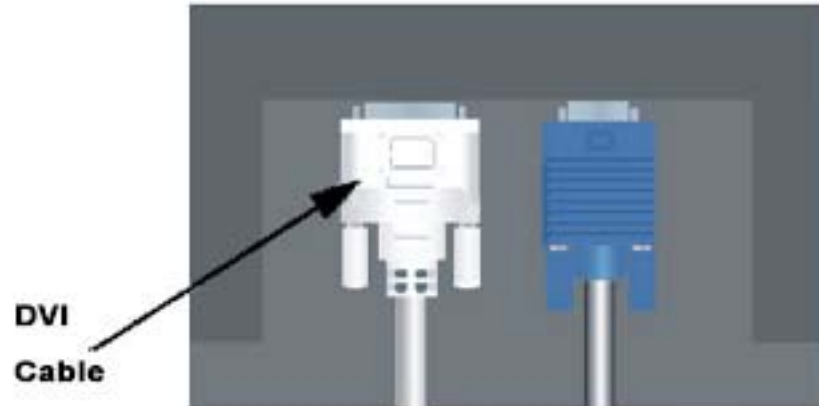

4. Connect the other end of the signal cable to the DVI port located on the back of the graphics adapter. See picture below.

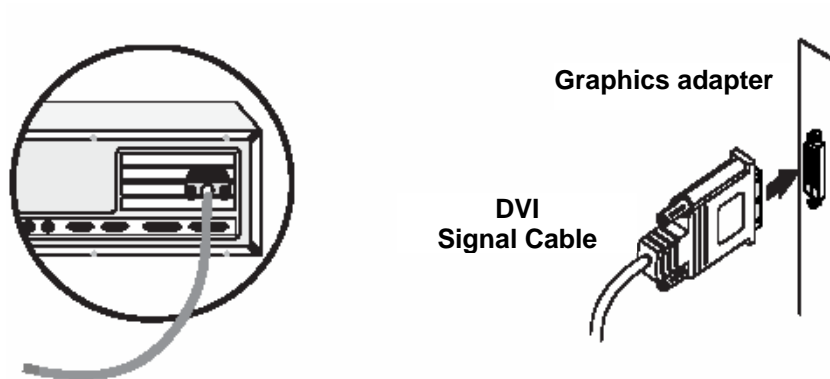

Switching on your Monitor

1. Switch on the power source and your computer.
2. Switch on your monitor by pushing and releasing the power switch marked .

(To switch off your monitor, push and release the power switch again.)

3. To update or install device drivers, follow the instructions in the **Device Driver Installation** section on page 9.
4. To optimize the displayed image, run Auto Setup by following the instructions in the **Auto Setup** section on page 11.

Device Driver Installation

Driver Installation for Windows 2003 or Windows Me

This section must be completed before continuing with the Windows 2003, Windows Me Auto Setup on page 13



On LCD monitors, unlike CRTs, a faster refresh rate does not improve display quality. IBM recommends using 1600 x 1200 at a refresh rate of 60Hz.

To use the Plug and Play feature in Microsoft® Windows® 2003 or Microsoft Windows Millennium Edition (Me) files should be loaded from the **IBM Monitor CD**.

1. Turn off the computer and all attached devices.
2. Ensure that the monitor is connected correctly.
3. Turn on the monitor and then the system unit. Allow the system to boot into Windows 2003 or Windows Me.
4. Open the **DISPLAY PROPERTIES** window by clicking **START, SETTINGS, CONTROL PANEL** and then double-clicking the **DISPLAY** icon.
5. Click the **SETTINGS** tab.
6. Click the **ADVANCED** button.
7. Click the **MONITOR** tab.
8. Click the **PROPERTIES** button.
9. Click the **DRIVER** tab.
10. Open the **UPGRADE DEVICE DRIVER WIZARD** window by clicking on **UPDATE DRIVER** and then click the **NEXT** button.
11. Select the "Display a list of the known drivers for this device so that I can choose a specific driver" and then click the **NEXT** button.
12. Insert the Setup CD into the CD drive and click the **HAVE DISK** button.
13. Click **OK**.
14. Ensure that the CD drive letter is selected, and then select the 'Drivers' folder.
15. Choose **IBM T120 monitor** and click **OK**. The files will be copied from the CD to your hard disk drive.
16. Close all open windows and remove the CD.
17. Restart the system.

The system will automatically select the maximum refresh rate and corresponding Color Matching Profiles.

Driver Installation for Windows XP

This section must be completed before continuing with the Windows XP Auto Setup on page 13

i *On LCD monitors, unlike CRTs, a faster refresh rate does not improve display quality. IBM recommends using 1600 x 1200 at a refresh rate of 60Hz.*

To use the Plug and Play feature in Microsoft® Windows® XP files should be loaded from the **IBM Monitor CD**.

1. Turn off the computer and all attached devices.
2. Ensure that the monitor is connected correctly.
3. Turn on the monitor and then the system unit. Allow the system to boot into Windows XP.
4. Open the **DISPLAY PROPERTIES** window by clicking **START, SETTINGS, CONTROL PANEL** and then double-clicking the **DISPLAY** icon.
5. Click the **SETTINGS** tab.
6. Click the **ADVANCED** button.
7. Click the **MONITOR** tab.
8. Click the **PROPERTIES** button.
9. Click the **DRIVER** tab.
10. Open the Hardware Update Wizard window by clicking on **UPDATE DRIVER** and then click the **NEXT** button.
11. Select the "Install from a list or Specific location (Advanced)" and then click the **NEXT** button.
12. Insert the Setup CD into the CD drive: and click the **HAVE DISK** button.
13. Click OK.
14. Ensure that the CD drive letter is selected, and then select the 'Drivers' folder.
15. Choose **IBM T120 monitor** and click OK. The files will be copied from the CD to your hard disk drive.
16. Close all open windows and remove the CD.
17. Restart the system.

The system will automatically select the maximum refresh rate and corresponding Color Matching Profiles.

Auto Setup

Auto Setup



The Setup Utility included on the installation CD is for displaying dot patterns. They do not replace or modify the display driver.

The Auto Setup instructions require the monitor to be warmed up for 15 minutes. This is not required for normal operation.

By pressing the Auto key, you will have direct access to Auto Adjustment.



The AUTO SETUP process only applies to the current screen mode. When a new mode is selected, repeat this section to reset the monitor.

Auto setup is not required when using digital input

When you first use your monitor you must perform Auto Setup. This procedure sets up your monitor to process the video signals from your computer without image discoloration or smearing. After you perform Auto Setup, the settings are stored and used each time you turn on the monitor.

To optimize the displayed image a set-up utility is provided on the CD. Operation of the utility is dependent on the operating system on your computer. For correct operation locate the operating system on your computer from the table below and follow the appropriate instructions. You can choose to run AUTO SETUP for each operating system that you use. This means that if you sometimes use your monitor while running a version of Windows and sometimes also use it from within DOS (not a DOS window), you must run AUTO SETUP for both Windows and DOS. You can run versions of AUTO SETUP in any order.

Operating System	Corresponding Auto Setup procedure
DOS	<i>Auto Setup for DOS on page 12</i>
Windows 2003, Windows Me or Windows XP	<i>Auto Setup for Windows 2003, Windows Me or Windows XP on page 13</i>

Before you begin AUTO SETUP for your computer:

Make sure the computer's video mode is set in the range of the supported screen resolution shown in the Table on page 20.

You should perform AUTO SETUP for each screen mode you use.

Auto Setup for DOS

i If the monitor is in power saving mode, it may automatically turn off while you are waiting for it to warm up. If this happens, switch off the monitor and switch it on again after a few seconds.

i If you are using PC-DOS/V, change to U.S. mode by typing 'CHEV US' and pressing ENTER at the command prompt.

i The size and diversity of the dot pattern varies with the screen resolution.

To set up the monitor automatically in DOS, do the following:

1. Turn on the monitor first; then turn on the computer.

If the message Attention No Signal is displayed, or if nothing is displayed, check:

- That the video interface cable is connected properly.
- The correct video adapter card is installed.
- The correct supported display mode is selected for your computer.

2. Wait approximately 15 minutes, until the monitor warms up.
3. Insert the User's Guide and Installation Files CD into the computer CDROM drive.
4. Display the command prompt screen of the DOS full-screen display.
5. Type d:\ (change the drive letter to match your CD-ROM drive if it is not drive D).
6. Type **TESTPATD** and press ENTER.
7. Select from the screen the number for the color or text mode you want to set up.
8. Select from the screen the number for the video mode you want to set up. You can repeat this process for as many of the color and video modes as you need.
9. When the dot pattern appears, press the **AUTO** button at the bottom of the monitor. This activates the AUTO SETUP procedure, which will optimize the display settings with the provided dot-patterns.

The screen will momentarily turn black while auto adjustment proceeds.

10. When finished, the Auto Adjustment menu disappears and the screen returns to a normal display.
11. Press the ESCAPE key to exit the test pattern program.
12. Type **Exit** at the command prompt to return to Windows.

If you use other operating systems, perform the appropriate Auto Setup for those systems using instructions given in "Auto Setup for Windows 2003, Windows Me or Windows XP on page 13".

Auto Setup for Windows 2003, Windows Me or Windows XP

To set up the monitor automatically in Windows 2003, Windows Me, or Windows XP, do the following:

 *If the monitor is in power saving mode, it may automatically turn off while you are waiting for it to warm up.*

1. Turn on the monitor first; then the computer.

If the message Attention No Signal is displayed, or if nothing is displayed, check:

- That the video interface cable is connected properly.
- The correct video adapter card is installed.
- The correct supported display mode is selected for your computer.
- If the message "Input not supported" is displayed, configure your computer for 1600 x1200@60HZ

 *The size and diversity of the dot pattern varies with the screen resolution.*

2. Wait approximately 15 minutes, until the monitor warms up.
3. Drag the icon bar and tool bar, if they are displayed, to the bottom of the screen.
4. Insert the User's Guide and Installation CD into the computer CDROM drive.
5. Check the operating system installed on your computer and follow the instructions from the table below.

Operating system installation steps

Operating System	Step1	Step2	Step3
Windows 2003, Windows XP, Window 2000 server	Select START	Select RUN	Type d:\TESTPAT (change the drive letter to match your CD-ROM drive if it is not drive D) and press ENTER

6. When the test pattern appears, press the **AUTO** button at the bottom of the monitor. This activates the AUTO SETUP procedure, which will optimize the display settings with the provided test patterns.

The screen will momentarily turn black while auto adjustment proceeds.
7. When finished, the Auto Adjustment menu disappears and the screen returns to a normal display.
8. Press the ESC key to return to Windows.

You have completed the monitor setup for Windows. If you are using the DOS operating system, go to *Auto Setup for DOS* on page 12.

Manual Setup



If the monitor is in power saving mode, it might automatically turn off while you are waiting for it to warm up.

Manual setup is not required when using digital input.

Normally, you can complete the setup procedure using **AUTO SETUP**; however, if your screen image is still distorted after you perform **AUTO SETUP** or the Installation CD does not run on your system, perform **MANUAL SETUP**.

1. Have your monitor turned on for about 15 minutes, until the monitor warms up.
2. Display the image you most frequently use on the screen then go to windows shut down mode.
3. Press the OSD Enter button **MENU** at the bottom of the monitor to display the initial OSD menu.
4. Use the **^** or **v** button and **MENU** to select Image Setup then adjust clock or Focus

(a) "Clock" (pixel frequency) controls the number of pixels scanned by one horizontal sweep.

If the frequency is not correct, the screen shows vertical stripes and the picture does not have the correct width.

(b) "Focus" adjusts the Phase of the pixel clock signal. With a wrong phase adjustment the picture has horizontal disturbances in light picture.

5. Use the **^** or **v** button to manually adjust and optimize the screen quality. Save by pressing the Exit button **AUTO** once & press 2 more times to exit the OSD menu.

You have completed monitor setup.



Adjusting Your LCD Monitor

User controls





User control features

- Direct access controls when OSD is not displayed,

Icon	Control	Description
AUTO	Image Setup	Activates automatic image adjustment.
	Brightness	Directly accesses to Brightness on the OSD menu.
MENU	OSD Enter	Displays the OSD main menu.
	Power Switch	Switches the monitor on and off.
	Contrast	Directly accesses to contrast on the OSD menu.
SOURCE	Input	Switches between DVI and D-Sub

- Main OSD menu when OSD is displayed,

Icon	Control	Description
AUTO	Exit	Exits from menus and sub-menus Exits the OSD.
	Up Arrow	Moves the cursor to highlight icons and other options.
	Down Arrow	Moves the cursor to highlight icons and other options.
MENU	OSD Enter	Enters menus and sub-menus and selects the highlighted option.
SOURCE	Input	Switches between DVI and D-Sub



The image is already optimized for many display modes; however the user controls can be used to adjust the image to your liking.

OSD Operation

- Press the OSD Enter button to display the main OSD menu.
- Use the Arrow buttons to move among the icons. Select an icon and press OSD Enter to access that function. If there is a sub-menu, you can move between options using the Arrow buttons, then press OSD Enter **MENU** to select that function. Use the Arrow buttons to make adjustments. Press the **MENU** button to save.
- Press the Exit (**AUTO**) button to move backwards through the sub-menus and exit from the OSD.

OSD Lock / Unlock

- This feature allows you to secure the current control settings, so that they cannot be changed, while allowing you to adjust the brightness and contrast. You can unlock the OSD controls at any time using the same procedure.
- To lock the OSD, first turn off the monitor. Then, hold down the "**Menu**" key and press "**Power**" key once to turn on the monitor. This will lock the OSD and show the message "Attention OSD Locked".
When the OSD is locked, if you press the "**Menu**" key, the message "Attention OSD Locked" will be displayed.
When the OSD is locked, the "**Power**" key and **Hot-Key** functions are still available.
To unlock the OSD, first turn off the monitor. Then, hold down the "**Menu**" key and press the "**Power**" key once to turn on the monitor. The OSD will be unlocked.

On-screen display (OSD) controls

i The LCD monitor needs time to become thermally stable the first time you turn it on each day. Thus, to achieve more accurate adjustments for parameters, allow the LCD monitor to warm up for at least 15 minutes before making any screen adjustments.





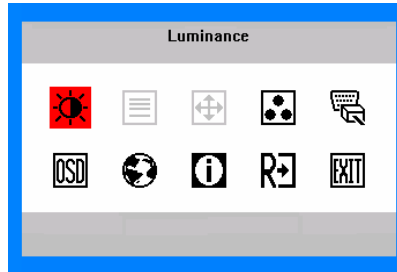



The settings adjustable with the user controls are viewed through the On-screen display (OSD). Press the OSD **MENU** button (**MENU**) to activate the OSD.

Initial appearance of OSD



OSD functions

Main Menu Item	Main Menu Icon	Sub Menu Item	Sub Menu Icon	Description
Luminance		Contrast		Contrast from Digital-register.
		Brightness		Backlight Adjustment
Image Setup		Focus		Adjust Picture Phase to reduce Horizontal-Line noise
		Clock		Adjust picture Clock to reduce Vertical-Line noise.
Image Position		H. Position		Adjust the horizontal position of the picture.
		V. Position		Adjust the vertical position of the picture.
Color Temp.		Warm	N/A	Recall Warm Color Temperature from EEPROM.
		Cool	N/A	Recall Cool Color Temperature from EEPROM.
		User / Red	R	Red Gain from Digital-register.
		User / Green	G	Green Gain Digital-register.
		User / Blue	B	Blue Gain from Digital-register.

Main Menu Item	Main Menu Icon	Sub Menu Item	Sub Menu Icon	Description
Input Select		Analog	N/A	Select input signal from analog (D-Sub)
		Digital	N/A	Select input signal from digital (DVI)
OSD Setup		H. Position		Adjust the horizontal position of the OSD.
		V. Position		Adjust the vertical position of the OSD.
		OSD Timeout		Adjust the OSD timeout.
Language		English	N/A	Set OSD display language to English.
		Deutsch	N/A	Set OSD display language to German.
		Français	N/A	Set OSD display language to French.
		Español	N/A	Set OSD display language to Spanish.
		Italiano	N/A	Set OSD display language to Italian.
			N/A	Set OSD display language to Simplified Chinese.
			N/A	Set OSD display language to Japanese.
Information		Information	N/A	Show the resolution, H/V frequency and current input
Reset		Yes	N/A	Adjusts all controls to factory settings.
		No	N/A	Do not execute reset, return to main menu.
Exit		N/A	N/A	Exit OSD

General Information

Display modes

The display mode the monitor uses is controlled by the computer. Therefore, refer to your computer documentation for details on how to change display modes.

The image size, position and shape might change when the display mode changes. This is normal and the image can be readjusted using **AUTO SETUP** and the monitor controls.

Unlike CRT monitors, which require a high refresh rate to minimize flicker, TFT technology is inherently flicker-free. If possible, configure your computer for 1600 × 1200 addressability at 60Hz vertical refresh rate.

For the display modes listed on the next page, the screen image has been optimized during manufacture.

i To optimize image quality, you may want to run **AUTO Setup** after switching between modes shown in this section. **AUTO SETUP** can fix the problems in most cases. See **Auto Setup for DOS** on page 12 for details.

Factory Set Display Modes

Addressability	Refresh Rate
640 × 350	70 Hz
640 × 480	60 Hz
640 × 480	72 Hz
640 × 480	75 Hz
720 × 400	70 Hz
800 × 600	60 Hz
800 × 600	72 Hz
800 × 600	75 Hz
1024 × 768†	60 Hz
1024 × 768	70 Hz
1024 × 768	75 Hz
1280×1024	60 Hz
1280×1024	75 Hz
1600×1200	60Hz
640×480	66 Hz
640×480	85 Hz
800×600	56 Hz
800×600	85 Hz
1024×768	85 Hz
1280×1024	85 Hz
1280×1024	70 Hz

† Recommended

Note: VESA timings conform to detailed in the VESA “Display Monitor Timing Specification”. Version 1.0, Revision 0.8, dated 09/17/98.

Power Management

i *If your computer has previously been used with a CRT monitor and is currently configured to a display mode outside the range that the Flat Panel monitor can display, you may need to re-attach the CRT monitor temporarily until you have re-configured the computer, preferably to 1600 x 1200 at 60Hz.*

To benefit from power management, the monitor must be used in conjunction with a computer that implements the Video Electronics Standards Association (VESA) Display Power Management Signalling (DPMS) Standard.

The power management feature is invoked when the computer recognizes that you have not used your mouse or keyboard for a user-definable period. There are several states as described in the table below.

For optimal performance, switch off your monitor at the end of each working day, or whenever you expect to leave it unused for long periods during the day.

State	Power Indicator	Screen	Restoring Operation
On	Steady green	Normal	
Power saving	Amber	Blank	Press a key or move the mouse. *

* There may be a slight delay before the picture reappears.

Product Disposal

The fluorescent lamp in the liquid crystal display contains mercury. Dispose of it as required by local ordinances and regulations.

Troubleshooting

i To optimize image quality, you may want to run *AUTO Setup* again before consulting this section. In most cases, *AUTO SETUP* can fix the problems. See *Auto Setup for DOS* on page 12 for details.

If you have a problem setting up or using your monitor, you might be able to solve it yourself. Before calling your retailer or IBM, try the suggested actions that are appropriate to your problem.

Problem	Possible Cause	Suggested Action	Reference
Computer does not boot after the graphics adapter is installed	There is another Graphics adapter in the computer	<ul style="list-style-type: none"> ◆ Remove the other graphics adapter plugged into one of the expansion slot. ◆ If the card is built-in to the motherboard, check your system manual for instructions on how to disable the built-in adapter. 	<i>Connecting your Monitor</i> section on page 6-8
The screen image is garbled or unusable (rolling screen images, overlapping screen images or a blank screen)	The display driver is trying to use a setting your monitor does not support	<ul style="list-style-type: none"> ◆ Select the correct monitor resolution, 1600 x 1200 at 60 Hz. 	<i>Connecting your Monitor</i> section on page 6-8
Screen is blank and power indicator is off	No power to monitor	<ul style="list-style-type: none"> ◆ Ensure that the electrical outlet and the monitor are both switched on. ◆ Check that the power cord is firmly plugged into the electrical outlet and the power supply unit. ◆ If the power cord plug has a removable fuse, replace it. ◆ Try another power cord. ◆ Try another electrical outlet. 	<i>Connecting your Monitor</i> section on page 6-8

Problem	Possible Cause	Suggested Action	Reference
Screen is blank and power indicator is steady green	Brightness and Contrast may be too low	<ul style="list-style-type: none"> ◆ Adjust brightness and contrast. 	<i>User controls</i> section on page 15
Screen is blank and power indicator is Amber	The monitor is in the Power saving status	<ul style="list-style-type: none"> ◆ Press any key on the keyboard or move the mouse to restore operation. ◆ Check the Power Management software on your computer 	<i>Power Management</i> section on page 21
Screen shows "Attention - No Signal" message	The monitor is not receiving a video signal	<ul style="list-style-type: none"> ◆ Check that the signal cable is firmly connected to the computer. ◆ Check that no pins are bent in the signal cable connector. 	<i>Connecting your Monitor</i> section on page 6~8
Screen shows "Input Not Supported" message	Display mode of the computer is outside the range of the monitor	<ul style="list-style-type: none"> ◆ Reconfigure the computer to use a supported display mode. 	<i>General Information</i> section on page 19
Image appears to be smeared	There are noises in the video signal	<ul style="list-style-type: none"> ◆ Select Image Setup menu in the OSD. Then select MANUAL to adjust Phase/Clock settings. 	<i>User Controls</i> section on page 15
Image appears to be discolored	The Color setting may be incorrect	<ul style="list-style-type: none"> ◆ Adjust the Color settings. 	<i>User Controls</i> section on page 15
A few bright or dark dots are visible on the screen.	<ul style="list-style-type: none"> ◆ This is an intrinsic characteristic of the TFT LCD technology and is not an LCD defect. 	None	

Further Help

If you are unable to correct the problem yourself, you may seek further help as follows:

Call the IBM support center®.

In the US call 1-800-772-2227

In Canada (Toronto Only) call 416-383-3344

In Canada (all others) call 1-800-565-3344

In other countries contact your dealer, retailer, or other IBM authorized Servicer.

Before calling, please have available as much of the following information as possible:

1. Model and serial number from the label on your monitor.
2. Purchase receipt.
3. Description of problem.
4. Computer type and model.
5. System configuration (hardware fitted, etc.).
6. System BIOS version number.
7. Operating System and version number.
8. Display driver version number.
9. Video Adapter Type.

 *If possible, stay by your computer. Your Technical Support Representative may wish to go through the problem with you during the call.*

 *More help, late-breaking news and details of the latest accessories for these products may be found on the worldwide web at:
<http://www.ibm.com/support>*

Specifications

This color monitor (Type-model 4945-20*) uses a 20.1-inch TFT LCD

Contents		Model	T120
Dimensions	Height: (max) Height : (min) Depth: Width:		416.6 mm (16.40 in.) 361.6 mm (14.24 in) 246.0 mm (9.69 in.) 445.6 mm (17.54 in.)
Weight	Unpackaged: Packaged:		7.5 kg (16.53 lb) 8.6 kg (18.96 lb)
Image	Viewable Image Display area Pixel Pitch:		510.5 mm (20.1 in.) 408.0 mm (H) x 306 mm (V) 0.255 mm
Power Input	Supply Voltage: Supply Current:		100-240 V ac, 60/50 ± 3Hz 1.5A at 120 V ac
Power Consumption	Normal Operation: DPMS Stand-by: DPMS Suspend: DPMS off: Switch off:		< 60W < 2W < 2W < 1.5W 0W
Video Input (Analog)	Input Signal: Horiz. Addressability: Vert. Addressability: Clock Frequency:		Analog Direct Drive, 75 ohm 0.7 V 1600 pixels (max) 1200 lines (max) 162 MHz
Video Input (Digital)	Interface: Input Signal: Horiz. Addressability: Vert. Addressability: Clock Frequency:		DVI input, TMDS 1600 pixels (max) 1200 lines (max) 162 MHz
Communications	VESA DDC:		2 B
Supported Display Modes	VESA Standard modes between Horiz. Frequency: Vert. Frequency:		30 kHz – 91.1 kHz 55 Hz - 85 Hz (1600x1200 limited to 60Hz)
Environment	Temperature: Operating: Storage: Shipping: Humidity: Operating: Storage: Shipping:		10 to 35°C (5 to 95° F) -20 to 60°C (-4 to 140° F) -20 to 60°C (-4 to 140° F) 10 to 80% 10 to 90% 10 to 90%
Lift			55mm
Swivel			N/A
Tilt			-5° / + 40°

Product recycling and disposal

This unit must be recycled or discarded according to applicable local and national regulations. IBM encourages owners of information technology (IT) equipment to responsibly recycle their equipment when it is no longer needed. IBM offers a variety of product return programs and services in several countries to assist equipment owners in recycling their IT products. Information on IBM product recycling offerings can be found on IBM's Internet site at <http://www.ibm.com/ibm/environment/products/prp.shtml>.

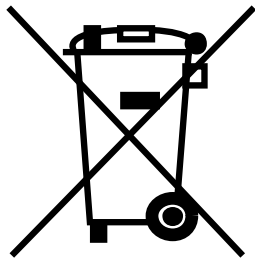

Notice: This mark applies only to countries within the European Union (EU) and Norway.

This appliance is labeled in accordance with European Directive 2002/96/EC concerning waste electrical and electronic equipment (WEEE). The Directive determines the framework for the return and recycling of used appliances as applicable throughout the European Union. This label is applied to various products to indicate that the product is not to be thrown away, but rather reclaimed upon end of life per this Directive.

In accordance with the European WEEE Directive, electrical and electronic equipment (EEE) is to be collected separately and to be reused, recycled, or recovered at end of life. Users of EEE with the WEEE marking per Annex IV of the WEEE Directive, as shown above, must not dispose of end of life EEE as unsorted municipal waste, but use the collection framework available to customers for the return, recycling, and recovery of WEEE. Customer participation is important to minimize any potential effects of EEE on the environment and human health due to the potential presence of hazardous substances in EEE. For proper collection and treatment, contact your local IBM representative.