



Matrox® **Extio™ Central Manager**

User Guide

20267-301-0350
2023.03.31

www.matrox.com/video

matrox[®]
— video —

Contents

1 Matrox Extio Central Manager software	5
1.1 Before you begin.....	5
1.2 Installing your software.....	6
1.3 Accessing Matrox Extio Central Manager	7
1.4 More information.....	7
2 Getting started	8
2.1 Extio Central Manager main interface	8
2.2 Extio Central Manager main menu	9
2.3 Extio Central Manager basic functions.....	10
2.4 Understanding your Extio devices.....	11
2.5 Opening the information dashboard.....	13
2.6 Understanding the status of your devices.....	13
3 Setup overview.....	16
3.1 Before you begin.....	16
3.2 Basic setup	16
3.3 Using Quick setup	18
4 Logging in and out	19
4.1 Logging into Extio Central Manager	19
4.2 Logging out of Extio Central Manager.....	19
4.3 User access	19
5 Communicate using self-signed or client-provided certificates.....	21
5.1 Generate https client-provided certificates	21
5.2 Deploy certificates to the Extio 3 devices	22
5.3 Install CA certificate in Windows trusted store.....	22
5.4 Configure to only connect to devices with client-provided certificates.....	22
6 Discovering devices manually	24
6.1 Scanning one or more IP addresses.....	24
6.2 Scanning a range of IP addresses.....	24

7	Using the connection broker	25
7.1	Understanding the icons.....	25
7.2	Allowing a connection between devices	25
7.3	Filtering by group.....	26
7.4	Select the monitor to use.....	26
8	Managing users.....	27
8.1	Adding users.....	27
8.2	Deleting users	27
8.3	Overwriting a password (local users only)	28
8.4	Granting privileges.....	28
8.5	Logging in automatically (local users only)	28
9	Testing network bandwidth	29
9.1	Test the network bandwidth of a Tx-Rx connection	29
10	Extio 3 Transmitter (Tx) settings.....	32
10.1	Sharing mode	32
10.2	EDID.....	32
10.3	Streaming.....	34
10.4	Network	36
10.5	Date and time	38
10.6	More options.....	38
11	Extio 3 Receiver (Rx) settings.....	41
11.1	Connection	41
11.2	Monitors.....	43
11.3	Aggregator mode.....	45
11.4	OSD (On-screen display)	54
11.5	USB.....	56
11.6	Audio.....	57
11.7	Transmitter discovery.....	58
11.8	Network	58
11.9	Date and time	64
11.10	RS232	65
11.11	Keyboard shortcuts.....	66
11.12	More options.....	68

12 Importing and exporting device settings	71
12.1 Exporting	71
12.2 Importing.....	71
13 Adjusting the date and time of your device	72
13.1 Setting the date and time	72
13.2 Setting the time zone.....	73
14 Notes and limitations	74
14.1 General	74
14.2 Network	74
14.3 Date and time	74
15 Troubleshooting	75
15.1 What to do if you have a problem.....	75
15.2 Common problems and solutions.....	75
16 Appendix A – Setting up link redundancy.....	79
16.1 Connection setup guidelines	79
16.2 Enabling link redundancy.....	80
16.3 Disabling link redundancy.....	80
17 Appendix B – Configuring your audio settings.....	81
17.1 Receiver output	81
17.2 Receiver input.....	82
17.3 Receiver audio destination	83
18 Appendix C – Firewall requirements	84
18.1 Extio Central Manager software	84
18.2 Firmware updater.....	84
18.3 Extio 3 devices.....	85
18.4 Accessing your Windows Firewall settings.....	86
18.5 Adding rules to your Windows Firewall settings.....	87
19 Customer support	89
19.1 Matrox web	89
19.2 Technical support	89
19.3 View your warranty information	89
19.4 View the third party software notices	89
19.5 Register your Matrox product.....	90

1 Matrox Extio Central Manager software



Matrox Extio Central Manager software enables you to remotely manage, monitor, and configure your networked Extio 3 devices.



Note: This guide describes all Matrox Extio Central Manager features and controls. However, the support and availability of some of the Matrox features and controls detailed in this document depends on your product, your operation mode (Networked-LAN, Networked-Internet / WAN with Site-to-Site VPN, or Networked-Internet with IPsec VPN), and software version.

1.1 Before you begin

To get the most out of your product:

- Make sure you connect your product *before* configuring Extio Central Manager software. For more information on the connection setup of your product, see the user guide for your Matrox hardware.
- Whenever you change your connection setup, make sure you're using the correct connectors and that all connectors are properly fastened. Also, don't change connections while your Extio transmitter and receiver are turned on.
- You may need administrator rights to install or uninstall certain software. For more information, see Windows documentation or contact your system administrator.
- To assign an initial IP address to your devices, a DHCP (Dynamic Host Configuration Protocol) server is required.
- **Windows Server 2022 and Windows Server 2019** – Make sure the SSDP Discovery service, network discovery, and file sharing options are enabled.

1.1.1 Software versions and mismatches

- Make sure all of your Extio 3 transmitter and receiver devices are using the latest version of the Matrox Extio 3 firmware. Also, all Extio 3 devices must use the *same version* of the firmware package.
- The version of your firmware package must match the version of your Extio Central Manager software package. If a mismatch is detected, a warning (⚠) icon appears on the device tile.

For more information on updating your firmware package, see your Matrox Extio 3 Series User Guide.

1.1.2 Supported operating systems

Matrox Extio Central Manager supports the following operating systems:

- Windows® Server® 2022
- Windows® Server® 2019
- Windows® 11 (64-bit)
- Windows® 10 (64-bit)

1.1.3 Supported Matrox hardware

Matrox Extio Central Manager supports the following Matrox hardware:

- Extio N3408 transmitter card
- Extio N3408 transmitter unit
- Extio N3408 receiver unit
- Extio N3208 transmitter card
- Extio N3208 transmitter unit
- Extio N3208 receiver unit

1.1.4 Obtaining Matrox Extio Central Manager

Matrox makes the latest Extio Central Manager software available on the Matrox web site (www.matrox.com/extio3/software).

1.2 Installing your software

To install the software for your Extio 3 product, run the installation program for your software package on any system on the network. Follow the on-screen instructions.



Note: Only one (1) instance of Extio Central Manager software needs to be installed.

1.3 Accessing Matrox Extio Central Manager

Windows 11/10 – To access the main interface of Extio Central Manager:

- Windows 11/10 – Click **Start** → **All apps*** → **Matrox Extio Central Manager*** → **Matrox Extio Central Manager**. (* Depending on your configuration of Windows, this part may not be necessary.)

1.4 More information

This guide assumes your Matrox product is properly connected. For more information on the connection setup of your product, see the user guide for your Matrox hardware.

Be sure to check for any last-minute release notes included with your product. Also, check the Matrox web site (www.matrox.com/video) for the latest Matrox software, technical support, and product information.

2 Getting started

This section describes the main interface, main menu, and basic functions of Matrox Extio Central Manager software.

2.1 Extio Central Manager main interface

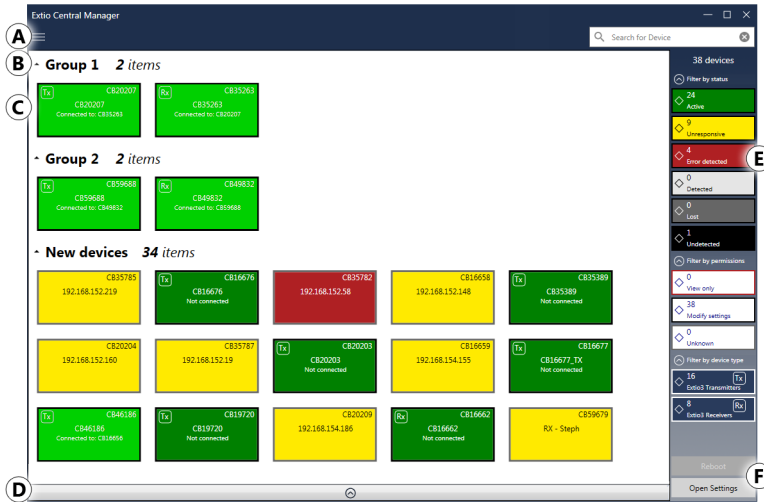

A	Main menu	The Extio Central Manager main menu contains options for managing users and passwords. For more information, see “2.2 - Extio Central Manager main menu”, page 9.
B	Device groups	Your Extio 3 devices are depicted as colored tiles and sorted into groups. For more information, see “2.4 - Understanding your Extio devices”, page 11.
C	Device tiles	Your Extio 3 devices are depicted as colored tiles. For more information, see “2.4 - Understanding your Extio devices”, page 11.
D	Information dashboard	The dashboard provides information for a device (such as the device type, serial number, firmware version, name, IP address, date, time, and status). For more information, see “2.5 - Opening the information dashboard”, page 13.

E	Device filtering	The devices are filtered by status, user privileges, and type. You can also choose to show more or less information on your device tiles. For more information, see “2.4.3 - Filtering your device tiles”, page 13.
F	Basic functions	These buttons provide the basic functions for Extio Central Manager software. For more information, see “2.3 - Extio Central Manager basic functions”, page 10.

2.2 Extio Central Manager main menu

The main menu of Extio Central Manager contains the following options.

Log in / Log out	Log into your Extio Central Manager by entering the user type (local user or domain user), user name, and password for your Extio 3 device.
Only accept devices with client-provided certificates	Select this option to configure Extio Central Manager to connect <i>only</i> to devices with client-provided certificates and deny connection to devices with self-signed certificates. For more information, see “5.4 - Configure to only connect to devices with client-provided certificates”, page 22.
Manual device discovery	Extio Central Manager automatically detects the devices in your subnet. If devices aren’t automatically detected, you can manually add these devices. For more information, see “6 - Discovering devices manually”, page 24.
Connection broker	Allow connections between your Extio transmitter and receiver devices. For more information, see “7 - Using the connection broker”, page 25.
Change password	Change the password for your Extio 3 Series products. For more information, see “4.3.2.1 - Changing your device password (local users only)”, page 20.
Manage users	Manage the users for your Extio 3 Series products. For more information, see “8 - Managing users”, page 27.
Quick setup	Provides a checklist to quickly configure your Extio software and devices. For more information, see “3.3 - Using Quick setup”, page 18.
Network bandwidth test	Determine the expected performance from a connection between an Extio 3 transmitter and a receiver pair. For more information, see “9 - Testing network bandwidth”, page 29.
About	Provides information specific to your Extio Central Manager software (such as the version).

2.2.1 Extio Central Manager shortcut menu

To access the shortcut menu, right-click your device tile. The menu items available will vary depending on your product and setup. The menu items include:

Reboot	Click this to reboot your device. This keeps all of your device settings, including the IP address and password. After rebooting your device, allowed connections are restored.
Download logs	Click this to see the device logs.
Multi-device settings	Select multiple receiver device tiles (), then click this to see the settings for those devices. To modify your settings, enable Modify settings .
Attempt wake	Click this to wake up your transmitter or receiver which is asleep.
Open settings	Click this to see the settings for your device. This opens the last page accessed.
Remove lost devices	Click this to remove a device that's listed as Lost (dark grey) or Undetected (black).
Move to group	To create a new tile group, right-click a tile, select Move to group → Create a new device group , then enter a new Name . The tile used to create the new group moves to that new group. For more information, see “2.4.1 - Device groups”, page 11.

2.3 Extio Central Manager basic functions

The following buttons provide basic functions for managing your Extio Central Manager software.

Reboot	Click this to reboot your device. This keeps all of your device settings, including the IP address and password.
Apply / Cancel	Click Apply for your changes to take effect. Click Cancel to discard any changes that weren't applied.
Back	Click this to return to the main interface.
Open settings	Select a device tile, then click this to see the settings for that device. This opens the last page accessed.
Multi-device settings	Select multiple device tiles (only transmitter devices, only receiver devices, or a mixed selection of both receiver and transmitter devices)), then click this to see the settings for those devices. When you choose both transmitter and receiver devices, a Mixed selection message screen displays with the option to select which devices to open.
Undo changes	Click this to undo your last changes.

2.4 Understanding your Extio devices

In Extio Central Manager, the Extio 3 devices are depicted as colored tiles and sorted into groups. To understand the status of your devices, see “2.6 - Understanding the status of your devices”, page 13.

- **Group 1** 2 items



- **Group 2** 2 items

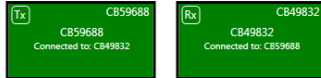

- **New devices** 34 items

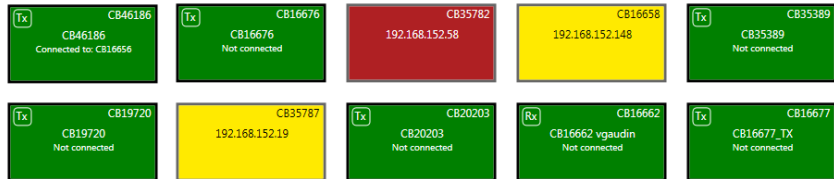

2.4.1 Device groups

When Extio Central Manager is started for the first time, or whenever a new device is detected, the device or devices are added to the **New devices** group. These devices can then be sorted into *groups*.



Managing your device groups



- To collapse or expand the tile list under a group, click the arrow (⤴ / ⤵).
- To create a new tile group, right-click a tile, select **Move to group** → **Create a new device group**, then enter a new **Name**. The tile used to create the new group moves to that new group.
- To reorder your groups, right-click next to the group name, then select a location for that group in the group list.
- To rename a group, double-click the group name, then enter a new name for the group.
- To shift tiles from one group to another, drag and drop the tiles from the current group into the target group.
- Tiles can't be deleted. They can only be moved from one group to another.
- When there are no tiles left in a group, the group automatically disappears.

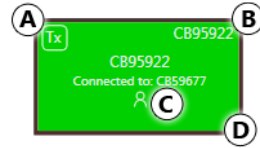

2.4.2 Device tiles

The tile provides the following information about your device.



A	Device type identified by icon: <ul style="list-style-type: none">▪  – Extio 3 transmitter device.▪  – Extio 3 receiver device.
B	Device serial number.
C	Device name, device serial number, or IP address, depending on the status of the Extio 3 device. It also indicates if the device is Connected to a device (and the name of the connected device or user name) or Not connected to a device.
D	Device status (tile color and border color). For more information, see “2.6 - Understanding the status of your devices”, page 13.

 **Note:** The version of your firmware package must match the version of your Extio Central Manager software package. If a mismatch is detected, a warning () icon appears on the device tile. For more information, see “1.1.1 - Software versions and mismatches”, page 5.

 **Note:** When you click the **Change** button beside the **Currently adapted for LAN** field in the **Network** page to change to WAN network settings, a settings warning () icon appears on the device tile. When you hover over the icon, “Transmitter discovery settings are not set. Receiver will not be able to see any transmitter.” message displays. Make sure your transmitters are detected by using Transmitter discovery.

Managing your device tiles

- To reorder your tiles, drag a tile to a new location.
- To move a tile to a different group, drag the tile to a new group. You can also right-click the tile, and select a group.
- To access the settings of a device, select a device, then click **Open settings**.
- To rename a device, click **Open settings**, then enter a new **Name** for that device.
- To delete a device that’s lost or undetected, click the **Delete** () icon. You can also right-click the tile, and click **Remove lost devices**.

2.4.3 Filtering your device tiles

You can filter your devices by *status*, *privileges*, and *device type*. The number at the top indicates the total number of devices. The number in the colored tiles indicate the number of devices with that status.



To filter your devices, click the appropriate tile. You can select multiple tiles to view devices with a different status. While filtering is in effect, at least one tile is highlighted.

2.4.3.1 Showing details

Click this to determine how much information to show on the device tile in the Extio Central Manager main interface.

To show only the device name (except when the device is selected or when hovering over it with your mouse), click **Show less details**. To show all device information (including the device name, serial number, and status), click **Show more details**.

2.5 Opening the information dashboard

To see the current status and information of a device, select the device, then click the (⌵) at the bottom of the Extio Central Manager main interface. This opens an information dashboard.









The dashboard provides the **Details** (such as the device type and software information, telemetry, detected monitors, and inputs) of a device and streaming **Statistics** for each monitor connected to that device.

2.6 Understanding the status of your devices



Depending on the status of a device, the color of the tile changes:

Active (Green) 	Device is active and working properly. It also indicates if the device is Not connected to a device.
--	---

Connected (Bright green) 	<p>Connection between a transmitter device and receiver device is allowed. It also indicates if the device is Connected to a device and the name of the device it's connected to. For more information on allowing a connection between devices, see “7 - Using the connection broker”, page 25.</p>
Unresponsive (Yellow) 	<p>Device is unresponsive.</p>
Error detected (Red) 	<p>Device has encountered an error. The status and information of the device can't be updated by Extio Central Manager. To fix this, try rebooting your device.</p>
Detected (Light grey) 	<p>Device is present on the network but not initialized. When a device is present on the network, the IP address appears on the tile.</p>
Lost (Dark grey) 	<p>Device was once detected, but can no longer be detected by Extio Central Manager. When a device is no longer detected, the tile lists the last known IP address of that device. If your transmitter or receiver is Lost, and you can't reboot your device, your device may be asleep. To wake up your transmitter or receiver, right-click your device tile, then click Attempt wake.</p>
Undetected (Black) 	<p>Device can't be detected by Extio Central Manager. When a device is no longer detected, the tile lists the last known IP address of that device. To remove the tile of a device that's no longer needed, select the tile and click the Delete (⊗) icon.</p>

2.6.1 User access privileges

Depending on the user access privileges of a device, the color of the tile border changes.

View only (Red border) 	<p>Device can be accessed, and the settings of the device can be viewed but not modified. To modify the settings, you need a valid password and user name. Extio 3 Series devices must be configured with your user name and password.</p>
No device administrator (Red dotted border) 	<p>Device can be accessed, and the settings of the device can be viewed, but not modified. To modify the settings, you need to take ownership of that device. For more information, see “ - Take ownership of a device”, page 17.</p>
Unknown (Grey border) 	<p>Device can be accessed but no password was created. You're prompted for a password when you click Apply. Once a password is provided, the status becomes View only.</p>

<p>Modify settings (Black border)</p> 	<p>Device can be accessed and the settings can be modified. A valid password is provided.</p>
---	---

3 Setup overview

The following section explains the basic steps needed to set up your Extio Central Manager software and devices.

3.1 Before you begin

- *Before* configuring Extio Central Manager software, make sure you connect your product and that all of your Extio 3 devices are turned on and have power. For more information on the connection setup of your product, see your Extio 3 Series User Guide.
- Make sure all of your Extio 3 transmitter and receiver devices are using the latest version of the Matrox Extio 3 firmware. Also, all Extio 3 devices on an Extio 3 network must use the *same version* of the firmware package. The version of your firmware package must match the version of your Extio Central Manager software package.
- Make sure latest version of Matrox Extio Central Manager software is installed on a separate system. For more information, see “1 - Matrox Extio Central Manager software”, page 5.
- Make sure all of your Extio 3 devices are detected and listed in the main interface. For more information, see “6 - Discovering devices manually”, page 24.

3.2 Basic setup

To set up your Extio 3 device:

1 Log into Extio Central Manager

To modify the settings of your Extio 3 device, you need to log into Extio Central Manager. To log into Extio Central Manager:

- a From the Extio Central Manager main menu, click **Log in**.
- b Specify if you're a **Local user** or a **Domain user**:
 - **Local user** – Enter your user name and password.
 - **Domain user** – Enter your user name, the domain name of the server, and your network password.
- c When you're done, click **Apply**.

For more information, see “4 - Logging in and out”, page 19.

2 Take ownership of a device

If the status of a device is **No device administrator**, you need to **Take ownership** of that device:

- a** From the main interface, select the Extio 3 devices you want to manage (these devices must be without an administrator). Click the **Take ownership** () icon in the upper right corner of a device tile, then click **Yes**.
- b** To see only these devices in the **Connection broker**, move them to one or more groups.

For more information, see [“8 - Managing users”, page 27](#).

3 Allow device connections

- a** From the main menu, select **Connection broker**.
- b** Make sure all of your Extio 3 devices are detected and listed in the main interface. For more information, see [“6 - Discovering devices manually”, page 24](#).
- c** If you created a group for your Extio devices, click **Filter by group**, select the group, then click **Close**.
- d** Click the () icon to allow the connection between your Extio transmitter and receiver devices.
- e** Click **Apply**.

For more information, see [“7 - Using the connection broker”, page 25](#).

4 Manage your users

- a** From the main menu, select **Manage users**.
- b** Click **Add user**, then enter a user name. Specify if it's a **Local user** or a **Domain user**.
- c** When you're done, click **OK**.
- d** Click the **Add** () icon for each device you want to add a user to. Adding a user to a device enables the user to log into a receiver and connect to a transmitter. To allow the connection to a transmitter, the connection must also be allowed in the **Connection broker** (see [“7.2 - Allowing a connection between devices”, page 25](#)).

To view the users and connections allowed for a device, select that device next to **Display users for** when assigning privileges.
- e** Repeat [step b](#) to [step d](#) for each user you want to add.
- f** When you're done, click **Apply**. This creates a **Local users summary** and generates a device password for each local user.

To copy the summary to the clipboard, click **Copy to clipboard** ()

g To close the dialog box, click **OK**.

For more information, see “8 - Managing users”, page 27.

3.3 Using Quick setup

Use the Quick setup checklist to quickly configure your Extio software and devices.

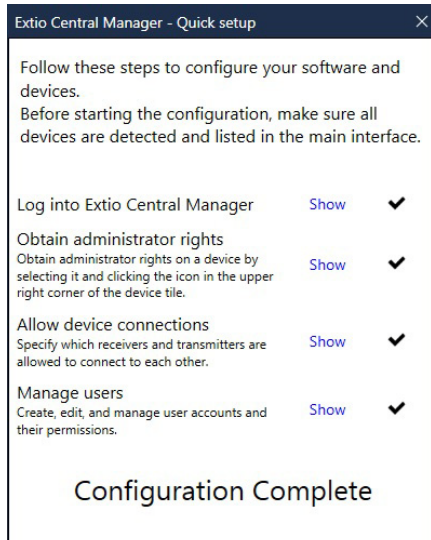

To use the quick setup:

- 1 Quick setup** launches automatically the first time you open Extio Central Manager software. You can also access the Quick setup checklist from the main menu of Extio Central Manager by selecting **Quick setup**.
- 2** Make sure all of your Extio 3 devices are detected and listed in the main interface. For more information, see “6 - Discovering devices manually”, page 24.
- 3** Once all of your devices are detected, start the setup by clicking **Show** next to the first item in the list. Once that item is configured, a black checkmark appears (✓).
- 4** Repeat [step 3](#) for each item in the list.

4 Logging in and out

4.1 Logging into Extio Central Manager

To modify the settings of your Extio 3 device, you need to log into Extio Central Manager. To log into Extio Central Manager:

- 1 From the Extio Central Manager main menu, click **Log in**.
- 2 Specify if you're a **Local user** or a **Domain user**:
 - **Local user** – Enter your user name and password.
 - **Domain user** – Enter your user name, the domain name of the server, and your network password.
- 3 When you're done, click **Apply**.

For more information, see “4.3 - User access”, page 19.

4.2 Logging out of Extio Central Manager

To log out, click **Log out** from the main menu of Extio Central Manager.

4.3 User access

4.3.1 Extio 3 administrator

The *Extio 3 administrator* does the following:

- Builds a list of users for each Extio 3 device. A user can be a *local user* or a *domain user*.
- Creates and manages *local user* accounts (see “**Local users**”), and their privileges, locally on the device using Extio Central Manager. **Note:** *Domain users* are created by the *network administrator*. For more information, see “**Domain users**”.
- Grants privileges to domain users using Extio Central Manager. For more information on privileges, see “8.4 - Granting privileges”, page 28.
- Allows device connections between transmitters and receivers.

4.3.2 Local users

Local users are defined by the *Extio 3 administrator* and managed through Extio Central Manager.

To obtain a local user name and device password for a *local user* (or if you've forgotten your user name or device password), contact your *Extio 3 administrator*. To change your current password, see “4.3.2.1 - Changing your device password (local users only)”, page 20.

4.3.2.1 Changing your device password (local users only)



Note: Don't change the password of a *local user* while a connection is enabled (for example, while a user is logged into the OSD). Changing a password while a connection is enabled will prevent a user from accessing and using the OSD.



Note: Passwords are case-sensitive and must be at least 6 alphanumeric characters long.

If the status of a device is **View only**, you need to change the device password to match your current password. To update your current password, click **Change password** from the Extio Central Manager main menu.

To change the device password to match your current password, select the device tile and click the **Update password** () icon in the upper right corner of the device tile. Enter a valid device password, then click **OK**.

If the device password is successfully changed, the status of the device is updated to **Modify settings**. If the status of the device remains **View only**, contact the administrator of that device to change your user settings. For more information, see “2.6 - Understanding the status of your devices”, page 13.

4.3.3 Domain users

Domain users are defined by your *network administrator* and managed through an *Active Directory*[®] network. Extio software and hardware use *Active Directory* to authenticate the user name and password of domain users.

Extio Central Manager supports user groups. Instead of specifying *domain users* individually, an existing *Active Directory user group* can be specified as *domain users* for easy set up.

A *domain user* who's also part of a user group is granted the highest privilege available (as a user group member or as an individual user). For more information, contact your network administrator.

To obtain a user name and password for a *domain user* (or if you've forgotten your domain user name or password), contact your *network administrator*.

5 Communicate using self-signed or client-provided certificates

You need to specify whether the devices will communicate with one another and with the Extio Central Manager using the Matrox-provided self-signed certificates that come with the devices, or with the client-provided certificates that you have to generate and deploy to the devices.

- **Matrox-provided self-signed certificates** - If you are not deploying client-provided certificates, then you don't have to configure anything as the Extio 3 devices come with self-signed certificates that are enough for enabling HTTPS based communication. You can proceed to "[Discovering devices manually](#)", page 24.



Note: In case you had configured to use client-provided certificates and you would like to change to self-signed certificates, you can select the **Accept all devices with certificates** option from the main menu.

- **Client-provided certificates** - If you would like to use client-provided certificates for authentication and communication, follow the steps provided below.

5.1 Generate https client-provided certificates

Your IT department needs to generate certificates for all the Extio 3 devices that have to be deployed on the network. This is required for the devices to safely communicate with each other and with the Extio Central Manager.

There are two types of certificates that the IT department can generate.

- **Device-specific certificates** - In this type of deployment, a distinct certificate is generated for each device. Two types of certificate identity can be used for device-specific certificate generation.
 - **DNS name of the device** – Certificates are generated using the DNS name of the devices. For this, a DNS server has to be active on the network. This is the preferred type of certificate generation.
 - **IP address of the device** – Certificates are generated using the IP address of the devices. In this case, special care must be taken to configure the devices either with static IP addresses, or configure the DHCP server in such a way that the same IP address is always assigned to the same device.

- **Wildcard certificate** - A single wildcard certificate can be deployed to multiple devices whose DNS names all end with the same suffix. For example, devices that have their DNS names formatted as abc1.xyz.com, def2.xyz.com, and ghi3.xyz.com (all having xyz.com as their common suffix) can use “*.xyz.com” as the DNS name string in the wildcard certificate.

5.2 Deploy certificates to the Extio 3 devices

The device-specific (or wildcard) certificate, corresponding private key, and the certificate authority (CA) certificate used to sign the device certificate must be zipped together and deployed to the device via the Extio 3 Firmware Updater. For more information, refer to the **Modifying the SSL/TLS certificate** section in the **Matrox Extio 3 Series OEM Customization.pdf** document.

When device-specific certificate zip files are used, the correct certificate zip file must be deployed to the corresponding device. When wildcard certificates are used, the same certificate zip can be deployed to all devices.

5.3 Install CA certificate in Windows trusted store

For Extio Central Manager to consider the deployed device certificate as valid, the certificate authority that signed the device's certificate *must* have its certificate (also known as CA certificate) stored in the Windows' Trusted Root Certification Authorities Certificate Store of the PC running Extio Central Manager. This is usually done by the IT department.

In cases where a new CA certificate is used to sign the devices' certificates, this CA certificate must be added to Window's Trusted Root Certification Authorities Certificate Store.

5.4 Configure to only connect to devices with client-provided certificates

After the appropriate certificates are deployed on the devices (Tx and Rx) as well as the PC running Extio Central Manager, you need to configure Extio Central Manager to connect *only* to devices with client-provided certificates and deny connection to devices with self-signed certificates.

To connect only to devices with client-provided certificates:

- 1 From the Extio Central Manager main menu, click **Only accept devices with client-provided certificates**. The **Extio Central Manager** pop-up confirmation screen appears.

- 2 Click **Yes**. The option is activated and any Extio 3 device without a client-provided certificate will be inoperative and have a red device tile in the main screen.



Note: The main menu will now have the **Accept all devices with certificates** option available instead of the **Only accept devices with client-provided certificates** option.

6 Discovering devices manually

Extio Central Manager automatically detects new devices in the subnet. If devices aren't detected, Extio Central Manager can scan one or more specific IP addresses or a range of IP addresses for Extio 3 devices.

If Extio Central Manager doesn't automatically detect the devices, you can add them manually.

6.1 Scanning one or more IP addresses

- 1 From the Extio Central Manager menu, select **Manual Device Discovery**.
- 2 Select **Scan a list of IP addresses**.
- 3 Enter the IP address of the device you want to add, then click **Add to list**.
- 4 When you're done, click **Scan list**.

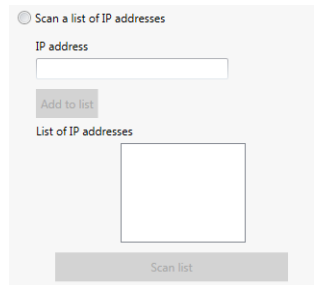

The screenshot shows a web interface for scanning a list of IP addresses. At the top, there is a radio button labeled "Scan a list of IP addresses" which is selected. Below it is a text input field for "IP address". To the right of the input field is a grey button labeled "Add to list". Below the input field is a text label "List of IP addresses" and a large empty rectangular box. At the bottom of the interface is a grey button labeled "Scan list".

If a new device is found at an IP address provided, that device is added to the **New devices** group.

6.2 Scanning a range of IP addresses

- 1 From the Extio Central Manager menu, select **Manual Device Discovery**.
- 2 Select **Scan a range of IP addresses**.
- 3 Enter the starting and ending IP addresses of the range you want to scan.
- 4 Enter the subnet mask to use when scanning for IP addresses. For more information on the subnet mask to use, contact your network administrator.
- 5 Click **Scan range**. If the starting or ending addresses are invalid, the **Scan range** button is disabled.

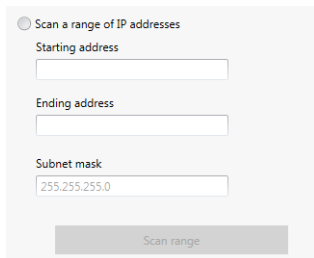

The screenshot shows a web interface for scanning a range of IP addresses. At the top, there is a radio button labeled "Scan a range of IP addresses" which is selected. Below it are three text input fields: "Starting address", "Ending address", and "Subnet mask". The "Subnet mask" field contains the value "255.255.255.0". At the bottom of the interface is a grey button labeled "Scan range".

If a new device is found, that device is added to the **New devices** group.

7 Using the connection broker

The connection broker provides a grid view of your Extio 3 transmitter and receiver devices. Use the connection broker to allow connections between your Extio transmitter and receiver devices.

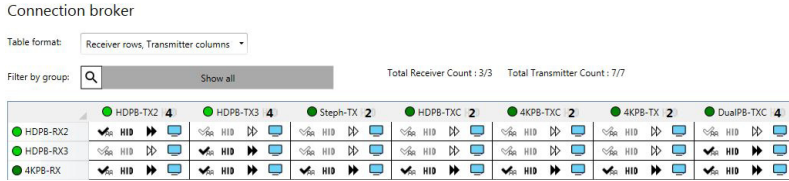

7.1 Understanding the icons

	Connection between a transmitter and receiver is allowed.
	Devices are available, but a connection between a transmitter and receiver hasn't been allowed.
HID	Reserve USB HID (Human Interface Device). This enables you to reserve the USB port so that previously connected devices (keyboard or mouse) can connect more quickly. When this is reserved, the number of HID USB devices will be listed. The maximum number of USB reservations is 16.
HID	USB HID isn't reserved.
	Shared connection with a guest is allowed.
	Devices may be unresponsive, lost, or undetected.
	Conflict between a transmitter and receiver is detected.
	Fast switching between transmitters is enabled.
	Fast switching between transmitters isn't enabled.
	Access to monitor management. Select the monitor (or monitors) to use when connecting to a transmitter.

7.2 Allowing a connection between devices

- 1 From the main menu of Extio Central Manager, select **Connection broker**.
- 2 If you created a group for your Extio devices, click **Filter by group**, select the group, then click **Close** (see “7.3 - Filtering by group”, page 26).

- 3 Click the (✓) icon to allow the connection between your Extio transmitter and receiver devices.
- 4 When you're done, click **Apply** to apply your changes.

7.3 Filtering by group

You can filter your devices by *group*. To filter your groups, select the groups you want to view, then click **Close**. To select all the groups, select **Select all**.

7.4 Select the monitor to use

Select the monitors to use when connecting to a transmitter. A disabled output means that monitor won't be used when connecting to a transmitter.

- 1 From the main menu of Extio Central Manager, select **Connection broker**.
- 2 Click the monitor (🖥️) icon from the row and column corresponding to the receiver and transmitter.
- 3 From the **Selected outputs** section, select the monitors to use when connecting to that transmitter. The outputs represent the physical connections on your transmitter. For example, to use a 4Kp60 resolution, disable outputs 1, 2, and 3, and select only output 4 (connector 4). If you don't want to use an output, click that output. When the output is disabled, the monitor icon (🖥️) turns black (⬛). To enable a disabled output, click that output.

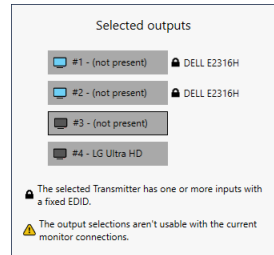

8 Managing users

To be able to access and use a device, a user must be added to that device and given privileges.

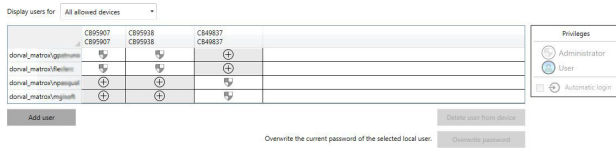

8.1 Adding users

To add a user to a device:

- 1 Click **Add user**, then enter a user name. Specify if you're adding a **Local user** or a **Domain user**.
- 2 When you're done, click **OK**.
- 3 Click the **Add** (+) icon for each device you want to add the user to, and select the device privileges the user should have (**User** or **Administrator**) under **Privileges**. For more information on privileges, see "8.4 - Granting privileges", page 28. Users can log into a receiver and connect to a transmitter. To be able to connect to a transmitter, that connection must also be allowed in the **Connection broker** (see "7.2 - Allowing a connection between devices", page 25).

When granting privileges, you can view only the users and the connections allowed for a device by selecting that device next to **Display users for**.

- 4 Repeat [step 1](#) to [step 3](#) for each user you want to add.
- 5 When you're done, click **Apply**. This creates a **Summary of the local users created** and generates a device password for each local user.

To copy the summary to the clipboard, click **Copy to clipboard** ().

- 6 To close the dialog box, click **OK**.

8.2 Deleting users

To delete a user from a device:

- 1 Select the user you want to delete, then click **Delete user from device**.
- 2 When you're done, click **Apply**.

8.3 Overwriting a password (local users only)

To overwrite the password of a local user:

- 1 Select the user whose password you want to overwrite, then click **Overwrite password**.
- 2 Enter the new password, confirm the password entered, then click **Change**. (We recommend you take note of the new password.)
- 3 When you're done, click **Apply**.

8.4 Granting privileges

You can grant device **Administrator** (🛡️) or **User** (👤) privileges to a user.

- **User** - A user with **User** privileges for a device can:
 - Operate a receiver and perform any operation available on the receiver through the on-screen display, such as connecting to or disconnecting from transmitters, changing volume, and more.
 - Use the Extio Central Manager for the device in read-only mode, that is, the user can't make changes to the device settings.
- **Administrator** - A user with **Administrator** privileges for a device can:
 - Operate a receiver and perform any operation available on the receiver through the on-screen display, such as connecting to or disconnecting from transmitters, changing volume, and more.
 - Change the settings for the device through Extio Central Manager or the API.

If **Automatic login** (🔄) is allowed for a device, this is also displayed (see “8.5 - Logging in automatically (local users only)”, page 28).

8.5 Logging in automatically (local users only)

To automatically log a local user into the On-Screen Display (OSD), select the **Automatic login** permission. When this option is selected, the **Logout** button is disabled in the OSD unless the user has **Full control** access on the OSD (Receiver settings > **OSD (on-screen display) control** > **Full control**).



Note: When **Automatic login** is enabled, you should not use the **Log out users when idle** option in the OSD page of the receiver settings as this could lead to conflicts.

9 Testing network bandwidth

You can use the **Network bandwidth test** feature to determine the expected performance from a connection between an Extio 3 transmitter and a receiver pair. This is especially useful when an Extio 3 receiver connects to an Extio 3 transmitter through a WAN or VPN connection where the available bandwidth is normally more limited than on a typical LAN. You can do this testing during initial installation or for troubleshooting purpose.



Note: Bandwidth testing could use up a significant portion of the available network bandwidth. Testing should be carefully considered and managed by the administrator.



Note: You cannot connect to, change settings, or do other operations on the units that are involved in the testing while the testing is being executed.

9.1 Test the network bandwidth of a Tx-Rx connection



Note: The test results are impacted by any network traffic, including the network bandwidth used by any other units connected to the network that are not involved in the testing. Hence, prior to starting the test, it is highly recommended to ensure that all the other Extio 3 units on the same network segment that are not part of the testing do not stream when the test is run to get a more meaningful test result.

To get an understanding of the expected performance of a connection between a specific transmitter and receiver:

- 1 Select **Network bandwidth test** from the main menu.

The **Network Bandwidth Test** screen appears.

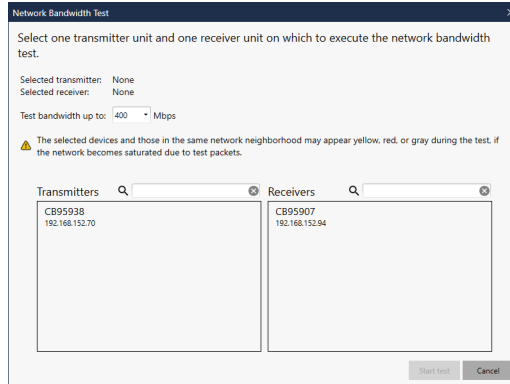

- 2 The **Test bandwidth up to** field defaults to **400 Mbps** which is the maximum bit rate that can be tested. Change this if required.
- 3 Select a transmitter unit from the **Transmitters** section.
- 4 Select a receiver unit from the **Receivers** section. **Note:** Only the receivers that are configured to run over WAN or internet (**Rx** → **Network** → **Adapt for WAN / LAN**) will be visible in this list. The **Start test** button gets enabled.

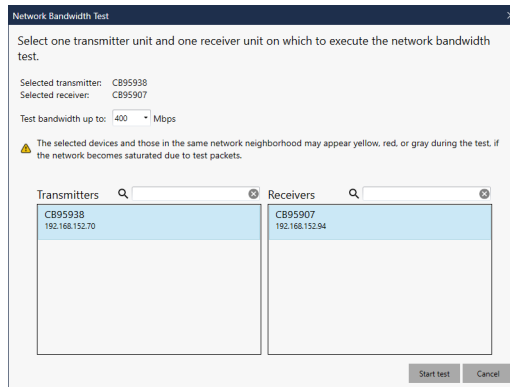

- 5 Click the **Start test** button.

The test procedure will take a few minutes to complete (there is no visual clue to indicate the progress of the test procedure).

The units involved in the testing will be disconnected during the test period.

The device tile of the units involved in the testing show the status as **Testing network bandwidth**.



An information bar on top of the main screen shows **Network bandwidth test in progress on transmitter xxxxxx and receiver xxxxxx**.



In the **Network** page of the receiver appliance, **Network bandwidth test in progress** informatory message displays on top.



In the **Connection** page of the transmitter appliance, **Network bandwidth test in progress** informatory message displays on top.

When testing is complete, the information bar on top of the screen changes to **Network bandwidth test has completed on transmitter xxxxxx and receiver xxxxxx**, and the **Download results** and **View results** buttons display. When you click **View results**, the test results are shown on the screen in a message box.

- 6 Click the **Download results** button to download the file with the details of the test results. Once the file is downloaded, a confirmation screen displays including the path where the file is saved (default path is My Documents), with the **OK** and **Open file location** button options. Click **Open file location** to access the test results file.

You can also download and save the test results file any time later by right-clicking the device tile and selecting the **Download latest network bandwidth test results [Date-Time]** option. **Note:** This is available for the receivers only and not for transmitters.

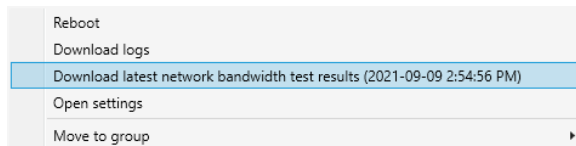

10 Extio 3 Transmitter (Tx) settings

This enables you to view, configure, and manage the settings specific to an Extio 3 Transmitter (Tx) device.

10.1 Sharing mode

Use this to select if and how to share your transmitter with a guest.

Guest connections	<ul style="list-style-type: none">▪ No guest allowed – Don't allow guest connections.▪ Guest allowed (without USB devices) – Allow guest connections. The first user connected to the system has control of keyboard and mouse. Guest connections can connect to the system, but don't have control of USB devices (no keyboard or mouse).▪ Guest allowed (with USB devices) – Allow guest connections. Guest connections have control of keyboard and mouse.
Show name of user connected	Show the name of the user who's connected to the device.
Show previews when a user is connected	Show a monitor preview in the On-Screen Display (OSD) when a user is connected to the selected receiver.

10.2 EDID

EDID management features enable you to select which EDID settings are used by the input connectors on your Extio 3 transmitter device.

EDID management

Inputs	
1: Dell Computer Corp. - DELL P2212H	Cached EDID
2: Dell Computer Corp. - DELL 2009W	Cached EDID
3: No monitor	Cached EDID
4: No monitor	Cached EDID

Current EDID	
Manufacturer: Dell Computer Corp.	
Model: DELL P2212H	
Serial number: NDMRP1C04AAM	
Preferred mode: 1920 x 1080 @ 60.00	
EDID mode	
<input checked="" type="radio"/> Cached	
<input type="radio"/> Fixed	
Manufacturer: Dell Computer Corp.	
Model: DELL P2212H	
Serial number: NDMRP1C04AAM	
Preferred mode: 1920 x 1080 @ 60.00	
Use EDID from file:	<input type="button" value="Import"/>
Report no monitor	<input type="button" value="No monitor"/>
Use current EDID	<input type="button" value="Use current"/>

10.2.1 Using a cached EDID

If a monitor *is* connected to an output connector on the receiver, your transmitter will use the EDID settings of that monitor.

If a monitor *isn't* connected to an output connector on the receiver (for example, if your monitor was disconnected), your transmitter uses the EDID settings of the monitor that was last connected to that output connector.

10.2.2 Using a fixed EDID



Note: To avoid unwanted changes to the source system, we recommend using a fixed EDID on all transmitter inputs (including inputs not connected to the system).

If a monitor *is* connected to an output connector on the receiver, your transmitter uses the EDID settings of that monitor. If a monitor *isn't* connected to an output connector on the receiver, no EDID is applied.

You can use the EDID from a file or disable the EDID information.

10.2.3 Using the EDID from a file



Note: You must export your EDID settings before you can import them. For information, see [“11.2.4 - Exporting EDID settings to a file”](#), page 44.

- 1 From the list, select the monitor (output) you want to use.
- 2 Make sure the output is set to use a **Fixed** EDID.
- 3 Next to **Use EDID from file**, click **Import**.
- 4 Browse to the location where you saved your EDID file, and open your EDID file (*.bin*).
- 5 Click **Apply** for your changes to take effect.

10.2.3.1 Reporting no monitor

When using the following resolutions, make sure your transmitter reports only the monitor supported.

Resolution	Number of monitors supported
3840 × 2160 @ 60 Hz	1 (connector 4)
3840 × 2160 @ 30 Hz	2

2560 × 1600 @ 60 Hz	2
1920 × 1200 @ 60 Hz	3

Your transmitter must report the other monitors as disconnected (no monitor). To configure your transmitter to report the monitors that are disconnected:

- 1 From the list, select the monitor (output) that's not used by your transmitter. Make sure the output is set to use a **Fixed** EDID.
- 2 Next to **Report no monitor**, click **No monitor**.
- 3 Repeat steps 1 to 3 for each monitor (output) that's not used by your transmitter.
- 4 Click **Apply** for your changes to take effect.

10.2.3.2 Using the current EDID

- 1 From the list, select the monitor (output) whose EDID you want to use.
- 2 Make sure the output is set to use a **Fixed** EDID.
- 3 Next to **Use current EDID**, click **Use current**.
- 4 Click **Apply** for your changes to take effect.

10.3 Streaming

This contains the streaming and encryption settings for your device.

Encoding quality	Set the quality value for your encoding (Low , Typical , High , or Very high). The default is Typical . For Internet / WAN with Site-to-Site VPN mode, set the quality to Low .
Routing scheme	<ul style="list-style-type: none"> ▪ Unicast – Unicast streaming establishes a direct connection between a transmitter and a receiver. When selecting unicast, you can specify the destination IP address of the stream. For Internet support, you must select Unicast. ▪ Multicast – In multicast streaming, a single stream is received by all the receivers connected to the same multicast address. When transmitting to multiple receivers, a transmitter that's properly configured for multicast transmission uses less bandwidth. <p>The default value assigned to each multicast address can be seen in the Video In and Line In fields. An administrator can change these values if required. Using multicast may require additional network configuration to support the transmission protocol (some network switches and routers can block multicast signals). Multicast is the default Routing scheme. For more information, contact your network administrator.</p>

Multicast address	If Multicast is selected, a Multicast address field is provided for each video port.
Encrypt A/V stream	Secure your stream. This flag is enabled by default, in all operation modes. In cases where unencrypted audio and video streams are shared between an Extio 3 transmitter and Matrox Mura IPX powered video wall controllers, this flag should be deselected.
Third-party encryption	Encrypted audio and video streams can be shared between an Extio 3 transmitter (v3.04 or later) and Matrox Mura IPX (v3.08.00 or later) powered video wall controllers in unicast or multicast routing. For this, a password or passphrase known as an encryption key must be shared between both. For more information, see “10.3.2 - Configure the encryption key”, page 35. Note: This option is not applicable for Point-to-Point configurations. Note: When a Mura IPX client connects to the Extio 3 transmitter, the Extio 3 transmitter will display the guest connection using the net client name created by Mura IPX.

10.3.1 Exporting your Extio stream addresses (for display wall)

To use your Extio product with a display wall product, you need to export your Matrox Extio stream addresses. This enables your display wall to connect to your Extio transmitter device.

To export your Extio stream addresses (multicast addresses):

- 1 Click **Export Extio stream addresses**.
- 2 Browse to the location where you want to save your file.
- 3 When prompted, enter a **File name**, then click **Save**.

10.3.2 Configure the encryption key

You need to configure the encryption key to allow Extio to share encrypted video streams with a third-party, such as Mura IPX.

To configure the encryption key (shared password or passphrase):

- 1 Click the **Configure** button under **Third-party encryption**. **Note:** This button is enabled only when the **Encrypt A/V stream** flag option is enabled.

The **Extio Central Manager** pop-up screen displays.

- 2 Enter between 3 to 95 alpha numeric characters in the **Enter encryption key** field.

Your entry is validated as you type. **Note:** No special characters or blank space is allowed. The **Apply** button gets enabled only if the text you entered is in the valid format.

- 3 Click **Apply** to send the encryption key to the transmitter device.

The **Remove** button gets enabled. The “*Encryption key is already configured*” message displays above the **Configure** button.



Note: The **Configure** button is available even after the encryption key is sent to the transmitter. This allows you to change the password or passphrase whenever required.



Note: To stop sharing streams with Mura IPX, use the **Remove** button to remove the encryption key from the transmitter.

10.4 Network

This contains the network settings (**LAN 1** and **LAN 2**) for the connection and IP address of your device.

Link redundancy
Link redundancy is currently disabled **Change**

LAN 1 1000 Mb/s Full duplex	LAN 2 (ethernet interface not used)
IP address <input type="radio"/> Dynamic IP address (DHCP) <input checked="" type="radio"/> Static IP address	IP address <input checked="" type="radio"/> Dynamic IP address (DHCP) <input type="radio"/> Static IP address
MTU <input type="text" value="1500"/>	MTU <input type="text" value="1500"/>
IPv4 address <input type="text" value="192.168.129.35"/>	IPv4 address <input type="text"/>
IPv4 netmask <input type="text" value="255.255.240.0"/>	IPv4 netmask <input type="text"/>
IPv4 gateway <input type="text" value="192.168.128.1"/>	IPv4 gateway <input type="text"/>
DNS servers <input type="text" value="192.168.225.20 192.168.225.21"/>	DNS servers <input type="text"/>

Adapt for WAN / LAN
Currently adapted for LAN **Change**

Network congestion control

Security Options
IGMPv3

IEEE 802.1X
 This feature requires a certificate to be deployed on the device. To use this feature, install the certificate using the firmware updater.
 Enable EAP-TLS
EAPOL Version



Note: When the IP address or the method of assigning an IP address to a device changes, you need to reboot the device for the changes to take effect.

10.4.1 Enabling link redundancy



Note: *Before* enabling this option, make sure your Extio 3 devices are on the same subnet and connected to a switch. If you're using multiple switches, your switches must be connected to each other. For more information on connecting your Extio 3 device, see “16 - Appendix A – Setting up link redundancy”, page 79.

Enable the link redundancy option to ensure network availability in case of network cable or switch failure. In the case of a network cable or switch failure, your device will automatically switch to a secondary network path. Depending on your network, switching may take up to 5 seconds.

To enable the option, click the **Change** button beside the **Link redundancy is currently disabled** label. This option must be enabled on both your transmitter and receiver devices.

10.4.2 Dynamic IP addressing

By default, **Dynamic IP address (DHCP)** is used. Extio Central Manager automatically detects all the Extio 3 devices in the same subnet as your controller system through the UPnP (Universal Plug and Play) protocol.

10.4.3 Static IP addressing

Once Extio Central Manager has detected a device, you can manually assign a static IP address to your device through the **Network** settings of your Extio 3 product.

You must specify the following:

IPv4 address	An IP address between 192.168.0.0 and 192.168.255.255 (recommended). Also, we recommend you assign an IP address within the subnet of your network.
IPv4 netmask	The netmask defining group of IP addresses in your subnet. By default, the subnet mask is 255.255.255.0.
IPv4 gateway	The gateway is often the same as your IP address, but the last byte may be 0 or 1.
DNS servers	The address of your DNS (Domain Name System) server or servers. If multiple addresses are entered, separate each address with a space.

For more information on assigning a static IP address, contact your network administrator.

10.4.4 Maximum transmission unit

The Maximum Transmission Unit (MTU) range supported is 1280 to 1500. The default is set to 1500. For a private Wide Area Network (WAN) deployment, we recommend that you set this to 1400 when configuring your units initially, and adjust as needed.

10.5 Date and time

Use this to update the date, time, and time zone of your Extio 3 device. For more information, see [“13 - Adjusting the date and time of your device”](#), page 72.

10.6 More options



Note: Depending on your Matrox Extio 3 Series product, certain options may not be available.

Power recovery policy	Set up your Extio device to start up after a power loss. <ul style="list-style-type: none">▪ Never start – Never turn on your Extio device after a power loss.▪ Always start – Always turn on your Extio device after a power loss.▪ Restore last state – Always turn on and restore the last state of your Extio device after a power loss.
Power button control	To prevent your device from being manually shut down, enable the Disable shutdown option.
Reboot control	To remotely force a reboot of your device if it stops responding, enable the Enable force reboot option.
Wake-on-LAN control	To remotely wake up an Extio device, enable the Enable Wake-on-LAN option.
Advanced display modes	Extio N3408 devices only – Enable the Enable advanced display modes option to support the following display modes: <ul style="list-style-type: none">▪ 1× 3840 × 2160 @ 60Hz + 1× 1920 × 1080 @ 60Hz▪ 1× 3440 × 1440 @ 60Hz + 1× 1920 × 1080 @ 60Hz▪ 4× 2560 × 1600 @ 60Hz▪ 4× 1920 × 1200 @ 60Hz

<p>Local console</p>	<ul style="list-style-type: none"> ▪ Enable local console on the transmitter – This is applicable in both network and point-to-point modes. When this option is selected, a user with access to a transmitter can gain access and take control of the source PC by attaching a keyboard, monitor, and mouse to the transmitter. The user can take control individually, or simultaneously with another operator on a connected receiver. <p>The first video signal of the source PC displays when a monitor is attached. You can cycle through the input signals with the [Scroll-lock] key. Note: If parts of the desktop content are not visible at first, you can navigate to them using the keyboard and mouse.</p> <p>When no video signal is provided by the source PC, a symbol representing no signal () displays on the local output.</p> <p>Note: 1) The signal sent to the monitor attached to the transmitter is limited to 30 FPS (this refers to the update cadence and not the refresh rate). If the resolution of the input signal fed to the monitor is above HD, the signal is scaled down to HD and limited to 15 FPS. 2) When the source PC signal sent to the monitor exceeds the maximum resolution of the monitor, the source PC signal is scaled. This could result in text that might be hard to read.</p>
<p>Logs</p>	<ul style="list-style-type: none"> ▪ Download diagnostic device logs – Download the log files. This file contains information on your Extio devices. This information is used by Matrox Technical Support for debugging purposes. ▪ Download administrative device logs – Download the VPN log files related to configuring and establishing the VPN connection. The logs are not password protected and can be used by your IT team to diagnose and troubleshoot the VPN configuration and connection issues. ▪ Erase device logs – Erase the log files created for your Extio devices.
<p>Audits</p>	<ul style="list-style-type: none"> ▪ Download device audits – This file contains information on the user interactions with your Extio devices. This information is used by your Extio administrator.

<p>Troubleshooting</p>	<p>The following options are useful for troubleshooting your devices:</p> <ul style="list-style-type: none"> ▪ Audio – To disable the audio on your Extio 3 device, enable the Disable audio option. Your device will reboot for this change to take effect. ▪ Debug configurations – Get help and troubleshooting information for your configuration. For more information, contact Matrox Technical Support.
<p>Locate transmitter card</p>	<p>Transmitter card only – To see where your Extio 3 transmitter card is located, enable the Enable LED to locate card option. The card can be identified by a red LED light on the bracket of the card.</p>

11 Extio 3 Receiver (Rx) settings

This enables you to view, configure, and manage the settings specific to an Extio 3 receiver (Rx) device.

11.1 Connection

This enables you to remotely connect a receiver to a transmitter, or to multiple transmitters in an aggregated layout, to disconnect a transmitter, or to disconnect multiple transmitters in an aggregated layout, and to switch connections. For more information on aggregated layout, see “11.3 - Aggregator mode”, page 45.

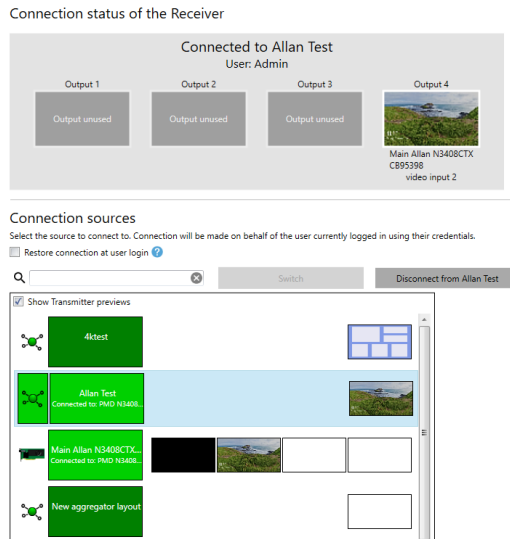

11.1.1 Connection status of the receiver

This shows the name and IP address of the transmitter device or the aggregated layout connected to the receiver. Depending on the connection settings of the transmitter, this may also show the name of the user connected to the transmitter device (see “10.1 - Sharing mode”, page 32). The transmitter name and input source details are shown for each output connected.

To stop this connection, click **Disconnect**.

11.1.2 Connection sources

This shows the transmitter devices and the aggregated layouts that are available to be connected to the receiver, based on the connections specified in the connection broker. The connection is limited to the transmitters on which the currently logged-in user has access. If this user does not have access to *some* of the transmitters in the aggregated layout, it will result in a partial application of the aggregated layout and a black screen displays with a message in the center for the streams to which the user doesn't have access. If the user doesn't have access to *any* of the transmitters in the aggregated layout, the aggregated layout can't be applied in the Extio Central Manager.

Note: From Extio Central Manager, you can't switch to a different source when you are already connected to an aggregated layout that includes Dynamic sources. You have to do this from the OSD.

For information on setting an allowed connection between a receiver device and a transmitter device, see “7 - Using the connection broker”, page 25.

Switch	If you're <i>already</i> connected to a transmitter or an aggregated layout, select the transmitter or the aggregated layout you want to switch to from Connection sources , then click Switch .
Connect	If you're <i>not</i> connected to a transmitter or an aggregated layout, select the transmitter or aggregated layout you want to connect to from Connection sources , then click Connect .
Disconnect from X	If you're connected to a transmitter or an aggregated layout and want to stop the connection, click Disconnect from X .
Show transmitter previews	Enable this to see the previews of connection sources. When this is not selected, only the transmitter details are shown without any previews.
Restore connection at user login	If enabled, the connection will be restored automatically the next time the <i>same</i> user logs in.

11.2 Monitors

This lists the monitors currently connected to your transmitter device. This also enables you to export the EDID settings of your monitors to a file. If you use the aggregator mode, you need to define the physical monitors' layout here.

The screenshot shows a configuration interface for monitors. It is divided into several sections:

- Monitor power saving:** Includes a checked checkbox for "Allow monitors to enter power saving mode" and a dropdown menu for "Turn off the display" set to "15" minutes.
- Aggregator mode:** Includes a section for "Behavior of unused monitors" with a dropdown menu set to "Put monitors in standby", and a section for "Physical layout" with a dropdown menu set to "4 x 1" and a "Reorder monitors" button.
- Monitor connections:** Includes a checked checkbox for "Optimize video mode compatibility with monitors".
- Export EDID:** Includes a "Select a monitor:" dropdown menu set to "Monitor 1: No monitor detected" and an "Export" button.

At the bottom of the physical layout section, there is a visual representation of a 4x1 monitor array with four numbered boxes (1, 2, 3, 4). Box 4 is highlighted in blue.

11.2.1 Monitor power saving

Enable **Allow monitors to enter power saving mode** to turn off the display after X minutes of inactivity. When you're done, click **Apply**.

11.2.2 Monitor connections

11.2.2.1 Optimizing video mode compatibility

Different monitor models can support different video parameters (such as resolutions, formats, or EDID). In a setup with multiple displays, the image quality or performance of different displays may vary. The **Optimize video mode compatibility with monitors** option can improve image quality of your displays and optimize monitor compatibility with your device. This option is enabled by default.

11.2.3 Aggregator mode: Behavior of unused monitors

Aggregator mode only – Select how to manage the monitors that are part of your layout but not in use (for example, if your monitor layout is made up of 4 monitors, but only 2 monitors are currently being used). You can choose to keep your unused monitors awake or force them into standby mode.

Put monitors in standby	Force all monitors not used in the monitor layout into standby mode.
Keep monitors awake	Keep all monitors not used in the monitor layout awake.

11.2.4 Exporting EDID settings to a file

- 1 Choose the monitor whose EDID you want to export, then click **Export**.
- 2 Save your EDID file (*.bin*).
- 3 When prompted, click **OK**.

For more information, see “10.2 - EDID”, page 32.

11.2.5 Physical layout

You need to define the physical position of the monitors for aggregator mode here.

- 1 From the **Monitors** page, click the **Reorder monitors** button under the **Physical layout** section.
- 2 Choose a configuration from the drop-down list.

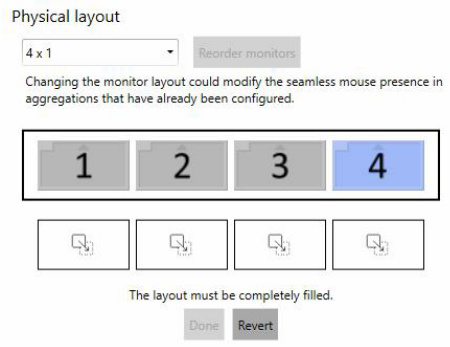

- 3 Drag and drop the displays one by one into their correct position on the layout.

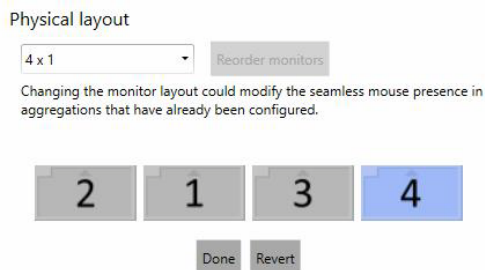

- 4 Click **Done**.

You can also use **Physical layout** to match the layout with the physical wiring and placement of the monitors. When the actual sequence of wiring of monitors is different from the sequence in the layout, you can reorder the monitors by dragging and dropping them into the right sequence and then clicking **Done**. You can use **Revert** to undo the changes and go back to the original layout.

11.3 Aggregator mode

With aggregator mode, you can have multi-system control from a remote workspace using aggregated layouts.

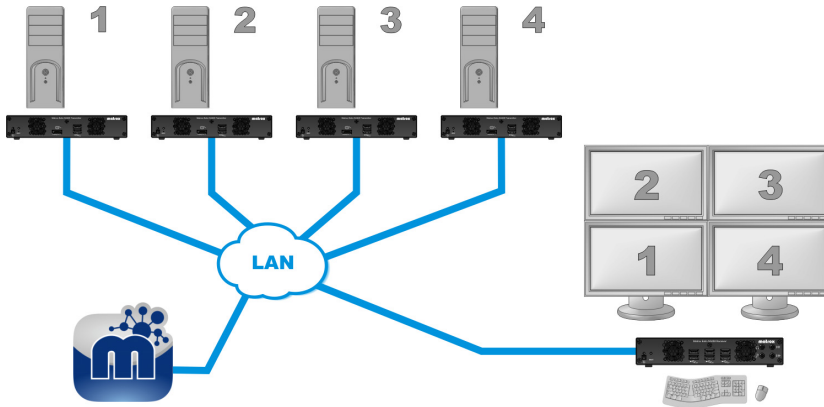

11.3.1 Aggregated layouts

Using aggregated layouts, your Extio 3 receiver unit can gather video streams from multiple transmitter units into a single layout.

There are different types of layouts that you can choose for an aggregated layout:

- **Standard** - A standard layout configuration contains outputs displaying a single stream each.
- **Tile display** - A tile display configuration is one where streams can be displayed in multiple tiles in a 4K monitor. A 4Kp60 resolution tile display can be configured on Output 4 only. You can also have two 4Kp30 resolution tile display configurations in a layout using Outputs 1 and 4.
- **Dynamic sources** - A dynamic sources configuration in the aggregated layout lets you switch between transmitter sources dynamically. **Note:** Only one display in a layout can be dedicated to dynamic sources. You cannot have dynamic sources in a tile display.

11.3.2 Before you begin

- **Fixed EDID** - Make sure the **Fixed EDID** option is enabled. Aggregator mode is supported only with **Fixed EDID**, except for aggregated layouts with tile displays which need to have **Cached EDIDs** initially when configuring. After configuring aggregated layouts with tile displays, we recommend setting **Fixed EDIDs** on the transmitter units for maximum compatibility. **Note:** The **Fixed EDID** option is used for aggregator mode only.
- **Audio configuration** – Review your system’s Windows® audio settings to know which DisplayPort output is configured to use audio. Depending on your audio configuration, we also recommend you review the following:
 - **Digital audio to displays with speakers** – Make sure the host systems are using the video output of the graphics card as the destination for the sound.
 - **Digital audio to analog (Headphone or Line Out)** – Select a receiver, then go to the **Audio** page. Make sure you select the proper **Headphone audio source** and **Line Out audio source** for the **Video In** of the transmitter unit.
 - **Analog audio (Line In)** – Verify where the **Line In** you want is coming from (for example, **Line In** from the transmitter on monitor 1, 2, 3, or 4), or if you want **Line In** to follow the mouse position.
- **Physical layout** - Make sure the layout of the physical monitors are defined before you start creating an aggregated layout.
- **Operating system** - Certain limitations may occur. For more information on operating system compatibility with aggregator mode, see the Matrox Extio 3 Series Release Notes.

11.3.3 Dynamic sources

You can dynamically change the transmitter source (stream from a system) displayed on one of the monitors attached to a receiver in aggregator mode. This enables you to easily access and switch between different systems from a large group (pool) of systems to view the stream currently of interest to you, without affecting the other displays.

- You can dedicate only one monitor to using dynamic sources in aggregator mode. The other monitors need to have fixed sources assigned to them.
- The dynamic sources feature is supported only while using aggregator mode.

11.3.4 Tile displays

Using tile displays, you can view multiple video streams from one or more transmitters, on a single monitor. A tile display is composed of multiple tiles. A single 4Kp60 resolution tile display, or two 4Kp30 resolution tile displays can be used in a layout.

- The monitor must be 4Kp60 or UHD (3840 x 2160 @60Hz).
- Each stream should be a maximum of HD (1920 x 1080 @60Hz) resolution.
- The Dynamic sources feature is not supported in tile displays.
- Touch screens are not supported in tile displays.

11.3.5 Configure a new aggregated layout

To configure a new aggregated layout:

- 1 From the receiver’s settings menu, select **Aggregator mode**.
- 2 Click **Create new layout**. The **Aggregator mode editor** page appears with the **Available transmitters** list on the left containing the transmitters that this receiver is allowed to connect to as defined in the connection broker, and the **Layout** and **Audio** tabs on the right. **Note:** An **RS232** tab appears to the right of the **Audio** tab when **Use destination defined in aggregated layout** is selected in the **Aggregator mode: RS232 destination** field on the **RS232** settings page.

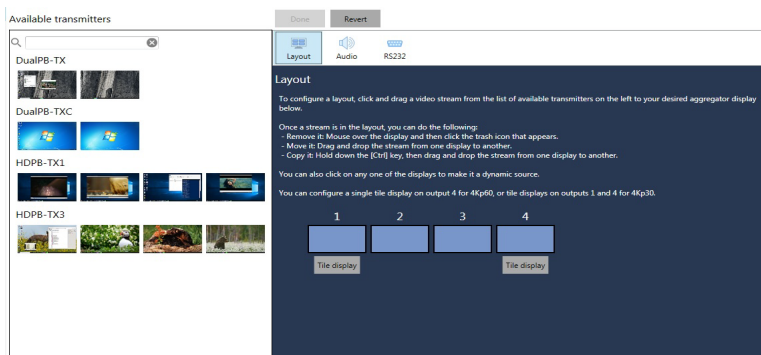

- 3 Enter a name for the layout in the **Layout name** box on top.



- 4 In the **Layout** tab, a standard layout appears with the number of displays equal to the number of monitors specified in the physical monitors layout on the **Monitors** setting. For more information, see “11.2.5 - Physical layout”, page 44. Select the type of aggregated layout you want. You can have a standard aggregated layout, an aggregated layout with dynamic inputs on one of its displays, an aggregated layout with one 4Kp60 tile display on display 4 (no streams on any of the other displays), or an aggregated layout with a 4Kp30 tile display on display 1 and another 4Kp30 tile display on display 4 (no streams on displays 2 and 3 in this case).

- **Standard layout:** The layout defaults to a standard layout so you do not have to select anything. You can proceed to step 5 to select the streams.
- **Dynamic sources layout:** If you want to enable a display to show dynamic sources, click the box representing the display in the layout. The display is now labeled as **Dynamic sources**. **Note:** You can assign only one display to show dynamic sources.



- **Tile display layout:** If you would like to have a 4Kp60 resolution output, click the **Tile display** button under display 4 and select one of the pre-configured layouts from **Tile layout**. If you would like to have two 4Kp30 resolution outputs, click the **Tile display** button under display 1 and 4 and select a pre-configured layout from **Tile layout**. **Note:** The tile layout you select here will be displayed in the **Sources** list in the On-screen display (OSD) for easy identification of the connection source.

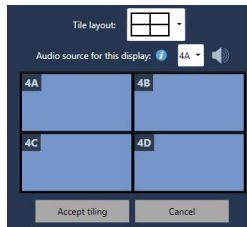

5 Select your video streams.

- **Standard layout:** Click a video stream (tile) from the list on the left and drag it onto the proper display. Repeat this for every stream you want to add to your layout.
- **Dynamic sources layout:** **Note:** Selecting a stream or switching from one stream to another for dynamic sources has to be done from the On-screen display (OSD). If you drag and drop a stream into the **Dynamic sources** display in the aggregated layout from the Extio Central Manager, the dynamic sources assignment to the display will be removed and the **Dynamic sources** label under the display will disappear.
- **Tile display layout:** On displays 1 and 4, you can have tile displays. For a 4Kp60 resolution output, you can drag and drop streams onto the tiles within the tile display on display 4 only. **Note:** In this case, you will not be able to assign streams for displays 1 to 3. For 4Kp30 outputs, you can drag and drop streams onto the tiles

within the tile display on displays 1 and 4. **Note:** In this case, you will not be able to assign streams to displays 2 and 3.



Note: To copy a stream from one display to another, press the **[Ctrl]** key while dragging and dropping the stream onto the target display.

You can remove a stream from the layout by clicking the **Delete** () icon when hovering over the preview.

- 6** For a tile display, select the tile where the digital audio stream will play in **Audio source for this display**. The audio icon displays on the selected region. For a 2 x 2 configuration, the options are 1A, 1B, 1C, and 1D. You can also drag and drop the audio icon onto the tile. In this case, the **Audio source for this display** selection changes correspondingly. Click **Accept tiling**.
- 7** Click the **Audio** tab if you would like to configure the analog audio source for your streams.
- 8** Select the proper options for **Headphone audio source**, **Line Out audio source**, and **Microphone or Line In audio source (from Receiver)**.

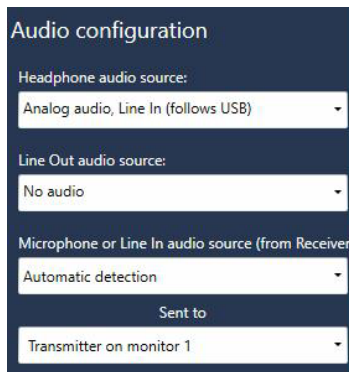

Audio configuration

Headphone audio source:
Analog audio, Line In (follows USB) ▾

Line Out audio source:
No audio ▾

Microphone or Line In audio source (from Receiver)
Automatic detection ▾

Sent to
Transmitter on monitor 1 ▾

- **Headphone audio source** – Select the audio source (for your headphone) from the transmitter.
- **Line Out audio source** – Select the audio source (for your Line Out device) from the transmitter.

- **Microphone or Line In audio source (from Receiver)** – Select the input audio source (for your Microphone or Line In device) from the receiver. From **Sent to**, select the destination.



Note: Doing this step may overwrite the audio settings already configured through the **Audio** settings page. If audio was already configured through the **Audio** settings page, skip this step.

- 9 Click the **RS232** tab to designate a tile in a tile display as the RS232 destination.
- 10 In the **RS232 destination** field, select one of the options: **None**, **Transmitter on monitor 1**, **Transmitter on monitor 2**, **Transmitter on monitor 3**, or **Transmitter on monitor 4**.



- 11 When you're satisfied with the aggregated layout, click **Done** on top of the page. This new aggregated layout now appears in the list of aggregated layouts on the left of the screen.
Note: This aggregated layout is still not sent to the receiver.
- 12 Click **Apply** for the changes to take effect. The aggregated layout is sent to the receiver and will be listed on the **Connections** page.

11.3.6 Edit an aggregated layout

To edit an aggregated layout:

- 1 Select the aggregated layout from the aggregated layouts list on the **Aggregator mode** page.
- 2 Click the **Edit** (✎) icon.
- 3 Make your changes, then click **Done**.
- 4 Click **Apply** for the changes to take effect.

11.3.7 Remove an aggregated layout

To delete an aggregated layout:

- 1 Select the aggregated layout from the aggregated layout list on the **Aggregator mode** page.
- 2 Click the **Delete** (✖) icon.

- 3 In the confirmation message, click **OK** to permanently remove the layout..



Note: If you delete an aggregated layout while it is currently in use by the receiver, the receiver will be disconnected.

- 4 Click **Apply** for the changes to take effect.

11.3.8 Connect to an aggregated layout

To connect to an aggregated layout:

- 1 Select the aggregated layout from the **Connection sources** list on the **Connections** page.
- 2 Click the **Connect** button if you are not connected to any connection source (transmitter device, or an aggregated layout), or select a new source and click **Switch** if you are already connected to a connection source.
- 3 The **Connection status of the receiver** section shows the aggregated layout you selected as the connection source the receiver is currently connected to.

11.3.9 Disconnect from an aggregated layout

To disconnect from an aggregated layout:

- 1 Make sure the aggregated layout is highlighted in the **Connection sources** list on the **Connections** page.
- 2 Click the **Disconnect from x** button.
- 3 The **Connection status of the receiver** section shows **Not connected**.

11.3.10 Monitor and control

Once you are connected to an aggregated layout, you can monitor and control the computer systems remotely. There are temporary and constant visual cues to identify which source PC is under your current control via the mouse, keyboard, or other HID USB device.

11.3.11 Switch sources via mouse and keyboard shortcuts

By default, you can use your mouse to navigate between displays and to switch seamlessly between sources. As the mouse crosses the edge of a display to another display, you take control of the target desktop. You can readily identify the target desktop by reading the friendly name of the transmitter attached to it that is shown on the monitor. This overlay message displays for a brief period of time as soon as the transition happens. For a more constant visual confirmation of where your current USB

input focus is, a colored border is shown around the video streams (all monitors or tiles regions) that originate from the target desktop. Administrators can enable or disable this border, and also customize the color of the border through a setting in the Extio Central Manager (Receiver settings > **OSD > Show the USB input focus border indicator**).

You can also use a keyboard shortcut to switch sources. To use *only* keyboard shortcuts to switch sources, select a receiver, then go to the **Keyboard shortcuts** page, and enable the **Use only keyboard shortcuts (no mouse) for USB switching** option.

11.3.12 Navigate between tiles using keyboard shortcut

You can use keyboard shortcuts to move between tiles in a tile display. When you are in a tile display, repeat the keyboard shortcut for the display to move between the tiles. The navigation sequence depends on the order of the definition of the tiles in the display configuration as specified in the firmware. For a 2 x 2, you will be cycling from top left to top right, followed by bottom left, then bottom right, then back to top left.

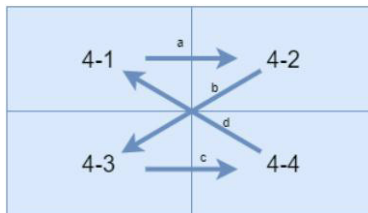

11.3.13 Alerts and troubleshooting messages

Messages that inform the user or help to troubleshoot are displayed on the corresponding tile of the tile display.

Issue	Cause and message
Loss of stream	When you're unable to connect to a stream, the corresponding region remains black. When connection takes more than a couple of seconds, the Connecting to message appears.
Loss of transmitter	When a transmitter is unreachable on the network, regions where streams from this transmitter should be displayed remain black and show the message transmitter name not present .
Loss of transmitter input signal	When a stream is missing because the corresponding input has no signal, its region remains black and shows the message Signal lost from transmitter name .

Stream resolution mismatch	When the resolution of a stream differs from that of the region, the stream is scaled to fit inside the confines of the region. When the aspect ratio of the stream differs from that of the region, black borders are used. The message Video scaler on is shown overlaid on the region.
Resolution too large to decode	A stream with a resolution above that of the region is likely to cause the receiver's decoder to exceed its decoding capacity. In this case the stream is not shown, the region remains black and shows the message Insufficient capabilities to support the operation .
Stream refresh rate mismatch	When the frame rate of a stream differs from that of the display, the message Frame rate conversion on is shown overlaid on the region.
Frame rate too large to decode	A stream with a frame rate above that of the receiver's display is likely to cause the receiver's decoder to exceed its decoding capacity. In this case, the stream is not shown, the region remains black and shows the message Insufficient capabilities to support the operation .
Connection forbidden	When connecting to a transmitter whose user list has just changed, and the current receiver's user is not in the updated list, regions where streams from this transmitter should be displayed remain black and show the message Connection not allowed for username .
Guests forbidden	When connecting to a transmitter where another receiver is already connected and guests are not allowed, regions where streams from this transmitter should be displayed remain black and show the message Guest connections not allowed on transmitter name .
Network loss	When a receiver unit loses connection to the network, all regions remain black and the message Network unavailable is shown in the center of the whole display.
Secure network failure	When a secure network collapses and is being rebuilt, all regions remain black and the message Restoring connection is shown in the center of the whole display.

11.4 OSD (On-screen display)

OSD options enable you to control the level of information that a user sees in the OSD and also set the language options for the OSD and the keyboard.

OSD (on-screen display) control

Full control

Allows a user to connect to or disconnect from a Transmitter through the on-screen display (OSD) or keyboard shortcuts.

Hide overlay messages (except monitor identification information)

Show the USB input focus border indicator (visible in aggregator mode)

Border color #FF6495ED

No previews in the OSD

Sources list filter Filter out all transmitters, leaving only aggregations

Log out users when idle

Log out user after : 100 minutes of inactivity

 Automatic Logout should not be used while Automatic Login is enabled in Connection broker for this receiver

OSD visibility

Show OSD on:

Display 1

Display 2

Display 3  No monitor attached

Display 4  No monitor attached

Default OSD keyboard settings

Keyboard English (US)

OSD (on-screen display) control	<p>Select the level of control a user has for managing information in the OSD (On-screen display) control section:</p> <ul style="list-style-type: none">▪ Full control – Allows a user to connect to, or disconnect from a transmitter, through the on-screen display (OSD) or keyboard shortcuts.▪ Full control, less details – Allows a user to connect to, or disconnect from a transmitter, through the on-screen display (OSD) or keyboard shortcuts. Less details about the transmitter are provided in the OSD.▪ No control – Does not allow control in the on-screen display (OSD). Less details are provided in the OSD.
--	--

Overlay messages are shown over a video stream on the monitor(s) attached to a receiver. When the message refers to a device (normally a transmitter), the friendly name of the device is shown instead of the serial number. If you want to hide the overlay messages but keep the monitor information in the top left-hand of the display, enable the **Hide overlay messages (except monitor identification information)**.

Show the USB input focus border indicator (visible in aggregator mode) - Enable this if you want a border to be shown on the monitor or tiled regions in an aggregated layout where the streams come from the target desktop (where the current USB input focus is). You can pick the color to be used for the border from the **Border color** selection option.

For security reasons, if you do not want the user to see previews in the OSD, enable **No previews in the OSD**.

Sources list filter - Select **No filter** if all the sources have to be shown in the list. **Filter out all connected sources** and **Filter out incomplete aggregations** are the other options available. **Note:** An incomplete aggregation is an aggregation which has at least one transmitter that is not accessible (for example, when the transmitter is offline). Select **Filter out all transmitters, leaving only aggregations** if only aggregations have to be shown in the list by hiding the transmitters. **Note:** This is not applicable in the point-to-point mode of operation.

Log out users when idle - Enable this to automatically log out users after a certain time of inactivity. You can set the period after which the user will get logged out in the **Log out user after xx minutes of inactivity** field. You can set whole minutes only (without seconds). After being logged out, a popup message displays stating that the session has expired and takes the user to the log-in screen.

⚠ Note: This option should not be enabled if the **Automatic login** (🔄) permission is allowed for a device under **Manage users**.

Note: At the time you change this threshold period, if the receiver's current inactivity period exceeds this new threshold period, the user will be logged out immediately.

Note: While different inactivity threshold periods can be configured for different receivers on a given operator station, it is preferable to keep them the same.

<p>OSD visibility</p>	<p>Using this option you can control on which monitor or monitors the OSD needs to be displayed. A checkbox is available for each display and all the checkboxes are selected by default, meaning all the monitors will display the OSD.</p> <p>If you do not want the OSD to appear on a display, you need to deselect the corresponding checkbox.</p> <p>If no monitor is attached to an output, a warning message displays beside it.</p> <p>If no checkbox is selected, the Apply button remains disabled and a warning sign (red X) displays on the OSD tab.</p> <p>Note: When a checkbox is deselected, though the monitor will be dimmed and the OSD will not be displayed, overlay messages will be displayed.</p>
<p>Default OSD keyboard settings</p>	<p>Select the language of the keyboard connected to your receiver in Keyboard. This sets the default keyboard settings to use in your On-screen display (OSD) user interface.</p>

11.5 USB

USB device management options enable you to authorize and view which USB devices can connect to your Extio 3 receiver.

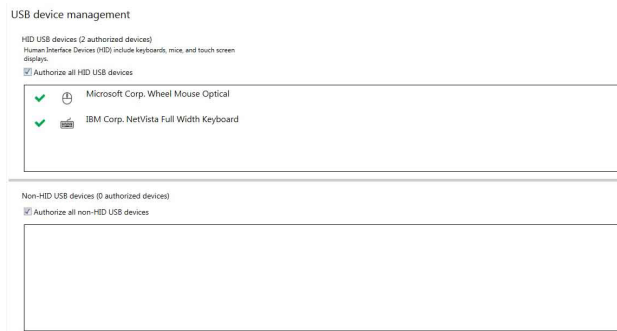

11.5.1 Authorizing USB devices

To authorize all HID (Human Interface Devices) USB devices, enable **Authorize all HID USB devices**.
 To authorize all non-HID USB devices, enable **Authorize all non-HID USB devices**.

A USB device that's authorized is identified as (✓). It also indicates if a USB device is currently **Connected** or **Disconnected**. You can manually block a USB device from being connected. To manually block a USB device, disable the option, then click the (✓) icon next to the selected device. A device that's blocked is identified as (⊘).

11.6 Audio

This contains the audio settings for your device.

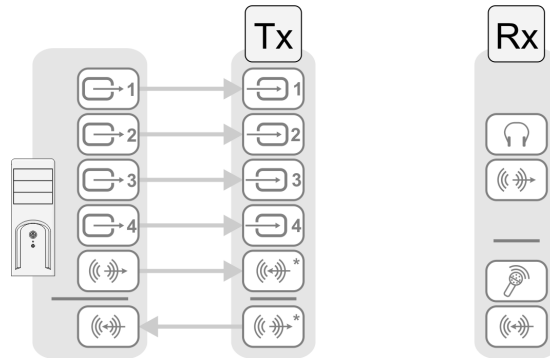

* N3408 device with four video sources from system and unique transmitter connection shown. The Line In and Line Out connectors aren't present on Extio 3 transmitter cards.

11.6.1 Configuring audio settings

Depending on your connection type (to a unique transmitter or to multiple transmitters), select your audio setting:

- **Mute audio on monitors when headphones are connected** – Select to mute audio on all the monitors when headphones are connected.
- **Override aggregated layout audio settings** – When selected, the settings below will be used for all aggregated layouts instead of the audio settings in the aggregated layouts.
- **Headphone audio source (from transmitter)** – Select the audio source (for your headphone) from the transmitter.
- **Line Out audio source (from transmitter)** – Select the audio source (for your Line Out device) from the transmitter.
- **Microphone or Line In audio source (from receiver)** – Select the input audio source (for your Microphone or Line In device) from the receiver.

For more information on selecting the proper audio settings for your configuration, see “17 - Appendix B – Configuring your audio settings”, page 81.

11.7 Transmitter discovery

This enables you to detect and connect to devices that are on multiple subnets, a WAN network, or a unicast-only network.

11.7.1 Discovery status of transmitters

This shows the name and IP address of the transmitter device connected to the receiver.

11.7.2 IP address to scan

Enter the IP address for the device you want to scan. When you're done, click **Add to list** → **Apply**.

11.7.3 Network to scan (CIDR notation)

Enter the CIDR (Classless Inter-Domain Routing) subnet mask for the network to scan. When you're done, click **Add to list** → **Apply**.

11.8 Network

This contains the network settings (**LAN 1** and **LAN 2**) for the connection, the WAN settings, the security options, and the IP address of your device. You can also set up the link redundancy option from here. **Note:** The options visible on the Network page may differ depending on your mode of operation.



Note: For devices that are in Internet with IPSec VPN mode, the **Network** configuration is not editable. You will only be able to view the details.

Link redundancy

Link redundancy is currently disabled **Change**

LAN 1	LAN 2
1000 Mb/s Full duplex	(ethernet interface not used)
IP address <input type="radio"/> Dynamic IP address (DHCP) <input checked="" type="radio"/> Static IP address	IP address <input checked="" type="radio"/> Dynamic IP address (DHCP) <input type="radio"/> Static IP address
MTU <input type="text" value="1500"/>	MTU <input type="text" value="1500"/>
IPv4 address <input type="text" value="192.168.129.35"/>	IPv4 address <input type="text"/>
IPv4 netmask <input type="text" value="255.255.240.0"/>	IPv4 netmask <input type="text"/>
IPv4 gateway <input type="text" value="192.168.128.1"/>	IPv4 gateway <input type="text"/>
DNS servers <input type="text" value="192.168.225.20 192.168.225.21"/>	DNS servers <input type="text"/>

Adapt for WAN / LAN

Currently adapted for LAN **Change**

Network congestion control

Security Options

IGMPv3

IEEE 802.1X

i This feature requires a certificate to be deployed on the device. To use this feature, install the certificate using the firmware updater.

Enable EAP-TLS

EAPOL Version

Networked-LAN mode



Note: When the IP address or the method of assigning an IP address to a device changes, you need to reboot the device for the changes to take effect.

11.8.1 Enabling link redundancy



Note: *Before* enabling this option, make sure your Extio 3 devices are on the same subnet and connected to a switch. If you're using multiple switches, your switches must be connected to each other. For more information on connecting your Extio 3 device, see “16 - Appendix A – Setting up link redundancy”, page 79.

Enable the link redundancy option to ensure network availability in case of network cable or switch failure. In the case of a network cable or switch failure, your device will automatically switch to a secondary network path. Depending on your network, switching may take up to 5 seconds.

To enable the option, click the **Change** button beside the **Link redundancy is currently disabled** label. This option must be enabled on both your transmitter and receiver devices.

11.8.2 Dynamic IP addressing

By default, **Dynamic IP address (DHCP)** is used. Extio Central Manager automatically detects all the Extio 3 devices in the same subnet as your controller system through the UPnP (Universal Plug and Play) protocol.

11.8.3 Static IP addressing

Once Extio Central Manager has detected a device, you can manually assign a static IP address to your device through the **Network** settings of your Extio 3 product.

You must specify the following:

IPv4 address	An IP address between 192.168.0.0 and 192.168.255.255 (recommended). Also, we recommend you assign an IP address within the subnet of your network.
IPv4 netmask	The netmask defining group of IP addresses in your subnet. By default, the subnet mask is 255.255.255.0.
IPv4 gateway	The gateway is often the same as your IP address, but the last byte may be 0 or 1.
DNS servers	The address of your DNS (Domain Name System) server or servers. If multiple addresses are entered, separate each address with a space.

For more information on assigning a static IP address, contact your network administrator.

11.8.4 Maximum transmission unit

The Maximum Transmission Unit (MTU) range supported is 1280 to 1500. The default is set to 1500. For a Networked-Internet / WAN with Site-to-Site VPN deployment, we recommend that you set this to 1400 when configuring your units initially, and adjust as needed.

11.8.5 Adapt for WAN / LAN

You can use the **Change** button beside the **Currently adapted for LAN** or the **Currently adapted for WAN** option in the **Adapt for WAN / LAN** section to switch between LAN and WAN configurations.

When you click the **Change** button beside the **Currently adapted for LAN** option, you get a confirmation screen. Click **Yes** to switch to WAN.

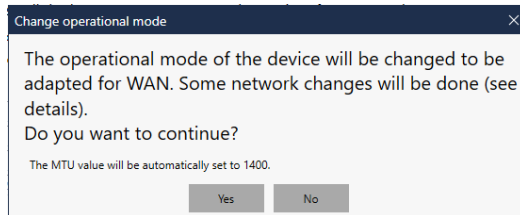

Note: The Maximum Transmission Unit (**MTU**) is automatically changed from the default of 1500 to the recommended **1400** for a private WAN configuration.

The **Optimize for high-bandwidth WAN / VPN environments** option becomes available for selection.

Once you click the **Change** button, the button is disabled during the entire network change operation. The **Apply** button also remains disabled as the network change operation becomes effective immediately when the **Change** button is clicked.

You can specify the following options for WAN:

Optimize for high-bandwidth WAN / VPN environments	The Adapt for WAN / LAN mode uses by default the lowest possible bandwidth for video content streaming and it encodes every other frame that is recommended for most over Internet or WAN configurations. If higher bandwidth is available and you would like to set the encoding quality level manually according to the bandwidth availability, select the Optimize for high-bandwidth WAN / VPN environments option. In this case, the input frame rate uses all frames (similar to LAN).
	Note: The Optimize for high-bandwidth WAN / VPN environments option is available only when the receiver unit is configured in the Networked-Internet / WAN with Site-to-Site VPN or the Networked-Internet with IPSec VPN mode. When you select this option and apply the changes, the device will be rebooted.

Network congestion control	This option is applicable for the Networked-Internet / WAN with Site-to-Site VPN and the Networked-Internet with IPsec VPN modes only. It improves user experience on networks where there is significant packet loss. This option can be inactive (set to Off), or set to Low , Mid , or High . Note: Increasing the Network congestion control level will increase the latency.
-----------------------------------	--

11.8.6 Security options

You can set the following network security related features from the **Security options** section:

- **IGMPv3** – This internet group management protocol allows control over the origin from which a multicast stream is requested by a receiver. This prevents malicious or corrupt video content that could be ingested by a receiving device unknowingly. It also helps to protect against certain denial-of-service attacks leveraging existing multicast channels.
- **802.1X EAP-TLS** – The 802.1X is a standard used to control access to a network for devices and PCs. Extio 3 uses EAP-TLS protocol used by 802.1X to securely identify the device prior to its authorization to join the network.



You can specify the following security options:

IGMPv3	<p>Select Automatic if you want IGMPv3 control over the source. Streams from other IP addresses will not be accepted by the Extio 3 receiver devices. This is a useful security feature for multicast streaming management.</p> <p>The default is Off.</p> <p>Note: All IGMP-capable devices on the network must support IGMPv3 for the protocol to be used. The presence of a single IGMPv2 device is sufficient to cause all the devices in the network to use the IGMPv2 protocol, which has no source-specific filtering.</p>
---------------	--

<p>IEEE 802.1X</p>	<p>Note: This sub-section is applicable for the Networked-LAN mode only (not applicable for the Networked-Internet / WAN with Site-to-Site VPN and the Networked-Internet with IPsec VPN modes).</p> <p>The IEEE 802.1X sub-section becomes available under the Security options section only after the certificates necessary for 802.1X are uploaded via the firmware updater.</p> <p>When you enable the Enable EAP-TLS option, you need to choose the EAPOL version from the drop-down list. The EAPOL version defaults to 2.</p> <p>Note: The EAPOL version information will be provided along with the certificates by your IT department (in charge of the network where 802.1X is used).</p>
---------------------------	--

11.8.6.1 Configure device for deployment on a 802.1X EAP-TLS network

The EAP-TLS protocol requires the deployment of a certificate file on the device (transmitter and receiver). **Note:** Each device must be configured individually. The certificate file contains the public server certificate authority, the client certificate, and the client private key associated with the device certificate.

Prior to joining the 802.1X network, the device has no IP address assigned to it. Extio Central Manager allows the administrator to configure a device to use 802.1X EAP-TLS for its network on-boarding. You can deploy this certificate file to the device using the Extio firmware updater on a regular network first.

- 1 Deploy the Extio 3 device on a regular network without any 802.1X authentication.
- 2 Using the firmware updater, store the certificate file on the device (done by the administrator). **Note:** During the firmware updating process, the firmware updater will display the following progress status message: *Updating "EAP TLS certificate."*

The certificate file should contain the following information:

- A certificate to identify the device. This certificate is used by the 802.1X authentication server to authenticate the device.
- The private key associated with the device certificate.
- The public certificate identifying the certificate authority (CA) used to sign the 802.1X authentication server (for example, the Radius server). This certificate is

used by the device to verify the authenticity of the 802.1X authentication server, preventing hostile attacks.

 **Note:** The certificate file has to be named *eaptls_cert.pem* and placed in the update package. The updater program will verify and deploy it to the right location.

 **Note:** To uninstall the certificates from the device, you need to reset to default settings or configuration on the device.

- 3 From Extio Central Manager, enable 802.1X EAP-TLS and configure the appropriate settings in the **Network** page of the device settings. That is, select the **Enable EAP-TLS** option and choose the **EAPOL version** from the drop-down list (these have to be done by the administrator).

 **Note:** The **Enable EAP-TLS** option will not be available if the necessary certificates are not stored on the device.

- 4 You can then disconnect the device from the normal network and connect it to an 802.1x network. Once connected, it will obtain an IP address.

 **Note:** A device not properly configured for 802.1X EAP-TLS will be unable to obtain an IP address when it is connected to a 802.1X EAP-TLS network and hence will not be visible on the network. When the feature is disabled, the device will disappear from the network. In this case, you must connect the device to a network without 802.1X authentication, correctly configure the device as described above, then re-connect the device to the 802.1X network.

 **Note:** For Extio Central Manager to work on a 802.1X EAP-TLS network, the host PC on Windows 10 must be properly configured to work on the 802.1X EAP-TLS network. For more information, contact Matrox support.

11.9 Date and time

Use this to update the date, time, and time zone of your Extio 3 device. For more information, see [“13 - Adjusting the date and time of your device”](#), page 72.

11.10 RS232

Enable **Enable RS232** to virtualize an RS232 (or serial) connection.

RS232 virtualization

Enable RS232

RS232 settings

Baud rate: 115200

Data bits: 8

Parity: None

Stop bits: 1

Flow control: None

Aggregator mode: RS232 destination

Transmitter on monitor 1

11.10.1 Enabling RS232 virtualization

To enable RS232, enable the **Enable RS232** option, then click **Apply**.

11.10.2 Configuring your RS232 settings

Baud rate	The speed, in bits per seconds (or baud), used for the RS232 connection. The default is 115200.
Data bits	The number of bits per block of data transmitted. The default is 8.
Parity	The type of parity bits (None , Odd , or Even) used for the data transmitted. The default is None .
Stop bits	The number of bits used to identify the end of a data block. The default is 1.
Flow control	The signal type (None or RTS/CTS) used to pause and resume data transmission. The default is None .

11.10.3 Aggregator mode: RS232 destination

Aggregator mode only – Choose the transmitter you want to control through RS232. For tile displays, you need to select **Use destination defined in aggregated layout**.

Aggregator mode: RS232 destination

Transmitter on monitor 1

This setting will override the RS232 destination found in saved aggregations.

11.11 Keyboard shortcuts

Keyboard shortcuts provide a way to quickly do certain tasks in the receiver, such as switching to a different connection source (transmitter or aggregated layout), bringing up the **On-Screen Display (OSD)**, or accessing the **Dynamic sources** tab directly to enable you to switch between sources.

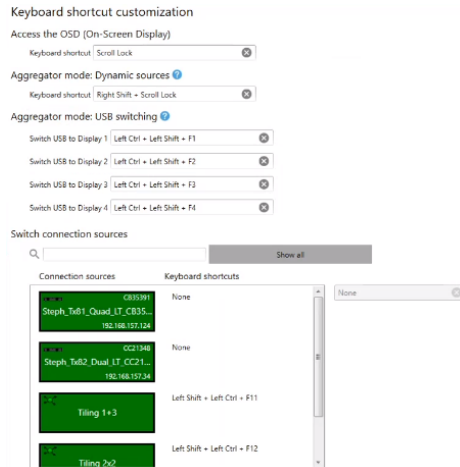

You can assign keystroke combinations in the **Keyboard shortcut customization** screen. This screen appears when you select **Keyboard shortcuts** in the settings screen for a receiver. You can open the settings screen by either right-clicking the receiver tile and selecting **Open settings**, or by double-clicking the receiver tile.



Note: A standalone key must be used with a modifier key (Alt, Shift, or Ctrl).

11.11.1 Assign shortcut keys for accessing the on-screen display (OSD)

The default shortcut key for this is [Scroll Lock]. To assign a new key combination for accessing the on-screen display (OSD):

- 1 In the **Access the OSD (On-Screen Display)** section of the **Keyboard shortcut customization** screen, click the edit icon next to **Keyboard shortcut** to clear the previous information. You can also click the edit box and press [Backspace] or [Delete].
- 2 Press a key combination (for example, [Ctrl]+[F10]).
- 3 Click **Apply**.

11.11.2 Aggregator mode: Assign shortcut keys for accessing Dynamic sources

The default shortcut key for accessing the **Dynamic sources** tab directly on the OSD is [Right Shift]+[Scroll Lock]. To assign a new key combination:

- 1 In the **Aggregator mode: Dynamic sources** section of the **Keyboard shortcut customization** screen, click the edit icon next to **Keyboard shortcut** to clear the previous information. You can also click the edit box and press [Backspace] or [Delete].

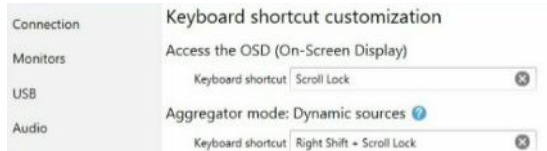

- 2 Press a key combination (for example, [Ctrl]+[F10]).
- 3 Click **Apply**.

11.11.3 Aggregator mode: Assign shortcut keys for USB switching

Aggregator mode only – By default, you can use your mouse to switch between sources while using aggregator mode.

You can also use keyboard shortcuts to switch sources. By default, keyboard shortcuts for switching are assigned. To change a key combination for USB switching:

- 1 Next to **Switch USB to Display X**, click the edit box.
- 2 Press a key combination (for example, [Left Ctrl]+[Left Shift]+[F10]). Repeat this for each **Display** (for example, **1, 2, 3, 4**) in your monitor layout.
- 3 Click **Apply**.

To use *only* the keyboard shortcuts (no mouse) to switch sources, enable **Use only keyboard shortcuts (no mouse) for USB switching**. **Note:** To switch between tiles in a tile display, repeat the keyboard shortcut for the display.

11.11.4 Assign shortcut keys for switching to a connection source

To assign a key combination for switching to a connection source (transmitter or aggregated layout):

- 1 From the **Connection sources** list under the **Switch connection sources** section, select a transmitter or aggregated layout.



Note: You can filter your devices by *group*. To filter your groups, select the groups you want to view, then click **Close**. To select all the groups, select **Select all**.

- 2 Click the edit box next to the transmitter or aggregated layout.
- 3 Press a key combination (for example, [Ctrl]+[F10]).
- 4 Repeat steps 1 to 3 for each connection source and when done, click **Apply**. **Note:** The keyboard shortcut for the connection source you enter here will be displayed in the **Sources** list in the On-screen display (OSD).

11.11.5 Removing keyboard shortcuts

To remove a keyboard shortcut, click the **Delete** (✕) icon. You can also click the edit box and press [Backspace] or [Delete]. Then, click **Apply**.

11.12 More options

Miscellaneous controls (such as Power button, Reboot, Wake-on-LAN, and LED), the power recovery policy, audits, logs, and troubleshooting options can be set from the **More options** page.

Power recovery policy

Restore last state

Power button control

Disable shutdown

Reboot control

Enable force reboot

Wake-on-LAN control

Enable Wake-on-LAN

LED control

Suppress LED blinking when no keyboard attached

Logs

Download diagnostic device logs

Download administrative device logs

Erase device logs

Audits

Download device audits

Troubleshooting

Audio

Disable audio

Debug configurations ☺

System Logging (Syslog)

To use this feature, install the server certificate using the firmware updater tool.

Enable audit logs

Minimum audit log level

Info

Server address or DNS name

Server port

514

Use BSD format instead of IETF (RFC5424)



Note: Depending on your Matrox Extio 3 Series product, certain options may not be available.

Power recovery policy	<p>Set up your Extio device to start up after a power loss.</p> <ul style="list-style-type: none">▪ Never start – Never turn on your Extio device after a power loss.▪ Always start – Always turn on your Extio device after a power loss.▪ Restore last state – Always turn on and restore the last state of your Extio device after a power loss.
Power button control	<p>To prevent your device from being manually shut down, enable the Disable shutdown option.</p>
Reboot control	<p>To remotely force a reboot of your device if it stops responding, enable the Enable force reboot option.</p>
Wake-on-LAN control	<p>To remotely wake up an Extio device, enable the Enable Wake-on-LAN option.</p>
LED control	<p>If you would like to prevent a receiver's LED from flashing when there is no keyboard connected, you need to select the Suppress LED blinking when no keyboard attached option under LED control.</p>
Logs	<ul style="list-style-type: none">▪ Download diagnostic device logs – Download the log files. This file contains information on your Extio devices. This information is used by Matrox Technical Support for debugging purposes.▪ Download administrative device logs – Download the VPN log files related to configuring and establishing the VPN connection. The logs are not password protected and can be used by your IT team to diagnose and troubleshoot the VPN configuration and connection issues.▪ Erase device logs – Erase the log files created for your Extio devices. <p>If a receiver is connected to multiple transmitters, you can download the device logs of the receiver and all of its connected devices.</p>
Audits	<p>Download device audits. This file contains information on the user interactions with your Extio devices. This information is used by your Extio administrator.</p> <p>If a receiver is connected to multiple transmitters, you can download the device logs of the receiver and all of its connected devices.</p>

<p>Troubleshooting</p>	<p>The following options are useful for troubleshooting your devices:</p> <ul style="list-style-type: none"> ▪ Audio – To disable the audio on your Extio 3 device, enable the Disable audio option. Your device will reboot for this change to take effect. ▪ Debug configurations – Get help and troubleshooting information for your configuration. For more information, contact Matrox Technical Support.
<p>System logging (Syslog)</p>	<p>This allows you to redirect system log entries to a remote system logging server on the network.</p> <ul style="list-style-type: none"> ▪ Enable audit logs – To include audit logs, enable this option. Then from the Minimum audit log level drop-down list, select the level of information you would like the log to contain. ▪ Server address or DNS name – The address of the syslog server to which the content is to be forwarded. ▪ Server port – The port number of the syslog server to which the content is to be forwarded. ▪ Use BSD format instead of IETF (RFC 5424) – Enable this option if you would like the content to be formatted using the BSD format.

12 Importing and exporting device settings

This enables you to back up (export) and restore (import) the settings specific to an Extio 3 transmitter or receiver.



Note: The connection broker manages connections between all the devices. Restoring only a few devices could cause inconsistencies that will be displayed with "!" in the connection broker table. It is recommended to restore all involved devices.

12.1 Exporting

Note: You need to export your device settings *before* you can import them.

To export your device settings:

- 1 Click **Export settings**.
- 2 Browse to the location where you want to save the *.backup* device file.
- 3 When prompted, enter a **File name**, then click **Save**.

12.2 Importing

To import your device settings:

- 1 Click **Import settings**.
- 2 Browse to the location where your device backup file was saved.
- 3 Select the device file (*.TX.backup* for a transmitter or *.RX.backup* for a receiver) you want to import, then click **Open**.

13 Adjusting the date and time of your device

Use this to update the date, time, and time zone of your Extio 3 device.

```
NTP server: Disabled
NTP server URL: time.matrox.com
Time zone: (UTC-5:00) Toronto
```

Date and time

- Use current date and time settings of the device
- Use date and time of the current system
- Use the following date and time
- Enable synchronization with an NTP (Network Time Protocol) server
NTP server URL
- Disable synchronization with an NTP server

Time zone

- Use current time zone of the device
- Use the following time zone

The box at the top lists the current time settings. Extio Central Manager updates this information every two (2) seconds.



Note: After applying new settings, it may take some time for the changes to take effect.

13.1 Setting the date and time

Select how to set the date and time for your device.

Use current date and time settings of the device	Keep the current date, time, and NTP (Network Time Protocol) synchronization settings for your devices. This is the default.
Use date and time of the current system	Use the date and time of your controller system to update your devices. This setting uses the time zone of the controller system. If your controller system and your device are using different time zones, the date and time will differ. This setting disables synchronization with an NTP server.
Use the following date and time	Use the date and time specified to update your devices. This setting doesn't use the time zone of your controller system. You can use the arrow keys to change the date and time specified. This setting disables synchronization with an NTP server.

Enable synchronization with an NTP server	Use an NTP server to update the date and time for your device at regular intervals. You must provide a server URL, even if one is already stored on your device. For more information on using NTP, contact your network administrator.
Disable synchronization with an NTP server	Stop using an NTP server to update the date and time for your device. Disabling NTP keeps the current date and time of the device, but it won't update the devices at regular intervals.

13.2 Setting the time zone

Select the time zone to use for your device. When using an NTP server, we recommend setting the time zone of your device.

Use current time zone of the device	Use the time zone currently set for your devices. This is the default.
Use the following time zone	Change the time zone for your devices to the one selected. Changing the time zone may adjust the date and time for a device.

14 Notes and limitations

14.1 General

- **Windows Server 2022 and Windows Server 2019** – Make sure the SSDP Discovery service, network discovery, and file sharing are enabled.

14.2 Network

- When transmitting in multicast, we recommend using a router with multicast addressing support and switches with IGMP v2 support.
- Slow response from certain routers may cause a slow device detection in Extio Central Manager.
- **Windows 11/10** – If your controller system doesn't have access to a DNS (Domain Name System) server, or if response from its DNS server is slow, Extio Central Manager may take a long time to start up (several minutes). To avoid this delay, configure your controller system to use a fixed IP address (such as local host 127.0.0.1) as its DNS server.

14.3 Date and time

- Extio Central Manager updates the date and time information of your device every two (2) seconds.

15 Troubleshooting

15.1 What to do if you have a problem

If you experience problems with your Matrox product:

- Make sure you're using the correct connectors, and that all connectors are properly fastened. For more information on the connection setup of your product, see the user guide for your Matrox hardware.
- Review the documentation provided with your Matrox product, including the information in this section, to see if your problem is already addressed. For information on Matrox Extio 3 Central Manager software features and options, see the help file included with your Extio 3 Central Manager software.

If your problem persists, contact Matrox. For more information, see [“19 - Customer support”](#), page 89.

15.2 Common problems and solutions

This section addresses common problems that could prevent you from using your devices.

Problem Extio Central Manager not starting or Extio device not discovered on the network

Cause Your Matrox product may not be properly connected or may be on a different subnet.

Solution Verify the connection and status LEDs on your Matrox product. Also, make sure your Matrox product is properly connected and that all connectors are properly fastened. For more information, see your Matrox Extio 3 Series User Guide.

Cause Windows Server 2022 and 2019 – The Windows SSDP Discovery service may be disabled on your system.

Solution Make sure the SSDP Discovery service is enabled on your system.

- 1 Windows Server 2022 and 2019 – From the **Start** screen, click **All Programs** → **Administrative Tools** → **Services***. (* You may need administrator rights to access Windows services.)
- 2 Double-click **SSDP Discovery**.
- 3 Next to **Startup type**, select **Manual** or **Automatic**.
- 4 Click **OK**.

Cause Network discovery and file sharing may not be enabled on your system.

Solution Enable network discovery and file sharing on your system.

Windows 10 –

- 1 Windows 10 – Click **Start** → **Settings** → **Network & Internet** → **Ethernet**.
- 2 Click **Network and Sharing Center** → **Change advanced sharing settings**. (* Depending on your version and configuration of Windows, this part of the step may not be necessary.)
- 3 Under your current profile, make sure the following options are selected:
 - **Turn on network discovery**
 - **Turn on file and printer sharing**
- 4 If you make changes to your current profile settings, click **Save changes**.

Windows 11 –

- 1 Type **control panel** from the search box and click on **Control Panel** to open it.
- 2 Select **Network & Internet** → then select **Network and Sharing Center**.
- 3 Select **Change advanced sharing settings**.
- 4 Turn on file sharing by doing the following:
 - Under **Private** (current profile), select **Turn on network discovery**. Also check **Turn on automatic setup of network connected devices**.
 - Expand **Private** (current profile) and check **Turn on file and printer sharing** under **File and printer sharing**.
 - Scroll down and expand **All networks**. Check **Turn on sharing so that everyone with network access can read and write files in the Public folders** under **Public folder sharing**.
- 5 Save your changes.

Cause You may not be using the latest version of Matrox Extio 3 Central Manager software, or your Matrox firmware may be out of date.

Solution Make sure all Matrox software is up to date.

Cause The firewall for your controller system or for your network may be enabled and may prevent communication with your Extio devices.

Solution Make sure your firewall is properly configured to allow the necessary communication between your controller system and your Extio devices. For more information, see “18 - Appendix C – Firewall requirements”, page 84.

Problem Can't access Extio device through Extio 3 Central Manager (listed as 'View only')

Cause The device may be a recent addition to your environment and has no password.

Solution Try changing the password for that device (see “8 - Managing users”, page 27).

Solution Contact your Extio 3 administrator to obtain your device password, then change the device password. For more information, see “8 - Managing users”, page 27.

Problem No picture or output at all

Cause Your monitor may not be properly connected (the connectors aren't properly fastened or the monitor power cable isn't firmly in place) or may have been disconnected.

Solution Make sure you're using the correct connectors, that all connectors are properly fastened, and that all power cables are firmly in place.

Problem Extio 3 Central Manager may be slow to start (several minutes)

Cause Your controller system may not have access to a DNS (Domain Name System) server.

Solution Configure your system to use a fixed IP address (such as local host – 127.0.0.1) as the DNS server.

Windows 11/10/ –

- 1 Windows 11/10 – Click **Start** → **Settings** → **Network & Internet** → **Ethernet**.
- 2 Click **Change adapter settings**.
- 3 Double-click the icon for your network adapter (such as **Local Area Connection** or **Ethernet**).
- 4 Click **Properties** → **Yes***. (* Depending on your version and configuration of Windows, this part of the step may not be necessary.)
- 5 Double-click **Internet Protocol Version 4 (TCP/IPv4)**.
- 6 Select **Use the following DNS server addresses**.

7 Next to **Preferred DNS server**, enter **127.0.0.1**.

8 Click **OK** → **OK** → **Close**.

Problem Extio 3 Central Manager stops responding

Cause Your Extio 3 Central Manager software or Extio 3 device may have encountered an error.

Solution Try closing, then restarting Matrox Extio 3 Central Manager software.

Solution Restart your controller system.

Problem Extio 3 device tile is listed as unresponsive (yellow device tile)

Cause Your network may be slow, causing a delay in the response time from your Extio 3 device.

Solution Wait a few minutes, then make sure the status of the device was properly updated.

Cause Your Extio Central Manager software or device may have encountered an error.

Solution Try closing, then restarting Matrox Extio Central Manager software.

Solution If your device status is still listed as initializing, click **Reboot** to reboot your device.

Solution Try a configuration reset of your device. For more information, see your Matrox Extio 3 Series User Guide.

Problem Poor image quality or display flickering occurs (skipping or dropping frames)

Cause High network traffic may be degrading the quality of your stream.

Solution Make sure your network equipment supports the bandwidth required.

Problem No sound or sound is distorted

Cause The audio source connector on your device may be disabled.

Solution Enable your audio source. For more information, see “11.6 - Audio”, page 57.

Cause Audio cables may be loose, or the audio output device may not be properly connected.

Solution Make sure you’re using the correct connectors, all connectors are properly fastened, and that all power cables are firmly in place. For more information, see your Extio 3 Series User Guide.

16 Appendix A – Setting up link redundancy

Link redundancy ensures your Extio 3 devices continue to work in case of a network cable or switch failure.



Note: This feature is supported in Networked-LAN and Point-to-Point operation modes. It is not supported in Networked-Internet / WAN with Site-to-Site VPN and Networked-Internet with IPsec VPN operation modes.

16.1 Connection setup guidelines

The following provides a basic outline for how to connect your Extio 3 transmitter and receiver to support link redundancy.

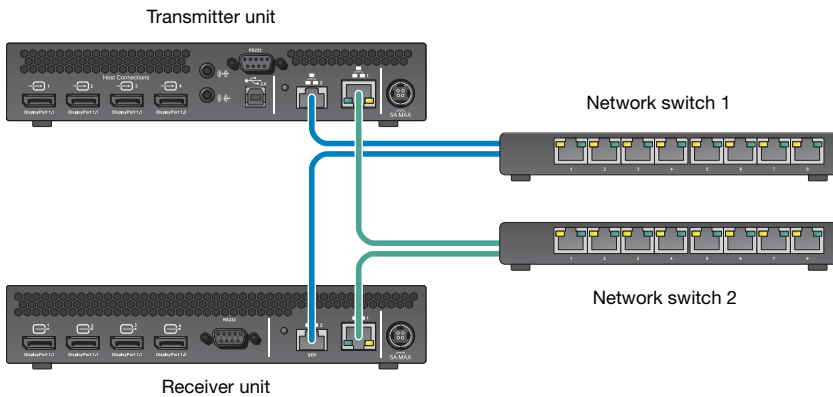

Note: Link redundancy is supported only on the following hardware: Extio N3408 transmitter units, N3208 transmitter units, N3408 receiver units, and N3208 receiver units. Extio N3408 and N3208 transmitter cards aren't supported.



Note: For information on setting up your network infrastructure and configuring your network switch, contact your network administrator.

- Make sure your Extio 3 units are all on the same subnet.
- Connect each Extio 3 transmitter and receiver unit to a managed network switch pair. Make sure to connect **LAN1** to network switch 1 and connect **LAN2** to network switch 2.

- Make sure the **LAN1** and **LAN2** connectors are connected before enabling the **Link redundancy** feature.
- Do not hot plug the SFP modules.

16.2 Enabling link redundancy

To enable link redundancy:

- 1 Enable the link redundancy option in your Matrox software:
 - **Networked mode** – In the Extio Central Manager software, select your Extio device, click **Network**, and then click the **Change** button beside the **Link redundancy is currently disabled** label. Click **Yes** in the confirmation screen that displays.
 - **Point-to-point mode** – In the OSD, click **More options**, and then click the **Change** button beside the **Link redundancy is currently disabled** label. Click **Yes** in the confirmation screen that displays.
- 2 For the changes to take effect, your device will automatically reboot.
- 3 After your device reboots, connect the second network cable to your device. For more information, see the “Connecting your Extio 3 devices” topic in your Matrox Extio 3 Series User Guide.

16.3 Disabling link redundancy

To disable link redundancy:

- 1 Disconnect the second network cable. For more information, see the “Connecting your Extio 3 devices” topic in your Matrox Extio 3 Series User Guide.
- 2 Make sure your devices are detected on the network.
- 3 Disable the link redundancy option in your Matrox software:
 - **Networked mode** – In Extio Central Manager software, select your Extio device, click **Network**, and then click the **Change** button beside the **Link redundancy is currently enabled** label.
 - **Point-to-point mode** – In the OSD, click **More options**, and then click the **Change** button beside the **Link redundancy is currently enabled** label.

17 Appendix B – Configuring your audio settings



Note: We recommend you review your system's Windows® audio settings to know which DisplayPort output is configured to use audio.



Note: You need to configure audio for a tile display in the aggregated layout's **Audio** tab and not in the general **Audio** settings page.

17.1 Receiver output

Audio source from transmitter	Standard mode	Aggregator mode*
	When receiver connects to a unique transmitter unit	When receiver connects to multiple transmitter units
No audio	No audio available on the receiver output.	No audio available on the receiver output.
Digital audio 1†	Audio originates from the audio portion of the A/V signal of DisplayPort 1 on the transmitter unit.	Audio originates from the digital A/V signal displayed on monitor 1 of the receiver.
Digital audio 2†	Audio originates from the audio portion of the A/V signal of DisplayPort 2 on the transmitter unit.	Audio originates from the digital A/V signal displayed on monitor 2 of the receiver.
Digital audio 3†	Audio originates from the audio portion of the A/V signal of DisplayPort 3 on the transmitter unit.	Audio originates from the digital A/V signal displayed on monitor 3 of the receiver.
Digital audio 4†	Audio originates from the audio portion of the A/V signal of DisplayPort 4 on the transmitter unit.	Audio originates from the digital A/V signal displayed on monitor 4 of the receiver.
Analog audio (Follows USB)‡	Audio originates from the Line In connector of the transmitter.	Audio originates from the Line In connector of the transmitter unit where the keyboard and mouse are active.
Analog audio, Line In 1	Audio originates from the Line In connector of the transmitter.	Audio originates from the Line In connector of the transmitter unit providing the video stream for monitor 1 on the receiver unit.
Analog audio, Line In 2	Audio originates from the Line In connector of the transmitter.	Audio originates from the Line In connector of the transmitter unit providing the video stream for monitor 2 on the receiver unit.

Analog audio, Line In 3	Audio originates from the Line In connector of the transmitter.	Audio originates from the Line In connector of the transmitter unit providing the video stream for monitor 3 on the receiver unit.
Analog audio, Line In 4	Audio originates from the Line In connector of the transmitter.	Audio originates from the Line In connector of the transmitter unit providing the video stream for monitor 4 on the receiver unit.

* This column is applicable for standard aggregated layouts only and may differ for aggregated layouts with tile displays.

† In aggregator mode, the A/V signal may come from a transmitter input other than the monitor on which it's displayed (for example, monitor 1 shows a stream that comes from input 3 of a transmitter).

‡ In aggregator mode, the audio source switches from one transmitter to another when the mouse moves to a monitor showing an image from a different transmitter.

17.2 Receiver input

Audio source from receiver	Standard mode	Aggregator mode
	When receiver connects to a unique transmitter unit	When receiver connects to multiple transmitter units
No audio	No audio available on the Line Out connector of the transmitter.	No audio available on any of the Line Out connectors of the transmitter.
Microphone	Audio from the Microphone connector of the receiver unit is sent to the Line Out connector of the transmitter unit.	The Microphone signal from the receiver unit is sent to a transmitter following the destination option chosen (see “ Receiver audio destination ”).
Line In	Audio from the Line In connector of the receiver unit is sent to the Line Out connector of the transmitter unit.	The Line In signal from the receiver unit is sent to a transmitter following the destination option chosen (see “ Receiver audio destination ”).
Automatic detection	Audio from the Microphone connector of the receiver unit is sent to the Line Out connector of the transmitter unit. If no cable is present on the Microphone connector of the receiver unit, but a cable is present on the Line Out connector, the signal of the Line Out connector is sent to the Line Out connector of the transmitter unit.	Audio from the Microphone connector of the receiver unit is used. If no cable is present on the Microphone connector of the receiver unit, but a cable is present on the Line In connector, the signal of the Line In connector is used. The signal is then sent to a transmitter following the destination option chosen (see “ Receiver audio destination ”).

17.3 Receiver audio destination

Receiver audio destination	Standard mode	Aggregator mode
	When receiver connects to a unique transmitter unit	When receiver connects to multiple transmitter units
Monitor 1	Audio from the selected audio source of the receiver (Microphone or Line In) is sent to the Line Out connector of the transmitter.	Audio from the selected audio source of the receiver (Microphone or Line In) is sent to the Line Out connector of the transmitter unit that provides the video stream to monitor 1 .
Monitor 2	Audio from the selected audio source of the receiver (Microphone or Line In) is sent to the Line Out connector of the transmitter.	Audio from the selected audio source of the receiver (Microphone or Line In) is sent to the Line Out connector of the transmitter unit that provides the video stream to monitor 2 .
Monitor 3	Audio from the selected audio source of the receiver (Microphone or Line In) is sent to the Line Out connector of the transmitter.	Audio from the selected audio source of the receiver (Microphone or Line In) is sent to the Line Out connector of the transmitter unit that provides the video stream to monitor 3 .
Monitor 4	Audio from the selected audio source of the receiver (Microphone or Line In) is sent to the Line Out connector of the transmitter.	Audio from the selected audio source of the receiver (Microphone or Line In) is sent to the Line Out connector of the transmitter unit that provides the video stream to monitor 4 .

18 Appendix C – Firewall requirements

The following are the firewall requirements for your Extio 3 device.

18.1 Extio Central Manager software

The following are the firewall requirements for your controller system.

Network Port	Type	Inbound	Outbound	Functionality
53	TCP	—	✓	DNS: DNS requests
443*	TCP	—	✓	HTTPS: Central Manager commands
1900*	UDP	✓	✓	UPnP: Microsoft SSDP for discovery of UPnP devices Note: ICMP must be enabled (ping).

* Minimum requirements.

18.2 Firmware updater

The following are the firewall requirements for a system running the Matrox Firmware Updater.

Network Port	Type	Inbound	Outbound	Functionality
20,21	TCP	—	✓	FTP: File upload
22*	TCP	✓	✓	SSH: Firmware update
443*	TCP	—	✓	HTTPS: Authentication
1900*	UDP	✓	✓	UPnP: Microsoft SSDP for discovery of UPnP devices

* Minimum requirements.

18.3 Extio 3 devices

The following are the requirements for a network firewall present on a network with an Extio 3 environment.

Network Port	Type	Inbound	Outbound	Functionality
20,21	TCP	✓	—	FTP: File download (firmware)
22*	TCP	✓	✓	SSH: Firmware update
69	UDP	—	✓	DHCP: DHCP client
123	UDP	✓	✓	NTP: Network Time Protocol
161	UDP	✓	✓	SNMP: Network management (public community string)
443*	TCP	✓	—	HTTPS: Extio Central Manager commands and Firmware Updater Authentication
1900*	UDP	✓	✓	UPnP: Microsoft SSDP for discovery of UPnP devices
Ephemeral*	UDP	✓	✓	RTP/RTCP: Audio and video streams and control
12000	TCP	✓	✓	RS232: RS232 virtualization
80	TCP	✓	—	Transmitter unit: Publishing of desktop thumbnails
80	TCP	—	✓	Receiver unit: Retrieving of desktop thumbnails
3240	TCP	✓	—	Receiver unit: USB IP
3240	TCP	—	✓	Transmitter unit: USB IP
6804 - 6816	TCP	✓	—	Transmitter unit: Audio back channel control
6804 - 6816	TCP	—	✓	Receiver unit: Audio back channel control
8884	TCP	✓	—	Receiver unit: Control channel

Network Port	Type	Inbound	Outbound	Functionality
8884	TCP	—	✓	Transmitter unit: Control channel
8886	UDP	✓	—	Transmitter unit: Audio back channel
8886	TCP	—	✓	Receiver unit: Audio back channel
8809 - 8872	TCP	✓	—	Receiver unit: A/V streams control
8809 - 8872	TCP	—	✓	Transmitter unit: A/V streams control
9223 - 9254	UDP	✓	—	Receiver unit: Multicast A/V streams
9223 - 9254	UDP	—	✓	Transmitter unit: Multicast A/V streams
10322 - 10438	UDP	✓	—	Transmitter unit: Streaming to Mura IPX
11900	UDP	✓	—	Transmitter unit: SSDP unicast M-SEARCH requests for UPnP discovery and presence monitoring for out-of-subnet and WAN devices
11900	UDP	—	✓	Receiver unit: SSDP unicast M-SEARCH requests for UPnP discovery and presence monitoring for out-of-subnet and WAN devices
12346 - 12752; 13414 - 13719	UDP	✓	—	Receiver unit: Unicast A/V streams
12346 - 12752; 13414 - 13719	UDP	—	✓	Transmitter unit: Unicast A/V streams

* Minimum requirements.

18.4 Accessing your Windows Firewall settings



Note: You may need administrator rights to modify your Windows Firewall settings. For more information, see Windows documentation or contact your system administrator.

To access your Windows Firewall settings:

Windows 11/10 –

- 1 Windows 11 – Click **Start** → **Settings** → **Network & Internet** → **Ethernet** → **Configure Firewall and security settings**.

Windows 10 – Click **Start** → **Settings** → **Network & Internet** → **Ethernet** → **Windows Firewall**.

- 2 Windows 11/10 – In the left panel, click **Advanced Settings**.

18.5 Adding rules to your Windows Firewall settings



Note: You may need administrator rights to modify your Windows Firewall settings. For more information, see Windows documentation or contact your system administrator.

Windows 11/10 –

- 1 Windows 11 – Click **Start** → **Settings** → **Network & Internet** → **Ethernet** → **Configure Firewall and security settings**.

Windows 10 – Click **Start** → **Settings** → **Network & Internet** → **Ethernet** → **Windows Firewall**.

- 2 Windows 11/10 – In the left panel, click **Advanced Settings**.
- 3 Click **Inbound Rules**.
- 4 In the **Actions** panel, click **New Rule**. Configure the new rule with the following settings:
 - **Rule** – Select **Custom**.
 - **Program** – Select **All programs**.
 - **Protocol and Ports** – Next to **Protocol**, select **TCP**. Next to **Local port**, select **Specific ports**. For the port number, enter **445**. Next to **Remote port**, select **All Ports**.
 - **Scope** – Under the remote IP address, add the IP range you want to use for your transmitter. You can use a range (such as *192.168.1.0/24*) or a single IP address (such as *192.152.168.62*).
 - **Action** – Select **Allow the connection**.
 - **Profile** – Select the network location of your system (**Domain**, **Private**, or **Public**).
 - **Name** – Enter the name for your rule (such as *Extio 3 – TCP rule*).
- 5 In the **Actions** panel, click **New Rule**. Configure the new rule with the following settings:
 - **Rule type** – Select **Custom**.
 - **Program** – Select **All programs**.
 - **Protocol and Ports** – Under **Protocol type**, select **ICMPv4**.
 - **Scope** – Under the remote IP address, add the IP range you want to use for your transmitter. You can use a range (such as *192.168.1.0/24*) or a single IP address (such as *192.152.168.62*).
 - **Action** – Select **Allow the connection**.

- **Profile** – Select the network location of your system (**Domain**, **Private**, or **Public**).
- **Name** – Enter the name for your rule (such as *Extio 3 – ICMPv4 rule*).

For more information on configuring your Windows firewall, see your network administrator.

19 Customer support

19.1 Matrox web

Our web site has product literature, press releases, technical material, a sales office list, trade show information, and other relevant material. Visit the Matrox Graphics Web site at www.matrox.com/video.

19.2 Technical support

Matrox values your business and offers professional support for your Matrox product.

If your product was purchased through a Matrox dealer, contact your dealer for product support. This is the quickest and most effective method of technical assistance. Your dealer is familiar with your complete system.

If your product was purchased through Matrox, contact your Matrox representative or visit our technical support Web site at www.matrox.com/en/video/support.

19.2.1 Information we need

Please give a complete description of the problem, and include:

- Matrox product serial number, model number, revision number, and firmware number.
- Source specifications.
- Control system (system running Extio Central Manager) specifications.
- Specific Extio Central Manager or OSD (On-Screen Display) options and features used.

19.3 View your warranty information

Matrox makes warranty information available on the Matrox site (www.matrox.com/en/video/support/warranty).

19.4 View the third party software notices

Matrox makes third party software notices and/or additional terms and conditions available on the Matrox site (<https://thirdpartylicenses.matrox.com>).

19.5 Register your Matrox product

Please register online (www.matrox.com/en/video/apps/registration) to be eligible for customer support, new product announcements, and information on special offers and upcoming events.

Hot surface Allow hot surfaces to cool before touching your Matrox unit.

Surface chaude Laissez refroidir les surfaces chaudes avant de toucher votre appareil Matrox.

Battery replacement The battery is non replaceable. To dispose of your product, see www.matrox.com/environment/weee.



Remplacement des piles La pile n'est pas remplaçable. Pour se défaire du produit, voir www.matrox.com/environment/weee.

USA

FCC Compliance Statement

Remark for the Matrox hardware products supported by this guide This equipment has been tested and found to comply with the limits for a Class A digital device, pursuant to Part 15 of the FCC Rules. These limits are designed to provide reasonable protection against harmful interference when the equipment is operated in a commercial environment. This equipment generates, uses, and can radiate radio frequency energy and, if not installed and used in accordance with the instructions manual, may cause harmful interference to radio communications. Operation of this equipment in a residential area is likely to cause harmful interference in which case the user will be required to correct the interference at his own expense.

WARNING Changes or modifications to this unit not expressly approved by the party responsible for the compliance could void the user's authority to operate this equipment. The use of shielded cables for connection of the monitor to the card is required to meet FCC requirements.

CANADA

(English) Innovation, Science and Economic Development Canada

Remark for the Matrox hardware products supported by this guide These digital apparatus does not exceed the Class A limits for radio noise emission from digital devices set out in the Radio Interference Regulation of Industry Canada.

(Français) Innovation, Sciences et Développement économique Canada

Remarque sur les produits matériels Matrox couverts par ce guide Ce présent appareil numérique n'émet aucun bruit radioélectrique dépassant les limites applicables aux appareils numériques de Classe A prescrites dans le Règlement sur le brouillage radioélectrique édicté par Industrie Canada.

JAPAN

VCCI Compliance Statement

Remark for the Matrox hardware products supported by this guide This is a Class A product based on the standard of the Voluntary Control Council for Interference by Information Technology Equipment (VCCI). If this equipment is used in a domestic environment, radio disturbance may occur, in which case, the user may be required to take corrective actions.

この装置は、クラスA情報技術装置です。この装置を家庭環境で使用すると電波妨害を引き起こすことがあります。この場合には使用者が適切な対策を講ずるよう要求されることがあります。 VCCI-A

KOREA

A 급 기기 (업무용 방송통신기자재)

이 기기는 업무용 (A 급) 전자파적합기기로서 판 매자 또는 사용자는 이 점을 주의하시기 바라며, 가정외의 지역에서 사용하는 것을 목적으로 합니다.

(English) European user's information – Declaration of Conformity



Remark for the Matrox hardware products supported by this guide These devices comply with EC Directive 2014/30/EU for a Class A digital device. They have been tested and found to comply with EN55032/CISPR32 and EN55024/CISPR24. In a domestic environment these products may cause radio interference in which case the user may be required to take adequate measures. To meet EC requirements, shielded cables must be used to connect the monitor and other peripherals to the card. These products have been tested in a typical class A compliant host system. It is assumed that these products will also achieve compliance in any class A compliant system.

(Français) Informations aux utilisateurs Européens – Déclaration de conformité

Remarque sur les produits matériels Matrox couverts par ce guide Ces unités sont conformes à la directive communautaire 2014/30/EU pour les unités numériques de classe A. Les tests effectués ont prouvé qu'elles sont conformes aux normes EN55032/CISPR32 et EN55024/CISPR24. Le fonctionnement de ces produits dans un environnement résidentiel peut causer des interférences radio, dans ce cas l'utilisateur peut être amené à prendre les mesures appropriées. Pour respecter les impératifs communautaires, les câbles de connexion entre le moniteur ou autres périphériques et la carte doivent être blindés. Ces produits ont été testés dans un système hôte typique compatible classe A. On suppose qu'ils présenteront la même compatibilité dans tout système compatible classe A.

(Deutsch) Information für europäische Anwender – Konformitätserklärung

Anmerkung für die Matrox Hardware-Produktunterstützung durch dieses Handbuch Diese Geräte entsprechen EC Direktive 2014/30/EU für ein digitales Gerät Klasse A. Sie wurden getestet und entsprechen demnach EN55032/CISPR32 und EN55024/CISPR24. In einer Wohnumgebung können diese Produkte Funkinterferenzen erzeugen, und der Benutzer kann genötigt sein, entsprechende Maßnahmen zu ergreifen. Um EG-Anforderungen zu entsprechen, müssen zum Anschließen des Monitors und anderer Peripheriegeräte an die Karte abgeschirmte Kabel verwendet werden. Diese Produkte wurden in einem typischen, der Klasse A entsprechenden, Host-System getestet. Es wird davon ausgegangen, daß diese Produkte auch in jedem Klasse A entsprechenden System entsprechend funktionieren.

(Italiano) Informazioni per gli utenti europei – Dichiarazione di conformità

Nota per i prodotti hardware Matrox supportati da questa guida Questi dispositivi sono conformi alla direttiva CEE 2014/30/EU relativamente ai dispositivi digitali di Classe A. Sono stati provati e sono risultati conformi alle norme EN55032/CISPR32 e EN55024/CISPR24. In un ambiente domestico, questi prodotti possono causare radiointerferenze, nel qual caso all'utente potrebbe venire richiesto di prendere le misure adeguate. Per soddisfare i requisiti CEE, il monitor e le altre periferiche vanno collegati alla scheda grafica con cavi schermati. Questi prodotti sono stati provati in un tipico sistema host conforme alla classe A. Inoltre, si dà per scontato che questi prodotti acquisiranno la conformità in qualsiasi sistema conforme alla classe A.

(Español) Información para usuarios europeos – Declaración de conformidad

Observación referente a los productos de hardware de Matrox apoyados por este manual Estos dispositivos cumplen con la directiva de la CE 2014/30/EU para dispositivos digitales de Clase A. Dichos dispositivos han sido sometidos a prueba y se ha comprobado que cumplen con las normas EN55032/CISPR32 y EN55024/CISPR24. En entornos residenciales, estos productos pueden causar interferencias en las comunicaciones por radio; en tal caso el usuario deberá adoptar las medidas adecuadas. Para satisfacer las disposiciones de la CE, deberán utilizarse cables apantallados para conectar el monitor y demás periféricos a la tarjeta. Estos productos han sido sometidos a prueba en un típico sistema anfitrión que responde a los requisitos de la clase A. Se supone que estos productos cumplirán también con las normas en cualquier sistema que responda a los requisitos de la clase A.

(English) European user's information – Directive on Waste Electrical and Electronic Equipment (WEEE)



Please refer to the Matrox Web site (www.matrox.com/environment/en/weee) for recycling information.

(Français) Informations aux utilisateurs Européens – Règlementation des déchets d'équipements électriques et électroniques (DEEE)

Se référer au site Web de Matrox (www.matrox.com/environment/en/weee) pour l'information concernant le recyclage.

(Deutsch) Information für europäische Anwender – Europäische Regelungen zu Elektro- und Elektronikgeräten (WEEE)

Bitte wenden Sie sich an der Matrox-Website (www.matrox.com/environment/en/weee) für Recycling-Informationen.

(Italiano) Informazioni per gli utenti europei – Direttiva sui rifiuti di apparecchiature elettriche ed elettroniche (RAEE)

Si prega di riferirsi al sito Web Matrox (www.matrox.com/environment/en/weee) per le informazioni di riciclaggio.

FRANCE

Avertissement sur l'épilepsie

À lire avant toute utilisation d'un jeu vidéo par vous-même ou votre enfant Certaines personnes sont susceptibles de faire des crises d'épilepsie ou d'avoir des pertes de conscience à la vue de certains types de lumières clignotantes ou d'éléments fréquents dans notre environnement quotidien. Ces personnes s'exposent à des crises lorsqu'elles regardent certaines images télévisées ou qu'elles jouent à certains jeux vidéo. Ces phénomènes peuvent apparaître alors même que le sujet n'a pas d'antécédent médical ou n'a jamais été confronté à une crise d'épilepsie.

Si vous-même ou un membre de votre famille avez déjà présenté des symptômes liés à l'épilepsie (crise ou perte de conscience) en présence de stimulations lumineuses, veuillez consulter votre médecin avant toute utilisation.

Nous conseillons aux parents d'être attentifs à leurs enfants lorsqu'ils jouent avec des jeux vidéo. Si vous-même ou votre enfant présentez un des symptômes suivants: vertige, trouble de la vision, contraction des yeux ou des muscles, perte de conscience, trouble de l'orientation, mouvement involontaire ou convulsion, veuillez immédiatement cesser de jouer et consultez un médecin.

Précautions à prendre dans tous les cas pour l'utilisation d'un jeu vidéo Ne vous tenez pas trop près de l'écran.

- Jouez à bonne distance de l'écran de TV et aussi loin que le permet le cordon de raccordement.
- Utilisez de préférence les jeux de vidéo sur un écran de petite taille.
- Évitez de jouer si vous êtes fatigué ou si vous manquez de sommeil.
- Assurez-vous que vous jouez dans une pièce bien éclairée.
- En cours d'utilisation, faites des pauses de dix à quinze minutes toutes les heures.

Trademarks • Marques déposées • Warenzeichen • Marchi registrati • Marcas registradas

Matrox Electronic Systems Ltd. /

Matrox Graphics Inc.	Matrox®, DualHead®, Avio™, C-Series™, D-Series™, DualHead2Go™, Extio™, G400™, G450™, G550™, GXM™, Maevex™, Marvel™, MED2mp™, MED2mp-DVI™, MED3mp-DVI™, MED4mp™, MED5mp-DVI™, MED5mp™, Millennium™, MMS™, Multi-Monitor Series™, MultiDesk™, Mura™, MuraControl™, Mystique™, P650™, P690™, P750™, Parhelia™, Parhelia™ APVe, Parhelia-512™, Parhelia-LX™, Parhelia HR256™, PJ4OLP™, QID™, Quad Information Display™, RAD™, Quick Connect™, MaxVIEW™, Onyx™, PixelTOUCH™, PrecisionCAD™, Precision SGT™, QuadHead2Go™, QuickDesk™, RAD2mp™, RAD3mp™, RAD9mp™, RADQ2mp™, Rainbow Runner®, TheatreVUE™, TripleHead™, TripleHead2Go™, VDA™, Veos™, Xenia™
Adobe Systems Inc.	Acrobat®, Reader®
Advanced Micro Devices, Inc.	AMD®
Apple Computer, Inc.	App Store®, Apple®, iPad®, Mac®, Mac OS®
Belden Inc.	Belden®
Dolby Laboratories, Inc.....	Dolby®, Dolby Digital®
Facebook, Inc.	Facebook®
Google, Inc.....	YouTube®
HDMI Licensing LLC.....	HDMI®
Intel Corporation.....	Intel®
International Business Machines.....	IBM Video Streaming™
Linus Torvalds.....	Linux®
Microsoft Corporation.....	Active Directory®, Aero®, Direct3D®, DirectShow®, DirectX®, Microsoft®, MS-DOS®, PowerPoint®, Windows®, Windows NT®, Windows Server®, Windows Vista®
NVIDIA Corporation.....	NVIDIA®
Panopto, Inc.....	Panopto™
PCI-SIG.....	PCI™, PCI-X®, PCIe®, PCI Express®
Radio Corporation of America.....	RCA®
RealVNC Ltd.	VNC®
Restream, Inc.....	Restream™
SD-3C, LLC.....	SD™, SDHC™, SDXC™
Silicon Graphics, Inc.	OpenGL®
Silicon Image, Inc.....	PanelLink®, TMDS®
Twitch Interactive, Inc.	Twitch™
U.S. Environmental Protection Agency.....	ENERGY STAR®
Video Electronics Standards Association.....	DisplayPort™
VideoLAN.....	VideoLAN®, VLC®, VLC® media player
Vimeo, LLC.....	Vimeo®

Wibu-Systems..... WIBU®
Wowza Media Systems, LLC Wowza™

Copyright © 1996-2020 VideoLAN. This logo or a modified version may be used or modified by anyone to refer to the VideoLAN project or any product developed by the VideoLAN team, but does not indicate endorsement by the project.

HTML5 Logo by World Wide Web Consortium ([W3C](http://www.w3.org)). This HTML5 logo is licensed under this Public License (<http://www.creativecommons.org/licenses/by/3.0/legalcode>). The logo has been modified to meet the resolution and size required by this application.

• (English) Registered trademarks are registered in the United States, Canada, and/or other countries. All other nationally and internationally recognized trademarks and tradenames are hereby acknowledged. • (Français) Les marques déposées sont déposées aux États-Unis, au Canada et/ou dans d'autres pays. Toutes les autres marques et tous les autres noms déposés reconnus nationalement ou internationalement sont également reconnus par les présentes. • (Deutsch) Die eingetragenen Warenzeichen sind in den USA, Kanada und/oder anderen Ländern registriert. Alle sonstigen national und international bekannten Warenzeichen und Produktnamen werden hiermit anerkannt. • (Italiano) I marchi registrati sono registrati negli Stati Uniti, in Canada e/o in altri paesi. Tutti gli altri marchi registrati e nomi commerciali riconosciuti a livello nazionale e internazionale sono ugualmente riconosciuti qui. • (Español) Las marcas registradas están registradas en los EE.UU., Canadá u otros países. Por medio del presente se reconocen todas las demás marcas y nombres comerciales reconocidos a nivel nacional e internacional.

(English) Disclaimer

THE INFORMATION IN THIS GUIDE IS SUBJECT TO CHANGE AT ANY TIME AND WITHOUT NOTICE.

Matrox Graphics Inc. reserves the right to make changes in specifications at any time and without notice. The information provided by this document is believed to be accurate and reliable at the time it is written. However, no responsibility is assumed by Matrox Graphics Inc. for its use, for its reproduction and/or distribution, in whole or in part; nor for any infringements of patents or other rights of third parties resulting from its use.

(Français) Responsabilité

LES INFORMATIONS CONTENUES DANS CE MANUEL PEUVENT ÊTRE MODIFIÉES EN TOUT TEMPS ET CE SANS PRÉAVIS.

Les Graphiques Matrox Inc. se réserve le droit de modifier les spécifications en tout temps et ce sans préavis quelconque. Les informations contenues dans ce manuel sont reconnues comme étant précises et fiables à la date de rédaction. Cependant, Matrox Graphics Inc. n'assume aucune responsabilité concernant leur utilisation, leur reproduction et/ou distribution, en tout ou en partie, ni leur contrefaçon de brevets ou de tout autre droit appartenant à des tiers résultant de leur utilisation. Aucune licence n'est accordée sur aucun brevet ou droit d'exploiter un brevet de Matrox Graphics Inc.

(Deutsch) Haftungsablehnungserklärung

DIE IN DIESEM HANDBUCH ENTHALTENEN ANGABEN UND DATEN KÖNNEN OHNE VORHERIGE ANKÜNDIGUNG GEÄNDERT WERDEN.

Die Matrox Graphics Inc. behält sich das Recht vor, jederzeit und ohne Ankündigung technische Daten zu ändern. Zum Zeitpunkt der Erstellung dieses Handbuchs sind die Inhalte korrekt und verlässlich. Weiterhin übernimmt Matrox Graphics Inc. keinerlei Verantwortung für die Benutzung dieses Handbuchs, die Vervielfältigung und/oder Verteilung im Ganzen oder zum Teil; weder für Verstöße gegen Patentrechte noch für andere Rechte Dritter, die aus seinem Gebrauch resultieren mögen. Es werden keinerlei Lizenzrechte gewährt für sämtliche Patente oder Patentrechte der Matrox Graphics Inc.

(Italiano) Discrezionalità

LE INFORMAZIONI CONTENUTE NEL PRESENTE DOCUMENTO SONO SOGGETTE A MODIFICHE IN QUALUNQUE MOMENTO E SENZA PRAEAVVISO.

Matrox Graphics Inc. si riserva il diritto di apportare variazioni di qualunque tipo alle specifiche tecniche in qualunque momento e senza alcun preavviso. Le informazioni contenute in questa documentazione sono ritenute corrette e attendibili al momento della pubblicazione. In ogni caso, non è imputabile a Matrox Graphics Inc. nessuna responsabilità per il loro utilizzo, per la loro distribuzione e/o riproduzione completa o in parte, come nessuna violazione a brevetti o diritti di altri produttori derivante dal loro utilizzo.

(Español) Renuncia

LA INFORMACION QUE CONTIENE EL PRESENTE MANUAL ESTA SUJETA A CAMBIOS SIN PREVIO AVISO EN CUALQUIER MOMENTO.

Matrox Graphics Inc. se reserva el derecho de realizar modificaciones en cualquier momento y sin previo aviso. La información facilitada en este documento se considera que es exacta y fiable hasta la fecha de publicación. Sin embargo, Matrox Graphics Inc. no asume ninguna responsabilidad por su uso, por su reproducción y/o distribución parcial o total; ni por cualquier infracción de patentes u otros derechos de terceras partes derivados de su uso. No se concede ninguna licencia bajo cualesquiera patentes o derechos de patentes de Matrox Graphics Inc.

Matrox Graphics Inc.

1055 Saint Regis Boulevard
Dorval, Quebec, Canada H9P 2T4
(514) 822-6000

video@matrox.com
www.matrox.com/video

matrox[®]
— video —