

Matrox® Extio™ 3 Series

- N3408 Transmitter card • N3408 Transmitter unit
 - N3408 Receiver unit
- N3208 Transmitter card • N3208 Transmitter unit
 - N3208 Receiver unit

User Guide

20266-301-0320
2020.12.15

Contents

| | |
|---|-----------|
| Matrox safety information | 5 |
| Installation and operation | 5 |
| If a power supply (internal or external) was included with your product | 6 |
| If your product includes laser-based technology | 6 |
| If your product includes a battery | 6 |
| Repair | 6 |
| Overview | 8 |
| Hardware supplied | 8 |
| Software available | 8 |
| Hardware required (sold separately) | 9 |
| Optional hardware (sold separately) | 9 |
| Matrox rack mount kit | 9 |
| More information | 10 |
| Getting started | 11 |
| Networked mode | 11 |
| Point-to-point mode | 11 |
| Link redundancy | 12 |
| Installing your Extio 3 transmitter card | 13 |
| Before you begin | 13 |
| Step-by-step installation | 14 |
| Installing multiple cards | 15 |
| Connecting your Extio 3 devices | 16 |
| Before you begin | 16 |
| Extio N3408 or N3208 transmitter card | 18 |
| Extio N3408 transmitter or receiver unit | 19 |
| Extio N3208 transmitter or receiver unit | 21 |
| Installing the SFP module | 24 |
| Setting up link redundancy | 26 |
| Connection setup guidelines | 26 |
| Enabling link redundancy | 27 |
| Disabling link redundancy | 27 |

| | |
|---|-----------|
| Description of LEDs | 28 |
| Power/status LEDs | 28 |
| Network LEDs | 30 |
| Updating your Extio 3 firmware | 32 |
| Before you update your firmware | 32 |
| Obtaining the Matrox Extio 3 firmware updater package | 32 |
| Updating your Matrox Extio 3 firmware (networked mode) | 33 |
| Updating your Matrox Extio 3 firmware (point-to-point mode) | 35 |
| Setting up networked mode | 37 |
| Before you begin | 37 |
| Validating network discovery | 38 |
| Installing Matrox Extio Central Manager software | 38 |
| Accessing the OSD (On-Screen Display) | 39 |
| Using the OSD (On-Screen Display) | 40 |
| Sources | 41 |
| Receiver information | 42 |
| Aggregator mode | 43 |
| Touch-screen monitors | 46 |
| Setting up point-to-point mode | 49 |
| Before you begin | 49 |
| Accessing the OSD (On-Screen Display) | 50 |
| Using the OSD (On-Screen Display) | 50 |
| Sources | 51 |
| Receiver settings and information | 52 |
| Rebooting or resetting your Extio 3 device | 55 |
| When to reboot or reset your device | 55 |
| Software reboot | 55 |
| Hardware reboot or configuration reset | 56 |
| Changing the operation mode of your devices | 58 |
| Changing from copper to fiber optic | 58 |
| Troubleshooting | 59 |
| What to do if you have a problem | 59 |
| Common problems and solutions | 59 |

| | |
|---|---------------|
| Product information | 62 |
| Hardware specifications | 62 |
| Product dimensions | 64 |
| Maximum distance (point-to-point mode) | 65 |
| External power supply | 65 |
| Environmental | 66 |
| Notes | 66 |
| Fiber optic transceiver SFP (Small Form Factor Pluggable) modules | 66 |
| Battery | 66 |
| Appendix A – Providing adequate airflow to your Extio 3 device | 68 |
| Appendix B – Firewall requirements | 69 |
| Extio Central Manager software | 69 |
| Firmware updater | 69 |
| Extio 3 devices | 70 |
| Accessing your Windows Firewall settings | 71 |
| Adding rules to your Windows Firewall settings | 72 |
| Appendix C – Mounting your devices | 74 |
| Mounting guidelines | 74 |
| Mounting your Extio 3 device | 74 |
| Appendix D – Configuring your audio settings | 76 |
| Receiver output | 76 |
| Receiver input | 77 |
| Receiver audio destination | 78 |
| Customer support | 79 |
| Matrox web | 79 |
| Technical support | 79 |
| View your warranty information | 79 |
| View the third party software notices | 79 |
| Register your Matrox product | 80 |

Matrox safety information



To ensure safe and reliable operation of your Matrox product, to avoid personal injury, and to prevent damage to your computer or Matrox hardware, read the following guidelines.

Installation and operation

- Read and retain all instructions. Only use your Matrox product according to the instructions, operating ranges, and guidelines provided in the Matrox user guide and other related Matrox documentation. Failure to follow these instructions could result in damage to your product or injury to the user or installer.

- Don't expose your Matrox product to rain, water, condensation, or moisture.

- **Caution: Hot Surface, Do Not Touch**

Your Matrox product can become hot while operating. Ensure that your computer cover is secured in place before turning it on.



Always turn off your computer, unplug it, and then wait for it to cool before removing the cover of your computer to touch any of its internal parts or to install your Matrox card. Allow hot surfaces to cool before touching your Matrox unit.

- **Attention: Surface chaude, ne pas toucher**

Votre produit Matrox peut devenir chaud durant son fonctionnement. Assurez-vous de bien fermer le couvercle de votre ordinateur avant de l'allumer.



Éteignez votre ordinateur, débranchez-le et attendez qu'il refroidisse avant d'ouvrir son couvercle pour accéder à ses parties internes ou pour installer votre carte Matrox. Laissez les surfaces chaudes refroidir avant de toucher votre appareil Matrox.

- Static electricity can severely damage electronic parts. Before touching any electronic parts, drain static electricity from your body (for example, by touching the metal frame of your computer).
- When handling a card, carefully hold it by its edges and avoid touching its circuitry.
- Don't stack devices or place devices so close together that they're subject to recirculated or preheated air.
- Don't operate your system or Matrox product near a heat source or restrict airflow to your system, and make sure the ambient temperature doesn't exceed the maximum recommended temperatures. Don't block ventilation holes on your unit or system.

If a power supply (internal or external) was included with your product

- Don't place the external power supply directly on top of the device.
- Only use power supplies originally supplied with the product or use a replacement that's approved by Matrox. Don't use the power supply if it appears to be defective or has a damaged chassis.
- Don't defeat the safety purpose of the polarized or grounding-type plug. A polarized plug has two blades with one wider than the other. A grounding-type plug has two blades and a third grounding prong. The wide blade or the third prong are provided for your safety. If the provided plug doesn't fit into your outlet, consult an electrician to replace the obsolete outlet.
- Make sure that nothing rests on the power cables and that the cables aren't located where they can be stepped on, pinched, or tripped over.
- Don't use damaged power cables.
- Unplug your system or device during lightning storms or if unused for long periods of time.

If your product includes laser-based technology

- The device contains a Class 1 laser product for use only under the recommended operating conditions and guidelines. For more information, see your Matrox user guide.
- Invisible laser radiation may be emitted from disconnected fibers or connectors. Don't stare into beams or view directly with optical instruments.
- Only use optical transceivers originally supplied with the product or use a replacement that's approved by Matrox.
- For more information on laser support and compliance, see your Matrox user guide.

If your product includes a battery

- The battery is non replaceable.
- To dispose of your product, see www.matrox.com/environment/weee.



Repair

- Don't attempt to open or repair a power supply unit (if one was supplied).

- Don't attempt to open or repair your Matrox product.
- If there's a fault with your Matrox product, review your Matrox warranty for more information.

Overview

Thank you for purchasing a Matrox Extio 3 Series product. Matrox Extio 3 is an IP KVM extender that enables you to work on a computer from a distance. It captures the peripheral signals from the computer (such as the keyboard, video, mouse, audio, and other peripherals) and extends these signals to a remote location.

Matrox Extio N3408 IP KVM extenders support up to four (4) monitors. Matrox Extio N3208 IP KVM extenders support up to two (2) monitors.

Hardware supplied*

Depending on your Extio 3 device, the following hardware is supplied:

- **Extio N3408 or N3208 transmitter card** – Transmitter card, 1 USB cable (A to mini B connectors), RJ45 transceiver.
- **Extio N3408 or N3208 transmitter unit** – Transmitter unit, 1 USB cable (A to B connectors), 1 power supply.
- **Extio N3408 or N3208 receiver unit** – Receiver unit, 1 power supply.

Software available

Depending on your setup (*networked* mode or *point-to-point* mode), the following software is available:

| | On-Screen Display (OSD)* | Extio Central Manager |
|----------------------------|---|---|
| Networked mode | Log into your receiver and switch to different transmitters. For more information, see “Setting up networked mode” , page 37. | Remotely manage, monitor, and configure your networked Extio 3 devices. For more information, see “Installing Matrox Extio Central Manager software” , page 38. |
| Point-to-point mode | Configure and manage your Extio 3 devices. For more information, see “Setting up point-to-point mode” , page 49. | — |

* The On-Screen Display (OSD) is available only on the receiver.

* The hardware supplied with your Matrox product may vary depending on the SKU or part number of your product. For more information, contact your Matrox representative.

Hardware required (sold separately)

Depending on your device and setup, you may need the following hardware:

- CAT5e, CAT6, or CAT7 cable
- LC-LC fiber optic cable
 - Multi-mode (62.5/125 µm (OM1), 50/125 µm (OM2, OM3, or OM4))
 - Single-mode (9/125 µm (OS1 or OS2))
- Shielded DisplayPort™ 1.1 or 1.2 cable*

Optional hardware (sold separately)

You may also need any of the following hardware:

- Multi-mode fiber optic transceiver†
- Single-mode fiber optic transceiver†
- Mini DisplayPort to DisplayPort adapter‡
- Analog audio cable
- Matrox secure cable solution

Matrox rack mount kit

Matrox makes available a rack mount kit to mount your Extio devices. To purchase a Matrox rack mount kit, contact your Matrox representative.

* Shielded DisplayPort™ 1.2 cable is required for 4K60 resolutions.

† To purchase a multi-mode fiber optic transceiver (part number XTO3-SFPMM) or single-mode fiber optic transceiver (part number XTO3-SFPSM) for your Matrox product, contact your Matrox representative.

‡ Not recommended for 4K60 resolutions.

More information

Your Matrox Extio 3 Series User Guide provides information on installing and connecting your Matrox hardware, updating your firmware package, and using the Extio OSD.

For information on how to use and configure Extio Central Manager software, see the Matrox Extio Central Manager User Guide.

Be sure to check for any last-minute release notes included with your product. Also, check the Matrox web site (www.matrox.com/video) for the latest Matrox software, technical support, and product information.

Getting started

The following outlines the steps for installing, connecting, and setting up your Extio 3 device.

Networked mode

In networked mode, Extio 3 devices operate over a copper-based or fiber-based Gigabit Ethernet network.

- 1 Install your card – see “Installing your Extio 3 transmitter card”, page 13.
- 2 Connect your devices – see “Connecting your Extio 3 devices”, page 16.
- 3 Validate your setup – see “Description of LEDs”, page 28.
- 4 Update your firmware – see “Updating your Extio 3 firmware”, page 32.
- 5 Validate your network discovery – see “Validating network discovery”, page 38.
- 6 Install your Extio Central Manager software – see “Installing Matrox Extio Central Manager software”, page 38.
- 7 Configure your Extio devices through Extio Central Manager software – For more information on using Extio Central Manager software, see the Matrox Extio Central Manager User Guide.
- 8 Log into your receiver and switch to different transmitters (OSD) – see “Using the OSD (On-Screen Display)”, page 40.

Point-to-point mode

In point-to-point mode, Extio 3 transmitter and receiver devices are directly linked to each other using copper or fiber optic cable.

- 1 Install your card – see “Installing your Extio 3 transmitter card”, page 13.
- 2 Connect your devices – see “Connecting your Extio 3 devices”, page 16.
- 3 Update your firmware – see “Updating your Extio 3 firmware”, page 32.
- 4 Enable point-to-point mode – see “Using the OSD (On-Screen Display)”, page 50 and “Setting up point-to-point mode”, page 49.
- 5 Configure your Extio devices – see “Basic functions”, page 50.

Link redundancy

For more information on connecting a redundant network, see [“Setting up link redundancy”](#), page 26.

Installing your Extio 3 transmitter card

This section describes how to install your Matrox Extio 3 transmitter card. If your Matrox card is already installed in your system, skip to [“Connecting your Extio 3 devices”](#), page 16. For information specific to your system, like how to remove its cover, see your system manual.

Before you begin

To avoid personal injury and to prevent damage to your system or Matrox hardware, read the following guidelines before installing and connecting your Matrox hardware.

Preventing damage to your hardware

- Always turn off your system, unplug it, then wait for it to cool before touching any of the internal parts of your computer or installing your Matrox product.
- While your system is turned off but still plugged in, some electrical current is supplied to the motherboard. This current may prevent newly installed hardware from working properly.
- Always try to insert or remove your card as straight as possible.
- When connecting devices, make sure the connectors are properly fastened.
- Before installing your transmitter card, make sure the SFP module is removed. For more information on removing the SFP module, see [“Removing the SFP module”](#), page 24.
- Review the safety information provided. For more information, see [“Matrox safety information”](#), page 5.

Step-by-step installation



WARNING: Before installing your transmitter card, make sure the SFP module is removed. For more information on removing the SFP module, see “Removing the SFP module”, page 24.

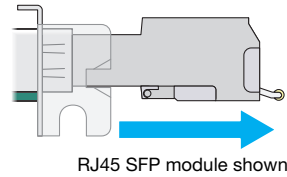

1 Choose an expansion slot

Most systems have different types of expansion slots. Choose a PCI Express® ×8 or ×16 (PCIe®) slot. Your system manual should identify the location of each type of expansion slot in your system.

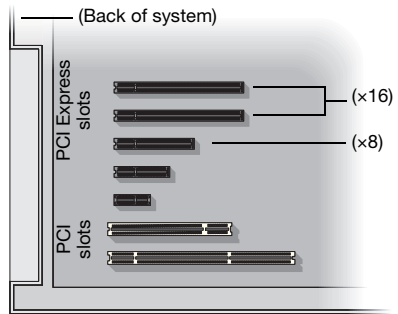

2 Insert your Matrox card

- a** Position your Matrox card over the expansion slot you've chosen.
- b** Push the card in firmly and evenly until it's fully seated in the slot.
- c** Secure the bracket of your Matrox card to the frame of your system.

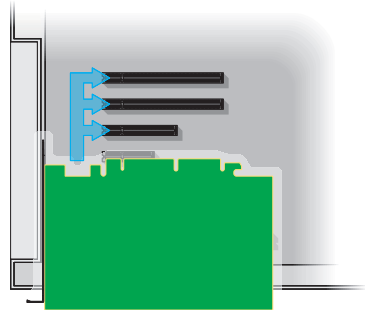

Your Matrox card is now installed. If you're installing more than one card, see “Installing multiple cards”, page 15. *Before restarting your system*, connect your devices (see the “Connection setup” section for the card you want to connect).

Installing multiple cards

Your system may support the installation of multiple Extio 3 transmitter cards in your system.



WARNING: To avoid damaging your cards, always insert your card as straight as possible into the slot. Don't rock the card from side to side. If you meet resistance, don't force the card into the slot.

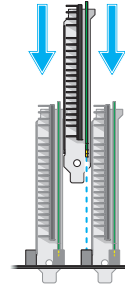

Connecting your Extio 3 devices

This section describes the connectors available on your Matrox Extio 3 devices.

Before you begin

To avoid possible problems that could damage your monitors or prevent you from using your Matrox product, read the following guidelines before connecting your Matrox graphics hardware.

- Whenever you change your connection setup, make sure you're using the correct connectors and that all connectors are properly fastened.
- Make sure your devices are powered off. Never change connections while your system, Extio transmitter, or receiver are turned on.
- Review the safety information provided. For more information, see [“Matrox safety information”](#), page 5.

Supported monitor adapters

| Adapter | Description |
|---|---|
| Mini DisplayPort to DisplayPort* † | If your graphics hardware has a DisplayPort connector, use a mini DisplayPort to DisplayPort adapter to connect your graphics hardware to the mini DisplayPort connector on your Matrox device. |
| DisplayPort to mini DisplayPort† | If your monitor has a mini DisplayPort connector, use a DisplayPort to mini DisplayPort adapter to connect your monitor cable to the DisplayPort connector on your Matrox device. |
| DisplayPort to DVI (active)‡ | If your monitor has a DVI connector, use a DisplayPort to DVI adapter (active) to connect your monitor cable to the DisplayPort connector on your Matrox device. |
| DisplayPort to HDMI (active)‡ | If your monitor has an HDMI connector, use a DisplayPort to HDMI adapter (active) to connect your monitor cable to the DisplayPort connector on your Matrox device. |

* Mini DisplayPort to DisplayPort adapter is supported on Extio N3408 or N3208 transmitter card only.

† Not recommended for 4K60 resolutions.

‡ Only active adapters (sold separately) are supported. Passive adapters aren't supported.



WARNING: To avoid damaging the DisplayPort connector on your DisplayPort monitor cable or on your Matrox product, carefully remove the DisplayPort cable by pressing the latch on the top of the DisplayPort connector while removing the connector.

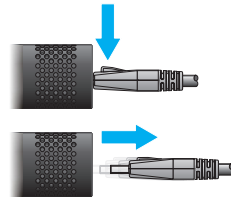

Output capabilities*

| | Connector 1 | Connector 2 | Connector 3* | Connector 4* |
|-----------------|-------------|-------------|--------------|--------------|
| DisplayPort 1.2 | — | — | — | ✓† |
| DisplayPort 1.1 | ✓ | ✓ | ✓ | ✓ |
| HDMI 1.4 | ✓ | ✓ | ✓ | ✓ |
| Single link DVI | ✓ | ✓ | ✓ | ✓ |
| Dual link DVI | ✓ | ✓ | ✓ | ✓ |

* Connector 3 and connector 4 are available on Extio N3408 devices only.

† Connector 4 supports 3840 × 2160 @ 60 Hz. For more information, see [“Using 4K60 resolutions”](#), page 17.

Using 4K60 resolutions

N3408 transmitter/receiver only – To use 4K resolutions, use your monitor cable to connect your monitor to the DisplayPort 1.2 connector labeled **4**. You can connect only one (1) 4K monitor to your device.

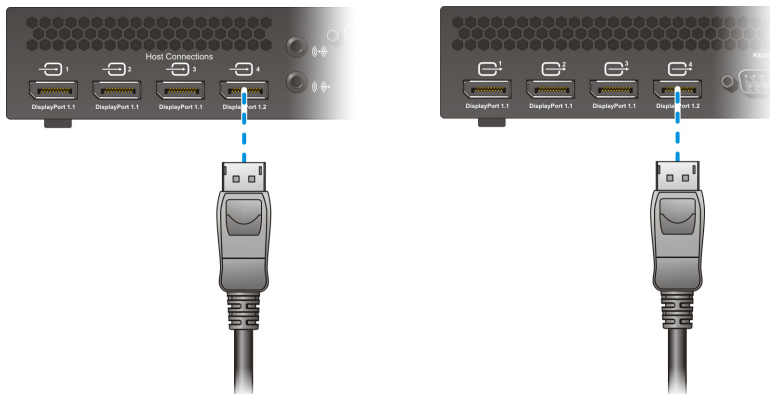

* For more information on supported resolutions and video signals, see [“Product information”](#), page 62.

Extio N3408 or N3208 transmitter card

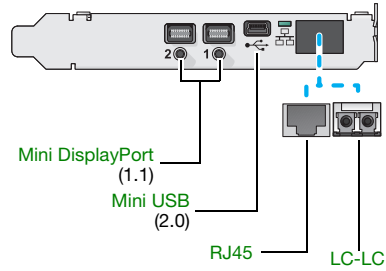
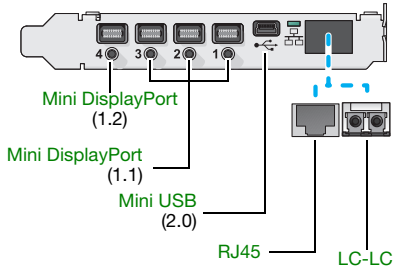

Note: Connect one end of the USB cable included with your product to the mini USB connector on your transmitter card. Connect the other end of your cable to a USB connector on the motherboard of your system. Make sure your connectors are properly connected.

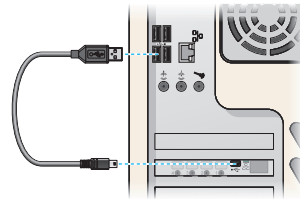

Description of supported connections

| Connector | Description |
|-------------------------|--|
| Mini DisplayPort | Connect your mini DisplayPort to DisplayPort cable to your Matrox card. Connect the other end of the cable to your host system. |
| Mini USB | Connect one end of your USB cable to the USB connector on your transmitter card. Connect the other end of your cable to a USB connector on the motherboard of your system. |
| RJ45 | Connect an RJ45 cable to this connector. |
| LC-LC | Connect an LC-LC fiber optic cable to this connector. |

Extio N3408 transmitter or receiver unit



Note: For more information on connecting a redundant network, see “Setting up link redundancy”, page 26.

Extio N3408 transmitter unit (Front)

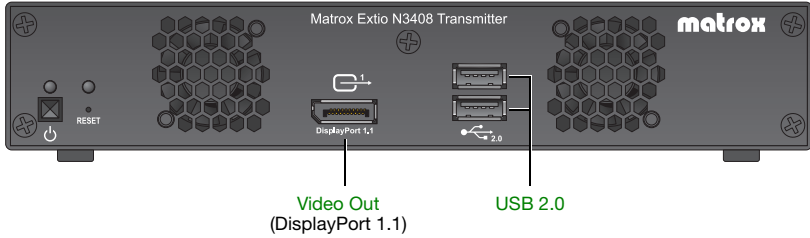

Extio N3408 transmitter unit (Back)

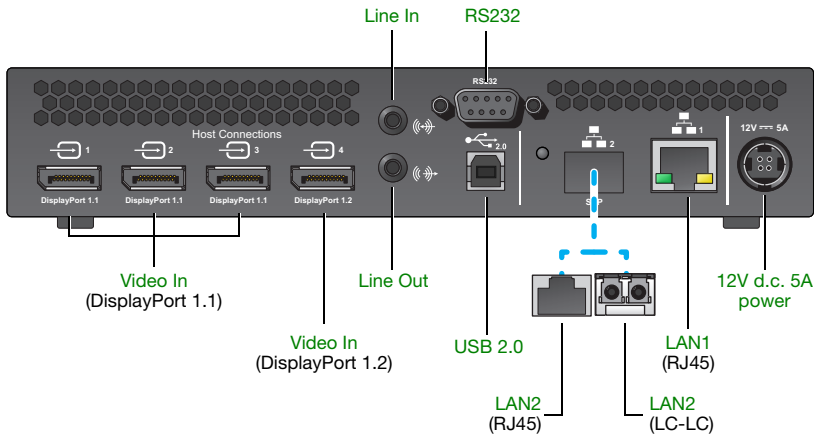

Extio N3408 receiver unit (Front)

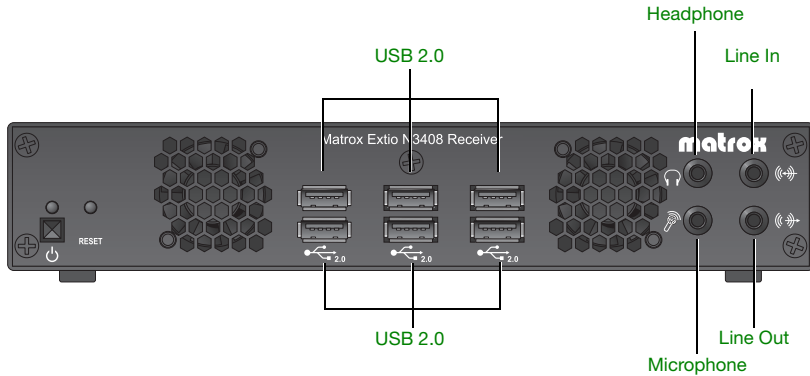

Extio N3408 receiver unit (Back)

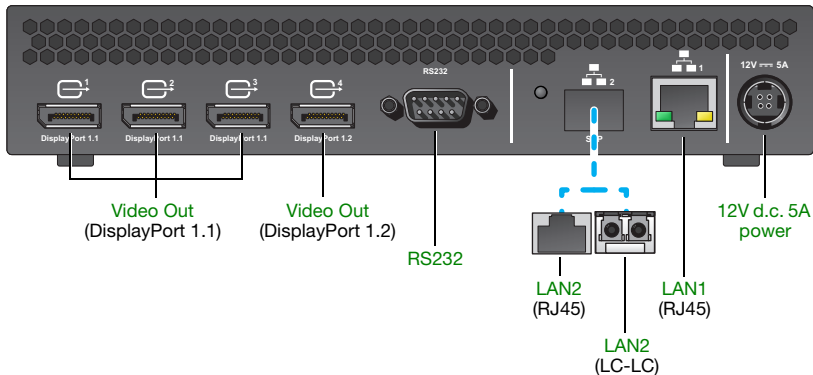

Description of supported connections

| Connector | TX | RX | Description |
|-------------------|----|----|--|
| 12V d.c. 5A power | ✓ | ✓ | Connect the 12V d.c. 5A power supply included with your product to this connector. |
| Video In | ✓ | | Connect your video source (graphics hardware) to this connector. |
| Video Out | ✓ | ✓ | Connect a digital monitor to this connector. Note: This connector is currently disabled on the transmitter unit. Support is expected in a future release. |
| Headphone | | ✓ | Connect your headphones to this connector. This connector supports a 3.5 mm stereo jack. While headphones are connected, the Line Out connector remains enabled. |

| Connector | Tx | Rx | Description |
|------------|----|----|---|
| LAN1 | ✓ | ✓ | Connect an RJ45 cable to this connector. Note: If you're using link redundancy, make sure the LAN1 and LAN2 connectors are connected before enabling the Link redundancy feature. |
| LAN2 | ✓ | ✓ | Connect an SFP module (RJ45 cable or LC-LC fiber optic cable) to this connector. For more information, see "Installing the SFP module", page 24. Note: If you're using link redundancy, make sure the LAN1 and LAN2 connectors are connected before enabling the Link redundancy feature. |
| Line In | ✓ | ✓ | Connect the Line Out connector of your computer (host) or of another audio device (local or remote) to this connector. This connector supports a 3.5 mm stereo jack. |
| Line Out | ✓ | ✓ | Connect the Line In connector of your computer (host) or of another audio device (local or remote) to this connector. This connector supports a 3.5 mm stereo jack. |
| Microphone | | ✓ | Connect your microphone to this connector. This connector supports a 3.5 mm stereo jack. |
| RS232 | ✓ | ✓ | Control an RS232 device on one of your devices with an RS232 controller connected to device, or with an RS232 controller sending commands over the network. If your RS232 device has a DB25 connector, use a DE9 (also known as a DB9) to DB25 converter to connect your device to this connector. |
| USB 2.0 | ✓ | ✓ | Connect a USB device to this connector. |

Extio N3208 transmitter or receiver unit

Extio N3208 transmitter unit (Front)

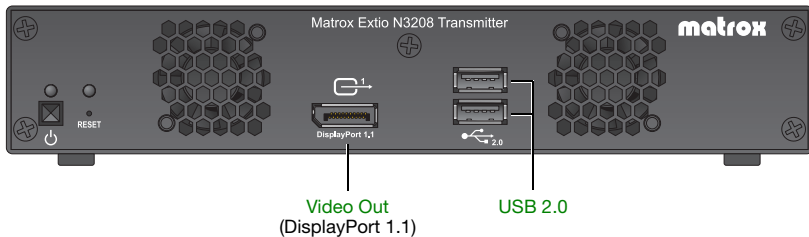

Extio N3208 transmitter unit (Back)

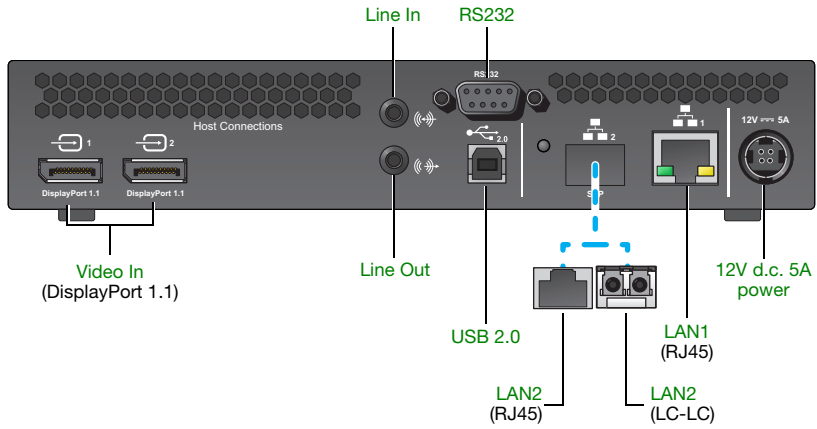

Extio N3208 receiver unit (Front)

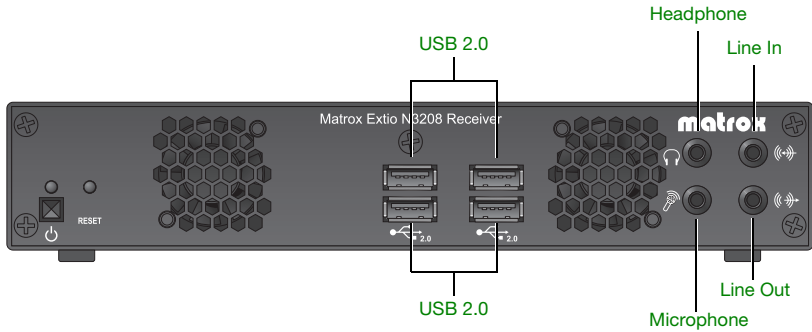

Extio N3208 receiver unit (Back)

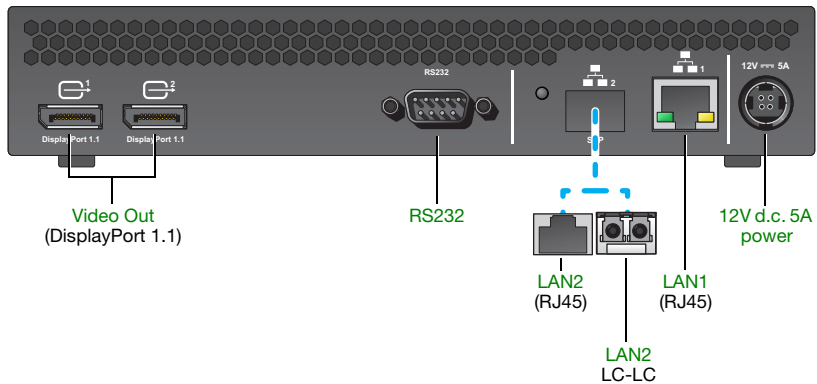

Description of supported connections

| Connector | Tx | Rx | Description |
|--------------------------|----|----|--|
| 12V d.c. 5A power | ✓ | ✓ | Connect the 12V d.c. 5A power supply included with your product to this connector. |
| Video In | ✓ | | Connect your video source (graphics hardware) to this connector. |
| Video Out | ✓ | ✓ | Connect a digital monitor to this connector. Note: This connector is currently disabled on the transmitter unit. Support is expected in a future release. |
| Headphone | | ✓ | Connect your headphones to this connector. This connector supports a 3.5 mm stereo jack. While headphones are connected, the Line Out connector remains enabled. |
| LAN1 | ✓ | ✓ | Connect an RJ45 cable to this connector. Note: If you're using link redundancy, make sure the LAN1 and LAN2 connectors are connected before enabling the Link redundancy feature. |
| LAN2 | ✓ | ✓ | Connect an SFP module (RJ45 cable or LC-LC fiber optic cable) to this connector. For more information, see "Installing the SFP module", page 24. Note: If you're using link redundancy, make sure the LAN1 and LAN2 connectors are connected before enabling the Link redundancy feature. |
| Line In | ✓ | ✓ | Connect the Line Out connector of your computer (host) or of another audio device (local or remote) to this connector. This connector supports a 3.5 mm stereo jack. |
| Line Out | ✓ | ✓ | Connect the Line In connector of your computer (host) or of another audio device (local or remote) to this connector. This connector supports a 3.5 mm stereo jack. |
| Microphone | | ✓ | Connect your microphone to this connector. This connector supports a 3.5 mm stereo jack. |
| RS232 | ✓ | ✓ | Control an RS232 device on one of your devices with an RS232 controller connected to device, or with an RS232 controller sending commands over the network. If your RS232 device has a DB25 connector, use a DE9 (also known as a DB9) to DB25 converter to connect your device to this connector. |
| USB 2.0 | ✓ | ✓ | Connect a USB device to this connector. |

Installing the SFP module

When installing the SFP (Small Form Factor Pluggable) module, make sure you properly secure the module in its housing.

To install the SFP module:

- 1 Close the latch handle.

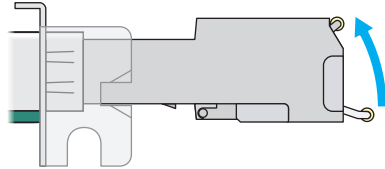

(RJ45 SFP module shown)

- 2 Push the module into the SFP housing in your Matrox product. Make sure the module is properly oriented. A properly oriented module should slide easily into the housing.

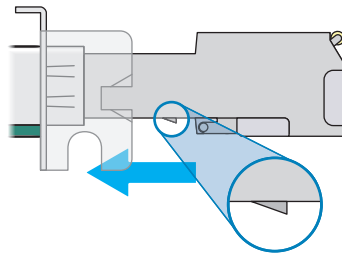

- 3 Make sure the SFP module is inserted all the way into the housing. When locking in place, you may hear a “click” sound. To make sure the SFP module is securely inserted, you can pull gently on the module without lowering the latch handle.

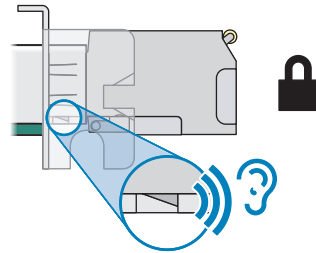

Removing the SFP module



WARNING: A properly installed SFP module is securely locked in its housing. Forcing the SFP module out of its housing without unlocking it may damage your SFP module, the housing, or your Matrox product.

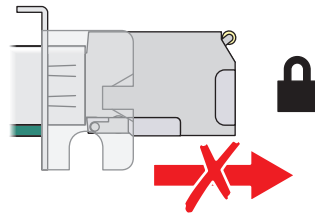

To remove the SFP module:

- 1** Pull the latch handle down to unlock the SFP module from its housing.

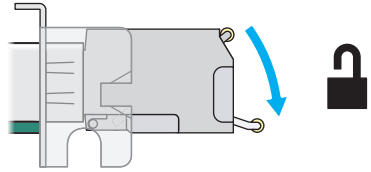

- 2** Grasp the SFP module by the side walls and carefully pull the module out of the housing.

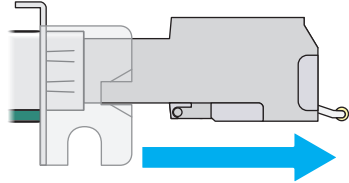

Setting up link redundancy

Link redundancy ensures your Extio 3 devices continue to work in case of a network cable or switch failure.

Connection setup guidelines

The following provides a basic outline for how to connect your Extio 3 transmitter and receiver to support link redundancy.

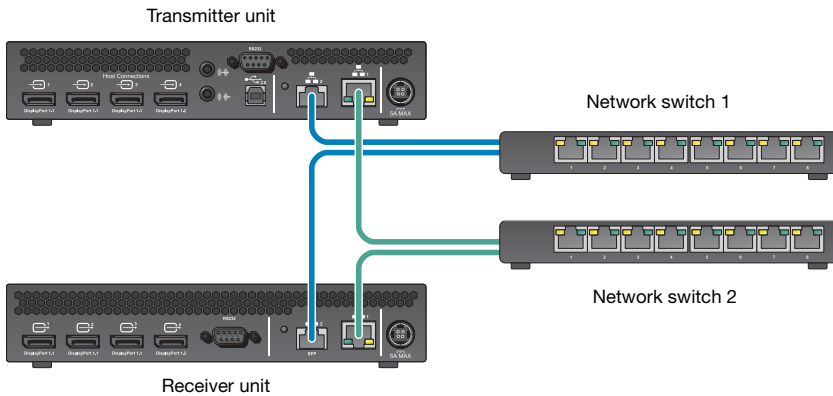

Note: Link redundancy is supported only on the following hardware: Extio N3408 transmitter units, N3208 transmitter units, N3408 receiver units, and N3208 receiver units. Extio N3408 and N3208 transmitter cards aren't supported.



Note: For information on setting up your network infrastructure and configuring your network switch, contact your network administrator.

- Make sure your Extio 3 units are all on the same subnet.
- Connect each Extio 3 transmitter and receiver unit to a managed network switch pair. Make sure to connect **LAN1** to network switch 1 and connect **LAN2** to network switch 2.
- Make sure the **LAN1** and **LAN2** connectors are connected before enabling the **Link redundancy** feature. For more information, see [“Connecting your Extio 3 devices”](#), page 16.

Enabling link redundancy

To enable link redundancy:

- 1 Connect the second network cable to your device (see “Connecting your Extio 3 devices”, page 16).
- 2 Enable the **Enable link redundancy** option in your Matrox software:
 - **Networked mode** – In Extio Central Manager software, select your Extio device, click **Network**, and then enable the **Enable link redundancy** option. For more information, see your Matrox Extio Central Manager User Guide.
 - **Point-to-point mode** – In the OSD, click **More options**, and then enable the **Enable link redundancy** option (see “Input and output information”, page 54).
- 3 For the changes to take effect, your devices will automatically reboot.

Disabling link redundancy

To disable link redundancy:

- 1 Disconnect the second network cable (see “Connecting your Extio 3 devices”, page 16).
- 2 Make sure your devices are detected on the network.
- 3 Disable the **Enable link redundancy** option in your Matrox software:
 - **Networked mode** – In Extio Central Manager software, select your Extio device, click **Network**, and then disable the **Enable link redundancy** option. For more information, see your Matrox Extio Central Manager User Guide.
 - **Point-to-point mode** – In the OSD, click **More options**, and then disable the **Enable link redundancy** option. For more information, see “Input and output information”, page 54.

Description of LEDs

The LED on your Extio 3 device provides information to help you troubleshoot your Extio 3 product. The following describes the LED on your Extio 3 device.

Power/status LEDs

The LEDs on your device provide information on the power and status of your device.

Extio N3408 or N3208 transmitter card



| LED color | Status LED |
|---------------------------|--|
| Green (standby) | Device is turned off but still powered. |
| Green (solid) | Device is active. |
| Green (fast blink) | Configuration reset in process. |
| Amber (solid) | Card is in maintenance mode. |
| Amber (slow blink) | Card is restarting in maintenance mode. |
| Amber (fast blink) | Device is updating the firmware. |
| Red (solid) | No source detected. |
| Red (slow blink) | No network detected. |
| Red (fast blink) | Device has detected a fatal error. Try rebooting your device. If, after rebooting your device, the LED is still fast blink red, contact your vendor for technical support (see “Customer support” , page 79). For more information on rebooting your Extio 3 device, see “Rebooting or resetting your Extio 3 device” , page 55. |

Extio N3408 or N3208 unit

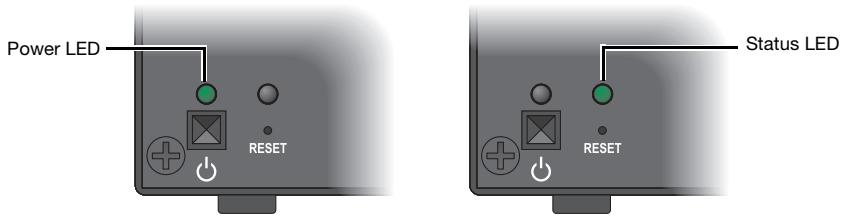

| LED color | Power LED | Status LED |
|---------------------------|--|--|
| Green (standby) | Device is turned off but still powered. | — |
| Green (solid) | Device is active. | Software is ready. |
| Green (slow blink) | Device is restarting. | — |
| Green (fast blink) | Configuration reset in process. | — |
| Amber (solid) | Device is in maintenance mode. | Device is restarting. |
| Amber (slow blink) | Device is restarting and is in maintenance mode. | Firmware mismatch detected. |
| Amber (fast blink) | Device is updating the firmware. | <ul style="list-style-type: none"> ▪ Transmitter – No USB connected. ▪ Receiver – No keyboard detected. |
| Red (solid) | — | <ul style="list-style-type: none"> ▪ Transmitter – No source detected. ▪ Receiver – No monitor detected. |
| Red (slow blink) | — | No network detected or network cable connection is invalid (see “Setting up link redundancy” , page 26). |
| Red (fast blink) | Error detecting the driver. | Fatal error occurred. |
| Black (no LED) | No power. Make sure your device is properly installed. Also, make sure your system isn't in power saving mode (see “Connecting your Extio 3 devices” , page 16). For more information, contact your vendor (see “Customer support” , page 79). | — |

Network LEDs

The network connectors on your device use LEDs to provide information on the network activity and presence. The following describes the different network connector LEDs.

Extio N3408 or N3208 transmitter card



| LED color | Network |
|--------------------|---|
| No LED (black) | No power. |
| Green (fast blink) | Network cable detected. Transmitting at 1 Gbps. |
| Amber (fast blink) | Network cable detected. Current transmission speed not supported. |
| Red (fast blink) | Network cable detected. Transmission error occurred. |
| Red (solid) | Detection mode activated in Extio Central Manager. |

Extio N3408 or N3208 unit (LAN1)

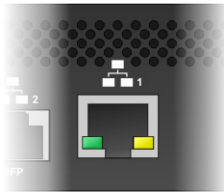

| LED color | LAN1 (Left LED) | LAN1 (Right LED) |
|--------------------|----------------------------|---------------------------|
| No LED (black) | No activity detected. | Transmitting at 1 Gbps. |
| Green (solid) | — | — |
| Green (fast blink) | Network activity detected. | — |
| Amber (solid) | — | Transmitting at 100 Mbps. |

Extio N3408 or N3208 unit (LAN2)

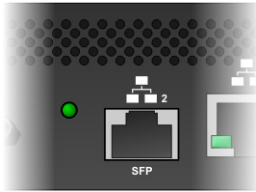

| LED color | LAN2 |
|--------------------|---|
| No LED (black) | No power. |
| Green (solid) | Network activity detected. |
| Green (fast blink) | Data transfer in progress. |
| Amber (solid) | No transceiver detected. |
| Red (solid) | Error establishing communication. Verify all network connections, then reboot your Extio 3 devices. For more information on rebooting your Extio 3 device, see “Rebooting or resetting your Extio 3 device” , page 55. |

Updating your Extio 3 firmware

The Matrox Extio 3 Firmware enables you to update the firmware of your Matrox Extio 3 products.



Note: Your Matrox Extio 3 product may ship with an older firmware version. Before using your Extio 3 product, you must update the firmware version installed on your devices to use the version of your deployed release. All Extio 3 devices must use the same version of the firmware package.

Before you update your firmware

Before you update the firmware on your Extio 3 devices, read the following guidelines:

- Make sure you have at least 1 GB of free disk space available.
- To avoid possible problems with your Extio 3 devices, we recommend running only one instance of the Extio 3 firmware updater on your network at a time.
- Make sure you're running the latest version of the Matrox Extio 3 Firmware Updater.
- Make sure Microsoft .NET Framework version 4.5.x is installed on your system.
- Make sure you have a DHCP (Dynamic Host Configuration Protocol) server on your network. The firmware updater requires constant IP addresses to update the devices properly. As the firmware updater requires a device to reboot multiple times, make sure your DHCP server maintains the IP address of a device when it reappears on the network. Otherwise, we recommend assigning fixed IP addresses to your devices.
- Close any programs that may be running (such as Extio Central Manager).
- If your system doesn't have access to a DNS server, configure your system to use a fixed IP address (such as local host - 127.0.0.1) as its DNS server. Otherwise, the firmware update process may take a long time to complete.

Obtaining the Matrox Extio 3 firmware updater package

Matrox makes the latest Extio 3 firmware updater package available on the Matrox web site (www.matrox.com/extio3/software).

Updating your Matrox Extio 3 firmware (networked mode)



Note: If you're using networked mode, make sure the version of your firmware package matches the version of the Matrox Extio Central Manager software package installed on your controller system.

1 Download and extract the firmware package

Download the latest firmware package and extract the files to a local folder on your system (for example, *C:\Extio3FirmwareUpdate*).

2 Run the *Updater Over Network* file

Browse to the folder containing the extracted files, then run the *UpdaterOverNetwork.exe* file.

3 Search for available Extio 3 devices or locate your Extio 3 device using the IP address

Automatic detection – To search for the Extio 3 devices on your subnet, select **Automatic detection**.

To start searching for devices, click **Search**.

Manual detection – If devices aren't automatically detected, you can manually locate one or more Extio 3 devices using their IP address. To manually locate the devices, select **Manual detection**, and next to **Address or URL** enter the IP address of each Extio 3 device you want to locate.

If you're entering multiple addresses, separate each address with a space. (You can also enter the addresses or URLs by clicking the browse button (⋮) and entering one IP address per line.)

When you're done entering the addresses or URLs, click **Apply**. To discard the last changes made, click **Cancel**.

To start searching for devices, click **Search**.

To stop searching for devices, click **Stop**. To resume searching for devices, click **Search** again.

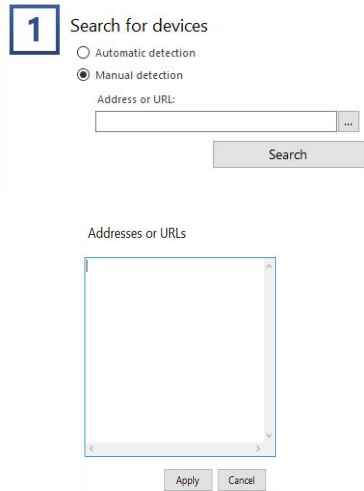

4 Authenticate the devices found

If you provided a password for your Extio 3 Series devices, you may be prompted to authenticate the devices found.

- If you're prompted, enter your credentials for the Extio 3 Series devices found:
 - **Local user** – Enter your user name and password.
 - **Domain user** – Enter your user name, the domain name of the server, and your network password.

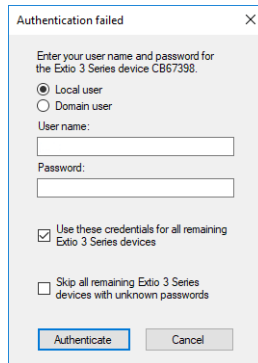

Local user

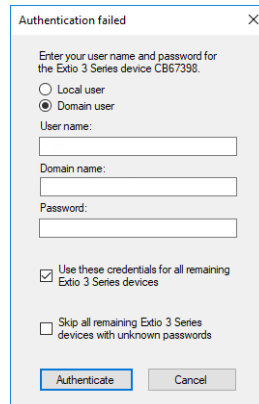

Domain user

- If you're updating multiple Extio devices, enable the **Use these credentials for all remaining Extio 3 Series devices** check box.
- If you don't know the password of some of the Extio devices on your network, enable **Skip all remaining Extio 3 Series devices with unknown passwords**. Enabling this option ignores the Extio devices that don't use any of the passwords already entered. Any skipped devices won't be available for update.

When you're done, click **Authenticate**.



Note: If a configuration reset of the Extio device was performed, the device password was also reset. The device will be detected as having no password. In this case, you'll be prompted to add that device to the list of devices to update. When prompted, click **Yes**.



5 Sync time on all devices

If you want to sync the date and time of your device with the date and time of your system, enable **Sync time of all devices**.

6 Reset configuration

If you want to reset device settings, including the IP address, while updating the firmware, enable **Reset configuration**.

7 Update selected devices

To update the firmware of your devices and apply any changes made to your configuration, click **Update**. Wait while the devices are being updated.

For more information on the device update process, click **Show log** () at the bottom of the program window.

Updating your Matrox Extio 3 firmware (point-to-point mode)

You can update the firmware of a single Extio 3 transmitter or of an Extio 3 transmitter and receiver pair (in point-to-point mode) using the USB connection between your host system and transmitter unit.

1 Download and extract the firmware package

Download the latest firmware package and extract the files to a local folder (for example, *C:\Extio3FirmwareUpdate*) on your host system (the system connected to your Extio 3 transmitter).

2 Run the *Updater from host* file

On your host system, browse to the folder containing the extracted files, then run the *Updaterfromhost.exe* file.



Note: To update the firmware, the *Updaterfromhost.exe* file installs a USB mass storage device on the Extio 3 transmitter unit. On certain systems, the Group Policy Object (GPO) may prevent the *Updaterfromhost.exe* file from installing the USB mass storage device. To allow the installation of this Matrox device, you may need to apply an exception to your GPO rules (for example, by adding *USBSTOR\DiskMatrox__Virtual_Storage_1.00*). For more information on modifying your GPO rules, contact your system administrator.

3 Update the firmware

Make sure the devices you want to update are listed in the program window. Devices that require an update are listed with a green status bar.

Click **Update** to update your devices. Wait while the devices are being updated (up to 20 minutes).

Setting up networked mode

Your Matrox Extio 3 product is an IP KVM extender. In networked mode, Extio 3 devices operate over a copper-based or fiber-based Gigabit Ethernet network.

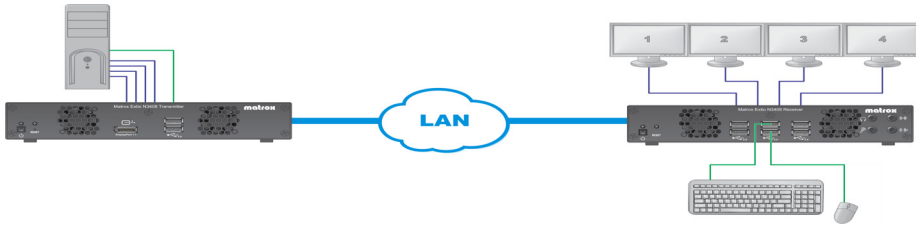

Before you begin

- If you operate on a private Wide Area Network (WAN), make sure you have the required bandwidth. For a private WAN to be supported, you should have Quality of Service (QoS) and a Virtual Private Network (VPN) tunnel. For additional details, contact Matrox.
- Whenever you change your connection setup, make sure you're using the correct connectors and that all connectors are properly fastened. Also, don't change connections while your Extio transmitter and receiver are turned on. For more information, see [“Connecting your Extio 3 devices”, page 16](#).
- Make sure your Extio Central Manager software is installed on a separate system on your network, and you've set the allowed connections between your Extio transmitter and receiver devices. For more information, see your Matrox Extio Central Manager User Guide.
- Make sure all of your Extio 3 transmitter and receiver devices are using the latest version of the Matrox Extio 3 firmware package. For more information, see [“Updating your Matrox Extio 3 firmware \(networked mode\)”, page 33](#).
- Make sure all your Extio 3 devices are using the *same version* of the firmware package. Also, the version of your firmware package must match the version of your Extio Central Manager software package.
- To assign an initial IP address to your devices, a DHCP (Dynamic Host Configuration Protocol) server is required.
- **Windows Server 2016 and Windows Server 2008 R2** – Make sure the SSDP Discovery service, network discovery, and file sharing options are enabled.

- Review the safety information provided. For more information, see “Matrox safety information”, page 5.

Software available in networked mode

- Extio Central Manager
- On-Screen Display (OSD)

Validating network discovery

Extio 3 devices are initially assigned their IP addresses through DHCP (Dynamic Host Control Protocol). After connecting your devices, we recommend verifying that all of your devices are discovered by the network.

Windows 10/7 – To make sure all of your devices are discovered by the network:

- **Windows 10** – Click **Start** → **File Explorer** → **Network**. Under **Other Devices**, make sure all the Extio 3 devices connected are listed.
- **Windows 7** – Click **Start** → **Accessories** → **Windows Explorer** → **Network**. Under **Other Devices**, make sure all the Extio 3 devices connected are listed.

If prompted to enable network discovery and file sharing on your network when validating network discovery, enable these two features by clicking on the prompt at the top of your Windows Explorer window. These two features must be enabled for Extio Central Manager software to detect the Extio 3 devices.

Installing Matrox Extio Central Manager software

Matrox Extio Central Manager software enables you to remotely manage, monitor, and configure your *networked* Extio 3 devices.



Supported operating systems

Matrox Extio Central Manager supports the following operating systems: *Windows® Server® 2016*, *Windows® 10 (64-bit)*, *Windows® Server® 2008 R2*, and *Windows® 7*.

Obtaining Matrox Extio Central Manager software

To obtain the latest Extio Central Manager software, contact your Matrox representative. Matrox makes the latest Extio Central Manager software available on the Matrox web site (www.matrox.com/extio3/software).

Installing Matrox Extio Central Manager software

To install the software for your Extio 3 product, run the installation program for your software package on any system on the network. Follow the on-screen instructions.



Note: Only one (1) instance of Extio Central Manager software needs to be installed.

Accessing Extio Central Manager software

Windows 10/7 – To access the main interface of Extio Central Manager software:

- Windows 10 – Click **Start** → **All apps*** → **Matrox Extio Central Manager*** → **Matrox Extio Central Manager**. (* Depending on your configuration of Windows, this part may not be necessary.)
- Windows 7 – Click **Start** → **All Programs** (or **Programs**) → **Matrox Extio Central Manager*** → **Matrox Extio Central Manager**. (* Depending on your version and configuration of Windows, this part may not be necessary.)

Configuring Extio Central Manager software

Before you can access and use the OSD, your Extio Central Manager software must be configured. For information on how to use and configure Extio Central Manager software, see the Matrox Extio Central Manager User Guide.

Accessing the OSD (On-Screen Display)



Note: To access the OSD, make sure you obtain a user name and password from your Extio 3 administrator. For more information, contact your network administrator.

The OSD is available only with Extio 3 receiver devices. To access the OSD, enter the OSD keyboard shortcut on the keyboard connected to your receiver. The default keyboard shortcut is the [Scroll Lock] key.

Changing the OSD keyboard shortcut

You can change the keyboard shortcut used to access the OSD.

Change the keyboard shortcut through Extio Central Manager. For more information, see your Matrox Extio Central Manager User Guide.

Enabling networked mode



Note: To change the operation mode of your Extio 3 configuration (for example, changing from networked mode to point-to-point mode), you need to perform a configuration reset of your devices. For more information, see [“Changing the operation mode of your devices”](#), page 58.

To use **Networked** mode, you need a user name and password. To obtain a user name and device password (or if you’ve forgotten your user name or device password), contact your Extio 3 administrator.

Using the OSD (On-Screen Display)

If your devices are networked, the OSD enables you to log into your receiver and switch to different transmitters.

Basic functions

| | |
|-----------------------|---|
| Logout | Click this to log out of the device. |
| Search | Search for a system by device serial number, friendly name, IP address, or name of the user connected. |
| Wake-on-LAN | Click this to wake up your transmitter if it turns off. This has no effect if a transmitter isn’t detected. |
| Rescan network | Click this to discover devices outside of the receiver’s subnet or unicast network. |
| Disconnect | Click this to disconnect from a transmitter. |
| Connect | Click this to connect to a new transmitter. |
| Get logs | Click this to get detailed logs for troubleshooting. |
| Close | Click this to close the OSD. |

Sources

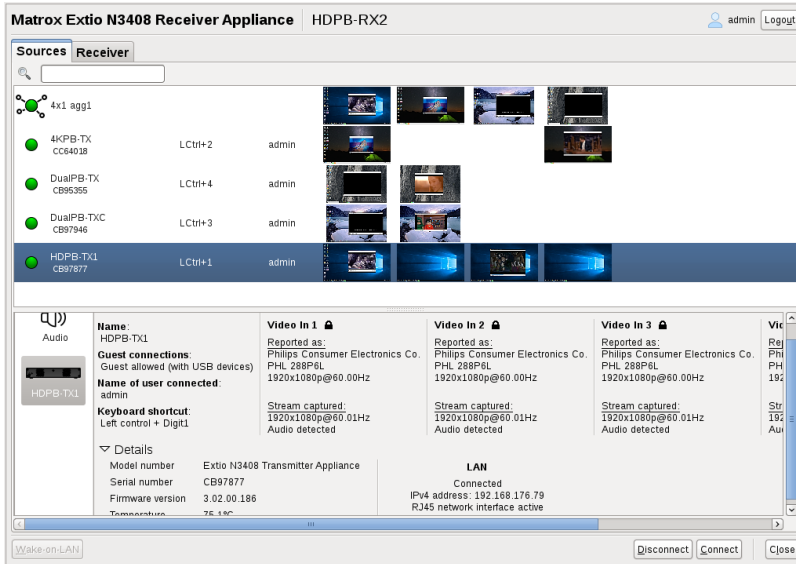

Note: For the transmitters to be available under **Sources**, an allowed connection must first be set between your Extio transmitter and receiver devices. For more information, see your Matrox Extio Central Manager User Guide.

To view information on a transmitter, select a transmitter under **Sources**.

Switching to a different transmitter

- 1 Under **Sources**, select the transmitter you want to switch to.
- 2 Click **Connect**.

Transmitter status

View the status information (**Name**, **Guest connections**, **Name of user connected**, and **Keyboard shortcut**) of the selected transmitter.

Inputs

View the connection information of the devices (**Monitor**, **Microphone**, and **Line In**) connected to the selected transmitter.

Details

Provides information (such as the model, serial number, firmware package version, and temperature) on your Extio 3 device and the connection status and IP address of the device (connected through **LAN1** or **LAN2**).

Receiver information

View and modify the settings for your receiver.

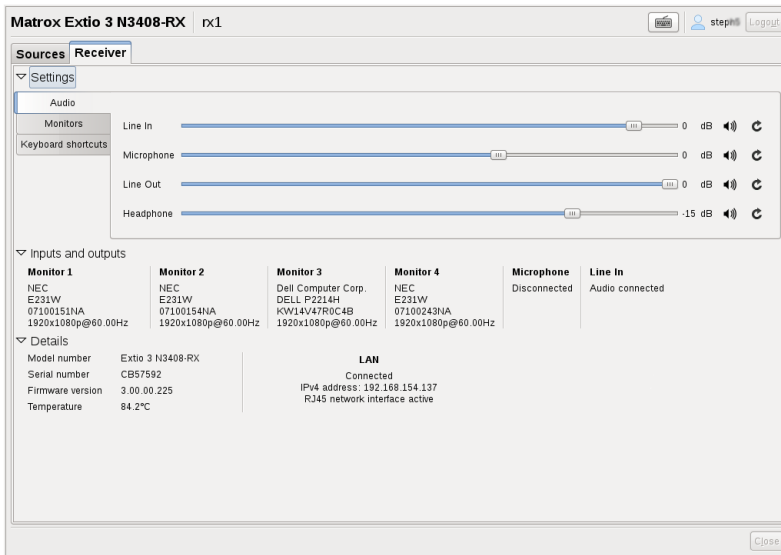

Settings

| | |
|---------------------------|---|
| Audio | Control the settings of your analog audio inputs and outputs (Line In , Microphone , Line Out , and Headphone). |
| Monitors | <ul style="list-style-type: none"> ▪ Aggregator mode only – To change a monitor layout for aggregator mode, click the Change monitor layout button under Aggregator mode: Monitor layout. ▪ You can configure touch-screen monitor identification here using the Touch screen monitor identification button. ▪ To pivot the OSD (on-screen display), use the arrow buttons to pivot left or right. |
| Keyboard shortcuts | Aggregator mode only – Keyboard shortcuts enable you to switch the mouse focus to a specific display (for example, 1, 2, 3, or 4) in your monitor layout. The default keyboard shortcuts are shown. These can be changed in the Extio Central Manager. |

Inputs and outputs

View the connection information of the devices (**Monitor**, **Microphone**, and **Line In**) connected to the selected transmitter.

Details

Provides information (such as the model, serial number, firmware package version, and temperature) on your Extio 3 device and the connection status and IP address of the device (connected through **LAN1** or **LAN2**).

Get logs

Provides detailed logs that are useful for auditing and troubleshooting.

- 1 Click the **Get logs** button. The **Log files retrieval** dialog box appears.
- 2 Insert a new USB mass storage device in the receiver.



Note: Only USB keys are supported, not USB drives.

- 3 In the **Log files retrieval** dialog box, select this USB device from the **USB mass storage inventory** list as the location where you want to save the log files.
- 4 Click **OK**. The zip files of the logs are created in the root folder of the USB device.

Aggregator mode

With aggregator mode, your Extio 3 receiver unit can gather video streams from multiple Extio 3 transmitter units into a single layout.

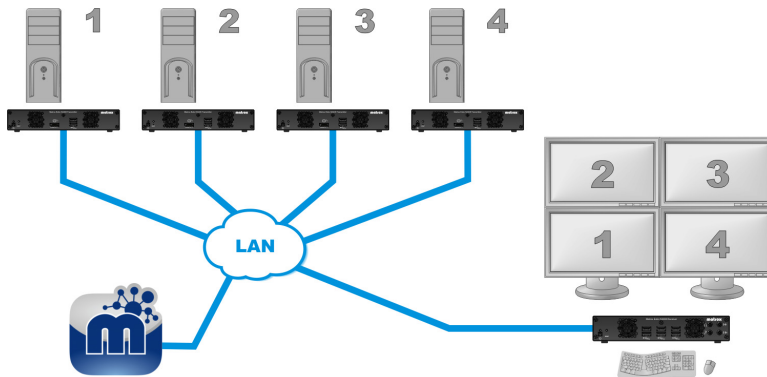

Before you begin

- **USB switching** – By default, you can use your mouse to switch between sources. You can also use a keyboard shortcut to switch sources. To use *only* keyboard shortcuts (no mouse) to switch sources, in Extio Central Manager, select a Receiver, then go to the **Keyboard shortcuts** page, and enable the **Use only keyboard shortcuts (no mouse) for USB switching** option.
- **Dynamic sources** – You can dynamically change the transmitter source (stream from a system) displayed on one of the monitors attached to a receiver in aggregator mode. This enables you to easily access and switch between different systems from a large group (pool) of systems to view the stream currently of interest to you, without affecting the other displays.
 - Dynamic sources is shown on only one monitor.
 - Dynamic sources feature is supported only while using aggregator mode.
- **Tile display** - A tile display configuration is one where streams are displayed in multiple tiles in a 4K monitor. A 4Kp60 resolution tiled display appears on Output 4 only. You can see two 4Kp30 resolution tiled displays in a layout - on Outputs 1 and 4. **Note:** You can't have dynamic sources in a tile display.
- **Operating system** - Certain limitations may occur. For more information on operating system compatibility with aggregator mode, see the Matrox Extio 3 Series Release Notes.

Switching between dynamic sources

You can change the dynamic source as frequently as you like.

To switch to a different source:

- 1 Open the on-screen-display (OSD) and click the **Dynamic sources** tab (or, you can use the keyboard shortcut to go directly to the **Dynamic sources** tab). This tab contains all the source streams from the accessible transmitter units. Each source is shown with its preview image, the friendly name of the transmitter, and the source input number. If a transmitter has only a single available source, the input number is omitted.

- 2 Select a target stream. (To find a specific stream from a large list, use the search box on top to filter.)

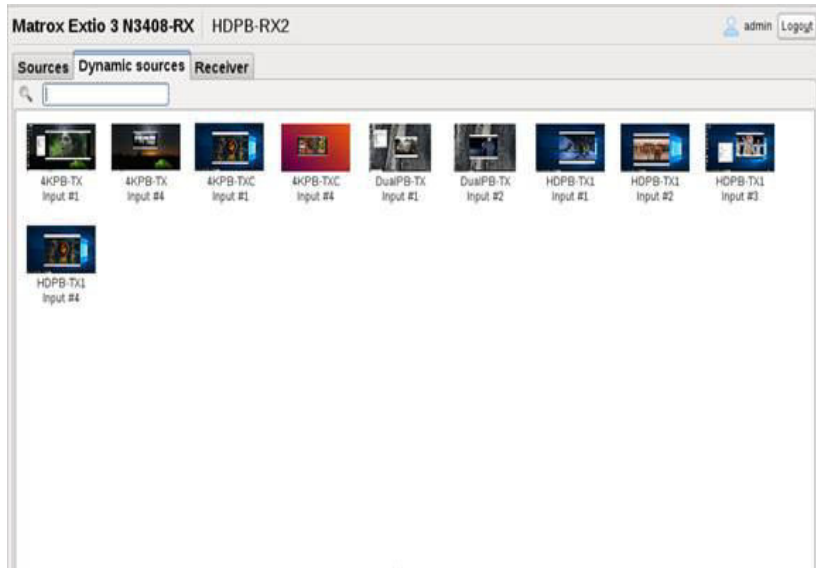

- 3 To switch to the transmitter associated with the stream, click **Connect** (or, double-click the target stream). The selected stream is now displayed on the monitor assigned with dynamic sources.

Specify keyboard shortcut for dynamic sources

To enable you to quickly switch between streams, you can assign a keyboard shortcut that will take you directly to the **Dynamic sources** tab.

- 1 To display the **Dynamic sources** tab, from the receiver unit, press the shortcut key combination. The default is [Right Shift] + [Scroll Lock]. **Note:** This default shortcut key combination can be reassigned using the Extio Central Manager software. For more information on keyboard shortcuts, see your Matrox Extio Central Manager User Guide.
- 2 In the search box, type the source and input name if you know it, and press [Enter] to filter. (Alternatively, you can select the source thumbnail directly if you're able to visually scan and locate the source.)
- 3 Select the source.
- 4 To switch to the appropriate transmitter, click **Connect**.

Disconnecting dynamic sources

To stop viewing dynamic sources, on the **Dynamic sources** tab, click **Disconnect**. Disconnecting dynamic sources doesn't affect the streams on the fixed-source monitors.

Touch-screen monitors

To use touch-screen monitors with Extio, you need to configure them first to ensure they operate as expected. The touch functionality of the monitor is provided by a touch-screen USB device, also known more generically as a digitizer USB device. Since there is no matching information between the monitor EDID and the digitizer USB report, the software (firmware on the device) is unable to link a monitor with its digitizer USB device automatically. You need to perform a matching procedure between the monitor and its digitizer USB device for the receiver to properly handle the touch screen.

Note: For tablets and other touch display devices, you have to do the same matching procedure between the touch display device and its digitizer USB device.

Note: Touch-screen monitors are not supported in Tile displays.

Match touch-screen monitor with digitizer USB device

To perform a touch-screen matching procedure:

- 1 Log into the receiver. If new digitizer USB devices are found, or if a new digitizer USB device is inserted while the receiver is already in operation, the OSD appears with a prompt asking if you would like to start performing the touch-screen matching configuration.

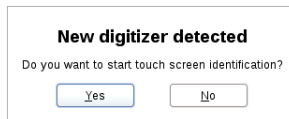

- 2 Click **Yes**. The **Touch screen monitor identification** screen on the OSD appears on all the monitors.

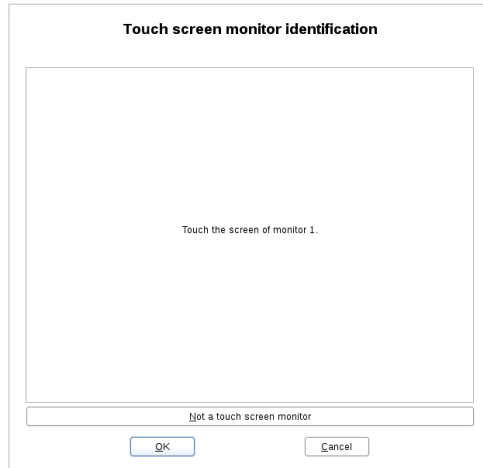

- 3 On the touch screen of the monitor (**x**) identified on the top-left corner of the screen, tap the designated area in the middle of the OSD where **Touch the screen of monitor x** appears. **Note:** The firmware detects your touch on the screen and links the corresponding digitizer USB device and its port number to the current monitor being calibrated.
- 4 Repeat step 3 for all the touch-screen monitors.
- 5 For a monitor without touch screen, click the **Not a touch screen monitor** button at the bottom of the screen. Repeat for each non touch-screen monitor that is detected.
- 6 When you're done, click **OK**. The touch-screen monitors are now matched with their corresponding digitizer USB devices.

The matching information between touch-screen monitors and their digitizer USB devices is kept in the non-volatile memory on the receiver unit so this information is not lost when you reboot the receiver unit. If the digitizer USB device has a serial number, the digitizer matching information is retained even if the digitizer USB device is changed to a different USB port, so there is no need to do the matching procedure again. If the digitizer USB device doesn't have a serial number, the digitizer matching information is lost when the digitizer USB device is changed to a different USB port. In this case, you have to do the matching procedure again.

Note: The matching procedure can also be done at any time by using the **Touch screen monitor identification** button in the **Monitors** section under **Receiver** tab → **Settings**.

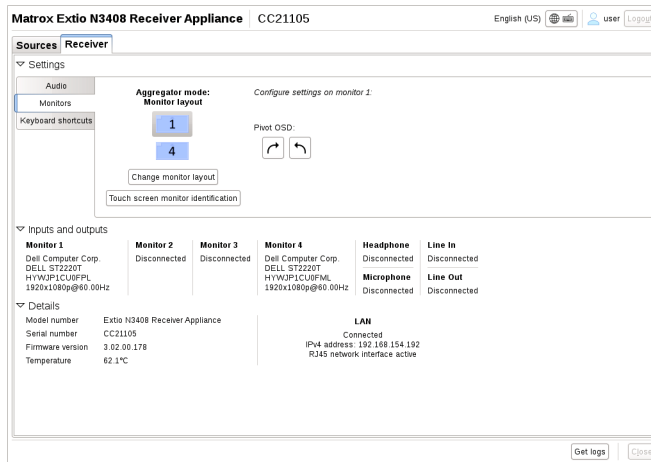

Note: For the touch screen to work properly, you need to do some set ups on the Tablet PC settings in the Control panel as well. Refer to the user manual of the touch screen for details on how to set up, calibrate, and associate a monitor with the touch screen.

Once configured, when you connect to a source, the digitizer USB device corresponding to the touch-screen monitor that displays the stream is connected to the transmitter providing the stream.

If the touch screen doesn't work properly after monitor identification, you have to go to the Control panel of the operating system and set up through Tablet PC Settings.

Setting up point-to-point mode

Matrox Extio 3 transmitters and receivers can be configured as point-to-point extenders. In point-to-point mode, Extio 3 transmitter and receiver devices are directly linked to each other using copper or fiber optic cable.



Before you begin

- Whenever you change your connection setup, make sure you're using the correct connectors and that all connectors are properly fastened. Also, don't change connections while your Extio transmitter and receiver are turned on. For more information, see [“Connecting your Extio 3 devices”](#), page 16.
- Make sure all of your Extio 3 transmitter and receiver devices are using the latest version of the Matrox Extio 3 firmware package.
- To enable point-to-point mode, make sure your transmitter device and receiver device are directly (physically) connected to each other. For more information, see [“Connecting your Extio 3 devices”](#), page 16.
- For information on supported cable types and distances, see [“Maximum distance \(point-to-point mode\)”](#), page 65.
- Review the safety information provided. For more information, see [“Matrox safety information”](#), page 5.

Software available in point-to-point mode

- On-Screen Display (OSD)

Accessing the OSD (On-Screen Display)

The OSD is available only with Extio 3 receiver devices. To access the OSD, enter the OSD keyboard shortcut on the keyboard connected to your receiver. The default keyboard shortcut is the [Scroll Lock] key.

Changing the OSD keyboard shortcut

You can change the keyboard shortcut used to access the OSD. To change the keyboard shortcut, use the **OSD settings** option.

Using the OSD (On-Screen Display)

Enabling point-to-point mode



Note: To change the operation mode of your Extio 3 configuration (for example, changing from networked mode to point-to-point mode), you need to perform a configuration reset of your devices. For more information, see [“Changing the operation mode of your devices”, page 58.](#)

To use your devices in point-to-point mode, click **Point-to-Point** from the OSD startup screen. Wait for the mode to be enabled. For more information, see [“Basic functions”, page 50.](#)

Basic functions

| | |
|----------------------------|--|
| Wake up transmitter | Click this to wake up your transmitter if it turns off. |
| Refresh connection | Click this if the connection between your receiver and transmitter devices is lost. Wait while your connection is refreshed. |
| Close | Click this to close the OSD. |

Sources

View the input, device, and network information for your transmitter.

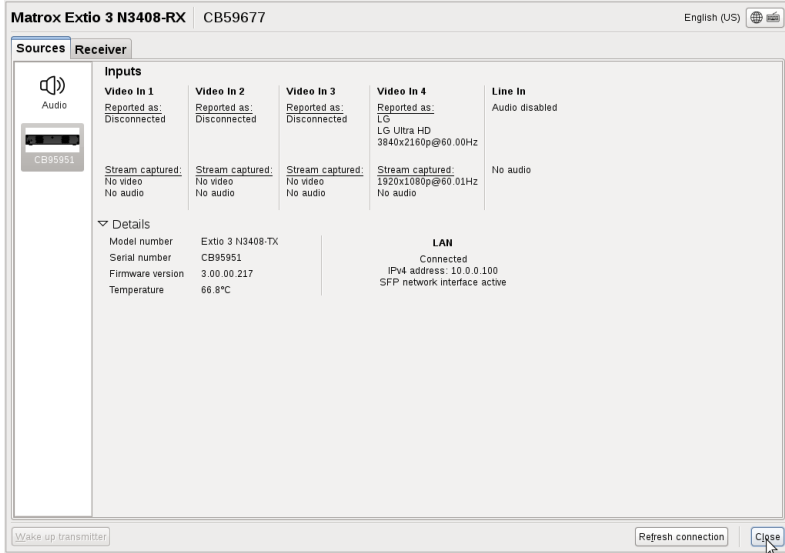

Inputs

View the connection information of the devices (**Monitor**, **Microphone**, and **Line In**) connected to the selected transmitter.

Details

Provides information (such as the model, serial number, firmware package version, and temperature) on your Extio 3 device, and provides the connection status and IP address of the device (connected through **LAN**).

Receiver settings and information

View and modify the settings for your receiver.

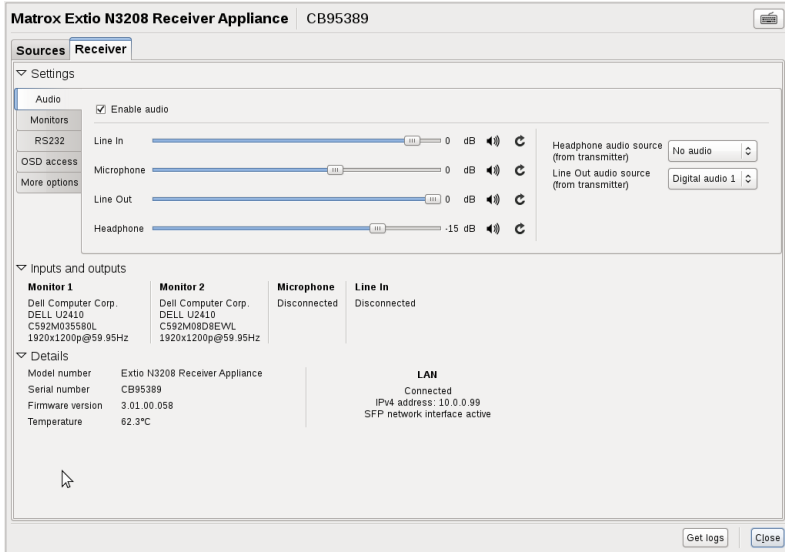

Audio settings

To enable audio, make sure the **Enable audio** option is enabled.

To adjust the audio settings for your device:

| | |
|---|--|
| Headphone audio source | Select the audio source (for your headphone) from the transmitter. |
| Line Out audio source | Select the audio source (for your Line Out device) from the transmitter. |
| Microphone or Line In audio source | Select the input audio source from the receiver. |

Monitor settings

| | |
|--|--|
| Optimize video mode compatibility with monitors | Enable this to make sure the video parameters and EDID of your monitors are optimized for maximum compatibility with your device. This option is enabled by default. |
|--|--|

| | |
|---|--|
| Enable advanced display modes | <p>Enable the Enable advanced display modes option to support the following display modes:</p> <ul style="list-style-type: none"> ▪ 1× 3840×2160@60Hz + 1× 1920×1080@60Hz ▪ 1× 3840×1440@60Hz + 1× 1920×1080@60Hz ▪ 4× 2560×1600@60Hz ▪ 4× 1920×1200@60Hz |
| Stabilize display output | <p>Enable this to reduce flickering associated with video output. This option is enabled by default. For more information, see “Random display flickering occurs while using a point-to-point connection”, page 60.</p> |
| Allow monitors to enter power saving mode | <p>Enable this to turn off the display after X minutes of inactivity.</p> |
| Configure monitor behavior on transmitter inputs | <p>Select a Monitor (1, 2, 3, or 4) to apply a fixed EDID to that output. If a monitor is currently connected, click Update to apply the EDID settings of that monitor. If using a 4K resolution, make sure your transmitter reports only the monitor (output) supported. In this case, your transmitter must report the other monitors as disconnected (no monitor). To report those monitors as disconnected, click No monitor.</p> |

RS232 settings

To modify your RS232 settings, click **Edit RS232**. This opens a new dialog box. To enable RS232, enable the **Enable RS232** option, edit your RS232 settings.

| | |
|---------------------|---|
| Baud rate | The speed, in bits per seconds (or baud), used for the RS232 connection. The default is 115200. |
| Data bits | The number of bits per block of data transmitted. The default is 8. |
| Parity | The type of parity bits (None , Odd , or Even) used for the data transmitted. The default is None . |
| Stop bits | The number of bits used to identify the end of a data block. The default is 1. |
| Flow control | The signal type (None or RTS/CTS) used to pause and resume data transmission. The default is None . |

When you're done, click **Apply**.

OSD access

Assign a keyboard shortcut for accessing the on-screen display (OSD).

More options

| | |
|--|--|
| Enable link redundancy | To ensure network uptime in case of network failure, enable the Enable link redundancy option. In the case of a network failure, your device will automatically switch to a secondary network path. For more information, see “ Setting up link redundancy ”, page 26. |
| Disable shutdown using power button | To disable the power button on your device, enable Disable power button . |
| Power recover policy | <ul style="list-style-type: none">▪ Never start – Never start your Extio device after a power loss.▪ Always start – Always start your Extio device after a power loss.▪ Restore last state – Always start and restore the last state of your Extio device after a power loss. |
| Reboot transmitter | Click this to reboot your transmitter device. |
| Reboot receiver | Click this to reboot your receiver device. |

Input and output information

View the connection information of the devices (**Monitor**, **Microphone**, and **Line In**) connected to the selected transmitter.

Details

Provides information (such as the model, serial number, firmware package version, and temperature) on your Extio 3 device, and provides the connection status and IP address of the device (connected through **LAN**).

Get logs

Provides detailed logs that are useful for auditing and troubleshooting.

- 1 Click the **Get logs** button. The **Log files retrieval** dialog box appears.
- 2 Insert a new USB mass storage device in the receiver.



Note: Only USB keys are supported, not USB drives.

- 3 In the **Log files retrieval** dialog box, select this USB device from the **USB mass storage inventory** list as the location where you want to save the log files.
- 4 Click **OK**. The zip files of the logs are created in the root folder of the USB device.

Rebooting or resetting your Extio 3 device

This section describes how to *reboot* or perform a *configuration reset* of your Extio 3 card or unit.

When to reboot or reset your device

| What to do... | When to do it... | What the result is... |
|---|---|---|
| Software reboot (Extio Central Manager) | <ul style="list-style-type: none">Your Extio device has encountered an error (red device tile). | Keeps all of your device settings, including the IP configuration and password. |
| Software reboot (OSD – Point-to-point mode only) | | |
| Hardware reboot | <ul style="list-style-type: none">Your Extio device is listed as unresponsive (yellow device tile).Extio Central Manager software is unresponsive, and you can't perform an Extio Central Manager software reboot. | Keeps all of your device settings, including the IP configuration and password. |
| Configuration reset | <ul style="list-style-type: none">Your Extio device is still listed as unresponsive (yellow device tile) after a hardware reboot.You're changing the operation mode of your Extio device. | Resets all of your device settings, including the IP configuration and password. |

Software reboot

Extio Central Manager

From the Extio Central Manager main interface, select your device then click the **Reboot** button to reboot your device.

For more information on Extio Central Manager software, see your Extio Central Manager user guide.

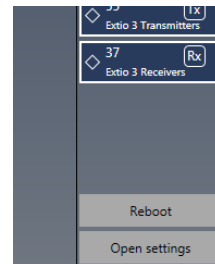

OSD (point-to-point mode only)

From the OSD main interface, click **Reboot transmitter** to reboot your transmitter device or **Reboot receiver** to reboot your receiver device. You can also click **Reboot both devices** to reboot both the transmitter and the receiver devices.

Reboot transmitter

Reboot receiver

Hardware reboot or configuration reset



WARNING: A configuration reset restores the default settings of your Extio 3 device. This *resets all of* your device settings, including the IP configuration and password.



WARNING: Point-to-point mode – Performing a configuration reset on an Extio receiver also resets the settings of the transmitter device connected to the receiver.

Extio N3408 or N3208 transmitter card

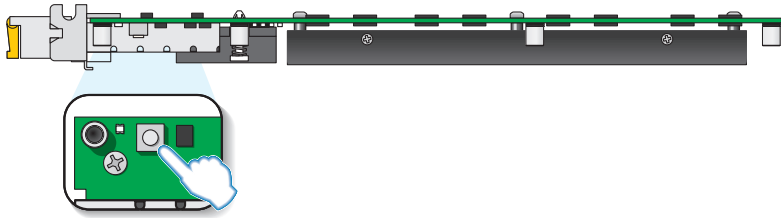

- **Hardware reboot** – Quickly press the button (*1 second*) to reboot your device.
- **Configuration reset** – Press and hold the button for *4-5 seconds* (until the LED turns fast blinking green) to reboot your device and restore the default settings.

Extio N3408 or N3208 unit

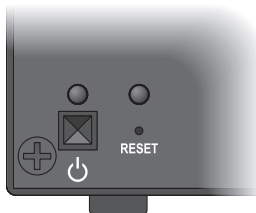

- **Hardware reboot** – Press and hold the **Reset** button on your device with the tip of a paper clip for *less than 2 seconds* (until the LED turns slow blinking green) to reboot your device.

- **Configuration reset** – Press and hold the **Reset** button on your device with the tip of a paper clip for *4-5 seconds* (until the LED turns fast blinking green) to reboot your device and restore the default settings.

Changing the operation mode of your devices

If you change the operation mode of your Extio 3 configuration (for example, changing from networked mode to point-to-point mode, or vice versa), you need to do the following:

- 1 Disconnect the network cables from your Matrox transmitter device and receiver device (see [“Connecting your Extio 3 devices”](#)).
- 2 Perform a configuration reset on your transmitter device and receiver device (see [“Hardware reboot or configuration reset”](#), page 56).
- 3 Change the connection setup of your devices (see [“Connecting your Extio 3 devices”](#), page 16).
- 4 Reboot both your Matrox transmitter device and receiver devices (see [“Rebooting or resetting your Extio 3 device”](#), page 55). **Note:** This step is not required if you’re using RJ45 connections.
- 5 Configure your Extio 3 devices again:
 - **Networked mode** – Use Extio Central Manager software to configure your devices. For more information, see your Matrox Extio Central Manager user guide.
 - **Point-to-Point mode** – Use the OSD to configure your devices (see [“Setting up point-to-point mode”](#), page 49).

Changing from copper to fiber optic

When you have to switch from copper Ethernet to fiber optic cables, you need to do the following:

- 1 Disconnect the network cables from your Matrox transmitter device and receiver device (see [“Connecting your Extio 3 devices”](#)).
- 2 Perform a configuration reset on your transmitter device and receiver device (see [“Hardware reboot or configuration reset”](#), page 56).
- 3 Switch the power off. **Note:** Never hot plug the SFP module.
- 4 Replace the copper cables with fiber optic cables.
- 5 Switch the power on.

Troubleshooting

What to do if you have a problem

If you experience problems with your Matrox product:

- Make sure your Matrox device is properly installed, you're using the correct connectors, and that all connectors are properly fastened.
- Try rebooting or resetting your device (see [“Rebooting or resetting your Extio 3 device”](#), page 55).
- Make sure you have administrator rights on the system you want to use. For more information, see Windows documentation.
- For more information on problems related to Matrox Extio Central Manager software, see the Matrox Extio Central Manager User Guide.

If your problem persists, contact Matrox. For more information, see [“Customer support”](#), page 79.

Common problems and solutions

This section addresses specific problems to your Matrox product that could prevent you from using your system or product.

Problem After changing operation mode, Extio 3 device doesn't work

Cause Your Extio device may be trying to use settings that no longer exist.

Solution Try performing a configuration reset of your Extio devices. A configuration reset restores the default settings of your Extio 3 device. For more information, see [“Changing the operation mode of your devices”](#), page 58.

Problem Extio device not discovered on the network

Cause Your Matrox product may not be properly installed or connected.

Solution Verify the connection and status LEDs on your Matrox product (see [“Description of LEDs”](#), page 28). Also, make sure your Matrox product is properly installed or connected, and that all connectors are properly fastened.

Cause Windows Server 2016/2008 R2 only – The Windows SSDP Discovery service may be disabled on your system.

Solution Make sure the SSDP Discovery service is enabled on your system.

Cause Network discovery and file sharing may not be enabled on your system.

Solution Enable network discovery and file sharing on your system.

Cause The firewall for your system or for your network may be enabled and may prevent communication with your Extio devices.

Solution Make sure your firewall is properly configured to allow the necessary communication between your Extio devices and the various networked components. For more information, see [“Appendix B – Firewall requirements”](#), page 69.

Problem **Screen image defects appear**
(example: image corruption or blockiness)

Cause Temporal dithering may be enabled on some GPUs.

Solution Configure your GPU settings so that the output’s color format is set to RGB and the dynamic range is set to the highest level. For more information, see the documentation of your GPU.

Problem **Random display flickering occurs, or on-screen message (“Frame rate conversion or video scaler on”, “Frame rate conversion on”, or, “Video scaler on”) appears**

Cause Your video input and output are not at the same resolution or refresh rate.

Solution Point-to-point mode – In the OSD, click **Settings** → **Monitors**. Make sure the **Stabilize display output** option is enabled.

Network mode – In the Extio Central Manager, make sure the **Optimize video mode compatibility with monitors** option is enabled.

Problem **Random display flickering occurs while using a point-to-point connection**

Cause Your video output is unstable, or you may be using a fixed frequency monitor.

Solution Point-to-point mode only – In the OSD, click **Settings** → **Monitors**. Make sure the **Stabilize display output** option is enabled.

Problem In point-to-point, the receiver cannot connect to the transmitter

Cause Firmware version on the transmitter and the receiver does not match in point-to-point.

Solution Run the **updaterfromhost.exe** file. This will report the firmware version of the transmitter. Update the transmitter and/or the receiver so that both have the same firmware version.

Solution Matrox recommends that you connect each appliance to a DHCP network and run the firmware updater tool to see if your units require a firmware update. If you don't have a DHCP server on your network, Matrox recommends that you connect all your Matrox Extio 3 devices to a network switch and let DHCP time out (this could take several minutes) so that the Extio 3 devices receive a link local address. Also do the same with a laptop that will run the firmware **updaterfromhost.exe** file.

Product information

Hardware specifications

Extio 3 transmitter card

| | Extio N3408 transmitter card | Extio N3208 transmitter card |
|---|--|--|
| Product type | PCIe x16 card (x8 electrical and mechanical, x16 mechanical) | PCIe x16 card (x8 electrical and mechanical, x16 mechanical) |
| Form factor | Full height, ¾ length | Full height, ¾ length |
| Video input connectors | 4x Mini DisplayPort | 2x Mini DisplayPort |
| DisplayPort 1.1 | ✓ | ✓ |
| DisplayPort 1.2 | ✓* | — |
| Color space | YUV 4:4:4 RGB 8:8:8 | YUV 4:4:4 RGB 8:8:8 |
| Networking interface | 1000 Base-T Ethernet | 1000 Base-T Ethernet |
| SFP cage | ✓ | ✓ |
| RJ45 copper transceiver | ✓ | ✓ |
| SFP fiber module | Optional | Optional |
| Power consumption | 41W | 32.5W |
| Laser emissions† | 850 µm laser compliant to 21CFR, Subpart J, Class 1 | |
| Regulatory compliance | Class A: CE, FCC, ICES-3, KC, RCM, VCCI | |
| Electrical safety considerations | <p>The card d.c. input is to be separately approved with Reinforced Insulation to MAINS, and power to the card is to be limited to 250 VA.</p> <p>The card must only be installed and operated in a system meeting the fire enclosure requirements of the IEC/CAN/CSA-C22.2/ANSI/UL 62368-1 and IEC/CAN/CSA-C22.2/ANSI/UL 60950-1 safety standards.</p> <p>L'accès CC de la carte doit être approuvé séparément avec une isolation renforcée au SECTEUR et la puissance fournie à la carte doit être limitée à 250 VA.</p> <p>La carte doit seulement être installée et utilisée dans un système qui rencontre les exigences liées aux enveloppes ignifuges des normes de sécurité IEC/CAN/CSA-C22.2/ANSI/UL 62368-1 et IEC/CAN/CSA-C22.2/ANSI/UL 60950-1.</p> | |

* DisplayPort version 1.2 is supported on connector labeled 4 only.

† Only when using a multi-mode SFP module.

Extio 3 transmitter unit

| | Extio N3408 transmitter unit | Extio N3208 transmitter unit |
|---------------------------------------|---|---|
| Product type | Standalone appliance | Standalone appliance |
| Form factor | 1 RU, half width | 1 RU, half width |
| Video input connectors | 4× DisplayPort (with stereo L-PCM audio) | 2× DisplayPort (with stereo L-PCM audio) |
| Video output connectors* | 1× DisplayPort (for local console) | 1× DisplayPort (for local console) |
| Audio input connector (analog) | 1× mini-stereo jack | 1× mini-stereo jack |
| Audio output connector | 1× mini-stereo jack | 1× mini-stereo jack |
| RS232 connector | 1× DE9 (or DB9) – Female | 1× DE9 (or DB9) – Female |
| Networking interface | 1000 Base-T Ethernet | 1000 Base-T Ethernet |
| SFP cage | ✓ | ✓ |
| RJ45 copper transceiver | ✓ | ✓ |
| SFP fiber module | Optional | Optional |
| USB ports | 2× USB 2.0 (front)†, 1× USB 2.0 (back) | 2× USB 2.0 (front)†, 1× USB 2.0 (back) |
| DisplayPort version 1.1 | ✓ | ✓ |
| DisplayPort version 1.2 | ✓‡ | — |
| Color space | YUV 4:4:4 RGB 8:8:8 | YUV 4:4:4 RGB 8:8:8 |
| Maximum input resolution§ | 4× 1920 × 1080 @60 Hz, 3× 1920 × 1200 @60 Hz, 2× 2560 × 1600 @60 Hz, 2× 3840 × 2160 @30 Hz, 1× 3840 × 2160 @60 Hz | 2× 1920 × 1200 @60 Hz, 1× 2560 × 1600 @60 Hz |
| Power connector | DIN 4-pin female | DIN 4-pin female |
| Power consumption | 57W (typical 44W) | 34W (typical 25W) |
| Laser emissions¶ | 850 µm laser compliant to 21CFR, Subpart J, Class 1 | |
| Regulatory compliance | Class A: CE, FCC, ICES-3, KC, RCM, VCCI | |

* Expected in an upcoming release.

† Currently disabled.

‡ DisplayPort version 1.2 is supported on connector labeled 4 only.

§ Additional display resolutions may be available. For more information, contact your Matrox representative.

¶ Only when using a multi-mode SFP module.

Extio 3 receiver unit

| | Extio N3408 receiver unit | Extio N3208 receiver unit |
|---------------------------------------|---|---|
| Product type | Standalone appliance | Standalone appliance |
| Form factor | 1 RU, half width | 1 RU, half width |
| Video output connectors | 4× DisplayPort (with stereo L-PCM audio) | 2× DisplayPort (with stereo L-PCM audio) |
| Audio input connector (analog) | 4× mini-stereo jacks | 4× mini-stereo jacks |
| Audio output connector | 1× mini-stereo jack | 1× mini-stereo jack |
| Microphone input | 1× mini-stereo jack | 1× mini-stereo jack |
| RS232 connector | 1× DE9 (or DB9) – Male | 1× DE9 (or DB9) – Male |
| Networking interface | 1000 Base-T Ethernet | 1000 Base-T Ethernet |
| USB ports | 6× USB 2.0 (front) | 4× USB 2.0 (front) |
| DisplayPort version 1.1 | ✓ | ✓ |
| DisplayPort version 1.2 | ✓* | — |
| Color space | YUV 4:4:4 RGB 8:8:8 | YUV 4:4:4 RGB 8:8:8 |
| Maximum output resolution† | 4× 1920 × 1080 @60 Hz, 3× 1920 × 1200 @60 Hz, 2× 2560 × 1600 @60 Hz, 2× 3840 × 2160 @30 Hz, 1× 3840 × 2160 @60 Hz | 2× 1920 × 1200 @60 Hz, 1× 2560 × 1600 @60 Hz |
| Power connector | DIN 4-pin female | DIN 4-pin female |
| Power consumption | 57W (typical 41W) | 35W (typical 27W) |
| Laser emissions‡ | 850 µm laser compliant to 21CFR, Subpart J, Class 1 | |
| Regulatory compliance | Class A: CE, FCC, ICES-3, KC, RCM, VCCI | |

* DisplayPort version 1.2 is supported on connector labeled **4** only.

† Additional display resolutions may be available. For more information, contact your Matrox representative.

‡ Only when using a multi-mode SFP module.

Product dimensions

| | Extio N3408/N3208 transmitter unit | Extio N3408/N3408 receiver unit |
|--------------------|------------------------------------|---------------------------------|
| Length | 18.9 cm (7.45 inches) | |
| Height | 4.26 cm (1.676 inches) | |
| Width/Depth | 21.66 cm (8.526 inches) | |

Maximum distance (point-to-point)*

| | Extio N3408/N3208 transmitter card | Extio N3408/N3208 transmitter unit | Extio N3408/N3408 receiver unit |
|--|------------------------------------|------------------------------------|---------------------------------|
| OM2, OM3, OM4 (50/125µm) multi-mode cable type | | 550 meters (1804 feet) | |
| OM1 (62.5/125µm) multi-mode cable type | | 275 meters (902 feet) | |
| OS1, OS2 (9/125µm) single-mode cable type | | 5 kilometers (3.10 miles) | |
| CAT5e, CAT6 | | 100 meters (328 feet) | |

External power supply†

| | Extio N3408/N3208 transmitter unit | Extio N3408/N3208 receiver unit |
|--------------------------|------------------------------------|---------------------------------|
| Input a.c. voltage range | 100V to 240V a.c. | |
| Input frequency | 50 to 60 Hz | |
| Input connector | IEC 60320-C14 | |
| Output voltage | 12V d.c. | |
| Output current | 5A | |
| Output connector | DIN 4-pin male with lock | |
| Maximum power | 60W | |

* Longer distances are supported in networked mode. For more information, contact your Matrox representative.

† Only use the power supply originally supplied by Matrox with your Matrox Extio 3 Series product.

Environmental

| | |
|---|---|
| Temperature, operational | Operating: 0 to 45 °C (32 to 104 °F) |
| Temperature, non-operational storage and transportation | -40 to 70 °C (-40 to 158 °F) |
| Humidity, operational (indoor) | 20 to 80% (non-condensing) |
| Humidity, non-operational storage and transportation | 5% to 95% (non-condensing) |
| Atmospheric pressure, operational | 660hPa (3,000 meters / 9,842 feet) to 1013hPa (0 meters / 0 feet) |
| Atmospheric pressure, non-operational and transportation | 192hPa (12,000 meters / 39,370 feet) to 1020hPa (-50 meters / -164 feet) |

Notes

- When using a touch screen monitor, make sure your monitor is set as the main display in Windows.
- **Link redundancy** – After disabling link redundancy and unplugging the RJ45 cable, the receiver unit switches back to SFP.

Fiber optic transceiver SFP (Small Form Factor Pluggable) modules

When optical SFP modules are used, Extio 3 products are certified for safety only when operated with SFP modules purchased through Matrox, with the part number XTO3-SFPMM for multi-mode, or part number XTO3-SFPSM for single-mode SFP modules.

Battery

Non-replaceable battery: To dispose of your product, see www.matrox.com/environment/weee.



Caution: There is a risk of explosion if the battery is replaced by an incorrect type. This product contains no user-serviceable parts inside.

Battery:

- Used to maintain the time and date settings for the product.
- Chemistry: Lithium Manganese Dioxide (Li/MnO₂)
- Capacity: 225mAh

- Battery voltage: 3V
- Diameter (max): 20mm
- Battery type: CR2032

Pile non remplaçable: Pour se défaire du produit, voir www.matrox.com/environment/weee.



Attention: Il y a risque d'explosion si la pile est remplacée par un type incorrect. Cet appareil ne contient aucune pièce que l'utilisateur puisse réparer.

Pile:

- Utilisée pour maintenir les paramètres d'heure et de date du produit.
- Chimie: Dioxyde de Manganèse-lithium (Li/MnO₂)
- Capacité: 225mAh
- Tension de la batterie: 3V
- Diamètre (max): 20mm
- Type de batterie: CR2032

Appendix A – Providing adequate airflow to your Extio 3 device

Extio N3408/N3208 transmitter and receiver units only – Because your Extio device disperses heat, it requires adequate airflow to ensure proper operation and to prevent damage. The following provides guidelines for effective airflow around your device.

- **Leave the proper amount of room around your device** – To prevent airflow restriction, we recommend allowing *at least* 0.75 inches (1.91 cm) of clearance between the top of your device and anything above it. More space may be required depending on your environment.

When your device is resting on a plain surface, make sure your device is resting on the original rubber feet.

- **Operate your device in a well ventilated location** – Don't operate your device near a heat source or restrict airflow to your device (for example, by operating your device inside a desk cabinet).
- **Monitor your ambient temperatures** – Make sure the ambient temperature doesn't exceed the maximum recommended temperatures.

For more information on supported operating temperatures, see [“Environmental”](#), page 66.

Appendix B – Firewall requirements

The following are the firewall requirements for your Extio 3 device.

Extio Central Manager software

The following are the firewall requirements for your controller system.

| Network Port | Type | Inbound | Outbound | Functionality |
|--------------|------|---------|----------|--|
| 53 | TCP | — | ✓ | DNS: DNS requests |
| 443* | TCP | — | ✓ | HTTPS: Central Manager commands |
| 1900* | UDP | ✓ | ✓ | UPnP: Microsoft SSDP for discovery of UPnP devices Note: ICMP must be enabled (ping). |

* Minimum requirements.

Firmware updater

The following are the firewall requirements for a system running the Matrox Firmware Updater.

| Network Port | Type | Inbound | Outbound | Functionality |
|--------------|------|---------|----------|---|
| 20,21 | TCP | — | ✓ | FTP: File upload |
| 22* | TCP | ✓ | ✓ | SSH: Firmware update |
| 443* | TCP | — | ✓ | HTTPS: Authentication |
| 1900* | UDP | ✓ | ✓ | UPnP: Microsoft SSDP for discovery of UPnP devices |

* Minimum requirements.

Extio 3 devices

The following are the network firewall requirements for Extio 3 devices.

| Network Port | Type | Inbound | Outbound | Functionality |
|--------------|------|---------|----------|--|
| 20,21 | TCP | ✓ | — | FTP: File download (firmware) |
| 22* | TCP | ✓ | ✓ | SSH: Firmware update |
| 69 | UDP | — | ✓ | DHCP: DHCP client |
| 123 | UDP | ✓ | ✓ | NTP: Network Time Protocol |
| 161 | UDP | ✓ | ✓ | SNMP: Network management (public community string) |
| 443* | TCP | ✓ | — | HTTPS: Extio Central Manager commands and Firmware Updater Authentication |
| 1900* | UDP | ✓ | ✓ | UPnP: Microsoft SSDP for discovery of UPnP devices |
| Ephemeral* | UDP | ✓ | ✓ | RTP/RTCP: Audio and video streams and control |
| 12000 | TCP | ✓ | ✓ | RS232: RS232 virtualization |
| 80 | TCP | ✓ | — | Transmitter unit: Publishing of desktop thumbnails |
| 80 | TCP | — | ✓ | Receiver unit: Retrieving of desktop thumbnails |
| 3240 | TCP | ✓ | — | Receiver unit: USB IP |
| 3240 | TCP | — | ✓ | Transmitter unit: USB IP |
| 6804 - 6816 | TCP | ✓ | — | Transmitter unit: Audio back channel control |
| 6804 - 6816 | TCP | — | ✓ | Receiver unit: Audio back channel control |

| Network Port | Type | Inbound | Outbound | Functionality |
|---------------------------------|------|---------|----------|--|
| 8884 | TCP | ✓ | — | Receiver unit: Control channel |
| 8884 | TCP | — | ✓ | Transmitter unit: Control channel |
| 8886 | UDP | ✓ | — | Transmitter unit: Audio back channel |
| 8886 | TCP | — | ✓ | Receiver unit: Audio back channel |
| 8809 - 8872 | TCP | ✓ | — | Receiver unit: A/V streams control |
| 8809 - 8872 | TCP | — | ✓ | Transmitter unit: A/V streams control |
| 9223 - 9254 | UDP | ✓ | — | Receiver unit: Multicast A/V streams |
| 9223 - 9254 | UDP | — | ✓ | Transmitter unit: Multicast A/V streams |
| 11900 | UDP | ✓ | — | Transmitter unit: SSDP unicast M-SEARCH requests for UPnP discovery and presence monitoring for out-of-subnet and WAN devices |
| 11900 | UDP | — | ✓ | Receiver unit: SSDP unicast M-SEARCH requests for UPnP discovery and presence monitoring for out-of-subnet and WAN devices |
| 12346 - 12752; 13414 - 13719 | UDP | ✓ | — | Receiver unit: Unicast A/V streams |
| 12346 - 12752; 13414 - 13719 | UDP | — | ✓ | Transmitter unit: Unicast A/V streams |

* Minimum requirements.

Accessing your Windows Firewall settings



Note: You may need administrator rights to modify your Windows Firewall settings. For more information, see Windows documentation or contact your system administrator.

To access your Windows Firewall settings:

Windows 10/7 –

- 1 Windows 10 – Click **Start** → **Settings** → **Network & Internet** → **Ethernet** → **Windows Firewall**.

Windows 7 – Click **Control Panel** → **Network and Internet*** → **Network and Sharing Center**. (* Depending on your configuration, these steps may be unnecessary.)

- 2 Windows 10 – In the left panel, click **Advanced Settings**.

Windows 7 – In the left panel, click **Windows Firewall** → **Advanced Settings**.

Adding rules to your Windows Firewall settings



Note: You may need administrator rights to modify your Windows Firewall settings. For more information, see Windows documentation or contact your system administrator.

Windows 10/7 –

1 Windows 10 – Click **Start** → **Settings** → **Network & Internet** → **Ethernet** → **Windows Firewall**.

Windows 7 – Click **Control Panel** → **Network and Internet*** → **Network and Sharing Center***. (* Depending on your configuration, these steps may be unnecessary.)

2 Windows 10 – In the left panel, click **Advanced Settings**.

Windows 7 – In the left panel, click **Windows Firewall** → **Advanced Settings**.

3 Click **Inbound Rules**.

4 In the **Actions** panel, click **New Rule**. Configure the new rule with the following settings:

- **Rule** – Select **Custom**.
- **Program** – Select **All programs**.
- **Protocol and Ports** – Next to **Protocol**, select **TCP**. Next to **Local port**, select **Specific ports**. For the port number, enter **445**. Next to **Remote port**, select **All Ports**.
- **Scope** – Under the remote IP address, add the IP range you want to use for your transmitter. You can use a range (such as *192.168.1.0/24*) or a single IP address (such as *192.152.168.62*).
- **Action** – Select **Allow the connection**.
- **Profile** – Select the network location of your system (**Domain**, **Private**, or **Public**).
- **Name** – Enter the name for your rule (such as *Extio 3 – TCP rule*).

5 In the **Actions** panel, click **New Rule**. Configure the new rule with the following settings:

- **Rule type** – Select **Custom**.
- **Program** – Select **All programs**.
- **Protocol and Ports** – Under **Protocol type**, select **ICMPv4**.
- **Scope** – Under the remote IP address, add the IP range you want to use for your transmitter. You can use a range (such as *192.168.1.0/24*) or a single IP address (such as *192.152.168.62*).
- **Action** – Select **Allow the connection**.

- **Profile** – Select the network location of your system (**Domain**, **Private**, or **Public**).
- **Name** – Enter the name for your rule (such as *Extio 3 – ICMPv4 rule*).

For more information on configuring your Windows firewall, see your network administrator.

Appendix C – Mounting your devices

This section provides guidelines for mounting your Extio N3408 or N3208 device.

Mounting guidelines

To prevent damage to your Matrox hardware, read the following guidelines before mounting your Matrox hardware:

- Make sure not to block the ventilation holes on your device.
- Don't stack anything directly over the device.
- Make sure all cables and cords are slack.
- Make sure the ambient temperature doesn't exceed the maximum recommended temperatures.

Mounting your Extio 3 device

You can mount two (2) devices horizontally on a single shelf.

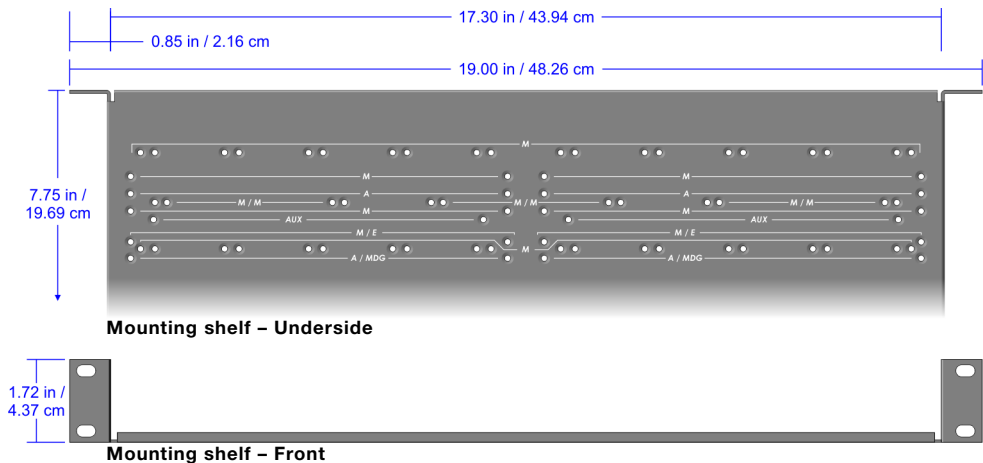

- To mount your device, use the holes labeled **M/E**. These holes are 3.15 inches (8.00 cm) from the front edge of the mounting shelf.
- Your device has two (2) mounting holes under its casing. Use two (2) 6 mm M3 flat-head screws (included in the kit) to secure each device. You need to remove the four (4) rubber pads under your device before you can secure your device to the shelf.

Appendix D – Configuring your audio settings



Note: We recommend you review your system's Windows® audio settings to know which DisplayPort output is configured to use audio.

Receiver output

| Audio source from transmitter | Standard mode | Aggregator mode |
|-------------------------------|--|--|
| | When receiver connects to a unique transmitter unit | When receiver connects to multiple transmitter units |
| No audio | No audio available on the receiver output. | No audio available on the receiver output. |
| Digital audio 1* | Audio originates from the audio portion of the A/V signal of DisplayPort 1 on the transmitter unit. | Audio originates from the digital A/V signal displayed on monitor 1 of the receiver. |
| Digital audio 2* | Audio originates from the audio portion of the A/V signal of DisplayPort 2 on the transmitter unit. | Audio originates from the digital A/V signal displayed on monitor 2 of the receiver. |
| Digital audio 3* | Audio originates from the audio portion of the A/V signal of DisplayPort 3 on the transmitter unit. | Audio originates from the digital A/V signal displayed on monitor 3 of the receiver. |
| Digital audio 4* | Audio originates from the audio portion of the A/V signal of DisplayPort 4 on the transmitter unit. | Audio originates from the digital A/V signal displayed on monitor 4 of the receiver. |
| Analog audio (Follows USB)† | Audio originates from the Line In connector of the transmitter. | Audio originates from the Line In connector of the transmitter unit where the keyboard and mouse are active. |
| Analog audio, Line In 1 | Audio originates from the Line In connector of the transmitter. | Audio originates from the Line In connector of the transmitter unit providing the video stream for monitor 1 on the receiver unit. |
| Analog audio, Line In 2 | Audio originates from the Line In connector of the transmitter. | Audio originates from the Line In connector of the transmitter unit providing the video stream for monitor 2 on the receiver unit. |
| Analog audio, Line In 3 | Audio originates from the Line In connector of the transmitter. | Audio originates from the Line In connector of the transmitter unit providing the video stream for monitor 3 on the receiver unit. |

| | | |
|--------------------------------|--|--|
| Analog audio, Line In 4 | Audio originates from the Line In connector of the transmitter. | Audio originates from the Line In connector of the transmitter unit providing the video stream for monitor 4 on the receiver unit. |
|--------------------------------|--|--|

* In aggregator mode, the A/V signal may come from a transmitter input other than the monitor on which it's displayed (for example, monitor 1 shows a stream that comes from input 3 of a transmitter).

† In aggregator mode, the audio source switches from one transmitter to another when the mouse moves to a monitor showing an image from a different transmitter.

Receiver input

| Audio source from receiver | Standard mode | Aggregator mode |
|----------------------------|--|---|
| | When receiver connects to a unique transmitter unit | When receiver connects to multiple transmitter units |
| Disabled | No audio available on the Line Out connector of the transmitter. | No audio available on any of the Line Out connectors of the transmitter. |
| Microphone | Audio from the Microphone connector of the receiver unit is sent to the Line Out connector of the transmitter unit. | The Microphone signal from the receiver unit is sent to a transmitter following the destination option chosen (see “ Receiver audio destination ”). |
| Line In | Audio from the Line In connector of the receiver unit is sent to the Line Out connector of the transmitter unit. | The Line In signal from the receiver unit is sent to a transmitter following the destination option chosen (see “ Receiver audio destination ”). |
| Automatic detection | Audio from the Microphone connector of the receiver unit is sent to the Line Out connector of the transmitter unit. If no cable is present on the Microphone connector of the receiver unit, but a cable is present on the Line Out connector, the signal of the Line Out connector is sent to the Line Out connector of the transmitter unit. | Audio from the Microphone connector of the receiver unit is used. If no cable is present on the Microphone connector of the receiver unit, but a cable is present on the Line In connector, the signal of the Line In connector is used. The signal is then sent to a transmitter following the destination option chosen (see “ Receiver audio destination ”). |

Receiver audio destination

| Receiver audio destination | Standard mode | Aggregator mode |
|----------------------------|---|--|
| | When receiver connects to a unique transmitter unit | When receiver connects to multiple transmitter units |
| Monitor 1 | Audio from the selected audio source of the receiver (Microphone or Line In) is sent to the Line Out connector of the transmitter. | Audio from the selected audio source of the receiver (Microphone or Line In) is sent to the Line Out connector of the transmitter unit that provides the video stream to monitor 1 . |
| Monitor 2 | Audio from the selected audio source of the receiver (Microphone or Line In) is sent to the Line Out connector of the transmitter. | Audio from the selected audio source of the receiver (Microphone or Line In) is sent to the Line Out connector of the transmitter unit that provides the video stream to monitor 2 . |
| Monitor 3 | Audio from the selected audio source of the receiver (Microphone or Line In) is sent to the Line Out connector of the transmitter. | Audio from the selected audio source of the receiver (Microphone or Line In) is sent to the Line Out connector of the transmitter unit that provides the video stream to monitor 3 . |
| Monitor 4 | Audio from the selected audio source of the receiver (Microphone or Line In) is sent to the Line Out connector of the transmitter. | Audio from the selected audio source of the receiver (Microphone or Line In) is sent to the Line Out connector of the transmitter unit that provides the video stream to monitor 4 . |

Customer support

Matrox web

Our web site has product literature, press releases, technical material, a sales office list, trade show information, and other relevant material. Visit the Matrox Graphics Web site at www.matrox.com/video.

Technical support

Matrox values your business and offers professional support for your Matrox product.

If your product was purchased through a Matrox dealer, contact your dealer for product support. This is the quickest and most effective method of technical assistance. Your dealer is familiar with your complete system.

If your product was purchased through Matrox, contact your Matrox representative or visit our technical support Web site at www.matrox.com/en/video/support.

Information we need

Please give a complete description of the problem, and include:

- Matrox product serial number, model number, revision number, and firmware number.
- Source specifications.
- Control system (system running Extio Central Manager) specifications.
- Specific Extio Central Manager or OSD (On-Screen Display) options and features used.

View your warranty information

Matrox makes warranty information available on the Matrox site (www.matrox.com/en/video/support/warranty).

View the third party software notices

Matrox makes third party software notices and/or additional terms and conditions available on the Matrox site (<https://thirdpartylicenses.matrox.com>).

Register your Matrox product

Please register online (www.matrox.com/en/video/apps/registration) to be eligible for customer support, new product announcements, and information on special offers and upcoming events.

USA

FCC Compliance Statement

Remark for the Matrox hardware products supported by this guide This equipment has been tested and found to comply with the limits for a Class A digital device, pursuant to Part 15 of the FCC Rules. These limits are designed to provide reasonable protection against harmful interference when the equipment is operated in a commercial environment. This equipment generates, uses, and can radiate radio frequency energy and, if not installed and used in accordance with the instructions manual, may cause harmful interference to radio communications. Operation of this equipment in a residential area is likely to cause harmful interference in which case the user will be required to correct the interference at his own expense.

WARNING Changes or modifications to this unit not expressly approved by the party responsible for the compliance could void the user's authority to operate this equipment. The use of shielded cables for connection of the monitor to the card is required to meet FCC requirements.

CANADA

(English) Innovation, Science and Economic Development Canada

Remark for the Matrox hardware products supported by this guide These digital apparatus does not exceed the Class A limits for radio noise emission from digital devices set out in the Radio Interference Regulation of Industry Canada.

(Français) Innovation, Sciences et Développement économique Canada

Remarque sur les produits matériels Matrox couverts par ce guide Ce présent appareil numérique n'émet aucun bruit radioélectrique dépassant les limites applicables aux appareils numériques de Classe A prescrites dans le Règlement sur le brouillage radioélectrique édicté par Industrie Canada.

JAPAN

VCCI Compliance Statement

Remark for the Matrox hardware products supported by this guide This is a Class A product based on the standard of the Voluntary Control Council for Interference by Information Technology Equipment (VCCI). If this equipment is used in a domestic environment, radio disturbance may occur, in which case, the user may be required to take corrective actions.

この装置は、クラスA情報技術装置です。この装置を家庭環境で使用すると電波妨害を引き起こすことがあります。この場合には使用者が適切な対策を講ずるよう要求されることがあります。 VCCI-A

KOREA

A 급 기기 (업무용 방송통신기자재)

이 기기는 업무용 (A 급) 전자파적합기기로서 판 매자 또는 사용자는 이 점을 주의하시기 바라며, 가정외의 지역에서 사용하는 것을 목적으로 합니다.

EUROPE

(English) European user's information - Declaration of Conformity

Remark for the Matrox hardware products supported by this guide These devices comply with EC Directive 2014/30/EU for a Class A digital device. They have been tested and found to comply with EN55032/CISPR32 and EN55024/CISPR24. In a domestic environment these products may cause radio interference in which case the user may be required to take adequate measures. To meet EC requirements, shielded cables must be used to connect the monitor and other peripherals to the card. These products have been tested in a typical class A compliant host system. It is assumed that these products will also achieve compliance in any class A compliant system.



(Français) Informations aux utilisateurs Européens – Déclaration de conformité

Remarque sur les produits matériels Matrox couverts par ce guide Ces unités sont conformes à la directive communautaire 2014/30/EU pour les unités numériques de classe A. Les tests effectués ont prouvé qu'elles sont conformes aux normes EN55032/CISPR32 et EN55024/CISPR24. Le fonctionnement de ces produits dans un environnement résidentiel peut causer des interférences radio, dans ce cas l'utilisateur peut être amené à prendre les mesures appropriées. Pour respecter les impératifs communautaires, les câbles de connexion entre le moniteur ou autres périphériques et la carte doivent être blindés. Ces produits ont été testés dans un système hôte typique compatible classe A. On suppose qu'ils présenteront la même compatibilité dans tout système compatible classe A.

(Deutsch) Information für europäische Anwender – Konformitätserklärung

Anmerkung für die Matrox Hardware-Produktunterstützung durch dieses Handbuch Diese Geräte entsprechen EC Direktive 2014/30/EU für ein digitales Gerät Klasse A. Sie wurden getestet und entsprechen demnach EN55032/CISPR32 und EN55024/CISPR24. In einer Wohnumgebung können diese Produkte Funkinterferenzen erzeugen, und der Benutzer kann genötigt sein, entsprechende Maßnahmen zu ergreifen. Um EG-Anforderungen zu entsprechen, müssen zum Anschließen des Monitors und anderer Peripheriegeräte an die Karte abgeschirmte Kabel verwendet werden. Diese Produkt wurden in einem typischen, der Klasse A entsprechenden, Host-System getestet. Es wird davon ausgegangen, daß diese Produkte auch in jedem Klasse A entsprechenden System entsprechend funktionieren.

(Italiano) Informazioni per gli utenti europei – Dichiarazione di conformità

Nota per i prodotti hardware Matrox supportati da questa guida Questi dispositivi sono conformi alla direttiva CEE 2014/30/EU relativamente ai dispositivi digitali di Classe A. Sono stati provati e sono risultati conformi alle norme EN55032/CISPR32 e EN55024/CISPR24. In un ambiente domestico, questi prodotti possono causare radiointerferenze, nel qual caso all'utente potrebbe venire richiesto di prendere le misure adeguate. Per soddisfare i requisiti CEE, il monitor e le altre periferiche vanno collegati alla scheda grafica con cavi schermati. Questi prodotti sono stati provati in un tipico sistema host conforme alla classe A. Inoltre, si dà per scontato che questi prodotti acquisiranno la conformità in qualsiasi sistema conforme alla classe A.

(Español) Información para usuarios europeos – Declaración de conformidad

Observación referente a los productos de hardware de Matrox apoyados por este manual Estos dispositivos cumplen con la directiva de la CE 2014/30/EU para dispositivos digitales de Clase A. Dichos dispositivos han sido sometidos a prueba y se ha comprobado que cumplen con las normas EN55032/CISPR32 y EN55024/CISPR24. En entornos residenciales, estos productos pueden causar interferencias en las comunicaciones por radio; en tal caso el usuario deberá adoptar las medidas adecuadas. Para satisfacer las disposiciones de la CE, deberán utilizarse cables apantallados para conectar el monitor y demás periféricos a la tarjeta. Estos productos han sido sometidos a prueba en un típico sistema anfitrión que responde a los requisitos de la clase A. Se supone que estos productos cumplirán también con las normas en cualquier sistema que responda a los requisitos de la clase A.

EUROPE

(English) European user's information – Directive on Waste Electrical and Electronic Equipment (WEEE)

Please refer to the Matrox Web site (www.matrox.com/environment/en/weee) for recycling information.



(Français) Informations aux utilisateurs Européens – Règlementation des déchets d'équipements électriques et électroniques (DEEE)

Se référer au site Web de Matrox (www.matrox.com/environment/en/weee) pour l'information concernant le recyclage.

(Deutsch) Information für europäische Anwender – Europäische Regelungen zu Elektro- und Elektronikaltgeräten (WEEE)

Bitte wenden Sie sich an der Matrox-Website (www.matrox.com/environment/en/weee) für Recycling-Informationen.

(Italiano) Informazioni per gli utenti europei – Direttiva sui rifiuti di apparecchiature elettriche ed elettroniche (RAEE)

Si prega di riferirsi al sito Web Matrox (www.matrox.com/environment/en/weee) per le informazioni di riciclaggio.

Avertissement sur l'épilepsie

À lire avant toute utilisation d'un jeu vidéo par vous-même ou votre enfant Certaines personnes sont susceptibles de faire des crises d'épilepsie ou d'avoir des pertes de conscience à la vue de certains types de lumières clignotantes ou d'éléments fréquents dans notre environnement quotidien. Ces personnes s'exposent à des crises lorsqu'elles regardent certaines images télévisées ou qu'elles jouent à certains jeux vidéo. Ces phénomènes peuvent apparaître alors même que le sujet n'a pas d'antécédent médical ou n'a jamais été confronté à une crise d'épilepsie.

Si vous-même ou un membre de votre famille avez déjà présenté des symptômes liés à l'épilepsie (crise ou perte de conscience) en présence de stimulations lumineuses, veuillez consulter votre médecin avant toute utilisation.

Nous conseillons aux parents d'être attentifs à leurs enfants lorsqu'ils jouent avec des jeux vidéo. Si vous-même ou votre enfant présentez un des symptômes suivants: vertige, trouble de la vision, contraction des yeux ou des muscles, perte de conscience, trouble de l'orientation, mouvement involontaire ou convulsion, veuillez immédiatement cesser de jouer et consultez un médecin.

Précautions à prendre dans tous les cas pour l'utilisation d'un jeu vidéo Ne vous tenez pas trop près de l'écran.

- Jouez à bonne distance de l'écran de TV et aussi loin que le permet le cordon de raccordement.
- Utilisez de préférence les jeux de vidéo sur un écran de petite taille.
- Évitez de jouer si vous êtes fatigué ou si vous manquez de sommeil.
- Assurez-vous que vous jouez dans une pièce bien éclairée.
- En cours d'utilisation, faites des pauses de dix à quinze minutes toutes les heures.

Trademarks • Marques déposées • Warenzeichen • Marchi registrati • Marcas registradas

Matrox Electronic Systems Ltd. /

| | |
|--|---|
| Matrox Graphics Inc. | Matrox [®] , DualHead [®] , Avio [™] , C-Series [™] , D-Series [™] , DualHead2Go [™] , Extio [™] , G400 [™] , G450 [™] , G550 [™] , GXM [™] , Maevex [™] , Marvel [™] , MED2mp [™] , MED2mp-DVI [™] , MED3mp-DVI [™] , MED4mp [™] , MED5mp-DVI [™] , MED5mp [™] , Millennium [™] , MMS [™] , Multi-Monitor Series [™] , MultiDesk [™] , Mura [™] , MuraControl [™] , Mystique [™] , P650 [™] , P690 [™] , P750 [™] , Parhelia [™] , Parhelia [™] APVe, Parhelia-512 [™] , Parhelia-LX [™] , Parhelia HR256 [™] , PJ4OLP [™] , QID [™] , Quad Information Display [™] , RAD [™] , Quick Connect [™] , MaxVIEW [™] , Onyx [™] , PixelTOUCH [™] , PrecisionCAD [™] , Precision SGT [™] , QuadHead2Go [™] , QuickDesk [™] , RAD2mp [™] , RAD3mp [™] , RAD9mp [™] , RADQ2mp [™] , Rainbow Runner [®] , TheatreVUE [™] , TripleHead [™] , TripleHead2Go [™] , VDA [™] , Veos [™] , Xenia [™] |
| Adobe Systems Inc. | Acrobat [®] , Reader [®] |
| Advanced Micro Devices, Inc. | AMD [®] |
| Apple Computer, Inc. | App Store [®] , Apple [®] , iPad [®] , Mac [®] , Mac OS [®] |
| Belden Inc. | Belden [®] |
| Dolby Laboratories, Inc. | Dolby [®] , Dolby Digital [®] |
| Facebook, Inc. | Facebook [®] |
| Google, Inc. | YouTube [®] |
| HDMI Licensing LLC. | HDMI [®] |
| Intel Corporation | Intel [®] |
| International Business Machines | IBM Video Streaming [™] |
| Linus Torvalds | Linux [®] |
| Microsoft Corporation. | Active Directory [®] , Aero [®] , Direct3D [®] , DirectShow [®] , DirectX [®] , Microsoft [®] , MS-DOS [®] , PowerPoint [®] , Windows [®] , Windows NT [®] , Windows Server [®] , Windows Vista [®] |
| NVIDIA Corporation | NVIDIA [®] |
| Panopto, Inc. | Panopto [™] |
| PCI-SIG. | PCI [™] , PCI-X [®] , PCIe [®] , PCI Express [®] |
| Radio Corporation of America | RCA [®] |
| RealVNC Ltd. | VNC [®] |
| Restream, Inc. | Restream [™] |
| SD-3C, LLC. | SD [™] , SDHC [™] , SDXC [™] |
| Silicon Graphics, Inc. | OpenGL [®] |
| Silicon Image, Inc. | PanelLink [®] , TMDS [®] |
| Twitch Interactive, Inc. | Twitch [™] |
| U.S. Environmental Protection Agency. | ENERGY STAR [®] |
| Video Electronics Standards Association | DisplayPort [™] |
| VideoLAN | VideoLAN [®] , VLC [®] , VLC [®] media player |
| Vimeo, LLC | Vimeo [®] |

Wibu-Systems WIBU®
Wowza Media Systems, LLC Wowza™

Copyright © 1996-2020 VideoLAN. This logo or a modified version may be used or modified by anyone to refer to the VideoLAN project or any product developed by the VideoLAN team, but does not indicate endorsement by the project.

HTML5 Logo by World Wide Web Consortium ([W3C](http://www.w3.org)). This HTML5 logo is licensed under this Public License (<http://www.creativecommons.org/licenses/by/3.0/legalcode>). The logo has been modified to meet the resolution and size required by this application.

• (English) Registered trademarks are registered in the United States, Canada, and/or other countries. All other nationally and internationally recognized trademarks and tradenames are hereby acknowledged. • (Français) Les marques déposées sont déposées aux États-Unis, au Canada et/ou dans d'autres pays. Toutes les autres marques et tous les autres noms déposés reconnus nationalement ou internationalement sont également reconnus par les présentes. • (Deutsch) Die eingetragenen Warenzeichen sind in den USA, Kanada und/oder anderen Ländern registriert. Alle sonstigen national und international bekannten Warenzeichen und Produktnamen werden hiermit anerkannt. • (Italiano) I marchi registrati sono registrati negli Stati Uniti, in Canada e/o in altri paesi. Tutti gli altri marchi registrati e nomi commerciali riconosciuti a livello nazionale e internazionale sono ugualmente riconosciuti qui. • (Español) Las marcas registradas están registradas en los EE.UU., Canadá u otros países. Por medio del presente se reconocen todas las demás marcas y nombres comerciales reconocidos a nivel nacional e internacional.

(English) Disclaimer

THE INFORMATION IN THIS GUIDE IS SUBJECT TO CHANGE AT ANY TIME AND WITHOUT NOTICE.

Matrox Graphics Inc. reserves the right to make changes in specifications at any time and without notice. The information provided by this document is believed to be accurate and reliable at the time it is written. However, no responsibility is assumed by Matrox Graphics Inc. for its use, for its reproduction and/or distribution, in whole or in part; nor for any infringements of patents or other rights of third parties resulting from its use.

(Français) Responsabilité

LES INFORMATIONS CONTENUES DANS CE MANUEL PEUVENT ÊTRE MODIFIÉES EN TOUT TEMPS ET CE SANS PRÉAVIS.

Les Graphiques Matrox Inc. se réserve le droit de modifier les spécifications en tout temps et ce sans préavis quelconque. Les informations contenues dans ce manuel sont reconnues comme étant précises et fiables à la date de rédaction. Cependant, Matrox Graphics Inc. n'assume aucune responsabilité concernant leur utilisation, leur reproduction et/ou distribution, en tout ou en partie, ni leur contrefaçon de brevets ou de tout autre droit appartenant à des tiers résultant de leur utilisation. Aucune licence n'est accordée sur aucun brevet ou droit d'exploiter un brevet de Matrox Graphics Inc.

(Deutsch) Haftungsablehnungserklärung

DIE IN DIESEM HANDBUCH ENTHALTENEN ANGABEN UND DATEN KÖNNEN OHNE VORHERIGE ANKÜNDIGUNG GEÄNDERT WERDEN.

Die Matrox Graphics Inc. behält sich das Recht vor, jederzeit und ohne Ankündigung technische Daten zu ändern. Zum Zeitpunkt der Erstellung dieses Handbuchs sind die Inhalte korrekt und verlässlich. Weiterhin übernimmt Matrox Graphics Inc. keinerlei Verantwortung für die Benutzung dieses Handbuchs, die Vervielfältigung und/oder Verteilung im Ganzen oder zum Teil; weder für Verstöße gegen Patentrechte noch für andere Rechte Dritter, die aus seinem Gebrauch resultieren mögen. Es werden keinerlei Lizenzrechte gewährt für sämtliche Patente oder Patentrechte der Matrox Graphics Inc.

(Italiano) Discrezionalità

LE INFORMAZIONI CONTENUTE NEL PRESENTE DOCUMENTO SONO SOGGETTE A MODIFICHE IN QUALUNQUE MOMENTO E SENZA PRAEAVVISO.

Matrox Graphics Inc. si riserva il diritto di apportare variazioni di qualunque tipo alle specifiche tecniche in qualunque momento e senza alcun preavviso. Le informazioni contenute in questa documentazione sono ritenute corrette e attendibili al momento della pubblicazione. In ogni caso, non è imputabile a Matrox Graphics Inc. nessuna responsabilità per il loro utilizzo, per la loro distribuzione e/o riproduzione completa o in parte, come nessuna violazione a brevetti o diritti di altri produttori derivante dal loro utilizzo.

(Español) Renuncia

LA INFORMACION QUE CONTIENE EL PRESENTE MANUAL ESTA SUJETA A CAMBIOS SIN PREVIO AVISO EN CUALQUIER MOMENTO.

Matrox Graphics Inc. se reserva el derecho de realizar modificaciones en cualquier momento y sin previo aviso. La información facilitada en este documento se considera que es exacta y fiable hasta la fecha de publicación. Sin embargo, Matrox Graphics Inc. no asume ninguna responsabilidad por su uso, por su reproducción y/o distribución parcial o total; ni por cualquier infracción de patentes u otros derechos de terceras partes derivados de su uso. No se concede ninguna licencia bajo cualesquiera patentes o derechos de patentes de Matrox Graphics Inc.

Matrox Graphics Inc.

1055 Saint Regis Boulevard
Dorval, Quebec, Canada H9P 2T4
(514) 822-6000

video@matrox.com
www.matrox.com/en/video

matrox[®]