

ISP2150 2U Rack Server Platform Product Guide

A Guide for Technically Qualified Assemblers of Intel® Identified Subassemblies/Products

Order Number: A09581-001

Disclaimer

Intel Corporation (Intel) makes no warranty of any kind with regard to this material, including, but not limited to, the implied warranties of merchantability and fitness for a particular purpose. Intel assumes no responsibility for any errors that may appear in this document. Intel makes no commitment to update nor to keep current the information contained in this document. No part of this document may be copied or reproduced in any form or by any means without prior written consent of Intel.

An Intel product, when used in accordance with its associated documentation, is "Year 2000 Capable" when, upon installation, it accurately stores, displays, processes, provides, and/or receives date data from, into, and between the twentieth and twenty-first centuries, including leap year calculations, provided that all other technology used in combination with said product properly exchanges date data with it.

† Third party brands and names are the property of their respective owners.

Copyright © 1999, Intel Corporation.

Contents

1 Description

Server Board Features	9
Front Panel Controls and Indicators.....	10
Back Panel Connectors	11
Major System Elements.....	12
Server Board Connector and Component Locations	13
Processor	14
Memory	14
440GX Host Bridge / Memory Controller.....	15
Peripherals.....	15
Super I/O Chip.....	15
Add-in Board Slots	16
Video.....	16
SCSI Controller	16
IDE Controller.....	17
Network Controller.....	17
Keyboard and Mouse	18
ACPI	18
Server Management.....	18
Baseboard Management Controller (BMC)	18
Emergency Management Port Console	19
Platform Event Paging.....	20
Software Security	20
Using Passwords.....	21
Secure Mode	21
Summary of Software Security Features.....	22
Checking the Power Cords.....	23
Equipment Rack Precautions	24

2 Upgrading and Installing Server Components

Tools and Supplies Needed.....	25
Warnings and Cautions	25
Bezel	27
Opening and Closing the Front Bezel	27
Locking and Unlocking the Front Bezel.....	28
Attaching and Removing the Front Bezel.....	28
Covers.....	29
Opening the Cover.....	29
Closing the Cover	29
Processors	30
Installing a Processor.....	31
Removing a Processor.....	32
Memory	33
Installing DIMMs	33

Removing DIMMs	34
Peripheral Devices	35
Removing the Diskette Drive.....	35
Re-installing the Diskette Drive	36
Installing a Hard Drive.....	36
Installing a Slim-line CDROM Drive	38
Removing a CDROM Drive	39
Add-in Cards	40
Installing Add-in Cards.....	40
Power Supply	42
Removing and Re-installing a Power Supply	42
System Mounts.....	43
Installing the Front Bracket and Racking the System	43
Installing the Rail Rack and Racking the System (Optional Accessory)	45
Replacing the Back up Battery	49

3 Configuration Software and Utilities

Hot Keys.....	51
Power On Self Test (POST)	52
Using BIOS Setup	53
Record Your Setup Settings.....	53
If You Cannot Access Setup	53
Starting Setup	54
Setup Menus	54
Main Menu.....	55
Security Menu.....	61
Server Menu	62
Boot Menu	65
Exit Menu.....	67
Using the System Setup Utility	67
When to Run the System Setup Utility	68
What You Need to Do.....	68
Running the SSU.....	69
Customizing the SSU.....	71
Launching a Task	71
Resource Configuration Add-in (RCA) Window.....	72
Multiboot Options Add-in.....	73
Security Add-in	74
SEL Manager Add-in	75
FRU Manager Add-in.....	76
SDR Manager Add-in.....	77
Exiting the SSU.....	77
Platform Event Paging.....	78
Using Platform Event Paging	78
Emergency Management Port Console	79
How EMP Console Works.....	80
Requirements	82
Setting up the Server for the EMP	83
Main EMP Console Window.....	84

Server Control Operations	85
Phonebook	88
Management Plug-ins	89
FRUSDR Load Utility	92
When to Run the FRUSDR Load Utility	92
What You Need to Do	92
How You Use the FRUSDR Load Utility	93
Upgrading the BIOS	95
Preparing for the Upgrade	95
Upgrading the BIOS	97
Recovering the BIOS	97
Changing the BIOS Language	98
Using the Firmware Update Utility	98
Running the Firmware Update Utility	98
Installing Video Drivers	99
Using the Adaptec SCSI Utility	99
Running the SCSI Utility	99

4 Solving Problems

Resetting the System	101
Fault Resilient Booting	101
Initial System Startup	101
Checklist	102
Running New Application Software	102
Checklist	102
After the System Has Been Running Correctly	103
Checklist	103
More Problem Solving Procedures	104
Preparing the System for Diagnostic Testing	104
Monitoring POST	104
Verifying Proper Operation of Key System Lights	104
Confirming Loading of the Operating System	104
Specific Problems and Corrective Actions	105
Power Light Does Not Light	105
No Characters Appear on Screen	105
Characters Are Distorted or Incorrect	106
System Cooling Fans Do Not Rotate Properly	106
Diskette Drive Activity Light Does Not Light	107
Hard Disk Drive Activity Light Does Not Light	107
CD-ROM Drive Activity Light Does Not Light	107
Cannot Connect to a Server	108
Problems with Network	108
PCI Installation Tips	109
Problems with Application Software	109
Bootable CD-ROM Is Not Detected	109
Error and Informational Messages	110
Port-80 Codes and Countdown Codes	110

5 Technical Reference

Connectors.....	112
ATX Style Front Panel Connector	113
Main Power Connector	114
Fan Interface	114
Server Board Jumpers.....	115
General Procedure to Change Jumper Setting	116
CMOS Jumper	117
Password Jumper	117
Recovery Boot Jumper	118
Boot Block Write Protect Jumper	118
FRB Timer Enable Jumper	119
Chassis Intrusion Detection Jumper.....	119

6 Product Regulation and Certification Information

Regulatory Information Safety Compliance For Information Technology Equipment.....	121
EMC Compliance.....	121
Regulatory Compliance Markings	121
Electromagnetic Compatibility Notices	122
Lithium Battery Replacement.....	124
Equipment Rack Precautions.....	125
Cautions	126
Use Only for Intended Applications	126
Power Cords.....	126
Warnings.....	127
WARNING: English (US)	128
AVERTISSEMENT: Français.....	130
WARNUNG: Deutsch.....	132
AVVERTENZA: Italiano	134
ADVERTENCIAS: Español.....	136

7 Equipment Log and Power Consumption Worksheets

Equipment Log	138
Current Usage	140
Calculating Power Consumption	140

Index	143
--------------------	-----

Figures

1. Front View of ISP2150.....	10
2. Front Panel Controls and Indicators.....	10
3. Back Panel Connectors	11
4. Major System Elements.....	12
5. Server Board Connector and Component Locations	13
6. Opening the Bezel	27
7. Opening the Cover.....	29
8. Installing a Processor	31
9. Installing a Termination Board	32
10. Installing DIMMs	34
11. Removing the Diskette Drive from the Chassis	35

12.	Removing the Hard Drive Carrier from the Chassis	36
13.	Attaching the Drive to the Carrier	37
14.	Attaching a Slim-line CDROM Drive to the CDROM Tray	38
15.	Installing a Slim-line CDROM Drive	39
16.	Removing the Slot Cover Retention Bracket	40
17.	Installing an Add-in Card	41
18.	Replacing the Power Supply	42
19.	Mounting the Front Brackets and Support Washers	43
20.	Mounting the Back Support Brackets	43
21.	Mounting the Front Brackets to the Cabinet Chassis	44
22.	Mounting the Front Brackets Midway Along the System	44
23.	Mounting the Front Brackets to the Relay Rack	44
24.	Rail System	45
25.	Aligning Rail to Chassis	45
26.	Chassis Rear and Side View	46
27.	Rail Brackets	46
28.	Attaching Rail Brackets to Cabinet Rack	46
29.	Attaching Outer Pieces to Rail Brackets	47
30.	Attaching Rail System to Rear Rail Bracket	47
31.	Extending the Rails	48
32.	Guiding Chassis into the Rack	48
33.	Chassis Mounted into the Rack	48
34.	Replacing the Lithium Battery	50
35.	System Setup Utility Main Window	70
36.	EMP Console in Command State	80
37.	EMP Console in Redirect State	81
38.	Connect Dialog	86
39.	Power On/Off Dialog	87
40.	Reset Dialog	87
41.	Phonebook Dialog	88
42.	Connector Locations	112
43.	ATX Style Front Panel Connector	113
44.	Jumper Locations	115

Tables

1.	Server Board Features	9
2.	NIC LEDs	11
3.	Software Security Features	22
4.	Configuration Utilities	51
5.	Hot Keys	51
6.	EMP Console Access Modes (Server configured for console redirection)	81
7.	EMP Console Access Modes (Server not configured for console redirection)	82
8.	ATX Style Front Panel Connector Pinout	113
9.	Main Power Connector Pinout	114
10.	Fan Connector Pinout	114
11.	Server Board Jumper Summary	115
12.	Power Usage Worksheet 1	141
13.	Power Usage Worksheet 2	141

1 Description

Server Board Features

Table 1. Server Board Features

Feature	Description
Processor	Installed: Up to two Intel® Pentium® II or Pentium III processors operating at 1.8 V to 3.5 V. The server board's voltage regulator is automatically programmed by the processor's VID pins to provide the required voltage.
Memory (DRAM)	Four 72 bit sockets for 168-pin, gold contact, 100 MHz, PC/100 compliant, ECC or non-ECC, registered or unbuffered, SDRAM dual inline memory modules (DIMM).
Video Memory	Installed: 2 MB of video memory.
PCI bus	Two standard PCI (PCI-33/32 bit) expansion slots on a riser card for add-in boards. Embedded devices: video controller, Network Interface Controller (NIC), and SCSI controller.
Server Management	Thermal/voltage monitoring and error handling. Real time clock/calendar (RTC). Front panel controls and indicators (LEDs). System Setup Utility (SSU). Basic Input/Output System (BIOS), Power On Self Test (POST), and Setup stored in flash memory.
Graphics	Integrated onboard Cirrus Logic† CL-GD5480 super video graphics array (SVGA) controller.
SCSI	Adaptec† AIC-7896, supporting onboard Ultra2 (LVDS) Wide and Ultra-wide SCSI interfaces.
Network	Integrated onboard NIC, an Intel® 82559 single chip PCI LAN controller for 10 or 100 Mbps TX Fast Ethernet networks. RJ-45 Ethernet connector and indicator LEDs at I/O back panel.
System I/O	PS/2-compatible keyboard and mouse ports, 6 pin DIN. Advanced parallel port, supporting Enhanced Parallel Port (EPP) level 1.7 and 1.9, ECP, compatible 25 pin. VGA video port, 15 pin. Two serial ports, 9 pin. RJ-45 Ethernet port. Two USB ports.

Front Panel Controls and Indicators

The front panel controls and indicators are located behind the front bezel of the ISP2150 as shown in Figure 1. To access the panel, grasp the bezel at its edges and gently pull it towards you.



Figure 1. Front View of ISP2150

Figure 2 presents the controls and indicators for the unit.

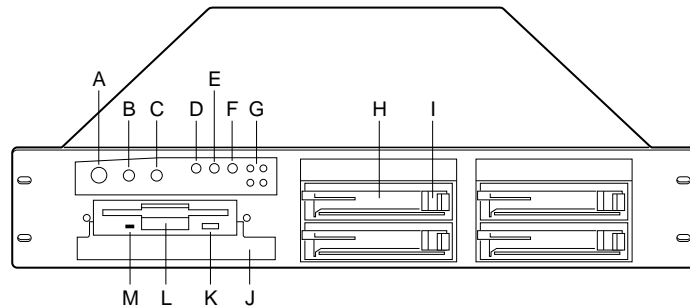

OM09320

Figure 2. Front Panel Controls and Indicators

- | | |
|----------------------------|---------------------------|
| A. Power button | H. Hard drive bay |
| B. Sleep button | I. Hard drive eject lever |
| C. Reset button | J. CDROM drive bay |
| D. Power LED | K. Diskette eject button |
| E. NIC activity LED | L. Diskette drive |
| F. Fail LED | M. Diskette activity LED |
| G. Disk activity/fail LEDs | |

Back Panel Connectors

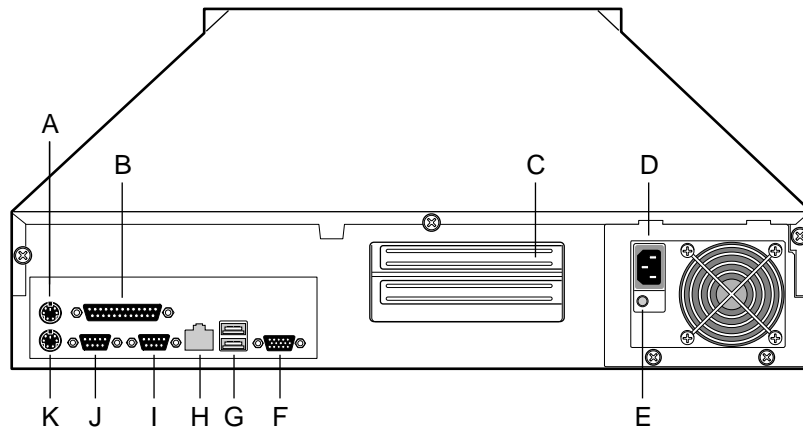

OM09321

Figure 3. Back Panel Connectors

- A. Mouse connector
- B. Parallel Port connector
- C. PCI Expansion slots
- D. AC input power connector
- E. Power supply fault indicator
- F. Video connector
- G. USB connectors
- H. RJ45 Network connector
- I. Serial port connector (COM1)
- J. Serial port connector (COM2)
- K. Keyboard connector

Table 2. NIC LEDs

NIC LED Color	If it's on	If it's blinking	If it's off
Orange	100 Mbps network connection	NA	10 Mbps network connection
Green	Linked to network, no network traffic	Linked to network, sending or receiving data	Not linked to network

Major System Elements

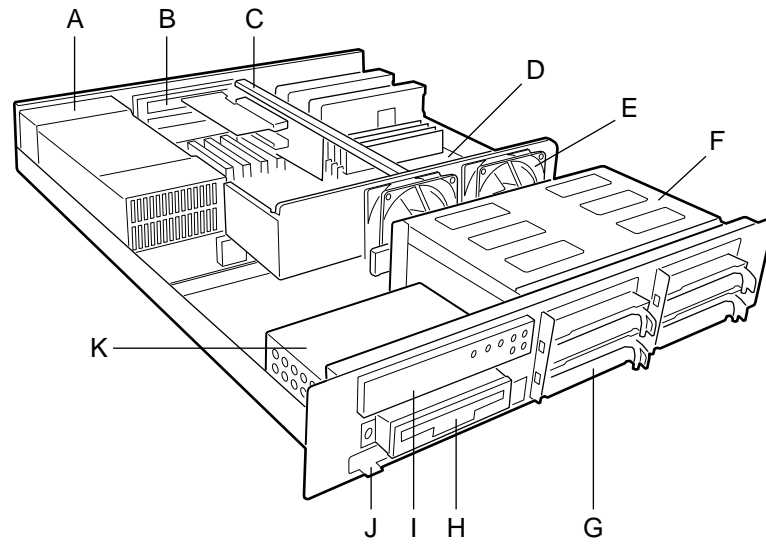

OM09322

Figure 4. Major System Elements

- | | |
|---------------------------|--------------------------|
| A. Power supply | G. Hard drive carrier |
| B. Expansion slot covers | H. Diskette drive |
| C. PCI riser card bracket | I. Front panel |
| D. Server board | J. CDROM drive bay cover |
| E. Fan | K. Floppy/CDROM housing |
| F. Hot-swap drive bay | |

Server Board Connector and Component Locations

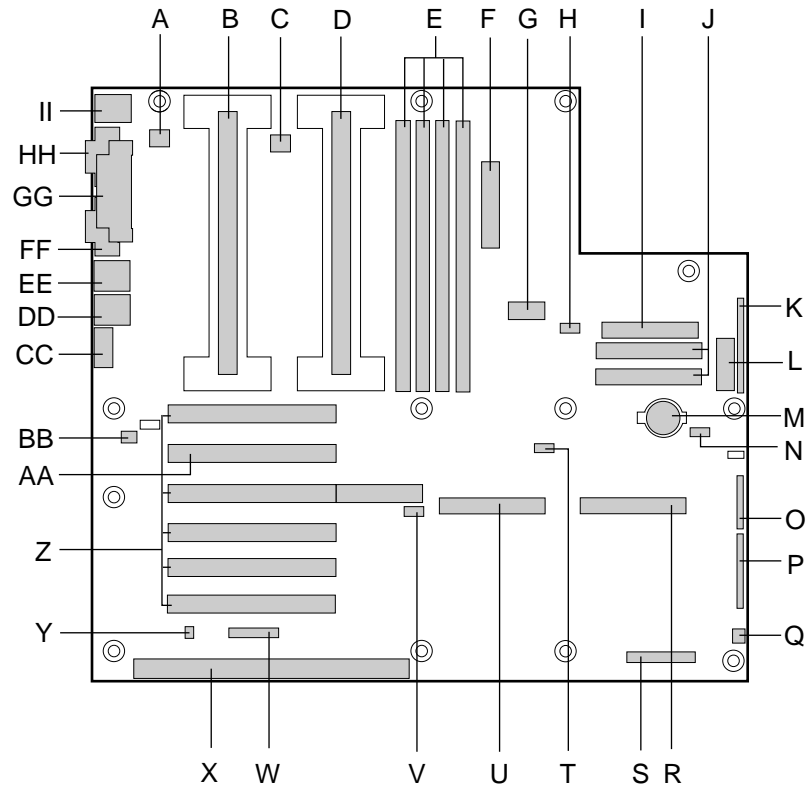

OM08561

Figure 5. Server Board Connector and Component Locations

- | | |
|--|--|
| A. Fansink connector 2 | T. External Wake on LAN† connector |
| B. Secondary processor | U. Ultra2/LVD SCSI connector |
| C. Fansink connector 1 | V. Hard drive LED connector |
| D. Primary processor | W. Intelligent Chassis Management Bus (ICMB) header |
| E. DIMM slots | X. ISA connector (do not install a card in this connector) |
| F. Main power connector | Y. Chassis intrusion connector |
| G. ATX aux power connector | Z. PCI connectors (do not install cards in these connectors) |
| H. Fan connector FAN2A | AA. Riser card connector |
| I. Floppy connector | BB. Fan connector FAN2B |
| J. IDE connectors | CC. Video connector |
| K. ATX front panel connector | DD. USB connectors |
| L. Front panel connector, 16 pin | EE. NIC connector |
| M. Battery | FF. Serial port connector |
| N. Isolated Server Management (ISOL) IMB connector | GG. Parallel port connector |
| O. Jumper block | HH. Serial port connector |
| P. Jumper block | II. Mouse/keyboard connectors |
| Q. Fan connector 1 | |
| R. Ultra wide SCSI connector | |
| S. Server Monitor Module (SMM) connector | |

Processor

Each Pentium II or Pentium III processor is packaged in a cartridge. The cartridge includes the processor core with an integrated 16 KB primary (L1) cache, the secondary (L2) cache, and a back cover.

The processor implements the MMX™ technology and maintains full backward compatibility with the 8086, 80286, Intel386™, Intel486™, Pentium, Pentium Pro, Pentium II, and Pentium III processors. The processor's numeric coprocessor significantly increases the speed of floating point operations and complies with ANSI/IEEE standard 754-1985.

Each processor cartridge connects to the server board through a 242-pin slot 1-edge connector. A retention module attached to the server board secures the cartridge. Depending on the configuration, your server may have one or two processors.

The processor external interface is MP (Multi-Processor) ready and operates at 100 MHz. The processor contains a local APIC (Advanced Programmable Interrupt Controller) section for interrupt handling in MP and UP (Uni-Processor) environments.

The second level cache is located on the substrate of the S.E.C. cartridge. The cache includes burst pipelined synchronous static RAM (BSRAM).

Memory

Only 100 MHz PC/100 ECC or Non-ECC SDRAM is supported by the server board. Memory is partitioned as four banks of SDRAM DIMMs, each providing 72 bits of non-interleaved memory (64 bit main memory plus ECC):

- Install from 64 MB to 2 GB of memory, using registered DIMMs.
- Install from 32 MB to 1 GB of memory, using unbuffered DIMMs.

Memory should be added in order from slot 1 to slot 4.

⇒ NOTE

Do not mix registered and unbuffered memory. Non ECC memory may be installed but ECC memory is recommended in a server environment. Mixing Non-ECC memory and ECC memory causes all ECC features to be disabled.

The controller automatically detects, sizes, and initializes the memory array, depending on the type, size, and speed of the installed DIMMs, and reports memory size and allocation to the server via configuration registers.

⇒ NOTE

Use DIMMs that have been tested for compatibility with the server board. Contact your sales representative or dealer for a current list of approved memory modules. Check the Intel Customer Support web site for the latest tested memory list:

<http://support.intel.com/support/motherboards/server/L440gx/compat.htm>

440GX Host Bridge / Memory Controller

The ISP2150 is designed around the Intel® 82440GX AGPSet (440GX). This device provides 100 MHz processor host bus interface support, DRAM controller, PCI bus interface, AGP interface (used on LB440GX for PCI-66/5V), and power management functions. The host bus/memory interface in the 440GX is optimized for 100 MHz operation, using 100 MHz SDRAM main memory. The PCI interface is PCI 2.1-compliant, providing a 33 MHz / 5V signaling environment for embedded controllers and slots in the riser card. The 440GX memory controller supports up to 2 GB of ECC or Non-ECC memory, using PC/100 compliant Synchronous DRAM (SDRAM) devices on DIMM plug-in modules. ECC can detect and correct single-bit errors, and detect multiple-bit errors.

Peripherals

Super I/O Chip

The National† 87309 device supports two serial ports, one parallel port, diskette drive, PS/2-compatible keyboard and mouse. The server board provides a connector interface for each port.

Serial Ports

Each serial port can be set to one of four different COMx ports and can be enabled separately. When enabled, each port can be programmed to generate edge or level sensitive interrupts. When disabled, serial port interrupts are available to add-in boards.

Parallel Port

The 87309 provides one IEEE 1284-compatible 25 pin bi-directional EPP (supporting levels 1.7 and 1.9). BIOS programming of the 87309 registers enable the parallel port and determine the port address and interrupt. ECP mode is supported with 2 possible DMA channels. When disabled, the interrupt is available to add-in boards.

Add-in Board Slots

You can only add two PCI cards to this server. You must use the PCI slots on the riser card. Do not use any expansion slots on the server board.

The server board has two full length standard PCI connectors on the riser card. PCI features:

- Bus speed up to 33 MHz
- 32 bit memory addressing
- 5 V signaling environment
- Burst transfers of up to 133 Mbps
- 8, 16, or 32 bit data transfers
- Plug and Play ready
- Parity enabled

Video

The onboard, integrated Cirrus Logic CL-GD5480 64 bit VGA chip contains an SVGA controller that is fully compatible with these video standards: CGA, EGA, Hercules† Graphics, MDA LAN, and VGA. The standard configuration comes with 2 MB of 10 ns onboard Synchronous Graphics Memory (SGRAM). The video controller supports pixel resolutions of up to 1600 x 1200 and up to 16.7 Million colors.

The SVGA controller supports analog VGA monitors (single and multiple frequency, interlaced and non-interlaced) with a maximum vertical retrace non—interlaced frequency of 100 Hz.

You cannot add video memory to the server board. Depending on the environment, the controller displays up to 16.7 M colors in some video resolutions. It also provides hardware accelerated bit block transfers (BITBLT) of data.

SCSI Controller

The embedded Adaptec AIC-7896 dual function SCSI controller provides both Ultra2 (LVDS) wide and Ultra wide SCSI interfaces as two independent PCI functions.

The SCSI bus is terminated on the server board with active terminators that cannot be disabled. The onboard device must always be at one end of the bus. The device at the end of the cable must be terminated. LVDS devices generally do not have termination capabilities. Non-LVDS devices generally are terminated through a jumper or resistor pack. If your device does not have a termination jumper or resistor pack, you must add a terminator to the end of the cable. A terminator is not supplied with your board. You must purchase one separately.

The hot-swap backplane in the ISP2150 system provides termination for the LVD SCSI bus.

IDE Controller

IDE is a 16 bit interface for intelligent disk drives with disk controller electronics onboard. The PCI/ISA/IDE Accelerator, also known as PIIX4e, is a multifunction device on the server board that acts as a PCI based Fast IDE controller. The device controls:

- PIO and IDE DMA/bus master operations
- Mode 4 timings
- Transfer rates up to 33 MB/s
- Buffering for PCI/IDE burst transfers
- Master/slave IDE mode
- Up to two devices per channel; two channels, IDE0 and IDE1

⇒ NOTE

18 inch maximum length of IDE cable on each channel: You can connect an IDE signal cable, up to a maximum of 18 inches each, to each IDE connector on the server board. Each cable can support two devices, one at the end of the cable and one 6 inches from the end of the cable.

Network Controller

The server board includes a 10BASE-T/100BASE-TX network solution based on the Intel 82559 single chip Fast Ethernet PCI Bus Controller. As a PCI bus master, the controller can burst data at up to 132 MB/s. The controller contains two receive and transmit FIFO buffers that prevent data overruns or underruns while waiting for access to the PCI bus. The controller has the following:

- 32 bit PCI bus master interface (direct drive of bus), compatible with PCI Bus Specification, Revision 2.1
- Chained memory structure with improved dynamic transmit chaining for enhanced performance
- Programmable transmit threshold for improved bus utilization
- Early receive interrupt for concurrent processing of receive data
- On-chip counters for network management
- Autodetect and autoswitching for 10 or 100 Mbps network speeds
- Support for both 10 Mbps and 100 Mbps networks, capable of full or half duplex, with back-to-back transmit at 100 Mbps

The network status LEDs on the server board indicate:

- Transmit/receive activity on the LAN
- Valid link to the LAN
- 10/100 Mbps transfer mode

Keyboard and Mouse

The keyboard/mouse controller is PS/2-compatible. The server may be locked automatically if there is no keyboard or mouse activity for a predefined length of time, if specified through the System Setup Utility (SSU). Once the inactivity (lockout) timer has expired, the keyboard and mouse do not respond until the previously stored password is entered.

ACPI

The ISP2150 supports the Advanced Configuration and Power Interface (ACPI) as defined by the ACPI 1.0 and PC97 specifications. An ACPI aware operating system can put the system into a state where the hard drives spin down, the system fans stop, and all processing is halted. However, the power supply will still be on and the processors will still be dissipating some power, so the power supply fan and processor fans will still run.

The ISP2150 supports sleep states s0, s1, s4, and s5. With future versions of Microsoft Windows[†] 9X that support ACPI, the BIOS will only support sleep states s0, s1, and s5. With future versions of Microsoft Windows NT[†]x that support ACPI, the BIOS will support sleep states s0, s1, s4, and s5.

- s0: Normal running state.
- s1: Processor sleep state. No context will be lost in this state and the processor caches will maintain coherency.
- s4: Hibernate or Save to Disk: The memory and machine state are saved to disk. Pressing the power button or other wakeup event will restore the system state from the disk and resume normal operation. This assumes that no hardware changes have been made to the system while it was off.
- s5: Soft off: Only the RTC section of the PIIX4 and the BMC are running in this state.



CAUTION

The system is off only when the AC power is disconnected.

Server Management

Server Management features are implemented using one microcontroller.

Baseboard Management Controller (BMC)

All server management functionality is concentrated in the BMC. The BMC and associated circuitry are powered from +5V_Standby, which remains active when server power is switched off and the server is still plugged into AC power.

One major function of the BMC is to autonomously monitor system management events, and log their occurrence in the nonvolatile System Event Log (SEL). These include events such as over-temperature and over-voltage conditions, fan failure, or chassis intrusion. To enable accurate monitoring, the BMC maintains the nonvolatile Sensor Data Record (SDR), from which sensor information can be retrieved. The BMC provides an ISA host interface to SDR sensor information, so software running on the server can poll and retrieve the server's current status.

SEL contents can be retrieved after system failure, for analysis by field service personnel using server management software tools such as Intel® Server Control available on the CD-ROM that ships with the ISP2150 server or from the Intel Customer Support web site:

<http://support.intel.com/support/motherboards/server/LB440gx/>

Because 5V_Standby powers the BMC, SEL and SDR information are also available via the IMB (Intelligent Management Bus). An Emergency Management Card, such as the Intel® LANDesk® SMM (Server Monitor Module) card available with the LANDesk Server Manager Pro package, can obtain the SEL and make it remotely accessible using a LAN or telephone line connection. While it receives the proper current, the BMC does the following:

- Monitors server board temperature and voltage
- Monitors processor presence and controls FRB
- Detects and indicates baseboard fan failure
- Manages the SEL interface
- Manages the SDR Repository interface
- Monitors the SDR/SEL timestamp clock
- Manages the server board Field Replaceable Unit (FRU) information interface
- Monitors the system management watchdog timer
- Monitors the periodic SMI timer
- Manages front panel NMI handling
- Monitors the event receiver
- Manages the ISA host and IMB interface
- Controls secure mode, including video blanking, floppy write-protect monitoring, and front panel lock/unlock initiation
- Manages the sensor event initialization agent
- Controls Wake on LAN via Magic Packet[†] support

Emergency Management Port Console

The Emergency Management Port (EMP) Console provides an interface to the Emergency Management Port (EMP). This interface allows remote server management via a modem or direct (serial port to serial port) connection.

The server control operations available with EMP Console are:

- Connecting to remote servers
- Powering the server on or off
- Resetting the server

The EMP Console uses three management plug-ins to monitor the server:

- SEL Viewer
- SDR Viewer
- FRU Viewer

The EMP Console also has Phonebook plug-in that can be used to create and maintain a list of servers and their phone numbers.

⇒ NOTE

EMP and PEP (Platform Event Paging) share your modem. PEP has priority over all applications except EMP. If an alert occurs, PEP will reset your modem and page you.

Platform Event Paging

With Platform Event Paging (PEP), your server can be configured to automatically dial up a paging service and page you when a platform event occurs. Platform events include temperature out-of-range, voltage out-of-range, chassis intrusion, fan failure, etc.

If PEP is enabled and the BMC receives or detects a new event, it automatically sends a page. It can send a page if the processors are down or if the system software is unavailable.

PEP needs an external modem connected to the server's EMP (Emergency Management Port) serial connection. This is typically the COM2 serial connector.

Software Security

The BIOS Setup and the System Setup Utility (SSU) provide a number of security features to prevent unauthorized or accidental access to the system. Once the security measures are enabled, you can access the system only after you enter the correct password(s). For example:

- Enable the keyboard lockout timer so that the server requires a password to reactivate the keyboard and mouse after a specified time out period—1 to 120 minutes.
- Set and enable an administrative password.
- Set and enable a user password.
- Set secure mode to prevent keyboard or mouse input and to prevent use of the front panel reset and power switches.
- Activate a hot key combination to enter secure mode quickly.
- Disable writing to the diskette drive when secure mode is set.
- Disable access to the boot sector of the operating system hard disk drive.

Using Passwords

You can set the user password, the administrator password, or both passwords. If only the user password is set, you:

- Must enter the user password to enter BIOS Setup or the SSU.
- Must enter the user password to boot the server if Password on Boot is enabled in either the BIOS Setup or SSU.
- Must enter the user password to exit secure mode.

If only the administrator password is set, you:

- Must enter the administrator password to enter BIOS Setup or the SSU.
- Must enter the administrator password to boot the server if Password on Boot is enabled in either the BIOS Setup or SSU.
- Must enter the administrator password to exit secure mode.

If both passwords are set, you:

- May enter the user password to enter BIOS Setup or the SSU. However, you will not be able to change many of the options.
- Must enter the administrator password if you want to enter BIOS Setup or the SSU and have access to all of the options.
- May enter either password to boot the server if Password on Boot is enabled in either the BIOS Setup or SSU.
- May enter either password to exit secure mode.

Secure Mode

Configure and enable the secure boot mode by using the SSU. When secure mode is in effect:

- You can boot the server and the operating system will run, but you must enter the user password to use the keyboard or mouse.
- You cannot turn off system power from the front panel button.

Secure mode has no effect on functions enabled via the Server Manager Module or power control via the real time clock.

Taking the server out of secure mode does not change the state of system power. That is, if you press and release the power switch while secure mode is in effect, the system will not be powered off when secure mode is later removed. However, if the front panel power switch remains depressed when secure mode is removed, the server will be powered off.

Summary of Software Security Features

The table below lists the software security features and describes what protection each offers. In general, to enable or set the features listed here, you must run the SSU and go to the Security Subsystem Group, menu. The table also refers to other SSU menus and to the Setup utility.

Table 3. Software Security Features

Feature	Description
Secure mode	<p>How to enter secure mode:</p> <p>Setting and enabling passwords automatically places the system in secure mode. If you set a hot-key combination (through the SSU or Setup), you can secure the system simply by pressing the key combination. This means you do not have to wait for the inactivity time-out period.</p> <p>When the system is in secure mode:</p> <p>The server can boot and run the operating system, but mouse and keyboard input is not accepted until the user password is entered.</p> <p>At boot time, if a CD is detected in the CD-ROM drive or a diskette in drive A, the system prompts for a password. When the password is entered, the server boots from CD or diskette and disables the secure mode.</p> <p>If there is no CD in the CD-ROM drive or diskette in drive A, the server boots from drive C and automatically goes into secure mode. All enabled secure mode features go into effect at boot time.</p> <p>To leave secure mode: Enter the correct password(s).</p>
Disable writing to diskette.	<p>In secure mode, the server will not boot from or write to a diskette unless a password is entered. To set this feature, use the SSU Security Subsystem Group. To write protect access to diskette whether the server is in secure mode or not, use the Setup main menu, Floppy Options, and specify Floppy Access as read only.</p>
Disable the power button.	<p>Enable the feature through the SSU. Then the power button is disabled when the server is in secure mode.</p>
Set a time out period so that keyboard and mouse input are not accepted. Also, screen can be blanked, and writes to diskette can be inhibited.	<p>Specify and enable an inactivity time out period of from 1 to 120 minutes.</p> <p>If no keyboard or mouse action occurs for the specified period, attempted keyboard and mouse input will not be accepted.</p> <p>The monitor display will go blank, and the diskette drive will be write protected (if these security features are enabled through Setup or the SSU).</p> <p>To resume activity: Enter the correct password(s).</p>
Control access to using the SSU: set administrative password.	<p>To control access to setting or changing the system configuration, set an administrative password and enable it through Setup or the SSU.</p> <p>If both the administrative and user passwords are enabled, either can be used to boot the server or enable the keyboard and/or mouse, but only the administrative password will allow Setup and the SSU to be changed.</p> <p>To disable a password, change it to a blank entry or press CTRL-D in the Change Password menu of the Administrative Password Option menu found in the Security Subsystem Group.</p> <p>To clear the password if you cannot access Setup or the SSU, change the Clear Password jumper (see Chapter 5).</p>

continued

Table 3. Software Security Features (continued)

Feature	Description
Control access to the system other than SSU: set user password.	To control access to using the system, set a user password and enable it through Setup or the SSU. To disable a password, change it to a blank entry or press CTRL-D in the Change Password menu of the User Password Option menu found in the Security Subsystem Group. To clear the password if you cannot access Setup or the SSU, change the Clear Password jumper (see Chapter 5).
Boot without keyboard.	The system can boot with or without a keyboard. During POST, before the system completes the boot sequence, the BIOS automatically detects and tests the keyboard if it is present and displays a message. There is no entry in the SSU to enable or disable a keyboard.
Specify the boot sequence.	The sequence that you specify on the menu in the SSU MultiBoot Group will determine the boot order. If secure mode is enabled (a user password is set), then you will be prompted for a password before the server fully boots. If secure mode is enabled and the "Secure Boot Mode" option is also enabled, the server will fully boot but will require a password before accepting any keyboard or mouse input.

Checking the Power Cords

WARNING

Do not attempt to modify or use AC power cords that are not the exact type required.

In some cases the power cord supplied with this system may not be compatible with the AC wall outlet in your region. If this is true, you must obtain a suitable power cord that meets the following criteria:

- The cord must be rated for the available AC voltage and have a current rating that is at least 125% of the current rating of the server.
- The AC plug end that plugs into the wall outlet must be terminated in a grounding-type plug designed for use in your region. The plug ends must be labeled or marked to indicate an acceptable certifier in your region has certified them.
- The connector that plugs into the AC inlet on the server must be an IEC 320, sheet C13, female type connector.
- For use in Europe, the cord must be less than 4.5 meters (14.76 feet) long, and it must be flexible <HAR> (harmonized) or VDE certified cordage.

Equipment Rack Precautions



SAFETY WARNINGS

ANCHOR THE EQUIPMENT RACK: The equipment rack must be anchored to an unmovable support to prevent it from falling over when one or more servers are extended in front of it on slide assemblies. The anchors must be able to withstand a force of up to 113 kg (250 lbs.). You must also consider the weight of any other device installed in the rack.

MAIN AC POWER DISCONNECT: You are responsible for installing an AC power disconnect for the entire rack unit. This main disconnect must be readily accessible, and it must be labeled as controlling power to the entire unit, not just to the server(s).

GROUNDING THE RACK INSTALLATION: To avoid the potential for an electrical shock hazard, you must include a third wire safety grounding conductor with the rack installation. If server power cords are plugged into AC outlets that are part of the rack, then you must provide proper grounding for the rack itself. If server power cords are plugged into wall AC outlets, the safety grounding conductor in each power cord provides proper grounding only for the server. You must provide additional, proper grounding for the rack and other devices installed in it.

OVERCURRENT PROTECTION: The server is designed for an AC line voltage source with up to 20 amperes of overcurrent protection. If the power system for the equipment rack is installed on a branch circuit with more than 20 amperes of protection, you must provide supplemental protection for the server. If more than one server is installed in the rack, the power source for each server must be from a separate branch circuit.



CAUTIONS

Temperature: The operating temperature of the server, when installed in an equipment rack, must not go below 5 °C (41 °F) or rise above 35 °C (95 °F). Extreme fluctuations in temperature can cause a variety of problems in your server.

Ventilation: The equipment rack must provide sufficient airflow to the front of the server to maintain proper cooling. It must also include ventilation sufficient to exhaust a maximum of 1,500 Btu's per hour for each server. The rack selected and the ventilation provided must be suitable to the environment in which the server will be used.

2 Upgrading and Installing Server Components

Tools and Supplies Needed

- Phillips (cross head) screwdriver (#1 bit and #2 bit)
- Jumper removal tool or needle nosed pliers
- Pen or pencil
- Anti-static wrist strap and conductive foam pad (recommended)

Warnings and Cautions

These warnings and cautions apply throughout this chapter. Only a technically qualified person should access the inside of the system.



SAFETY WARNINGS

System power on/off: To remove power from system, you must press the power button off and unplug the AC power cords from the wall outlet or the system.

Hazardous conditions, power supply: Hazardous voltage, current, and energy levels are present inside the power supply. There are no user-serviceable parts inside it; servicing should be done by technically qualified personnel.

Hazardous conditions, devices, and cables: Hazardous electrical conditions may be present on power, telephone, and communication cables. Turn off the system and disconnect the power cords, telecommunications systems, networks, and modems attached to the system before opening it. Otherwise, personal injury or equipment damage can result.



CAUTIONS

Electrostatic discharge (ESD) and ESD protection: ESD can damage disk drives, boards, and other parts. We recommend that you do all procedures in this chapter only at an ESD-protected workstation. If one is not available, provide some ESD protection by wearing an anti-static wrist strap attached to chassis ground—any unpainted metal surface—on your system when handling parts.

ESD and handling boards: Always handle boards carefully. They can be extremely sensitive to ESD. Hold boards only by their edges. After removing a board from its protective wrapper or from the system, place it component-side UP on a grounded, static-free surface. If you place the baseboard on a conductive surface, the battery leads may short out. If they do, this will result in a loss of CMOS data and will drain the battery. Use a conductive foam pad if available but NOT the board wrapper. Do not slide board over any surface.

Cooling and airflow: For proper cooling and airflow, always install the chassis access cover before turning on the system. Operating the system without the cover in place can damage system parts.

Installing or removing jumpers: A jumper is a small plastic encased conductor that slips over two jumper pins. Some jumpers have a small tab on top that you can grip with your fingertips or with a pair of small or fine needle nosed pliers. If your jumpers do not have such a tab, take care when using needle nosed pliers to remove or install a jumper; grip the narrow sides of the jumper with the pliers, never the wide sides. Gripping the wide sides can damage the contacts inside the jumper, causing intermittent problems with the function controlled by that jumper. Take care to grip with, but not squeeze, the pliers or other tool you use to remove a jumper, or you may bend or break the stake pins on the board.

Bezel

Opening and Closing the Front Bezel

With the bezel open you have access to all of your system's front panel functions and indicators. With the bezel closed you can protect critical functions and still view the system's indicators.

To open the bezel, do the following:

1. Stand in front of the chassis and grasp the edges of the bezel from each side.
2. Gently pull the bezel towards you until it begins to separate from the chassis.
As the bezel separates from the chassis, allow it to swing to its open position situated below the chassis.
3. As the bezel separates from the chassis, allow it to swing to its open position situated below the chassis.



Figure 6. Opening the Bezel

To close the bezel, gently raise it upwards. The hinging mechanism will guide the bezel into the correct position where it will snap shut.

Locking and Unlocking the Front Bezel

The bezel can be locked and unlocked to prevent unwanted access to the system.

To lock the bezel:

1. Remove the keys from inside the bezel (they should be taped to the inside).
2. Close the bezel and insert the key into the lock. Turn the counterclockwise until it stops (about a quarter turn). The bezel is now locked and cannot be opened.

To unlock the bezel, insert the key into the lock and turn the lock clockwise until it stops (about a quarter turn). The bezel is now unlocked and can be opened again.

Attaching and Removing the Front Bezel

The front bezel can be installed or removed from the system.

To attach the bezel:

1. With the LED light tunnels located at the top of the bezel, push in the arms on either side of the bezel far enough so that the tabs on the ends of the arms can be inserted into the holes in the chassis.
2. Insert the tabs into the holes in the handles on the chassis. Make sure the tabs on each side of the bezel are completely in the holes in the handles.

To remove the bezel:

1. Push the arms far enough in so that the tabs on the end of the arms are completely out of the holes in the handles on the chassis. The bezel should now be able to be removed.
2. The bezel should now be able to open and close easily and completely.

Covers

Opening the Cover

1. Loosen the three screws on the rear of the system.
2. Pull the cover back and remove it from the chassis.

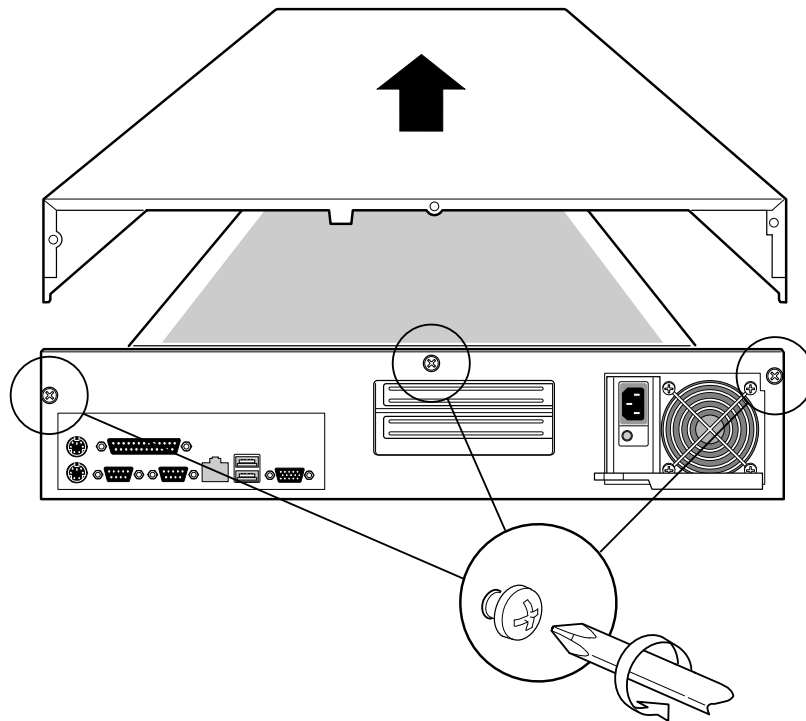

OM09327

Figure 7. Opening the Cover

Closing the Cover

1. Place the cover on the chassis and slide it forwards as far as possible.
2. Tighten the three screws on the rear of the chassis.

Processors



WARNING

If the server has been running, any installed processor and heat sink on the processor board(s) will be hot. To avoid the possibility of a burn, be careful when removing or installing server board components that are located near processors.



CAUTIONS

Processor must be appropriate: You may damage the server if you install a processor that is inappropriate for your server. Make sure your server can handle a newer, faster processor (thermal and power considerations). For exact information about processor interchangeability, contact your customer service representative or visit the Intel Customer Support web site:

<http://support.intel.com/support/motherboards/server/LB440gx>

Heat sink must be appropriate: Depending on your configuration, the existing processor may have a passive heat sink. If you **REPLACE** the processor with a faster one, it must have an active fan heat sink (powered fan instead of a passive heat sink). If you **ADD** a second processor, it must have a fan heat sink. When adding a processor, you must leave the existing one in the primary connector (closest to the DIMM slots on the server board).

ESD and handling processors: Reduce the risk of electrostatic discharge (ESD) damage to the processor by doing the following: (1) Touch the metal chassis before touching the processor or server board. Keep part of your body in contact with the metal chassis to dissipate the static charge while handling the processor. (2) Avoid moving around unnecessarily.

Installing a Processor

The server supports up to two Intel Pentium II or Pentium III processors (with 100 MHz system bus). If you are installing two processors, make sure they are the same speed, voltage, and stepping.

1. Observe the safety and ESD precautions at the beginning of this chapter and the additional cautions given here.
2. Remove the new processor from its anti-static package and place it on a grounded, static free surface or conductive foam pad.
3. Attach the small end of the power cable to the fan connector on the S.E.C. cartridge, then attach the connector (E) to the 3-pin signal prongs (F) on the server board.

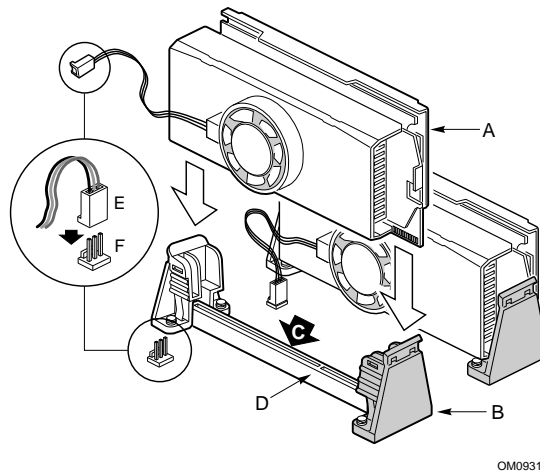

Figure 8. Installing a Processor

- A. Second processor
- B. Retention mechanism (right side)
- C. Secondary processor slot
- D. Off-center notch on secondary slot connector
- E. Processor fan 2 connector
- F. Processor fan 2 signal prongs

4. Orient the processor so that the heat sink faces the I/O connectors. Slide the processor into the retention module. Push down firmly, with even pressure on both sides of the top, until the processor is seated.
5. To lock in the processor, push the latches inward on the retention module until they click into place. The latches must be secured for proper electrical connection of the processor.
6. After you have installed the processor, you must configure its speed in BIOS set-up.



CAUTION, SINGLE-PROCESSOR CONFIGURATIONS

If you install only one processor in a system, it must go in the primary connector (closest to the DIMM sockets). With a single-processor configuration, you must install a termination board and termination latch assembly (A) in the empty secondary connector (B) to ensure proper operation of your system. A termination board is provided with your system.

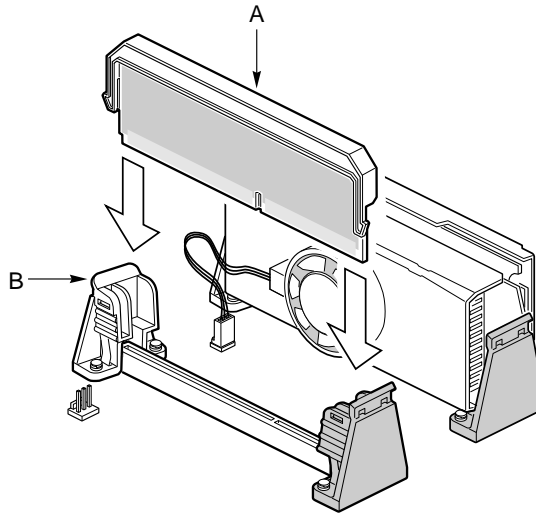

OM09328

Figure 9. Installing a Termination Board

- A. Terminator Latch Assembly (TLA)
- B. Secondary retention mechanism

Removing a Processor

If your server has one processor and you are REPLACING it, leave the termination board intact in the secondary connector. Remove the processor you want to replace. If your server has two processors and you are REPLACING one or both, remove the appropriate one(s).

1. Observe the safety and ESD precautions at the beginning of this chapter and the additional cautions given here. If the processor has a fan heat sink, disconnect the power wire (E in Figure 8) from the connector on the server board (F in Figure 8).
2. As you work, place boards and processors on a grounded, static free surface or conductive foam pad.
3. Press the processor latches away from the center of the S.E.C. cartridge (A in Figure 8) to free them from the retention module (B in Figure 8).
4. Lift the S.E.C. cartridge upward, out of the retention module.
5. Put the processor in a piece of conductive foam and store in an anti-static package.

Memory

Installing DIMMs

The server only supports 100 MHz PC/100-compliant SDRAM.

- Install from 32 MB to 2 GB of unbuffered memory, using up to four single or double-banked DIMMs
- Or
- Install from 32 MB to 2 GB of registered memory, using up to four single or double-banked DIMMs

Installed DIMMs must be the same speed and either all registered or all unbuffered. For a list of supported memory, call your service representative or visit the Intel Support website:

[Http://support.intel.com/support/motherboards/server/1440gx/compat.htm](http://support.intel.com/support/motherboards/server/1440gx/compat.htm)



CAUTION

Use extreme care when installing a DIMM. Applying too much pressure can damage the socket. DIMMs are keyed and can be inserted in only one way.

Mixing dissimilar metals may cause later memory failures resulting in data corruption. Only install DIMMs with gold-plated edge connectors in gold-plated sockets.

To install your memory:

1. Observe the safety and ESD precautions at the beginning of this chapter.
2. Open your server.
3. Holding the DIMM only by its edges, remove it from its anti-static package.
4. Orient the DIMM so that the two notches in the bottom edge of the DIMM align with the keyed socket.
5. Insert the bottom edge of the DIMM into the socket, and press down firmly on the DIMM until it seats correctly.
6. Gently push the plastic ejector levers on the socket ends to the upright position.

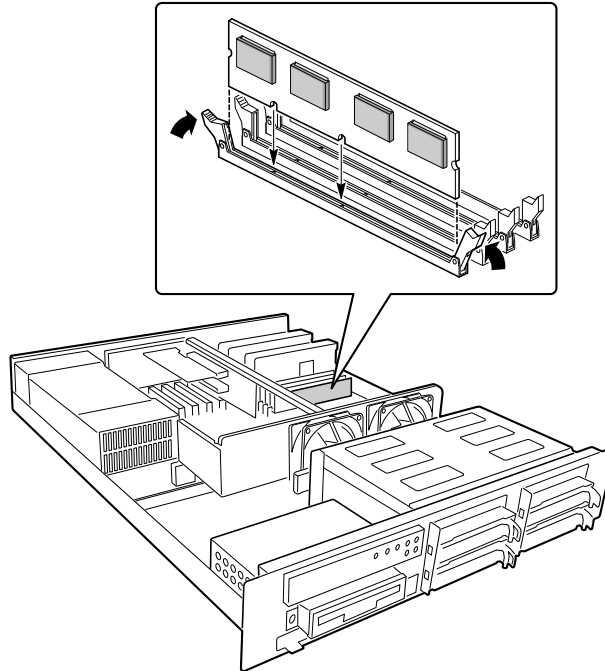

OM09318

Figure 10. Installing DIMMs

7. Repeat the steps to install each DIMM.
8. Ensure that no cables are protruding from the server chassis and then close the server.
9. Connect all external cables and the power cord to the server.
10. Turn on the monitor and then the server.

Removing DIMMs



CAUTION

Use extreme care when removing a DIMM. Too much pressure can damage the socket slot. Apply only enough pressure on the plastic ejector levers to release the DIMM.

1. Observe the safety and ESD precautions at the beginning of this chapter.
2. Open the server.
3. Gently push the plastic ejector levers out and down to eject a DIMM from its socket.
4. Hold the DIMM only by its edges, being careful not to touch its components or gold edge connectors. Carefully lift it away from the socket, and store it in an antistatic package.
5. Repeat to remove other DIMMs as necessary.
6. Close the server.
7. Connect all external cables and the power cord to the server.
8. Turn on the monitor and then the server.

Peripheral Devices

Removing the Diskette Drive

1. Observe the safety and ESD precautions at the beginning of this chapter.
2. Disconnect the power (B) and signal (A) cables from the diskette drive. The connectors are keyed for ease in reconnecting them to the drive.

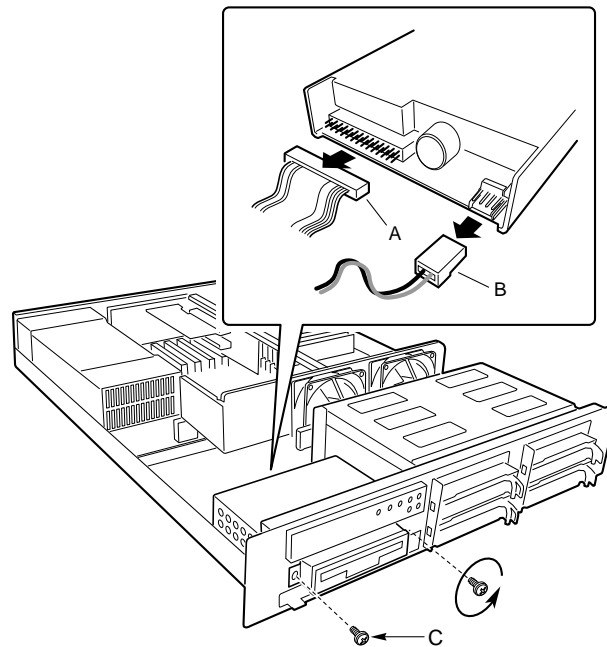

OM09316

Figure 11. Removing the Diskette Drive from the Chassis

- A. Signal cable
- B. Power cable
- C. Screws

3. Remove and save the screws (C) that secure the diskette drive carrier to the front of the chassis.
4. Slide the drive carrier out the front of the chassis.
5. Remove and save the screws from the sides of the drive carrier.
6. Pull the drive out of the carrier and place the drive in an anti-static protective wrapper if you are not reinstalling it.

Re-installing the Diskette Drive

1. Remove the 3.5-inch diskette drive from its protective wrapper, and place it component-side up on an anti-static surface.
2. Install the drive into the drive carrier and secure it with the screws that you removed.
3. Slide the drive carrier through the front of the chassis.
4. Secure the drive carrier to the front of the chassis with the screws you removed earlier.
5. Connect the signal and power cables to the drive according to the manufacturer's specifications.

Installing a Hard Drive

Your server does not include a hard drive. You must purchase them separately and install them. The server has four hot-swappable hard drive bays.

1. Remove the drive carrier(s) from the drive bays by unclipping the retention lever on the right side of the handle. Pull the retention lever toward you until the tab end (B) of the lever is free of the housing slot (A). Pull the drive forward and out of the housing.
2. Remove the hard drive from its wrapper and place it on an anti-static surface.
3. Set any jumpers and/or switches on the drive according to the drive manufacturer's instructions.

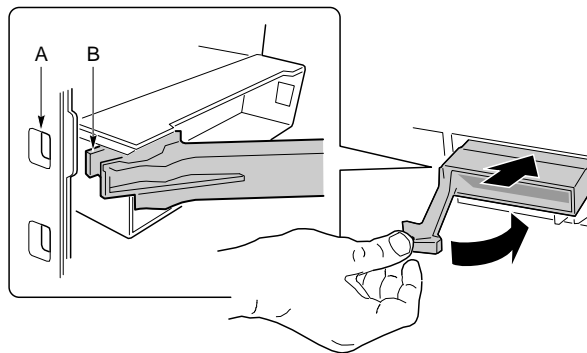

OM09317

Figure 12. Removing the Hard Drive Carrier from the Chassis

4. Remove and save the four screws (D in Figure 13) from the drive carrier/drive slide track.

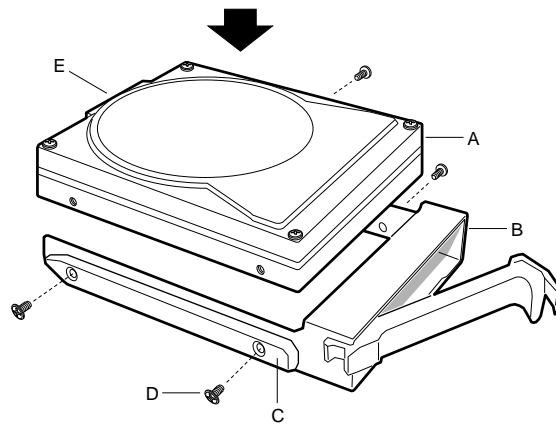

OM09323

Figure 13. Attaching the Drive to the Carrier

- | | |
|----------------------------|---------------------------|
| A. Hard disk drive | D. Screws (4) |
| B. Drive carrier | E. Connector end of drive |
| C. Plastic slide rails (2) | |

5. Align the drive holes to the holes in the drive carrier slide track (C), insert the screws that you previously removed, and attach the carrier (B) to the drive (A). Make sure that the connector end of the drive (E) is facing the back of the carrier and the drive top is facing upward before inserting the screws.
6. Slide the carrier/drive into the chassis with the retention mechanism extended in the open position, then push the arm towards the front of the chassis until the lever tab (B) clicks into the chassis slot (A) indicating that it is closed.

Installing a Slim-line CDROM Drive

Your server does not come with an integrated slim-line CD-ROM drive. You must purchase one separately and install it.

1. Remove the drive from its protective wrapper, and place it on an anti-static surface.
2. Set any jumpers and/or switches on the drive according to the drive manufacturer's instructions.
3. Attach the CD-ROM drive to the CDROM tray using the mounting screws (A) supplied with the system.

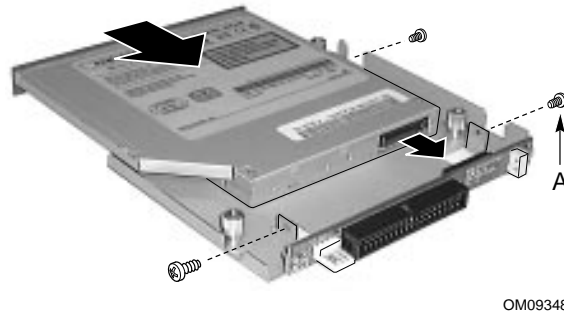
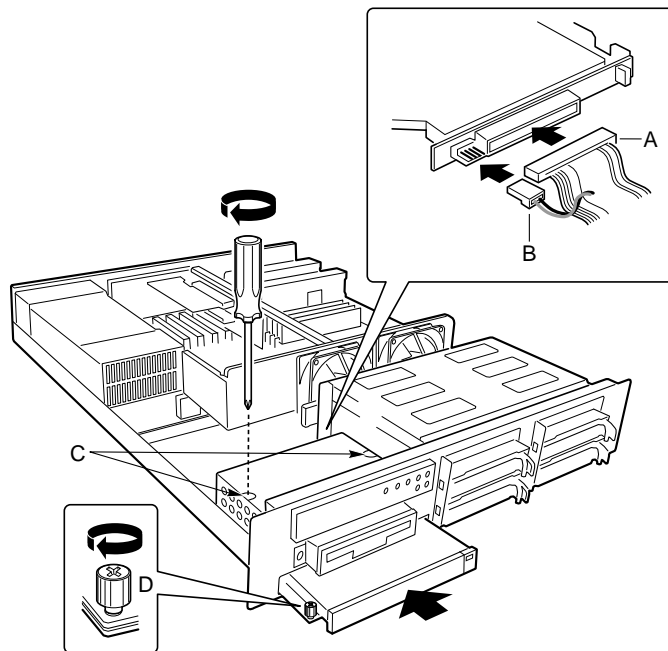

Figure 14. Attaching a Slim-line CDROM Drive to the CDROM Tray

A. Mounting screws

4. Remove the screws that hold the filler panel to the front of the chassis and slide out the panel.



OM09319

Figure 15. Installing a Slim-line CDROM Drive

- A. Signal cable
- B. Power cable
- C. Screws
- D. Retention screw

5. Slide the slim-line CDROM tray into the CDROM bay. It is recommended that you first remove the diskette drive in the section “Removing the Diskette Drive”.
6. Connect the CDROM IDE cable (A) and power (B) cables to the connector at the back of the CD tray.
7. Reinstall the diskette drive in the section “Re-Installing the Diskette Drive”.
8. Insert the recessed retention screws (C) through the access holes in the top of the drive bay housing.
9. Insert the retention screw (D) on the front of the chassis.

Removing a CDROM Drive

1. Remove the diskette drive housing as outlined in the section “Removing the Diskette Drive”.
2. Remove the three screws holding the drive to the chassis.
3. Disconnect the power and data cables from the drive.
4. Slide the drive tray out of the front of the chassis.
5. Remove the CDROM from the CDROM tray.
6. Place the drive in an anti-static protective wrapper if you are not reinstalling the same drive.
7. Re-install the diskette drive housing as outlined in the section “Installing the Diskette Drive”.

Add-in Cards

Installing Add-in Cards

You can only add two PCI cards to this server. You must use the PCI slots on the riser card. Do not use any expansion slots on the server board.

1. Remove the expansion slot cover for the slot you wish to use. Remove the thumbscrew (B) holding the cover retention bracket (A) to the chassis. Remove the bracket from the chassis.
2. Remove the expansion slot cover (C) for the slot you wish to use.

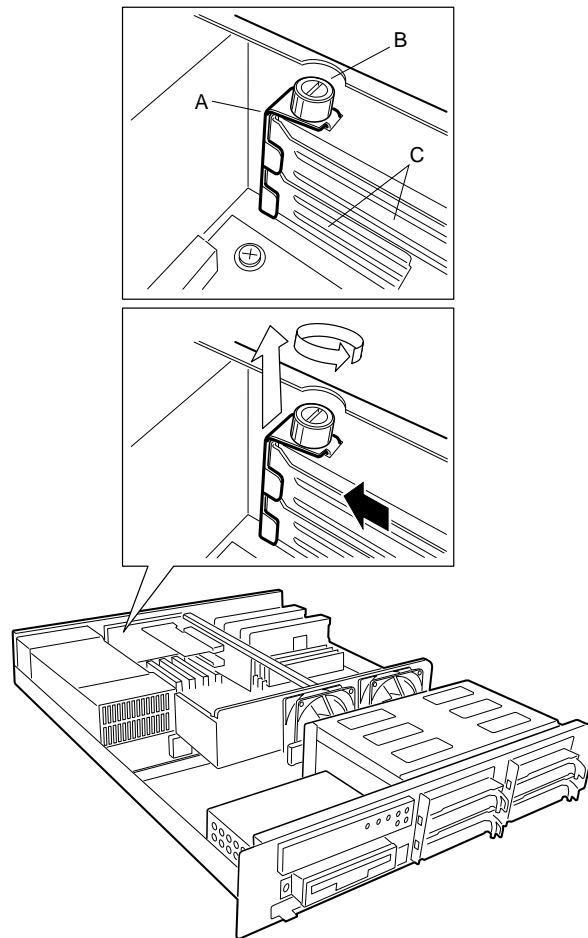

OM09325

Figure 16. Removing the Slot Cover Retention Bracket

- A. Slot cover retention bracket
- B. Thumbscrew
- C. Slot covers

3. Remove the add-in board from its protective wrapper. Set jumpers or switches according to the manufacturer's instructions.

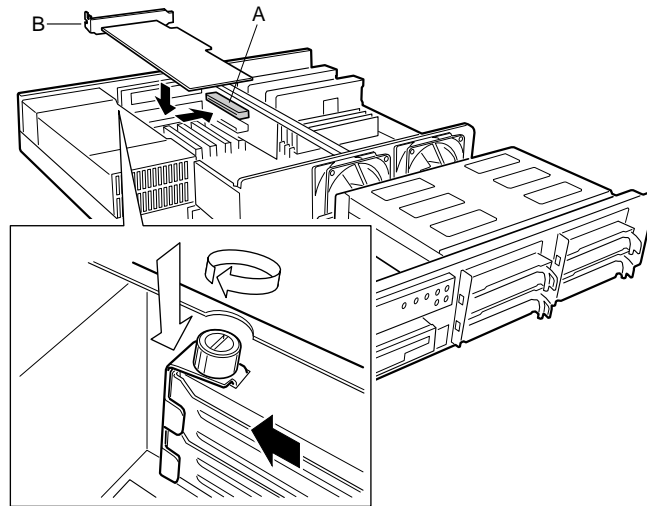

OM09326

Figure 17. Installing an Add-in Card

- A. PCI slot
- B. Add-in card bracket

4. Hold board by its top edge or upper corners. Firmly press it into an open expansion slot on the riser card. The tapered foot of the board-retaining bracket must fit into the mating slot in the expansion slot frame. Install the board component side **DOWN**.

⇒ **NOTE**

If you are installing a full-length PCI card, slide the card guide in front of the fans before installing the card.

5. Align the rounded notch in the retaining bracket (B) with the threaded hole in the frame. The bracket fits the space that was occupied by the slot cover.

⇒ **NOTE**

If you are installing a full-length PCI card, slide the card guide back into place. The back edge of the card should be held in place by the rail of the card guide.

6. Install the cover retention bracket and thumbscrew.

Power Supply

Removing and Re-installing a Power Supply

To replace the power supply:

1. Unplug the power cord from the power source and from the power cord receptacle (A) at the right rear side of the system.
2. Remove the top cover of the system. Refer to “Opening the Cover” on page 29.
3. Remove and save the two screws (B) from the power supply cover (C).
4. Grasp the bottom edge of the power supply cover and lift it up and away from the power supply.
5. Grasp the sides of the power supply and slide it forward, out of the chassis.

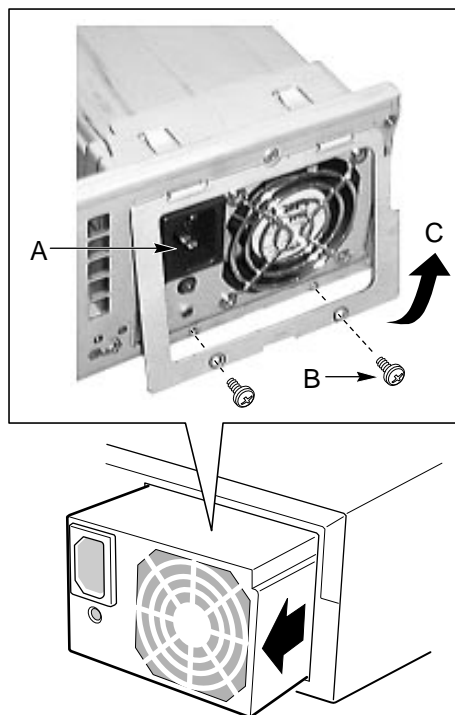

OM09324

Figure 18. Replacing the Power Supply

- A. Power cord receptacle
- B. Screws
- C. Cover

6. Slide the new power supply into the chassis and make sure it is seated in the chassis connector.
7. Close the power supply cover and re-insert the screws you set aside earlier.
8. Re-connect the power cord to the power cord receptacle and plug the cord back into its power source.

System Mounts

There are two methods for installing the ISP2150, using the front bracket hardware or optionally using rack rail system.

Installing the Front Bracket and Racking the System

The ISP2150 system comes with mounting bracket hardware that allows you to install it into cabinets and relay racks. The following procedures describe how to mount the ISP2150 system in each type of chassis.

Installing the Front Bracket in a Cabinet

1. *Attach the left and right front brackets to the system.* Your system comes with left and right front brackets (A in Figure 19) and mounting bolts (B in Figure 19) to attach them to the system. Mount the brackets to the sides of the system with the bracket flange flush with the front panel.
2. *Attach the rear support washer to the system.* The system also comes with two support washers (C in Figure 19). Mount one on each side towards the rear panel of the system.
3. *Mount the back support bracket to the cabinet.* Left and right rear support brackets (A and B in Figure 20) also come with the system. Mount the rear brackets in the desired position in the cabinet using the supplied mounting bolts (C in Figure 20) supplied by the cabinet manufacturer.
4. *Slide the system into the back support bracket.* After attaching the rear brackets, slide the system into the rack using the support washers as rollers.

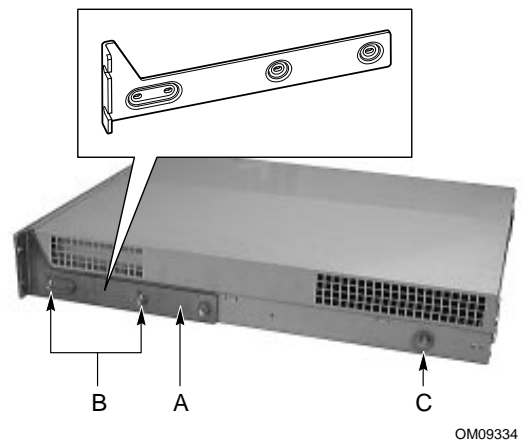

Figure 19. Mounting the Front Brackets and Support Washers

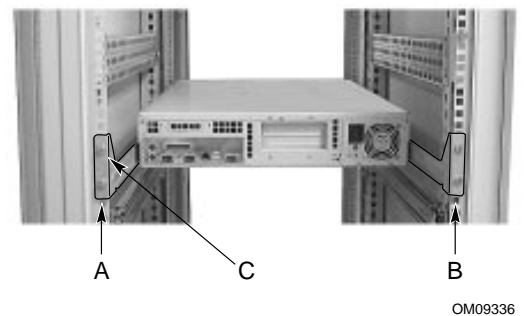

Figure 20. Mounting the Back Support Brackets

5. *Mount the front bracket to the cabinet.*
To complete the installation, bolt the system's front brackets to the cabinet using the mounting bolts (A in Figure 21) supplied by the cabinet manufacturer.



OM09346

Figure 21. Mounting the Front Brackets to the Cabinet Chassis

Installing the Front Bracket in a Center-Mount, Relay Rack

1. *Attach the left and right front brackets to the system.* Your system comes with left and right front brackets (A in Figure 22) and mounting bolts (B in Figure 22) to attach them to the system. Mount the brackets mid-way down the sides of the system as shown in the figure.

⇒ NOTE

You can also mount the bracket so that the flange is flush with the front panel.

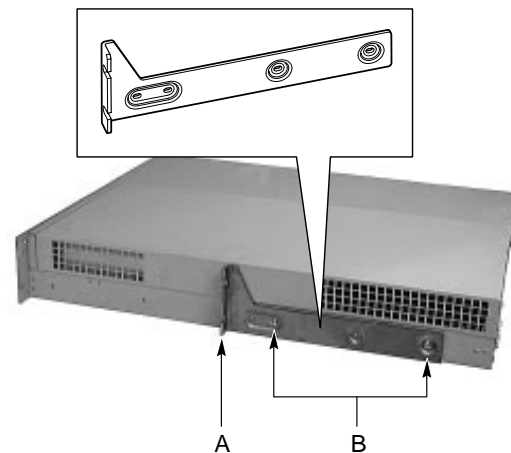

OM09335

Figure 22. Mounting the Front Brackets Midway Along the System

2. *Mount the bracket to the center channel of the relay rack.* To complete the installation, bolt the system's front brackets to the cabinet using the mounting bolts (A in Figure 23) supplied by the cabinet manufacturer.

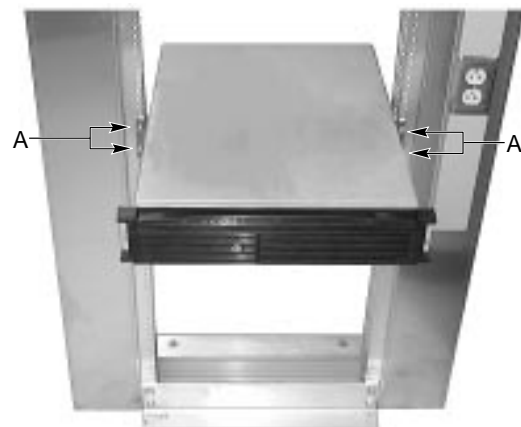

OM09347

Figure 23. Mounting the Front Brackets to the Relay Rack

Installing the Rail Rack and Racking the System (Optional Accessory)

The rail kit that comes with your system allows you to install it into a four-post, network server cabinet (e.g. APC Netshelter). If the cabinet is not of this general type, you will have to purchase a separate rail kit that is specific to your cabinet.

Follow these steps to install the rail kit and place your system into the cabinet.

1. *Assemble tools and miscellaneous parts.*
You will need a Phillips screwdriver and assorted lock washers and nuts.
2. *Remove the inside piece (C in Figure 24) from both sides of the rail system.* To remove an inside piece of the rail system, slide the part as far out as you can. This action reveals a brass colored finger tab (D in Figure 24) that when depressed allows you to completely separate the inside rail piece from the outer (A in Figure 24) and middle (B in Figure 24) rail pieces.

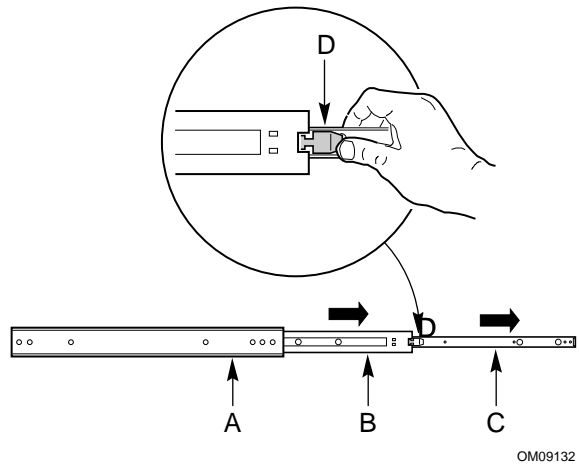

Figure 24. Rail System

3. *Align each inside rail (A in Figure 25) to a side of the chassis.* Be sure that the flat end of the inside rail is toward the front of the chassis and that the brass colored finger tab (D in Figure 25) is facing outward. With the holes in the chassis (C in Figure 25) aligned with the holes in the rail, fasten the rail using the largest screws (B in Figure 25) supplied with the rail kit.

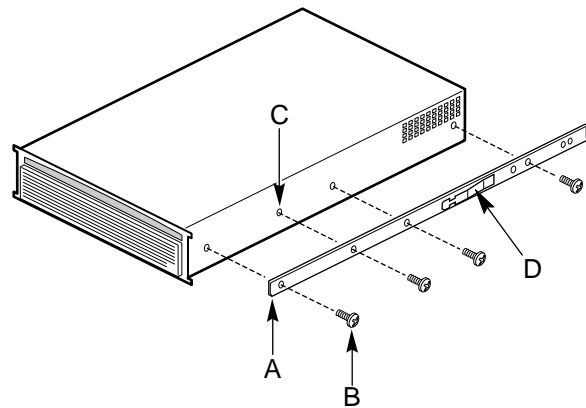

Figure 25. Aligning Rail to Chassis

4. Here is a combination side and rear view (Figure 26) of the chassis after the right inside rail has been attached.



Figure 26. Chassis Rear and Side View

5. Locate the front and rear rail brackets for one side of the rail kit. One pair (A and B in Figure 27) exists for each side of the cabinet rack.

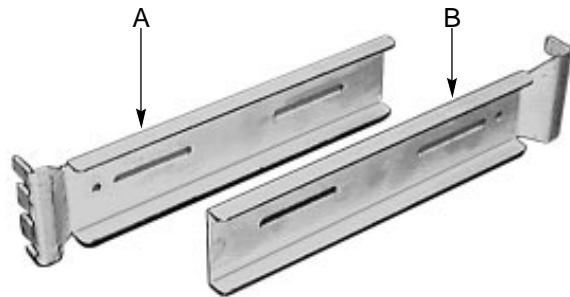

OM09145

Figure 27. Rail Brackets

6. Attach all four rail brackets to the cabinet rack. Be sure that the sharper angled side of each bracket is facing up (C in Figure 28). Use eight mounting screws (D in Figure 28) provided by the manufacturer of the cabinet rack. In the illustration to the right, the left photo (A in Figure 28) shows the left-front bracket attached to the cabinet, while the right photo (B in Figure 28) shows the left-rear bracket. (The photo shows the rails inside the brackets. You should not have the rails attached inside the brackets yet.)

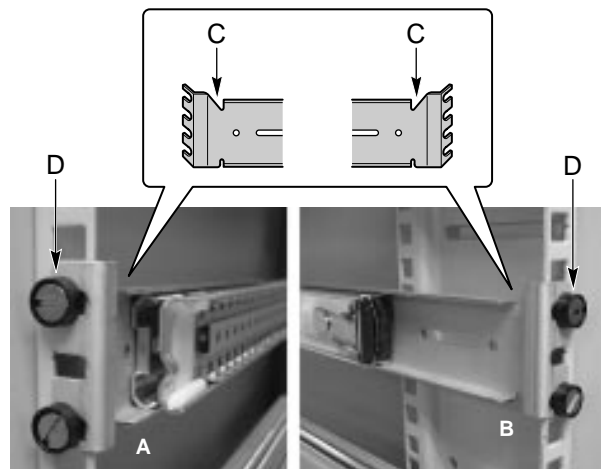

OM09142

Figure 28. Attaching Rail Brackets to Cabinet Rack

7. *Attach the side rail system's outer pieces (total of two) to the rail brackets you installed in step six. To attach the front part of an outer piece to a rail bracket, you must reveal the access hole (A in Figure 29) by sliding the innermost piece toward the back. Once you see the access hole, align it with the slot in the rail bracket such that you can secure the bolt. Do not tighten the nut and bolt until you have aligned the rear portion of the rail system (see the next step).*

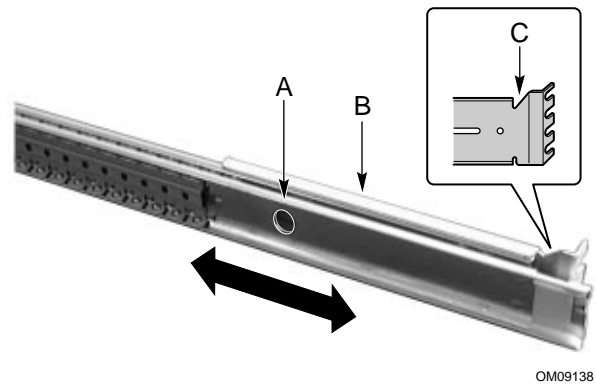

Figure 29. Attaching Outer Pieces to Rail Brackets

8. *To attach the rear part of the rail system to the rear rail bracket (A in Figure 30), slide the rail system within the rail brackets such that you can place a bolt through the rail's hole (B in Figure 30) and into the rail bracket's slot. Loosely tighten the bolt and nut. You should be able to slide the entire rail system back and forth in the rail brackets. When you have centered the rails in the bracket, tighten the fastening bolts and nuts.*

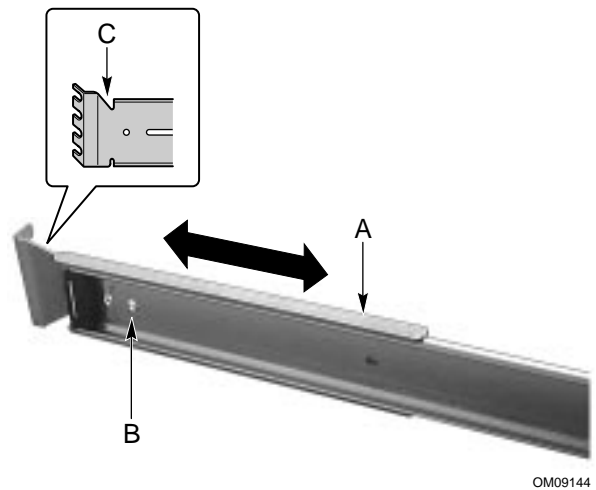
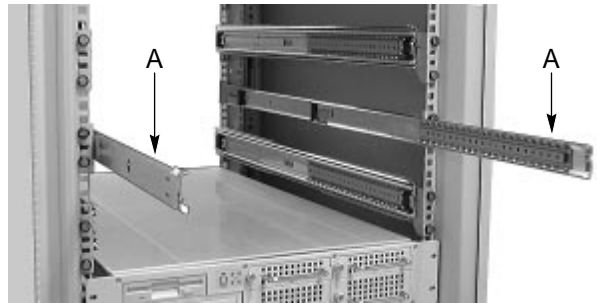

Figure 30. Attaching Rail System to Rear Rail Bracket

9. *Extend the right and left rails (A in Figure 31) so they fully extend in front of the cabinet rack. The rail system is now ready to receive the chassis.*



OM09141

Figure 31. Extending the Rails

10. *Lift the chassis with its front facing you and carefully guide the inner rail (A in Figure 32), which is mounted to the chassis system, into the outer pieces (B in Figure 32) you attached in previous steps. Gently move the system evenly towards the rear of the cabinet. Be sure to depress the brass colored finger tabs located in the center of each inner side rail piece as you slide the chassis back.*

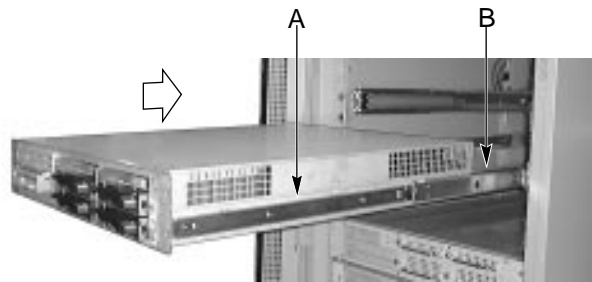

OM09143

Figure 32. Guiding Chassis into the Rack

11. *With the chassis fully inserted into the cabinet rack, you can easily access both the front and rear of the system. The photo in Figure 33 shows the system from the rear fully inserted into the cabinet.*



Figure 33. Chassis Mounted into the Rack

Replacing the Back up Battery

The lithium battery on the server board powers the real time clock (RTC) for up to 10 years in the absence of power. When the battery starts to weaken, it loses voltage, and the server settings stored in CMOS RAM in the RTC (for example, the date and time) may be wrong. Contact your customer service representative or dealer for a list of approved devices.

WARNING

Danger of explosion if battery is incorrectly replaced. Replace only with the same or equivalent type recommended by the equipment manufacturer. Discard used batteries according to manufacturer's instructions.

ADVARSEL!

Lithiumbatteri - Eksplosjonsfare ved fejløgt håndtering. Udskiftning må kun ske med batteri af samme fabrikat og type. Levér det brugte batteri tilbage til leverandøren.

ADVARSEL

Lithiumbatteri - Eksplosjonsfare. Ved utskifting benyttes kun batteri som anbefalt av apparatfabrikanten. Brukt batteri returneres apparatleverandøren.

VARNING

Explosionsfara vid felaktigt batteribyte. Använd samma batterityp eller en ekvivalent typ som rekommenderas av apparattillverkaren. Kassera använt batteri enligt fabrikantens instruktion.

VAROITUS

Paristo voi räjähtää, jos se on virheellisesti asennettu. Vaihda paristo ainoastaan laitevalmistajan suosittelemaan tyyppiin. Hävitä käytetty paristo valmistajan ohjeiden mukaisesti.

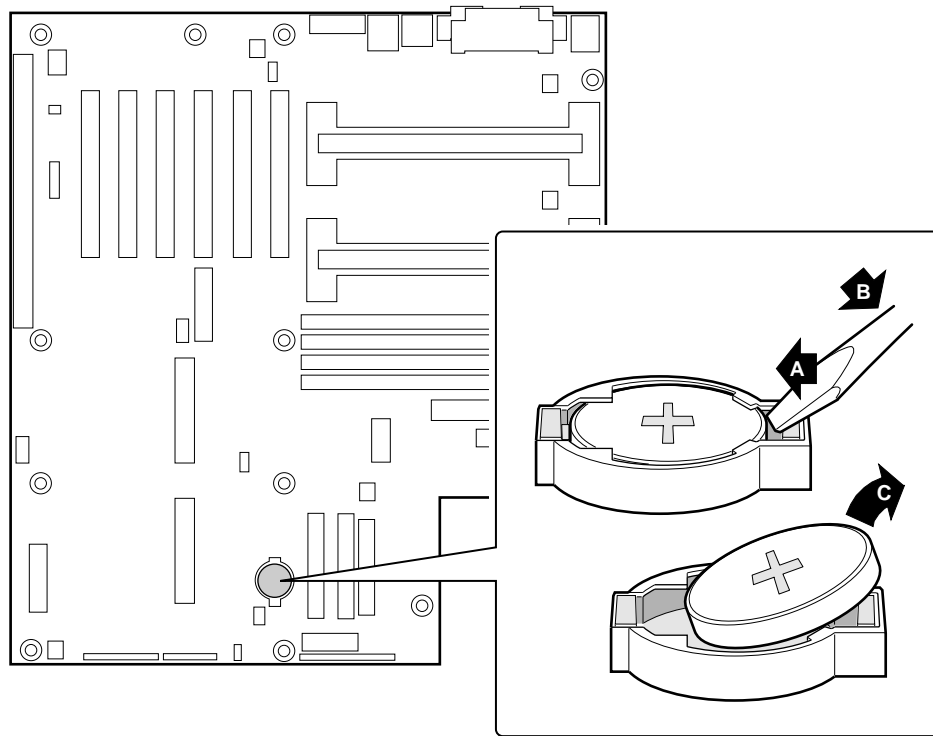

OM07843

Figure 34. Replacing the Lithium Battery

1. Observe the safety and ESD precautions at the beginning of this chapter.
2. Open the chassis.
3. Insert the tip of a small flat bladed screwdriver, or equivalent, under the tab in the plastic retainer.
4. Gently push down on the screwdriver to lift the battery.
5. Remove the battery from its socket.
6. Dispose of the battery according to local ordinance.
7. Remove the new lithium battery from its package, and, being careful to observe the correct polarity, insert it in the battery socket.
8. Reinstall the plastic retainer on the lithium battery socket.
9. Close the chassis.
10. Run the SSU to restore the configuration settings to the RTC.

3 Configuration Software and Utilities

This chapter describes the Power On Self Test (POST) and server configuration utilities. The table below briefly describes the utilities.

Table 4. Configuration Utilities

Utility	Description and brief procedure	Page
BIOS Setup	If the system does not have a diskette drive, or the drive is disabled or mis-configured, use Setup to enable it. Or, you can move the CMOS jumper on the server board from the default setting (Protect CMOS memory) to the Clear setting; this will allow most server configurations to boot. For the procedure to do this, see the section "CMOS Jumper" in Chapter 5 in this manual. Then run the SSU to configure the server.	53
System Setup Utility (SSU)	Use for extended system configuration of onboard resources and add-in boards, and for viewing the system event log, setting boot device priority, or setting system security options. The SSU may be run from either the Server Configuration CD or from a DOS-bootable diskette. Information entered via the SSU overrides information entered via BIOS Setup.	67
EMP Console	Use to access and monitor the server remotely.	79
FRUSDR Load Utility	Use to update the Field Replacement Unit (FRU), Sensor Data Record (SDR), and Desktop Management Interface (DMI) flash components.	92
BIOS Update Utility	Use to update the BIOS or recover from a corrupted BIOS update.	95
Firmware Update Utility	Use to update BMC and HSC flash ROM.	98
Using the Adaptec SCSI Utility	Use to configure or view the settings of the SCSI host adapters and onboard SCSI devices in the server.	99

Hot Keys

Use the keyboard's numeric pad to enter numbers and symbols.

Table 5. Hot Keys

To do this:	Press these keys
Clear memory and reload the operating system—this is a system reset.	<Ctrl+Alt+Del>
Secure your system immediately.	<Ctrl+Alt>+hotkey (Set your hot key combination with the SSU or Setup.)

Power On Self Test (POST)

Each time you turn on the system, POST starts running. POST checks the server board, processor, memory, keyboard, and most installed peripheral devices. During the memory test, POST displays the amount of memory that it is able to access and test. The length of time needed to test memory depends on the amount of memory installed. POST is stored in flash memory.

1. Turn on your video monitor and server. After a few seconds POST begins to run.
2. After the memory test, these screen prompts and messages appear until POST completes or until the user presses F2:

```
Press <F2> key if you want to run SETUP
```

```
Keyboard.....Detected
```

```
Mouse.....Detected
```

3. During peripheral device detection, the following message appears:

```
Press <Ctrl><A> to enter SCSI Utility
```

4. Press <Ctrl+A> if there are SCSI devices installed. When the utility opens, follow the displayed instructions to configure the onboard SCSI host adapter settings and to run the SCSI utilities. Also see “Using the Adaptec SCSI Utility” on page 99. If you do not enter the SCSI utility, the boot process continues.
5. Press <Esc> during POST to pop up a boot menu when POST finishes. From this menu you can choose the boot device or enter BIOS Setup.

After POST completes, the system beeps once.

What appears on the screen after this depends on whether you have an operating system loaded and if so, which one.

If the system halts before POST completes running, it emits a beep code indicating a fatal system error that requires immediate attention. If POST can display a message on the video display screen, it causes the speaker to beep twice as the message appears.

Note the screen display and write down the beep code you hear; this information is useful for your service representative. For a listing of beep codes and error messages that POST can generate, see the “Solving Problems” chapter in this manual.

Using BIOS Setup

This section describes the BIOS Setup options. Use Setup to change the server configuration. You can run Setup with or without an operating system being present. Setup stores most of the configuration values in battery backed CMOS; the rest of the values are stored in flash memory. The values take effect when you boot the server. POST uses these values to configure the hardware; if the values and the actual hardware do not agree, POST generates an error message. You must then run Setup to specify the correct configuration.

Run Setup: You may run Setup to modify such server board feature as:

- Select diskette drive
- Select parallel port
- Select serial port
- Set time/date (to be stored in RTC)
- Configure IDE hard drive
- Specify boot device sequence
- Enable SCSI BIOS
- View processor speed

Run SSU, not Setup: You must run the SSU instead of Setup to do the following:

- Add or remove any ISA board that is not Plug and Play-compatible
- Enter or change information about a board
- Alter server resources (such as interrupts, memory addresses, I/O assignments) to user selected choices instead of choices selected by the BIOS resource manager

Record Your Setup Settings

If the values ever need to be restored (after a CMOS clear, for example), you must run Setup again. Referring to the worksheets could make your task easier.

If You Cannot Access Setup

If the diskette drive is mis-configured so that you cannot access it to run a utility from a diskette, you may need to clear CMOS memory. You will need to open the server, change a jumper setting, use Setup to check and set diskette drive options, and change the jumper back. For a step-by-step procedure, see Chapter 5, under the heading, "CMOS Jumper."

Starting Setup

You can enter Setup after power on or reset by pressing F2. After booting, you will see the following prompt:

```
Press <F2> to enter SETUP
```

If CMOS/NVRAM has been corrupted, you will see other prompts:

```
Warning:  cmos checksum invalid
Error 0271:  check date and time settings
```

In this condition, the BIOS will load default values for CMOS and attempt to boot.

Setup Menus

To:	Press
Get general help	<F1> or <Alt+H>
Move between menus	← →
Go to the previous item	↑
Go to the next item	↓
Change the value of an item	+ or -, F5, F6, space
Select an item or display a submenu	<Enter> or <Alt+X>
Leave a submenu or exit Setup	<Esc>
Reset to Setup defaults	<F9>
Save and exit Setup	<F10>

When you see this:	What it means
On screen, an option is shown but you cannot select it or move to that field.	You cannot change or configure the option in that menu screen. Either the option is auto-configured or auto-detected, or you must use a different Setup screen, or you must use the SSU.
On screen, the phrase Press Enter appears next to the option.	Press <Enter> to display a submenu that is either a separate full screen menu or a popup menu with one or more choices.

The rest of this section lists the features that display onscreen after you press <F2> to enter Setup. Not all of the option choices are described, because (1) a few are not user selectable but are displayed for your information, and (2) many of the choices are relatively self explanatory.

Main Menu

You can make the following selections on the Main Menu itself. Use the submenus for other selections.

Feature	Choices	Description
System Time	HH:MM:SS	Sets the system time
System Date	MM/DD/YYYY	Sets the system date
Legacy Diskette A:	Disabled 360KB 1.2 MB 720KB 1.44/1.25 MB 2.88 MB	Selects the diskette type
Legacy Diskette B:	Disabled 360KB 1.2 MB 720KB 1.44/1.25 MB 2.88 MB	
Primary IDE Master		Enters submenu
Primary IDE Slave		Enters submenu
Secondary IDE Master		Enters submenu
Secondary IDE Slave		Enters submenu
Keyboard Features		Enters submenu
Processor Settings		Enters submenu
Language	English (US) Français Español Deutsch Italiano	Selects which language BIOS displays

Note: **Bold type** indicates the default choice.

Primary/Secondary IDE Master and Slave Submenu

Feature	Choices	Description
Type	Auto None CD-ROM IDE Removable ATAPI Removable User	Auto forces the server to attempt autodetection of the drive type. None informs the server to ignore this drive. CD ROM allows the manual entry of some fields described below. IDE Removable allows the manual entry of some fields described below. ATAPI Removable allows the manual entry of some fields described below. User allows the manual entry of all fields described below.
CHS Format		
Cylinders	0 to 65535	Number of Cylinders on Drive. This field is changeable only for Type User.
Heads	1 to 16	Number of read/write heads on drive. This field is available only for Type User.
Sectors	0 to 63	Number of sectors per track. This field is available only for Type User.
Maximum Capacity	N/A	Computed size of drive from cylinders, heads, and sectors entered. This field is informational only.
LBA Format		
Total Sectors	N/A	This field is informational only.
Maximum Capacity	N/A	This field is informational only.
Multi-Sector Transfer	Disabled 2, 4, 8, or 16 sectors	Determines the number of sectors per block for multi-sector transfers. This field is informational only for Type Auto.
LBA Mode Control	Disabled Enabled	Enabling LBA causes logical block addressing to be used in place of cylinders, heads, and sectors. This field is informational only for Type Auto.
32 Bit I/O	Disabled Enabled	Enabling allows 32 bit IDE data transfers.
Transfer Mode	Standard Fast PIO 1 Fast PIO 2 Fast PIO 3 Fast PIO 4 FPIO 3 / DMA 1 FPIO 4 / DMA 2	Selects the method for moving data to and from the drive. This field is informational only for Type Auto.
Ultra DMA Mode	Disabled Mode 0 Mode 1 Mode 2	Selects the Ultra DMA mode used for moving data to/from the drive.

Note: **Bold type** indicates the default choice.

Keyboard Submenu

Feature	Choices	Description
Num Lock	On Off	Selects the power on state for Num Lock.
Key Click	Disabled Enabled	Enables or disables the audible key click.
Keyboard auto-repeat rate	30/sec 26.7/sec 21.8/sec 18.5/sec 13.3/sec 10/sec 6/sec 2/sec	Sets the numbers of time per second a key will repeat while it is held down.
Keyboard auto-repeat delay	1/4 sec 1/2 sec 3/4 sec 1 sec	Sets the delay before a key starts to repeat when it is held down.

Note: **Bold type** indicates the default choice.

Processor Settings Submenu

Feature	Choices	Description
CPU Speed Setting	350 MHz 400 MHz 450 MHz 500 MHz 550 MHz 600 MHz 650 MHz 667 MHz 700 MHz	<p>Sets the speed for the installed processor(s). This feature is not active (that is, it is grayed out) if the CPU speed setting is locked.</p> <p> CAUTION</p> <p>Attempting to set this higher than the proper speed for the installed processor(s) may cause damage to the processor(s) or prevent the server from booting until a CMOS clear is performed.</p>
CPU POST Speed Settings	N/A	This field is informational only.
Processor Retest	Yes No	Yes tells BIOS to clear the historical processor status and retest all processors on the next boot. BIOS automatically resets to No in next boot.
Processor serial number	Enabled Disabled	Controls the detection of the processor's serial number.
Memory Cache	Enabled Disabled	Enables processor cache.
Processor 1 Stepping ID	N/A	This field is informational only.
Processor 1 L2 Cache Size	N/A	This field is informational only.
Processor 2 Stepping ID	N/A	This field is informational only.
Processor 2 L2 Cache Size	N/A	This field is informational only.

Note: **Bold type** indicates the default choice.

Advanced Menu

You can make the following selections on the Advanced Menu itself. Use the submenus for the three other selections that appear on the Advanced Menu.

Feature	Choices	Description
Installed OS	Other Plug-N-Play	Select Plug-N-Play if you are booting a Plug and Play capable operating system.
Reset Configuration Data	No Yes	Select Yes if you want to clear the server configuration data during next boot. System automatically resets to No in next boot.
PCI Configuration		Enters submenu.
Integrated Peripherals Configuration		Enters submenu.
Advanced Chipset Control		Enters submenu.
Use Multiprocessor Specification	1.1 1.4	Selects the version of multiprocessor specification to use. Some operating systems do not support version 1.4.
Large Disk Access Mode	CHS LBA	Select CHS if your OS is DOS. A large disk has more than 1024 cylinders, more than 16 heads, or more than 63 tracks per sector.
Delay on Option ROMs	Disabled Enabled	Forces a short delay at the end of each Option ROM scan.

Note: **Bold type** indicates the default choice.

PCI Configuration Submenu

The PCI Configuration Menu contains selections that access other submenus.

PCI Device, Embedded SCSI Submenu

Feature	Choices	Description
Option ROM Scan	Enabled Disabled	Enables option ROM scan of the onboard SCSI chip. There are 2 SCSI channels that are controlled by the same option ROM.
Enable Master	Enabled Disabled	Enabled selects the device as a PCI bus master.
Latency Timer	Default 0020h 0040h 0060h 0080h 00A0h 00C0h 00E0h	<p>Minimum guaranteed time, in units of PCI bus clocks, that a device may be master on a PCI bus.</p> <p> CAUTION</p> <p>Do not change this setting unless you fully understand the priority of this device on the PCI bus.</p>

Note: **Bold type** indicates the default choice.

PCI Device, Slot 1 - Slot 6 Submenus

Feature	Choices	Description
Enable Master	Enabled Disabled	Enables selected device as a PCI bus master.
Latency Timer	Default 020h 040h 060h 080h 0A0h 0C0h 0E0h	Minimum guaranteed time, in units of PCI bus clocks, that a device may be master on a PCI bus.  CAUTION Do not change this setting unless you fully understand the priority of this device on the PCI bus.

Note: **Bold type** indicates the default choice.

Integrated Peripheral Configuration Submenu

Feature	Choices	Description
COM 1	Disabled Enabled Auto OS Controlled	Auto forces BIOS to configure the port. OS Controlled forces the OS to configure the port.
Base I/O Address	3F8 2F8 3E8 2E8	Selects the base I/O address for COM1.
Interrupt	IRQ 3 IRQ 4	Selects the IRQ for COM1.
COM 2	Disabled Enabled Auto OS Controlled	Auto forces BIOS to configure the port. OS configures the port.
Base I/O Address	3F8 2F8 3E8 2E8	Selects the base I/O address for COM2.
Interrupt	IRQ 3 IRQ 4	Selects the IRQ for COM2.
Parallel Port	Disabled Enabled Auto OS Controlled	Auto forces BIOS to configure the port. OS configures the port.
Mode	Output only Bi-directional EPP ECP	Selects parallel port mode.
Base I/O Address	378 278	Selects the base I/O address for LPT port.

continued

Integrated Peripheral Configuration Submenu (continued)

Feature	Choices	Description
Interrupt	IRQ 5 IRQ 7	Selects the IRQ for LPT port.
DMA channel	DMA 1 DMA 3	Selects the DMA for LPT port (only used for ECP mode).
Floppy disk controller	Disabled Enabled	Enables onboard diskette controller.

Note: **Bold type** indicates the default choice.

Advanced Chipset Control

Feature	Choices	Description
640-768K Memory Region	Enabled Disabled	Enabled forwards ISA Master and DMA cycles to the PCI bus. Disabled forwards these cycles to memory.
Delayed Transaction	Enabled Disabled	Enables the delayed transaction mechanism when the PIIX4e is the target of a PCI transaction.
Passive Release	Enabled Disabled	Enables the passive release mechanism on the PHOLD# signal when the PIIX4 is a PCI Master.

Note: **Bold type** indicates the default choice.

Security Menu

You can make the following selections on the Security Menu itself. Enabling the Supervisor Password field requires a password for entering Setup. The passwords are not case-sensitive.

Feature	Choices	Description
User Password is	Clear Set	Status only; user cannot modify. Once set, this can be disabled by setting it to a null string, or by clearing password jumper on server board.
Supervisor Password is	Clear Set	Status only; user cannot modify.
Set User Password	Press Enter	When the <Enter> key is pressed, you are prompted for a password; press ESC key to abort. Once set, this can be cleared by setting it to a null string, or by clearing password jumper on server board (see Server Board Jumpers in Chapter 5).
Set Supervisor Password	Press Enter	When the <Enter> key is pressed, you are prompted for a password; press ESC key to abort. Once set, this can be cleared by setting it to a null string, or by clearing password jumper on server board (see Server Board Jumpers in Chapter 5).
Password on Boot	Disabled Enabled	Requires password entry before boot. System will remain in secure mode until password is entered. Password on Boot takes precedence over Secure Mode Boot.
Fixed Disk Boot Sector	Normal Write Protect	Write protects boot sector on hard disk to protect against viruses.
Secure Mode Timer	1 min 2 min 5 min 10 min 20 min 1 hr 2 hr	Period of key/PS/2 mouse inactivity specified for secure mode to activate. A password is required for secure mode to function. Cannot be enabled unless at least one password is enabled.
Secure Mode Hot Key (Ctrl-Alt-)	[0-9-] [A, B, ..., Z]	Key assigned to start the Quicklock feature. Cannot be enabled unless user password is enabled.
Secure Mode Boot	Disabled Enabled	System will boot in secure mode. You must enter a password to unlock the system. Cannot be enabled unless user password is enabled.
Video Blanking	Disabled Enabled	Blank video when secure mode is activated. You must enter a password to unlock the system. Cannot be enabled unless user password is enabled.
Floppy Write Protect	Disabled Enabled	When secure mode is activated, the diskette drive is write protected. You must enter a password to disable. Cannot be enabled unless user password is enabled.
Front Panel Lockout	Disabled Enabled	When secure mode is activated, the reset and power switches are locked. You must enter a password to unlock the system. Cannot be enabled unless user password is enabled.

Note: **Bold type** indicates the default choice.

Server Menu

You can make the following selections on the Server Menu itself.

Feature	Choices	Description
System Management		Enters submenu.
Console Redirection		Enters submenu.
PEP Management		Enters submenu.
Enable Sleep Button	Disabled Enabled	Enables optional ACPI support for the sleep button.
PCI IRQs to IO-APIC mappings	Disabled Enabled	Enabled - BIOS can describe all 24 IO APIC pins in the MP table for PCI interrupts. Not all MP operating systems and drivers can understand this description of the interrupts in the MP table. Disabled - BIOS will only use 16 IO APIC pins in the MP table for PCI interrupts. All PCI interrupts are routed to a standard ISA IRQ pins on IO APIC. All operating systems will work with standard ISA IRQ entries.
Processor Retest	Yes No	Yes tells BIOS to clear the historical processor status and retest all processors on the next boot. BIOS automatically resets to No in next boot.
Assert NMI on SERR	Disabled Enabled	Enabled generates an NMI on SERR.

Note: **Bold type** indicates the default choice.

System Management Submenu

Feature	Choices	Description
Server Management Info		Enters submenu.
System Event Logging	Disabled Enabled	When enabled, system events will be logged by BIOS and BMC in system event log.
Clear Event Log	No Yes	Yes clears the system event log (SEL) in BMC. BIOS automatically resets to NO for next boot.
EMP Password switch	Disabled Enabled	Sets the EMP password.
EMP Password	[A..Z, 0..9]	This field only shows up when the EMP password switch is enabled. Entering a password and pressing return will send the password immediately to the BMC. If a beep is heard the password was not accepted. If no password is entered, anyone has access to the server through the EMP Console.
EMP Escape sequence	+++	Sets the escape sequence for the modem being used for EMP. This will force the modem to command mode. This is only used if the EMP direct connect/modem mode is set to modem.

continued

System Management Submenu (continued)

Feature	Choices	Description
EMP Hang-up Line String	ATH	Sets the Hang-up Line Sequence for the modem being used for EMP. Used in EMP modem mode.
Modem Init String	AT&F0S0=1S14=0&D	Sets the initialization string for the modem being used for EMP. Used in EMP modem mode. This field is only 16 characters long. The High Modem Init String field is a continuation of the Modem Init string so you can enter in another 4 characters.
High Modem Init String	0	This is a continuation of the Modem Init String. When 16 characters are typed into the Modem Init String field, this field will appear to allow another 4 characters to be typed in.
EMP Access Mode	Pre-boot Only Always Active Disabled	Pre-boot Only - EMP is only enabled during power down through end of POST. COM2 is returned to system use at the end of Post when operating system boots. Always Active - EMP is always enabled. COM2 cannot be used by operating system. It is now dedicated for EMP use. Disabled - EMP is disabled. COM2 is always available for system use by console redirection or operating system.
EMP Restricted Mode Access	Disabled Enabled	If set to Enabled, Power on/off and Reset server controls via EMP are no longer available.
EMP Direct Connect/Modem Mode	Direct Connect Modem Mode	Sets how EMP connects to the server. Direct Connect means a null modem serial cable directly connects COM2 connector port to the EMP console machine. Modem mode indicates that a modem is connected on COM2 for EMP use.

Note: **Bold type** indicates the default choice.

Server Management Information Submenu

Items on this menu are set when the server board is manufactured and cannot normally be changed. The last two items refer to the firmware level of the BMC on the server board and HSC (Hot Swap Controller) from the Astor II server chassis. If circumstances require a change in the LB440GX server board's firmware, specific direction will be provided by Intel Customer Support.

Feature	Choices	Description
Board Part Number	N/A	Information field only
Board Serial Number	N/A	Information field only
System Part Number	N/A	Information field only
System Serial Number	N/A	Information field only
Chassis Part Number	N/A	Information field only
Chassis Serial Number	N/A	Information field only
BMC Revision	N/A	Information field only
Primary HSBP Revision	N/A	Information field only

Note: **Bold type** indicates the default choice.

Console Redirection Submenu

Feature	Choices	Description
COM Port Address	Disabled 3F8 2F8 3E8	When enabled, console redirection uses the I/O port specified. 3F8 - typically is COM1 2F8 - typically is COM2 All keyboard/mouse and video will be directed to this port. This is designed to be used only under DOS in text mode.
IRQ #	N/A	This field is informational only.
Baud Rate	9600 19.2k 38.4k 115.2k	When console redirection is enabled, specifies the baud rate to be used.
Flow Control	No Flow Control CTS/RTS XON/XOFF CTS/RTS + CD	None disallows flow control. CTS/RTS is hardware-flow control. XON/XOFF is software-flow control. CTS/RTS +CD is hardware plus carrier-detect flow control.

Note: **Bold type** indicates the default choice.

PEP Management Submenu

Verify in BIOS Setup of your server board whether or not your system BIOS includes PEP. If not, when it becomes available, you can download it from the Intel Customer Support web site:

<http://support.intel.com/support/motherboards/server/LB440gx>

Feature	Choices	Description
PEP Filter Events		Enters submenu.
PEP Enable	Disable Enable	Enables Platform Event Paging.
PEP Blackout Period	[0...9]	Sets the amount of time between pages in minutes. Valid range is from 0 to 255. A value of 0 indicates no blackout period.
PEP Page String		Sets the string used to page you. Generally this is the attention command for your modem, followed by the number of your paging service, followed by the message you want to appear on your pager, followed by a modem hang-up command. Use commas for 1second pauses. This field is only 16 characters long. The 17-32, 33-48, and 49-64 fields are a continuation of the PEP Page String Field so you can enter in another 48 characters for 64 characters total.
17-32		This is a continuation of the PEP Page String Field. When 16 characters are typed into the Modem Init String field, this field will appear to allow another 16 characters to be typed in.
33-48		This is a continuation of the PEP Page String Field. When 16 characters are typed into the Block #2 field, this field will appear to allow another 16 characters to be typed in.
49-64		This is a continuation of the PEP Page String Field. When 16 characters are typed into the Block #3 field, this field will appear to allow another 16 characters to be typed in.
Send Test Page	Press Enter Send Test Page Now	To send a test page, select "Send Test Page Now" from the popup menu.

Note: **Bold type** indicates the default choice.

PEP Filter Submenu

This submenu allows you to set which events or error conditions cause the system to page you.

Feature	Choices	Description
PEF Enable	Disable Enable	Enables the Platform Event Filtering. If this is enabled, and one of the events you enable below occurs, the server will page you using the Page String information.
Temperature Sensor	Disable Enable	Temperature out of range notification.
Voltage Sensor	Disable Enable	Voltage out of range notification.
Fan Sensor	Disable Enable	Fan failure notification.
Chassis Sensor	Disable Enable	Chassis intrusion notification.
Power Supply Sensor	Disable Enable	Power supply fault notification.
BIOS (SMI Handler)	Disable Enable	Uncorrectable ECC memory error notification.
BIOS POST Error	Disable Enable	POST error code notification.
FRB Sensor	Disable Enable	FRB failure notification.
Fatal NMI	Disable Enable	Fatal NMI notification.
Watchdog Timer Reset	Disable Enable	Watchdog timer reset/power down/power cycle notification.
System Restart	Disable Enable	System reboot notification.

Note: **Bold type** indicates the default choice.

Boot Menu

You can make the following selections on the Boot Menu itself.

Feature	Choices	Description
Boot-time Diagnostic Screen	Disabled Enabled	Enables or disables the diagnostic screen during system boot operations. This screen is alphanumeric text that displays on the monitor during a boot operation to report status about such things as the boot memory test, the number & type of processors, and the disk drives in the system. When it is disabled, an image is displayed with a bar across the top of the screen to indicate boot progress instead of the detailed status information.

continued

Boot Menu (continued)

Feature	Choices	Description
Extended RAM Step	1 MB 1 KB Every location No memory test	Sets extended memory test to verify once every KB, every MB, every location, or not at all (no test).
BIOS Boot Spec Support	Limited Disabled	The limited choice may be required if more than eight drives are installed in certain configurations.
Boot Device Priority		Enters submenu.
Hard Drive		Enters submenu.
Removable Devices		Enters submenu.

Note: **Bold type** indicates the default choice.

Boot Device Priority

Use the up or down arrow keys to select a device; then press the <+> or <-> keys to move the device higher or lower in the boot priority list.

Boot Priority	Device	Description
1.	Removable Devices	Attempts to boot from a removable media device.
2.	Diskette Drive	Attempts to boot from a diskette drive.
3.	Hard Drive	Attempts to boot from a hard drive device.
4.	ATAPI CD-ROM Drive	Attempts to boot from an ATAPI CD-ROM drive.
5.	LANDesk (R) Service Agent II	Attempts to boot from the local area network.

Hard Drive

For options on this menu, use the up or down arrow keys to select a device; then press the <+> or <-> keys to move the device higher or lower in the boot priority list.

Option	Description
1. Hard Drive #1 (or actual drive string)	IDE drives will have a suffix attached to the drive ID string. PM - hard drive on Primary Master Channel PS - hard drive on Primary Slave Channel SM - hard drive on Secondary Master Channel SS - hard drive on Secondary Slave Channel SCSI CD-ROMs will be displayed here because the onboard SCSI BIOS treats CD-ROMs as hard drives. SCSI ZIP or removable drives will also appear here. Removable IDE ZIP drives will only show up if the removable media is formatted as a hard drive.
2. Other Bootable Device	Covers all the boot devices that are not reported to the system BIOS through the BIOS boot specification mechanism. This includes all PCI cards that are not BIOS boot compliant (legacy) as well as ISA cards that are not PnP compliant. ISA legacy cards will boot first before non BIOS boot compliant PCI cards (in scan order from lowest slot to highest).

Removable Devices

For options on this menu, use the up or down arrow keys to select a device, then press the <+> or <-> keys to move the device higher or lower in the boot priority list.

Option	Description
1. Legacy Floppy Drive	Refers to the onboard 3.5" floppy drive. Removable IDE media may also show up here if the removable media was formatted in floppy emulation.

Exit Menu

You can make the following selections on the Exit Menu. Select an option using the up or down arrow keys; then press <Enter> to execute the option. Pressing <Esc> does not exit this menu. You must select one of the items from the menu or menu bar to exit.

Choices	Description
Exit Saving Changes	Exits after writing all modified Setup item values to NVRAM.
Exit Discarding Changes	Exits leaving NVRAM unmodified.
Load Setup Defaults	Loads values of all Setup items from previously saved custom defaults.
Load Custom Defaults	Loads default values for all Setup items.
Save Custom Defaults	Saves present Setup values to custom defaults.
Discard Changes	Reads previous values of all Setup items from NVRAM.
Save Changes	Writes all Setup item values to NVRAM.

Using the System Setup Utility

The SSU provides a graphical user interface (GUI) over an extensible framework for server configuration. For the ISP2150 system, the SSU framework supports the following functions and capabilities:

- assigns resources to baseboard devices and add-in cards prior to loading the operating system (OS)
- allows you to specify boot device order and system security options
- permits viewing and clearing of the system's system event log
- allows troubleshooting of the server when the OS is not operational
- provides a system level view of the server's I/O devices

When to Run the System Setup Utility

The SSU is a DOS-based utility that supports extended system configuration operations for onboard resources and add-in boards. You can also view the system event log and to set system boot and security options. Use the SSU when you need to:

- add and remove boards affecting the assignment of resources (ports, memory, IRQs, DMA)
- modify the server's boot device order or security settings
- change the server configuration settings
- save the server configuration
- view or clear the system event log

If you install or remove an ISA add-in board, you must run the SSU to reconfigure the server. Running the SSU is optional for PCI and Plug and Play ISA add-in boards.

The SSU is PCI aware, and it complies with the ISA Plug and Play specifications. The SSU works with any compliant configuration (.CFG) files supplied by the peripheral device manufacturer.

The I/O baseboard comes with a .CFG file. The .CFG file describes the characteristics of the board and the system resources that it requires. The configuration registers on PCI and ISA Plug and Play add-in boards contain the same type of information that is in a .CFG file. Some ISA boards also come with a .CFG file.

The SSU uses the information provided by .CFG files, configuration registers, FLASH, and the information that you enter, to specify a system configuration. The SSU writes the configuration information to flash memory.

The SSU stores configuration values in FLASH memory. These values take effect when you boot the server. POST checks the values against the actual hardware configuration; if they do not agree, POST generates an error message. You must then run the SSU to specify the correct configuration before the server boots.

The SSU always includes a checksum with the configuration data so the BIOS can detect any potential data corruption before the actual hardware configuration takes place.

What You Need to Do

The SSU may be run directly from the Server Resource CD by booting the server system to the CD and selecting "Utilities" or from a set of DOS diskettes.

If you choose to run the SSU from a set of DOS diskettes, you must create the SSU diskettes from the Server Resource CD by booting to the CD and selecting "Create Diskettes." Alternatively, if you have a Windows 98 or Windows NT workstation, you can insert the CD into that system and create diskettes from the "Utilities" menu of the graphical user interface.

If your diskette drive is disabled, or improperly configured, you must use the flash resident Setup utility to enable it so that you can use the SSU. If necessary, you can disable the drive after you exit the SSU. Information entered using the SSU overrides any entered using Setup.

Running the SSU

- **Running the SSU Locally**

Running the ssu.bat file provided on the SSU media starts the SSU. If the server boots directly from the SSU media, the ssu.bat file is automatically run. If it boots from a different media, the SSU can be started manually or by another application. When the SSU starts in the local execution mode (the default mode), the SSU accepts input from the keyboard and/or mouse. The SSU presents a VGA based Graphical User Interface (GUI) on the primary monitor.

The SSU runs from writable, non-writable, removable, and non-removable media. If the SSU is run from non-writable media, user preference settings (such as screen colors) can not be saved.

The SSU supports the ROM-DOS V6.22 operating system. It may run on other ROM-DOS-compatible operating systems but they are not supported. The SSU will not operate from a “DOS box” running under an operating system such as Windows.

- **Running the SSU Remotely**

Running the SSU remotely requires a remote server with a LANDesk Server Monitor Module 2 (SMM2) card and a local system with Remote Control software available.

The SMM2 card provides video memory, keyboard, and mouse redirection support for the remote server. The Remote Control console of the local system displays and sends video memory and user input to the remote server through either a modem or an Ethernet link.

Because the SSU runs exclusively on the remote server, any files required for the SSU to run must be available on the remote server (on removable or non-removable media).

If you connect the local system to the remote server through a network or modem you can see the console, control the mouse, and control the keyboard of the remote server.

Starting the SSU

SSU consists of a collection of task oriented modules plugged into a common framework called the Application Framework (AF). The Application Framework provides a launching point for individual tasks and a location for setting customization information. For full functionality the SSU requires the availability of the AF.INI, AF.HLP, plus any .ADN files and their associated .HLP and .INI files.

1. Turn on your video monitor and your system.
2. There are two ways to start the SSU.
 - a. **After creating set of three SSU diskettes from the CD:** Insert the first SSU diskette in drive A, and <Ctrl+Alt+Del> to reboot your server from the diskette.
 - b. **Directly from the Server Resource CD:** Insert the Server Resource CD into your CD ROM drive and press <Ctrl-Alt-Del> to reboot. When prompted to do so, press <F2> to enter BIOS Setup. From the Boot Menu, select the Boot Device Priority option and then select CD-ROM as your primary boot device. Save those settings and exit BIOS Setup. The server will boot from the CD-ROM and display a menu of options. Follow the instructions in the menu to start the SSU.
3. When the SSU title appears on the screen, press <Enter> to continue.
4. The mouse driver loads if it is available, press <Enter> to continue.

5. This message appears:
Please wait while the Application Framework loads....
6. When the main window of the SSU appears, you can customize the user interface before continuing.

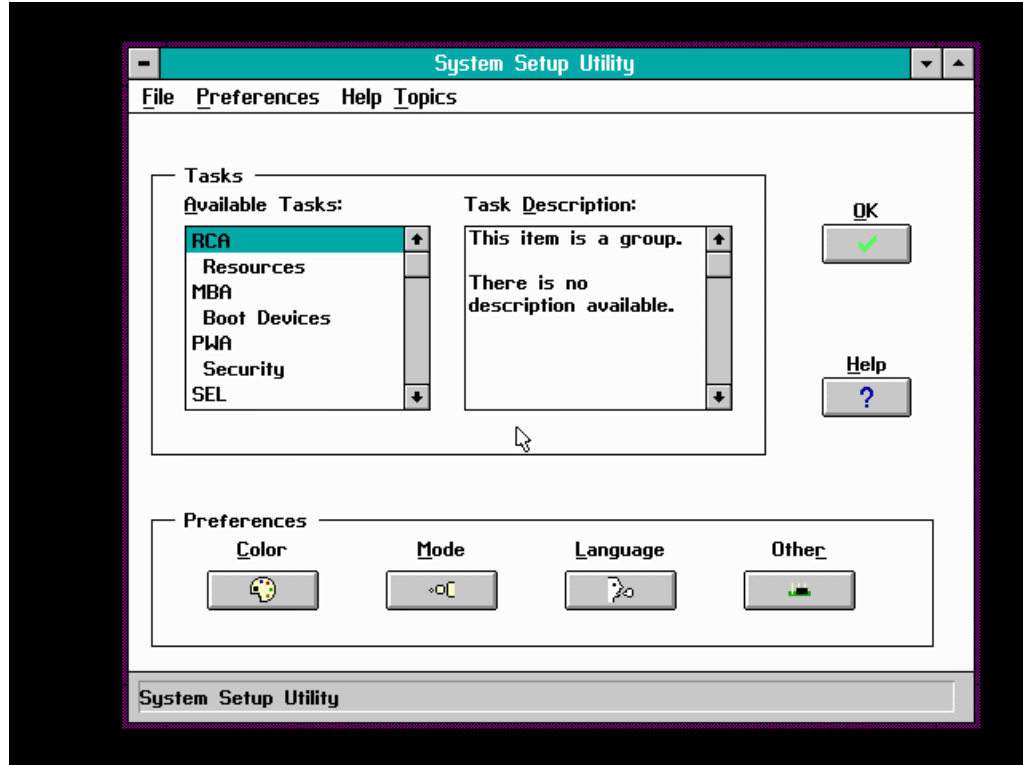

Figure 35. System Setup Utility Main Window

Customizing the SSU

The SSU lets you customize the user interface according to your preferences. The AF sets these preferences and saves them in the AF.INI file so that they take effect the next time you start the SSU. There are four user customizable settings:

- **Color** - this button lets you change the default colors associated with different items on the screen with predefined color combinations. The color changes are instantaneous.
- **Mode** - this button lets you set the desired expertise level.
 - novice
 - intermediate
 - expert

The expertise level determines which tasks are visible in the Available Tasks section and what actions each task performs. For a new mode setting to take effect, you must exit the SSU and restart it.

- **Language** - this button lets you change the strings in the SSU to strings of the appropriate language. For a new language setting to take effect, you must exit the SSU and restart it.
- **Other** - this button lets you change other miscellaneous options in the SSU. The changes take effect immediately.

To change the interface default values:

Use the mouse to click on the proper button in the Preferences section of the SSU Main window.

or

Use the tab and arrow keys to highlight the desired button, and press the spacebar or <Enter>.

or

Access the menu bar with the mouse or hot keys (Alt + underlined letter).

⇒ NOTE

If you run the SSU from non-writable media (like a CD-ROM), these preferences will be lost when you exit the SSU.

Launching a Task

It is possible to have many tasks open at the same time, although some tasks may require complete control to avoid possible conflicts. The tasks achieve complete control by keeping the task as the center of operation until you close the task window.

To launch a task:

In the SSU Main window, double click on the task name under Available Tasks to display the main window for the selected task.

or

Highlight the task name, and click on OK.

or

Use the tab and arrow keys to highlight the desired button, and press the spacebar or <Enter>.

Resource Configuration Add-in (RCA) Window

The RCA provides three major functions:

- Creates representations of devices that cannot be discovered by the system (ISA cards)
- Modifies the contents of the system by adding and removing devices
- Modifies the resources used by devices

You can use the RCA window to define an ISA card or add an ISA card by clicking on the appropriate button. Removing an ISA card requires that the card be highlighted in the Devices section of the screen before clicking on the button. You can only add as many ISA cards as you have ISA slots available.

1. From the SSU main window, launch the RCA by selecting the “Resources” task under the RCA heading in the task box.
2. When the RCA window appears, it displays messages similar to the following:

```
Baseboard:  Server board Server board
PCI Card:  Bus 00 dev 00 -- Host Processor Bridge
PCI Card:  Bus 00 dev 0D -- Multifunction Controller
PCI Card:  Bus 00 dev 0F -- Ethernet Controller
PCI Card:  Bus 00 dev 12 -- Multifunction Controller
PCI Card:  Bus 00 dev 14 -- VGA Controller
```

3. To configure a device, select its name in the Devices section of the RCA window, and press the spacebar or <Enter>, or click on it.
4. It is possible to close the RCA window and return to the AF by clicking on the Close button. Any changes made will be kept in memory for use by the RCA when it is rerun.
5. Save all the changes made by clicking on the Save button. Saving writes your current configuration to nonvolatile storage where it will be available to the system after every reboot.
6. Closing the window by clicking on the system menu, the dash in the upper left corner, discards all changes.

Defining an ISA Card

An ISA card usually comes with a vendor created .CFG file that specifies the resources the card requires to function properly. If the .CFG file is unavailable, you must manually create it or define the card through the SSU. Defining an ISA card consists of specifying the name of the card and the resources it consumes. This allows the RCA to consider the ISA card resource requirements when the RCA tries to resolve conflicts. The information is also used by the system BIOS to configure the hardware when the system is booted.

1. To add or remove ISA card resources, click on the appropriate resource buttons, select the desired value, and click on Add or Remove.
2. After you complete the necessary information, click on Save.
3. To edit a card, click on Load to retrieve the card information. After making changes, click on Save.
4. To create a card, click on New.
5. To remove a current definition of a card, click on Delete.

Adding and Removing ISA Cards

Adding and removing cards through the RCA provides a way for the RCA to run its conflict detection algorithms on the resources requested by the cards. This alerts you to any possible problems with that particular card in the current configuration.

- **To add an ISA card:**
 1. Click on Add ISA Card in the RCA window.
 2. Specify the directory for the .CFG file.
 3. Select the file and click on Ok.
- **To remove an ISA card:**
 1. Select a valid ISA card in the Devices section of the RCA window.
 2. Click on Remove ISA Card.

Modifying Resources

Modifying the resources of a device may be necessary to accommodate certain operating systems, applications, and drivers. It may also be necessary to modify resources to resolve a conflict.

- **To modify the resources associated with a device:**
 1. Highlight the device in the Devices section of the RCA window.
 2. Press the spacebar or <Enter>, or double click on the entry.
This displays the functions of the selected device along with possible choices and the resources associated with those choices.
- **To make a modification:**
 1. Highlight the function in the Configuration window.
 2. Press the spacebar or <Enter>, or double click on the entry (this updates the Choice and resource lists).
 3. Press the tab key to get to the Choice list, and press <Enter>.
 4. Use the arrow keys to select a proper choice, and press <Enter> again.
 5. If the choice allows multiple possible values for a particular resource, use the hot key to select a resource, and press the spacebar or double click on the resource.
 6. Select the desired resource, and click on Ok.

System Resource Usage

Clicking on the Resource Use button in the Configuration window displays the System Resource Usage window. This window shows what resources each device is consuming. This information is useful for choosing resources if a conflict occurs. Devices can be organized according to the resources you want to examine using the options in the Resource section of the screen. The resource information can also be written to a plain text file through this window.

Multiboot Options Add-in

Under this window you can change the boot priority of a device.

1. Select a device.
2. Press the + button to move it up in the list. Press the - button to move it down.

Security Add-in

Under this window, you can set the User and Administrator passwords, and security options.

To Set the User Password

1. Click on the user password button.
2. Enter the password in the first field.
3. Confirm the password by entering it again in the second field.

To Change or Clear the User Password

1. Click on the User password button.
2. Enter the old password in the first field.
3. Enter the new password in the second field (or leave blank to clear).
4. Confirm the password by entering it again in the second field (or leave blank to clear).

To Set the Administrator Password

1. Click on the Administrator password button.
2. Enter the password in the first field.
3. Confirm the password by entering it again in the second field.

To Change or Clear the Administrator Password

1. Click on the Administrator password button.
2. Enter the old password in the first field.
3. Enter the new password in the second field (or leave blank to clear).
4. Confirm the password by entering it again in the second field (or leave blank to clear).

Security Options

Under this window, you can set the other security options:

- **Hot Key** - Set a key sequence that, when pressed, will drop the server into secure mode.
- **Lock-Out Timer** - Set an interval that, if no activity takes place during it, will drop the server into secure mode.
- **Secure Boot Mode** - Force the server to boot directly into secure mode.
- **Video Blanking** - Turn off the video when the server is in secure mode.
- **Floppy Write** - Control access to the diskette drive while the server is in secure mode.
- **Reset/Power Switch Locking** - Control the power and reset buttons while the server is in secure mode.

SEL Manager Add-in

Clicking on the SEL Manager Add-in task brings up the Server Event Log (SEL) viewer. You can load and view the current SEL data stored in the BMC, save the currently loaded SEL data to a file, view previously saved SEL data, or clear the SEL. The SEL Viewer has the following menus:

File

The File menu has the following options:

- **Load SEL...** View data from a previously saved SEL file.
- **Save SEL...** Save the currently loaded SEL data to a file.
- **Clear SEL** Clears the SEL data from the BMC.
- **Exit** Quits the SEL Viewer.

View

The View menu has the following options:

- **SEL Info** Displays information about the SEL. These fields are display only.
- **All Events** Displays the current SEL data from the BMC.
- **By Sensor** Brings up a pop-up menu that allows you to view only the data from a certain sensor type.
- **By Event** Brings up a pop-up menu that allows you to view only the data from a certain event type.

Settings

The Settings menu has the following options:

- **Display HEX/Verbose** Toggles between the Hex/interpreted mode of displaying the SEL records.
- **Output Text/Binary** Determines whether SEL data will be saved to the file (as under File - Save) in binary format or verbose format.

Help

The Help menu has the following option:

- **About** Displays the SEL Viewer version information.

FRU Manager Add-in

Clicking on the FRU Manager Add-in task brings up the Field Replaceable Unit (FRU) viewer. You can load and view the current FRU data stored in the BMC, save the currently loaded FRU data to a file, view previously saved FRU data. The FRU Viewer has the following menus:

File

The File menu has the following options:

- **Load...** View data from a previously saved FRU file.
- **Save...** Saves the currently loaded FRU data to a file.
- **Save As...** Saves the currently loaded FRU data to a file.
- **Exit** Quits the FRU Viewer.

View

The View menu has the following options:

- **FRU Info** Displays information about the FRU. These fields are display only.
- **All FRU Areas** Displays the current FRU data from the BMC.
- **By Device Type** Brings up a pop-up menu that allows you to view only the data from a certain device type.

Settings

The Settings menu has the following options:

- **Display HEX/Verbose** Toggles between the Hex/interpreted mode of displaying the FRU records.
- **Output Text/Binary** Determines whether FRU data will be saved to the file (as under File - Save) in binary format or verbose format.

Help

The Help menu has the following option:

- **About** Displays the FRU Viewer version information.

SDR Manager Add-in

Clicking on the SDR Manager Add-in task brings up the Sensor Data Record (SDR) viewer. You can load and view the current SDR data stored in the BMC, save the currently loaded SDR data to a file, view previously saved SDR data. The SDR Viewer has the following menus:

File

The File menu has the following options:

- **Load...** View data from a previously saved SDR file.
- **Save...** Saves the currently loaded SDR data to a file.
- **Save As...** Saves the currently loaded SDR data to a file.
- **Exit** Quits the SDR Viewer.

View

The View menu has the following options:

- **SDR Info** Displays information about the SDR. These fields are display only.
- **All Records** Displays the current SDR data from the BMC.
- **By Record Type** Brings up a pop-up menu that allows you to view only the data from a certain record type.

Settings

The Settings menu has the following options:

- **Display HEX/Verbose** Toggles between the Hex/interpreted mode of displaying the SDR records.
- **Output Text/Binary** Determines whether SDR data will be saved to the file (as under File - Save) in binary format or verbose format.

Help

The Help menu has the following option:

- **About** Displays the SDR Viewer version information.

Exiting the SSU

Exiting the SSU causes all windows to close.

1. Exit the SSU by opening the menu bar item **F**ile in the SSU Main window.
2. Click on Exit.

or

Highlight Exit, and press <Enter>.

Platform Event Paging

With Platform Event Paging (PEP), your server can be configured to automatically dial up a paging service and page you when a server management related event occurs. Platform events include temperature out-of-range, voltage out-of-range, chassis intrusion, and fan failure.

If PEP is enabled and the BMC receives or detects a new event, it automatically sends a page. It can send a page if the processors are down or if the system software is unavailable.

PEP needs an external modem connected to the server's EMP (Emergency Management Port) serial connection. This is typically the COM2 serial connector.

Verify in BIOS Setup of your server board whether or not your system BIOS includes PEP. If not you can download it from the Intel Customer Support website when it becomes available.

<http://support.intel.com/support/motherboards/server/LB440gx>

Using Platform Event Paging

1. Enter Setup.
2. Enter the PEP Management submenu from the Server Menu.
3. Set the PEP Enable field to Enable.
4. Enter your page string in the PEP Page String field. This consists of the attention command for you modem (generally ATDT), the number of your paging service, several commas (each comma is a 1 second pause), the number/message you wish to appear on your pager, and the hang-up command for your modem (generally ATH). You will need to experiment with the timing to ensure you are paged properly. Set the Send Test Page field to Send Test Page Now to generate a test page.
5. If you wish to filter events so that only certain events will originate a page, enter the PEP Filter submenu.
 - a. Set the PEF Enable field to Enable.
 - b. Enable all of the events about which you want to be paged.
 - c. Escape out of the PEP Filter submenu.
6. Set the time between pages with the Page Blackout Field. If you want to wait five minutes between pages, set it to 5. The range is from 0 to 255 minutes.
7. Exit BIOS Setup.

Emergency Management Port Console

The Emergency Management Port (EMP) Console is a software application designed to run on a Windows 98 or Windows NT 4.0 workstation and provides a server administrator's interface to the Emergency Management Port (EMP) of the ISP2150 server. This interface allows remote server management via a modem or direct connection.

The server control operations available with EMP Console are:

- Connecting to remote servers
- Powering the server on or off
- Resetting the server

The EMP Console uses three management plug-ins to monitor the server:

- SEL Viewer
- SDR Viewer
- FRU Viewer

The EMP Console also has Phonebook plug-in that can be used to create and maintain a list of servers and their phone numbers.

How EMP Console Works

The EMP shares use of the COM2 port with the system on the server. When the EMP has control of the port, the port operates in command mode. When the system has control, the port operates in console redirect mode. When connecting to a server, the EMP Console checks to determine the mode of the COM2 port. The following discussion covers how EMP Console functions in each mode:

- *Command mode* is the default COM2 state. In this state, EMP Console communicates with the server's firmware, allowing the client to remotely reset or power the server up or down. The client can also view the server's System Event Log (SEL), Field Replaceable Unit (FRU) information, or Sensor Data Record (SDR) table.
- In *console redirect mode*, EMP Console serves as a PC ANSI terminal window for BIOS console redirection. Commands typed in this terminal window are transmitted through BIOS to the server's console, and text displayed on the server console is displayed on the EMP Console's terminal window. In this mode, you can remotely view boot messages, access BIOS setup, and run DOS text mode applications through the EMP Console's terminal window.

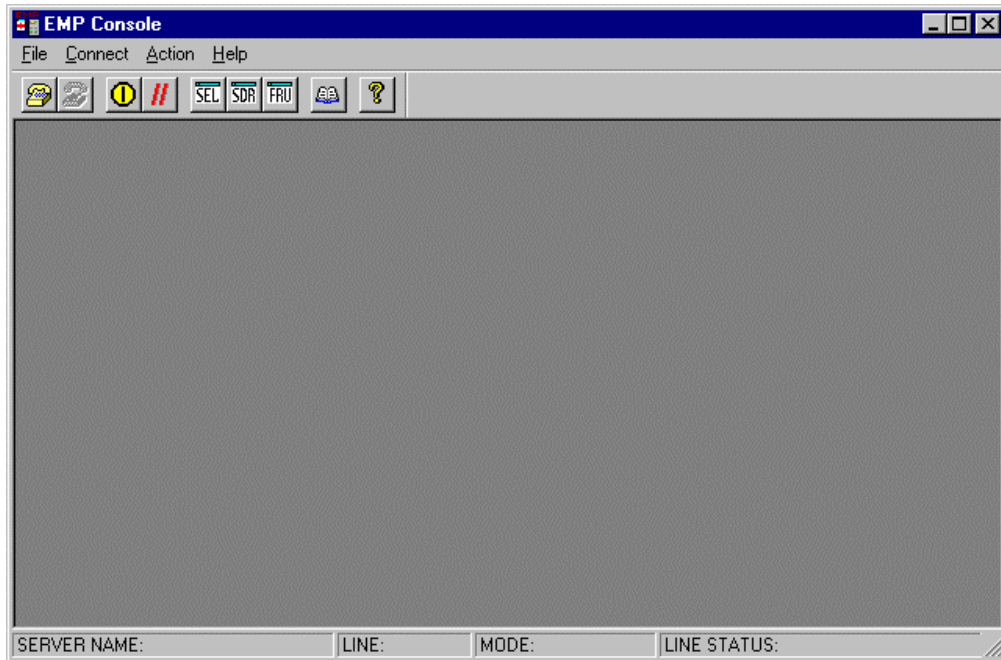

Figure 36. EMP Console in Command State

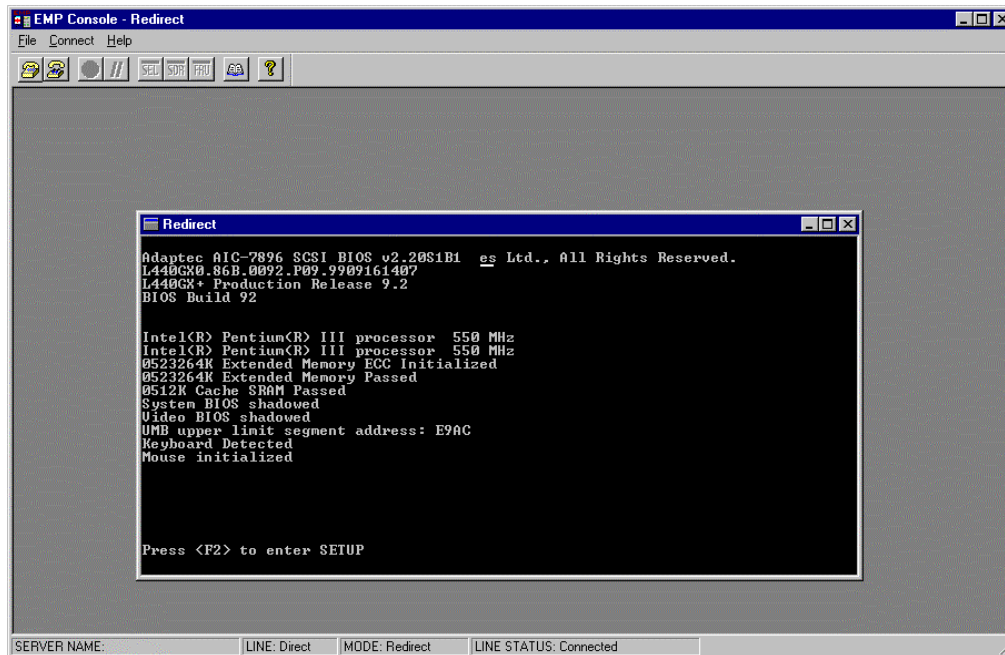

Figure 37. EMP Console in Redirect State

Figure 37 shows EMP Console window in redirect mode with the terminal window. The text that appears on the server monitor displays in the Redirect window.

Availability of the various EMP Console features are determined by two factors: the BIOS EMP access mode and if the server's COM2 port is configured for console redirection. The three EMP access modes are disabled, pre-boot, and always active.

Table 6. EMP Console Access Modes (Server configured for console redirection)

Mode	Server is powered off	During BIOS POST	After OS boots
Disabled	Redirect window appears, but is blank	Redirect window	Redirect window
Pre-boot	EMP commands available	Redirect window*	Redirect window
Always Active	EMP commands available	Redirect window*	EMP commands available

* The operation mode can be modified by selections in the Reset and Power on/off dialogs. These are server control dialogs available in EMP Console.

Table 7. EMP Console Access Modes (Server not configured for console redirection)

Mode	Server is powered off	During BIOS POST	After OS boots
Disabled	Redirect window appears, but is blank	Redirect window appears, but is blank	Redirect window appears, but is blank
Pre-boot	EMP commands available	EMP commands available	Redirect window appears, but is blank
Always Active	EMP commands available	EMP commands available	EMP commands available

Requirements

This section outlines the requirements and configurations necessary for using EMP Console.

Operating Systems:

- Windows 98
 - 16 MB of RAM, 32 MB recommended
 - 20 MB disk space
- Windows NT
 - Windows NT 4.0
 - 24 MB of RAM, 32 MB recommended
 - 20 MB disk space

Client Configuration: EMP Console supports all COM ports on the client system, along with any Windows NT/98 compatible modem.

Server Configuration: EMP Console requires the server's COM2 port to be connected to an external modem or directly connected to a serial cable.

Direct Connect Configuration: A null modem serial cable is needed. Connect one end of the cable to the COM2 port of server and the other to a port on the client machine.

Modem Configuration: On the client, EMP Console uses the Windows Application Program Interface (API) to determine if a modem is connected and available. The EMP Console does not configure the modem; it should be preconfigured through Windows.

For modem support, the server must use a Hayes compatible modem that supports a baud rate of 19.2k. The modem must be on the Windows 98 or NT Hardware Compatibility List provided by Microsoft. The server modem must be set in auto-answer mode for EMP Console to be able to connect to it.

Setting up the Server for the EMP

To use the EMP, you must configure the server's BIOS with specific settings. These settings are found in two submenus of the BIOS Server menu, the System Management Submenu and the Console Redirection submenu. The BIOS settings section, found earlier in this document, shows all the available options. This section focuses on the settings that must be configured in order to use the EMP.

System Management Submenu

All EMP related settings occur in the Server main menu. Change only the items below; all other default settings should remain the same.

EMP Password Switch & EMP Password: Anytime an attempt to initiate a connection is made, a prompt for the user password appears. If no EMP password is setup, then anyone can access the EMP by clicking OK.

In the EMP Password area of the Server menu, the EMP Password Switch option must be set to enable. Then type in a password of up to eight alphanumeric characters. If a beep is heard, the password was accepted.

EMP Access Modes: Choose either Disabled, Pre-boot, or Always Active, depending on the type of EMP access needed. The tables above show what is available with a given setting.

EMP Restricted Mode Access: Set Restricted Mode to either enabled or disabled as needed. If in enabled mode, this means that EMP Console's server control options, Power off and Reset, are unavailable, except power on. In disabled mode, these same server control options are available.

EMP Direct Connect/Modem Mode: Select Direct Connect if a null modem serial cable directly connects the server's COM2 port to the EMP Console client machine. If they are connected via a modem, select Modem Mode.

Console Redirection Submenu

The settings in the Console Redirection Submenu of the Server menu must be set exactly as noted to be able to use the EMP.

COM Port Address: Select 2F8. This is the COM2 port that must be used by the EMP. The IRQ# setting is automatically populated with the correct number based on the COM Port Address choice.

Baud Rate: Select 19.2k.









Flow Control: Choose CTS/RTS + CD.

Main EMP Console Window

The main EMP Console window provides a graphical user interface (GUI) to access server control operations and to launch the management plug-ins. At the top of the window is the menu and tool bar. These provide the options to initiate plug-ins and other support features. A status bar at the bottom displays connection information such as server name, line status, and mode.

Toolbar

The tool bar buttons of the EMP Console main window combine server control and management plug-in commands available from both the Connect and Action menus as follows:

	Displays the Connect dialog to allow connection to a selected server.
	Disconnects from the currently connected server.
	Displays the Power On/Off dialog.
	Displays the Reset dialog.
	Launches the SEL Viewer.
	Launches the SDR Viewer.
	Launches the FRU Viewer.
	Displays the Phonebook Dialog.
	Displays the online help.

Status Bar

The status bar is displayed at the bottom of the main window. It contains the following status information:

- **SERVER NAME:** The name of the connected server when connecting via modem.
- **LINE:** The type of line connection. This is either direct or modem.
- **MODE:** Either Redirect of EMP, depending on whether the EMP has control of the COM2 port.
- **LINE STATUS:** Gives status information about the server connection. For example, if a server is connected, the status bar says "Connected." Otherwise, the line is blank.

EMP Console Main Menu

- **File**
 - **Exit** - exits EMP Console.
- **Connect**
 - **Disconnect** - disconnects the server connection.
 - **[Re]Connect** - displays the connect dialog.
 - A list of the five most recent modem connections. Click on one of these server names to initiate a connection.
- **Action**
 - **Power On/Off** - displays the Power on/off dialog.
 - **Reset** - displays the Reset dialog.
 - **SEL Viewer** - displays the SEL Viewer.
 - **SDR Viewer** - displays the SDR Viewer.
 - **FRU Viewer** - displays the FRU Viewer.
 - **Phonebook** - displays the Phonebook dialog.
- **Help**
 - **Help Topics** - help topics for EMP Console.
 - **Help About** - provides version information.

Server Control Operations

Three server control operations are available from the menu or toolbar in EMP Console: remote server connection, powering the server on and off, and resetting the server. The server console mode can also be switched between EMP active and BIOS redirect modes through post-power-up and reset options.

Connect

When [Re]Connect is selected from the Connect menu, the Connect dialog in Figure 38 is displayed. This dialog allows you to connect to a server. If the client machine is already connected to a server, initiating connection generates a warning message. The message indicates that the existing connection will be terminated if you continue trying to initiate the new connection. You are prompted to enter the EMP password whenever a connection is attempted.

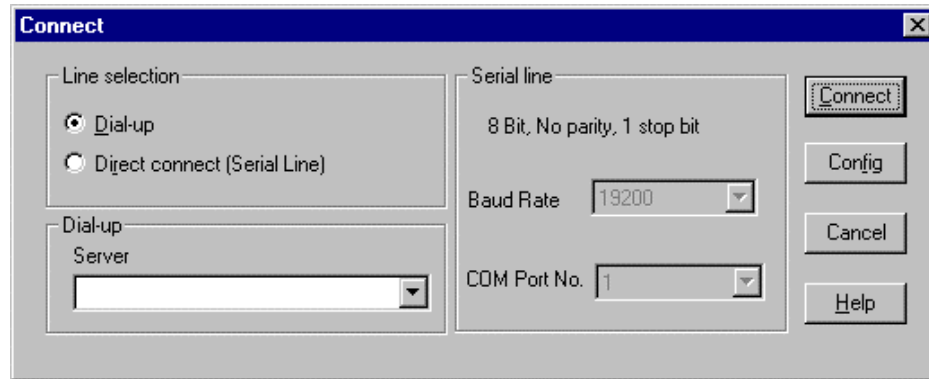

Figure 38. Connect Dialog

Options available in the dialog are:

- **Line Selection** - you can specify whether to use a direct connection or dial-up modem connection to the server.
 - **Dial-up** - connects to a selected server with a modem.
 - **Direct connect (Serial Line)** - connects to the selected server directly using a null modem serial cable.
- **Server** - a server name can be selected from the dropdown list of available servers. A server must be selected when the line selection is Dial-up.
- **Serial Line** - These options are enabled when the line selection is set to Direct connect (Serial Line).
 - **Baud Rate** - must be 19200 for EMP to connect properly.
 - **COM Port No.** - set the COM Port number to the port which the null modem serial cable is connected to.
- **Connect** - initiates the connection to the connected server. When this button is clicked, you are prompted for the EMP password.
- **Config** - displays the Phonebook dialog.
- **Cancel** - exits the Connect dialog without taking any action.
- **Help** - displays the help information for this dialog.

Power On/Off

Selecting Power On/Off from the Action menu displays the Power on/off dialog. This dialog provides commands to remotely power on or power off the server.

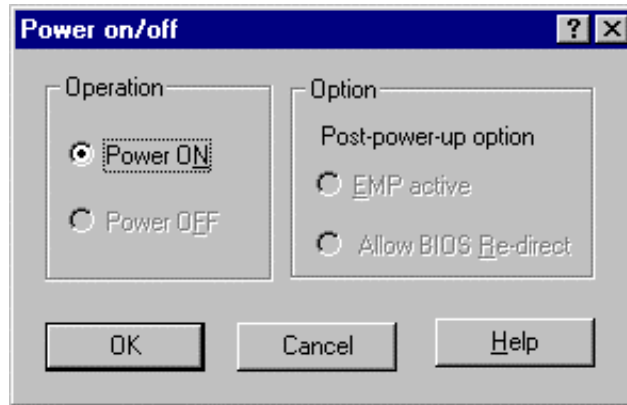

Figure 39. Power On/Off Dialog

Options available in the dialog are:

- **Power ON** - powers on the server.
- **Power OFF** - powers off the server. This option is not allowed if the server is configured in RESTRICTED mode for EMP operations.
- **Post-power-up option** - sets the mode selection of the server to EMP active or BIOS redirection. The setting is available after the next power-up. The default selection is EMP active.
- **Cancel** - exits the Connect dialog without taking any action.
- **Help** - displays the help information for this dialog.

Reset

Selecting Reset from the Action menu displays the Reset dialog. This dialog provides the ability to remotely reset the server with post-reset options.

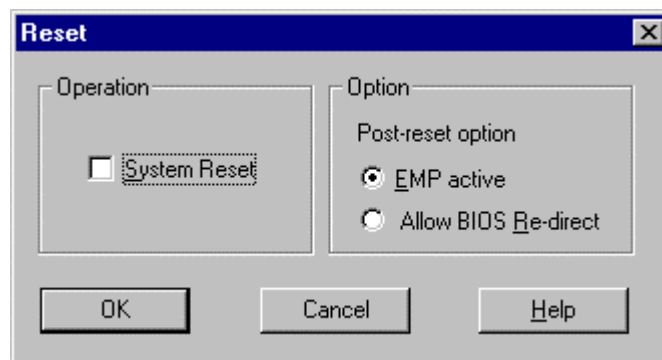

Figure 40. Reset Dialog

Options available in the dialog are:

- **System Reset** - resets the server with the selected post-reset options. This operation is not allowed if the server is configured in RESTRICTED mode for EMP operations.
- **Post-reset option** - sets the post-reset option that will be in effect after reset. The options are EMP active or BIOS redirection. The default selection is EMP active.
- **Cancel** - exits the Connect dialog without taking any action.
- **Help** - displays the help information for this dialog.

Phonebook

EMP Console provides a support plug-in known as the Phonebook. The Phonebook stores names and numbers of servers in a list that can be updated by adding, modifying or deleting entries. The Phonebook can be opened from the main menu and toolbar, or launched from the Connect dialog by clicking the Config button.

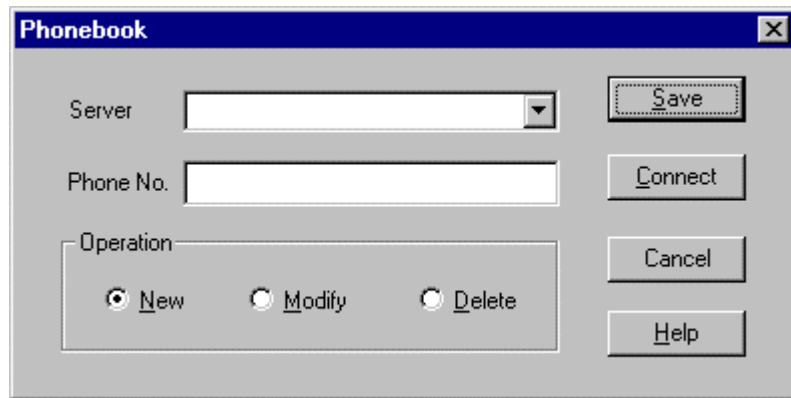

Figure 41. Phonebook Dialog

Options available in the dialog are:

- **Server** - a dropdown list of server names stored in the Phonebook. If the New radio button is selected in the Operation area, this area is cleared.
- **Phone No.** - the number of the selected server. If the New radio button is selected in the Operation area, this area is cleared.
- **Operation**
 - **New** - lets you add a new entry in the Phonebook. Selecting this option clears the Server and Phone No. fields. You must click Save for the entry to be added to the Phonebook.
 - **Modify** - lets you edit an existing entry. You must select an existing entry from the Server dropdown list box and modify the existing phone number before selecting this option. Click Save in order to update the entry in the phonebook.
 - **Delete** - lets you delete an entry from the Phonebook. You must first select an existing server from the Server dropdown list box before selecting this option. You must click Save for the entry to be deleted.
- **Save** - saves a new or modified Phonebook entry, or deletes an entry if the Delete radio button is selected.
- **Connect** - displays the Connect dialog with the server from the Phonebook's Server dropdown list box already populating the Connect dialog's Server field.

- **Cancel** - exits the Connect dialog without taking any action.
- **Help** - displays the help information for this dialog.

Management Plug-ins

SEL Viewer

The SEL Viewer provides access to the System Event Log on the server and can display records in either hexadecimal or text (verbose) form. Options available through the SEL Viewer are:

- View the SEL from a saved file
- Save the SEL to a file
- View SEL summary info
- View all SEL entries
- View SEL entries by sensor type
- View SEL entries by event type
- Set SEL display mode to either Hex or verbose mode
- Set the SEL output file format to either text or binary format
- Close the SEL Viewer
- Exit the EMP Console

SEL Viewer Menu Options

The following menu options are found on the SEL Viewer menu bar:

- **File**
 - **Open** - views SEL data from a previously saved file if it was stored in binary format. Selecting the Open menu item allows you to specify a filename under which the data is found. If the file cannot be opened, the program displays an error message.
 - **Close** - closes the SEL Viewer.
 - **Save** - saves the SEL events to a file in either binary raw or verbose text format. The binary file may be retrieved later. Once data has been saved to a file, selecting this option will save the data to the previously saved file. If no SEL events have been retrieved, then this menu option is not available.
 - **Save As** - saves the SEL events to a new file in either binary raw or verbose text format. The binary file may be retrieved later. Selecting this option lets you specify a filename to which the data will be saved. If no SEL events have been retrieved, then this menu option is not available.
 - **Exit** - exits the EMP Console.

- **View**
 - **SEL Information** - displays SEL summary information as returned by the server.
 - **All Events** - displays all events in the SEL.
 - **By Sensor Type** - displays all events in the SEL generated by a specific sensor type such as voltage, temperature, etc. A submenu lets you select the sensor type to be displayed.
 - **By Event** - displays all the events in the SEL of a particular event type; for example, threshold, digital, or discrete. A pop-up menu lets you select the event type to be displayed.
- **Settings** - changes several operating parameters for the SEL Viewer. This menu displays the following suboptions:
 - **Display HEX/Verbose** - toggles between HEX mode and interpreted mode of displaying SEL records.
 - **Output Text/Binary** - toggles between whether the SEL events will be saved to the file in binary format or verbose format.
- **Window** - gives options for displaying currently open windows.
- **Help**
 - **Help Topics** - help topics for EMP Console.
 - **Help About** - provides version information.

SDR Viewer

The SDR Viewer lets you view the Sensor Data Records from the SDR repository. Options available through the SDR Viewer are:

- View all SDR records
- View SDR entries by SDR type
- View SDR summary info
- Set SDR display mode to either HEX or verbose mode
- Close the SDR Viewer
- Exit the EMP Console

SDR Viewer Menu Options

The following menu options are found on the SDR Viewer menu bar:

- **File**
 - **Close** - closes the SDR Viewer.
 - **Exit** - exits the EMP Console.
- **View**
 - **Display all Records** - displays all records from the SDR repository.
 - **SDR Type** - displays the records of a particular SDR type. Select an SDR type from a pop-up menu that displays all the SDR types available for the given hardware.
 - **SDR Information** - displays the SDR summary information as returned by the server.

- **Settings** – changes the operating parameters for the SDR Viewer. This menu displays the following suboption:
 - **Display HEX/Verbose** - toggles between HEX mode and interpreted mode of displaying SDR records.
- **Window** - gives options for displaying currently open windows.
- **Help**
 - **Help Topics** - help topics for EMP Console.
 - **Help About** - provides version information.

FRU Viewer

The FRU Viewer allows you to view the server's FRU (Field Replaceable Unit) data from the server's Front Panel FRU information area. The options available in the FRU Viewer are:

- View all FRU records
- View FRU summary info
- Set FRU display mode to either Hex or verbose mode
- Close the FRU Viewer
- Exit EMP Console

FRU Viewer Menu Options

The following menu options are found on the FRU Viewer menu bar:

- **File**
 - **Close** - closes the FRU Viewer.
 - **Exit** - exits EMP Console.
- **View**
 - **Display all Records** - displays all FRU data, which consists of chassis, board, and product information.
 - **FRU Information** - displays the FRU summary information as returned by the server.
- **Settings** - changes operating parameters for the FRU Viewer. This menu displays the following options:
 - **Display HEX/Verbose** - toggles between HEX mode and interpreted mode of displaying FRU records.
- **Window** - gives options for displaying currently open windows.
- **Help**
 - **Help Topics** - help topics for EMP Console.
 - **Help About** - provides version information.

FRUSDR Load Utility

The Field Replacement Unit (FRU) and Sensor Data Record (SDR) Load Utility is a DOS-based program used to update the server management subsystem's product level FRU, SDR, and the Desktop Management Interface (DMI) nonvolatile storage components (EEPROMs). The load utility

- discovers the product configuration based on instructions in a master configuration file
- displays the FRU information
- updates the nonvolatile storage device (EEPROM) associated with the Baseboard Management Controller (BMC) that holds the SDR and FRU area
- updates the DMI area located in the BIOS nonvolatile storage device
- generically handles FRU devices that may not be associated with the BMC

When to Run the FRUSDR Load Utility

You should run the FRUSDR Load Utility each time you upgrade or replace the hardware in your server, excluding add-in boards, hard drives, and RAM. For example, if you replace an array of fans, you need to run the utility. It programs the sensors that need to be monitored for server management.

Because the firmware must reload to properly initialize the sensors after programming, turn the server off and remove the AC power cords from the server. Wait approximately 60 seconds, and reconnect the power cords.

What You Need to Do

The FRUSDR Load Utility may be run directly from the Configuration Software CD or from a diskette you create from the CD. It can be extracted from the CD by booting to the CD and selecting "Make Diskettes" or by inserting the CD into a PC running Windows 98 or NT and selecting the "Utilities" section.

⇒ NOTE

If your diskette drive is disabled, or improperly configured, you must use BIOS Setup to enable it. If necessary, you can disable the drive after you are done with the FRUSDR utility.

How You Use the FRUSDR Load Utility

This utility is compatible with ROM-DOS Ver. 6.22, MS-DOS⁺ Ver. 6.22, and later versions. The utility accepts CFG, SDR and FRU load files. The executable file for the utility is frusdr.exe. The utility requires the following supporting files:

- one or more .fru files describing the system's field replaceable units
- a .cfg file describing the system configuration
- a .sdr file describing the sensors in the system

Command Line Format

The basic command line format is

```
frusdr [/?] [/h] [/d {dmi, fru, sdr}] [/cfg filename.cfg] /p
```

Command	Description
frusdr	Is the name of the utility.
/? or /h	Displays usage information.
/d {dmi, fru, sdr}	Only displays requested area.
/cfg filename.cfg	Uses custom CFG file.
/p	Pause between blocks of data.

Parsing the Command Line

The FRUSDR Load Utility allows only one command line function at a time. A command line function may consist of two parameters; for example, cfg filename.cfg. Any invalid parameters result in displaying an error message and exiting the program. You can use either a slash (/) or a minus sign (-) to specify command line options. The /p flag may be used in conjunction with any of the other options.

Displaying Usage Information

When the utility is run with the /? or /h command line flags, the following message is displayed:

```
FRU & SDR Load Utility Version 3.0

Usage:  Frusdr           Is the name of the utility.
        /? Or /h       Displays usage information.
        /d {dmi,fru,sdr} Only displays requested area.
        /cfg filename.cfg Uses custom CFG file.
        /p             Pause between blocks of data.
```

Displaying a Given Area

When the utility is run with the /d DMI, /d FRU, or /d SDR command line flag, the indicated area is displayed. Each area represents a sensor; one sensor for each instrumented device in the server. If the given display function fails because of an inability to parse the data present or a hardware failure, the utility displays an error message and exits.

Displaying DMI Area

The DMI area is displayed in ASCII format when the field is ASCII or as a number when the field is a number. Each DMI area displayed is headed with the DMI area designated name. Each field has a field name header followed by the field in ASCII or as a number.

Displaying FRU Area

The FRU area is displayed in ASCII format when the field is ASCII or as a number when the field is a number. Each FRU area displayed is headed with the FRU area designated name. Each field has a field name header followed by the field in ASCII or as a number. The Board, Chassis, and Product FRU areas end with an END OF FIELDS CODE that indicates there is no more data in this area. The Internal Use area is displayed in hex format, 16 bytes per line.

Displaying SDR Area

The SDR nonvolatile storage area is displayed in the following hex format. The data is separated by a Sensor Record Number X header, where X is the number of that sensor record in the SDR area. The next line after the header is the sensor record data in hex format delineated by spaces. Each line holds up to 16 bytes. The data on each line is followed by the same data in ASCII format; nonprintable characters are substituted by a period (.).

Using Specified CFG File

The utility can be run with the command line parameter of `-cfg filename.cfg`. The filename can be any DOS accepted, eight-character filename string. The utility loads the specified CFG file and uses the entries in the configuration file to probe the hardware and to select the proper SDRs to load into nonvolatile storage.

Displaying Utility Title and Version

The utility displays its title :

```
FRU & SDR Load Utility, Version 3.0
```

Where X.XX is the revision number for the utility.

Configuration File

The configuration file is in ASCII text. The utility executes commands formed by the strings present in the configuration file. These commands cause the utility to perform various tasks needed to ultimately load the proper SDRs into the nonvolatile storage of the BMC and possibly generic FRU devices. Some of the commands may be interactive and require you to make a choice.

Prompting for Product Level FRU Information

Through the use of a Configuration File, the utility may prompt you for FRU information.

Filtering Sensor Data Record From the SDR File

The MASTER.SDR file has all the possible SDRs for the system. These records may need to be filtered based on the current product configuration. The configuration file directs the filtering of the SDRs.

Updating the SDR Nonvolatile Storage Area

After the utility validates the header area of the supplied SDR file, it updates the SDR repository area. Before programming, the utility clears the SDR repository area. The SDR file is loaded via the .cfg File. Then the utility filters all tagged SDRs depending on the product configuration set in the Configuration File. Nontagged SDRs are automatically programmed. It contains an image of what was loaded, and the TMP file is also useful for debugging the server.

Updating FRU Nonvolatile Storage Area

After the configuration is determined, the utility updates the FRU nonvolatile storage area. First it verifies the Common Header area and checksum from the specified FRU file. The Internal Use Area is read out of the specified .FRU file and is programmed into the nonvolatile storage. The Chassis, Board, Product and MultiRecord areas are read out of the specified .FRU file, if they exist, then those areas are programmed into the FRU nonvolatile storage.

Updating DMI FRU Nonvolatile Storage Area

After programming the BMC FRU area, the utility then programs the following Chassis, Board, and Product FRU information to the DMI fields, but only when dictated by the Configuration File.

If a failure occurs, the utility displays an error message and exits.

Cleaning Up and Exiting

If an update was successfully performed, the utility displays an appropriate message and then exits with a DOS exit code of zero.

If the utility fails, it immediately exits with an error message and a non-zero DOS exit code.

Upgrading the BIOS

Preparing for the Upgrade

Before you upgrade the BIOS, prepare for the upgrade by recording the current BIOS settings, obtaining the upgrade utility, and making a copy of the current BIOS.

Recording the Current BIOS Settings

1. Boot the computer and press <F2> when you see the message:
`Press <F2> Key if you want to run SETUP`
2. Write down the current settings in the BIOS Setup program.

⇒ NOTE

Do not skip step 2. You will need these settings to configure your computer at the end of the procedure.

Obtaining the Upgrade Utility

You can upgrade to a new version of the BIOS using the new BIOS files and the BIOS upgrade utility, iFLASH.EXE. You can obtain the BIOS upgrade file and the iFLASH.EXE utility through your computer supplier or from the Intel Customer Support website:

<http://support.intel.com/support/motherboards/server/LB440gx>

⇒ NOTE

Please review the instructions distributed with the upgrade utility before attempting a BIOS upgrade.

This upgrade utility allows you to:

- Upgrade the BIOS in flash memory.
- Update the language section of the BIOS.

The following steps explain how to upgrade the BIOS.

Creating a Bootable Floppy Diskette

1. Use a DOS or Windows 98 system to create the floppy disk.
2. Insert a formatted, bootable floppy disk in floppy drive A.
3. At the C:\ prompt, for an unformatted floppy disk, type:
`format a: /s`
or, for a formatted floppy disk, type:
`sys a:`
4. Press <Enter>

Creating the BIOS Upgrade Floppy Diskette

The BIOS upgrade file is a compressed self-extracting archive that contains the files you need to upgrade the BIOS.

1. Copy the BIOS upgrade file to a temporary directory on your hard disk.
2. From the C:\ prompt, change to the temporary directory.
3. To extract the file, type the name of the BIOS upgrade file, for example:
`10006BI1.EXE`
4. Press <Enter>. The extracted file contains the following files:
`LICENSE.TXT`
`README.TXT`
`BIOS.EXE`
5. Read the `LICENSE.TXT` file, which contains the software license agreement and the `README.TXT` file, which contains the instructions for the BIOS upgrade.
6. Insert the bootable floppy disk into drive A.
7. To extract the `BIOS.EXE` file to the floppy disk, change to the temporary directory that holds the `BIOS.EXE` file and type:
`BIOS A:`
8. Press <Enter>.
9. The floppy disk now holds the BIOS upgrade and recovery files.

Upgrading the BIOS

The following procedure describes how to upgrade the BIOS. Once the upgrade starts, do not shut down the system until the process completes. If the system is brought down during the upgrade, refer to the section “Recovering the BIOS” for how to proceed.

1. Boot the computer with the floppy disk in drive A.
2. A menu is displayed. Type 1 to automatically update the BIOS and continue at step 9, or type 2 to run the Iflash.exe utility and follow steps 3 to 8.
3. The BIOS upgrade utility screen appears, press enter to continue.
4. Select `Update Flash Memory From a File`.
5. Select `Update System BIOS`. Press `<Enter>`.
6. Use the arrow keys to select the correct `.bio` file. Press `<Enter>`.
7. When the utility asks for confirmation that you want to flash the new BIOS into memory, select `Continue with Programming`. Press `<Enter>`.
8. When the utility displays the message `upgrade is complete`, remove the floppy disk. Press `<Enter>`.
9. As the computer boots, check the BIOS identifier (version number) to make sure the upgrade was successful.
10. To enter the Setup program, press `<F2>` when you see the message:
`Press <F2> Key if you want to run SETUP`
9. For proper operation, load the Setup program defaults. To load the defaults, press `<F9>`.
10. To accept the defaults, press `<Enter>`.
11. Set the options in the Setup program to the settings you wrote down before the BIOS upgrade.
12. To save the settings, press `<F10>`.
13. To accept the settings, press `<Enter>`.
14. Turn off the computer and reboot.

Recovering the BIOS

It is unlikely that anything will interrupt the BIOS upgrade; however, if an interruption occurs, the BIOS could be damaged. The following steps explain how to recover the BIOS if an upgrade fails. The following procedure use recovery mode for the Setup program.

⇒ NOTE

Because of the small amount of code available in the nonerasable boot block area, there is no video support. You will not see anything on the screen during the procedure. Monitor the procedure by listening to the speaker and looking at the floppy drive LED.

1. Turn off all peripheral devices connected to the computer. Turn off the computer.
2. Remove the computer cover.
3. Locate jumper block J3J2.
4. Move the Recovery Boot jumper from pins 9-10 to pins 10-11 (see Figure 5).
5. Insert the bootable BIOS upgrade floppy disk into floppy drive A.
6. Replace the cover, turn on the computer, and allow it to boot. The recovery process will take a few minutes.

7. Listen to the speaker.
8. Two beeps and the end of activity in drive A indicate successful BIOS recovery.
9. A series of continuous beeps indicates failed BIOS recovery.
10. If recovery fails, return to step 1 and repeat the recovery process.
11. If recovery is successful, turn off the computer. Remove the computer cover and continue with the following steps.
12. Move the Recovery Boot jumper back to pins 9-10.
13. Replace the computer cover. Leave the upgrade disk in drive A and turn on the computer.
14. Continue with the BIOS upgrade (see page 97).

Changing the BIOS Language

You can use the BIOS upgrade utility to change the language the BIOS uses for messages and the Setup program. Use a bootable floppy disk containing the Intel flash utility and language files.

1. Boot the computer with the bootable floppy disk in drive A. The BIOS upgrade utility screen appears.
2. Select `Update Flash Memory From a File`.
3. Select `Update Language Set`. Press `<Enter>`.
4. Select drive A and use the arrow keys to select the correct `.lng` file. Press `<Enter>`.
5. When the utility asks for confirmation that you want to flash the new language into memory, select `Continue with Programming`. Press `<Enter>`.
6. When the utility displays the message `upgrade is complete`, remove the floppy disk. Press `<Enter>`.
7. The computer will reboot and the changes will take effect.

Using the Firmware Update Utility

The Firmware Update Utility is a DOS-based program used to update the Baseboard Management Controller's or HSC firmware code. You only need to run the Firmware Update Utility if new firmware code becomes necessary.

Running the Firmware Update Utility

1. Create a DOS bootable diskette. The version of DOS must be 6.0 or higher.
2. Place the firmware update utility (FWUPDATE.EXE) and the *.hex file on the diskette. Make a note of the *.hex file name, you will need it later.
3. Insert the diskette into the drive and boot to it.
4. At the DOS prompt, run the executable file (FWUPDATE.EXE).
5. The utility will display a menu screen. Select "Upload Flash."
6. The utility will ask for a file name. Enter the name of the *.hex file.
7. The program will load the file and then ask if it should "Upload Boot Block." Press "N" to continue.
8. The program will next ask if it should "Upload Operational Code." Press "Y" to continue.
9. Once the operational code has been updated and verified, press any key to continue. Then press the "ESC" key to exit the program.

10. Shut the system down and remove any floppy disks that may be in the system.
11. Disconnect the AC power cord from the system and wait 60 seconds.
12. Connect the AC power cord and power up the system.

Installing Video Drivers

After configuring the system, you need to install video drivers to take full advantage of the features of the onboard Cirrus Logic CL-GD5480 super VGA video controller.

- The LB440GX Resource CD includes video drivers for use with DOS and Windows NT. Check the README.TXT file on the CD for information on installing these drivers.
- For other operating systems, see your OS instructions for installing device drivers.

Using the Adaptec SCSI Utility

The Adaptec SCSI utility detects the SCSI host adapters on the server board. The utility runs out of BIOS and is used to

- Change default values
- Check and/or change SCSI device settings that may conflict with those of other devices in the server

Running the SCSI Utility

1. When this message appears on the video monitor:
`Press Ctrl-A to run SCSI Utility...`
2. Press <Ctrl+A> to run this utility. When it appears, choose the host adapter that you want to configure.

Another Adaptec utility that is available on the LB440GX Resource CD is the Adaptec EZ SCSI utility. It is designed to be installed from diskettes on to a DOS or Windows operating system.

4 Solving Problems

This chapter helps you identify and solve problems that might occur while you are using the system.

Resetting the System

To do this:	Press:
Soft boot reset, which clears system memory and reloads the operating system.	<Ctrl+Alt+Del> or Reset button on system front panel
Cold boot reset. Turn the system power off and then on. This clears system memory, restarts POST, reloads the operating system, and halts power to all peripherals.	Power off/on

Fault Resilient Booting

Fault resilient booting insures the system will not stop from a boot problem. Two sets of timers are implemented in the BMC that will automatically reset the system if the system should halt for some reason.

- FRB 2 - 5 sec timer. If the primary processor does not come up in 5 seconds the system will automatically reset and switch to the secondary processor (if installed). If a second processor is not installed, the system will try to restart off the primary processor.
- FRB 3 - 7 minute timer. If the system does not make it up to the end of POST in 7 minutes, the system will automatically reset and try again. It is assumed that the processor failed regardless of what may have caused the system to hang. The primary processor is taken off line and the system will boot off the secondary (if installed otherwise it will try to restart again off of the primary). Bad memory or a bad plug in card may cause an FRB 3 failure.

All failures are logged to the system event log.

The system will remember all FRB errors and display them at the end of POST until you select the Processor Retest option from the BIOS Setup utility.

Initial System Startup

Incorrect installation or configuration usually causes problems that occur at initial system startup. Hardware failure is a less frequent cause.

Checklist

- Are all cables correctly connected and secured?
- Are the processors or processor termination board fully seated in their slots on the server board?
- Are all add-in PCI boards fully seated in their slots on the riser card?
- Are all switch and jumper settings on the server board correct?
- Are all jumper and switch settings on add-in boards and peripheral devices correct? To check these settings, refer to the manufacturer's documentation that comes with them. If applicable, ensure that there are no conflicts—for example, two add-in boards sharing the same interrupt.
- Are all SDRAM DIMMs installed correctly?
- Are all peripheral devices installed correctly?
- If the system has a hard disk drive, is it properly formatted or configured?
- Are all device drivers properly installed?
- Are the configuration settings made with the SSU correct?
- Is the operating system properly loaded? Refer to the operating system documentation.
- Did you press the system power on/off switch on the front panel to turn the server on (power on light should be lit)?
- Is the system power cord properly connected to the system and plugged into a NEMA 5-15R outlet for 100-120 V~ or a NEMA 6-15R outlet for 200-240 V~?
- Is AC power available at the wall outlet?
- Are all integrated components from the tested components lists? Check the tested memory, and chassis lists, as well as the supported hardware and operating system list on the Intel Customer Support website:

<http://support.intel.com/support/motherboards/server/LB440gx/compat.htm>

Running New Application Software

Problems that occur when you run new application software are usually related to the software. Faulty equipment is much less likely, especially if other software runs correctly.

Checklist

- Does the system meet the minimum hardware requirements for the software? See the software documentation.
- Is the software an authorized copy? If not, get one; unauthorized copies often do not work.
- If you are running the software from a diskette, is it a good copy?
- If you are running the software from a CD-ROM disk, is the disk scratched or dirty?
- If you are running the software from a hard disk drive, is the software correctly installed? Were all necessary procedures followed and files installed?
- Are the correct device drivers installed?
- Is the software correctly configured for the system?
- Are you using the software correctly?

If the problems persist, contact the software vendor's customer service representative.

After the System Has Been Running Correctly

Problems that occur after the system hardware and software have been running correctly often indicate equipment failure. Many situations that are easy to correct, however, can also cause such problems.

Checklist

- If you are running the software from a diskette, try a new copy of the software.
- If you are running the software from a CD-ROM disk, try a different disk to see if the problem occurs on all disks.
- If you are running the software from a hard disk drive, try running it from a diskette. If the software runs correctly, there may be a problem with the copy on the hard disk drive. Reinstall the software on the hard disk, and try running it again. Make sure all necessary files are installed.
- If the problems are intermittent, there may be a loose cable, dirt in the keyboard (if keyboard input is incorrect), a marginal power supply, or other random component failures.
- If you suspect that a transient voltage spike, power outage, or brownout might have occurred, reload the software and try running it again. (Symptoms of voltage spikes include a flickering video display, unexpected system reboots, and the system not responding to user commands.)

⇒ NOTE

Random errors in data files: If you are getting random errors in your data files, they may be getting corrupted by voltage spikes on your power line. If you are experiencing any of the above symptoms that might indicate voltage spikes on the power line, you may want to install a surge suppressor between the power outlet and the system power cord.

More Problem Solving Procedures

This section provides a more detailed approach to identifying a problem and locating its source.

Preparing the System for Diagnostic Testing



CAUTION

Turn off devices before disconnecting cables: Before disconnecting any peripheral cables from the system, turn off the system and any external peripheral devices. Failure to do so can cause permanent damage to the system and/or the peripheral devices.

1. Turn off the system and all external peripheral devices. Disconnect all of them from the system, except the keyboard and video monitor.
2. Make sure the system power cord is plugged into a properly grounded AC outlet.
3. Make sure your video display monitor and keyboard are correctly connected to the system. Turn on the video monitor. Set its brightness and contrast controls to at least two thirds of their maximum ranges (see the documentation supplied with your video display monitor).
4. If the operating system normally loads from the hard disk drive, make sure there is no diskette in drive A. Otherwise, place a diskette containing the operating system files in drive A.
5. Turn on the system. If the power LED does not light, see “Power Light Does Not Light” on page 105.

Monitoring POST

See Chapter 3.

Verifying Proper Operation of Key System Lights

As POST determines the system configuration, it tests for the presence of each mass storage device installed in the system. As each device is checked, its activity light should turn on briefly. Check for the following:

- Does the diskette drive activity light turn on briefly? If not, see “Diskette Drive Activity Light Does Not Light” on page 107.
- If a second diskette drive is installed, does its activity light turn on briefly? If not, see “Diskette Drive Activity Light Does Not Light” on page 107.
- If there is a hard disk drive or SCSI devices installed in the system, does the hard disk drive activity light on the control panel turn on briefly? If not, see “Hard Disk Drive Activity Light Does Not Light” on page 107.

Confirming Loading of the Operating System

Once the system boots up, the operating system prompt appears on the screen. The prompt varies according to the operating system. If the operating system prompt does not appear, see “Initial System Startup” on page 101.

Specific Problems and Corrective Actions

This section provides possible solutions for these specific problems:

- Power light does not light.
- There is no beep or an incorrect beep pattern.
- No characters appear on screen.
- Characters on the screen appear distorted or incorrect.
- System cooling fans do not rotate.
- Diskette drive activity light does not light.
- Hard disk drive activity light does not light.
- CD-ROM drive activity light does not light.
- There are problems with application software.
- The bootable CD-ROM is not detected.

Try the solutions in the order given. If you cannot correct the problem, contact your service representative or authorized dealer for help.

Power Light Does Not Light

Check the following:

- Is the system operating normally? If so, the power LED is probably defective or the cable from the front panel to the server board is loose.
- Are there other problems with the system? If so, check the items listed under “System Cooling Fans Do Not Rotate Properly.”

If all items are correct and problems persist, contact your service representative or authorized dealer for help.

No Characters Appear on Screen

Check the following:

- Is the keyboard functioning? Check to see that the “Num Lock” light is functioning.
- Is the video monitor plugged in and turned on?
- Are the brightness and contrast controls on the video monitor properly adjusted?
- Are the video monitor switch settings correct?
- Is the video monitor signal cable properly installed?
- Is the onboard video controller enabled?

If you are using an add-in video controller board, do the following:

1. Verify that the video controller board is fully seated in the server board connector.
2. Reboot the system for changes to take effect.

3. If there are still no characters on the screen after you reboot the system and POST emits a beep code, write down the beep code you hear. This information is useful for your service representative. See “Port-80 Codes and Countdown Codes” on page 110.
4. If you do not receive a beep code and characters do not appear, the video display monitor or video controller may have failed. Contact your service representative or authorized dealer for help.

Characters Are Distorted or Incorrect

Check the following:

- Are the brightness and contrast controls properly adjusted on the video monitor? See the manufacturer’s documentation.
- Are the video monitor signal and power cables properly installed?

If the problem persists, the video monitor may be faulty or it may be the incorrect type. Contact your service representative or authorized dealer for help.

System Cooling Fans Do Not Rotate Properly

If the system cooling fans are not operating properly, system components could be damaged.

Check the following:

- Is AC power available at the wall outlet?
- Is the system power cord properly connected to the system and the wall outlet?
- Did you press the power button?
- Is the power on light lit?
- Have any of the fan motors stopped (use the server management subsystem to check the fan status)?
- Are the fan power connectors properly connected to the server board?
- Is the cable from the front panel board connected to the server board?
- Are the power supply cables properly connected to the server board?
- Are there any shorted wires caused by pinched cables or power connector plugs forced into power connector sockets the wrong way?

If the switches and connections are correct and AC power is available at the wall outlet, contact your service representative or authorized dealer for help.

Diskette Drive Activity Light Does Not Light

Check the following:

- Are the diskette drive power and signal cables properly installed?
- Are all relevant switches and jumpers on the diskette drive set correctly?
- Is the diskette drive properly configured?
- Is the diskette drive activity light always on? If so, the signal cable may be plugged in incorrectly.

If you are using the onboard diskette controller, use the SSU to make sure that “Onboard Floppy” is set to “Enabled.” If you are using an add-in diskette controller, make sure that “Onboard Floppy” is set to “Disabled.” To run the SSU, see Chapter 3.

If the problem persists, there may be a problem with the diskette drive, server board, or drive signal cable. Contact your service representative or authorized dealer for help.

Hard Disk Drive Activity Light Does Not Light

If you have installed one or more hard disk drives in your system, check the following:

- Are the power and signal cables to the drive properly installed?
- Are all relevant switches and jumpers on the hard drive and adapter board set correctly?
- Is the onboard IDE controller enabled? (IDE hard drives only)
- Is the hard disk drive properly configured?

⇒ NOTE

Front panel hard disk LED indicates IDE and SCSI devices: The hard disk drive activity light on the front panel lights when either an IDE hard disk drive, or a SCSI device controlled by the onboard SCSI host controller, is in use. This LED does not display CD-ROM activity.

CD-ROM Drive Activity Light Does Not Light

Check the following:

- Are the power and signal cables to the CD-ROM drive properly installed?
- Are all relevant switches and jumpers on the drive set correctly?
- Is the drive properly configured?
- Is the onboard IDE controller enabled?

⇒ NOTE

Front panel hard disk LED indicates IDE and SCSI devices: The hard disk drive activity light on the front panel lights when either an IDE hard disk drive, or a SCSI device controlled by the onboard SCSI host controller, is in use. This LED does not display CD-ROM activity.

Cannot Connect to a Server

- Make sure you are using the drivers that are shipped on the system Configuration Software CD for the onboard network controller.
- Make sure the driver is loaded and the protocols are bound.
- Make sure the network cable is securely attached to the connector at the system back panel and that the network controller Link LED is on (visible at back panel). If the cable is attached but the problem persists, try a different cable.
- Make sure the hub port is configured for the same duplex mode as the network controller.
- Check with your LAN administrator about the correct networking software that needs to be installed.
- If you are directly connecting two servers (no hub), you will need a crossover cable (see your hub documentation for more information on crossover cables).
- Check the network controller LEDs that are visible through an opening at the system back panel.

Problems with Network

The server hangs when the drivers are loaded.

- Change the PCI BIOS interrupt settings. Try the “PCI Installation Tips” below.

Diagnostics pass, but the connection fails.

- Make sure the network cable is securely attached.
- Make sure you specify the correct frame type in your NET.CFG file.

The Link LED doesn't light.

- Make sure you have loaded the network drivers.
- Check all cable connections.
- Try another port on the hub.
- Make sure you have the correct type of cable between the adapter and the hub. Some hubs require a crossover cable while others require a straight through cable (for more information on crossover cabling, see your hub documentation).

The Activity LED doesn't light.

- Make sure you've loaded the correct network drivers.
- Network may be idle. Try accessing a server.

The controller stopped working when an add-in adapter was installed.

- Make sure the cable is connected to the port from the onboard network controller.
- Make sure your PCI BIOS is current. Try the “PCI Installation Tips” below.
- Make sure the other adapter supports shared interrupts. Also, make sure your operating system supports shared interrupts; OS/2[†] does not.
- Try reseating the add in adapter.

The add-in adapter stopped working without apparent cause.

- Try reseating the adapter first; then try a different slot if necessary.
- The network driver files may be corrupt or deleted. Delete and then reinstall the drivers.
- Run the diagnostics.

PCI Installation Tips

Some common PCI tips are listed here.

- Reserve interrupts (IRQs) and/or memory addresses specifically for ISA adapters. This prevents PCI cards from trying to use the same settings ISA cards are using. Use the SSU to keep track of ISA adapter resources.
- Certain drivers may require interrupts that are not shared with other PCI drivers. The SSU can be used to adjust the interrupt numbers for PCI devices. For certain drivers, it may be necessary to alter settings so that interrupts are not shared.

Problems with Application Software

If you have problems with application software, do the following:

- Verify that the software is properly configured for the system. See the software installation and operation documentation for instructions on setting up and using the software.
- Try a different copy of the software to see if the problem is with the copy you are using.
- Make sure all cables are installed correctly.
- Verify that the server board jumpers are set correctly. See Chapter 5.
- If other software runs correctly on the system, contact your vendor about the failing software.

If the problem persists, contact the software vendor’s customer service representative for help.

Bootable CD-ROM Is Not Detected

Check the following:

- Is the BIOS set to allow the CD-ROM to be the first bootable device?

Error and Informational Messages

When you turn on the system, POST displays messages that provide information about the system. If a failure occurs, POST emits beep codes that indicate errors in hardware, software, or firmware. If POST can display a message on the video display screen, it causes the speaker to beep twice as the message appears.

Port-80 Codes and Countdown Codes

After the video adapter has been successfully initialized, the BIOS indicates the current testing phase during POST after the video adapter has been successfully initialized by outputting a 2-digit hex code to I/O location 80h. If a port-80h ISA POST card is installed, it displays the 2-digit code on a pair of hex display LEDs. Refer to the POST card documentation for a listing of specific errors.

5 Technical Reference

This chapter includes the following:

- Environmental specifications
- Board interrupts
- Electromagnetic Compatibility (EMC) notices

Connectors

The figure shows connector locations on the server board. This section provides pin information about the connectors.

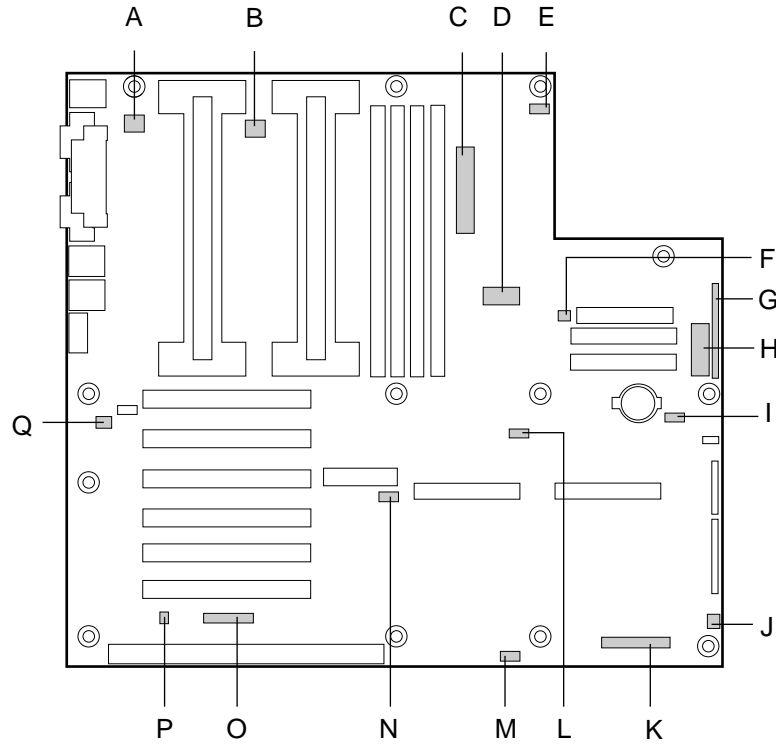

OM08839

Figure 42. Connector Locations

- | | |
|----------------------------------|--|
| A. Fansink connector 2 | J. Fan connector 1 |
| B. Fansink connector 1 | K. Server monitor module (SMM) connector |
| C. Main power connector | L. External Wake on LAN connector |
| D. ATX Aux power connector | M. BUD connector |
| E. SM IMB | N. Hard drive LED connector |
| F. Fan connector 2A | O. ICMB header |
| G. ATX front panel connector | P. Chassis intrusion connector |
| H. Front panel connector, 16 pin | Q. Fan connector 2B |
| I. ISOL IMB | |

ATX Style Front Panel Connector

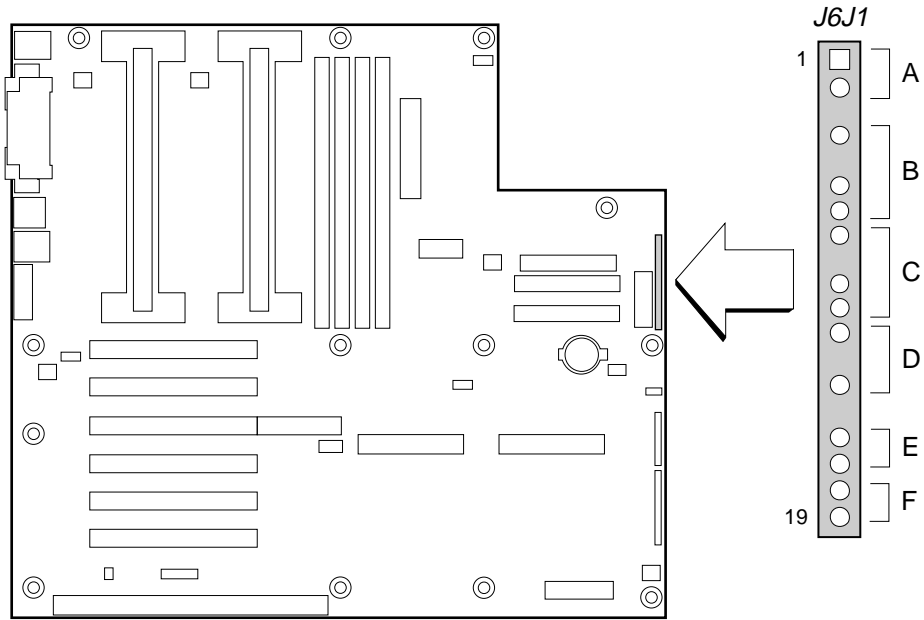

OM07498

Figure 43. ATX Style Front Panel Connector

Table 8. ATX Style Front Panel Connector Pinout

Connector	Pin	Signal
A. Power switch	1	Power switch
	2	GND
	3	N/C
B. Hard drive activity LED	4	Current limited +5V
	5	Key
	6	HD activity LED
	7	Current limited +5V
C. Speaker	8	GND
	9	N/C
	10	PIEZO_IN
	11	SPKR_HDR
D. Power LED	12	Current limited +5V
	13	N/C
	14	GND
	15	N/C
E. Reset switch	16	GND
	17	Reset switch
F. Sleep switch	18	GND
	19	Sleep switch

Main Power Connector

Table 9. Main Power Connector Pinout

Pin	Signal	Pin	Signal
1	+3.3V	13	+3.3V
2	+3.3V	14	-12V
3	COM	15	COM
4	+5V	16	PS_ON
5	COM	17	COM
6	+5V	18	COM
7	COM	19	COM
8	PWR_OK	20	-5V
9	+5VSB	21	+5V
10	+12V	22	+5V
11	+12V	23	+5V
12	+3.3V	24	COM

Fan Interface

The server board has five 3-pin fan connectors that are shrouded and keyed. Two are located next to the processor sockets (one for each processor); each is intended to be used for a tachometer fan heat sink.

⇒ NOTE

Fan connectors 2A and 2B can not be used simultaneously. If you plug fans into both connectors, the fans will not operate properly.

Table 10. Fan Connector Pinout

Pin	Signal
1	GND
2	+12V
3	Fan Sensor

Server Board Jumpers

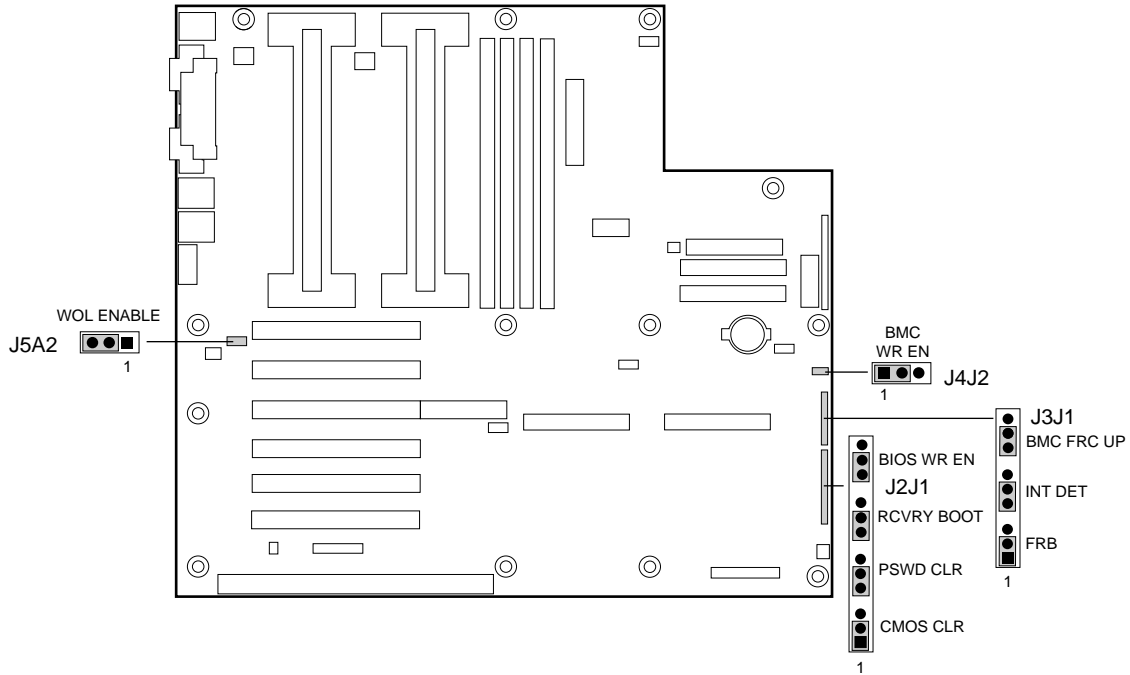

OM08429

Figure 44. Jumper Locations

Table 11. Server Board Jumper Summary

Jumper Block	Jumper Name	Pins (default in bold)	What it does at system reset
J5A2	WOL ENABLE	1-2, Disabled	Disables Wake On LAN. If your power supply does not provide 0.8 A of +5 V Standby current, you must move the WOL Enable jumper to this position.
		2-3, Enabled	
J4J2	BMC WR EN	1-2, Protect	BMC boot block is write protected.
		2-3, Erase/Program	BMC boot block is erasable and programmable.
J3J1	FRB	1-2, Enable	FRB operation is enabled (system boots from processor 1 if processor 0 does not respond).
		2-3, Disable	FRB is disabled.
J3J1	INT DET	5-6, Enable	Switch installed on chassis indicates when cover has been removed.
		6-7, Disable	Chassis intrusion switch is bypassed.
J3J1	BMC FRC UP	9-10, Normal	System boots normally.
		10-11, Program	System attempts to update BMC firmware.

continued

Table 11. Server Board Jumper Summary (continued)

Jumper Block	Jumper Name	Pins (default in bold)	What it does at system reset
J2J1	CMOS CLR	1-2, Protect	Preserves the contents of NVRAM.
		2-3, Erase	Replaces the contents of NVRAM with the manufacturing default settings.
J2J1	PSWD CLR	5-6, Protect	Maintains the current system password.
		6-7, Erase	Clears the password.
J2J1	RCVRY BOOT	9-10, Normal	System attempts to boot using the BIOS stored in flash memory.
		10-11, Recovery	BIOS attempts a recovery boot, loading BIOS code from a floppy diskette into the flash device. This is typically used when the BIOS code has been corrupted.
J2J1	BIOS WR EN	13-14, Protect	BIOS boot block is write-protected.
		14-15, Erase/Program	BIOS boot block is erasable and programmable.

General Procedure to Change Jumper Setting

The short general procedure for changing a configuration setting is the same for most of the jumper functions, so we will describe it here.

1. Observe the safety and ESD precautions at the beginning of this chapter.
2. Turn off all connected peripherals, turn off system power, and disconnect the AC power cord.
3. Remove the cover. You do not need to remove the server board from the chassis, and you probably do not need to remove any add-in boards.
4. Locate the configuration jumpers at the edge of the server board toward the front of the system.
5. Move jumper to pins specified for the desired setting.
6. Reinstall the cover, connect the power cord, and turn on the system for the change to take effect.
7. You may need to repeat these steps to move the jumper back to its original setting, depending on the jumper function.

CMOS Jumper

The jumper at pins 1, 2, and 3 controls whether settings stored in CMOS nonvolatile memory (NVRAM) are retained during a system reset.

Procedure to restore the system's CMOS and RTC to default values:

1. See "General Procedure to Change Jumper Setting" on page 116.
2. Move the CMOS jumper from pins 1 and 2 to pins 2 and 3 (the Clear CMOS memory position).
3. Reinstall the cover for your safety, and connect the power cord to the system.
4. Turn the system on. Wait for POST to complete and for the messages "NVRAM cleared by jumper" and "Press F2 to enter Setup" to appear. This automatically reprograms CMOS and RTC to their default settings.
5. Enter Setup and make any changes necessary (for example, changing the boot device). Press F10 to save the new Setup configuration and exit Setup.
6. Turn off the system, and disconnect the power cord from the system.
7. Again remove the cover.
8. Move the jumper from pins 2 and 3 back to pins 1 and 2 (the Protect CMOS memory position).
9. Reinstall the cover, and connect the power cord to the system.
10. Run BIOS Setup or the SSU to verify the correct settings. See Chapter 3.

Password Jumper

The jumper at pins 5, 6, and 7 controls whether the user and administrative passwords are retained or cleared during a system reset.

Procedure to clear the current password and then enter a new one:

1. See "General Procedure to Change Jumper Setting" on page 116.
2. Move the Password jumper from pins 5 and 6 to pins 6 and 7.
3. Reinstall the cover for your safety, and connect the power cord to the system.
4. Turn the system on, and wait for POST to complete. This automatically clears the password.
5. Turn off the system, and disconnect the power cord.
6. Again remove the cover.
7. Move the jumper from pins 6 and 7 back to pins 5 and 6.
8. Reinstall the cover, and connect the power cord to the system.
9. Run the SSU to specify a new password. See Chapter 3.

Recovery Boot Jumper

The jumper at pins 9, 10, and 11 controls whether the system attempts to boot using the BIOS programmed in the boot block area of the FLASH memory. This should be used only if the operational area of the BIOS is corrupted or needs to be upgraded. Contact your local service representative before doing this.

Procedure to disable recovery booting:

1. See “General Procedure to Change Jumper Setting” on page 116.
2. Move the recovery boot jumper from pins 9 and 10 to pins 10 and 11.
3. Reinstall the cover for your safety, connect the power cord to the system.
4. Turn the system on, and insert the Flash Memory Update Utility diskette in drive A. After the system boots, the speaker emits a single beep and the recovery process starts. This takes about two-to-four minutes. When the recovery process completes, the speaker emits two beeps.

While in the recovery mode, there is no screen display on the monitor. The keyboard is disabled as the system automatically recovers the BIOS. The following beep codes describe the recovery status.

Beep Code	Message
2	Successful completion, no errors.
4	The system could not boot from the diskette. The diskette may not be bootable.
Continuous series of low beeps	The wrong BIOS recovery files are being used and/or the flash memory jumper is in the wrong position.

5. Turn the system off, disconnect the power cord(s) from the system, and remove the cover.
6. Move the jumper from pins 9 and 10 to pins 10 and 11 to enable the normal boot mode.
7. Replace the cover, remove the diskette from drive A, and connect the power cord(s) to the system.
8. After running the special recovery mode, run the SSU to specify a new password. See Chapter 3.

Boot Block Write Protect Jumper

The jumper at pins 13, 14, and 15 controls whether the BIOS boot block is protected from being erased and reprogrammed.



CAUTION

Leave boot block jumper at factory default setting: Programming the boot block incorrectly will prevent the system from booting. Programming *should be done only* by a technically qualified person. The procedure requires a special “Boot Block Update Utility.” Contact your dealer or sales representative for more information.

Procedure to permit boot block erasing and programming:

1. See “General Procedure to Change Jumper Setting” on page 116.
2. Move the boot block jumper from pins 13 and 14 to pins 14 and 15 to erase and program the BIOS boot block.
3. Reinstall the cover for your safety, and connect the power cord to the system.
4. Run the Boot Block Update Utility.
5. Turn off the system, and disconnect the power cord from the system.
6. Remove the cover.
7. Move the jumper from pins 14 and 15 back to pins 13 and 14 to write protect the BIOS boot block.
8. Reinstall the cover, and connect the power cord to the system.

FRB Timer Enable Jumper

The jumper at pins 5, 6, and 7 controls the FRB timers. See page 101.

Procedure to disable FRB timer:

1. See “General Procedure to Change Jumper Setting”.
2. Remove the cover.
3. Move the recovery boot jumper from pins 5 and 6 to pins 6 and 7.
4. Reinstall the cover for your safety, and connect the power cord to the system.
5. Turn the system on, and wait for POST to complete.
6. Run the SSU to configure the system. See Chapter 3.

Chassis Intrusion Detection Jumper

The chassis contains an alarm switch that sends a notification signal to the server management software if a cover is removed. The jumper at pins 9, 10, and 11 controls whether this alarm feature is enabled or disabled.

Procedure to disable (bypass) the chassis intrusion switch:

1. See “General Procedure to Change Jumper Setting”.
2. Remove the cover.
3. Move the chassis intrusion detection jumper from pins 9 and 10 to pins 10 and 11 to disable the alarm switch.
4. Reinstall the cover for your safety, and connect the power cord to the system.
5. Turn the system on, and wait for POST to complete.
6. Run the SSU to configure the system. See Chapter 3.

To enable the intrusion switch, do the above steps but move the jumper back to pins 9 and 10.

6 Product Regulation and Certification Information

Regulatory Information Safety Compliance For Information Technology Equipment

- UL 1950 - CSA 950 (US/Canada)
- EN 60 950 (European Union)
- IEC60 950 (International)
- CE – Low Voltage Directive (73/23/EEC) (European Union)
- EMKO-TSE (74-SEC) 207/94 (Nordics)

EMC Compliance

- FCC (Class B) – Radiated & Conducted Emissions (USA)
- ICES-003 (Class B) – Radiated & Conducted Emissions (Canada)
- CISPR 22 (Class B) – Radiated & Conducted Emissions (International)
- EN55022 (Class B) – Radiated & Conducted Emissions (European Union)
- EN50082-1 (Immunity) (European Union)
- VCCI (Class B) – Radiated & Conducted Emissions (Japan)
- AS/NZS 3548 (Class B) – Radiated & Conducted Emissions (Australia)
- CE – EMC Directive (89/336/EEC) (European Union)

Regulatory Compliance Markings

This product is provided with the following Product Certification Markings.

- UL & cUL Listing Mark
- CE Mark
- The CE marking on this product indicates that it is in compliance with the European community's EMC (89/336/EEC) and low voltage directives (73/23/EEC)
- NEMKO Mark
- German GS Mark
- Russian GOST Mark
- FCC, Class B Markings (Declaration of Conformity)
- ICES-003 (Canada EMC Compliance Marking)
- VCCI, Class B Mark
- Australian C-Tick Mark
- Taiwan BSMI Class A Markings

Electromagnetic Compatibility Notices

FCC Declaration of Conformity (USA)

Product Type: BAR 2

This device complies with Part 15 of the FCC Rules. Operation is subject to the following two conditions: (1) This device may not cause harmful interference, and (2) this device must accept any interference received, including interference that may cause undesired operation.

Intel Corporation
5200 N.E. Elam Young Parkway
Hillsboro, OR 97124-6497
Phone: 1-800-628-8686

This equipment has been tested and found to comply with the limits for a Class B digital device, pursuant to Part 15 of the FCC Rules. These limits are designed to provide reasonable protection against harmful interference in a residential installation. This equipment generates, uses, and can radiate radio frequency energy and, if not installed and used in accordance with the instructions, may cause harmful interference to radio communications. However, there is no guarantee that interference will not occur in a particular installation. If this equipment does cause harmful interference to radio or television reception, which can be determined by turning the equipment off and on; the user is encouraged to try to correct the interference by one or more of the following measures:

- Reorient or relocate the receiving antenna.
- Increase the separation between the equipment and the receiver.
- Connect the equipment into an outlet on a circuit different from that to which the receiver is connected.
- Consult the dealer or an experienced radio/TV technician for help.

Any changes or modifications not expressly approved by the grantee of this device could void the user's authority to operate the equipment. The customer is responsible for ensuring compliance of the modified product.

Only peripherals (computer input/output devices, terminals, printers, etc.) that comply with FCC Class B limits may be attached to this computer product. Operation with noncompliant peripherals is likely to result in interference to radio and TV reception.

All cables used to connect to peripherals must be shielded and grounded. Operation with cables, connected to peripherals that are not shielded and grounded may result in interference to radio and TV reception.

⇒ NOTE

If a Class A device is installed within this system, then the system is to be considered a Class A system. In this configuration, operation of this equipment in a residential area is likely to cause harmful interference.

ICES-003 (Canada)

Cet appareil numérique respecte les limites bruits radioélectriques applicables aux appareils numériques de Classe B prescrites dans la norme sur le matériel brouilleur: “Appareils Numériques”, NMB-003 édictée par le Ministre Canadian des Communications.

(English translation of the notice above.) This digital apparatus does not exceed the Class B limits for radio noise emissions from digital apparatus set out in the interference-causing equipment standard entitled “Digital Apparatus,” ICES-003 of the Canadian Department of Communications.

VCCI (Japan)

この装置は、情報処理装置等電波障害自主規制協議会（VCCI）の基準に基づくクラスB情報技術装置です。この装置は、家庭環境で使用することを目的としていますが、この装置がラジオやテレビジョン受信機に近接して使用されると、受信障害を引き起こすことがあります。
取扱説明書に従って正しい取り扱いをして下さい。

(English translation of the notice above) This is a Class B product based on the standard of the Voluntary Control Council For Interference (VCCI) from Information Technology Equipment. If this is used near a radio or television receiver in a domestic environment, it may cause radio interference. Install and use the equipment according to the instruction manual.

When used near a radio or TV receiver, it may become the cause of radio interference.

Read the instructions for correct handling.

This equipment has been tested for radio frequency emissions and has been verified to meet CISPR 22 Class B.

BSMI (Taiwan)

The following EMC Warning along with the BSMI ID number is located on the outside rear area of the product.

警告使用者：
這是甲類的資訊產品，在居住的環境中使用時，
可能會造成射頻干擾，在這種情況下，使用者會
被要求採取某些適當的對策。

Lithium Battery Replacement



Refer to technically qualified persons only for replacement of battery



WARNING

Danger of explosion if battery is incorrectly replaced. Replace with only the same or equivalent type recommended by the manufacturer. Dispose of used batteries according to the manufacturer's instructions.



ADVARSEL!

Lithiumbatteri - Eksplosjonsfare ved feilagtig håndtering. Utskiftning må kun ske med batteri af samme fabrikat og type. Levér det brugte batteri tilbage til leverandøren.



ADVARSEL!

Lithiumbatteri - Eksplosjonsfare. Ved utskifting benyttes kun batteri som anbefalt av apparatfabrikanten. Brukt batteri returneres apparatleverandøren.



WARNING

Explosionsfara vid felaktigt batteribyte. Använd samma batterityp eller en ekvivalent typ som rekommenderas av apparattillverkaren. Kassera använt batteri enligt fabrikantens instruktion.



VAROITUS

Paristo voi räjähtää, jos se on virheellisesti asennettu. Vaihda paristo ainoastaan laitevalmistajan suosittelemaan tyyppiin. Hävitä käytetty paristo valmistajan ohjeiden mukaisesti.

Equipment Rack Precautions

WARNINGS

ANCHOR THE EQUIPMENT RACK: The equipment rack must be anchored to an unmovable support to prevent it from falling over when one or more servers are extended in front of it on slide assemblies. The anchors must be able to withstand a force of up to 113 kg (250 lbs). You must also consider the weight of any other device installed in the rack.

MAIN AC POWER DISCONNECT: You are responsible for installing an AC power disconnect for the entire rack unit. This main disconnect must be readily accessible, and it must be labeled as controlling power to the entire unit, not just to the server(s).

GROUNDING THE RACK INSTALLATION: To avoid the potential for an electrical shock hazard, you must include a third wire safety grounding conductor with the rack installation. If server power cords are plugged into AC outlets that are part of the rack, then you must provide proper grounding for the rack itself. If server power cords are plugged into wall AC outlets, the safety grounding conductor in each power cord provides proper grounding only for the server. You must provide additional, proper grounding for the rack and other devices installed in it.

Overcurrent protection: The server is designed for an AC line voltage source with up to 20 amperes of overcurrent protection. If the power system for the equipment rack is installed on a branch circuit with more than 20 amperes of protection, you must provide supplemental protection for the server. If more than one server is installed in the rack, the power source for each server must be from a separate branch circuit. The overall current rating of a server configured with three power supplies is under 12 amperes.

CAUTIONS

Temperature: The operating temperature of the server, when installed in an equipment rack, must not go below 5 °C (41 °F) or rise above 35 °C (95 °F). Extreme fluctuations in temperature can cause a variety of problems in your server.

Ventilation: The equipment rack must provide sufficient airflow to the front of the server to maintain proper cooling. It must also include ventilation sufficient to exhaust a maximum of 4,100 Btu's per hour for the server. The rack selected and the ventilation provided must be suitable to the environment in which the server will be used.

Cautions

There are no user serviceable parts inside this product. Please refer to technically qualified service person.

Use Only for Intended Applications

This product was evaluated as Information Technology Equipment (ITE) that may be installed in offices, homes, schools, computer rooms and similar locations. The suitability of this product for other Product Categories and Environments other than ITE applications, (such as medical, industrial, alarm systems, and test equipment) may require further evaluation.

WARNING

System power on/off: The on/off button (a convex button) on the front panel DOES NOT turn off the system AC power. To remove power from system, you must unplug the AC power cord from the wall outlet or the system.

Power Cords

WARNING

Do not attempt to modify or use AC power cords that are not the exact type required.

If power cord supplied with system is not suitable for your region, you must obtain power cords that meet the following criteria:

- The cord must be rated for the available AC voltage and have a current rating that is at least 125% of the current rating of the server.
- The connector that plugs into the wall outlet must be a grounding-type plug designed for use in your region. It must have certification marks showing certification by an agency acceptable in your region.
- The connector that plugs into the AC inlet receptacle on the product must be an IEC 320, sheet C13, type female connector.
- The cord must be less than 4.5 meters (14.76 feet) long, and it must be flexible <HAR> (harmonized) or VDE certified cordage to comply with the server safety certifications.

Warnings

WARNING: English (US)

AVERTISSEMENT: Français

WARNUNG: Deutsch

AVVERTENZA: Italiano

ADVERTENCIAS: Español

WARNING: English (US)

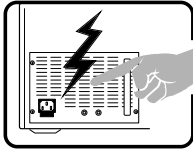

The power supply in this product contains no user-serviceable parts. There may be more than one supply in this product. Refer servicing only to qualified personnel.

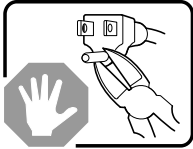

Do not attempt to modify or use the supplied AC power cord if it is not the exact type required. A product with more than one power supply will have a separate AC power cord for each supply.

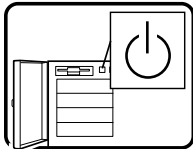

The DC push-button on/off switch on the system does not turn off system AC power. To remove AC power from the system, you must unplug each AC power cord from the wall outlet or power supply.

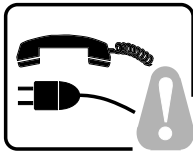

SAFETY STEPS: Whenever you remove the chassis covers to access the inside of the system, follow these steps:

1. Turn off all peripheral devices connected to the system.
 2. Turn off the system by pressing the power button.
 3. Unplug all AC power cords from the system or from wall outlets.
 4. Label and disconnect all cables connected to I/O connectors or ports on the back of the system.
 5. Provide some electrostatic discharge (ESD) protection by wearing an antistatic wrist strap attached to chassis ground of the system—any unpainted metal surface—when handling components.
 6. Do not operate the system with the chassis covers removed.
-

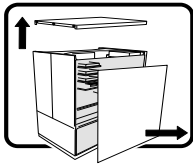

After you have completed the six SAFETY steps above, you can remove the system covers. To do this:

1. Unlock and remove the padlock from the back of the system if a padlock has been installed.
 2. Remove and save all screws from the covers.
 3. Remove the covers.
-

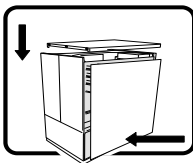

For proper cooling and airflow, always reinstall the chassis covers before turning on the system. Operating the system without the covers in place can damage system parts. To install the covers:

1. Check first to make sure you have not left loose tools or parts inside the system.
 2. Check that cables, add-in boards, and other components are properly installed.
 3. Attach the covers to the chassis with the screws removed earlier, and tighten them firmly.
 4. Insert and lock the padlock to the system to prevent unauthorized access inside the system.
 5. Connect all external cables and the AC power cord(s) to the system.
-

continued

WARNING: English (US) (continued)

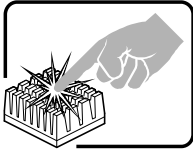

A microprocessor and heat sink may be hot if the system has been running. Also, there may be sharp pins and edges on some board and chassis parts. Contact should be made with care. Consider wearing protective gloves.

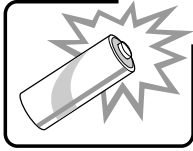

Danger of explosion if the battery is incorrectly replaced. Replace only with the same or equivalent type recommended by the equipment manufacturer. Dispose of used batteries according to manufacturer's instructions.

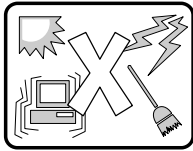

The system is designed to operate in a typical office environment. Choose a site that is:

- Clean and free of airborne particles (other than normal room dust).
 - Well ventilated and away from sources of heat including direct sunlight.
 - Away from sources of vibration or physical shock.
 - Isolated from strong electromagnetic fields produced by electrical devices.
 - In regions that are susceptible to electrical storms, we recommend you plug your system into a surge suppresser and disconnect telecommunication lines to your modem during an electrical storm.
 - Provided with a properly grounded wall outlet.
 - Provided with sufficient space to access the power supply cords, because they serve as the product's main power disconnect.
-

AVERTISSEMENT: Français

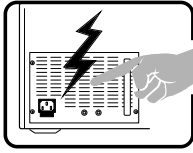

Le bloc d'alimentation de ce produit ne contient aucune pièce pouvant être réparée par l'utilisateur. Ce produit peut contenir plus d'un bloc d'alimentation. Veuillez contacter un technicien qualifié en cas de problème.

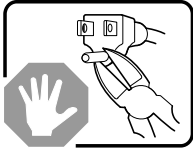

Ne pas essayer d'utiliser ni modifier le câble d'alimentation CA fourni, s'il ne correspond pas exactement au type requis. Le nombre de câbles d'alimentation CA fournis correspond au nombre de blocs d'alimentation du produit.

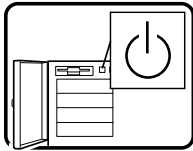

Notez que le commutateur CC de mise sous tension /hors tension du panneau avant n'éteint pas l'alimentation CA du système. Pour mettre le système hors tension, vous devez débrancher chaque câble d'alimentation de sa prise.

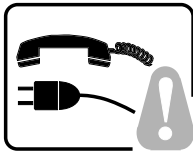

CONSIGNES DE SÉCURITÉ – Lorsque vous ouvrez le boîtier pour accéder à l'intérieur du système, suivez les consignes suivantes :

1. Mettez hors tension tous les périphériques connectés au système.
 2. Mettez le système hors tension en mettant l'interrupteur général en position OFF (bouton-poussoir).
 3. Débranchez tous les cordons d'alimentation c.a. du système et des prises murales.
 4. Identifiez et débranchez tous les câbles reliés aux connecteurs d'E-S ou aux accès derrière le système.
 5. Pour prévenir les décharges électrostatiques lorsque vous touchez aux composants, portez une bande antistatique pour poignet et reliez-la à la masse du système (toute surface métallique non peinte du boîtier).
 6. Ne faites pas fonctionner le système tandis que le boîtier est ouvert.
-

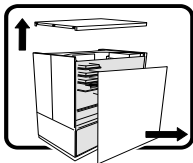

Une fois TOUTES les étapes précédentes accomplies, vous pouvez retirer les panneaux du système. Procédez comme suit :

1. Si un cadenas a été installé sur à l'arrière du système, déverrouillez-le et retirez-le.
 2. Retirez toutes les vis des panneaux et mettez-les dans un endroit sûr.
 3. Retirez les panneaux.
-

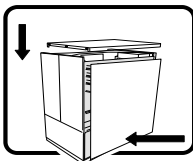

Afin de permettre le refroidissement et l'aération du système, réinstallez toujours les panneaux du boîtier avant de mettre le système sous tension. Le fonctionnement du système en l'absence des panneaux risque d'endommager ses pièces. Pour installer les panneaux, procédez comme suit :

1. Assurez-vous de ne pas avoir oublié d'outils ou de pièces démontées dans le système.
 2. Assurez-vous que les câbles, les cartes d'extension et les autres composants sont bien installés.
 3. Revissez solidement les panneaux du boîtier avec les vis retirées plus tôt.
 4. Remettez le cadenas en place et verrouillez-le afin de prévenir tout accès non autorisé à l'intérieur du système.
 5. Rebranchez tous les cordons d'alimentation c. a. et câbles externes au système.
-

suite

AVERTISSEMENT: Français (suite)

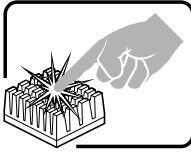

Le microprocesseur et le dissipateur de chaleur peuvent être chauds si le système a été sous tension. Faites également attention aux broches aiguës des cartes et aux bords tranchants du capot. Nous vous recommandons l'usage de gants de protection.

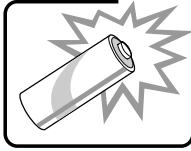

Danger d'explosion si la batterie n'est pas remontée correctement. Remplacer uniquement avec une batterie du même type ou d'un type équivalent recommandé par le fabricant. Disposez des piles usées selon les instructions du fabricant.

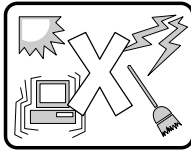

Le système a été conçu pour fonctionner dans un cadre de travail normal. L'emplacement choisi doit être :

- Propre et dépourvu de poussière en suspension (sauf la poussière normale).
 - Bien aéré et loin des sources de chaleur, y compris du soleil direct.
 - A l'abri des chocs et des sources de vibrations.
 - Isolé de forts champs électromagnétiques générés par des appareils électriques.
 - Dans les régions sujettes aux orages magnétiques il est recommandé de brancher votre système à un supresseur de surtension, et de débrancher toutes les lignes de télécommunications de votre modem durant un orage.
 - Muni d'une prise murale correctement mise à la terre.
 - Suffisamment spacieux pour vous permettre d'accéder aux câbles d'alimentation (ceux-ci étant le seul moyen de mettre le système hors tension).
-

WARNUNG: Deutsch

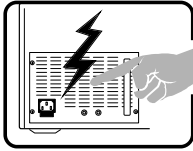

Benutzer können am Netzgerät dieses Produkts keine Reparaturen vornehmen. Das Produkt enthält möglicherweise mehrere Netzgeräte. Wartungsarbeiten müssen von qualifizierten Technikern ausgeführt werden.

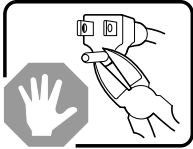

Versuchen Sie nicht, das mitgelieferte Netzkabel zu ändern oder zu verwenden, wenn es sich nicht genau um den erforderlichen Typ handelt. Ein Produkt mit mehreren Netzgeräten hat für jedes Netzgerät ein eigenes Netzkabel.

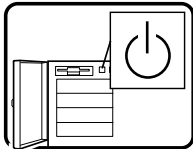

Der Wechselstrom des Systems wird durch den Ein-/Aus-Schalter für Gleichstrom nicht ausgeschaltet. Ziehen Sie jedes Wechselstrom-Netzkabel aus der Steckdose bzw. dem Netzgerät, um den Stromanschluß des Systems zu unterbrechen.

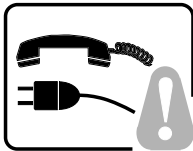

SICHERHEISSCHRIITTE: Immer wenn Sie die Gehäuseabdeckung abnehmen um an das Systeminnere zu gelangen, sollten Sie folgende Schritte beachten:

1. Schalten Sie alle an Ihr System angeschlossenen Peripheriegeräte aus.
2. Schalten Sie das System mit dem Hauptschalter aus.
3. Ziehen Sie den Stromanschlußstecker Ihres Systems aus der Steckdose.
4. Auf der Rückseite des Systems beschriften und ziehen Sie alle Anschlußkabel von den I/O Anschlüssen oder Ports ab.
5. Tragen Sie ein geerdetes Antistatik Gelenkband, um elektrostatische Ladungen (ESD) über blanke Metallstellen bei der Handhabung der Komponenten zu vermeiden.
6. Schalten Sie das System niemals ohne ordnungsgemäß montiertes Gehäuse ein.

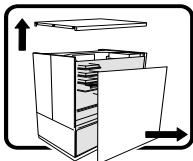

Nachdem Sie die oben erwähnten ersten sechs SICHERHEITSSCHRITTE durchgeführt haben, können Sie die Abdeckung abnehmen, indem Sie:

1. Öffnen und entfernen Sie die Verschlusseinrichtung (Padlock) auf der Rückseite des Systems, falls eine Verschlusseinrichtung installiert ist.
2. Entfernen Sie alle Schrauben der Gehäuseabdeckung.
3. Nehmen Sie die Abdeckung ab.

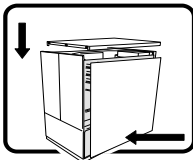

Zur ordnungsgemäßen Kühlung und Lüftung muß die Gehäuseabdeckung immer wieder vor dem Einschalten installiert werden. Ein Betrieb des Systems ohne angebrachte Abdeckung kann Ihrem System oder Teile darin beschädigen. Um die Abdeckung wieder anzubringen:

1. Vergewissern Sie sich, daß Sie keine Werkzeuge oder Teile im Innern des Systems zurückgelassen haben.
2. Überprüfen Sie alle Kabel, Zusatzkarten und andere Komponenten auf ordnungsgemäßen Sitz und Installation.
3. Bringen Sie die Abdeckungen wieder am Gehäuse an, indem Sie die zuvor gelösten Schrauben wieder anbringen. Ziehen Sie diese gut an.
4. Bringen Sie die Verschlusseinrichtung (Padlock) wieder an und schließen Sie diese, um ein unerlaubtes Öffnen des Systems zu verhindern.
5. Schließen Sie alle externen Kabel und den AC Stromanschlußstecker Ihres Systems wieder an.

Fortsetzung

WARNUNG: Deutsch (Fortsetzung)

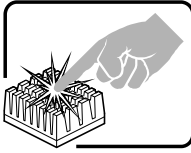

Der Mikroprozessor und der Kühler sind möglicherweise erhitzt, wenn das System in Betrieb ist. Außerdem können einige Platinen und Gehäuseteile scharfe Spitzen und Kanten aufweisen. Arbeiten an Platinen und Gehäuse sollten vorsichtig ausgeführt werden. Sie sollten Schutzhandschuhe tragen.

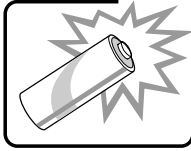

Bei falschem Einsetzen einer neuen Batterie besteht Explosionsgefahr. Die Batterie darf nur durch denselben oder einen entsprechenden, vom Hersteller empfohlenen Batterietyp ersetzt werden. Entsorgen Sie verbrauchte Batterien den Anweisungen des Herstellers entsprechend.

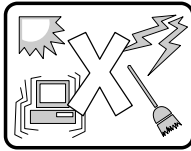

Das System wurde für den Betrieb in einer normalen Büroumgebung entwickelt. Der Standort sollte:

- sauber und staubfrei sein (Hausstaub ausgenommen);
 - gut gelüftet und keinen Heizquellen ausgesetzt sein (einschließlich direkter Sonneneinstrahlung);
 - keinen Erschütterungen ausgesetzt sein;
 - keine starken, von elektrischen Geräten erzeugten elektromagnetischen Felder aufweisen;
 - in Regionen, in denen elektrische Stürme auftreten, mit einem Überspannungsschutzgerät verbunden sein; während eines elektrischen Sturms sollte keine Verbindung der Telekommunikationsleitungen mit dem Modem bestehen;
 - mit einer geerdeten Wechselstromsteckdose ausgerüstet sein;
 - über ausreichend Platz verfügen, um Zugang zu den Netzkabeln zu gewährleisten, da der Stromanschluß des Produkts hauptsächlich über die Kabel unterbrochen wird.
-

AVVERTENZA: Italiano

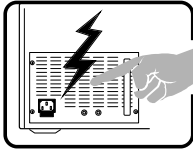

Rivolgersi ad un tecnico specializzato per la riparazione dei componenti dell'alimentazione di questo prodotto. È possibile che il prodotto disponga di più fonti di alimentazione.

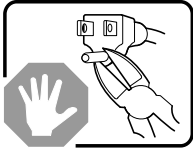

Non modificare o utilizzare il cavo di alimentazione in c.a. fornito dal produttore, se non corrisponde esattamente al tipo richiesto. Ad ogni fonte di alimentazione corrisponde un cavo di alimentazione in c.a. separato.

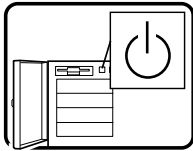

L'interruttore attivato/disattivato nel pannello anteriore non interrompe l'alimentazione in c.a. del sistema. Per interromperla, è necessario scollegare tutti i cavi di alimentazione in c.a. dalle prese a muro o dall'alimentazione di corrente.

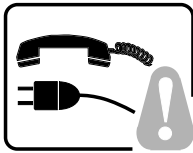

PASSI DI SICUREZZA: Qualora si rimuovano le coperture del telaio per accedere all'interno del sistema, seguire i seguenti passi:

1. Spegner tutti i dispositivi periferici collegati al sistema.
 2. Spegner il sistema, usando il pulsante spento/acceso dell'interruttore del sistema.
 3. Togliere tutte le spine dei cavi del sistema dalle prese elettriche.
 4. Identificare e sconnettere tutti i cavi attaccati ai collegamenti I/O od alle prese installate sul retro del sistema.
 5. Qualora si tocchino i componenti, proteggersi dallo scarico elettrostatico (SES), portando un cinghia anti-statica da polso che è attaccata alla presa a terra del telaio del sistema – qualsiasi superficie non dipinta – .
 6. Non far operare il sistema quando il telaio è senza le coperture.
-

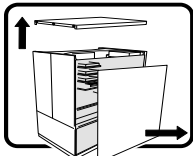

Dopo aver seguito i sei passi di SICUREZZA sopracitati, togliere le coperture del telaio del sistema come segue:

1. Aprire e rimuovere il lucchetto dal retro del sistema qualora ve ne fosse uno installato.
 2. Togliere e mettere in un posto sicuro tutte le viti delle coperture.
 3. Togliere le coperture.
-

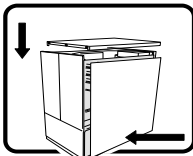

Per il giusto flusso dell'aria e raffreddamento del sistema, rimettere sempre le coperture del telaio prima di riaccendere il sistema. Operare il sistema senza le coperture al loro proprio posto potrebbe danneggiare i componenti del sistema. Per rimettere le coperture del telaio:

1. Controllare prima che non si siano lasciati degli attrezzi o dei componenti dentro il sistema.
 2. Controllare che i cavi, dei supporti aggiuntivi ed altri componenti siano stati installati appropriatamente.
 3. Attaccare le coperture al telaio con le viti tolte in precedenza e avvitarle strettamente.
 4. Inserire e chiudere a chiave il lucchetto sul retro del sistema per impedire l'accesso non autorizzato al sistema.
 5. Ricollegare tutti i cavi esterni e le prolunghe AC del sistema.
-

continua

AVVERTENZA: Italiano (continua)

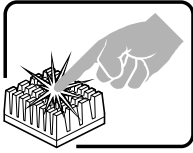

Se il sistema è stato a lungo in funzione, il microprocessore e il dissipatore di calore potrebbero essere surriscaldati. Fare attenzione alla presenza di piedini appuntiti e parti taglienti sulle schede e sul telaio. È consigliabile l'uso di guanti di protezione.

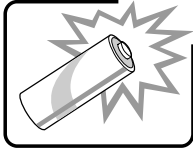

Esiste il pericolo di un'esplosione se la pila non viene sostituita in modo corretto. Utilizzare solo pile uguali o di tipo equivalente a quelle consigliate dal produttore. Per disfarsi delle pile usate, seguire le istruzioni del produttore.

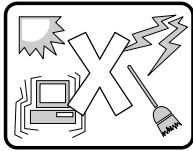

Il sistema è progettato per funzionare in un ambiente di lavoro tipo. Scegliere una postazione che sia:

- Pulita e libera da particelle in sospensione (a parte la normale polvere presente nell'ambiente).
 - Ben ventilata e lontana da fonti di calore, compresa la luce solare diretta.
 - Al riparo da urti e lontana da fonti di vibrazione.
 - Isolata dai forti campi magnetici prodotti da dispositivi elettrici.
 - In aree soggette a temporali, è consigliabile collegare il sistema ad un limitatore di corrente. In caso di temporali, scollegare le linee di comunicazione dal modem.
 - Dotata di una presa a muro correttamente installata.
 - Dotata di spazio sufficiente ad accedere ai cavi di alimentazione, i quali rappresentano il mezzo principale di scollegamento del sistema.
-

ADVERTENCIAS: Español

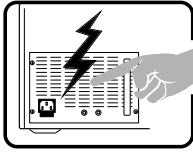

El usuario debe abstenerse de manipular los componentes de la fuente de alimentación de este producto, cuya reparación debe dejarse exclusivamente en manos de personal técnico especializado. Puede que este producto disponga de más de una fuente de alimentación.

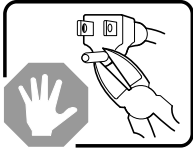

No intente modificar ni usar el cable de alimentación de corriente alterna, si no corresponde exactamente con el tipo requerido.

El número de cables suministrados se corresponden con el número de fuentes de alimentación de corriente alterna que tenga el producto.

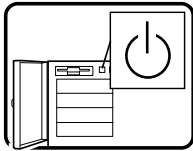

Nótese que el interruptor activado/desactivado en el panel frontal no desconecta la corriente alterna del sistema. Para desconectarla, deberá desenchufar todos los cables de corriente alterna de la pared o desconectar la fuente de alimentación.

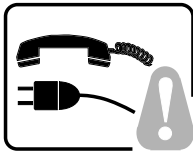

INSTRUCCIONES DE SEGURIDAD: Cuando extraiga la tapa del chasis para acceder al interior del sistema, siga las siguientes instrucciones:

1. Apague todos los dispositivos periféricos conectados al sistema.
 2. Apague el sistema presionando el interruptor encendido/apagado.
 3. Desconecte todos los cables de alimentación CA del sistema o de las tomas de corriente alterna.
 4. Identifique y desconecte todos los cables enchufados a los conectores E/S o a los puertos situados en la parte posterior del sistema.
 5. Cuando manipule los componentes, es importante protegerse contra la descarga electrostática (ESD). Puede hacerlo si utiliza una muñequera antiestática sujeta a la toma de tierra del chasis — o a cualquier tipo de superficie de metal sin pintar.
 6. No ponga en marcha el sistema si se han extraído las tapas del chasis.
-

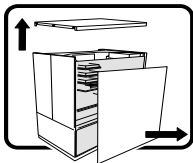

Después de completar las seis instrucciones de SEGURIDAD mencionadas, ya puede extraer las tapas del sistema. Para ello:

1. Desbloquee y extraiga el bloqueo de seguridad de la parte posterior del sistema, si se ha instalado uno.
 2. Extraiga y guarde todos los tornillos de las tapas.
 3. Extraiga las tapas.
-

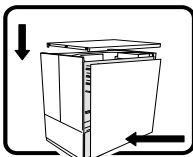

Para obtener un enfriamiento y un flujo de aire adecuados, reinstale siempre las tapas del chasis antes de poner en marcha el sistema. Si pone en funcionamiento el sistema sin las tapas bien colocadas puede dañar los componentes del sistema. Para instalar las tapas:

1. Asegúrese primero de no haber dejado herramientas o componentes sueltos dentro del sistema.
 2. Compruebe que los cables, las placas adicionales y otros componentes se hayan instalado correctamente.
 3. Incorpore las tapas al chasis mediante los tornillos extraídos anteriormente, tensándolos firmemente.
 4. Inserte el bloqueo de seguridad en el sistema y bloquéelo para impedir que pueda accederse al mismo sin autorización.
 5. Conecte todos los cables externos y los cables de alimentación CA al sistema.
-

continúa

ADVERTENCIAS: Español (continúa)

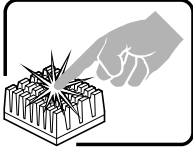

Si el sistema ha estado en funcionamiento, el microprocesador y el disipador de calor pueden estar aún calientes. También conviene tener en cuenta que en el chasis o en el tablero puede haber piezas cortantes o punzantes. Por ello, se recomienda precaución y el uso de guantes protectores.

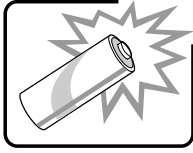

Existe peligro de explosión si la pila no se cambia de forma adecuada. Utilice solamente pilas iguales o del mismo tipo que las recomendadas por el fabricante del equipo. Para deshacerse de las pilas usadas, siga igualmente las instrucciones del fabricante.

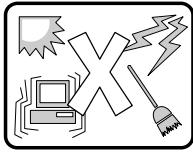

El sistema está diseñado para funcionar en un entorno de trabajo normal. Escoja un lugar:

- Limpio y libre de partículas en suspensión (salvo el polvo normal).
 - Bien ventilado y alejado de fuentes de calor, incluida la luz solar directa.
 - Alejado de fuentes de vibración.
 - Aislado de campos electromagnéticos fuertes producidos por dispositivos eléctricos.
 - En regiones con frecuentes tormentas eléctricas, se recomienda conectar su sistema a un eliminador de sobrevoltage y desconectar el módem de las líneas de telecomunicación durante las tormentas.
 - Provisto de una toma de tierra correctamente instalada.
 - Provisto de espacio suficiente como para acceder a los cables de alimentación, ya que éstos hacen de medio principal de desconexión del sistema.
-

7 Equipment Log and Power Consumption Worksheets

Equipment Log

Use the blank equipment log provided here to record information about your system. You will need some of this information when you run the SSU.

Item	Manufacturer Name and Model Number	Serial Number	Date Installed
System			
Server board			
Primary Processor speed and cache			
Secondary Processor speed and cache			
Video display			
Keyboard			
Mouse			
Diskette drive A			
CD-ROM drive			
Hard disk drive 1			
Hard disk drive 2			
Hard disk drive 3			
Hard disk drive 4			

continued

Current Usage

As an overall current usage limitation on the power supply, do not exceed a combined power output of 167 watts for the +5 and +3.3 volt outputs.

The PCI slots on the server board are rated at a maximum of 5 amperes per slot. The maximum power allowed for each slot is 20 watts at +5 volts. The average current usage per slot should not exceed 3.0 amperes per slot; that is, 15 watts.

The cooling efficiency varies per slot; therefore, ensure that adequate cooling is available in the target slot—especially in an expansion slot drawing more than 2.0 amperes.

Calculating Power Consumption

The total combined wattage for the system configuration must be less than the output of your power supply. Use the two worksheets in this section to calculate the power used by your server boards. For current and voltage requirements of add-in boards and peripherals, see your vendor documents.

Worksheet, Calculating DC Power Usage

1. List the current for each board and device in the appropriate voltage level column.
2. Add the currents in each column. Then go to the next worksheet.

Table 12. Power Usage Worksheet 1

Device	Current (maximum) at voltage level:				
	+3.3 V	+5 V	-5 V	+12 V	-12 V
Server board	1.0 A	8.0 A	0.1 A	1.1 A	0.4 A
Primary Processor					
Secondary Processor (if present)					
Terminator card, if no second processor	1.6 A				
Memory (four 128 MB DIMMs)	1.8 A	0.3 A			
PCI slot 1					
PCI slot 2					
1 st 3.5-inch hard disk drive					
2 nd 3.5-inch hard disk drive					
3 rd 3.5-inch hard disk drive					
4 th 3.5-inch hard disk drive					
3.5-inch diskette drive					
CD-ROM drive					
Cooling fan 1				.300	
Cooling fan 2				.300	
Total Current					

Worksheet, Total Combined Power Used by the System

1. From the previous worksheet, enter the total current for each column.
2. Multiply the voltage by the total current to get the total wattage for each voltage level.
3. Add the total wattage for each voltage level to arrive at a total combined power usage on the power supply.

Table 13. Power Usage Worksheet 2

Voltage level and total current (V X A = W)	Total Watts for each voltage level
(+3.3 V) X (_____ A)	_____ W
(+5 V) X (_____ A)	_____ W
(-5 V) X (_____ A)	_____ W
(+12 V) X (_____ A)	_____ W
(-12 V) X (_____ A)	_____ W
Total Combined Wattage	_____ W

Index

A

- add-in board, sensitive to ESD, 26
- Add-in boards
 - IDE bus slots, 16
 - ISA, 68
 - PCI, 68
- administrative password, 20
 - limiting access to SCU, 22
- Advanced Menu, configuring in Setup, 58
- audible beep error codes, 52

B

- Back Panel Connectors, 11
- battery
 - disposing of safely, 49
 - installing, 50
 - removing, 49
- beep codes, 52
- BIOS
 - changing the language, 98
 - recovering, 97
 - upgrading, 95
- BIOS update utility, 51
- BMC, 18
- boot block write protect default jumper, 118
- Boot Device Priority menu, configuring, Setup, 66
- Boot menu, configuring, Setup, 65
- boot sequence
 - booting without keyboard, 23
 - setting in Setup, 23
- booting cold, 101
- bus termination requirements, SCSI devices, 16

C

- cables, IDE bus length limit, 17
- Caution
 - avoid damaging jumpers when changing, 26
 - avoid touching processor pins, 30
 - DIMM types, matching, 33

- DIMMs, use extreme care when installing, 33
- ESD protection, 25
- installing chassis covers for cooling and airflow, 26
- leave boot block protect jumper at default, 118
- selecting correct heat sink, 30
- selecting correct processor, 30
- CFG files, 68
- chassis intrusion detection default jumper, 119
- Checking the Power Cord, 23
- CMOS
 - clear to reconfigure diskette drive, 53
 - retaining settings, 117
- configuration, limiting access to system with administrative password, 22
- configuring server board jumpers
 - boot block protect, 118
 - chassis intrusion detection, 119
 - FRB timer, enabling or disabling, 119
 - general procedure to change, 116
 - location on server board, 115
 - retaining CMOS settings, 117
 - retaining stored password, 117
- configuring system
 - SCU, 51
 - Setup, 51
- connector
 - fan, 114
 - front panel, 113
 - locations on server board, 112
- Console Redirection menu, configuring in Setup, 64, 65
- controller
 - baseboard management (BMC), 18
 - diskette (floppy), 17
 - IDE, 17
 - keyboard/mouse, 18
 - network, 9, 17
 - SCSI, 16
 - video, 9, 16
- cooling
 - heat sink for processor, 30
 - installing all covers for correct airflow, 26

D

- diagnostics, preparing system for testing, 104
- DIMM (memory), removing, 34
- diskette
 - drive controller, 17
 - enabling/disabling floppy writes, 22
 - installing drive in bay, 36
 - no booting in secure mode without password, 22
 - reconfiguring if cannot enter Setup, 53
 - removing bracket from drive, 35
 - removing drive from bay, 35
 - routing drive cable, 36
 - running SCU from, 51

E

- electrostatic discharge. *See* ESD
- Emergency Management Port
 - FRU viewer, 91
 - main console window, 84
 - phonebook, 88
 - requirements, 82
 - SDR viewer, 90
 - server control operations, 85
- Emergency Management Port Console, 19, 79
- EMP. *See* Emergency Management Port Console. *See* Emergency Management Port Console
- equipment log, 138
- error, messages, 52, 110
- ESD
 - add-in boards, 26
 - do not touch processor pins, 30
- Exit menu, configuring, Setup, 67
- expanded video memory, 16

F

- fan
 - connectors on server board, 114
 - heat sink, disconnecting, 32
- feature summary
 - back panel connectors, 11
 - board, 9
- Firmware update utility, 51
- Firmware Update Utility, 98
- FRB timer enable default jumper, 119

- front panel control board
 - connector on server board, 113
- FRUSDR load utility, 51
 - when to run, 92
- FRUSDR Load Utility, 92

H-I

- Hard Drive menu, configuring, Setup, 66, 67
- heat sink, fan, 30, 32
- hot key option, quick reference, 51
- I/O
 - PCI expansion slots, 9
 - ports provided, 9
- I2C bus for monitoring status, 18
- IDE
 - bus length limit, 17
 - controller, 17
 - feature summary, 16
 - primary, master and slave, configuring, Setup, 56
- Integrated Peripheral Configuration menu, configuring in Setup, 59
- intrusion detection, 18

J-L

- jumpers, do not damage when changing, 26
- keyboard
 - compatibility, 18
 - features, configuring, Setup, 57
 - lockout timer, setting in SCU, 18
- language, changing in BIOS, 98
- lithium backup battery
 - disposing of safely, 49
 - installing, 50
 - removing, 49

M

- Main power supply, connector, 114
- memory
 - amount tested, POST, 52
 - capacity, 9
 - DIMM size, 14
 - expansion, 14
 - removing DIMM, 34
 - video amount, 9
 - video size, 16
 - what type to install, 9

messages, error and informational, 110

monitoring server status, 18

mouse

compatibility, 18

inactivity timer, 18

N-P

network, controller, 9, 17

password, 21

administrative, 20

administrator, 21

entering to unblank screen, 22

retaining at system reset, 117

user, 20, 21

using to reactivate keyboard/mouse, 22

using to reactivate keyboard/mouse, 18

PCI

embedded devices, 9

expansion slots, 9

slot current ratings, 140

PCI Configuration Menu, configuring in Setup, 58

PCI Device, Embedded SCSI menu, configuring in Setup, 58, 60

PCI Device, Slot 1 - Slot 4 menu, configuring in Setup, 59

PEP. *See* Platform Event Paging

PEP Filter Submenu, 65

PEP Management Submenu, 64

Platform Event Paging, 20, 78

POST

countdown codes, 110

error messages, 52

memory, amount tested, 52

Power cord

length, 23, 126

obtaining, 126

power cords, disconnect all before opening system, 25

power on/off

locking on/off switch, Setup, 22

switch does not turn off AC power, 25, 126

power supply

calculating power usage, 140

current usage, 140

hazardous conditions, 25

main connector pins, 114

monitoring power state, 18

worksheet, calculating DC power, 141

problems

after running new application software, 102

after system has been running correctly, 103

application software, 109

bootable CD-ROM not detected, 109

cannot connect to network server, 108

CD-ROM drive activity light, 107

confirm OS loading, 104

diskette drive light, 107

hard drive light, 107

initial system startup, 101

network, 108

no characters on screen, 105

PCI installation tips, 109

power light, 105

preparing system for diagnostic testing, 104

random error in data files, 103

screen characters incorrect, 106

system cooling fans do not rotate, 106

system lights, 104

processor, 30

installing, 31

selecting the correct processor, 30

use grounded, static free surface, 32

processor description, 14

R

real time clock, running SCU to configure settings, 50

recovery boot jumper, retaining settings, 118

removing termination board, 31

reset system, 51, 101

S

SCI files, 68

SCSI, bus termination requirements, 16

SCSI controller, 16

SCU

administrative password limits access to, 22

changing configuration, 51

- diskette drive required to run SCU, 51
 - inactivity (lockout) timer, 18
- secure mode, 21
 - affects boot sequence, 23
 - enter by setting passwords, 22
 - locking reset and power on/off switches, 22
 - no booting from diskette without password, 22
 - using hot keys to enter, 51
- security, 22
 - boot sequence, 23
 - enabling/disabling floppy writes, 22
 - locking mouse, keyboard with timer, 18, 22
 - locking reset and power on/off switches, Setup, 22
 - password, 22
 - secure mode, 22
 - secure mode, setting in SCU, 21
 - unattended start, 23
 - using hot key combination, 51
 - video blanking, 22
- Security menu, configuring, Setup, 61
- server board
 - boot block protect, jumper, 118
 - chassis intrusion detection, jumper, 119
 - CMOS settings, jumper, 117
 - component locations, figure, 13
 - configuration jumpers, 116
 - configurations, 115
 - fan connectors, 114
 - FRB timer enable, jumper, 119
 - front panel connector, 113
 - password jumper, 117
 - recovery boot settings, jumper, 118
- server management
 - BMC, 18
 - features, 18
- Server Management, 9
- Server Management Information menu, configuring in Setup, 63
- Server menu, configuring in Setup, 62
- service, no user-serviceable parts, power supply, 25
- Setup
 - Advanced menu, 58
 - Boot Device Priority menu, 66
 - Boot menu, 65
 - cannot enter, need to reconfigure diskette, 53
 - changing configuration, 51
 - Console Redirection menu, 64, 65
 - description, 54
 - Exit menu, 67
 - Hard Drive menu, 66, 67
 - Integrated Peripheral Configuration menu, 59
 - keyboard features menu, 57
 - locking reset and power on/off switches, 22
 - Main menu, 55
 - PCI Configuration menu, 58
 - PCI Device, Embedded SCSI menu contents, 58, 60
 - PCI Device, Slot 1 - Slot 4 menu, 59
 - primary IDE master and slave menu, 56
 - recording settings, 53
 - security menu contents, 61
 - Server Management Information menu contents, 63
 - server menu contents, 62
- soft boot, 101
- SSU. *See* system setup utility
- switches
 - locking reset and power on/off, Setup, 22
 - power on/off, 25, 126
- Switches, DC power, 101
- System Configuration Utility. *See* SCU
- System setup utility
 - CFG files, 68
 - customizing, 71
 - defining an ISA card, 72
 - exiting, 77
 - launching a task, 71
 - location, 67
 - removing an ISA card, 73
 - running, 69
 - locally, 69
 - remotely, 69
 - SCI files, 68
 - when to run, 68

T-U

termination board, removing, 31

timer

 keyboard or mouse inactive, 18

 lockout (inactivity), setting in SCU, 18

upgrade Flash utility, 96

user password, 20

 limit access to using system, 23

utilities

 BIOS update, 51

 Emergency Management Port Console,
 19, 79

 Firmware update, 51, 98

 FRUSDR load, 51

 SCSI, 51

 SCU, 51

 Setup, 51, 53

Utilities, FRUSDR load utility, 92

V-W

video

 blanking for security, 22

 controller, 16

 expansion, 16

 memory, 9

 resolutions supported, 16

video controller, 9

video memory, 16

Warning

 components may be hot, 30

 disconnect power cords, cables, 25

 dispose of lithium battery safely, 49

 no user-serviceable parts, power
 supply, 25

 power on/off switch, 25, 126

Warnings

 translations

 English, 128

 French, 130

 German, 132

 Italian, 134

 Spanish, 136

worksheet, calculating DC power usage, 141

write protect boot block, jumper, 118

write to diskette, disabling, 22

