



**PLEASE CHECK FOR CHANGE INFORMATION  
AT THE REAR OF THIS MANUAL.**

**P6046  
PROBE  
AND  
AMPLIFIER**

**INSTRUCTION MANUAL**

**Tektronix, Inc.**  
**P.O. Box 500**  
**Beaverton, Oregon 97077**  
  
070-0756-00  
Product Group 60

Serial Number \_\_\_\_\_

First Printing JAN 1968  
Revised MAY 1986

Copyright © 1968 Tektronix, Inc. All rights reserved.  
Contents of this publication may not be reproduced in any  
form without the written permission of Tektronix, Inc.

Products of Tektronix, Inc. and its subsidiaries are covered  
by U.S. and foreign patents and/or pending patents.

TEKTRONIX, TEK, SCOPE-MOBILE, and  are  
registered trademarks of Tektronix, Inc. TELEQUIPMENT  
is a registered trademark of Tektronix U.K. Limited.

Printed in U.S.A. Specification and price change privileges  
are reserved.

### INSTRUMENT SERIAL NUMBERS

Each instrument has a serial number on a panel insert, tag,  
or stamped on the chassis. The first number or letter  
designates the country of manufacture. The last five digits  
of the serial number are assigned sequentially and are  
unique to each instrument. Those manufactured in the  
United States have six unique digits. The country of  
manufacture is identified as follows:

B000000	Tektronix, Inc., Beaverton, Oregon, USA
100000	Tektronix Guernsey, Ltd., Channel Islands
200000	Tektronix United Kingdom, Ltd., London
300000	Sony/Tektronix, Japan
700000	Tektronix Holland, NV, Heerenveen, The Netherlands

# CONTENTS

- Section 1 Characteristics
- Section 2 Operating Instructions
- Section 3 Circuit Description
- Section 4 Maintenance
- Section 5 Performance Check
- Section 6 Calibration

Abbreviations and Symbols  
Parts Ordering Information

## Section 7 Electrical Parts List

## Section 8 Mechanical Parts List Information

## Section 9 Mechanical Parts List

- Diagrams
- Mechanical Parts List Illustrations
- Accessories

Abbreviations and symbols used in this manual are based on or taken directly from IEEE Standard 260 "Standard Symbols for Units", MIL-STD-12B and other standards of the electronics industry. Change information, if any, is located at the rear of this manual.

SEE PARTS LIST FOR SEMICONDUCTOR TYPES

SERIES M MODEL 1,2,3

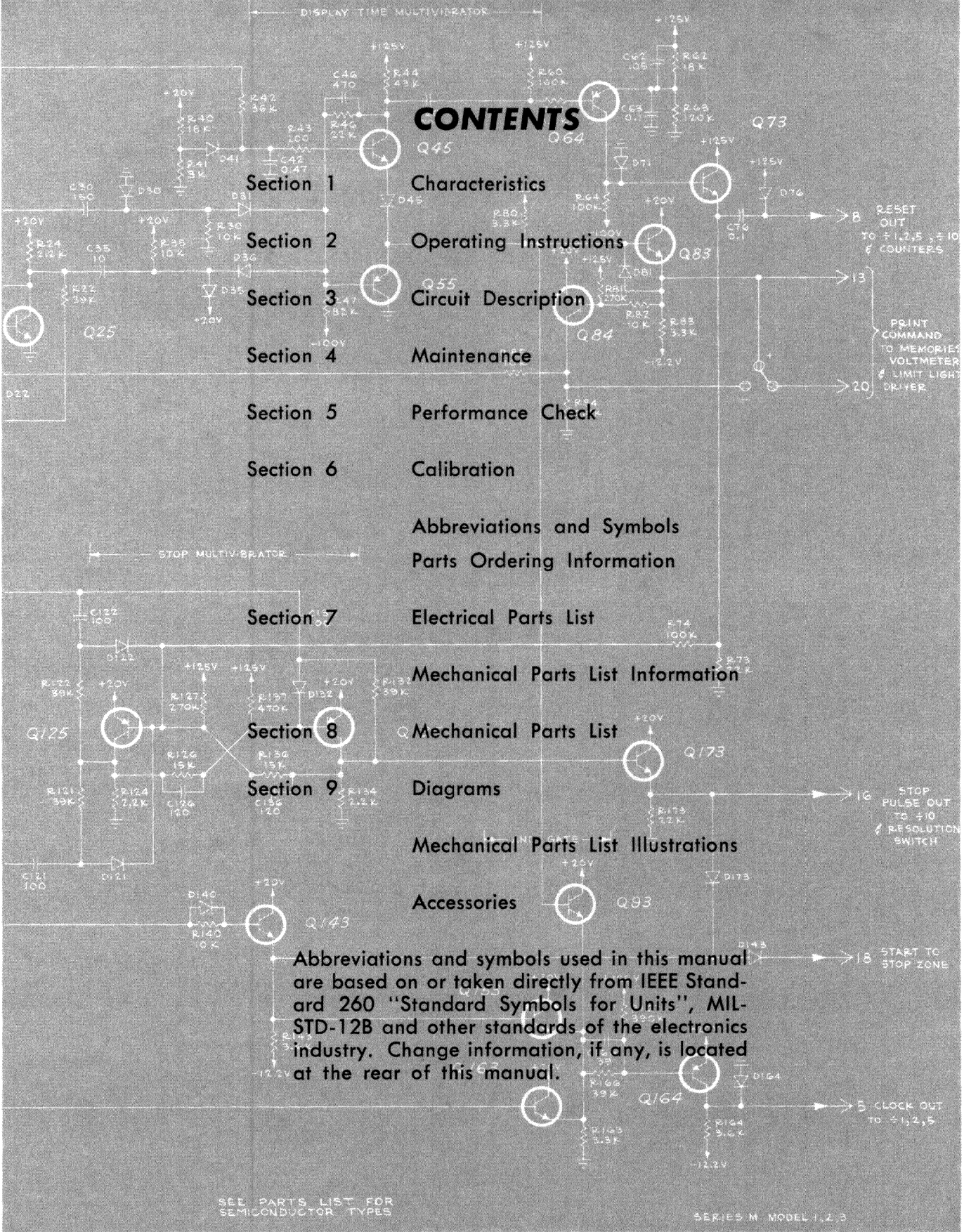

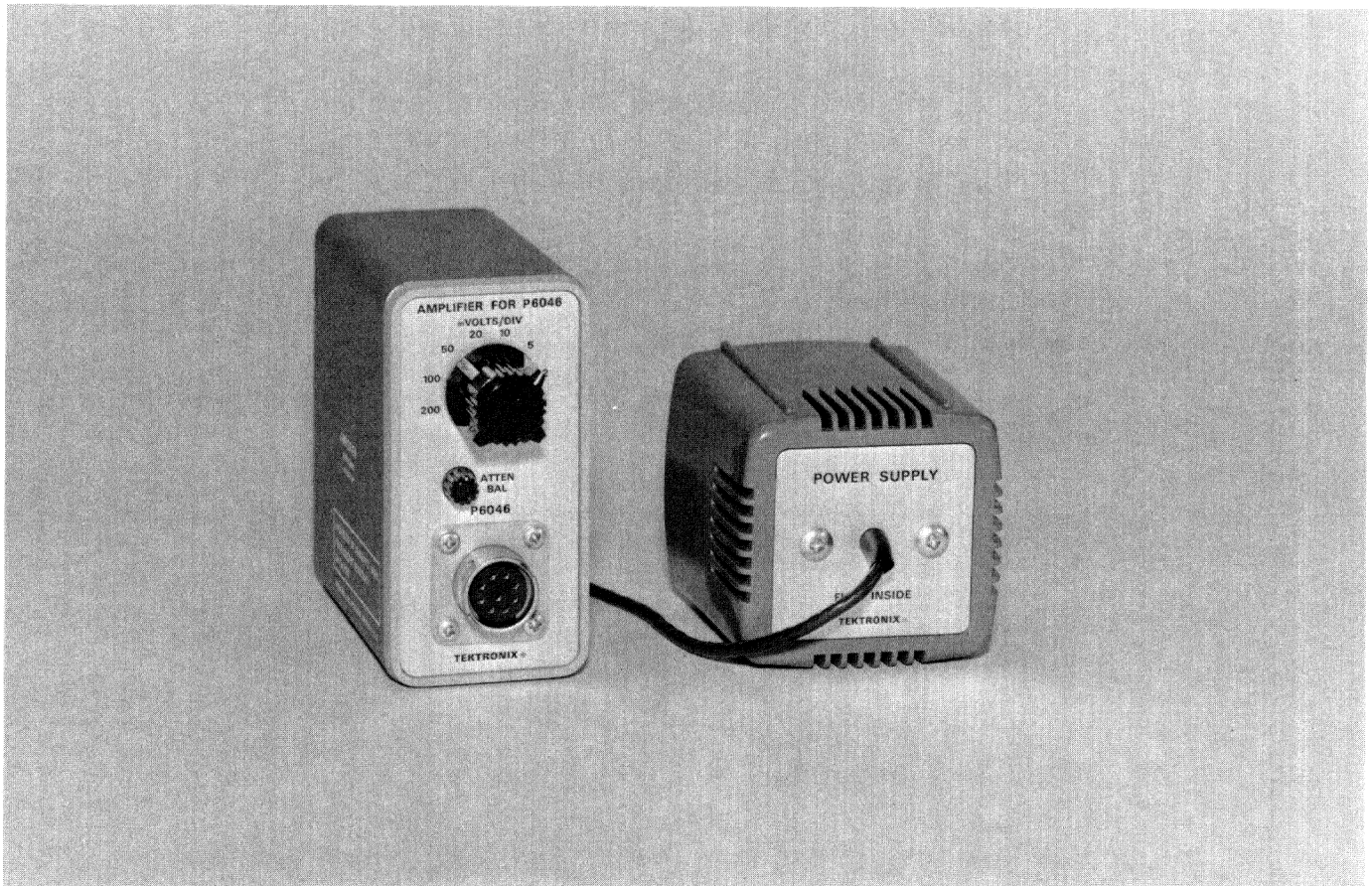
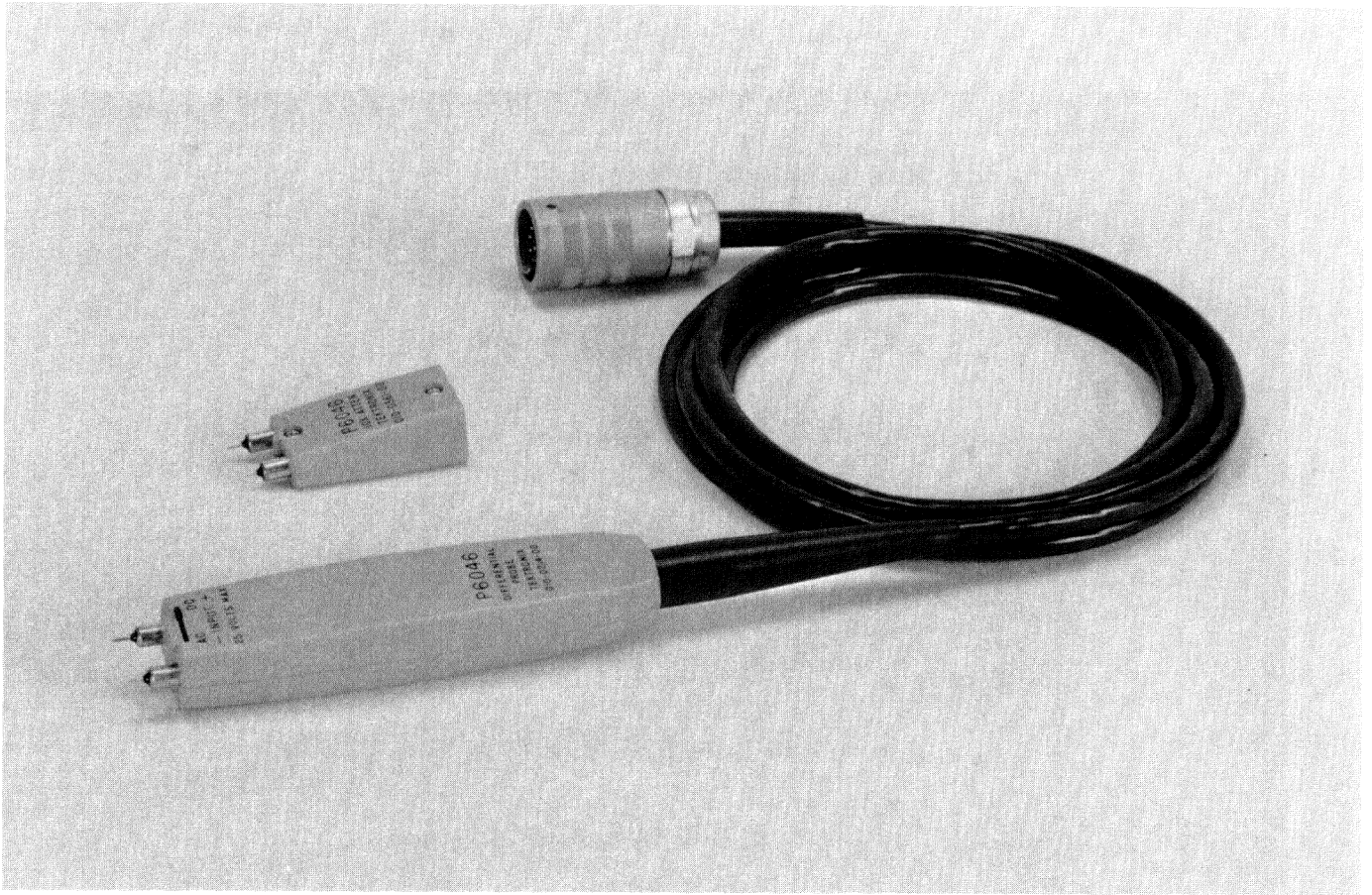

Fig. 1-1. P6046 Differential Probe and Amplifier For P6046.

# SECTION 1

## CHARACTERISTICS

Change information, if any, affecting this section will be found at the rear of the manual.

### General Information

The P6046 Differential Probe is an active, dual input probe designed for use with the Tektronix Type 1A5 Differential Amplifier or the "Amplifier For P6046". High common-mode rejection ratios are provided at high frequencies by performing the common-mode rejection within the probe body. Calibrated vertical deflection factors of from 1 mV through 200 mV/division (in 1, 2, 5 sequence) can be selected by switching at the Type 1A5 or at the Amplifier for P6046. These deflection factors can be increased to ten times the indicated amount through use of a calibrated Dual Attenuator Head, which is a standard accessory to the P6046 Probe.

The Probe and Type 1A5 combination has a 45 MHz bandwidth when used with an appropriate oscilloscope. The Probe and Amplifier For P6046 combination has a 100 MHz bandwidth. This provides a 70 MHz overall system bandwidth when the Probe and Amplifier are operated into the single-ended input of any 100 MHz oscilloscope having a vertical deflection factor of 10 mV/division.

The Probe has a 5-V common-mode operating range and a 25-V maximum input which can be extended by a factor of ten through use of the Dual Attenuator Head.

### Characteristics

A summary of the P6046 Differential Probe electrical characteristics, and pertinent mechanical and environmental characteristics are contained in Table 1-1. Specifications pertain to operation with both the Type 1A5 and the Amplifier For P6046, except where noted otherwise.

Fig. 1-2, 1-3, and 1-4 contain graphs of common-mode rejection ratios (CMRR) under different equipment setups at 25°C. MINIMUM refers to the values required to meet specifications. TYPICAL indicates the approximate values which most probes will obtain.

Fig. 1-5 shows how CMRR varies as temperature deviates from 25°C. For example, if the Probe is to be operated at 20°C to test a 50 MHz circuit, the specified CMRR should be multiplied by 0.95 to determine the minimum CMRR value which may be expected.

Fig. 1-6 displays the effect that source impedance has on the gain of the Probe as a function of frequency. It can be applied to differential operation as follows: Relate the upper graph to the display amplitude ÷ input signal when the signal source impedances are matched (up to a 5:1 source impedance ratio); Relate the lower graph to the display amplitude ÷ input amplitude when the signal source impedances are greatly mis-matched.

### Accessories

A number of accessories which extend operating capabilities are supplied with the P6046 Probe and the Amplifier For P6046 as Standard Accessories. These are listed on the last page of the Mechanical Parts List.

An optional accessory which must be used during Probe calibration is listed in the Calibration section. Additional miscellaneous accessories are listed in the Tektronix catalog. All accessories can be purchased through the Tektronix Field Office.

**TABLE 1-1**  
**CHARACTERISTICS**

Characteristic	Performance Requirement at 25°C		Supplemental Information
Step Response			
With Type 1A5	Bandwidth	Risetime	
5 to 200 mV/CM	≥ 45 MHz	≤ 7.8 ns	
2 mV/CM and 20 mV/CM—Retained Range	≥ 43 MHz	≤ 8.1 ns	
1 mV/CM and 10 mV/CM—Retained Range	≥ 38 MHz	≤ 9.2 ns	
With Amplifier For P6046	Bandwidth	Risetime	
1 mV/DIV through 200 mV/DIV	≥ 100 MHz	≤ 3.5 ns	Bandwidth in 1 and 2 mV/DIV positions decreases to 90 MHz at 50°C.

## Characteristics—P6046 Probe and Amplifier

Characteristic	Performance Requirement	Supplemental Information
Ringing, Rounding, Over-shoot and Tilt With Type 1A5	$\leq \pm 4\%$ ( $\leq 6\%$ peak to peak) in first 70 ns $\leq \pm 1.5\%$ ( $\leq 2\%$ peak to peak) thereafter	Percent of deviation specification increases by 4% within the first 10 ns at 0°C and +50°C.
With Amplifier For P6046	$\leq \pm 2\%$ ( $\leq 2\%$ peak to peak) after the first 70 ns	
2 to 200 mV/DIV	$\leq \pm 4\%$ ( $\leq 5\%$ peak to peak) in first 70 ns	
1 mV/DIV	$\leq \pm 5\%$ ( $\leq 6\%$ peak to peak) in first 70 ns	
AC Low Frequency Response Basic (1X)	20 Hz	At 70% Voltage point (−3 dB)
With 10X Dual Attenuator Head	2 Hz	
Deflection Factor Basic (1X)	1 mV/div to 200 mV/div calibrated in 1, 2, 5 steps	1 mV/div through $\geq 500$ mV/div uncalibrated with 1A5
With 10X Dual Attenuator Head	10 mV/div to 2 V/div calibrated in 1, 2, 5 steps	10 mV/div through $\geq 5$ V/div uncalibrated with 1A5
mV/div Accuracy With Type 1A5 1 mV/CM to 20 mV/CM		Within 2%; function of Type 1A5
50 mV/CM to 200 mV/CM	Within 4%	Function of Probe and Type 1A5
With Amplifier For P6046	Within 3%	1 mV through 200 mV/DIV
Dual Attenuator Head	Within 2%	Probe and Type 1A5 or Probe and Amplifier For P6046 accuracy must also be considered
Source impedance effect on gain as a function of frequency Basic (1X)		See Fig. 1-6
With 10X Dual Attenuator Head		Typically within 1.5%
Common-Mode Operating Range DC to 10 MHz	$\pm 5$ V (DC + peak AC) from average signal level; not exceeding $\pm 5$ V with respect to ground	
10 MHz to 50 MHz	Decreasing from $\pm 5$ V (DC + peak AC) at 10 MHz to $\pm 2$ V at 50 MHz	
Linear Differential Input Range	$\pm 10$ div	
Common Mode Rejection Ratio, 25°C		Typically 100:1 at 100 MHz when used with Amplifier For P6046.
1 mV through 20 mV/div	See Fig. 1-2	See Fig. 1-5 for temperature effects
50 mV/div through 200 mV/div	See Fig. 1-3	Also pertains to 10 and 20 mV-Retained Range positions of Type 1A5
In combination with 10X Dual Attenuator Head	See Fig. 1-4	
Input Resistance Probe	1 M $\Omega$ $\pm 1\%$	See Fig. 1-7.
10X Dual Attenuator Head	10 M $\Omega$ $\pm 2\%$	
Input Capacitance Probe		10 pF or less; see Fig. 1-7.
10X Dual Attenuator Head		3 pF or less
DC Thermal Drift Probe	Equivalent to $\leq 250$ $\mu$ V/°C at Probe head	
Amplifier	$\leq 200$ $\mu$ V/°C	$\leq 450$ $\mu$ V/°C combined drift of Probe and Amplifier

Characteristic	Performance Requirement	Supplemental Information		
Displayed Noise With Type 1A5	200 $\mu$ V tangentially measured	RMS value is approximately $\frac{1}{2}$ of the tangentially measured value. Peak to peak value is approximately 5.1 times RMS.		
	With Amplifier For P6046			
DC Shift Due to Overdrive	1.5% or less of input signal			
Overdrive Recovery Time With Type 1A5	0.15 $\mu$ s or less (to within 10 mV of DC shifted level)	5 V Input		
	With Amplifier For P6046			
Maximum Allowable Input	25 V total DC + Peak AC; 25 V total difference between + and - Input tips	AC or DC-coupled		
Gate Leakage Current	$\leq 0.3$ nA at 25°C	$\leq 2$ nA at 50°C		
Warm-up Time	20 minutes for rated accuracies at 25° C $\pm 5^\circ$ C			
Amplifier For P6046 Operating Voltage	90 to 136 V or 180 to 272 V AC, 50 to 400 Hz	Change power connections for range and voltage within range. See Table 4-3.		
Temperature	Non-operating			
	Operating			
Altitude	Non-operating	To 50,000 feet	May be tested during Non-operating Temperature tests at -40°C	
	Operating	To 15,000 feet		
Humidity	Non-operating	5 cycles MIL-STD-202C, Method 106B, omitting freezing and vibration subcycles.		
Vibration	Operating	15 minutes each axis at 0.015 inch. Frequency varied from 10-50-10 c/s in 1-minute cycles with instrument secured to vibration platform. Three minutes each axis at any resonant point or at 50 c/s.		
Shock	Non-operating Probe Body	400 g's $\frac{1}{2}$ sine; 6 shocks along transverse axis at $\frac{1}{2}$ ms, 1 ms and 2 ms duration (total of 18 shocks); 3 additional shocks in longitudinal axis at $\frac{1}{2}$ ms, 1 ms and 2 ms (total of 9)		
	Amplifier			
Transportation	Package Vibration	1 hour at 1 g		
	Package Drop	30 inches on 1 corner, all edges radiating from that corner and all flat surfaces for a total of 10 drops		
Dimensions (inches)		H	W	L
Probe Body		0.75	1	5
Cable				72
Amplifier		3.6	1.9	5
Power Supply		3.5	2.5	2.6
Power Cable				54

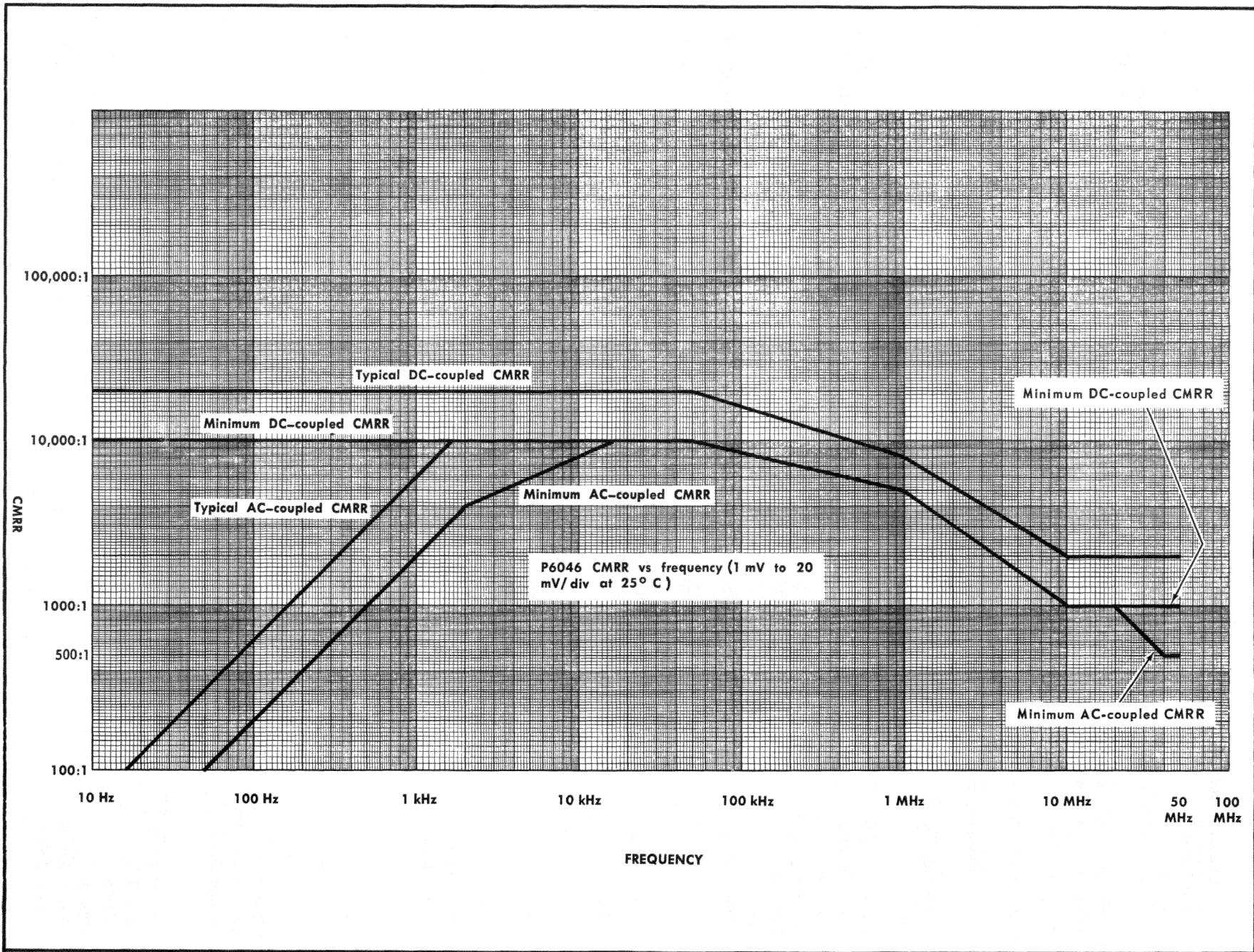

Fig. 1-2. P6046 CMRR versus frequency for 1 mV through 20 mV/division at 25° C.



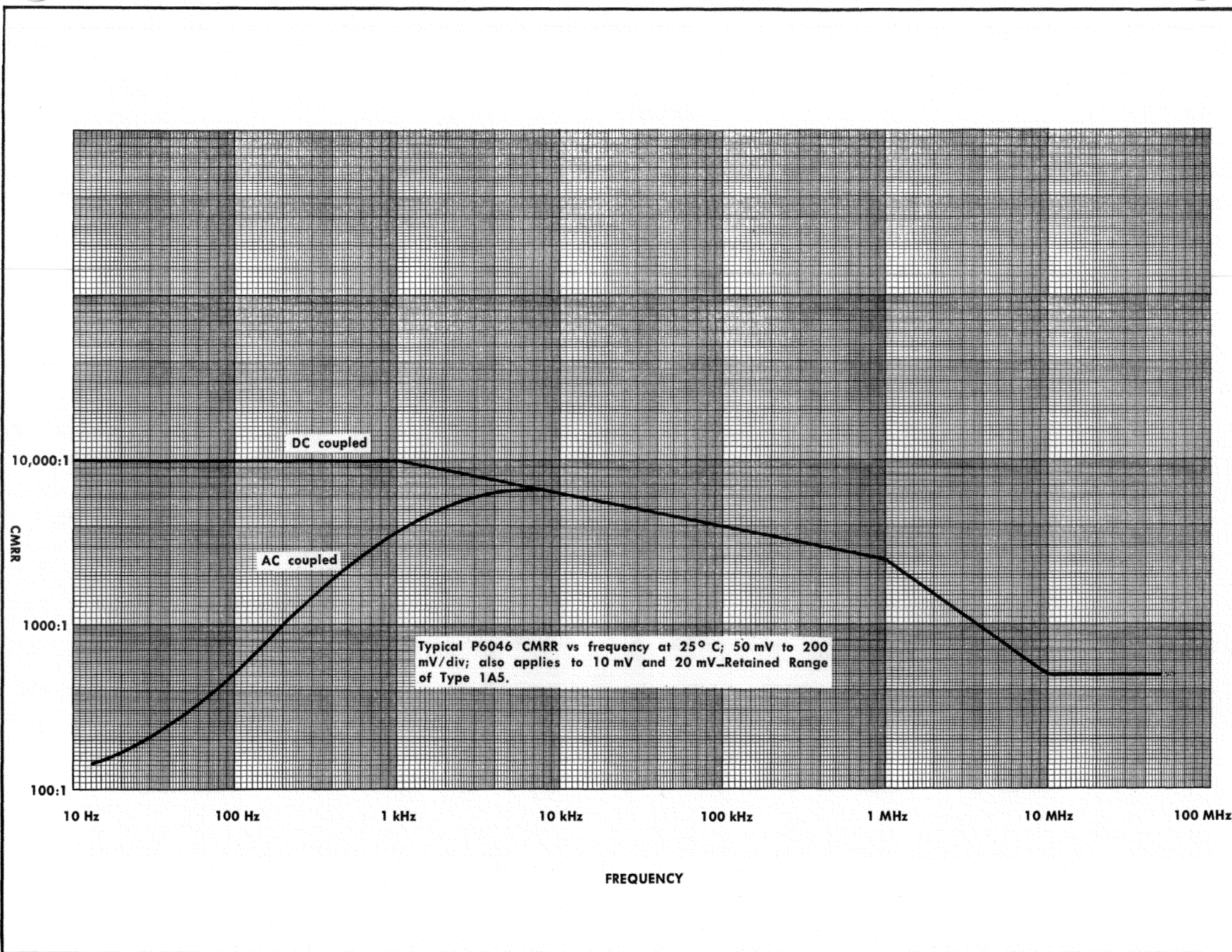

Fig. 1-3. Typical P6046 CMRR versus frequency for 50 mV through 200 mV division at 25° C. Also applies to 10 and 20 mV—Retained Range positions of Type 1A5.

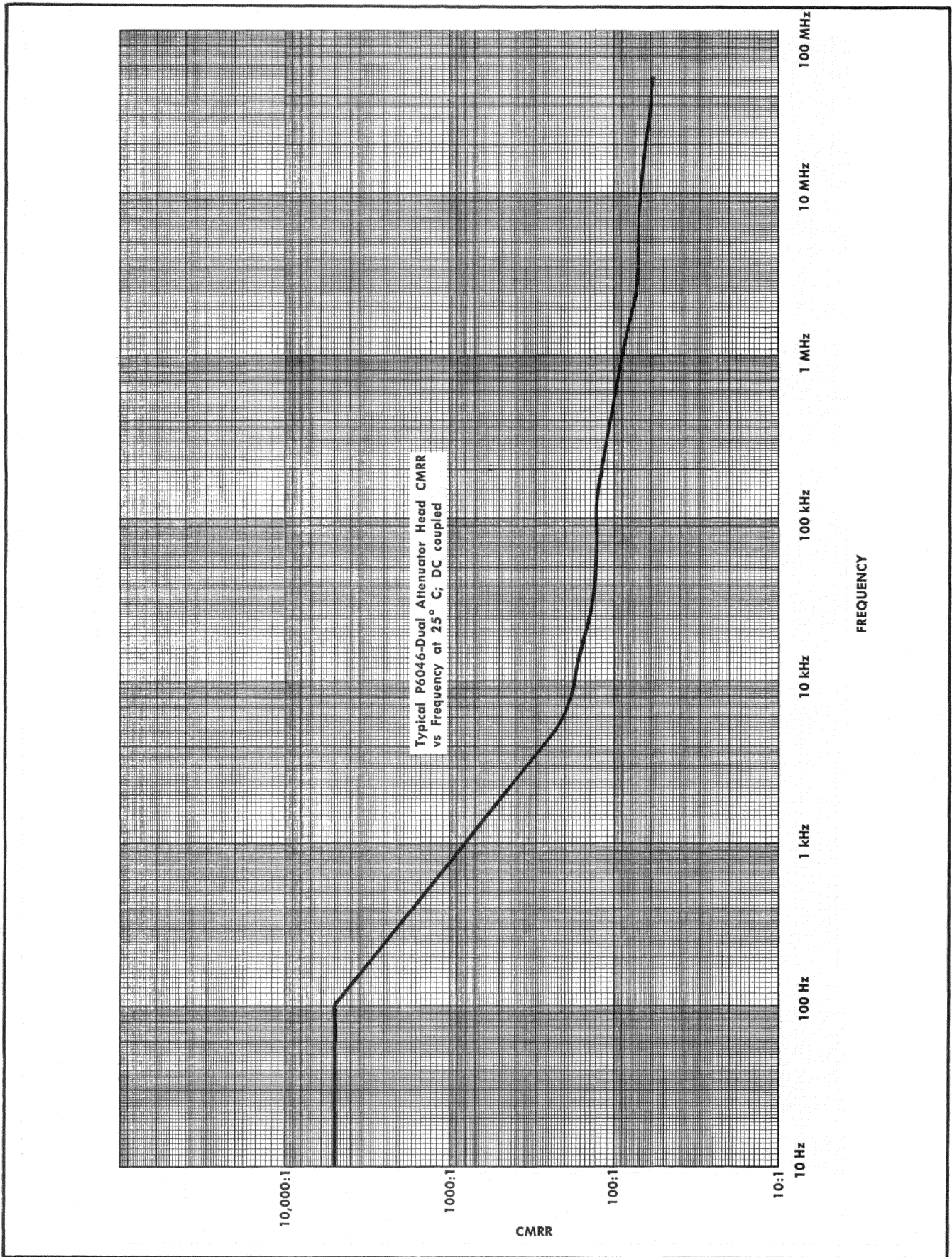

Fig. 1-4. Typical DC-coupled CMRR versus frequency of P6046 Differential Probe with the Dual Attenuator Head Attached; temperature 25° C.

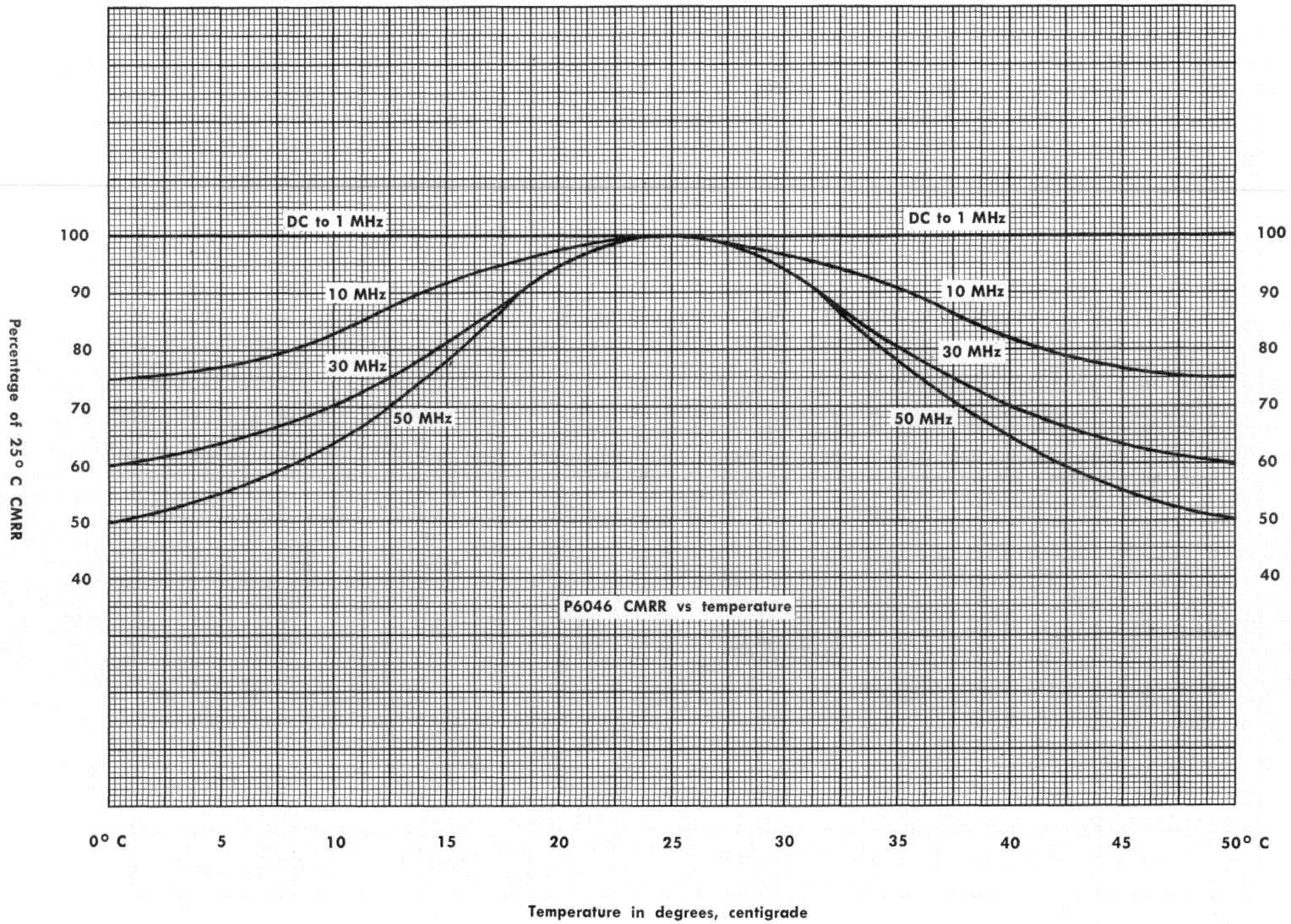

Fig. 1-5. P6046 Probe CMRR variation with temperature; 1 mV through 20 mV/division.

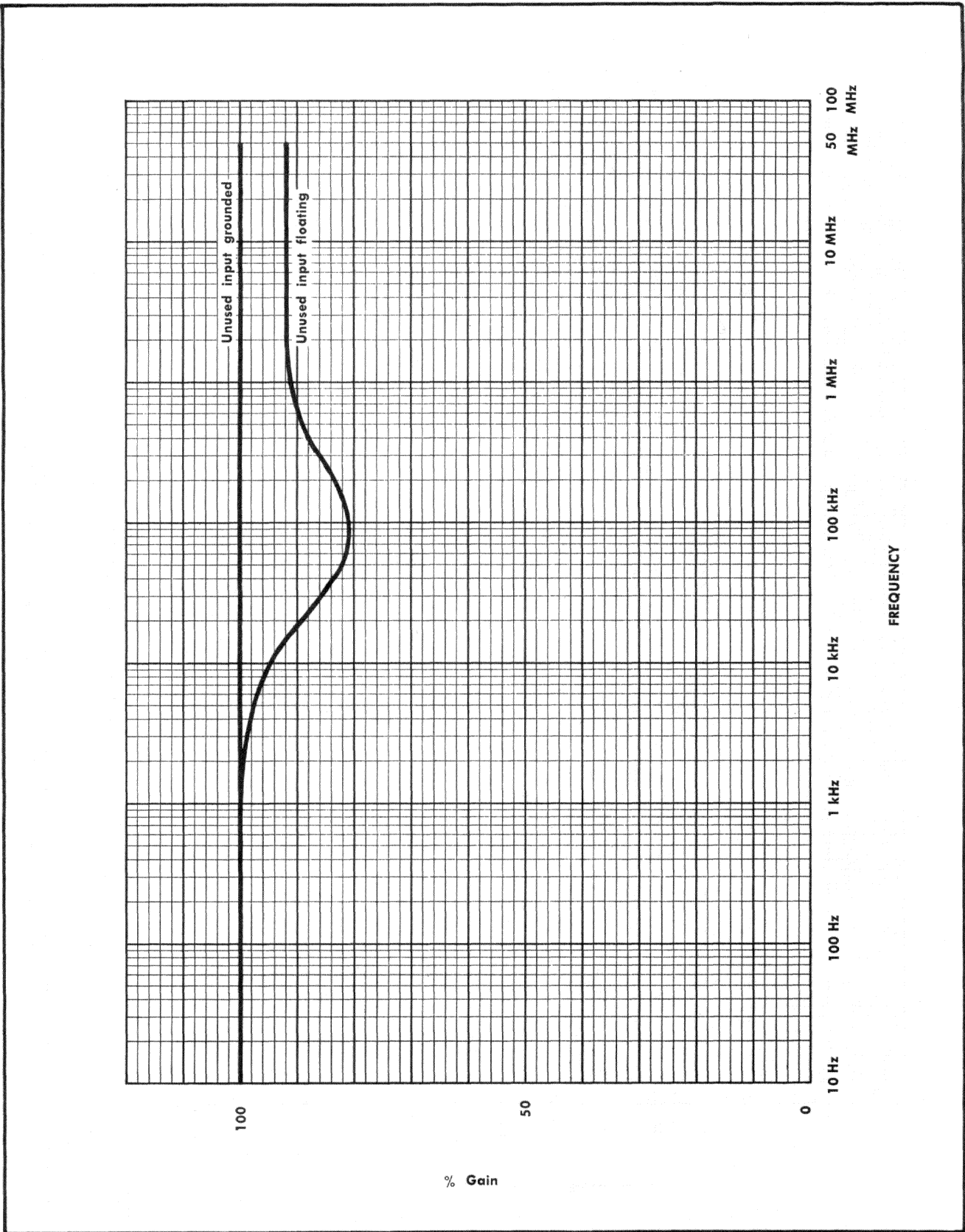

Fig. 1-6. Source impedance effect on gain as a function of frequency.

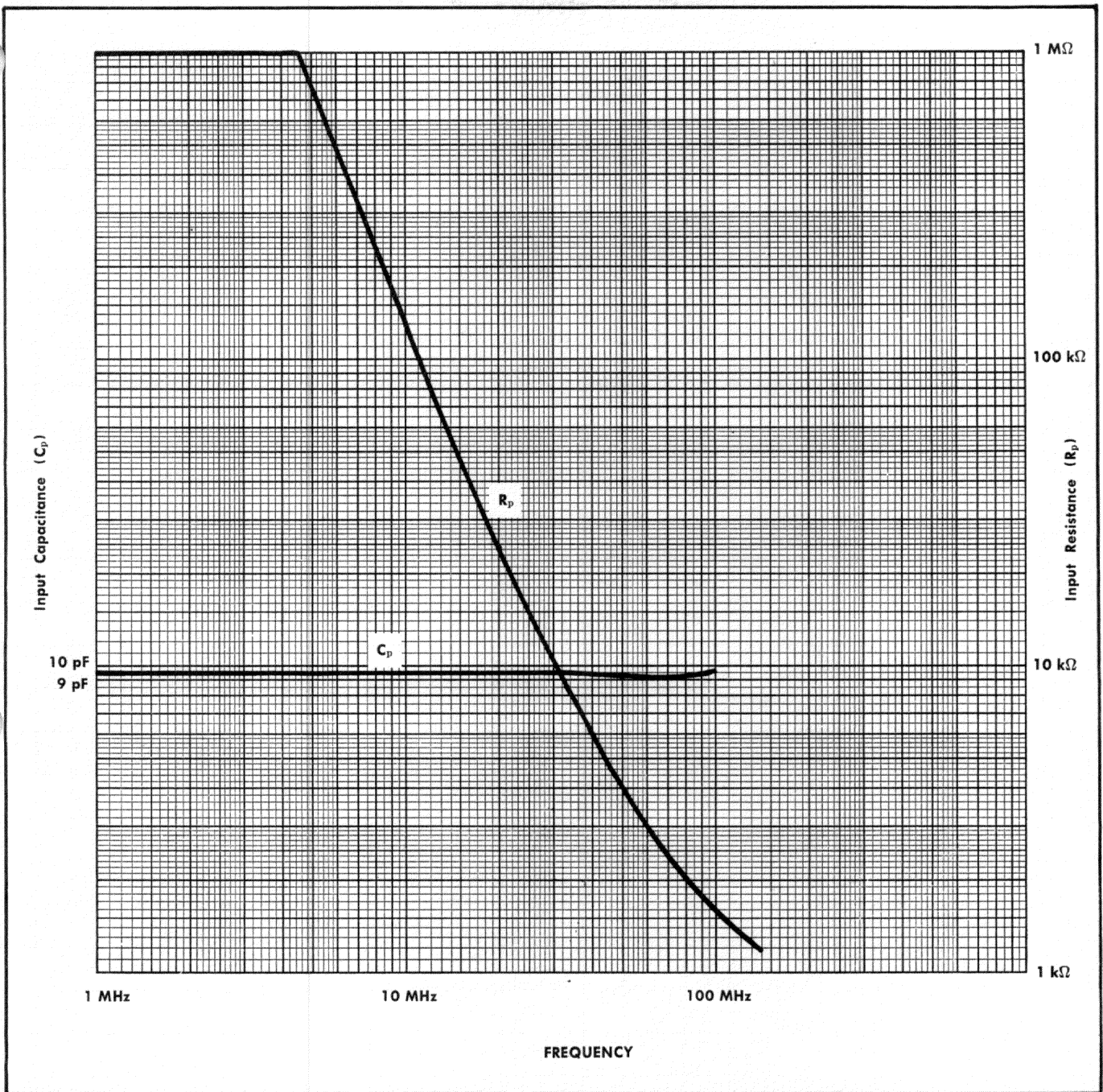

Fig. 1-7. P6046 Input capacitance ( $C_p$ ) and resistance ( $R_p$ ) versus frequency. (Input to positive tip; negative tip grounded).



# SECTION 2

## OPERATING INSTRUCTIONS

Change information, if any, affecting this section will be found at the rear of the manual.

### CAUTION

Operating the P6046 Differential Probe without a common reference (ground) between it and the unit under test may destroy components in the Probe input circuitry. Connect a ground lead from the probe grounding lug to the equipment to be tested before touching the Probe to the equipment or its test jacks.

### Introduction

The P6046 Differential Probe is essentially a differential amplifier with unity gain. Proper operation of it is dependent upon a basic knowledge of differential principles. A summary of these principles therefore precedes the operating instructions.

### GENERAL DIFFERENTIAL AMPLIFIER INFORMATION

An oscilloscope with a differential amplifier is a device that amplifies and displays a voltage difference which exists at every instant between signals applied to its two input connectors. The following conclusions can be drawn from this definition.

1. If the two signals are in phase and of equal amplitude (hereafter called common mode), the output will be zero.
2. If the two signals are in phase but of different amplitudes, the output will equal the amplitude difference.
3. If the two signals are out of phase and of equal amplitude the output will be the phasor difference between the two signals (sinusoidal signals).
4. If the two signals are out of phase and of different amplitudes, the output signal will be a complex quantity derived from both amplitude and phase differences.

### Common Mode Rejection

The definition of the term "differential amplifier" implies a rejection of equal amplitude, coincident signals. This implication is correct. However, the degree of rejection depends primarily on the symmetry of the amplifier inputs. The amount of difference signal contributed by a particular amplifier at a specific frequency is documented with a mathematical relationship that is called the common-mode rejection ratio (CMRR). This ratio and associated terms are defined as follows:

**Common Mode**—Refers to signals that are identical in both amplitude and time. It is also used to identify the respective parts of two signals that are identical in amplitude and time.

**Common-Mode Rejection Ratio**—A ratio which expresses the efficiency of a device in preventing common-mode signals from affecting its output. A differential amplifier, like all other things, cannot be a perfect device. Some output signal, however small, always occurs in response to common-mode signals applied to the two inputs. In any specific instance, an output resulting from application of common-mode signals can be duplicated by grounding one input and applying a specific size signal to the second input. The comparison of the common-mode signal to the single-ended signal is the Common-Mode Rejection Ratio of the device. See Fig. 2-1.

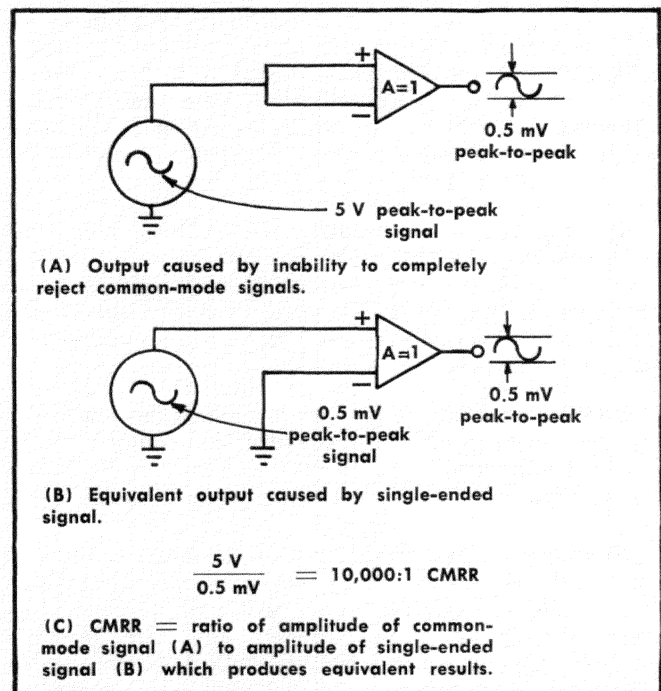

Fig. 2-1. Common-mode rejection ratio.

### NOTE

Since the differential amplifier is part of an oscilloscope, the output signal used to calculate the CMRR is measured from the CRT display and VOLTS/CM switch setting.

## Factors Which Affect CMRR

**Frequency.** Since the common-mode rejection ratio is affected by the gain and phase shift introduced by the two sides of the amplifier, the frequency of the input common-mode signal has a direct bearing on the CMRR. Generally, as the frequency of the input signal increases, the CMRR decreases. (Exception: with AC-coupled inputs the CMRR will become higher as frequency is increased from DC to over 1 kHz).

**Source Impedance.** To obtain optimum CMRR, points being measured must have identical source impedance. The source impedance and the amplifier input impedance form an RC divider which determines the portion of the signal that appears across the amplifier input. Unequal source impedances show up as an apparent decrease in CMRR.

**Signal Transporting Leads.** The input connectors of a differential amplifier are usually remote from the actual signal source. Even with a portable amplifier such as the P6046 Probe, some transporting of the signal is required from the source to connectors which are compatible with the Probe inputs.

Several undesirable effects can be introduced by transporting leads. If they are unshielded, stray pickup will occur. Differences between the stray pickup in the two leads will be accepted by the differential amplifier as signals. The capacitance of unshielded leads is relatively unpredictable and will vary with the lead location. AC signals will be affected by this (especially at high frequencies), and a difference between the source signal and that delivered to the differential amplifier will occur. Unless the introduced difference is equal in both leads, the amplifier will again see a differential signal that is not actually present at the sources. See Fig. 2-2.

The capacitance of shielded cables affects signals, just as it does in unshielded leads. However, the capacitance of shielded cables is known and can be kept relatively equal by matching the two signal cables in every respect. The cables should normally be short to keep their capacitance as low as possible.

Signal transporting cables can also affect the source signal by causing reflections. These reflections can be eliminated by terminating the cables in their characteristic impedance unless prohibitive source-loading would result.

**Attenuators.** Any device (such as capacitors or resistors) connected between the source and the amplifier, unless perfectly matched, will also cause additional differences between the signals at the amplifier. Attenuators therefore normally lower a system's common-mode rejection capabilities. This is illustrated in Fig. 2-3 and its accompanying table.

**Ground Connections.** In addition to providing a common reference for safety reasons, proper ground connections are essential for eliminating signal interference caused by ground loop currents. Ground leads should be as short as possible in all instances. A ground lead should accompany each signal lead to the proximity of the test jack. The shield of the signal's coaxial cable is usually used for this purpose.

Probe input tips very often are accidentally touched to equipment ground during insertion into test jacks. If sufficient difference exists between the differential amplifier reference and reference for the equipment being tested, valuable input components can be destroyed. Proper grounding will also eliminate this problem.

## P6046 DIFFERENTIAL PROBE CONTROLS, CONNECTORS AND ACCESSORIES

The P6046 Probe and accessories are shown in Fig. 2-4. The P6046 Probe has an Amphenol power and signal connector, dual signal input tips, and an AC-DC Input Coupling switch which controls the mode of coupling for both tips. Accessories and their uses are as follows:

1. Dual Attenuator Head—Provides  $10\times$  attenuation of signals applied to its inputs. Attaches directly to P6046 Probe tips. Has same tip configuration as the Probe.

2. Swivel Tips—Sleeve-type connectors which fit individually over probe tip input connectors. Not equipped with coaxial ground connectors. They adapt the probe tips to terminals whose spacings are between  $\frac{3}{16}$  and  $1\frac{1}{2}$  inches.

3. Spring Ground Clip—Clips to coaxial ground at probe tip. Equipped with wire-soldering lug.

4. Special Ground Tip—Sleeve-type adapter. Internally short tip to coaxial ground connection. Adapts Probe for single-ended operation. A common ground connection between the Probe and the equipment under test is still required.

5. Test Jacks—Coaxial female connectors, normally installed permanently into or near the equipment being tested. Spacing should conform to the  $\frac{1}{2}$  inch tip spacing. (If the swivel tips are used with the probe, additional spacings are possible. It should be noted that no coaxial ground contact accompanies the swivel tip.) The test jacks can be installed by drilling holes through the selected mounting plate, inserting the threaded end through from the front of the plate, and fastening the test jack in place with a nut and star washer. A soldering lug can be fastened between the nut and the back of the plate to facilitate the making of ground connections.

6. Alligator Clip—Threaded for use with ground leads.

7. Hook Tips—Sleeve-type connectors which fit individually over probe tip input connectors. Facilitates "hanging" the Probe into circuitry.

8. Insulating Tube—Sleeve-type adapter for insulating the tip's coaxial ground. Permits use of tip in close quarters with minimum danger of causing a short circuit.

9. 12-inch Ground Lead—Same as 5-inch, except that it should be used only when the 5-inch will not reach.

10. 5-inch Ground Lead—Equipped with a spring clip on one end intended to snap onto the Probe ground lug; machine screw on the other end for attachment to an alligator clip. It should be connected between the Probe ground lug and the equipment being tested before the Probe is connected to the equipment.



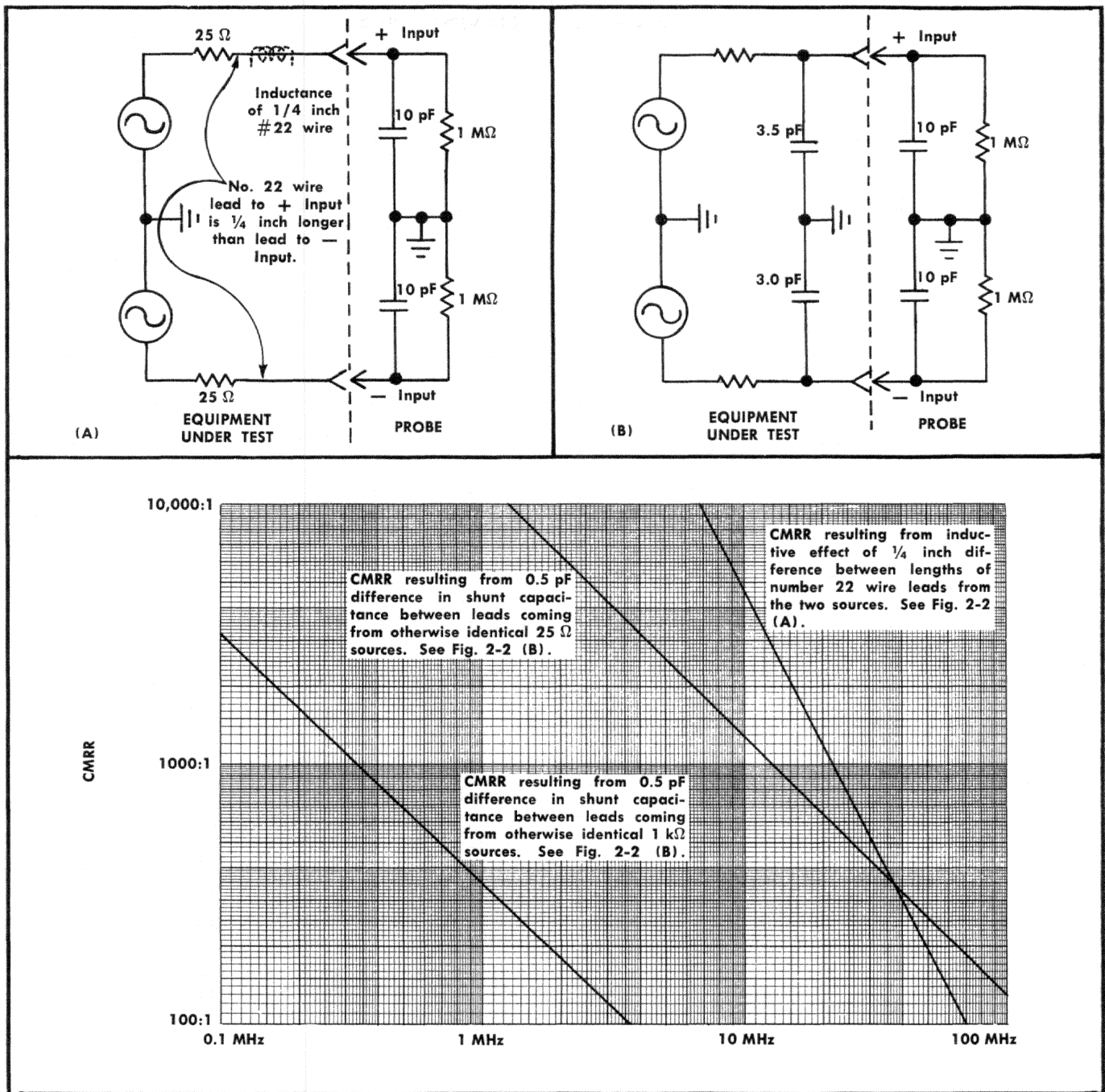

Fig. 2-2. Impedance effects upon apparent CMRR.

### Amplifier For P6046

The Amplifier For P6046 is an optional P6046 Probe accessory consisting of an Amplifier unit and a Power Supply unit. See Fig 2-4. It makes the Probe compatible with any oscilloscope and plug-in combination which has 10 mV/div deflection capability and appropriate bandwidth. Operating it into a less sensitive device (higher mV/div) will provide unreliable results because of overdriving the Probe and Amplifier. Operating it into a more sensitive device can produce some usable results if proper consideration is given to the signal-to-noise ratio.

The Power Supply unit attached to the Amplifier For P6046 must be wired to conform with the source voltage. Three ranges are available in the vicinity of 115 V-AC, and three are available in the vicinity of 230 V-AC. Connection instructions are contained in the Maintenance section.

The Amplifier For P6046 comes equipped with the following accessories:

An 18 inch 50  $\Omega$  coaxial cable with which to couple its output to an oscilloscope input connector.

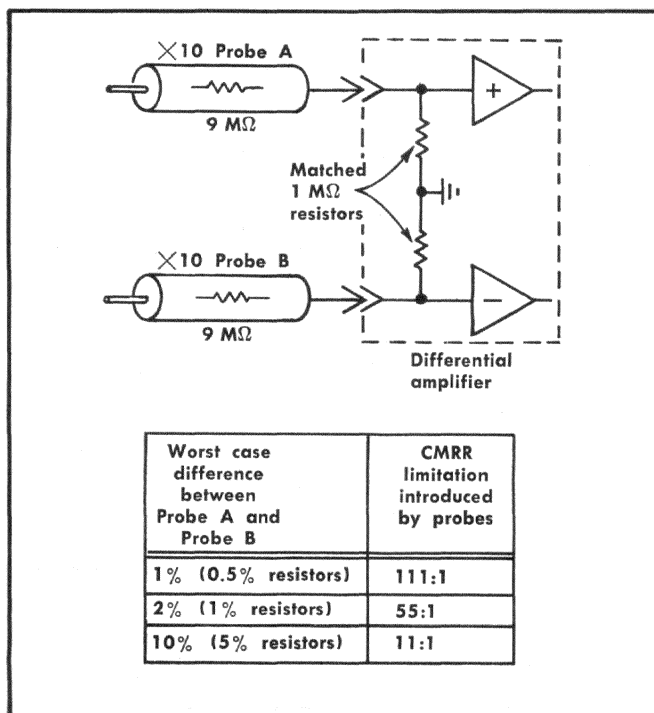

Fig. 2-3. Simplified circuit showing the limitation in CMRR that a difference between attenuator probes can introduce. Differences between probe capacitances add to the effect on AC signals.

A 50 Ω BNC termination with which to terminate the Amplifier output.

A hanger bracket which can be mounted at a convenient location on the side cover of the oscilloscope with which it is used.

### HANDLING THE PROBE

The P6046 Differential Probe is made as rugged as possible without sacrificing performance or portability. However, its sensitive circuitry, small size and mobility make necessary the use of some caution in its handling. Use normal care to avoid severe mechanical shocks to the device, and do not subject the circuitry to voltages in excess of its breakdown values. It is suggested that points to be checked be tested with another device to insure that voltages do not exceed the P6046 Probe capabilities.

### OPERATING PROCEDURE

The P6046 Probe is designed to operate either with a Type 1A5 Differential Amplifier Plug-In Unit or with an Amplifier For P6046 whose output is connected to an oscilloscope having a 10 mV/div vertical sensitivity and an appropriate bandwidth. This procedure covers both situations. It includes setting up the equipment, performing operator adjustments, checking gain through single-ended operation, checking common-mode rejection, observing AC-coupled operation and attenuator operation. Differential operation and external triggering operation information is also included. Pertinent precautions are contained along with techniques to improve operating results.

### Equipment Required

The following equipment is recommended for use in this operating procedure.

Oscilloscope. Tektronix Type 544, 546, 547 or 556. A 580-series Oscilloscope may be used if it is equipped with a Type 81A Plug-In Adapter. (If the Amplifier For P6046 is to be used with the P6046 Probe, any oscilloscope and plug-in combination having a vertical deflection factor of 10 mV/div and an appropriate bandwidth can be substituted.)

Type 1A5 Differential Amplifier Plug-In Unit. (Not required if the Amplifier For P6046 is to be used with the P6046 Probe.)

Amplifier For P6046 and Standard Accessories; Tektronix Part No. 015-0106-00. (Not required if a Type 1A5 Differential Amplifier Plug-In Unit is used.)

P6046 Differential Probe, Dual Attenuator Head, and Standard Accessories.

Probe Tip-to-GR Adapter, Tektronix Part No. 017-0076-00.

GR-to-BNC Male Adapter, Tektronix Part No. 017-0064-00.

50 Ω Termination, Tektronix Part No. 011-0049-01. (Not required if the Type 1A5 is to be used.)

Probe Dual Tip-to-BNC Female Adapter, Tektronix Part No. 067-0562-00.

42 inch Coaxial Cable, Tektronix Part No. 012-0057-01.

GR-to-BNC Male Adapter, Tektronix Part No. 017-0064-00.

### Operator Adjustments

An attenuator balance adjustment is available at both the Amplifier For P6046 (ATTEN BAL), and the Type 1A5 (PROBE STEP ATTEN BAL) to eliminate trace shifts which might otherwise accompany switching from one deflection factor to another.

The High Frequency CMRR should always be checked (refer to Section 5, step 10) and adjusted, if necessary, after the probe has warmed up. The HF CMRR adjustments (R209, C209, and C245) are accessible through the probe cover (refer to Section 6, step 10).

The exposed adjustments in the Dual Attenuator Head have been factory-calibrated to the Probe with which the Head is shipped. No further adjustment should be required unless the Head is used with a different Probe. In that event, the attenuator calibration procedure contained in the Calibration section should be accomplished.

### CAUTION

1. A common ground must always exist between the P6046 Probe and any equipment with which it is being used. A ground lug is built into the Probe, and ground leads are supplied as standard accessories for ground purposes.
2. Maximum allowable single-ended input is ±25 V DC + peak AC with respect to Probe ground.
3. Maximum allowable difference between voltages at tips is 25 V DC + peak AC.

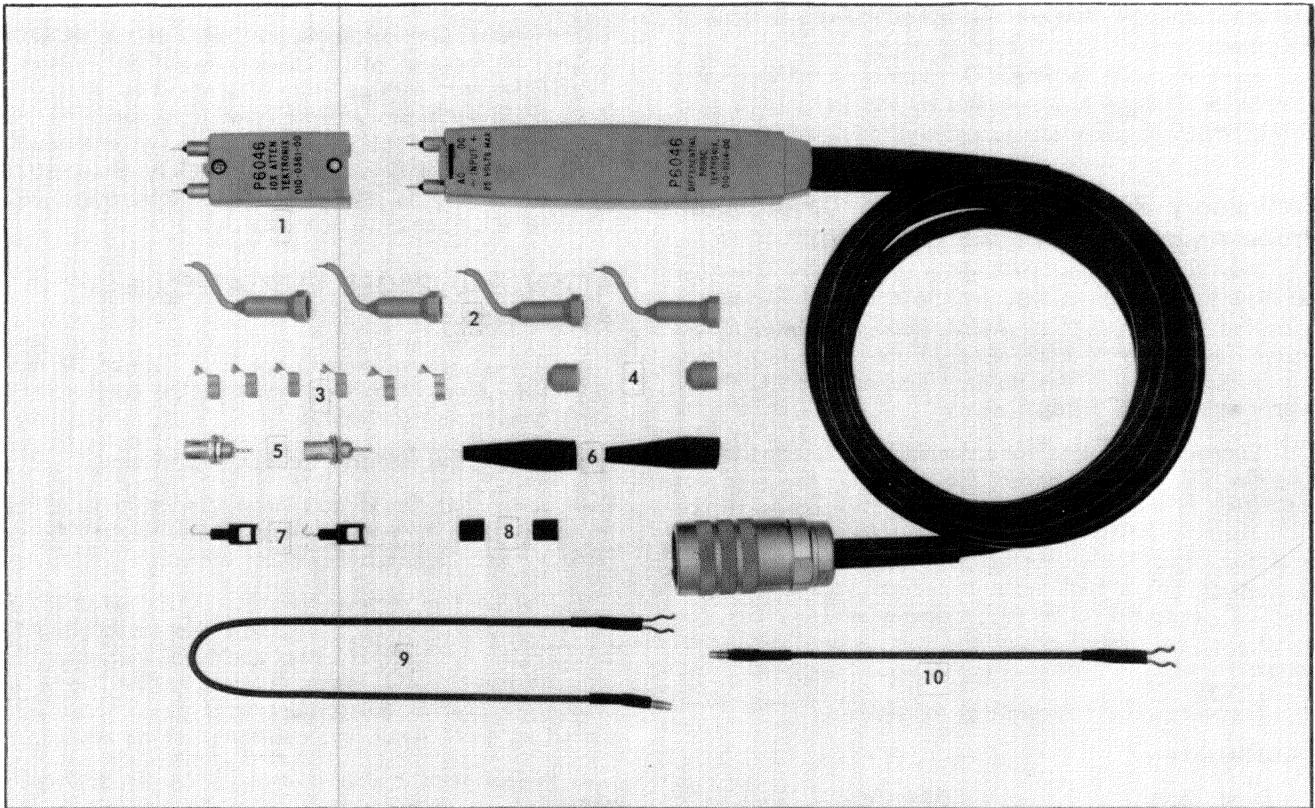

(A) P6046 Differential Probe and Standard Accessories.

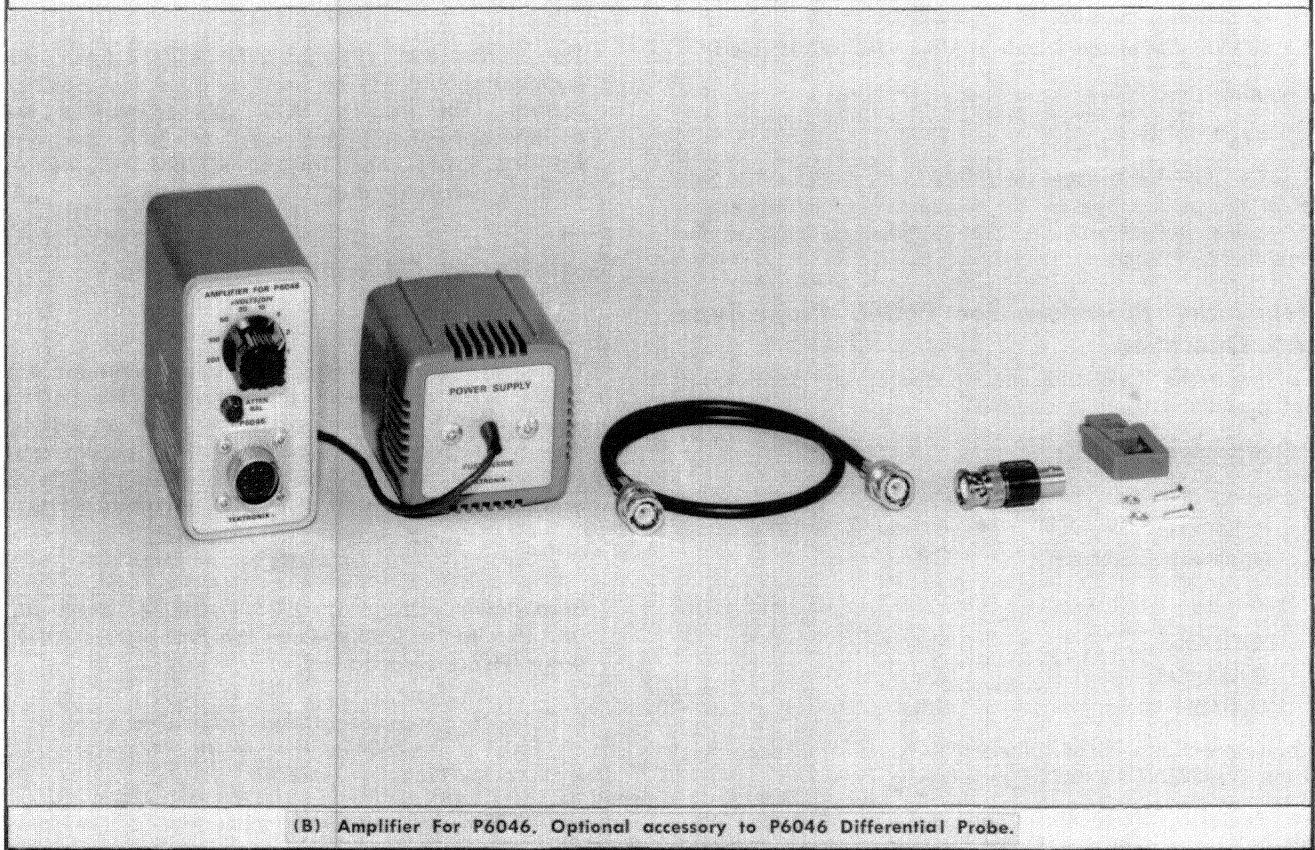

(B) Amplifier For P6046. Optional accessory to P6046 Differential Probe.

Fig. 2-4. P6046 Differential Probe and Accessories.

## Operating Instructions—P6046 Probe and Amplifier

The Type 1A5 controls associated with the P6046 Differential Probe operation are high-lighted in Fig. 2-5. None of the other controls on the Type 1A5 directly affect the Type 1A5 operation while the Probe On lamp is on, although the comparison voltage (Vc) selected by the POLARITY and AMPLITUDE controls is still available at the MONITOR jack.

### Preliminary Procedure For P6046 Differential Probe-Amplifier For P6046 Operation

a. The Power Supply Unit shipped with the Amplifier For P6046 is wired for 104 to 126 V AC, 50 to 400 Hz operation. Rewire the unit in accordance with table 4-3 (located in the maintenance section) if the unit is to be used with voltages outside this range. Then connect the Power Supply Unit to the voltage source.

b. Connect the P6046 Probe Amphenol connector to the Amplifier For P6046. Connect the output of the Amplifier For P6046 to the vertical input of the oscilloscope. If the oscilloscope has 50  $\Omega$  input impedance, the connection may be made directly through the 50  $\Omega$  coaxial cable. If the oscilloscope has a high input impedance, the 50  $\Omega$  cable must be connected to a 50  $\Omega$  termination (Amplifier For P6046 standard accessory) at the oscilloscope input connector.

c. Preset equipment controls as follows:

#### Oscilloscope

Sweep Rate	0.2 ms/div
Triggering	Automatic, Internal
Amplitude Calibrator	Off
Vertical Deflection Factor	10 mV/div (Calibrated)

#### Amplifier For P6046

mVOLTS/DIV	20
------------	----

d. Do not change the calibrated vertical deflection factor at the oscilloscope for the remainder of this procedure. All vertical deflection factor changes must be made at the Amplifier For P6046.

### Preliminary Procedure for P6046 Probe-Type 1A5 Operation

a. Insert the Type 1A5 into an appropriate oscilloscope and preset the controls as follows:

#### Oscilloscope

Sweep Rate	0.2 ms/div
Triggering	Automatic, Internal
Amplitude Calibrator	Off

#### Type 1A5

POSITION	Midrange
VOLTS/CM	20 mV
VARIABLE	CAL

b. Connect the P6046 Differential Probe Amphenol plug to the DIFFERENTIAL PROBE jack on the Type 1A5.

c. Energize the equipment and depress the PUSH ON/OFF button to light the Probe On lamp which is located in the PUSH ON/OFF button assembly.

## NOTE

The Probe On lamp will not light if the VOLTS/CM control is at a lower sensitivity (higher VOLTS/CM) setting than 0.2 V. The Probe is supplied with power whenever it is connected to an energized Type 1A5, regardless of the condition of the Probe On lamp. Only the P6046 Probe inputs to the Type 1A5 are interrupted when the Probe On lamp is out.

### ATTEN BAL (PROBE STEP ATTEN BAL) Adjustment

a. Connect special ground tips to the Probe + and — Input tips. Wait 5 minutes or more for the equipment operating temperature to stabilize.

b. Set the CRT controls for optimum display.

c. Check that the vertical deflection factor is set at 20 mV/div. Using the vertical position control, set the oscilloscope trace to graticule vertical center.

d. Change the vertical deflection factor (at the Amplifier For P6046, if used) to 1 mV/div and adjust the ATTEN BAL (PROBE STEP ATTEN BAL) control as necessary to return the trace to the center of the graticule. Some small amount of drift of the trace vertical position can be expected at 1 mV sensitivity, especially during warmup.

e. Repeat steps c and d until no further adjustment is necessary.

## IMPORTANT

The ATTEN BAL (PROBE STEP ATTEN BAL) adjustment should not be used as a vertical position control. The Vertical POSITION control at the oscilloscope should be used for this purpose. An occasional check of the ATTEN BAL adjustment is recommended.

### Single-Ended Operation—Gain Check

## NOTE

The single-ended linear operation limit of the Probe, with or without the Amplifier For P6046, is + or — 10 divisions of DC + peak AC deflection from 0 reference position. The oscilloscope and vertical plug-in limit must also be considered in determining the limit of the complete system.

## CAUTION

Breakdown voltage is  $\pm 25$  V, DC + peak AC, and extends to 250 V when the Probe Dual Attenuator Head is installed.

a. Connect a special ground tip (P6046 accessory) to the — Input of the P6046 Probe. Connect a probe tip-to-GR adapter to the Probe + Input tip.

b. The habit of ALWAYS connecting a ground lead before connecting the Probe tips should be developed. Therefore, connect a ground lead and alligator clip (P6046

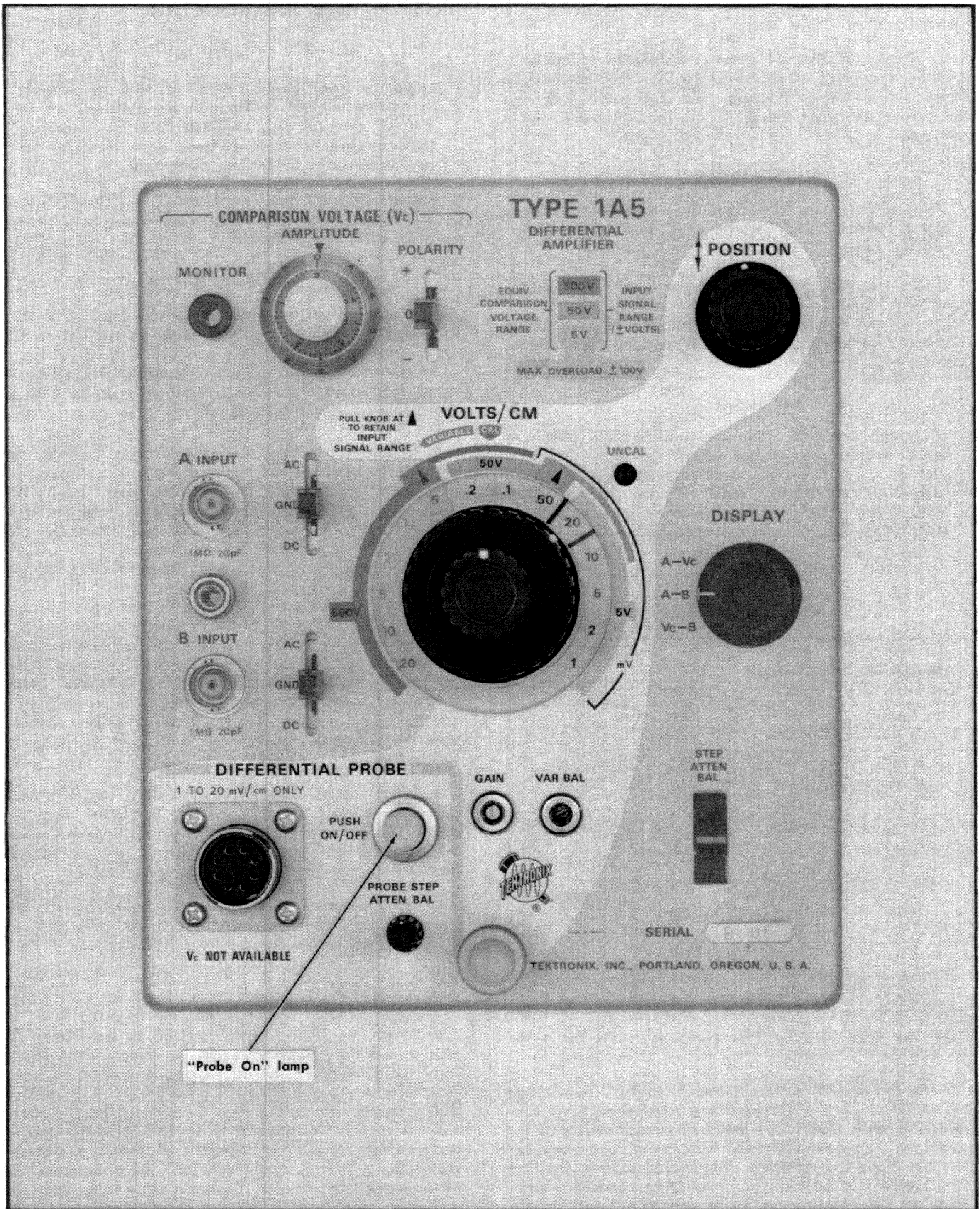

"Probe On" lamp

Fig. 2-5. Type 1A5 front panel, high-lighting controls directly associated with the P6046 Differential Probe operation.

## Operating Instructions—P6046 Probe and Amplifier

Probe accessories) from the P6046 Probe ground lug to a ground terminal at the oscilloscope.

c. Check that the oscilloscope's amplitude calibrator is off. Set the Probe AC-DC switch to DC. Then connect the Probe tip to the oscilloscope calibrator output jack, via the probe tip-to-GR adapter and the GR-to-BNC male adapter.

### CAUTION

The output from the amplitude calibrator must never exceed 25 V while it is applied to the P6046 Probe.

d. Set the vertical deflection factor and the amplitude calibrator output to the values given in Table 2-1. Set the triggering and position controls to obtain a centered, stable display. Check the display for the specified amplitude at each setting.

### NOTE

Although the gain can be adjusted to obtain exact results, adjustment is not recommended if the gain has been previously set with a standard amplitude calibrator. Most standard amplitude calibrators have a higher accuracy than calibrators which are built into oscilloscopes.

**TABLE 2-1**  
P6046 GAIN CHECK

AMPLITUDE CALIBRATOR	Vertical Deflection Factor	Amplitude	Tolerance
5 mV	1 mV	5 cm	See Performance Check
10 mV	2 mV	5 cm	
20 mV	5 mV	4 cm	
.05 V	10 mV	5 cm	
.1 V	20 mV	5 cm	
50 mV	10 mV Retained Range <sup>1</sup>	5 cm	
.1 V	20 mV Retained Range <sup>1</sup>	5 cm	
.2 V	50 mV	4 cm	
.5 V	100 mV (.1 V)	5 cm	
1 V	200 mV (.2 V)	5 cm	

<sup>1</sup>Type 1A5 only; VOLTS/CM knob placed at 50 mV, then pulled out and rotated clockwise.

e. Switch the P6046 AC-DC control to AC. Two effects are obvious. The 0-V DC reference supplied with the calibrator signal is blocked by the coupling capacitor and the waveform shifts down 2½ divisions to operate above and below the Probe DC reference. The second result is that the time constant introduced by the coupling capacitor causes a tilt in the 1 kHz square wave presentation. Return the Probe switch to DC, and then turn the amplitude calibrator control off.

## Common-Mode Rejection Check

### NOTE

Linear common-mode operation with or without the Amplifier For P6046 can be obtained up to 5 V DC + peak AC, provided that the difference between the two signals does not exceed + or - 10 divisions of vertical deflection.

Linear common-mode operation is extended to 50 V DC + peak AC when the Probe Dual Attenuator Head is installed.

### CAUTION

The applied voltage must never exceed 25 V with respect to Probe ground. The difference between the voltages applied to the two tips of the Probe must never exceed 25 V DC + peak AC. These values increase to 250 V when the Probe Dual Attenuator Head is installed.

a. Disconnect the Probe and adapter from the calibrator. Remove the adapter from the one tip, and the ground tip from the other. Connect the calibrator signal to both tips, using a probe dual tip-to-BNC female adapter and a 42 inch 50Ω coaxial cable equipped with BNC-male connectors. Set the amplitude calibrator control to 5 V and the vertical deflection factor to 1 mV. Set the oscilloscope triggering controls to stabilize the presentation, if possible. (The CMRR may be so high that insufficient signal exists to trigger the oscilloscope.) Divide the peak-to-peak value of the presentation into 5 V to determine the CMRR which is in effect. LACK OF IDENTICAL SIGNAL CONNECTIONS TO THE TWO TIPS WILL DECREASE THE APPARENT CMRR. (If the two tips were connected to two separate signals, the common-mode portions would be almost totally rejected, with the difference between the two being processed for display.)

b. Switch the P6046 AC-DC control to AC and again calculate the CMRR. (A slight increase in display amplitude and a change in the shape of the presentation will possibly be noted. Both are caused by the lack of total identity between the matched input coupling capacitors)

c. Turn the oscilloscope amplitude calibrator off and disconnect the Probe and adapter from the calibrator output jack. Remove the adapter from the Probe.

## Attenuator Operation

a. Attach the Dual Attenuator Head to the Probe. Attach a special ground tip to the - Input. Connect the Probe + Input tip to the oscilloscope amplitude calibrator jack, using the probe tip-to-GR adapter and a GR-to-BNC male adapter. Set the vertical deflection factor to 20 mV and the amplitude calibrator to 1 volt. Set the triggering and position controls as necessary to obtain a centered square wave. A 5 cm square wave with sharp corners should be observed, indicating ×10 attenuation of the amplitude calibrator signal, and proper compensation adjustment. Remove the adapter from the amplitude calibrator output jack.

b. Disconnect the adapter from the + tip and remove the ground tip from the — tip. Attach the probe dual tip-to-BNC adapter to the Dual Attenuator Head. Connect the BNC connector to the amplitude calibrator output jack, using a 42 inch coaxial cable. Set the amplitude calibrator control to 50 volts. Measure the display amplitude and divide it into 50 volts. The quotient is the CMRR of the Attenuator-Probe-Amplifier (or 1A5) combination.

**CAUTION**

Never exceed 250 V DC + peak AC input to either tip of the Dual Attenuator Head. Never exceed 250 V DC + peak AC difference between Attenuator Input tips.

**Additional Operating Hints**

**Differential Amplifier Operation**

Connecting the two inputs to separate signals will result in a display of the instantaneous phasor and amplitude differences between the two signals.

**NOTE**

Do not exceed 5 V DC + peak AC common-mode input, or 10 divisions of difference between signals for linear operation. Never exceed 25 V DC + peak AC difference between signals applied to the probe.

**External Triggering**

Use of one of the signal sources to provide external triggering will introduce an apparent common-mode difference due to the loading caused by the triggering circuit. External triggering during differential measurements which require a high CMRR should only be used if identical loading is provided to the second signal source, or if a signal-associated source is available which will not affect the signal being observed.

**Differential Comparator Operation**

Any adjustable DC voltage source of 5 V or less can be used for differential comparator operation.

The Type 1A5 COMPARISON VOLTAGE makes a 0 to 5 volt DC output available which can be connected to one side of the Probe (DC-coupled) while a signal is connected to the other side. This enables common-mode cancellation of an equivalent DC or instantaneous level of AC, permitting the observation of specific amplitude points on signals up to 5 V DC + peak AC, using a much more sensitive VOLTS/CM setting than would otherwise be possible. Use a comparison voltage of the same amplitude and polarity as that existing at the point being checked. A .001  $\mu$ F capacitor must be close-coupled between the Probe tip and ground to bypass voltages induced in the Vc lead which would otherwise be accepted as signals.





## SECTION 3

# CIRCUIT DESCRIPTION

Change information, if any, affecting this section will be found at the rear of the manual.

### NOTE

Electron flow is used throughout this circuit description.

## PART A—P6046 CIRCUITRY

### Introduction

The P6046 Differential Probe circuitry has two identical signal processing circuits which are interconnected to provide push-pull outputs in response to either differential or single-ended signals. Power for the Probe operation is obtained through a 9-pin Amphenol connector which also conducts the output signals to the indicator unit with which the Probe is being used. The Probe has high input impedance and low output impedance, and normally provides unity gain. The gain factor can be electrically decreased to 1/10 by application of a gain switching signal from the parent equipment.

### Block Diagram Description

Refer to Fig. 3-1. The P6046 Probe circuitry can be considered as three sections—the plus side, the minus side and the circuitry which is common to both sides. The two sides derive their names from the polarity of input signal required to produce upward deflection on an oscilloscope cathode-ray tube.

Each side consists of an Input Amplifier, a Bootstrap Circuit and an Output Amplifier. The Input Amplifier provides high impedance to input signals, and develops a push-pull output in response to either single-ended or push-pull signals. The Bootstrap Circuit permits good low-frequency common-mode rejection by preventing common-mode signals from changing the voltage differences between elements of the Input Amplifiers. The Output Amplifiers deliver low impedance signals to the indicator unit via the Amphenol connector, and insure that the output has unity gain with respect to the Probe input signals.

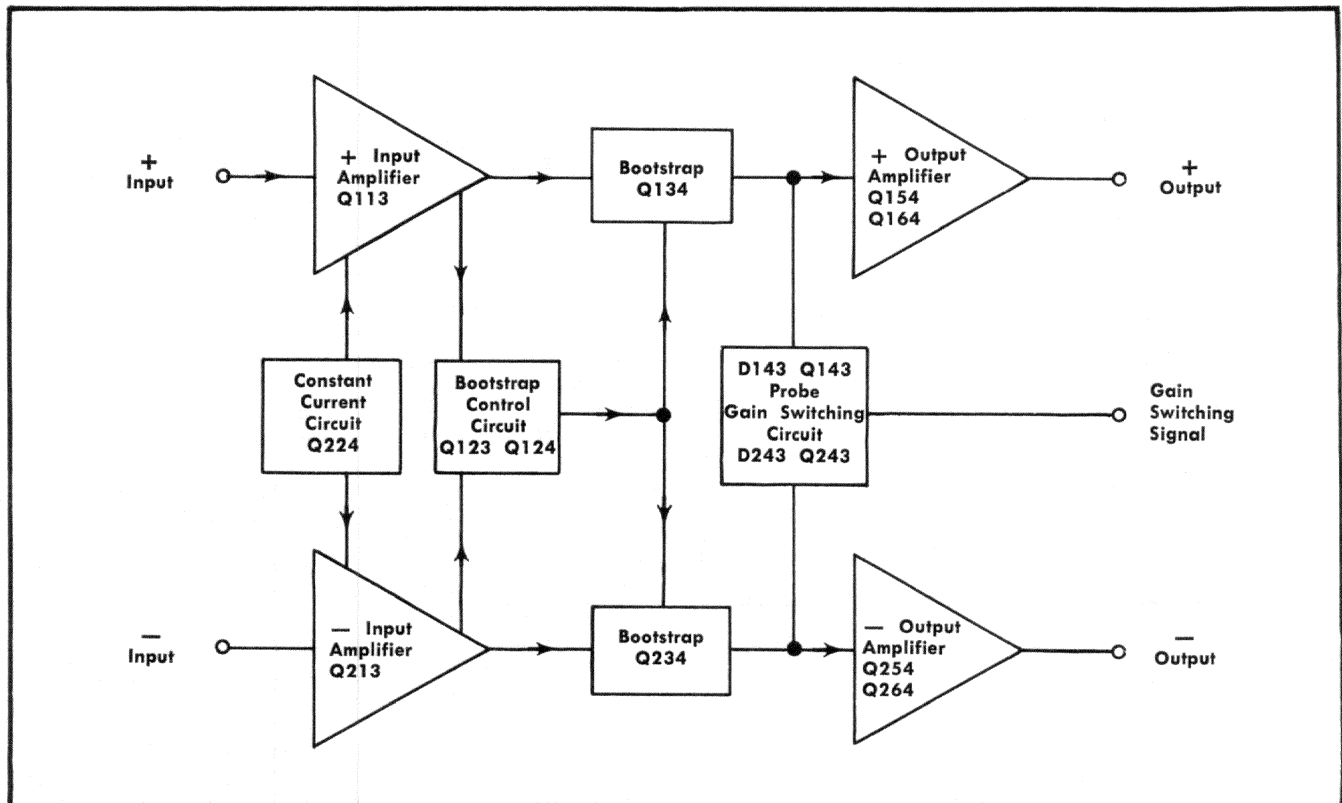

Fig. 3-1. P6046 Differential Probe block diagram.

## Circuit Description—P6046 Probe and Amplifier

The Constant Current Circuit aids in common-mode rejection and causes paraphase amplification of input signal differences by providing a relatively constant current regardless of the value of input signals. If identical signals are applied to both inputs, each side will attempt to change current conduction by the same amount, and in the same direction. The two sides remain balanced and the current through each side remains unchanged. When the signals into the two sides are different in amplitude, any change in current through one side is accompanied by an equal and opposite change through the other side, keeping the total current constant and causing paraphase amplification.

The Probe Gain Switching Circuit changes the gain of the Probe to 1/10 of the normal unity gain factor whenever switched into the circuit by the gain control signal.

### Detailed Description

Refer to the P6046 Differential Probe schematic near the back of this manual.

**Input Amplifier.** Current for the Input Amplifier and for the Bootstrap Control Circuit is supplied by Q224. The voltage divider in its base sets the base and emitter voltage, which then determines the total circuit current as a function of R224 and the -50-volt supply. Under quiescent conditions the current is divided equally through R117 and R217, with the majority passing through Q113 and Q213. During  $\times 1$  Gain operation the resultant voltage drop across R146-R147 and R246-R247 determines the voltage at the bases of Output Amplifier transistor Q154 and Q254. (Q143 and Q243 do not conduct during  $\times 1$  gain operation.)

The N-channel Field Effect Transistors (FET) which receive the input signals operate in essentially the same fashion as triode vacuum-tubes. See Fig. 3-2. Like the triode, the gate is reverse-biased and draws virtually no current during normal operating conditions.

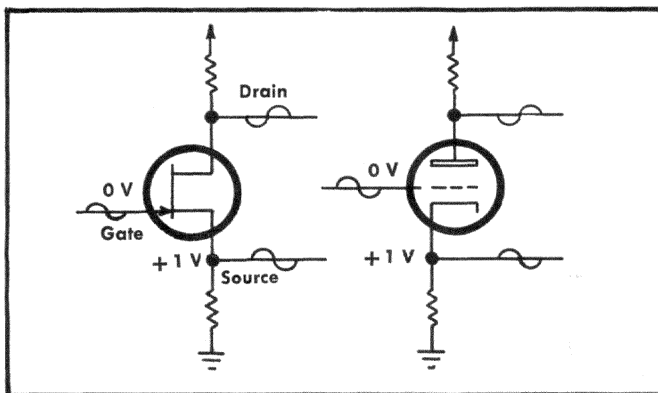

Fig. 3-2. Comparison between vacuum tube and N-channel field effect transistor circuitry.

During unbalanced input signal conditions, the source voltages of Q113 and Q213 become unequal. Because of the constant current source the current through one side of the amplifier can only be increased by decreasing the current through the other side. Most of this exchange of cur-

rent flows through the low resistance path of R113, R114 and R115. This causes equal and opposite signals to occur at the bases of Q154 and Q254, regardless of whether the unbalanced input was caused by a single-ended or differential input signal. R115 provides thermal compensation for Q113 and Q213 to maintain uniform gain response throughout the normal operating temperature range.

**Bootstrap Circuit.** The difference of potential between the drains and gates of Q113 and Q213 are kept constant for all low frequency common-mode input signals by the action of Q123, Q124, Q134 and Q234. This provides linear operation throughout the common-mode operating range of the Probe. The collector current of Q124 is determined in much the same manner as was the Q224 current. Since effectively no current flows through the Q123 gate junction, the voltage drop across R121 is wholly a function of the Q124 current. The voltage at the wiper of R120 is always equal to the instantaneous average of the Q113 and Q213 source voltages. The voltage at the Q123 gate is therefore equal to this voltage plus the voltage drop across R121. This establishes the Q123-source voltage and thus the Q134 and Q234 base and emitter voltages. Q114 and Q213 drain voltages are thereby slaved to follow the instantaneous average of the voltage at their sources, which is in turn set by the value of input signal.

During common-mode changes, the voltages at the elements of Q113 and Q213 remain constant with respect to each other. During differential signal conditions, each FET source follows its gate voltage, but the drain voltages change in a direction opposite to that at the gates.

Balancing of the two sides of the circuit for optimum low-frequency common-mode rejection is accomplished through R120 (50 kHz CM BAL). R125 (DRAIN VOLTS) sets the quiescent voltage at the Q113 and Q213 drains.

**Probe Gain Switching Circuit.** The current path during  $\times 1$  operation is through D143, R146, R147 and through their counterparts on the other side of the amplifier. Q143 and Q243 are kept cut off by the voltage divider operating between the gain switching signal at P150 terminal D and the +50-V supply. When a Probe gain factor of 1/10 is selected, the gain switching signal line is opened externally. Q143 and Q243 go into saturation. Q143 and Q243 emitter-collector voltage is less than that required for conduction of D143 and D243. This causes the R146 and R246 part of the  $\times 1$  load resistance to be by-passed and the Input Amplifier gain is reduced to 1/10 of its  $\times 1$  value.

A difference between circuit components in the two sides of the amplifier can cause a slight unbalance in output voltages. This unbalance will change by a factor of 10 during gain switching. An adjustable compensating current is therefore introduced by the R234-R235-R236 circuit to adjust the current to the load resistors. With the voltages balanced across the load resistors, gain switching causes equal changes at both sides and no differential output occurs.

When a gain of 1/10 is selected, R144 and C144 provide high-frequency coupling through the Q143 and Q243 base-emitter junctions to the collectors of Q134 and Q234. This compensates for the capacitive coupling effects of non-conducting diodes D143 and D243.

**Output Amplifier.** The push-pull signals at the Q154-Q254 bases increase the current through one side of the amplifier while decreasing it through the other. Total current through the R158-R159 parallel combination remains relatively constant. The signal current is exchanged between the two sides of the amplifier, principally through R154 and R155. Since one emitter increases its voltage as the other decreases, a point midway through the combined resistance of R154 and R155 remains at signal ground. The signal current through these resistances is the same signal current that flows through load resistor R164, making the gain of the circuit approximately equal to R164 divided by  $\frac{1}{2}$  the effective resistance of the R154-R155 combination. And, as is characteristic of push-pull amplifiers, circuit gain is equal to the gain of either side and can be expressed in the same manner.

Q164 and Q264 reduce the operating voltages across Q154 and Q254 and act as buffers to isolate the Probe from external circuit feedback. R161, C161, R261 and C261 provide thermal compensation for Q154 and Q254. In addition to acting as load resistors, R164 and R264 provide reverse termination for the 93  $\Omega$  signal-output cables.

**Additional Components.** Numerous additional components are used to improve the operating characteristics of the Probe. The following is a brief description of their functions.

The AC-DC switch (SW101) inserts or removes coupling capacitors C101 and C201 from the signal path. These capacitors are matched to provide optimum AC-coupled low frequency common-mode rejection. C107 permits adjustment of the capacitance of the two inputs to further improve the AC-coupled common-mode rejection ratio. (The detachable Dual Attenuator Head has adjustable capacitors in each side to permit attenuator compensation according to the input capacitance established by C107.) Slight resistance mismatches which may exist in the detachable Dual Attenuator Head can be compensated for by adjustment of R105.

C113 and C155 improve circuit gain at upper frequencies to provide flatter overall gain response. C109, R109, C209 and R209 permit matching of the Q113 and Q123 gate-to-drain capacitances. C106, R106, C206 and R206 suppress

high frequency oscillations. C245 and C246 permit matching the capacitances at the output amplifier, thereby improving the high-frequency common-mode rejection.

**PART B—AMPLIFIER FOR P6046 CIRCUITRY**

The Amplifier For P6046 consists of an Amplifier unit and a Power Supply unit. The Amplifier accepts the P6046 Probe's push-pull signal and develops a single-ended signal from it. A BNC connector makes the single-ended signal available for application to oscilloscopes or other display devices.

The Power Supply unit is connected to the Amplifier through a non-removable cord which provides + and - 50 V, +20.6 V and -6.2 V for Amplifier operation.

**Amplifier**

**Block Diagram Description.** Refer to Fig. 3-3. The push-pull signals from the Probe are applied to emitter followers which provide isolation between the Probe and the Q424-Q524 amplifiers. After being amplified by Q424 and Q524, the signals pass through another pair of emitter-followers and are applied to a second amplifier stage, consisting of Q454 and Q554. The output from the + side of the second amplifier stage is then applied to the final emitter-follower stage, whose output is designed to supply a drive signal into a 50  $\Omega$  load.

The gain of the various stages of the Amplifier For P6046 is controlled by the mVOLTS/DIV switch. This switch also controls the Probe gain. The combined effect is that the Amplifier supplies a 10 mV/div signal at its output, regardless of the Amplifier's mVOLTS/DIV switch setting. This is illustrated in Table 3-1. The gain factors for the Probe and each of the stages of the Amplifier are listed in the table opposite each possible mVOLTS/DIV setting. Multiplying a mVOLT/DIV factor by every gain factor appearing in line with it results in a 10 mV/div in each case.

**Detailed Description.** Refer to the Amplifier For P6046 schematic which appears near the rear of this manual. Only the top half of the amplifier will be explained, since the top and bottom halves are basically the same.

**TABLE 3-1**  
Probe and Amplifier Gain Analysis

System Vertical Deflection Factor (mV/div)	Probe Gain	Q424-Q524 Stage Gain	Q454-Q554 Stage Gain	Q473 Gain	Output Termination Attenuation
1	1	5	4	1	0.5
2	1	5	2	1	0.5
5	1	5	0.8	1	0.5
10	1	2.5	0.8	1	0.5
20	1	1.25	0.8	1	0.5
50	0.1	5	0.8	1	0.5
100	0.1	2.5	0.8	1	0.5
200	0.1	1.25	0.8	1	0.5

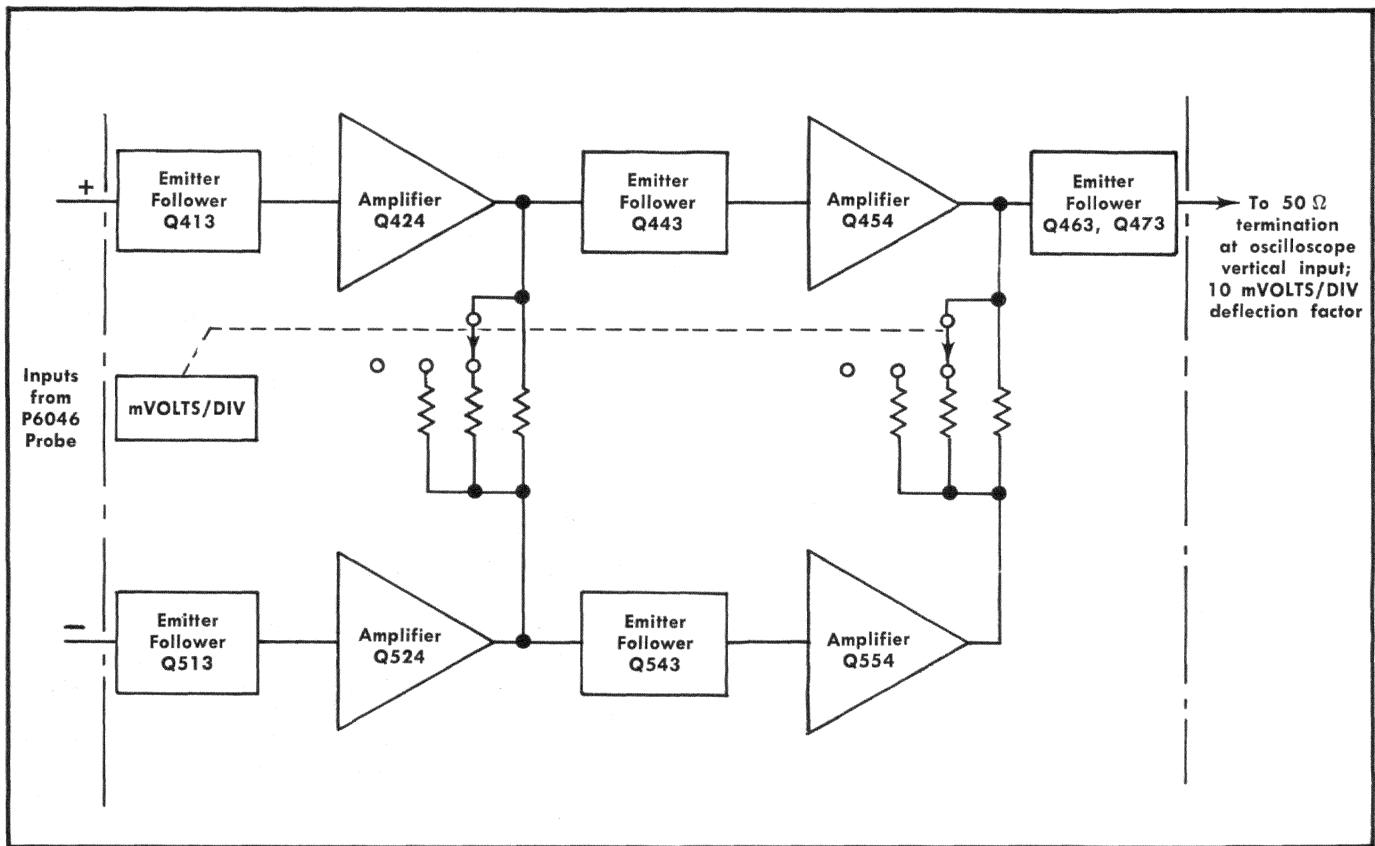

Fig. 3-3. Amplifier For P6046 block diagram.

The push-pull signals arriving from the Probe at J150 terminals C and J are applied to the bases of the input emitter followers. D405, D505 and the associated voltage divider provide a clamp at +2.6 V to protect Q413 and Q513 when the Probe is disconnected. No negative protection is required. The + signal is developed across emitter resistor R415 and applied to the base of Q424. The resultant change of current through R422 causes a signal voltage to be developed across R424 and applied to the base of Q443. (No change of voltage occurs across R425, because of the equal and opposite current changes occurring through Q424 and Q524.) The gain of Q424 is equal to its load resistance (154 Ω) divided by its emitter resistance (422 plus the internal emitter resistance which is approximated at 6 Ω). The result of this division is 5.

Under certain switching conditions, R429 is inserted into the circuit. The signal voltages at the base of Q443 and Q543 change in opposite directions, leaving the point midway through R429 at signal virtual ground. This places 1/2 of the R429 resistance in parallel with R424, modifying the Q424 signal load resistance and the circuit gain accordingly. The gain of the circuit under various switching conditions is given in Table 3-1. R423 does not effect the circuit gain, but is in the circuit to suppress oscillations.

The signal is developed across R443 and applied to Q454, where it encounters an amplifier circuit similar to the Q424 circuit. There are, however, two distinct differences. The emitter resistance is variable to permit gain adjustment, and

only the output from the + side is used. The gain of the Q545 circuit is also contained in Table 3-1.

R456 and C456 are thermal compensation components; R445-C445 provides decoupling.

The output circuit consists of two cascaded emitter-followers which prevent the output from loading the Q454 and Q554 circuits. The cascading of NPN and PNP transistors provides good thermal balance.

Decoupling components are included in the collector circuits of Q463 and Q473, and R473 thermally balances Q473. The internal emitter impedance of Q473 combines with R479 to create a 50 Ω output circuit which, when applied to a 50 Ω load, delivers 1/2 of the Q473 emitter signal.

**Circuit Adjustments.** R480 modifies the circuit current as necessary to develop a 0-V output when the Q463 base is at exactly 0 V. R555 modifies the total Q454-Q554 current as necessary to obtain 0 V at the Q463 base when the R456-R457 junction is at the same potential as the R556-R557 junction. R550 divides the current between Q454 and Q554 as necessary to develop a 0-V output when the base of Q443 is at the same potential as the base of Q543. Under this condition, no trace shift should occur as a result of changing the mVOLTS/DIV control setting. R400 permits modification of drive current to Q413 to compensate for slight differences which may exist between components in the two sides of the input emitter follower and amplifier circuits.

**Miscellaneous Circuitry.** A Probe gain switching signal originates in the Amplifier for P6046. When any deflection factor between 1 and 20 is selected by the mVOLTS/DIV switch, R501 completes the Probe circuit which is connected to J150 terminal D. This maintains a Probe gain factor of 1. When 50, 100, or 200 mVOLTS/DIV is selected, R501 is disconnected from ground and the Probe gain factor switches to 1/10.

Constant current for the Q424-Q524 amplifier stage is provided by Q534. A Voltage divider sets its base and emitter voltage, and therefore dictates the current which flows through R536. This current is divided equally between Q424 and Q524 during no-signal conditions. D532 provides thermal compensation for Q534 to maintain constant current through a wide temperature range.

The Power Supply voltages are referenced to ground within the Amplifier. 100 V appears across terminals A and B of the Output Board, and is applied across the Q497 referencing circuit. The emitter of Q497 is connected to ground, and sets the base voltage at about 0.6 V. R493 and R494 are of approximately equal value and therefore approximately half of the 100 V supply is dropped across each of them. This places terminal A at +50 V and terminal B at -50 V. Any attempt of these two points to shift positive or negative will either increase or decrease the current drive through Q497. The trans-resistance of Q497 will change accordingly, balancing the + and -50-V loads.

In a similar manner, 26.8 V appears across Output Board terminals F and H. D499 causes terminal H to maintain -6.2 V with respect to ground. This causes point F to remain at +20.6 V with respect to ground.

## Power Supply

Refer to the Power Supply schematic. The Power Supply develops regulated 100 V and 26.8 V DC supplies from either 115 V or 230 V AC inputs. The supplies are referenced to ground in the Amplifier unit, establishing potentials of -50 V, +50 V, +20.6 V and -6.2 V DC with respect to ground at Power Supply terminals E, C, B and D. These voltages are routed to the Amplifier through a non-detachable cord. + and -50 V and +20.6 V are then made available to the Probe through Amphenol connector J150.

The 100-V regulator consists of voltage comparator-amplifier Q324, non-inverting amplifier Q304-Q314, and series regulator Q327. The Q304 side of the non-inverting amplifier also serves as the driver for Q327.

Voltage from T301 secondary terminals 9 and 11 is full-wave rectified by D302 and developed across C302 and C303. (R302 and R303 maintain a balance of voltage across the two capacitors.) The voltage across C302 and C303 causes current flow through the parallel-paths of R308 and Q327. Part of the current then flows through the regulator control circuit to establish a regulated 100-V supply between terminals E and C.

The voltage selected by the wiper of R325 is applied to the base of Q324, where it compares against the reference voltage established by D322 to set the current through Q324 and R321. The current through R321 sets the base voltage of Q314 with respect to terminal C. The emitter of Q324 follows its base, and establishes the voltage at the emitter of Q304. This compares against the value set by R306 and R307 to determine the Q304 collector current. The current from Q304 flows through R304 to provide Q327 with forward bias.

The setting of R325 determines the amount of drive which Q314 receives, and therefore affects the emitter voltage of Q304. This controls the amount of conduction of Q304, which then controls the trans-resistance of Q327. When R325 is properly set, enough voltage will appear across Q327 to maintain 100 V between Power Supply terminals C and E. If the voltage tends to increase, Q324 conducts more current, increasing the Q314 drive. This decreases the Q304 drive current, and therefore the Q327 drive current. More voltage is dropped across Q327, keeping the 100-V output within design limits.

C322 suppresses Zener noise. D323 protects the Q324 base-emitter junction during transient reverse-polarity conditions.

Terminals 11 and 12 supply power to the 26.8 V part of the power supply. The +50-V line provides current through R344, forward biasing the base-emitter junctions of driver Q343 and series-regulator Q347, causing them to conduct. The resultant voltage drop across R347, R348 and R349 forward biases the emitter-base junction of comparator transistor Q344, putting it into conduction. The setting of R348 determines the amount of Q344 conduction, thus setting the drive current for Q343 and Q347. When properly set, the voltage drop across Q347 will cause 26.8 V to exist across Power Supply terminals B and D. If this voltage tends to increase, Q344 will conduct more current, providing less drive to Q343 and Q347. More voltage will be dropped across Q347, keeping the output voltage within design limits.



# SECTION 4

## MAINTENANCE

Change information, if any, affecting this section will be found at the rear of the manual.

This section of the manual contains general maintenance information, specific data concerning the P6046 Differential Probe, and specific data relevant to the Amplifier For P6046 and its associated Power Supply.

### General

Maintenance of the P6046 Differential Probe and the Amplifier For P6046 includes routine maintenance, calibration, and corrective maintenance. Routine maintenance consists of checking Probe and Amplifier performance approximately twice a year. The Power Supply associated with the amplifier should be opened and dusted out at that time. The exterior surfaces of all components should be kept clean at all times to provide optimum heat dissipation capability. Special attention should be paid to the cleanliness of the probe tips and the Amphenol connectors so that the high-frequency performance is not impaired.

The Probe and Amplifier have a minimum number of working parts and are relatively well protected from environmental conditions. The minimum size and critical performance requirements make it practical to leave the units closed except to correct malfunctions, and to recalibrate when performance indicates that it is necessary. Any internal cleaning can be done at that time. Cleaning should be limited to removing dust by brushing the components lightly with a soft-bristled brush, or blowing it out with a stream of low pressure air. Solvents or high pressure air should never be used on the Probe or its accessories.

The Performance Check and the Calibration Procedure are located in separate sections of this manual under those titles.

### Soldering Techniques

A soldering iron with a  $\frac{1}{16}$  inch tip and a 15 watt rating is recommended for use on circuit boards and on most components in the P6046 Differential Probe and the Amplifier For P6046. Do not attempt to solder on the metallic plating on the inside of the Probe case. Never touch plastic parts with the soldering iron tip. Apply heat to component leads only as long as required for removal or replacement, using heat sinks as necessary. Old solder can be removed and holes cleaned out by using a vacuum-type solder removing device after the solder is heated. If the device is plunger-actuated, be careful that its kick-back does not damage the small circuit components.

Ordinary electrical solder is recommended for all soldering work. All newly soldered joints should be cleaned with rosin solvent and inspected for proper bonding.

Pre-bend leads prior to component replacement, gripping the lead between the component and point of bend with a

pair of pliers to avoid damage. Cut the leads to their proper length, preferably before installation.

### NOTE

Frequency response and common-mode rejection are partially dependent upon component location and lead length. All replacement parts should therefore be installed in the same manner as the original. The calibration status should be checked after any soldering work has been done on the Probe or Amplifier.

### Test Equipment Recommended For Troubleshooting

The oscilloscope with which the Probe and Amplifier are used can be used as a DC voltmeter as well as a waveform monitor. An ohmmeter with a 1.5 V and 2 mA or less output, and a transistor curve tracer (or transistor tester) are the only additional testing units required for troubleshooting the Probe and Amplifier.

### Troubleshooting Techniques

**Determining the Defective Unit.** The fastest method of isolating faulty system performance to a specific unit is to use each unit with equipment that is known to be operating properly.

In the event that additional equipment is not available, trouble affecting DC and low-frequency operation can be traced to the defective unit as follows:

1. Check the oscilloscope's response to direct inputs.
2. Disconnect the Probe's Amphenol connector from the Amplifier (or the 1A5). Then connect two 51  $\Omega$  resistors between ground terminals C and J of J150, as shown in Fig. 4-1. Be careful not to contact other terminals of J150; as much as 100 V may be present on them.
3. Perform the ATTN BAL (PROBE STEP ATTN BAL) adjustment.
4. Set the mVOLTS/DIV switch (VOLTS/CM on 1A5) to 10 mV. Set the oscilloscope Time/Div switch to 0.2 ms and the Amplitude Calibrator to 50 mV.
5. Connect a lead from the oscilloscope's Calibrator Output jack through a 0.1  $\mu$ F capacitor to terminal C of the Amphenol connector and check for a square-wave presentation of approximately  $2\frac{1}{2}$  divisions.
6. Move the connection to terminal J of the Amphenol connector and again check for approximately  $2\frac{1}{2}$  divisions of square-wave presentation.

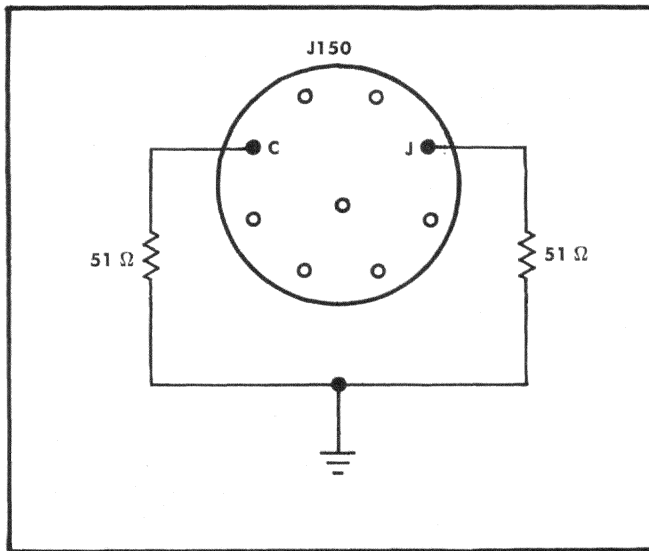

Fig. 4-1. Test setup for checking amplifier DC and low-frequency response.

**NOTE**

The Amplitude Calibrator source impedance of 50  $\Omega$  causes its output to be reduced to 1/2 when operating into a 50 $\Omega$  load.

If the preceding proves satisfactory, turn the (PROBE STEP) ATTEN BAL fully counter-clockwise and check the Amphenol connector for output voltages approximately equal to those given in Table 4-1.

**TABLE 4-1**

J150 Voltages With P6046 Probe Disconnected

	D	E	F	K
Amplifier For P6046	0	+50	+20.6	-50
1A5	+6.2	+20.7	+50	-150

If the voltage check also proves satisfactory, the trouble can be assumed to be in the Probe.

**Analyzing Symptoms.** After the trouble has been isolated to a unit, check for all the trouble symptoms which can be found. The Performance Check can be used effectively for this purpose. Analyzing a combination of symptoms will often pin-point the trouble to a specific area or component.

**Physical Inspection.** Physically inspect the circuitry for loose or broken connections, improperly seated transistors, and burned or otherwise damaged components. Investigate the cause of any heat damage. A 4X or better magnifying glass is recommended for examining the circuit boards and components.

**DC Balance Check.** The balanced nature of the Probe and Amplifier circuitry provides a handy troubleshooting tool. Under quiescent conditions, identical points on the + and - side of the circuits should be operating at identical voltages. The source of unbalanced outputs can therefore be found by starting at the output and checking to-

ward the input until a balanced condition is found. The area between the unbalanced and balanced condition will probably be at fault.

Some of the transistors in the Probe respond to current changes with no appreciable change in voltage. The preceding check is therefore not effective at Q154, and can be used at Q134 only with an extremely sensitive voltmeter.

**Schematic Diagrams.** The schematic diagrams located near the back of this manual contain waveforms, voltages, and resistor values to assist in troubleshooting. A prerequisite for using the voltages and waveforms is that the specified operating conditions be duplicated.

Several high impedance points exist in the Probe. A non-loading voltmeter was therefore used to obtain the voltages given on that schematic. Use of other than a non-loading voltmeter will give a wide variety of readings and cannot be relied upon without individual analysis.

**Transistor and Diode Troubleshooting.** The principal ways of troubleshooting transistors and diodes are by using transistor checking devices (such as a Tektronix Type 575 Transistor Curve Tracer), voltage checks, signal tracing, replacement and ohmmeter checks. Recommended preference is in the order given.

The results of signal tracing and of voltage checks can be compared against those given on the schematics near the rear of this manual, provided that the conditions given with the schematics are duplicated before the comparison is made.

Voltmeter checks across base-emitter, gate-source, or diode junctions are generally more effective than checks between elements and ground, because of the small differences in voltages. A conducting silicon transistor will have a forward emitter-base bias of approximately 0.6 V. A saturated transistor has approximately 0.2 V across its emitter-collector junction. The voltage across a conducting silicon diode is approximately 0.6 V. (The bands on diodes are located nearest the cathode end.) N-channel field effect transistors normally have their gate-source junction reverse-biased by approximately 0.5 to 2 V.

If the replacement method is used, replace only one transistor at a time. Return each one to its original socket before checking the next one. Bend the leads to the proper shape before inserting. Use Fig. 4-3, 4-4 and 4-5 to insure proper insertion. Cut the leads to proper length (approximately 3/16 inch for plug-in type transistors in the Probe; approximately 1/4 inch for transistors in the Amplifier and its Power Supply Unit) for permanent installation. Matched components should only be replaced in pairs.

During ohmmeter checks, insure that the meter will not apply more than 1.5 V and 2 mA to the transistor. Typical transistor resistance values are given in Table 4-2.

The soldered-in transistors should be checked in the circuit to avoid unnecessary circuit disturbance.

**Resistors.** Resistor types, sizes and tolerances vary as necessary to meet circuit requirements and should only be replaced with ones which are equivalent in all respects. Resistances are either color-coded or written on each resistor, but their small size may make the value difficult to determine. The schematic or the parts list should be referred



to in case of doubt. In-circuit resistance checks should not be made with ohmmeters having more than 1.5 V and 2 mA output unless associated semiconductors are removed from the circuit.

**TABLE 4-2**  
Transistor Resistance Checks

Ohmmeter Connections <sup>1</sup>	Resistance Reading to be expected when using a 20,000 $\Omega$ /V DC Meter on the R $\times$ 1 k Range
Emitter-Collector	High reading both ways (100 k $\Omega$ to 500 k $\Omega$ , approx.)
Emitter-Base	High reading one way (200 k $\Omega$ or more). Low reading the other way (400 $\Omega$ to 3.5 k $\Omega$ , approx.)
Base-Collector	High reading one way (200 k $\Omega$ or more). Low reading the other way (400 $\Omega$ to 3.5 k $\Omega$ , approx.)

<sup>1</sup>Test prods from the ohmmeter are first connected to the transistor leads and then the test lead connections are reversed. Thus, the effects of the polarity reversal of the voltage applied from the ohmmeter to the transistor can be observed.

**Capacitors.** Although values are written on capacitors used in the Probe and Amplifier, miniaturization makes them difficult to read. Refer to the schematic or parts list to determine their values. Replace them with electrically equivalent capacitors of the same physical size. Matched capacitors must be replaced in pairs. The capacitors which are riveted in place in the Probe are supplied as integral parts of the circuit board and are not replaceable.

### Parts Procurement

All replacement parts can be purchased through a Tektronix Field Office or representative. However, replacements for standard electronic items can be readily obtained from local electronic parts stores. Consult the Electrical Parts List to determine the required specifications.

#### NOTE

When selecting replacement parts, it is important to remember that the physical size and shape of a component may affect its performance at high frequencies. All replacement parts should be direct replacements unless it is known that a different component will not adversely affect instrument performance.

**Special Parts.** Some electrical parts are specially reworked, quality checked, or manufactured by or for Tektronix to fulfill a specific requirement. Most mechanical parts used are common to only Tektronix instruments, or to a particular type of instrument. All electrical parts whose stock numbers are preceded by asterisks, and most mechanical parts, can be obtained only through a Tektronix Field Office or Representative.

### P6046 DIFFERENTIAL PROBE

Component locations and wire color code appear in Fig. 4-6. Transistor installation information appears in Fig. 4-3.

#### IMPORTANT

Component size and performance requirements make it advisable to return the P6046 Differential Probe to a Tektronix Field Office in the event repairs are necessary. Contact the office for instructions before sending the Probe. If repairs are made locally, the precautions and corrective maintenance hints contained in this section should be adhered to.

It is recommended that the Dual Attenuator Head case never be opened. The resistors in it are not replaceable, and the position of wires in it is very critical. The Tektronix Field Office should be consulted in the event repairs are required.

#### CAUTION

1. Read the disassembly instructions before opening the Probe case. Failure to do so may result in damage or loss of parts.
2. Ground connections are normally made through the metallic plating on the interior of the P6046 Probe case. Do not damage the plating. Do not attempt to operate the Probe with the case open except as specified in these instructions.
3. The Probe should be in a holding device while it is being worked on. This minimizes the possibility of causing short circuits. The holding device should not apply so much pressure that the case or board warps or is otherwise damaged.
4. Use a small screwdriver and slight pressure when removing or fastening screws to insure against damage to the plastic threads. Re-engage screws into their original threads. The screws must be tight enough to insure good ground connections, but not tight enough to damage the Probe.
5. Be careful not to lose the externally small detent spring while the case is open. It is located between the AC-DC switch lever and the tip assembly. Keeping the AC-DC switch lever perpendicular to the tips will help keep it in place.

**Test Fixtures.** A Calibration Shield (Tektronix Part No. 067-0563-00) provides limited access to adjustments for calibration purposes. No attempt should be made to calibrate the Probe without the shield in place.

The plating on the inside of the case completes the Probe ground circuits. This requires that special provisions be made for operating the Probe while the case is opened for troubleshooting purposes.

If total access to the transistor side of the main board is required while the probe is energized, remove the top and then bolt the board to the bottom of the case with one screw at the front and one screw at the back, thus completing the ground circuits. Two No. 2-56 nuts (not supplied) are required. Tighten the screws sufficiently to provide good contact, but not so much that the plastic becomes damaged.

For access to both sides of the main board during operation the board must be completely removed from the case.

## Maintenance—P6046 Probe and Amplifier

A shorting strap must either be bolted or clipped to a front and rear post before the board is energized. No connection is required at the center post for DC or low frequency operation. If clips are used, make the connections to the steel posts. Do not scratch or otherwise damage the plating on the circuit board.

### PROBE DISASSEMBLY AND ASSEMBLY

#### Probe Case

**Opening.** Remove the two screws from the front of the top of the case and then remove the four screws from the bottom of the case. Set the AC-DC switch to mid-position. Lift the top away from the bottom, keeping the two sections parallel. All of the components will remain in the bottom of the case.

**Closing.** Set the AC-DC switch perpendicular to the tip assembly. Bring the top and bottom of the Probe case to-

gether, keeping them parallel while doing so. Insure that the tip assembly fits into its slot. Manipulate the strain relief boot as necessary to align the hexagonal bushing with the detents. The two parts should come together snugly, with only slight pressure required at the rear end to keep them that way. Insert and fasten screws through the bottom of the case and the two screws through the front of the case. Tighten the screws enough to insure good ground connections, but not so tight that they damage the plastic threads. Position the Input Coupling switch to either AC or DC, as desired.

#### Circuit Boards

Circuit board component layout and wire color code is shown in Fig. 4-6.

**Removing the Main Board.** Remove the one screw which is located near the center of the board. This releases the board and attached cable from the bottom of the case. Lift the circuit board away from the case, cable-end first.

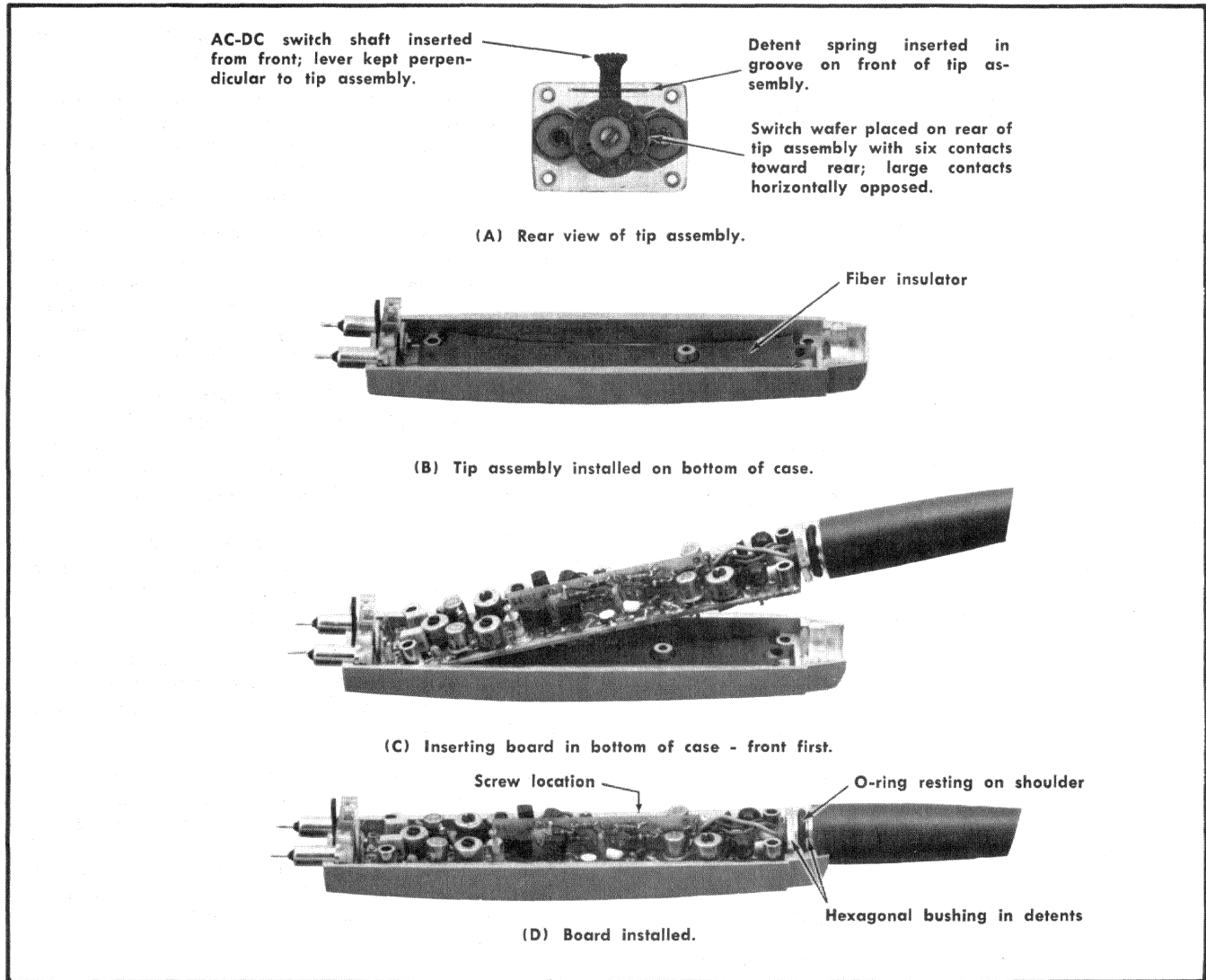

Fig. 4-2. Assembling probe components; see text for complete procedure.

**Replacing the Main Board.** Put the large fiber insulator in place in the bottom of the case. Insert the board front first into the bottom of the Probe case as shown in Fig. 4-2 (C). Put the rear end of it into place, aligning the neoprene O-ring with the shoulder at the rear of the case. The hexagonal bushing should fit in detents in front of and behind the shoulder. Insert and tighten the short screw near the center of the board. Be careful not to damage the plastic threads. See Fig. 4-2 (D).

**Removing the Upper Board.** Grip the board near one end at a point where no components or wiring are encountered. A small-nosed pair of pliers whose tips are cushioned with electrical tape can be used for this purpose if extreme care is exercised. Lift very slightly. Repeat at the opposite end. Continue pulling alternately at the two ends until the connectors are disengaged.

**Replacing the Upper Board.** Do not trap any wires underneath the board. Align the pins and connectors carefully. Seat the board completely but do not apply excessive pressure.

### Tip Assembly

**Removal.** The main circuit board must be removed first. Then remove the 2 screws from the front of the case. Keep the AC-DC switch lever perpendicular to the case to hold the detent spring in place. Slide the assembly from the case. The tips of the probe cannot be removed from the tip assembly. The switch lever and contact wafer can be disassembled by removing the screw and plastic washer from the rear of the lever shaft.

#### CAUTION

Be careful not to lose the extremely small detent spring which is located between the AC-DC switch lever and the tip body.

**Replacement.** The tip assembly should be put together as shown in Fig. 4-2 (A) with particular attention being given to the positioning of the AC-DC switch contact assembly and the detent spring. Insert the assembly into the bottom of the Probe case as in Fig. 4-2 (B) before the main circuit board is installed. Keep the AC-DC switch perpendicular to the assembly to keep the detent spring in place. Fasten the two screws to the tip assembly through the front of the probe case.

### Strain Relief Boot

**Removal.** Removal should not be required unless the cable is replaced. Changing cable length will affect the Probe performance.

Remove the main board and cable assembly from the case. Attach a wrench to the hexagonal nut which is located at the end of the cable. Then grip the strain relief boot and unscrew it. Slide the boot up the cable far enough to expose the plastic cable clamp. The nut assembly, plastic cable clamp, and strain relief boot can now be slid to the desired position. Use caution in unsoldering and soldering wires on the circuit boards.

**Replacement.** Observe the color coding given in Fig. 4-6. The length of the cable shields between the cable and the circuit board must be kept as short as possible. The teflon heat-insulating sleeves must be in place over the insulation on the signal output leads before the shield wires are soldered to the board. The hexagonal nut which holds the strain relief boot should be located at the extreme end of the cable insulation, putting it approximately  $\frac{1}{32}$  inch from the large circuit board. Push the plastic cable clamp up against the nut assembly, matching the clamp notches with the keys on the nut assembly. Hold the nut assembly in place and screw on the strain relief boot assembly.

### Amphenol Connector

**Removal.** Using two wrenches, unscrew the end nut. Slide the nut and the strain relief boot up the cable enough to expose the inner nut. Again using two wrenches, unscrew the inner nut. The contact assembly now can be pulled out of the rear of the housing.

**Replacement.** Observe the color coding given in Fig. 4-6 when re-connecting wires. Keep the soldered connections neat. Re-assemble in reverse order, insuring that the notch in the contact assembly straddles the key located in the housing.

## AMPLIFIER FOR P6046

### Amplifier Unit

Component locations and wire color code appear in Fig. 4-7 and 4-8. Transistor information and miscellaneous wiring information is shown in Fig. 4-4. Most components in the Amplifier unit can be removed and replaced with the circuit boards and switch left in place. If additional access is required, it is recommended that the rear panel, the frame-posts and the front panel be removed.

A soldering iron with a  $\frac{1}{16}$  inch tip, a pair of tweezers, and a vacuum-type solder removing device are recommended for use in component replacement.

The following disassembly instructions are independent of each other, except where noted otherwise.

**Cover Removal.** Extract the two screws from the rear of the unit. Withdraw the unit from the cover.

**Rear Panel and Frame-Post Removal.** Remove the cover. Check the rear panel wire color code against Fig. 4-7. Disconnect the 6 square-pin connectors which connect the cable and BNC connector to the circuit board. Unscrew the 5 screws from the rear panel, freeing it from the assembly.

If the frame-posts are to be removed, remove the 4 screws which hold the output board to the frame-posts. Remove the mVOLTS/DIV knob, using a  $\frac{1}{16}$  inch allen wrench. Remove the nut from the front of the switch bushing. Pull the ATTEN BAL knob off the front of its shaft. Lift the front cover plate from the front panel, exposing the 4 frame-post screws. Remove the screws, freeing the frame-posts.

	Superimposed Sketch of Transistor and Socket as Viewed from Above	View of Bottom of Transistor
Q113 Q213 Q154 Q254		
Q124 Q224 Q134 Q234		
Q164 Q264		
Q143 Q243		
Q123	<p style="text-align: center;">DIMPLE INDICATES TOP OF TRANSISTOR</p>	

Fig. 4-3. Probe transistor installation.

**Front Panel Removal.** Remove the cover. Remove the mVOLTS/DIV switch knob, using a 1/16 inch allen wrench. Then remove the nut which holds the switch in place. Pull the ATTEN BAL knob off the front of its shaft. Lift the front cover plate away from the front panel, exposing the frame-post screws. Check the wire color coding against Fig. 4-7. Unsolder the connections from terminals C and J of the Amphenol connector. Disconnect the square-pin connectors which connect to terminals D, E, F and K. Unscrewing the four frame-post screws at the front panel will free the panel from the assembly.

**Amphenol Connector Removal.** Remove the cover. The connector can then be removed with or without removing the front panel. Unsolder the connections from terminals A, C, F and J. Disconnect the square-pin connectors which lead to terminals D, E and K. Remove the four bolts which

hold the connector in place and extract the connector out the front of the panel.

**ATTEN BAL Potentiometer Removal.** The front panel assembly must be removed from the Amplifier before the potentiometer can be removed. Unsolder the connections from the three terminals. Remove the set screw from the front panel sleeve and unscrew the potentiometer from the front panel.

**Output Board Removal.** After the Amplifier cover has been removed, the output board wire color code should be checked against Fig. 4-7, and any exceptions noted. The 14 square pin connectors should then be removed from the board pins. The 7 soldered connections which go to the switch assembly must then be unsoldered. Do not use too large an iron, or apply heat for too long a time. Use

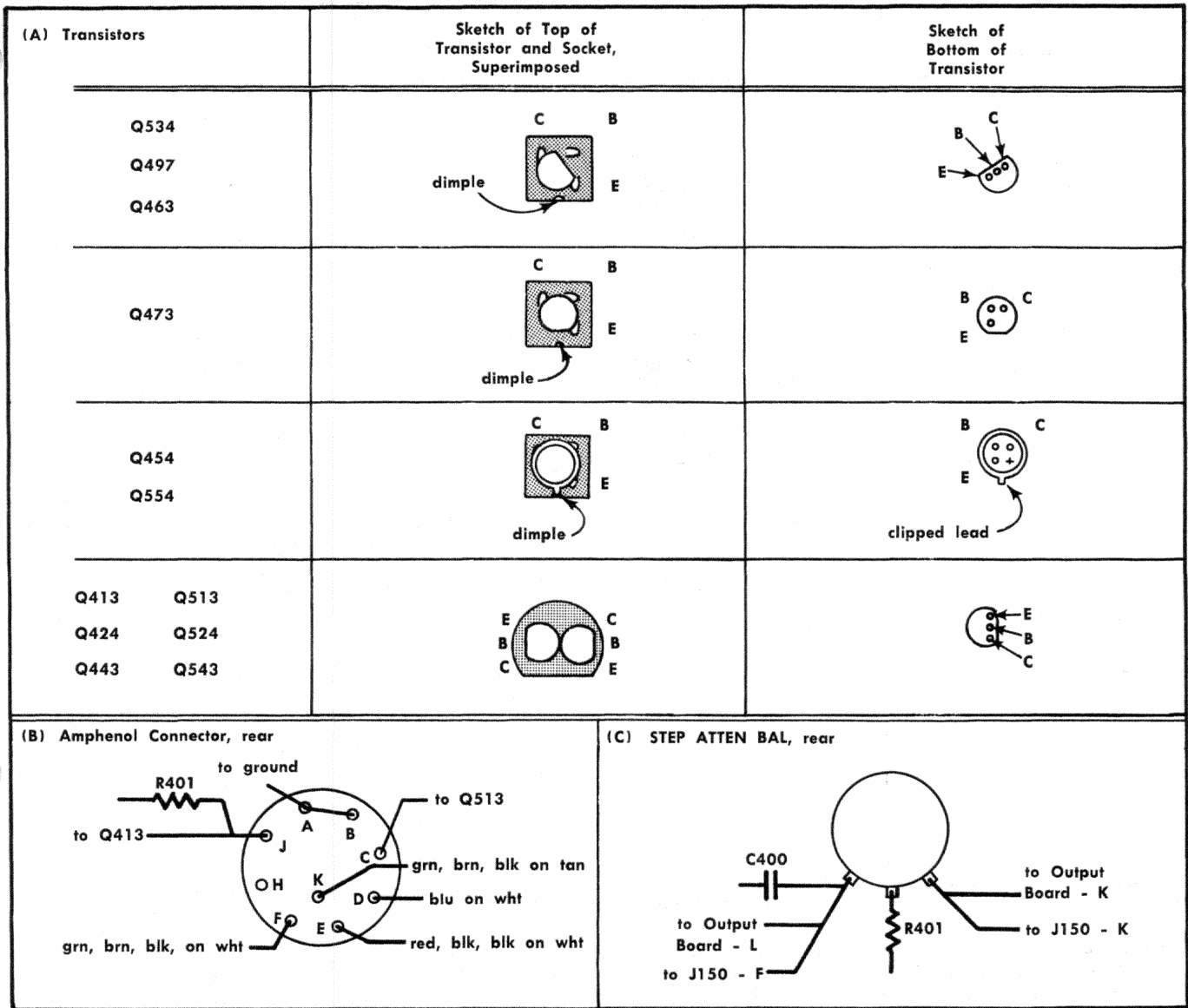

Fig. 4-4. Amplifier component details.

a pair of pliers as heat sinks where necessary. Removal of 4 screws from the corners of the board will then free the board from the unit.

**Switch Assembly Removal.** The switch and Input Board can be removed most easily as one unit. Remove the cover and the rear panel, using the preceding directions. At the Input Board, unsolder two leads from between the Amphenol connector and the Input Board. Disconnect 5 square-pin connectors from between the Output Board and the Input Board. At the Output Board, unsolder 7 connections which go to the switch assembly.

Remove the mVOLTS/DIV switch knob, using a 1/16 inch allen wrench to loosen the set screw. This exposes the nut which holds the switch in place. Remove the nut, and slide the switch and Input Board assembly out the rear of the unit.

The Input and Comp boards can be removed from the switch assembly by using a vacuum-type solder removing device to clean solder from the interconnecting points. Then separate the board from the switch, working from one end and reapplying heat to each point as necessary.

**Switch Maintenance Information.** Switch wafers are numbered from front to rear of the assembly. Letters are included to indicate whether the contacts are on the front or the rear of the wafer. Example: 5R indicates the rear of the fifth wafer from the front.

The switch positioning detent mechanism should receive a light application of grease whenever the Amplifier Unit is disassembled for repair or calibration, or at yearly intervals, whichever occurs first. The grease (Tektronix Part No. 006-0219-00) contained in the Tektronix lubrication kit, Part No. 003-0342-01, is recommended for that purpose.



Transistor Number	Sketch of Top of Transistor and Socket, Superimposed	Sketch of Bottom of Transistor
Q304		
Q314, Q324 Q343, Q344		
Q327		
Q347		

Fig. 4-5. Power Supply transistor installation.

Individual parts of the mVOLTS/DIV switch are not normally replaced. A complete switch, either wired or unwired, should be ordered in event the switch becomes inoperable.

### Power Supply Unit

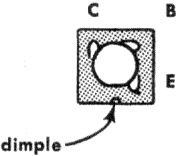
Component locations and wire colors are shown in Fig. 4-9. Transistor Installation information appears in Fig. 4-5.

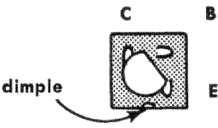
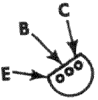
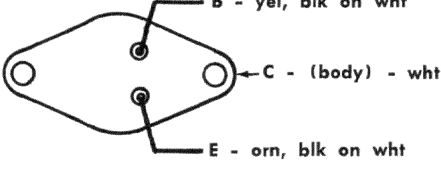
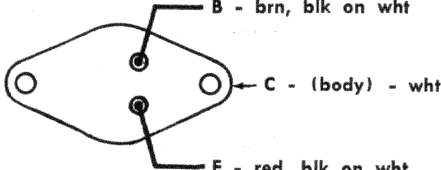
**Transformer Rewiring.** The transformer must be re-wired, and fuses changed according to Table 4-3 whenever it is desired to operate from a source other than that for which it is wired. Only the cover need be removed to perform this rewiring.

The Power Supply output voltage should be re-checked after the transformer has been re-wired. Voltages should remain within tolerance. If not, recheck the source voltage,

TABLE 4-3  
Power Supply Transformer Connections

50 to 400 Hz Voltage	Power Source Range	F301 Size	Fused Lead Connection(s)	Non-fused Lead Connection(s)	Jumper Connections
100	90-110	1/4 A	4 and 5	1 and 8	
115	104-126	1/4 A	4 and 3	1 and 2	
136	112-136	1/4 A	4 and 6	1 and 7	
200	180-220	1/8 A	4	1	5 to 8
230	208-252	1/8 A	4	1	2 to 3
248	224-272	1/8 A	4	1	6 to 7

the transformer connections, and then the Power Supply Calibration Procedure.

**IMPORTANT**

A 115/230 operating voltage tag appears on the base of the Power Supply Unit. Always invert it to indicate the nominal operating voltage range when the transformer is changed between the 100 V and 200 V ranges. (Engage the tag screws into their previously-used threads to avoid stripping threads.)

**Disassembly of Power Supply Unit.** Remove 2 screws from the top of the Power Supply Unit cover and slide the cover off the top of the Power Supply chassis. Remove the two screws from the base of either or both of the two circuit boards. Check the wire color code against Fig. 4-9 before disconnecting the square-pin connectors.

**Transformer Removal.** After the screws are removed from both boards, remove the two screws which straddle the fuse, and the two screws on the opposite side. Disconnect the 4 square-pin connectors which go to the transform-

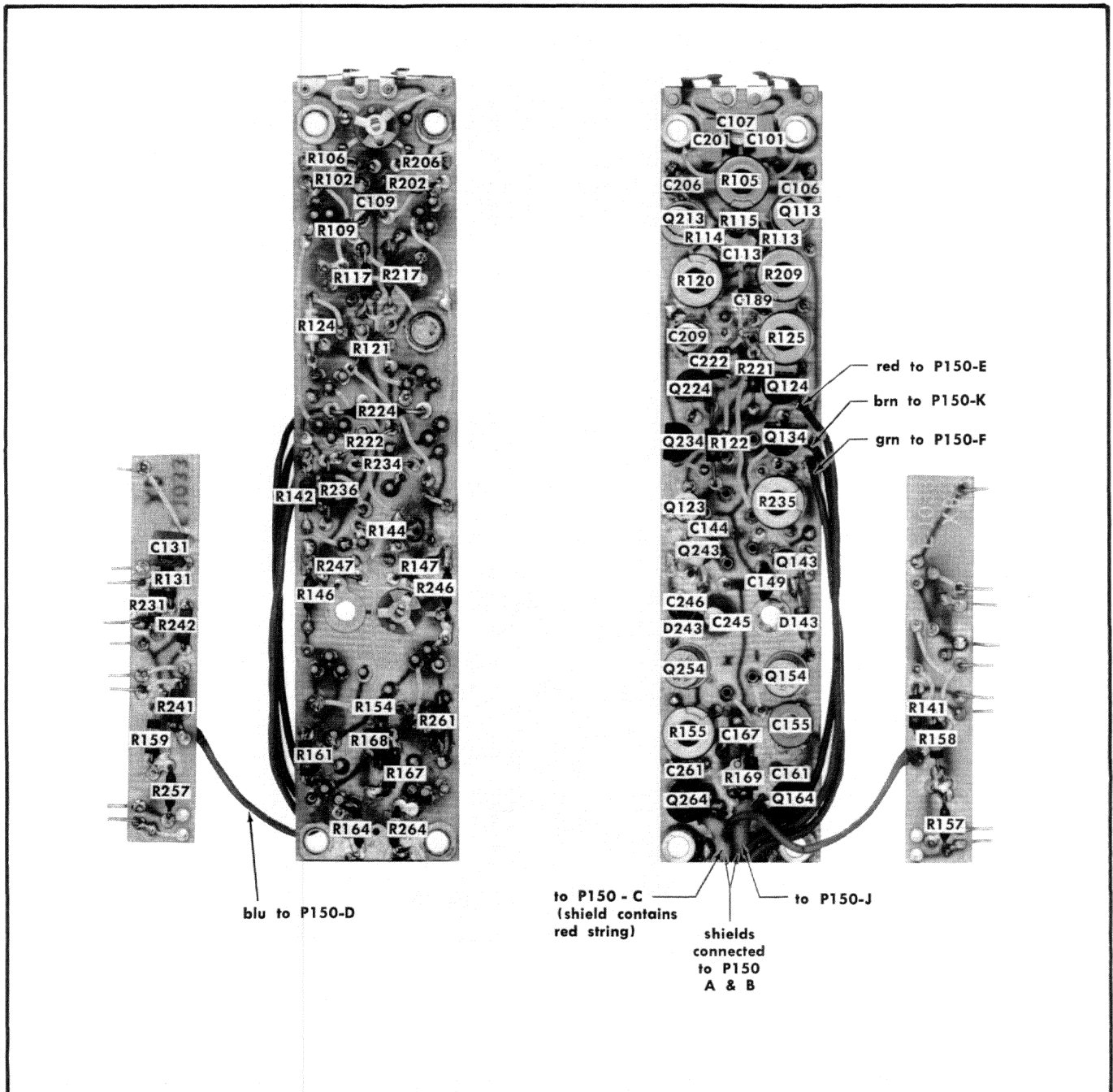

Fig. 4-6. P6046 Probe circuit board component locations.

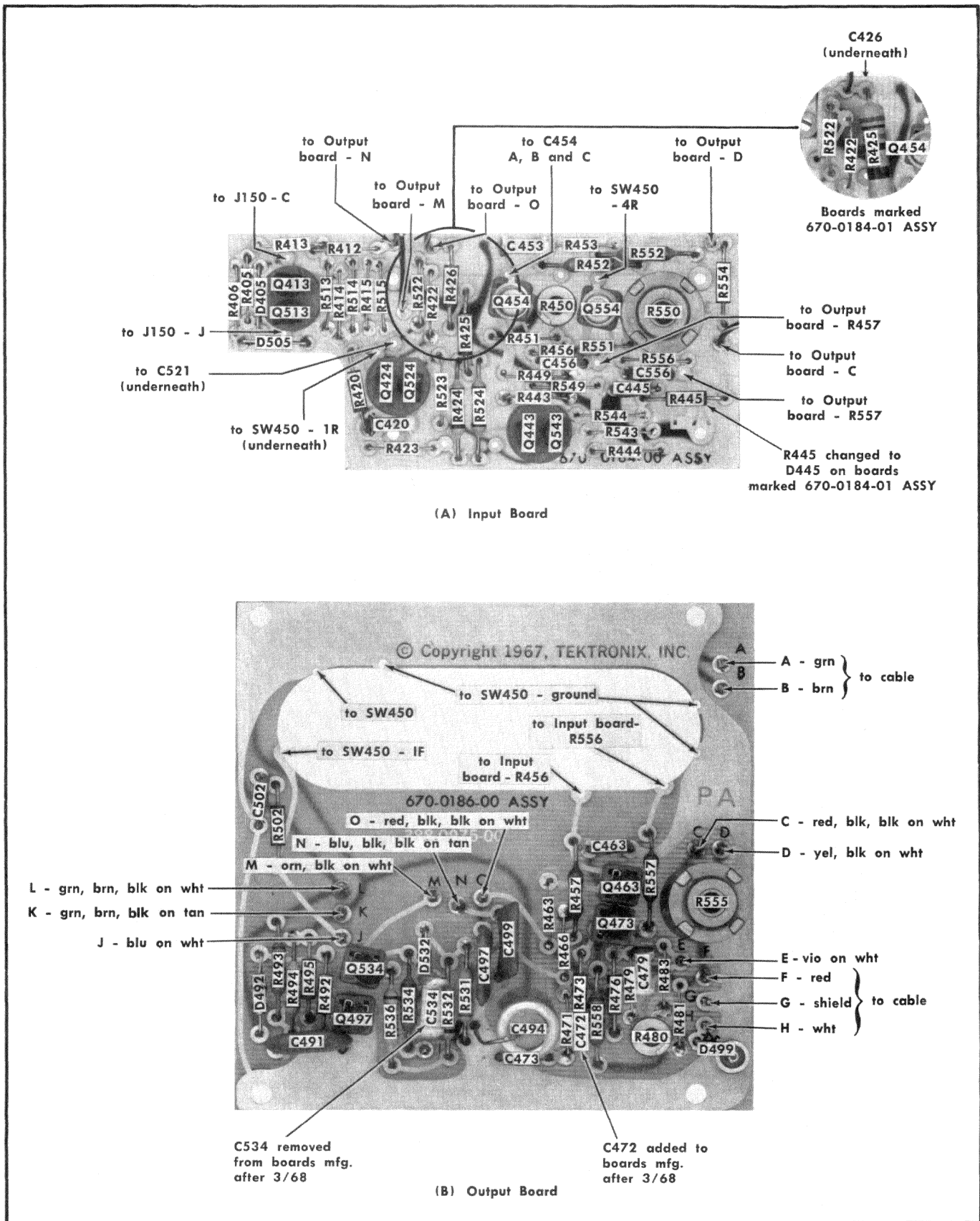
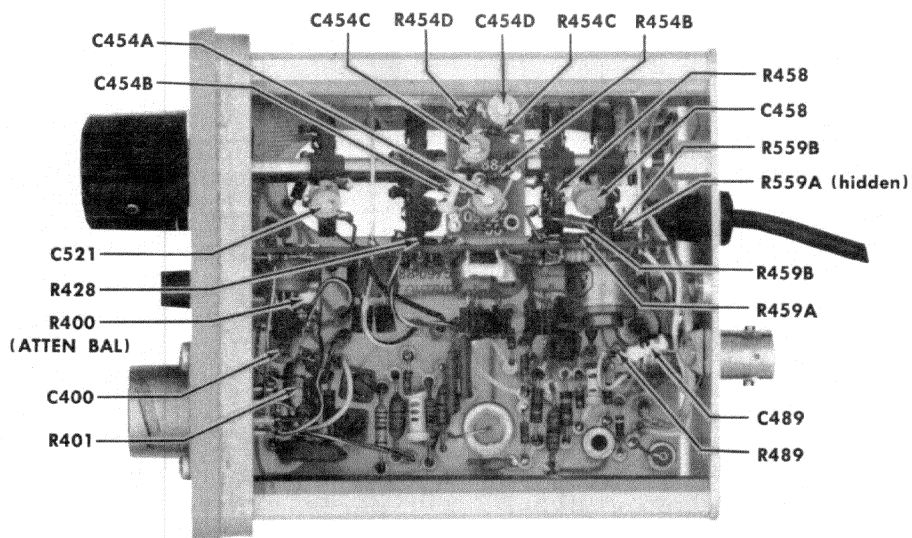
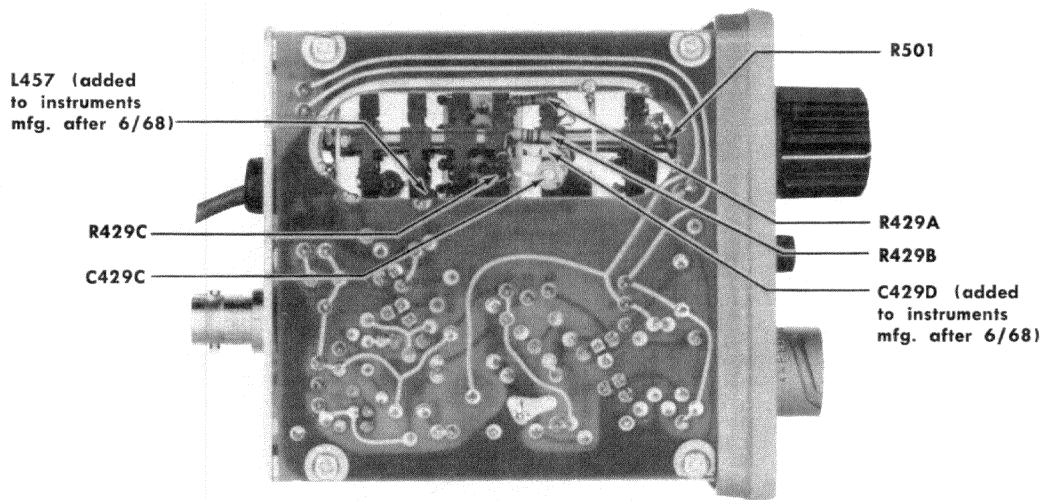

Fig. 4-7. Amplifier circuit board component locations.





(A) Right Side



(B) Left Side

Fig. 4-8. Amplifier miscellaneous component locations.

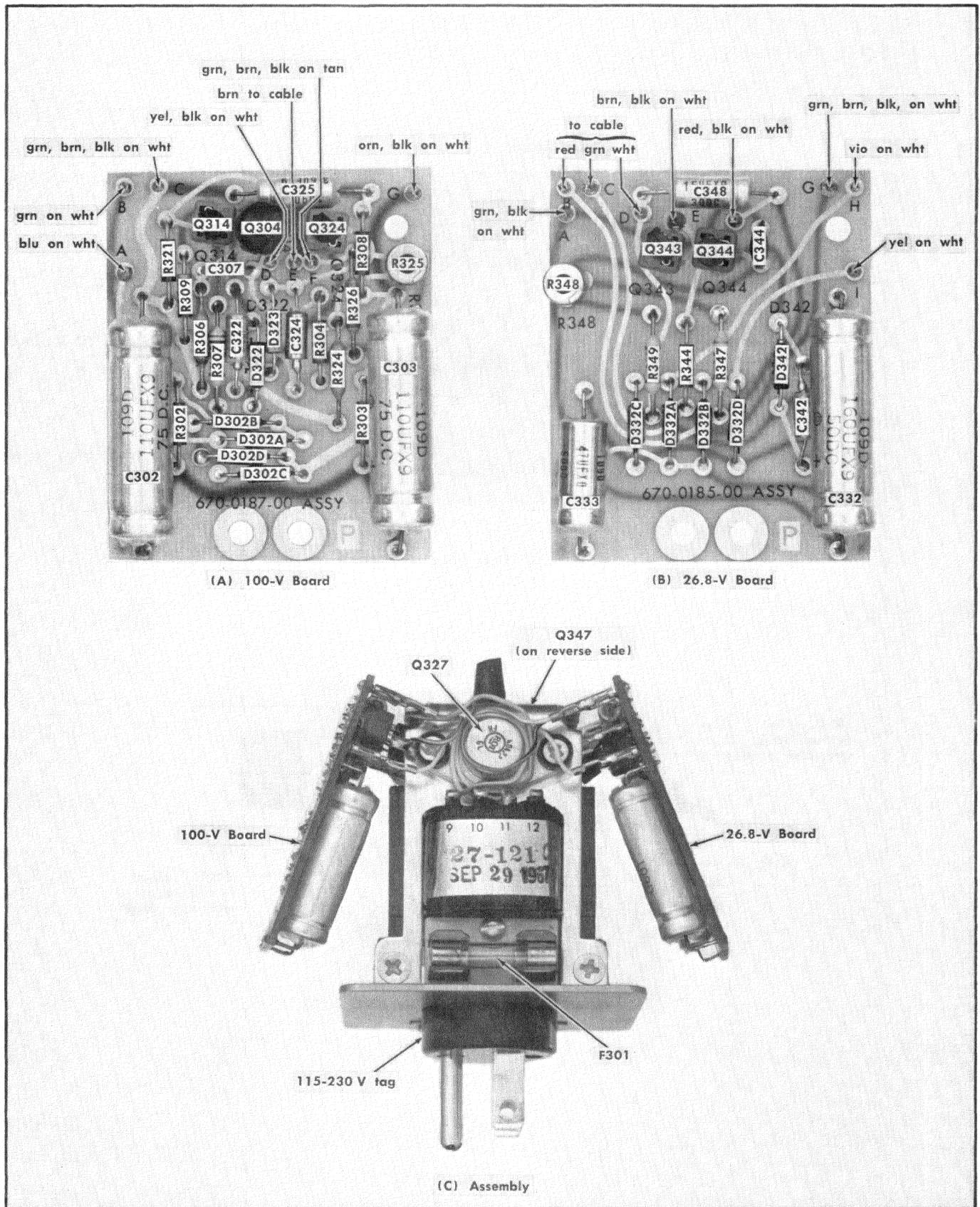

Fig. 4-9A. Power Supply component locations before 7144.

er. Slide the transformer holding bracket off the transformer. Remove the screw which fastens the fuse holder to the transformer. Unsolder the power input leads at the transformer. The transformer now can be removed.

**Reassembly.** Replace the transformer, reversing the removal procedure. Then re-assemble the unit according to Fig. 4-9 (C). The wire color code shown in Fig. 4-9 (A) and (B) should be used to avoid making incorrect connections.

**Series-Regulator Transistors.** Q327 and Q347 are power transistors and are therefore heat-sinked to the chassis. Each transistor can be removed as follows: disconnect the

two square-pin connectors which are fastened to the wires which are connected to the emitter and base leads; then remove the two screws which fasten the transistor to the chassis.

The transistor bodies are insulated from the chassis by mica washers. Mounting screws are insulated from the body by plastic bushings. Contact to the body (collector) is made by a soldering lug which fastens between the screw insulator and the transistor body. The insulator, bushings, and soldering lug must be in place whenever the transistors are re-installed.

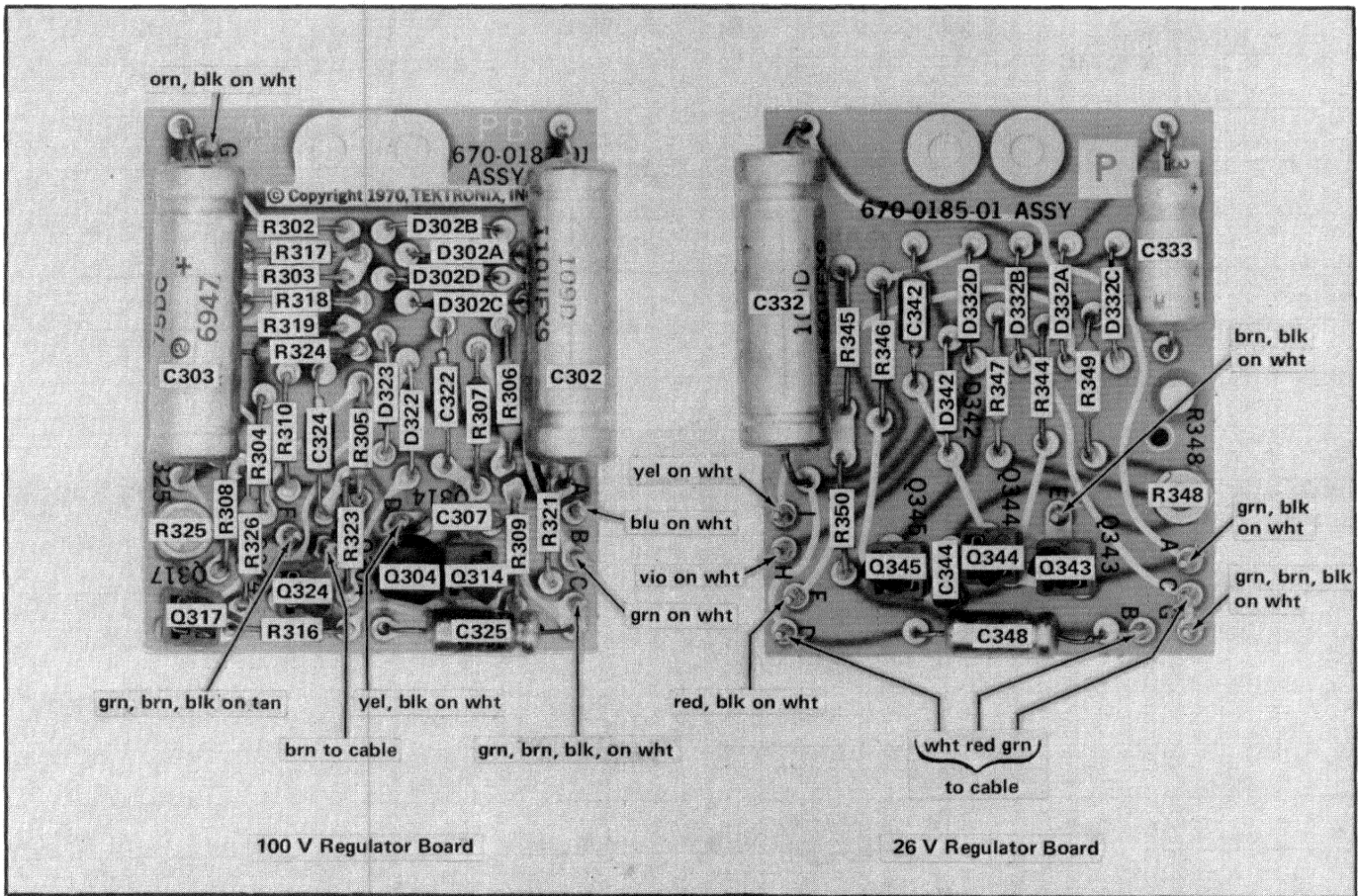

Fig. 4-9B. Power Supply component locations after 7144.

**REPACKAGING FOR SHIPMENT**

If the Tektronix instrument is to be shipped to a Tektronix Service Center for service or repair, attach a tag showing: owner (with address) and the name of an individual at your firm that can be contacted, complete instrument serial number and a description of the service required.

Save and re-use the package in which your instrument was shipped. If the original packaging is unfit for use or not available, repackage the instrument as follows:

Surround the instrument with polyethylene sheeting to protect the finish of the instrument. Obtain a carton of corrugated cardboard of the correct carton strength and having inside dimensions of no less than six inches more than the instrument dimensions. Cushion the instrument by tightly packing three inches of dunnage or urethane foam between carton and instrument, on all sides. Seal carton with shipping tape or industrial stapler.

The carton test strength for your instrument is 200 pounds.



# SECTION 5

## PERFORMANCE CHECK

Change information, if any, affecting this section will be found at the rear of the manual.

### Introduction

This performance check offers a means of rapidly checking the operation of the P6046 Differential Probe and the Probe's Dual Attenuator Head with either a Type 1A5 or the Amplifier For P6046. Only external operating adjustments are associated with it.

### Procedure Format

Two separate Preliminary Procedures are included to describe setting up the equipment with either a Type 1A5 or an Amplifier For P6046. The same performance check is used for checking the Probe with either instrument. Specific instances where deviations are unavoidable are identified by the terms (P6046 Probe/Type 1A5 only), (P6046 Probe/Amplifier For P6046 only) or similar notations.

The basic control settings are listed in the preliminary procedures and apply to every step in the Performance Check. Deviations are specified in each step as required. Reproductions of waveform photographs are included where appropriate.

The term "divisions" (or div) refers to graticule major divisions. mVOLTS/DIV and VOLTS/CM are both referred to as "vertical deflection factor" to allow interchangeable application without misnaming the control.

Names of calibration equipment have initial letters capitalized. Names of the equipment controls are written in upper case letters for quick recognition.

Most checks have been outlined with reference to the Probe + Input tip. Checks employing the — Input tip are equally effective if due consideration is given to polarity in signal application and waveform observation.

### Common Reference (Ground)

The use of a ground lead is stressed throughout this procedure. It can be eliminated only if a common ground definitely exists between all equipment used.

#### CAUTION

The Probe tips often come in contact with equipment ground during insertion into test jacks. A common ground between the Probe and equipment being tested must therefore exist before the Probe is connected to the equipment to insure against Probe damage due to ground loop currents.

### Equipment

The equipment contained in the following list is required for performance-checking the P6046 Differential Probe, Dual Attenuator Head and the Amplifier For P6046. Tektronix part numbers are included for ordering purposes. Items which accompany the Probe and Amplifier are listed as Standard Accessories. The GR 90° elbow is an optional item, used only for convenient positioning of the test cables.

All equipment must be operating within its specified limits. Substitutions can be used in many instances, provided that the substitute meets or exceeds the performance requirements of the equipment listed.

1. Oscilloscope. Tektronix Type 544, 545, 547, or 556; 580-series Oscilloscopes equipped with a Type 81A Plug-In Adapter can be used if the 5 cm parameters are modified to 4 cm throughout the procedure. A Type 547 is used in this procedure. (Not required if the Amplifier for P6046 is used with the 100 MHz oscilloscope listed as item 3.)
2. Tektronix Type 1A5 Differential Plug-In unit. (Not required if the Amplifier For P6046 is used.)
3. Oscilloscope. 100 MHz bandwidth. Tektronix Type 454 or Tektronix Type 647A equipped with 10A2A and 11B2A plug-in units. (Not required if a Type 1A5 is used.)
4. Standard Amplitude calibrator. Amplitude accuracy within 0.25%; signal amplitude 50 V and 5 mV through 1 V in 1, 2, 5 sequence; 1 kHz square wave output. Tektronix Standard Amplitude Calibrator, Part No. 067-0502-01 recommended.
5. Square-wave generator. Frequency —100 kHz; High Amplitude output of 5 V into 50  $\Omega$ ; Fast Rise output variable from 50 mV to 100 mV into 50  $\Omega$ , with 1 nanosecond or less rise time. Tektronix Type 106 Square-Wave generator recommended.
6. Constant amplitude sine wave generator. Output requirements (peak-to-peak) into a 50  $\Omega$  load: 80 mV at 50 kHz and 50 MHz; 4 mV through 800 mV at 50 kHz and 100 MHz; 5 V at 50 kHz and 1 MHz; 2 V at 50 MHz. Tektronix Type 191 Constant Amplitude Signal Generator recommended.
7. Low frequency sine wave generator. Output requirements: 10 V peak to peak at 60 Hz and 10 kHz General Radio Oscillator Type 1310-A used in this procedure.
8. Coaxial cable. 42 inches, 50  $\Omega$ ; equipped with BNC male connectors. Tektronix Part No. 012-0057-01.
9. Cable, type RG8/213. GR connectors; 5 ns delay; (5 ns GR cable). Tektronix Part No. 017-0502-00.
10. GR 90° elbow. Tektronix Part No. 017-0070-00. (Optional)

## Performance Check—P6046 Probe and Amplifier

11. Adapter, GR-to-BNC male. Tektronix Part No. 017-0064-00.
12. Adapter, GR-to-BNC female. Tektronix Part No. 017-0063-00.
13. Probe tip-to-GR adapter. Tektronix Part No. 017-0076-00.
14. Probe dual tip-to-BNC adapter. Tektronix Part No. 067-0562-00.
15. Termination, 50  $\Omega$ , GR-to-BNC. Tektronix Part No. 017-0083-00.
16. Attenuator, 2:1, 50  $\Omega$ , GR type. Tektronix Part No. 017-0080-00.
17. Attenuator, 5:1, 50  $\Omega$ , GR type. Tektronix Part No. 017-0079-00.
18. Attenuator, 10:1, 50  $\Omega$ , GR type. Two required. Tektronix Part No. 017-0078-00.
19. Adapter, dual banana plug-to-BNC female connector. General Radio Company Type 274-QBJ.
20. Special ground tip. Two required. Tektronix Part No. 206-0163-00. (P6046 Probe standard accessory).
21. 12-inch ground lead equipped with alligator clip. Tektronix Part No. 175-0125-00 and 344-0046-00 (P6046 Probe standard accessory).
22. Screwdriver, Phillips head,  $\frac{1}{8}$  inch tip.
23. Coaxial Cable, 18 inch, 50  $\Omega$ . Tektronix Part No. 012-0076-00. (Amplifier For P6046 standard accessory.)
24. Termination, 50  $\Omega$ , BNC. Tektronix Part No. 011-0049-01. (Amplifier For P6046 standard accessory.)

## PERFORMANCE CHECK

### NOTE

The Oscilloscope, Type 1A5, and all test equipment and accessories must be within their specified operating limits before an effective performance check can be performed on the P6046 Differential Probe. The Probe and/or Amplifier should be recalibrated if any of the performance requirements cannot be met.

### P6046 Probe/1A5 Preliminary Procedure

- a. Insert the Type 1A5 (item 2) into the plug-in compartment of the Type 547 Oscilloscope (item 1).
- b. Preset the equipment controls to the following positions:

#### P6046 Probe

Input Coupling                      DC

#### Type 1A5

POSITION                              Midrange  
VOLTS/CM                              20 mV  
VARIABLE                              CAL

## Type 547 Oscilloscope

### TIME BASE A

#### TRIGGERING

LEVEL                                      0  
MODE                                      AUTO STABILITY

SLOPE                                      +

COUPLING                                AC

SOURCE                                 NORM

TIME/CM                                .5 ms

VARIABLE                                CALIBRATED

#### HORIZONTAL

DISPLAY                                 A

#### SWEEP

MAGNIFIER                               $\times 1$  OFF

#### HORIZONTAL

POSITION                                Midrange

#### AMPLITUDE

CALIBRATOR                              OFF

c. Energize the Oscilloscope and the test equipment which is to be used in this procedure. Set the CRT controls for optimum display.

d. Connect the P6046 Probe Amphenol connector to the Type 1A5 DIFFERENTIAL PROBE jack. Depress the PUSH ON/OFF button, lighting the Probe On lamp which is located in the button housing. Warm up the equipment for 20 minutes before continuing.

## P6046 Probe/Amplifier For P6046

### Preliminary Procedure

a. Check that the Amplifier For P6046 Power Supply Unit is not connected to a power supply. Then remove the Power Supply Unit cover and determine the voltage for which the transformer is wired, referring to Table 4-3 in the Maintenance section. If necessary, rewire the transformer and change the fuse and voltage tag (as outlined in the Maintenance section) to conform to the voltage with which the Amplifier For P6046 is to be used. Then replace the cover on the Power Supply Unit.

- b. Make the following equipment connections:

Connect a 50  $\Omega$  BNC termination (item 24) to the Vertical CH 1 INPUT connector of the Type 647A Oscilloscope (item 3).

Connect an 18 inch 50  $\Omega$  cable (item 23) from the 50  $\Omega$  termination to the Amplifier For P6046 Output connector.

Connect the Probe Amphenol plug connector to the Amplifier For P6046 Amphenol jack.

- c. Set the equipment controls as follows:

#### P6046 Probe

Input Coupling                      DC

**Amplifier For P6046**

mVOLTS/DIV 20

**Type 647A Oscilloscope**

CH 1 AC-GND-DC	DC
VOLTS/CM	.01 <sup>1</sup>
VARIABLE	CAL <sup>1</sup>
INVERT PULL	In
TRIGGER	Norm

**11B2A**

MODE	CH 1
HORIZ DISP	A
MAG	OFF
TRIG MODE	AUTO
TIME/CM	.5 ms
VARIABLE A	CALIB
A Triggering SLOPE	+
COUPLING	AC
SOURCE	INT

<sup>1</sup>The Oscilloscope's VOLTS/CM and VARIABLE controls must remain at .01 and CAL throughout the procedure. All deflection factor switching is to be performed at the Amplifier For P6046.

d. Apply power to the Oscilloscope, Amplifier For P6046, and to the test equipment which will be used in the procedure. Allow 20 minutes warmup before continuing.

**1. Perform PROBE STEP ATTEN BAL (ATTEN BAL) Adjustment**

REQUIREMENT—Trace remains within 1 div of reference position at any of the 1 mV through .2 V (200 mV) deflection factor positions.

- The preliminary control settings apply.
- With no inputs to the Probe tips and a vertical deflection of 20 mV selected, set the trace to graticule vertical center, using the vertical POSITION control.
- Select a vertical deflection factor of 1 mV.
- Adjust the PROBE STEP ATTEN BAL (ATTEN BAL) control to return the trace to graticule vertical center.
- Repeat steps b, c and d until no further adjustment is necessary.

**2. Check Input Gate Current**

REQUIREMENT—Not more than 0.3 nA at 25°C; Not more than 2 nA at 50°C.

- The preliminary control settings apply.
- Attach special ground tips (item 20) to the Probe + and — Input tips.
- Switch to 1 mV vertical deflection factor.

d. CHECK—The — Input gate current by observing the amount of instantaneous trace shift as the — Input ground tip is removed or replaced. Not more than 0.3 divisions of trace shift should occur, indicating not more than 0.3 nA gate current. Replace the — Input ground tip.

e. CHECK—The + Input gate current, using the same procedure with the + Input ground tip.

**3. Check Gain**

REQUIREMENT	1 mV to 20 mV/div: $\leq 2\%$ with 1A5; $\leq 3\%$ with Amplifier For P6046
	50 mV to 200 mV/div: $\leq 4\%$ with 1A5; $\leq 3\%$ with Amplifier For P6046
	Dual Attenuator Head $\leq 2\%$

- The preliminary control settings apply.
- Switch to 20 mV vertical deflection factor. Check that the special ground tip is on the — tip.
- Set the Standard Amplitude Calibrator (item 4) controls as follows:

MODE	Square Wave
Output Selector	Up
AMPLITUDE	.1 VOLTS

d. Connect the following components to the Standard Amplitude Calibrator right OUTPUT connector in the sequence listed:

- 42-inch coaxial cable (item 8)
- GR to BNC female adapter (item 12)
- Probe tip-to-GR adapter (item 13)

e. Connect a ground lead (item 21) between the P6046 ground lug and the Standard Amplitude Calibrator case.

**CAUTION**

Do not set the Standard Amplitude Calibrator AMPLITUDE to more than 20 VOLTS while it is connected to the Probe.

- Insert the P6046 + Input tip into the probe tip-to-GR adapter.
- Adjust the vertical POSITION control to obtain a centered display. Set the Oscilloscope Triggering controls as necessary to obtain a free-running sweep, resulting in two horizontal traces.

h. (P6046 Probe/Type 1A5 only) CHECK—Gain according to the setups given in Table 5-1. Record (for later use) the exact amplitude obtained at 20 mV/CM. Measure between the trace centers to avoid the effect of trace width.

**IMPORTANT**

The 20 mV/CM gain of the Type 1A5 must be accurately calibrated in response to an A or B INPUT signal before Probe gain can be checked.

- (P6046/Amplifier For P6046 only) CHECK—Gain according to the setups given in Table 5-2. Record (for later use) the exact amplitude obtained at 20 mV/DIV. Measure between the trace centers to avoid the effect of trace width.

## Performance Check—P6046 Probe and Amplifier

**TABLE 5-1**

Vertical Deflection Factor	Standard Amplitude Calibrator	Display Amplitude	Tolerance
20 mV	.1 V	5 div	±0.1 div (2%)
.2 V	1 V	5 div	±0.2 div (4%)

### IMPORTANT

The 10 mV/div gain of the 100 MHz Oscilloscope must be accurately calibrated before the following checks are made.

**TABLE 5-2**

Vertical Deflection Factor	Standard Amplitude Calibrator	Display Amplitude	Tolerance (3%)
5 mV	20 mV	Adjust the 100 MHz Oscilloscope GAIN control to provide exactly 4 divisions of display amplitude	
200 mV	1 V	5	0.15 div
100 mV	.5 V	5	0.15 div
50 mV	.2 V	4	0.12 div
20 mV	.1 V	5	0.15 div
10 mV	50 mV	5	0.15 div
2 mV	10 mV	5	0.15 div
1 mV	5 mV	5	0.15 div

j. Move the equipment from the Probe + and - Input tips to the Dual Attenuator Head + and - Input tips, respectively.

k. Attach the Dual Attenuator Head to the Probe, matching the detent and shoulder.

l. Switch the Standard Amplitude Calibrator AMPLITUDE control to 1 V.

m. CHECK—Dual Attenuator Head + Input attenuator accuracy. Switch to 20 mV vertical deflection factor and check for a display amplitude which is within 0.1 div of the value recorded in step h or i, as appropriate.

n. Remove the ground tip from the Dual Attenuator Head - Input tip. Move the adapter from the + to the - Input tip. Connect the special ground tip to the + Input tip.

o. CHECK—Dual Attenuator Head - Input attenuator accuracy. The display amplitude should be within 0.1 div of the value recorded in step h or i as appropriate.

## 4. Check ATTEN DC BAL (R105)

REQUIREMENT—See graph, Fig. 1-4 for complete requirements. The balance is checked here for a CMRR of greater than 800:1 at 1 kHz.

a. The preliminary control settings apply, except that the Dual Attenuator Head is connected to the P6046 Probe.

b. Remove the ground tip from the Dual Attenuator Head + Input tip and the adapter from the - Input tip. Then

check the PROBE STEP ATTEN BAL (ATTEN BAL) adjustment as explained in step 1 b, c, d and e.

c. Check that the Probe ground lead remains connected to the Standard Amplitude Calibrator chassis; then connect the following components to the Standard Amplitude Calibrator's right OUTPUT jack in the sequence listed:

42 inch coaxial cable

Probe dual tip-to-BNC adapter (item 14)

Dual Attenuator Head and Probe assembly

d. Set the Standard Amplitude Calibrator controls as follows:

AMPLITUDE                    50 VOLTS  
 MODE                         Square Wave  
 Output Selector             Up

e. Select a 1 mV vertical deflection factor; then adjust the vertical POSITION control and the Oscilloscope triggering controls for a centered stable display as in Fig. 5-1.

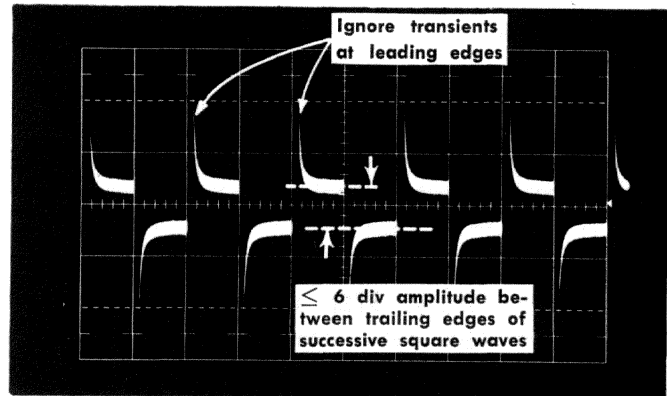

Fig. 5-1. Attenuator DC balance waveform, step 4. Sweep rate 0.5 ms/div; deflection factor 10 mV/div.

f. CHECK—Attenuator DC balance. 6 divisions or less display amplitude should exist between the trailing edges of the square waves as indicated in Fig. 5-1.

g. Set the Standard Amplitude Calibrator AMPLITUDE to 1 V.

h. Switch to a 20 mV vertical deflection factor and remove the Probe dual tip-to-BNC adapter from the Dual Attenuator Head.

## 5. Check Dual Attenuator Head AC Compensation

REQUIREMENT—Optimum squareness with 2% or less aberration.

a. Preliminary control settings apply, except that the Dual Attenuator Head is connected to the Probe.

b. Connect a special ground tip to the - tip of the Dual Attenuator Head.



## Performance Check—P6046 Probe and Amplifier

c. Check that the Standard Amplitude Calibrator controls are set as follows:

AMPLITUDE	1 V
MODE	Square Wave
Output Selector	Up

d. Check that 20 mV vertical deflection factor is selected, and that the ground lead remains connected between the Probe ground lug and the Standard Amplitude Calibrator chassis.

e. Connect the following to the Standard Amplitude Calibrator right OUTPUT connector in the sequence given:

- 42-inch coaxial cable
- GR-to-BNC female adapter
- Probe tip-to-GR adapter
- Dual Attenuator Head + Input tip

f. Adjust the Oscilloscope triggering controls and the vertical POSITION control to obtain a stable, centered 5 div square-wave display.

g. CHECK—Attenuator + Input AC compensation. Observe the upper left hand corner of the square waves for optimum squareness with  $\pm 0.1$  div or less aberration. See Fig. 5-2.

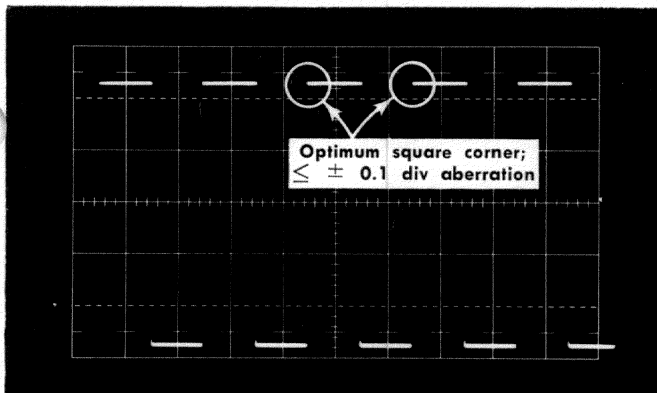

Fig. 5-2. Waveform for Dual Attenuator Head + Input tip AC compensation, step 5. Sweep rate 0.5 ms/div; deflection factor 0.2 V/div (including Dual Attenuator head).

h. Remove the ground tip from the — Input tip. Move the adapter from the + Input tip to the — Input tip. Connect a special ground tip to the + Input tip.

i. CHECK—Attenuator — Input AC compensation. Observe the **lower** left corner of the square waves for optimum squareness;  $\pm 0.1$  div or less aberration.

j. Remove the adapter from the Dual Attenuator Head. Disconnect the coaxial cable and the ground lead from the Standard Amplitude Calibrator. Use of the Standard Amplitude Calibrator has been completed.

## 6. Check DC Shift Due to Overdrive; Check Overdrive Recovery Time

REQUIREMENT—DC shift:  $\leq 1.5\%$  of input signal. Over-

drive Recovery Time:  $\leq 10$  mV within 150 ns with Type 1A5;  $\leq 10$  mV within 100 ns with Amplifier For P6046.

a. The preliminary control settings apply except that the Dual Attenuator Head is connected to the Probe.

b. Move the special ground tip from the + Input tip to the — Input tip; then connect a ground lead from the P6046 ground lug to the chassis of the Type 106 Square Wave Generator (item 5).

### CAUTION

**Never connect the HI AMPLITUDE OUTPUT to the P6046 Probe without using a 50  $\Omega$  termination. Changing the HI AMPLITUDE/FAST RISE switch position generates transients which, if unterminated, exceed the Probe's maximum input voltage.**

c. Switch to 100 mV vertical deflection factor.

d. Set the oscilloscope TIME/CM control to .1  $\mu$ SEC and the TRIGGERING SOURCE to EXT; check that the TRIGGERING SLOPE is at +.

e. Switch the Square Wave Generator HI AMPLITUDE/FAST RISE switch to HI AMPLITUDE and set the AMPLITUDE control fully counterclockwise. Check that the REPETITION RATE RANGE is set to 100 kHz, and that the MULTIPLIER control is at 1.

f. Connect the 42 inch coaxial cable from the Square Wave Generator TRIGGER OUTPUT connector to the oscilloscope TRIGGER INPUT connector.

g. Connect equipment to the Square Wave Generator HI AMPLITUDE OUTPUT connector in the sequence given:

- GR 2 $\times$  attenuator (item 16)
- GR 90° elbow (item 10) (optional)
- 5 ns GR cable (item 9)
- GR-to-BNC female adapter
- GR-to-BNC 50  $\Omega$  termination (item 5)
- Probe tip-to-GR adapter
- Dual Attenuator Head + Input tip

h. Adjust the Square Wave Generator AMPLITUDE control to provide a 5 division square wave. Adjust the Oscilloscope TRIGGERING LEVEL as necessary to obtain a stable display. Using the horizontal position controls, set the leading edge of the square wave to start exactly 2 divisions from the first vertical graticule line as shown in Fig. 5-3(A). Do not move the horizontal position or triggering controls for the remainder of this step.

i. Disconnect the Dual Attenuator Head from the Probe. Connect special ground tips to the Probe + and — Input tips.

j. Check the PROBE STEP ATTEN BAL (ATTEN BAL) adjustment (see step 1b, c, d and e).

k. Switch to 20 mV vertical deflection factor. Using the vertical POSITION control, set the trace exactly one division below graticule vertical center.

l. Remove the ground tip from the Probe + Input tip, then remove the Dual Attenuator Head from the cable assembly.

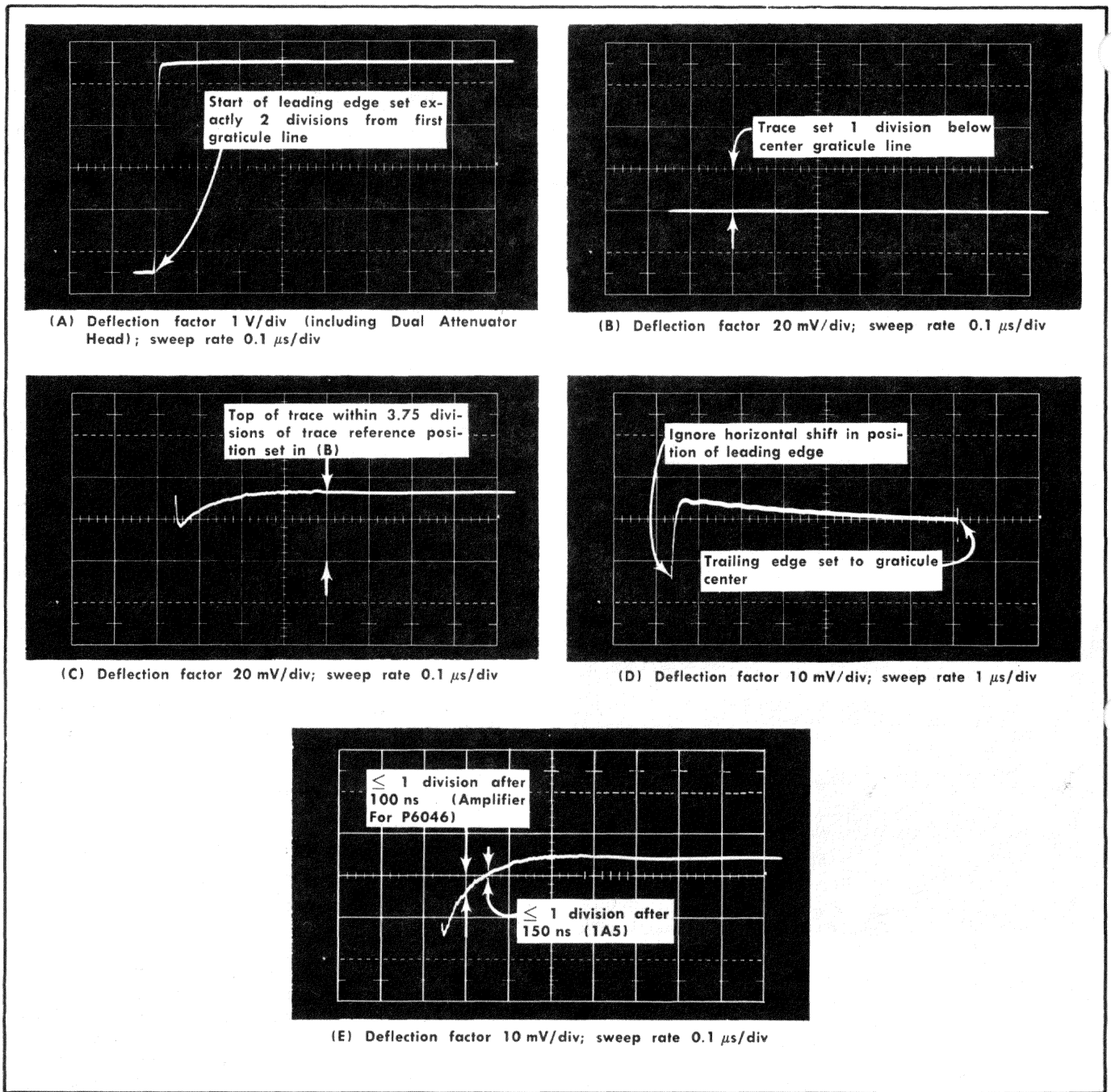

Fig. 5-3. DC shift and overdrive recovery waveforms, step 6.

m. CHECK—DC shift due to overdrive. Connect the + Input tip to the Probe tip-to-GR adapter and associated equipment. (A special Ground tip should remain connected to the - Input tip.) Check the position of the top of the square wave 1 second after making the connection. 3.75 divisions or less trace shift should occur, for a trace shift of 1.5% or less of input signal. See Fig. 5-3 (B) and (C).

n. Switch to 10 mV vertical deflection factor. Switch the Time/Div control to 1  $\mu$ s. Using the vertical POSITION control, set the trailing edge of the top of the square wave to the vertical center of the graticule as in Fig. 5-3 (D).

o. (P6046 Probe/Type 1A5 only) CHECK—Over-drive recovery time. Switch the Time/Div Control back to .1  $\mu$ s and check the vertical separation between the trace and the graticule vertical center 5 divisions from the first vertical graticule line (300 ns after start of step function as shown in Fig. 5-3 E). At that point the trace should be within 1 division of graticule vertical center, and stay within for the remainder of the positive excursion of the square wave.

p. (P6046 Probe/Amplifier For P6046 only). CHECK—Overdrive Recovery Time. Switch the Time/Div control back to .1  $\mu$ s and check the vertical separation between the trace

and graticule center 3 divisions from the first vertical graticule line (100 ns after start of step function). At that point the trace should be within 1 division of graticule vertical center, and stay within for the remainder of the positive excursion of the square wave. See Fig. 5-3 (E).

q. Disconnect the cable assembly from the Probe and the Square Wave Generator. Disconnect the external triggering cable; switch the Oscilloscope Triggering SOURCE to Internal.

### 7. Check Transient Response

REQUIREMENT—With 1A5; Transient response  $\leq \pm 4\%$  aberrations (not exceeding 6% peak to peak) in first 70 ns;  $\leq \pm 1.5\%$  aberrations (not exceeding 2% peak to peak) thereafter.

With Amplifier For P6046; Transient response within the first 70 ns as observed on a 100 MHz Oscilloscope:

1 mVOLTS/DIV  $\leq \pm 5\%$ ;  $\leq 6\%$  peak to peak

2 through 200 mVOLTS/DIV  $\leq \pm 4\%$ ;  $\leq 5\%$  peak to peak.

Aberrations  $\leq \pm 2\%$ , (not exceeding 2% peak to peak) after 70 ns in all switch positions.

a. The preliminary control settings apply.

b. Switch to 20 mV vertical deflection factor. Check that the Oscilloscope TIME/CM control is at .1  $\mu$ s.

c. Connect the following components to the Type 106 Square-Wave Generator FAST RISE + OUTPUT in the sequence given:

- GR 90° elbow (optional)
- 5 ns GR cable
- GR-to-BNC female adapter
- GR-to-BNC 50  $\Omega$  termination
- Probe tip-to-GR adapter

d. Check that a special ground tip is connected to the Probe — Input tip and check that the ground lead remains connected from the Probe ground lug to the chassis of the Square Wave Generator.

e. Connect the Probe + Input tip to the probe tip-to-GR adapter.

f. Set the Square Wave Generator HI/AMPLITUDE FAST RISE switch to FAST RISE. Adjust its + TRANSITION AMPLITUDE to provide a 4 division display.

g. Adjust the Oscilloscope triggering and horizontal position controls to position the display as shown in Fig. 5-4.

h. (P6046 Probe/Type 1A5 only): CHECK—Transient response. Optimum squareness should exist at the upper left corner of the square wave, with  $\pm 0.16$  divisions or less aberration, not exceeding 0.24 divisions peak to peak, within the first 70 ns;  $\pm .06$  divisions or less aberration, not exceeding .08 divisions peak to peak, thereafter.

i. (P6046 Probe/Amplifier For P6046 only): CHECK—Transient response. Optimum squareness should exist at

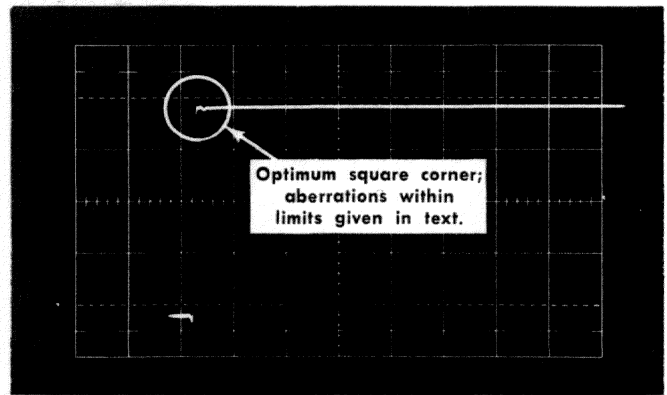

Fig. 5-4. Transient response waveform, step 7. Sweep rate 0.1  $\mu$ s/div; deflection factor 20 mV/div.

the upper left corner of a four division square wave at each position of the mVOLTS/DIV switch. Aberrations within the first 70 ns should not exceed the values given in Table 5-3. Aberrations after the first 70 ns should be within  $\pm .08$  divisions, not exceeding .08 divisions peak to peak in all mVOLTS/DIV switch positions.

TABLE 5-3

mVOLTS/DIV	Allowable Aberrations	Comments
1	$\leq \pm 0.20$ div; $\leq 0.24$ div p-p	Insert a 10:1 attenuator in the signal path
2 through 100	$\leq \pm 0.16$ div; $\leq 0.20$ div p-p	Remove the 10:1 attenuator at 10 mVOLTS/DIV
200	$\leq \pm 4\%$ of observed signal; $\leq 5\%$ p-p	Observe maximum signal (not exceeding 4 divisions)

NOTE

Table 5-3 is applicable during ambient temperatures of 15 to 35°C. 4% of the observed signal must be added to the tabulated allowable aberrations during the first 10 ns at ambient temperatures between 0 and 15° C and 35 to 50° C.

j. Set the Oscilloscope TIME/CM control to 5  $\mu$ s. Center the horizontal position controls.

### 8. Check Noise

REQUIREMENT—P6046 Probe/1A5:  $\leq 200 \mu$ V, tangentially measured; P6046 Probe/Amplifier For P6046:  $\leq 280 \mu$ V, tangentially measured.

a. The preliminary control settings apply, except that the Oscilloscope TIME/CM is at 5  $\mu$ s.

## Performance Check—P6046 Probe and Amplifier

b. Check that the Probe ground lead is connected to the Square-Wave Generator chassis, and that a special ground tip is attached to the Probe — Input tip.

c. Connect the following components to the Square-Wave Generator Fast Rise + OUTPUT in the sequence given:

- GR 90° elbow (optional)
- 5 ns GR cable
- GR 5× attenuator (item 17)
- Two GR 10× attenuators (item 18)
- GR-to-BNC female adapter
- GR-to-BNC 50 Ω termination
- Probe tip to GR adapter
- Probe + Input tip

d. Check that the REPETITION RATE RANGE is at 100 kHz.

e. Select a vertical deflection factor of 1 mV. Adjust the Oscilloscope position controls and the Square Wave Generator + Transition Amplitude as necessary to obtain a centered on-screen display of approximately 1 division amplitude.

f. Set the TRIGGERING LEVEL for a triggered display and adjust the CRT controls for optimum viewing. Care should be used to obtain the sharpest FOCUS and ASTIGMATISM adjustment.

g. Turn the TRIGGERING LEVEL control fully clockwise. Two traces should appear on the CRT, caused by the upper and lower excursions of the square wave being presented on a free-running sweep.

h. Decrease the + TRANSITION AMPLITUDE to a point where the dark line between the two traces is just eliminated. Use Fig. 5-5 as a guide. (The desired presentation is obtained when a point is reached where doubt exists as to whether the dark line is or is not eliminated.)

i. Remove the two 10× attenuators from the signal path. Switch to 10 mV vertical deflection factor. Two traces will again appear. (This increases trace separation by a factor of 10, allowing more accurate measurement.)

j. CHECK—Noise. Measure the vertical separation between trace centers. Divide by 100. The result should be as follows:

$$\text{P6046 Probe/Type 1A5: } \leq 200 \mu\text{V}$$

$$\text{P6046 Probe/Amplifier For P6046: } \leq 280 \mu\text{V}$$

### NOTE

The relationship between different measurement units of noise is as follows:

$$\frac{1}{2} \text{ Tangential} \approx \frac{\text{P-P}}{5.1} \approx \text{RMS}$$

k. Disconnect the 5 ns GR cable and the accessories from the Probe and the Square-Wave Generator. Use of the Square-Wave Generator has been completed.

## 9. Check Bandwidth

REQUIREMENT—With Type 1A5, 20 mV/div vertical deflection factor:  $\leq 3$  dB attenuation at 45 MHz.

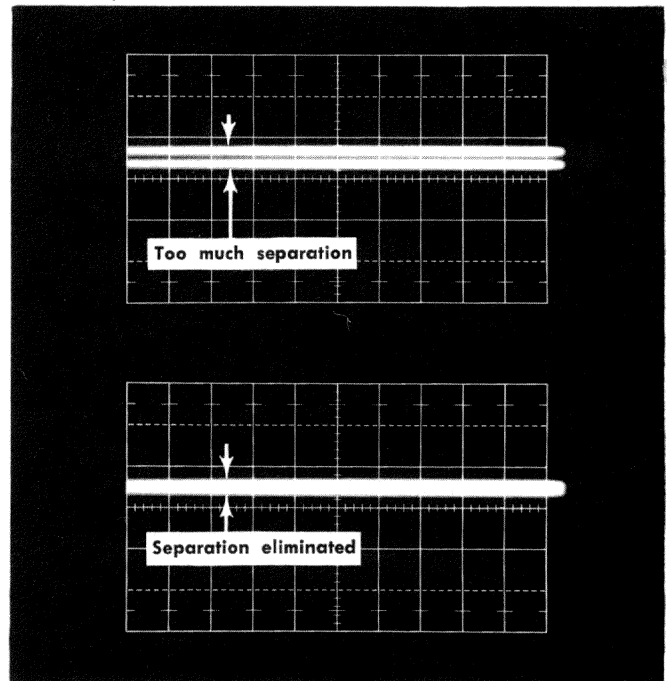

Fig. 5-5. Noise waveform, step 8. Sweep rate 5  $\mu\text{s}/\text{div}$ ; deflection factor 1 mV/div.

With Amplifier For P6046:  $\leq 3$  dB attenuation at 100 MHz.

a. The preliminary control settings apply.

b. Set the vertical deflection factor control to 20 mV.

c. Set the Oscilloscope Time/Div to .5 ms and the Horizontal Position controls to mid-position.

d. (P6046 Probe/Type 1A5 only)

(1) Connect the following equipment to the OUTPUT connector of the Type 191 Constant Amplitude Signal Generator (item 6) in the sequence given:

90° elbow (optional)

5 ns GR cable

GR-to-BNC female adapter

GR-to-BNC 50 Ω termination

Probe tip-to-GR adapter

(2) Connect a ground lead from the Probe ground lug to the Constant Amplitude Signal Generator Chassis. Connect the probe + Input tip to the adapter on the cable assembly. (A special ground tip should remain on the — Input tip.)

(3) CHECK—Probe/Type 1A5 Bandwidth. Set the Constant Amplitude Signal Generator Frequency to 50 kHz ONLY; adjust its Amplitude controls to provide exactly 4 divisions of display. Adjust the Vertical POSITION control as necessary to center the display. Switch the Generator frequency to 45 MHz and check for 2.8 divisions or more amplitude, indicating 45 MHz or greater bandwidth.

e. (Probe/Amplifier For P6046 only)

(1) Disconnect the 18 inch coaxial cable and 50 Ω BNC termination from the Oscilloscope Vertical INPUT connector. Connect the GR-to-BNC 50 Ω termination directly to the Oscilloscope Vertical Input connector. Then connect the 5 ns GR cable between the Constant Amplitude Signal Generator and the GR-to-BNC 50 Ω termination.

(2) With the Oscilloscope VOLTS/CM control set at 10 mV and the Constant Amplitude Signal Generator set for a 50 kHz ONLY output, adjust the Generator Amplitude controls until the Oscilloscope display is exactly 4 divisions. Switch the Generator frequency to 100 MHz and record the number of divisions of 100 MHz display amplitude.

(3) Disconnect the 5 ns GR cable and the 50 Ω termination from the Oscilloscope Vertical INPUT.

(4) Reconnect the Amplifier Output connector to the Oscilloscope via the 18 inch coaxial cable and 50 Ω BNC termination. Connect the following components to the Constant Amplitude Signal Generator in the sequence given:

- 90° elbow (optional)
- 5 ns GR cable
- GR to BNC-female adapter
- GR to BNC 50 Ω termination
- Probe tip to GR adapter
- Probe + Input tip

(5) CHECK—Probe/Amplifier Bandwidth at each mVOLTS/DIV position of the Amplifier using the following procedure:

(a) Switch the Generator frequency to 50 kHz ONLY.

(b) Adjust the Generator output for a 4 division display at the selected mVOLTS//DIV position. (A 10× GR attenuator must be inserted between the Generator and its 50 Ω termination to reduce the signal input for the 1 and 2 mVOLTS/DIV positions.)

(c) Switch the Generator frequency to 100 MHz.

(d) Divide the display amplitude by the display amplitude recorded in step (2). The result should be 0.7 or more for 30% or less voltage attenuation, indicating a bandwidth of 100 MHz or more.

**NOTE**

There is a direct relationship between bandwidth and risetime expressed as approximately:

$$T_r (\mu s) \times BW (MHz) \approx 0.35$$

Bandwidths of 45 and 100 MHz therefore indicate risetimes of approximately 7.8 and 3.5 ns respectively.

**10. Check Common-Mode Rejection**

REQUIREMENT—See Graph, Fig. 1-2, for complete requirements. The following values are checked here:

Frequency	Common-Mode Rejection Ratio	
	DC-Coupled	AC-Coupled
100 Hz		200:1
50 kHz	10,000:1	10,000:1
1 MHz	5,000:1	
50 MHz	1,000:1	

a. The preliminary control settings apply.

b. Connect the following components to the Type 191 Constant Amplitude Signal Generator OUTPUT connector in the sequence listed:

- GR 90° elbow (optional)
- 5 ns GR cable
- GR-to-BNC 50 Ω termination
- Probe dual tip to BNC adapter

c. Set the Constant Amplitude Signal Generator controls as follows, providing a 5-V peak to peak output:

- FREQUENCY RANGE      50 kHz only
- AMPLITUDE              50
- VARIABLE              CAL
- AMPLITUDE RANGE      .5-5 V

d. Connect a special ground tip to the + Input tip and check the PROBE STEP ATTEN BAL (ATTEN BAL) adjustment (step 1b, c, d and e).

e. Remove the special ground tips from the + and — Input tips; check that the Probe ground lead remains connected to the Constant Amplitude Signal Generator chassis.

f. Connect the Probe tips to the Probe dual tip-to-BNC adapter.

g. Switch the vertical deflection factor control to 1 mV.

h. CHECK—50 kHz CMRR. 0.5 division or less display amplitude should exist, indicating 10,000:1 or greater CMRR.

**NOTE**

CMRR measurements can usually be made with a free-running sweep by measuring total display amplitude. However, a more accurate evaluation of CMRR can be made by measuring the peak-to-valley amplitude of a triggered display, allowing for trace width. The TIME/CM control must be reset according to the frequency being observed. See Fig. 5-6. This method of determining display amplitude should always be used when CMRR adjustment results (free-running) appear marginal.

i. CHECK—AC-coupled CMRR. With a 1 mV vertical deflection factor selected, switch the P6046 Input Coupling switch to AC and check for 0.5 division or less display amplitude, indicating 10,000:1 or greater CMRR.

j. Switch the Probe Input Coupling switch back to DC.

k. CHECK—1 MHz CMRR. Set the Constant Amplitude Signal Generator frequency to 1 MHz and check for 1 div or less display amplitude, indicating 5000:1 or greater CMRR.

l. Switch the Constant Amplitude Signal Generator AMPLITUDE control to 20 to provide a 2-V peak-to-peak output. Set its frequency to 50 MHz.

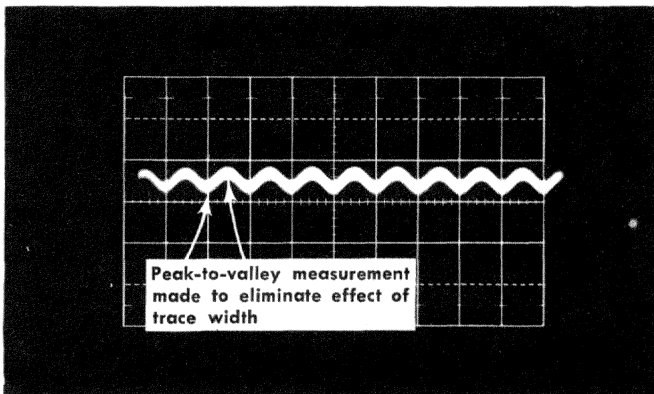

Fig. 5-6. Triggered CMRR waveform, step 10. Sweep rate dependent upon frequency; deflection factor 1 mV/div.

m. CHECK—High frequency CMRR. Check for 2 divisions or less display amplitude, indicating 1000:1 or greater CMRR.

n. Disconnect the cable assembly from the Probe and from the Constant Amplitude Signal Generator. Disconnect the Probe ground lead from the Constant Amplitude Signal Generator. Use of the Constant Amplitude Signal Generator has been completed.

o. Connect a special ground tip to the Probe — Input tip; connect a ground lead from the Probe ground lug to the Low Frequency Sine-Wave Generator (item 7).

p. Switch to 200 mV vertical deflection factor. Set the Oscilloscope Time/Div control to 2 ms.

q. Set the Low Frequency Sine Wave Generator output amplitude to minimum, and its frequency to 100 Hz.

r. Connect the following components to the Low Frequency Sine-Wave Generator in the sequence given:

- Dual banana plug-to-BNC female connector (item 19)
- 42-inch coaxial cable
- GR-to-BNC female adapter
- GR 5× attenuator
- Probe tip-to-GR adapter
- Probe + Input tip

s. Increase the 100 Hz signal amplitude and set the Oscilloscope Triggering controls to provide a stable 5 division display.

t. Verify the 100 Hz signal frequency against the Oscilloscope time base (2 cycles per 10 divisions).

u. Switch the Oscilloscope TIME/CM to .1 s.

v. Disconnect the Probe tip-to-GR adapter from the Probe and remove the special ground tip from the — Input tip.

w. Replace the Probe tip-to-GR adapter with a GR-to-BNC male adapter (item 11) and the probe dual tip-to-BNC

adapter. Then connect the cable assembly to the Probe tips, via the dual tip adapter.

x. Switch the vertical deflection factor control to 1 mV and the Probe AC-DC Input Coupling switch to AC.

y. CHECK—100 Hz CMRR. 3 divisions or less display amplitude should exist for 200:1 or greater CMRR.

z. Disconnect the probe dual tip-to-BNC adapter from the probe.

## 11. Check AC-Coupled Low Frequency Response

REQUIREMENT—3 dB or less attenuation at 20 Hz.

a. The preliminary equipment settings apply.

b. Reduce the Low Frequency Sine-Wave Generator amplitude output to minimum.

c. Set the vertical deflection factor control to 20 mV.

d. Connect a special ground tip to the Probe — Input tip. Set the Probe Input Coupling switch to DC.

e. Check that the ground lead remains connected between the Probe ground lug and the Low Frequency Sine-Wave Generator chassis; then connect the following equipment to the Generator output connector in the sequence given:

- Banana jack-to-BNC adapter
- 42 inch coaxial cable
- GR-to-BNC female adapter
- GR 10× attenuator
- Probe tip-to-GR adapter
- Probe + Input tip

f. Set the Generator for a 20 Hz, 80 mV (4 division) output. (Confirm the frequency by comparing it against the Oscilloscope time base. 1 cycle/division should appear at 50 ms/CM.)

g. Check AC-coupled low frequency response. Set the Probe Input Coupling switch to AC and check for 2.8 divisions or more display amplitude, indicating 3 dB or less AC-coupled attenuation at 20 Hz.

### NOTE

This check, combined with the AC-coupled common-mode check (step 10), verifies the AC-coupled low-frequency —3 dB limit for both the + and — inputs.

h. Switch the Probe Input Coupling Control to DC, and disconnect the equipment. The Performance Check has been completed.

# SECTION 6

## CALIBRATION

Change information, if any, affecting this section will be found at the rear of the manual.

### Introduction

The P6046 Differential Probe and Amplifier For P6046 should be calibrated whenever operation or the Performance Check indicates that they are not operating within specified capabilities. Calibration should be preceded by cleaning and inspection as outlined in the Maintenance section.

If the Probe is to be used with a Type 1A5, it must be calibrated with a Type 1A5 unit. The Amplifier For P6046 can then be calibrated to the Probe. This permits use of the Probe interchangeably with Type 1A5 and Amplifier For P6046 units.

The P6046 Probe and Amplifier For P6046 can also be calibrated to each other, independent of a Type 1A5 unit. They will then operate within specification when used as a set but will not provide specified results when used with a Type 1A5, other Probes, or other Amplifier For P6046 units.

Table 6-1 lists the calibration steps that must be performed to satisfy different operating requirements.

A calibration record and index is contained at the beginning of the calibration procedure. It refers to each step by number and gives the name and a brief description of the check or adjustment performed. It is suggested that the calibration record and index be duplicated for check-off and record purposes.

### Malfunctions

Any repairs require that a complete calibration procedure be performed. Any malfunctions discovered during calibration should be corrected at the time they are located. The calibration procedure should then be performed from the beginning.

### Procedure Format

The basic control settings are listed in the preliminary procedure (step 1) and apply to every step in the procedure. Deviations are specified in each step as required. Setup pictures, adjustment locations, and waveform photographs accompany the procedure where appropriate.

The adjustment sequence is designed to permit a complete calibration with a minimum of setups and interaction.

Those steps containing adjustments are identified by the symbol **ⓘ** appearing on the right margin of the column. ADJUST indicates the point within the numbered steps at which the actual adjustment is performed. "CHECK" identifies either a pre-adjustment check or a check of a non-adjustable parameter. Specific equipment control names are written in capital letters for easy recognition.

The term "division" (or div) refers to major graticule divisions. Smaller increments are expressed as decimal parts of divisions.

**TABLE 6-1**  
Calibration Procedure and Equipment Guide

Operating Requirement	Calibration Requirement	Calibration Procedure to be Performed	Equipment Required	Comment
Probe to be used with Type 1A5 units, or interchangeably with Type 1A5 and Amplifier For P6046 units	Calibrate Probe to a Calibrated Type 1A5	P6046 Probe Calibration Procedure, using the Probe-Type 1A5 Preliminary Procedure	Items 1, 2 and 4 through 25	This is the recommended procedure. It permits use of the Probe interchangeably with Type 1A5 and Amplifier For P6046 units.
	Calibrate Amplifier For P6046 to a calibrated P6046 Probe	Amplifier For P6046 Calibration Procedure	Items 3 through 6, 8 through 13; 15, 18, 20, 21, 26, through 29	
Probe and Amplifier For P6046 to be used as a set; Probe and Amplifier will not be interchanged with other P6046 Probes, Amplifier For P6046 units, or used with Type 1A5 units	Calibrate Probe and Amplifier For P6046, independent of the Type 1A5	P6046 Probe Calibration Procedure, using the Probe-Amplifier For P6046 Preliminary Procedure and additional steps as indicated	Items 3 through 29	

## Calibration—P6046 Probe and Amplifier

Most adjustments have been outlined with reference to the Probe + Input tip. Adjustments employing the — Input tip are equally effective if due consideration is given to polarity in signal application and waveform observation.

### Partial Calibration Procedure

Each step in the procedure is complete within itself, but is dependent upon the preceding checks or adjustments being within their limits. In addition, an adjustment will probably have an effect upon performance qualities which are checked or adjusted in subsequent steps. Partial calibration procedures are therefore not recommended, unless all subsequent CHECKS are made.

### Common Reference (Ground)

The use of a ground lead is stressed throughout this procedure. It can be eliminated only if a common ground definitely exists between all equipment used.

#### CAUTION

The Probe tips often come in contact with equipment ground during insertion into test jacks. A common ground between the Probe and equipment being tested must therefore exist before the Probe is connected to the equipment to insure against Probe damage due to ground loop currents.

## CALIBRATION EQUIPMENT ACCESSORIES AND TOOLS

The equipment contained in the following list is required for calibrating the P6046 Differential Probe, Dual Attenuator Head and Amplifier For P6046. Tektronix part numbers are included for ordering purposes. Items which accompany the Probe or Amplifier are identified as Standard Accessories. The GR 90° elbow is an optional item, used only for convenient positioning of the test cables. Items are illustrated in Fig. 6-1 and 6-2 except where noted otherwise.

All equipment must be operating within its specified limits. Substitutions can be used in many instances, provided that the substitute meets or exceeds the performance requirements of the equipment listed.

### Required Equipment (See Table 6-1 and Figs. 6-1 and 6-2.)

1. Oscilloscope. Tektronix Type 544, 546, 547 or 556; 580-Series Oscilloscopes equipped with a Type 81A Plug-In Adapter can be used if the 5 cm parameters are modified to 4 cm throughout the procedure. A Type 547 is used in this procedure.

2. Tektronix Type 1A5 Differential Amplifier Plug-In unit.

3. Oscilloscope, 100 MHz Bandwidth, 10 mV deflection factor. Recommended types are Tektronix Type 454 or Tektronix Type 647A equipped with Type 10A2A and 11B2A Plug-In units. The Type 647A appears in the accompanying illustrations.

4. Standard Amplitude calibrator. Amplitude accuracy within 0.25%; signal amplitude 50 V and 5 mV through 1 V in 1-2-5 steps; 1 kHz square wave output. Tektronix Standard Amplitude Calibrator, (Part No. 067-0502-01) recommended.

5. Square-wave generator. Frequency — 100 kHz; High Amplitude output of 5 V into 50  $\Omega$ ; Fast Rise output variable from 45 mV to 100 mV into 50  $\Omega$ , with 1 nanosecond or less risetime. Tektronix Type 106 Square-Wave Generator recommended.

6. Constant amplitude sine wave generator. Output requirements (peak to peak) into a 50  $\Omega$  load: 80 mV at 50 kHz and 45 MHz; 5 V at 50 kHz and 1 MHz; 1 V and 2 V at 50 kHz and 18, 42 and 50 MHz. Tektronix Type 191 Constant Amplitude Signal Generator recommended.

7. Low frequency sine wave generator. Output requirements: 80 mV peak to peak at 20 Hz. General Radio Oscillator Type 1310-A used in this procedure.

8. Differential Voltmeter and test leads. Range 0 to 100 V. Accuracy 0.1% Fluke Model 825A used in this procedure.

9. Coaxial cable. 42 inch, 50  $\Omega$ ; equipped with BNC-male connectors. Tektronix Part No. 012-0057-01.

10. Cable, type RG8/213. GR connectors; 5 ns delay; (5 ns GR cable). Tektronix Part No. 017-0502-00.

11. GR 90° elbow. Tektronix Part No. 017-0070-00. (Optional.)

12. Adapter, GR-to-BNC female. Tektronix Part No. 017-0063-00.

13. Probe tip-to-GR adapter. Tektronix Part No. 017-0076-00.

14. Probe dual tip-to-BNC adapter. Tektronix Part No. 067-0562-00.

15. Termination, 50  $\Omega$ , GR-to-BNC. Tektronix Part No. 017-0083-00.

16. Attenuator, 2:1, 50  $\Omega$ , GR type. Tektronix Part No. 017-0080-00.

17. Attenuator, 5:1, 50  $\Omega$ , GR type. Tektronix Part No. 017-0079-00.

18. Attenuator, 10:1, 50  $\Omega$ , GR type. Two required. Tektronix Part No. 017-0078-00.

19. Adapter, dual banana plug-to-BNC female connector. General Radio Company Type 274-QBJ.

20. Special ground tip. Two required. Tektronix Part No. 206-0163-00. (P6046 Probe standard accessory).



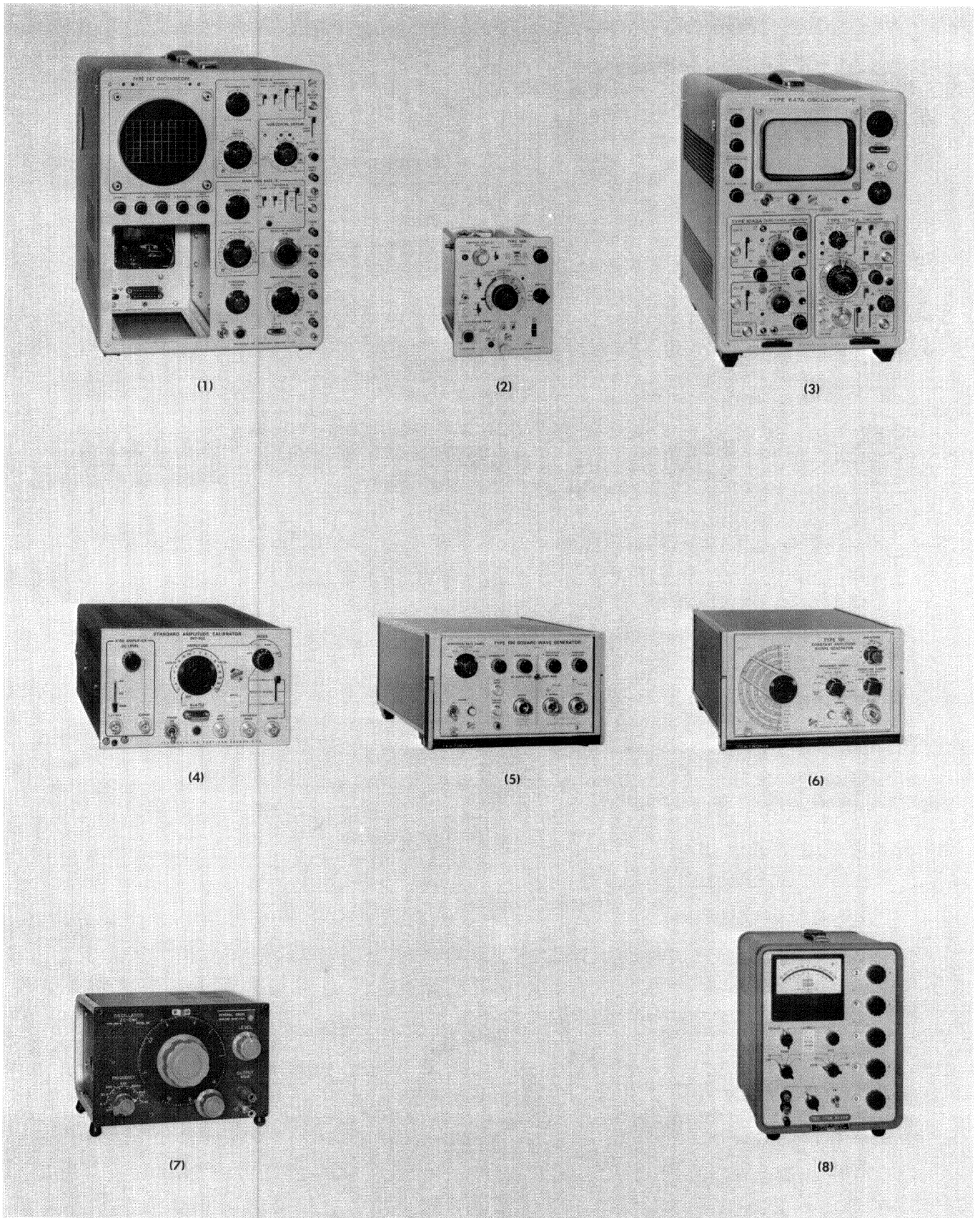

Fig. 6-1. Equipment required for calibrating the P6046 Differential Probe and the Amplifier For P6046.

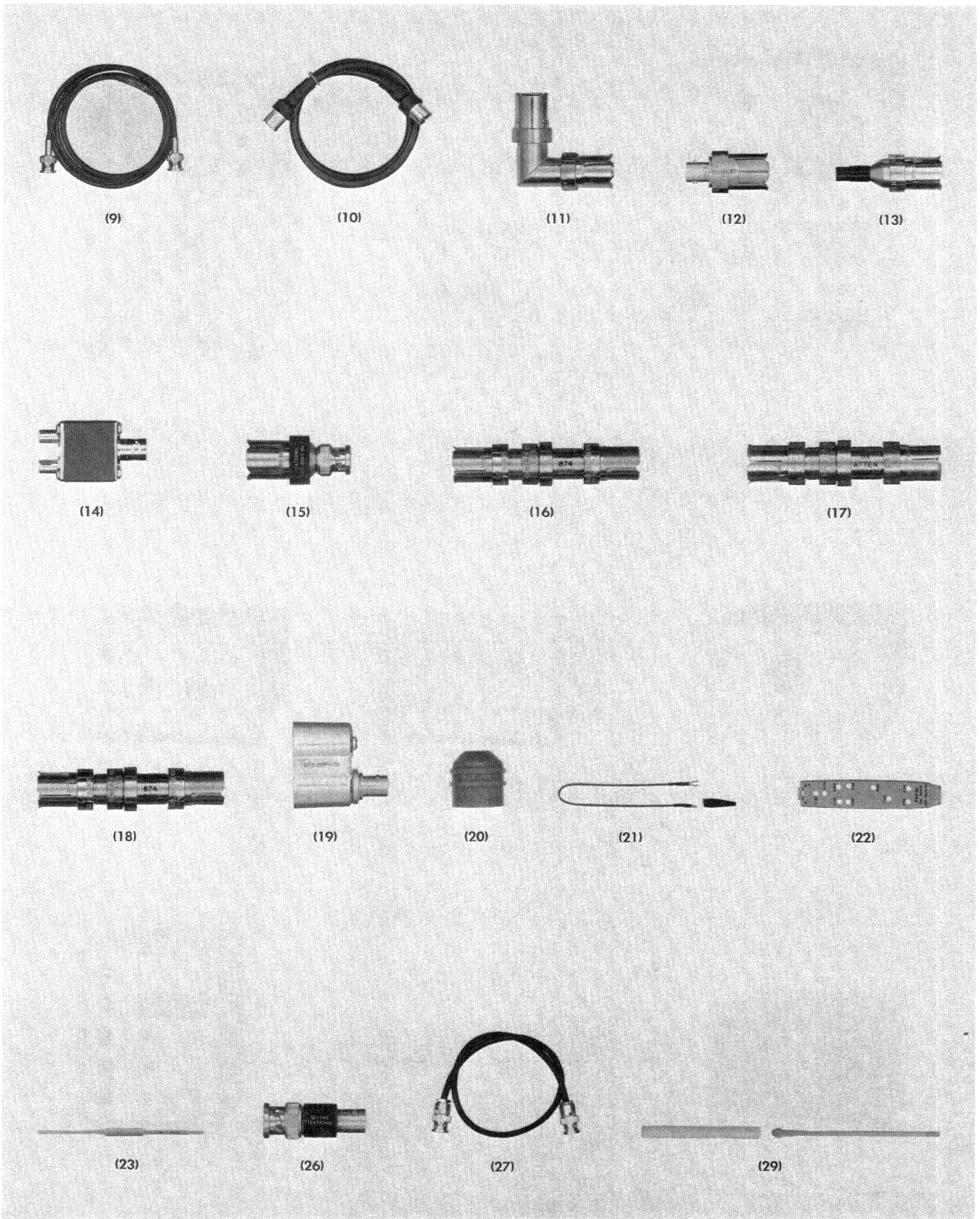

Fig. 6-2. Accessories and tools required for calibrating the P6046 Differential Probe and the Amplifier For P6046.

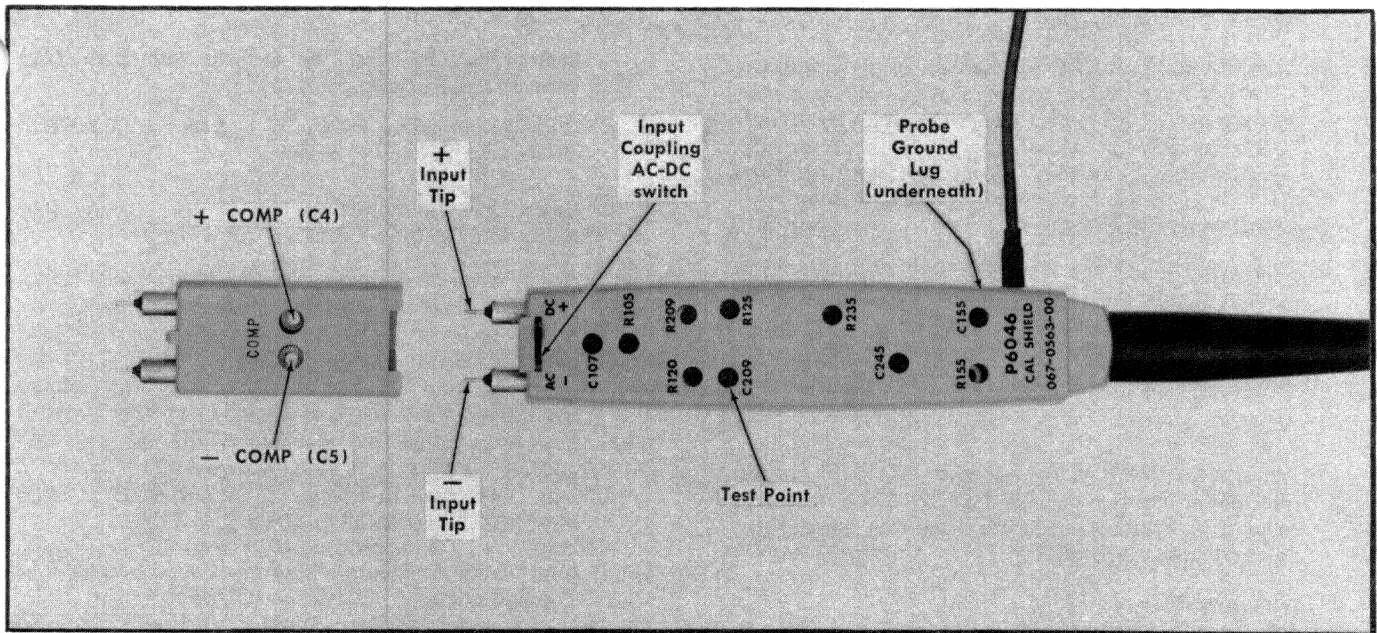

Fig. 6-3. P6046 Probe with Calibration Shield installed.

21. 12 inch ground lead equipped with alligator clip. Tektronix Part No. 175-0125-00 and 344-0046-00. (P6046 Probe standard accessory).

22. Calibration Shield. Tektronix Part No. 067-0563-00.

23. Aligning rod, non-metallic;  $\frac{3}{32}$  inch standard screwdriver tip. Tektronix Part No. 003-0301-00.

24. Screwdriver, phillips-head;  $\frac{3}{16}$  inch tip. (Not shown).

25. Screwdriver, jewelers;  $\frac{3}{32}$  inch standard tip. (Not shown.)

26. Termination, BNC, 50  $\Omega$ . Tektronix Part No. 011-0049-01. Amplifier For P6046 standard accessory.

27. Cable, 18 inch, 50  $\Omega$ . Tektronix Part No. 012-0076-00. Amplifier For P6046 standard accessory.

28. Resistor; 10  $\Omega$ ,  $\frac{1}{4}$  W. Leads should be cut so that overall length is  $\frac{3}{4}$  inches.

29. Alignment tool, plastic handle and recessed metal tip insert. Tektronix Part No. 003-0307-00 with Tektronix Part No. 003-0334-00 insert.

### P6046 PROBE CALIBRATION RECORD AND INDEX

The title and performance requirement of each calibration procedure step is listed here. This record and index can be used as a calibration check-off list, a record of calibration, a page index for the calibration procedure itself, or it can be used as a short-form calibration procedure for experienced calibrators. It is recommended that duplicate copies be made for repeated check-off and record usage.

#### P6046 Probe

Calibrated with (Type 1A5) (Amplifier For P6046)

Calibration Date \_\_\_\_\_

Calibration Technician \_\_\_\_\_

#### Preliminary Procedure

- 1. Adjust DRAIN VOLTS (R125) Page 6-7  
10.5  $\pm$  0.25 V DC at C209
- 2. Adjust GAIN SWITCHING BAL (R235) Page 6-7  
Adjust for centered trace at 1 mV/div after PROBE STEP ATTEN BAL (ATTEN BAL) has been adjusted.
- 3. Adjust 10 $\times$  HEAD DC ATTEN CM BAL Page 6-8  
(R105)  
Adjust at 1 mV/div for minimum (2.5 div or less) display amplitude between trailing edges of 50 V - 1 kHz square wave applied common-mode to Dual Attenuator Head inputs.
- 4. Adjust  $\times 1$  GAIN (R155) Check  $\times 1/10$  Page 6-9  
Gain and Dual Attenuator Head + Input Gain  
With Type 1A5.  
Adjust at 20 mV/div for exactly 5 div amplitude (0.1 V - 1 kHz square wave); check at 200 mV for 2% or better accuracy of 5 div square wave; check at 20 mV/div for 2% or better accuracy of 5 div square wave applied to Dual Attenuator Head + Input.

## Calibration—P6046 Probe and Amplifier

With Amplifier For P6046:

Adjust at 5 mV/DIV for exactly 4 div amplitude (20 mV-1 kHz square wave); check at all other positions for 3% or better accuracy; check at 20 mV/DIV for 2% or better accuracy of 5 div square-wave applied to Dual Attenuator Head + Input.

5. Check Input Gate Current Page 6-10

Check for 0.3 div or less trace shift at 1 mV/div as special ground tip is removed or replaced. (+ and -)

6. Adjust Transient Response (C155) Page 6-10

With Type 1A5:

Adjust at 20 mV/CM for + and -0.16 div or less aberration, not to exceed 0.24 div peak to peak, using a 4 division -100 kHz Fast Rise signal from Square-Wave Generator.

With Amplifier For P6046

Preset Amplifier's C454D to mid-position; adjust Probe's C155 at 5 mV/DIV for 0.16 div or less aberration, not to exceed 0.24 div peak to peak, of a 4 division signal. Then adjust or check Amplifier for P6046 for the response indicated at each deflection factor as follows,, using a 4 division signal:

1 mV	$\leq \pm 0.20$ div;	$\leq 0.24$ P-P	Adjust C521 <sup>1</sup> , C454A
2 mV	$\leq \pm 0.16$ div;	$\leq 0.20$ P-P	Adjust C454C, C521 <sup>1</sup>
10 mV	$\leq \pm 0.16$ div;	$\leq 0.20$ P-P	Adjust C458
20 mV	$\leq \pm 0.16$ div;	$\leq 0.20$ P-P	Adjust C429C
50 mV	$\leq \pm 0.16$ div;	$\leq 0.20$ P-P	Check
100 mV	$\leq \pm 0.16$ div;	$\leq 0.20$ P-P	Check
200 mV	$\leq \pm 4\%$ of maximum ( $\leq 4$ div) available signal $\leq 5\%$ P-P		Check; readjust C429C if necessary and recheck 20 mV

<sup>1</sup>Adjust at 1 mV/DIV. Readjust at 2 mV/DIV if necessary; then readjust C454A at 1 mV/DIV. Repeat as necessary.

7. Check Noise Page 6-12

With 1A5:

200  $\mu$ V or less tangential noise at 1 mV/CM

With Amplifier For P6046:

280  $\mu$ V or less tangential noise at 1 mV/DIV

8. Check DC Shift Due To Over-Drive; Check Over-Drive Recovery Time Page 6-13

Check at 20 mV/div for 3.75 div or less DC shift due to overdrive 1 second after application of a 5 V - 100 kHz signal from Square-Wave Generator. Using same signal, check at 10 mV/DIV for time required for trace to recover to within 1 division of the shifted DC level. Requirements are as follows: With Type 1A5  $\leq 300$  ns; With Amplifier For P6046  $\leq 100$  ns.

9. Check Bandwidth Page 6-15

With 1A5:  $\leq -3$  dB at 45 MHz with 20 mV/CM vertical deflection factor.

With Amplifier For P6046:  $\leq -3$  dB at 100 MHz at all vertical deflection factors.

10. Adjust Common-Mode Rejection (R120, C107, C209, C245) Page 6-16

Signal applied common-mode to both inputs; adjust R120 for minimum (0.5 div or less) display amplitude of 5 V peak to peak-50 kHz sine wave at 1 mV/div; adjust R235 for centered display; Adjust C107 for equal AC and DC-coupled (0.5 div or less) display amplitude of 5 V peak to peak-50 kHz sine wave at 1 mV/div; adjust for minimum (1 div or less) DC-coupled display at 1 mV/div against 1 V peak to peak sine wave as follows: C209 and R209 at 21.35 MHz, C245 and R209 at 50 MHz.

11. Adjust Dual Attenuator Head Input AC Compensation (+ COMP, - COMP) Page 6-17

Adjust + COMP and - COMP at 20 mV/div for minimum (0.1 div or less) rounding, overshoot or tilt of 1 V - 1 kHz square wave applied to Dual Attenuator Head + Input tip and - Input tip.

12. Check AC-Coupled Low-Frequency Response Page 6-18

Check for -3 dB response at 20 Hz, using an 80 mV peak to peak sine wave at 20 mV/div.

### P6046 Probe—Type 1A5 Preliminary Procedure

a. Replace the upper half of the P6046 Probe body with the calibration shield (item 22). Follow the disassembly and assembly procedure given in the Maintenance section. The probe cannot be reliably calibrated without the shield.

b. Insert the Type 1A5 (item 2) into the plug-in compartment of the Type 547 Oscilloscope (item 1).

c. Preset the equipment controls to the following positions:

#### P6046 Probe

Input Coupling DC

#### Type 1A5

POSITION Midrange  
VOLTS/CM 20 mV  
VARIABLE CAL

#### Type 547 Oscilloscope

TIME BASE A  
TRIGGERING  
LEVEL 0  
MODE AUTO STABILITY  
SLOPE +  
COUPLING AC  
SOURCE NORM

TIME/CM	.5 ms
VARIABLE	CALIBRATED
HORIZONTAL DISPLAY	A
SWEEP MAGNIFIER	×1 OFF
HORIZONTAL POSITION	Midrange
AMPLITUDE CALIBRATOR	OFF

d. Energize the oscilloscope and the calibration equipment which is to be used in this procedure. Set the CRT controls for optimum display.

e. Connect the P6046 Probe Amphenol connector to the Type 1A5 DIFFERENTIAL PROBE jack. Depress the PUSH ON/OFF button, lighting the Probe On lamp which is located in the button housing. Allow 20 minutes warmup before continuing.

f. Perform the P6046 Probe Calibration Procedure, ignoring those steps specified for Amplifier For P6046.

### Probe—Amplifier for P6046 Preliminary Procedure

This Preliminary Procedure is to be accomplished only if the P6046 Probe is to be calibrated independent of the Type 1A5.

a. Replace the upper half of the P6046 Probe body with the calibration shield (item 22). Follow the disassembly and assembly procedure given in the Maintenance section. The probe cannot be reliably calibrated without the shield.

b. Perform steps 1, 2 and 3 of the Amplifier For P6046 Calibration Procedure which appears at the end of the P6046 Probe Calibration Procedure.

c. Perform the P6046 Differential Probe calibration procedure, omitting those steps specified for the Type 1A5. The connections to the P6046 Probe, and the test equipment setups remain as shown in the figures, although the Amplifier For P6046 and the Type 647 Oscilloscope have been substituted for the Type 1A5 and Type 547 Oscilloscope. The waveforms may be used for reference, but indicated values must be changed as specified in the text.

### P6046 PROBE CALIBRATION PROCEDURE

#### NOTE

The Oscilloscope, Type 1A5, all calibrating equipment and accessories must be within their specified operating limits before an effective calibration procedure can be performed on the P6046 Differential Probe.

A small-tipped non-metallic screwdriver (aligning rod, item 23) must be used when performing Probe adjustments throughout this procedure.

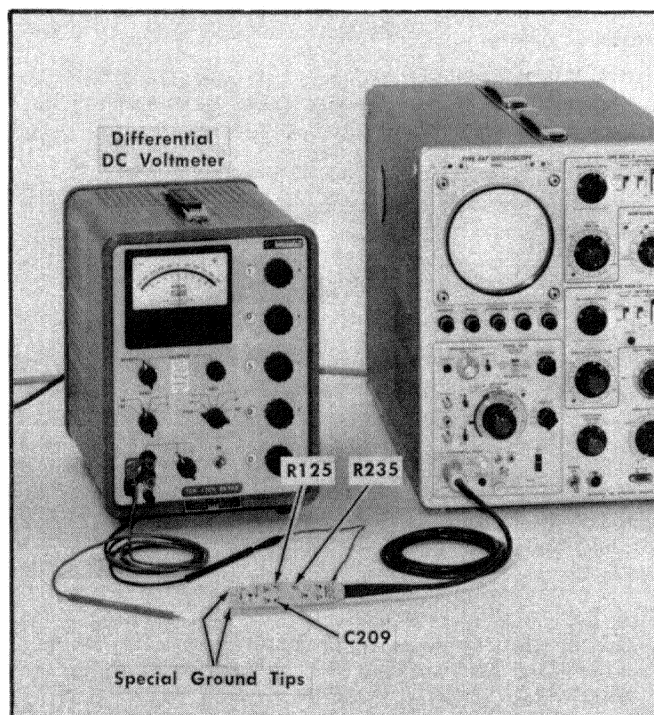

Fig. 6-4. Equipment setup for steps 1 and 2.

### 1. Adjust DRAIN VOLTS (R125) ①

a. Equipment setup, adjustment location and test point are shown in Fig. 6-4.

b. Attach the special ground tips (item 20) to the P6046 Probe + and - Input tips.

c. CHECK—Drain Voltage. Using the Differential Voltmeter (item 8), check for 10.5 V DC  $\pm 0.25$  V at the C209 adjusting screw with respect to the Probe ground lug. (See Fig. 6-4).

d. Adjust—DRAIN VOLTS (R125, Fig. 6-4) for 10.5 V DC at the C209 adjusting screw.

e. Disconnect the Differential Voltmeter.

### 2. Adjust GAIN SWITCHING BAL (R235) ①

#### NOTE

Final adjustment of this control is made during the common-mode rejection adjustment, step 11.

a. The preliminary control settings apply. Locations of adjustments are shown in Fig. 6-4.

b. Switch the vertical deflection factor control to .2 V (200 mV).

## Calibration—P6046 Probe and Amplifier

- c. Using the vertical POSITION control, set the trace to graticule center.
- d. Switch the vertical deflection factor to 50 mV, and adjust the PROBE STEP ATTEN BAL (1A5) or the ATTEN BAL (Amplifier For P6046) as necessary to return the trace to graticule center.
- e. Repeat steps b, c and d until no further adjustment is necessary.
- f. Switch the vertical deflection factor to 1 mV.
- g. CHECK—Trace is within 2 div of graticule center.
- h. ADJUST—GAIN SWITCHING BAL (R235, Fig. 6-4) to position the trace to graticule center. A slight amount of drift around the adjusted position may be present at 1 mV sensitivity.)
- i. REPEAT—Steps b through h until the trace is within 1 div of graticule center for any of the 1 mV through .2 V (200 mV) deflection factors.

### IMPORTANT

During this calibration procedure, do not reset the PROBE STEP ATTEN BAL (ATTEN BAL) adjustment unless directed to do so.

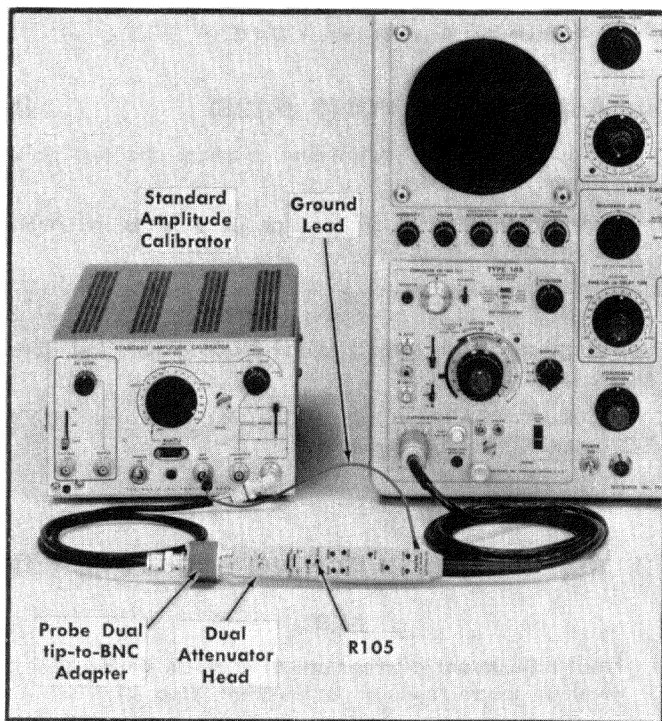

Fig. 6-5. Equipment setup for attenuator DC common-mode balance, step 3.

### 3. Adjust $\times 10$ HEAD DC ATTEN CM BAL (R105)

- a. The preliminary control settings apply. The equipment setup and adjustment location appear in Fig. 6-5.

- b. Remove the ground tips from the Probe and attach the Dual Attenuator Head to the Probe, aligning the detent and shoulder.

- c. Connect a ground lead (item 21) from the Probe ground lug to the chassis of the Standard Amplitude Calibrator (item 4); then connect the following components to the Standard Amplitude Calibrator right OUTPUT jack in the sequence listed:

42 inch coaxial cable (item 9)

Probe dual tip-to-BNC adapter (item 14)

Dual Attenuator Head and Probe assembly

- d. Set the Standard Amplitude Calibrator controls as follows:

AMPLITUDE	50 VOLTS
MODE	Square Wave
Output Selector	Up

- e. Set the vertical deflection factor control to 1 mV.

- f. Adjust the vertical POSITION control and the Oscilloscope triggering controls for a centered, stable display as in Fig. 6-6.

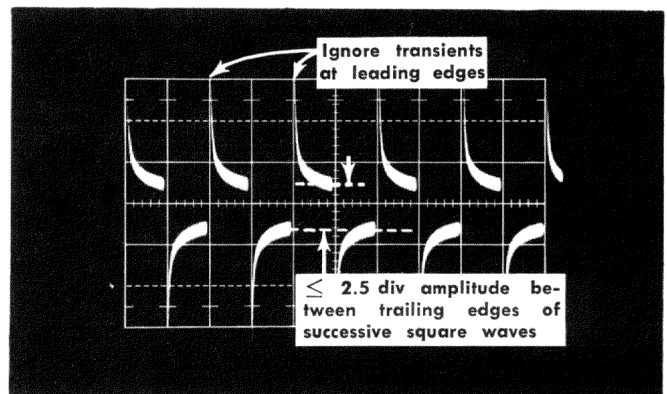

Fig. 6-6. Attenuator DC common-mode balance waveform, step 3. Sweep rate 0.5 ms/div; deflection factor 10 mV/div.

- g. CHECK—Attenuator DC balance. 2.5 div or less display amplitude should exist between the trailing edges of the square waves as indicated in Fig. 6-6.

- h. ADJUST— $\times 10$  HEAD DC ATTEN CM BAL (R105, Fig. 6-5) for minimum display amplitude between the trailing edges of the square waves. See Fig. 6-6. (Ignore the transients at the leading edges of the square waves.) 2.5 div or less for 2000:1 or greater CMRR.

- i. Set the Standard Amplitude Calibrator AMPLITUDE to .1 V; then disconnect the cable assembly and Dual Attenuator Head from the Probe.

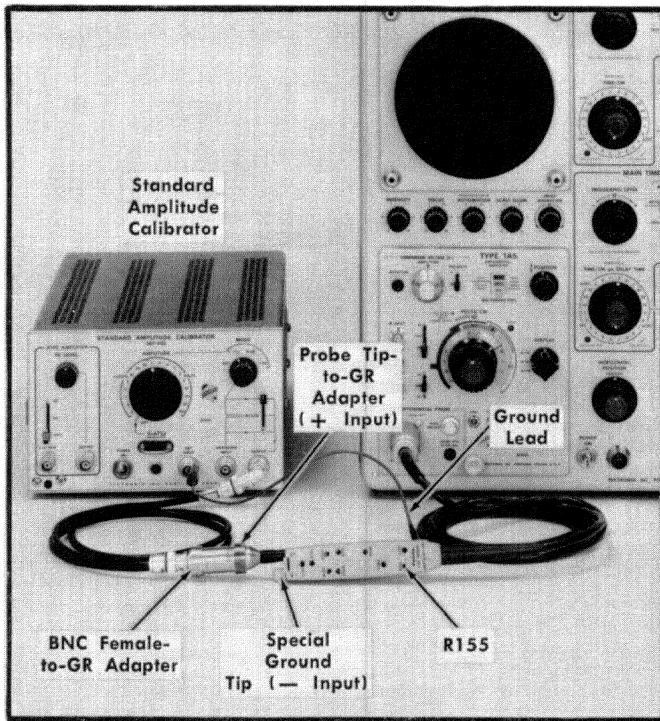

Fig. 6-7. Equipment setup for gain adjustment, step 4.

**4. Adjust  $\times 1$  GAIN (R155); Check  $\times 1/10$  Gain and Dual Attenuator Head + Input Gain**

**IMPORTANT**

The gain of the parent instrument should be checked (and adjusted if necessary) before this step is performed. Check the Type 1A5 at 20 mV/CM in response to a direct input at the A or B INPUT connector. Check the 100 MHz Oscilloscope at 10 mV/div.

- a. The preliminary control settings apply. The equipment setup and adjustment location appear in Fig. 6-7.
- b. Set the vertical deflection factor control as follows:  
1A5 — 20 mV; Amplifier For P6046 — 5 mV
- c. Connect a special ground tip to the Probe — Input tip.
- d. Check that the Standard Amplitude Calibrator controls are set as follows:

	For 1A5	For Amplifier For P6046
AMPLITUDE	.1 VOLTS	20 mV
MODE	Square Wave	Square Wave
Output Selector	Up	Up

- e. Connect the following components to the Standard Amplitude Calibrator right OUTPUT jack in the sequence listed:

- 42 inch coaxial cable
- BNC female-to-GR adapter (item 12)
- Probe tip-to-GR adapter (item 13)

f. Check that the ground lead remains connected between the P6046 ground lug and the Standard Amplitude Calibrator case.

g. Insert the P6046 + Input tip into the probe tip-to-GR adapter.

**NOTE**

(P6046 Probe/Amplifier For P6046 only). If the Amplifier For P6046 GAIN potentiometer has been moved, reset it to its mid-position prior to performing step h. See Fig. 6-8.

h. Adjust the vertical POSITION control to obtain a centered display. Set the Oscilloscope TRIGGERING LEVEL fully clockwise to obtain a free-running sweep, resulting in two horizontal traces.

i. ADJUST—Gain (R155, Fig. 6-7) for exactly 5 divisions (with the Type 1A5) or 4 divisions (with the Amplifier For P6046) amplitude between centers of the two traces. Adjust the vertical POSITION control as necessary for convenient measurement.

j. (1A5 only) CHECK— $\times 1/10$  gain. Set the Type 1A5 VOLTS/CM control to .2V and switch the Standard Amplitude Calibrator AMPLITUDE control to 1 VOLT. Check for 5 cm  $\pm 1$  mm display amplitude.

k. (Amplifier For P6046 only) CHECK—Probe and Amplifier gain response as indicated in Table 6-2. Readjust Gain, R155, if necessary to bring all deflection factors within tolerance.

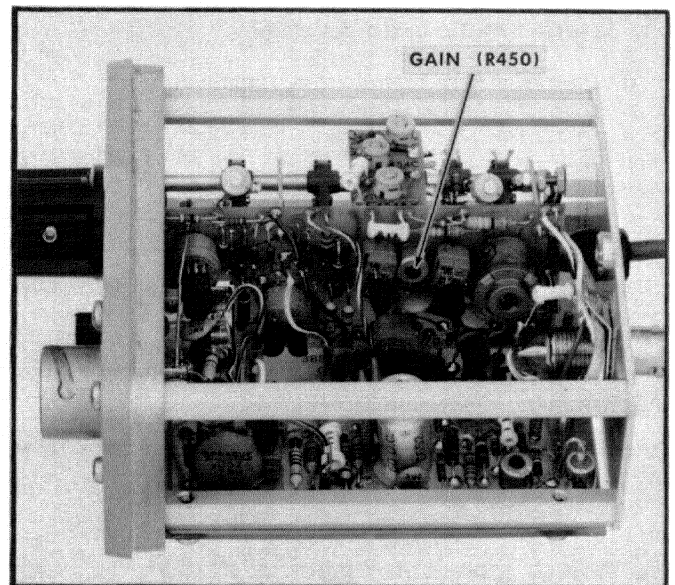

Fig. 6-8. Amplifier For P6046 GAIN adjustment location.

TABLE 6-2

Standard Amplitude Calibrator	Amplifier For P6046 mVOLTS/DIV	Display Divisions	Tolerance
5 mV	1	5	±0.15 div
10 mV	2	5	±0.15 div
20 mV	5	4	±0.12 div
50 mV	10	5	±0.15 div
.1 V	20 <sup>2</sup>	5	±0.15 div
.2 V	50	4	±0.12 div
.5 V	100	5	±0.15 div
1 V	200	5	±0.15 div

<sup>2</sup>Record the exact amplitude at this setting, for later use.

l. Move the equipment from the Probe + and - Input tips to the Dual Attenuator Head + and - Inputs tips, respectively.

m. Attach the Dual Attenuator Head to the Probe.

n. Switch the Standard Amplitude Calibrator AMPLITUDE control to 1 VOLT.

o. CHECK—Dual Attenuator Head + Input attenuator accuracy. Switch the vertical deflection factor control to 20 mV and check for 5 div display amplitude. Accuracy should be within ±0.1 div with the Type 1A5, or (with the Amplifier For P6046) within 2% of the value recorded in step k.

p. Disconnect the cable assembly and Dual Attenuator Head from the Probe. Disconnect the Probe ground lead from the Standard Amplitude Calibrator chassis. (The - Input attenuator accuracy will be checked during the Dual Attenuator Head Common-Mode Rejection adjustment, step 12.)

### 5. Check Input Gate Current

a. The preliminary control settings apply.

b. Attach special ground tips to the Probe + and - Input tips; then check the PROBE STEP ATTEN BAL (ATTEN BAL) adjustment by repeating steps 2b, c, d and e.

c. Set the vertical deflection factor control to 1 mV.

d. CHECK—The - Input gate current by observing the amount of instantaneous trace shift as the - Input ground tip is removed or replaced. At 25°C a maximum of 0.3 div trace shift should occur, indicating 0.3 nA or less gate current. Replace the - Input ground tip.

e. CHECK—The + Input gate current using the same procedure with the + Input ground tip.

### 6. Adjust Transient Response (C155) ❶

a. The preliminary control settings apply. The equipment setup and adjustment location appear in Fig. 6-9.

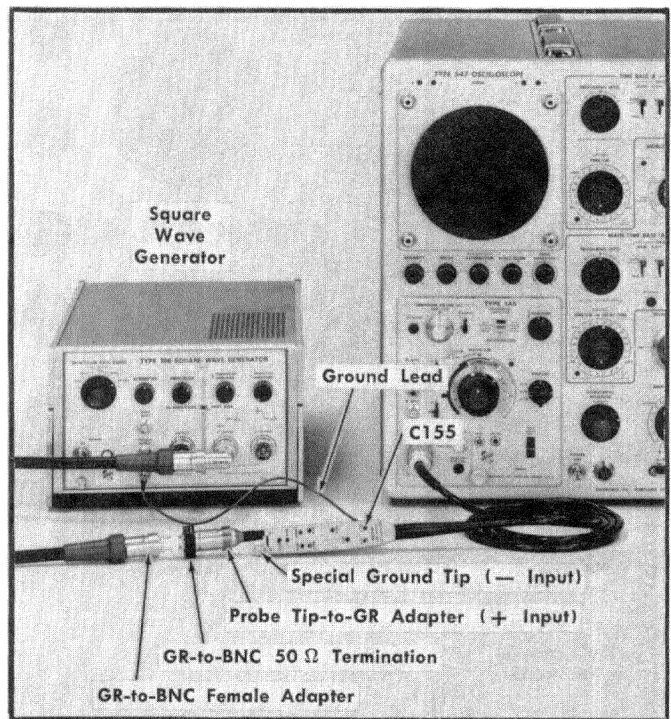

Fig. 6-9. Equipment setup for transient response adjustment, step 6.

b. Set the vertical deflection factor according to the equipment being used, as follows:

Type 1A5	20 mV
Amplifier For P6046	5 mV

c. Set the Oscilloscope TIME/CM control to .1 μs. Increase CRT brightness as necessary for optimum viewing.

d. Connect the following components to the Type 106 Square-Wave Generator (item 5) FAST RISE + OUTPUT in the sequence given:

- GR 90° elbow (item 11) (optional)
- 10:1 GR Attenuator (item 18) (Amplifier For P6046 only)
- 5 ns GR cable (item 10)
- GR-to-BNC female adapter
- GR-to-BNC 50 Ω termination (item 15)
- Probe tip-to-GR adapter

e. Check that a special ground tip is connected to the Probe - Input tip; connect a ground lead from the Probe ground lug to the chassis of the Square-Wave Generator.

f. Connect the Probe + Input tip to the probe tip-to-GR adapter and cable assembly.

g. Set the Square-Wave Generator controls as follows:

HI AMPLITUDE/FAST RISE	FAST RISE
REPETITION RATE RANGE	100 kHz
MULTIPLIER	1



h. Adjust the Square-Wave Generator + TRANSITION AMPLITUDE to provide a 4 div display.

i. Adjust the Oscilloscope triggering and horizontal position controls to center the display as shown in Fig. 6-10.

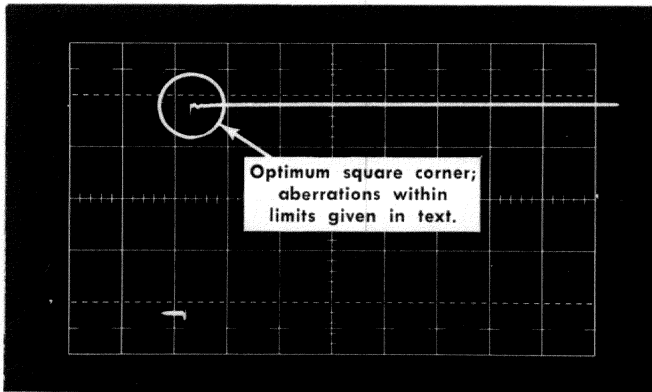

Fig. 6-10. Transient response waveform, step 6. Sweep rate 0.1  $\mu$ s/div; deflection factor 20 mV/div.

j. CHECK—Transient response. Optimum squareness should exist at the upper leading corner of the square wave, with + or - 0.16 or less aberration, not to exceed 0.24 div peak to peak with a Type 1A5, or 0.20 div peak to peak with an Amplifier For P6046, within the first 70 ns;  $\pm 0.06$  div with a Type 1A5 or  $\pm 0.08$  div with an Amplifier For P6046 (not exceeding 0.08 div peak to peak) thereafter.

k. (Amplifier For P6046 only.) If C454D in the Amplifier For P6046 has been moved, reset it to mid-position prior to adjusting the Probe transient response. Observe the leading edge of the square wave while adjusting C454D to determine its mid-position. See Fig. 6-11 (B) for C454D location.

l. ADJUST—C155 (Fig. 6-9) for optimum transient response as exhibited by optimum squareness at the upper leading corner of the square wave. Rounding, overshoot and tilt should be within the following values. Use Fig. 6-10 as a guide.

With Type 1A5:  $\leq \pm 0.16$  div ( $\leq 0.24$  div peak to peak) within the first 70 ns.

With Amplifier For P6046:  $\leq \pm 0.16$  div ( $\leq 0.20$  div peak to peak) within the first 70 ns. Readjust C454D in the Amplifier if this result cannot be obtained with C155.

m. (Amplifier For P6046 only.) CHECK and ADJUST—Transient response of a 4 division square wave at each setting of the mVOLTS/DIV switch in the same manner as was done in the 5 mV/DIV position, using the Amplifier For P6046 adjustments given in Table 6-3. See Fig. 6-11 for adjustment locations.

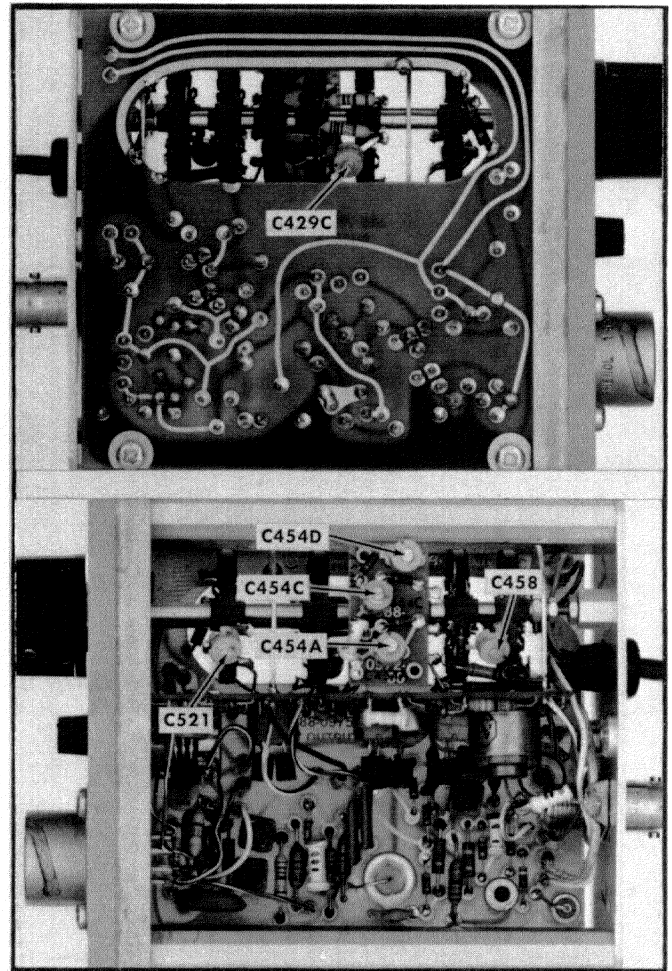

Fig. 6-11. Amplifier For P6046 transient response adjustment locations.

TABLE 6-3

mVOLTS/ DIV	Adjust	Aberration Tolerance (Divisions)
1	C521 <sup>3</sup> C454A	$\leq \pm 0.20$ ; $\leq 0.24$ P-P
2	C521 <sup>3</sup> C454C	$\leq \pm 0.16$ ; $\leq 0.20$ P-P
Remove the 10:1 attenuator from the signal path		
10	C458	$\pm \leq 0.16$ ; $\leq 0.20$ P-P
20	C429C	$\pm \leq 0.16$ ; $\leq 0.20$ P-P
50, 100	Check	$\pm \leq 0.16$ ; $\leq 0.20$ P-P compromise the C454D adjustment, if necessary, to bring the 5 through 100 positions within allowable limits.
200	Check	$\pm \leq 0.16$ ; $\leq 0.20$ P-P; readjust C429C, if necessary, comprising between the 20 and 200 mV positions.

<sup>3</sup>Adjust at 1 mV in conjunction with C454A. Adjust at 2 mV only if satisfactory results are not obtained with C454C, and then readjust C454 at 1 mV. Repeat as necessary.

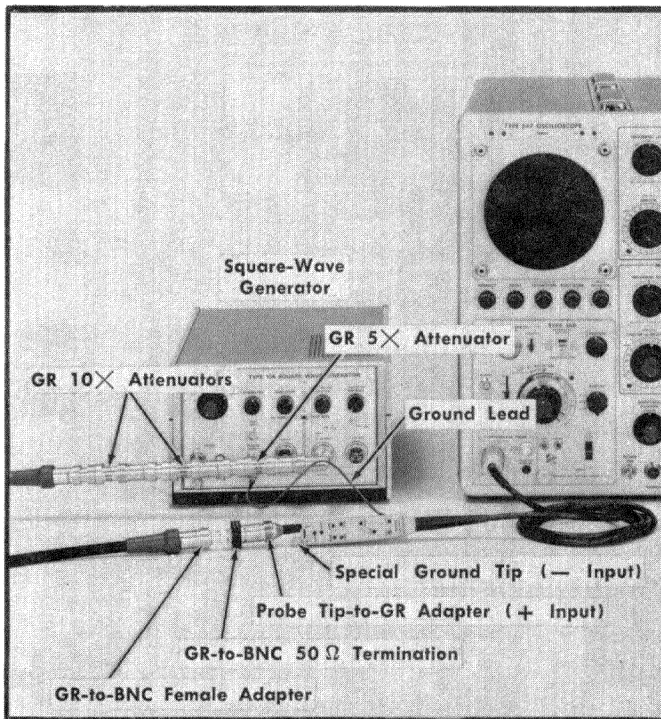

Fig. 6-12. Equipment setup for noise measurement, step 7.

### 7. Check Noise

a. The preliminary control settings apply. The equipment setup is shown in Fig. 6-12.

b. Check that the Probe ground lead is connected to the Square-Wave Generator chassis, and that a special ground tip is attached to the Probe —Input tip.

c. Connect the following components to the Square-Wave Generator Fast Rise + OUTPUT in the sequence given:

- GR 90° elbow (optional)
- GR 5× attenuators
- Two GR 10× attenuators
- 5 ns GR cable
- GR-to-BNC female adapter
- GR-to-BNC 50 Ω termination
- Probe tip-to-GR-adapter
- Probe + Input tip

d. Set the Square Wave Generator + TRANSITION AMPLITUDE fully clockwise. Check that the REPETITION RATE RANGE is at 100 kHz.

e. Set the Oscilloscope Time/Div control to 5 μs. Set the vertical deflection factor control to 1 mV. Adjust the horizontal and vertical position controls to center the display.

f. Set the TRIGGERING LEVEL for a triggered display and adjust the CRT controls for optimum viewing. Care should be

used to obtain the sharpest FOCUS and ASTIGMATISM adjustment.

g. Turn the TRIGGERING LEVEL control fully clockwise. Two traces should appear on the CRT, caused by the upper and lower excursions of the square wave presented on a free-running sweep.

h. Decrease the + TRANSITION AMPLITUDE to a point where the dark line between the two traces is just eliminated. Use Fig. 6-13 as a guide. (The desired presentation is obtained when a point is reached where doubt exists as to whether the dark line is or is not eliminated.) The two traces are now separated by noise.

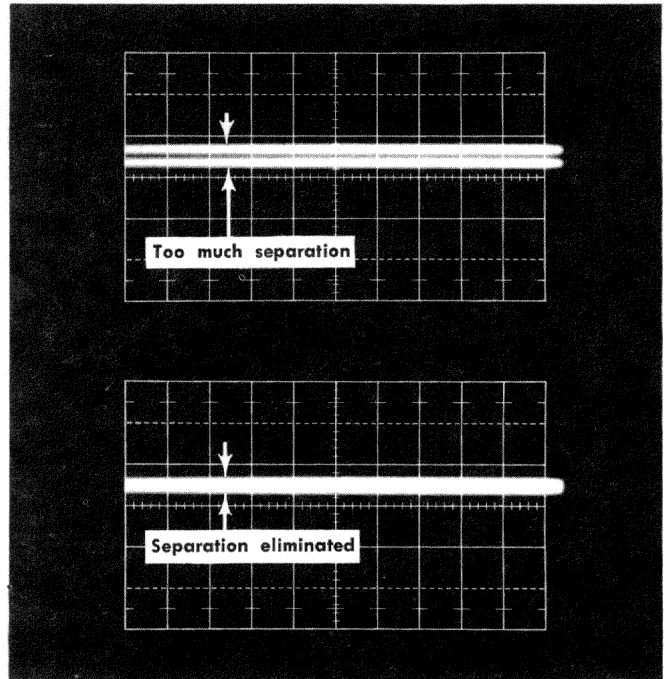

Fig. 6-13. Noise waveforms, step 7. Sweep rate 5 μs/div; deflection factor 1 mV/div.

i. Remove the two 10× attenuators from the signal path. Switch the vertical deflection factor control to 10 mV. Two traces will again appear. (This increases trace separation by a factor of 10, allowing more accurate measurement.)

j. CHECK. Noise. Measure the vertical amplitude between trace centers. Divide by 100. The result should be tangential noise within the following values:

With 1A5 —200 μV (represented by 2 divisions)

With Amplifier For P6046 —280 μV (represented by 2.8 divisions)

#### NOTE

Noise measurements are related as follows:  $\frac{1}{2}$  Tangential  $\approx$  PP/5.1  $\approx$  RMS.

k. Disconnect the 5 ns GR cable and the accessories from the Probe and the Square-Wave Generator.

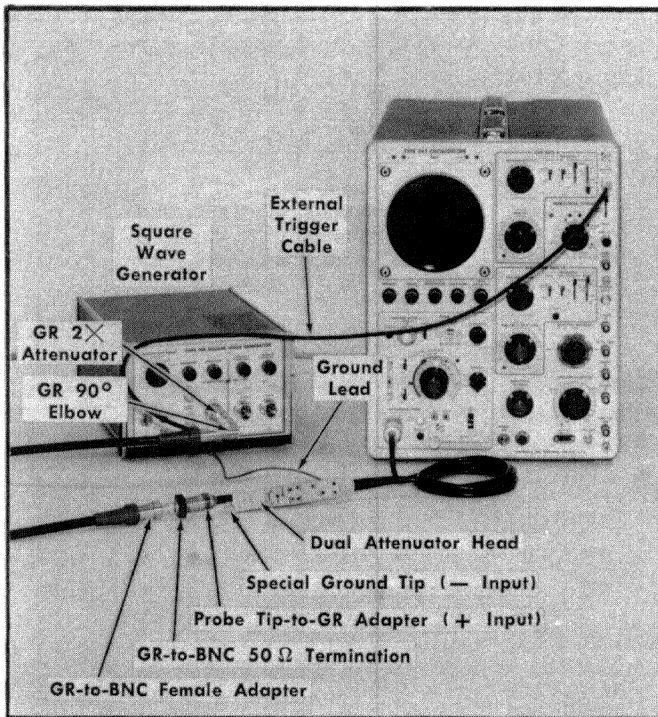

Fig. 6-14. Equipment initial setup for DC shift and overdrive recovery checks, step 8.

## 8. Check DC Shift Due to Overdrive: Check Overdrive Recovery Time

a. The preliminary control settings apply. The equipment setup appears in Fig. 6-14.

b. Set the vertical deflection factor to 100 mV.

c. Set the Oscilloscope Time/Div control to  $.1 \mu\text{s}$  and the TRIGGERING SOURCE to EXT; check that the TRIGGERING SLOPE is at +.

d. Remove the ground tip from the Probe — Input tip and attach the Dual Attenuator Head to the Probe. Connect the special ground tip to the Attenuator — tip.

e. Switch the Square-Wave Generator HI AMPLITUDE/FAST RISE switch to HI AMPLITUDE and set the AMPLITUDE control fully counterclockwise. Check that the REPETITION RATE RANGE is set to 100 kHz, and that the MULTIPLIER is at 1.

### CAUTION

Never connect the HI AMPLITUDE OUTPUT to the P6046 Probe without using a  $50 \Omega$  termination. Changing the HI AMPLITUDE/FAST RISE switch position generates transients which, if unterminated, exceed the Probe's maximum input voltage.

f. Connect the 42 inch coaxial cable from the Square-Wave Generator TRIGGER OUTPUT connector to the Oscilloscope TRIGGER INPUT connector.

g. Connect equipment to the Square-Wave Generator HI AMPLITUDE OUTPUT connector in the sequence given:

GR 2 $\times$  attenuator (item 16)

GR 90° elbow (optional)

5 ns GR cable

GR-to-BNC female adapter

GR-to-BNC  $50 \Omega$  termination

Probe tip-to-GR adapter

Dual Attenuator Head + Input tip

h. Adjust the Square-Wave Generator AMPLITUDE control to provide a 5 div square wave. Adjust the Oscilloscope TRIGGERING LEVEL as necessary to obtain a stable display. Using the horizontal position controls, set the leading edge of the positive square wave to start exactly 2 div from the first vertical graticule line as shown in Fig. 6-15 (A). Do not move the horizontal position or triggering controls for the remainder of this step.

i. Disconnect the Dual Attenuator Head from the Probe and probe tip-to-GR adapter.

j. Check the PROBE STEP ATTEN BAL (ATTEN BAL) adjustment (see step 2b, c, d and e).

k. Set the vertical deflection factor control to 20 mV. Using the vertical POSITION control, set the trace exactly one division below graticule vertical center.

l. CHECK—DC shift due to overdrive. Connect a special ground tip to the Probe — Input tip, then connect the + Input tip to the Probe tip-to-GR adapter and associated equipment. Check the position of the top of the square wave 1 second after making the connection. 3.75 div or less trace shift should occur, for a trace shift of 1.5% or less of input signal. See Fig. 6-15 (B) and (C).

m. Set the vertical deflection factor control to 10 mV and the oscilloscope Time/Div to  $1 \mu\text{s}$ . Using the vertical POSITION control, set the trailing edge of the top of the square wave to the vertical center of the graticule as in Fig. 6-15 (D).

n. (P6046 Probe — Type 1A5 only) Check—Overdrive recovery time. Switch the Time/Div control back to  $.1 \mu\text{s}$  and check the vertical separation between the trace and the graticule vertical center 3.5 div from the first vertical graticule line (150 ns after start of step function as shown in Fig. 6-15 E). At that point the trace should be within 1 div of graticule vertical center, and stay within 1 div for the remainder of the positive excursion of the square wave.

o. (P6046 Probe — Amplifier For P6046 only) CHECK—Overdrive recovery time. Switch the oscilloscope Time/CM to  $.1 \mu\text{s}$  and check the vertical separation between the trace and the graticule vertical center 3 divisions from the first vertical graticule line (100 ns after start of step function, as shown in Fig. 6-15 E). At that point the trace should be within 1 div of graticule vertical center, and stay within 1 div for the remainder of the positive excursion of the square wave.

p. Disconnect the accessories from the Probe and the Square-Wave Generator. Disconnect the Probe ground lead from the Square Wave Generator. Disconnect the external triggering cable and switch the Oscilloscope TRIGGERING SOURCE to NORM.

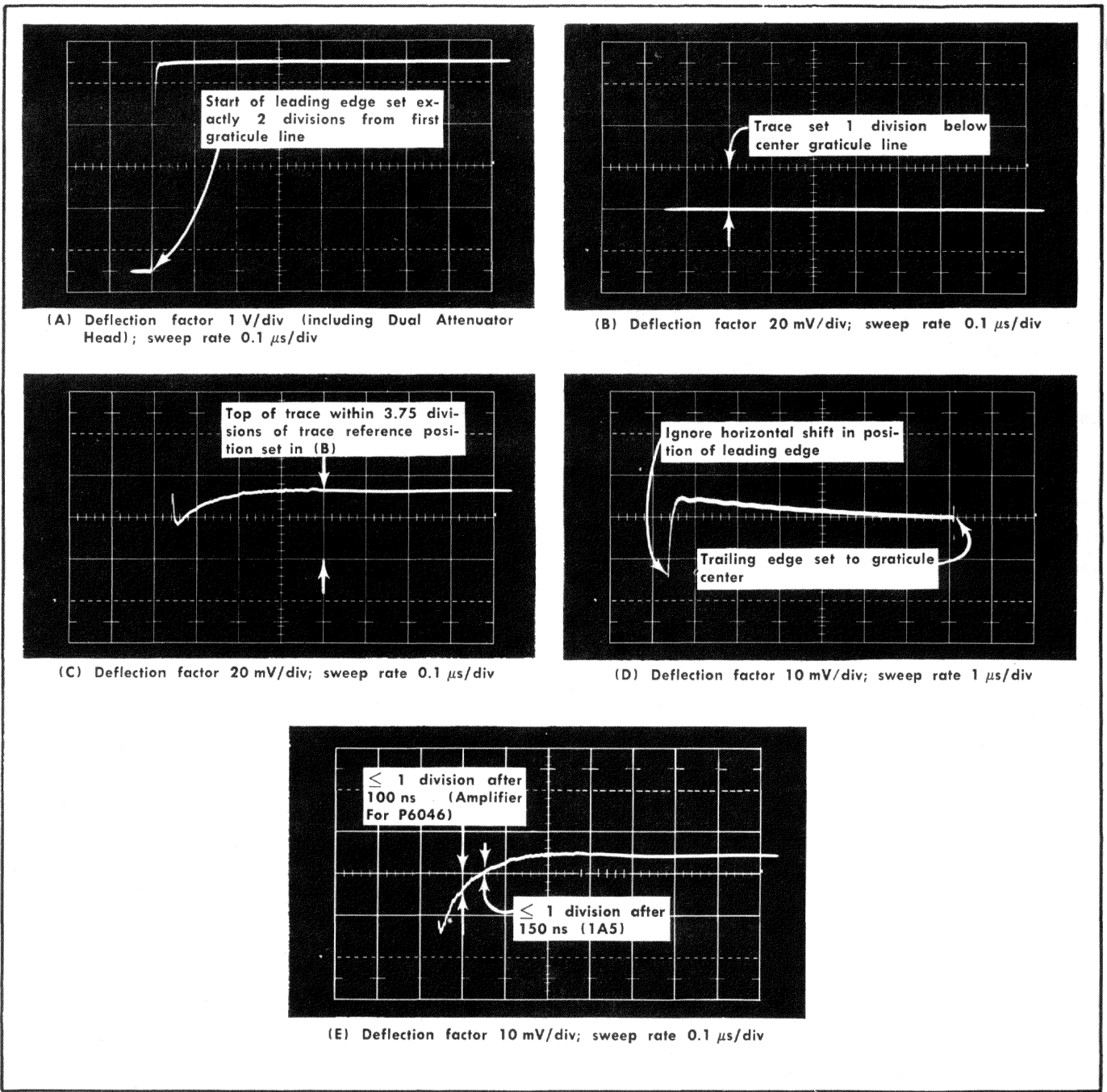

Fig. 6-15. DC shift and overdrive recovery waveforms, step 8.

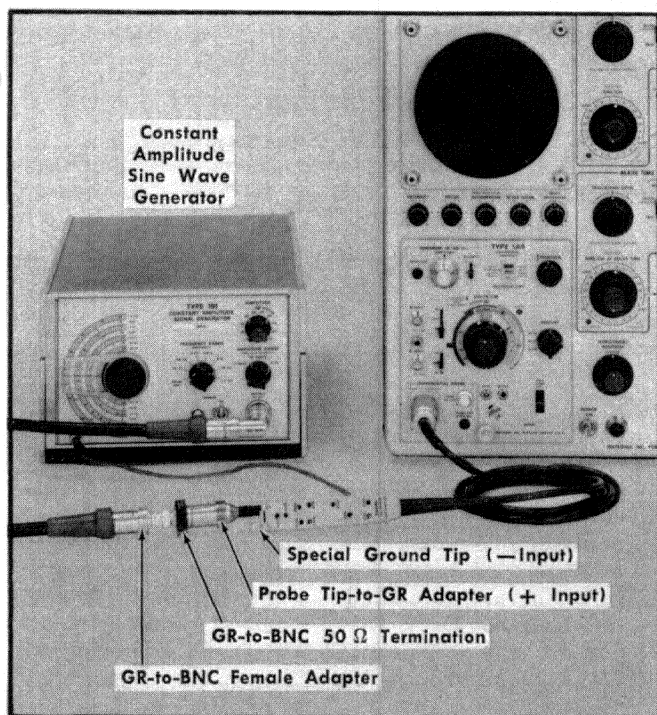

Fig. 6-16. Equipment setup for bandwidth check, step 9.

## 9. Check Bandwidth

a. The preliminary control settings apply. The equipment setup is shown in Fig. 6-16.

b. Set the vertical deflection factor control to 20 mV.

c. Set the Oscilloscope Time/Div to .5 ms and the HORIZONTAL POSITION control to mid-position.

d. (P6046 Probe/Type 1A5 only)

(1) Connect the following equipment to the OUTPUT connector of the Type 191 Constant Amplitude Signal Generator (item 6) in the sequence given:

- 90° elbow (optional)
- 5 ns GR cable
- GR-to-BNC female adapter
- GR-to-BNC 50 Ω termination
- Probe tip-to-GR adapter

(2) Connect a ground lead from the Probe ground lug to the Constant Amplitude Signal Generator chassis. Connect the probe + Input tip to the adapter on the cable assembly. (A special ground tip should remain on the - Input tip.)

(3) CHECK—Probe/Type 1A5 Bandwidth. Set the Constant Amplitude Signal Generator frequency to 50 kHz ONLY; adjust the amplitude controls to provide exactly 4 divisions of display. Adjust the vertical POSITION control as necessary

to center the display. Switch the Generator frequency to 45 MHz and check for 2.8 divisions or more amplitude, indicating 45 MHz or greater bandwidth.

e. (Probe/Amplifier For P6046 only)

(1) Disconnect the 18 inch coaxial cable and the BNC 50 Ω termination from the input of the Oscilloscope. Connect the GR to BNC 50 Ω termination directly to the Oscilloscope vertical INPUT connector. Connect the 5 ns GR cable between the 50 Ω termination and the Type 191 Constant Amplitude Signal Generator OUTPUT connector.

(2) With the Oscilloscope (Volts/DIV control set at 10 mV, and the Constant Amplitude Signal Generator set for a 50 kHz ONLY output, adjust the Generator Amplitude controls until the Oscilloscope display is exactly 4 divisions. Switch the Generator frequency to 100 MHz and record the 100 MHz display amplitude.

(3) Disconnect the 5 ns GR cable and the 50 Ω termination from the Oscilloscope Vertical INPUT. Reconnect the Amplifier Output connector to the Oscilloscope, via the 18 inch coaxial cable and 50 Ω termination. Connect the following components to the Constant Amplitude Signal Generator in the sequence given:

- 90° elbow (optional)
- 5 ns GR cable
- GR to BNC-female adapter
- GR to BNC 50 Ω termination
- Probe tip to GR adapter
- Probe + Input tip

(4) CHECK—Probe/Amplifier Bandwidth at each mVOLTS/DIV position of the Amplifier using the following procedure:

Switch the Generator frequency to 50 kHz ONLY.

Adjust the Generator output for a 4 division display at the selected mVOLTS/DIV position. A (10× GR attenuator must be inserted between the generator and its 50 Ω termination to reduce the signal input for the 1 and 2 mVOLTS/DIV positions.)

Switch the Generator Frequency to 100 MHz.

Divide the display amplitude by the display amplitude recorded in step (2). The result should be 0.7 or more for 30% or less attenuation, indicating a bandwidth of 100 MHz or more at 25° C. (Bandwidth for the 1 and 2 mVOLTS/DIV position decreases to 90 MHz at 50° C.)

### NOTE

There is a direct relationship between bandwidth and risetime, expressed as approximately:

$$T_r (\mu s) \times BW (MHz) \approx 0.35$$

Bandwidths of 50 and 100 MHz therefore indicate risetimes of approximately 7 and 3.5 ns respectively.

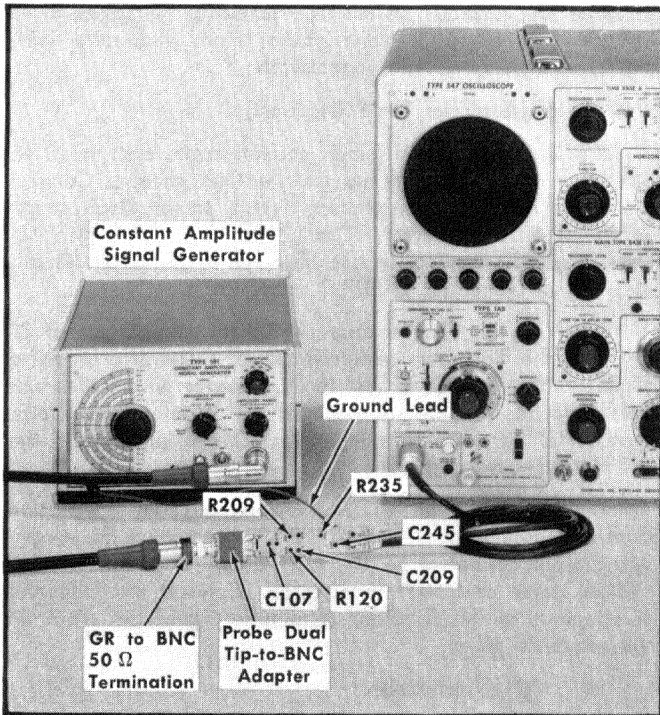

Fig. 6-17. Equipment setup for CMRR adjustment, step 10.

### 10. Adjust Common-Mode Rejection (R120, C107, C209, R209, C245)

a. The preliminary control settings apply. The equipment setup and adjustment locations are shown in Fig. 6-17.

b. Connect the following adjustment components to the Type 191 Constant Amplitude Signal Generator OUTPUT connector in the sequence listed:

- GR 90° elbow (optional)
- 5 ns GR cable
- GR to BNC 50 Ω termination
- Probe dual tip to BNC adapter

c. Set the Constant Amplitude Signal Generator controls as follows, providing a 5 V peak to peak output.

FREQUENCY RANGE	50 kHz ONLY
AMPLITUDE	50
VARIABLE	CAL
AMPLITUDE RANGE	.5—5 V

d. Connect a special ground tip to the + Input tip and check the PROBE STEP ATTEN BAL (ATTEN BAL) adjustment (step 2b, c, d, and e).

e. Remove the special ground tip from the + and — Input tips; check that the Probe ground lead remains connected to the Constant Amplitude Signal Generator chassis.

f. Connect the Probe tips to the Probe dual tip to BNC adapter.

g. Set the vertical deflection factor control to 1 mV.

h. CHECK—50 kHz CMRR. 0.5 div or less display amplitude should exist, indicating 10,000:1 or greater CMRR.

i. Set the vertical deflection factor control to 20 mV.

j. ADJUST—50 kHz CMRR. Adjust 50 kHz CM BAL (R120, Fig. 6-17) for minimum display amplitude; then adjust GAIN SWITCHING BALANCE (R235, Fig. 6-17) for a centered display.

k. REPEAT Step j adjustment at the 1 mV vertical deflection factor position. Adjust for 0.5 division or less display amplitude at the 1 mV position, indicating 10,000:1 or greater CMRR.

#### NOTE

CMRR adjustments can usually be made with a free-running display by measuring the total display amplitude. However, a more accurate evaluation of CMRR can be made by measuring the peak-to-valley amplitude of a triggered display, allowing for trace width. The Time/Div control must be reset according to the frequency being observed. See Fig. 6-18. This method of determining display amplitude should always be used when CMRR adjustment results (free running) appear marginal.

l. CHECK—AC-coupled CMRR. With the vertical deflection factor control at 1 mV, switch the P6046 Input Coupling switch to AC and check for 0.5 Div or less display amplitude.

m. ADJUST—AC-coupled CMRR. With the vertical deflection factor control at 1 mV, adjust C107 (Fig. 6-17) for equal AC-coupled and DC-coupled display amplitude. Switch the Probe Input Coupling switch back and forth between AC and DC for comparison purposes; 0.5 div or less for 10,000:1 or greater CMRR.

n. Switch the Probe Input Coupling switch back to DC. Switch the Constant Amplitude Signal Generator AMPLITUDE control to 10 to provide a 1 V peak-to-peak output.

o. CHECK—High frequency CMRR. Check for 1 div or less display amplitude at 18, 42 and 50 MHz, indicating 1000:1 or greater CMRR.

p. ADJUST—High frequency CMRR. With the Constant Amplitude Signal Generator set for a 1.0 V peak to peak output, adjust for minimum display amplitude in the sequence listed in Table 6-4. See Fig. 6-17 for adjustment locations.

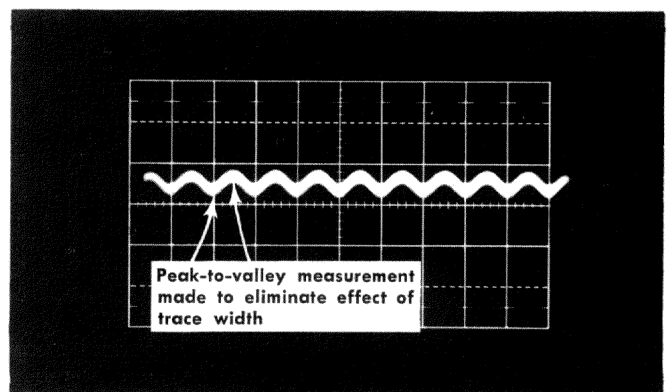

Fig. 6-18. Triggered CMRR waveform, step 10. Sweep rate dependent upon frequency; deflection factor 1 mV/div.

**CAUTION**

The C209 adjustment screw is at 10.5 V.

**TABLE 6-4**

Signal Generator Frequency	Adjust	Comment
21.35 MHz	C209; then R209	Adjust for minimum display amplitude, adjusting the capacitor first at each frequency. Repeat the adjustment sequence twice. Then check for 1 division or less amplitude at each frequency, indicating 1000:1 or greater CMRR. If requirement cannot be met at each frequency, reset R209 to midrange and repeat the adjustments twice more. If the amplitude still cannot be reduced to within 1 division, select other positions for R209 and repeat. <b>If more than a minimum amount of adjustment is required, step 6 should be rechecked.</b>
50 MHz	C245; then R209	

q. REPEAT—Step p until 1 div or less display amplitude appears at each frequency, indicating 1000:1 or greater CMRR.

r. CHECK—AC-Coupled 50 MHz CMRR. 2 division or less display amplitude should exist, indicating 500:1 or greater CMRR.

s. Switch the Probe Input Coupling switch to DC. Disconnect the cable assembly from the Probe and the Constant Amplitude Signal Generator. Disconnect the Probe ground lead from the Constant Amplitude Generator.

t. Switch the Probe Input Coupling switch to DC. Disconnect the cable assembly from the Probe and the Constant Amplitude Signal Generator. Disconnect the Probe ground lead from the Constant Amplitude Generator.

**NOTE**

If more than a minimum amount of CMRR adjustment is required, steps 6 and 10 should be repeated.

**11. Adjust Dual Attenuator Head AC Compensation (+ COMP —COMP)**

a. Preliminary control settings apply. The equipment setup and adjustment locations appear in Fig. 6-19.

b. Connect the Dual attenuator Head to the Probe.

c. Connect a special ground tip to the — Input tip of the Dual Attenuator Head. Connect a ground lead between the Probe and the Standard Amplitude Calibrator chassis.

d. Set the vertical deflection factor control to 20 mV.

e. Check that the standard Amplitude Calibrator controls are set as follows.

AMPLITUDE	1 V
MODE	Square Wave
Output Selector	Up

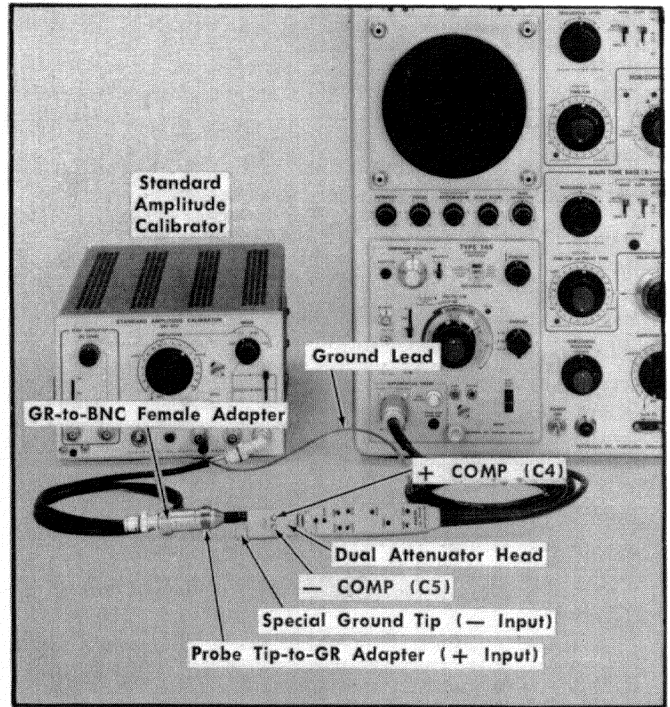

Fig. 6-19. Equipment setup for Dual Attenuator Head AC compensation, step 11.

f. Connect the following to the Standard Amplitude Calibrator right OUTPUT connector in the sequence given:

- 42 inch coaxial cable
- GR-to-BNC female adapter
- Probe tip-to-GR adapter
- Dual Attenuator Head + Input tip

g. Adjust the Oscilloscope triggering controls and the vertical POSITION control to obtain a stable, centered 5 div square wave display.

h. CHECK—Attenuator + Input AC compensation. Observe the upper left corner of the square wave for optimum squareness with  $\pm 0.1$  div or less aberration. See Fig. 6-20.

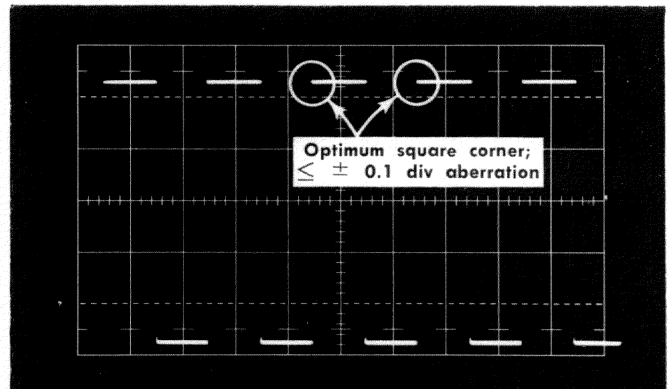

Fig. 6-20. Waveform for Dual Attenuator Head + Input tip AC compensation, step 11. Sweep rate 0.5 ms/div; deflection factor 0.2 V/div (including Dual Attenuator Head).

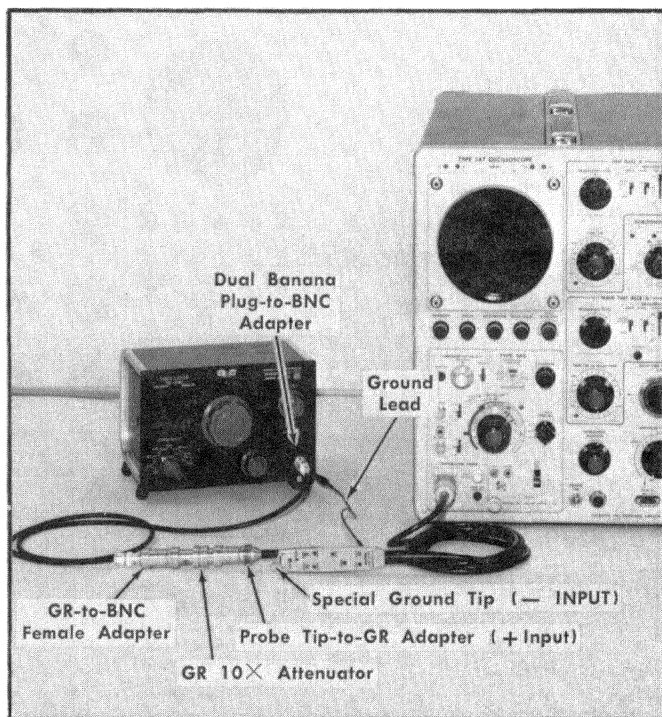

Fig. 6-21. Equipment setup for AC-Coupled low-frequency response check, step 12.

i. ADJUST— + COMP (Fig. 6-19) for optimum squareness at the upper left corner of the square wave.  $\pm 0.1$  div or less rounding, overshoot or tilt.

j. Exchange the connections on the Dual Attenuator Head + and - Input tips. Then readjust the vertical POSITION control to center the display.

k. CHECK—Attenuator - Input AC compensation. Observe the lower left corner of the square wave for optimum squareness with  $\pm 0.1$  div or less aberration.

l. ADJUST—Attenuator - COMP (Fig. 6-19) for optimum squareness at the lower left corner of the square wave.  $\pm 0.1$  div or less rounding, overshoot or tilt.

## 12. Check AC-Coupled Low Frequency Response

a. The preliminary equipment settings apply. The equipment setup is shown in Fig. 6-21.

b. Switch the Oscilloscope Time/Div control to 5 ms.

c. Remove the Dual Attenuator Head from the Probe tips.

d. Connect a special ground tip to the Probe - Input tip.

e. Connect the Probe ground lead to the chassis of the Low Frequency Sine-Wave Generator (item 7); then connect the following equipment to the Generator output connector in the sequence given:

- Banana jack-to-BNC adapter
- 42 inch coaxial cable
- GR-to-BNC female adapter
- GR 10 $\times$  attenuator
- Probe tip-to-GR adapter
- Probe + Input tip

f. Set the Generator for a 20 Hz, 80 mV (4 div) display. (Confirm the frequency by comparing it against the Oscilloscope time base. 1 cycle/div should appear at 50 ms/div.)

g. CHECK—AC-coupled low frequency response. Set the Probe Input Coupling switch to AC and check for 2.8 div or more display amplitude, indicating 30% or less AC-coupled voltage attenuation at 20 Hz.

### NOTE

Step 12, combined with the AC-coupled common-mode check (step 10), verifies the AC-coupled low frequency -3 dB limit for both the + and - inputs.

h. Disconnect the adapter from the Probe. Use of the Low-Frequency Sine-Wave Generator has been completed. Disconnect the Probe from the Type 1A5 and replace the calibration shield with the operating cover. The Probe Calibration Procedure has been completed.

If the P6046 Probe was calibrated to a Type 1A5 in the preceding procedure, continue with the Amplifier For P6046 Calibration Procedure to calibrate the Amplifier For P6046.

If the P6046 Probe and the Amplifier For P6046 were calibrated together in the preceding procedure, no further calibration of the Amplifier For P6046 is required.

## AMPLIFIER FOR P6046 CALIBRATION RECORD AND INDEX

The title and performance requirement of each calibration procedure step is listed here. This record and index can be used as a calibration check-off list, a record of calibration, a page index for the calibration procedure itself, or it can be used as a short-form calibration procedure for experienced calibrators. It is recommended that duplicate copies be made for repeated check-off and record usage.

- 1. Preliminary Procedure Page 6-19
- 2. Adjust Power Supply 100 VOLTS (R325), Page 6-19  
26.8 VOLTS (R348); Check +50 V,  
-50 V, +20.6 V, -6.2 V.  
Adjust for 100 V differential between terminals C and E on the 100 V circuit board, and 26.8-V differential between terminals B and D on the 26.8-V circuit board.  
Check 50-V supplies for  $\pm 1$  V, +20.6 V supply for  $\pm 0.6$  V, -6.2-V supply for  $\pm 0.3$  V.
- 3. Adjust Amplifier DC Output and DC Page 6-20  
Balance (R480, R550, R555)  
Adjust R480 for 0-V output with Q463 base grounded through 10  $\Omega$ , R555 for 0-V output with Q463 base shorted through 10  $\Omega$  to R556-R557 junction, R550 for 0-V output with Q443 base shorted to Q543 base.
- 4. Adjust ATTEN BAL (R400) Page 6-20  
Adjust ATTEN BAL (R400) for less than 1 div trace shift when the mVOLTS/Div Control is switched through its entire range with no signal input.
- 5. Adjust GAIN (R450) Page 6-20  
Adjust R450 for 4 divisions display at 5 mV/div with 20 mV Standard Amplitude Calibrator input. Check at all Amplifier switch positions for  $\pm 3\%$  accuracy.
- 6. Adjust Transient Response (C521, C429C, Page 6-22  
C454A, C454C, C454D, C459)



With 100 kHz input from square wave generator, perform indicated adjustments for optimum squareness at the upper left corner of a 4 division positive square wave; note that C521 affects both the 1 and 2 mVOLTS positions and that the 5 mVOLTS position adjustment must be made before the 10 or 20 mVOLTS: 1 mV — C454A and C521; 2 mV — C454C and C521; 5 mV — C454D; 10 mV — C458; 20 mV — C429C.

- 7. Check Bandwidth Page 6-24

Check for 30% or less voltage attenuation of 100 MHz input due to P6046 Probe and Amplifier For P6046.

### AMPLIFIER FOR P6046 CALIBRATION PROCEDURE

This procedure contains instructions for calibrating the Amplifier For P6046 to a Probe which has been calibrated to a Type 1A5 Differential Amplifier in accordance with the P6046 Differential Probe Calibration Procedure.

#### 1. Preliminary Procedure

a. Check that the Power Supply Unit is disconnected from the power source. Then remove the two screws from the back of the Amplifier For P6046 and pull the rear panel and cover off toward the back of the chassis.

b. Remove the two screws from the top of the Power Supply Unit. Then pull the cover off toward the top of the chassis. Check that the transformer connections conform with the voltage to which the Power Supply unit will be connected during calibration. See Table 4-3 in the Maintenance section. Rewire the transformer and change the tag on the base of the unit as necessary.

c. Make the following equipment connections:

50 Ω BNC termination (item 26) to the Type 647A Oscilloscope CH 1 vertical INPUT connector.

18 inch 50 Ω cable (item 27) from the 50 Ω termination to the Amplifier For P6046 output connector.

Probe Amphenol connector to the Amplifier For P6046 Amphenol connector.

De-energized line cord to Amplifier For P6046 Power Supply unit. (Set the Power Supply unit down on its fused side.)

#### CAUTION

Use extreme caution when handling the energized Power Supply unit while it is uncovered.

d. Apply power to the Type 647A Oscilloscope, the Amplifier For P6046 Power Supply unit, and to the test equipment which will be used in the Calibration Procedure.

e. Set the equipment controls as follows:

#### Type 647A Oscilloscope

CH 1 VOLTS/CM	.01 <sup>4</sup>
VARIABLE	CAL
AC-GND-DC	DC
INVERT PULL	In
MODE	CH 1
TRIGGER	NORM
CALIBRATOR	OFF
TIME/DIV	.5 ms

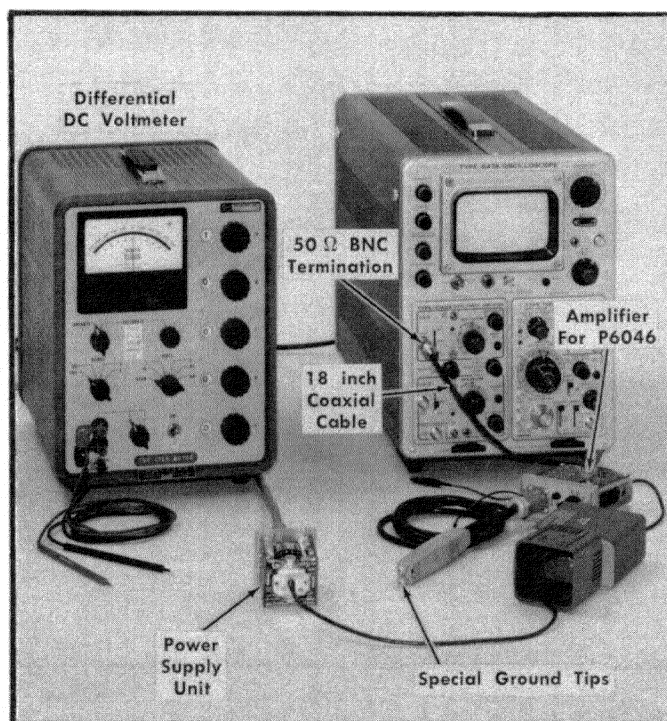

Fig. 6-22. Equipment setup for steps 2 through 4.

VARIABLE A	CALIB
HORIZ DISPLAY	A
MAG	OFF
TRIG MODE	AUTO
A Triggering	
SLOPE	+
COUPLING	AC
SOURCE	INT

#### P6046 Probe

AC-DC	DC
-------	----

#### Amplifier For P6046

mVOLTS/DIV	5
------------	---

<sup>4</sup>The Oscilloscope VOLTS/CM control must remain at .01 throughout the procedure. All vertical deflection factor switching is to be done at the Amplifier For P6046.

#### 2. Adjust Power Supply 100 VOLTS (R325 and 26.8 VOLTS (R348); Check +50 V, -50 V, +20.6 V, -6.2 V

a. The equipment setup appears in Fig. 6-22.

b. Isolate both the + and - input connectors of the Differential Voltmeter (item 8) from ground. Set the voltmeter for 100 volts. Then connect the positive lead to terminal C of the 100 V circuit board and the negative lead to the body of Q327. See Fig. 6-23.

c. CHECK—100 V ±1 V exists between terminal C and the body of Q327.

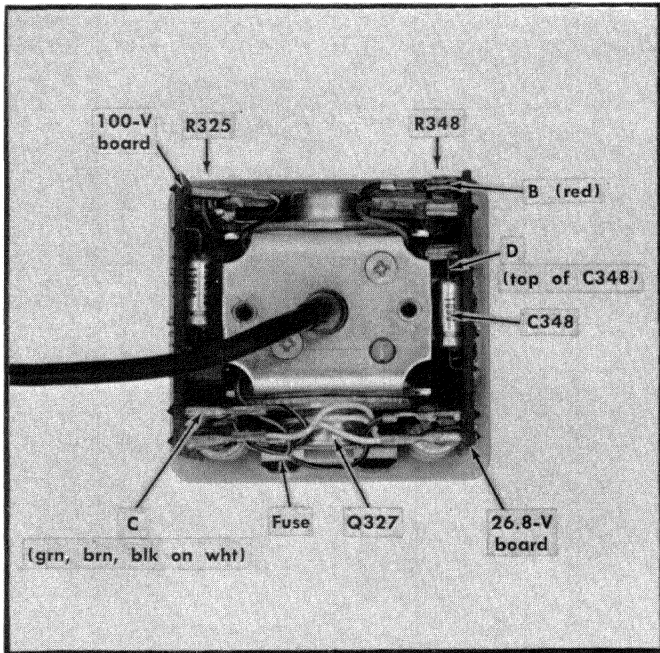

Fig. 6-23. Voltage test points and adjustment locations for step 2.

d. ADJUST—100 VOLTS (R325) for exactly 100 V between terminal C and the body of Q327.

e. Remove the Voltmeter leads from the 100 V supply and connect the positive lead to terminal B of the 26.8 V circuit board; connect the negative lead to terminal D. See Fig. 6-23.

f. CHECK—26.8 V  $\pm$ 0.3 V exists between terminals B and D.

g. ADJUST—26.8 VOLTS (R348) for exactly 26.8 V between terminals B and D.

h. CHECK—+ and - Voltages. Check for voltages with respect to ground at points indicated in Table 6-5. The values are not adjustable with respect to ground. Values outside of allowable tolerances must be corrected by troubleshooting components in the Amplifier Unit.

TABLE 6-5

Test Point (Fig. 6-23)	Voltage	Tolerance
C	+50	$\pm$ 1 V
Q327 Body	-50	$\pm$ 1 V
D	-6.2	$\pm$ 0.3 V
B	+20.6	$\pm$ 0.6 V

i. Disconnect the Voltmeter. Replace the cover on the Power Supply unit.

**CAUTION**

Avoid contact with the equipment circuitry. It is advisable to de-energize the Power Supply unit before replacing cover. Allow 5 minutes after re-energizing to permit temperature to stabilize.

**3. Adjust Amplifier DC Output and DC Balance (R480, R550, R555)**

a. The preliminary control settings apply. The equipment setup appears in Fig. 6-22.

b. Set the Oscilloscope Vertical CH 1 Input AC-GND-DC switch to GND.

c. Using the Oscilloscope Vertical POSITION control, set the trace to the exact vertical center of the graticule.

d. Return the AC-GND-DC switch to DC.

e. CHECK and ADJUST—Amplifier DC balance. The trace should remain exactly at graticule vertical center under the setups given in Table 6-6. Perform the steps in the sequence given. Temporarily solder a 10  $\Omega$   $\frac{1}{4}$  W resistor (item 28) between indicated points while making each adjustment. The resistor and lead length should be cut to  $\frac{3}{4}$  inch (end to end) to minimize circuit interference. See Fig. 6-24 (B) and (C) for connection and adjustment locations.

TABLE 6-6

Connect 10 $\Omega$ Resistor Between	Adjust	Results
Q463 base and ground	R480	Adjust trace to graticule vertical center
Q463 base and the R556-R557 junction	R555	
Q443 base and Q543 base	R550	

f. If the Probe Calibration Procedure has already been completed in conjunction with a Type 1A5, ignore step 3f and continue with step 4. If the P6046 Probe is to be calibrated to the Amplifier For P6046, proceed with step 1 of the P6046 Differential Probe Calibration Procedure.

**4. Adjust ATTEN BAL (R400)**

a. The preliminary control settings apply. The equipment setup appears in Fig. 6-22.

b. Set the Oscilloscope Vertical Input AC-GND-DC switch to GND. Check that the Oscilloscope VOLTS/DIV switch is set at 10 mV. Then adjust the vertical POSITION control to set the trace to graticule vertical center.

c. Attach special ground tips (item 20) to the Probe's + and - tips.

d. Switch the Oscilloscope Vertical Input AC-GND-DC control to DC.

e. CHECK—1 div or less trace shift occurs as the Amplifier For P6046 mVOLTS/DIV control is switched between 20 and 1.

f. ADJUST—ATTEN BAL (located on the Amplifier front panel) until less than 1 div trace shift occurs when the mVOLTS/DIV control is switched through its entire range.

**5. Adjust GAIN (R450)**

**IMPORTANT**

The 10 mV/div gain of the 100 MHz Oscilloscope must be accurately calibrated before the following adjustment is made.

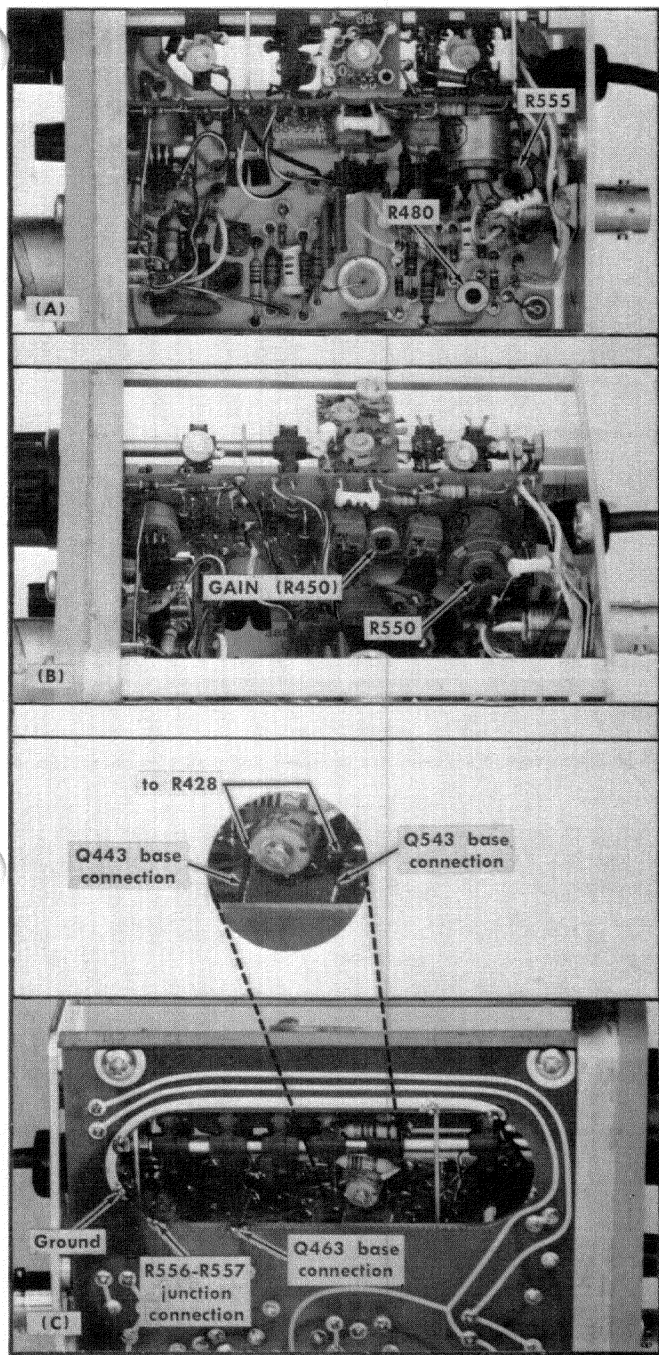

Fig. 6-24. Test points and adjustment locations for steps 3 and 5.

a. The preliminary control settings apply. The equipment setup appears in Fig. 6-25.

b. Set the Amplifier mVOLTS/DIV switch to 5.

c. Remove a special ground tip from the Probe + Input tip. Connect the ground lead (item 21) from the Probe ground lug to the chassis of the Standard Amplitude Calibrator (item 4).

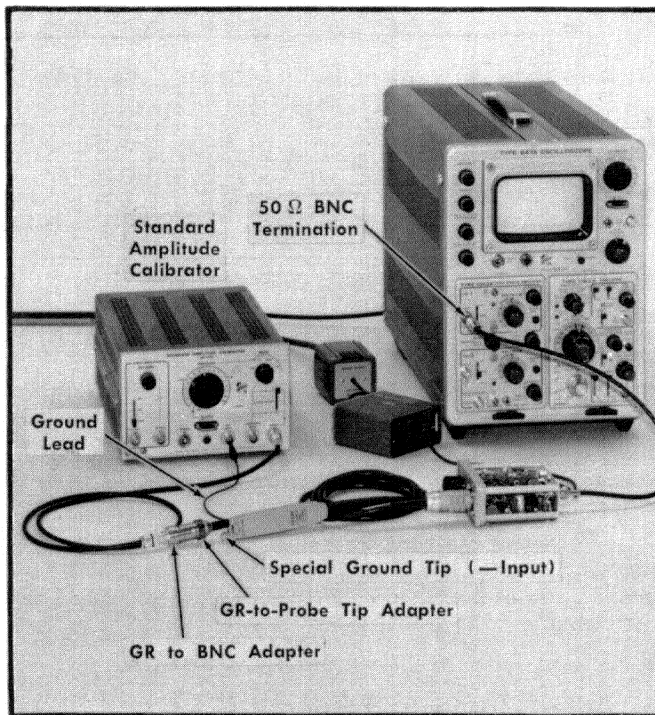

Fig. 6-25. Equipment setup for GAIN adjustment, step 5.

d. Set the Standard Amplitude Calibrator controls as follows:

AMPLITUDE	20 mVOLTS
MODE	Square Wave
Output Selector	Up

e. Connect the following components to the Standard Amplitude Calibrator right OUTPUT connector in the sequence listed:

- 42 inch 50 Ω cable (item 9)
- GR to BNC female adapter (item 12)
- Probe tip to GR adapter (item 13)
- Probe + Input tip

f. CHECK—Gain. 4 divisions  $\pm 0.12$  divisions of display amplitude should exist between trace centers. Use the vertical POSITION control as necessary to center the presentation. (A more convenient gain measurement can be made if the TRIGGERING LEVEL is adjusted to provide a free-running sweep, resulting in two horizontal traces.)

g. ADJUST—GAIN, R450, Fig. 6-24 (B), to provide exactly 4 divisions of vertical display.

h. CHECK—Gain at all positions of the mVOLTS/DIV switch, using Table 6-7 as a guide. Re-adjust R450, if necessary, until gain is within allowable tolerance in all switch positions.

TABLE 6-7

Standard Amplitude Calibrator	Amplifier mVOLTS/DIV	Display Amplitude (divisions)
5 mV	1 <sup>5</sup>	5 ±0.15
10 mV	2 <sup>5</sup>	5 ±0.15
20 mV	5	4 ±0.12
50 mV	10	5 ±0.15
100 mV	20	5 ±0.15
200 mV	50	4 ±0.12
500 mV	100	5 ±0.15
1 V	200	5 ±0.15

<sup>5</sup>Displayed noise can be decreased to permit easier measurement by temporarily connecting a 0.1 μF —25 V capacitor from the Amplifier Output terminal to ground. (This method of decreasing noise cannot be used at high frequencies because of the resultant decrease in bandwidth.)

i. Disconnect the equipment from the Probe tip, then disconnect the ground lead from the Standard Amplitude Calibrator. Use of the Standard Amplitude Calibrator has been completed.

### 6. Adjust Transient Response (C521, C429C, C454A, C454C, C454D, C458) ①

a. The preliminary control settings apply. The equipment setup appears in Fig. 6-26.

b. Check that the special ground tip remains on the Probe — Input tip. Connect the ground lead from the Probe ground lug to the chassis of the Type 106 Square-Wave Generator (item 5). Set the Square-Wave Generator controls as follows:

REPETITION RATE RANGE	100 kHz
MULTIPLIER	1
HI AMPLITUDE/FAST RISE	FAST RISE

c. Connect the following components to the Square-Wave Generator + OUTPUT in the sequence listed:

- 90° GR elbow (optional) (item 11)
- 10:1 GR attenuator (item 18)
- 5 ns GR cable (item 10)
- GR to BNC-female adapter
- GR to 50 Ω termination (item 15)
- Probe tip to GR adapter
- Probe + Input tip

d. Set the Amplifier mVOLTS/DIV switch to 1 mV and adjust the Square-Wave Generator + TRANSITION AMPLITUDE to provide a 4 division display.

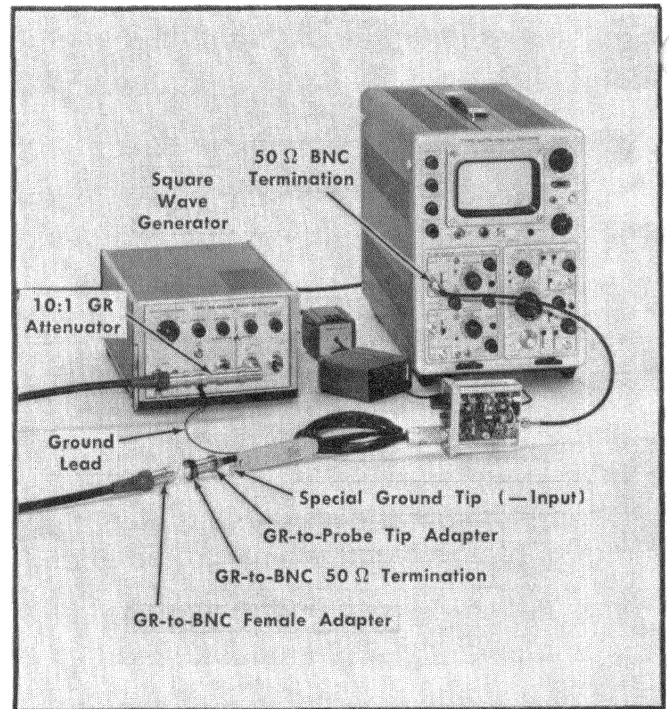

Fig. 6-26. Equipment setup for transient response adjustment, step 6.

e. Set the Oscilloscope TIME/DIV to .1 μs and adjust the triggering and position controls as necessary to provide a presentation as in Fig. 6-27.

f. CHECK and ADJUST—Transient response of a 4 division square wave at each setting of the mVOLTS/DIV switch in the sequence listed in Table 6-8. Optimum squareness should exist at the upper left corner of the square wave. Use Fig. 6-27 as a reference. Adjustment locations are shown in Fig. 6-28.

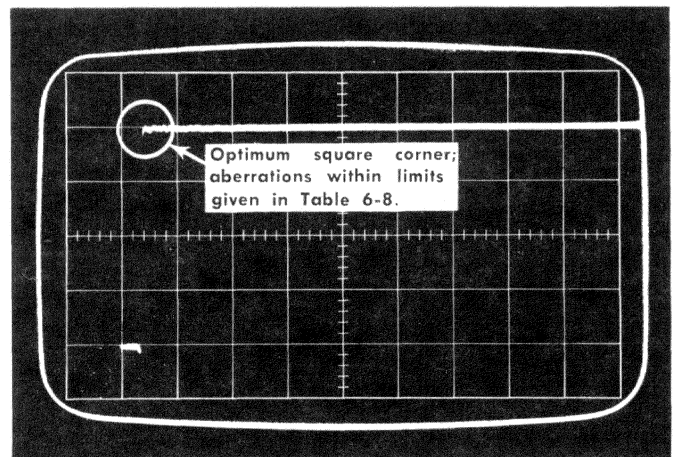

Fig. 6-27. Transient response waveform, step 6.



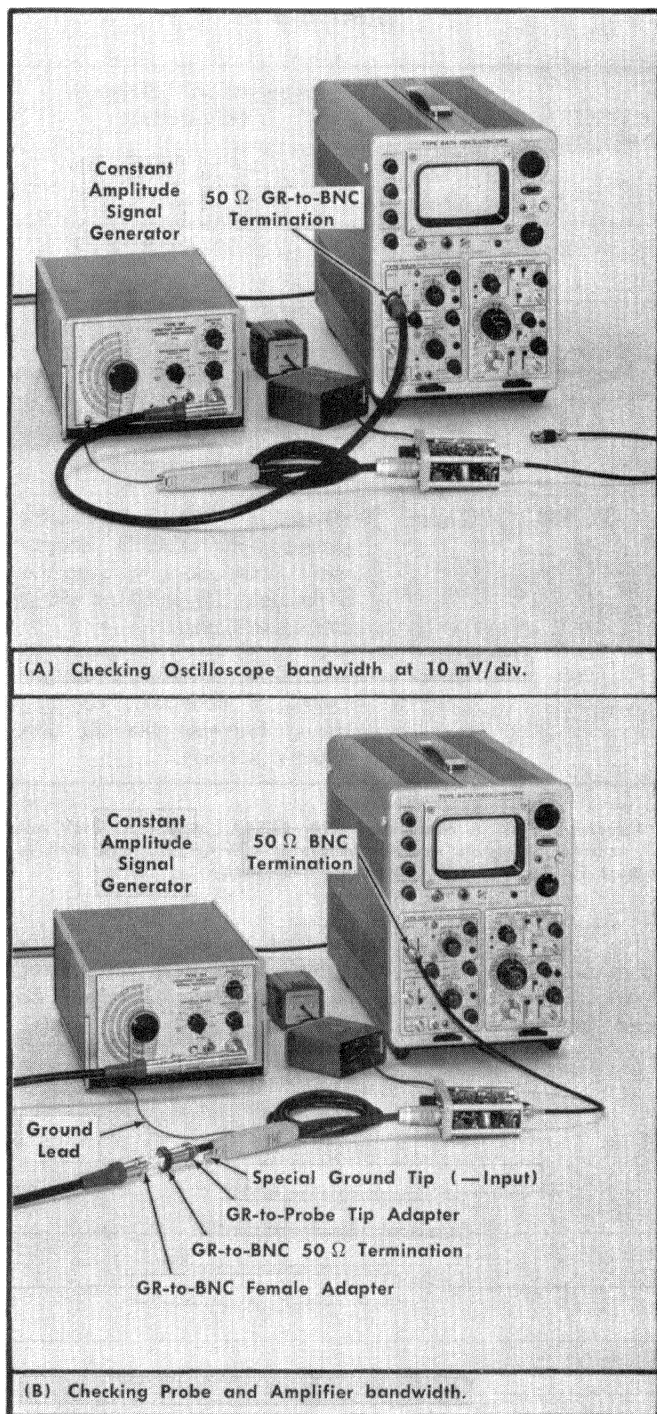

Fig. 6-29. Equipment setup pictures for bandwidth check, step 7.

## 7. Check Bandwidth

a. The preliminary control settings apply. The equipment setups are shown in Fig. 6-29.

b. Set the Oscilloscope TIME/DIV control to .5 ms.

c. Disconnect the Amplifier's 18 inch cable and 50 Ω BNC termination from the Oscilloscope CH 1 INPUT connector. Connect the following components to the OUTPUT connector of the Constant Amplitude Signal Generator (item 6) in the sequence listed:

GR 90° elbow (optional)

5 ns GR cable

GR to BNC 50 Ω termination

Oscilloscope CH 1 INPUT connector

d. With the Oscilloscope VOLTS/CM control set at 0.1 V and the Constant Amplitude Signal Generator set for a 50 kHz ONLY output, adjust the Generator Amplitude controls until the Oscilloscope display is exactly 4 divisions. Switch the Generator frequency to 100 MHz and record the 100 MHz display amplitude.

e. Connect the ground lead from the Probe ground lug to the Constant Amplitude Signal Generator chassis, and a special ground tip to the —Input tip. Disconnect the 5 ns GR cable and the 50 Ω termination from the Oscilloscope Vertical INPUT and connect them to the Probe + Input tip using the GR to BNC female adapter and GR to probe tip adapter. Reconnect the Amplifier Output connector to the Oscilloscope, via the 18 inch coaxial cable and 50 Ω BNC termination.

f. Check Probe Amplifier Bandwidth at each mVOLTS/DIV position of the Amplifier using the following procedure:

- (1) Switch the Generator frequency to 50 kHz ONLY.
- (2) Adjust the Generator output for a 4 division display at the selected mVOLTS/DIV position. (The 10:1 GR attenuator must be inserted between the generator and its 50 Ω termination to reduce the signal input for the 1 mVOLTS/DIV position.)
- (3) Switch the Generator Frequency to 100 MHz.
- (4) Divide the display amplitude by the display amplitude recorded in step d. The result should be 0.7 or more for 30% or less attenuation, indicating a bandwidth of 100 MHz or more.

The calibration procedure has been completed. Disconnect the equipment from the Amplifier and disconnect the Amplifier's Power Supply unit from its power source.

Replace the cover on the Amplifier unit.

# REPLACEABLE ELECTRICAL PARTS

## PARTS ORDERING INFORMATION

Replacement parts are available from or through your local Tektronix, Inc. Field Office or representative.

Changes to Tektronix instruments are sometimes made to accommodate improved components as they become available, and to give you the benefit of the latest circuit improvements developed in our engineering department. It is therefore important, when ordering parts, to include the following information in your order: Part number, instrument type or number, serial number, and modification number if applicable.

If a part you have ordered has been replaced with a new or improved part, your local Tektronix, Inc. Field Office or representative will contact you concerning any change in part number.

Change information, if any, is located at the rear of this manual.

### LIST OF ASSEMBLIES

A list of assemblies can be found at the beginning of the Electrical Parts List. The assemblies are listed in numerical order. When the complete component number of a part is known, this list will identify the assembly in which the part is located.

### CROSS INDEX-MFR. CODE NUMBER TO MANUFACTURER

The Mfr. Code Number to Manufacturer index for the Electrical Parts List is located immediately after this page. The Cross Index provides codes, names and addresses of manufacturers of components listed in the Electrical Parts List.

### ABBREVIATIONS

Abbreviations conform to American National Standard Y1.1.

### COMPONENT NUMBER (column one of the Electrical Parts List)

A numbering method has been used to identify assemblies, subassemblies and parts. Examples of this numbering method and typical expansions are illustrated by the following:

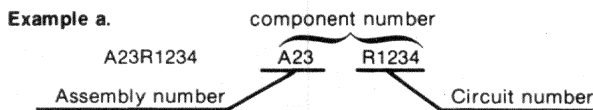

Read: Resistor 1234 of Assembly 23

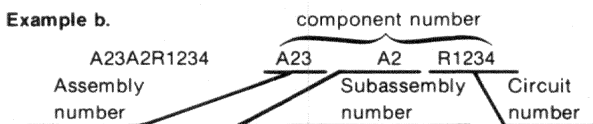

Read: Resistor 1234 of Subassembly 2 of Assembly 23

Only the circuit number will appear on the diagrams and circuit board illustrations. Each diagram and circuit board illustration is clearly marked with the assembly number. Assembly numbers are also marked on the mechanical exploded views located in the Mechanical Parts List. The component number is obtained by adding the assembly number prefix to the circuit number.

The Electrical Parts List is divided and arranged by assemblies in numerical sequence (e.g., assembly A1 with its subassemblies and parts, precedes assembly A2 with its subassemblies and parts).

Chassis-mounted parts have no assembly number prefix and are located at the end of the Electrical Parts List.

### TEKTRONIX PART NO. (column two of the Electrical Parts List)

Indicates part number to be used when ordering replacement part from Tektronix.

### SERIAL/MODEL NO. (columns three and four of the Electrical Parts List)

Column three (3) indicates the serial number at which the part was first used. Column four (4) indicates the serial number at which the part was removed. No serial number entered indicates part is good for all serial numbers.

### NAME & DESCRIPTION (column five of the Electrical Parts List)

In the Parts List, an Item Name is separated from the description by a colon (:). Because of space limitations, an Item Name may sometimes appear as incomplete. For further Item Name identification, the U.S. Federal Cataloging Handbook H6-1 can be utilized where possible.

### MFR. CODE (column six of the Electrical Parts List)

Indicates the code number of the actual manufacturer of the part. (Code to name and address cross reference can be found immediately after this page.)

### MFR. PART NUMBER (column seven of the Electrical Parts List)

Indicates actual manufacturers part number.

Replaceable Electrical Parts  
P6046 Probe and Amplifier

CROSS INDEX - MFR. CODE NUMBER TO MANUFACTURER

Mfr. Code	Manufacturer	Address	City, State, Zip Code
00213	NYTRONICS COMPONENTS GROUP INC SUBSIDIARY OF NYTRONICS INC	ORANGE ST	DARLINGTON SC 29532
01121	ALLEN-BRADLEY CO	1201 SOUTH 2ND ST	MILWAUKEE WI 53204
02114	AMPEREX ELECTRONIC CORP FERROXCUBE DIV	5083 KINGS HWY	SAUGERTIES NY 12477
02660	BUNKER RAMO CORP AMPHENOL NORTH AMERICA DIV	2801 S 25TH AVE	BROADVIEW IL 60153
02735	RCA CORP SOLID STATE DIVISION	ROUTE 202	SOMERVILLE NJ 08876
03508	GENERAL ELECTRIC CO SEMI-CONDUCTOR PRODUCTS DEPT	W GENESEE ST	AUBURN NY 13021
03614	BUSSMAN MFG DIVISION OF MCGRAM EDISON CO		LOS ANGELES CA
03888	KOI PYROFILM CORP	60 S JEFFERSON RD	MHIPPANY NJ 07981
04222	AVX CERAMICS DIV OF AVX CORP	19TH AVE SOUTH P O BOX 867	MYRTLE BEACH SC 29577
04713	MOTOROLA INC SEMICONDUCTOR GROUP	5005 E MCDOWELL RD	PHOENIX AZ 85008
05397	UNION CARBIDE CORP MATERIALS SYSTEMS DIV	11901 MADISON AVE	CLEVELAND OH 44101
07263	FAIRCHILD CAMERA AND INSTRUMENT CORP SEMICONDUCTOR DIV	464 ELLIS ST	MOUNTAIN VIEW CA 94042
07716	TRW INC TRW ELECTRONICS COMPONENTS TRW IRC FIXED RESISTORS/BURLINGTON	2850 MT PLEASANT AVE	BURLINGTON IA 52601
12697	CLAROSTAT MFG CO INC	LOWER WASHINGTON ST	DOVER NH 03820
12954	MICROSEMI CORP	8700 E THOMAS RD P O BOX 1390	SCOTTSDALE AZ 85252
12969	UNITRODE CORP	580 PLEASANT ST	WATERTOWN MA 02172
14193	CAL-R INC	1601 OLYMPIC BLVD	SANTA MONICA CA 90404
14433	ITT SEMICONDUCTORS DIV		WEST PALM BEACH FL
14552	MICRO/SEMICONDUCTOR CORP	2830 S FAIRVIEW ST	SANTA ANA CA 92704
19701	MEPCO/ELECTRA INC A NORTH AMERICAN PHILIPS CO	P O BOX 760	MINERAL WELLS TX 76067
22229	SOLITRON DEVICES INC SEMICONDUCTOR GROUP SAN DIEGO OPERS	8808 BALBOA AVE	SAN DIEGO CA 92123
24931	SPECIALTY CONNECTOR CO INC	2620 ENDRESS PLACE P O BOX D	GREENWOOD IN 46142
27014	NATIONAL SEMICONDUCTOR CORP	2900 SEMICONDUCTOR DR	SANTA CLARA CA 95051
31433	UNION CARBIDE CORP ELECTRONICS DIV	PO BOX 5928	GREENVILLE SC 29606
32997	BOURNS INC TRIMPOT DIV	1200 COLUMBIA AVE	RIVERSIDE CA 92507
51642	CENTRE ENGINEERING INC	2820 E COLLEGE AVE	STATE COLLEGE PA 16801
52763	STETTNER ELECTRONICS INC	6135 AIRWAYS BLVD PO BOX 21947	CHATTANOOGA TN 37421
56289	SPRAGUE ELECTRIC CO	87 MARSHALL ST	NORTH ADAMS MA 01247
57668	ROHM CORP	16931 MILLIKEN AVE	IRVINE CA 92713
59660	TUSONIX INC	2155 N FORBES BLVD	TUCSON, ARIZONA 85705
71400	MCGRAM-EDISON CO BUSSMANN MFG DIV	502 EARTH CITY PLAZA P O BOX 14460	ST LOUIS MO 63178
73138	BECKMAN INSTRUMENTS INC HELIPOT DIV	2500 HARBOR BLVD	FULLERTON CA 92634
74970	JOHNSON E F CO	299 10TH AVE S W	MASECA MN 56093
76854	OAK SWITCH SYSTEMS INC SUB OF OAK TECHNOLOGY INC	100 S MAIN ST	CRYSTAL LAKE IL 60014
80009	TEKTRONIX INC	4900 S W GRIFFITH DR P O BOX 500	BEAVERTON OR 97077
91637	DALE ELECTRONICS INC	P O BOX 609	COLUMBUS NE 68601
S0545	NIPPON ELECTRIC CO LTD		TOKYO JAPAN



Replaceable Electrical Parts  
P6046 Probe and Amplifier

Component No.	Tektronix Part No.	Serial/Assembly No. Effective Dscont	Name & Description	Mfr. Code	Mfr. Part No.
A1	670-0160-03	8437	CIRCUIT BD ASSY:MAIN	80009	670-0160-03
C2	281-0670-00		CAP,FXD,CER DI:1.8PF,+/-0.1PF,500V	52763	2R0PLZ007 1P808C
C10	281-0670-00		CAP,FXD,CER DI:1.8PF,+/-0.1PF,500V	52763	2R0PLZ007 1P808C
C101	295-0111-00		CAP SET,MATCHED:(2) 0.01UF,MATCHED 1% (C101 AND C201 FURNISHED AS A MATCHED PAIR)	80009	295-0111-00
C106	283-0158-00		CAP,FXD,CER DI:1PF,+/-0.1PF,50V	51642	100-050-NP0-109B
C107	-----		(PART OF E.C. BOARD)		
C109	283-0158-00		CAP,FXD,CER DI:1PF,+/-0.1PF,50V	51642	100-050-NP0-109B
C113	283-0157-00		CAP,FXD,CER DI:7PF,5%,50V	05397	C315C70905G5CA
C122	283-0185-00	6934	CAP,FXD,CER DI:2.5PF,0.5%,50V	51642	100-050-NP0-259B
C131	283-0154-00		CAP,FXD,CER DI:22PF,5%,50V	04222	SR155A220JAA
C144	283-0159-00		CAP,FXD,CER DI:18PF,5%,50V	04222	SR155A180JAA
C144	283-0168-00	6812	CAP,FXD,CER DI:12PF,5%,100V	05397	C315C120J1G5CA
C149	283-0156-00		CAP,FXD,CER DI:0.001 UF,+80-20%,200V	05397	C315C102Z2R5CA
C149	283-0176-00	6902	CAP,FXD,CER DI:0.0022UF,20%,50V	04222	SR205C222MAA
C150	283-0156-00		CAP,FXD,CER DI:0.001 UF,+80-20%,200V	05397	C315C102Z2R5CA
C155	281-0123-00		CAP,VAR,CER DI:5-25PF,100V	59660	518-000A5-25
C159	283-0156-00		CAP,FXD,CER DI:0.001 UF,+80-20%,200V	05397	C315C102Z2R5CA
C161	283-0156-00		CAP,FXD,CER DI:0.001 UF,+80-20%,200V	05397	C315C102Z2R5CA
C167	283-0156-00		CAP,FXD,CER DI:0.001 UF,+80-20%,200V	05397	C315C102Z2R5CA
C201	295-0111-00		CAP SET,MATCHED:(2) 0.01UF,MATCHED 1% (C101 AND C201 FURNISHED AS A MATCHED PAIR)	80009	295-0111-00
C206	283-0158-00		CAP,FXD,CER DI:1PF,+/-0.1PF,50V	51642	100-050-NP0-109B
C209	281-0124-00		CAP,VAR,PLASTIC:0.4-2.0PF,400V	80009	281-0124-00
C209	281-0138-00	6812	CAP,VAR,PLASTIC:0.4-1.2PF,600V	74970	273-0001-007
C222	283-0156-00		CAP,FXD,CER DI:0.001 UF,+80-20%,200V	05397	C315C102Z2R5CA
C245	-----		(PART OF E.C. BOARD)		
C246	283-0160-00		CAP,FXD,CER DI:1.5PF,+/-0.1PF,50V (ADDED IF NECESSARY)	51642	100050NP0159B
C261	283-0156-00		CAP,FXD,CER DI:0.001 UF,+80-20%,200V	05397	C315C102Z2R5CA
C302	290-0393-00		CAP,FXD,ELCTLT:110UF,10%,75V	56289	109D117X9075M2
C303	290-0393-00		CAP,FXD,ELCTLT:110UF,10%,75V	56289	109D117X9075M2
C307	283-0000-00		CAP,FXD,CER DI:0.001UF,+100-0%,500V	59660	831-610-Y5U0102P
C322	290-0246-00		CAP,FXD,ELCTLT:3.3UF,10%,15V	12954	D3R3EA15K1
C324	290-0327-00		CAP,FXD,ELCTLT:0.56UF,20%,100V	05397	T110A564M100A5
C325	290-0392-00		CAP,FXD,ELCTLT:3.6UF,10%,125V	56289	109D365X9125C2
C332	290-0394-00		CAP,FXD,ELCTLT:160UF,10%,50V	56289	109D167X9050M2
C333	290-0272-00		CAP,FXD,ELCTLT:47UF,20%,50V	56289	109D476X0050F2
C342	290-0246-00		CAP,FXD,ELCTLT:3.3UF,10%,15V	12954	D3R3EA15K1
C344	283-0047-00		CAP,FXD,CER DI:270PF,5%,500V	59660	831604Z5F0271J
C348	290-0391-00		CAP,FXD,ELCTLT:15UF,10%,30V	56289	109D156X9030C2
C400	283-0000-00		CAP,FXD,CER DI:0.001UF,+100-0%,500V	59660	831-610-Y5U0102P
C420	281-0617-00		CAP,FXD,CER DI:15PF,10%,200V	52763	2R0PLZ007 15P0KC
C426	283-0067-00	6828	CAP,FXD,CER DI:0.001UF,10%,200V	59660	835-515-Y5E0102K
C429	281-0123-00		CAP,VAR,CER DI:5-25PF,100V (C429C ONLY)	59660	518-000A5-25
C429	281-0618-00	6828	CAP,FXD,CER DI:4.7PF,+/-0.5PF,500V (C429D ONLY)	52763	2R0PLZ007 4P700C
C445	283-0000-00		CAP,FXD,CER DI:0.001UF,+100-0%,500V	59660	831-610-Y5U0102P
C453	281-0615-00		CAP,FXD,CER DI:3.9PF,+/-0.5PF,200V	52763	2R0PLZ007 3P900C
C454	281-0123-00		CAP,VAR,CER DI:5-25PF,100V (C454A ONLY)	59660	518-000A5-25
C454	281-0657-00		CAP,FXD,CER DI:13PF,2%,500V (C454B ONLY)	52763	RDPL130GC0G
C454	281-0615-00	6906	CAP,FXD,CER DI:3.9PF,+/-0.5PF,200V (C454C ONLY)	52763	2R0PLZ007 3P900C
C454	281-0123-00		CAP,VAR,CER DI:5-25PF,100V (C454D ONLY)	59660	518-000A5-25
C456	283-0000-00		CAP,FXD,CER DI:0.001UF,+100-0%,500V	59660	831-610-Y5U0102P

Replaceable Electrical Parts  
P6046 Probe and Amplifier

Component No.	Tektronix Part No.	Serial/Assembly No. Effective Dscont	Name & Description	Mfr. Code	Mfr. Part No.
C458	281-0123-00		CAP,VAR,CER DI:5-25PF,100V	59660	518-000A5-25
C459	281-0653-00	7339	CAP,FXD,CER DI:3.3PF,4%,200V	52763	2RDPLZ007 3P30FC
C463	283-0000-00		CAP,FXD,CER DI:0.001UF,+100-0%,500V	59660	831-610-Y5U0102P
C472	281-0610-00	6828	CAP,FXD,CER DI:2.2PF,+/-0.1PF,500V	52763	2RDPLZ007 2P208C
C473	283-0000-00		CAP,FXD,CER DI:0.001UF,+100-0%,500V	59660	831-610-Y5U0102P
C479	281-0610-00		CAP,FXD,CER DI:2.2PF,+/-0.1PF,500V	52763	2RDPLZ007 2P208C
C489	281-0657-00		CAP,FXD,CER DI:13PF,2%,500V	52763	RDPL130GCOG
C491	283-0010-00		CAP,FXD,CER DI:0.05UF,+80-20%,50V	04222	SR305E503ZAA
C494	290-0273-00		CAP,FXD,ELCTLT:68UF,10%,60V	56289	109D686X9060T2
C497	283-0026-00		CAP,FXD,CER DI:0.2UF,+80-20%,25V	31433	C330C204M5R5CA
C499	283-0026-00		CAP,FXD,CER DI:0.2UF,+80-20%,25V	31433	C330C204M5R5CA
C502	283-0000-00		CAP,FXD,CER DI:0.001UF,+100-0%,500V	59660	831-610-Y5U0102P
C521	281-0123-00		CAP,VAR,CER DI:5-25PF,100V	59660	518-000A5-25
C534	281-0528-00		CAP,FXD,CER DI:82PF,+/-8.2PF,500V	59660	301-000U2M0820K
C556	283-0000-00		CAP,FXD,CER DI:0.001UF,+100-0%,500V	59660	831-610-Y5U0102P
D143	152-0141-02		SEMICON DVC,DI:SM,SI,30V,150MA,30V	03508	DA2527 (1N4152)
D243	152-0141-02		SEMICON DVC,DI:SM,SI,30V,150MA,30V	03508	DA2527 (1N4152)
D302	152-0107-00		SEMICON DVC,DI:RECT,SI,400 V,400MA,A1	12969	"G727"
D322	152-0127-00		SEMICON DVC,DI:ZEN,SI,7.5V,5%,0.4M,00-7	14433	Z5347 (1N958B)
D323	152-0141-02		SEMICON DVC,DI:SM,SI,30V,150MA,30V	03508	DA2527 (1N4152)
D332	152-0107-00		SEMICON DVC,DI:RECT,SI,400 V,400MA,A1	12969	"G727"
D342	152-0127-00		SEMICON DVC,DI:ZEN,SI,7.5V,5%,0.4M,00-7	14433	Z5347 (1N958B)
D405	152-0141-02		SEMICON DVC,DI:SM,SI,30V,150MA,30V	03508	DA2527 (1N4152)
D445	152-0055-00	6728	SEMICON DVC,DI:ZEN,SI,11V,5%,0.4M,00-7	14433	Z5407
D492	152-0241-00		SEMICON DVC,DI:ZEN,SI,33V,5%,0.4M,00-7	14552	1N9738
D499	152-0309-00		SEMICON DVC,DI:ZEN,SI,6.2V,5%,1M,A31A	04713	S114310(1N3828A)
D505	152-0141-02		SEMICON DVC,DI:SM,SI,30V,150MA,30V	03508	DA2527 (1N4152)
D532	152-0141-02		SEMICON DVC,DI:SM,SI,30V,150MA,30V	03508	DA2527 (1N4152)
F301	159-0020-00		FUSE,CARTRIDGE:8AG,0.25A,250V,0.1SEC	71400	AGX 1/4
F301	159-0052-00		FUSE,CARTRIDGE:3AG,0.125A,250V,0.1SEC	03614	AGC-CM-1/8
J150	136-0089-00		CONN,RCPT,ELEC:TYPE MS,9 CONT,FEMALE	02660	165-16
J489	131-0352-01		CONN,RCPT,ELEC:BNC,FEMALE	24931	2BJR119-1
L456	276-0528-00	7813	SHLD BEAD,ELEK:FERRAMIC	02114	56-0590-65C/38
L457	276-0528-00	6828	SHLD BEAD,ELEK:FERRAMIC	02114	56-0590-65C/38
Q113	153-0559-00		SEMICON DVC SE:MATCHED PAIR (Q113 & Q213 FURNISHED AS A MATCHED PAIR)	80009	153-0559-00
Q123	151-1017-00	7948	TRANSISTOR:FET,N-CHAN,SI,	22229	F1333
Q123	151-1017-01	7949	TRANSISTOR:FE,SI,N-CHANNEL	04713	MMT3823
Q124	151-0188-00		TRANSISTOR:PNP,SI,TO-92	80009	151-0188-00
Q134	153-0557-00	6811	TRANSISTOR:SELECTED	80009	153-0557-00
Q134	153-0565-00	6812	SEMICON DVC SE:MATCHED PAIR (Q134 & Q234 FURNISHED AS A MATCHED PAIR)	80009	153-0565-00
Q143	151-0206-00		TRANSISTOR:NPN,SI,U26	50545	Z5C288A
Q154	153-0554-00	6811	SEMICON DVC SE:MATCHED PAIR (Q254 & Q154 FURNISHED AS A MATCHED PAIR)	80009	153-0554-00
Q154	153-0566-00	6812	SEMICON DVC SE:MTCHD PAIR (Q254 & Q154 FURNISHED AS A MATCHED PAIR)	80009	153-0566-00
Q164	151-0220-00		TRANSISTOR:PNP,SI,TO-92	80009	151-0220-00
Q213	153-0559-00		SEMICON DVC SE:MATCHED PAIR (Q213 & Q113 FURNISHED AS A MATCHED PAIR)	80009	153-0559-00
Q224	153-0557-00	8513	TRANSISTOR:SELECTED	80009	153-0557-00
Q224	151-0190-00	8514	TRANSISTOR:NPN,SI,TO-92	80009	151-0190-00
Q234	153-0557-00	6811	TRANSISTOR:SELECTED	80009	153-0557-00
Q234	153-0565-00	6812	SEMICON DVC SE:MATCHED PAIR (Q234 & Q134 FURNISHED AS A MATCHED PAIR)	80009	153-0565-00
Q243	151-0206-00		TRANSISTOR:NPN,SI,U26	50545	Z5C288A
Q254	153-0554-00	6811	SEMICON DVC SE:MATCHED PAIR (Q254 & Q154 FURNISHED AS A MATCHED PAIR)	80009	153-0554-00
Q254	153-0566-00	6812	SEMICON DVC SE:MTCHD PAIR (Q254 & Q154 FURNISHED AS A MATCHED PAIR)	80009	153-0566-00

Replaceable Electrical Parts  
P6046 Probe and Amplifier

Component No.	Tektronix Part No.	Serial/Assembly No.		Name & Description	Mfr. Code	Mfr. Part No.
		Effective	Dscont			
Q264	151-0220-00			TRANSISTOR:PNP,SI,TO-92	80009	151-0220-00
Q304	151-0228-00			TRANSISTOR:PNP,SI,TO-105	07263	S21862
Q314	151-0188-00			TRANSISTOR:PNP,SI,TO-92	80009	151-0188-00
Q317	151-0190-00	7144	7816	TRANSISTOR:NPN,SI,TO-92	80009	151-0190-00
Q317	151-0190-02	7817		TRANSISTOR:NPN,SI,2N3904 FAMILY,TO-92	04713	SPS3319(2N3904)
Q324	151-0192-00			TRANSISTOR:SELECTED	04713	SPS8801
Q327	151-0210-00			TRANSISTOR:NPN,SI,TO-66	02735	39626
Q343	151-0192-00			TRANSISTOR:SELECTED	04713	SPS8801
Q344	151-0192-00			TRANSISTOR:SELECTED	04713	SPS8801
Q345	151-0192-00	7144		TRANSISTOR:SELECTED	04713	SPS8801
Q347	151-0148-00			TRANSISTOR:NPN,SI,TO-66	02735	2N4231A
Q413	151-0199-00			TRANSISTOR:PNP,SI,TO-92	27014	ST65057
Q424	151-0192-00			TRANSISTOR:SELECTED	04713	SPS8801
Q443	151-0198-00			TRANSISTOR:SELECTED	04713	SPS8802-1
Q454	151-0202-00			TRANSISTOR:PNP,SI,TO-72	04713	SS2025
Q463	151-0198-00			TRANSISTOR:SELECTED	04713	SPS8802-1
Q473	151-0221-00			TRANSISTOR:PNP,SI,TO-92	80009	151-0221-00
Q497	151-0192-00			TRANSISTOR:SELECTED	04713	SPS8801
Q513	151-0199-00			TRANSISTOR:PNP,SI,TO-92	27014	ST65057
Q524	151-0192-00			TRANSISTOR:SELECTED	04713	SPS8801
Q534	151-0190-00			TRANSISTOR:NPN,SI,TO-92	80009	151-0190-00
Q543	151-0198-00			TRANSISTOR:SELECTED	04713	SPS8802-1
Q554	151-0202-00			TRANSISTOR:PNP,SI,TO-72	04713	SS2025
R102	325-0029-00			RES,FXD,FILM:985K OHM,1%,0.05M,TC=TO,MET	80009	325-0029-00
R105	311-0614-00			RES,VAR,NONNM:TRMR,30K OHM,0.5M	32997	3329H-L58-303
R106	317-0391-00			RES,FXD,CMPSN:390 OHM,5%,0.125M	01121	BB3915
R109	317-0102-00			RES,FXD,CMPSN:1K OHM,5%,0.125M	01121	BB1025
R113	317-0301-00			RES,FXD,CMPSN:300 OHM,5%,0.125M	01121	BB3015
R114	317-0271-00			RES,FXD,CMPSN:270 OHM,5%,0.125M	01121	BB2715
R115	307-0127-01			RES,THERMAL:1K OHM,10%	14193	1D13
R117	325-0025-00			RES,FXD,FILM:3.16K OHM,1%,0.05M,TC=T9	03888	PME50E31600F
R120	311-0609-00			RES,VAR,NONNM:TRMR,2K OHM,0.5M	32997	3329H-L58-202
R121	317-0104-00			RES,FXD,CMPSN:100K OHM,5%,0.125M	01121	BB1045
R122	317-0823-00			RES,FXD,CMPSN:82K OHM,5%,0.125M	01121	BB8235
R124	317-0274-00			RES,FXD,CMPSN:270K OHM,5%,0.125M	01121	BB2745
R125	311-0660-00			RES,VAR,NONNM:TRMR,200K OHM,0.5M	32997	3329H-L58-204
R131	317-0270-00		6811	RES,FXD,CMPSN:27 OHM,5%,0.125M	01121	BB2705
R131	317-0390-00	6812		RES,FXD,CMPSN:39 OHM,5%,0.125M	01121	BB3905
R141	317-0183-00			RES,FXD,CMPSN:18K OHM,5%,0.125M	01121	BB1835
R142	317-0623-00			RES,FXD,CMPSN:62K OHM,5%,0.125M	01121	BB6235
R144	317-0430-00			RES,FXD,CMPSN:43 OHM,5%,0.125M	01121	BB4305
R146	325-0026-00			RES,FXD,FILM:180 OHM,1%,0.05M,TC=T9,MET	91637	CMF50-C180R0F
R147	325-0028-00		6834	RES,FXD,FILM:	80009	325-0028-00
R147	325-0041-00	6835		RES,FXD,FILM:19.75 OHM,1%,0.05M,TC=T2	91637	CMF50C19R75F
R154	317-0330-00			RES,FXD,CMPSN:33 OHM,5%,0.125M	01121	BB3305
R155	311-0622-00			RES,VAR,NONNM:TRMR,100 OHM,0.5M	32997	3329H-L58-101
R157	325-0031-00			RES,FXD,FILM:2.5K OHM,1%,0.05M,TC=TO,MET	91637	CMF50F25000F
R158	317-0242-00			RES,FXD,CMPSN:2.4K OHM,5%,0.125M	01121	BB2425
R159	317-0242-00			RES,FXD,CMPSN:2.4K OHM,5%,0.125M	01121	BB2425
R161	317-0201-00			RES,FXD,CMPSN:200 OHM,5%,0.125M	01121	BB2015
R164	325-0027-00			RES,FXD,FILM:93 OHM,1%,0.5M,TC=T9,METAL	91637	CMF50C93R00F
R167	317-0101-00			RES,FXD,CMPSN:100 OHM,5%,0.125M	01121	BB1015
R168	317-0512-00			RES,FXD,CMPSN:5.1K OHM,5%,0.125	01121	BB5125
R169	317-0153-00			RES,FXD,CMPSN:15K OHM,5%,0.125M	01121	BB1535
R202	325-0029-00			RES,FXD,FILM:985K OHM,1%,0.05M,TC=TO,MET	80009	325-0029-00
R206	317-0391-00			RES,FXD,CMPSN:390 OHM,5%,0.125M	01121	BB3915
R209	311-0609-00			RES,VAR,NONNM:TRMR,2K OHM,0.5M	32997	3329H-L58-202
R217	325-0025-00			RES,FXD,FILM:3.16K OHM,1%,0.05M,TC=T9	03888	PME50E31600F
R221	317-0622-00			RES,FXD,CMPSN:6.2K OHM,5%,0.125M	01121	BB6225

Replaceable Electrical Parts  
P6046 Probe and Amplifier

Component No.	Tektronix Part No.	Serial/Assembly No. Effective	Dscont	Name & Description	Mfr. Code	Mfr. Part No.
R222	317-0622-00			RES,FXD,CMPSN:6.2K OHM,5%,0.125M	01121	B86225
R224	308-0462-00			RES,FXD,MM:2.4K OHM,1%,0.5M	00213	500S-2R400F
R231	317-0270-00		6811	RES,FXD,CMPSN:27 OHM,5%,0.125M	01121	B82705
R231	317-0390-00	6812		RES,FXD,CMPSN:39 OHM,5%,0.125M	01121	B83905
R234	325-0030-00			RES,FXD,FILM:150K OHM,1%,0.05M,TC=TO,MET	19701	5023RD150K0F
R235	311-0660-00			RES,VAR,NONMM:TRMR,200K OHM,0.5M	32997	3329H-L58-204
R236	317-0683-00			RES,FXD,CMPSN:68K OHM,5%,0.125M	01121	B86835
R241	317-0183-00			RES,FXD,CMPSN:18K OHM,5%,0.125M	01121	B81835
R242	317-0623-00			RES,FXD,CMPSN:62K OHM,5%,0.125M	01121	B86235
R246	325-0026-00			RES,FXD,FILM:180 OHM,1%,0.05M,TC=T9,MET	91637	CMF50-C180R0F
R247	325-0028-00		6834	RES,FXD,FILM:	80009	325-0028-00
R247	325-0041-00	6835		RES,FXD,FILM:19.75 OHM,1%,0.05M,TC=T2	91637	CMF50D19R75F
R257	325-0031-00			RES,FXD,FILM:2.5K OHM,1%,0.05M,TC=TO,MET	91637	CMF50F25000F
R261	317-0201-00			RES,FXD,CMPSN:200 OHM,5%,0.125M	01121	B82015
R264	325-0027-00			RES,FXD,FILM:93 OHM,1%,0.5M,TC=T9,METAL	91637	CMF50C93R00F
R302	315-0104-00			RES,FXD,FILM:100K OHM,5%,0.25M	57668	NTR25J-E100K
R303	315-0104-00			RES,FXD,FILM:100K OHM,5%,0.25M	57668	NTR25J-E100K
R304	315-0681-00			RES,FXD,FILM:680 OHM,5%,0.25M	57668	NTR25J-E680E
R305	316-0100-00	7144		RES,FXD,CMPSN:10 OHM,10%,0.25M	01121	CB1001
R306	321-0380-00			RES,FXD,FILM:88.7K OHM,1%,0.125M,TC=TO	07716	CEAD88701F
R307	321-0293-00			RES,FXD,FILM:11.0K OHM,1%,0.125M,TC=TO	07716	CEAD11001F
R308	315-0103-00			RES,FXD,FILM:10K OHM,5%,0.25M	19701	5043CX10K00J
R309	315-0433-00			RES,FXD,FILM:43K OHM,5%,0.25M	19701	5043CX43K00J
R310	315-0205-00	7144		RES,FXD,FILM:2M OHM,5%,0.25M	01121	CB2055
R316	316-0102-00	7144		RES,FXD,CMPSN:1K OHM,10%,0.25M	01121	CB1021
R317	316-0332-00	7144		RES,FXD,CMPSN:3.3K OHM,10%,0.25M	01121	CB3321
R318	316-0102-00	7144		RES,FXD,CMPSN:1K OHM,10%,0.25M	01121	CB1021
R319	307-0107-00	7144		RES,FXD,CMPSN:5.6 OHM,5%,0.25M	01121	CB5665
R321	315-0823-00			RES,FXD,FILM:82K OHM,5%,0.25M	57668	NTR25J-E82K
R323	316-0102-00	7144		RES,FXD,CMPSN:1K OHM,10%,0.25M	01121	CB1021
R324	321-0634-00			RES,FXD,FILM:84.65K OHM,0.25%,0.125M,TC=T2	19701	5033RC84K65C
R325	311-0635-00			RES,VAR,NONMM:TRMR,1K OHM,0.5M	32997	3329H-G48-102
R326	321-0274-00			RES,FXD,FILM:6.98K OHM,1%,0.125M,TC=TO	19701	5043ED6K980F
R344	315-0103-00			RES,FXD,FILM:10K OHM,5%,0.25M	19701	5043CX10K00J
R345	316-0102-00	7144		RES,FXD,CMPSN:1K OHM,10%,0.25M	01121	CB1021
R346	315-0203-00	7144		RES,FXD,FILM:20K OHM,5%,0.25M	57668	NTR25J-E 20K
R347	321-0267-00			RES,FXD,FILM:5.90K OHM,1%,0.125M,TC=TO	19701	5033ED5K900F
R348	311-0634-00			RES,VAR,NONMM:TRMR,500 OHM,0.5M	32997	3329H-L58-501
R349	321-0229-00			RES,FXD,FILM:2.37K OHM,1%,0.125M,TC=TO	19701	5043ED2K37F
R350	316-0100-00	7144		RES,FXD,CMPSN:10 OHM,10%,0.25M	01121	CB1001
R400	311-0604-00			RES,VAR,NONMM:PNL,250K OHM,0.5M	12697	381-CM40258
R401	321-0356-00			RES,FXD,FILM:49.9K OHM,1%,0.125M,TC=TO	19701	5033ED49K90F
R405	317-0183-00			RES,FXD,CMPSN:18K OHM,5%,0.125M	01121	B81835
R406	317-0202-00			RES,FXD,CMPSN:2K OHM,5%,0.125M	01121	B82025
R412	317-0111-00			RES,FXD,CMPSN:110 OHM,5%,0.125M	01121	B81115
R413	317-0470-00			RES,FXD,CMPSN:47 OHM,5%,0.125M	01121	B84705
R414	317-0510-00			RES,FXD,CMPSN:51 OHM,5%,0.125M	01121	B85105
R415	317-0512-00			RES,FXD,CMPSN:5.1K OHM,5%,0.125M	01121	B85125
R420	315-0911-00			RES,FXD,FILM:910 OHM,5%,0.25M	57668	NTR25J-E910E
R422	317-0240-00			RES,FXD,CMPSN:24 OHM,5%,0.125M	01121	B82405
R423	317-0300-00			RES,FXD,CMPSN:30 OHM,5%,0.125M	01121	B83005
R424	321-0115-00			RES,FXD,FILM:154 OHM,1%,0.125M,TC=TO	19701	5043ED154R0F
R425	315-0471-00		6811	RES,FXD,FILM:470 OHM,5%,0.25M	57668	NTR25J-E470E
R425	323-0183-00	6812		RES,FXD,FILM:787 OHM,1%,0.5M,TC=TO	19701	5053RD787R0F
R426	315-0331-00		6811	RES,FXD,FILM:330 OHM,5%,0.25M	57668	NTR25J-E330E
R428	317-0273-00			RES,FXD,CMPSN:27K OHM,5%,0.125M	01121	B82735
R429	321-0143-00			RES,FXD,FILM:301 OHM,1%,0.125M,TC=TO (R429A ONLY)	07716	CEAD301R0F
R429	321-0636-00			RES,FXD,FILM:100 OHM,0.5%,0.125M,TC=T2	91637	CMF55116D100R0D

Replaceable Electrical Parts  
P6046 Probe and Amplifier

Component No.	Tektronix Part No.	Serial/Assembly No. Effective	Dscont	Name & Description	Mfr. Code	Mfr. Part No.
R429	317-0820-00			(R429B ONLY) RES,FXD,CMPNS:82 OHM,5%,0.125M	01121	8B8205
R443	317-0621-00			(R429C ONLY) RES,FXD,CMPNS:620 OHM,5%,0.125M	01121	8B6215
R444	317-0470-00	6828	6827	RES,FXD,CMPNS:47 OHM,5%,0.125M	01121	8B4705
R444	317-0131-00			RES,FXD,CMPNS:130 OHM,5%,0.125M	01121	8B1315
R445	315-0162-00		6827	RES,FXD,FILM:1.6K OHM,5%,0.25M	19701	5043CX1K600J
R449	317-0220-00			RES,FXD,CMPNS:22 OHM,5%,0.125M	01121	8B2205
R450	311-0643-00			RES,VAR,NONNM:TRMR,50 OHM,0.5M	32997	3329H-L58-500
R451	317-0270-00			RES,FXD,CMPNS:27 OHM,5%,0.125M	01121	8B2705
R452	321-0164-00			RES,FXD,FILM:499 OHM,1%,0.125M,TC=TO	19701	5033ED499R0F
R453	317-0272-00			RES,FXD,CMPNS:2.7K OHM,5%,0.125M	01121	8B2725
R454	317-0201-00			RES,FXD,CMPNS:200 OHM,5%,0.125M (R454B ONLY)	01121	8B2015
R454	317-0220-00			RES,FXD,CMPNS:22 OHM,5%,0.125M (R454C ONLY)	01121	8B2205
R454	317-0910-00			RES,FXD,CMPNS:91 OHM,5%,0.125M (R454D ONLY)	01121	8B9105
R456	317-0300-00			RES,FXD,CMPNS:30 OHM,5%,0.125M	01121	8B3005
R457	321-0127-00			RES,FXD,FILM:205 OHM,1%,0.125M,TC=TO	07716	CEAD205R0F
R458	317-0201-00			RES,FXD,CMPNS:200 OHM,5%,0.125M	01121	8B2015
R459	321-0126-00			RES,FXD,FILM:200 OHM,1%,0.125M,TC=TO (R459A ONLY)	19701	5033ED200R0F
R459	321-0751-06			RES,FXD,FILM:50 OHM,0.25%,0.125M,TC=T9 (R459B ONLY)	91637	CMF55116C50R00C
R463	317-0332-00			RES,FXD,CMPNS:3.3K OHM,5%,0.125M	01121	8B3325
R466	317-0122-00			RES,FXD,CMPNS:1.2K OHM,5%,0.125M	01121	8B1225
R471	317-0301-00			RES,FXD,CMPNS:300 OHM,5%,0.125M	01121	8B3015
R473	315-0270-00	6812	6811	RES,FXD,FILM:27 OHM,5%,0.25M	19701	5043CX27R00J
R473	315-0430-00			RES,FXD,FILM:43 OHM,5%,0.25M	19701	5043CX43R00J
R476	315-0242-00			RES,FXD,FILM:2.4K OHM,5%,0.25M	57668	NTR25J-E02K4
R479	317-0430-00			RES,FXD,CMPNS:43 OHM,5%,0.125M	01121	8B4305
R480	311-0607-00			RES,VAR,NONNM:TRMR,10K OHM,0.5M	73138	82-25-2
R481	317-0392-00			RES,FXD,CMPNS:3.9K OHM,5%,0.125M	01121	8B3925
R483	317-0222-00			RES,FXD,CMPNS:2.2K OHM,5%,0.125M	01121	8B2225
R489	317-0270-00			RES,FXD,CMPNS:27 OHM,5%,0.125M	01121	8B2705
R492	315-0470-00			RES,FXD,FILM:47 OHM,5%,0.25M	57668	NTR25J-E47E0
R493	321-0327-00			RES,FXD,FILM:24.9K OHM,1%,0.125M,TC=TO	07716	CEAD24901F
R494	321-0328-00			RES,FXD,FILM:25.5K OHM,1%,0.125M,TC=TO	19701	5043ED25K50F
R495	315-0153-00			RES,FXD,FILM:15K OHM,5%,0.25M	19701	5043CX15K00J
R501	315-0682-00			RES,FXD,FILM:6.8K OHM,5%,0.25M	57668	NTR25J-E06K8
R502	315-0271-00			RES,FXD,FILM:270 OHM,5%,0.25M	57668	NTR25J-E270E
R513	317-0470-00			RES,FXD,CMPNS:47 OHM,5%,0.125M	01121	8B4705
R514	317-0510-00			RES,FXD,CMPNS:51 OHM,5%,0.125M	01121	8B5105
R515	317-0512-00			RES,FXD,CMPNS:5.1K OHM,5%,0.125	01121	8B5125
R522	317-0240-00			RES,FXD,CMPNS:24 OHM,5%,0.125M	01121	8B2405
R523	317-0300-00			RES,FXD,CMPNS:30 OHM,5%,0.125M	01121	8B3005
R524	321-0115-00			RES,FXD,FILM:154 OHM,1%,0.125M,TC=TO	19701	5043ED154R0F
R531	321-0641-00			RES,FXD,FILM:1.8K OHM,1%,0.125M,TC=TO	91637	MFF1816618000F
R532	321-0201-00			RES,FXD,FILM:1.21K OHM,1%,0.125M,TC=TO	19701	5043ED1K210F
R534	321-0300-00			RES,FXD,FILM:13.0K OHM,1%,0.125M,TC=TO	07716	CEAD13001F
R536	321-0122-00			RES,FXD,FILM:182 OHM,1%,0.125M,TC=TO	19701	5033ED182R0F
R543	317-0621-00			RES,FXD,CMPNS:620 OHM,5%,0.125M	01121	8B6215
R544	317-0470-00	6828	6827	RES,FXD,CMPNS:47 OHM,5%,0.125M	01121	8B4705
R544	317-0131-00			RES,FXD,CMPNS:130 OHM,5%,0.125M	01121	8B1315
R549	317-0220-00			RES,FXD,CMPNS:22 OHM,5%,0.125M	01121	8B2205
R550	311-1222-00			RES,VAR,NONNM:TRMR,100 OHM,0.5M	32997	3386F-T04-101
R551	317-0300-00			RES,FXD,CMPNS:30 OHM,5%,0.125M	01121	8B3005
R552	321-0164-00			RES,FXD,FILM:499 OHM,1%,0.125M,TC=TO	19701	5033ED499R0F
R554	315-0301-00			RES,FXD,FILM:300 OHM,5%,0.25M	57668	NTR25J-E300E

Replaceable Electrical Parts  
P6046 Probe and Amplifier

Component No.	Tektronix Part No.	Serial/Assembly No. Effective	Dscont	Name & Description	Mfr. Code	Mfr. Part No.
R555	311-1223-00			RES,VAR,NONMM:TRMR,250 OHM,0.5M	32997	3386F-T04-251
R556	317-0300-00			RES,FXD,CMPSN:30 OHM,5%,0.125M	01121	BB3005
R557	321-0127-00			RES,FXD,FILM:205 OHM,1%,0.125M,TC=TO	07716	CEAD205R0F
R558	321-0116-00			RES,FXD,FILM:158 OHM,1%,0.125M,TC=TO	07716	CEAD158R0F
R559	317-0201-00			RES,FXD,CMPSN:200 OHM,5%,0.125M (R559A ONLY)	01121	BB2015
R559	317-0510-00			RES,FXD,CMPSN:51 OHM,5%,0.125M (R559B ONLY)	01121	BB5105
SM101	-----			(SEE RMPL FOR REPLACEMENT PARTS)		
SM450	262-0823-00			SWITCH,WIRED:MVOLTS/DIV	80009	262-0823-00
SM450	260-0923-00			SWITCH,ROTARY:POWER & AMPL	76854	5-34741-411
T301	120-0543-00			XFMR,PMR,STPDN:	80009	120-0543-00

# REPLACEABLE MECHANICAL PARTS

## PARTS ORDERING INFORMATION

Replacement parts are available from or through your local Tektronix, Inc. Field Office or representative.

Changes to Tektronix instruments are sometimes made to accommodate improved components as they become available, and to give you the benefit of the latest circuit improvements developed in our engineering department. It is therefore important, when ordering parts, to include the following information in your order: Part number, instrument type or number, serial number, and modification number if applicable.

If a part you have ordered has been replaced with a new or improved part, your local Tektronix, Inc. Field Office or representative will contact you concerning any change in part number.

Change information, if any, is located at the rear of this manual.

### ITEM NAME

In the Parts List, an Item Name is separated from the description by a colon (:). Because of space limitations, an Item Name may sometimes appear as incomplete. For further Item Name identification, the U.S. Federal Cataloging Handbook H6-1 can be utilized where possible.

### FIGURE AND INDEX NUMBERS

Items in this section are referenced by figure and index numbers to the illustrations.

## INDENTATION SYSTEM

This mechanical parts list is indented to indicate item relationships. Following is an example of the indentation system used in the description column.

```

1 2 3 4 5           Name & Description
Assembly and/or Component
Attaching parts for Assembly and/or Component
    **** END ATTACHING PARTS ****
Detail Part of Assembly and/or Component
Attaching parts for Detail Part
    **** END ATTACHING PARTS ****
Parts of Detail Part
Attaching parts for Parts of Detail Part
    **** END ATTACHING PARTS ****
    
```

Attaching Parts always appear in the same indentation as the item it mounts, while the detail parts are indented to the right. Indented items are part of, and included with, the next higher indentation.

**Attaching parts must be purchased separately, unless otherwise specified.**

## ABBREVIATIONS

"	INCH	ELCTRN	ELECTRON	IN	INCH	SE	SINGLE END
#	NUMBER SIZE	ELEC	ELECTRICAL	INCAND	INCANDESCENT	SECT	SECTION
ACTR	ACTUATOR	ELCTLT	ELECTROLYTIC	INSUL	INSULATOR	SEMICOND	SEMICONDUCTOR
ADPTR	ADAPTER	ELEM	ELEMENT	INTL	INTERNAL	SHLD	SHIELD
ALIGN	ALIGNMENT	EPL	ELECTRICAL PARTS LIST	LPHLDR	LAMPHOLDER	SHLDR	SHOULDERED
AL	ALUMINUM	EQPT	EQUIPMENT	MACH	MACHINE	SKT	SOCKET
ASSEM	ASSEMBLED	EXT	EXTERNAL	MECH	MECHANICAL	SL	SLIDE
ASSY	ASSEMBLY	FIL	FILLISTER HEAD	MTG	MOUNTING	SLFLKG	SELF-LOCKING
ATTEN	ATTENUATOR	FLEX	FLEXIBLE	NIP	NIPPLE	SLVG	SLEEVING
AWG	AMERICAN WIRE GAGE	FLH	FLAT HEAD	NON WIRE	NOT WIRE WOUND	SPR	SPRING
BD	BOARD	FLTR	FILTER	OBD	ORDER BY DESCRIPTION	SQ	SQUARE
BRKT	BRACKET	FR	FRAME or FRONT	OD	OUTSIDE DIAMETER	SST	STAINLESS STEEL
BRS	BRASS	FSTNR	FASTENER	OVH	OVAL HEAD	STL	STEEL
BRZ	BRONZE	FT	FOOT	PH BRZ	PHOSPHOR BRONZE	SW	SWITCH
BSHG	BUSHING	FXD	FIXED	PL	PLAIN or PLATE	T	TUBE
CAB	CABINET	GSKT	GASKET	PLSTC	PLASTIC	TERM	TERMINAL
CAP	CAPACITOR	HDL	HANDLE	PN	PART NUMBER	THD	THREAD
CER	CERAMIC	HEX	HEXAGON	PNH	PAN HEAD	THK	THICK
CHAS	CHASSIS	HEX HD	HEXAGONAL HEAD	PWR	POWER	TNSN	TENSION
CKT	CIRCUIT	HEX SOC	HEXAGONAL SOCKET	RCPT	RECEPTACLE	TPG	TAPPING
COMP	COMPOSITION	HLCPS	HELICAL COMPRESSION	RES	RESISTOR	TRH	TRUSS HEAD
CONN	CONNECTOR	HLEXT	HELICAL EXTENSION	RGD	RIGID	V	VOLTAGE
COV	COVER	HV	HIGH VOLTAGE	RLF	RELIEF	VAR	VARIABLE
CPLG	COUPLING	IC	INTEGRATED CIRCUIT	RTNR	RETAINER	W/	WITH
CRT	CATHODE RAY TUBE	ID	INSIDE DIAMETER	SCH	SOCKET HEAD	WSHR	WASHER
DEG	DEGREE	IDNT	IDENTIFICATION	SCOPE	OSCILLOSCOPE	XFMR	TRANSFORMER
DWR	DRAWER	IMPLR	IMPELLER	SCR	SCREW	XSTR	TRANSISTOR

CROSS INDEX - MFR. CODE NUMBER TO MANUFACTURER

Mfr. Code	Manufacturer	Address	City, State, Zip Code
00779	AMP INC	P O BOX 3608	HARRISBURG PA 17105
02114	AMPEREX ELECTRONIC CORP FERROXCUBE DIV	5083 KINGS HWY	SAUGERTIES NY 12477
02660	BUNKER RAMO CORP AMPHENOL NORTH AMERICA DIV	2801 S 25TH AVE	BROADVIEW IL 60153
02768	ILLINOIS TOOL WORKS INC FASTEX DIVISION	195 ALGONQUIN ROAD	DES PLAINES IL 60016
04811	PRECISION COIL SPRING CO	10107 ROSE ST P O BOX 5450	EL MONTE CA 91734
05820	EG AND G MAKEFIELD ENGINEERING	60 AUDUBON RD	MAKEFIELD MA 01880
06950	VSI CORP SCREMCORP DIVISION	13001 E TEMPLE AVE	CITY OF INDUSTRY CA 91746
12327	FREEMAY CORP	9301 ALLEN DR	CLEVELAND OH 44125
18203	ENGELMANN MICROMAVE CO	SKYLINE DRIVE	MONTVILLE NJ 07045
22526	DU PONT E I DE NEMOURS AND CO INC DU PONT CONNECTOR SYSTEMS	30 HUNTER LANE	CAMP HILL PA 17011
24931	SPECIALTY CONNECTOR CO INC	2620 ENDRESS PLACE P O BOX 0	GREENWOOD IN 46142
28520	HEYCO MOLDED PRODUCTS	147 MICHIGAN AVE P O BOX 160	KENILWORTH NJ 07033
70318	ALLMETAL SCREW PRODUCTS CO INC	821 STEWART AVE	GARDEN CITY NY 11530
71785	TRM INC TRM CINCH CONNECTORS	1501 MORSE AVE	ELK GROVE VILLAGE IL 60007
73743	FISCHER SPECIAL MFG CO	446 MORGAN ST	CINCINNATI OH 45206
76854	OAK SWITCH SYSTEMS INC SUB OF OAK TECHNOLOGY INC	100 S MAIN ST	CRYSTAL LAKE IL 60014
77900	SHAKEPROOF DIV OF ILLINOIS TOOL WORKS	SAINT CHARLES RD	ELGIN IL 60120
78189	ILLINOIS TOOL WORKS INC SHAKEPROOF DIVISION	ST CHARLES ROAD	ELGIN IL 60120
80009	TEKTRONIX INC	4900 S W GRIFFITH DR P O BOX 500	BEAVERTON OR 97077
83385	MICRODOT MANUFACTURING INC GREER-CENTRAL DIV	3221 W BIG BEAVER RD	TROY MI 48098
86928	SEASTROM MFG CO INC	701 SONORA AVE	GLENDALE CA 91201
93907	TEXTRON INC CAMCAR DIV	600 18TH AVE	ROCKFORD IL 61101
98278	MICRODOT MANUFACTURING INC MALCO SOUTH PASADENA DIV	220 PASADENA AVE	SOUTH PASADENA CA 91030
TK0435	LEMIS SCREM CO	4114 S PEORIA	CHICAGO IL 60609



Replaceable Mechanical Parts  
P6046 Probe and Amplifier

Fig. & Index No.	Tektronix Part No.	Serial/Assembly No.		Qty	12345	Name & Description	Mfr.	
		Effective	Dscont				Code	Mfr. Part No.
1-	010-0232-00		8512	1		PROBE,VOLTAGE:P6046,72.0 L,1 X M/ACCESS	80009	010-0232-00
	-----	8513		1		PROBE,VOLTAGE:P6046,72.0 L,10 X M/ACCESS		
-1	010-0213-00		8512	1		.PROBE,VOLTAGE:P6046,72.0 L,10 X M/ACCESS	80009	010-0213-00
	-----	8513		1		.PROBE,VOLTAGE:P6046,72.0 L,10 X M/ACCESS		
-2	015-0106-00			1		.POWER SUPPLY:M/AMPLIFIER	80009	015-0106-00

Replaceable Mechanical Parts  
P6046 Probe and Amplifier

Fig. & Index No.	Tektronix Part No.	Serial/Assembly No. Effective Dscont	Qty	12345 Name & Description	Mfr. Code	Mfr. Part No.
2-1	010-0213-00	8512	1	PROBE,VOLTAGE:P6046,72.0 L,10 X W/ACCESS	80009	010-0213-00
	-----	8513	1	PROBE,VOLTAGE:P6046,72.0 L,10 X W/ACCESS		
-2	010-0361-00		1	.ATTEN HD,PROBE:	80009	010-0361-00
	010-0419-00	8239	1	.ATTEN HD,PROBE:P6046 DUAL	80009	010-0419-00
	210-0997-00	8239	2	WASHER,FLAT:0.042 ID X 0.135 OD X 0.01	80009	210-0997-00
-3	206-0162-00		2	.TIP,PROBE:SNIVEL TYPE	80009	206-0162-00
	206-0164-00	6831	2	.TIP,PROBE:ADJUSTABLE TYPE,HEX	80009	206-0164-00
-4	214-0283-00		6	.CONTACT,ELEC:GROUNDING,CU BE GOLD PL	80009	214-0283-00
-5	131-0258-00		2	.CONN,RCPT,ELEC:TEST JACK	24931	33JR115-2
-6	344-0046-00		2	.CLIP,ELECTRICAL:ALLIGATOR,1.56 L,STL	80009	344-0046-00
-7	206-0163-00		2	.GROUND TIP ASSY:	80009	206-0163-00
-8	206-0114-00		2	.TIP,PROBE:HOOK	80009	206-0114-00
-9	166-0404-00	7009	2	.TUBE,INSULATOR:	80009	166-0404-00
	166-0404-01	7010	1	.COVER,GROUND:	80009	166-0404-01
-10				.LEAD,ELEC:STRD,24AMG,GRY VINYL,12.0L		
-11	175-0124-00		1	.LEAD,ELECTRICAL:STRD,36 AMG,GY VINYL,5.0L	80009	175-0124-00
	016-0111-00		1	.CASE,CRYG,PROBE:	80009	016-0111-00
	200-0372-00		4	.CAP,SCREW TIP:U/W#10 SCR THD,POLTHN	80009	200-0372-00

Replaceable Mechanical Parts  
P6046 Probe and Amplifier

Fig. & Index No.	Tektronix Part No.	Serial/Assembly No. Effective Dscont	Qty	12345	Name & Description	Mfr. Code	Mfr. Part No.
3-	010-0214-00		1		PROBE,VOLTAGE:P6046,PROBE ONLY	80009	010-0214-00
	-----	8513	1		PROBE,VOLTAGE:P6046,72.0 L,10 X W/ACCESS		
-1	206-0153-00		1		.TIP,PROBE:	80009	206-0153-00
	210-0504-00	7818	1		.NUT,PLAIN,HEX:0-80 X 0.156 HEX,BRS CD PL	80009	210-0504-00
	210-1037-00	7818	2		.WASHER,FLAT:0.068 ID X 0.175 OD X 0.01	80009	210-1037-00
					.PROBE TIP INCLUDES;		
-2	214-0948-00		1		..LEVER,SWITCH:	80009	214-0948-00
-3	214-0947-00		1		..SPRING,SM DTT:0.38 L X 0.01,SPR STL WIRE	04811	ORDER BY DESCR
-4	388-0872-00		1		..CIRCUIT BOARD:LEVER SWITCH	80009	388-0872-00
	200-1167-00	8437	1		..COVER,HT STAB:XSTR,2,TO-18	05820	259-18-40
-5	210-1037-00		1		..WASHER,FLAT:0.068 ID X 0.175 OD X 0.01	80009	210-1037-00
-6	213-0121-00		1	7817	..SCREW,MACHINE:0-80 X 0.094,PNH,SST	83385	ORDER BY DESCR
	211-0160-00	7818	1		..SCREW,MACHINE:0-80 X 0.188,FILH,SST	70318	ORDER BY DESCR
-7	211-0135-00		4		..SCREW,MACHINE:0-80 X 0.25,FLH,82 DEG,STL	83385	ORDER BY DESCR
-8	670-0160-00		1	8811	.CIRCUIT BD ASSY:CAPACITOR ROTOR	80009	670-0160-00
	670-0160-01	6812	1	8436	.CIRCUIT BD ASSY:MAIN AMPLIFIER	80009	670-0160-01
	670-0160-03	8437	1		.CIRCUIT BD ASSY:MAIN	80009	670-0160-03
	176-0121-00	8437	2		..WIRE,ELECTRICAL:20 AWG,BARE,12.0 L	80009	176-0121-00
-9	136-0252-00		39		..SOCKET,PIN TERM:U/W 0.019 DIA PINS	00779	2-330808-7
					..(ATTACHING PARTS FOR CKT BD)		
-10	211-0069-00		1		.SCREW,MACHINE:2-56 X 0.125,PNH,STL	TK0435	ORDER BY DESCR
					.(END ATTACHING PARTS)		
-11	670-0166-00		1		.CIRCUIT BD ASSY:SIMPLIFIER PLUG IN	80009	670-0166-00
-12	214-0946-00		1		.INSULATOR,PLATE:CIRCUIT BOARD,FISH PAPER	80009	214-0946-00
-13	204-0303-01		1	7817	.BODY HALF,PROBE:UPPER	80009	204-0303-01
	204-0303-04	7818	1	8512	.BODY HALF,PROBE:UPPER,W/HOLES,PLATED	80009	204-0303-04
	204-0303-08	8513	1		.BODY HALF,PROBE:UPPER,W/HOLES,PLATED	80009	204-0303-08
	204-0303-06	7818	1		.BODY HALF,PROBE:UPPER,W/PLUGS,PLATED	80009	204-0303-06
	348-0023-00	7818	4		.PLUG,HOLE:U/MO.14 DIA HOLE,MHT PLSTC	02768	207090201000101
-14	204-0307-00		1		.BODY HALF,PROBE:LOWER	80009	204-0307-00
					.(ATTACHING PARTS)		
-15	211-0034-00		4		.SCREW,MACHINE:2-56 X 0.5,PNH,STL	06950	ORDER BY DESCR
					.(END ATTACHING PARTS)		
-16	175-0477-00		1		.CABLE ASSY,RF:3,26 AWG,2,93 OHM COAX,72.0L	80009	175-0477-00
	015-0201-00		1		.TIP,PROBE:IC TEST	80009	015-0201-00

Replaceable Mechanical Parts  
P6046 Probe and Amplifier

Fig. & Index No.	Tektronix Part No.	Serial/Assembly No. Effective Dscont		Qty	12345 Name & Description	Mfr. Code	Mfr. Part No.
4-	015-0106-00			1	POWER SUPPLY:W/AMPLIFIER	80009	015-0106-00
	015-0115-00			1	..AMPLIFIER,DIFF:	80009	015-0115-00
-1	366-0322-01			1	..KNOB:CHAR,0.252ID X 0.87900 X 0.75H	80009	366-0322-01
-2	262-0823-00			1	..SWITCH,WIRED:MVOLTS/DIV	80009	262-0823-00
	260-0923-00			1	...SWITCH,ROTARY:POWER & AMPL	76854	5-34741-411
-3	670-0183-00			1	..CIRCUIT BD ASSY:COMPENSATION	80009	670-0183-00
-4	670-0184-00		6827	1	..CIRCUIT BD ASSY:INPUT	80009	670-0184-00
	670-0184-01	6828	8512	1	..CIRCUIT BD ASSY:INPUT	80009	670-0184-01
	670-0184-03	8513		1	..CIRCUIT BD ASSY:INPUT	80009	670-0184-03
-5	131-0371-00			5	..CONNECTOR,TERM:U/W 26 AWG WIRE	98278	122-0182-019
-6	136-0220-00			2	...SKT,PL-IN ELEK:TRANSISTOR 3 CONTACT	71785	133-23-11-034
-7	136-0235-00			3	..SKT,PL-IN ELEK:TRANSISTOR,6 CONTACT	71785	133-96-12-062
	276-0507-00	8513		2	...SHLD BEAD,ELEK:FERRITE	02114	56-590-658/38
-8	211-0079-00			1	..SCREW,MACHINE:2-56 X 0.188,PNH,STL	TK0435	5549-418
-9	129-0157-00			1	..SPACER,POST:0.23 L,2-56 THRU,AL,0.25 HEX	80009	129-0157-00
-10	210-0405-00			1	..NUT,PLAIN,HEX:2-56 X 0.188,BRS CD PL	73743	12157-50
-11	210-0840-00			1	..WASHER,FLAT:0.39 ID X 0.562 OD X 0.02,STL	86928	ORDER BY DESCR
-12	210-0590-00			1	..NUT,PLAIN,HEX:0.375-32 X 0.438 BRS CD PL	73743	28269-402
-13	366-0283-00			1	..KNOB:GY,0.125 ID X 0.312 OD X 0.562 H	80009	366-0283-00
-14	136-0089-00			1	..CONN,RCPT,ELEC:TYPE MS,9 CONT,FEMALE ..(ATTACHING PARTS)	02660	165-16
-15	211-0097-00			4	..SCREW,MACHINE:4-40 X 0.312,PNH,STL	TK0435	ORDER BY DESCR
-16	210-0201-00			1	..TERMINAL,LUG:0.12 ID,LOCKING,BRZ TIN PL	86928	A373-157-2
-17	210-0551-00			1	..NUT,PLAIN,HEX:4-40 X 0.25,ST CD PL	TK0435	ORDER BY DESCR
-18	210-0586-00			3	..NUT,PL,ASSEM MA:4-40 X 0.25,STL CD PL ..(END ATTACHING PARTS)	78189	211-041800-00
-19	670-0186-00			1	..CIRCUIT BD ASSY:OUTPUT	80009	670-0186-00
-20	136-0220-00			4	...SKT,PL-IN ELEK:TRANSISTOR 3 CONTACT	71785	133-23-11-034
-21	214-0506-00			15	...TERMINAL,PIN:0.375 L X 0.045 SQ,BRS	80009	214-0506-00
-22	211-0008-00			4	..SCREW,MACHINE:4-40 X 0.25,PNH,STL	93907	ORDER BY DESCR
-23	131-0352-01			1	..CONN,RCPT,ELEC:BNC,FEMALE	24931	28JR119-1
-24	210-0255-00			1	..TERMINAL,LUG:0.391 ID,LOCKING,BRS CD PL	12327	ORDER BY DESCR
-25	333-1050-00			1	..PANEL,FRONT:	80009	333-1050-00
-26	386-1347-00			1	..SUBPANEL,FRONT:	80009	386-1347-00
-27	211-0538-00			4	..SCREW,MACHINE:6-32 X 0.312,FLH,100 DEG	93907	ORDER BY DESCR
-28	129-0149-00			2	..SPACER,POST:3.406 L,6-32 INT BOTH ENDS,AL	80009	129-0149-00
-29	129-0149-01			2	..SPACER,POST:3.407 L,6-32 INT BOTH ENDS,AL	80009	129-0149-01
-30	210-0006-00			4	..WASHER,LOCK:#6 INTL,0.018 THK,STL	77900	1206-00-00-0541C
-31	386-1348-00			1	..SUBPANEL,REAR: ..(ATTACHING PARTS)	80009	386-1348-00
-32	211-0538-00			4	..SCREW,MACHINE:6-32 X 0.312,FLH,100 DEG ..(END ATTACHING PARTS)	93907	ORDER BY DESCR
-33	358-0091-00			1	..BSHG,STRAIN RLF:U/W 0.19 OD CA,STRAIGHT	28520	1060 (SR 2M-4)BL
-34	380-0127-00			1	..HOUSING,AMPL:ALUMINUM	80009	380-0127-00
-35	386-1349-00			1	..PANEL,REAR: ..(ATTACHING PARTS)	80009	386-1349-00
-36	211-0101-00			2	..SCREW,MACHINE:4-40 X 0.25,FLH,100 DG,STL ..(END ATTACHING PARTS)	TK0435	ORDER BY DESCR
	015-0114-00			1	..POWER SUPPLY:	80009	015-0114-00
-37	175-0478-01			1	..CA ASSY,SP,ELEC:4,26 AWG,54.0 L	80009	175-0478-01
-38	200-0579-00			1	..CABLE NIP,ELEC:0.15 ID X 0.895 L,BLACK	80009	200-0579-00
-39	334-1177-00			1	..PLATE,IDENT:MKD POWER SUPPLY,FUSE ..(ATTACHING PARTS)	80009	334-1177-00
-40	211-0008-00			2	..SCREW,MACHINE:4-40 X 0.25,PNH,STL ..(END ATTACHING PARTS)	93907	ORDER BY DESCR
-41	200-0691-00			1	..COVER,PMR SPLY:PROBE	80009	200-0691-00
-42	407-0427-00			1	..BRACKET,XFMR:STEEL CD PL ..(ATTACHING PARTS)	80009	407-0427-00
-43	211-0541-00			4	..SCREW,MACHINE:6-32 X 0.25,FLH,100 DEG,STL ..(END ATTACHING PARTS)	TK0435	ORDER BY DESCR
-44	-----			2	..TRANSISTOR: ..(ATTACHING PARTS)		
-45	211-0038-00			2	..SCREW,MACHINE:4-40 X 0.312,FLH,STL	TK0435	ORDER BY DESCR
-46	358-0288-00			2	..INSULATOR,BSHG:0.115 ID X 0.28 OD X 0.145	80009	358-0288-00
-47	210-0261-00			1	..TERMINAL,LUG:0.14 ID,PLAIN,BRASS	80009	210-0261-00
-48	386-0143-00			1	..INSULATOR,PLATE:TRANSISTOR MICA ..(END ATTACHING PARTS)	80009	386-0143-00

Replaceable Mechanical Parts  
P6046 Probe and Amplifier

Fig. & Index No.	Tektronix Part No.	Serial/Assembly No.		Qty	12345	Name & Description	Mfr.		
		Effective	Dscont				Code	Mfr.	Part No.
4-	391-0067-00			1		..CLP, STRN RLF:BLK, PLSTC, 0.295X0.271X0.089	80009	391-0067-00	
-49	343-0158-00			1		..CLP, STRAIN RLF:RIGHT ANGLE, FEEDTHRU, PLSTC ..(ATTACHING PARTS)	80009	343-0158-00	
-50	211-0105-00			2		..SCREN, MACHINE:4-40 X 0.188, FLH, 100 DEG	TK0435	ORDER BY DESCR	
-51	210-0406-00			2		..NUT, PLAIN, HEX:4-40 X 0.188, BRS CD PL ..(END ATTACHING PARTS)	73743	12161-50	
-52	210-0259-00			1		..TERMINAL, LUG:0.099 ID, LOCKING, BRS CD PL ..(ATTACHING PARTS)	80009	210-0259-00	
-53	211-0073-00			1		..SCREN, MACHINE:2-56 X 0.218, FLH, SST	TK0431	ORDER BY DESCR	
-54	210-0405-00			1		..NUT, PLAIN, HEX:2-56 X 0.188, BRS CD PL ..(END ATTACHING PARTS)	73743	12157-50	
-55	352-0103-00			1		..FUSEHOLDER, BLK:3AG, 15A, 250V, ..(ATTACHING PARTS)	80009	352-0103-00	
-56	211-0021-00			1		..SCREN, MACHINE:4-40 X 1.25, PNH, STL	TK0435	ORDER BY DESCR	
	210-0054-00			1		..WASHER, LOCK:#4 SPLIT, 0.025 THK STL	78189	ORDER BY DESCR	
-57	210-0406-00			1		..NUT, PLAIN, HEX:4-40 X 0.188, BRS CD PL ..(END ATTACHING PARTS)	73743	12161-50	
-58	670-0187-00		7143	1		..CIRCUIT BD ASSY:REGULATOR	80009	670-0187-00	
	670-0187-01	7144		1		..CIRCUIT BD ASSY:REGULATOR	80009	670-0187-01	
-59	136-0220-00		7143	3		...SKT, PL-IN ELEK:TRANSISTOR 3 CONTACT	71785	133-23-11-034	
	136-0220-00	7144	7719	4		...SKT, PL-IN ELEK:TRANSISTOR 3 CONTACT	71785	133-23-11-034	
	136-0252-04	7720		12		...SOCKET, PIN TERM:U/M 0.016-0.018 DIA PINS	22526	75060-007	
	214-0506-00			7		...TERMINAL, PIN:0.375 L X 0.045 SQ, BRS	80009	214-0506-00	
-60	211-0504-00			2		..SCREN, MACHINE:6-32 X 0.250, PNH, STL	TK0435	ORDER BY DESCR	
-61	670-0185-00		7143	1		..CIRCUIT BD ASSY:REGULATOR	80009	670-0185-00	
	670-0185-01	7144		1		..CIRCUIT BD ASSY:REGULATOR	80009	670-0185-01	
-62	136-0220-00		7143	2		...SKT, PL-IN ELEK:TRANSISTOR 3 CONTACT	71785	133-23-11-034	
	136-0220-00	7144	7719	3		...SKT, PL-IN ELEK:TRANSISTOR 3 CONTACT	71785	133-23-11-034	
	136-0252-04	7720		9		...SOCKET, PIN TERM:U/M 0.016-0.018 DIA PINS	22526	75060-007	
-63	214-0506-00			9		...TERMINAL, PIN:0.375 L X 0.045 SQ, BRS	80009	214-0506-00	
-64	211-0504-00			2		..SCREN, MACHINE:6-32 X 0.250, PNH, STL	TK0435	ORDER BY DESCR	
-65	131-0371-00			17		..CONNECTOR, TERM:U/M 26 ANG WIRE	98278	122-0182-019	
-66	426-0307-01			1		..BASE, PMR SUPPLY:	80009	426-0307-01	
-67	334-2201-00			1		..PLATE, INSTR:MKD VOLTAGE INFO ..(ATTACHING PARTS)	80009	334-2201-00	
-68	213-0055-00			2		..SCREN, TPG, TF:2-32 X 0.188, TYPE B, PNH, STL ..(END ATTACHING PARTS)	93907	ORDER BY DESCR	
-69	377-0041-00			1		..INSR, ELEC CONN:0.936 OD X 0.25, BLACK	80009	377-0041-00	
-70	214-0078-00			2		..CONTACT, ELEC:1.395 X 0.359 X 0.067, BRASS	80009	214-0078-00	
-71	200-0185-00			1		..CONN BODY, RCPT:POWER RECPTACLE	80009	200-0185-00	
-72	129-0060-00			1		..CONTACT, ELEC:GROUNDING, STEEL	80009	129-0060-00	
-73	211-0015-00			1		..SCREN, MACHINE:4-40 X 0.5, RDH, STL	83385	ORDER BY DESCR	
STANDARD ACCESSORIES									
-74	011-0049-00		6901	1		..TERMN, COAXIAL:50 OHM, 5M, BNC	80009	011-0049-00	
	011-0049-01	6902		1		..TERMN, COAXIAL:50 OHM, 2M, BNC	18203	T132 06	
-75	012-0076-00			1		..CABLE ASSY, RF:50 OHM COAX, 20.0 L	80009	012-0076-00	
-76	014-0029-00			1		..HDM KIT, ELEC EQ:ACCESSORY HANGER	80009	014-0029-00	
	070-0756-00			1		..MANUAL, TECH:INSTRUCTION	80009	070-0756-00	

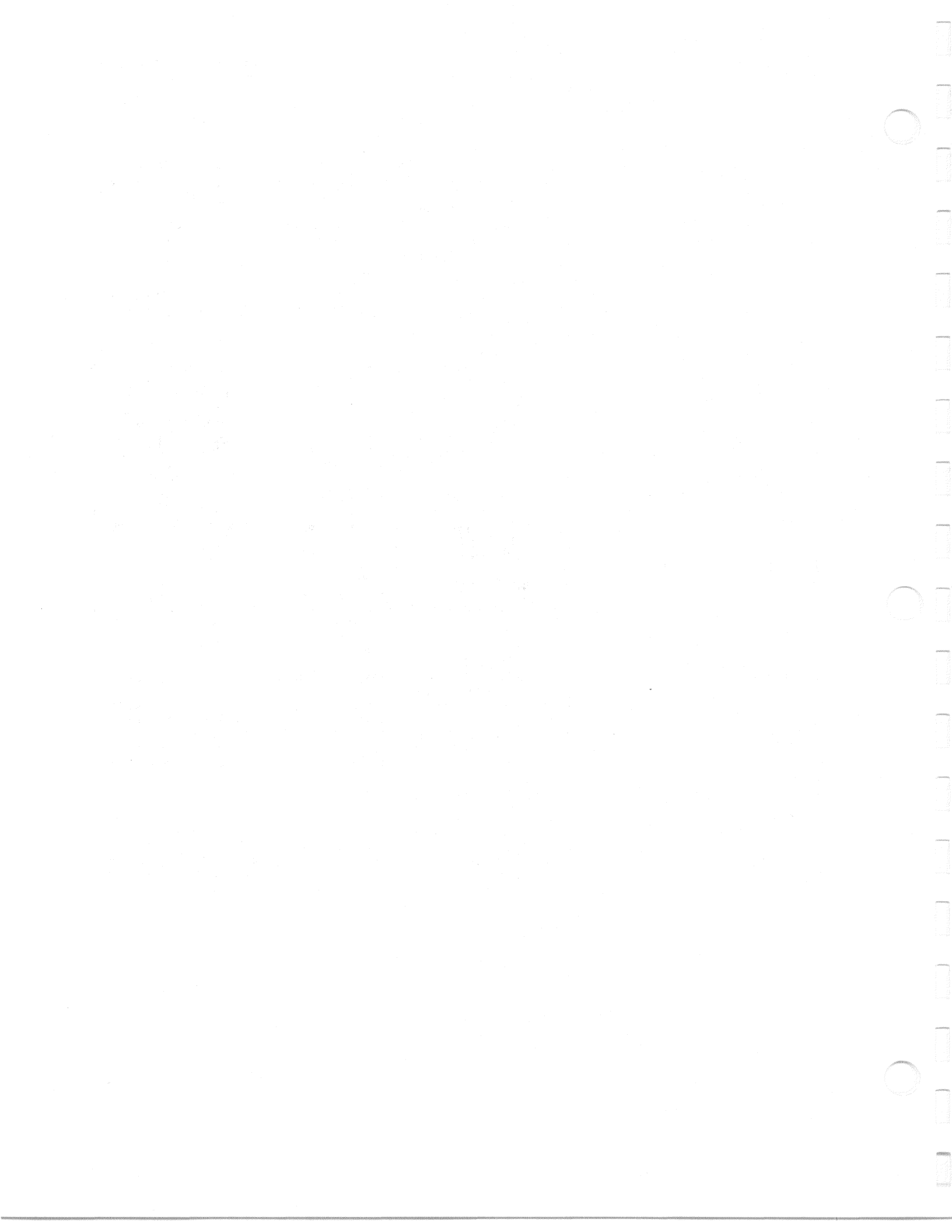

### VOLTAGE AND WAVEFORM INFORMATION FOR AMPLIFIER AND/OR PROBE

#### Basic Equipment Setup

**P6046 Probe:** Remove the top and bottom P6046 Probe body covers and connect a shorting strap between a front, center and a rear post. Follow the procedure given in the Maintenance section. Connect the Amphenol connector to either a Type 1A5 Plug-In Unit/Oscilloscope combination, or to an Amplifier For P6046.

**Amplifier For P6046:** Remove the covers from the Amplifier and its Power Supply unit. Connect the P6046 Probe to the Amplifier and connect the Power Supply Unit to an appropriate voltage source. Terminate the Amplifier's BNC connector with 50 Ω.

Warm up the equipment for at least 5 minutes. Then perform the Probe Step ATTN BAL adjustment at the Type 1A5 or at the Amplifier For P6046, as appropriate.

Voltage and waveforms are referenced to ground except where otherwise indicated. They may vary slightly between instruments, and are also dependent upon the test equipment used.

**NOTE**

The voltages and waveforms are affected by gain switching, and indicated values apply only under the specified conditions.

(Continued on AMPLIFIER  diagram)

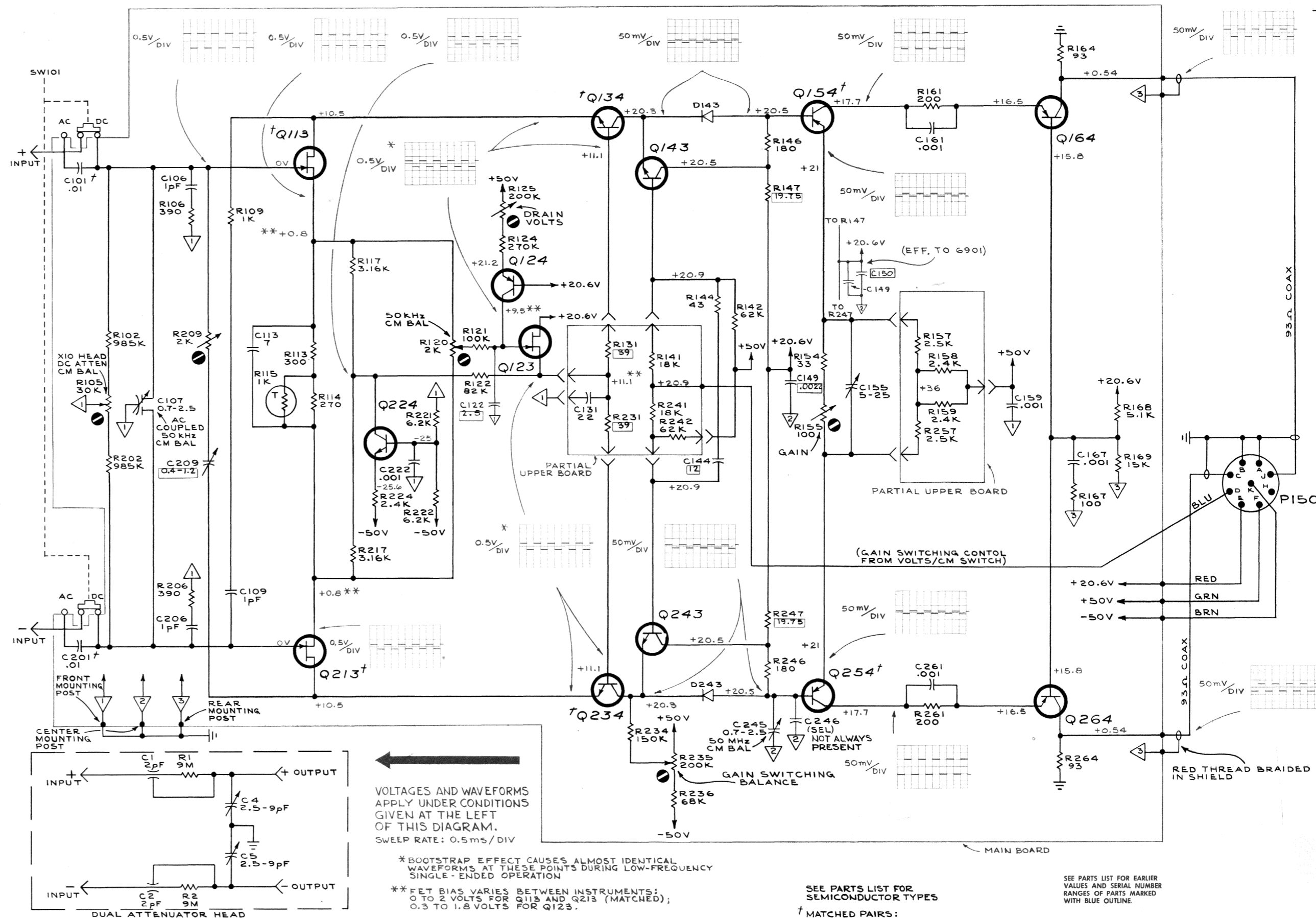

VOLTAGES AND WAVEFORMS APPLY UNDER CONDITIONS GIVEN AT THE LEFT OF THIS DIAGRAM. SWEEP RATE: 0.5ms/DIV

\* BOOTSTRAP EFFECT CAUSES ALMOST IDENTICAL WAVEFORMS AT THESE POINTS DURING LOW-FREQUENCY SINGLE-ENDED OPERATION  
 \*\* FET BIAS VARIES BETWEEN INSTRUMENTS: 0 TO 2 VOLTS FOR Q113 AND Q213 (MATCHED); 0.3 TO 1.8 VOLTS FOR Q123.

SEE PARTS LIST FOR SEMICONDUCTOR TYPES  
 † MATCHED PAIRS: Q113-Q213; Q134-Q234; Q154-Q254; C101-201

SEE PARTS LIST FOR EARLIER VALUES AND SERIAL NUMBER RANGES OF PARTS MARKED WITH BLUE OUTLINE.





(Continued from DIFFERENTIAL PROBE 1 diagram)

**Additional VOLTAGE Conditions**

No signal applied to the Probe. Vertical deflection factor of 50 mV selected at the Type 1A5, or 200 mV selected at the Amplifier For P6046. Voltages obtained with a non-loading voltmeter.

**Additional WAVEFORM conditions:**

A Tektronix C12 Camera System and Projected Graticule were used to photograph the time-related waveforms. Equipment setup follows:

P6046 Probe: Amphenol plug connected to an Amplifier For P6046  
 Amplifier waveforms: Amphenol plug connected to either an Amplifier For P6046 or to a Type 1A5 for P6046 Probe waveforms.

— Input contact grounded

**CAUTION**

Do not scratch or bend the switch input contacts.

1-V square wave from Oscilloscope Amplitude Calibrator applied to + Input contact

AC-DC switch set at DC

Type 1A5 (Amplifier For P6046 may be substituted for the Type 1A5 as the Probe power source.)

VOLTS/CM set at 200 mV

PROBE STEP ATTEN BAL adjustment performed

Amplifier For P6046 (Type 1A5 may be substituted for the Amplifier For P6046 as the power source for Probe waveform observation.)

mVOLTS/DIV set at 200

BNC output connector terminated with 50 Ω

ATTEN BAL adjustment performed

Test Oscilloscope

Vertical Deflection Factor: As indicated on each waveform

Horizontal Sweep Rate: 0.5 ms/div except as noted

Horizontal Triggering: Externally triggered by P6046 Probe input signal except as noted

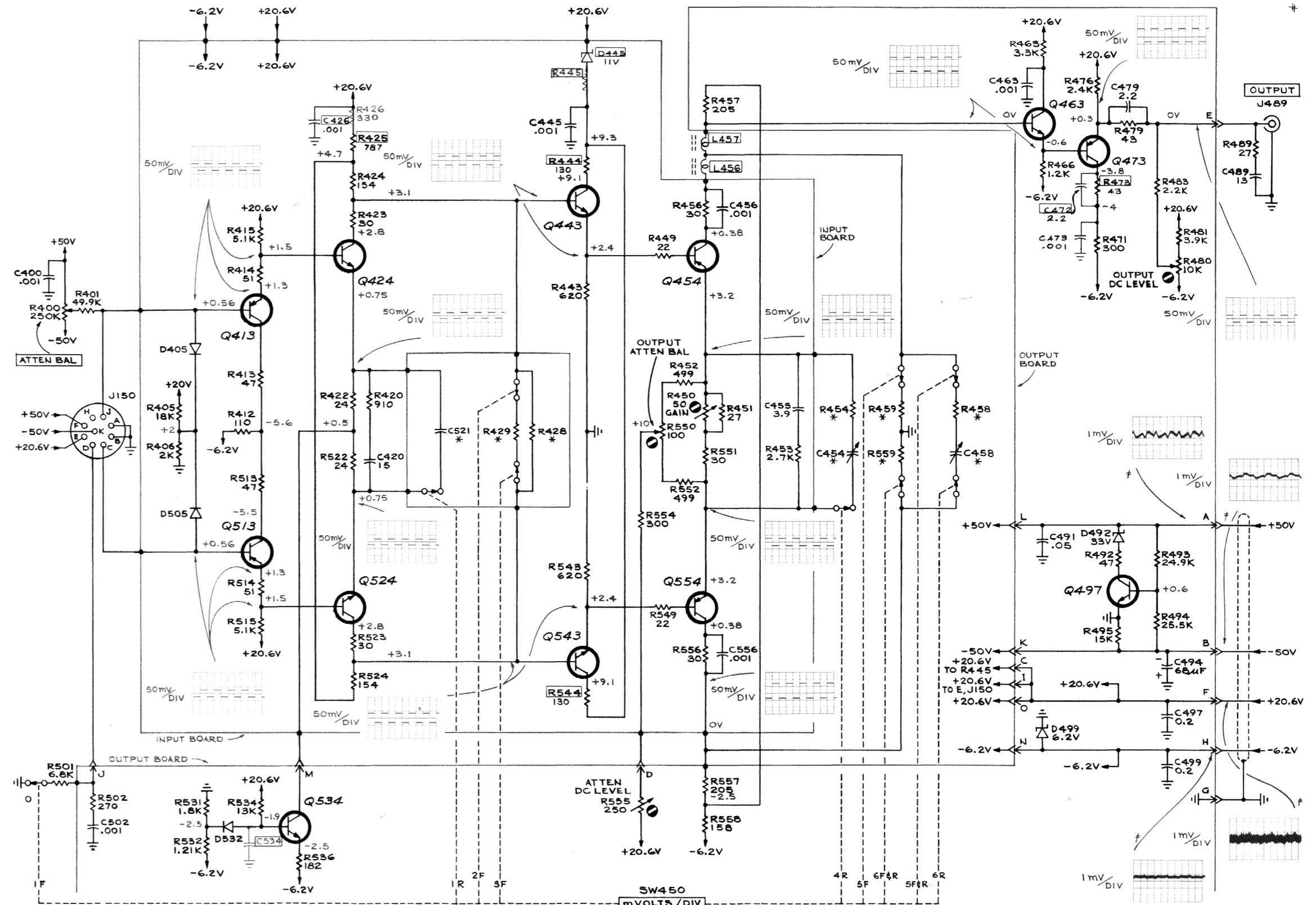

VOLTAGES AND WAVEFORMS APPLY UNDER CONDITIONS GIVEN AT THE LEFT OF THE PROBE DIAGRAM

SEE PARTS LIST FOR EARLIER VALUES AND SERIAL NUMBER RANGES OF PARTS MARKED WITH BLUE OUTLINE  
 \* NO SIGNAL INTO P6046 PROBE; LINE TRIGGERED 5ms/DIV HORIZONTAL SWEEP

\* FOR DETAILS SEE mVOLTS/DIV SWITCH DIAG

SEE PART LIST FOR SEMICONDUCTOR TYPES



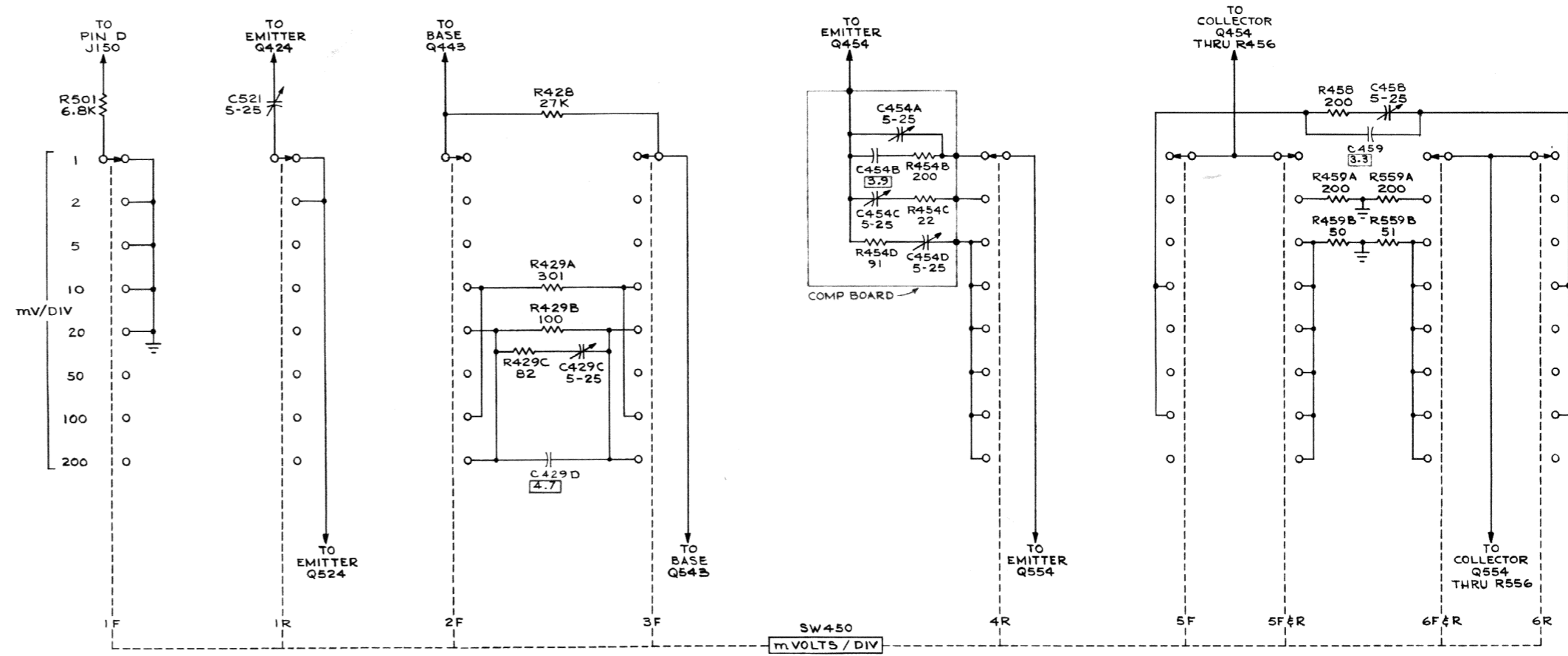

AMPLIFIER FOR P6046

SEE PARTS LIST FOR EARLIER VALUES AND SERIAL NUMBER RANGES OF PARTS MARKED WITH BLUE OUTLINE.

m VOLTS/DIV SWITCH 1073



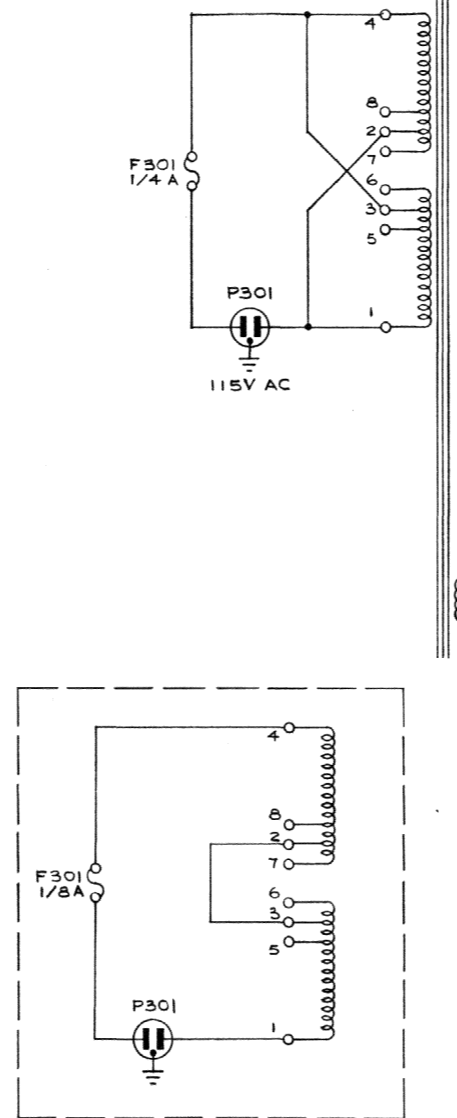

ALTERNATE T301 PRIMARY WIRING DIAGRAM—  
230 VAC OPERATION

AMPLIFIER FOR P6046

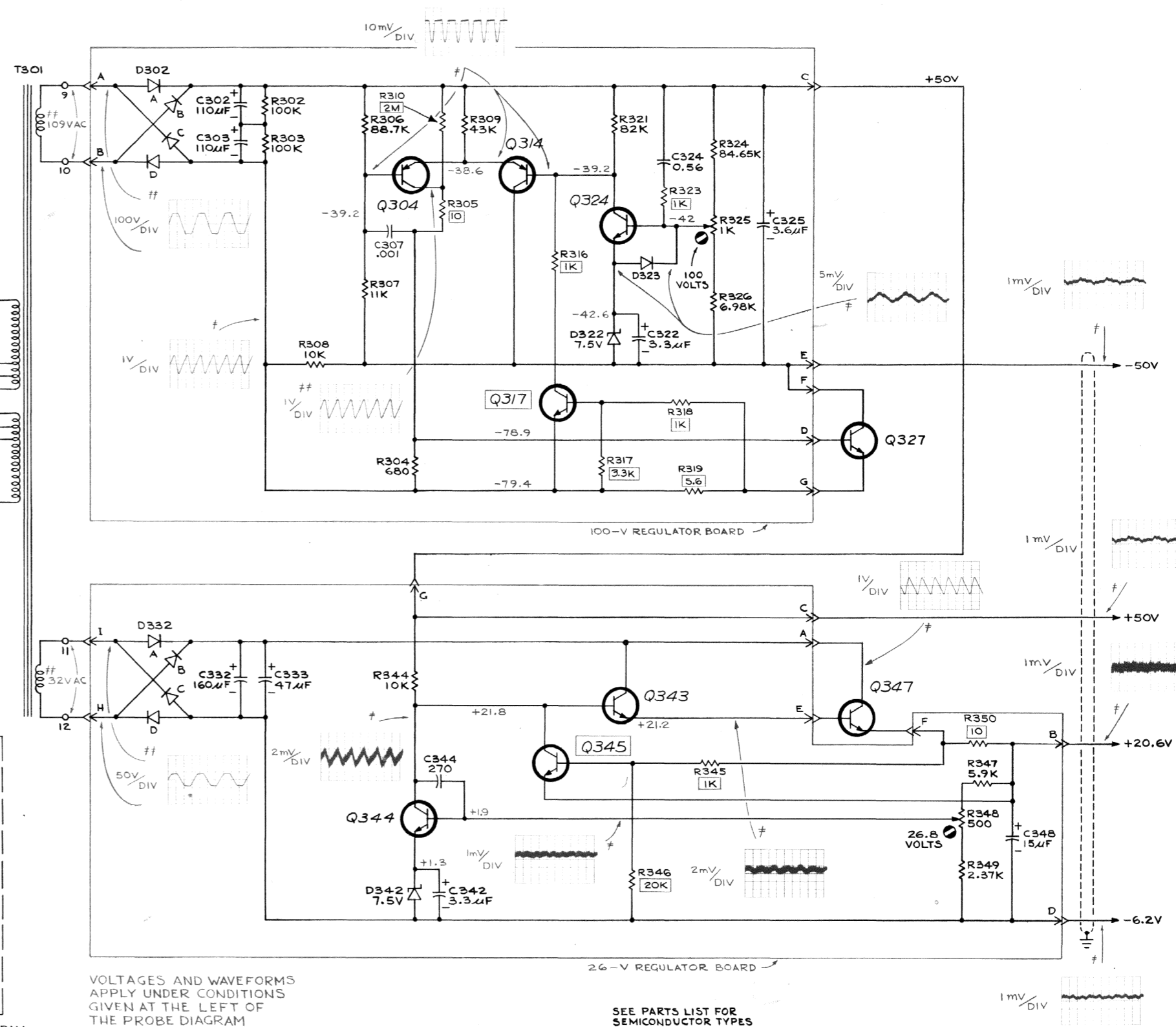

VOLTAGES AND WAVEFORMS  
APPLY UNDER CONDITIONS  
GIVEN AT THE LEFT OF  
THE PROBE DIAGRAM

# NO SIGNAL INTO P6046 PROBE; LINE TRIGGERED 5ms/DIV HORIZ SWEEP  
## DIFFERENTIAL MEASUREMENT BETWEEN POINTS INDICATED

SEE PARTS LIST FOR  
SEMICONDUCTOR TYPES

SEE PARTS LIST FOR EARLIER  
VALUES AND SERIAL NUMBER  
RANGES OF PARTS OUTLINED  
OR DEPICTED IN BLUE.

REV. C, JUN 1977

POWER SUPPLY MRH  
172



FIG. 1 P6046 PACKAGE W/AMPLIFIER & POWER SUPPLY

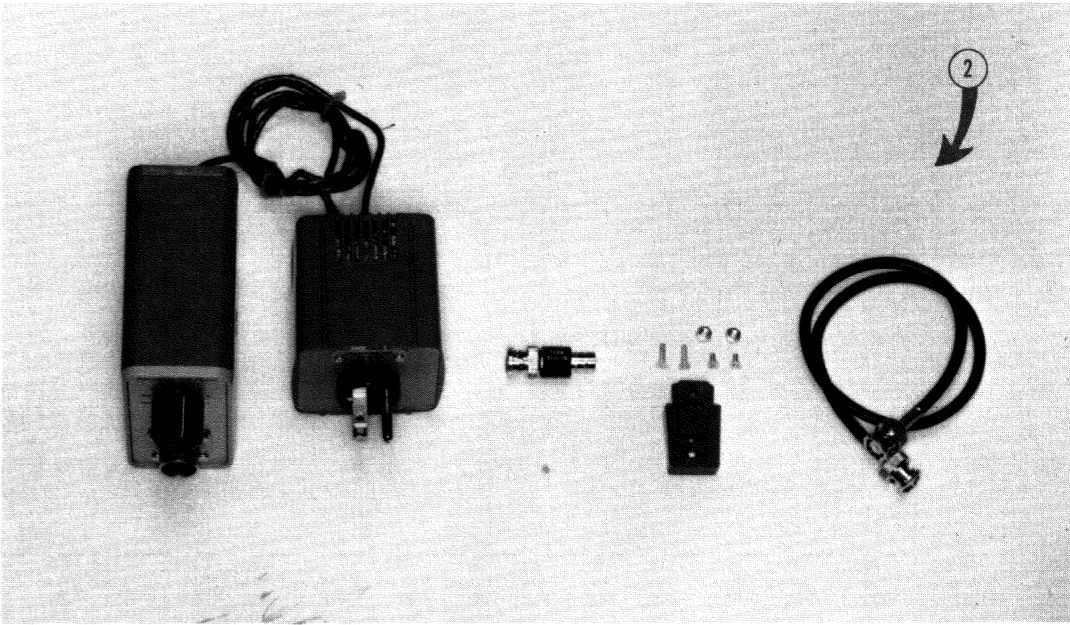
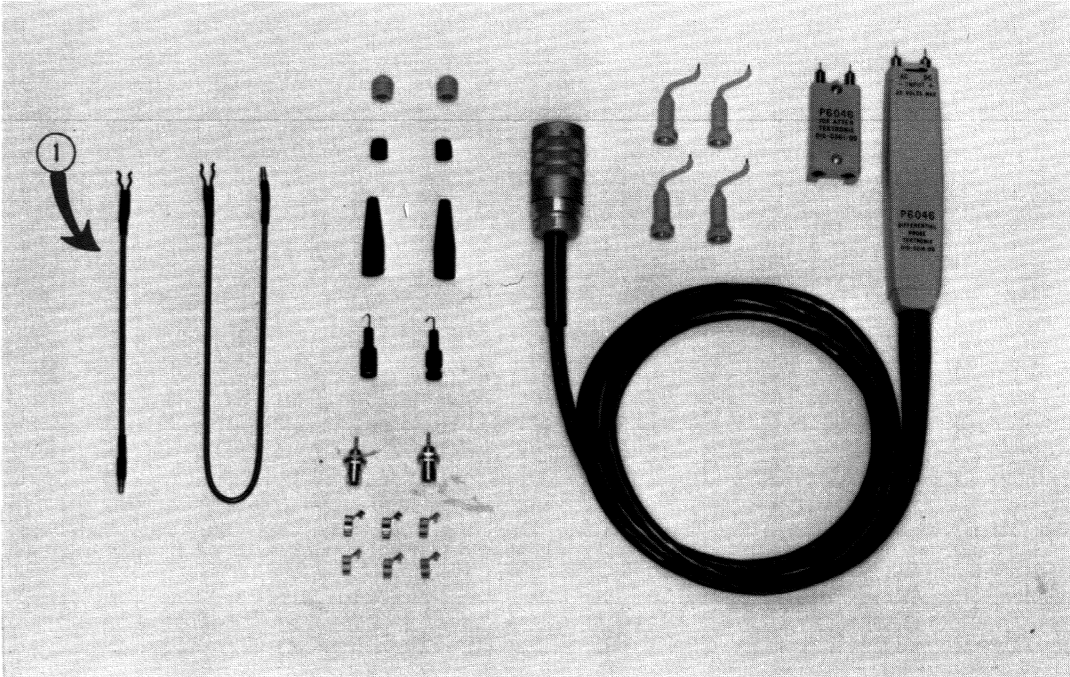





FIG. 2 P6046 PROBE PACKAGE (STANDARD ACCESSORIES)

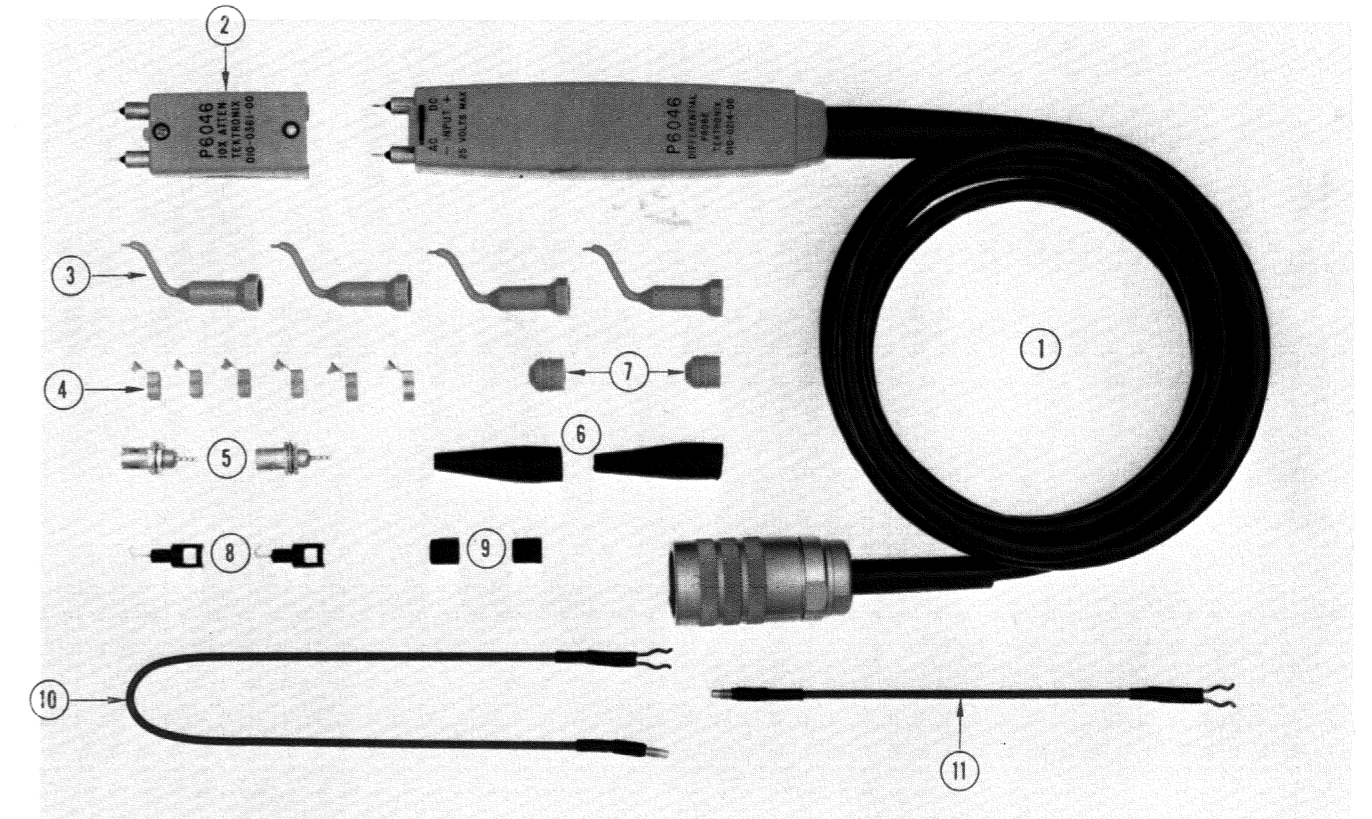



FIG. 3 P6046 PROBE MECHANICAL PARTS

+

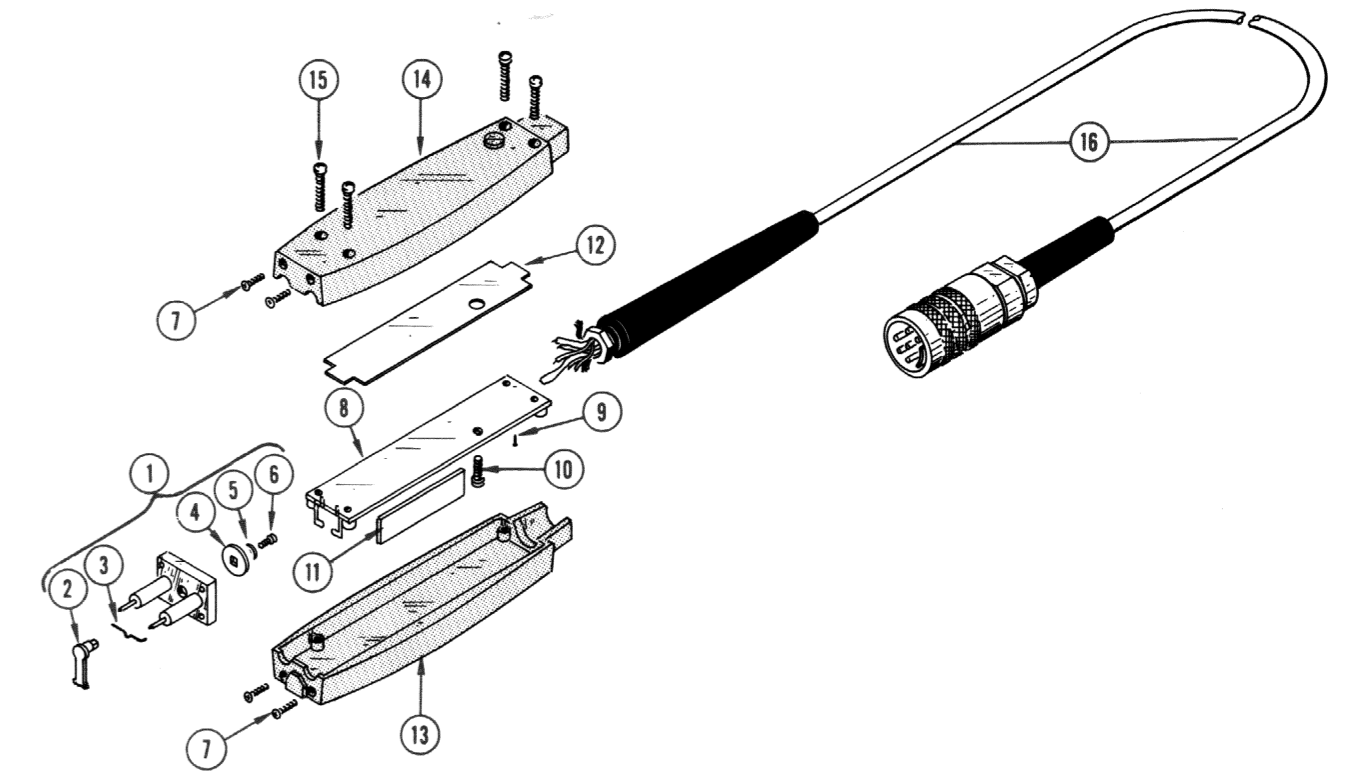



FIG. 4 AMPLIFIER & POWER SUPPLY MECHANICAL PARTS

