

HP 16515A/16516A

1 GHz TIMING ANALYZER MODULE
for THE HP 16500A LOGIC ANALYSIS SYSTEM

Front-panel Operation Reference



 HEWLETT
PACKARD

Front-Panel Operation Reference

HP 16515A/16516A
1 GHz Timing Analyzer Module
for the HP 16500A Logic Analysis System



© Copyright Hewlett Packard Company 1988

Manual Set Part Number 16515-90902
Microfiche Part Number 16515-90802

Printed in U.S.A June 1988

Printing History

First Edition - June 1988

Printed in U.S.A.

Product Warranty

This Hewlett-Packard product has a warranty against defects in material and workmanship for a period of 1 year from date of shipment. During warranty period, Hewlett-Packard Company will, at its option, either repair or replace products that prove to be defective.

For warranty service or repair, this product must be returned to a service facility designated by Hewlett-Packard. However, warranty service for products installed by Hewlett-Packard and certain other products designated by Hewlett-Packard will be performed at Buyer's facility at no charge within the Hewlett-Packard service travel area. Outside Hewlett-Packard service travel areas, warranty service will be performed at Buyer's facility only upon Hewlett-Packard's prior agreement and Buyer shall pay Hewlett-Packard's round trip travel expenses.

For products returned to Hewlett-Packard for warranty service, the Buyer shall prepay shipping charges to Hewlett-Packard and Hewlett-Packard shall pay shipping charges to return the product to the Buyer. However, the Buyer shall pay all shipping charges, duties, and taxes for products returned to Hewlett-Packard from another country.

Hewlett-Packard warrants that its software and firmware designated by Hewlett-Packard for use with an instrument will execute its programming instructions when properly installed on that instrument. Hewlett-Packard does not warrant that the operation of the instrument, software, or firmware will be uninterrupted or error-free.

Limitation of Warranty

The foregoing warranty shall not apply to defects resulting from improper or inadequate maintenance by the Buyer, Buyer-supplied software or interfacing, unauthorized modification or misuse, operation outside of the environmental specifications for the product, or improper site preparation or maintenance.

**NO OTHER WARRANTY IS EXPRESSED OR IMPLIED.
HEWLETT-PACKARD SPECIFICALLY DISCLAIMS THE IMPLIED
WARRANTIES OF MERCHANTABILITY AND FITNESS FOR A
PARTICULAR PURPOSE.**

Exclusive Remedies

THE REMEDIES PROVIDED HEREIN ARE BUYER'S SOLE AND EXCLUSIVE REMEDIES. HEWLETT-PACKARD SHALL NOT BE LIABLE FOR ANY DIRECT, INDIRECT, SPECIAL, INCIDENTAL, OR CONSEQUENTIAL DAMAGES, WHETHER BASED ON CONTRACT, TORT, OR ANY OTHER LEGAL THEORY.

Assistance

Product maintenance agreements and other customer assistance agreements are available for Hewlett-Packard products.

For assistance, contact your nearest Hewlett-Packard Sales and Service Office. Addresses are provided at the back of this operating manual.

Certification

Hewlett-Packard Company certifies that this product met its published specifications at the time of shipment from the factory. Hewlett-Packard further certifies that its calibration measurements are traceable to the United States National Bureau of Standards, to the extent allowed by the Bureau's calibration facility, and to the calibration facilities of other International Standards Organization members.

Safety

This product has been designed and tested according to International Safety Requirements. To ensure safe operation and to keep the product safe, the information, cautions, and warnings in this operating manual must be heeded.

Table of Contents

Introduction

Chapter 1: What is the HP 16515A/16516A?

- 1-1 Introduction
 - 1-1 Key Features
 - 1-2 Manuals Supplied
 - 1-3 Accessories Supplied
 - 1-4 Menus
-

Chapter 2: Probes

- 2-1 What Probes are Included?
- 2-2 Probe Assembly Identification
- 2-3 Identifying Cards and Probes
- 2-4 Labeling Pods
- 2-5 Connecting Probes to Your Target System
- 2-7 Signal Line Loading

Table of Contents (Continued)

Chapter 3:

Basic User Interface Information

- 3-1 User Interface Devices
 - 3-1 System Power Up
 - 3-2 Using the Touch Screen
 - 3-3 Module Menus
 - 3-5 Moving to the 1 GHz Timing Analyzer
 - 3-6 1 GHz Timing Analyzer Menus
 - 3-7 Data Entry Fields
 - 3-7 What's the Knob For?
 - 3-8 Using the Mouse
-

Chapter 4:

The Format Menu

- 4-1 Introduction
- 4-2 Format Menu Field Index
- 4-3 Format Menu Map
- 4-4 Format Menu Overview
- 4-5 Activity Indicators
- 4-6 Labels
 - 4-7 Turning Labels On
 - 4-8 Turning Labels Off
 - 4-9 Modifying Labels
- 4-10 Polarity
- 4-11 Pod and Channel Numbering
- 4-12 Assigning Input Channels to Labels
 - 4-12 Assigning Input Channels
 - 4-14 Unassigning Input Channels
- 4-15 Pod Threshold

Table of Contents (Continued)

Chapter 7:

Acquiring Data

- 7-1 Introduction
 - 7-1 Run/Stop Field
 - 7-3 Single Mode
 - 7-4 Repetitive Mode
 - 7-5 Cancel
 - 7-5 Reminder
-

Chapter 8:

The Waveforms Menu

- 8-1 Introduction
 - 8-2 Menu Area
 - 8-2 Waveforms Area
 - 8-3 Waveforms Menu Field Index
 - 8-4 Waveforms Menu Map
 - 8-5 Accumulate Field
 - 8-6 Sample Period
 - 8-7 s/Div Field
 - 8-8 Delay Field
-

Chapter 9:

Waveform Selection

- 9-1 Introduction
- 9-3 Waveform Selection Menu Map
- 9-4 Channel Mode
- 9-5 Replacing a Channel
- 9-8 Inserting a Channel
- 9-10 Deleting a Channel
- 9-11 Example
- 9-13 Inserting Waveforms from other Modules

Table of Contents (Continued)

Chapter 10:

Markers

- 10-1 Introduction
 - 10-1 Markers Field
 - 10-2 Markers Menu Map
 - 10-3 Selecting a Markers Function
 - 10-3 Markers Off
 - 10-4 Markers Time
 - 10-5 Markers Patterns
 - 10-7 Specifying Patterns
 - 10-7 Label Field
 - 10-8 The Base Field
 - 10-9 Entering/Leaving
 - 10-9 Pattern
 - 10-13 Stop Measurement
 - 10-17 X-Pattern from Trigger
 - 10-18 O-Pattern from Trigger/X Marker
 - 10-20 X to O Field
 - 10-21 Markers Statistics
-

Chapter 11:

Using the Timing Analyzer

- 11-1 Introduction
- 11-2 Problem Solving with the Timing Analyzer
 - 11-2 What Am I Going to Measure?
- 11-3 Connecting the Probes
 - 11-3 Activity Indicators
- 11-4 Configuring the Timing Analyzer
- 11-6 Specifying a Trigger Condition
- 11-7 Acquiring the Data
- 11-9 Configuring the Display
 - 11-9 Display Resolution
- 11-10 Making the Measurement
- 11-11 Finding the Answer

Table of Contents (Continued)

Chapter 12: Solving Intermittent Timing Problems

- 12-1 Introduction
 - 12-2 Problem Solving with the Timing Analyzer
 - 12-2 What Am I Going to Measure?
 - 12-2 Connecting the Probes
 - 12-3 Configuring the Timing Analyzer
 - 12-5 Specifying a Trigger Condition
 - 12-8 Specifying Patterns for the X and O Markers
 - 12-15 Specifying Waveforms
 - 12-16 Acquiring the Data
 - 12-18 Checking the Amount of Deviation in the Results
-

Chapter 13: Saving and Recalling Setups

- 13-1 Introduction
 - 13-1 Storing a Configuration
 - 13-6 Loading a Configuration
 - 13-8 Autoloading a Configuration
-

Chapter 14: Using a Printer

- 14-1 Setting Printer Configuration
- 14-1 Printing Options
- 14-2 Printing On-Screen Data

Table of Contents (Continued)

Appendix A:

Installing New Analyzer Boards into the Mainframe

- A-1 Introduction
- A-1 Initial Inspection
- A-1 Power Requirements
- A-2 Probe Assembly Installation
- A-2 Multiple Timing Analyzer Installation
- A-2 Installation
- A-3 Module Installation
- A-3 Installation Considerations
- A-3 Installation Procedure
- A-6 Adding an Expansion Card
- A-6 Installation Considerations
- A-6 Installation Procedure
- A-12 Operating Environment
- A-12 Storage
- A-13 Packaging
- A-13 Tagging for Service

Appendix B:

Specifications and Characteristics

- B-1 Specifications
- B-1 Characteristics
- B-7 General Characteristics

Index



Introduction

Welcome to the Hewlett Packard Logic Analysis System. The HP 16500A Logic Analysis System has been designed to be the easiest logic analyzer to use, ever. In addition, because of its configurable architecture, it can easily be tailored to your specific logic design and debug needs.

The user interface of the HP 16500A is designed to make its operation as intuitive as possible. Pop-up menus and color graphics lead you through setups and measurements step-by-step, eliminating the need to memorize a lot of steps. As you read this manual and the other manuals about the mainframe and acquisition modules, you will see just how easy the HP 16500A is to use.

The *HP 16515A/16516A 1 GHz Timing Analyzer Reference* manual is divided as follows:

- Chapter 1 contains introductory information about the timing analyzer features and accessories.
- Chapter 2 gives you information on how to hook up probes.
- Chapter 3 contains introductory information about the user interface.
- Chapters 4 through 6 give you information on how to set up the Format and Trace menus in preparation for making measurements.
- Chapters 8 through 12 provide information on viewing waveforms and making measurements on waveforms.
- Chapters 13 through Appendix B discuss other timing analyzer functions such as storing and recalling setups, printing on-screen data, specifications, etc.

If you aren't familiar with the HP 16515A/16A 1 GHz Timing Analyzer, we suggest you read the *HP 16515A/16A Getting Started Guide*. This guide contains tutorial examples on the basic functions of the 1 GHz timing analyzer.

If you are new to logic analyzers, or just need a refresher, we think you will find *Feeling Comfortable With Logic Analyzers* valuable reading. It will eliminate any misconceptions or confusion you may have about their application, and will show you how to get the most out of your new logic analyzer.

1

What is the HP 16515A/16516A?

Introduction

The HP 16515A/16516A module is a high-speed timing analyzer with up to a 1 GHz sample rate that plugs into the HP 16500A Logic Analysis System mainframe. The HP 16515A is the master card, offering the user a 1 GHz sample rate on 16 channels with 8k of memory per channel. The HP 16516A expansion card offers an additional 16 channels for a maximum of 32 channels per module set or 80 channels per HP 16500A (with the appropriate combination of HP 16515A and HP 16516A cards).

Key Features

The key features of the HP 16515A/16A are:

- 1 GHz sample rate
- 1 ns single-shot resolution
- 8k memory depth
- 16 channels per HP 16515A (master)
- 16 channels per HP 16516A (expansion)
- Up to 32 channels per module set
- Up to 80 channels per HP 16500A mainframe (with the appropriate combination of HP 16515A and HP 16516A cards)
- Time correlated measurements between modules using the intermodule bus
- Easy setup with full color touch screen or mouse
- Lightweight, passive probes
- ECL and TTL presets

- Pattern and edge triggering
 - Time measurement between X and O markers
 - Automatic pattern search
 - Statistical time-interval analysis
 - Delayed trigger
 - Store and recall configurations for fast setup
 - Print menus and waveform data for accurate documentation
-

Manuals Supplied

The following manuals are supplied with the HP 16515A/16A 1 GHz Timing Analyzer module:

- *HP 16515A/16516A Getting Started Guide* -- A tutorial for new and casual users.
- *HP 16515A/16516A Front-Panel Operation Reference manual* -- A complete operating manual for this module.
- *HP 16515A/16516A Programming Reference manual* -- A complete programming manual for this module.
- *HP 16515A/16516A Service Manual* -- A guide to troubleshooting and module-level repair.

Accessories Supplied

The following accessories are supplied with each HP 16515A and HP 16516A card. The probe assemblies listed below are already connected to the instrument when you receive it and exit out of the rear panel of the instrument. Rubber probe clips separate the probe assemblies into groups of eight. Each card (master and expansion) comes with:

- 16 - 5 ft probe assemblies with blue probe tips.
(HP part number 16515-61604)

Each card (master or expansion) comes with two bags of leads (HP part number 16515-69502), two bags of twenty grabbers (HP part number 5959-0288), and one pod identification label (HP part number 16500-94303). Each bag of leads contains:

- 8 - signal leads (blue)
- 8 - ground leads (black)

Menus

In the HP 16515A/16516A 1 GHz Timing Analyzer, similar functions are generally placed together under a single menu. The HP 16515A/16516A has three main menus:

- The **Format** menu, which is where you describe how the analyzer is connected to the system under test. This includes grouping channels into different labels, renaming labels, and setting the sampling threshold voltages for each pod (see chapters 4 and 5).

		1 GHz Timing D		Format		Print		Run	
		Pod D2		Pod D1		Pod C2		Pod C1	
		TTL		TTL		TTL		TTL	
Label		7.....0		7.....0		7.....0		7.....0	
		Symbols							
A	+
B	+

- The **Trace** menu, which is where you describe when and how the data will be acquired (see chapter 6). This is somewhat similar to setting the trigger level and slope on an oscilloscope.

1 GHz Timing D Trace Print Run

Label >	A	B	
Base >	Hex	Hex	
Find Pattern	Equal	XXXX	XXXX
Then find Edge	present for	>	16 ns
	

- The **Waveforms** menu, which is where the waveform data is displayed after the analyzer runs the measurement (see chapters 8 through 10).

1 GHz Timing D Waveforms Print Run

Accumulate Off Sample period = -----

s/Div Delay Markers
1.00 us 0 s Off

A	0
A	1
A	2
A	3
A	4
A	5
A	6
A	7
A	8
A	9
A	10
A	11
A	12
A	13
A	14
A	15



2

Probes

What Probes are Included?

The probe assemblies listed below are already connected to the module when you receive it and exit out of the rear panel of each card. Rubber probe clips (HP part number 16515-43102) separate the probe assemblies into groups of eight.

Each HP 16515A master card comes with the following:

- 16 - 1.52 m (5 ft) probe assemblies with blue tips.
(HP part number 16515-61604)
- Two - bags of leads.
(HP part number 16515-69502)
- Two - bags of twenty grabbers.
(HP part number 5959-0288)
- One - Pod Identification Label Set
(HP part number 16500-94303)

Each HP 16516A expansion card comes with the following:

- 16 - 1.52 m (5 ft) probe assemblies with blue tips.
(HP part number 16515-61604)
- Two - bags of leads.
(HP part number 16515-69502)
- Two - bags of twenty grabbers.
(HP part number 5959-0288)
- One - Pod Identification Label Set
(HP part number 16500-94303)

Each bag of leads contains the following:

- Eight - 51 mm (2 in.) signal leads (blue tip)
- Eight - 51 mm (2 in.) probe ground leads (black)

Probe Assembly Identification

The illustration shown below identifies the different probes and assemblies you use to connect to a test system.

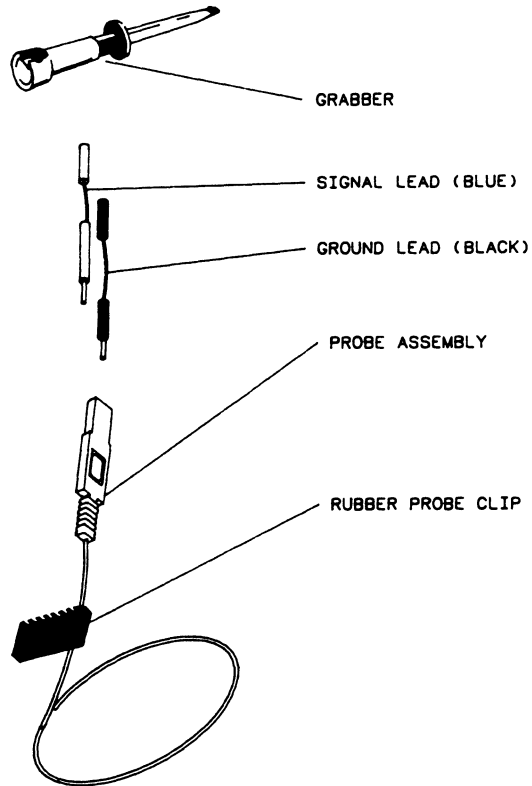

16515/EX40

Identifying Cards and Probes

On the upper-right corner of the rear panel of each master or expansion card is a label that identifies that card.

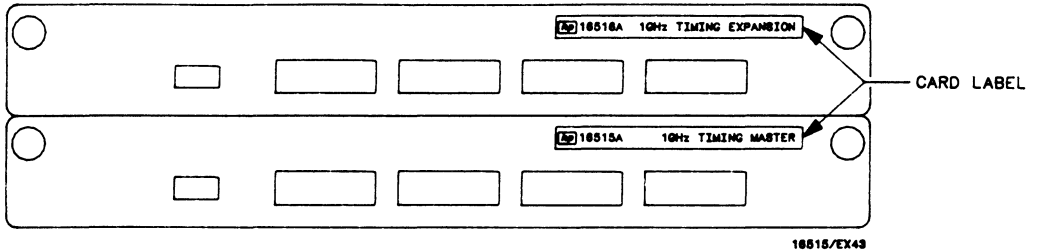

To identify each probe assembly, look at the rear panel of HP 16515A master or HP 16516A expansion card. The probe assemblies are identified on the rear panel according to both probe and pod number.

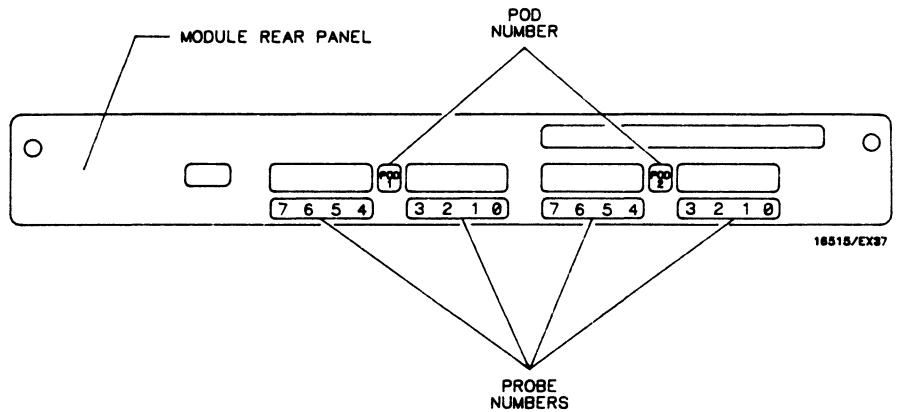

Starting from the far right of the rear panel of the card, probes 0 through 3 of pod 2 exit out of the first slot, probes 4 through 7 exit out of the next slot, and probes 0 through 7 of pod 1 exit out of the next two slots. The probes assemblies can also be identified by color coded labels on each probe tip.

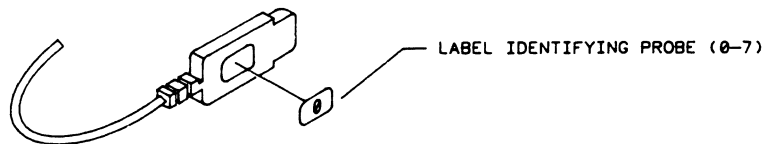

The letter displayed on screen with the pod number represents the slot in which the card is located. For example, if the master card was located in slot D of the mainframe, then the probes that exit out of the first two slots closest to the edge of the rear panel would be for pod D2. The probes that exit out of the third and fourth slots from the edge would be for pod D1.

Labeling Pods

To identify pods quickly and easily, color coded, self adhesive labels for you to attach to the rubber probe clips that separate the probe assemblies are included with each card. To label pods, identify each group of probe assemblies according to the pod number on the rear panel and the slot in which the card resides. Then remove the appropriate stick-on label provided and place it on the recessed area on the rubber probe clip closest to the probe tips. The brown labels are for pod 1 and the red labels are for pod 2. The other labels are not used for this module.

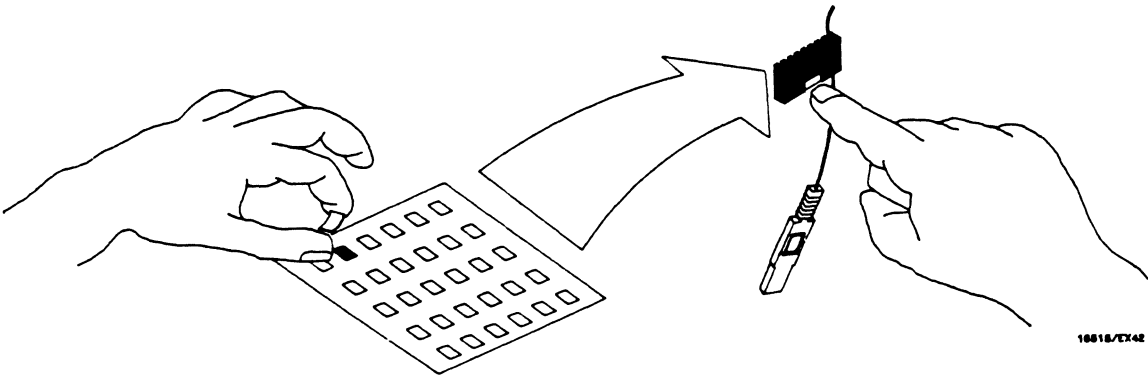

10018/EX4E

Connecting Probes to Your Target System

The individual probe ground and signal input of the probe assembly should be connected directly to the test points on the system under test. Since each probe assembly has a signal and ground recessed socket, it can be connected directly to square (0.63 mm) or round (0.66 mm) test points. The ground side of the probe assembly is identified by an embossed symbol (GND) on the probe body.

When the probe assembly cannot be connected directly to the test system, short leads are provided to connect the signal and ground sockets to the test points or to grabbers. The short blue lead incorporates a damping resistor and connects to the signal socket. The black lead connects to the ground socket (GND) of the probe assembly.

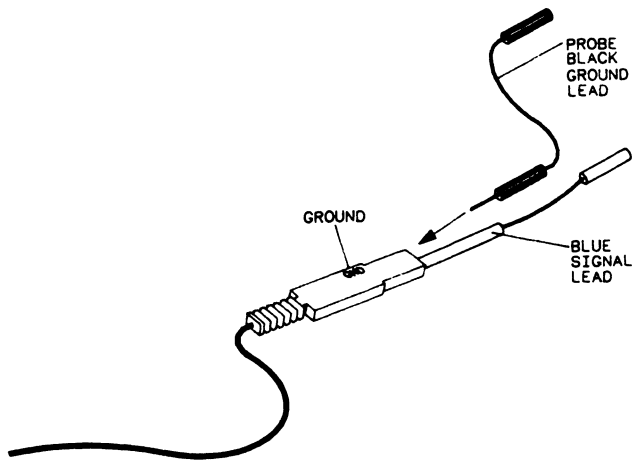

16518/EX41

The probe leads will connect directly to an IC clip or round pins with a diameter from 0.66 mm (0.026 in.) to 0.84 mm (0.033 in.).

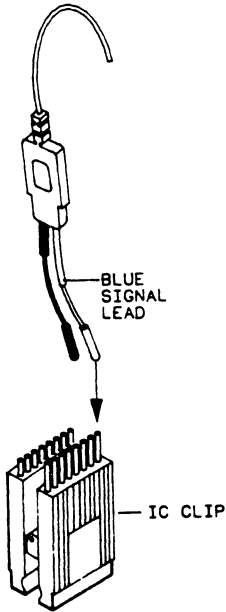

18515/EX38

You may also clip directly onto your circuit using the grabbers with the probes. To connect the grabbers to the probes, push the probe lead onto the pin in the head of the grabber.

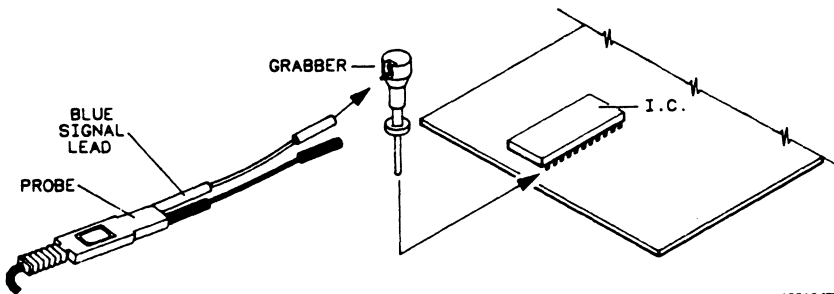

18515/EX44

The grabbers have a hook that fits around IC pins and component leads. To connect the grabber, push on the rear of the grabber to expose the hook, hook the test lead, and then release the rear of the grabber.

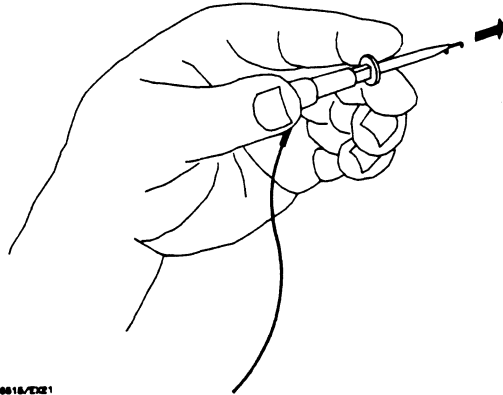

10816/10021

Signal Line Loading

Any signal line that you intend to connect to a probe must be able to supply a minimum of 500 mV to the probe tip, which has an input impedance of 10 k ohms shunted by 3 pF. If the signal line is not capable of this, you will not be able to make a reliable measurement and the module may load down the test system.

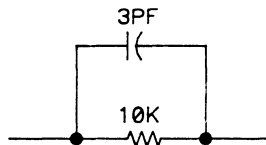

10515/10001



3

Basic User Interface Information

User Interface Devices

The HP 16500A has three user interface devices: the knob on the front panel, the touch-sensitive screen, and the optional mouse. If you are unfamiliar with any of these, read this chapter. It covers the basic concepts of their use. For more detailed information, refer to the *HP 16500A Reference Manual*.

System Power Up

When the HP 16500A system is powered up, the menu you see should look similar to the one shown below.

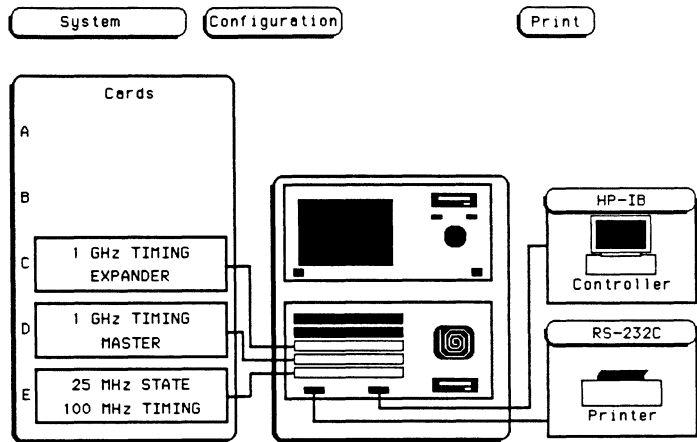

Using the Touch Screen

Any dark-blue field on screen is a "touchable" field. That is, if you touch a dark-blue field, the field will toggle to another value, or a pop-up will appear allowing you to select another function. For example, touch the dark-blue field labeled **System** in the upper-left corner of the screen. A pop-up appears listing all the modules of the mainframe. The actual order and content of this pop-up may vary depending on the modules you have installed and in which slots the modules are located.

Note

With default colors, touchable fields are dark blue and fields that are connected to the knob are light blue. These colors may vary if you are not using the default colors. For more information on screen colors, refer to the HP 16500A Reference Manual.

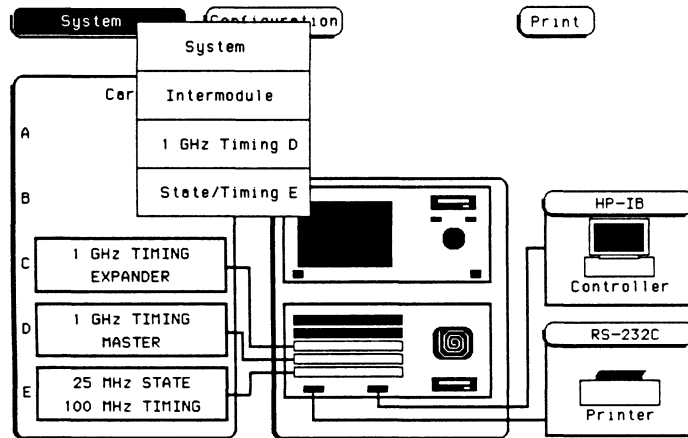

Notice that the **System** field in the pop-up is highlighted in light blue. This tells you that you are in a System menu. To move to any module in the list, touch that field in the pop-up. The pop-up will close and the module you chose will appear on screen.

If you are in any other module menu, you can return to System by touching the module field in the upper-left corner of the screen. When the pop-up appears, notice again that the module you are in is highlighted in light blue. To return to System, touch the field displaying **System**. Remember that the dark-blue field in the upper-left corner of the screen allows you to move among the modules.

Module Menus

Each module may have several menus within it. To see these menu selections, touch the dark-blue field second from the left at the top of the screen.

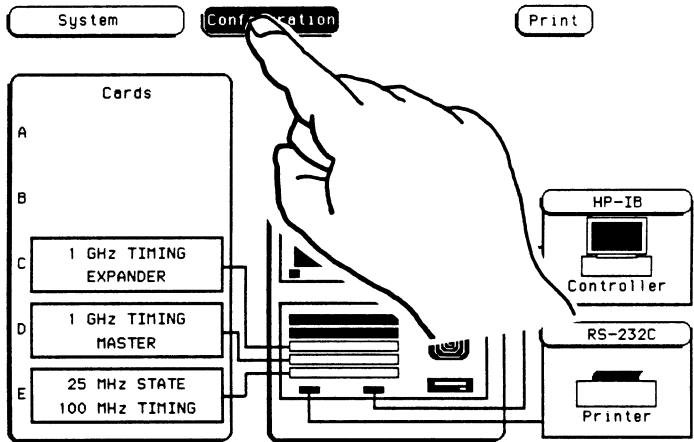

This menu field works the same as the module field to the left of it, except instead of showing all the modules, the menus within each module are displayed. For instance, if you touch this menu field while you are in System, you'll get a pop-up that looks like the one shown below.

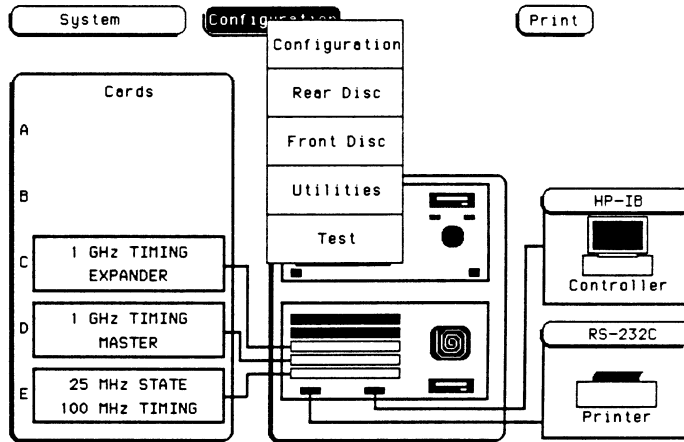

Moving to the 1 GHz Timing Analyzer

Touch the module field in the upper-left corner of the screen. A pop-up will appear similar to the one shown below displaying all the modules in the mainframe. The actual order and content of the pop-up will vary depending on the modules you have installed and their slots. The capitalized letter to the right of the module name refers to the slot in the mainframe where the master card for this module is installed.

In this example, to get to the 1 GHz Timing Analyzer menus, you touch the **1 GHz Timing D** field.

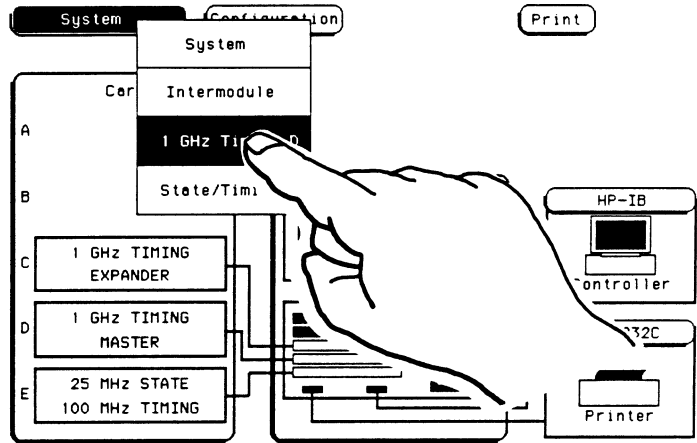

This will bring up the **1 GHz Timing Format** menu.

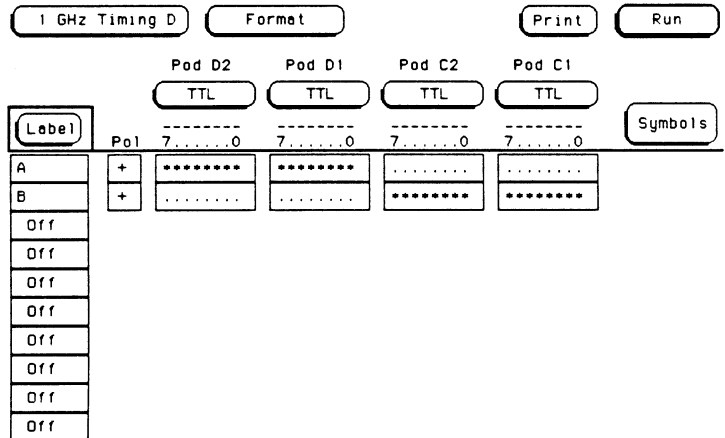

1 GHz Timing Analyzer Menus

The 1 GHz Timing Analyzer has three menus. You can access them by touching the menu field to the right of the **1 GHz Timing** field. Touch the **Format** menu field which is currently being displayed.

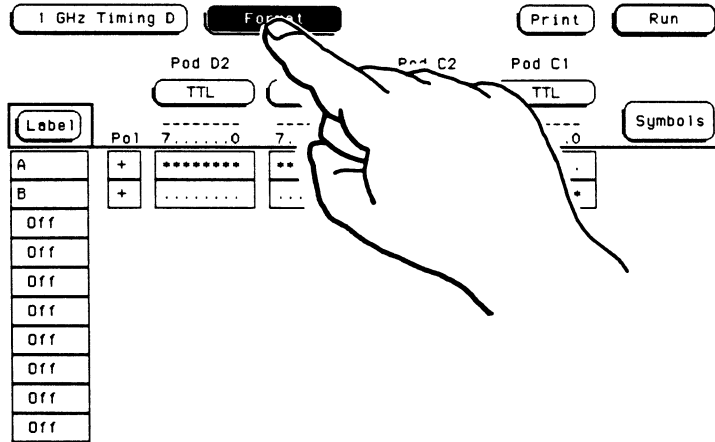

A pop-up appears with all the 1 GHz Timing Analyzer menu selections.

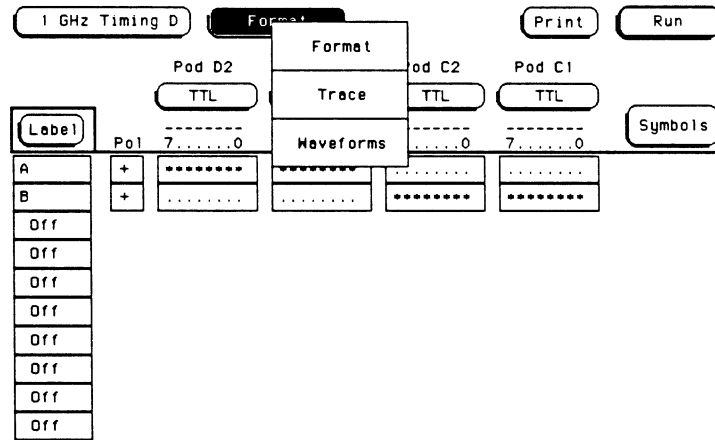

The following chapters will familiarize you with these analyzer menus. For now, touch the **Format** field in the pop-up menu to return to the Format menu. Just remember that the field next to **1 GHz Timing** always shows which analyzer menu is displayed.

Data Entry Fields

When you need to enter alphanumeric or numeric data in some fields, a pop-up keypad will appear on screen to allow you to enter the information. In this pop-up there is a field labeled **DONE**. This field lets the instrument know that you are finished entering data. The keypad pop-up will not close until you touch the **DONE** field.

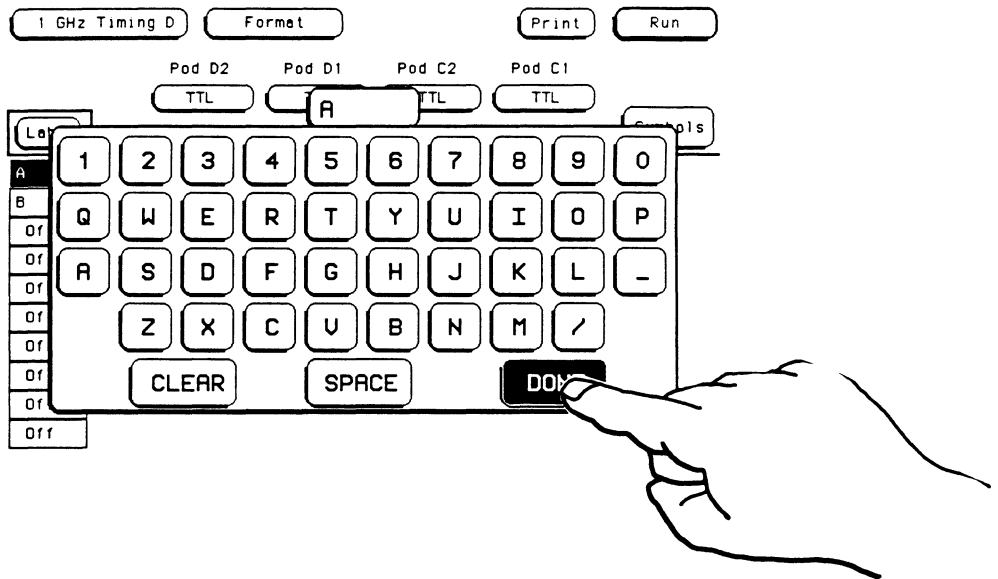

What's the Knob For?

To the right of the screen is a knob. Turning the knob allows you to increment or decrement values in a selected numeric field in the analyzer menu, and to roll the display. "Rolling the display" refers to the instrument's ability to rotate or scroll through information on the screen.

Using the Mouse

Everything that can be done with the touch screen and knob on the HP 16500A can also be done with the optional mouse. The mouse plugs into the connector in the lower right corner of the front panel. As soon as the mouse is plugged in, it is active.

When the mouse is plugged in, a white cursor (cross) appears on screen. Moving the mouse causes the cursor to move. To "touch" a field with the mouse, move the cursor to the field and press the left button on the mouse.

To use the mouse to perform the functions of the front-panel knob, hold down the right button and move the mouse. When you release this button, the function returns to the cursor.

4

The Format Menu

Introduction

In the **Format** menu you describe how the analyzer is connected to the system under test. This includes grouping channels into different labels, renaming labels, and setting the sampling threshold voltages for each pod. The default **Format** menu is shown below.

Note

In the figure shown below, pods C1 and C2 are for the HP 16516A expansion card and pods D1 and D2 are for the HP 16515A master card.

1 GHz Timing D		Format				Print	Run
		Pod D2	Pod D1	Pod C2	Pod C1		
		TTL	TTL	TTL	TTL		
Label	Po1	7.....0	7.....0	7.....0	7.....0	Symbols	
A	+	*****	*****		
B	+	*****	*****		
Off							
Off							
Off							
Off							
Off							
Off							
Off							
Off							

Format Menu Field Index

The pictorial index shown below gives you a visual map of the **Format** menu. It lists the name of each field in the menu, along with the page or chapter number where you will find more information about its function.

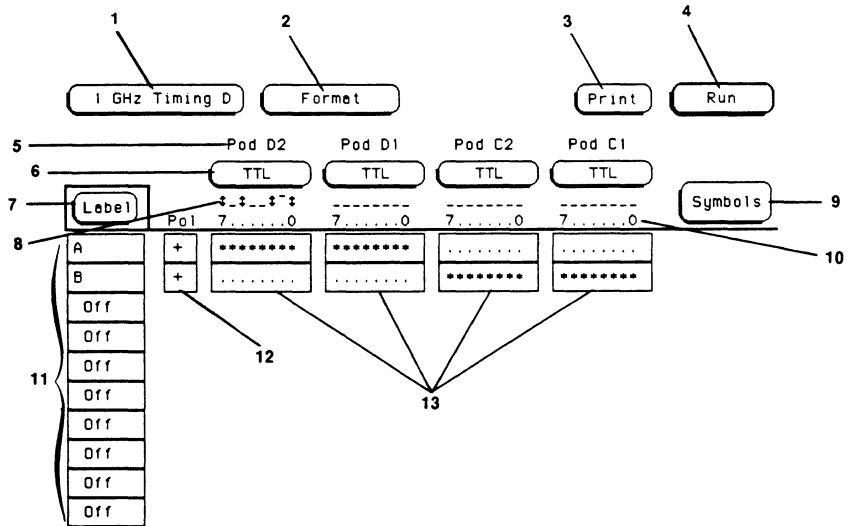

	Description	Manual Page or Chapter
1	Module Field	Chapter 3
2	Menu Field	Chapter 3
3	Print Field	Chapter 14
4	Run Field	Chapter 7
5	Pod Numbering	Page 4-11
6	Pod Threshold Field	Page 4-15
7	Label Roll Field	Page 4-6
8	Activity Indicator	Page 4-5
9	Symbol Definition Field	Chapter 5
10	Channel Numbering	Page 4-11
11	Label Fields	Page 4-6
12	Polarity Field	Page 4-10
13	Channel Assignment Fields	Page 4-12

Format Menu Map

The menu map for the **Format** menu is shown below.

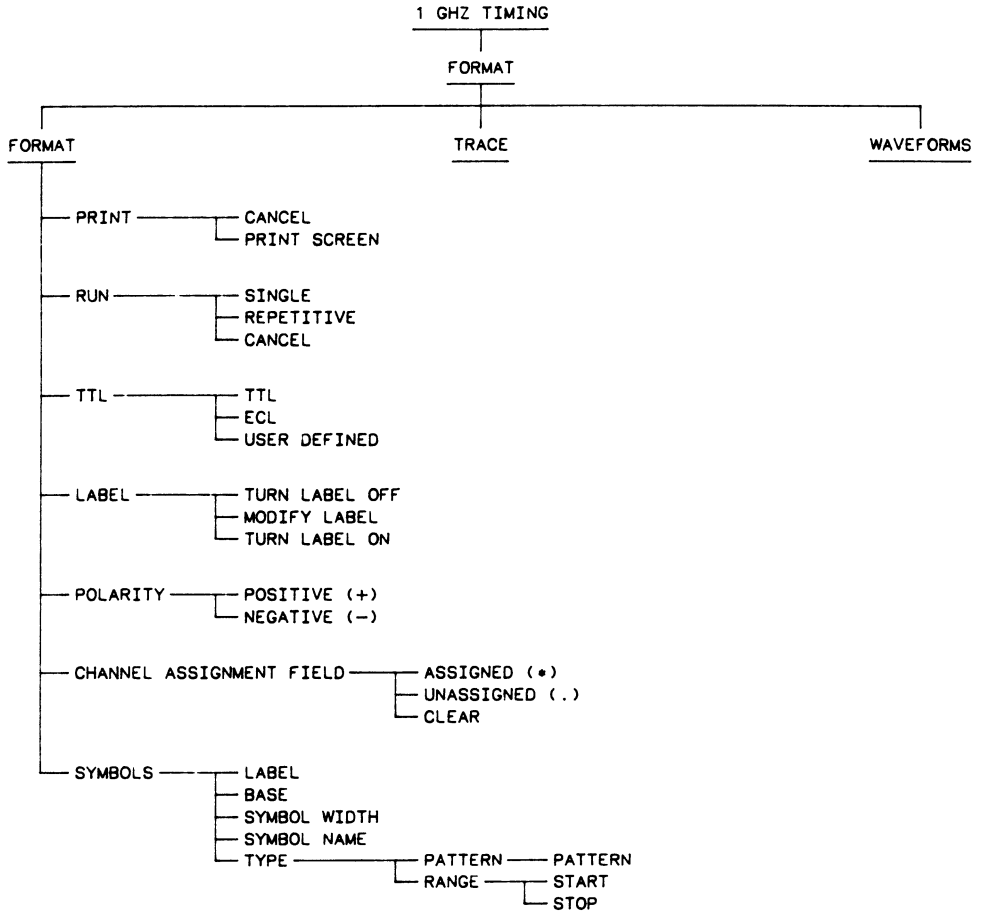

18515/BL12

Format Menu Overview

For an overview of the **Format** menu, think of this menu as a switch matrix. The bits of the channel assignment fields are your columns or inputs and the labels are your rows or outputs. The asterisk (*) connects the input in that column to the output in the corresponding row. The period indicates that no connection exists between that column and the corresponding row.

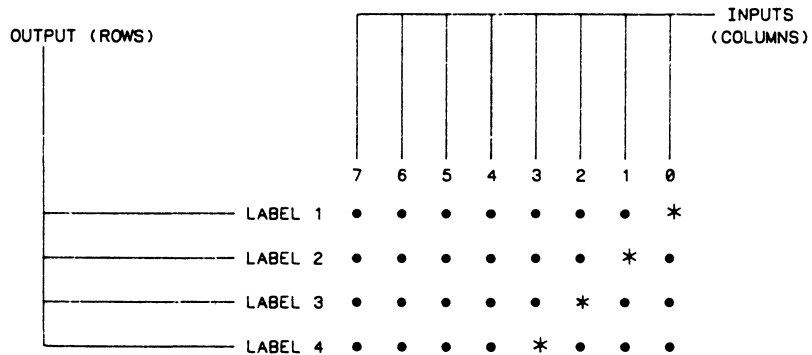

18515/BL0.

In the figure above, input 0 (bit 0) is connected to output label 1, input 1 (bit 1) is connected to output label 2, and so forth.

The bits represent the channels or inputs of the instrument. The label is a symbolic name in which common channels are grouped for reference.

Activity Indicators

A portion of the menu that is not a field is the **Activity Indicators** display. These indicators appear above the bits of the channel assignment fields and indicate which channels are active. When the timing analyzer is connected to your target system and the system is running, a double-ended arrow is displayed for each channel that has activity. These tell you that the signals on these channels are transitioning about the displayed threshold. The hyphens may be high or low, depending on whether the inactive signals are above or below threshold.

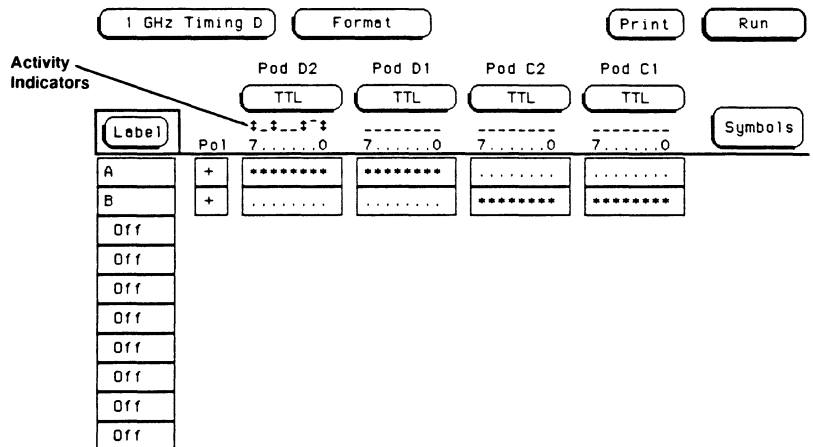

Labels

Each channel you use must be assigned to a label. A label is a name for a channel or group of channels, like **DATA** or **INPUT**. You can give the label any name you want, up to a maximum of six alphanumeric characters.

The HP 16515A/16A module offers you 20 different labels in which you can group channels. The menu will display 10 labels at any given time. To display the additional labels, rotate the knob on the front panel.

Note

*When a field is displayed with a light-blue background, it is attached to the knob on the front panel. The light-blue **Label** roll field indicates that rotating the knob on the front panel will allow you to roll through the labels on the display.*

When the **Format** menu first comes up, it has one label already assigned for HP 16515A master card. If an HP 16516A expansion card is also installed in the HP 16500A, then a label will also be assigned for this card. You will notice the label **A** in the upper label field and label **B** in the field below it. These are the default labels. These labels can be changed, but the default names appear at first because every label used must have a name. This means that you can't have a label that contains only blank spaces.

Turning Labels On To turn a label on, touch the label field you want to turn on.

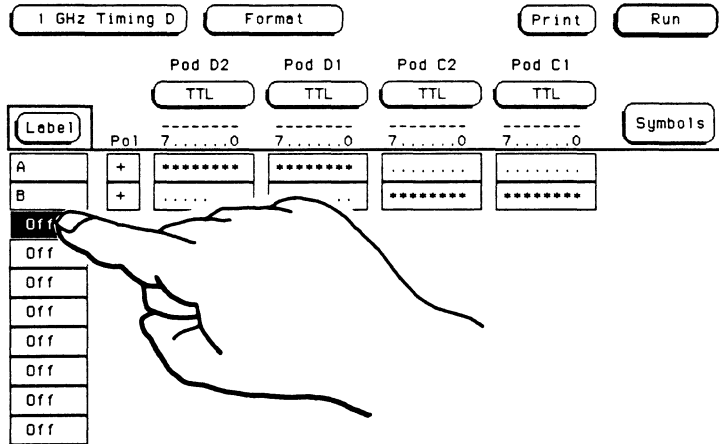

When a label field is touched, a pop-up appears with three choices: **Turn Label Off**, **Modify Label**, and **Turn Label On**. Touching the **Turn Label On** field turns the label on and assigns a default name. If the label was previously assigned a name, then the previous name will be displayed.

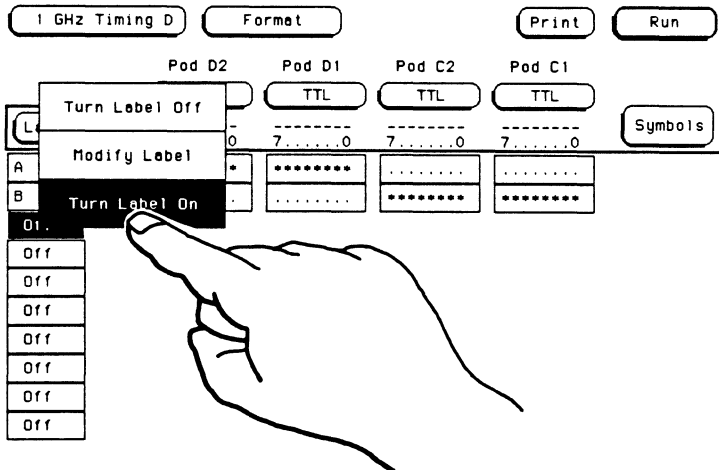

Turning Labels Off

When you touch a label field, a pop-up appears with three choices: **Turn Label Off**, **Modify Label**, and **Turn Label On**. To turn a label off, touch the field labeled **Turn Label Off**.

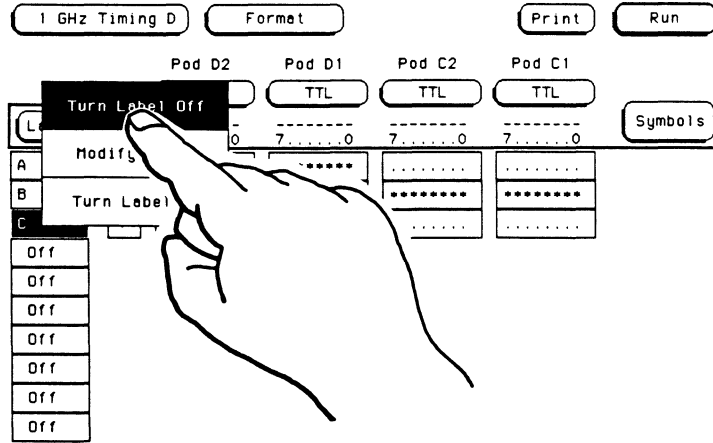

Turning a label off will not destroy the label name previously assigned to that label. When the label is turned on again, the name will still be there.

If you turn off a label that has channels assigned to it, the channels will still be sampled by the timing analyzer, but the data for these channels will not be displayed.

Note

Any symbols defined for a label will remain assigned even when the label is turned off.

Modifying Labels

When you touch a label field, a pop-up appears with three choices: **Turn Label Off**, **Modify Label**, and **Turn Label On**. Touching the **Modify Label** field causes a pop-up keypad to appear on screen as shown below.

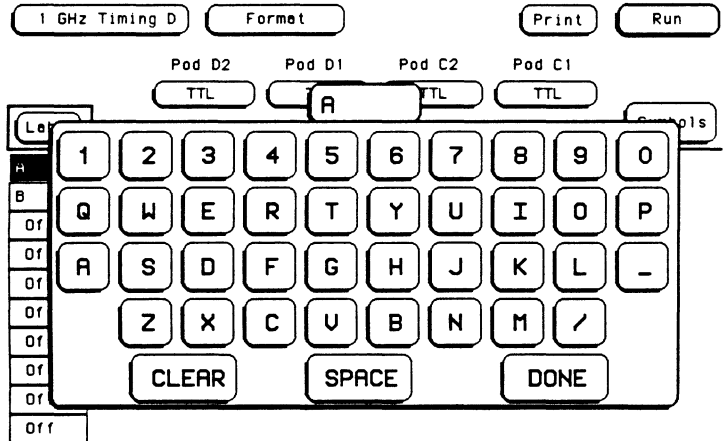

From this keypad you can enter a name for a new label or change the name of an existing label. This name can be up to six characters long and can contain any combination of alphanumeric characters, spaces, or other special characters shown on the keypad.

To clear the label and start over, touch the **CLEAR** key. If you make an error while entering a label, move the cursor to the incorrect character with the knob on the front panel and enter the correct character. When you are finished with the label, touch the **DONE** key.

Note

*If you touch a label field that displays **Off**, you don't need to turn the label field on to modify the label name. When you touch a label that is turned off, just touch **Modify Label** when the pop-up appears and enter the desired name for the label.*

Polarity

Each label has a polarity assigned to it. The default for all the labels is positive (+) polarity. To change the polarity, simply touch the the polarity field located to the right of the label field. This toggles the polarity between positive (+) and negative (-).

In the timing analyzer, negative polarity allows you to use "low true logic" where a low voltage (below threshold) is represented as a 1 and a high voltage (above threshold) is represented as a 0 whenever data is presented numerically. This does not affect the way the waveforms are displayed. A high level on a waveform always represents a sampled high voltage (above threshold).

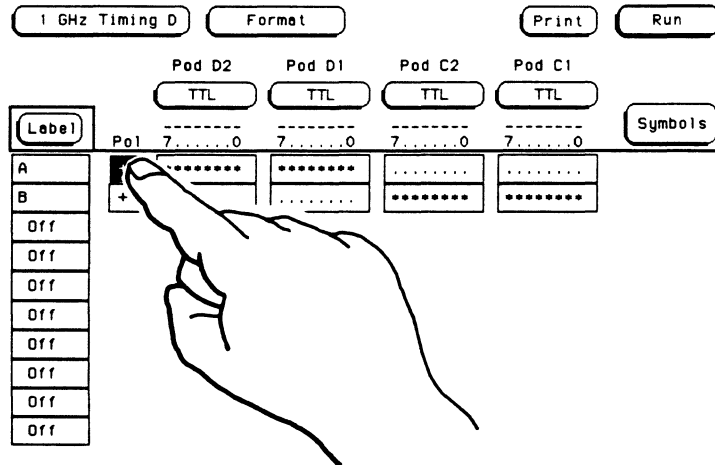

Pod and Channel Numbering

Above the pod threshold fields are the pod numbers. The letters in the pod numbers (A, B, C, D, or E) indicate the physical location of a card for a given pod. The numbers following the letters tell you which pod you are using within a given card.

The number of pods shown in the **Format** menu depends on how many cards the analyzer is configured with. If configured with just the HP 16515A master, two pods will be shown containing eight input channels or bits each. If configured with both the HP 16515A master and HP 16516A expansion cards, four pods are shown with a total of 32 channels.

The channels (bits) of each pod are numbered from right to left starting with channel zero. The channel numbers (7.....0) are displayed directly above the channel assignment fields. Together with the pod numbers, the channel numbers tell you where each channel is located.

The channel numbers across the top and the labels along the left side of the screen make up a matrix. The channel numbers indicate the physical grouping of the input channels, and the labels show the logical grouping of the channels.

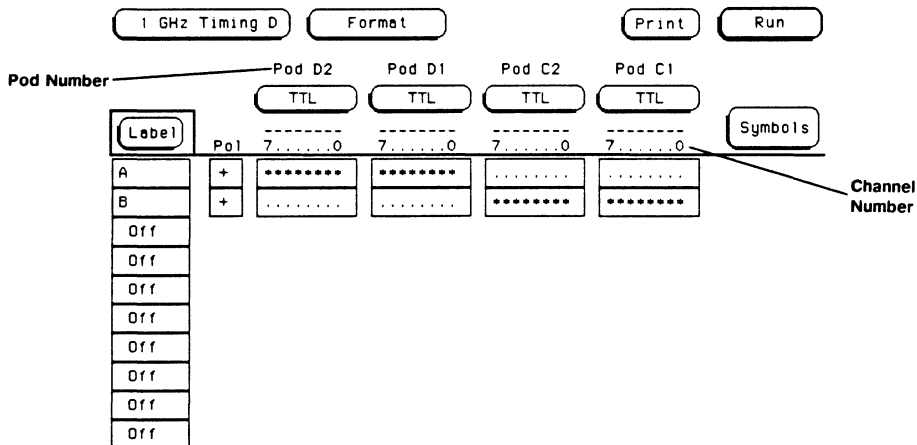

Assigning Input Channels to Labels

The process of assigning channels (bits) tells the timing analyzer which channels are active and to which label each channel belongs.

Each label can have up to 32 channels assigned to it and channels can be assigned to more than one label. For instance, you may have 32 channels assigned to a single label and have 6 of these same channels assigned to another label.

Note

*If you turn on a label, but you do NOT assign channels to the label, the label will automatically turn off when you switch between menus (for example, from the **Format** menu to the **Trace** menu).*

Assigning Input Channels

To the right of each label are channel assignment fields (bit fields) that allow you to specify which channels from each pod are associated with each label. Each label can have multiple channels assigned to it and those channels can be on the same pod or on different pods. To assign a channel, touch the channel assignment field for that channel.

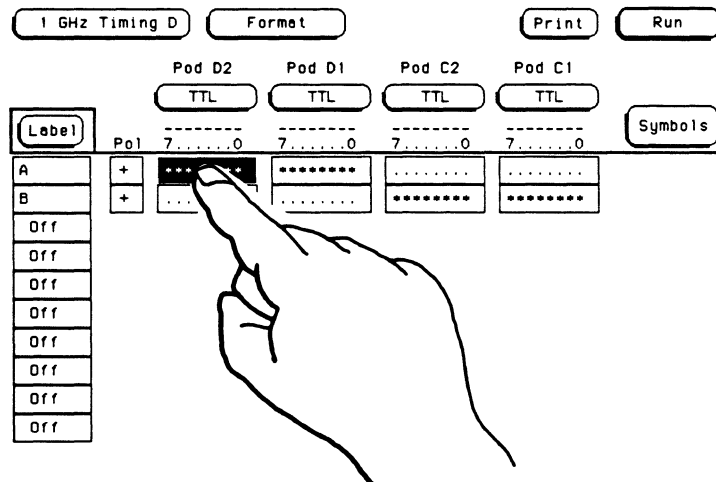

After selecting the appropriate channel assignment field, a pop-up appears as shown below.

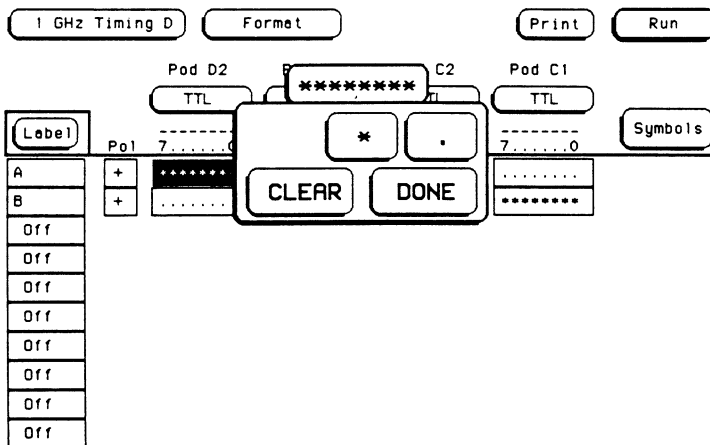

To clear any previously assigned channels, touch **CLEAR**. To assign a channel, move the cursor to the appropriate channel with the knob on the front panel and touch the field in the pop-up displaying an asterisk (*). This will assign the channel to the corresponding label. Bit 0 has been assigned in the following figure.

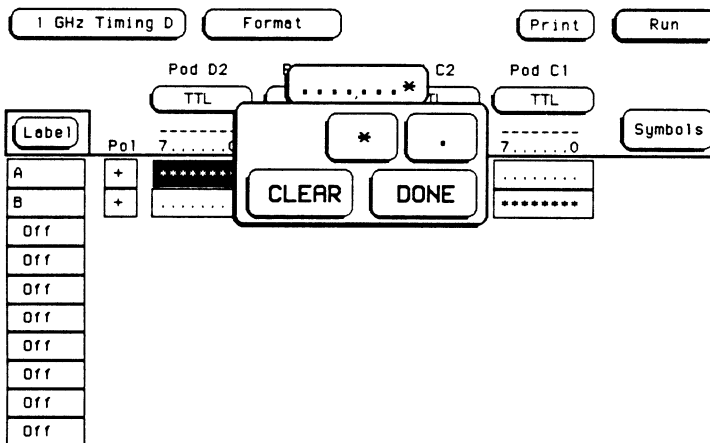

After entering an asterisk (*) for each channel you want assigned, touch **DONE** and the pop-up will disappear.

Unassigning Input Channels

To unassign a channel, touch the channel assignment field for that channel. When the pop-up appears, move the cursor to the appropriate channel with the knob on the front panel and touch the field in the pop-up displaying a period (.). This will unassign this channel from the corresponding label.

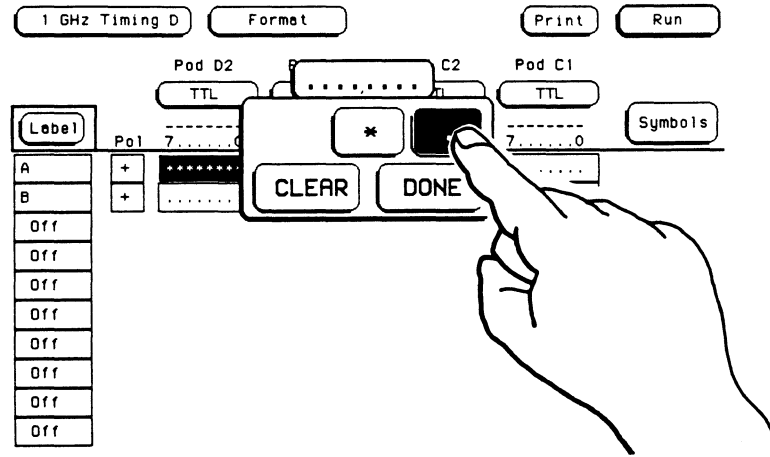

To clear all previously assigned channels, touch **CLEAR**.

Note

*Touching **CLEAR** when all of the bits within an assignment field are already unassigned, assigns all the bits in that field to the corresponding label.*

After entering a period (.) in the appropriate bits, touch **DONE** and the pop-up will disappear.

Pod Threshold

Each pod has a threshold level assigned to it. For the HP 16515A/16A timing analyzer, threshold levels may be defined for each pod individually.

If you touch the pod threshold field for one of the pods, the following pop-up will appear.

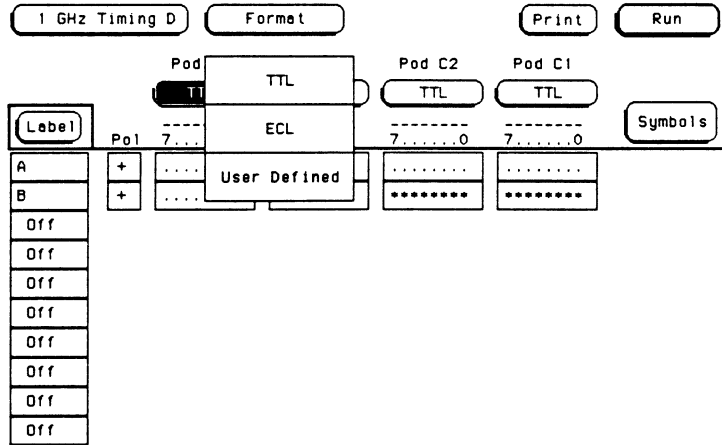

TTL sets the threshold at +1.5 volts, and **ECL** sets the threshold at -1.3 volts.

The **User Defined** option lets you set the threshold to a specific voltage between +5.0 volts and -3.5 volts. If you select this option, a numeric pop-up keypad will appear on screen as shown below. When the keypad appears, simply enter the value you want and select the proper unit of voltage.

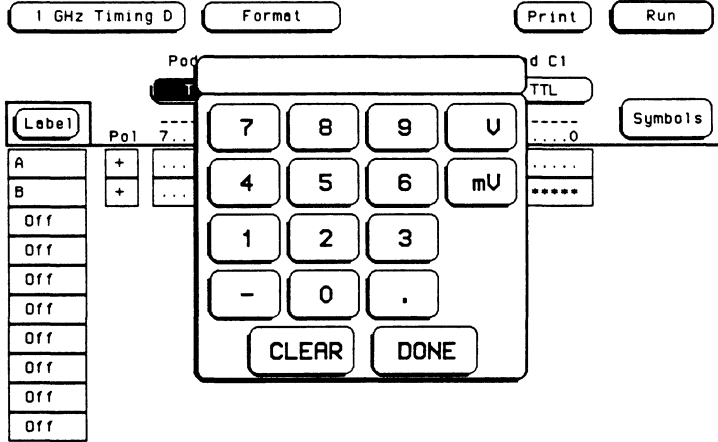

To change the polarity of the threshold, touch the negative (-) key to change the threshold from positive (+) to negative (-) or from negative (-) to positive (+).

To clear the value and start over, touch the **CLEAR** key. When you are finished entering the threshold voltage, touch the **DONE** key and the pop-up will disappear.

Note

If you attempt to set the pod threshold to a value outside the given range, the analyzer will automatically set it to the nearest limit.

5

Specifying Symbols

Introduction

Because long strings of binary patterns are difficult to recognize, we often give patterns functional or symbolic names to make them easier to remember. In the HP 16515A/16516A you can define a symbolic name for a specific bit pattern of a label. Then you can use this symbolic name in place of the pattern in any field where you would normally specify a pattern (as long as the symbol base is selected). Appropriately enough, we call these symbolic names **Symbols**.

It is possible to specify up to 100 symbols in the HP 16515A/16A timing analyzer. This allows you to create a table of symbols to enter into menus without having to remember the binary or hex code for each pattern.

Getting Into the Symbol Menu

To get into the **Symbols** menu, touch the field labeled **Symbols** on the **Format** menu.

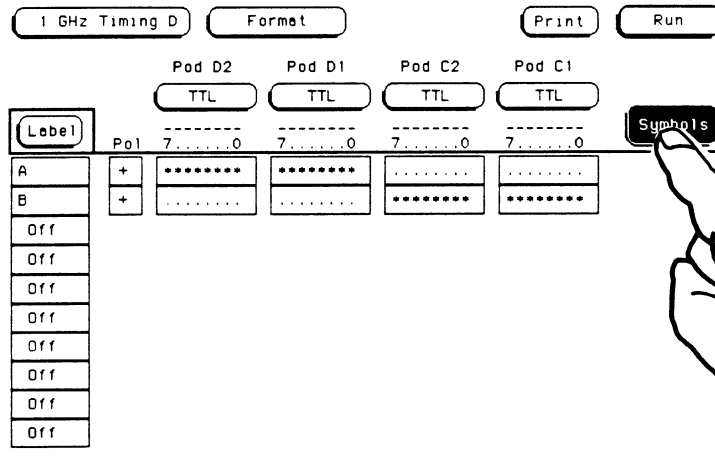

There are four fields in the default **Symbols** menu. They are:

- Label
- Base
- Symbol Width
- Symbol (name)

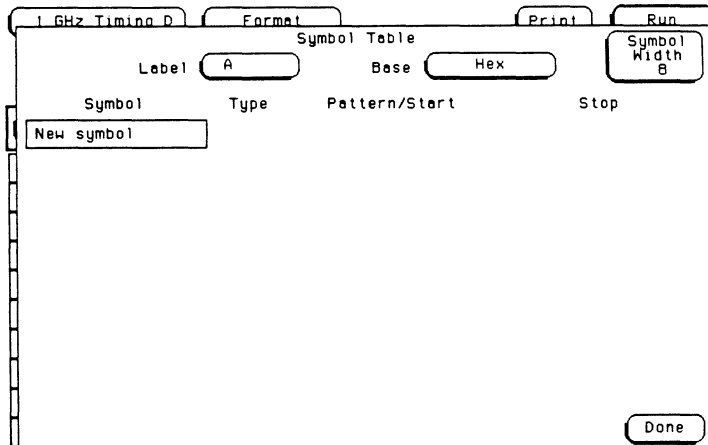

Label

The **Label** field identifies the label for which you are specifying symbols. If you select this field, a pop-up will appear that lists all of the current labels for the timing analyzer.

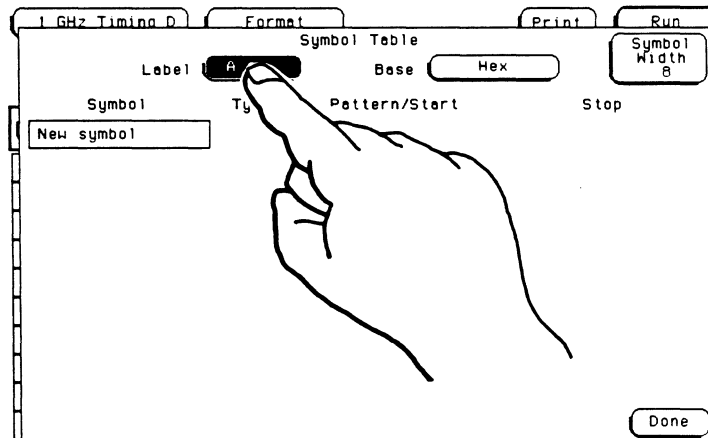

Each label has a separate symbol table. This allows you to give the same name to symbols defined under different labels.

After selecting the **Label** field, touch the field for the label in which you want to specify symbols.

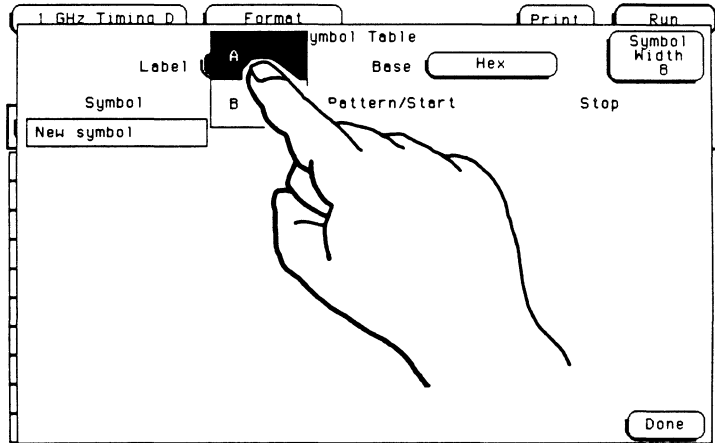

Base

The **Base** field is used to select the numeric base for the pattern for a particular symbol. The base you choose here will also affect other pattern fields (in other menus) that are displayed in the "symbol" base.

To change the base, touch the **Base** field and a pop-up will appear as shown below.

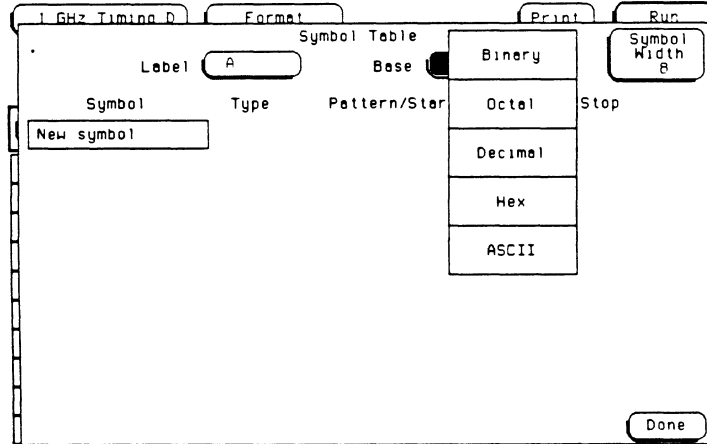

Decide which base you want to work in and touch the appropriate field in the pop-up for that base. The pop-up will disappear, placing the appropriate selection in the **Base** field.

If you select the **ASCII** option, you can see the ASCII characters that the patterns and ranges defined by your symbols represent. ASCII characters represented by the decimal numbers 0 to 127 (hex 00 to 7F) are offered by your timing analyzer. Specifying patterns and ranges are discussed on page 5-8.

Note

*You cannot specify a pattern or range when the base is **ASCII**. You must define the pattern or range in one of the other bases and then switch to **ASCII** to see the ASCII characters.*

Symbol Width

The **Symbol Width** field lets you specify how many characters of the symbol name will be displayed when the symbol is referenced in the **Trace** or **Waveforms** menus. To select the symbol width when the **Symbol Width** field is light blue, rotate the knob on the front panel clockwise to increase the width and counterclockwise to decrease the width. If the field isn't already light blue, touching it once will change its background to light blue.

If you touch the **Symbol Width** field when it is already light blue, a pop-up keypad will appear on screen as shown below.

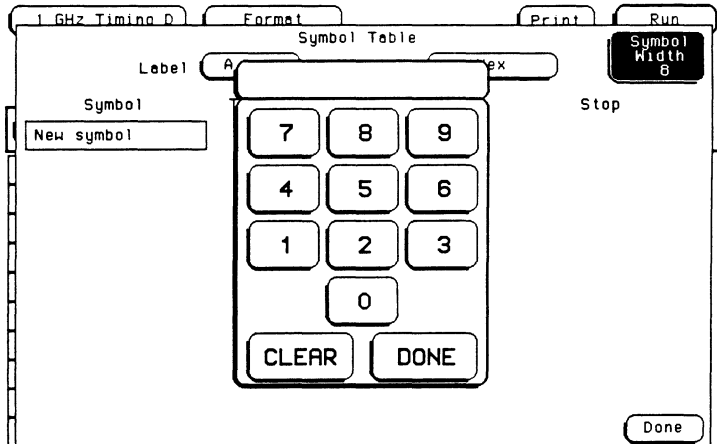

You can have the timing analyzer display from 1 to 16 of the characters in the symbol name. To enter the value with the keypad, simply touch the appropriate keys. To clear the value and start over, touch the **CLEAR** key. When you are finished entering the value, touch the **DONE** key and the pop-up will disappear.

Note

If you attempt to set the symbol width to a value outside the given range, the analyzer will automatically set it to the nearest limit.

Symbol Name

When you first access the **Symbols** menu, there are no symbols specified and the symbol name field reads **New symbol**. If you select this field, an alphanumeric keypad will appear on screen. Use the keys in this pop-up to enter the name of your symbol. Your symbol name can be up to 16 characters long and can contain any combination of alphanumeric characters, spaces, or other special characters shown on the keypad.

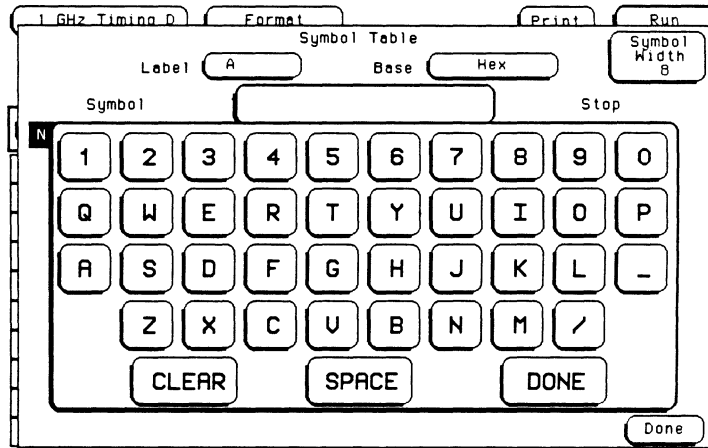

To clear the symbol name and start over, touch the **CLEAR** key. If you make an error while entering a label, move the cursor to the incorrect character with the knob and enter the correct character. When you are finished with the name, touch the **DONE** key and the pop-up will disappear. The name you entered will appear in the symbol name field and two more fields will appear to the right of that field as shown below.

The image shows a software interface titled "Symbol Table" with several tabs at the top: "1 GHz Timing D", "Format", "Print", and "Run". The main area contains the following fields and controls:

- Label:** A text field containing the character "A".
- Base:** A dropdown menu currently set to "Hex".
- Symbol Width:** A field containing the number "8".
- Symbol Table Header:** A table with four columns: "Symbol", "Type", "Pattern/Start", and "Stop".
- Table Row 1:**
 - Symbol:** "SYMBOL1"
 - Type:** "pattern"
 - Pattern/Start:** "0000"
 - Stop:** (empty field)
- Done:** A button located at the bottom right of the interface.

Adding Symbols

To add more symbols to your symbol table, touch a symbol that appears on the symbol table. A pop-up menu appears as shown below.

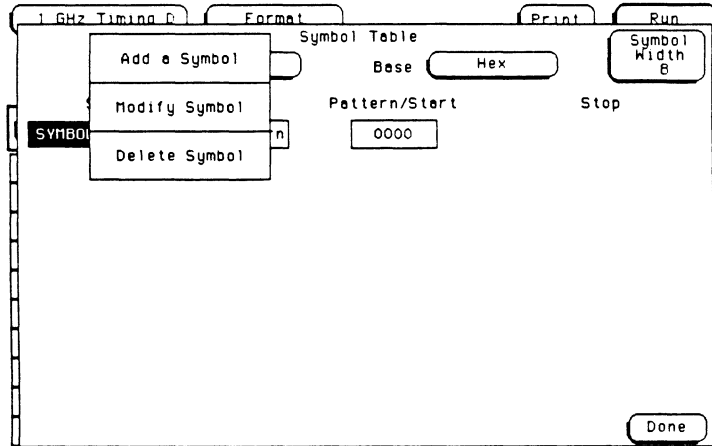

The first option in the pop-up is **Add a Symbol**. This allows you to specify another symbol. When you select it, an alphanumeric keypad appears on screen to allow you to enter a name for your new symbol. When you are finished, touch **DONE** and your new symbol will appear in the symbol table.

The second option in the pop-up is **Modify Symbol**. If you select this option, an alphanumeric keypad will appear on screen to allow you to change the current name of the symbol.

The third option in this pop-up is **Delete Symbol**. Selecting this option will delete the symbol from the symbol table.

You can specify up to 100 symbols in the HP 16515A/16A timing analyzer, but only 10 will be displayed in the **Symbols** menu at a given time. When more than 10 symbols are specified, a **Symbols** field appears in the upper-left corner of the menu. To display the additional symbols, touch this field and when its background turns light blue, use the knob on the front panel to bring the other symbols on screen. This allows you to roll through the symbols, which means that as you bring one symbol on screen, you are simultaneously taking another symbol off screen.

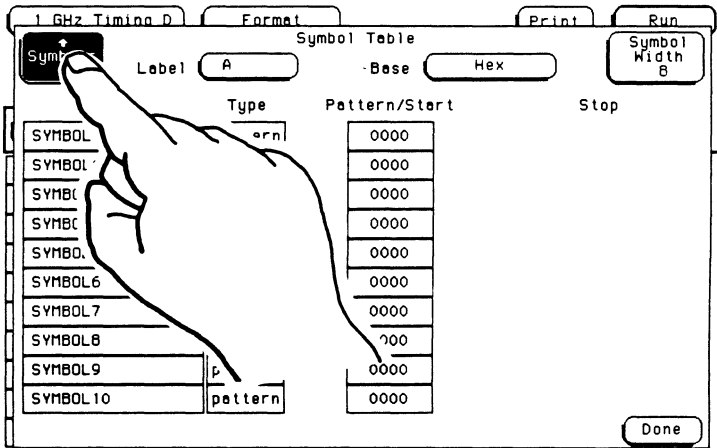

Pattern and Range

The **Type** field to the right of the symbol name defines the symbol as either a **Pattern** or a **Range**. If you touch this field, it will toggle between **Pattern** and **Range**.

Pattern When the symbol is defined as a **Pattern**, the pattern is specified in the **Pattern/Start** field. To specify a pattern, touch the **Pattern/Start** field.

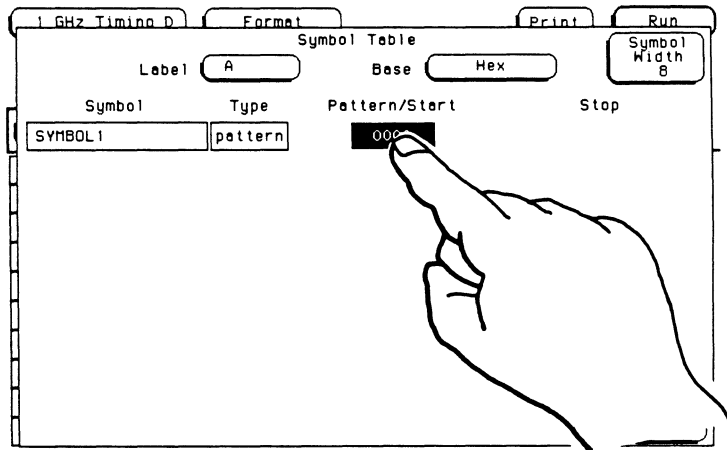

A pop-up keypad will appear to enter the pattern you want. Enter the pattern in the same numeric base that you specified in the **Base** field.

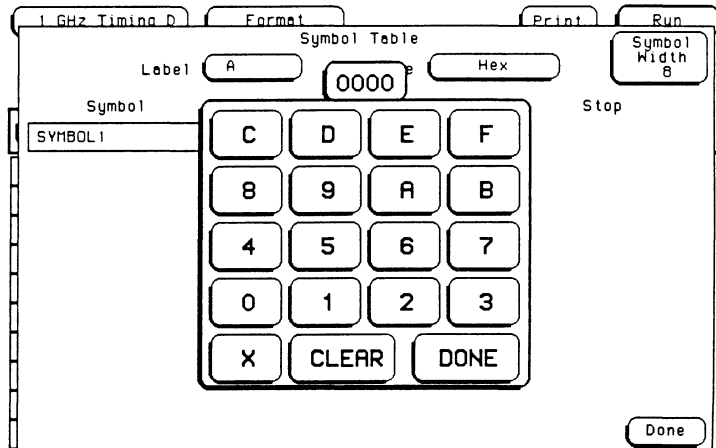

- X = DON'T CARE

To clear the value and start over, touch the **CLEAR** key. If you make an error while entering the value, move the cursor to the incorrect character with the knob and enter the correct character. When you are finished entering the pattern, touch the **DONE** key.

Range If the symbol is defined as a **Range**, two fields appear to specify the upper and lower boundaries of the range.

The screenshot shows a dialog box titled "Symbol Table" with tabs for "1 GHz Timing D", "Format", "Print", and "Run". The "Format" tab is active. At the top, there are fields for "Label" (containing "A"), "Base" (containing "Hex"), and "Symbol Width" (containing "8"). Below these is a table with the following structure:

Symbol	Type	Pattern/Start	Stop
SYMBOL1	range	0000	0000

At the bottom right of the dialog is a "Done" button.

When you select one of these fields, a pop-up keypad appears as shown below.

This screenshot is identical to the previous one, but a pop-up keypad is overlaid on the "Pattern/Start" field. The keypad contains the following elements:

- Buttons for hexadecimal digits: C, D, E, F, 8, 9, A, B.
- Buttons for decimal digits: 4, 5, 6, 7, 0, 1, 2, 3.
- Buttons for "CLEAR" and "DONE".

The "Pattern/Start" field in the background now contains the value "0000". The "Done" button at the bottom right of the dialog is still visible.

You can specify ranges that overlap or that are nested within each other, but **Don't Cares (X)** are not allowed. When you are finished entering a value, touch **DONE** and the pop-up keypad will disappear.

Leaving the Symbol Menu

When you have specified all of your symbols, touch the **Done** field in the lower-right corner of the menu to return to the **Format** menu.

The screenshot shows a software interface with a 'Symbol Table' menu. At the top, there are tabs for '1 GHz Timing D', 'Format', 'Print', and 'Run'. The 'Format' tab is active. Below the tabs, there are fields for 'Label' (set to 'A'), 'Base' (set to 'Hex'), and 'Symbol Width' (set to '8'). A table with the following columns is visible: 'Symbol', 'Type', 'Pattern/Start', and 'Stop'. The first row contains the values 'SYMBOL1', 'range', '0000', and '0000'. A 'Done' button is located in the bottom right corner of the menu.

Symbol	Type	Pattern/Start	Stop
SYMBOL1	range	0000	0000

Looking Up Symbols in the Symbols Table

When information is displayed in the symbol base, the analyzer looks up symbols for the values as follows:

- Pattern symbols are always checked before range symbols in the order in which the symbols appear in the symbols table.
- If a pattern symbol is not matched and the value the analyzer is looking up does not contain don't cares (X), then the analyzer checks the range symbols in the order they appear in the symbols table.

If a value is not matched to any symbol (pattern or range), then it is displayed as absolute \pm the value in the appropriate symbol offset base.



6

The Trace Menu

Introduction

The **Trace** menu lets you specify the trigger point for the timing analyzer. You configure the timing analyzer to find a pattern first and then find a transition in the signal or signals. The default **Trace** menu is shown below.

1 GHz Timing D		Trace		Print	Run
Label >	A	B			
Base >	Hex	Hex			
Find Pattern	Equal	XXXX	XXXX		
Then find Edge	present for	>	16 ns		
			

Trace Menu Field Index

The pictorial index shown below gives you a visual map of the **Trace** menu. It lists the name of each field in the menu, along with the page or chapter number where you will find more information about its function.

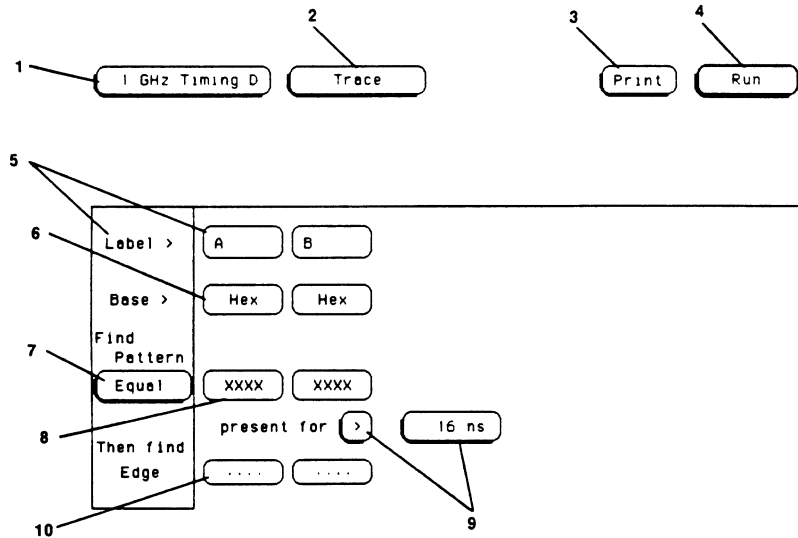

	Description	Manual Page or Chapter
1	Module Field	Chapter 3
2	Menu Field	Chapter 3
3	Print Field	Chapter 14
4	Run Field	Chapter 7
5	Label Fields	Page 6-4
6	Base Fields	Page 6-7
7	Equal Field	Page 6-8
8	Pattern Fields	Page 6-9
9	Pattern Duration Fields	Page 6-14
10	Edge Fields	Page 6-20

Trace Menu Map

The menu map for the **Trace** menu is shown below.

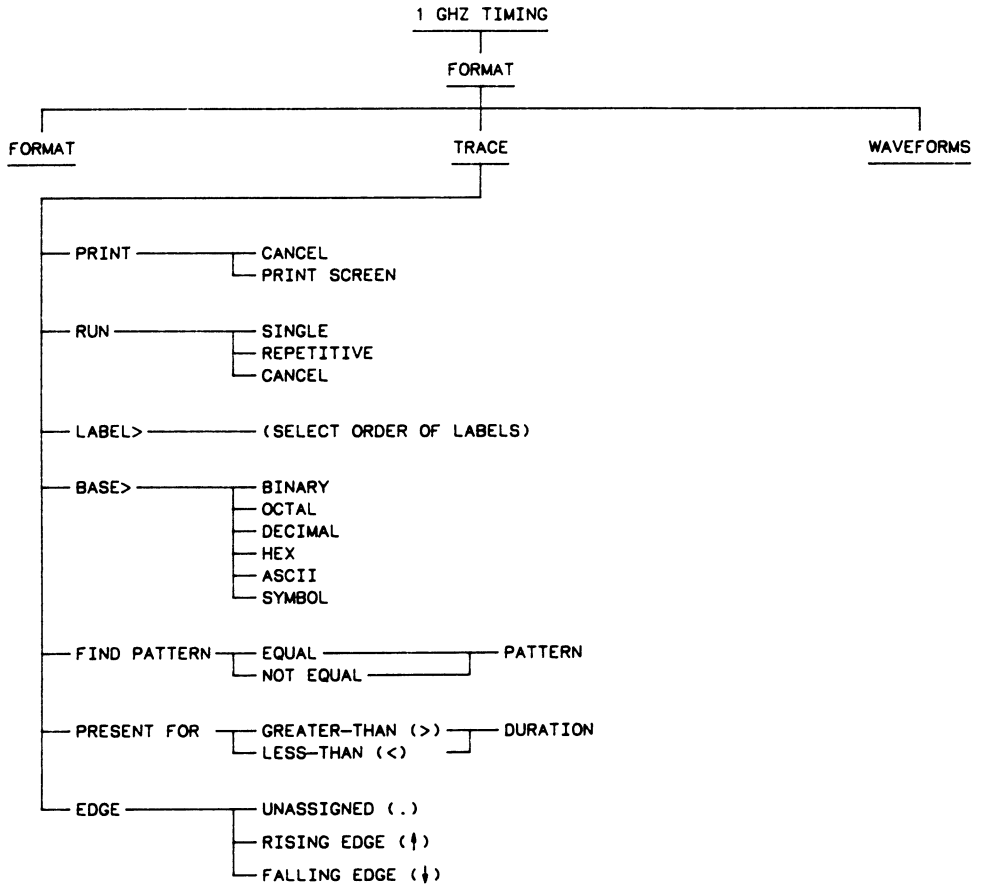

18515/BL19

The Label Fields

The **Label** fields contain the labels you defined in the **Format** menu. If there are more labels than the analyzer can fit on screen, a field appears to the left of the label fields as shown below. Touch this field and when its background turns light blue, use the knob on the front panel to bring the other labels on screen. This feature actually rolls through the labels, which means that as you bring one label on screen, you are simultaneously taking another label off screen.

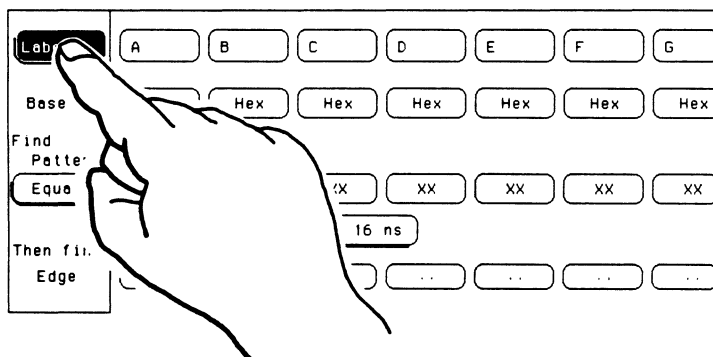

Note

*Only labels that have channels assigned to them will appear in the **Trace** menu. If no channels were assigned to a label in the **Format** menu, switching between menus will automatically turn off that label.*

To arrange the labels in a more usable order, touch one of the labels and a pop-up menu will appear as shown below.

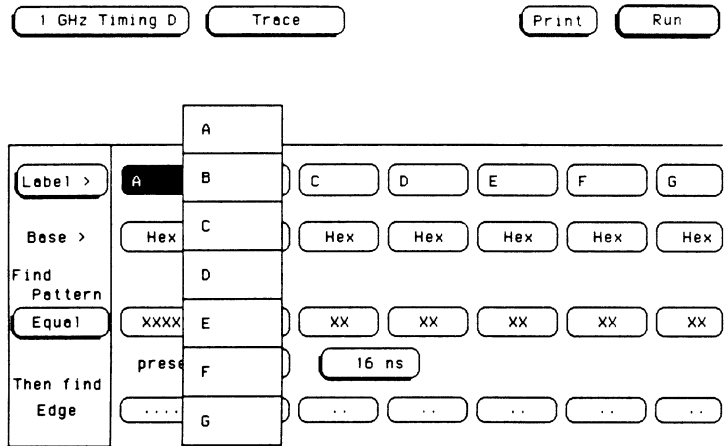

The pop-up menu shows the current order of the labels with your current label selection shown with a light-blue background. To rearrange the labels, touch the label that is now in the position where you want the label you selected to go. The pop-up will disappear and the labels involved will switch places.

For example, if you wanted to position the label **A** where the label **C** is now, touch the label **A** and a pop-up will appear displaying all the current labels including **A** and **C**. Touch the field displaying the **C** label and the pop-up will disappear.

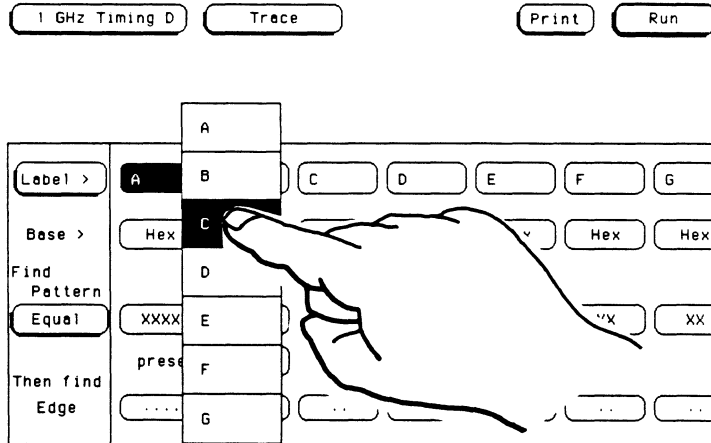

The label **A** will now be displayed where **C** originally was displayed. Likewise, the label **C** now is displayed where **A** was originally displayed.

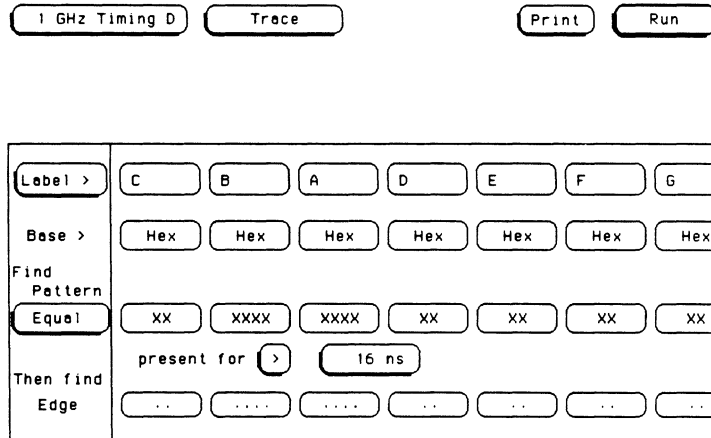

This feature allows you to arrange the labels so that labels that interact with each other can be displayed together on screen.

The Base Field

The **Base** fields allow you to specify the numeric base for the patterns you define for each label. These fields also let you use a symbol that was specified in the **Format** menu for the pattern. Each label has its own base defined separately from the other labels. If you select one of the **Base** fields, you will see the following pop-up menu.

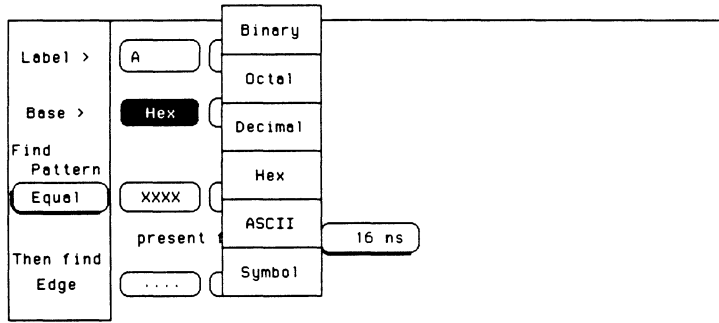

One of the options in the **Base** pop-up is **ASCII**. This allows you to see the characters represented by the pattern you specified in the **Find Pattern** field. When you select **ASCII**, you cannot specify ASCII characters directly. You must specify a pattern in one of the other bases and then switch to the ASCII base to see what characters the pattern represents.

The **Symbol** option in the **Base** pop-up allows you to use a symbol that has been already specified in the **Format** menu as a pattern, or allows you to specify absolute and enter another pattern. You specify the symbol you want using the **Find Pattern** field.

Decide which base you want to define your pattern in and select that option. The pop-up will disappear, placing your choice in the appropriate field.

The Equal Field

The field below "Find Pattern" on the **Trace** menu allows you to specify whether you want to trigger on a pattern that is **Equal** or **Not Equal** to the pattern you specified. By touching this field, you can toggle between **Equal** and **Not Equal**.

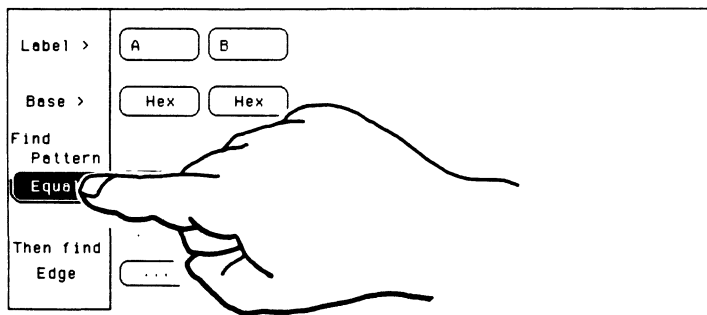

When this field displays **Equal**, the instrument is going to trigger on the pattern specified in the **Trace** menu. When this field displays **Not Equal**, the instrument will trigger on any pattern except the one specified in the **Trace** menu. Also, when **Not Equal** is selected, the less-than (<) option for pattern duration is no longer available.

Find Pattern

With the **Find Pattern** fields, you configure the timing analyzer to look for a certain pattern in the data. Each label has its own pattern field that you use to specify a pattern for that label.

When running a measurement, the timing analyzer looks for a pattern in your data that is the logical **AND** of all of the patterns specified for all the labels. That is, it looks for a simultaneous occurrence of all of the specified patterns. When it finds the pattern which satisfies the duration value, the analyzer looks for an edge on which to trigger (see page 6-20). If no edge is specified, the analyzer triggers immediately after the pattern duration has been satisfied.

Note

Since all of the patterns for all of the labels must be valid to trigger, you must clear any unwanted patterns (see page 6-13) so that the analyzer does not consider them trigger conditions.

ASCII Base

When you touch a pattern field, one of three things will happen. If you selected **ASCII** as your base, then the error message "**ASCII entry not available**" will appear to remind you that you cannot specify a pattern in ASCII. You must specify a pattern in one of the other bases and then switch to the ASCII base to see what characters the pattern represents.

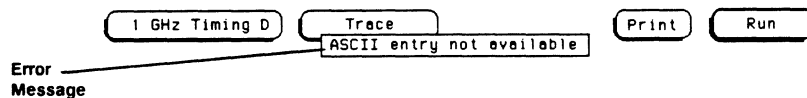

Label >	A	B
Base >	ASCII	Hex
Find Pattern	XXXXXXXXXX	XXXX
Then find Edge	present for >	16 ns

Symbols Base

If you selected **Symbol** for your base, the pattern field will display "absolute." When you touch this field a pop-up will appear as shown below.

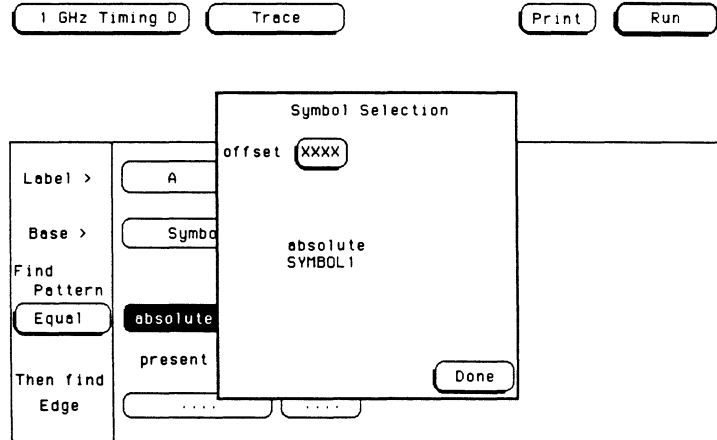

The pop-up lists all the symbols defined for that label and contains the option "absolute."

Note

*When you specify symbols in the **Format Symbols** menu, you also specify the number of characters in the symbol name that are to be displayed (**Symbol Width**). If you specify three for the **Symbol Width**, only the first three characters of your symbols will be displayed in the **Find Pattern** field. In addition, only the first three letters of "absolute" will be displayed.*

To select an option from the pop-up, rotate the knob to scroll the options up and down through the cursor until the desired option is inside the cursor.

Note

*If no symbols were specified in the **Format** menu, only **absolute** will appear in the symbol selection pop-up.*

If you choose the **absolute** option, or if you selected the range option in the **Format** menu for the symbol you specified, the **offset** field will appear at the top of the pop-up. This field allows you to specify a pattern which isn't defined by one of the other symbols.

If you touch the **offset** field, a pop-up keypad appears on screen as shown below.

Note

*The pop-up keypad will vary depending on which **Base** you selected in the **Format Symbols** menu.*

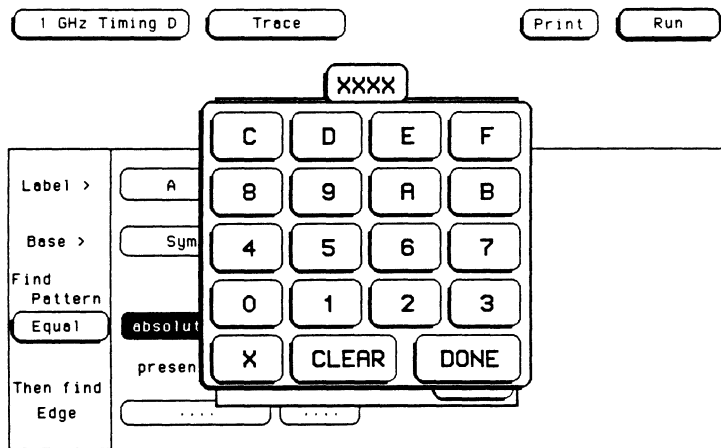

Use the keypad to enter the pattern you want, but be sure to enter the pattern in the same numeric base that you specified in the **Base** field of the **Format Symbols** menu.

- X = DON'T CARE

To clear the value and start over, touch the **CLEAR** key. If you make an error while entering the value, move the cursor to the incorrect character with the knob and enter the correct character. When you are finished entering the pattern, touch the **DONE** key.

Note

*You cannot specify a pattern if the base you selected in the **Symbols** menu was **ASCII**. If you want to change the pattern, you must define the pattern in one of the other bases and then switch back to **ASCII**.*

When you are finished configuring the pop-up, touch the **Done** field and the symbol or absolute value you specified will be displayed in the appropriate pattern field.

Numeric Base

If you selected **Binary**, **Octal**, **Decimal**, or **Hex** as your base, then a pop-up keypad will appear on screen as shown below.

Note

*The pop-up keypad will vary depending on which **Base** you selected for this label.*

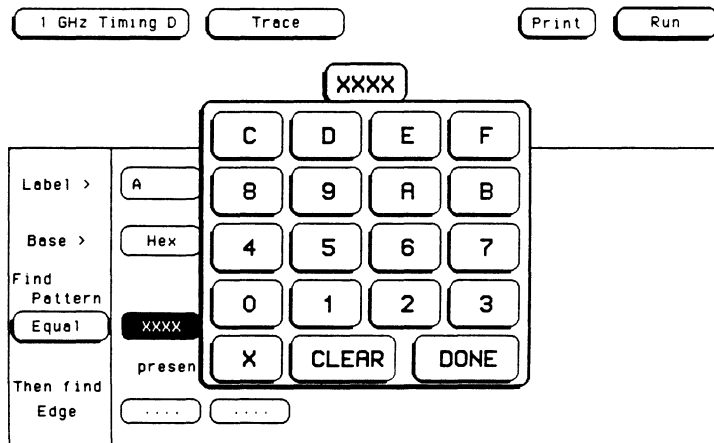

Use the keypad to enter the pattern you want, but be sure to enter the pattern in the same numeric base that you specified in the **Base** field.

- X = DON'T CARE

To clear the value and start over, touch the **CLEAR** key. If you make an error while entering the value, move the cursor to the incorrect character with the knob and enter the correct character. When you are finished entering the pattern, touch the **DONE** key.

Note

A dollar sign (\$) will appear in a pattern field whenever a value cannot be displayed in the current base. The information in that field is still valid and the actual value can be displayed by changing to a more appropriate base (such as, from "Hex" to "Binary").

Pattern Duration

There are two fields with which you specify the pattern duration. They are located to the right of **present for** in the **Trace** menu. Use these fields to tell the timing analyzer to trigger when the specified pattern has occurred for less-than or greater-than a given length of time.

Note

*When **Not Equal** has been selected in the **Trace** menu, the less-than (<) option is no longer available for pattern duration.*

The first field can be set to greater-than (>) or less-than (<). If you touch this field, it toggles between greater-than (>) and less-than (<).

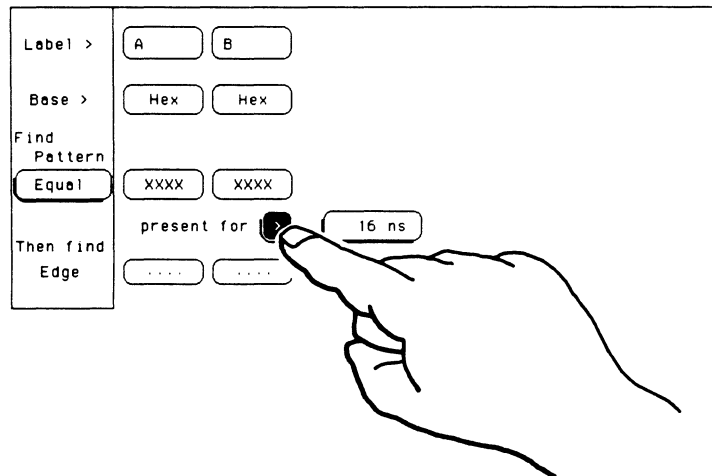

Greater-than (>) sets up the instrument to trigger on a pattern that is valid for greater-than the specified pattern duration. Less-than (<) sets up the instrument to trigger on a pattern that is valid for less-than the specified pattern duration. Also, when you select less-than (<), you no longer have the option to specify an edge to trigger on. Instead, the instrument triggers when the specified pattern becomes "invalid" in less-than the specified pattern duration.

Note

If a pattern is specified across boards (HP 16515A/16516A), less-than is no longer available.

1 GHz Timing D Trace Print Run

Label >	A	B
Base >	Hex	Hex
Find Pattern		
Equal	XXXX	XXXX
present for	<	27 ns

The second field to the right of **present for** is where you specify the length of time that a pattern must be valid (pattern duration). The values in which pattern duration can be set varies depending on the sample rate and duration mode (less-than or greater-than) of the module. For more information, refer to the appendix "Specifications and Characteristics."

Note

If you attempt to set the pattern duration to a value outside the given range, the analyzer will automatically set it to the nearest limit.

Knob Entry To change the value of the pattern duration, make sure that the second field has a light-blue background. If this field doesn't have a light-blue background, touch this field once and the background will change to light blue. Once this field has a light-blue background, it is connected to the knob on the front panel and rotating the knob will change the value shown in this field. Rotate the knob clockwise to increase the value and counterclockwise to decrease the value.

Note

With default colors, touchable fields are dark blue and fields that are connected to the knob are light blue. These colors may vary if you are not using the default colors. For more information on screen colors, refer to the HP 16500A Reference Manual.

Keypad Entry

If you touch the second field when it already has a light-blue background, a pop-up keypad will appear on screen as shown below. Use the keypad to enter the pattern duration you want. To clear the value and start over, touch the **CLEAR** key. When you are finished entering the pattern duration, touch the **DONE** key.

Note

*If you attempt to set the pattern duration to a value outside the given range, the analyzer will automatically set it to the nearest limit. The values for pattern duration follow a preset sequence which varies depending on the current sample rate and duration mode (less-than or greater-than). To view the values available for your current configuration, enter the value you want with the keypad and touch **DONE**. When the pop-up disappears, the closest available value will be displayed. For higher resolution, rotate the knob on the front panel.*

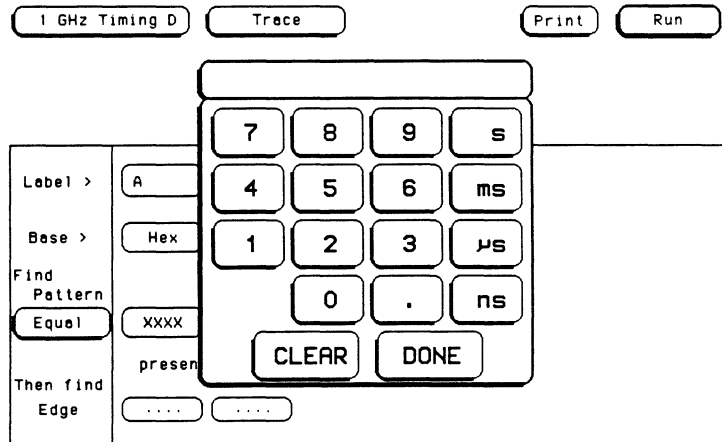

Example As an example, suppose you configure the pattern duration fields as shown below.

1 GHz Timing D Trace Print Run

Label >	A	B	
Base >	Hex	Hex	
Find Pattern	Equal	1010	XXXX
	present for	>	58 ns
Then find Edge	

This configuration tells the timing analyzer to look for the pattern you specified (1010) to occur for more than 58 ns. Once the timing analyzer finds this condition, it can then look for the appropriate edge to trigger on if an edge is specified. If no edge is specified, the analyzer will trigger immediately after the duration has been satisfied.

If you choose less-than (<), you can no longer specify an edge on which to trigger. Instead, the timing analyzer triggers immediately at the end of the pattern that meets the duration requirements. For example, if you configure the pattern duration as shown below:

1 GHz Timing D Trace Print Run

Label >	A	B
Base >	Hex	Hex
Find Pattern Equal	1010	XXXX
	present for	< 55 ns

The analyzer will trigger when the specified pattern (1010) is present for a period of less than 55 ns. The pattern must also be valid for at least a predetermined minimum amount of time. The predetermined minimum time varies depending on whether your measurement is within a pod or between pods. For more information refer to the appendix "Specifications and Characteristics."

Edge Field

The **Edge** fields allow you to specify edges (transitions) of the data on which to trigger the timing analyzer. Each label has its own edge trigger specification field which allows you to specify either a positive edge or a negative edge on any channel.

Note

*The **Edge** field will not appear on screen if less-than (<) has been selected for the pattern duration in the **Trace** menu.*

When you specify an edge on more than one channel, the timing analyzer looks at the edges as logically ORed edges. This means that the timing analyzer will trigger when it sees any one of the edges you specified and without regard to the order in which they are specified.

To specify an edge, touch the appropriate edge field and a pop-up will appear as shown below.

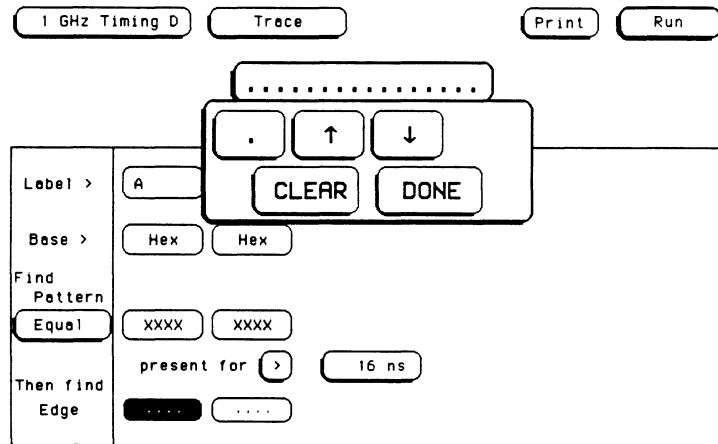

The pop-up may vary slightly depending on the number of channels you assigned to this label.

- The period (.) indicates that no edge is specified for this channel and that this channel is not a trigger condition.
- The upward arrow (↑) indicates that a transition from low to high on this channel will trigger the analyzer.
- The downward arrow (↓) indicates that a transition from high to low on this channel will trigger the analyzer.

To specify a negative edge, move the cursor with the knob on the front panel to the channel you want and touch the downward arrow (↓) key. The period changes to ↓ as shown below.

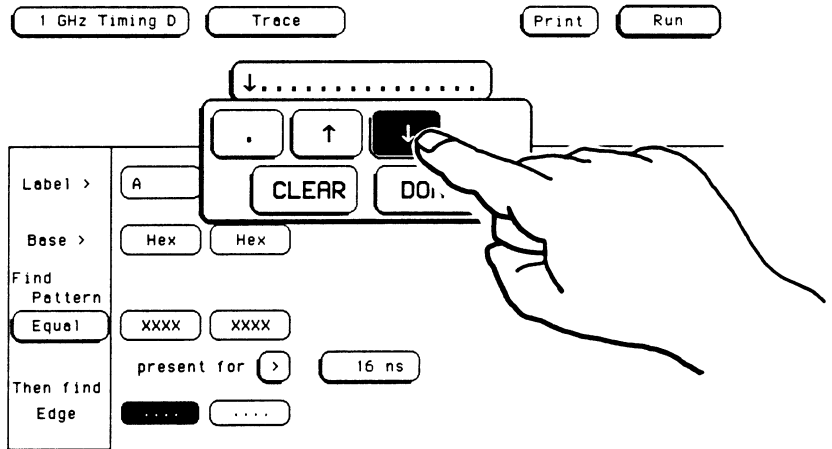

To specify a positive edge, move the cursor with the knob on the front panel to the channel you want and touch the upward arrow (↑) key. The period changes to ↑ as shown below.

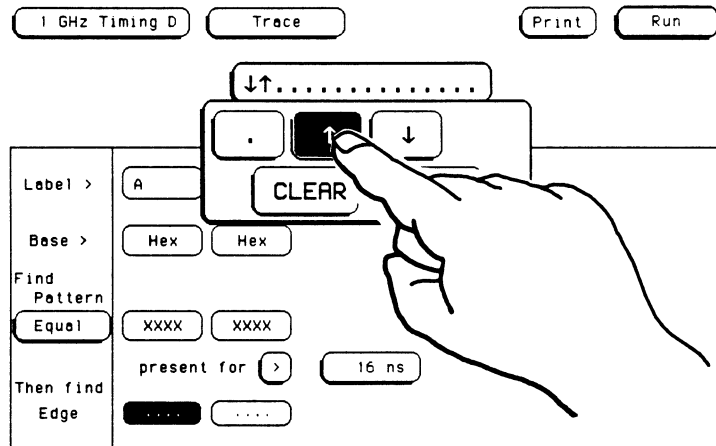

If you want to delete an edge specification for a channel, move the cursor to that channel and touch the period (.) key. To clear an entire label, touch the **CLEAR** key.

Note

*Since the analyzer looks at the edges to trigger on as ORed edges, it can trigger on any edge shown, without regard to the order shown on the **Trace** menu. Because of this, you must clear any unwanted edges so that the analyzer doesn't consider them trigger conditions.*

When you have finished specifying edges for this field, touch the **DONE** key and the pop-up will disappear.

Note

A dollar sign (\$) will appear in a edge field whenever a value cannot be displayed in the current base. The information in that field is still valid and the actual value can be displayed by changing to a more appropriate base (such as, from "Hex" to "Binary").

7

Acquiring Data

Introduction

When the HP 16500A is first powered up, none of the modules installed in the mainframe are running. This prevents any unwanted interaction between modules.

Run/Stop Field

The **Run/Stop** field controls how the timing analyzer acquires waveform data. This field is located in the upper-right corner of all of the timing analyzer menus as shown below.



Label >	A	B	
Base >	Hex	Hex	
Find Pattern	Equal	XXXX	XXXX
Then find Edge	present for	>	16 ns
	*...	

There are two basic run modes in the timing analyzer: single and repetitive. In addition, the timing analyzer can run independent of other modules in the mainframe or in conjunction with other modules through the intermodule bus. In total, there are four possible run modes:

- **Independent Run Single** - the timing analyzer makes a single acquisition independent of the other modules in the mainframe and displays the results in the **Waveforms** menu.
- **Independent Run Repetitive** - the timing analyzer makes repetitive real-time acquisitions that are independent of the other modules in the mainframe. In this mode, the display is updated each time a new acquisition is made. You must touch **Stop** to stop the measurement.
- **Group Run Single** - the timing analyzer makes a single acquisition and displays the results in the **Waveforms** menu. Running is in conjunction with other modules through the intermodule bus.
- **Group Run Repetitive** - the timing analyzer makes repetitive real-time acquisitions. At the end of each run the analyzer stops and waits for an indication through the intermodule bus that the other modules have finished their acquisitions. Then the timing analyzer starts another acquisition. In this mode, the display is updated each time a new acquisition is made. You must touch **Stop** to stop the measurement.

The **Intermodule** menu lets you tell the mainframe which module is to send an arming signal and which modules are to act upon that arming signal. If you need more information on how to use the intermodule capabilities of the HP 16500A, see the chapter in the *HP 16500A Reference Manual* entitled "Intermodule Measurements."

If the field in the upper-right corner of the screen displays **RUN**, the timing analyzer is set to run independently of the other modules in the mainframe. If, however, this field displays **Group Run**, the logic analyzer is tied to another module or modules through the intermodule bus.

Single Mode

To start the analyzer running in the single acquisition mode, touch the green **Run** field and slide your finger down to the **Single** field in the pop-up until this field turns white. Then remove your finger from the screen.

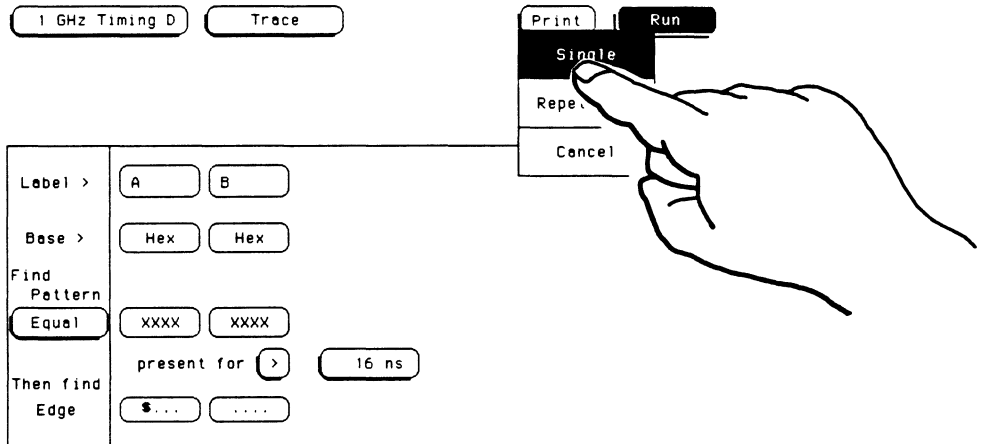

This starts the analyzer running in the **Single** mode. While the acquisition is being made, the **Run/Stop** field displays **Stop**. When the acquisition is completed, the field returns to **Run**. In this mode the analyzer makes a single acquisition and displays the data in the **Waveforms** menu. Then the analyzer waits until the **Run** field is touched again to make another acquisition.

Note

*The run mode (**Single** or **Repetitive**) will remain in the last mode that was selected until you change it. If **Single** was the last run mode selected, it will stay in **Single** for each run cycle until you change it to another mode.*

Repetitive Mode

To start the timing analyzer running in the repetitive mode, touch the green **Run** field and slide your finger down to the **Repetitive** field in the pop-up until this field turns white. Then remove your finger from the screen.

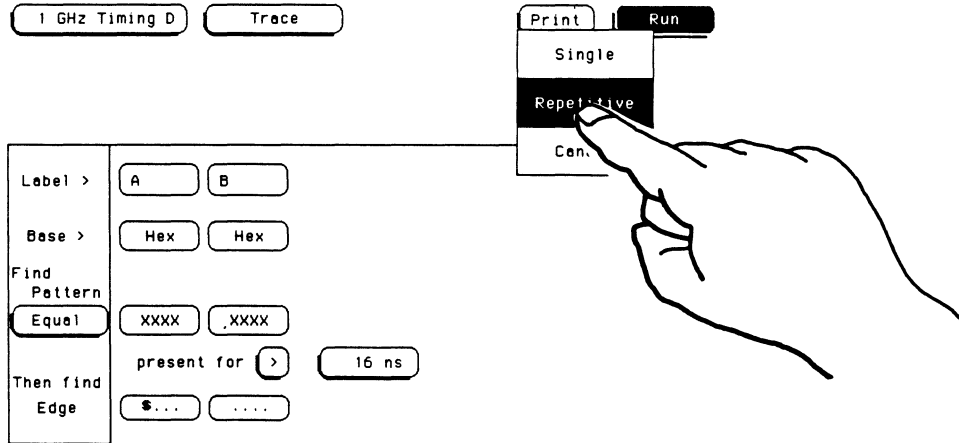

This starts the analyzer running in the **Repetitive** mode. In this mode, the display is updated each time a new acquisition is made. While the real-time repetitive acquisitions are being made the **Run/Stop** field displays **Stop**. When you want to stop making repetitive acquisitions, touch the **Stop** field. To resume making repetitive acquisitions, touch the **Run** field again.

If the analyzer cannot find the proper signal, the advisory "Waiting for Trigger" will be displayed.

Note

*The run mode (**Single** or **Repetitive**) will remain in the last mode that was selected until you change it. If **Repetitive** was the last run mode selected, it will stay in **Repetitive** for each run cycle until you change it to another mode.*

Cancel

If you accidentally touch the **Run** field or if you select the **Run** field and decide that you are not ready to run the measurement, slide your finger down to the **Cancel** field in the pop-up until this field turns white. Then remove your finger from the screen. This will return the analyzer to the state it was in before the **Run** field was selected.

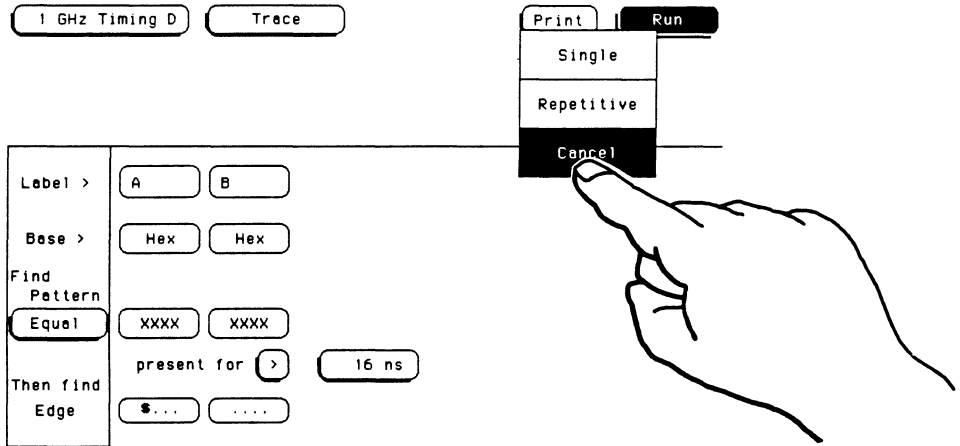

Reminder

Remember, when the **Run/Stop** field displays **Run**, the analyzer is stopped and touching the **Run** field will start the analyzer running. Likewise, when the **Run/Stop** field displays **Stop**, the analyzer is running and touching the **Stop** field will stop the measurement.

—

—

—

8

The Waveforms Menu

Introduction

The **Waveforms** menu is the display menu of the timing analyzer. When you touch the **Run** field, the analyzer runs the measurement and the data is displayed in this menu. The default **Waveforms** menu is shown below.

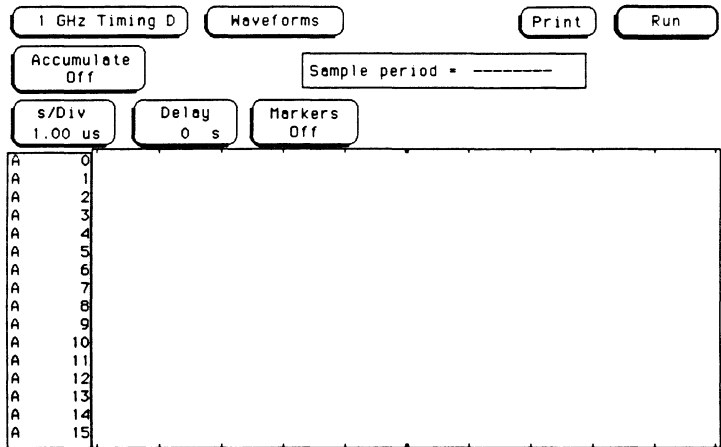

The **Waveforms** menu is divided into two main areas: the menu area and the waveforms area. The menu area is the top one-third of the screen and the waveforms area is the bottom two-thirds of the screen.

Menu Area

The menu area (as shown below) contains the fields that allow you to change the display parameters, place markers, and display waveform measurement parameters.

The Menu Area interface consists of several control elements:

- 1 GHz Timing D**: A button for timing settings.
- Waveforms**: A button for waveform display options.
- Print**: A button for printing the display.
- Run**: A button for executing the measurement.
- Accumulate Off**: A button to toggle the accumulate function.
- Sample period = -----**: A field for setting the sample period.
- s/Div 1.00 us**: A button for setting the vertical scale.
- Delay 0 s**: A button for setting the delay.
- Markers Off**: A button to toggle the markers function.

Waveforms Area

The waveforms area (as shown below) displays the data that the timing analyzer acquires. The data is displayed in a format similar to an oscilloscope with the horizontal axis representing time and the vertical axis representing amplitude. The basic difference between an oscilloscope display and the timing analyzer display is that the timing analyzer's vertical axis only displays highs (above threshold) and lows (below threshold). Also, the waveform lows on the timing analyzer are represented by a thicker line than the highs for easier differentiation. This makes it much easier and quicker to discriminate between traces.

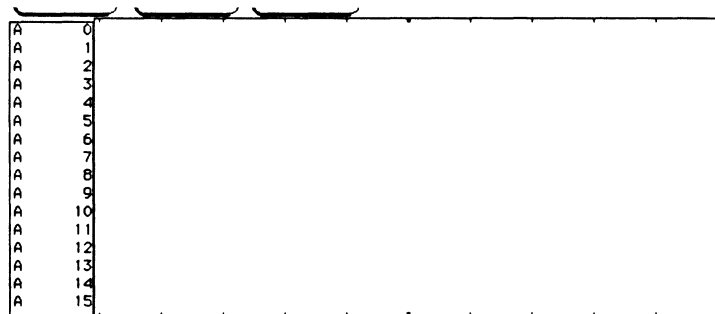

Waveforms Menu Field Index

The pictorial index shown below gives you a visual map of the **Waveforms** menu. It lists the name of each field in the menu, along with the page or chapter number where you will find more information about its function.

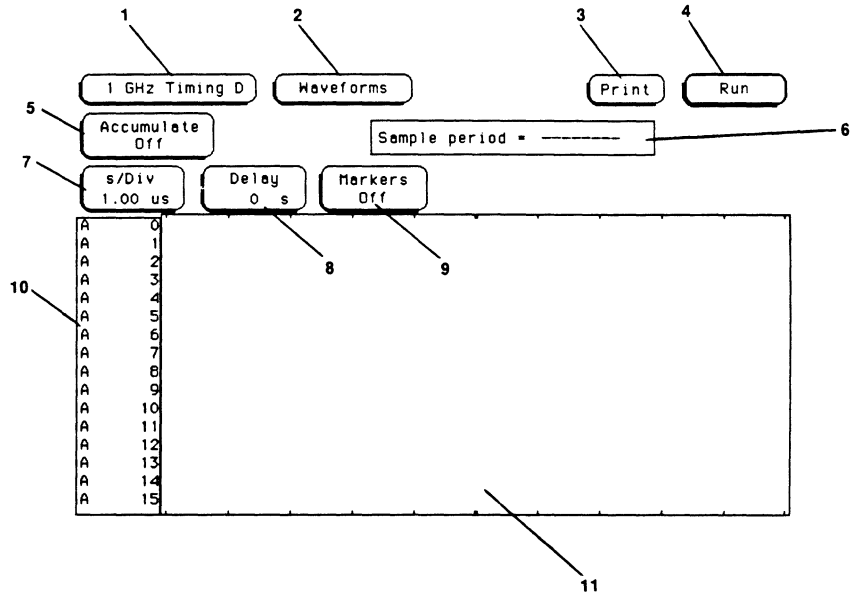

	Description	Manual Page or Chapter
1	Module Field	Chapter 3
2	Menu Field	Chapter 3
3	Print Field	Chapter 14
4	Run Field	Chapter 7
5	Accumulate Field	Page 8-5
6	Sample Period	Page 8-6
7	Time/Division Field	Page 8-7
8	Delay Field	Page 8-8
9	Markers Field	Chapter 10
10	Channel Label Field	Chapter 9
11	Waveforms Display	Page 8-2

Waveforms Menu Map

The menu map for the **Waveforms** menu is shown below.

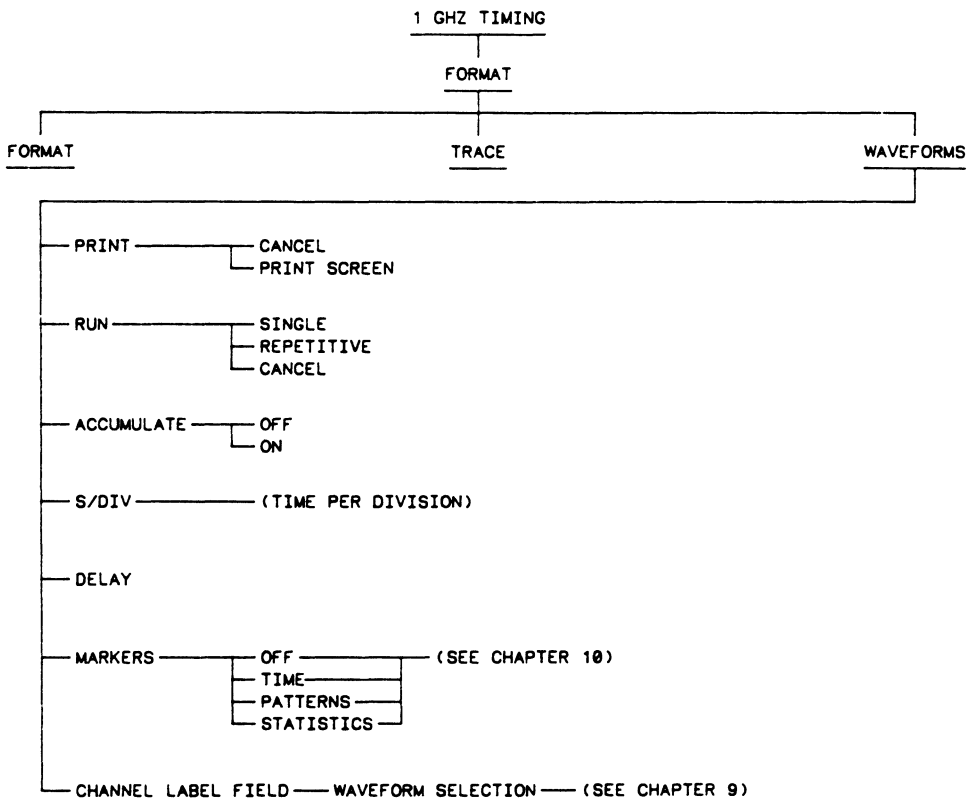

18515/BL14

Accumulate Field

Touching the **Accumulate** field toggles the accumulate mode on and off.

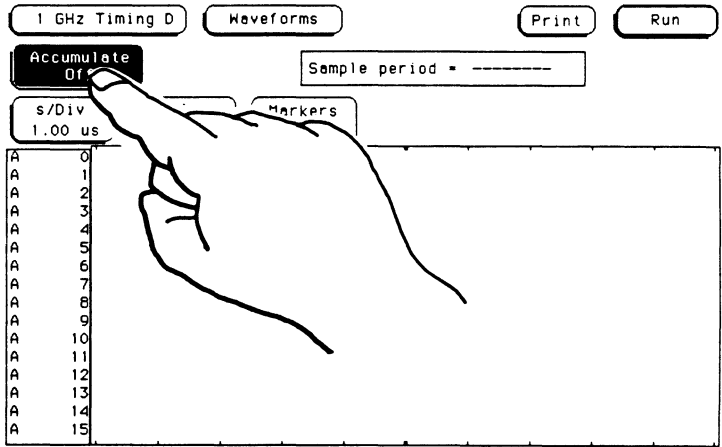

When accumulate is on, the timing analyzer displays the data from a current acquisition on top of the previously acquired data.

When you are running the analyzer in the **Single** mode, new data is displayed on top of the old data each time **Run** is selected as long as you stay in the **Waveforms** menu. Leaving the **Waveforms** menu always clears the accumulated data.

If you are running the analyzer in the **Repetitive** mode, data is cleared from the screen only when you start running a measurement after stopping the previous acquisition by touching **Stop**.

Sample Period

The sample period varies with the current setting of the time per division (**s/Div**) field. When you touch **Run**, the analyzer looks at the current setting of the **s/Div** field and calculates the lowest sample period available that will fill the screen.

Note

*The sample period displayed is the sample period of the last acquisition. If you change the **s/Div** setting, you must touch **Run** to initiate another acquisition before the sample period is updated.*

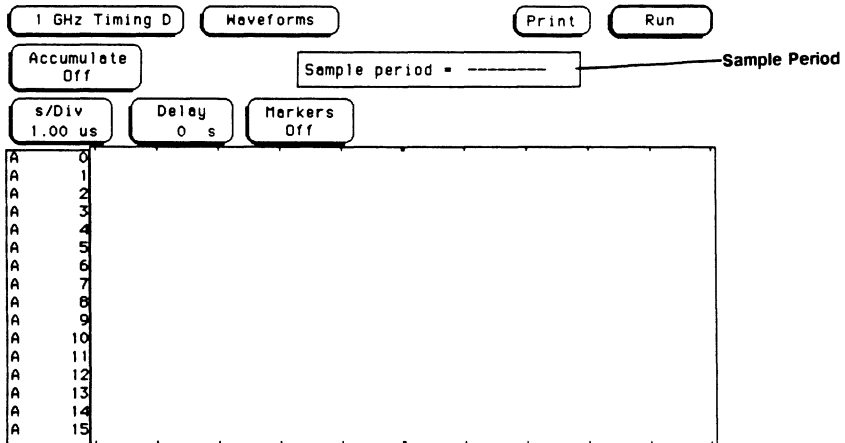

s/Div Field

The time per division (**s/Div**) field allows you to change the width of the time window of the **Waveforms** menu. When the **s/Div** field has a light-blue background, you can change the time per division by rotating the knob on the front panel. Rotating the knob increments or decrements the value of this field in a 1-2-5 sequence from 1 ns to 1.00 s. To increase the value, rotate the knob counterclockwise. To decrease the value, rotate the knob clockwise.

If you touch the **s/Div** field when it already has a light-blue background, a pop-up keypad will appear on screen as shown below. Use this keypad to enter the value you want for the time per division. To clear the value and start over, touch the **CLEAR** key. When you are finished entering the value, touch the **DONE** key.

Note

When you enter a value from the keypad, the value for time per division does not have to be a 1-2-5 sequence.

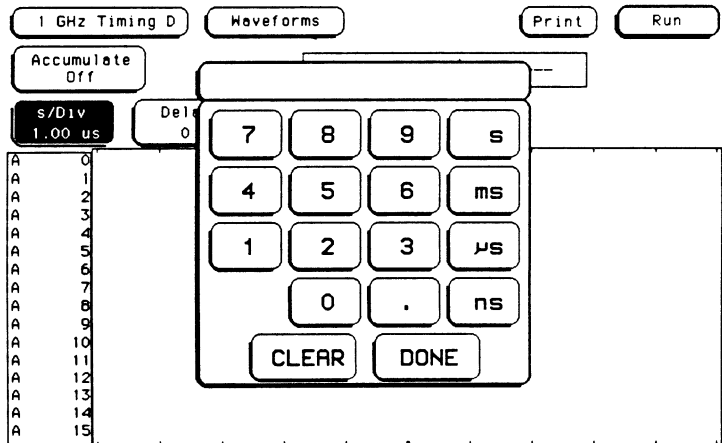

Note

If you attempt to set the time per division to a value outside the given range, the analyzer will automatically set it to the nearest limit.

Delay Field

The **Delay** field allows you to enter either a positive or negative delay. This allows you to place the time window (selected by s/Div) of the acquired data at center screen.

The tic mark at the horizontal center of the top of the waveforms area represents the trigger + delay reference point. The red vertical dotted line (shown on screen) represents the trigger point. When delay = 0, the trigger point is at the horizontal center of the waveforms display.

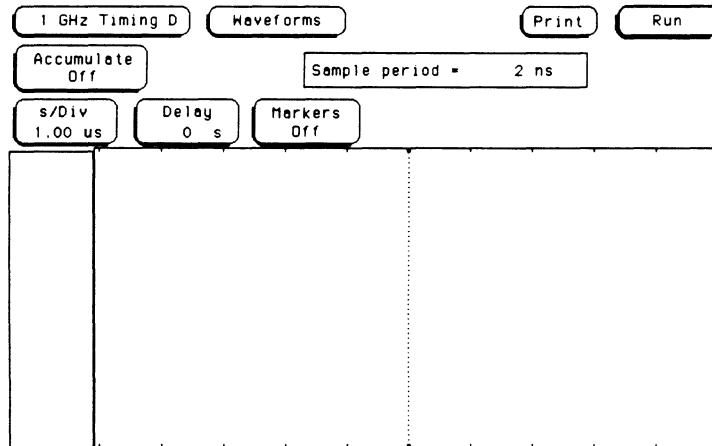

If you want to see the data after the trigger point, enter a positive delay. If you want to look at the data before the trigger point, enter a negative delay. The timing analyzer is capable of maximum delays of -100 seconds to +53.5 k seconds.

To change the the amount of delay, touch the **Delay** field and when it turns light blue, change the delay by rotating the knob on the front panel. If you touch the **Delay** field when it already has a light-blue background, a pop-up keypad will appear on screen as shown below. Use this keypad to enter the value you want for the delay. To clear the value and start over, touch the **CLEAR** key. When you are finished entering the value, touch the **DONE** key.

Note

If you attempt to set the delay to a value outside the given range, the analyzer will automatically set it to the nearest limit.

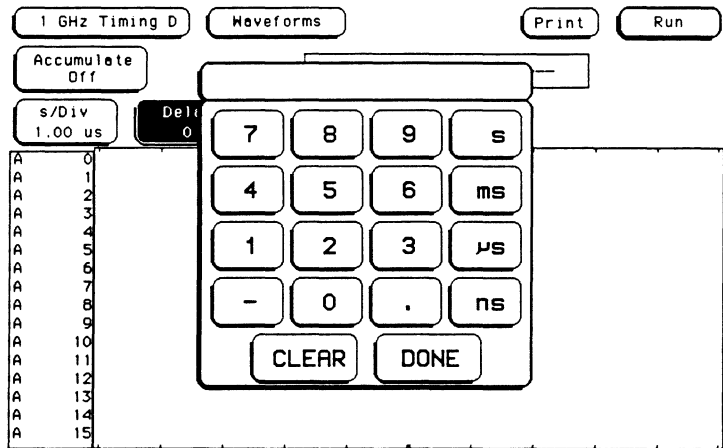

—

—

—

9

Waveform Selection

Introduction

This chapter will show you how to insert, replace, and delete input channels on the waveform display and how to perform channel mode functions. Any of these operations can be performed from the timing analyzer **Waveforms** menu.

The dark-blue **Channel Label** field to the left of the waveform display shows the input channels that are being displayed. In this example, **A0** through **A15** signify INPUT 0 through INPUT 15 of the analyzer card. The **Waveforms** menu can display up to 24 input channels at the same time.

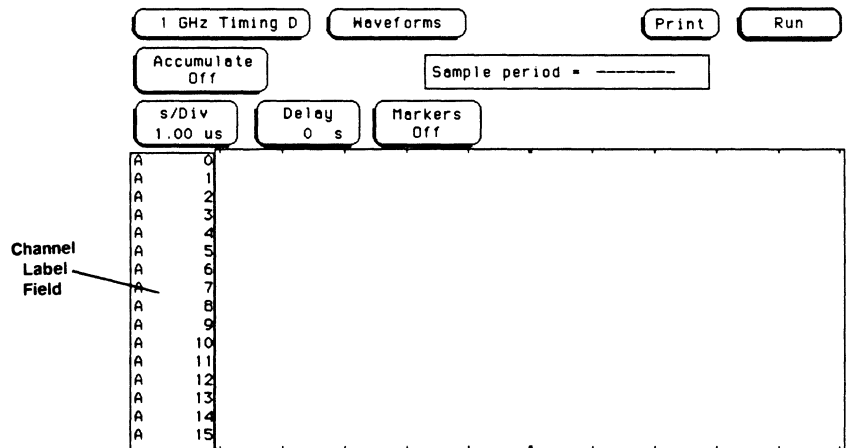

When you touch the **Channel Label** field, the **Waveform Selection** pop-up menu will appear as shown below. This pop-up menu allows you to insert, replace, or delete an input channel and choose channel modes.

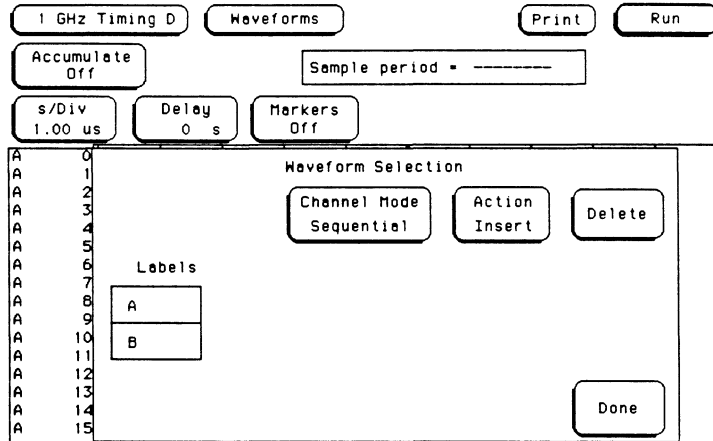

Waveform Selection Menu Map

The menu map for the **Waveform Selection** pop-up is shown below.

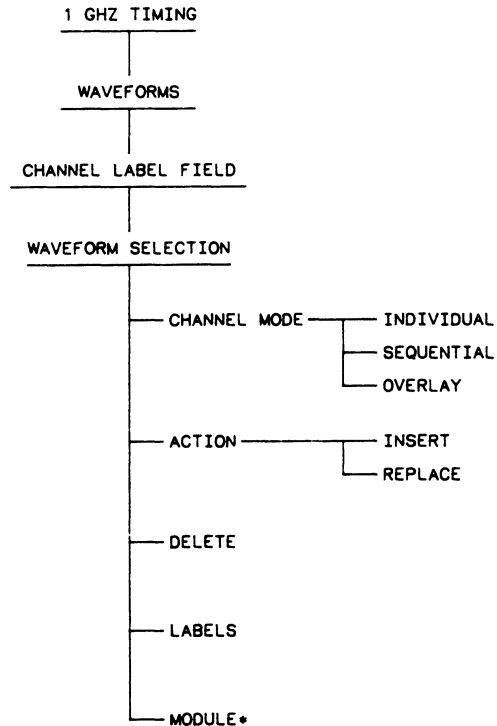

18515/BL15

* When the module is part of an intermodule configuration, a field appears in the upper-left corner of the **Waveform Selection** menu to allow you to insert time correlated waveforms from other modules. For more information, refer to the section "Inserting Waveforms from other Modules" in this chapter.

Channel Mode

While you are still in the **WAVEFORM SELECTION** pop-up, touch the **Channel Mode** field. A pop up will appear showing the channel mode selections available.

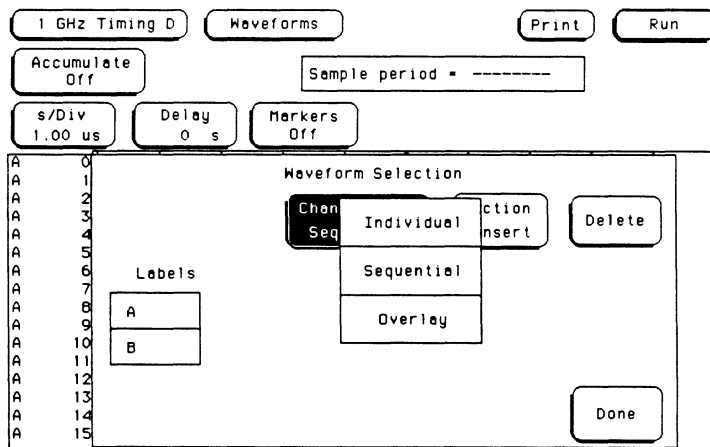

The **Channel Mode** field selects how the waveform will be displayed.

- The **Individual** channel mode allows you to display individual input channels on the waveform display.
- The **Sequential** channel mode allows you to display all the channels that are grouped within a particular in their appropriate sequence.
- The **Overlay** channel mode allows you to to overlay all of the channels that are grouped within a particular label to compare waveform data.

Note

*If you want to overlay only certain channels within a label, go to the **Format** menu and group these channels into a new label. Then return to the **Waveform Selection** pop-up of the **Waveforms** menu and overlay the channels.*

Replacing a Channel

After selecting the **Waveform Selection** pop-up by touching the **Channel Label** field, touch the **Action** field. Each time you touch this field, the action will toggle between **Insert** and **Replace**. This field allows you to insert a channel or replace a channel with another channel.

Turn the knob on the front panel both directions and notice that one of the channels in the channel label field is always highlighted in white. The area highlighted in white tells you where the channel will be inserted or replaced.

For example, to replace channel A0 with channel A5:

1. Touch the **Action** field until **Replace** is displayed.
2. Touch the **Channel Mode** field and when the pop-up appears, select **Individual**.
3. Turn the knob on the front panel so that **A0** is highlighted in white.
4. Touch the label **A** as shown below.

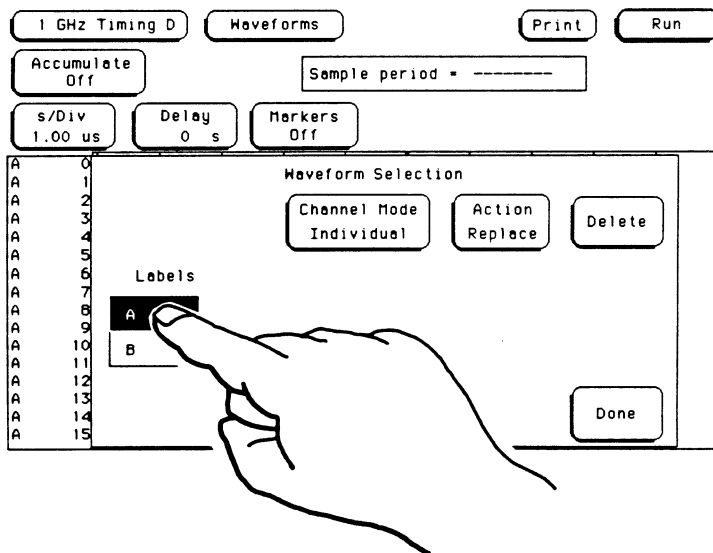

5. When the pop-up appears, touch **A5**.

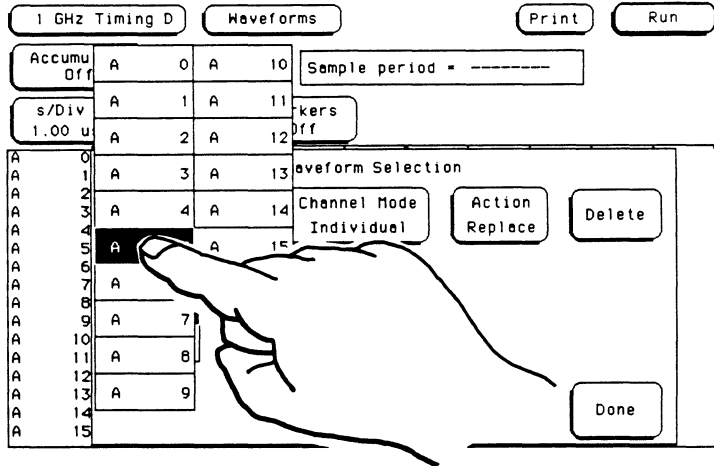

Input channel **A5** has now replaced **A0**. Remember, when you replace an input channel, the new channel replaces the input channel highlighted in white.

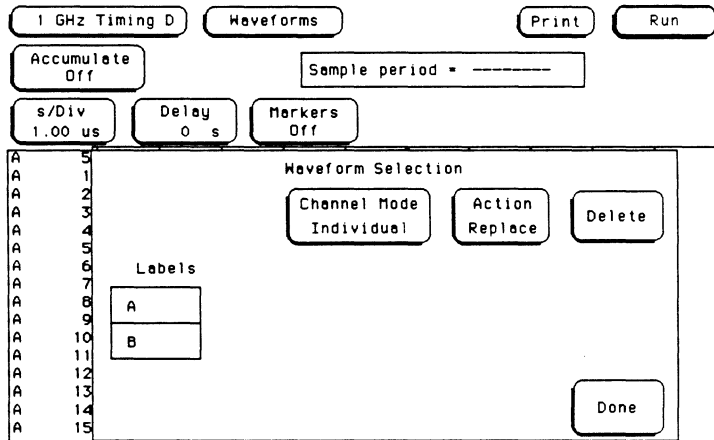

In the **Sequential** channel mode, the analyzer will replace up to the number of labels displayed from the highlighted label to the bottom of the screen with the channels of the label you selected.

1. Touch the **Channel Mode** field and when the pop-up appears, select **Sequential**.
2. Turn the knob on the front panel so that **A6** is highlighted in white.
3. Touch the label **A** field and labels **A6** through **A15** will be replaced by labels **A0** through **A9**.

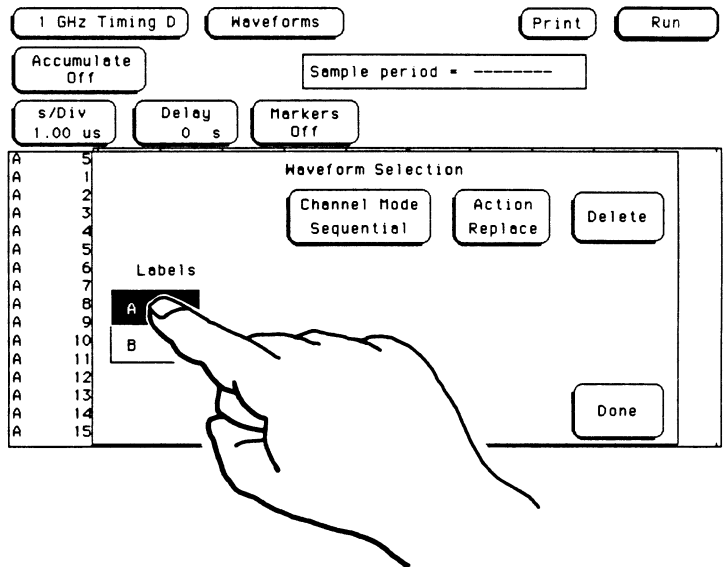

Inserting a Channel

Inserting an input channel works similar to replacing a channel.

1. Touch the **Channel Label** field.
2. When the **Waveform Selection** pop-up appears on screen, touch the **Action** field until **Insert** is displayed.
3. Turn the knob so that the channel at the top of the **Channel Label** field is highlighted in white.
4. Touch the label **A** as shown below.

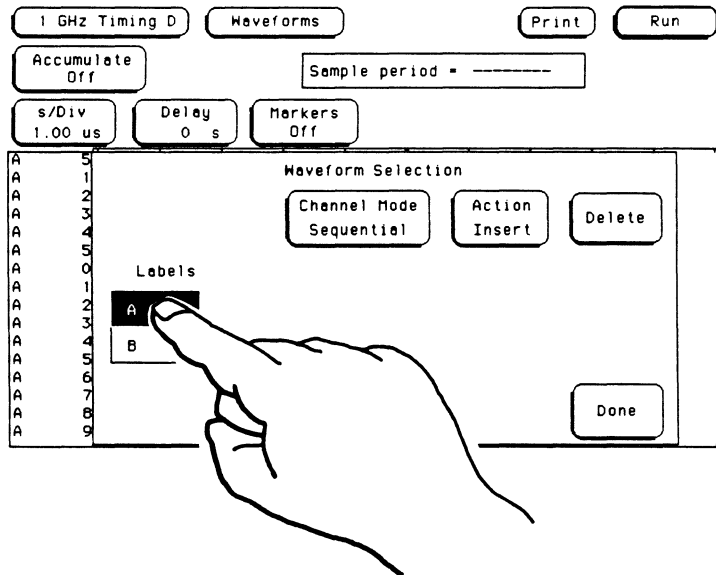

Input channels **A0** through **A15** have now been inserted after the first channel.

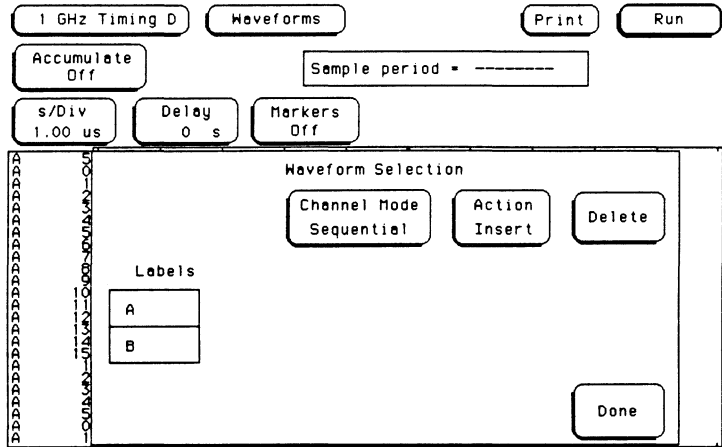

Remember, when you insert an channel, the inserted channel will always appear below the input channel highlighted in white.

Note

*The analyzer will only display up to 24 channels on the **Waveforms** menu at one time. If you try to insert more than 24 channels, the excess channels will be pushed off screen and automatically deleted.*

Deleting a Channel

If you are not in the **Waveform Selection** pop-up menu, touch the channel label field at the left of the waveform display to return the **Waveform Selection** pop-up. Use the knob on the front panel to select the waveform label you want to delete. Then touch the **Delete** field in the pop-up and the input channel highlighted in white will be deleted.

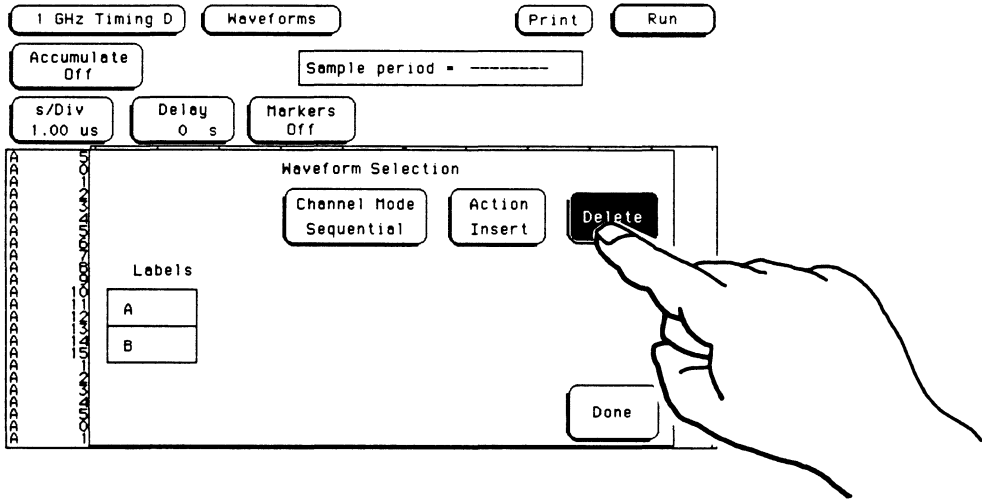

Touch **Done** when you are finished with the **Waveform Selection** pop-up.

Example

Suppose you wanted to compare the signals from Input A0 through Input A15. The easiest way to do this would be to put all of these waveforms on the same waveform display, or overlay the waveforms.

1. Touch the **Channel Label** field.
2. When the **Waveform Selection** pop-up appears, touch the **Channel Mode** field.
3. When the **Channel Mode** pop-up appears, touch the **Overlay** field.

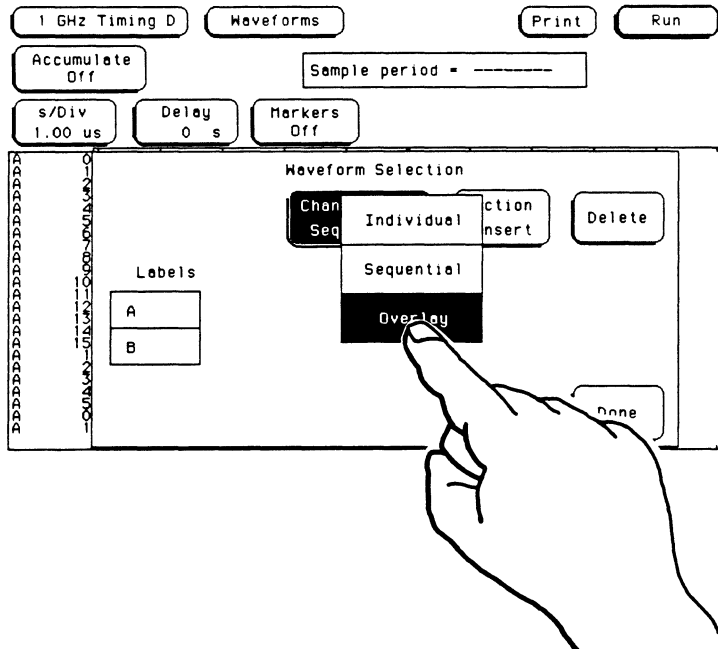

4. Now overlay Input 0 through Input 15 in the top waveform display.
 - a. Turn the knob so that **A0** is highlighted in white.
 - b. Touch the **Action** field until **Replace** is displayed.
 - c. Touch the label **A** in the pop-up and **A0** through **A15** will be displayed in the top channel label field (**A all**).

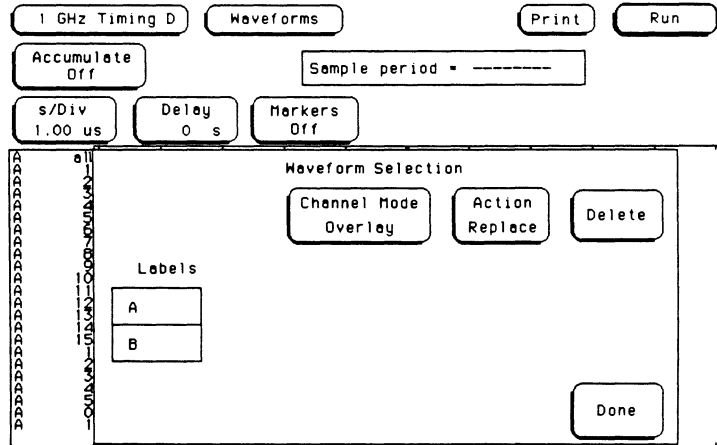

5. Touch the **Done** field in the pop-up to return to the waveforms display.

To display only **A all**, return to the **Waveform Selection** pop-up and rotate the knob until the channel directly below **A all** is highlighted in white. Then touch the **Delete** field once for each channel you want deleted. When you are finished, touch **Done**.

Inserting Waveforms from other Modules

When the module is part of an intermodule configuration, a field appears in the upper-left corner of the **Waveform Selection** menu to allow you to insert time correlated waveforms from other modules. When you select this field, a pop-up appears listing the modules that contain time correlated waveforms.

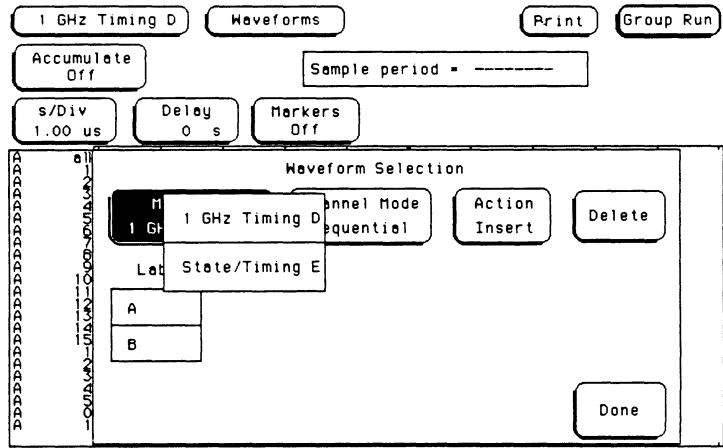

To insert waveforms from other modules or replace existing waveforms with waveforms from other modules simply select the module that contains the waveforms you need to insert.

When the pop-up disappears, the name of the module you selected is displayed in the upper-left corner of the **Waveform Selection** menu. The labels or channels for this module are listed in the label section of the menu. In this example, the only label that is listed is "POD 1."

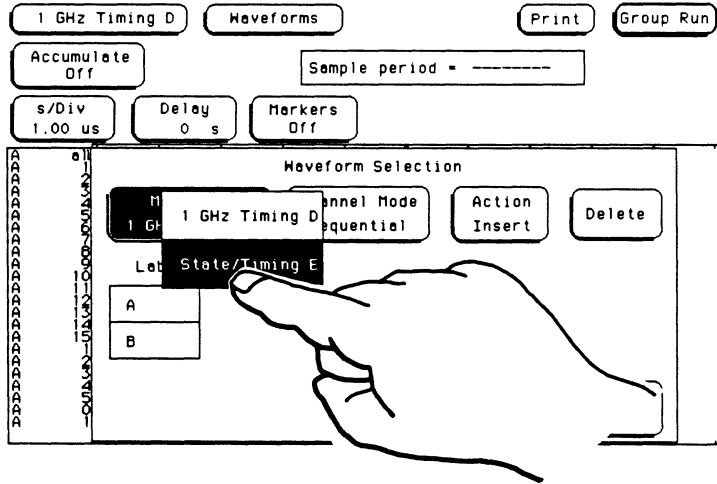

To insert, replace, or delete channels, simply follow the same procedures shown earlier in this chapter.

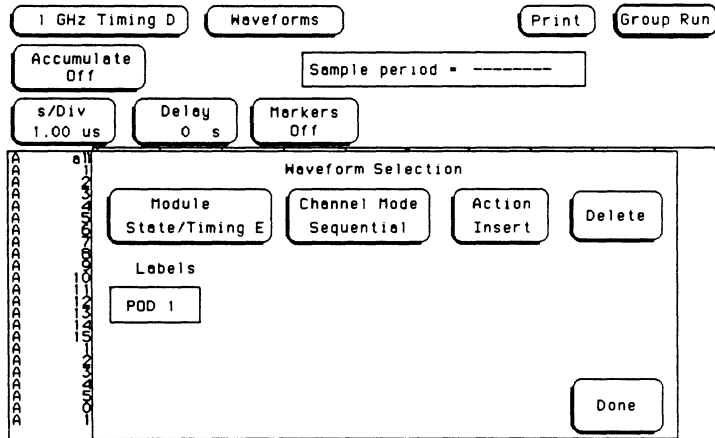

10

Markers

Introduction

The X and O markers are used to make time measurements between specific points on the waveforms display. The X marker is displayed as a green vertical line and the O marker is displayed as a yellow vertical line. The trigger marker is a red vertical line.

Markers Field

The **Markers** field allows you to specify how the X and O markers will be positioned on the waveform data. The options are:

- Off
- Time
- Patterns
- Statistics

Markers Menu Map

The menu map for the **Markers** field of **Waveforms** menu is shown below.

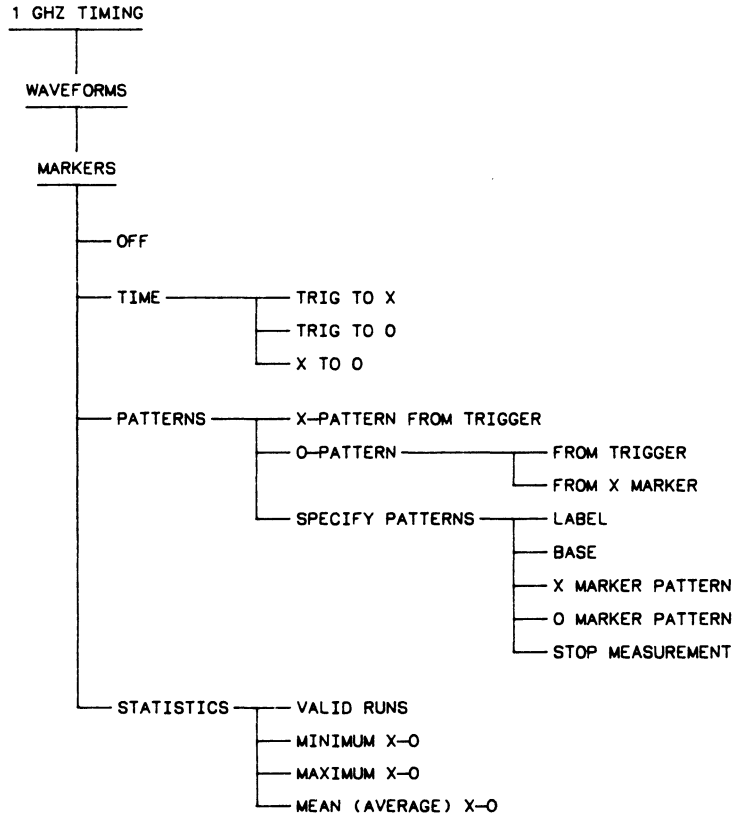

16515/BL16

Selecting a Markers Function

To select a particular markers function, touch the **Markers** field. A pop-up will appear as shown below. Touch the selection you want and the pop-up will disappear, bringing up the appropriate fields.

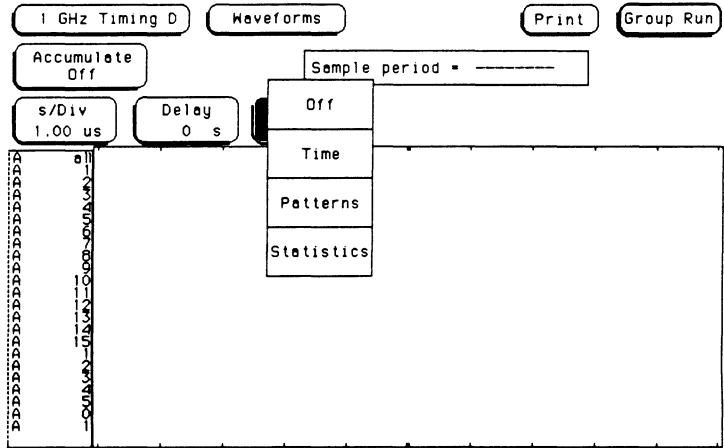

Markers Off

When the markers are off they are not visible and the sample period is displayed as shown below. The sample period displayed is the sample period of the last acquisition. If you change the **s/Div** setting, you must touch **Run** to initiate another acquisition before the sample period is updated.

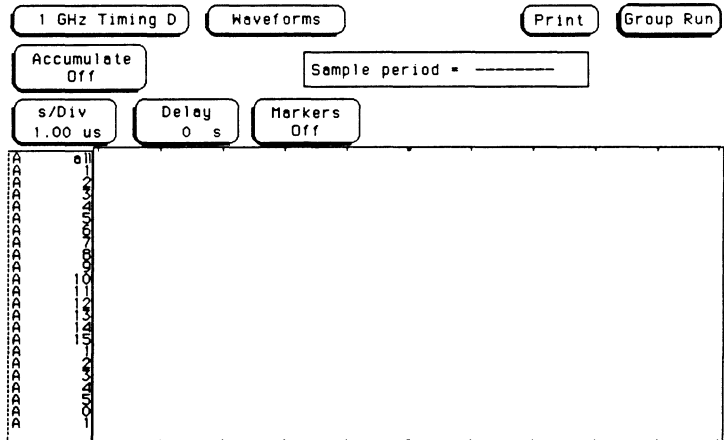

Markers Time

When the markers are set to **Time**, you can place the markers on the waveforms at events of interest and the timing analyzer will display:

- Time from X to O
- Time from Trig(ger) to X
- Time from Trig(ger) to O

To position the markers, touch either the **Trig to X** or **Trig to O** field and when the background for this field turns light blue, rotate the knob on the front panel to position the appropriate marker. The current time setting for the marker will appear in the appropriate field.

If you touch the **Trig to X** or **Trig to O** field when the field is already light blue, a pop-up keypad appears on screen as shown below.

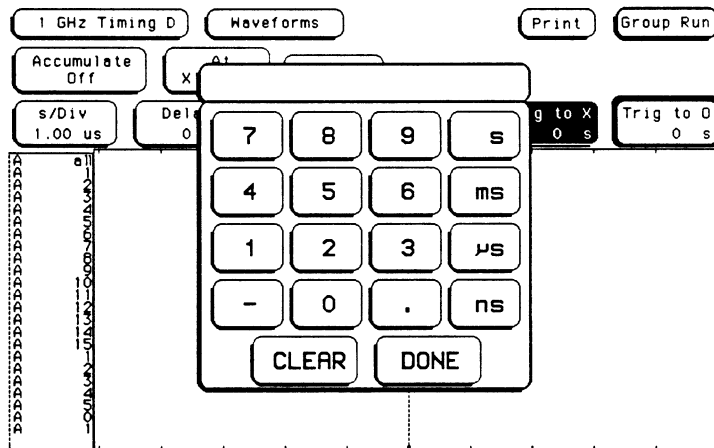

Use the keypad to enter the appropriate value for the field you selected. To clear the value and start over, touch the **CLEAR** key. When you are finished entering the value, touch the **DONE** key.

The time in the **X to O** field will change according to the position of the X (green) and O (yellow) markers. If you select the **X to O** field, rotating the knob will move both the X and O markers, but the relative placement between the markers will not change.

Markers Pattern

When the markers are set to **Pattern** as shown below, you can preset the timing analyzer to place the markers on specific patterns. You can also configure the analyzer to place the markers on a particular occurrence of each marker pattern. This allows you to find the time between specific patterns in the acquired data.

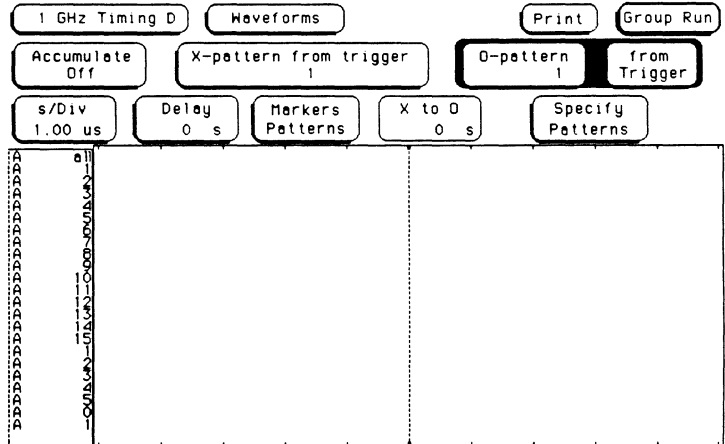

Patterns for each marker (X and O) can be specified for each label in the **Specify Patterns** pop-up menu. You can also specify whether the marker is placed on the pattern at the beginning of its occurrence (entering) or at the end of its occurrence (leaving). The timing analyzer searches for the logical "AND" of patterns for all labels even though only one label's search pattern can be specified at a time.

Label A Base Hex

X Marker > entering pattern XXXX

O Marker > entering pattern XXXX

Stop measurement when X-O Off

Done

Another feature that you have when **Markers** are set to **Pattern** is the **Stop measurement when X-O** feature. The options for this field are:

- Off
- Less than
- Greater than
- In range
- Not in range

With this feature you can use the timing analyzer to look for a specified time or range of time between the marked patterns and have it stop acquiring data when it sees this time between markers.

Note

The upper and lower "range" boundaries must NOT be the same value. For example, if you want to stop a measurement when X and O markers are in the range of 200 ns, set the range values to 190 ns and 210 ns. This eliminates erroneous measurement termination.

Specifying Patterns

To specify patterns, touch the **Specify Patterns** field and a pop-up will appear as shown below.

A screenshot of a dialog box titled "Specify Patterns". It contains the following fields and controls:

- Label:** A text field containing the letter "A".
- Base:** A dropdown menu currently set to "Hex".
- X Marker:** A label followed by a text field containing "entering", a label "pattern", and a text field containing "XXXX".
- 0 Marker:** A label followed by a text field containing "entering", a label "pattern", and a text field containing "XXXX".
- Stop measurement when X=0:** A dropdown menu currently set to "Off".
- Done:** A button in the bottom right corner.

Label Field Touch the Label field and a pop-up will appear displaying all of the current labels. These are the same labels that you defined in the **Format** menu. Select the label you want and the pop-up will disappear.

A screenshot of the same "Specify Patterns" dialog box, but with a pop-up menu open over the "Label" field. The pop-up menu lists the following options:

- A** (highlighted)
- A
- Hex

The rest of the dialog box fields and controls are the same as in the previous screenshot.

The Base Field

The **Base** field allows you to specify the numeric base in which you want to define a pattern for a label. These fields also let you use a symbol that was specified in the **Format** menu for the pattern. Each label has its own base defined separately from the other labels. If you select the **Base** field, you will see the following pop-up menu.

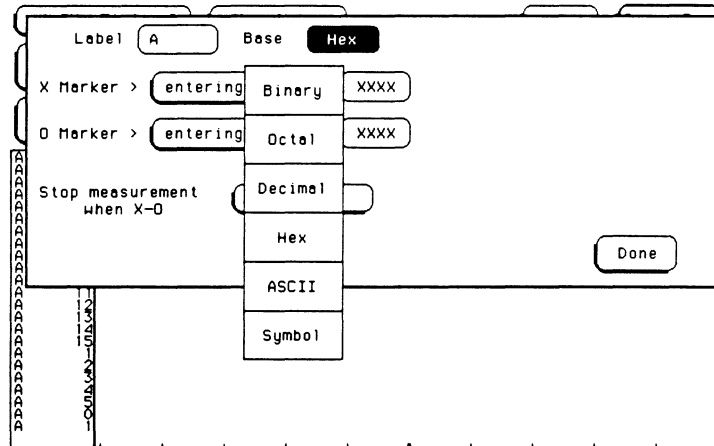

One of the options in the **Base** pop-up is **ASCII**. This allows you to see the characters represented by the pattern you specified in the **pattern** field. When you select ASCII, you cannot specify ASCII characters directly. You must specify a pattern in one of the other bases and then switch to the ASCII base to see what characters the pattern represents.

The **Symbol** option in the **Base** pop-up allows you to use a symbol that has been already specified in the **Format** menu as a pattern, or allows you to specify absolute and enter another pattern. You specify the symbol you want in the **pattern** field.

Decide which base you want to define your pattern in and select that option. The pop-up will disappear, placing your choice in the appropriate field.

Entering/Leaving

The field to the right of **X Marker >** and **O Marker >** allows you to specify whether the the marker is placed on the pattern at the beginning of its occurrence (entering) or at the end of its occurrence (leaving).

By touching this field, you can toggle between **entering** and **leaving**.

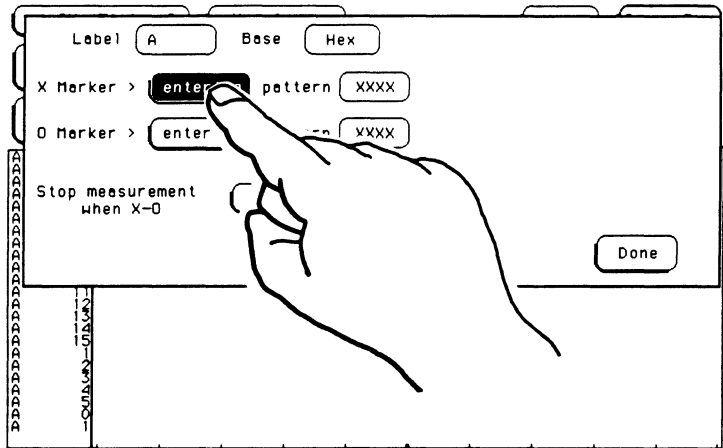

Pattern

With the **Pattern** fields, you configure the timing analyzer to look for specific patterns and place the X and O markers on those patterns. Each label has its own pattern field that you use to specify a pattern for that label.

After completing an acquisition, the timing analyzer looks for a pattern in your data that is the logical **AND** of all of the patterns specified for all the labels for each marker. That is, it looks for a simultaneous occurrence of all of the specified patterns. When it finds the appropriate patterns, it places the markers on the patterns, measures the time between the markers, and places the result in the **X to O** field of the **Waveforms** menu.

If the timing analyzer cannot find a valid pattern for either the X or the O marker, an error message will appear on screen indicating that a marker pattern was not found. If you are running the measurement in the **Repetitive** mode, the analyzer will run the measurement again and look for valid patterns for the X and O markers. If you are running in the **Single** mode, the measurement will stop when the error message appears on screen.

ASCII Base. When you touch a pattern field, one of three things will happen. If you selected **ASCII** as your base, then the error message "**ASCII entry not available**" will appear to remind you that you cannot specify a pattern in ASCII. You must specify a pattern in one of the other bases and then switch to the ASCII base to see what characters the pattern represents.

Symbols Base. If you selected **Symbol** for your base, a pop-up will appear as shown below.

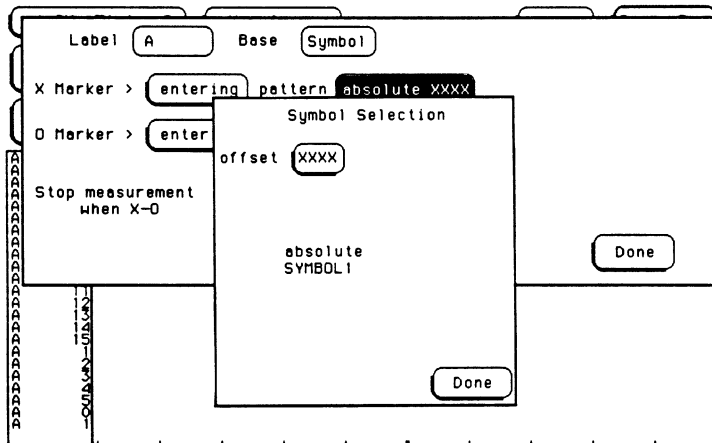

The pop-up lists all the symbols defined for that label and contains the option "absolute."

Note

When you specify symbols in the **Format Symbols** menu, you also specify the number of characters in the symbol name that are to be displayed (**Symbol Width**). If you specify three for the **Symbol Width**, only the first three characters of your symbols will be displayed in the **pattern** field. In addition, only the first three letters of "absolute" will be displayed.

To select an option from the pop-up, rotate the knob to scroll the options up and down through the cursor until the desired option is inside the cursor.

If you wish to select a symbol for the pattern, rotate the knob on the front panel until the desired symbol is displayed inside the cursor. Then touch **Done** and that symbol will be displayed in the appropriate pattern field.

If you specified a range for the symbol you specified in the **Format** menu or if you select the **absolute** option, another field appears in the pop-up to allow you to specify a pattern which isn't defined by one of the other symbols. If you touch this field (marked **offset**), a pop-up keypad appears on screen as shown below.

Note

The pop-up keypad will vary depending on which **Base** you selected in the **Format Symbols** menu.

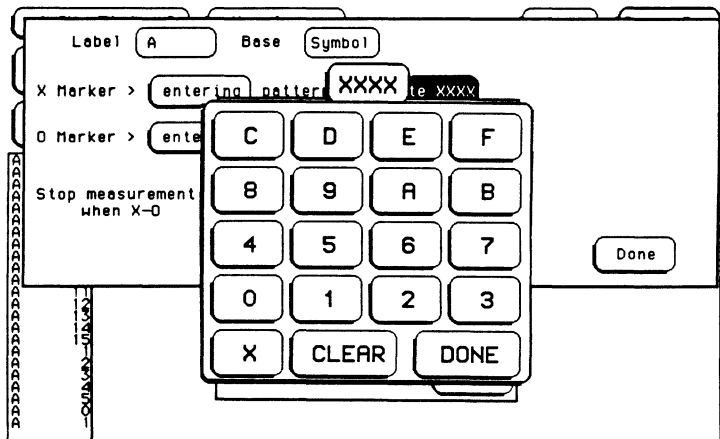

Use the keypad to enter the pattern you want, but be sure to enter the pattern in the same numeric base that you specified in the **Base** field of the **Format Symbols** menu.

- X = DON'T CARE

To clear the value and start over, touch the **CLEAR** key. If you make an error while entering the value, move the cursor to the incorrect character with the knob and enter the correct character. When you are finished entering the pattern, touch the **DONE** key.

Note

*You cannot specify a pattern if the base you selected in the **Symbols** menu was **ASCII**. If you want to change the pattern, you must define the pattern in one of the other bases and then switch back to **ASCII**.*

Numeric Base. If you selected **Binary**, **Octal**, **Decimal**, or **Hex** as your base, then a pop-up keypad will appear on screen (as shown below) when you select a **pattern** field.

Note

*The pop-up keypad will vary depending on which **Base** you selected for this label.*

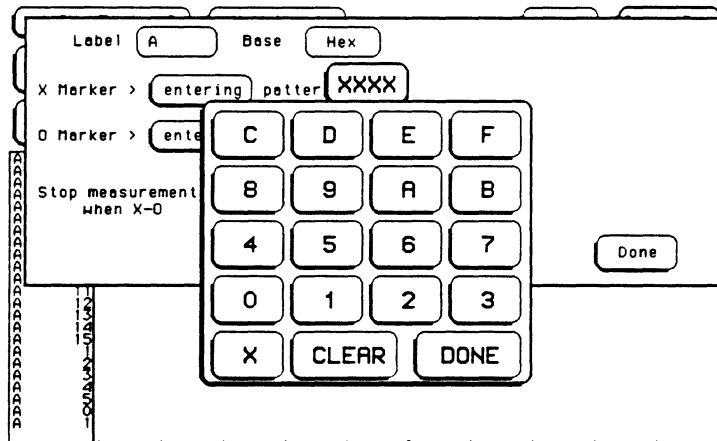

Use the keypad to enter the pattern you want, but be sure to enter the pattern in the same numeric base that you specified in the **Base** field.

- X = DON'T CARE

To clear the value and start over, touch the **CLEAR** key. If you make an error while entering the value, move the cursor to the incorrect character with the knob and enter the correct character. When you are finished entering the pattern, touch the **DONE** key.

Note

A dollar sign (\$) will appear in a pattern field whenever a number cannot be represented in the current base. The information in that field is still valid and the actual value can be displayed by changing to a more appropriate base (such as, from "Hex" to "Binary").

Stop Measurement

Touch the field to the right of **Stop measurement when X=0** and a pop-up appears as shown below.

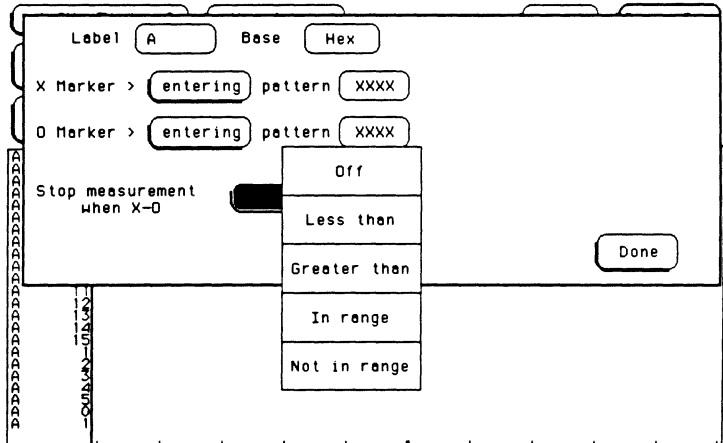

With the stop measurement feature you can use the timing analyzer to look for a specified time or range of time between the marked patterns and have it stop acquiring data when it sees this time between markers.

Note

*Since the timing analyzer places the markers after completing an acquisition, the **Stop Measurement** feature can only be used when you are running a measurement in the **Repetitive** mode.*

If you select **Less than** or **Greater than**, the pop-up disappears and a new field appears to allow you to specify the time between markers. Each time an acquisition is completed, the timing analyzer looks for the specified patterns for the X and O markers and, when it finds the patterns, it places the X and O markers on the appropriate patterns. Then the analyzer measures the time between the markers and compares this value to the value you specified in the **Stop measurement** fields. If the value meets the specified **Less than** or **Greater than** condition, the analyzer stops the measurement and the message **Stop Condition Satisfied** appears on screen. Otherwise, the analyzer continues to run the measurement until the stop measurement conditions are met.

The image shows a screenshot of a timing analyzer's configuration window. The window has a title bar with three tabs. The main content area is divided into several sections:

- Label:** A text field containing the letter 'A'.
- Base:** A dropdown menu currently set to 'Hex'.
- X Marker >:** A button labeled 'entering' followed by a text field containing 'XXXX'.
- O Marker >:** A button labeled 'entering' followed by a text field containing 'XXXX'.
- Stop measurement when X-O:** A dropdown menu set to 'Less than' and a text field containing '0 s'.
- Done:** A button located in the bottom right corner of the window.

The window has a standard Mac OS-style border with a vertical scroll bar on the left side.

If you select **In range** or **Not in range**, two fields appear to allow you to specify the upper and lower limits for the amount of time between the markers. If you select **In range**, the time between the markers must fall between the upper and lower limits to stop the measurement. If you select **Not in range**, the time between the markers must fall outside of the specified limits to stop the measurement. If the time between the markers does not meet the specified range conditions, the analyzer will continue to run the measurement until the stop measurement conditions are met.

Note

The upper and lower "range" boundaries must NOT be the same value. For example, if you want to stop a measurement when X and O markers are in the range of 200 ns, set the range values to 190 ns and 210 ns. This eliminates erroneous measurement termination.

The screenshot shows a configuration window with the following elements:

- Label:** A text box containing the letter 'A'.
- Base:** A dropdown menu currently set to 'Hex'.
- X Marker >:** A field with a button labeled 'entering' and a text box containing 'XXXX'.
- O Marker >:** A field with a button labeled 'entering' and a text box containing 'XXXX'.
- Stop measurement when X-O:** A section containing a dropdown menu set to 'In range', followed by two text boxes both containing '0 s', and the word 'to' between them.
- Done:** A button located at the bottom right of the configuration area.

On the left side of the window, there is a vertical stack of 'D' characters and a vertical line with the label 'COUNT' below it.

Knob Entry. To change the value of the numeric **Stop measurement** fields, make sure that the field you want to change has a light-blue background. If this field doesn't have a light-blue background, touch this field once and the background will change to light-blue. Once this field has a light-blue background, it is connected to the knob on the front panel and rotating the knob will change the value shown in this field. Rotate the knob clockwise to increase the value and counterclockwise to decrease the value.

Keypad Entry. If you touch the numeric field when it already has a light-blue background, a pop-up keypad will appear on screen as shown below. Use the keypad to enter the value you want. To clear the value and start over, touch the **CLEAR** key. When you are finished entering the value, touch the **DONE** key.

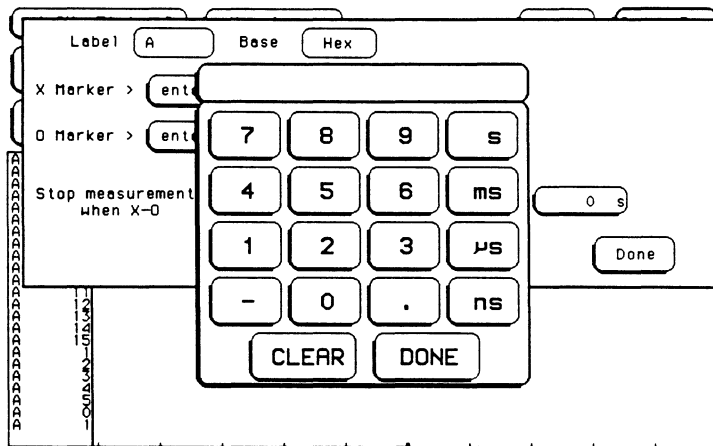

When you are finished configuring the **Specify Patterns** pop-up, touch **Done** and the pop-up will disappear.

X-Pattern from Trigger

Use the **X-pattern from Trigger** field to specify which occurrence of the specified pattern for the X marker that you want the X marker on. A negative value would indicate so many occurrences before the trigger, a positive value would indicate so many occurrences after the trigger, and zero would indicate at the trigger point. For example, if the value was 6, the timing analyzer would place the X marker on the sixth occurrence of the specified pattern after the trigger.

Knob Entry. To change the value of this field, touch the field once and the background will change to light-blue. Once this field has a light-blue background, it is connected to the knob on the front panel and rotating the knob will change the value shown in this field. Rotate the knob clockwise to increase the value and counterclockwise to decrease the value.

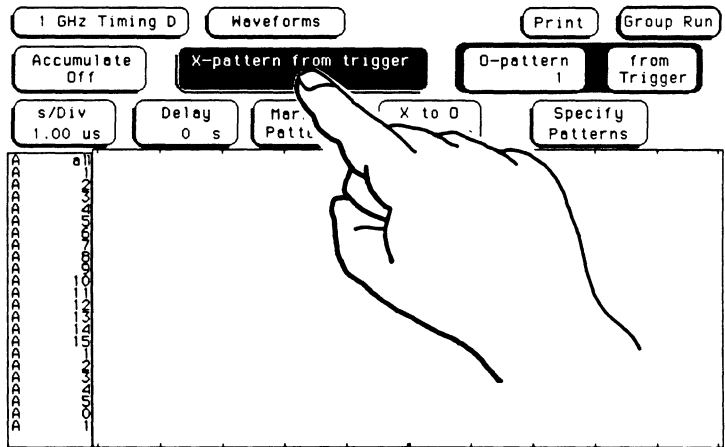

Keypad Entry. If you touch the field when it already has a light-blue background, a pop-up keypad will appear on screen as shown below. Use the keypad to enter the value you want. To clear the value and start over, touch the **CLEAR** key. When you are finished entering the value, touch the **DONE** key.

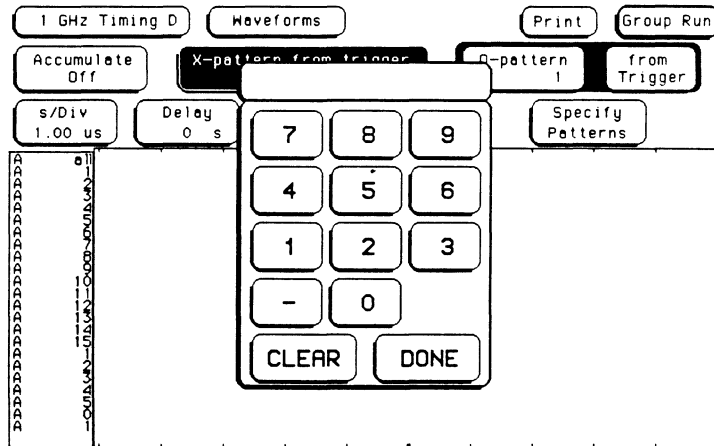

O-Pattern from Trigger/X marker

Use the **O-pattern from Trigger/X marker** fields to specify which occurrence of the specified pattern for the O marker that you want the O marker on. If you touch the **from Trigger** field a pop-up appears as shown below. This field allows you to specify an occurrence with reference to either the trigger or the X marker. Make the selection you want and the pop-up will disappear.

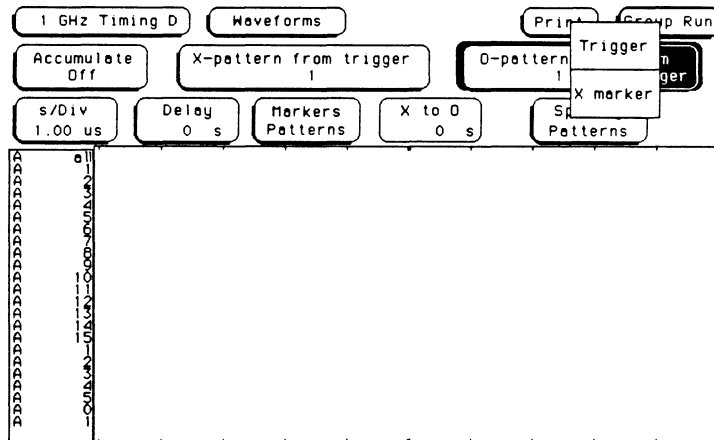

A negative value in the **O-pattern** field indicates so many occurrences before the reference point. A positive value indicates so many occurrences after the reference point, and zero indicates at the reference point.

For example, if the value in the **O-pattern** field was -3 and the next field displayed **from X marker**, the timing analyzer would place the O marker on the third occurrence of the specified pattern before the X marker.

Knob Entry. To change the value of the **O-pattern** field, touch the field once and the background will change to light-blue. Once this field has a light-blue background, it is connected to the knob on the front panel and rotating the knob will change the value shown in this field. Rotate the knob clockwise to increase the value and counterclockwise to decrease the value.

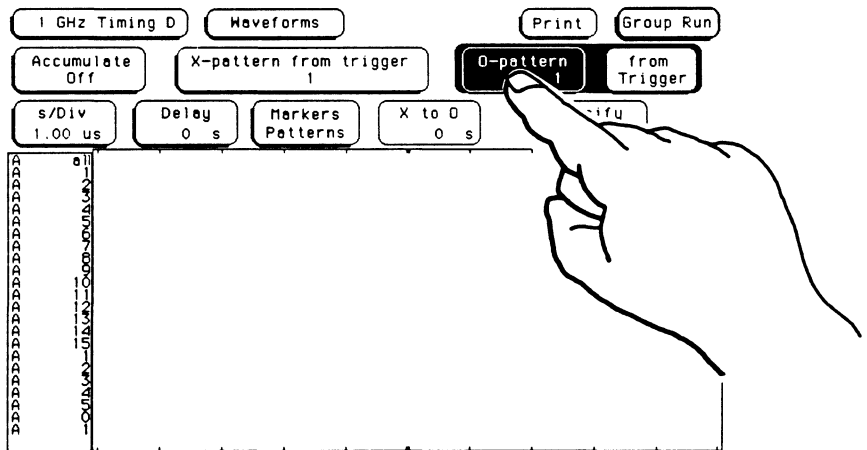

Keypad Entry. If you touch the **O-pattern** field when it already has a light-blue background, a pop-up keypad will appear on screen as shown below. Use the keypad to enter the value you want. To clear the value and start over, touch the **CLEAR** key. When you are finished entering the value, touch the **DONE** key.

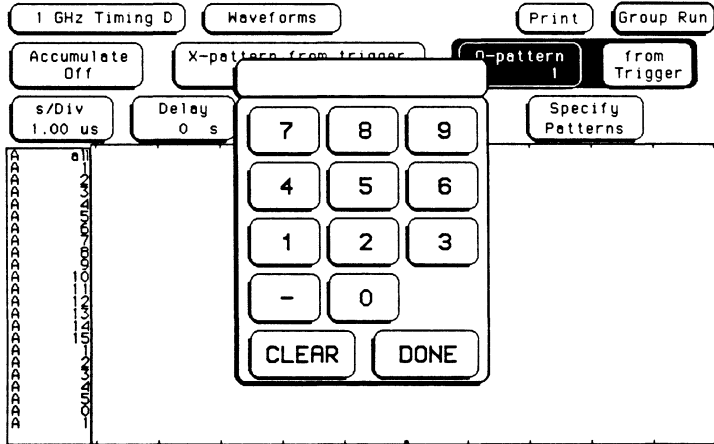

X to O Field After you run the measurement, the time between the X and O markers will be displayed in the **X to O** field on the **Waveforms** menu.

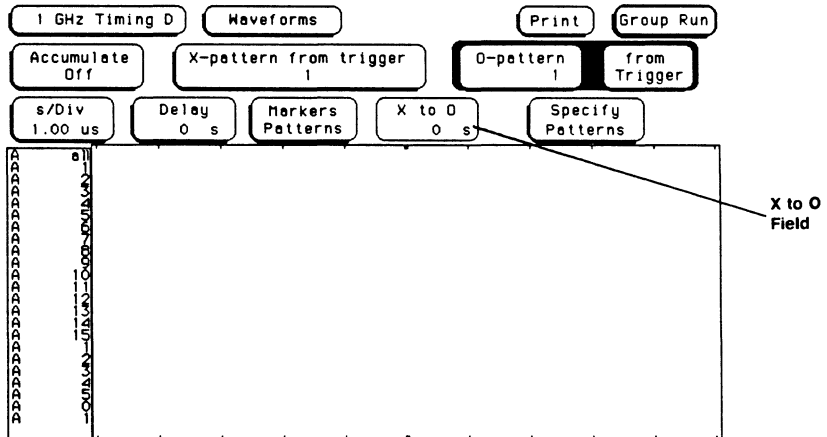

Markers Statistics

When **Statistics** are specified for markers, the timing analyzer will display the following:

- Number of valid runs (runs where markers were able to be placed on specified patterns)
- Number of total runs
- Minimum time between the X and O markers
- Maximum time between the X and O markers
- Average (Mean) time between X and O markers

Statistics are based on the time between markers that are placed on specific patterns. If a marker pattern is not specified, the marker will be placed on the trigger point by the timing analyzer. In this case, the statistical measurement will be the time from trigger to the specified marker.

Note

*The X and O patterns for the markers for statistical measurements must be specified in the **Specify Patterns** pop-up of the **Markers Patterns** menu. After specifying the patterns, select **Markers Statistics** and run the measurement.*

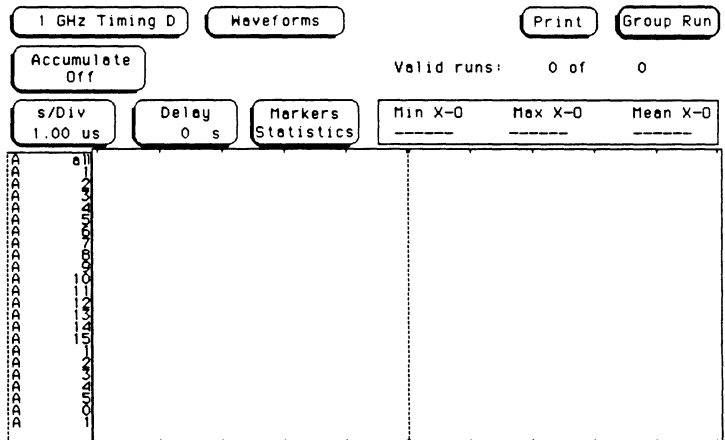

How the statistics will be updated depends on how you are running the measurement (single or repetitive).

- In **Single**, each time you touch **Run** an additional valid run will be added to the data and the statistics will be updated. This will continue until you change the placement criteria of the X and O markers.
- In **Repetitive**, statistics will be updated each time a valid run occurs until you touch **Stop**. When you touch **Run** after stopping the measurement, the statistics are cleared and will restart from zero.

To specify the patterns for the X and O markers, touch the **Markers** field and when the pop-up appears, select **Patterns**. Configure the **Specify Patterns**, **X-pattern from Trigger**, and **O-pattern from Trigger/X marker** fields. Then select **Markers Statistics** and run the measurement.

11

Using the Timing Analyzer

Introduction

In this chapter you will learn how to use the timing analyzer by setting up the analyzer to make a simple measurement. We give you the measurement results as actually measured by the timing analyzer, since you may not have the same circuit available.

This chapter is organized in a task format. The steps in this format are both numbered and lettered. The numbered steps state the step objective and the lettered steps explain how to accomplish each step objective. There is also an example of each menu after it has been properly configured for this measurement.

How you use the steps depends on how familiar you are with the HP 16515A/16A 1 GHz Timing Analyzer. If you can set up each menu by just looking at the menu picture, go ahead and do so. If you need a reminder of what steps you need to perform, follow the numbered steps. If you need additional information, use the lettered steps.

Problem Solving with the Timing Analyzer

In this exercise, assume you are designing a dynamic RAM memory (DRAM) controller and you must verify the timing of the row address strobe (RAS) and the column address strobe (CAS). You are using a 4864 dynamic ram and the data book specifies that the minimum time from when LRAS is asserted (goes low) to when LCAS is no longer asserted (goes high) is 200 ns. You could use an oscilloscope, but since you don't need voltage parametrics, the HP 16515A/16A timing analyzer will do just fine.

What Am I Going to Measure?

After configuring the timing analyzer and hooking it up to your circuit under test, you will be measuring the time (x) from when the RAS goes low to when the CAS goes high, as shown below.

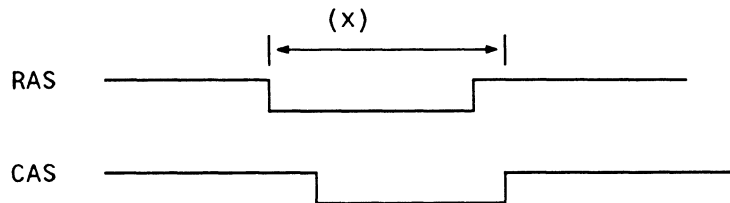

Configuring the Timing Analyzer

Now that you have connected to the test system, you are ready to configure the timing analyzer. You will be:

- Creating two names (labels) for the input signals
 - Assigning the channels connected to the input signals
 - Specifying a trigger condition
1. Display the **1 GHz Timing Format** menu.
 - a. Touch the field second from the left in the upper-left corner.
 - b. When the pop-up appears, touch the **Format** field.
 2. Name two labels, one RAS and one CAS.
 - a. Touch the top field in the label column.
 - b. When the pop-up appears, touch **Modify Label**.
 - c. Using the alphanumeric keyboard, enter the label RAS and touch **DONE**.
 - d. Touch the next field down from the RAS label and repeat steps b and c for the CAS label.
 3. Assign the channels connected to the input signals (Pod D1 bits 0 and 1) to the labels RAS and CAS respectively.
 - a. Touch the bit assignment field below Pod D1 and to the right of RAS.
 - b. Any combination of bits may be assigned to this pod; however, you will want only bit 0 assigned to the RAS label. The easiest way to assign bits is to touch the **CLEAR** key to un-assign any assigned bits before you start.

Note

*If you touch the **CLEAR** key when the bits for that pod are already cleared, all of the bits in that pod will be assigned.*

- c. Using the front-panel knob, place the cursor on the period for bit 0 in the bit assignment pop-up and touch the asterisk field. This will place an asterisk in the 0 bit. Touch **DONE** when the asterisk is in place.
- d. Clear the other bits in the other pods to the right of the RAS label.
- e. Touch the bit assignment field below Pod D1 and to the right of CAS.
- f. Clear any previously assigned bits in this field by touching the **CLEAR** key.
- g. Using the front-panel knob, place the cursor on the period for bit 1 in the bit assignment pop-up and touch the asterisk field. This will place an asterisk in the 1 bit. Touch **DONE** when the asterisk is in place.
- h. Clear the other bits in the other pods to the right of the CAS label.

The **1 GHz Timing Format** menu should now be configured as shown below.

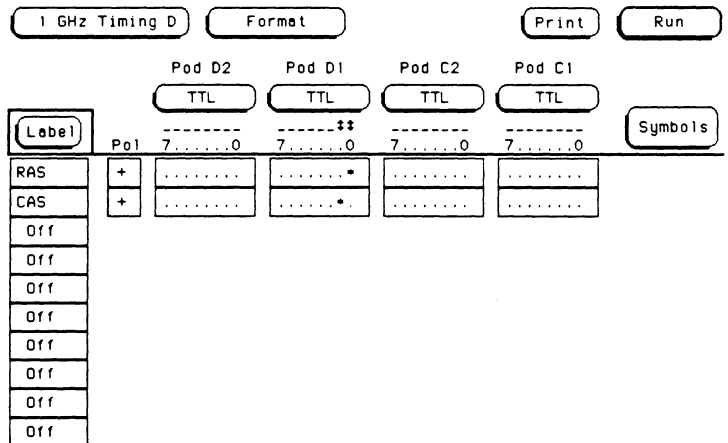

Specifying a Trigger Condition

To capture the data and then place the data of interest in the center of the display of the **1 GHz Timing Waveforms** menu, you need to tell the logic analyzer when to trigger. Since the first event of interest is when the LRAS is asserted (negative-going edge of RAS), you need to tell the timing analyzer to trigger on a negative-going edge of the RAS signal.

1. Display the **1 GHz Timing Trace** menu.
 - a. Touch the field second from the left in the upper left corner.
 - b. When the pop-up appears, touch the **Trace** field.
2. Since all of the patterns must be valid to trigger, make sure the pattern field below each has an X (Don't Care) in it. If not, touch the pattern field and when the pop-up appears, touch **CLEAR** and then **DONE** to input an X in it.
3. Set the trigger so that the logic analyzer triggers on the negative-going edge of the RAS.
 - a. Touch the **Then find Edge** field under the label RAS.
 - b. When the pop-up appears, touch the field with the arrow pointing down (\downarrow). This selects a negative-going edge. Touch **DONE** when your selection is complete.
 - c. Since the analyzer looks at the edges to trigger on as ORed edges, it can trigger on any edge shown, without regard to the order shown on the **Trace** menu. Because of this, make sure the **Edge** field below the label CAS has a period (.) in it to indicate that it is not a trigger condition. If this field does not have a period in it, touch this field and when the pop-up appears, touch **CLEAR** and then **DONE**.

The **1 GHz Timing Trace** menu should now be configured as shown below.

1 GHz Timing D Trace Print Run

Label >	RAS	CAS
Base >	Hex	Hex
Find Pattern	Equal	X X
Then find Edge	present for >	16 ns
	↓	.

Acquiring the Data

Now that you have configured and connected the timing analyzer, you acquire the data for your measurement by touching the **Run** field. The logic analyzer will look for a negative edge on the RAS signal and trigger if it sees one. When it triggers, the display switches to the **1 GHz Timing Waveforms** menu as shown below.

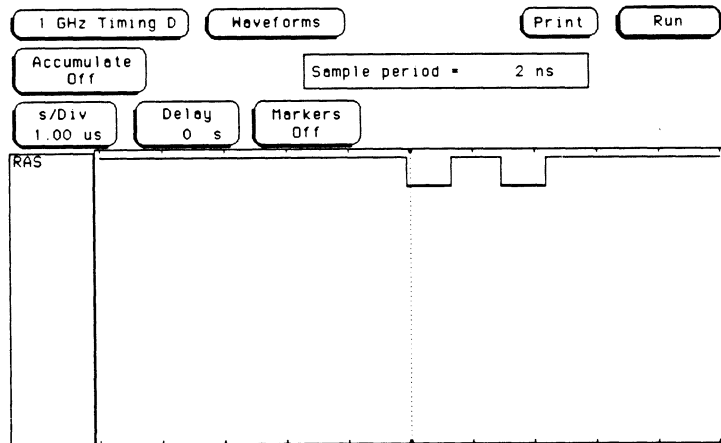

If this is the first time you acquired data and you have not previously set up the **Waveforms** menu, you will only see a label named "RAS." Don't worry, this is normal. To turn on the "CAS" label, follow these steps:

1. Touch the "RAS" label.
2. When the pop-up appears, touch the "CAS" field and the "CAS" label will appear below the "RAS" label.
3. Touch **Done** when you are finished.

The RAS label shows you the RAS signal and the CAS label shows you the CAS signal. Notice in the figure below that the RAS signal goes low at or near the center of the waveform display area (horizontal center).

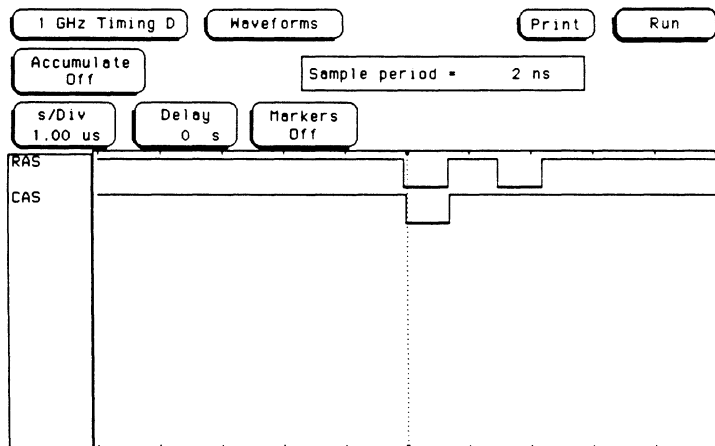

Configuring the Display

Now that you have acquired the RAS and CAS waveforms, you need to configure the **1 GHz Timing Waveforms** menu for best resolution and to obtain your answer.

Display Resolution

You get the best resolution by changing the seconds/division to a value that displays one negative-going edge of both the RAS and CAS waveforms. Set the seconds/division by following these steps.

1. If the **s/Div** (seconds/division) field isn't already light-blue, touch this field and its background will turn light-blue.
2. Rotate the knob on the front panel until only one negative-going edge of the RAS and one positive-going edge of the CAS waveform is shown on screen (see below). In this example 200 ns is best.

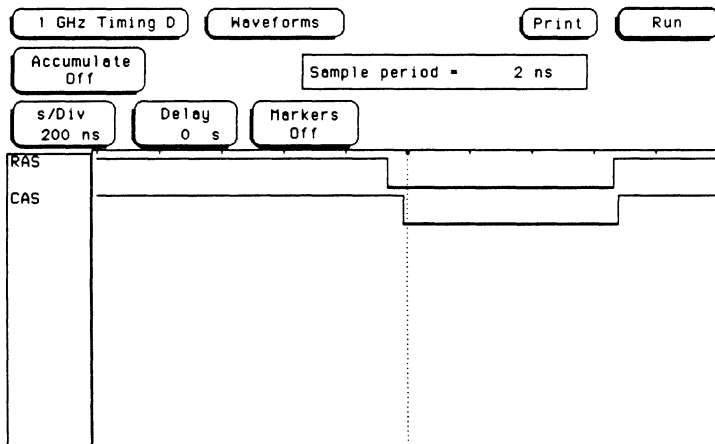

Making The Measurement

What you want to know is how much time elapses between the time RAS goes low and the time CAS goes high again. Use the **Time** function of the X and O markers to find the answer.

1. Select the **Markers Time** function.
 - a. Touch the **Markers** field of the **1 GHz Timing Waveforms** menu.
 - b. When the pop-up appears on screen, touch **Time**.
2. Since you specified the negative going edge of the RAS signal to be your trigger point, place the X marker (green) on this edge.
 - a. Touch the **Trig to X** field.
 - b. When the field turns light blue, use the knob on the front panel to set the X marker (green) on the negative going edge of the RAS waveform.
3. Place the O marker on the first positive going edge of the CAS signal after the X marker.
 - a. Touch the **Trig to O** field.
 - b. When the field turns light blue, use the knob on the front panel to set the O marker (yellow) on the first positive going edge of the CAS waveform after the X marker.

Finding the Answer

Your answer could be calculated by adding the **Trig to X** and **Trig to O** times, but you don't have to. The logic analyzer has already calculated this answer and displays it in the **X to O** field on the display.

This example indicates the time is 744 ns. Since the data book specifies a minimum of 200 ns, it appears your DRAM controller circuit is designed properly.

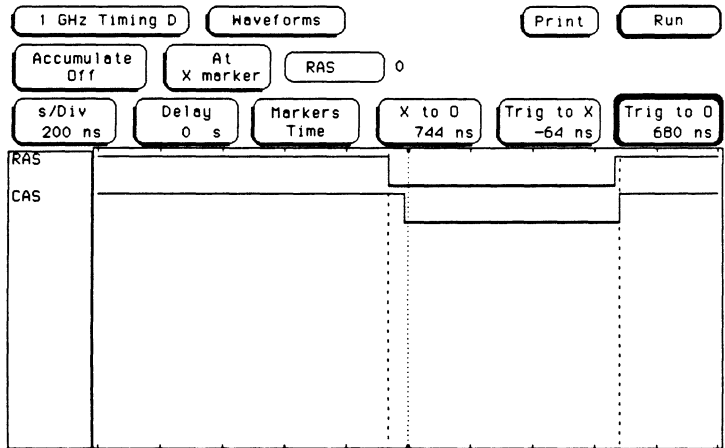



12

Solving Intermittent Timing Problems

Introduction

This chapter introduces some additional features and capabilities of the HP 16515A/16516A timing analyzer. These include setting up the analyzer to make automatic X to O measurements and finding the amount of deviation in the results. We give you the measurement results as actually measured by the timing analyzer, since you may not have the same circuit available.

This chapter is organized in a task format. The steps in this format are both numbered and lettered. The numbered steps state the step objective and the lettered steps explain how to accomplish each step objective. There is also an example of each menu after it has been properly configured for this measurement.

How you use the steps depends on how familiar you are with the HP 16515A/16516A 1 GHz Timing Analyzer. If you can set up each menu by just looking at the menu picture, go ahead and do so. If you need a reminder of what steps you need to perform, follow the numbered steps. If you need additional information, use the lettered steps.

Problem Solving with the Timing Analyzer

In this exercise, assume you have designed a dynamic RAM memory (DRAM) controller and an intermittent has developed that crashes the system during a routine where ROM code is pushed into RAM. After several measurements, you feel the problem is in the timing of the row address strobe (RAS) and the column address strobe (CAS). You are using a 4864 dynamic ram and the data book specifies that the minimum time from when LCAS is asserted (goes low) to when LRAS is no longer asserted (goes high) is 135 ns. You want to look at these signals over a period of time to determine if the minimum time from when LCAS is asserted (goes low) to when LRAS is no longer asserted (goes high) ever falls below 135 ns.

What Am I Going to Measure?

After configuring the timing analyzer and hooking it up to your circuit under test, you will be measuring the time (x) from when the RAS goes low to when the CAS goes high, as shown below.

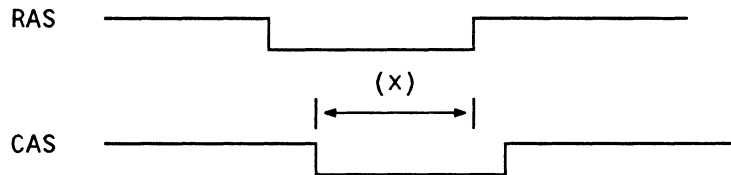

Connecting the Probes

At this point, if you had a target system with a 4864 DRAM memory IC, you would connect the timing analyzer to your system.

Since you will be assigning Pod D1 bit 0 to the RAS label, you hook Pod D1 bit 0 to the memory IC pin connected to the RAS signal. You hook Pod D1 bit 1 to the IC pin connected to the CAS signal.

Configuring the Timing Analyzer

Now that you have configured the system, you are ready to configure the timing analyzer. You will be:

- Creating two names (labels) for the input signals
 - Assigning the channels connected to the input signals
 - Specifying a trigger condition
 - Specifying patterns for the X and O markers
 - Using the statistics feature to determine the amount of deviation in the results
1. Display the **1 GHz Timing Format** menu.
 - a. Touch the field second from the left in the upper-left corner.
 - b. When the pop-up appears, touch the **Format** field.
 2. Name two labels, one RAS and one CAS (as you did in chapter 11).
 - a. Touch the top field in the label column.
 - b. When the pop-up appears, touch **Modify Label**.
 - c. Using the alphanumeric keyboard, enter the label RAS and touch **DONE**.
 - d. Touch the next field down from the RAS label and repeat steps b and c for the CAS label.
 3. Assign the channels connected to the input signals (Pod D1 bits 0 and 1) to the labels RAS and CAS respectively (as you did in chapter 11).
 - a. Touch the bit assignment field below Pod D1 and to the right of RAS.
 - b. Any combination of bits may be assigned to this pod; however, you will want only bit 0 assigned to the RAS label. The easiest way to assign bits is to touch the **CLEAR** key to un-assign any assigned bits before you start.

Note

*If you touch the **CLEAR** key when the bits for that pod are already cleared, all of the bits in that pod will be assigned.*

- c. Using the front-panel knob, place the cursor on the period for bit 0 in the bit assignment pop-up and touch the asterisk field. This will place an asterisk in the 0 bit. Touch **DONE** when the asterisk is in place.
- d. Clear the other bits in the other pods to the right of the RAS label.
- e. Touch the bit assignment field below Pod D1 and to the right of CAS.
- f. Clear any previously assigned bits in this field by touching the **CLEAR** key.
- g. Using the front-panel knob, place the cursor on the period for bit 1 in the bit assignment pop-up and touch the asterisk field. This will place an asterisk in the 1 bit. Touch **DONE** when the asterisk is in place.
- h. Clear the other bits in the other pods to the right of the CAS label.

The **1 GHz Timing Format** menu should now be configured as shown below.

<input type="button" value="1 GHz Timing D"/>		<input type="button" value="Format"/>		<input type="button" value="Print"/>		<input type="button" value="Run"/>			
		Pod D2		Pod D1		Pod C2		Pod C1	
		<input type="button" value="TTL"/>		<input type="button" value="TTL"/>		<input type="button" value="TTL"/>		<input type="button" value="TTL"/>	
<input type="button" value="Label"/>	Pod	7 0		7 0		7 0		7 0	
RAS	+*		
CAS	+*		
Off		
Off		
Off		
Off		
Off		
Off		
Off		
Off		
Off		
Off		
		<input type="button" value="Symbols"/>							

Specifying a Trigger Condition

To capture the data and then place the data of interest in the center of the display of the **1 GHz Timing Waveforms** menu, you need to tell the logic analyzer when to trigger. Since the first event of interest is when the LCAS is asserted (negative-going edge of CAS), you need to tell the timing analyzer to trigger on a negative-going edge of the CAS signal.

The data book also specifies that the minimum time from when LRAS is asserted (goes low) to when LCAS is asserted (goes low) is 25 ns. Use this information to pre-qualify the trigger.

1. Display the **1 GHz Timing Trace** menu.
 - a. Touch the field second from the left in the upper-left corner of the display.
 - b. When the pop-up appears, touch the **Trace** field.
2. Pre-qualify the trigger by configuring the analyzer to find a pattern where LRAS is asserted (low) and LCAS is not asserted (high).
 - a. Touch the **Find Pattern** field below the RAS label.
 - b. Touch the **CLEAR** key to clear any previously assigned pattern.
 - c. Touch the "0" key to indicate a low condition.
 - d. Touch the **DONE** key and the pop-up will disappear.
 - e. Touch the **Find Pattern** field below the CAS label.
 - f. Touch the **CLEAR** key to clear any previously assigned pattern.
 - g. Touch the "1" key to indicate a high condition.
 - d. Touch the **DONE** key and the pop-up will disappear.

3. Since the minimum time from when LRAS is asserted (goes low) to when LCAS is asserted (goes low) is 25 ns, configure the analyzer to look for a pattern that is present for greater than 25 ns.
 - a. Make sure the first pattern duration field displays greater-than (>). If not, touch this field and its value will change to greater-than (>).
 - b. Touch the second pattern duration field.

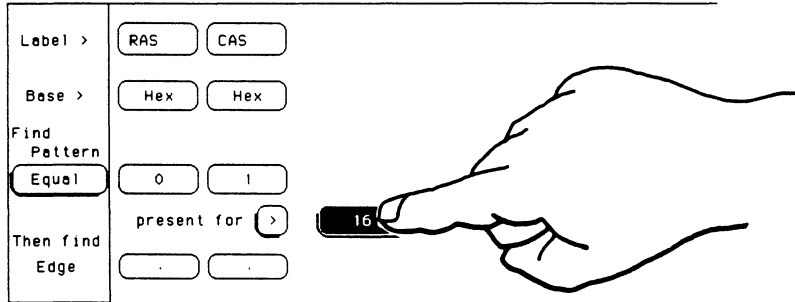

- c. When the pop-up keypad appears on screen, enter 25 ns and touch the **DONE** key. This will set the pattern duration to the closest available value (24 ns).

Note

*The values for pattern duration follow a preset sequence which varies depending on the current sample rate and duration mode (less-than or greater-than). To view the values available for your current configuration, enter the value you want with the keypad and touch **DONE**. When the pop-up disappears, the closest available value will be displayed. For higher resolution, rotate the knob on the front panel.*

4. Set the logic analyzer so that it triggers on the negative-going edge of the CAS signal.
 - a. Touch the **Then find Edge** field under the label CAS.
 - b. When the pop-up appears, touch the field with the arrow pointing down (↓). This selects a negative-going edge.
 - c. Touch **DONE** when your selection is complete.

5. Since the analyzer looks at edges to trigger on as ORed edges, it can trigger on any edge shown, without regard to the order shown on the **Trace** menu. Because of this, you must clear the edge field below the label RAS of any previous assignment.
 - a. Touch the edge field below the label RAS.
 - b. When the pop-up appears, touch **CLEAR**, then **DONE**.

The **1 GHz Timing Trace** menu should now be configured as shown below.



Label >	RAS	CAS
Base >	Hex	Hex
Find Pattern	Equal	0 1
Then find Edge	.	↓
	present for >	24 ns

Specifying Patterns for the X and O Markers

1. Display the **1 GHz Timing Waveforms** menu.
 - a. Touch the field second from the left in the upper-left corner of the display.
 - b. When the pop-up appears, touch the **Waveforms** field.
2. Select the **Markers Pattern** function.
 - a. Touch the **Markers** field.

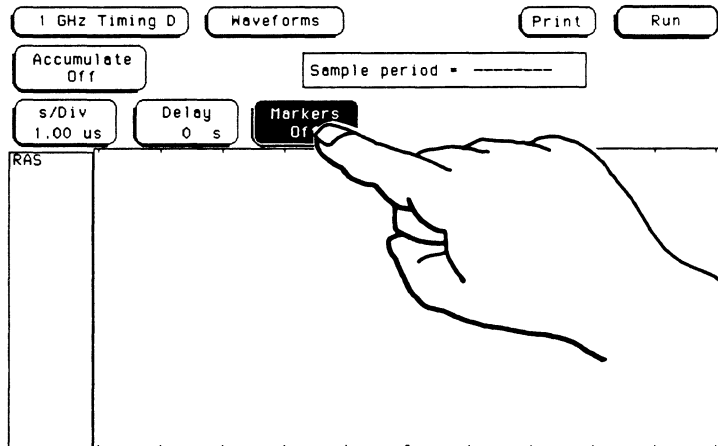

- b. When the pop-up appears, touch **Patterns**.

3. Configure the **Specify Patterns** pop-up to place the X marker on the negative going edge of the CAS signal and to place the O marker on the first positive going edge of the RAS signal after the X marker.

- a. Touch the **Specify Patterns** field.

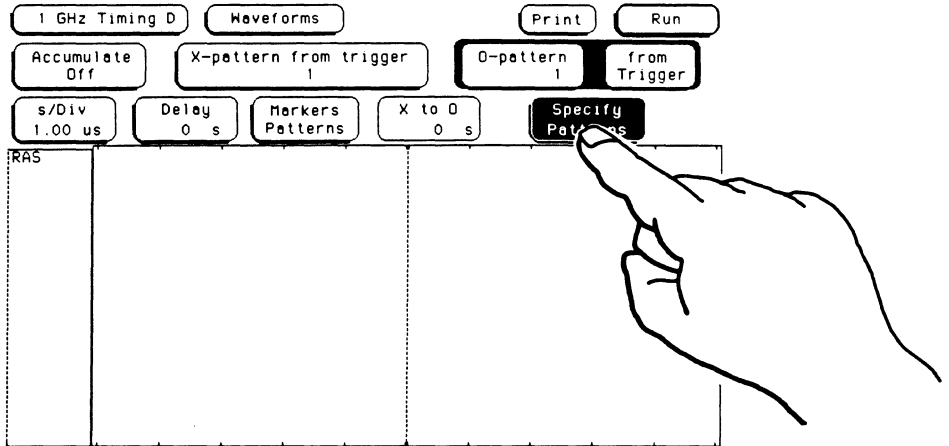

- b. When the pop-up appears, touch the label field.

- c. When the pop-up appears, touch CAS.

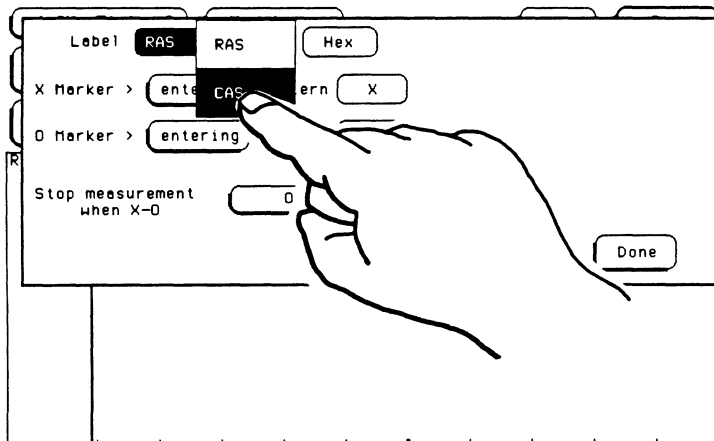

d. Touch the X marker pattern field.

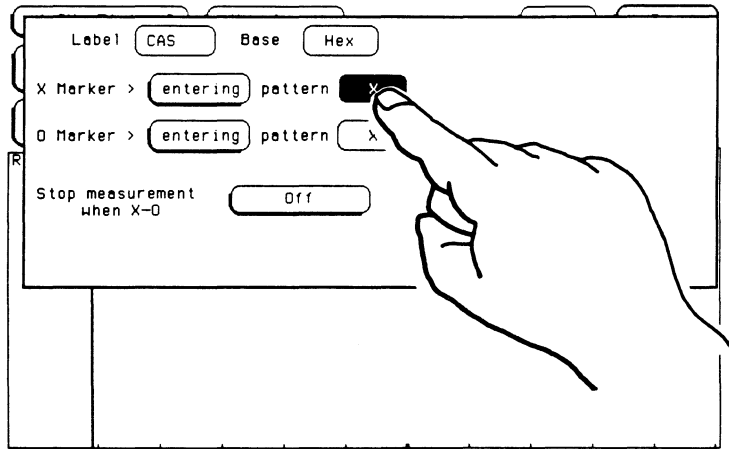

e. When the pop-up keypad appears, enter a 0 and touch **DONE**.

f. Since all of the patterns must be valid for the markers, make sure the O marker field for this label has an X (Don't Care) in it. If not, touch the O marker pattern field and when the pop-up appears, touch **CLEAR**, then **DONE**.

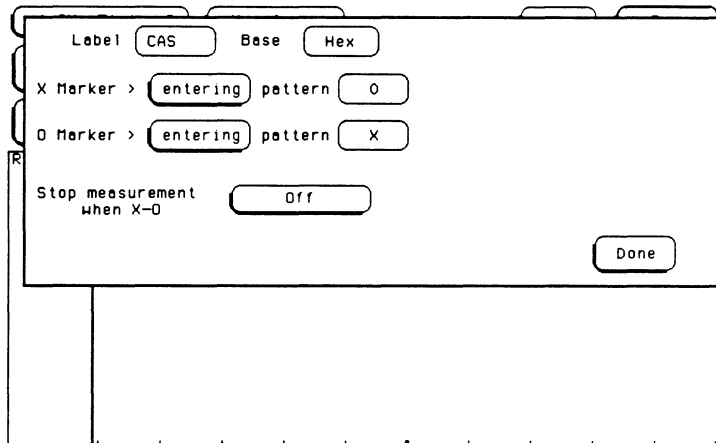

- g. Touch the label field and when the pop-up appears, touch RAS.
- h. Since all of the patterns must be valid for the markers, make sure the X marker field for this label has an X (Don't Care) in it. If not, touch the X marker pattern field and when the pop-up appears, touch **CLEAR**, then **DONE**.
- i. Touch the O marker pattern field.

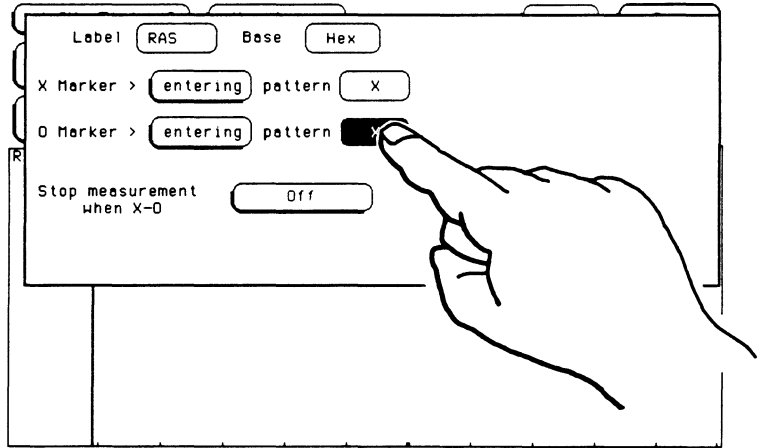

- j. When the pop-up keypad appears, enter a 1 and touch **DONE**.

4. Since you want to determine if the minimum time from when LCAS is asserted (goes low) to when LRAS is no longer asserted (goes high) ever falls below 135 ns, configure the **Specify Patterns** pop-up to stop the measurement when this time from X to O is less than 135 ns.
 - a. Touch the field to the right of **Stop measurement when X-O**.
 - b. When the pop-up appears, touch **Less than**.
 - c. Touch the field to the right of **Less than** and when the pop-up keypad appears, enter 135 ns.
 - d. When you are finished entering the value, touch **DONE**.

The image shows a screenshot of a software interface for configuring measurement patterns. The dialog box is titled "Specify Patterns" and contains the following elements:

- Label:** RAS
- Base:** Hex
- X Marker > entering pattern:** X
- O Marker > entering pattern:** 1
- Stop measurement when X-O:** Less than 135 ns
- Done** button

- e. When you are finished configuring the **Specify Patterns** field, touch **Done**.

5. Now configure the **Waveforms** menu to place the X marker on the first occurrence of the X pattern.
 - a. Touch the **X-pattern from trigger** field.
 - b. When the field turns light blue, rotate the knob on the front panel until a "0" is displayed in this field.

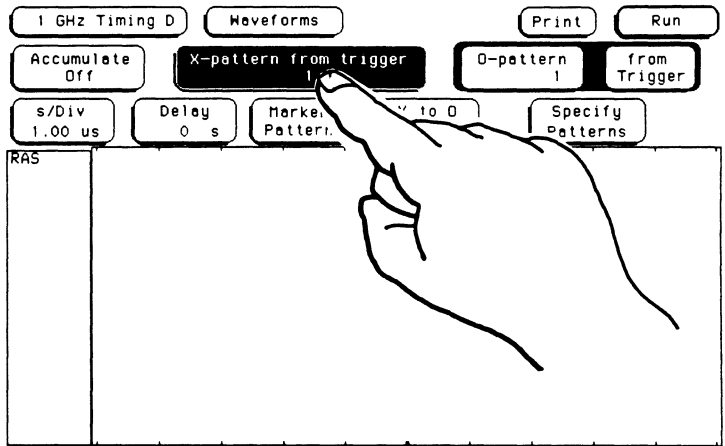

6. Configure the **Waveforms** menu to place the **O** marker on the first occurrence of the **O** pattern from the **X** marker.
 - a. Touch the **O-pattern** field.
 - b. When the field turns light blue, rotate the knob on the front panel until a "1" is displayed in this field.
 - c. Touch the **from Trigger/X marker** field.
 - d. When the pop-up appears, touch **X marker**.

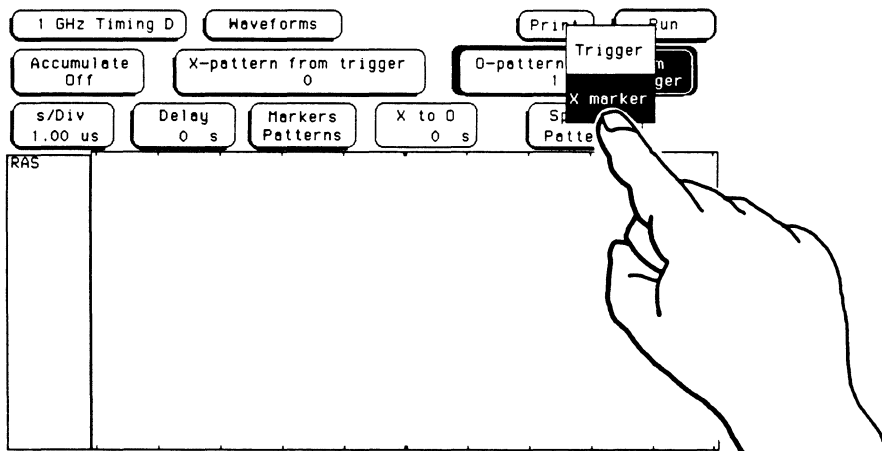

Specifying Waveforms

Normally, the first time you set up the **Waveforms** menu, you will only see one label (RAS) on screen. To turn on the other label (CAS), follow these steps:

1. Touch the "RAS" label.
2. When the pop-up appears, touch the "CAS" field and the "CAS" label will appear below the "RAS" label.
3. Touch **Done** when you are finished.

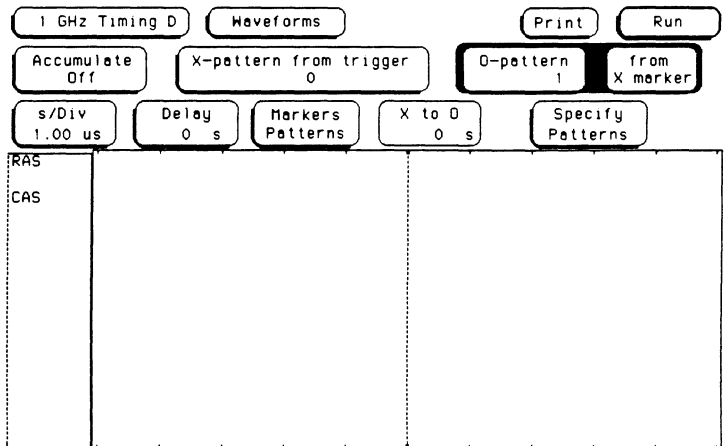

Acquiring the Data

Now that you have configured and connected the timing analyzer, you acquire the data for your measurement by touching the **Run** field and sliding your finger down to **Repetitive**. When this field turns white, remove your finger from the screen.

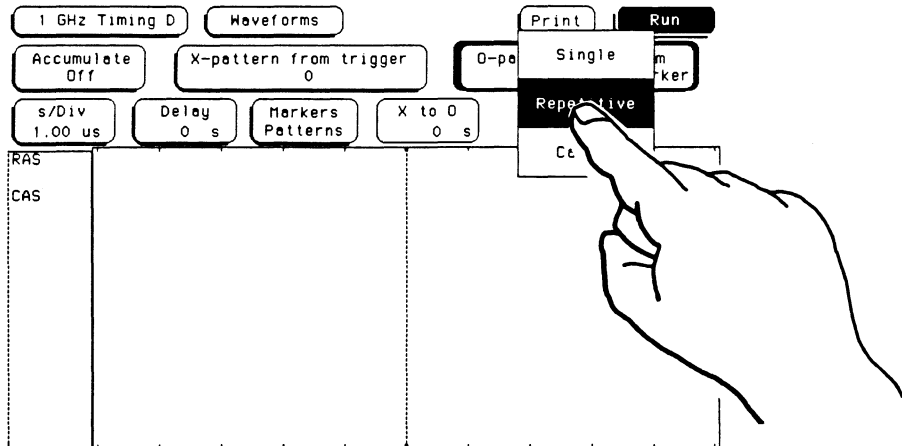

The logic analyzer will look for the pattern you specified in the **Trace** menu with a duration of 24 ns and when it finds the appropriate pattern, it will trigger on the negative going edge of the CAS signal.

The analyzer will place the X and O markers on the patterns you specified in the **Specify Patterns** pop-up, calculate the difference between the markers, and place the answer in the **X to O** field. Then the analyzer will run the measurement again and repeat the marker placement and calculations until the stop measurement condition is met, or until you touch **Stop**.

In the figure below, the RAS label shows you the RAS signal and the CAS label shows you the CAS signal.

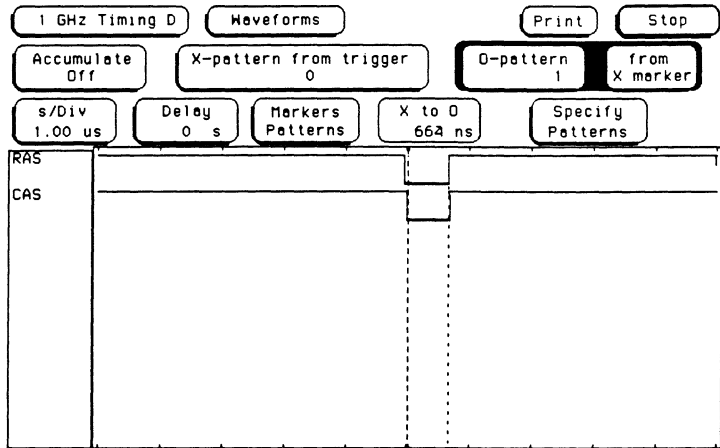

Checking the Amount of Deviation in the Results

To see how much the time from when LCAS is asserted (goes low) to when LRAS is no longer asserted (goes high) varies between measurements, select the **Markers Statistics** function.

1. Touch the **Markers** field.
2. When the pop-up appears, touch **Statistics** field.

When **Statistics** are specified for markers, the timing analyzer will display the following:

- Number of valid runs (runs where markers were able to be placed on specified patterns)
- Number of total runs
- Minimum time between the X and O markers
- Maximum time between the X and O markers
- Average (Mean) time between X and O markers

In **Repetitive**, statistics will be updated each time a valid run occurs until the stop measurement condition is met or until you touch **Stop**. When you touch **Run** after stopping the measurement, the statistics are cleared and will restart from zero.

The figure below shows the final results for this example. Since the stop condition was satisfied, we know that the problem is in the controller circuitry for the RAM.

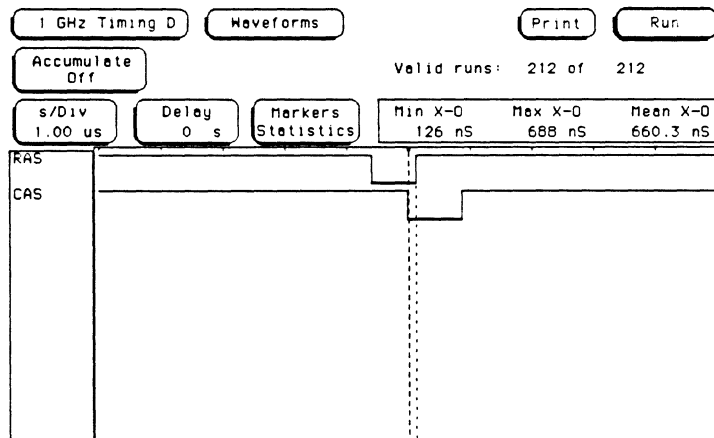

13

Saving and Recalling Setups

Introduction

You can store an analyzer configuration and all waveform display and measurement data to a floppy disc in the mainframe, then recall that information at a later time. Since the data is stored on floppy disc, you can store an unlimited number of configurations.

Besides recalling measurement data, recalling a configuration is a convenient way to return to a default condition without cycling the power on the mainframe.

You can also use the **Autoload** feature in the disc menu to automatically load a configuration other than the default analyzer configuration at power up.

Storing a Configuration

When you have an analyzer configuration you want to store to disc, you must go to a **System** disc menu to store the data. For this example, assume you are in a 1 GHz timing analyzer menu.

1. Insert a floppy disc into either the front or rear disc drive of the mainframe. If the disc has not been formatted, do so at this time. Refer to the *HP 16500A Reference Manual*.
2. Touch the **1 GHz Timing** module field in the upper left corner of the display and select **System** from the pop-up.
3. Touch the menu field next to the **System** field and select either **Front Disc** or **Rear Disc** from the pop-up, depending on where you inserted the floppy disc.

A disc menu similar to that shown on the next page should be displayed.

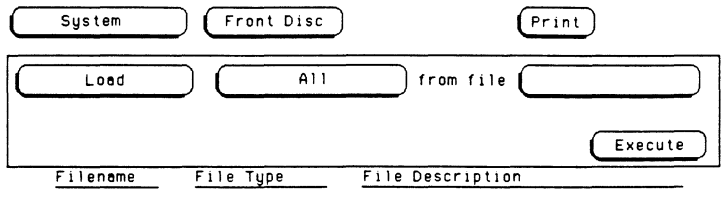

NO FILES

Choose the **Store** operation from the disc menu.

1. Touch the disc operation field at the left of the display (**Load** in this example).
2. Select **Store** from the pop-up.

Store the configuration for the 1 GHz timing analyzer only.

1. Touch the module field to the right of the **Store** field.

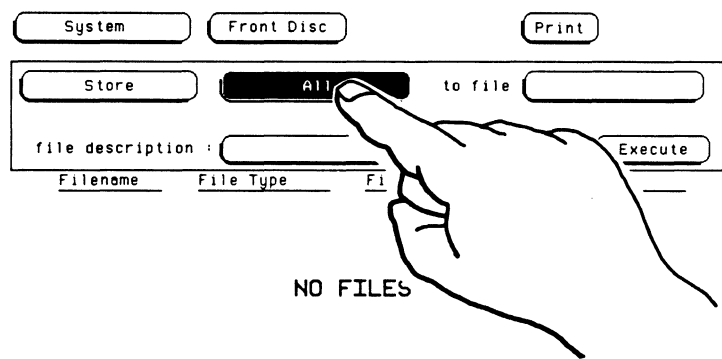

2. Select the **1 GHz Timing** field in the pop-up. If you have two 1 GHz timing analyzer modules in the mainframe, make sure you select the module that has the configuration you want saved.

Enter the name of the file to which the configuration will be saved.

1. Touch the field to the right of **to file** and a pop-up keyboard will appear.
2. Enter the name of a file. The filename must start with a letter and can contain up to eight characters with no blank spaces between characters. In this example, touch the appropriate keys to enter the filename **TIMING1**. If you make a mistake, turn the knob to move the cursor to the incorrect character and touch the correct character on the keypad. To clear the field and start over, touch the **CLEAR** key.
3. When you have entered the filename, touch the **DONE** field in the pop-up to return to the disc menu.

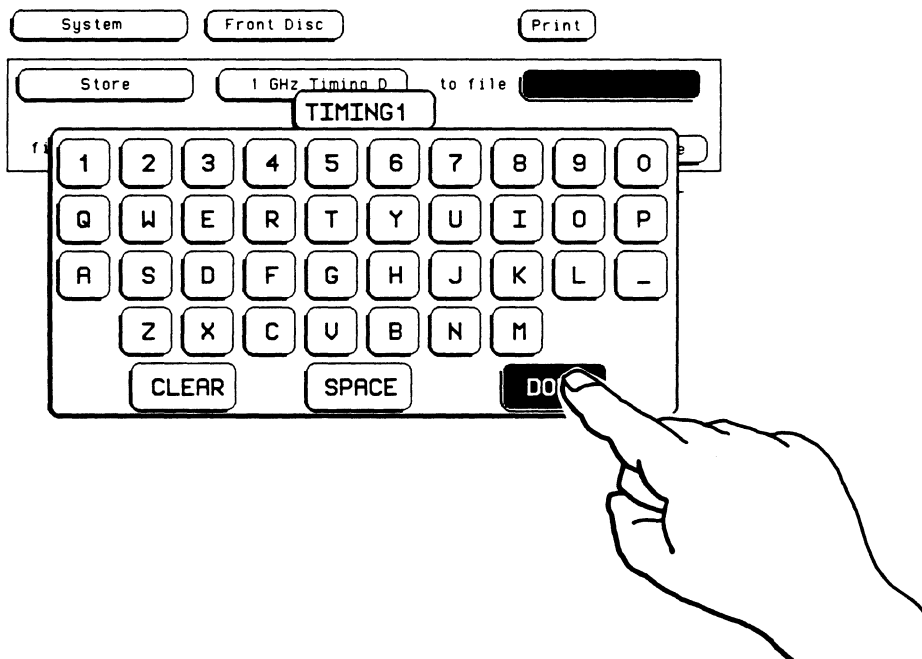

Notice that the filename you entered is appended with an underscore character and the letter of the mainframe slot in which the 1 GHz timing analyzer master card is located.

Note

*If you enter the name of a file that already exists on the disc, the analyzer will display **STORE WILL OVERWRITE SELECTED FILE(S)**.*

Enter a file description.

1. Touch the field to the right of **file description** and a pop-up keypad will appear.

Note

*Entering a file description is optional and for your convenience. This description will make it easier for you to identify the type of data in each file. If you do not want to enter a description, touch the **CLEAR** field in the pop-up to clear the field. Then touch the **DONE** field to return to the disc menu.*

2. Enter a description for the file. The description can be any combination of letters or numbers up to 32 characters long.
3. When you have entered the file description, make sure the description is correct since there is no way to change the description once the file has been saved. If you make a mistake, turn the knob to move the cursor to the incorrect character and touch the correct character on the keypad. To clear the field and start over, touch the **CLEAR** key. If the description is correct, touch the **DONE** field in the pop-up to return to the disc menu.

Store the file to disc.

CAUTION

*If you store a new configuration to an existing file, the new configuration will be written over the original information and will **DESTROY** the original information in that file.*

1. Touch the **Execute** field.
2. Select **Continue** from the pop-up to store the file.

The file is now stored on the disc and is highlighted in the list of files on disc. The analyzer assigns file type **16515A_config** to the file to indicate that this file is for the HP 16515A/16A module. All 1 GHz timing analyzer configuration files saved to the disc will have this file type.

System	Front Disc	Print
Store	1 GHz Timing D	to file TIMING1_D
file description :	FILE DESCRIPTION	Execute
Filename	File Type	File Description

TIMING1_D	16515A_config	FILE DESCRIPTION
-----------	---------------	------------------

Loading a Configuration

When you have an analyzer configuration stored on disc that you want to load into the analyzer, you must go to the **System** disc menu to load the data. For this example, assume you in a 1 GHz timing analyzer menu.

1. Insert the floppy disc that contains the stored configuration file into either the front or rear disc drive of the mainframe.
2. Touch the **1 GHz Timing** module field in the upper left corner of the display and select **System** from the pop-up.
3. Touch the menu field next to the **System** field and select either **Front Disc** or **Rear Disc** from the pop-up, depending on where you inserted the floppy disc.

A disc menu similar to that shown below should be displayed.

The screenshot shows a graphical user interface for a disc menu. At the top, there are three buttons: "System", "Front Disc", and "Print". Below these is a larger rectangular area containing a "Load" button, an "All" button, the text "from file", and a "TIMING1_D" button. At the bottom right of this area is an "Execute" button. Below the main interface area, there is a table header with three columns: "Filename", "File Type", and "File Description".

Filename	File Type	File Description
TIMING1_D	16515A_config	FILE DESCRIPTION

Choose the **Load** operation from the disc menu.

1. Touch the disc operation field at the left of the display if **Load** is not already displayed.
2. Select **Load** from the pop-up.

Load the configuration file for the 1 GHz timing analyzer only.

1. Touch the module field to the right of the **Load** field.

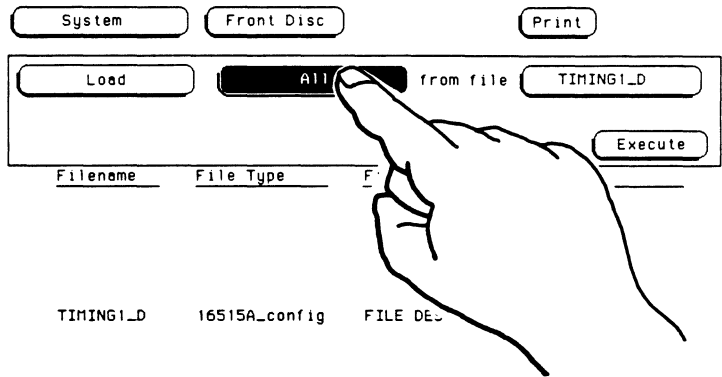

2. Select the **1 GHz Timing** field in the pop-up. If you have two 1 GHz timing analyzer modules in the mainframe, make sure you select the one you want to load the configuration for.

Turn the knob to move the cursor to the file you want to load, then touch the **Execute** field to load the configuration file into the 1 GHz timing analyzer.

The configuration file has now been loaded into the 1 GHz timing analyzer. The waveform data will stay in the analyzer memory the same as if it were acquired in the **Single** mode. As soon as you touch the **Run** field, the analyzer will acquire new waveform data.

Autoloading a Configuration

The **Autoload** feature in the **System** disc menu lets you automatically load a configuration other than the default analyzer configuration at power up. For this example, we will use the configuration file (**TIMING1_D**) that we stored at the beginning of the chapter for the autoload configuration.

1. Insert the floppy disc that contains the configuration file you want to use as an autoload file into either the front or the rear disc drive of the mainframe.
2. Touch the module field in the upper-left corner of the display, then select **System** from the pop-up.
3. Touch the menu field next to the **System** field and select either **Front Disc** or **Rear Disc** from the pop-up, depending on where you inserted the floppy disc.

A disc menu similar to that shown below should be displayed.

The screenshot shows a graphical user interface for a disc menu. At the top, there are three buttons: "System", "Front Disc", and "Print". Below these is a larger rectangular area containing a "Load" button, an "All" button, the text "from file", and a button labeled "TIMING1_D". At the bottom right of this area is an "Execute" button. Below the main interface area is a table with three columns: "Filename", "File Type", and "File Description". The table contains one row of data: "TIMING1_D", "16515A_config", and "FILE DESCRIPTION".

Filename	File Type	File Description
TIMING1_D	16515A_config	FILE DESCRIPTION

Choose the **Autoload** operation from the disc menu.

1. Touch the disc operation field at the left of the display.

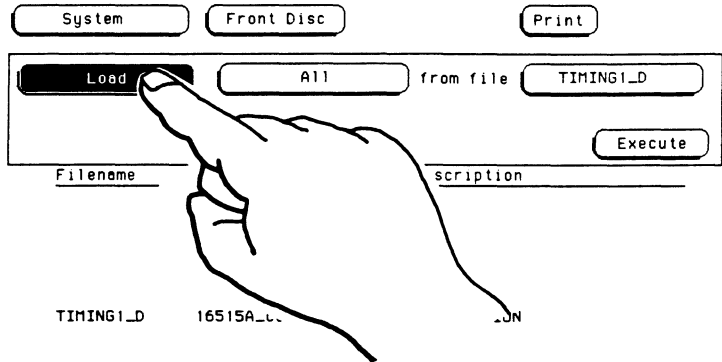

2. Select **Autoload** from the pop-up.

Enable the **Autoload** function.

1. Touch the **Disable** field next to the **Autoload** field.
2. Select **Enable** from the pop-up.

Turn the knob to move the cursor to the file you want to become the autoload file (**TIMING1_D** in this example). The name in the field to the right of **File** : should be **TIMING1_D**. Touch the **Execute** field to enable **TIMING1_D** as the autoload file.

The analyzer adds a new file named **AUTOLOAD** to the listing as shown below.

System	Front Disc	Print
Autoload	Enable	File : TIMING1_D
Current AUTOLOAD status : ENABLED		Execute
Current AUTOLOAD file : TIMING1_?		
<u>Filename</u>	<u>File Type</u>	<u>File Description</u>

```
AUTOLOAD      autoload_file      status: ENABLED file: TIMING1_?
TIMING1_D     16515A_config      FILE DESCRIPTION
```

Two status lines are displayed under the **Autoload** field. The first line gives the status of **Autoload** (ENABLED), and the second line gives the filename of the autoload file (TIMING1_?). The question mark (?) after the filename indicates that all files that start with the characters **TIMING1_** will be loaded at power-up when **Autoload** is enabled. This allows you to autoload configurations for any number of modules as long as the filenames are the same. The letter at the end the filename tells the mainframe which slots the modules are located in. For example, TIMING1_D indicates that this file is for the module in slot D.

As long as **Autoload** is enabled before the instrument is shut off, **Autoload** will remain enabled when you power-up the instrument and the autoload configuration file(s) will be loaded.

To disable the **Autoload** operation:

1. Touch the **Enable** field next to **Autoload**, and select **Disable** from the pop-up.
2. Touch the **Execute** field.

Autoload is now disabled. The status of the **AUTOLOAD** file is now **DISABLED**.

System	Front Disc	Print
Autoload	Disable	
Current AUTOLOAD status : DISABLED		Execute
Current AUTOLOAD file :		
<u>Filename</u>	<u>File Type</u>	<u>File Description</u>

AUTOLOAD	autoload_file	status: DISABLED
TIMING1_D	16515A_config	FILE DESCRIPTION

For more information on disc operations, refer to the chapter "The System Front and Rear Disc Menus" in the *HP 16500A Reference Manual*.



14

Using a Printer

Setting Printer Configuration

All printer parameters are set in the **System Configuration** menu. If you have just connected your printer and are unsure of how to set the configuration, refer to the *HP 16500A Reference Manual* chapter entitled "Connecting a Printer."

The HP 16500A supports HP-IB and selected RS-232C printers.

Printing Options

All 1 GHz timing analyzer menus include a **Print** field in the upper right of the screen. When you touch the **Print** field, a pop-up appears like the one shown below.

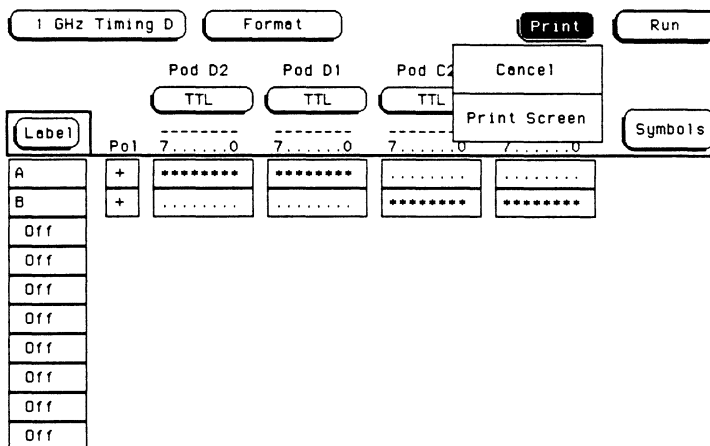

There are two fields in the pop-up, **Cancel** and **Print Screen**. If you touch the **Cancel** field, the print will be canceled.

Printing On-Screen Data

If you want a hardcopy record of the screen, touch the **Print** field, then touch the **Print Screen** field in the pop-up. This will send a copy of the screen to the printer in graphics mode.

While the print is being performed, the **Print** field displays **Cancel**. If you want to cancel the print before it is complete, touch the **Cancel** field. The advisory **Print Cancelled** will appear on screen and the **Print** field will return from **Cancel** to **Print**.

The screenshot shows a data entry interface with a print overlay. At the top, there are buttons for "1 GHz Timing D", "Format", "Cancel", and "Run". Below these are four "TTL" buttons labeled "Pod D2", "Pod D1", "Pod C2", and "Pod C1". A "Symbols" button is on the right. The main data area has a "Label" column and a "Pod" column. The "Pod" column has a "7" above each of the four "TTL" buttons. The data rows are:

Label	Pod	Pod D2	Pod D1	Pod C2	Pod C1
A	+	*****	*****
B	+	*****	*****
Off					
Off					
Off					
Off					
Off					
Off					
Off					
Off					

When a print is completed, the **Print** field returns to **Print** and the advisory **Print Completed** is displayed.

A

Installing New Analyzer Boards into the Mainframe

Introduction

This chapter explains how to add additional HP 16515A/16516A 1 GHz Timing Analyzer boards to the mainframe. Also included is initial inspection, preparation for use, storage, and shipment information.

Initial Inspection

Inspect the shipping container for damage. If the shipping container or cushioning material is damaged, it should be kept until the contents of the shipment have been checked for completeness and the module has been checked mechanically and electrically. The accessories and manuals included with the HP 16515A/16A 1 GHz Timing Analyzer module are listed in chapter 1.

Procedures for checking electrical performance are listed in the *HP 16515A/16A Service Manual*. If the contents of the container are incomplete, there is mechanical damage or defect, or the instrument does not pass the performance tests, notify the nearest Hewlett-Packard office.

If the shipping container is damaged, or the cushioning material shows signs of stress, notify the carrier as well as the Hewlett-Packard office. Keep the shipping material so the carrier can inspect it. The Hewlett-Packard office will arrange for repair or replacement at Hewlett-Packard's option.

Power Requirements

All power supplies required for operating the HP 16515A/16A 1 GHz Timing Analyzer Module are supplied to the module through the backplane connector.

Probe Assembly Installation

The HP 16515A/16A 1 GHz Timing Analyzer Module comes with probe assemblies installed by the factory. If a probe is replaced, refer to "PROBE CABLE REPLACEMENT" in Section VI of the *HP 16515A/16516A Service Manual*.

Multiple Timing Analyzer Installation

If you want to configure the mainframe with more than one timing analyzer, follow the installation instructions. Each HP 16515A/16516A card set is considered to be a separate analyzer module. No interconnecting cables are required between the two modules.

Intermodule control can be accomplished through the intermodule bus. For more information, refer to the chapter "Intermodule Measurements" in the *HP 16500A Reference Manual*.

Installation

CAUTION

Do not install, remove or replace the cards in the instrument unless the instrument power is turned off.

The HP 16515A 1 GHz Timing Master Card will take up one slot in the card cage. The HP 16516A Expansion Card will require one additional slot directly above the master card. Installation procedures for the module and procedures for the addition of an expansion card are shown step-by-step in the following paragraphs.

Module Installation

If you are installing the HP 16515A/16A 1 GHz Timing Analyzer Module (one master card or one master card and one expansion card), **follow this procedure**. If you are adding an expansion card to a master card, follow the procedure "Adding an Expansion Card" on page A-6.

CAUTION

The effects of ELECTROSTATIC DISCHARGE can damage electronic components. Use grounded wriststraps and mats when performing any kind of service to this module.

Installation Considerations

- A two card module must remain screwed together.
- Two adjacent slots are required for a two card module. A one card module may be installed in any available slot.
- If previously installed modules prevent proper installation, they must be repositioned in the card cage.
- Cards or filler panels below the empty slots intended for the module installation do not have to be removed.

Installation Procedure

1. Turn the instrument power switch off, unplug the power cord, and disconnect any input or output connections.
2. Starting **from the top**, loosen the thumb screws on filler panel(s) and card(s).

3. Starting **from the top**, begin pulling the card(s) and filler panel(s) out **half way**. See figure A-1.

CAUTION

All multi-card modules will be cabled together. Care should be taken to pull these cards out together.

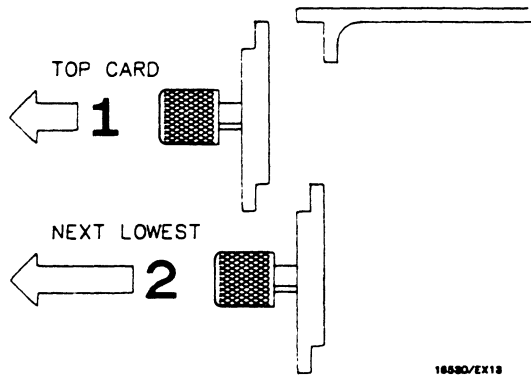

Figure A-1. Endplate Overlap

4. If the module consists of one master card, this card can be installed in any available slot. If the module consists of two cards, pick two adjacent slots. Then remove the appropriate filler panel(s).
5. Slide card(s) approximately **half way** into the slot(s) that you are using for this installation.

- Firmly seat bottom card(s) into backplane connector. **Keep applying pressure to the center of card(s) endplate while tightening the thumb screws finger tight.**

Note

If there are two cards in the timing module, follow the sequence in figure A-2 for tightening the thumbscrews.

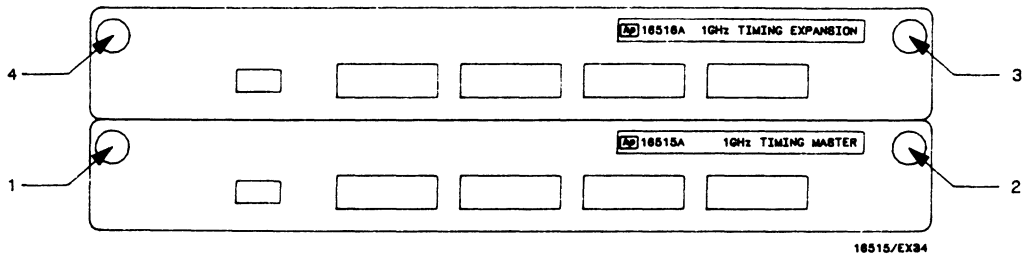

Figure A-2. Tightening Sequence

- Repeat step 6 for all cards and filler panels in a **bottom to top** order. See figure A-3.

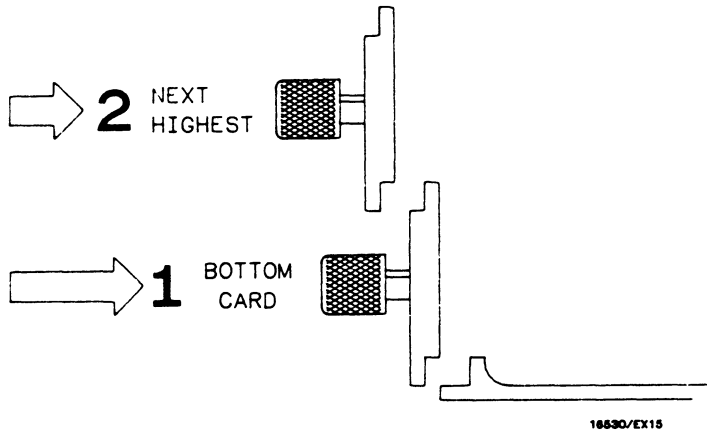

Figure A-3. Endplate Overlap

- Any filler panels that are not used should be kept for future use. Filler panels **must** be installed in all unused card slots for correct air circulation.

Adding an Expansion Card

This procedure should be used if you are adding an HP 16516A Timing Analyzer Expansion Card to a previously installed HP 16515A Timing Analyzer Master Card.

CAUTION

The effects of ELECTROSTATIC DISCHARGE can damage electronic components. Use grounded wriststraps and mats when performing any kind of service to this module.

Installation Considerations

- Cards must be screwed together.
- Two adjacent slots are required for a two card module installation.
- If previously installed modules prevent proper installation, they must be repositioned in the card cage.
- Cards or filler panels below the empty slots intended for the module installation do not have to be removed.

Installation Procedure

1. Turn the instrument power switch off, unplug the power cord, and disconnect any input or output connections.
2. Starting **from the top**, loosen the thumb screws on filler panel(s) and card(s).

3. Starting **from the top**, begin pulling the card(s) and filler panel(s) out **half way**. See figure A-4.

CAUTION

All multi-card modules will be cabled together. Care should be taken to pull these cards out together.

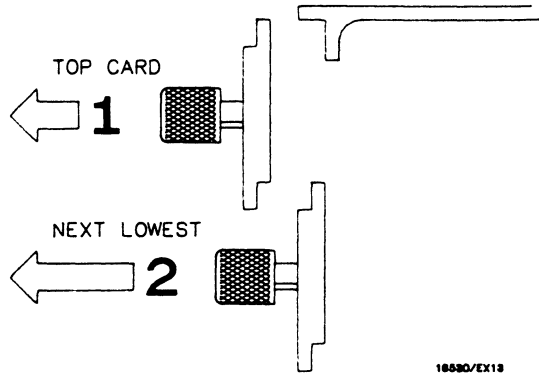

Figure A-4. Endplate Overlap

4. Pull the timing analyzer master card **completely out**.

5. Lay the timing analyzer master card on an antistatic mat. See figure A-5.

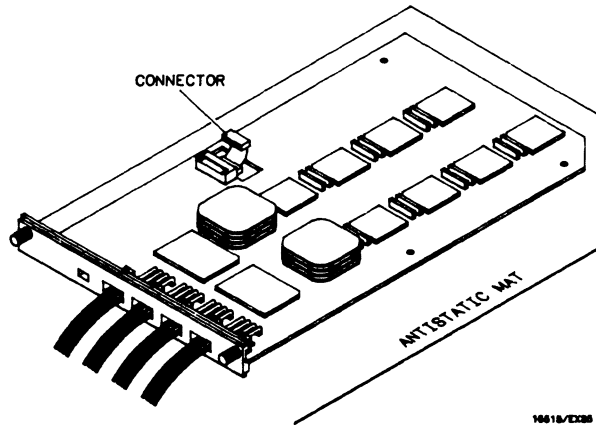

Figure A-5. Card On Mat

6. Connect intercard cable to the timing analyzer master card making sure to use the correct cable end. See figure A-6.

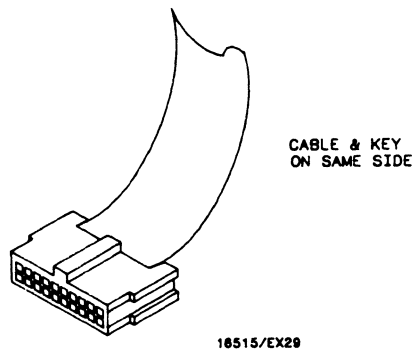



Figure A-6. Cable End

7. Fasten the timing analyzer expansion card to the timing analyzer master card using a No. 10 torx  driver and the six screws furnished with the timing analyzer expansion card. See figure A-7

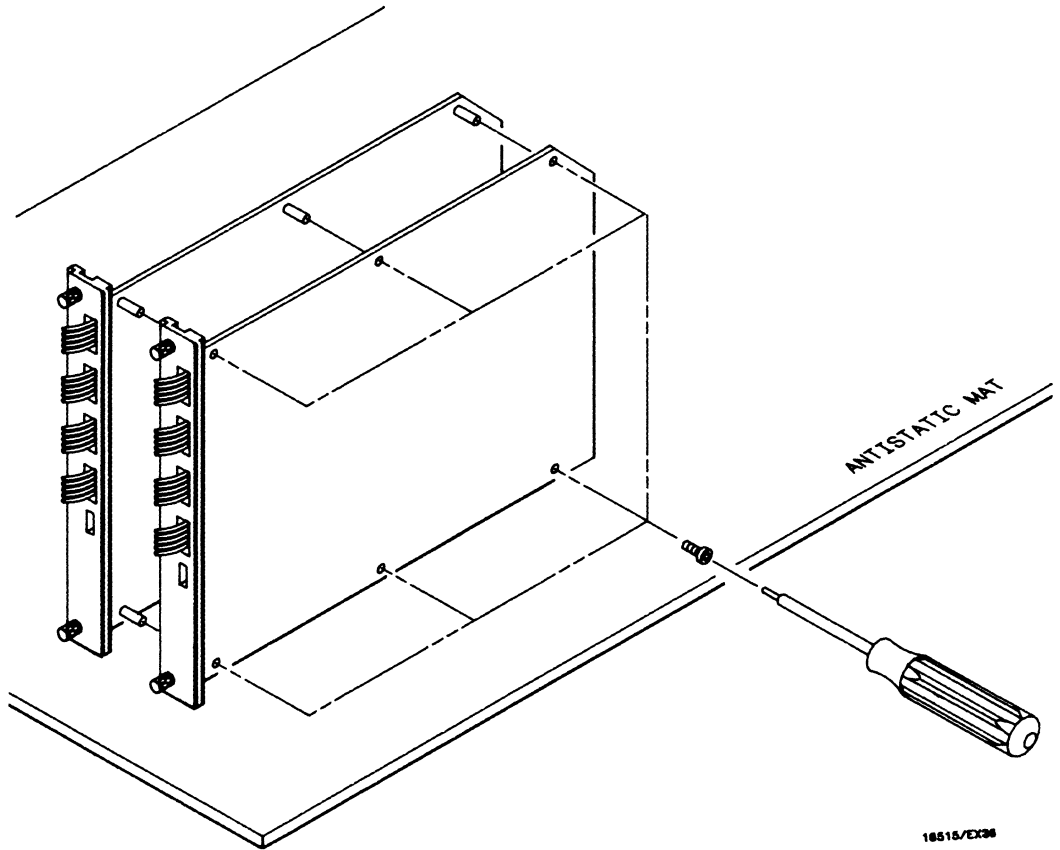

Figure A-7. Cards Fastened Together

8. Connect other end of intercard cable to expansion card.
9. Since the module consists of two cards, pick two adjacent slots. Then remove the appropriate filler panel(s).
10. Slide card(s) approximately **half way** into the slot(s) that you are using for this installation.
11. Firmly seat bottom card(s) into backplane connector. **Keep applying pressure to the center of card(s) endplate while tightening the thumb screws finger tight.**

Note

When there are two cards in the timing module, follow the sequence in figure A-8 for tightening the thumbscrews.

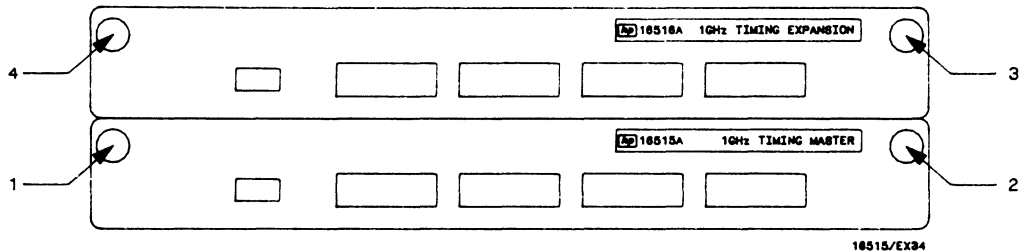

Figure A-8. Tightening Sequence

12. Repeat step 11 for all cards and filler panels in a **bottom to top** order. See figure A-9.

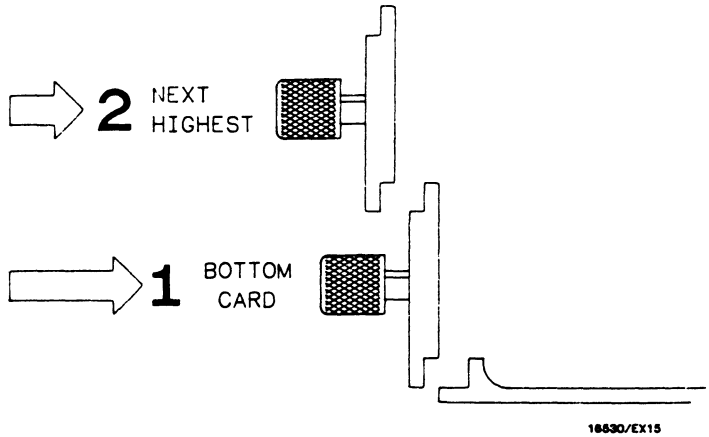

Figure A-9. Endplate Overlap

13. Any filler panels that are not used should be kept for future use. Filler panels **must** be installed in all unused card slots for correct air circulation.

Operating Environment

The operating environment is listed in "General Characteristics" in appendix B. Note the non-condensing humidity limitation. Condensation within the instrument can cause poor operation or malfunction. Protection should be provided against internal condensation.

The HP 16515A/16A will operate at all specifications within the temperature and humidity range given in appendix B. However, reliability is enhanced by operating the instrument within the following ranges.

Temperature: +20 to +35° C (+68 to +95° F)

Humidity: 20% to 80% non-condensing

Storage

The module may be stored or shipped in environments within the following limits:

Temperature: -40° C to +75° C

Humidity: Up to 90% at 65° C

Altitude: Up to 15,300 meters (50,000 Feet)

The module should also be protected from temperature extremes, which cause condensation on the module.

Packaging

The following general instructions should be used for repacking the module with commercially available materials.

- Wrap module in anti-static plastic.
- Use a strong shipping container. A double-wall carton made of 350 lb. test material is adequate.
- Use a layer of shock-absorbing material 70-to-100 mm (3-to- 4 inch) thick around all sides of the module to provide firm cushioning and prevent movement inside the container.
- Seal shipping container securely.
- Mark shipping container **FRAGILE** to ensure careful handling.
- In any correspondence, refer to module by model number and board number.

Tagging for Service

If the module is to be shipped to a Hewlett-Packard office for service or repair, attach a tag with your name and address, the complete board number, and a description of the service required.



B

Specifications and Characteristics

Specifications

Probes	Minimum Swing:	500 mV peak-to-peak.
	Threshold Accuracy:	± 150 mV $\pm 3.0\%$ over the range 0 volts to +5 volts.
		± 150 mV $\pm 2.0\%$ over the range -3.5 volts to 0 volts.
	Dynamic Range:	± 7.0 volts.

Characteristics

Probes	Input RC:	10 k Ω $\pm 2\%$ shunted by approximately 3 pF at the probe tip.
	Minimum Input Overdrive:	250 mV or 30% of the input amplitude, whichever is greater, above the pod threshold.
	Maximum Input Voltage:	± 40 volts.
	Threshold Setting:	Threshold levels may be defined for each pod individually.
	Threshold Range:	-3.5 to +5.0 volts in 0.1 volt increments.
	TTL Threshold Preset:	+1.5 volts
	ECL Threshold Preset:	-1.3 volts

Acquisition Memory	Memory Depth:	8192 samples/channel.
	Data Channels:	2 - eight channel pods (HP 16515A). 4 - eight channel pods (HP 16515A/16516A).
	Sample Period:	1 ns to 1.6 ms depending on seconds per division and delay settings.

Time Interval Accuracy *	Timebase Accuracy:	$\pm 0.01\%$ of the time interval reading plus: ± 500 ps at 250 MHz to 1 GHz sample rate. ± 2 ns at less-than or equal to 125 MHz sample rate.
	Time Interval Accuracy:	\pm Sample Period \pm Timebase Accuracy \pm (2 ns within a pod or 2.5 ns between pods)

Trigger	Asynchronous Pattern:	Trigger on an asynchronous pattern less than or greater than the specified duration, or trigger on a not-equal-to pattern greater than the specified duration. The pattern is the logical AND of the specified Low, High, or Don't Care for each assigned channel. If the pattern is valid, but duration is invalid, there is a 2.6 ns reset time before the instrument is ready to look for the pattern again. *
----------------	------------------------------	---

Greater Than Duration: Trigger occurs at pattern valid followed by duration expired.

Range: 2 ns to 507 sample periods for patterns specified within a pod.

7 ns to 507 sample periods for patterns specified across pods on the same board.

10 ns to 507 sample periods for patterns specified across boards (HP 16515A and HP 16516A) within a module.

Resolution: 4 sample periods.

Accuracy: ± 2 ns for 2 ns setting. *

± 1 sample period \pm

2 ns for patterns specified within a pod.

6 ns for patterns specified across pods on the same board.

8 ns for patterns specified across boards within a module.

for all other settings. *

Less Than Duration: Trigger occurs at the end of the pattern. Patterns specified within a pod must be valid for at least 1.5 ns. Patterns specified across pods on the same board must be valid for at least 11 ns. Patterns may not be specified across boards (HP 16515A/16516A). *

Range: 16 ns to 507 sample periods for patterns specified within a pod.

20 ns to 507 sample periods for patterns specified across pods on the same board.

Resolution: 4 sample periods.

Accuracy: ± 1 sample period \pm :

3 ns for patterns specified within a pod. *

7 ns for patterns specified across pods on the same board. *

Edge Trigger: Trigger on edge following the valid duration of an asynchronous pattern. Trigger is the OR of the specified rising or falling edges. Less than duration forces edge triggering off.

Minimum Pulse Width: 1.5 ns.

Delay from Trigger to BNC Output Port: Less than 50 ns from the probe tip. *

Display Functions

Data Display/Entry:

Labels: Channels may be grouped together and given a 6 character name. Up to 20 labels may be assigned with up to 32 channels per label. Primary use is for naming groups of channels such as address, data, and control busses.

Bases: Binary, Octal, Decimal, Hexadecimal, ASCII (display only), User-defined symbols.

Activity Indicators: Provided in the Format menu for identifying the current state of input lines as high, low, or changing.

Timing Waveform: Interleaved, time-correlated listing of timing waveforms and waveforms from other measurement modules (i.e., another timing analyzer or oscilloscope). Pattern readout of timing waveform at X or O marker in the selected base.

Waveform Display

Sec/Div: 1 ns to 1 s adjustable, with 3-digit resolution.

Delay -12.5 s to + 53.5 ks.

Accumulate: Waveform display is not erased between successive acquisitions.

Overlay Mode: Multiple channels can be displayed on one waveform display line. Primary use is to view summary of bus activity.

Maximum Number of Displayed Waveforms: 24.

Marker Functions:

Time Interval: The X and O markers, shown as dashed lines on the display, measure the time interval between one point on a timing waveform and trigger, two points on the same timing waveform, or two points on different waveforms.

Patterns: The X and O markers can be used to locate the 0 to 8192 occurrence of a specified pattern before or after trigger. The O marker can also be used to find the 0 to 8192 occurrence of a pattern before or after the X marker.

Statistics: X to O marker statistics are calculated for repetitive acquisitions. Patterns must be specified for both markers, and statistics are updated only when both patterns can be found in an acquisition. Statistics are minimum X to O time, maximum X to O time, average X to O time, and count of valid runs and total runs.

Trigger: Displayed as a vertical dashed line in the timing waveform display. Actual location of trigger in memory may vary from the marker by ± 4 samples (HP 16515A) and ± 6 samples (HP 16515A/16516A).

Acquisition Functions

Run:

Starts acquisition of data in specified trace mode. Single mode acquires data once while repetitive mode repeats single mode acquisitions until Stop is touched or until time interval between two specified patterns is less than or greater than a specified value, or within or outside a specified range.

Stop: In single trace mode, or the first run of a repetitive acquisition, STOP halts acquisition and displays the current acquisition data. For subsequent runs in repetitive mode, STOP halts acquisition of data and does not change the current display.

Arming: By the Run field or from any other module or the external port-in via the Intermodule Bus.

* These characteristics are true for input signal, $V_H = -0.90$ volts, $V_L = -1.70$ volts, threshold = -1.3 volts, slew rate = 1 V/ns.

General Characteristics

Operating Environment	Temperature:	Instrument, 0° to 55° C ($+32^{\circ}$ to 131° F). Probe lead sets and cables, 0° to 65° C ($+32^{\circ}$ to 149° F).
	Humidity:	Instrument, up to 95% relative humidity at $+40^{\circ}$ C ($+104^{\circ}$ F).
	Altitude:	To 4600 m (15,000 ft).
	Vibration:	
	Operation:	Random vibration 5-500 Hz, 10 minutes per axis, ≈ 0.3 g (rms).
	Non-operating:	Random vibration 5-500 Hz, 10 minutes per axis, ≈ 2.41 g (rms); and swept sine resonant search, 5-500 Hz, 0.75 g (0-peak), 5 minute resonant dwell @ 4 resonances per axis.



Index

This index covers the *HP 16515A/16516A Reference Manual*. Sequences of pages are represented with a slash (for example, 6-9/6-12).

A

Absolute,
 symbols, 6-10/6-11, 10-10/10-11
Accessories supplied, 1-3
Accumulate field, 8-5
Acquiring data, chapter 7, 11-7, 12-16
Acquisition functions, B-6/B-7
Acquisition memory, B-2
Action field, 9-5, 9-8
Activity indicators, 4-5, 11-3
 arrows, 4-5
 hyphens, 4-5
Adding symbols, 5-8
ANDed patterns, 6-9, 10-9
Arrows,
 activity indicator, 4-5
 double-ended, 4-5
 downward, 4-5
 edge, 6-21
 upward, 6-21
Arranging labels,
 Trace menu, 6-5/6-6
Assigning channels, 4-12/4-13, 11-4, 12-3/12-4
 clearing, 4-14
ASCII, 5-4, 6-7, 6-9, 6-12, 10-8, 10-10, 10-12
Asterisk, 4-13
Autolaod, 13-8/13-11
 disable, 13-11
 enable, 13-9
Average X to O, 10-21

B

Base,
 ASCII, 5-4, 6-7, 6-9, 6-12, 10-8, 10-10, 10-12
 numeric, 5-4, 6-7, 6-12, 10-8, 10-12/10-13
 specify patterns menu, 10-8
 symbols, 5-4, 6-7, 6-10/6-12, 10-8, 10-10/10-12
 Trace menu, 6-7
Bit assignment field,
 assigning bits, 4-12/4-13
 clearing bits, 4-14
 unassigning bits, 4-14
Boards,
 installation, A-2/A-11

C

Cancel,
 run mode, 7-5
Card,
 installation, A-2/A-11
Channel label field, 9-1
Channel mode, 9-4
 individual, 9-4
 overlay, 9-4
 sequential, 9-4
Channel numbers, 4-11
Channels,
 assigning, 4-12/4-13
 clearing, 4-14
 unassigning, 4-14
Characteristics, appendix B

Clearing

- channels, 4-14
- edges, 6-22
- patterns, 6-13

Clips,

- probe, 1-3, 2-1, 2-4

Connecting probes, 2-5/2-6, 11-3, 12-2

D

Damping resistor,

- probe lead, 2-5

Dark-blue field, 3-2

Data entry fields, 3-7

Default colors, 3-2, 6-16

Delay field, 8-8/8-9

Deleting,

- channels, 9-10
- labels, 4-8
- symbols, 5-8

Display functions, B-5

Display resolution, 8-7, 11-9

Dollar sign default, 6-13, 6-22, 10-13

Don't care (X), 6-11, 6-13, 10-12

Double-ended arrow, 4-5

Downward arrow, 6-21

Duration, 6-14/6-19, 12-6

- example, 6-18/6-19
- values, 6-15, 6-17, 12-6

E

ECL, 4-15

Edge field, 6-20/6-22, 11-6, 12-7

- arrow, 6-21
- clearing, 6-22
- dollar sign default, 6-22
- specifying, 6-20/6-22

Equal field, 6-14

- Trace menu, 6-8

Example,

- measurement, chapter 11, chapter 12
- pattern duration, 6-18/6-19
- waveform selection, 9-11/9-12

Expansion card, 1-1, 2-1, 2-3, 4-6

- accessories, 1-3, 2-1
- installation, A-6/A-11
- leads, 1-3, 2-1
- probes, 1-3, 2-1

F

Field, 3-2

- dark-blue, 3-2
- light-blue, 4-6

Field index,

- Format menu, 4-2
- Trace menu, 6-2
- Waveforms menu, 8-3

Find pattern, 6-9/6-13, 12-5

Format menu, 1-4, chapter 4

- activity indicators, 4-5
- channel assignment, 4-12/4-13
- channel numbering, 4-11
- field index, 4-2
- label roll field, 4-6
- labels, 4-6/4-9
- menu map, 4-3
- overview, 4-4
- pod numbering, 4-11
- pod threshold, 4-15/4-16
- polarity, 4-10
- print field, chapter 14
- run field, chapter 7
- selecting, 3-3, 11-4, 12-3
- symbols field, chapter 5

G

General characteristics, B-7
Grabbers, 2-6/2-7
 part number, 1-3, 2-1
Greater-than, 6-14/6-15, 10-14
Group run mode, 7-2

H

HP 16515A, 1-1, 2-1, 2-3, 4-6
 accessories, 1-3, 2-1
 leads, 1-3,2-1
 probes, 1-3, 2-1
HP 16516A, 1-1, 2-1, 2-3, 4-6
 accessories, 1-3, 2-1
 leads, 1-3,2-1
 probes, 1-3, 2-1
Hyphens,
 activity indicators, 4-5

I

Identifying cards, 2-3
Identifying pods, 2-3
Identifying probes, chapter 2
Independent run mode, 7-2
Individual mode, 9-4
Initial inspection, A-1
Inserting channels, 9-8/9-9
Installing boards, A-2/A-11
Instrument storage, A-12
Intermodule, 7-2, 9-3

K

Key features, 1-1
Keypad, 3-7
 entry, 6-17, 10-16, 10-18
Knob, 3-7
 entry, 6-16, 10-16, 10-17

L

Label roll field, 4-6
Labels, 4-6
 Format menu, 4-6/4-9, 11-4, 12-3
 modifying, 4-9
 naming, 4-9
 probe clips, 2-4
 probes, 2-3
 selecting, 4-7/4-9
 specifying patterns, 10-7
 symbols, 5-2/5-3
 Trace menu, 6-4/6-6
Leads, 2-5/2-6
 part number, 1-3, 2-1
Less-than, 6-14/6-15, 6-20, 10-14
Light-blue field, 4-6, 6-16
Loading,
 signal line, 2-7
Loading configurations, 13-6/13-7

M

Manuals supplied, 1-2
Markers, chapter 10
 off, 10-3
 menu map, 10-2
 pattern, 10-5/10-20, 10-21, 12-8/12-13
 selecting, 10-3
 statistics, 10-21/10-22, 12-18
 time, 10-4, 11-10

Master card, 1-1, 2-1, 2-3, 4-6
accessories, 1-3, 2-1
installation, A-3/A-5
leads, 1-3, 2-1
probes, 1-3, 2-1
Matching symbols, 5-13
Maximum X to O, 10-21
Mean X to O, 10-21
Measurement example, chapter 11, chapter 12

Menu map,
Format menu, 4-3
markers, 10-2
Trace menu, 6-3
Waveforms menu, 8-4
Waveform Selection menu, 9-3

Menus, 1-4/1-5,
Format, 1-4, chapter 4
selecting, 3-2/3-7
Trace, 1-5, chapter 6
Waveforms, 1-5, chapter 8
waveform selection, chapter 9

Minimum input, 2-7
Minimum X to O, 10-21

Modifying,
labels, 4-9
symbols, 5-8

Module,
installation, A-3/A-5

Module field,
waveform selection menu, 9-3, 9-13/9-14

Mouse, 3-8
buttons, 3-8
cursor, 3-8

N

Naming,
labels, 4-9
symbols, 5-6/5-7
Negative edge, 6-21
Negative polarity, 4-10

Not equal, 6-14
Trace menu, 6-8
Numeric base, 5-4, 6-7, 6-12, 10-8, 10-12/10-13

O

Off,
markers, 10-3
O pattern, 10-18/10-19, 12-13
Operating environment, A-12, B-7
ORed edges, 6-20, 6-22, 12-7
Overlay mode, 9-4

P

Packaging, A-13
Pattern,
clearing, 6-13
dollar sign default, 6-13
markers, 10-5/10-20
Trace menu, 6-9/6-13, 11-6, 12-5
specify patterns, 10-6/10-16
symbol, 5-10/5-11
Pattern duration, 6-14/6-19, 12-6
example, 6-18/6-19
values, 6-15, 6-17, 12-6
Period, 4-14
channel assignment, 4-14
edge field, 6-21, 6-22
Pod identification label, 2-4
part number, 1-3, 2-1
Pod numbers, 2-3, 4-11
Pod threshold, 4-15/4-16
user defined, 4-16
Polarity, 4-10
negative, 4-10
selecting, 4-10
Positioning labels,
Trace menu, 6-5/6-6
Positive edge, 6-22

- Power requirements, A-1
- Power up, 3-1
- Present for, 6-15
- Print, chapter 14
 - options, 14-1
- Printer configuration, 14-1
- Print Screen, 14-2
- Probe Assemblies, 1-3, chapter 2
 - identification, 2-2
 - installation, A-2
 - labels, 2-3
 - leads, 1-3, 2-1, 2-5/2-6
 - numbering, 2-3
 - part number, 1-3, 2-1
- Probe characteristics, B-1
- Probe clips, 1-3, 2-1, 2-4
 - part number, 2-1
- Probe specifications, B-1

R

- Range,
 - symbols, 5-12
- Recalling setups, 13-6/13-7
- Repetitive mode, 7-2, 7-4, 8-5, 10-10, 10-14, 10-22, 12-18
- Replacing channels, 9-5/9-7
- Resolution,
 - display, 8-7, 11-9, 12-15
- Rolling the display, 3-7
- Rubber probe clip, 1-3, 2-1, 2-2
- Run field, 7-2, 7-5, 8-1
- Run mode, 7-2/7-5
- Run/Stop field, 7-1

S

- Sample period, 8-6, 10-3
- Saving setups, 13-1/13-5
- s/Div field, 8-7, 11-9

- Selecting menus, 3-3
- Selecting waveforms, chapter 9, 11-8
 - action field, 9-5, 9-8
 - channel label field, 9-1
 - channel mode, 9-4
 - deleting channels, 9-10
 - example, 9-11/9-12
 - inserting channels, 9-8/9-9
 - menu, chapter 9
 - menu map, 9-3
 - module field, 9-3, 9-13/9-14
 - replacing channels, 9-5/9-7
- Sequential mode, 9-4
- Signal line loading, 2-7
- Single mode, 7-2, 7-3, 8-5, 10-10, 10-22
- Specifications, appendix B
- Specify patterns, 10-6/10-16, 12-9/12-12, 12-16
 - dollar sign default, 10-13
 - entering, 10-9
 - greater than, 10-14
 - leaving, 10-9
 - less than, 10-14
 - in range, 10-6, 10-15
 - label field, 10-7
 - not in range, 10-6, 10-15
 - stop measurement, 10-6, 10-13/10-16
- Specifying waveforms,
 - waveform selection, chapter 9, 11-8, 12-15
 - example, 9-11/9-12
- Storage,
 - instrument, A-12
- Statistics, 10-21/10-22, 12-18
- Stop field, 7-5
- Stop measurement field, 10-6, 10-13/10-16, 12-12
- Storing configurations, 13-1/13-5
- Switching labels,
 - Trace menu, 6-5/6-6
- Symbol menu, chapter 5
 - base field, 5-4
 - label field, 5-2/5-3
 - leaving, 5-13

- matching, 5-13
- name, 5-6/5-7
- pattern, 5-10/5-11
- range, 5-12
- selecting, 5-1
- symbol width field, 5-5, 6-10, 10-11

Symbols, 4-8, chapter 5

- absolute, 6-10/6-11, 10-10/10-11
- adding, 5-8
- base, 5-4, 6-7, 6-10/6-12, 10-8, 10-10/10-12
- modifying, 5-8
- selecting, chapter 5

Trace menu, 6-7

Symbols field, 5-9

System power up, 3-1

T

Tagging for service, A-13

Then Find Edge field, 6-20/6-22, 11-6

- arrow, 6-21
- clearing, 6-22
- dollar sign default, 6-22
- specifying, 6-20/6-22

Threshold, 4-15/4-16

- user defined, 4-16

Time interval accuracy, B-2

Time mode,

- markers, 10-4, 11-10
- Trigger to O, 10-4
- Trigger to X, 10-4
- X to O, 10-4

Touch screen, 3-2

Trace menu, 1-5, chapter 6

- base, 6-7
- edge field, 6-20/6-22
- equal field, 6-8
- field index, 6-2
- find pattern, 6-9/6-13
- greater-than, 6-14/6-15
- labels, 6-4/6-6

- less-than, 6-14/6-15, 6-20
- menu map, 6-3
- pattern, 6-9/6-13
- pattern duration, 6-14/6-19
- print field, chapter 14
- run field, chapter 7
- selecting, 3-3, 11-6, 12-5

Trigger, B-2/B-4

Trigger to O, 10-4

Trigger to X, 10-4

TTL, 4-15

Turning labels off, 4-8

Turning labels on, 4-7

U

Unassigning channels, 4-14

- clearing, 4-14

User interface, chapter 3

User defined,

- pod threshold, 4-16

V

Valid runs, 10-21/10-22

W

Waveforms menu, 1-5, chapter 8, 9-1

- accumulate field, 8-5
- characteristics, B-5/B-6
- delay field, 8-8/8-9
- field index, 8-3
- markers field, chapter 10
- menu area, 8-2
- menu map, 8-4
- print field, chapter 14
- run field, chapter 7
- sample period, 8-6

s/Div field, 8-7
 specify patterns, 10-6/10-16
 waveforms area, 8-2
 waveform selection, chapter 9
Waveform selection, chapter 9, 11-8, 12-14
 action field, 9-5, 9-8
 channel label field, 9-1
 channel mode, 9-4
 deleting channels, 9-10
 example, 9-11/9-12
 inserting channels, 9-8/9-9
 menu, chapter 9

menu map, 9-3
 module field, 9-3, 9-13/9-14
 replacing channels, 9-5/9-7
Width,
 symbols, 5-5, 6-10, 10-11

X

X (don't care), 6-11, 6-13, 10-12
X pattern, 10-17, 12-13
X to O, 10-4, 10-20, 11-11, 12-16

MEMORANDUM

TO: THE PRESIDENT

FROM: THE SECRETARY OF STATE

Subject: [Illegible text]

DIRECTORY

Worldwide Sales and Support

Hewlett-Packard products are sold and supported worldwide through HP offices.

- To contact one of the more than 240 HP Sales and Service Offices worldwide, check your telephone directory or contact one of the major HP offices listed.

- | | | |
|--|---|--|
| ■ Argentina
■ Martinez
Phone: 798-6086 | ■ Mississauga, Ontario
Phone: 416/678-9430 | ■ Japan
Yokogawa-Hewlett
Packard |
| ■ Australia
North Ryde, N.S.W.
Phone: 02/887-1611 | ■ Denmark
■ Birkeroed
Phone: 2/81-66-40 | ■ Osaka
Phone: 6/304-6021 |
| ■ Blackburn, Victoria
Phone: 03/890-6351 | ■ Finland
■ Espoo
Phone: 90/455-0211 | ■ Sagamihara
Phone: 427/59-1311 |
| ■ Austria
■ Vienna
Phone: 222/3516210 | ■ Jyvaaskyla
Phone: 41/216318 | ■ Tokyo
Phone: 3/331-6111 |
| ■ Belgium
■ Brussels
Phone: 02/762-3200 | ■ Oulu
Phone: 81/338785 | ■ Malaysia
■ Kuala Lumpur
Phone: 03/943-022 |
| ■ Brazil
■ Alphaville, Barueri
Phone: 011/421-1311 | ■ France
■ Les Ulis
Phone: 1/9077825 | ■ Mexico
■ Xochimilco, Mexico City
Phone: 905/676-8895 |
| ■ Canada
■ Edmonton, Alberta
Phone: 403/452-3670 | ■ Hong Kong
Wanchai
Phone: 5/832-3211 | ■ The Netherlands
■ Amstelveen
Phone: 020/472021 |
| ■ Richmond, British
Columbia
Phone: 604/270-2277 | ■ Italy
Cernusco Sul Naviglio
Phone: 2/903691 | ■ New Zealand
Pakuranga
Phone: 9/68-7159 |
-
- Full Field Repair Center capabilities.

- | | | |
|----------------------|-----------------------------|--------------------------|
| Norway | Switzerland | ■ Rockville, Maryland |
| ■ Oesteraas | ■ Widen | Phone: 301/948-6370 |
| Phone: 2/17-11-80 | Phone: 57/31-21-11 | |
| Puerto Rico | Taiwan | ■ Andover, Massachusetts |
| Carolina | ■ Taipei | Phone: 617/861-8960 |
| Phone: 809/762-725 | Phone: 2/712-0404 | ■ Novi, Michigan |
| | | Phone: 313/349-9200 |
| Saudi Arabia | United Kingdom | ■ Paramus, New Jersey |
| ■ HP Distributor; | ■ Altrincham | Phone: 201/265-5000 |
| Modern Electronics | Phone: 61/928-6422 | ■ King of Prussia, |
| Riyadh | ■ Winnersh, Wokingham | Pennsylvania |
| Phone: 01/4919715 | Phone: 734/784-774 | Phone: 215/265-7000 |
| Singapore | United States | ■ Richardson, Texas |
| ■ Singapore | ■ Santa Clara, California | Phone: 214/231-6101 |
| Phone: 631788 | Phone: 408/988-7000 | ■ Bellevue, Washington |
| South Africa | ■ Los Angeles, California | Phone: 206/643-4000 |
| ■ Sandton, Transvaal | Phone: 213/970-7500 | Venezuela |
| Phone: 11/802-511 | ■ Englewood, Colorado | ■ Caracas |
| Spain | Phone: 303/771-3455 | Phone: 2/239-4133 |
| ■ Mirasierra, Madrid | ■ Atlanta, Georgia | West Germany |
| Phone: 91/734-1162 | Phone: 404/955-1500 | ■ Boeblingen |
| Sweden | ■ Rolling Meadows, Illinois | Phone: 7031/667750 |
| ■ Spanga | Phone: 312/255-9800 | |
| Phone: 8/750-2000 | | |

-
- Full field Repair Center capabilities.

Other European Locations

For information on European locations other than those listed, contact:

Hewlett-Packard, S.A.
 150, Route du Nant-d'Avril
 P.O. Box
 1217 Meyrin 2
 Geneva, Switzerland

Other International Locations

For information on locations outside the U.S. and Europe that are not listed, contact:

Hewlett-Packard Intercontinental
 3495 Deer Creek Road
 Palo Alto, CA 94304 U.S.A.



HEWLETT
PACKARD