

44D0594

REVISIONS			
REV	DATE	DESCRIPTION	APPROVED
X1	CW	PROTOTYPE RELEASE	
X2	CW	ADDED CAPS C11, C12	
A		PRODUCTION RELEASE PER EN 80377	
B	CL	ADDED R12 THRU R16 PER EN 81895	
C	HA	ADDED R17 PER EN 81891	

▲ MARK SERIAL NO. WHERE SHOWN USING .12 HIGH PERMANENT CHARACTERS.
 ▲ MARK REVISION LETTER OF PARTS LIST TO WHICH PART WAS MANUFACTURED, APPROX. WHERE SHOWN IDENTIFICATION TO BE .12 HIGH AND PERMANENT.
 NOTE: UNLESS OTHERWISE SPECIFIED

REFERENCE DRAWINGS
 P.W. BOARD 40D0507
 LOGIC DIAGRAM 91D0358
 PHOTOMASTER 97D0700
 SOLDERMASK 97D0700
 SILKSCREEN 97D0702

FOR PARTS LIST SEE 44P0594

MODEL NO. 620/L-100	DESIGNER AND IN CHARGE AND AFTER FINISHING DATE 10-19-71	VMI series data machines / a series subsidiary 712 Michigan Ave / Ann Arbor / Michigan / 48106	TITLE
PART NAME OIA0145	DATE 1-14-72		MULTIPLY/DIVIDE, EA. DM 338 ASSEMBLY
MATERIAL	TOLERANCES UNLESS OTHERWISE SPECIFIED X ±.1 XX ±.05 XXX ±.025 ANGLES ±.85°	THIS DOCUMENT MAY CONTAIN PROPRIETARY INFORMATION AND SUCH INFORMATION MAY NOT BE DISCLOSED TO OTHERS FOR SUBJECT OR IN CONNECTION WITH THE PRODUCTION OF THIS ARTICLE OR SUBJECT, WITHOUT WRITTEN PERMISSION FROM VMI	CODE IDENT NO. 21101 DATE D DWG NO. 44D0594 SCALE 2/1 SHEET 1 OF 1

44P0594-000
SERIAL NO.

44D0594

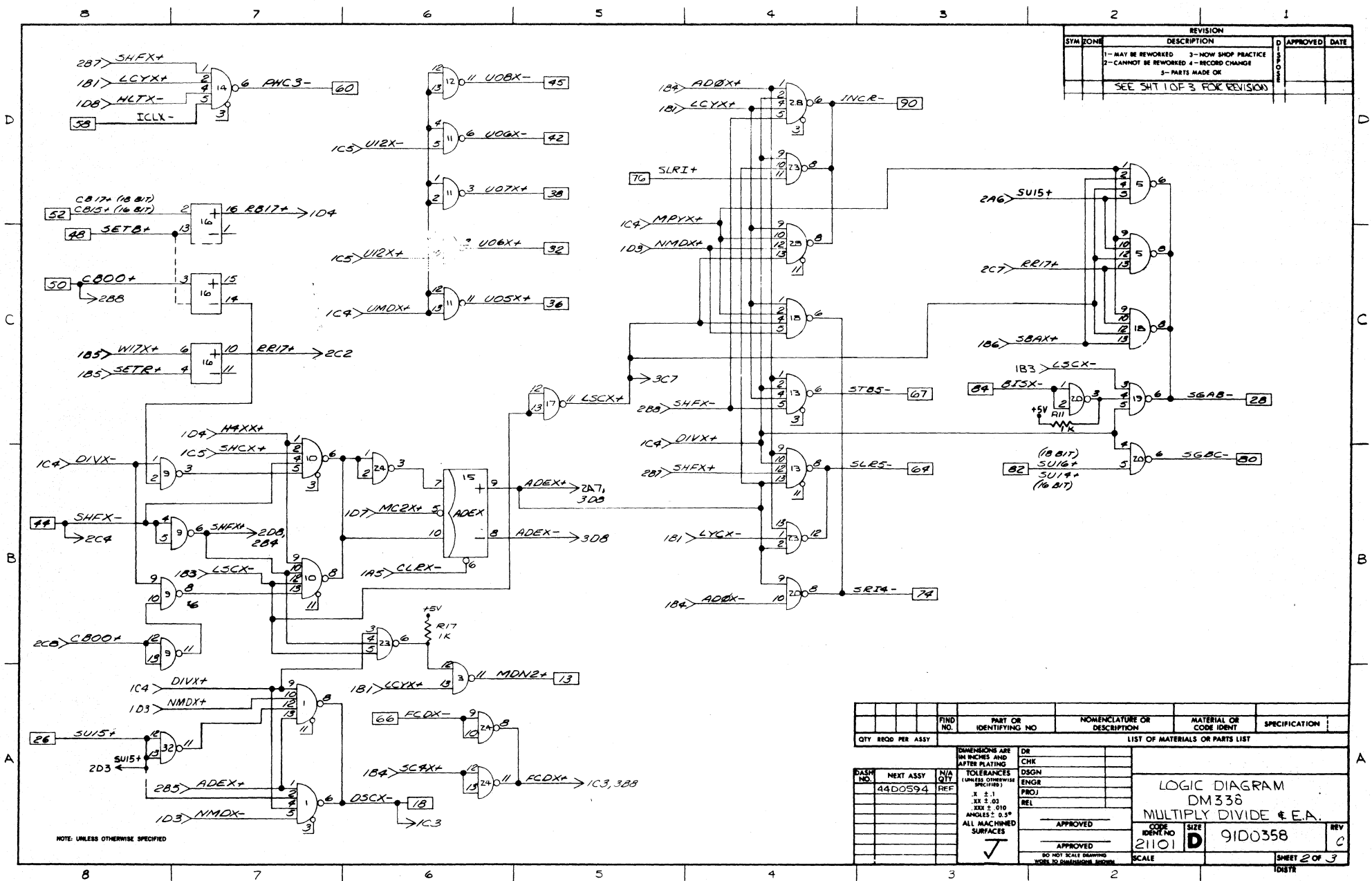

REVISION		APPROVED	DATE
1	MAY BE REWORKED		
2	CANNOT BE REWORKED 4 - RECORD CHANGE		
3	NOW SHOP PRACTICE		
4	PARTS MADE OK		
SEE SHIT 1 OF 3 FOR REVISION			

PART OR IDENTIFYING NO		NOMENCLATURE OR DESCRIPTION	MATERIAL OR CODE IDENT	SPECIFICATION
LIST OF MATERIALS OR PARTS LIST				
DIMENSIONS ARE IN INCHES AND AFTER PLATING				
TOLERANCES (UNLESS OTHERWISE SPECIFIED)				
X ± .1				
XX ± .05				
XXX ± .010				
ANGLES ± 0.5°				
ALL MACHINED SURFACES				
DR				
CHK				
DSGN				
ENGR				
PROJ				
REL				
APPROVED				
APPROVED				
DO NOT SCALE DRAWING				
WORK TO DIMENSIONS SHOWN				
DASH NO.		CODE IDENT NO		SIZE
NEXT ASSY		4400594		21101 D
LOGIC DIAGRAM				REV
DM 338				C
MULTIPLY DIVIDE & E.A.				
9100358				
SCALE				SHEET 2 OF 3
				10/8TR

NOTE: UNLESS OTHERWISE SPECIFIED

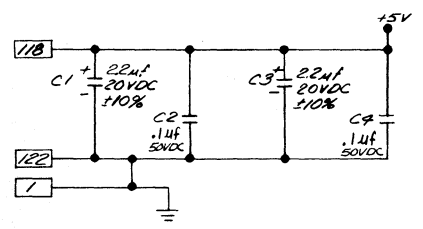
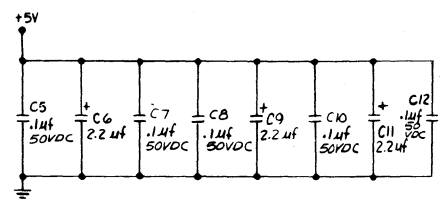
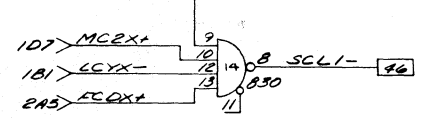
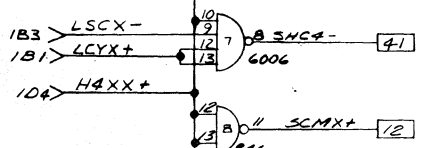
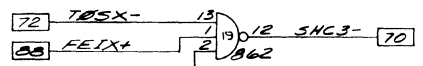
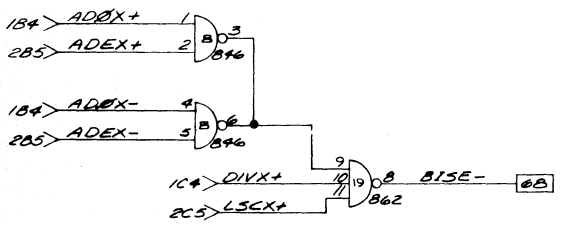

- 1
- 2
- 3
- 4
- 5
- 6
- 7
- 8
- 9
- 10 PHCX- →
- 11
- 12 SCMX+ →
- 13 MDVZ+ →
- 14
- 15 SC4X+ →
- 16
- 17 SCIX+ (10 BIT) →
(OPEN 16 BIT)
- 18 OSCX- →
- 19
- 20
- 21
- 22 DIVX+ →
- 23
- 24 DIVX- →
- 25
- 26 SU17+ (10 BIT) →
SU15+ (16 BIT)
- 27
- 28 SGAB- →
- 29
- 30 DIVX- →
- 31 LSCX- →
- 32 UOBX+ →
- 33
- 34 U12X+ →
- 35
- 36 UO5X+ →
- 37
- 38 UO7X+ →
- 39
- 40 U12X- →
- 41 SHC4- →
- 42 UOBX- →
- 43
- 44 SHEX- →
- 45 UOBX- →
- 46 SCL1- →
- 47 HAXX- →
- 48 SETB+ →
- 49 SHCX+ →
- 50 C800+ →
- 51
- 52 CB17+ (10 BIT) →
CB15+ (16 BIT)
- 53
- 54 SETR+ →
- 55
- 56 MCRX+ →
- 57
- 58 ICLX- →
- 59
- 60 PHC3- →
- 61
- 62
- 63
- 64 SLES- →

- 65
- 66 LCDX- →
- 67 STB5- →
- 68 BTSE- →
- 69
- 70 SHC3- →
- 71
- 72 TDSX- →
- 73
- 74 SETR- →
- 75 EMRX- →
- 76 SLRIT+ →
- 77
- 78 EDHX+ →
- 79
- 80 SGBC- →
- 81
- 82 SU16+ (10 BIT) →
SU14+ (16 BIT)
- 83
- 84 BT5X- →
- 85
- 86 CLRX+ →
- 87 SYRT+ →
- 88 FEIX+ →
- 89
- 90 INCR- →
- 91
- 92 SBAX+ →
- 93 ACBX+ →
- 94 N12X- (10 BIT) →
N15X- (16 BIT)
- 95 K2XX+ →
- 96 SBAX- →
- 97 HLTX- →
- 98
- 99 FEAI- →
- 100 UOEX+ →
- 101
- 102
- 103 UO0X+ →
- 104
- 105 SLPB- →
- 106
- 107 UOIX+ →
- 108
- 109 AC5X+ →
- 110
- 111
- 112
- 113
- 114
- 115 SLRX+ →
- 116
- 117
- 118 +5V →
- 119
- 120
- 121
- 122

REVISION		APPROVED	DATE
SYMBOL	DESCRIPTION		
1-	MAY BE REWORKED	3-	NOW SHOP PRACTICE
2-	CANNOT BE REWORKED	4-	RECORD CHANGE
5-	PARTS MADE OK		
SEE SHIT 1 OF 3 FOR REVISION			

FIND NO.		PART OR IDENTIFYING NO.		NOMENCLATURE OR DESCRIPTION		MATERIAL OR CODE IDENT		SPECIFICATION		
LIST OF MATERIALS OR PARTS LIST										
QTY	REQD	PER	ASSY							
DIMENSIONS ARE IN INCHES AND AFTER PLATING				OR				DMB INCHES, INC.		
TOLERANCES (UNLESS OTHERWISE SPECIFIED)				DSGN				HAYWARD BEACH, CALIF.		
X ± .1				ENGR				DIV. OF SECURITY CONTROLS, INC.		
.XX ± .03				PROJ				LOGIC DIAGRAM		
XXX ± .010				REL				DM 338		
ANGLES ± 0.5°				APPROVED				MULTIPLY/DIVIDE & E.A.		
ALL MACHINED SURFACES				APPROVED				CODE IDENT NO		
				DO NOT SCALE DRAWING				21101		
				WORK TO DIMENSIONS SHOWN				SIZE		
				SCALE				D 9100358		
								REV		
								10		
								SHEET 9 OF 9		
								INSTR		

NOTE: UNLESS OTHERWISE SPECIFIED