

TEXAS INSTRUMENTS

Improving Man's Effectiveness Through Electronics

Model 990 Computer Terminal Executive Development System (TXDS) Programmer's Guide

MANUAL NO. 946258-9701
ORIGINAL ISSUE 1 APRIL 1977
INCLUDES
CHANGE 1 1 JULY 1977
CHANGE 2 15 OCTOBER 1977

Digital Systems Division



The information and/or drawings set forth in this document and all rights in and to inventions disclosed herein and patents which might be granted thereon disclosing or employing the materials, methods, techniques or apparatus described herein are the exclusive property of Texas Instruments Incorporated.

No disclosure of the information or drawings shall be made to any other person or organization without the prior consent of Texas Instruments Incorporated.

LIST OF EFFECTIVE PAGES

INSERT LATEST CHANGED PAGES DESTROY SUPERSEDED PAGES

Note: The portion of the text affected by the changes is indicated by a vertical bar in the outer margins of the page.

Model 990 Computer Terminal Development System (TXDS) Programmer's Guide (946258-9701)

Original Issue 15 April 1977
 Change 1 1 July 1977 (ECN 419567)
 Change 2 15 October 1977 (ECN 419599)

Total number of pages in this publication is 202 consisting of the following:

| PAGE NO. | CHANGE NO. | PAGE NO. | CHANGE NO. | PAGE NO. | CHANGE NO. |
|---------------------------|------------|-----------------------|------------|--------------------------|------------|
| Cover | 2 | 4-13 | 0 | 9-35 - 9-36B | 1 |
| Effective Pages | 2 | 4-14 | 2 | 9-37 - 9-46 | 0 |
| iii - iv | 2 | 4-15 - 4-16 | 0 | 10-1 | 2 |
| v | 0 | 4-17 - 4-18 | 1 | 10-2 - 10-4 | 1 |
| vi | 1 | 4-19 - 4-22 | 0 | 10-5 | 2 |
| vii | 2 | 4-23 | 2 | 10-6 | 1 |
| viii - xii | 1 | 4-24 | 0 | 10-7 | 2 |
| 1-1 - 1-4 | 0 | 5-1 - 5-2 | 1 | 10-8 | 1 |
| 2-1 | 1 | 5-3 | 2 | 10-9 - 10-10 | 2 |
| 2-2 | 2 | 5-4 - 5-6 | 1 | 10-11 | 1 |
| 2-3 - 2-5 | 0 | 6-1 - 6-4 | 0 | 10-12 - 10-13 | 2 |
| 2-6 - 2-7 | 2 | 7-1 - 7-4 | 1 | 10-14 | 1 |
| 2-8 - 2-10 | 1 | 7-5 - 7-6 | 0 | 10-15 | 2 |
| 2-11 - 2-12 | 0 | 7-7 - 7-8 | 1 | 10-16 - 10-18 | 1 |
| 2-13 - 2-14 | 1 | 8-1 - 8-4 | 0 | 10-19 | 2 |
| 2-15 - 2-16 | 2 | 9-1 - 9-2B | 2 | 10-20 | 1 |
| 3-1 - 3-2 | 1 | 9-3 | 0 | 10-21 | 1 |
| 3-3 - 3-6 | 0 | 9-4 | 2 | 10-22 | 2 |
| 4-1 | 0 | 9-5 | 0 | 10-23 - 10-26 | 1 |
| 4-2 - 4-4 | 1 | 9-6 | 2 | 11-1 - 11-14 | 1 |
| 4-5 - 4-6 | 0 | 9-8 - 9-8B | 1 | 12-1 - 12-6 | 0 |
| 4-7 | 1 | 9-9 | 2 | Appendix A Div | 0 |
| 4-8 | 2 | 9-10 - 9-23 | 0 | A-1 - A-4 | 0 |
| 4-9 - 4-10 | 1 | 9-24 | 2 | Appendix B Div | 0 |
| 4-11 - 4-12 | 2 | 9-25 - 9-34 | 0 | B-1 - B-2 | 2 |

The information and/or drawings set forth in this document and all rights in and to inventions disclosed herein and patents which might be granted thereon disclosing or employing the materials, methods, techniques or apparatus described herein are the exclusive property of Texas Instruments Incorporated.

No disclosure of the information or drawings shall be made to any other person or organization without the prior consent of Texas Instruments Incorporated.

LIST OF EFFECTIVE PAGES

INSERT LATEST CHANGED PAGES DESTROY SUPERSEDED PAGES

Note: The portion of the text affected by the changes is indicated by a vertical bar in the outer margins of the page.

Model 990 Computer Terminal Development System (TXDS) Programmer's Guide (946258-9701)
 (continued)

Total number of pages in this publication is consisting of the following:

| PAGE NO. | CHANGE NO. | PAGE NO. | CHANGE NO. | PAGE NO. | CHANGE NO. |
|----------------------------------|------------|----------|------------|----------|------------|
| Appendix C Div | 0 | | | | |
| C-1 – C-2 | 0 | | | | |
| Appendix D Div | 0 | | | | |
| D-1 | 1 | | | | |
| D-2 | 0 | | | | |
| Alphabetical Index Div | 0 | | | | |
| Index 1 – Index -2 | 0 | | | | |
| User's Response | 2 | | | | |
| Business Reply | 0 | | | | |
| Cover Blank | 0 | | | | |
| Cover | 0 | | | | |



PREFACE

This manual enables the user to employ the Terminal Executive Development System (TXDS) in conjunction with the TX990 Operating System and the Model 990/4 and 990/10 Computer System hardware configuration to develop, improve, change, or maintain (1) the user's customized Operating System and the user's applications programs or (2) any other type of user-produced programs (e.g., the user's own supervisor call processors or the user's own utility programs). It is assumed the reader is familiar with the Model 990 Computer System assembly language and the concepts of the TX990 Operating System.

The sections and appendixes of this manual are organized as follows:

- I Introduction – Provides a general description of the TXDS utility programs and their capabilities. Also includes a description of the control functions of the TXDS Control Program.
- II Loading and Executing a Program – Provides a step-by-step procedure for loading and executing (1) each of the TXDS and TX990 Operating System utility programs and (2) a user program. Also describes the TXDS Control Program and how to correctly respond to its prompts.
- III Verification of Operation – Provides several short step-by-step procedures to checkout proper operation of the TXDS software.
- IV TXDS Text Editor (TXEDIT) Utility Program – Describes the capabilities of the TXEDIT utility program and how the user can employ those capabilities to edit or generate the text of source programs and object programs.
- V TX990 Assembler (TXMIRA) Utility Program – Describes how the user can employ the TXMIRA utility program to assemble source files (i.e., source code programs).
- VI TX990 Cross Reference (TXXREF) Utility Program – Describes how the user can employ the TXXREF utility program to produce a listing of each user-defined symbol in a 990 assembly source program along with the line numbers on which the symbol is defined and all of the line numbers on which the symbol is referenced.
- VII TXDS Linker (TXLINK) Utility Program – Describes how the user can employ the TXDS Linker utility program to form a single object module from a set of independently assembled object modules (in the form of object code or compressed object code).
- VIII TXDS Copy Concatenate (TXCCAT) Utility Program – Describes how the user can employ the TXCCAT utility program to copy one to three files to a single output file. ■
- IX TXDS Standalone Debug Monitor (TXDEBUG) Utility Program – Describes how the user can employ the TXDEBUG utility program to debug programs which have been designed to operate in a “standalone” situation without support of an operating system.
- X TXDS PROM (TXPROM) Programmer Utility Program – Describes how the user can employ the TXPROM programming utility program to control the Programming Module (PROM) hardware to make customized ROMs containing user-created data or programs.



- XI TXDS BNPF/High Low (BNPFHL) Dump Utility Program – Describes how the user can employ the BNPFHL utility program to produce a BNPF or high/low file format.
- XII TXDS IBM Diskette Conversion Utility (IBMUTL) Program – Describes how the user can employ the IBMUTL utility program to transfer standard IBM-formatted diskette datasets to TX990 Operating System files and to transfer TX990 Operating System files to standard IBM-formatted diskette datasets.
- A Glossary – Clarifies selected words used in this TX990 Operating System Programmer's Guide.
- B Compressed Object Code Format – Describes the compressed object code format.
- C Task State Codes – Lists and describes the task state codes.
- D I/O Error Codes – List and describes the I/O error codes available to the user, when coding a program, for printout or display on a terminal device.

The following documents contain additional information related to the TX990 Operating System and are referenced herein this manual:

| Title | Part Number |
|---|-------------|
| <i>Model 990 Computer TX990 Operating System Programmer's Guide</i> | 946259-9701 |
| <i>Model 990 Computer TMS9900 Microprocessor Assembly Language Programmer's Guide</i> | 943441-9701 |
| <i>Model 990 Computer Model FD800 Floppy Disc System Installation and Operation</i> | 945253-9701 |
| <i>Model 990 Computer Model 913 CRT Display Terminal Installation and Operation</i> | 943457-9701 |
| <i>Model 990 Computer Model 911 Video Display Terminal Installation and Operation</i> | 945423-9701 |
| <i>Model 990 Computer Model 733 ASR/KSR Data Terminal Installation and Operation</i> | 945259-9701 |
| <i>Model 990 Computer Model 804 Card Reader Installation and Operation</i> | 945262-9701 |
| <i>Model 990 Computer Models 306 and 588 Line Printers Installation and Operation</i> | 945261-9701 |
| <i>Model 990 Computer PROM Programming Module Installation and Operation</i> | 945258-9701 |
| <i>990 Computer Family Systems Handbook</i> | 945250-9701 |
| <i>Model 990 Computer Communications System Installation and Operation</i> | 945409-9701 |



TABLE OF CONTENTS

| Paragraph | Title | Page |
|---|--|------|
| SECTION I. INTRODUCTION | | |
| 1.1 | General | 1-1 |
| 1.2 | TXDS Text Editor (TXEDIT) Utility Program | 1-2 |
| 1.3 | TXDS Assembler (TXMIRA) Utility Program | 1-2 |
| 1.4 | TXDS Cross Reference (TXXREF) Utility Program | 1-2 |
| 1.5 | TXDS Linker (TXLINK) Utility Program | 1-2 |
| 1.6 | TXDS Copy/Concatenate (TXCCAT) Utility Program | 1-2 |
| 1.7 | TXDS Standalone Debug Monitor (TXDEBUG) Utility Program | 1-2 |
| 1.8 | TXDS PROM (TXPROM) Programmer Utility Program | 1-2 |
| 1.9 | TXDS BNPF/High Low (BNPFHL) Dump Utility Program | 1-2 |
| 1.10 | TXDS IBM Diskette Conversion Utility (IBMUTL) Program | 1-2 |
| SECTION II. LOADING AND EXECUTING A PROGRAM | | |
| 2.1 | Introduction | 2-1 |
| 2.2 | Loading and Executing a Program | 2-2 |
| 2.3 | Responding to TXDS Control Program Prompts | 2-4 |
| 2.3.1 | Prompt-Responses | 2-4 |
| 2.3.2 | Pathname Syntax and Default-Substitutes for Responses to PROGRAM:, INPUT:, and OUTPUT: Prompts | 2-6 |
| 2.3.3 | Special Keyboard Control Keys | 2-8 |
| 2.3.4 | Placement in Common Memory Block of the Response-Entries to the PROGRAM:, INPUT:, OUTPUT:, and OPTIONS: Prompts | 2-10 |
| 2.4 | Backing Up TI-Supplied TXDS Diskettes | 2-14 |
| 2.5 | TXDS Control Program Error Messages | 2-15 |
| SECTION III. VERIFICATION OF OPERATION | | |
| 3.1 | Introduction | 3-1 |
| 3.2 | Requirements | 3-1 |
| 3.3 | Operation | 3-1 |
| SECTION IV. TXDS TEXT EDITOR (TXEDIT) UTILITY PROGRAM | | |
| 4.1 | Introduction | 4-1 |
| 4.2 | LUNOs | 4-2 |
| 4.3 | Loading TXEDIT | 4-3 |
| 4.4 | Commands | 4-4 |
| 4.4.1 | General | 4-4 |
| 4.4.2 | Command Operands | 4-4 |
| 4.4.3 | Symbol Definition | 4-4 |
| 4.4.4 | Special Keys/Characters | 4-7 |
| 4.4.5 | Setup Commands | 4-7 |
| 4.4.6 | Pointer-Movement Commands | 4-8 |
| 4.4.7 | Edit Commands | 4-9 |
| 4.4.8 | Print Commands | 4-12 |
| 4.4.9 | Output Commands | 4-13 |
| 4.4.10 | Terminate-Sequence Commands | 4-14 |



TABLE OF CONTENTS (Continued)

| Paragraph | Title | Page |
|-----------|--|------|
| 4.5 | Error Messages | 4-14 |
| 4.6 | Example: Entering a Source Program on a Cassette or Diskette | 4-14 |
| 4.7 | Example of How to Edit a Source Program | 4-18 |
| 4.8 | Example of How to Edit an Object Program | 4-22 |

SECTION V. TXDS ASSEMBLER (TXMIRA) UTILITY PROGRAM

| | | |
|-------|---|-----|
| 5.1 | Introduction | 5-1 |
| 5.2 | LUNOs and Their Uses | 5-1 |
| 5.3 | Operation Interaction | 5-2 |
| 5.4 | TXMIRA Options | 5-2 |
| 5.4.1 | Memory Option (M) | 5-3 |
| 5.4.2 | Cross-Reference Option (X) | 5-3 |
| 5.4.3 | Listing Option (L) | 5-3 |
| 5.4.4 | Print Text Option (T) | 5-3 |
| 5.4.5 | Symbol Table Listing Option (S) | 5-3 |
| 5.4.6 | Compressed Object Option (C) | 5-3 |
| 5.5 | Errors | 5-4 |
| 5.5.1 | TXMIRA Error Messages | 5-4 |
| 5.6 | TXMIRA Example | 5-5 |

SECTION VI. TXDS CROSS-REFERENCE (TXXREF) UTILITY PROGRAM

| | | |
|-----|-------------------------------|-----|
| 6.1 | Introduction | 6-1 |
| 6.2 | LUNOs | 6-1 |
| 6.4 | Operating Procedure | 6-1 |
| 6.4 | Listing Format | 6-1 |
| 6.5 | Options | 6-4 |
| 6.6 | Error Messages | 6-4 |

SECTION VII. TXDS LINKER (TXLINK) UTILITY PROGRAM

| | | |
|-------|---|-----|
| 7.1 | Introduction | 7-1 |
| 7.2 | TXLINK File Structures and LUNO Assignments | 7-1 |
| 7.3 | TXLINK Execution | 7-1 |
| 7.4 | TXLINK Control Options | 7-3 |
| 7.4.1 | Memory Override (M) | 7-3 |
| 7.4.2 | Compressed Object (C) | 7-3 |
| 7.4.3 | Program Identifier, IDT, Option (I) | 7-4 |
| 7.4.4 | Partial Option (P) | 7-4 |
| 7.4.5 | Load Map Option (L) | 7-4 |
| 7.5 | Linked Object Module | 7-6 |
| 7.6 | Error Messages | 7-6 |
| 7.7 | TXLINK Example | 7-7 |

SECTION VIII TXDS COPY/CONCATENATE (TXCCAT) UTILITY PROGRAM

| | | |
|-----|--------------------------------|-----|
| 8.1 | Introduction | 8-1 |
| 8.2 | TXCCAT LUNOs | 8-1 |
| 8.3 | Operator Interaction | 8-1 |



TABLE OF CONTENTS (Continued)

| Paragraph | Title | Page |
|-----------|---------------------------------|------|
| 8.4 | Options | 8-2 |
| 8.4.1 | Truncate Option (TR) | 8-2 |
| 8.4.2 | Fix Records (FL) | 8-2 |
| 8.4.3 | Skip Records (SK) | 8-3 |
| 8.4.4 | List File (LF) | 8-3 |
| 8.4.5 | Space Listing (SL) | 8-3 |
| 8.4.6 | Number Lines (NL) | 8-3 |
| 8.4.7 | No Input Rewind (RI) | 8-3 |
| 8.4.8 | No Output Rewind (RO) | 8-3 |
| 8.5 | Errors | 8-3 |

SECTION IX. STANDALONE DEBUG MONITOR (TXDEBUG)

| | | |
|--------|--|-------|
| 9.1 | Introduction | 9-1 |
| 9.2 | General Description | 9-2 |
| 9.3 | Installation of TXDEBUG | 9-2 |
| 9.3A | Loading TXDEBUG | 9-2 |
| 9.4 | Debug Modes | 9-3 |
| 9.5 | Debug Monitor Command Structures | 9-4 |
| 9.5.1 | Debug Command Codes | 9-5 |
| 9.5.2 | Miscellaneous Commands | 9-6 |
| 9.5.3 | Command Entry | 9-6 |
| 9.5.4 | Notational Conventions | 9-7 |
| 9.6 | Command Descriptions | 9-8 |
| 9.6.1 | Execute User Program (EX) | 9-8 |
| 9.6.2 | Execute User Program under SIE or Trace (RU) | 9-8A |
| 9.6.3 | Hexadecimal Arithmetic (HA) | 9-9 |
| 9.6.4 | Find Byte (FB) | 9-10 |
| 9.6.5 | Find Word (FW) | 9-11 |
| 9.6.6 | Breakpoint Commands (SB, CB) | 9-13 |
| 9.6.7 | Communications Register Unit Commands (IC, MC) | 9-16 |
| 9.6.8 | Memory Commands (IM, MM) | 9-18 |
| 9.6.9 | Processor Register Commands (IR, MR) | 9-20 |
| 9.6.10 | Workspace Register Commands (IW, MW) | 9-21 |
| 9.6.11 | Snapshot Commands (SS, IS, CS) | 9-23 |
| 9.6.12 | Trace Commands (ST, SR, CR) | 9-27 |
| 9.6.13 | Write Protect Option Commands (SP, CP) | 9-34 |
| 9.7 | Debugging Techniques | 9-36B |
| 9.7.1 | General Debugging Techniques | 9-36B |
| 9.7.2 | Specific Debugging Techniques | 9-38 |
| 9.7.3 | Patching | 9-40 |
| 9.8 | Error Messages | 9-45 |



TABLE OF CONTENTS (Continued)

| Paragraph | Title | Page |
|---|--|-------|
| SECTION X. TXDS PROM (TXPROM) PROGRAMMER UTILITY PROGRAM | | |
| 10.1 | Introduction | 10-1 |
| 10.2 | Required Configuration | 10-1 |
| 10.3 | Description | 10-1 |
| 10.3.1 | PROM Burn and Verify | 10-2 |
| 10.3.2 | PROM Read Operation | 10-2 |
| 10.4 | Loading TXPROM | 10-4 |
| 10.5 | TXPROM Operation | 10-4 |
| 10.5.1 | Control File Creation | 10-4 |
| 10.5.2 | Control File Modification | 10-5 |
| 10.5.3 | Control File Execution | 10-6 |
| 10.6 | Data Files | 10-8 |
| 10.7 | Control Files | 10-8 |
| 10.7.1 | Data File Name | 10-8 |
| 10.7.2 | Data Bias | 10-9 |
| 10.7.3 | Transfer Code | 10-9 |
| 10.7.4 | Compare After | 10-9 |
| 10.7.5 | Memory Display | 10-10 |
| 10.7.6 | PROM Display | 10-10 |
| 10.7.7 | Memory Starting Address | 10-11 |
| 10.7.8 | Number of Memory Bytes | 10-11 |
| 10.7.9 | Memory Starting Bit | 10-11 |
| 10.7.10 | PROM Starting Address | 10-11 |
| 10.7.11 | Number of PROM Words | 10-12 |
| 10.7.12 | PROM Starting Bit | 10-12 |
| 10.7.13 | Memory Mapping Levels | 10-12 |
| 10.7.14 | Memory Level n Bit Step | 10-12 |
| 10.7.15 | Memory Level n Loop Count | 10-13 |
| 10.7.16 | PROM Mapping Levels | 10-13 |
| 10.7.17 | PROM Level n Bit Step | 10-13 |
| 10.7.18 | PROM Level n Loop Count | 10-14 |
| 10.7.19 | Transfer Bit Width | 10-14 |
| 10.7.20 | PROM Bits per Word | 10-14 |
| 10.7.21 | Program Zeros or Ones | 10-14 |
| 10.7.22 | Pulse Width | 10-15 |
| 10.7.23 | Duty Cycle | 10-16 |
| 10.7.24 | Number of Retries | 10-16 |
| 10.7.25 | Simultaneously Programmable Bits | 10-16 |
| 10.7.26 | CRU Base | 10-16 |
| 10.8 | Bit String Mapping | 10-16 |
| 10.8.1 | Level 1 Mapping Example | 10-17 |
| 10.8.2 | Level 2 Mapping Example | 10-17 |
| 10.8.3 | Level 3 Mapping Example | 10-19 |
| 10.9 | Standard Control Files | 10-19 |
| 10.10 | Variable Parameters | 10-19 |
| 10.11 | Programming EPROMs | 10-21 |
| 10.12 | Programming Examples | 10-23 |
| 10.12.1 | EPROM Example | 10-23 |
| 10.12.2 | PROM Example | 10-24 |
| 10.12.3 | Control File Change Example | 10-25 |
| 10.12.4 | Executing a Control File Example | 10-26 |



TABLE OF CONTENTS (Continued)

| Paragraph | Title | Page |
|---|---|-------|
| SECTION XI. TXDS BNPF AND HIGH-LOW (BNPFHL) DUMP UTILITY PROGRAM | | |
| 11.1 | Introduction | 11-1 |
| 11.2 | LUNOs | 11-3 |
| 11.3 | Loading the BNPFHL Utility Program | 11-3 |
| 11.3.1 | Response to the INPUT: Prompt | 11-4 |
| 11.3.2 | Response to the OUTPUT: Prompt | 11-4 |
| 11.3.3 | Response to the OPTIONS: Prompt | 11-4 |
| 11.3.4 | Response to the MEMORY: Prompt. | 11-6 |
| 11.4 | Error Messages | 11-7 |
| 11.5 | Examples of Usage of the BNPFHL Utility Program | 11-7 |
| 11.5.1 | Example of BNPF Formatted Dump Using Default Substitute Parameters | 11-9 |
| 11.5.2 | Example of HILO Formatted Dump Using Default Substitute | 11-10 |
| 11.5.3 | Example of HILO Formatted Dump Beginning at Position 4 of Initializing the Buffer to all Binary Ones | 11-11 |
| 11.5.4 | Example of a HILO Compare with Discrepant Data | 11-12 |
| 11.5.5 | Example of a BNPF Formatted Dump with Bias 100 | 11-13 |
| 11.5.6 | Example of a BNPF Compare with Discrepant Data | 11-13 |
| SECTION XII. TXDS IBM CONVERSION UTILITY (IBMUTL) PROGRAM | | |
| 12.1 | Introduction | 12-1 |
| 12.2 | IBMUTL Description | 12-1 |
| 12.2.1 | Formatting IBM Diskette | 12-1 |
| 12.2.2 | Transferring TX990 Files to IBM Datasets | 12-1 |
| 12.2.3 | Transferring IBM Datasets to TX990 Files | 12-1 |
| 12.3 | LUNOs and Their Uses | 12-1 |
| 12.4 | Loading and Executing | 12-1 |
| 12.5 | Operator Interaction | 12-2 |
| 12.5.1 | Special Characters | 12-2 |
| 12.5.2 | Operator Prompts | 12-2 |
| 12.6 | Error Reporting and Recovery | 12-4 |

APPENDIXES

| Appendix | Title | Page |
|----------|---|------|
| A | Glossary | A-1 |
| B | Compressed Object Code Format | B-1 |
| C | Task State Codes | C-1 |
| D | I/O Error Codes | D-1 |



LIST OF ILLUSTRATIONS

| Figure | Title | Page |
|--------|---|--------|
| 1-1 | Terminal Executive Software Development System, Data Flow and Control Paths | .1-3 |
| 1-2 | Model FS990/4 Floppy Based Software Development System, Minimum Hardware Configuration for TXDS | .1-4 |
| 3-1 | TXMIRA Sample Output Listing | .3-4 |
| 6-1 | Sample Cross Reference Listing (Abbreviated) | .6-2 |
| 7-1 | Files Accessed by TXLINK | .7-2 |
| 7-2 | Load Map Listing | .7-5 |
| 9-1 | Debug Monitor Memory Configuration | 9-35 |
| 9-1A | CRU Output Data Format | 9-35 |
| 9-2 | Trace Region Precedence of Lower Region Number | 9-39 |
| 9-3 | Using Both Trace and SIE | 9-40 |
| 10-1 | PROM Burn, Compare Operation | 10-3 |
| 10-2 | PROM Burn, Compare and Read Operation | 10-3 |
| 10-3 | Level 1 Mapping Example | .10-17 |
| 10-4 | Level 2 Mapping Example | .10-18 |
| 10-5 | Level 3 Mapping Example | .10-20 |
| 10-6 | EPROM Programming Example. | .10-23 |
| 10-7 | PROM Programming Example | .10-25 |
| 11-1 | Standard Object Code Format to BNPF Format Conversion | 11-1 |
| 11-2 | Standard Object Code Format to BNPF Format, Full, First Line Conversion | 11-1 |
| 11-3 | Standard Object Code Format to High-Low Format Conversion. | 11-2 |
| 11-4 | Standard Object Code Format to High-Low Format, Full First Line Conversion. | 11-2 |



LIST OF TABLES

| Table | Title | Page |
|-------|---|-------|
| 2-1 | Pathname Responses to PROGRAM:, INPUT:, and OUTPUT: Prompts | 2-7 |
| 2-2 | Utility Program File-Name Identifiers | 2-8 |
| 2-3 | Byte-Allocation of COMMON Memory | 2-11 |
| 2-4 | TXDS Control Program Error Messages | 2-16 |
| 4-1 | TXEDIT Default-Substitute | 4-4 |
| 4-2 | List of Commands and Special Keys/Characters. | 4-5 |
| 4-3 | TXEDIT Error Messages | 4-15 |
| 5-1 | Pathname Defaults | 5-2 |
| 5-2 | TXMIRA Options | 5-2 |
| 5-3 | Symbol Attributes | 5-3 |
| 5-4 | TXMIRA Fatal Errors | 5-4 |
| 5-5 | TXMIRA Nonfatal Errors | 5-5 |
| 6-1 | Pathname Defaults | 6-1 |
| 6-2 | Error Messages | 6-4 |
| 7-1 | Pathname Defaults | 7-2 |
| 7-2 | TXLINK Options | 7-3 |
| 7-3 | Error Messages | 7-7 |
| 8-1 | Pathname Defaults | 8-1 |
| 8-2 | TXCCAT Options | 8-2 |
| 8-3 | TXCCAT Errors | 8-4 |
| 9-1 | Valid Debug Command Combinations | 9-6 |
| 9-2 | TXDEBUG Keyboard Commands | 9-7 |
| 10-1 | Table of Control File Parameters Prompt | 10-7 |
| 10-2 | Pulse Widths | 10-15 |
| 10-3 | Minimum, Standard and Maximum Pulse Widths and Duty Cycles | 10-15 |
| 10-4 | Level 1 Mapping Example Parameters | 10-18 |
| 10-5 | Level 2 Mapping Example Parameters | 10-19 |
| 10-6 | Level 3 Mapping Example Parameters | 10-21 |
| 10-7 | Standard Control Files | 10-22 |
| 11-1 | BNPFHL Error Messages | 11-8 |
| 12-1 | IBMUTL Error Messages. | 12-5 |



SECTION I

INTRODUCTION

1.1 GENERAL

The Terminal Executive Development System (TXDS) provides an extensive software capability to assist in developing, improving, changing, or maintaining (1) the user's customized Operating System and the user's applications programs or (2) any other type of user-produced programs (e.g., the user's own supervisor call processors or the user's own utility programs). Essentially, TXDS delivers this capability by means of the following nine utility programs:

- TXDS Text Editor (TXEDIT) Utility Program
- TXDS Assembler (TXMIRA) Utility Program
- TXDS Cross Reference (TXXREF) Utility Program
- TXDS Linker (TXLINK) Utility Program
- TXDS Copy Concatenate (TXCCAT) Utility Program
- TXDS Standalone Debug Monitor (TXDEBUG) Utility Program
- TXDS PROM (TXPROM) Programmer Utility Program
- TXDS BNPF/High Low (BNPFHL) Dump Utility Program
- TXDS IBM Diskette Conversion Utility (IBMUTL) Program

Another important feature of TXDS is its capability to function as a control center by means of the TXDS Control Program. The TXDS Control Program simplifies operator interaction with the computer by (1) informing the operator, for example, when a program has been successfully loaded or executed or (2) by requesting the operator for an entry of data/information into the computer via the keyboard of the system console (i.e., the 911 or 913 Video Display Terminal, the 733 ASR/KSR Data Terminal, or the 743 KSR Data Terminal). Basically, the TXDS Control Program functions to prompt (i.e., request) the user for the name of the utility program to load, and the input, output, and options parameters required by the utility program. After the parameters have been entered via the system console keyboard, by the user, in response to the prompts, the specified utility program is loaded into memory and executed. When the utility program has completed execution, the TXDS Control Program again prompts the operator for the name of another program to load, and for the input, output, and options parameters required by the program.

TXDS can also be used to extend and upgrade the capabilities of the TX990 Operating System. By making appropriate use of the TXDS utility programs, users are able to more easily develop, improve, change, or maintain their software. TXDS is an ideal supplement to the TX990 Operating System software package.



The TXDS utility programs are briefly described in the following paragraphs; detailed descriptions (including step-by-step loading procedures, descriptions of available commands, and coding examples explaining typical employment of each utility program) are provided in the other sections in this manual. Figure 1-1 presents the data flow and control paths among the elements of the Terminal Executive Development System software; figure 1-2 presents a typical hardware configuration supporting TXDS capabilities.

1.2 TXDS TEXT EDITOR (TXEDIT) UTILITY PROGRAM

TXEDIT operates interactively with the operator's system console and provides a method of modifying existing source code on diskette files or cassettes and of creating new source files. Its features include the ability to make multiple single directional editing passes on the source file to add, remove, move, or change lines of source.

1.3 TXDS ASSEMBLER (TXMIRA) UTILITY PROGRAM

TXMIRA is a two-pass assembler that produces object code for any member of the Model 990 Computer family, including the TMS9900 Microprocessor. The assembler accepts an assembly language source program and produces a source listing and an object file. For more detailed information, refer to the *Model 990 Computer TMS9900 Microprocessor Assembly Language Programmer's Guide*.

1.4 TXDS CROSS REFERENCE (TXXREF) UTILITY PROGRAM

TXXREF produces a listing of each user-defined label in a 990 assembly source program along with the line number on which each label is defined and all of the numbers of the lines from which the label was referenced. The program may be invoked by either user directive, via the TXDS Control Program, or by chaining to it from the assembler.

1.5 TXDS LINKER (TXLINK) UTILITY PROGRAM

TXLINK links object modules produced by the assembler to form a single object module. The linker allows the specification of up to three input files each of which may contain multiple object modules. TXLINK can also perform partial links which may later be linked with additional modules to complete the linking process.

1.6 TXDS COPY CONCATENATE (TXCCAT) UTILITY PROGRAM

TXXCAT facilitates the transfer of data from file or device to file or device and allows for the specification of up to three source or object files to be copied to one output file or device.

1.7 TXDS STANDALONE DEBUG MONITOR (TXDEBUG) UTILITY PROGRAM

TXDEBUG is a memory-resident, standalone, system executive that provides extensive program debug features and responds interactively to user input from a 733 ASR Data Terminal.

1.8 TXDS PROM (TXPROM) PROGRAMMER UTILITY PROGRAM

TXPROM provides flexible user control of the PROM programming process as well as standardized programming options.

1.9 TXDS BNPF/HIGH LOW (BNPFHL) DUMP UTILITY PROGRAM

This utility allows a user to produce a BNPF-formatted file, output the file to an appropriate media (paper tape, cassette, etc.) and to compare the media contents to the BNPF-formatted file. It also allows a user to produce a TI 256 by 4 high/low-formatted file, output the file to an appropriate media, and compare the media contents to the input file contents.

1.10 TXDS IBM DISKETTE CONVERSION UTILITY (IBMUTL) PROGRAM

This utility provides a means of transferring standard IBM-formatted diskette data sets to TX990 files and transferring TX990 files to standard IBM-formatted diskette data sets.

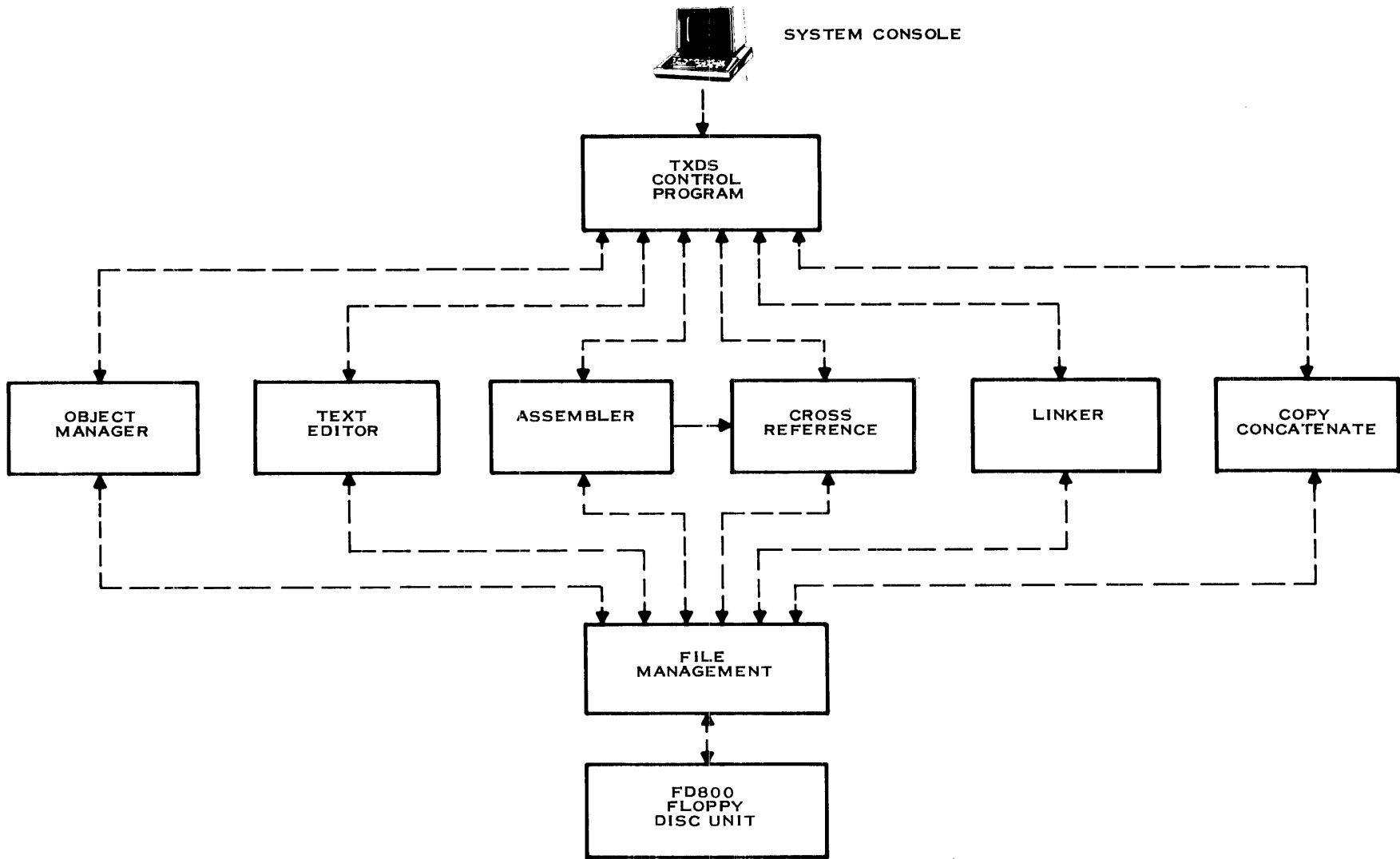

(A)135907B

Figure 1-1. Terminal Executive Software Development System, Data Flow and Control Paths

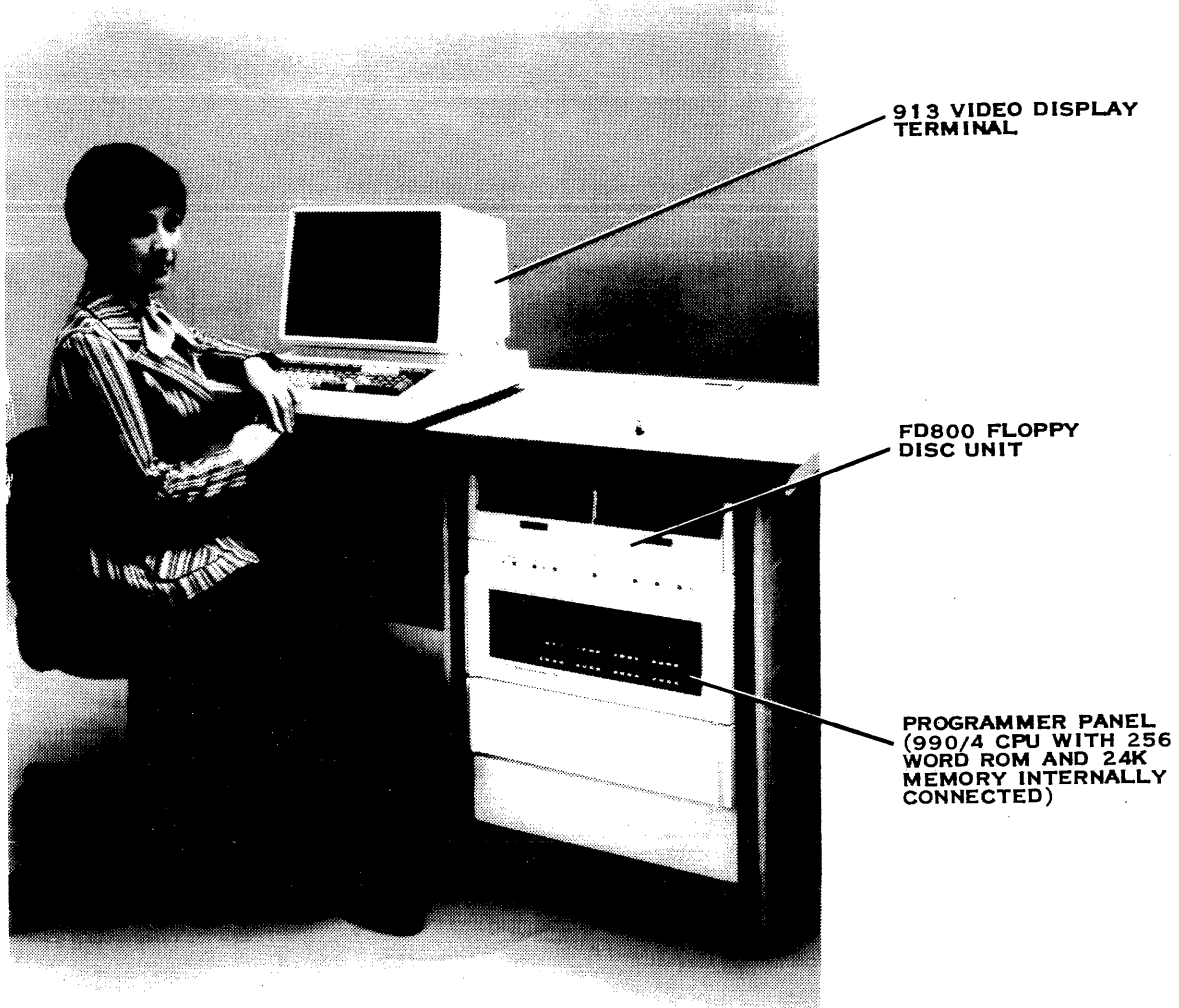

(A)135902

Figure 1-2. Model FS990/4 Floppy Based Software Development System,
Minimum Hardware Configuration for TXDS



SECTION II

LOADING AND EXECUTING A PROGRAM

2.1 INTRODUCTION

This section provides the user with a simple procedure for executing: (1) each of the TXDS and TX990 Operating System utility programs; and (2) a user program. The TXDS and TX990 Operating System utility programs are listed as follows:

TXDS Utility Programs

Text Editor (TXEDIT)
Assembler (TXMIRA)
Cross Reference (TXXREF)
Linker (TXLINK)
Copy Concatenate (TXXCAT)
Standalone Debug (TXDEBUG)
PROM Programmer (TXPROM)
BNPF/HIGH LOW Dump (BNPFHL)
IBM Diskette Conversion (IBMUTL)

TX990 Operating System Utility Programs

System Generation (GENTX)
Object Manager (OBJMGR)
Initialize Diskette (INITDSC)
Diskette Backup (BACKUP)
Diskette OCP System Utility (SYSUTL)
List 80-80 (LIST80)
Diskette Dump (DSKDMP)

The program loading and executing procedure is greatly simplified by the interactive, memory-resident TXDS Control Program, which enables loading and executing of any one of the above utility programs or a user program. The TXDS Control Program (only one of which is included with each Terminal Executive Development System) assists in program loading and execution by printing out or displaying prompts (i.e., requests) on the system console, sequentially, as follows:

PROGRAM:
INPUT:
OUTPUT:
OPTIONS:

The TXDS Control Program also prints out or displays information which indicates to the operator that a program has been successfully loaded or is in the process of being executed. For example, after the TXDS Control Program is executed, the following printout or display is presented at the system console:

```
TXDS  936215  **  152/77  1:05
```

PROGRAM:

The above display tells the operator that the TXDS Control Program is in execution and that the operator may respond to the PROGRAM: prompt by specifying the program to be loaded. The display heading indicates the name of the monitor (TXDS), the part number of the software, the revision status (** = no revision, *A = 1st revision, *B = 2nd revision, etc.), and the date and time of day that the program was loaded (152/77 = 152nd day of 1977).



The responses to the prompts of the TXDS Control Program are entered by the operator, using the keyboard of the system console, into a block of memory known as COMMON memory. The task which is being loaded and executed then accesses COMMON memory for the information contained in these responses. The response-information is stored in the bytes of COMMON memory in an organized manner using the format presented in table 2-3. The programmer, when coding a user utility program or a user applications program, will find it necessary to become familiar with the format of COMMON memory. Access to the response-information in COMMON memory is provided to the programmer by use of Get COMMON Data supervisor call 10_{16} . Get COMMON Data supervisor, when employed by the programmer, returns the memory address and the byte-size of COMMON to the task. The TXDS Control Program can only execute in an operating system which was generated with at least 170 bytes of COMMON memory. The user must take this into consideration when performing system generation using a different hardware configuration than the standard TI hardware configuration. (Refer to the System Generation (GENTX) Utility Program section of the *TX990 Operating System Programmer's Guide*.) A more detailed description of the COMMON memory area and how to meet its coding requirements is presented in paragraph 2.3.4.

The following paragraphs in this section present a procedure for loading and executing a program with supplementary supporting information describing: (1) how to correctly respond to the prompts; (2) how to use correct syntax; (3) how to use the special keyboard control keys; and (4) how to code the COMMON memory block. Also included in this section is a procedure for backing up a TI-supplied TXDS diskette and a description of the TXDS Control Program error messages.

2.2 LOADING AND EXECUTING A PROGRAM

Proceed as follows:

1. Load the Operating System (which has been customized to the user's software/hardware configuration) by performing the steps in Section II, entitled "Loading The Operating System", of the *TX990 Operating System Programmer's Guide*.
2. Execute the TXDS Control Program by proceeding to step 3 if OCP is not available or by proceeding to step 4 if OCP is available.
3. Press the exclamation point (!) key on the system console keyboard and proceed to step 6.
4. Press the exclamation point (!) key on the system console keyboard and observe the following period (.) prompt display:

!
.

5. Execute the TXDS Control Program by responding to the period (.) prompt as follows:

!
.EX,16.TE.



6. Observe the following printout or display presented on the system console:

```
TXDS  **  010/77  2:05
```

PROGRAM:

NOTE

To correctly respond to the PROGRAM:, INPUT:, OUTPUT:, and OPTIONS: prompts, the operator is required to understand the information presented under paragraph 2.3.

7. Respond to the PROGRAM: prompt in accordance with the parameters defined in paragraph 2.3 below by entering the device-name identifier of the input device on which the program to be loaded and executed is stored and/or the file-name identifier of the program to be loaded and executed.
8. After responding to the PROGRAM: prompt, the user can enter a carriage return and respond to the INPUT: prompt; then enter another carriage return and respond to the OUTPUT: prompt; and then enter another carriage return and respond to the OPTIONS: prompt. The user has an alternative and shortened procedure, using the asterisk (*) as described in the paragraph entitled "Special Keyboard Control Keys".

NOTE

1. If a syntax error was made, the prompt for the parameter line in error will be displayed and the operator must reenter that parameter and all of the parameters for the prompt line following the one in error.
 2. If a utility program bid by the operator was illegal, the printout or display readout presented in the paragraph entitled "TXDS Control Program Error Messages" will be displayed.
9. After responding to the OPTIONS: prompt, the operator depresses the carriage return key and causes the program to be loaded into memory and then executed. When the program is loaded into memory, a title identifying the utility will be displayed. Observe the following printout/display from the system console if, for example, the TXLINK utility program was loaded:

```
TXLINK  937537  **
```

(where 937537 is the part number of the TXLINK utility program)

10. After the loaded program has completed execution, observe the following printout or display readout from the system console:

```
TXDS  936215  **  359/77  1:05
```

PROGRAM:

**NOTE**

When the user desires to execute a task that already resides in memory without loading the task, a hexadecimal sign is entered, followed by the task ID (10). For example, after the TXEDIT utility program has been loaded into memory, it can be reexecuted as follows:

```
TXDS  936215  **  010/77  2:05
```

```
PROGRAM:  >10
INPUT:    DSC:TASK2/SRC
OUTPUT:   DSC:SCRATCH/SRC
OPTIONS:  (carriage return)
```

A description of the prompts and associated response-entries is provided in the following subparagraphs.

2.3 RESPONDING TO TXDS CONTROL PROGRAM PROMPTS

The operator's response to the PROGRAM:, INPUT:, or OUTPUT: prompt is used to specify (1) the device-name identifier of the input device on which the program to be loaded and executed is stored and/or (2) the file-name identifier of the program to be loaded and executed. When the file is on a diskette input device, the full response to any of the prompts requires inclusion of the diskette-name identifier (e.g. DSC, DSC2, DSC3, DSC4) and the file-name identifier (e.g. :TXLINK or :TXEDIT) and the extension. An example of a full response to a PROGRAM: prompt is:

```
PROGRAM:  DSC:TXLINK/SYS
```

When the file is on a non-diskette device such as a cassette unit, card reader, line printer or other I/O device, the full response to any of the prompts requires inclusion of solely the device-name identifier (e.g. CS1, CR, or LP). An example of a correct full response to a PROGRAM: prompt is:

```
PROGRAM:  CS1
```

The response to a prompt, in the case using a diskette I/O device or in the case using a non-diskette I/O device, is referred to as the pathname.

2.3.1 PROMPT-RESPONSES. The TXDS Control Program prompts the user to enter the program pathname, input pathname, output pathname, and option-selections. The TXDS Control Program then checks the pathnames for syntax. If the syntax is not correct, it will prompt the user again. After all of the responses to the prompts are entered, the TXDS Control Program loads and executes the specified program as task 10_{16} .

2.3.1.1 PROGRAM: Prompt. The operator's response to the PROGRAM: prompt is used for specifying the pathname of the program to be loaded and executed.

Only one pathname can be entered in response to the PROGRAM: prompt. When the program is to be loaded as a privileged task (enabling the task to execute certain supervisor calls), the user must enter the pathname followed by a "P". A task, when not linked with the TX990 Operating System, can only be made privileged when it is loaded. All tasks linked with the TX990 Operating System are privileged.



When the user does not enter the extension field in the **PROGRAM:** prompt pathname, the extension will default to **SYS** and **SYS** will be substituted into the pathname before any drives are searched.

When a **PROGRAM:** pathname, for a diskette configuration, does not specify the diskette transport drive, the TXDS Control Program starts a device-file search beginning with the diskette transport drive that is the default-substitute defined during system generation. For a standard TI-supplied TXDS system, the default-substitute is **DSC**. If the file is not on the diskette of the first default diskette transport drive, the TXDS Control Program will concatenate a 2 to **DSC** and the file search would then proceed to **DSC2**. In the same manner, the search continues to **DSC3** and to **DSC4**. The search is only effective when the diskette default-substitute is the main diskette transport drive and when its device-name identifier is comprised of three characters, (i.e., **DSC** or any other three characters). It should also be noted that whenever the user specifies the device-name identifier in response to the **PROGRAM:** prompt, only the specified device (e.g., the specified diskette transport drive) is searched.

2.3.1.2 INPUT: Prompt. The operator's response to the **INPUT:** prompt is used to specify the pathname of the input information needed by the program during its execution. For example: the **TXMIRA** utility program uses the response to the **INPUT:** prompt to specify the pathname of the source file; the **TXLINK** utility program uses the response to the **INPUT:** prompt to specify the pathname of the individual object modules to be linked; and the **TXCCAT** utility program uses the response to the **INPUT:** prompt to specify the pathname of the individual files to be copied together. The other utility programs each use the response to the **INPUT:** prompt in the manner described under each of the utility program sections herein this manual. The operator can enter zero to three input pathnames separated by commas. The TXDS Control Program will check each parameter for syntax. If the syntax is wrong, the TXDS Control Program will prompt the user again. The user must enter the entire line again.

The **INPUT:** pathname default-substitutes for each utility program are listed and described in each utility program section of this *TXDS Programmer's Guide* and in each utility program section of the *TX990 Operating System Programmer's Guide*.

2.3.1.3 OUTPUT: Prompt. The operator's response to the **OUTPUT:** prompt is used to specify the pathname for storage of the output information resulting from execution of the program. For example: the **TXMIRA** utility program uses the response to the **OUTPUT:** prompt to specify the pathname where object is stored and assembly source file listings are to be presented; the **TXLINK** utility program uses the response to the **OUTPUT:** prompt to specify the pathname where the linked object is to be stored and where load map listings are to be presented; and the **TXCCAT** utility program uses the response to the **OUTPUT:** prompt to specify the pathname where the copied files are to be stored. The other utility programs each use the response to the **OUTPUT:** prompt in the manner described under each of the utility program sections herein this manual. Up to three pathnames (separated by commas) can be entered in response to the **OUTPUT:** prompt.

The **OUTPUT:** pathname default-substitutes for each utility program are listed and described in each utility program section of this *TXDS Programmer's Guide* and in each utility program section of the *TX990 Operating System Programmer's Guide*.

2.3.1.4 OPTIONS: Prompt. The operator's response to the **OPTIONS:** prompt is used to specify the option(s) selected from the total alternative options available for the program which is to be loaded and executed. These options are described in the applicable utility program section in this *TXDS Programmer's Guide* or in the *TX990 Operating System Programmer's Guide*.



2.3.2 PATHNAME SYNTAX AND DEFAULT-SUBSTITUTES FOR RESPONSES TO PROGRAM:, INPUT:, AND OUTPUT: PROMPTS. Prior to loading and executing a program, the operator: (1) bids the program by responding with a pathname entry to the PROGRAM: prompt; (2) defines and enters the INPUT: and OUTPUT: pathnames; and (3) selects and enters the program's OPTIONS: parameters. A complete response to the PROGRAM:, INPUT:, and OUTPUT: prompts requires that the following items, when used, be appropriately entered on the keyboard of the system console:

- **DEV.** This is the device name identifier, defined during system generation. It is a one to four character name. The first character must be alphabetic (A-Z); the other characters must be alphabetic or numeric. No embedded blanks are allowed.
- **FILE.** This is the file name identifier specified when the file was created. It must be a one to seven character name. The first character must be alphabetic (A-Z); the other characters must be alphabetic or numeric. No embedded blanks are allowed.
- **EXT.** This is the file name extension specified when the file was created. It must be a one to three character qualifier which indicates the type of file. The first character must be alphabetic (A-Z); the other characters must be alphabetic or numeric. Some commonly used extensions are: SYS; LST; OBJ; SRC; et. al. No embedded blanks are allowed.

NOTE

There must not be embedded blanks within a PROGRAM:, or INPUT:, or OUTPUT: prompt line. Embedded blanks are allowed in the OPTIONS: response.

When the file is on a diskette unit the full or abbreviated pathname syntax, available for response to the PROGRAM:, INPUT:, and OUTPUT: prompts, are listed and described in table 2-1.

NOTE

The default-substitutes mentioned in table 2-1 are determined by the utility program being executed. Consequently, in some utility programs, a default-substitute may not exist. Further, the utility program being executed also determines whether or not a default-substitute results in an error.

The TXDS Control Program checks the syntax of all of the pathnames entered for the utility program before it is executed. If the pathname syntax is not legal, then the prompt associated with that entry is again printed out or displayed (to reprompt the operator).

When responding to the PROGRAM: prompt, the operator enters the pathname which specifies the file-name identifier of the utility program being bid. The TX990 Operating System uses the pathname to locate the utility program's object code. The file-name identifier for each utility program is listed in table 2-2.

**Table 2-1. Pathname Responses to PROGRAM:, INPUT:, and OUTPUT: Prompts**

| Response | Explanation |
|-----------------|--|
| DEV:FILE/EXT | This is the full pathname response for a diskette file. An example is: DSC:TXLINK/SRC. No default-substitute is employed when a full response is made. |
| :FILE/EXT | The missing DEV causes the default diskette name, defined during system generation, to be used in the device field. |
| DEV:FILE | This causes a blank to be provided for the extension. |
| :FILE | The default diskette name, defined during system generation, is used for the device field and a blank is used as the extension. |
| :FILE/ | This causes the default diskette name, defined during system generation, to be used for the device field and the extension will be as specified in the utility program being executed. |
| DEV/EXT | This causes a default-substitute to be provided for the file as specified in the utility program being executed. |
| /EXT | This causes the default diskette name, defined during system generation, to be used for the device field and the file default will be as specified in the utility program being executed. |
| / | This causes the default diskette name, defined during system generation, to be used for the device field and the file and extension will default as specified in the utility program being executed. |
| DEV: | This causes a default-substitute to be provided for the file and extension as specified in the utility program being executed. |
| DEV | This is a full device name. No default-substitutes apply. |



Table 2-2. Utility Program File-Name Identifiers

| File Name Identifier | Utility Program |
|----------------------|---|
| :GENTX/SYS | System Generation ^{1, 3} |
| :OBJMGR/SYS | Object Manager ^{1, 3} |
| :INITDSC/SYS | Initialize Diskette ^{1, 3} |
| :BACKUP/SYS | Diskette Backup ^{1, 3} |
| :SYSUTL/SYS | System Utility ^{1, 3} |
| :LIST80/SYS | List 80-80 ^{1, 4} |
| :DSKDMP/SYS | Diskette Dump ^{1, 3} |
| :TXMIRA/SYS | Assembler ² |
| :TXXREF/SYS | Cross Reference ² |
| :TXLINK/SYS | Linker ² |
| :TXCCAT/SYS | Copy Concatenate ² |
| :TXEDIT/SYS | Text Editor ² |
| :IBMUTL/SYS | IBM Diskette Conversion ^{2, 3} |
| :TXDEBUG/SYS | Standalone Debug ² |

Notes:

- ¹ - TX990 Operating System utility program.
- ² - TXDS Terminal Executive Development System utility program.
- ³ - Capable of being loaded and executed using OCP commands or the TXDS Control Program.
- ⁴ - This is the only utility in this list which can only be executed using OCP.

2.3.3 SPECIAL KEYBOARD CONTROL KEYS. The special keyboard control keys are described as follows:

1. RUB OUT/DELETE LINE
Allows the operator to reenter a parameter. Pressing the RUB OUT key causes a line feed followed by a carriage return. The operator may then enter the line again.
2. CONTROL H/Back Arrow
Allows the operator to backspace by character and correct a typing error.
3. Carriage Return/NEW LINE
Causes TXDS Control Program to terminate if the carriage return or NEW LINE was the only entry in response to the PROGRAM: prompt, otherwise terminates a prompt line entry.



- | | |
|-----------------|---|
| 4. ESCAPE/RESET | If an ESCAPE or RESET is entered during a print out, the TXDS Control Program terminates. |
| 5. , | Causes a default to be activated when entered as the response to the INPUT: or OUTPUT: prompts. |
| 6. & | In any prompt line, pressing the & key as the first character in the response causes the TXDS Control Program to restart with the PROGRAM: prompt. |
| 7. * | When entered after a prompt line entry, in place of a carriage return, permits the next prompt line to be entered without being prompted by the TXDS Control Program. When a prompt line is terminated with an asterisk (*) followed by a carriage return, no more prompts are given and default-substitutes are made by the utility program for those pathnames not entered. The experienced user can enter all or several of the parameters on one prompt line. |

The following examples utilize the asterisk (*) feature in lieu of the INPUT:, OUTPUT:, and OPTIONS: prompts:

Example 1:

To load the TXEDIT utility program after the TXDS Control Program has been loaded, the asterisk (*) is used as presented in the following example:

```
TXDS 936215 ** 010/77 2:05
PROGRAM: DSC:TXEDIT/SYS*DSC:TASK2/SRC*DSC:SCRATCH/SRC*
```

(where DSC:TASK2/SRC is the INPUT: pathname; DSC:SCRATCH/SRC is the OUTPUT: pathname; and the OPTIONS: entry is provided by the default-substitution specified in the TXEDIT utility program.)

The above can also be entered as follows:

```
TXDS 936215 ** 010/77 2:05
PROGRAM: DSC:TXEDIT/SYS
INPUT: DSC:TASK2/SRC*DSC:SCRATCH/SRC*
```

Example 2:

To load the SYSUTL utility program after the TXDS Control Program has been loaded, the asterisk (*) is used as follows:

```
TXDS 936215 ** 101/77 2:05
PROGRAM: :SYSUTL/SYS***CF,:TEMP/OBJ
```



(where the INPUT: and OUTPUT: parameters are null and the OPTIONS: parameter is CF,:TEMP/OBJ.

NOTE

1. In the above examples, it is necessary to press the carriage return key at the end of the parameter line to cause the program to be loaded and executed.
2. If a parameter line ends with an asterisk (*) and a pathname is not entered for each prompt, then default substitutes are made by the utility program for those pathnames not entered.

Example 3:

The following example utilizes the comma (,) to cause a default-substitution to be made in the OUTPUT: pathname below.

```
TXDS  9326215  **  010/77  2:05
```

```
PROGRAM:  :TXMIRA/SYS
INPUT:    :TASK1
OUTPUT:   ,CRT
OPTIONS:  M800,X,L
```

(where the OUTPUT: pathname defaults to a substitute specified in the TXMIRA Assembler utility program.)

The following example utilizes both the asterisk (*) and the comma (,) special keyboard controls:

To load the TXMIRA Assembler utility program after the TXDS Control Program has been loaded, the asterisk (*) is used as follows:

```
TXDS:  936215  **  010/77  2:05
```

```
PROGRAM:  :TXMIRA/SYS*:TASK1*,CRT*M800,X,L
```

(where TASK1 is the INPUT: pathname and where the OUTPUT: pathname is the default-substitute provided in the TXMIRA Assembler utility program.)

2.3.4 PLACEMENT IN COMMON MEMORY BLOCK OF THE RESPONSE-ENTRIES TO THE PROGRAM:, INPUT:, OUTPUT:, AND OPTIONS: PROMPTS. The TXDS Control Program codes the COMMON memory area according to the pathnames and characters entered by the operator in response to the PROGRAM:, INPUT:, OUTPUT:, and OPTIONS: prompts. The user program/task uses the Get COMMON supervisor call to get the pointer to COMMON memory. A minimum of 170 bytes of memory must be set aside for the COMMON memory area for allocation as prescribed in table 2-3.



Table 2-3. Byte-Allocation of COMMON Memory

| Parameter | Byte(s) | Explanation |
|-----------|---------|--|
| PROGRAM: | 0-15 | To be coded with the same pathname information that is entered in response to a PROGRAM: prompt. |

NOTE

The response-entries to the PROGRAM:, INPUT:, and OUTPUT: prompts are placed in byte-groups of 16 bytes each. The device name is entered in the first four bytes, left-justified, and space-filled with zeros. A colon is placed in the fifth byte; otherwise a binary zero is placed in the fifth byte. The file name is entered in the sixth through twelfth bytes, left-justified, and space-filled with binary zeros. A slash is placed in the thirteenth byte when a diskette file is to be referenced by the pathname being entered; otherwise a binary zero is placed in the thirteenth byte. The extension is placed in the fourteenth through sixteenth bytes, left-justified, and space-filled with binary zeros. Whenever the device, file, or extension is to be defaulted by the utility or the user's task, the binary field relating to the device, file, or extension will be space-filled with binary zeros. When the total parameter (which includes the device, file, and extension fields) is defaulted, a colon (:) is placed in the fifth byte and a slash is placed in the thirteenth byte and all the fields become space-filled with binary zeros.

| | | |
|------------|---------|---|
| INPUT: #1 | 16-31 | To be coded with the same pathname information that is entered for the first INPUT: parameter. |
| INPUT: #2 | 32-47 | To be coded with the same pathname information that is entered for the second INPUT: parameter. |
| INPUT: #3 | 48-63 | To be coded with the same pathname information that is entered for the third INPUT: parameter. |
| OUTPUT: #1 | 64-79 | To be coded with the same pathname information that is entered for the first OUTPUT: parameter. |
| OUTPUT: #2 | 80-95 | To be coded with the same pathname information that is entered for the second OUTPUT: parameter. |
| OUTPUT: #3 | 96-111 | To be coded with the same pathname information that is entered for the third OUTPUT: parameter. |
| OPTION: | 112-143 | To be coded with the character-entries that the operator entered in response to the OPTIONS: prompt. The characters entered in response to the OPTIONS: prompt will be copied into 112-143. Up to 30 characters can be entered and copied into COMMON memory and following the last character entered is a binary zero. |



Table 2-3. Byte-Allocation of COMMON Memory (Continued)

| Parameter | Byte(s) | Explanation |
|-------------------|---------|--|
| Chaining Pathname | 144-159 | Used for the chaining pathname, which is the pathname of the next program to be loaded and executed if the chaining flag in byte 160 is set to a nonzero number. The chaining pathname is initialized so that the first four bytes each have a binary zero, the fifth byte has a colon, the sixth through twelfth bytes each contain a binary zero, the thirteenth byte contains a slash, and the fourteenth through sixteenth bytes each contain a binary zero. |
| Chaining Flag | 160 | This is the chaining flag byte which is set to a nonzero number by a user program or a utility program when it is desired to chain from the end of one program to the pathname specified in bytes 144-159. The object program which is at the pathname specified in bytes 144-159 is then loaded and executed. One program (a user's task or TXDS utility program) can chain to another by setting the chaining flag in memory (byte 160), placing the access name (i.e. the chaining pathname) for the new program in bytes 144-159 and executing an End-of-Program 16_{16} supervisor call. The INPUT:, OUTPUT:, and OPTIONS: prompts can be used as required to pass parameters to the new program. |
| Batch Mode Flag | 161 | Set if batch job control stream is in progress. The TXDS Control Program loads and executes the object program which is in the pathname specified in bytes 144-159. |
| Batch Error | 162 | Set when a program terminates in error during a batch stream. |
| Chaining Error | 163 | Chaining Error Flag. Set when the program chained to terminate is in error. |
| Default Print | 164-167 | Default system console print device declared at time of system generation. |
| Reserved | 168-170 | Reserved for later enhancements. |



A typical example of an operator's response-entries to the TXDS Control Program's prompts is presented below, immediately followed by the hexadecimal and ASCII representation in binary code, of the operator's response-entries, that is placed in the COMMON memory block.

TXDS 936215 ** 010/77 2:05

PROGRAM: :TXLINK/
 INPUT: :TXTST,/,CS1
 OUTPUT: :TXTST2/OBJ,LP
 OPTIONS: ITXT,M4000

The above responses to the prompts are placed into the COMMON memory block as follows:

| Byte Address | Hexadecimal Representation (Upper Row) and ASCII Representation (Lower Row) | | | | | | | |
|--------------|--|------|---|------|------|-----------|-------|------|
| 0-15 | 0000 | 0000 | 3A54 | 584C | 494E | 4B00 | 2F00 | 0000 |
| | .. | .. | : T | X L | I N | K . | / . | .. |
| 16-31 | 0000 | 0000 | 3A54 | 5854 | 5354 | 0000 | 2F20 | 0000 |
| | .. | .. | : T | X T | S T | .. | / b = | .. |
| 32-47 | 0000 | 0000 | 3A00 | 0000 | 0000 | 0000 | 2F00 | 0000 |
| | .. | .. | : . | .. | .. | .. | / . | .. |
| 48-63 | 4353 | 3100 | 0000 | 0000 | 0000 | 0000 | 0000 | 0000 |
| | C S | 1 . | .. | .. | .. | .. | .. | .. |
| 64-79 | 0000 | 0000 | 3A54 | 5854 | 5354 | 3200 | 2F4F | 424A |
| | .. | .. | : T | X T | S T | 2 . | / 0 | B J |
| 80-95 | 4C50 | 0000 | 0000 | 0000 | 0000 | 0000 | 0000 | 0000 |
| | L P | .. | .. | .. | .. | .. | .. | .. |
| 96-111 | 0000 | 0000 | 3A00 | 0000 | 0000 | 0000 | 2F00 | 0000 |
| | .. | .. | : . | .. | .. | .. | / . | .. |
| 112-143 | 4954 | 5854 | 2C40 | 3430 | 3030 | UNDEFINED | | |
| | I T | X T | , M | 4 0 | 0 0 | | | |
| 144-159 | 0000 | 0000 | 2A00 | 0000 | 0000 | 0000 | 2F00 | 0000 |
| | .. | .. | : . | .. | .. | .. | / . | .. |
| 160 | 00 | | | | | | | |
| | . | | | | | | | |
| 161 | 00 | | | | | | | |
| | . | | | | | | | |
| 162 | 00 | | | | | | | |
| | . | | | | | | | |
| 163 | 00 | | | | | | | |
| | . | | | | | | | |
| 164-167 | 4C4F | 4720 | This assumes that LOG was defined as system | | | | | |
| | L 0 | G | default print device during system generation | | | | | |
| 168-n | | | Not used. | | | | | |



2.4 BACKING UP TI-SUPPLIED TXDS DISKETTES

Before the TI-supplied TXDS diskettes are used, they should be backed up onto scratch diskette(s): (1) to ensure that a backup diskette is available if the diskette(s) is destroyed; and (2) to ensure that either of the two diskettes (i.e., the original diskette and the backup diskette) will always be available to do future system generations with the use of a minimum 16K-memory configuration.

Backup the system diskette by performing the following step-by-step procedure:

1. Remove the system diskette from diskette transport drive 1 and insert in its place the TX990 parts diskette.
2. Take a scratch diskette and place it into diskette transport drive 2.
3. If the scratch diskette has been initialized, proceed to next step. If it needs to be initialized, respond to the TXDS PROGRAM: prompt as follows:

PROGRAM: :INITDSC/SYS*(C/R)

NOTE

1. (C/R) signifies a NEW LINE entry on a VDT or a carriage return on a KSR or ASR.
2. The items underlined below are the operator's response entries to the prompts.

The Initialize Disc Utility is loaded:

TX990 DISC INITIALIZATION 937545**

DISC NAME? DSC2 (C/R)

DISC I.D.? SCRATCH DISC (C/R)

OK TO ERASE DISC??? Y OR N Y

CHECKING DSC2

If any message other than the following message is output, see the Disc Initialization Utility section in the *TX990 Operating System Programmer's Guide* for a discussion of error messages.

INITIALIZATION COMPLETE

The TXDS Control Program is then reloaded and the following printout or display is presented on the system console:

TXDS 936215 ** 359/77 1:05

PROGRAM:



4. Start the backup procedure by bidding the BACKUP utility program as follows:

PROGRAM: .ACKUP/SYS*(C/R)

INPUT DISC NAME?

At this point remove the diskette from diskette transport drive 1 and load diskette transport drive 1 with the system diskette to be backed up. Then respond to the prompts as follows:

INPUT DISC NAME? DSC (C/R)

OUTPUT DISC NAME? DSC2 (C/R)

DO YOU WANT TO VERIFY THE DISCS? Y (C/R)

DO YOU WANT TO COPY THE INPUT DISC? Y (C/R)

OKAY TO ERASE OUTPUT DISC? Y (C/R)

ERROR LOG:

For a discussion of any error messages which are output at this point, see the Diskette Backup Utility section of the *TX990 Operating System Programmer's Guide*.

THE DISC IS NOW BEING VERIFIED

ERROR LOG:

For a discussion of any error messages which are output at this point, see the Diskette Backup Utility section of the *TX990 Operating System Programmer's Guide*.

FINISHED!

At this point the backup is complete and the TXDS Control Program is rebid and prints out or displays the following:

TXDS 936215 ** 359/77 1:05

PROGRAM:

It is recommended that a user back up the TXBOOT program onto the newly created diskette by performing the following:

1. Remove the system diskette from drive 1 and insert the TX990 Parts diskette.
2. Respond to the PROGRAM: prompt as follows:

PROGRAM: :SYSUTL/SYS*(C/R)



The system utility will identify itself when loading is completed by:

TX990 SYSTEMS UTILITY 937544 **

OP:

3. To copy the TXBOOT the user should enter:

BC,DSC2*(C/R)

When the copy is completed, the system will respond with:

OP:

4. Enter the command appropriate for the system type:

- a. When backing up the VDT913 system enter:

SF,DSC2:SYS913/CMP.TE.(C/R)

- b. When backing up the ASR733 system enter:

SF,DSC2:SYSASR/CMP.TE.(C/R)

- c. When backing up the VDT911 system enter:

SF,DSC2:SYS911/CMP.TE.(C/R)

This procedure is not applicable to non-system diskettes.

The user can then perform the Verification of Operation procedure described in the next section of this manual or proceed to load a program.

2.5 TXDS CONTROL PROGRAM ERROR MESSAGES

Refer to table 2-4 for a list of error messages, the reason for each error, and the recovery method.

Table 2-4. TXDS Control Program Error Messages

| Error | Reason | Recovery |
|----------------------------|---|---|
| nn-BAD PGM LOAD | nn represents error code listed in error appendix D. | Reenter parameter |
| -BAD PGM LOAD | Can't find object file. | Reenter parameter |
| nn-CAN'T BID TASK | nn represents the task state code of task 10 ₁₆ listed in state code appendix C. | Reenter parameter |
| CAN'T GET COMMON - ABORTED | System was configured without COMMON. | Configure a system with 168 bytes of common |



SECTION III

VERIFICATION OF OPERATION

3.1 INTRODUCTION

This section provides several short procedures to verify that the software is operating properly. These procedures are listed below and described in the following procedural steps: ■

- Load and Initialize TX990 Operating System
- Load and Initialize TXDS Control Program
- TXCCAT Verification Procedure
- TXEDIT Verification Procedure
- TXMIRA Verification Procedure
- OBJ MGR Verification Procedure
- TXLINK Verification Procedure

The Operating System Diskette mentioned in the procedure refers to either TXDS System Diskette 2 (for VDT systems) or TXDS System Diskette 3 (for ASR systems).

3.2 REQUIREMENTS

This procedure requires the following items in addition to the required hardware for a TXDS system:

- *TX990 Operating System Programmer's Guide*
- TXDS System Diskette
- TX990 Parts Diskette

3.3 OPERATION

The following steps of the verification procedure demonstrate that the system is operational.

1. Initialize TX990 by loading TXBOOT from TXDS system diskette.
 - a. Load TXDS System Diskette in diskette drive #1.
 - b. On the front panel, press the following pushbutton switches to load the system.

HALT
RESET
LOAD

TXDS control program will be bid when ! is entered at the system console.



2. Place scratch diskette in drive #2. If diskette is not initialized; place TX990 Parts Diskette in diskette transport drive #1 and execute the Disc Initialization (INITDSC) utility program as described in Section XI of *Model 990 Computer TX990 Operating System Programmer's Guide*. Replace the System Diskette in transport drive 1.

3. Copy :TXTST1/SRC from System Diskette to scratch diskette using TXCCAT. With System Diskette in transport drive 1 and the scratch diskette in transport drive 2, enter the following commands to copy :TXTST1/SRC to the scratch diskette:

```
PROGRAM: DSC:TXCCAT/SYS
INPUT: DSC:TXTST1/SRC
OUTPUT: DSC2:TXTST1/SRC
OPTIONS: (carriage return)
```

4. After completion of the copy, TXDS will come up and should be given the following parameters in order to execute TXEDIT:

```
PROGRAM: DSC:TXEDIT/SYS
INPUT: DSC2:TXTST1/SRC
OUTPUT: (carriage return)
OPTIONS: (carriage return)
```

5. Position TXEDIT to line 19 of TXTST1/SRC using the DOWN (D) command and print the line to assure that the pointer is positioned correctly.

```
?D19
?P
```

The following line should be printed

```
19          DATA OLD,CNT1
```

6. Edit line 19 to enable printing the new message by using the Change (C) command. Replace line 19 with the following line, spacing the DATA over seven spaces and the NEW,CNT one more space.

```
?C19-19

          DATA NEW,CNT
```

Enter extra carriage return to terminate Change command.

7. Print line 18 and the modified line to ensure the change has been made correctly.

```
?T
?D17
?P2

18          BLWP @WRITE          PRINT MESSAGE
          DATA NEW,CNT
```



8. Terminate the editing session by executing the Quit (Q) command.

?Q

Upon executing the Quit command, TXEDIT issues a prompt to ensure that it is time to terminate. After responding with a 'T', the current input file and buffer are copied to the output scratch file. Respond with a 'Y' when asked if the scratch file is to be copied to the input file.

```
TERMINATE/CONTINUE?T
TEXT IN SCRATCH FILE
TRANSFER TO INPUT? Y
END EDIT
```

TXEDIT is then terminated and the TXDS control program is rebid.

9. Now assemble TXTST1/SRC using TXMIRA. The assembled object is directed to the file TXTST1/OBJ on the scratch diskette. The object is designated as compressed object on the options line. The assembly output listing is listed to the default system printer as specified in the OPTIONS: parameter. Also, the cross reference listing output from TXXREF is listed to the default system printer. The sample output listings are illustrated in figure 3-1.

Enter the following parameters.

```
PROGRAM: DSC:TXMIRA/SYS
INPUT: DSC2:TXTST1/SRC
OUTPUT: DSC2:TXTST1/OBJ,LOG
OPTIONS: C,L,X
```

The output listing should reflect the changes made in step 6. Verify that no errors are detected by TXMIRA.

10. Place TX990 Parts Diskette in drive #1.
11. Object Manager is then loaded and executed to combine the three required object modules into one module for linking into the TX990 System. Execute object manager as follows:

```
PROGRAM: DSC:OBJMGR/SYS*

990 OBJECT MANAGER 945672 *B
```

After printing the above message, object manager requests specification of a file in which the combined object is to be placed. At this point the TX990 Parts Diskette should be removed and the System Diskette installed in drive #1. After specifying the output file, enter the pathname of the three required object files and designate that each input file is to be copied and rewound.



TXTST1 TXMIRA 936227 ** 17:12:02 088/77 PAGE 0001
 TXDS TEST PROGRAM 937808-9901**

```

0002          IDT  'TXTST1'
0003          *
0004          REF  CNT, NEW, WRITE
0005          *
0006 0000 0006'  DATA TSTWSP, START, 0
          0002 0045'
          0004 0000
0007 0006      TSTWSP B55 32
0008 0026 1600  ENDPRG DATA >1600      END OF PROGRAM OP CODE
0009          *
0010          DXOP SVC, 15      *** DEFINE XOP
0011          *
0012 0028 00  OLD  BYTE >00, >0A, >0A
          0029 0A
          002A 0A
0013 002B 20  TEXT  ' OLD MESSAGE -- WRONG !!'
0014 0043 00  BYTE >00, >0A
          0044 0A
0015          001D CNT1  EQU  $-OLD
  
```

TXTST1 TXMIRA 936227 ** 17:12:02 088/77 PAGE 0002
 TXDS TEST PROGRAM 937808-9901**

```

0017          START
0018 0046 0420  BLWP @WRITE      PRINT MESSAGE
          0048 0000
0019 004A 0028'  DATA OLD, CNT1
          004C 001D
0020 004E 2FE0  SVC  @ENDPRG      END OF PROGRAM
          0050 0026'
0021          END
  
```

0000 ERRORS

TXXREF 937542 ** 17:12:33 088/77 PAGE 0001

```

CNT          0004
CNT1 0015    0019
ENDPRG 0008    0020
NEW          0004
OLD 0012    0015 0019
START 0017    0006
SVC          0010
TSTWSP 0007    0006
WRITE          0004 0018
  
```

THERE ARE 0009 SYMBOLS

Figure 3-1. TXMIRA Sample Output Listing



```

                OUTPUT FILE: DSC2:TXTST/OBJ
            INPUT FILE: DSC2:TXTST1/OBJ
            OPEN INPUT FILE, WITH REWIND? Y
    TXTST1  ?  Y
    END-OF-FILE

```

```

                INPUT FILE: DSC:TXTST2/OBJ
            OPEN INPUT FILE, WITH REWIND? Y
    TXTST2  ?  Y
    END-OF-FILE

```

```

                INPUT FILE: DSC:TXTST3/OBJ
            OPEN INPUT FILE, WITH REWIND? Y
    TXTST3  ?  Y
    END-OF-FILE

```

```

                INPUT FILE:
            END OBJECT MANAGER

```

Object manager terminates upon entering only a carriage return on the input line.

12. Place the System Diskette in diskette drive 1. Execute TXLINK to link the object manager output as follows:

```

                PROGRAM: DSC:TXLING/SYS
                   INPUT: DSC2:TXTST/OBJ
                   OUTPUT: DSC2:TXTEST/OBJ,LOG
                   OPTIONS: C,ITXTEST,L
    TXLINK 937537 **

```

The output line contains the name of the file TXTEST/OBJ in which the linked object is to be placed, as well as the device to which the load map is directed. 'C' specifies that the object is to be compressed, 'ITXTEST' designates that the IDT for the linked object is to be TXTEST, and 'L' specifies that the output of TXLINK is to be listed. The default memory size of 12K is available for the link.

Following is the link output.

```

    TXLINK 937537 ** 10:51:01 032/77 PAGE 0001
    TXTEST          LENGTH 00A0

    MODULE      LENGTH  ORIGIN  DATE      TIME
    TXTST1      0052     0000
    TXTST2      001E     0052     01/25/77  15:11
    TXTST3      0030     0070     01/25/77  15:14

```

DEFINITIONS

```

    A CNT      001D  NEW  0052  WRITE  0070

```



13. The TXDS Test Program is now ready for execution. Execute by entering the compressed object module name on the program line followed by *. Upon executing, the following message is issued prior to termination and TXDS is rebid.

PROGRAM: DSC2:TXTEST/OBJ*

HAVE A GOOD DAY !!



SECTION IV

TXDS TEXT EDITOR (TXEDIT) UTILITY PROGRAM

4.1 INTRODUCTION

The TXEDIT utility program provides the user/programmer with the capability of editing the text of source programs and object programs and, in addition, the capability of creating source programs. Basically, 21 TXEDIT commands are available to fulfill the programmer's needs. The commands are grouped as follows:

- Setup commands:
 - Start Line Numbers (SL) command
 - Stop Line Numbers (SN) command
 - Set Print (SP) column margin number command
 - Set Margin (SM) for Find command
 - Set Tabs (ST) command
- Pointer-Movement commands
 - Down (D) command
 - Up (U) command
 - Top (T) command
 - Bottom (B) command
- Edit commands
 - Change (C) command
 - Insert (I) command
 - Move (M) command
 - Remove (R) command
 - Find (F) string command
- Print commands
 - Limits (L) command
 - Print (P) command



- Output commands
 - Keep (K) command
 - Quit (Q) command
 - End (E) command
- Terminate-Sequence commands
 - Terminate (T) command
 - Continue (C) command

All of the TXEDIT commands are capable of being entered via the keyboard of the system console. To edit a program or record, the user must first have the program or record recorded on a TI diskette or cassette. The text is then edited by feeding it from the TI diskette or cassette (hereinafter referred to as the input file) into a memory buffer where the editing is performed and then out to the scratch file (until an EOF character is read or a Quit command is entered). If further editing is required, the text data is reversed to flow back from the scratch file into the memory buffer and back to the input file (until the EOF is read again or a Quit command is entered again). This transfer between the two files (with multiple editing activities being automatically performed during each pass) continues until the user is finished. At that time, the TXEDIT program provides a print-out or display on the system console which states whether the input file or the scratch file contains the final edited text. The user then has the option of using a command to transfer the resultant final edited text back to the input file in substitution of the preedited source program or the preedited object program or record.

CAUTION

The user should ensure that the input file is not destroyed by copying it onto a temporary file diskette or cassette.

The TXEDIT program may be executed in a Model 990/4 microcomputer or a 990/10 minicomputer configured to support a TX990 Operating System. The minimum configuration includes a computer with 16K of memory and an interactive operator system console, the LOG.

The following paragraphs describe various TXEDIT program functions and procedures. A TXEDIT module loading procedure is presented, followed by a discussion of how to start execution. Initialization and finalization procedures, including initialization messages and user's responses to these messages, are also described in this section. Specific editing procedures using the TXEDIT commands are presented for: changing, adding, moving, or removing source or object records in the buffer and to locate and modify a character string in a group of records; using editor commands to move the text editor's buffer line pointer; moving lines/text into and out of the buffer; and handling file data formats with special terminal keyboard characters. Procedures for coding source or object files and writing a new source program are also explained. TXEDIT commands are listed and described and further supplemented with examples of the classes of commands, command operands, and notational conventions used in the command syntax. A description is provided of the error and warning messages and the operator's responses to these messages. Concluding this section is an example of how to enter and edit a source program and a discussion of how to edit an object program.

4.2 LUNOs

LUNOs 7 and 8 are assigned by the text editor. LUNO 7 is assigned to the input file, and LUNO 8 is assigned to the output file. The text editor uses the system console as the interactive device. When the text editor terminates, all files are closed and all LUNOs are released.



4.3 LOADING TXEDIT

The user can load the TXEDIT utility program only by use of the TXDS Control Program. (The TXEDIT utility program cannot be loaded via OCP.) After the TXDS Control Program is executed using the procedure in Section II, responses to the TXDS Control Program's PROGRAM:, INPUT:, OUTPUT: and OPTIONS: prompts are then entered by the user via the keyboard of the system console. The user responds to the PROGRAM: prompt as follows:

```
PROGRAM: :TXEDIT/SYS
```

The response to the INPUT: prompt requires the pathname of the source program file location on diskette or cassette. If the diskette file is specified by the pathname and none exists, it will be created. This is the correct procedure for generating a new source file. An insert (I) command may then be used to generate lines of source code. The response to the OUTPUT: prompt requires the pathname of the scratch file location on diskette or cassette. If the diskette file is specified by the pathname and none exists, it will be created. The OUTPUT: file pathname must not be the same as the INPUT: file pathname. In response to the OPTIONS: prompt, the user may specify the size of the memory buffer. Under the TXEDIT utility program, this is the only option available to be specified. The size of the memory buffer is specified by the user entering an M followed by a decimal number (which may vary from one to five characters in length). The decimal number specifies the number of bytes to be used for the memory buffer. The memory size is determined using the following procedural example: if the user wishes to edit 75 lines of text, each character on each line is used to specify one byte; further, each line is preceded by a six-byte header and followed by a one-byte carriage return. Consequently, if each line of text has an average length of 40 bytes plus 6 bytes for the header and 1 byte for the carriage return, then 75 lines of text would require 3525 bytes.

An example of loading TXEDIT from *diskette* follows:

```
TXDS 936215**0017 2:10  
  
PROGRAM: :TXEDIT/SYS  
INPUT: DSC2:UPDATE/SRC  
OUTPUT:  
OPTIONS: M4000
```

The above response-entries to the prompts cause the TXEDIT utility program to be loaded from diskette into memory and then to be executed. The OUTPUT: pathname is provided by the TXEDIT utility program with :SCRATCH/SRC as the default-substitute.

An example of loading a file from *cassette* follows:

```
TXDS 936215**0017 2:10  
  
PROGRAM: :TXEDIT/SYS  
INPUT: CS1  
OUTPUT:  
OPTIONS: M4000
```

The above response-entries to the prompts cause the TXEDIT utility program to be loaded from diskette into memory and then to be executed.



Table 4-1. TXEDIT Default-Substitutes

| Entry | Pathname | Default-Substitute |
|----------|------------|-----------------------|
| INPUT: | DEVICE | Default disc drive |
| | FILE | No default-substitute |
| | EXTENSION | SRC |
| OUTPUT: | DEVICE | Default disc drive |
| | FILE | SCRATCH |
| | EXTENSION | SRC |
| OPTIONS: | M (memory) | 3000 bytes |

4.4 COMMANDS

4.4.1 GENERAL. The TXEDIT utility program supplies 21 edit commands to fulfill the user's needs. Further, eight special keys/characters are also provided to meet general utility needs (e.g., RUB OUT, ESC, et. al.). The commands are entered at the keyboard of the system console in response to the printing of a question mark (?); and after the command is entered, it is executed by entering a carriage return. The syntax of the command is free form in that one or more spaces may be inserted between characters and operands of the commands. A list of the commands and a brief description of each command is provided in table 4-2. The detailed descriptive information pertaining to each command is provided in the following paragraphs.

4.4.2 COMMAND OPERANDS. Command operands are used to specify a number of lines, line numbers, or displacements from the pointer. The edit commands and one of the print commands may specify a group of lines by first and last line number of by a number of lines relative to the pointer.

4.4.3 SYMBOL DEFINITION. The symbols used in conjunction with TXEDIT commands are defined as follows:

- Angle brackets < > enclose items required to be supplied by the user.
- Brackets [] enclose optional items.
- Braces { } enclose items between which a choice must be made; one, and only one, of the items must be included.
- Items in capital letters must be entered as shown.

NOTE

The syntax definitions and examples presented in this section do not have spaces between the characters of the two-character commands, between the command and operands, or between operands. Spaces may be entered at these points if desired, and all operands are decimal numbers.



Table 4-2. List of Commands and Special Keys/Characters

| Command Syntax | Description |
|----------------------------------|--|
| <i>SETUP COMMANDS</i> | |
| SL | Start Line numbers (SL) command causes line numbers to be printed with each line of text. |
| SN | Stop line Numbers (SN) command causes line numbers not to be printed. |
| SP | Set Print margin (SP) command sets the right boundary for print display. |
| SM | Set Margin (SM) for Find command sets the left and right boundaries for the Find command. |
| ST | Set Tabs (ST) command sets up to five tab stops. |
| <i>POINTER-MOVEMENT COMMANDS</i> | |
| D | Down (D) command moves the pointer down toward the bottom of the buffer. |
| U | Up (U) command moves the pointer up towards the first line in the buffer. |
| T | Top (T) command moves the pointer to the first line in the buffer. |
| B | Bottom (B) command moves the pointer to the last line in the buffer. |
| <i>EDIT COMMANDS</i> | |
| C | Change (C) command removes lines from the buffer and inserts new ones in their place. The new lines are input from the terminal. |
| I | Insert (I) command takes input from the terminal and places the new lines into the buffer. |
| M | Move (M) command moves lines from one place in the buffer to another. |
| R | Remove (R) command deletes lines from the buffer. |
| F | Find string (F) command searches for the first occurrence of a character string in a line and replaces it with another string of characters. |
| <i>PRINT COMMANDS</i> | |
| L | Limits (L) command causes the first line and the last line to be displayed. |
| P | Print (P) command displays lines of text. |



Table 4-2. List of Commands and Special Keys/Characters (Continued)

| Command Syntax | Description |
|------------------------------------|--|
| <i>OUTPUT COMMANDS</i> | |
| K | Keep (K) command takes lines of text out of the buffer and puts them in the output file. |
| Q | Quit (Q) command takes lines of text out of the buffer or the input files and puts them in the output file. |
| E | An (E) command terminates without writing an EOF to the output file. |
| <i>TERMINATE-SEQUENCE COMMANDS</i> | |
| T or C | Allows the user to make multiple single directional editing passes on a source or object program. |
| <i>SPECIAL KEYS/CHARACTERS</i> | |
| CTRL-H | Pressing the control key and the H key simultaneously on the hard copy terminal causes the terminal to backspace a character to enable rewriting over an entered character-error. |
| RUB OUT | The RUB OUT key causes the line just entered to be deleted so that a new line can replace it. |
| CTRL-I | Pressing the control (CTRL) key and the I key simultaneously on a hard-copy terminal causes a tab stop to be entered in the input string, although only one space will be echoed on the terminal. |
| ESC/RESET | Pressing the ESCape or RESET key on the system console causes a display to be aborted. |
| position keys | When using a VDT, only the left position key (←) and the right (→) position key are recognized. The up and down position keys cause garbage to be entered into the input string. The left position key causes characters to be deleted from the character string; a right position key causes whatever was under the cursor to be entered. |
| DELETE LINE | DELETE LINE on a VDT acts the same as a RUB OUT on a hardcopy terminal. |
| TAB | A SPACE character is echoed. The TAB is interpreted by the text editor and spaces are inserted to fill the text line to the next TAB setting. Refer to paragraph 4.4.5.5 which follows. |



4.4.4 SPECIAL KEYS/CHARACTERS. The following special characters are recognized by the text editor when the terminal is an ASR or KSR. A backspace character (CTRL H) backspaces one character position. A RUB OUT character deletes the line that has just been entered from the keyboard. On an ASR or KSR, a tab (CTRL I) echoes as one space upon character input, but moves to the nearest tab stop when the line is printed. (Tab stops are initially defined at character positions 8, 13, 31, and 33.) An escape (ESC) entered from the keyboard during print output causes the current I/O operation and the command to be aborted; a question mark (?) prompt is then printed out or displayed, to which another TXEDIT command-response-entry can be made.

The following special characters are recognized by the text editor when the terminal is a VDT. The position keys will move the pointer for backspace, or forward space. The DELETE LINE key will delete the line that has just been entered from the keyboard. The RESET key, when entered during a printout, causes the current I/O operation and the command to be aborted. If the space bar is entered during a printout, the printout will halt until the space bar is entered again. This allows the user to scan the printout before it rolls off the top of the screen without aborting the I/O operation.

4.4.5 SETUP COMMANDS. Setup commands may be entered immediately following loading of TXEDIT to: set limits for the Find command; set the right margin for printing; enable or inhibit printing of line numbers; set tabs. If no Setup command is entered, line numbers are printed. The right margin for lines or print corresponds to column 72. Columns 1 through 72 are scanned by the Find command, and tabs are preset at 8, 13, 31, and 33, which are the standard columns for source code instructions, operands, and comments.

Setup commands may be entered anytime during an editing session. It is often desirable to change the Find command limits before entering a Find command, so that only certain columns are searched. The user may want to inhibit the printing of line numbers to enable more source codes to be printed on a line. If the user is generating code to be assembled by TXMIRA, he may want to set the right margin to column 60, since TXMIRA does not scan characters past column 60.

4.4.5.1 Start Line Numbers (SL). The Start Line Numbers (SL) command causes TXEDIT to print line numbers to the left of each statement or record. Syntax for the SL command is as follows:

SL

The SL command is used to restore printing of line numbers after line number printing has been inhibited by execution of an SN command.

4.4.5.2 Stop Line Numbers (SN). The Stop Line Numbers (SN) command causes TXEDIT to omit printing of line numbers except in the message resulting from the Limits (L) command. The syntax for the SN command is as follows:

SN

The SN command may be entered initially or at any time during the edit operation. Omitting the line numbers when editing object code may be desirable to permit printing the entire record.

4.4.5.3 Print Margin (SP). The Print Margin command specifies the column number of the right margin where printing is to end, except for the message resulting from the Limits (L) print command, described in this section. The syntax for the SP command is as follows:

SPs



The *s* represents the column number of the right margin where printing is to end (i.e., one of the columns between 10 and 80, inclusive). If line numbers are being printed, the line numbers are included in the margin column. Line numbers use six columns, so that if the right margin is column 60, only 54 characters plus 6 line number character digits and blanks for spacing are printed. The following example shows an SP command that specifies column 60 as the right margin for printing:

?SP60

4.4.5.4 Set Margin (SM). The Set Margin (SM) command specifies left and right limits for the Find command. Syntax for the SM command is as follows:

SM*s,t*

- There must be a comma between *s* and *t*. The Find command scans from column *s* through column *t* and may be limited to the desired field by the SM command. The default value for the scan limits is from column 1 to column 72 (or the end of the line if less than 72). The following example shows an SM command that limits the scan of subsequent Find commands to columns 8 through 25:

?SM8,25

4.4.5.5 Set Tabs (ST). The Set Tabs (ST) command allows up to five tabs to be set between column 1 and 72. Syntax for the ST command is as follows:

ST*n,n,n,n,n*

NOTE

There must be a comma between every column number. The column number is indicated by *n*. Tabs must be set in ascending order, and if they are not, a blank will be inserted for the descending tab. If more than five tabs are entered, an INVALID OPERAND error message is issued; however, the first five tabs are set and ready for use. If no column numbers are entered, all tabs are cleared.

4.4.6 POINTER-MOVEMENT COMMANDS. Pointer-movement commands may be used to move the pointer to any line in the buffer of TXEDIT. Initially, the pointer is at line 1. Moving the pointer with the Down (D) command past the last line in the buffer causes TXEDIT to read source lines or object records from the input file to fill the empty lines. Other commands move the pointer upward a specified number of lines, or to the top of the buffer, or downward to the bottom of the buffer. The pointer-movement commands permit the user to move the pointer as desired for effective use of commands that identify lines by specifying a displacement from the pointer. The pointer commands are described in the following subparagraphs.

4.4.6.1 Down (D). The Down (D) command causes TXEDIT to move the pointer down a specified number of lines. When the specified move is to a line number greater than the contents of the buffer, TXEDIT adds lines to the buffer and reads records from the input file to fill these lines. The syntax for the D command is as follows:

D*n*



The pointer is moved down n lines. The range of n is 1 to 9999, and the default value when n is omitted is 1. The D command may be entered to read in lines from the input file or to move the pointer to a line farther down in the buffer. Initially, or when the pointer is at the bottom of the buffer, TXEDIT reads n lines from the input file. When the pointer is m lines above the bottom of the buffer and n is greater than m , TXEDIT reads $n - m$ lines from the input file. In each of these cases, the pointer is at the bottom of the buffer after execution of the D command. However, when the pointer is m lines above the bottom of the buffer and m is greater than or equal to n , no lines from the input file are read. The pointer is $m - n$ lines above the bottom of the buffer after execution of the command. The following example shows a D command to move the pointer down 30 lines.

```
?D30
```

4.4.6.2 Up (U). The Up (U) command moves the pointer up a specified number of lines. Syntax for the U command is as follows:

```
Un
```

The pointer is moved up n lines. The range of n is 1 to 9999, and the default value when n is omitted is 1. The U command may be entered to move the pointer up to a specific line in the buffer. The following example shows a U command to move the pointer up 6 lines:

```
?U6
```

4.4.6.3 Top (T). The Top (T) command moves the pointer to the first line in the buffer. The syntax for the T command is as follows:

```
T
```

4.4.6.4 Bottom (B). The Bottom (B) command moves the pointer to the bottom (i.e., last) line in the buffer. The syntax for the B command is as follows:

```
B
```

4.4.7 EDIT COMMANDS. The edit commands add, change, remove, rearrange, or scan lines of source or object code, and act upon a set of lines in the buffer specified by line number or by a displacement from the pointer. The edit commands are described in the following paragraphs.

4.4.7.1 Change (C). The Change command deletes a specified set of lines and permits input of one or more lines to replace the deleted lines. The syntax for the command is as follows:

$$C \left\{ \begin{array}{l} \langle s \rangle - \langle t \rangle \\ [+] [\langle n \rangle] \\ - \langle n \rangle \end{array} \right\}$$

Line s through line t are deleted, or n lines with respect to the pointer are deleted. The values of s and t can be equal. As many replacement lines as required are entered. Each line is followed with a carriage return; the last line is followed with two carriage returns. When n is preceded by a minus sign, n lines preceding the pointer line are deleted, but the pointer line is not deleted. The new lines are inserted in their place. When n is unsigned or is preceded by a plus sign, n lines beginning with the pointer line are deleted, and the new lines are inserted. When no operand is entered, the pointer line is deleted, and replaced by the new lines. When the pointer line is deleted, the pointer is moved to the next line of the buffer following the newly inserted lines. If the line that was changed was the last line in the buffer, the pointer will be at the first line in the buffer. The following example shows a C command to change lines 5 through 7, replacing them with four lines.



```
?C5-7
LOD    MOV    1,4
        AI     4,1
        CI     4,WA+60
        JLT    SUM
```

The following example shows a C command to change the pointer line and the two lines that follow the pointer, replacing them with two lines:

```
?C3
LOD    MOV    1,4
        CI     4,WA+60
```

4.4.7.2 Insert (I). The Insert (I) command permits input of one or more lines following the pointer or a specified line. The syntax for the I command is as follows:

```
I [<s>]
```

As many lines as required are entered. Each line is followed with a carriage return; the last line is followed with two carriage returns. When *s* is in the range of 1 to 9999, lines are inserted following line *s*. When *s* is 0, lines are inserted ahead of the top line in the buffer. When *s* is omitted, lines are inserted following the pointer line. The following example shows the use of the I command to insert two lines following line 10:

```
?I10
        CKON
        DEC    7
```

4.4.7.3 Move (M). The Move (M) command moves a specified block of lines to a specified location and deletes the block of lines at the previous location. The block is specified by first and last line numbers or by a number of lines preceding or following the pointer. The location to which the block will be moved is specified as a line number or as the pointer. The syntax for the M command is as follows:

$$M \left\{ \begin{array}{l} \langle s \rangle - \langle t \rangle, [\langle r \rangle] \\ [+ \langle n \rangle, \langle r \rangle] \\ - \langle n \rangle, \langle r \rangle \end{array} \right\}$$

Line *s* through line *t* are moved, or *n* lines with respect to the pointer are moved. When *n* is preceded by a minus sign, *n* lines preceding the pointer line, but not the pointer line, are moved. When *n* is unsigned or preceded by a plus sign, *n* lines beginning with the pointer line are moved.

The specified lines are placed following line *r* when *r* is greater than zero. When *r* is zero, the specified lines are placed ahead of the top line in the buffer. When *r* is omitted, the lines are placed following the pointer line, but *r* can only be omitted when specifying lines *s* through line *t*. Numbered lines moved by the Move command retain their original line numbers, if any. When the pointer line is moved, the pointer moves with it. When *s* and *t* are specified, *r* must be less than *s* or greater than *t*. The following example shows an M command to move lines 6 through 8 to follow line 25:

```
?M6-8,25
```

The command in the following example moves four lines beginning with the pointer line to follow line 30:

```
?M4,30
```



4.4.7.4 Remove (R). The Remove (R) command removes a block of lines. The block is specified by first and last line numbers, or by a number of lines preceding or following the pointer. The syntax for the R command is as follows:

$$R \left\{ \begin{array}{l} \langle s \rangle - \langle t \rangle \\ [+] \langle n \rangle \\ - \langle n \rangle \end{array} \right\}$$

Lines *s* through *t* are removed, or *n* lines with respect to the pointer are removed. When *n* is preceded by a minus sign, *n* lines preceding the pointer line, but not the pointer line, are removed. When no operand is entered, the pointer line is removed. When the pointer line is removed, the pointer is moved to the next line of the buffer. If the last line in the buffer is removed the pointer will point to the first line in the buffer. The following example shows an R command to remove line 12:

```
?R12-12
```

The command in the following example removes the three lines preceding the pointer line:

```
?R-3
```

4.4.7.5 Find (F). The Find (F) command scans a block of lines for the first occurrence in each line of the specified character string. Optionally, the command may replace the string with or without printing the resulting line, or may print the line and permit the user to specify whether or not to substitute the string. In all cases, the command prints the count of matching lines found. The block is specified by first and last line numbers, or by a number of lines preceding or following the pointer. The syntax for the F command is as follows:

$$F \left\{ \begin{array}{l} \langle s \rangle - \langle t \rangle \\ [+] \langle n \rangle \\ - \langle n \rangle \end{array} \right\} \left\{ \begin{array}{l} L \\ F \end{array} \right\} \langle dl \rangle \langle string1 \rangle \langle dl \rangle \left\{ \begin{array}{l} [P] \\ \langle d2 \rangle [\langle string2 \rangle] \langle d2 \rangle [V] [P] \end{array} \right\}$$

Line *s* through line *t* are scanned, or *n* lines are scanned. When *n* is preceded by a minus sign, *n* lines preceding the pointer line, but not the pointer line, are scanned. When *n* is unsigned or preceded by a plus sign, *n* lines beginning with the pointer line are scanned.

When an F is entered following the lines to be scanned, the columns specified in an SM command are scanned for the first occurrence in each line. Columns 1 through 72 are the default scan columns unless the line is shorter than 72 columns, in which case it will scan to the end of the line. When an L is entered, the command performs a label scan, beginning at the left limit and extending to the first space.

The character string used in the scan is designated *string1*, and is enclosed by identical characters, each represented by *dl*. The character represented by *dl* may be any character that does not appear in *string1*.

When no other parameter is entered, the command scans the specified lines and prints the number of lines in which a match of *string1* was found. When P is entered following *dl*, the command prints each line in which a match of *string1* was found, and also prints the number of lines in which the string occurred following the last line scanned.

Character string, *string2*, enclosed by identical characters, each represented by *d2*, is the replacing string. *String2* may be omitted, or may be longer or shorter than *string1*. When the replacement is



made, the characters of string2, if any, replace the characters of string1 and the length of the resulting line is adjusted as necessary. When there are no characters entered for string2, the characters of string1 are deleted. Character d2 may be any character that does not appear in string2, V, or P.

When no other parameter is entered following string2, the specified lines are scanned and string2 replaces the first appearance on each line of string1, or label string1, each time a match is found. The command prints the number of lines in which the replacement was made after scanning the last line.

Either V or P, or both, may be entered following string2. The verify operation, specified by V, prints the line in which the match is found, and prints the question Y/N? on the next line. The user must enter Y or N followed by a carriage return to continue the operation. When the user enters Y the replacement is made. When the user enters N the replacement is not made. The scan continues in either case.

The print operation is specified by P. After the replacement is made, the resulting statement is printed and the scan continues.

When the specified lines have been scanned, TXEDIT prints the number of lines in which a match was found. The pointer is left unchanged throughout the operation.

The general rule of TXEDIT which allows spaces between characters or operands does not apply to string1 and string2. Any spaces between the characters represented by d1 are considered part of string1, and any spaces between the characters represented by d2 are considered part of string 2. Lines brought into memory have trailing blanks suppressed and therefore comparisons should not be made past the last non-blank character of a line.

The following example shows an F command to replace the first appearance in each line of the string EUEN with the string EVEN in lines 34 through 48 and print the resulting lines:

```
?F34-48F*EUEN*$EVEN$P
```

The command in the following example verifies the replacement of label P1 with string PUN1 in each of nine lines beginning with the pointer line:

```
?F9L'P1''PUN1'V
```

4.4.8 PRINT COMMANDS. The print commands cause TXEDIT to print the first and last lines in the buffer, or to print one or more specified lines. The print commands are described in the following paragraphs.

4.4.8.1 Limits (L). The Limits (L) command causes TXEDIT to print the first and last lines in the buffer, including the line number, if any, with the right margin at column 72. The SN and SP commands do not affect the operation of the L command. The syntax for the L command is as follows:

```
L
```

The L command is used to identify the top and bottom lines of the buffer.

4.4.8.2 Print (P). The Print command causes TXEDIT to print a block of lines. The block of lines is specified by first and last line numbers, or by a number of lines preceding or following the pointer. The SL and SN commands, when entered, control printing of line numbers, and the SP command, when entered, sets the right margin of the print lines. When these commands are not entered, line numbers are printed and the right margin is column 72. The syntax of the P command is as follows.



P <s> - <t>
 [+] [<n>]
 - <n>

Line s through line t are printed, or n lines are printed. When n is preceded by a minus sign, n lines preceding the pointer line, but not the pointer line, are printed. When n is unsigned or preceded by a plus sign, n lines beginning with the pointer line are printed. When no operand is entered, the pointer line is printed. The following example shows a P command to print lines 8 through 10:

?P8-10

The command in the following example prints the pointer line and the next three lines:

?P4

The user may terminate the Print command at any time by entering an ESC character at the keyboard. TXEDIT then prints a question mark and awaits input of another command.

4.4.9 OUTPUT COMMANDS. TXEDIT provides two commands to write source or object code and one command to end execution of TXEDIT. The Keep (K) command writes the entire buffer or specified lines from the buffer. The Quit (Q) command writes specified lines from the buffer, the entire buffer, or the buffer contents and the remainder of the input file, and writes an end-of-file record on the output file. The output commands are described in the following paragraphs.

4.4.9.1 Keep (K). The Keep (K) command writes a specified number of lines from the buffer to the output device. The syntax for the K command is as follows:

K[<n>]

The first n lines of the buffer, or all lines in the buffer when n is omitted, are written on the output file. When the pointer line is written, the pointer is moved to the top line remaining in the buffer. The K command is entered to write lines no longer required in the buffer in order to have space in the buffer for additional lines. The following example shows a K command to write the top 15 lines of the buffer:

?K15

4.4.9.2 Quit (Q). The Quit (Q) command writes lines from the buffer and input file followed by an end-of-file record. The syntax of the Q command is as follows:

Q[<s>]

The lines of the input file up to and including line number s are written. When line number s is in the buffer, lines are written from the buffer only. When line number s is not in the buffer, TXEDIT writes the lines in the buffer, reads the additional lines from the input file, and writes these lines. If line number s is never found, the rest of the file will be copied. When s is zero the edit is finished; no more data is written from the buffer or from the file, and an EOF character is inserted in the output file. The Q command is used to truncate data. When s is omitted, the lines in the buffer and the remainder of the input file are written. The Q command is entered to write the output file, or the remainder of the output file, including the end-of-file record. After the lines have been copied to the output file, the terminate sequence is entered.



4.4.9.3 END (E). Another command available to initiate the terminate sequence is the End command. This command ends the edit function without writing any data to the output file and does not cause the EOF character to be written. This provides an escape route from TXEDIT in the event a nonrecoverable error has been detected and there is no requirement to write an EOF on the output file. The system will respond to the E command with the TERMINATE/CONTINUE? prompt. The user must then enter a T to exit from the TXEDIT program and restart without affecting the current status of the input or scratch files.

4.4.10 TERMINATE-SEQUENCE COMMANDS. Two commands can be used to initiate a terminate sequence, depending on the particular situation. The normal method of terminating is with the Quit (Q) command, as explained above. The Q command always writes an EOF on the output file, and the system responds with the following message:

TERMINATE/CONTINUE?

In response to this message, the user enters a T or C. When it is desired to reverse the flow of the data and continue the editing, the Continue (C) command is entered. The system responds with the question mark (?) prompt and editing continues, starting at line one, again. When editing is completed and the T response is entered for terminate, the system responds with one of two messages as follows:

- TEXT IN INPUT FILE.

END EDIT.

or

- TEXT IN SCRATCH FILE.

TRANSFER TO INPUT?

The first message, "TEXT IN INPUT FILE", ends the TXEDIT and returns control to the TXDS Control Program. If the second message, "TEXT IN SCRATCH FILE", is printed and the user enters a Y for yes, the text is transferred from the scratch file back to the input file and control is returned to the TXDS Control Program. If an N for no is entered, the system prints "END EDIT" and without any additional action, returns control to the TXDS Control Program.

4.5 ERROR MESSAGES

The TXEDIT error messages capable of being presented on the system console by TXEDIT, their reason for occurring, and the procedure for recovery from each error is presented in table 4-3.

4.6 EXAMPLE: ENTERING A SOURCE PROGRAM ON A CASSETTE OR DISKETTE

The following paragraphs describe the use of TXEDIT to enter a new source program on a cassette or diskette. The Insert (I) command is used to input new source statements. Any of the commands may be used to correct any errors made in entering the statements. Because statements entered with the Insert command have no line numbers, the pointer-relative specification is the only available means of specifying a line in a command.



Table 4-3. TXEDIT Error Messages

| Message | Reason | Recovery |
|------------------|--|---|
| INVALID OPERATOR | The operator portion of a command entry is incorrect. | Enter a valid, correct command. |
| INVALID OPERAND | The operand is not entered correctly or is beyond the range of values for that operand. | Enter a valid, correct command or enter another command. |
| BUFFER EMPTY | A command that operates on data in the buffer is entered before data has been placed in the buffer from the input file or from the keyboard (either initially or after writing the entire buffer contents). | Enter a D or I command and data. |
| BUFFER FULL | A D, I, or C command has attempted to put more data into the buffer than the buffer can contain. | Enter a K command or write data from the buffer before entering or reading more data. |
| END OF FILE | End-of-file has been encountered on input or a D command has attempted to read more records than is contained in the input file. | Enter a Q command. Another editing session may be entered by entering a C to the TERMINATE/CONTINUE? question. TXEDIT will make no further attempt to read the input file until the program restarts. |
| OFF THE TOP | A negative displacement caused the pointer to be moved past the beginning of buffer. (That is, the negative displacement from the pointer line in a C, M, R, F, or P command is greater than the number of lines in the buffer before the pointer line.) | After printing the message, TXEDIT is positioned at the top (i.e., first) line of the buffer. |
| LAST LINE | A positive displacement caused the pointer to be moved beyond the last line at the end of the memory buffer. | TXEDIT prints a question mark and waits for another command. |
| LINE NOT FOUND | A line, or line number, was referenced but was not in the buffer. The first line in a C, M, R, F, or P command, or the line number in an I command, or the destination line number in an M command is not in the buffer. | The command is not executed by TXEDIT. Enter another command in response to the question mark (?) prompt. |
| CAN'T GET MEMORY | Memory option was greater than available memory. | Enter a smaller memory option. |
| CAN'T GET COMMON | COMMON was not included at system generation time. | Execute the system generation utility and include COMMON. |



Table 4-3. TXEDIT Error Messages (Continued)

| Message | Reason | Recovery |
|--|---|---|
| nn – I/O ERROR (where nn refers to the error code listed in Appendix I, entitled “I/O Error Codes”). | There was an I/O error. | Correct error and restart. |
| NAMES CANNOT BE THE SAME | The input file name entry and the output file name entry were the same. | Reenter INPUT: and OUTPUT: parameter. |
| ILLEGAL PARAMETER | The file name was not included in the INPUT: parameter. | Reenter the INPUT: parameter. |
| TRANSFER I/O ERROR | There was an I/O error transferring the output file to the input file. | Correct and use the TXCCAT utility to copy the output file to the input file. |
| I/O ERROR, RETRY? (Y, N, or CR to abort I/O) | If “Y” is entered, it will backspace one record and try to read that record again. If “N” is entered, it will try to read the next record. If a carriage return (CR) is entered, the text editor will terminate. | |

The following text describes an example of writing a source program using TXEDIT.

The initial message and the first command, with associated entries, are as follows:

```
TXEDIT      936220**
?I0
W1  BSS    32
START RSET
      LWP1  W1
      CLE   R0
```

The I command with an operand of zero causes TXEDIT to place the lines that follow at the top of the buffer. The buffer pointer is not moved as lines are entered and remains ahead of the first line entered. In the above example, an error was made in the operation field of the fourth line, so the user entered an additional carriage return to terminate the command, permitting entry of another command to correct the error.

The next part of the example program is:

```
?K3
?P1
      CLE   R0
```

The K command causes TXEDIT to write the first three lines on the output medium. The P1 command causes TXEDIT to print the pointer line to verify that the pointer is at the line that contains the error. An alternative to using the Keep command to write the correct portion of the program is to use a Down (D) command to position the pointer for correction of the error, leaving the first three lines in the buffer.



The next command and the associated entries are as follows:

```
?C
      CLR    R0
I1    INC    R0
      JNO    J1
D1    DEC    R0
      JNE    D1
      JMP    I1
      END    START
```

The C command deletes the error line and accepts seven lines of source code. The example source program is now complete, with three lines written on the output medium, and seven lines in the buffer.

The next command and the resultant printout or display follows:

```
?F10F'J1''I1'
LAST LINE
0001 FOUND
```

The F command scans the contents of the buffer, replacing the first appearance in each line of string J1 with string I1. The command attempts to scan 10 lines, and prints the message "LAST LINE" because there are only seven lines in the buffer. The V and P options (described above under the Find (F) command paragraph) could have been used. This is an alternate method of correcting an error in a source program entered from the keyboard using TXEDIT.

The next command and the resultant printout or display follows:

```
?P10
      CLR    R0
I1    INC    R0
      JNO    I1
D1    DEC    R0
      JNE    D1
      JMP    I1
      END    START
LAST LINE
```

The P command causes TXEDIT to print the contents of the buffer and the last line message. Entering the Quit command causes the terminate sequence to be entered.

```
?Q
TERMINATE/CONTINUE?
```

The Q command causes TXEDIT to write the buffer contents on the output medium following the records previously written by the Keep (K) command. An end-of-file record is written following the last record. The user then enters a T to terminate the text editor, and a Y to transfer the scratch file to the original input file.

```
TERMINATE/CONTINUE?T
TEXT IN SCRATCH FILE.
TRANSFER TO INPUT?Y
END EDIT
```



4.7 EXAMPLE OF HOW TO EDIT A SOURCE PROGRAM

The capabilities of TXEDIT to edit source programs include adding, moving, and removing statements, and replacing a character string in statements. The edited program may include portions of a number of source programs. The purpose of editing is to correct or modify a source program. The following paragraphs describe an example of editing a source program and considerations for editing source programs. For this example, a typical source program is used for which no Setup command is required because default values for print margin and F command limits are used and line numbers are printed.

The initialization messages and the first command are as follows:

```
TXEDIT 936220 **  
  
?D117
```

The D command moves the pointer down 117 lines, and TXEDIT reads in the source file to fill the buffer as defined by the D command. A smaller value could have been used to read part of the file, followed by a subsequent D command to read the remainder. Had a larger value been entered, TXEDIT would have read the 117 records of the file and printed the end-of-file message. TXEDIT prints the prompt character (?) and awaits another command.

The next command and printout result are as follows:

```
?L  
0001 TITL 'EDITING EXAMPLE'  
0117 END
```

The L command verifies the buffer contents by printing the first and last lines in the buffer. Had the SN and SP commands been entered, they would not have affected the printing of the limits resulting from the L command.

The next command is as follows:

```
?T
```

The T command moves the pointer to the top of the buffer (line 1) from line 117 where the first command had placed the pointer. Moving the pointer to the top of the buffer permits using pointer-relative commands for the area at the top of the buffer.

The following commands move line 46 to a position after line 116 and remove line 117.

```
?M46-46,116  
?R117-117
```

The following command is entered.

```
?M81-87.115
```



This M command moves lines 81-87 to a position following line 115 to cause the line numbers in the buffer to be out of sequence.

The following commands prepare the move operation for verifying.

```
?B
?P1
0046   END   START
```

The B command places the pointer on the last line of the buffer, and the P command prints the pointer line to verify that it is on the proper line.

The next command and the resultant printout or display on the system console are presented as follows:

```
?P-13
0111   UP2   MOV    *R10,*R10
0112           JNE    UP1
0113           BL    @ATTOP
0114           MOV    *DUMNXT,TMLOC
0115           JMP    UP3
0081   *ROUTINE COMMON TO UP AND DOWN
0082   UDCOM1 MOV    RTN,R5
0083           BL    @SCANOP
0084           INC    UDCNT
0085           MOV    UDCNT,UDCNT
0086           JEQ   EXIT
0087           B     *R5
0116   *
```

The P command prints the 13 lines preceding the pointer line, and the result shows that lines 81-87 have been placed after line 115. This result also shows the effect of the previous move and remove commands.

The next command and associated entries are as follows:

```
?I77
*TITLE = MSGOUT   MESSAGE OUTPUT
MSGOUT  MOV      *R11,*R10
        MOV      @MCOUNT(R10),R10
        BLWP     @PRINT
        B        *R11
```

The I command inserts five lines following line 77. The number of lines inserted is the number of lines entered with the command and may be one or more lines. After the carriage return that terminates the last line, an additional carriage return is entered to terminate the command.



The next command and resultant printout are as follows:

```
?P77-78
0077      JMP      EXIT
          *TITLE=  MSGOUT  MESSOUT OUTPUT
          MSGOUT  MOV      *R11,*R10
          MOV      @MCOUNT(R10),R10
          BLWP    @PRINT
          B        *R11
0078      EOFEXT  BL       @MSGOUT
```

The P command prints lines 77 through 78, which includes the five unnumbered lines inserted by the previous command. The result shows that the lines have been inserted correctly.

The next command and the resultant interaction are as follows:

```
?F1-46F'EXIT''EXTDWN'VP
0071      JMP      EXIT
Y/N?     Y
0071      JMP      EXTDWN
0077      JMP      EXIT
Y/N?     Y
0077      JMP      EXTDWN
0080      EXIT    RTWP
Y/N?     Y
0080      EXTDWN RTWP
0086      JEQ     EXIT
Y/N?     N
0004      FOUND
```

The F command finds the first appearance in a line of the string EXIT in lines 1 through 46. (Remember that line 46 is now the last line, i.e., after line 116.) The entire buffer is scanned because the top line in the buffer is line 1 and the bottom line is line 46. Line numbers greater than 46 between lines 1 and 46 are also scanned. The replacing string is used only when the user enters a Y following the printing of the line found. In the example shown, the replacement was not made in line 86 because the user entered an N following the printing of this line. Lines 71, 77 and 80 were replaced because the user entered a Y following the printing of these lines. The count of lines found is printed after all lines have been scanned. The F command may be used to scan only a portion of the buffer, from one line up to the entire buffer, and replace from one character to the entire statement.

The next three commands are as follows:

```
?R15-15
?R17-17
?R19-19
```

Each R command removes the specified line from the buffer. Three commands that remove one line each are necessary because the lines to be removed are not consecutive. A single R command may remove one or more consecutive lines.



The next command and the resultant printout are as follows:

```
?P14-20
0014  DUMNXT  EQU   0
0016  LINAD   EQU   2
0018  LINPTR  EQU   4
0020  CLLOC   EQU   6
```

The P command prints lines 14 through 20. The result shows that the lines specified in the Remove (R) command were removed.

The next command is as follows:

```
?U2
```

The U command positions the pointer to the second line preceding the pointer line. The pointer could have been moved any number of lines up to the top of the buffer.

The next two commands, the resultant printout of the first command, and the entry associated with the second are as follows:

```
?P68-68
0068          A      @MAXLIN,UDCNT
?C68-68
      A      @MINLIN,UDCNT
```

The P command prints line number 68 to verify that line 68 is the desired line. The C command changes line 68 to the line entered with the command. One or more consecutive lines may be deleted by a C command, and any number of lines, including zero lines, may be added. The number of lines added does not have to be equal to the number of lines deleted and the added lines have no line numbers.

If there were no more data in the input file, or if the remaining data were to be discarded, the next command would be ?Q117. This would place the data in the buffer in the SCRATCH file and place an EOF at the end of the data. If, however, there were more data in the input file but no editing was required, the next command would be just ?Q. The Q command would write the entire buffer, plus whatever was remaining in the input file would be placed into the scratch file and EOF would be placed at the end.

The next response from the system would be as follows:

```
TERMINATE/CONTINUE?
```

If no further editing is desired, the operator enters a T for terminate. The system would respond as follows:

```
TEXT IN SCRATCH FILE.
TRANSFER TO INPUT?
```

At this point the operator decides where the text is to reside. If a Y is entered for Yes, the scratch file text is transferred directly to the input file, or if N is entered, the text remains in the OUTPUT file. The system ends the TXEDIT by printing END EDIT and the TXDS control program is reactivated.



4.8 EXAMPLE OF HOW TO EDIT AN OBJECT PROGRAM

The capabilities of TXEDIT to edit object programs include adding, moving, and removing records, and replacing a character string in records. These capabilities allow the user to combine object code, correct object code, and add object code at the machine instruction level. In editing object code, it is necessary to thoroughly understand the object code format and the significance of tag characters (described in the Model 990 Computer/TMS9900 Microprocessor Assembly Language Programmer's Guide). Records may be inserted into an object program at any point except that the records that contain tag character 3 or 4, tag character 5 or 6, and tag character 1 or 2 must follow all other records in the object file. Further, the record that contains tag character D, if any, must precede the record that contains the first tag character 0. Each record must end with tag character F. When the contents of a record are altered, tag character 7 and associated field must be removed.

When the length of relocatable code is increased, the contents of the hexadecimal field associated with the final 0 tag character must be changed. The following paragraph describes an example of editing an object program.

NOTE

Compressed object code cannot be edited.

In the example, the purpose of the edit is to add a record to specify a load point, to change instructions that use workspace register 1 to use workspace register 7 instead, to change an instruction, and to add an instruction.

The initialization message and the first command are as follows:

```
?SN
```

The SN command is a setup command that inhibits printing of line numbers. When line numbers are printed, printing of an object record may be truncated because of the length of the print line.

The next command and the associated entry are as follows:

```
?I0  
D1000F
```

The I command with an operand of 0 inserts the associated line at the top of the buffer. The line will be the first record in the edited object file, and contains load point of 1000_{16} , specified with a D tag character.

The next command and the resultant printout are as follows:

```
?D10  
  
END OF FILE
```

The D command causes TXEDIT to read in the object file to be edited. The file contains six records, so the operand used causes TXEDIT to attempt to read past the end-of-file record. This inhibits further reading of any input file in this run of TXEDIT.



The next command and the resultant printout are as follows:

```
?L  
  
          D1000F  
0006    200CE10010C    7FCABF
```

The L command causes TXEDIT to print the limits. The top line in the buffer is the line entered with the I command, and has no line number. The bottom line is the last line of the object file, line 6.

The next command and the resulting interaction are as follows:

```
?F1-6F'B0002''B000E'VP  
  
00000SAMPROG 90040C0000A0020BC06DB000290042C0020A0024BC81BC002A7F219F  
Y/N?Y  
  
00000SAMPROG 90040C0000A0020BC06DB000E90042C0020A0024BC81BC002A7F219F  
A0028B0241B0000BCB41B0002B0380A00CAC0052C00A2B02E0C0032B0200B0F0F7F1DEF  
Y/N?Y  
  
A0028B0241B0000BCB41B000EB0380A00CAC0052C00A2B02E0C0032B0200B0F0F7F1DEF  
0002 FOUND
```

The F command scans for the character string B0002 with the verify and print options. The replacement string, B000E, changes the memory address of workspace register 1 to that of workspace register 7 in two instructions. Verification and printing provides control and documentation of the changes.

The next command and the resulting interaction are as follows:

```
?F1-6F'7F151''''VP  
  
A00D6BC0A0C00CAB04C3BC160C00CCBC1A0C00D0BC1F2B0287B3A00A00ECB02217F151F  
Y/N?Y  
  
A00D6DC0A0C00CAB04C3BC160C00CCBC1A0C00D0DC1F2B0287B3A00A00EB0221F  
0001 FOUND
```

The F command scans for the character string 7F151, which is a checksum tag character and associated field. The replacement character string is a null string, and the result is to remove the checksum from a record which was changed by an edit command not shown here.

The next command and the associated entry are as follows:

```
?I  
A00ECBC227A00F0B06C7A010AB04CTF  
A010CB10FFF
```



The I command inserts the associated two lines following the line on which the pointer had been positioned by an edit command not shown. The first line will cause the loader to overlay three words of the original file, which is another way of changing object code. The second line is an added instruction which will increase the size of the program module.

The next three commands, the resultant printout of the second, and the associated entry of the third are as follows:

```
?D3
?P1
200CE0010C      7FCABF
?C
200CE0010E      F
```

The D command moves the pointer line down three lines, and the P command causes TXEDIT to print the pointer line to verify the pointer position. The C command changes the pointer line to modify the number of words of relocatable code in the program. If this is not done, and another module is loaded following this module without specifying a load address for the subsequent module, the subsequent module will overlay the instruction that was added. The pointer line is also changed to delete the checksum.

The last command and the final messages are as follows:

```
?Q
TERMINATE/CONTINUE ?T
```

The Q command causes TXEDIT to write the contents of the buffer and any data remaining in the input file, followed by an end-of-file record, on the output medium. The T command causes TXEDIT to terminate and issue the message:

```
TEXT IN SCRATCH FILE.
TRANSFER TO INPUT?
```

If all editing is completed, the user responds with a Y (yes) and TXEDIT transfers the scratch file to the input file and prints "END EDIT".



SECTION V

TXDS ASSEMBLER (TXMIRA) UTILITY PROGRAM

5.1 INTRODUCTION

The TXMIRA Utility Program is a member of a family of assemblers that may be used with the Model 990 Computer family. It functions to substitute absolute operation codes and addresses (i.e. Model 990 machine language) for symbolic codes and addresses (i.e. assembly language source code programs). TXMIRA provides for the allocation of storage to the minimum extent of assigning storage locations to successive instructions and for the computation of relocatable addresses from symbolic addresses. The TXMIRA program has the following features:

- Assembles all 72 instructions for both the Model 990/4 and the Model 990/10 Computers
- Supports 19 directives
- Supports both pseudo instructions (NOP, RT)
- Supports a sorted symbol list option
- Provides error messages in text form
- Supports compressed object code
- Prints or truncates 'TEXT' string option

As a two-pass assembler program, TXMIRA reads the program source statements two times, providing maximum programming flexibility in the process of producing object code. On the first pass, the assembler maintains the location counter and builds a symbol table similar to those in a one-pass assembler. During this pass some errors may be detected and printed on the listing device. For the second pass, the source statements are read in again by rewinding the input file. During the second pass, the assembler generates the object code using the symbol table developed during the first pass. The two pass feature reduces the restrictions on forward referencing. TXMIRA produces a listing of the source code and the object code (i.e., machine language). Optionally, the assembler prints out the symbol table. Further, the resultant output produced by the TXMIRA utility program may be linked to other output modules or be loaded separately for execution.

For more details on the Model 990 assembly language, refer to *Model 990 TMS9900 Microprocessor Assembly Language Programmer's Guide*, part number 943441-9701.

5.2 LUNOs AND THEIR USES

LUNOs 5, 6, and 7 are used by TXMIRA program for source input, object output, and listing, respectively. All LUNOs are assigned by the TXMIRA program. Upon termination of the TXMIRA program, all LUNOs are released.



5.3 OPERATION INTERACTION

The TXMIRA program can only run under the control of the TXDS Control Program. The INPUT: parameter must have the pathname of the source file to be assembled. The first OUTPUT: parameter must have the pathname of the file or device to which the object code will be written. The second OUTPUT: parameter must have the pathname to which the listing will be written. The object pathname and the listing pathname must be separated by a comma. If the output file does not exist, it will be created as a sequential file with the name given. If the listing pathname is null, the system default printer will be used. If only part of the listing pathname is used, the defaults in table 5-1 will be used. The following is an example of loading and executing TXMIRA using the TXDS Control Program.

```
PROGRAM: :TXMIRA/SYS
INPUT: :SOURCE
OUTPUT: :OBJECT,LP
OPTIONS: SLM4000
```

5.4 TXMIRA OPTIONS

The TXMIRA assembler options are specified by a single alphabetic character followed in one case, M, by a numeric field. Input format is free-form in that delimiters (i.e. separators) may be commas, blanks or no delimiters. The options recognized by TXMIRA are listed and described in table 5-2. These options are described further in the following subparagraphs.

Table 5-1. Pathname Defaults

| Field | Source | Object | Listing |
|-------|-------------------|-------------------|-------------------|
| DEV | DEFAULT DISC NAME | DEFAULT DISC NAME | DEFAULT DISC NAME |
| FILE | NONE | SOURCE FILE | SOURCE FILE |
| EXT | SRC | OBJ | LST |

Table 5-2. TXMIRA Options

| Option | Description |
|--------|--|
| Mnnnn | Overrides memory size default; default is 2400 bytes |
| X | Produce cross-reference |
| L | Produce assembly listing |
| T | Expand TEXT code on listing |
| S | Produce sorted symbol list |
| C | Produce compressed object output |

where n is a decimal digit



5.4.1 MEMORY OPTION (M). The memory option is used to override the default memory size. The size is expressed in bytes. The syntax of the option is as follows:

Mn (where n is a decimal number up to five decimal digits)

Some examples follow:

M4096
M20000
M01000

5.4.2 CROSS-REFERENCE OPTION (X). This option is used when a cross-reference is desired. Upon termination of TXMIRA, the TXDS Control Program will chain to the TXXREF Utility Program (described in Section VI) to perform the cross-reference operations. To enable the cross-reference option to work properly, the TXXREF object code must be in a file with the following pathname:

:TXXREF/SYS

5.4.3 LISTING OPTION (L). This option is used when a listing is desired by the user. It may be overridden by the LIST and UNL assembler directives. Errors are always printed.

5.4.4 PRINT TEXT OPTION (T). This option is used when expansion of TEXT statements is desired by the user. Default results in no expansion of TEXT statements.

5.4.5 SYMBOL TABLE LISTING OPTIONS(S). This option is used when a sorted symbol list output is desired. The list presents four symbols to a line; and each symbol presents the following information in sequence: (1) attribute tag; (2) symbol; and (3) value. Table 5-3 defines the symbols used in the listing.

5.4.6 COMPRESSED OBJECT OPTION (C). This option is used when compressed object code is desired, and it may only be written to a diskette file. Compressed object takes up less diskette space. See Appendix B for a description of compressed object.

Table 5-3. Symbol Attributes

| Character | Meaning |
|-----------|---------------------------|
| R | Relocatable |
| E | External Reference (REF) |
| D | External Definition (DEF) |
| X | Extended Operation (XOP) |
| U | Undefined |



5.5 ERRORS

5.5.1 TXMIRA ERROR MESSAGES. The TXMIRA assembler processes five (5) fatal errors (table 5-4) and 12 nonfatal errors (table 5-5). The five fatal errors cause the run to abort with the appropriate error message printed.

The twelve (12) nonfatal errors do not cause the run to abort. An error message is printed following the statement containing the error. The format of the printout is as follows:

```
***** SYNTAX ERROR -- RCD nnnn
```

where nnnn is the source record number.

When there are undefined symbols in an assembly, the undefined symbols are listed at the end of the assembly listing under the following heading:

THE FOLLOWING SYMBOLS ARE UNDEFINED:

Table 5-4. TXMIRA Fatal Errors

| Error | Description | Recovery |
|-----------------------|--|----------------------------|
| CANT GET COMMON | COMMON Not in System | Re-Gen System with COMMON |
| CANT GET MEMORY | MEMORY Size Requested Too Large | Decrease Request |
| SYMBOL TABLE OVERFLOW | MEMORY Size Too Small | Increase Request |
| nn-ILLEGAL PATHNAME | PATHNAME Not Found or Open Error | Correct Pathname and Retry |
| nn-I/O ERROR-A | I/O ERROR on A, where A can be: S=SOURCE O=OBJECT L=LISTING | Correct and Retry |

Note: nn is a system returned error code. See Appendix D for explanation.



Table 5-5. TXMIRA Nonfatal Errors

```
***** SYNTAX ERROR – RCD nnnn
***** ILLEGAL EXTERNAL REF. – RCD nnnn
***** VALUE TRUNCATION – RCD nnnn
***** MULTIPLY DEFINED SYM – RCD nnnn
***** INVALID OPERATOR – RCD nnnn
***** ILLEGAL FORWARD REF. RCD nnnn
***** ILLEGAL TERM – RCD nnnn
***** ILLEGAL REGISTER – RCD nnnn
***** SYMBOL TRUNCATION – RCD nnnn
***** UNDEFINED SYMBOL – RCD nnnn
```

where nnnn is the record number in which
the error occurred

5.6 TXMIRA EXAMPLE

Following is an example of loading and executing TXMIRA. The diskette file :TXTST1/SRC is entered in the INPUT: source file parameter line. DSC2: is entered in the first OUTPUT: parameter causing TXMIRA defaults for the file name and extension. Therefore, the object (machine) code is written to the diskette file DSC2:TXTST1/OBJ. LOG is entered in the second output parameter producing the source listing output on the system console. Two options are entered in the OPTIONS: parameter line. The L option produces a source listing, and the S option produces a symbol table.

```
TXDS 936215 *H 1/ 0 00:01

PROGRAM: :TXMIRA/SYS
INPUT: :TXTST1/SRC
OUTPUT: DSC2:,LOG
OPTIONS: L,S
TXMIRA 936227 **
```



Following is an example of the source listing caused by entering an L in the OPTIONS: parameter line.

```

TXTST1          TXMIRA  936227 **                PAGE 0001
TXDS TEST PROGRAM  937808-9901**

0002              IDT  <TXTST1>
0003              *
0004              REF  CNT, NEW, WRITE
0005              *
0006 0000 0006<  DATA TSTWSP, START, 0
      0002 0045<
      0004 0000
0007 0006          TSTWSP BSS  32
0008 0026 1600    ENDPRG DATA >1600          END OF PROGRAM OP CODE
0009              *
0010              DXOP SVC, 15                *** DEFINE XOP
0011              *
0012 0028  0D    OLD   BYTE >0D, >0A, >0A
      0029  0A
      002A  0A
0013 002B  20          TEXT < OLD MESSAGE -- WRONG !!>
0014 0043  0D          BYTE >0D, >0A
      0044  0A
0015          001D  CNT1  EQU  $-OLD

```

```

TXTST1          TXMIRA  936227 **                PAGE 0002
TXDS TEST PROGRAM  937808-9901**

0017              START
0018 0046 0420          BLWP @WRITE          PRINT MESSAGE
      0048 0000
0019 004A 0028<  DATA OLD, CNT1
      004C 001D
0020 004E 2FE0          SVC  @ENDPRG          END OF PROGRAM
      0050 0026<
0021              END

```

Following is an example of the sorted symbol table caused by entering an S in the OPTIONS: parameter line.

```

TXTST1          TXMIRA  936227 **                PAGE 0003
TXDS TEST PROGRAM  937808-9901**

E CNT      0000          CNT1  001D  R ENDPRG  0026  E NEW      0000
R OLD      0028          R START 0045  X SVC     000F  R TSTWSP  0006
E WRITE    0048

0000 ERRORS

```

**SECTION VI****TXDS CROSS-REFERENCE (TXXREF) UTILITY PROGRAM****6.1 INTRODUCTION**

The TX990 Cross Reference (TXXREF) Program is a single pass cross-reference program. The program gives a listing of each user-defined symbol in a 990 assembly source program along with the line numbers on which the symbol is defined and all of the line numbers on which the symbol is referenced. The line numbers of the references to a symbol are in ascending order, and the symbols are in alphabetical order. If the symbol was never defined, only the line numbers of the references to the label will be listed.

6.2 LUNOs

LUNOs 5 and 6 are used by TXXREF. They are assigned when execution begins and released upon termination by the program. LUNO 5 is the source input LUNO, and LUNO 6 is the listing LUNO.

6.3 OPERATING PROCEDURE

TXXREF can only run under the control of TXDS. The object program may be loaded from a device or from the file, :TXXREF/SYS.

The INPUT: parameter must contain the pathname of a source program. The OUTPUT: parameter must contain the pathname of a listing device to which the cross-reference listing will be directed. If there is no response to the OUTPUT: prompt, the default print device will be used.

The pathname defaults are given in table 6-1. The input file must preexist, and if the output file does not exist, it is created with the name given. Lastly, an option may be entered to override the symbol table size.

6.4 LISTING FORMAT

An example of a listing is shown in figure 6-1. The heading gives the name and version of TXXREF and the time and date of the run, if the time and date are initialized. Each line of the cross-reference begins with the symbol, listed alphabetically, followed by the line number on which it was defined (appearance in the label field), if any, and the list of line numbers, in ascending order, on which the symbol was referenced, if any. The last line gives the number of symbols in the cross-reference.

NOTE

If TXXREF runs out of table space, it prints the references found at that point, and attempts to continue. If insufficient space was freed up by that process, then TXXREF terminates.

Table 6-1. Pathname Defaults

| Field | Input | Output |
|--------------|--------------|---------------|
| DEV | SYSTEM DISC | SYSTEM DISC |
| FILE | NONE | INPUT FILE |
| EXT | SRC | LST |



TXXREF 937542 ** 16:32:36 088/77 PAGE 0001

| | | | | | |
|--------|------|------|------|------|------|
| ASREXT | | 0175 | 0176 | | |
| ASRHAN | | 0167 | 0168 | | |
| BAD | 0283 | | | | |
| BADINT | | 0243 | 0285 | | |
| BUF1 | 0029 | 0149 | | | |
| BUF2 | 0105 | 0150 | | | |
| BUF3 | 0124 | 0151 | | | |
| BUFADH | 0143 | 0064 | | | |
| BUFADL | 0066 | 0064 | | | |
| BUFE | 0152 | 0146 | | | |
| BUFF | 0148 | 0146 | | | |
| BUFH | 0147 | 0146 | | | |
| COMSIZ | 0239 | 0238 | | | |
| CRTHAN | | 0229 | 0230 | | |
| DFLDSC | 0060 | 0059 | | | |
| DFLPTR | 0061 | 0059 | | | |
| DNT | 0039 | 0038 | | | |
| DNT2 | 0040 | 0038 | | | |
| DNTEND | 0057 | 0038 | | | |
| FMPBUF | 0155 | 0154 | | | |
| FPYDCD | | 0274 | 0275 | | |
| FPYDSR | | 0197 | 0198 | 0213 | 0214 |
| FPYINT | | 0200 | 0201 | 0216 | 0217 |
| FPYSPR | | 0193 | 0194 | 0209 | 0210 |
| FREQX2 | 0004 | 0003 | 0005 | | |
| GO | | 0170 | 0171 | 0266 | 0267 |
| G0913 | | 0232 | 0233 | | |
| IDL913 | | 0225 | 0226 | | |
| ILLSVC | | 0021 | | | |
| KBIDLE | | 0163 | 0164 | | |
| KBTAB | 0027 | 0026 | | | |
| KSB1 | 0033 | 0029 | 0224 | 0251 | |
| KYBIN | | 0250 | 0251 | | |
| KYBUT | 0028 | 0026 | 0031 | 0032 | |
| LDTSTR | 0065 | 0064 | | | |
| LEV3 | 0246 | 0290 | | | |
| LEV4 | 0254 | 0291 | | | |
| LEV6 | 0262 | 0292 | | | |
| LEV7 | 0270 | 0293 | | | |
| LOC3 | 0249 | 0247 | | | |
| LOC4 | 0257 | 0255 | | | |
| LOC6 | 0265 | 0263 | | | |
| LOC7 | 0273 | 0271 | | | |
| LPHAN | | 0184 | 0185 | | |
| LPJNT | | 0187 | 0188 | 0258 | 0259 |
| LPSPUR | | 0180 | 0181 | | |
| LVLPTR | 0013 | 0012 | | | |

Figure 6-1. Sample Cross Reference Listing (Abbreviated)
Sheet 1 of 2



| | | | | | | | |
|--------|------|------|------|------|------|------|------|
| MAXST2 | 0032 | 0026 | | | | | |
| MAXSTA | 0031 | 0026 | | | | | |
| PDT0 | 0160 | 0041 | 0043 | 0045 | 0078 | 0083 | 0267 |
| PDT3 | 0177 | 0047 | 0160 | 0259 | | | |
| PDT4 | 0190 | 0049 | 0068 | 0177 | 0276 | | |
| PDT5 | 0206 | 0051 | 0073 | 0190 | 0277 | | |
| PDT6 | 0222 | 0053 | 0206 | | | | |
| PDTSTR | 0159 | 0158 | | | | | |

TXXREF 937542 ** 10:32:36 088/77 PAGE 0002

| | | | | | | | |
|--------|------|------|------|------|------|--|--|
| PWRFLG | 0010 | 0009 | | | | | |
| RET | 0284 | 0248 | 0256 | 0264 | 0272 | | |
| SLICE | 0006 | 0003 | | | | | |
| STINTR | 0005 | 0003 | | | | | |
| TASKCM | 0240 | 0238 | | | | | |
| TRABAD | 0285 | 0283 | | | | | |
| TRAPRT | | 0243 | 0284 | | | | |
| TRPINT | 0289 | 0288 | | | | | |
| TXSTR3 | | 0007 | 0008 | | | | |
| UMXSVC | 0023 | 0020 | | | | | |
| USCTAB | 0022 | 0020 | 0023 | | | | |
| WSP3 | 0244 | 0290 | | | | | |
| WSP4 | 0252 | 0291 | | | | | |
| WSP6 | 0260 | 0292 | | | | | |
| WSP7 | 0268 | 0293 | | | | | |
| XWP4 | 0276 | 0192 | 0208 | 0275 | | | |
| XWS | | 0243 | 0285 | | | | |

THERE ARE 0072 SYMBOLS

Figure 6-1. Sample Cross Reference Listing (Abbreviated)
Sheet 2 of 2



6.5 OPTIONS

The only option that is recognized by TXXREF is the memory-size-override option. The size is given in bytes. The option is as follows:

Mnnnnn where n is a decimal digit.

The following are examples:

M4096

M00200

M2000

The default memory size is 4800 bytes. The memory block is used to build a symbol table. Therefore, the size must be at least 12 times the number of symbols in the source program, plus 4 times the number of references.

6.6 ERROR MESSAGES

The errors, descriptions and recovery for TXXREF are listed in table 6-2.

Table 6-2. Error Messages

| Error | Description | Recovery |
|-----------------------------|--------------------------------------|-------------------------------|
| CANT GET COMMON | System COMMON not in system. | Regenerate system with COMMON |
| CANT GET MEMORY | Memory request too large | Decrease size |
| nn - ILLEGAL PATHNAME | Pathname doesn't exist or open error | Correct name and retry |
| nn - I/O ERROR | Error on read or write | Retry |
| INSUFFICIENT MEMORY - ABORT | Symbol table exceeded memory | Increase memory request |



SECTION VII

TXDS LINKER (TXLINK) UTILITY PROGRAM

7.1 INTRODUCTION

The TXDS Link (TXLINK) utility program accepts standard Model 990 object code modules (described in the *Model 990 Computer TMS 9900 Microprocessor Assembly Language Programmer's Guide*, part number 943441-9701, and compressed object code, available as an option (illustrated in table 6-3) and links the modules according to command information supplied by the user and the linking information in the modules. The linked output module is written on the output file.

Linking allows a set of independently assembled object modules to be linked to form a single object module. The major linking function is the resolution of external references and definitions in the individual unlinked modules.

TXLINK also supports partial linking of modules. A partially linked module may be used as input to another run of TXLINK with additional modules that satisfy the unresolved references.

The following restrictions apply:

- Linking of modules having absolute original addresses (AORG directive) is not supported.
- There must be enough memory for all symbols, (12 bytes/symbol), IDTs (24 bytes/IDT) and twice the length of the longest module to be linked. Memory size is defined by the "M" option.
- TXLINK only recognizes object tags "0" through "F".

7.2 TXLINK FILE STRUCTURES AND LUNO ASSIGNMENTS

Figure 7-1 shows the relationship of the files accessed by TXLINK. Control information and file access names are passed by the Terminal Executive Development System (TXDS) via system COMMON.

TXLINK supports up to three object input files and two output files. Each input file can contain any number of concatenated object modules. Input LUNOs used are 10_{16} , 11_{16} and 12_{16} . The output of TXLINK consists of a linked object file and load map listing. Output LUNOs used are 7 for the object file and 6 for the load map listing.

7.3 TXLINK EXECUTION

TXLINK can only be executed under TXDS Control Program. The INPUT: parameter contains the pathnames of one to three input files. Each pathname must be separated by a comma. An input file may contain several object modules concatenated together. There may only be one end-of-file on each file, and the file must be a sequential file or device. All input files are rewound by TXLINK before they are used.

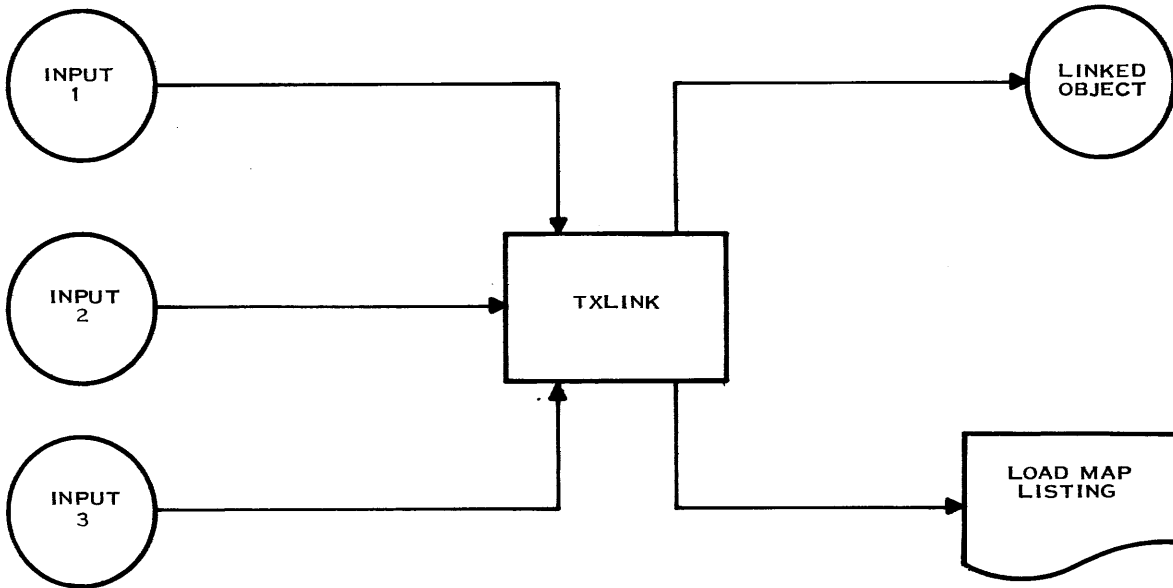

Figure 7-1. Files Accessed by TXLINK

The OUTPUT: parameter may contain two pathnames separated by a comma. The first pathname indicates the file to which the linked object code is written. The second pathname indicates the file to which the load map is listed. If either of the output files does not exist, TXLINK creates a sequential file with the pathnames entered. If the second output pathname is null, the system default printer is used. If only part of the pathname is defaulted, table 7-1 applies.

The defaults for the input and output pathnames are listed in table 7-1. Finally, the options are entered.

Table 7-1. Pathname Defaults

| Field | Input | Output | Listing |
|-------|-------------------|-------------------|-------------------|
| DEV | DEFAULT DISC NAME | DEFAULT DISC NAME | DEFAULT DISC NAME |
| FILE | NONE | NONE | OUTPUT FILE |
| EXT | OBJ | OBJ | LST |



7.4 TXLINK CONTROL OPTIONS

The following options control linking operations. All options are specified by a single alphabetic character followed in some cases by an override field. Input is free-form in that delimiters for options may be commas, blanks or no delimiters. The options are listed in table 7-2 and described in the following paragraphs.

7.4.1 MEMORY OVERRIDE (M). This option allows a larger block of memory for tables to be allocated to the Linker Utility. The default memory size is 11,800 bytes. The syntax for the option is:

Mnnnnn

Where n is a decimal number of the number of bytes required. There may be up to five decimal digits. The scan terminates when a nonnumeric character is encountered.

The following are examples of the memory option:

M4096
M00300
M24000

7.4.2 COMPRESSED OBJECT (C). The use of this object enables TXLINK to write compressed object code to the linked object file. TXLINK writes standard object code unless the C option is used. The syntax of the option is:

C

Compressed object format takes up less room on the diskette than standard 990 object code. The diskette is the only Floppy System device capable of supporting compressed object. The reader should be familiar with the Model 990 Computer object code format. If not, read the *Model 990 Computer TMS 9900 Microprocessor Assembly Language Programmer's Guide*, or refer to Appendix B.

Table 7-2. TXLINK Options

| Option | Description |
|------------|---|
| Mnnnnn | Override default memory size, default is 11800 bytes. |
| C | Compressed object output. |
| laaaaaaaaa | IDT for linked object. |
| P | Partial link desired. |
| L | Print load map and symbol list. |

Note: n is a decimal digit and a is an alphanumeric character.



7.4.3 PROGRAM IDENTIFIER, IDT, OPTION (I). This option enables the user to specify an object identifier for the linked object. Otherwise, the IDT of the first module input will be used. (An IDT is generated during assembly. It is the identification name of the module, and it is invoked by the “IDT” assembler directive.) The syntax of the option is:

Iaaaaaaaa

Where a is an alphanumeric character.

The scan terminates on a delimiter, blank or comma, or after eight characters.

Following are examples of the IDT option:

IMYLINK
IBADLINK
IWOW.

7.4.4 PARTIAL OPTION (P). The use of this option specifies that the module is to be partially linked. The partially linked module includes information for linking all unresolved references remaining in the module after the link. The partially linked object may be used in a subsequent linking operation to finish resolving the references. The syntax of the option is:

P

7.4.5 LOAD MAP OPTION (L). This option specifies that a load map listing is to be produced as shown in the example in figure 7-2. The two-line header of the load map listing identifies the version of TXLINK and shows the time and date of the run, provided the time and date have been initialized. The second line consists of the program name and its length.



TXLINK 937537 ** 12:07:47 013/77 PAGE 0001
 TXLINK LENGTH 1308

| MODULE | LENGTH | ORIGIN | DATE | TIME |
|--------|--------|--------|----------|-------|
| TXLNKD | 0302 | 0000 | 01/12/77 | 18:03 |
| TXLNK1 | 041E | 0302 | 01/12/77 | 18:06 |
| TXLNK2 | 03AC | 07E0 | 01/12/77 | 18:09 |
| TXLNK3 | 0466 | 0B8C | 01/12/77 | 18:12 |
| TXLNK4 | 0316 | 0FF2 | 01/13/77 | 13:10 |

D E F I N I T I O N S

| | | | | | | | |
|----------|------|----------|------|----------|------|----------|------|
| A0 | 032E | ASGFLG | 02EC | ASGIN | 03BE | ASGLUN | 02DF |
| ASGPRB | 02DC | ASGPTR | 02F2 | ASSERR | 1262 | A ATOCRT | 0200 |
| BADTAG | 0225 | BINDEC | 0052 | BINHEX | 0028 | BINONE | 032B |
| BLANK | 00DB | CBDA | 0312 | CBDA4 | 0316 | CBDA5 | 0317 |
| CBDA6 | 0318 | CBHA | 031A | CBHA2 | 031C | CDALIM | 0B98 |
| CDDLIM | 0B9A | CHAB | 030C | CHAB1 | 030D | CHAB2 | 030E |
| CLOSE | 02AC | CLROBJ | 0C9E | CLSLUN | 02AF | CLSOPC | 02AE |
| CMPDLA | 0320 | CMPDLD | 0322 | COMMA | 032F | COMMON | 038E |
| COMPRS | 03B4 | CRLF | 00FC | DATE | 0026 | DAY | 00E8 |
| A DEV | 0000 | DEVSET | 1154 | DTLIST | 034C | EF | 032D |
| EMSG1 | 0228 | EMSG2 | 024E | EMSG3 | 027A | ENTRY | 03C2 |
| EOL | 00FD | EPOINT | 03A8 | EPTAG | 03AA | A EXT | 000D |
| A FILE | 0005 | FLAGS | 07E6 | GETCM1 | 0303 | GETCOM | 0302 |
| GETDAT | 0308 | GETHEX | 0790 | GETMEM | 0304 | GETSVL | 080E |
| GETTAG | 0764 | HEAD1 | 0005 | HEAD2 | 00FE | HEDLEN | 0115 |
| HOUR | 00DC | IDTEND | 0398 | IDTLEN | 0328 | IDTSAV | 00FE |
| IDTTBL | 0396 | ILLCMN | 0186 | ILLHEX | 01AA | ILLMEM | 0198 |
| ILLPTH | 01DC | ILLPUN | 0202 | ILLRED | 01F2 | ILLSUM | 01CE |
| ILLTAG | 0212 | ILLWRT | 0202 | INCMPR | 0300 | INDFT | 0356 |
| INLUN | 0330 | INLUN1 | 0331 | INPNM | 0026 | INPNM1 | 0027 |
| INPTRS | 0388 | IOBF82 | 0076 | IOBUF | 0026 | IOREG | 0FF2 |
| LASTIN | 0332 | A LIBFLG | 158D | LIMCHK | 07D0 | LNCNT | 0392 |
| LODADD | 03B2 | LODPNT | 0398 | LOGERR | 0E2E | LOGID | 00C8 |
| LSTLUN | 033C | MEMDFT | 034A | MLEN | 0394 | MODCNT | 03BC |
| MODLEN | 03A0 | MULMOD | 0B80 | A NAMESZ | 0010 | NEWSYM | 03AC |
| OBJEOF | 02D4 | OBJIN | 02D0 | OBJLUN | 02D3 | OBJPTR | 0B94 |
| OBJR55 | 00AD | OBJR60 | 00B2 | OBJR80 | 00C6 | OBJRC1 | 0077 |
| OBJRCD | 0076 | N ONE | 032A | OPEN | 02A0 | OPNLUN | 02A3 |
| A OPTCNT | 0006 | A OPTION | 0070 | OPTTBL | 0344 | OUTLUN | 0334 |
| N OUTNM | 003A | OUTNM1 | 003B | N OUTOBJ | 0BB0 | PAGCNT | 0390 |
| PAGENO | 00F8 | PARTAL | 03BA | PASS | 039E | PASS2 | 04BC |
| PGHDR | 1012 | PNTLOG | 104C | PONTRS | 093A | PRGLEN | 03A2 |
| N PRGMEM | 0CCE | PRINT | 1042 | PROOPT | 108E | PUNCH | 02B8 |
| PUTCOD | 0D64 | PUTMEM | 0306 | READ | 0DA2 | RECORD | 0026 |
| REFDEF | 0874 | RELABS | 03A6 | RELES | 0333 | RELMEM | 03A4 |
| REWIND | 02C4 | REWLUN | 02C7 | A SOFTPR | 00A4 | SEQBIN | 03B6 |
| SEQDEC | 00C2 | SHEAD1 | 011C | SHEAD2 | 0150 | SRCSYM | 0832 |
| SVAL | 07EC | SVN | 032C | SYMBOL | 07E2 | SYMDMP | 09D6 |
| SYMEND | 039C | SYMLST | 03B8 | SYMOVR | 016C | SYNTAB | 039A |
| TBLN | 0926 | TERM | 0300 | N TXLINK | 0000 | A TYPE | 0004 |
| UCPDLA | 0324 | UCPDLD | 0326 | VALPTR | 07E8 | WF | 0006 |
| WP1 | 0007 | WRTOP | 02BA | | | | |

Figure 7-2. Load Map Listing



The heading is followed by a list of the modules, with the name (IDT) of each object module in the linked module, the length of each module, the origin of the module within the linked module and the date and time that each object module was generated.

The next section of the listing lists in alphabetical order the definitions in the modules. The symbols and corresponding hexadecimal values are printed four per line. The value is the definition within the linked module. When the listing shows an "N" preceding definition, the symbol was not referenced from another module.

When an "A" precedes a symbol, the symbol is self-defining (absolute). When the value is followed by a "U", the symbol is unresolved. When the value is followed by an "M", the symbol has been multiply defined, the first definition is the one that is used.

After all definitions have been listed and if there are multiply-defined modules, IDTs, or symbols or if there are unresolved symbols, a corresponding message is printed as presented in the examples in the next paragraph.

The load map is a useful tool during debug of an object module. After a task is loaded into memory, it has an absolute task origin, which is the absolute memory address of the task. If the user has the Operator Communication (OCP) Software Module in his system, he can calculate the task origin by using the (STATUS) command. By adding the absolute task origin to any of the values in the load map, the user can get the absolute memory address of that symbol.

The absolute memory address of a symbol that was not defined using a DEF directive within a module can be computed. First, add the relative address in the assembly listing (see Section IV, TX990 Assembler (TXMIRA)) to the relative origin value of the module's IDT found in the symbol map. Then add this sum to the absolute task origin in memory. The final sum is the absolute memory address of the symbol.

7.5 LINKED OBJECT MODULE

The linked object module produced by TXLINK consists of object code similar to that produced by the assemblers. Object code is described in the *Model 990 Computer TMS9900 Microprocessor Assembly Language Programmer's Guide*. As shown below, each module is terminated by a record beginning with a colon and containing the module name, date, time of linking and TXLINK identifier.

```
: MODULE 004/77 13:29:39 TXLINK
```

A fully-linked object module is ready to be loaded and executed by the operating system.

7.6 ERROR MESSAGES

Table 7-3 lists fatal error messages that are printed on the LOG when TXLINK encounters an error.



Table 7-3. Error Messages

| Message | Description | Recovery |
|----------------------|---|--------------------------|
| CANT GET COMMON | System COMMON not in system | Regen system with COMMON |
| CANT GET MEMORY | Memory requested is too large | Decrease size and retry |
| ILLEGAL HEX DATA | Nonhex digit found in input object | Reassemble module |
| MEMORY OVERFLOW | Tables exceeded available area | Increase size and retry |
| BAD CHECKSUM | Bad input object code | Reassemble module |
| nn-ILLEGALPATHNAME | Error in assigning or opening file | Correct and retry |
| nn-READ ERROR | Error in reading object input | Check file and retry |
| nn-WRITE ERROR | Error in writing linked object or load map | Retry |
| ILLEGAL OBJECT TAG-A | Module contains absolute load or entry address or garbage. "A" is tag that was found. | Reassemble module |

Note: The error code nn is returned from the system. See Error Appendix D for meaning.

7.7 TXLINK EXAMPLE

The following three object modules will be linked to form one object module by using TXLINK:

1. This is the contents of the object file entitled :TXTST1/OBJ

```
00052TXTST1 A0000C0006C0045B0000A0026B1600B0D0AB0A20B4F4CB44207F215F      0001
A0030B4D45B5353B4147B4520B2D2DB2057B524FB4E47B2021B210DB0A007F2B7F      0002
A0046B0420B0000C0028B001DB2FE0C00267F856F      0003
40000CNT 40000NEW 30048WRITE 7F8A8F      0004
:      TXTST1      054/77      08:49:34      TXMIRA      0005
```

2. This is the contents of the object file entitled :TXTST2/OBJ

```
0001DTXTST2 A0000B0D0AB0A48B4156B4520B4120B474FB4F44B2044B41597F1D0F      0001
B2021B2120B2020B2020B200DB0A007F984F      0002
6001DCNT 50000NEW 7FB3AF      0003
:      TXTST2      054/77      11:18:34      TXMIRA      0004
```

3. This is the contents of the object file entitled :TXTST3/OBJ

```
00030TXTST3 A0000C0006C0026B0000B0000B0B00B0000B0000B0000B00007F287F      0001
A0012A0026BC0FEB17EB2FE0C0006B03807F805F      0002
50000WRITE 7FD29F      0003
:      TXTST3      054/77      11:11:36      TXMIRA      0004
```



The following example loads and executes TXLINK using the above three files as input parameters. The resultant file, :TXTST/OBJ, holds the linked object module.

```
PROGRAM:      :TXLINK/SYS
INPUT:        :TXTST1/OBJ,;TXTST2/OBJ,;TXTST3/OBJ
OUTPUT:       :TXTST/OBJ
OPTIONS:      ITXTST,M400,L
TXLINK       937537**
```

Following is the link map, which is generated when an "L" is entered in the OPTION: parameter line:

```
TXLINK  937537  **  08:57:21  054/77  PAGE 0001
TXTST          LENGTH 00A0

MODULE   LENGTH  ORIGIN  DATE    TIME
TXTST1   0052    0000    054/77  08:49
TXTST2   001E    0052    054/77  11:18
TXTST3   0030    0070    054/77  11:11
```

DEFINITIONS

```
N  CNT  001D  N NEW  0052  WRITE  0070
```

Following is the contents of the object file entitled :TXTST/OBJ. This file may be loaded into memory and executed.

```
000A0TXTST  A0000C0006C0045B0000A0026B1600B0D0AB0A20B4F4CB44207F21CF  0001
A0030B4D45B5353D4147B4520B2D2DB2057B524FB4E47B2021B210DB0A007F2B7F  0002
A0046B0420C0070C0028B001DB2FE0C0026B0D0AB0A48B4156B4520B41207F2E0F  0003
A005CB474FB4F44B2044B4159B2021B2120B2020B2020B200DB0A00C00767F2EFF  0004
A0072C0096B0000B0000B0B00B0000B0000B0000B0000A0096BC0FEB17E7F30BF  0005
A009AB2FE0C0076B03807FB62F  0006
:      TXTST  054/77  08:57:21  TXLINK  0007
```



SECTION VIII

TXDS COPY/CONCATENATE (TXCCAT) UTILITY PROGRAM

8.1 INTRODUCTION

The TXCCAT program copies one to three files to a single output file. Although simple record modifications are supported upon output, the program is basically a file copy by which sequential and relative record files may be duplicated or concatenated together into one file with no embedded end-of-files. TXCCAT copies information from cassettes, files or card reader input to cassettes, files, or printing devices.

TXCCAT is a software module which runs under the Terminal Executive Development System (TXDS).

8.2 TXCCAT LUNOs

The TXCCAT program uses LUNOs 7, 10, 11 and 12. LUNOs 10, 11 and 12 are assigned to the input files; LUNO 7 is assigned to the output file. All LUNOs are released upon termination of TXCCAT.

8.3 OPERATOR INTERACTION

TXCCAT is executed via the TXDS control program. Input and output pathnames are passed via COMMON. Table 8-1 provides the pathname defaults.

The INPUT: parameters may have one to three pathnames separated by commas. The files will be used to generate an output file. The OUTPUT: parameter contains one pathname to be used for the output file. Input files must preexist and can be either sequential or relative record. Output files are assumed to have the same characteristics as input files, although input records may be modified for output. If input is from a device, the output file is sequential and, if the output file does not exist, it is created. If no output file is specified, the default-system print device is used. The default-system print device is defined during system generation.

Table 8-1. Pathname Defaults

| Field | Input | Output |
|-------|-------------|-----------------------|
| DEV | System Disc | System Disc |
| FILE | None | First Input File Name |
| EXT | SRC | First Input Extension |



8.4 OPTIONS

All TXCCAT options are specified by two alphabetic characters followed, in some cases, by a decimal numeric field. Input format is free-form. Delimiters for options may be commas, blanks or no delimiter. Each time a new pair of characters is read it is considered a new parameter. An illegal parameter results in an error message and program termination. Table 8-2 lists the options recognized by TXCCAT.

The numeric scan terminates after the maximum size is exhausted or a nonnumeric character is encountered.

8.4.1 TRUNCATE OPTION (TR). The truncate option truncates records to the size specified. The syntax is as follows:

TRnnnn

where n is a decimal number and four digits is the maximum field size. The following are examples:

TR76 Truncate to 76 characters.
TR0076 Truncate to 76 characters.

8.4.2 FIX RECORDS (FL). This option forces input records to a specified size by either padding with blanks or by truncation. The syntax is as follows:

FLnnnn

where n is a decimal number and four digits is the maximum field size. The following are examples:

FL76 Fix to 76 characters.
FL0076 Fix to 76 characters.

Table 8-2. TXCCAT Options

| Option | Description |
|--------|---|
| TRnnnn | Truncate record to length nnnn. |
| FLnnnn | Fix records to size nnnn by padding with blanks or by truncation. |
| SKnnnn | Skip nnnn input records, prior to output. |
| LFnn | List file, page length = nn, default = 55. |
| SLnn | Space lines on listing, nn = space count, default = 0. |
| NL | Number lines on listing. |
| RI | Do not rewind input on open. |
| RO | Do not rewind output on open. |

Note: n is a decimal digit and the maximum field size is given by the number of n's.



8.4.3 SKIP RECORDS (SK). This option skips the specified number of input records prior to output. The syntax is as follows:

SKnnnn

where n is a decimal number and four digits is the maximum field size. The following are examples:

SK200
SK0020
SK9999

8.4.4 LIST FILE (LF). This option lists files and allows the use of the NL and SL option. The numeric field gives the printer page length. If the page length is not specified, 55 lines per page is the default. The syntax is as follows:

LFnn

where n is a decimal number and 2 digits is the maximum field size. The following are examples:

LF
LF55
LF06
LF99

8.4.5 SPACE LISTING (SL). This option is only in effect with the list option LF. The numeric field gives the number of blank lines to print for each input line. The syntax is as follows:

SLnn

where n is one or two decimal digits. The following are examples:

| | |
|-----|----------------|
| SL | No Spacing |
| SL1 | Single Spacing |
| SL2 | Double Spacing |

8.4.6 NUMBER LINES (NL). This Option is only in effect with the list option LF and causes the printing of the line numbers associated with the input lines. The syntax is as follows:

NL

8.4.7 NO INPUT REWIND (RI). When this option is selected, the input is not rewound when opened. The syntax is as follows:

RI

8.4.8 NO OUTPUT REWIND (RO). When this option is selected, the output is not rewound when opened. The syntax is as follows:

RO

8.5 ERRORS

The errors generated by TXCCAT are listed in table 8-3 together with possible corrective action.

**Table 8-3. TXCCAT Errors**

| Error | Description | Action |
|--------------------------|---|-------------------------------|
| CANT GET COMMON | System COMMON not in system | Regenerate system with COMMON |
| ILLEGAL OPTION – aa | Option aa not found | Reenter correct option |
| nn – ILLEGAL PATHNAME | Input files does not exist or open error | Correct and Retry |
| nn – READ ERROR | Error in Reading File | Retry |
| nn – WRITE ERROR | Error in Writing File | Retry |

Note: nn is the system I/O status error given in Appendix D.



SECTION IX

TXDS STANDALONE DEBUG MONITOR (TXDEBUG) UTILITY PROGRAM

9.1 INTRODUCTION

This section discusses the capabilities and operation of the TXDS standalone debug monitor, TXDEBUG, explains how to debug under monitor control, gives detailed descriptions of the commands available to the user, and supplies debugging techniques. The following topics are covered:

- TXDEBUG installation procedures for 733ASR, 913 VDT or 911 VDT system consoles.
- A general description of TXDEBUG, including functions, features and capabilities.
- A detailed description of the operating procedures necessary to load TXDEBUG and the program to be debugged.
- A description of two modes of debugging: one in which the program being debugged executes with minimal TXDEBUG intervention, and one in which TXDEBUG exercises tight control of the program being debugged.
- A description of TXDEBUG command structures, and the operator interface to TXDEBUG.
- Detailed descriptions of each of the debug commands.
- A discussion of debugging techniques including general techniques and techniques specific to TX990.
- A discussion of methods used to patch programs (i.e., to correct them in memory rather than at the source code level.)
- A summary of errors which may occur during a debugging session.

The TXDEBUG provides for debugging programs which have been designed to operate in a "stand-alone" environment with no operating system support. The debug monitor attempts to "hide" itself from the program being debugged, using as few machine resources as possible in the performance of debug tasks.

The following minimum hardware system configuration is required to run the standalone debug monitor:

- 990/4 CPU (including 6-slot chassis and Programmer Panel), or 990/10 CPU
- When a 990/4 CPU is used, 4096 words dynamic RAM Memory Expansion including Memory Write Protect and Memory Parity are needed.
- 733 ASR Data Terminal, 913 VDT or 911 VDT
- FD Floppy Disc.



9.2 GENERAL DESCRIPTION

The TXDEBUG is memory-resident and communicates interactively with the operator through the 733 ASR Data Terminal keyboard and printer. It provides the following capabilities:

- Inspection and modification of memory, registers, and CRU space
- Controlled execution of user programs with optional trace of instructions and/or data
- Multiple breakpoints with optional automatic display of registers and specified memory
- Miscellaneous aids such as hexadecimal arithmetic and search-under-mask.

9.3 INSTALLATION TXDEBUG

To install TXDEBUG, a file name :SADBUG/SYS must be created on the TXDS Utilities Diskette. Then, one of the three stand-alone debug monitors listed below must be copied into it. The three debug monitors are named:

```
:SADPRT/SYS    733 ASR, 743 KSR or 33 ASR (TTY)
:SAD911/SYS    911 VDT
:SAD913/SYS    913 VDT
```

Example:

If the device to be used as the debug console is the 911 VDT, perform the following:

1. Place the TXDS System Diskette in DSC and TXDS Utilities Diskette in DSC2.
2. Respond to the following prompts by entering:

```
PROGRAM: :TXCCAT/SYS
INPUT:   DSC2:SAD911/SYS
OUTPUT:  DSC2:SADBUG/SYS
OPTIONS:
```

This will create the file :SADBUG/SYS on DSC2 and copy :SAD911/SYS from DSC2 to the :SADBUG/SYS file.

9.3A LOADING TXDEBUG

The TXDEBUG program is stored as a file on the TXDS Utilities Diskette. To load TXDEBUG and begin the debug session, invoke the program load facility of TXDS and specify the following parameters:

```
PROGRAM: :TXDEBUG/SYS
INPUT:   <file name of program to be debugged>
OUTPUT:
OPTIONS: <hexadecimal integer specifying the load point of the program to be debugged>
```

The file name supplied for the input parameter must include all extensions. The loader will search all available drives if the device name is not specified.

If the load point of the program to be debugged is not supplied, TXDEBUG assumes the default value >A0.



After TXDEBUG has been successfully loaded, the TXDEBUG load point, entry point, and length are printed:

TXDEBUG LOAD POINT = ENTRY POINT = LENGTH =

NOTE

For certain debug operations the TXDEBUG entry point is required. Make note of the entry point at this time.

When the loading process is completed, the TXDEBUG will prompt the operator with a period (“.”). At this time the memory configuration (for a 16K system) will appear as illustrated in figure 9-1, with the user’s program located as specified by the load point in the option parameter. TXDEBUG may be used to debug any program for which the instruction and data space does not overlap TXDEBUG.

NOTE

Since the user’s program overlays the TX990 executive, the TX990 executive must be rebooted when the debug session is finished.

Once the user program is entirely debugged, it may become the executing program when a disc boot is performed by using the “SF” operation described in the *TX990 Operating System Programmer’s Guide*.

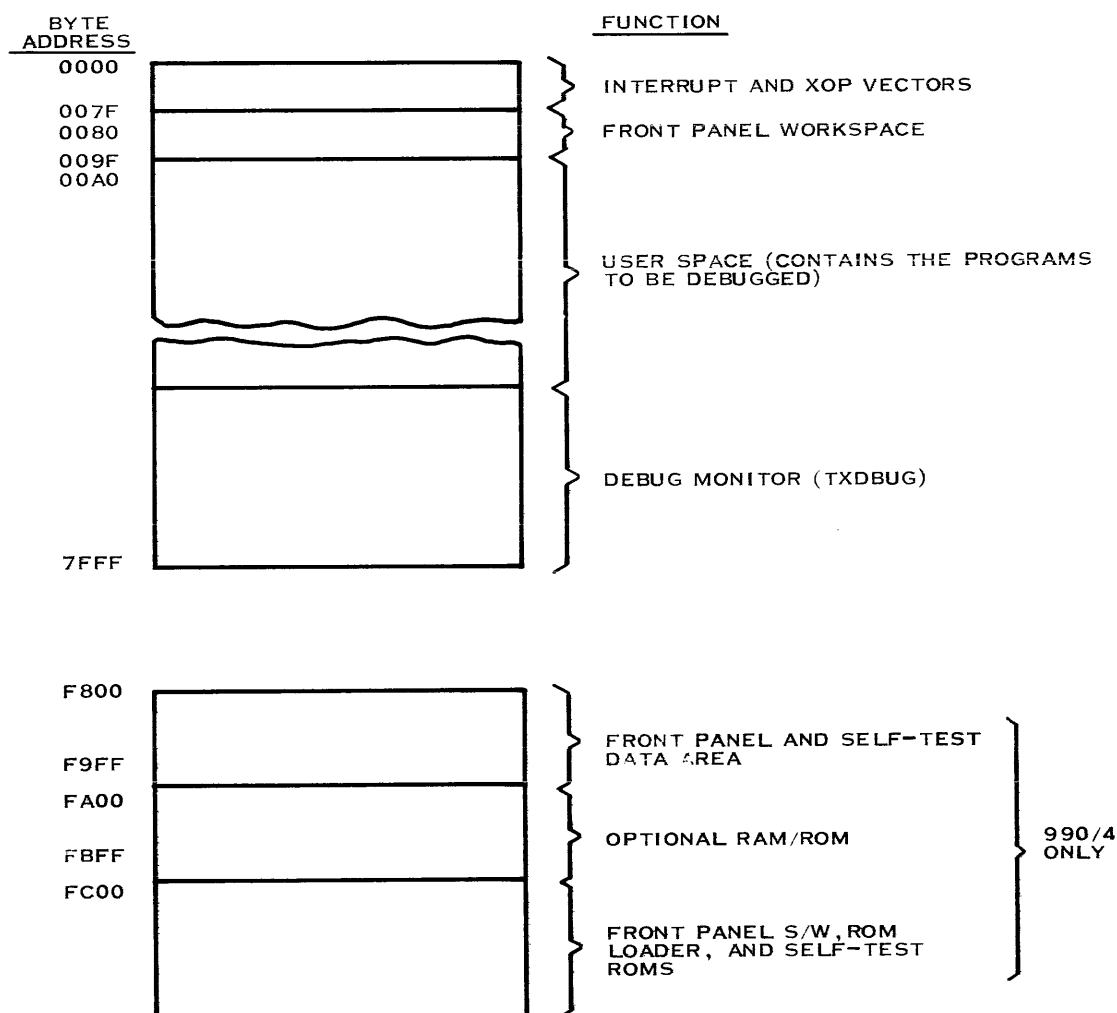

Figure 9-1. Debug Monitor Memory Configuration

9.4 DEBUG MODES

The user may specify that the debug monitor execute the program being debugged in either of two different modes: Execute free, or Run controlled. When executing free, the monitor relinquishes control to the test program which is then executed at full processor speed. This mode is only recommended when a program is expected to be error free or when timing considerations are being examined. The only way to interface with the monitor in this mode is to bracket instruction sequences in the test program with LREX instructions or with unconditional branches to the debug monitor entry point. An LREX has the same effect as pressing the HALT switch on the front panel. An unconditional branch to the monitor entry point restarts the monitor. If this is attempted and the monitor does not respond with a period prompt (“.”), the probable cause is that the executing program has destroyed the monitor.



The normal method of execution during program debug is to initialize the PC, WP, ST by using the Modify AU Registers (MR) command and use the RUN (RU) command. In the RUN mode, the monitor uses the Single Instruction Execution (SIE) facility to execute the user's program one instruction at a time. Execution continues until: the number of instructions specified have been executed; a breakpoint occurs; or the operator presses the ESCAPE key on the 733 ASR Data Terminal keyboard. The Execute (EX) command can be used in place of the RUN command. Using this command, the program is executed without using the SIE or trace features.

The highest level of control is exercised when a test program is being executed via the RUN command and the instruction address is within a Trace region. In this case, each instruction is interpretively executed by the monitor. Source and destination operands are examined and optionally printed before and after each instruction. The amount of information printed as each instruction is executed is determined by user-defined Trace regions (SR command).

NOTE

Trace regions are ignored when the EX command (Execute free) is used.

9.5 DEBUG MONITOR COMMAND STRUCTURES

To interact with TXDEBUG, the user enters commands at the 733 ASR Data Terminal.

The available debug commands may be classified into the following groups.

- *Set commands.* These commands allow the user to define up to four of each of the following aids: program-counter breakpoints, formatted snapshots, trace regions, and trace formats.
- *Clear commands.* These commands allow the user to remove the effect of a previously set command.
- *Inspect commands.* These commands allow the user to display the contents of AU registers, workspace registers, memory regions, and CRU lines. These commands are also used to force snapshots.
- *Modify commands.* These commands allow the user to examine and optionally modify: memory; workspace registers; AU registers; and CRU lines (by inspecting the input and modifying the output).
- *Miscellaneous commands.* These commands include functions such as word and byte memory searches, and hexadecimal arithmetic with automatic decimal conversion.

When debugging a program, the user may specify that TXDEBUG:

- Print data on the terminal for examination,
- Modify data,
- Specify program elements (parameters whose values are determined by the user) for interpreting the progress of his program,
- Set and clear program elements,



- Search for specific bit patterns in bytes and words,
- Perform arithmetic calculations with hexadecimal numbers.

These actions may be performed on memory, registers, and CRU input and output lines. They may also be performed on specifiable debug elements: breakpoints, snapshots, and trace regions. The debug elements are defined as follows:

- *Breakpoint* – A point during the execution of a program at which control is returned to TXDBUG to allow the user to examine the progress of his program or enter any of the debug commands.
- *Snapshot* – A printed display of the contents of contiguous workspace registers plus the contents of an area in memory as defined by the operator. A snapshot may be printed automatically at a breakpoint.
- *Trace region* – An area of the program about which information concerning the execution of an instruction is output on the printer. This information may be printed following the execution of each instruction, each branch, or each change in the contents of a data word.

9.5.1 DEBUG COMMAND CODES. All debug commands are comprised of a two-letter mnemonic, the first of which denotes the operation to be performed (inspect, modify, etc.). The second identifies the debug or machine element upon which the operation is to be performed (memory, CRU, etc.). The four general-purpose operations are as follows:

I – Inspect

M – Modify

S – Set

C – Clear.

The elements on which these operations may be performed are:

M – Memory

W – Workspace registers (R0 –R15)

R – AU Registers (WP, PC, ST) when used with I, or M.

R – Trace Region when used with S or C

C – CRU

B – Breakpoint

S – Snapshot

T – Trace Type

P – Protect region (invalid for computer without write-protect option).



Some combinations of operations and elements are illegal. Table 9-1 identifies the valid combinations. Table 9-2 lists the available two-letter mnemonics associated with the valid combinations.

9.5.2 MISCELLANEOUS COMMANDS. The following are classified as miscellaneous commands:

EX – Execute a user program.

RU – Run a user program.

HA – Hexadecimal arithmetic.

FB – Search under mask for a particular 8-bit pattern (Find Byte).

FW – Search under mask for a particular 16-bit pattern (Find Word).

9.5.3 COMMAND ENTRY. Readiness of the monitor to accept a command is indicated when the monitor “prompts” the operator by printing a period (“.”) as the first character of a new line. For all activities except when a user program is being executed free (EX command) the operator may force a return to the command mode by pressing the ESCAPE key on the 911 VDT or 733 ASR terminal, or RESET on the 913 VDT.

From zero to eight parameters may be entered with each two-letter command. The command is separated from its parameter list by a comma (“,”) or by one or more blanks. Each parameter in the list is terminated by a comma or by one or more blanks, with the parameter list being terminated by a carriage return. As each parameter is entered, its syntax is validated by the monitor. The parameter may either be a hexadecimal number, a binary number, or a character string. The backspace character (CTRL-H on the 911 VDT or 733 ASR terminal, or ← on the 913 VDT) may be used to change the entered characters, or the entire parameter may be reentered by pressing the delete key (RUB OUT on the 733 ASR terminal). The entire command entry may be aborted by pressing the ESCAPE key on 911 VDT or 733 ASR terminal (RESET on 913 VDT).

If an error is detected by the monitor during command entry, one of the following error codes will be printed:

| Code | Meaning |
|------|--|
| MP00 | Invalid parameter or hexadecimal number entered, or maximum parameter list exceeded. |
| MS01 | Invalid command. The first two characters do not match any known command. |

A complete list of error codes appears in paragraph 9.8.

Table 9-1. Valid Debug Command Combinations

| Operation | Element | | | | | | | |
|-----------|---------|---|---|---|---|---|---|---|
| | M | W | R | C | B | S | T | P |
| I | X | X | X | X | | X | | |
| M | X | X | X | X | | | | |
| S | | | X | | X | X | X | X |
| C | | | X | | X | X | | X |

(“X” indicates acceptable combination.)



Table 9-2. TXDEBUG Keyboard Commands

DEBUG Commands

| | |
|----|-------------------------------------|
| IC | Inspect Control Register Unit (CRU) |
| IM | Inspect Memory |
| IR | Inspect AU Register (WP, PC, ST) |
| IS | Inspect Snapshot |
| IW | Inspect Workspace Registers |
| MC | Modify Control Register Unit (CRU) |
| MM | Modify Memory |
| MR | Modify Registers |
| MW | Modify Workspace Registers |
| SB | Set Breakpoint |
| SP | Set H/W Write Protect Option |
| SR | Set Trace Region |
| SS | Set Snapshot |
| ST | Set Trace |
| CB | Clear Breakpoint |
| CP | Clear H/W Write Protect Option |
| CR | Clear Trace Region |
| CS | Clear Snapshot |

9.5.4 NOTATIONAL CONVENTIONS. The notational conventions used in the syntax definitions of the keyboard commands are as follows:

- < > Item to be supplied by the user. The term shown within angle brackets is a generic term.
- [] Optional item – may be included or left out, at the user's discretion. Items not enclosed in brackets are required.
- { } Choice to be made from two or more items, one of which must be included.

Items in capital letters in the syntax definition are entered into the command statement exactly as shown.

The fields in the command (the command mnemonic and the parameters) are separated by either commas or strings of one or more blanks. This choice is shown symbolically as:

{ ' ' }
{ b . . . }

When one or more parameters are omitted, two or more field separators may occur in sequence. The user must be sure that he includes the correct number of separators in a sequence; he should be aware of how they are interpreted by the computer. Two strings of blanks run together will be read as a single long string of blanks. A comma preceded or followed by a blank will be read as two separators in sequence. It is suggested, therefore, that commas (without preceding or following blanks) be used to set off omitted parameters.



In the examples of command statements, user-supplied data is underlined to distinguish it from data printed by the monitor. The carriage returns that terminate command statements are not shown in the examples.

9.6 COMMAND DESCRIPTIONS

Each command supported by the debug monitor and a brief functional description is presented in table 9-2. Detailed descriptions of the "miscellaneous" commands are presented in paragraphs 9.6.1 to 9.6.5. The remaining paragraphs provide detailed descriptions of the "debug" commands.

9.6.1 EXECUTE USER PROGRAM (EX). The Execute User Program command is used to execute a user program at speed with neither interference from nor control by the monitor. The program is executed at full processor speed. Initialize the AU registers (ST, PC, WP) using the MR command before using the EX command.

Syntax definition:

.EX

Description: The program is executed directly by the 990 computer without using the SIE or trace features. Execution is started with the PC, WP and ST that would be displayed if an Inspect Registers (IR) command were executed.

Application notes: In order to regain control from an executing user program, the user must transfer control to the monitor's starting memory location. This may be done by inserting a branch in the test program or by using the programmer panel.

Upon regaining control in the monitor, the WP, PC, and ST registers will have the same values as before the EX command unless execution of the user program destroyed the monitor data space.

Example:

Assume the user has written an assembler which assembles source from cassette or terminates depending on user input.

```
.IR  
PC=046C WP=0000 ST=0000  
.EX  
ASM/TERM? A  
  
ASM/TERM? T  
  
.IR  
PC=046C WP=0000 ST=0000
```

The EX command begins execution with the PC, WP, and ST registers equal to the values obtained when the Inspect Registers (IR) command is invoked. A program run under EX does not change the contents of these registers. The second IR command shows that the contents remain the same.



9.6.2 EXECUTE USER PROGRAM UNDER SIE OR TRACE (RU). The Execute User Program under SIE or Trace command provides controlled execution of the user's program. Initialize the AU registers (ST, PC, WP) using the MR command before using the RU command.

Syntax definition:

RU [{
 'b...' } <instruction count>]

*Parameter:*

instruction count Maximum number of instructions to be executed before returning to command mode. A value of 0 indicates an infinite instruction limit applies.

Parameter default value: The value of the instruction count at the last entry into command mode is used as the default value. If the previous RU command has exhausted the instruction count, the default is 0, implying no instruction limit. The system is initially loaded with a default value of 0.

Description: Instructions in the user's program are executed one at a time using either the hardware SIE feature or the software trace interpreter. The user may specify one of these two modes of operation with the Set Trace Region (SR) command (paragraph 9.6.12). The user is referred to *The 990 Computer Family System's Handbook*, part number 945250-9701, for a detailed explanation of SIE.

Before the monitor executes a user instruction, it checks whether the instruction is within a defined trace region. If the instruction is within a trace region, the trace interpreter is called and the instruction traced. If the instruction is not within a trace region, the instruction is executed using Single Instruction Execution. In both cases, the user's WP, PC, and ST registers are updated after each instruction executed. The monitor checks whether a breakpoint has been reached and if so, prints out the user's registers and snapshot, if defined. If a snapshot is assigned to a breakpoint, the monitor continues execution after the breakpoint has been reached, without operation intervention. If no snapshot was specified, the monitor returns control to the command processor. (Refer to the descriptions of the SB and SS commands in paragraph 9.6.6.1 and 9.6.11.1.) If the run count, number of instructions to be executed, is depleted, the monitor returns control to the command processor. Otherwise the monitor continues execution of the user program.

9.6.3 HEXADECIMAL ARITHMETIC (HA). The Hexadecimal Arithmetic command calculates the sum and difference of two hexadecimal numbers. The 2's complement hexadecimal value and the signed decimal value are printed.

Syntax definition:

$$\text{HA } \left[\left[\begin{array}{c} , \\ \text{b} \dots \end{array} \right] \left[\langle \text{value} \rangle \right] \left[\left[\begin{array}{c} , \\ \text{b} \dots \end{array} \right] \langle \text{value} \rangle \right] \right]$$
Parameters:

value Hexadecimal number value (0-4 digits).

Parameter default values:

If the value parameter is not specified, a default value of 0 is used.

Application note: No overflow checks are made; therefore, two positive numbers may have a negative sum. All results are represented in 16 bits.

*Examples:*

```
.HA 103A BA2
SUM=1BDC 07132 DIFF=0498 +01176
```

```
.HA 89 89
SUM=0112 00274 DIFF=0000 +00000
```

```
.HA 8030 EF00
SUM=6F30 28464 DIFF=9130 -28368
```

```
.HA EF00
SUM=EF00 -04352 DIFF=EF00 -04352
```

The calculated difference between the specified number values is the first value minus the second value.

9.6.4 FIND BYTE (FB). The Find Byte command is used to scan an area of memory for a particular byte value.

Syntax definition:

$$FB \left\{ \begin{array}{l} ' \\ \text{b} \dots \end{array} \right\} \left[\langle \text{start mem addr} \rangle \right] \left\{ \begin{array}{l} ' \\ \text{b} \dots \end{array} \right\} \left[\langle \text{ending mem addr} \rangle \right] \left\{ \begin{array}{l} ' \\ \text{b} \dots \end{array} \right\} \\ \langle \text{desired value} \rangle \left[\left\{ \begin{array}{l} ' \\ \text{b} \dots \end{array} \right\} \langle \text{mask} \rangle \right]$$

The command is terminated by a carriage return.

Parameters:

| | |
|--------------------|--|
| start mem addr | Memory address at which search begins. (1-4 character hexadecimal number.) |
| ending memory addr | Memory address at which search is terminated. (1-4 character hexadecimal number.) |
| desired value | Hexadecimal value for which the search is made. This value is required. |
| mask | Hexadecimal value to be ANDed with each byte before comparing it with the desired value. |

Parameter default values:

If the starting memory address is not specified, a value of 0 is used.

If the ending memory address is not specified, a value of $FFFF_{16}$ is used.

If the mask parameter is not specified, a value of FF_{16} is used.



Description: Each byte in the memory search range is ANDed with the mask and compared to the desired value. The memory location and contents are printed out whenever a match is found. After each match, the user must enter a space on the terminal keyboard to continue the search. If he enters a carriage return, the command terminates.

Error messages:

- DP13 The ending address is less than the starting address. Reenter the command.
- MS05 The <desired value> parameter is missing. Reenter the command.
- MX06 The beginning address is an invalid memory address. Reenter the command.

Application notes: No check is made to ensure that the mask does not exclude a bit required by the desired value, thereby making a match impossible. If the monitor data area is being searched, results may not appear to be correct since the monitor is changing during the search process.

Examples:

```
.FB 0,2000,0,0F  
0000=0000  
0000=0000  
0002=0000  
0002=0000  
0004=0000  
0004=0000  
0006=0000  
0006=0000  
0008=0000
```

```
.FB 0,2000,06,0F  
0300=0456  
0644=0556
```

In the first example, the high order four bits of each byte are masked so that any byte with a 0 in the low order four bits will be located. The address of the leftmost byte of each word is printed so that if both bytes of a word are printed, an address location will be printed twice. For example, if bytes 0004 and 0005 are printed, the address 0004 will appear twice in the listing.

In the second example, the high order four bits of each byte are masked so that any byte with a 6 in the low order four bits will be located.

9.6.5 FIND WORD (FW). The Find Word command is used to scan an area of memory for a particular word value.



Syntax definition:

$$\text{FW } \left\{ \begin{array}{l} \text{' } \\ \text{b...} \end{array} \right\} \left[\langle \text{start mem addr} \rangle \right] \left\{ \begin{array}{l} \text{' } \\ \text{b...} \end{array} \right\} \left[\langle \text{ending mem addr} \rangle \right] \left\{ \begin{array}{l} \text{' } \\ \text{b...} \end{array} \right\} \\ \langle \text{desired value} \rangle \left[\left\{ \begin{array}{l} \text{' } \\ \text{b...} \end{array} \right\} \langle \text{mask} \rangle \right]$$

The command is terminated by a carriage return.

Parameters:

| | |
|--------------------|--|
| start mem addr | Memory address at which search begins. (1-4 hexadecimal characters.) Must be even byte (word) address. |
| ending memory addr | Memory address at which search is terminated. (1-4 hexadecimal characters.) |
| desired value | Hexadecimal value for which the search is made. The value is required. |
| mask | Hexadecimal value to be ANDed with each word before comparing it with desired value. |

Parameter default values:

If the starting memory address is not specified, a value of 0 is used.

If the ending memory address is not specified, a value of FFFF_{16} is used.

If the mask parameter is not specified, a value of FFFF_{16} is used.

Description: Each word in the memory search range is ANDed with the mask and compared to the desired value. The memory location and contents are printed out whenever a match is found. After each match, the user must enter a space on the terminal keyboard to continue the search. If he enters a carriage return, the command terminates.

Error messages:

| | |
|------|---|
| DP13 | The ending address is less than the starting address. Reenter the command. |
| MP00 | The beginning address is an invalid memory address. Reenter the command. |
| MS05 | The $\langle \text{desired value} \rangle$ parameter is missing. Reenter the command. |



Application notes: No check is made to ensure that the mask does not exclude a bit required by the desired value, thereby making a match impossible. If the monitor is being searched, results may not appear to be correct since the monitor is changing during the search process.

Examples:

```
.FW 0,2999,456,
0300=0456
.FW 0,2000,56,00FF
0300=0456
0644=0556
```

In the second example, the monitor searches for words with a 56 in the low order byte. By pressing the space bar on the terminal keyboard, the user can cause the monitor to continue searching for another occurrence of the data word.

9.6.6 BREAKPOINT COMMANDS (SB, CB). These two commands control breakpoint as indicated in the following paragraphs.

9.6.6.1 Set Breakpoint (SB). The Set Breakpoint command is used to define a breakpoint which causes the processor to stop or interrupt execution of a user program prior to executing the instruction at the specified memory address.

Syntax definition:

$$SB \left\{ \begin{array}{l} ' \\ \text{b} \dots \end{array} \right\} \langle \text{bkpt no.} \rangle \left\{ \begin{array}{l} ' \\ \text{b} \dots \end{array} \right\} \langle \text{memory addr} \rangle \left[\left\{ \begin{array}{l} ' \\ \text{b} \dots \end{array} \right\} \left[\langle \text{ref cnt} \rangle \right] \right. \\ \left. \left[\left\{ \begin{array}{l} ' \\ \text{b} \dots \end{array} \right\} \langle \text{snapshot no.} \rangle \right] \right]$$

Parameters:

| | |
|--------------|---|
| bkpt no. | Breakpoint index number. The number may be 0, 1, 2 or 3. Required parameter which services as a unique identifier for individual breakpoints. |
| memory addr | Address of an instruction on which the breakpoint is to be set. Required parameter. (1-4 hexadecimal characters.) |
| ref cnt | The pass number (hexadecimal) on which a breakpoint is to be taken. For example, a reference count of 3 means to break on the third reference to the memory address for an instruction fetch. Default value is 1. |
| snapshot no. | Index number of a previously defined snapshot which is to be displayed when the breakpoint is taken (see SS command). Default value is no snapshot 0, 1, 2, 3. |

*Parameter default values:*

If the reference count (pass number) is not specified, a value of 1 is used. If the user enters a value of 0, it is equivalent to a reference count of $FFFF_{16}$.

If the snapshot number is not specified, a snapshot is not printed.

Use of breakpoints: The breakpoint is one of the key elements in program debugging because it enables the user to specify conditions under which he wants to receive control. Breakpoints are particularly useful when the user wants to intercept control after an unexpected control transfer occurs from a conditional branch. By setting a breakpoint on the unexpected or error path out of a conditional branch, the program may be allowed to execute without interruption unless some error condition occurs.

When a breakpoint is encountered, the contents of the processor registers are displayed. (The contents are the values that would be displayed if an IR command were to be invoked.) The breakpoint index number is also displayed to aid in determining which breakpoint was encountered.

Error message:

DP20 Breakpoint specification error. Required index number may be valid or missing, or the PC value (memory address) may have been omitted.

Application notes: The PC value for a breakpoint must point to the first word of a multiword instruction.

A breakpoint occurs *before* the execution of the instruction to which it points.

If a snapshot is associated with a breakpoint, execution of the user program resumes after the snapshot is printed. If no snapshot is associated with the breakpoint, execution terminates and the debugger accepts another command.

If more than one breakpoint is associated with a specific location, only the first (lowest numbered) will be found.

When execution is under the control of the Execute User Program under SIE or Trace (RU) command with an instruction count: (1) a breakpoint occurs; and (2) a new count is not specified on the next RU command. Then, when execution is resumed, counting is continued as if no breakpoint was encountered.

Breakpoints are not active when the user code is executed with the EX command.

An error is not reported when a Set Breakpoint (SB) command redefines an already defined breakpoint. The specified breakpoint is modified to take on a new definition. This feature may be used to modify the snapshot index associated with a breakpoint.

*Examples:*

.SB 0,1000,1,2

.SB 1,1000,1,0

.SB 2,1004

The first two examples set a breakpoint at address 1000 on the first reference to that address for an instruction fetch. The first example sets breakpoint index number 0 with snapshot index number 2 to be displayed, and the second example sets breakpoint index number 1 with snapshot index number 0 to be displayed. The third example specifies breakpoint index number 2 to be taken at memory location 1004₁₆. No snapshot is printed, and execution of the user program terminates after the breakpoint is encountered.

9.6.6.2 CLEAR BREAKPOINT (CB). The Clear Breakpoint command is used to disable previously specified breakpoints.

Syntax definition:
$$CB \left[\left[\begin{array}{c} . \\ b \end{array} \dots \right] \left[\langle \text{starting breakpoint number} \rangle \right] \left[\left[\begin{array}{c} . \\ b \end{array} \dots \right] \langle \text{ending breakpoint number} \rangle \right] \right]$$

The command is terminated by a carriage return.

Parameters:

| | |
|----------------------------|---|
| starting breakpoint number | The first breakpoint to be cleared. A number from 0 to 3. |
| ending breakpoint number | The last breakpoint to be cleared. A number from 0 to 3. |

Parameter default values:

If no parameters are specified, all breakpoints are cleared.

If only the first parameter is given, only the specified breakpoint will be cleared.

If only the second parameter is given, breakpoints 0 through the specified ending breakpoint will be cleared.

Description: If an attempt is made to clear a breakpoint that has not been set, the command is ignored.

Error message:

| | |
|------|---|
| DP13 | A breakpoint index greater than the maximum possible index number (3) was specified, or the ending breakpoint index was less than the starting breakpoint index number. |
|------|---|



Examples:

.CB 1,3

.CB

The first example clears all breakpoints except number 0. The second example clears all breakpoints.

9.6.7 COMMUNICATIONS REGISTER UNIT COMMANDS (IC, MC). Commands to control the 990 I/O port (the Communications Register Unit) are explained in the following paragraphs.

9.6.7.1 Inspect CRU Input Lines (IC). The Inspect CRU Input Lines command is used to display in hexadecimal format the contents of one or more consecutive CRU locations.

Syntax definition:

$$\text{IC } \left[\left\{ \begin{array}{l} \text{,} \\ \text{b. . .} \end{array} \right\} \left[\langle \text{CRU address lower limit} \rangle \left[\left\{ \begin{array}{l} \text{,} \\ \text{b. . .} \end{array} \right\} \langle \text{CRU address upper limit} \rangle \right] \right]$$

The command is terminated by a carriage return.

Parameters:

- | | |
|-----------------|--|
| CRU lower limit | CRU address that begins the display. The address must be in the range of 0 to 1FFF ₁₆ . (1-4 hexadecimal characters.) |
| CRU upper limit | CRU address that ends the display. The address must be in the range 0 to 1FFF ₁₆ . (1-4 hexadecimal characters.) |

Parameter default values:

If the CRU lower limit is not specified, a value of 0 is used.

If the CRU upper limit is not specified and the CRU lower limit is specified, the default value is the CRU lower limit. Sixteen bits are displayed.

If neither parameter is specified, the entire CRU is displayed.

Description: Data is displayed in groups of four words, two groups per line. The address of the first word on the line is printed on the left. The display may be terminated at any time by pressing the ESC key on the terminal keyboard.

The address displayed is the actual CRU bit address times two.

Error message:

- | | |
|------|--|
| DP13 | The highest CRU address specified is less than the lowest CRU address specified, or the highest CRU address specified is greater than the highest CRU address permitted (1FFF ₁₆). |
|------|--|



Examples:

```
.IC 1000 1060
1000=FFFF FFFF FFFF FFFF
```

```
.IC 100
0100=608D
```

In the first example, the CRU bits at addresses 1000_{16} through 1060_{16} , in 20_{16} bit increments, are displayed. Since the CRU addresses are twice the actual bit addresses, the address of the next 10_{16} CRU bits would be a 20_{16} address increment. In the second example, the 16 CRU bits at location 100_{16} are displayed.

Example:

```
.IC
0000=600D FFFF FFFF 40DF >0000 8001 0D00 409B
0100=FFFF FFFF FFFF FFFF >FFFF FFFF FFFF FFFF
0200=FFFF FFFF FFFF FFFF >FFFF FFFF FFFF FFFF
```

9.6.7.2 MODIFY CRU REGISTER (MC). The Modify CRU Register command reads and displays the data on CRU input lines, and sets data on CRU output lines.

Syntax definition:

$$MC \left[\left[\left[\text{b} \dots \right] \right] \left[\langle \text{CRU address} \rangle \right] \left[\left[\left[\text{b} \dots \right] \right] \langle \text{CRU width} \rangle \right] \right]$$

The command is terminated by a carriage return.

Parameters:

- CRU address The CRU word address. A value from 0 to $1FFF_{16}$. (1-4 hexadecimal characters.)
- CRU width The number of bits to be changed in each CRU word (hexadecimal). A value from 1 to 10_{16} . A value of 0 is interpreted as 10_{16} . (1-2 hexadecimal characters.)

Parameter default values:

If the CRU word address is not specified, a value of 0 is used.

If the CRU width is not specified, a value of 10_{16} is used.

Description: When the CRU bit width is less than 16 bits, the data value is displayed right justified in a four-digit hexadecimal value. The user's data may be input as a four-digit value; the rightmost bits, where the bit width is given by the CRU width parameter, are used to modify the CRU value. Enter a new value to change the value, a space to continue on to the next value, and a carriage return to terminate data modification.



The addresses are displayed as they would be used in workspace register 12 (the CRU base address), which is the actual CRU bit address times 2. Also, data is displayed and entered directly as the STCR/LDCR instruction receives/sends it.

If the CRU word address is greater than $1FFF_{16}$, the command is ignored.

Error message:

DP12 CRU bit width parameter too small (negative) or too large (greater than 10_{16}). Invalid bit string width.

Application note: The Modify CRU Register command may be used to change the data being sent to an external device during the debugging of a new interface.

Examples:

```
.MC 1000 8
1000=00FF 0080
1010=00FF 0040
```

```
.MC 1000
1000=FFFF 1000
```

9.6.8 MEMORY COMMANDS (IM, MM). The commands explained in the following paragraphs allow user knowledge and control of memory contents.

9.6.8.1 Inspect Memory (IM). The Inspect Memory command is used to display in hexadecimal format the contents of one or more consecutive memory locations.

Syntax definition:

$$\text{IM} \left[\left[\left\{ \begin{array}{c} ' \\ \text{b} \end{array} \right\} \right] \langle \text{starting mem addr} \rangle \left[\left[\left\{ \begin{array}{c} ' \\ \text{b} \end{array} \right\} \right] \langle \text{ending mem addr} \rangle \right] \right]$$

The command is terminated by a carriage return.

Parameters:

| | |
|-------------------|---|
| starting mem addr | Hexadecimal value representing the memory address of the first memory word displayed. (1-4 hexadecimal characters.) |
| ending mem addr | Hexadecimal value representing the memory address of the last memory word displayed. (1-4 hexadecimal characters.) |

Parameter default values:

If neither parameter is specified, all memory is dumped.

If the ending address is not specified, only one word is displayed.

An odd address is changed to the preceding word address before the addressed byte is displayed



Description: Memory is displayed in groups of four words, two groups per line. The address of the first word on the line is printed at the left. The display may be terminated at any time by pressing the ESC key on the terminal keyboard.

Error message:

DP13 The ending address specified is less than the starting address specified.

Examples:

```
.IM 1000,1004
1000=1002 C0E0 023E
```

```
.IM 1006
1006=1004
```

9.6.8.2 MODIFY MEMORY (MM). The Modify Memory command displays the address and contents of a memory word and accepts a new hexadecimal data value from the user.

Syntax definition:

$$\text{MM} \left[\left\{ \begin{array}{l} ' \\ \text{b} \dots \end{array} \right\} \langle \text{memory address} \rangle \right]$$

The command is terminated by a carriage return.

Parameter:

memory address Address of memory to be modified.

Parameter default value: If the memory address is not specified, a value of 0 is used.

Description: If the user inputs a new value, the memory location is modified to match the input value. If the user terminates his input with a blank (space), the next location value is printed and the process repeated. If the user terminates his input with a carriage return or comma, the command processing terminates.

Error message:

DP00 An invalid hexadecimal value was input.

Application note: The MM command is useful for setting up desired conditions in order to check out a routine. It is also convenient for creating patches and for examining memory one word at a time.

Example:

```
.MM 1000
1000=FFFF 1
1002=FFFF 3
1004=FFFF
1006=FFFF 8
```



These command statements place the value 1 in location 1000, 3 in location 1002, and 8 in location 1006. The user may enter a space (blank) if he does not want to modify a location but wants to go on to the next location. A carriage return terminates the command at any time.

9.6.9 PROCESSOR REGISTER COMMANDS (IR, MR). The following commands allow control of the 990 computer program control registers: the program counter, workspace pointer, and status registers.

9.6.9.1 Inspect Registers (IR). The Inspect Registers command displays the contents of the user's registers: the program counter (PC), workspace pointer (WP), and status (ST) registers for the current user program. These values are displayed in groups of four hexadecimal characters.

Syntax definition:

IR

The command is terminated by a carriage return.

Application note: The displayed register values are those values which are loaded into the processor in response to an EX or RU command.

Example:

```
.IR  
PC=0246 WP=0000 ST=0000  
.
```

9.6.9.2 Modify Registers (MR). The Modify Registers command displays the contents of the user's internal registers workspace pointer (WP), program counter (PC), and status (ST) registers and allows the user to modify them.

Syntax definition:

MR

The command is terminated by a carriage return.

Description: The register name and current contents are printed in hexadecimal and a hexadecimal input is accepted from the user. If the user inputs a valid hexadecimal number, the contents of the registers are changed. If the user enters a space, the processor prints the name and contents of the next register. If the user enters a carriage return, the command terminates.

Error message:

```
DP00 An invalid hexadecimal number was input, or the  
number input was greater than FFFF16.
```

Application notes: Modification of the Workspace Pointer (WP) register causes the registers that would be displayed by the Inspect Workspace Registers (IW) command to change. The Modify Registers command is used to establish the initial environment for a program executed with the Execute User Program Directly (EX) or the Execute User Program under SIE or Trace (RU) command.

*Examples:*.MR

PC=2000 244
 WP=0000 A6
 ST=0000

.MR

PC=0244
 WP=00A6 A2
 ST=0000 2

.MR

PC=0244 246

The first example changes the value in the PC register to 244_{16} and the value in the WP register to $A6_{16}$. The second example changes the WP register value to $A2_{16}$ and the ST register value to 2_{16} . The third example changes the PC register value to 246_{16} .

As in the second example, the user may press the space bar on the terminal keyboard if he does not wish to modify a particular register. As in the third example, he may press the RETURN key on the terminal keyboard after entering a new PC register value to terminate the command.

9.6.10 WORKSPACE REGISTER COMMANDS (IW, MW). The following commands allow precise control of the memory area selected to be the workspace registers.

9.6.10.1 Inspect Workspace Registers (IW). The Inspect Workspace Registers command is used to display the contents of a sequence of the user's workspace registers.

Syntax definition:

$$IW \left[\left[\left\{ \begin{array}{c} \cdot \\ \text{b} \end{array} \right\} \left[\langle \text{starting reg number} \rangle \right] \left[\left\{ \begin{array}{c} \cdot \\ \text{b} \end{array} \right\} \left[\langle \text{ending reg number} \rangle \right] \right] \right]$$

The command is terminated by a carriage return.

Parameters:

| | |
|---------------------|--|
| starting reg number | The number of the first workspace register to be displayed. Single hexadecimal number. |
| ending reg number | The number of the last workspace register to be displayed. Single hexadecimal number. |

*Parameter default values:*

If the starting workspace register is not specified, a value of 0, signaling register 0, is used.

If the ending workspace register is not specified, the value used is the starting workspace register.

If neither parameter is specified, all 16 registers are displayed.

Description: The set of workspace registers displayed are those pointed to by the WP that would be displayed if an IR command were executed. Workspace registers are displayed with the register number preceding the register contents.

Error message:

DP13 Either the starting workspace register number is greater than the ending workspace register number, or a workspace register number greater than F₁₆ was requested.

Examples:

```
.IW
R0=0000 R1=0000 R2=0026 R3=0000 R4=0000 R5=2032 R6=0000 R7=0000
R8=0000 R9=0000 RA=0000 RB=0000 RC=0000 RD=3798 RE=2008 RF=0002
```

If no workspace register or range is specified, all 16 registers are printed.

```
.IW 2,8
R2=0000 R3=0000 R4=0000 R5=0000 R6=0000 R7=0000 R8=0000
```

```
.IW 2
R2=0000
```

9.6.10.2 Modify Workspace Registers (MW). The Modify Workspace Registers command is used to display and change the contents of one or more of the user's workspace registers.

Syntax definition:
$$MW \left[\left\{ \begin{array}{l} , \\ b \dots \end{array} \right\} < \text{starting reg number} > \right]$$

The command is terminated by a carriage return.

Parameter:

starting workspace reg The number of the first workspace register to be displayed. (Hexadecimal value.)

*Parameter default value:*

If the starting workspace register is not specified, register zero is assumed and a value of 0 is used.

Description: The mnemonic and current contents of the workspace registers are displayed. The command processor accepts the user's input, which may be a new hexadecimal value for the register contents and a terminator. If this input is a new value, the current contents of the specified register are changed. If the terminator is a blank, the next register is printed for modification. If the terminator is a carriage return or comma, the command processing terminates. The command processing terminates automatically after processing workspace register 15 (F_{16}).

Application note: The user is cautioned to be sure that the workspace pointer actually points to the intended workspace. The Modify Workspace Registers command displays the registers within the current workspace (the workspace defined by displaying the WP in an IR command).

Example:

```
.MW 4
R4=0000 7
R5=0000 89
R6=0000
R7=0000 1000
```

This example changes the contents of workspace registers R4, R5 and R7 to 7_{16} , 89_{16} and 1000_{16} , respectively. A carriage return was entered after changing the contents of R7.

9.6.11 SNAPSHOT COMMANDS (SS, IS, CS). The following commands provide a convenient way to specify debugging information to be displayed.

9.6.11.1 Set Snapshot (SS). The Set Snapshot command is used to define a set of registers and memory locations to be displayed as a single unit.

Syntax definition:

$$SS \left\{ \begin{array}{l} ' \\ \text{b} \dots \end{array} \right\} \left[\langle \text{snapshot no.} \rangle \right] \left[\left\{ \begin{array}{l} ' \\ \text{b} \dots \end{array} \right\} \left[\langle \text{starting reg no.} \rangle \right] \left[\left\{ \begin{array}{l} ' \\ \text{b} \dots \end{array} \right\} \left[\langle \text{ending reg no.} \rangle \right] \right] \right] \left[\left\{ \begin{array}{l} ' \\ \text{b} \dots \end{array} \right\} \left[\langle \text{starting memory addr} \rangle \right] \left[\left\{ \begin{array}{l} ' \\ \text{b} \dots \end{array} \right\} \left[\langle \text{ending memory addr} \rangle \right] \right] \right] \right]$$

The command is terminated by a carriage return.

Parameters:

| | |
|----------------------|--|
| snapshot no. | Index number of snapshot to be defined. The index is a number in the range 0-3. |
| starting reg no. | First workspace register to be displayed. |
| ending reg no. | Last workspace register to be displayed. |
| starting memory addr | First memory word address to be displayed. |
| ending memory addr | Last memory word address to be displayed. |

*Parameter default values:*

If the snapshot number is not specified, a value of 0 is used.

If the starting workspace register number is not specified, a value of 0 is used.

If the ending workspace register number is not specified, the value used is the starting register number if the starting register number is specified. Otherwise, the value is 0_{16} .

If the starting memory address is not specified, a value of 0 is used.

If the ending memory address is not specified, the value used is the starting memory address if the starting memory address is specified. Otherwise, it is 0_{16} .

Description: Snapshots may be invoked with the Inspect Snapshot (IS) command or when a breakpoint which references the snapshot index is encountered.

Error messages:

- DP03 A parameter is greater than the required maximum value.
 Reenter the command.
- DP04 Snapshot is already defined. Reenter the command.
- DP13 The ending parameter (register or memory address) is
 less than the beginning parameter.

Application notes: Snapshots are convenient for defining a frequently used display during a debug session. If certain registers or memory data areas are frequently modified, they are likely choices for snapshots.

Since a snapshot may be attached to a PC breakpoint to dump some data and continue execution, a trace can be constructed which will be activated only when some specified event occurs. A dump may be produced and execution will continue without operator intervention.

Snapshots are useful for extended traces when the user wants to leave the computer running with breakpoints established. This would allow the computer to do an automatic dump when an exceptional condition is encountered and then continue execution.

Examples:

.SS 1,2,5,1000,1002

.SS 0,0,F

In the first example, the snapshot associated with index 1 displays workspace registers 2 through 5 and memory locations 1000_{16} through 1002_{16} . In the second example, the snapshot associated with index 0 displays workspace registers 0 through F_{16} and memory address 0 (the default). Refer to the IS command examples in paragraph 9.6.11.2 for the corresponding commands.



9.6.11.2 Inspect Snapshot (IS). The Inspect Snapshot command is used to display sequences of workspace registers and memory addresses.

Syntax definition:

$$\text{IS } \left[\left\{ \begin{array}{l} ' \\ \text{b} \dots \end{array} \right\} \left[\langle \text{starting snapshot no.} \rangle \right] \left[\left\{ \begin{array}{l} ' \\ \text{b} \dots \end{array} \right\} \langle \text{ending snapshot no.} \rangle \right] \right]$$

The command is terminated by a carriage return.

Parameters:

| | |
|-----------------------|--|
| starting snapshot no. | Index number (number of the snapshot in sequence) of the first snapshot to be displayed. A number from 0 to 3. |
| ending snapshot no. | Index number of the last snapshot to be displayed. A number from 0 to 3. |

Parameter default values:

If neither the starting snapshot number nor the ending snapshot number is specified, all snapshots are displayed.

If the starting snapshot number but not the ending snapshot number is specified, the named snapshot is displayed.

If the ending snapshot number but not the starting snapshot number is specified, the snapshots from 0 through the specified snapshot are displayed.

Description: Snapshots are defined with the Set Snapshot command. Attempts to display undefined snapshots are ignored.

Error message:

DP13 Either the ending snapshot number is greater than the starting snapshot number, or a snapshot number greater than the permitted maximum was input. Re-enter the command with the correct snapshot numbers.

Examples:

```
.IS
SNAP0
R0=0000 R1=0000 R2=0000 R3=0000 R4=0007 R5=0089 R6=0000 R7=0000
R8=0000 R9=0000 RA=0000 RB=0000 RC=0000 RD=0000 RE=0000 RF=0000
0000=0000
SNAP1
R2=0000 R3=0000 R4=0007 R5=0089
1000=0001 0003
```



```
.IS 1,3
SNAP1
R2=0000 R3=0000 R4=0007 R5=0089
1000=0001 0003
.
```

```
.IS 3
.
```

The snapshots in these examples were set in the examples of the Set Snapshot (SS) command (paragraph 9.6.11.1). In the last example, if a snapshot is not set, the monitor will return control without printing anything.

9.6.11.3 Clear Snapshot (CS). The Clear Snapshot command is used to disable previously specified snapshots.

Syntax definition:

$$CS \left[\left[\left[\begin{matrix} ' \\ \text{b} \end{matrix} \right] \left[\langle \text{starting snapshot number} \rangle \right] \right] \left[\left[\begin{matrix} ' \\ \text{b} \end{matrix} \right] \left[\langle \text{ending snapshot number} \rangle \right] \right] \right]$$

The command is terminated by a carriage return.

Parameters:

| | |
|--------------------------|---|
| starting snapshot number | The first snapshot to be cleared. A number from 0 to 3. |
| ending snapshot number | The last snapshot to be cleared. A number from 0 to 3. |

Parameter default values:

If no parameters are specified, all snapshots are cleared.

If only the first parameter is given, only the specified snapshot will be cleared.

If only the second parameter is given, snapshot 0 through the specified ending snapshot will be cleared.

Description: If an attempt is made to clear a snapshot that has not been set, the command is ignored.

Error message:

DPI3 A snapshot index greater than the maximum possible index number (3) was specified, or the ending snapshot index was less than the starting snapshot index number.

Examples:

```
.CS 0,2
```

```
.CS 2
```



In the first example, all snapshots except index number 3 are cleared. In the second example, only snapshot 2 is cleared.

9.6.12 TRACE COMMANDS (ST, SR, CR)

The following commands allow precise control of regions to be examined in detail during a debug session, including specification of the information to be displayed.

9.6.12.1 Set Trace Definition (ST). The Set Trace Definition command defines parameters that determine what information about instruction trace regions will be printed. There are up to four different trace formats that may be defined, any one of which may be associated with one or more “trace regions”. The format determines what is to be displayed for each instruction traced in the associated region.

Syntax definition:

$$ST \left\{ \begin{array}{l} ' \\ \text{b} \dots \end{array} \right\} \langle \text{format index} \rangle \left\{ \begin{array}{l} ' \\ \text{b} \dots \end{array} \right\} \langle \text{char string} \rangle$$

The command is terminated by a carriage return.

Parameters:

| | |
|--------------|---|
| format index | Trace format index number; a number from 0 to 3. |
| char string | Character string describing the options to be printed. The string contains from 1 to 27 characters. |

Parameter default values: There are no default values. Both parameters are required.

Character string symbols: The character string symbol definitions and the associated trace printouts are as follows:

| Character | Trace Output | Description |
|-----------|--------------|--|
| P | XXXX | Program counter. The program counter is printed for every instruction executed. The program counter value is printed if anything else is printed even if “P” was not specified (example 1). |
| I | I-III | Instruction and format. (Instruction formats are described in the <i>Model 990 Computer TMS9900 Microprocessor Assembly Language Programmer's Guide</i> , Manual No. 943441-9701.) The instruction and its format are printed for each instruction executed (example 2). |
| M | ST=XXXX | Status mask. The contents of the status mask, which is placed in the user status register is printed after each instruction executed (example 2). |
| W | WP=XXXX | Workspace pointer changes. When the user's workspace changes, the new workspace is printed. |
| T | BT=XXXX | Targets for branch or jump instruction. Whenever a branch or jump occurs, the target address of the branch/jump is printed. |



| Character | Trace Output | Description |
|-----------|--------------|--|
| C | C=XXXX | CRU address. When one of the instructions that references the CRU (LDCR, STCR, TB, SBO, SBZ) is executed, the address of the first bit referenced is printed. For example, for TB 2, the address is base (=R12) + 2. |
| N | (null) | Null trace. No printout occurs. If any other characters occur in the string, the null trace is overridden. |
| X | X-XXXX | XOP level. When an XOP instruction is executed, the XOP level is printed. |
| S | | Source. Refers to the source register. It is followed by an E, B, A or R. |
| E | SE=XXXX | Source effective address. This address is the memory location that the source field addresses. It is printed for every instruction (example 2) that has a source operand. |
| B | SB=XXXX | Contents of source effective address before execution. The contents of the source effective address before execution are printed for every instruction (example 2) with a source operand. |
| A | SA=XXXX | Contents of source effective address after execution. The contents of the source effective address are printed after each instruction with a source operand is executed (example 2). |
| R | SR=XXXX | Contents of source workspace register after execution for $T_s = 3$ (indirect addressing with autoincrement). (T_s is the source addressing mode field in an assembly language machine instruction.) The contents of the source register is printed if an autoincrement is specified. |
| D | | Destination. Refers to the destination. It is followed by an E, B, A or R. |
| E | DE=XXXX | Destination effective address. This address is the memory address that the destination field addresses. The destination effective address is only printed for Format 1, 3, and 9 assembly language machine instructions. All other instruction format types do not have a destination field (example 2). |
| B | DB=XXXX | Contents of destination effective address before statement executed. This is printed whenever a destination field exists (example 2). |
| A | DA=XXXX | Contents of destination effective address after execution. This is printed whenever a destination field exists (example 2). |
| R | DR=XXXX | Contents of destination workspace register after execution for $T_d = 3$ (indirect addressing with autoincrement). (T_d is the destination addressing mode field in an assembly language machine instruction.) The contents of the destination register is printed if an autoincrement is specified. |

Description: The character string is scanned for proper syntax. If the string conforms to the syntax, a trace print control template is built and placed in the trace format table.

The character string in the ST command allows the user to select only those portions of the trace output that he needs. For tutorial purposes, an extensive trace output could be requested, while minimal traces such as a PC or variable trace are also easily selected. Each character in the character string represents a desired portion of the trace.

If any trace option other than PC is printed, PC is also printed.

A trace on a variable (see ST command) is implemented by specifying the desired variable.



The character string is scanned from left to right. The characters E, B, A and R are modified by the most recent occurrence of S or D. If E, B, A or R is encountered before an occurrence of S or D, or if an invalid character is encountered, the scan is aborted and an invalid syntax message is issued. A character string consisting entirely of S or D is also an invalid syntax.

All four trace format table elements have initial values as follows when the debug monitor overlay containing the ST command is loaded:

| Index Number | Equivalent Character String |
|--------------|--|
| 0 | P |
| 1 | PIWSEADEA |
| 2 | T |
| 3 | PIMWTCXSEBARDEBAR (all trace output options) |

Error messages:

DP23 Syntax error in trace format character string.
Reenter the command.

DP26 Invalid trace format index number. Reenter
the command.

Examples of typical character strings: Some examples of typical character strings are presented here. To invoke a PC trace, the character string is

P

If a branch trace is desired, the character string is

T

The character string for a trace that includes PC, instruction and format, workspace pointer changes, and source and destination effective addresses is

PIWSEDE

To specify all options, the character string is the same as the string equivalent to default trace format index number 3 (above).

Example 1: Trace format 1 in the following example is defined as a program counter trace. The program counter is the only option printed.



```
.ST 1,P
.SR 1,0,2000,1,N
.MR
```

```
PC=198C 46C
.RU
046C
0470
0474
1A92
1A96
198C
198E
1992
1994
1996
```

Example 2: This example shows the trace format index number 1 set to a full trace.

```
.ST 1,PIMWTCXSEBARDEBAR
.SR 1,24C,260,1,S
.MR
```

```
PC=0250 24C
.RU
024C 8-02E0 ST=0000 SE=00A6 SB=024C SA=024C
0250 6-04E0 ST=0000 SE=01FC SB=0054 SA=0000
0254 6-04E0 ST=0000 SE=01B4 SB=C259 SA=0000
0258 6-04E0 ST=0000 SE=01B8 SB=C060 SA=0000
025C 6-0720 ST=0000 SE=01BA SB=01E6 SA=FFFF
0260 1-C820 ST=C000 SE=021E SB=109A SA=109A DE=00D2
      DB=1850 DA=109A
```

9.6.12.2 Set Trace Region (SR). The Set Trace Region command defined a trace region.

Syntax definition:

$$\text{SR } \left\{ \begin{array}{l} ' \\ \text{b} \dots \end{array} \right\} \langle \text{region index} \rangle \left\{ \begin{array}{l} ' \\ \text{b} \dots \end{array} \right\} \langle \text{lower mem addr} \rangle \left\{ \begin{array}{l} ' \\ \text{b} \dots \end{array} \right\} \langle \text{upper mem addr} \rangle$$

$$\left\{ \begin{array}{l} ' \\ \text{b} \dots \end{array} \right\} \langle \text{format index} \rangle \left[\left\{ \begin{array}{l} ' \\ \text{b} \dots \end{array} \right\} \langle \text{step region} \rangle \right] \left[\left\{ \begin{array}{l} ' \\ \text{b} \dots \end{array} \right\} \langle \text{v1} \rangle \left[\left\{ \begin{array}{l} ' \\ \text{b} \dots \end{array} \right\} \langle \text{v2} \rangle \right. \right. \right.$$

$$\left. \left. \left[\left\{ \begin{array}{l} ' \\ \text{b} \dots \end{array} \right\} \langle \text{v3} \rangle \right] \right] \right]$$

The command is terminated by a carriage return.

*Parameters:*

| | |
|----------------|---|
| region index | Trace region index number; a number from 0 to 3. |
| lower mem addr | First memory address in the trace region; a hexadecimal number in the range 0 to FFFE. |
| upper mem addr | Last memory address in the trace region; a hexadecimal number in the range 0 to FFFE. |
| format index | Trace format index number; a number from 0 to 3. |
| step region | If this field contains S, an instruction step region is specified. If it contains N, the field specifies no instruction step. Any other character specifies no instruction step. |
| v1, v2, v3 | Addresses of variables to be traced while in the designated region. Up to three variables may be specified. The range of values for each variable is 0 to FFFE ₁₆ . In the printed trace data, only changes are shown. |

Parameter default values:

The first four parameters in the syntax definitions are required.

If the step region parameter is not specified, a value of N is used.

If none of the parameters v1, v2, and v3 are specified, no variables will be traced in the designated region.

Description: The specified regions of memory are designated as the program area to be executed under control of the interpretive trace.

The trace region index number determines which trace type will be executed as defined by the Set Trace Definition (ST) command. If two overlapping regions have been defined, the region with the lowest index has precedence and the trace type defined in that region is executed. (See example 1.)

The trace format index number indicates the trace type vector assigned to the trace region. When the trace overlay is loaded, each of the four trace type vectors, indices 0 through 3, is assigned an initial value. These vectors may be modified by the Set Trace Definition (ST) command. Trace types may vary from a null trace to a full trace.

The function of the instruction step region is to control the execution of the user program. If the instruction step region is set by entering an S parameter on the terminal keyboard, only one instruction at a time will be executed and traced. To execute another instruction, the user must press the space bar.



If variables have been specified to be traced, only changes will be printed. The format of the output is:

AAAA = DDDD

Where AAAA is the address of the variable and DDDD is the new value of the variable. These are hexadecimal values.

Error messages:

- DP13 The specified last memory address was less than the first memory address. Reenter the command.
- DP10 Invalid trace region index number. Reenter the command.
- DP26 Invalid trace format index number. Reenter the command.

Example 1: This example shows the setting of two different trace regions, one a PC trace and the other a full trace. The region with the lower index is executed when the two regions overlap. In this manner, the user can get a general trace until he reaches a critical section of the program where he wants everything traced.

.ST 1,PIMWTCXSEBARDEBAR

.ST 2,P

.SR 2,0,2000,2,N

.SR 1,24C,260,1,S

.MR

PC=0250 246

.RU

0246

024A

024C 8-02E0 ST=0000 SE=00A6 SB=024C SA=024C

0250 6-04E0 ST=0000 SE=01FC SB=0054 SA=0000

0254 6-04E0 ST=0000 SE=01B4 SB=C259 SA=0000

0258 6-04E0 ST=0000 SE=01B8 SB=C060 SA=0C00

025C 6-0720 ST=0000 SE=01BA SB=01E6 SA=FFFF

0260 1-C820 ST=C000 SE=021E SB=109A SA=109A DE=00D2

DB=1850 DA=109A

0266

026A

0270

0274

0278

027A

027E

Outside the critical region, a continuous run is desired. Inside the critical region, there is a single instruction step. The operator must press the carriage return or space bar on the terminal keyboard after each statement executed.



Example 2: The trace region is set from 0 to 2000_{16} , with the trace format index number equal to 3. (Trace type 3 defaults to a full trace.) The snapshot prints workspace registers 1 through 4 and memory locations 1000_{16} to 1004_{16} . A breakpoint is set at 0474_{16} with snapshot 1 associated. A Modify Registers (MR) command sets the program counter to $046C_{16}$, and execution is begun by issuing an Execute User Program under SIE or Trace (RU) command.

.SR 1,0,2000,3,N

.SS 1,1,4,1000,1004

.SB 1,474,,1

.MR

PC=198C 46C

.RU

046C 8-02E0 ST=2000 WP=044C SE=1968 SB=0900 SA=0900

0470 1-C2A0 ST=C000 SE=00A6 SB=1A92 SA=1A92 DE=0460

DB=0000 DA=1A92

BKPT#1

PC=0474 WP=044C ST=C000

SNAP1

R1=11C0 R2=0000 R3=0000 R4=0000

1000=10D8 C145 1305

0474 6-045A ST=C000 BT=1A92 SE=1A92 SB=C2A0 SA=C2A0

1A92 1-C2A0 ST=2000 SE=00A8 SB=0000 SA=0000 DE=0460

DB=1A92 DA=0000

1A96 6-0420 ST=2000 WP=1968 BT=198C SE=1988 SB=1968

SA=1968

198C 6-04C3 ST=2000 SE=196E SB=FFFF SA=0000

198E 1

Following is a listing of the portion of the program executed in this example with all references resolved:

| Memory Location | Object Code | Source |
|-----------------|-------------|----------------------|
| 046C | 02E0 | LWPI MAINW |
| 046E | 044C | |
| 0470 | C240 | MOV @ENTRY,R10 |
| 0472 | 00A6 | |
| 0474 | 045A | B *R10 |
| . | . | . |
| . | . | . |
| 1A92 | C2A0 | INIT MOV @KBLUNO,R10 |
| 1A94 | 00A8 | |
| 1A96 | 0420 | BLWP @OPEN |
| 1A98 | 1988 | |
| . | . | . |
| . | . | . |
| 1988 | 1968 | OPEN DATA IOWKS |
| 198A | 198C | DATA OPEN1 |
| 198C | 04C3 | OPEN1 CLR R3 |



This is a typical example using snapshots, breakpoints and an instruction trace. Since a snapshot is associated with the breakpoint, the snapshot is printed and execution continued. An exit from the RU command is made by pressing the ESC key on the terminal keyboard.

9.6.12.3 Clear Trace Region (CR). The Clear Trace Region instruction is used to disable previously specified trace regions.

Syntax definition:

$$\text{CR } \left[\left\{ \begin{array}{l} \text{b} \\ \text{b} \dots \end{array} \right\} \left[\langle \text{starting trace region} \rangle \right] \left[\left\{ \begin{array}{l} \text{b} \\ \text{b} \dots \end{array} \right\} \langle \text{ending trace region} \rangle \right] \right]$$

The command is terminated by a carriage return.

Parameters:

| | |
|-----------------------|--|
| starting trace region | The first trace region to be cleared. A number from 0 to 3. |
| ending trace region | The last trace region to be cleared. A number from 0 to 3. |

Parameter default values:

If no parameters are specified, all trace regions are cleared.

If only the first parameter is given, only the specified trace region will be cleared.

If only the second parameter is given, trace regions 0 through the specified ending trace region will be cleared.

Error message:

DP13 A trace region index greater than the maximum possible index number (3) was specified, or the ending region index was less than the starting region index number.

Examples:

.CR 1,3

.CR

In the first example, all but region 0 are cleared. In the second example, all regions are cleared.

9.6.13 WRITE PROTECT OPTION COMMANDS (SP, CP)

These commands allow control of the optional hardware memory write protect feature on 990/4 computers.



9.6.13.1 Set Write Protect Region (SP). The Set Write Protect Region command sets the write protect region to the address specified in the command. This command is only valid if the user has a 990/4 computer with the write protect option. A protection violation generates a general interrupt signal which may be wired to any available interrupt level. Refer to the *Model 990/4 Computer Computer System Hardware Reference Manual* for the procedure for wiring a memory board to a desired interrupt level.

To set a write protect region, the lower and upper bounds must be output to CRU base address $1FA0_{16}$. The most significant bit (bit 0) is the Protect/Permit bit. Bit 0, when set to 1, indicates write permit, and, when set to 0, indicates write protect. To specify the protect region, memory is divided into 256-word blocks. The lower and upper bounds are each seven bits long and serve as an index into the memory addresses to specify which contiguous 256-word block of memory is to be protected. For example, the lower bound of the protect region equal to 2000_{16} would be represented in the Protect register as 10_{16} . The memory block beginning at location 2000_{16} is the sixteenth 256-word (512-byte) memory block. A bound is calculated by dividing the starting address of the memory block by 200_{16} (512_{10}). In this example, 2000_{16} divided by 200_{16} is equal to 10_{16} . The upper bound is not included in the protect region. When outputting to the CRU Protect register to specify the protect bounds, a Load CRU (LDCR) instruction with a count of 16 must be used to set all 16 bits because the Protect register works like a shift register. To protect the memory range 2000_{16} to 4000_{16} , the lower bound is set equal to 10_{16} , the upper bound is set to 20_{16} , and the Protect bit is set to 0. Therefore, the Protect register is set to 1020_{16} by outputting these fields to the CRU in the format specified in figure 9-1A.

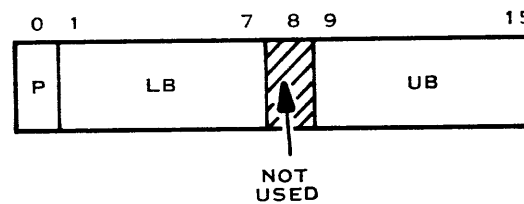

BIT FIELDS

| | |
|----|---|
| P | PROTECT/PERMIT BIT 0-PROTECT 1-PERMIT |
| LB | LOWER BOUND |
| UB | UPPER BOUND |

NOTES

THE CRU OUTPUT DATA FORMAT IS THE SAME AS THE FORMAT OF DATA IN MEMORY BEFORE IN LDCR INSTRUCTION IS EXECUTED.

BITS 1 AND 9 ARE THE MOST SIGNIFICANT BITS, AND BITS 7 AND 15 ARE THE LEAST SIGNIFICANT BITS OF THE LB AND UB FIELDS.

(A)133373

Figure 9-1A. CRU Output Data Format



When an attempt is made to write into a memory location within the protected region, the Protect Violation flag is set to $FFFF_{16}$. This flag, which is normally 0, can be sensed by reading any of the 16 CRU bits at base $1FA0_{16}$. If this protected region is within the TMS9900 on-board RAM, the write is not inhibited. If this protect region is on the expansion memory card, the write is inhibited.

The Protect Violation flag may be cleared in two different ways:

1. I/O RESET (RSET) – This machine instruction clears the violation flag and sets bit 0 of the Protect register to 1 (not protected).
2. Output a 1 to any or all of the 16 bits of the Protect register.

If the user has wired his system such that a write protection violation causes an interrupt at a certain level, he must initialize the trap vector for that level and process the interrupt. The level 2 trap vector is initialized automatically by the Debug Monitor. The user may take advantage of this fact and wire his memory board interrupt to level 2. The system then prints:

****MX06****

when a protection violation occurs. When this happens, a RSET instruction is executed and the user must reestablish the protect bounds before starting execution again.

Syntax definition:

$$SP \left\{ \text{b}' \dots \right\} \langle \text{lower mem addr} \rangle \left\{ \text{b}' \dots \right\} \langle \text{upper mem addr} \rangle$$

The command is terminated by a carriage return.

When the user issues an SP 0600,0800 and then an EX command, his program begins execution. Should the user program then attempt to write into memory location 0700, hardware write protect sets the protection violation flag in the CRU and interrupts the CPU if the user has wired that interrupt.

Parameters:

| | |
|----------------|--|
| lower mem addr | Lower boundary memory address of the protected region. Required parameter. Hexadecimal number. |
| upper mem addr | Upper boundary memory address of the protected region. Required parameter. Hexadecimal number. |

Description: This command sets the write protect region from the lower to the upper memory bound addresses. If the memory addresses entered are not on 256-word boundaries, the bounds will be set at the next lower 256-word boundary. The lower bound is included within the protect region but the upper bound is not.

The SP command overrides any previously defined protect region.



When the upper and lower bounds are sent to the CRU, the Protect Violation flag is cleared if it has been set.

Error message:

MS05 Parameter specification error. Either a required parameter is missing, or the lower bound is greater than or equal to the upper bound.

Application note: This command is ignored if the write protect option is not implemented in the system hardware.

Examples:

.SP 1000,2000

This command protects a region in memory from 1000_{16} to $1FFF_{16}$.

.SP 1000,1F00

This command protects a region from 1000_{16} to $1DFE_{16}$. The address $1F00_{16}$ is not a 256-word boundary; therefore, the upper bound is set at the next lower 256-word boundary, $1E00$.



9.6.13.2 Clear Write Protect Region (CP). The Clear Write Protect Region command clears the protect register and removes protection from the write-protected region.

Syntax definition:

CP

The command is terminated by a carriage return.

Description: The CP command clears the Protect register and sets the Protect/Permit bit to Permit. The Protect Violation flag is cleared if it has been set.

Application note: This command is ignored if the write protect option is not implemented in the system hardware.

Example:

.CP

9.7 DEBUGGING TECHNIQUES

Debugging techniques may be divided into three basic categories:

1. *Preventive techniques* – those which may be used to decrease the number of errors. Most of these techniques emphasize simplicity. Code should be simple and straightforward enough to make it obvious that the program works.
2. *Exposure techniques* – those which may be used to make the operation of a program easier to follow during the debugging process.
3. *Remedial techniques* – those used when a bug occurs in the user's program. Typically, most programmers' efforts are expended on these techniques.

Programming effort devoted to avoiding errors or making them apparent is important. Debugging and maintenance represent the majority of the cost in software development and support. The following paragraphs briefly discuss debugging in general and the specifics of debugging under TXDBUG.

9.7.1 GENERAL DEBUGGING TECHNIQUES. Several debug techniques will be helpful to the programmer in any debugging situation. These paragraphs offer some suggestions about debugging a program under development.

9.7.1.1 Debug Code in the Source Program. Include debug code in the source program. The user should keep the testing process in mind from the moment he starts to create a program. When referencing or changing data, the programmer should consider how to tell if the change is correct when reconstructing the results of a run. This often involves being aware of what intermediate results of a computation are lost.

For example, if the value of a variable D is calculated by the statement

D = A + B

and the program later encounters the statement

D = C + D



the second statement will cause a new value D to replace the previously calculated value. The calculated sum $A + B$ will therefore be lost. If, on the other hand, the program contains the statement

$$E = A + B$$

and, later in the program, the statement

$$D = C + E$$

the value of E will be preserved when D is calculated by the second statement. The programmer can examine the memory location containing the value of E to determine the calculated sum $A + B$.

After a computation is completed, reconstruction of the results of a program run involves distinguishing which decision paths have been taken through the program's code and determining what variables are relevant in calculating the results of a computation.

When the source code is written, it is often simple to store intermediate results in extra memory to record those results, branch paths, or the number of passes through loops. Such statements can be flagged with a character string (e.g., ****DEBUG****) in the comment field. When the source code is ready for production, TXEDIT can be used to locate and remove the code that stores intermediate results.

9.7.1.2 Checking the Program. Once a program has been successfully assembled, a thorough check of the program can often turn up errors which are hard to detect when the program is executing. In addition to making sure that the program is a correct implementation of the algorithm, it is often worthwhile to read through the program looking for specific errors:

- *Register errors.* Using the wrong register; referencing a register not in the current workspace; using a register as an immediate value (e.g., AI R1,R2 instead of A R1,R2 or AI R1,2); using byte-level operations or data where the data is in the wrong half of the register; or using byte-level data with the other half of the register containing incorrect data which affects the computation.
- *Variable names.* Misspelling of variable names such as T0 and TO; or using a single variable to contain different quantities.
- *Initialization errors.* Referencing values which may not have been properly initialized. This often occurs when a program is re-executed.
- *Buffer initialization.* Omitting an instruction to clear an input buffer between input operations when variable length records are read into a common fixed-length buffer.
- *Branch conditions and loop terminations.* Using the wrong branch instruction (especially JH, JL, JGT, JLE, JLT, JHE, or JOC with subtracts); or executing a loop one time too many or one time too few.
- *Inconsistent techniques.* Using conventions or debug elements which are inconsistent with the coding practice for the module.



- *Module interfaces.* Using variables or parameters which were not correctly set up for an interface; using registers or variables within a subroutine which have values that are not to be changed within the calling routine.
- *Boundary conditions.* Checking that the full range of the possible input data to a computation is correctly processed by the algorithm.

9.7.1.3 Execution Tree. In debugging or testing a program, it is often convenient to visualize the possible paths through the program as a tree with each node of the tree representing a conditional branch. Exhaustive testing of a program would then require testing each possible path through the program under all inputs which follow that path. While it is impossible to test all paths of a typical program, examination of the various paths (or small sets of paths) may reveal errors in the original logic.

9.7.2 SPECIFIC DEBUGGING TECHNIQUES. The following paragraphs describe techniques directed specifically to debugging under the debug monitor.

9.7.2.1 Planning the Debugging Session. Know the status of the debugging effort at all times. As the user interacts with the program through the console, he should be careful to record any changes made to the program and to be aware of the state of the program when examining it. In a debugging session, the user should have a clear idea of what he wants to accomplish and how he intends to accomplish it. Decisions made in the process of debugging should be carefully thought out.

9.7.2.2 Use of Breakpoints. There are three ways of stopping or interrupting the execution of a user's program which is being debugged at a specific location in the program:

1. Set an instruction count on the RUN command.
2. Execute with the single step option under instruction trace.
3. Set appropriate breakpoints.

Breakpoints stop execution at specific points in the user program rather than at arbitrary points controlled by the instruction count. The user may easily determine in advance and check the results of a computation without concerning himself about the state of the program.

When using breakpoints, be sure that the program will actually reach the desired breakpoint. This may involve putting additional breakpoints on the other paths from conditional branches.

Breakpoints are particularly useful when forcing some condition within a program which is not easily created from its parameters, for example, a CRU input. As an illustration of such a condition, an input value is to be read from a pressure transducer in an on-line process control environment. However, if the program is being debugged, a physically connected transducer is usually impractical and the values must be entered by the programmer. Breakpoints may be set prior to the start of a code sequence. When the breakpoint is taken, the user may set or modify the existing conditions in order to cause specific paths to be taken (as if a specific input had been received from the transducer).

The breakpoint reference count can be used to see that a loop is repeated the correct number of times. By setting the reference count equal to the number of iterations through the loop and setting another breakpoint outside the loop, the user may check that the loop is exhausted on the correct iteration. Breakpoints with attached snapshots with dump debug data or key variables yield a good trace aimed at checking the specific progress of a computation.



9.7.2.3 Excluding Loops from Instruction Traces. When tracing a program with printout, it is sometimes desirable to exclude printing of small loops which are very frequently executed or which run for many iterations. (See figure 9-2.) These may be excluded by carefully choosing trace regions, which are areas where an instruction trace is to be run within a program. In determining which trace region is applicable (and thus what trace type to use), the system will find the first (lowest numbered) region containing the user's PC. By selecting a high numbered trace (3) for the main trace control and then setting regions within that large region with lower numbered traces which do not print, the user may prevent a large quantity of output where it is not wanted.

An alternate mechanism is to allow the small loops to be executed by SIE and the remaining program traced. (See figure 9-3.) This can be done by setting trace regions to cover all of the program except the small loops or frequently executed parts. Such a mechanism works well unless the user is using XOPs (other than XOP 15 for debug monitor I/O) or interrupts which are processed differently by SIE and instruction trace.

If the user is performing I/O by means of supervisor calls (XOP 15), this XOP is executed directly (without SIE or instruction trace). If XOP 15 is not used for program I/O, it is executed directly under SIE.

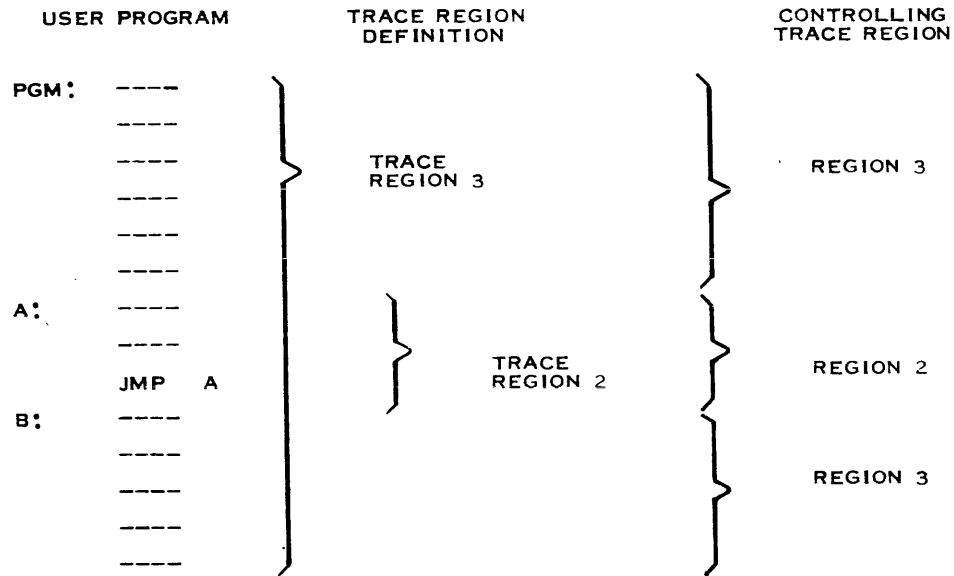

(A)133102

Figure 9-2. Trace Region Precedence of Lower Region Number

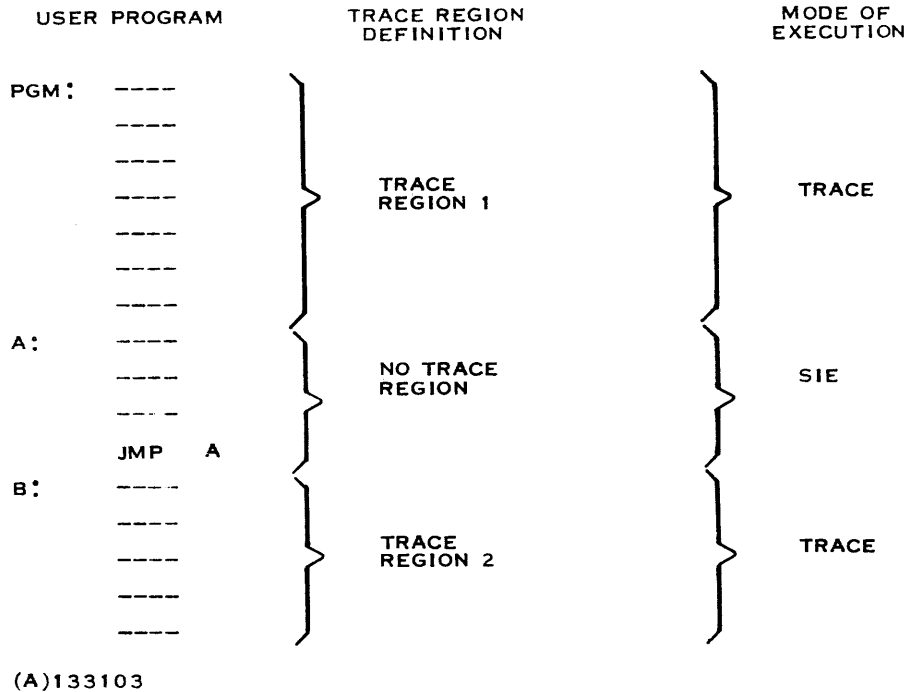

Figure 9-3. Using Both Trace and SIE

9.7.2.4 Simulating an Interrupt. A BLWP instruction may be used to control an interrupt routine which is being checked out. This can be handled with the following code sequence. The quantity “i” is the value to which “INTLVL” has been equated.

| Instruction | Operand | Generated Code |
|-------------|-----------|----------------|
| LIMI | INTLVL | 0300 i |
| BLWP | @INTLVL*4 | 0420 4*i |
| JMP | \$ | 10FF |

The LIMi sets the interrupt status to the correct level. The BLWP transfers control through the interrupt vector.

9.7.3 PATCHING. Patching (attaching portions of code to existing program code) should be avoided if possible.

During a debug session, it is generally necessary to make patches to object code; however, it is advisable never to leave patches in a completed program (or create ROM firmware from a program with patches). An object program for which there is no corresponding source program is inconvenient and troublesome.

The following paragraphs cover patching techniques. The examples show how to patch a two-address instruction; this instruction is used:

```
MOV *R1,*R2+
```



Because of the number of items to be considered, patching a two-address instruction is one of the more difficult operations. There are two ways to approach it: building a bit image and the additive method.

9.7.3.1 Patching by Building a Bit Image. In building a bit image, the user merely fills in each field in the 16-bit word on a bit-by-bit basis. When all fields are complete, the value is converted to hexadecimal for the patch contents.

Example:

Patch the following assembly language instruction:

```
MOV *R1,*R2+
```

by building a bit image.

The MOV instruction has this format:



Determine the bits that occupy each field. Starting with the op code field, the hexadecimal op code for a MOV instruction is C000. The first three bits of this op code are 110_2 ; transfer these bits into the op code field.

The Byte Indicator (B) field specifies whether or not the instruction is a byte instruction. The MOV instruction is a word instruction; therefore, this field is set to 0. (The B field is always 0 for a MOV instruction.) Another way of specifying the same information would be to use the MOV or MOVB instruction (as appropriate) and a four-bit op code.

The D field specifies the destination workspace register. The destination address is *R2+, which indicates workspace register 2 and the workspace register indirect autoincrement addressing mode. The addressing mode for the destination, 11_2 , is placed in the T_d field. Transfer the binary value of the register number, 0010_2 , into the D field.

Use a similar procedure for the source address, which is *R1. In this case, workspace register 1 is specified and the addressing mode is workspace register indirect. Therefore, transfer 01_2 into the T_s field and 0001_2 into the S field.

The instruction field contents will now be:

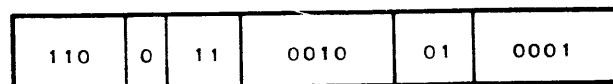

Now read these 16 bits as a four-digit hexadecimal number.

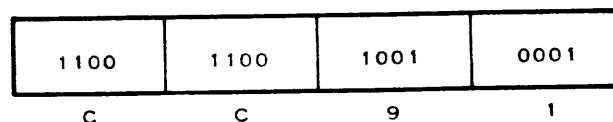

The resulting hexadecimal number is the desired value. The patch value is CC91.



9.7.3.2 Patching by the Additive Method. The second approach to the patching problem is the additive method. With a little practice, the patch described in the first approach can be created a little faster by treating each of the fields as a hexadecimal number and adding the results to produce the patch.

Example:

Patch the same assembly language instruction as in the bit image example:

MOV *R1,*R2+

by using the additive method. This method involves adding hexadecimal values corresponding to each field to the instruction's op code to get the patch value.

The programmer can think of a bit field value as being placed into the instruction word, right justified, and shifted left the number of bits necessary to move it to the appropriate field. This shift is equivalent to binary multiplication, so the bit field value times an appropriate multiplier will give a value to be added to similarly obtained values for other bit fields to yield a sum representing the contents of the instruction word.

Recall that the values for the addressing modes and workspace registers in the previous examples were:

| | |
|----------------------------|---|
| Destination mode (T_d) | 3 |
| Destination register (D) | 2 |
| Source mode (T_s) | 1 |
| Source register (S) | 1 |

In calculating the patch value by the additive method, these values are used.

The first number in the calculation is the hexadecimal op code for the MOV instruction, C000. The B field is always 0 in the MOV instruction; it can be considered part of the instruction op code and ignored in the calculation.

The second number to be added is the value of the destination mode. The code for the address mode is shifted left ten bits, equivalent to multiplication by 400_{16} . The code is 3_{16} ; therefore, the value to be added is

$$3_{16} * 400_{16} = 0C00_{16}$$

The third number is the destination register value. To create the value to be added, the register number, 2_{16} , is shifted left six bits, equivalent to multiplication by 40_{16} . The value is

$$2_{16} * 40_{16} = 0080_{16}$$

Calculation of the fourth value involves a code of 1_{16} for the source mode and a four-bit shift (multiplication by 10_{16}). The value is

$$1_{16} * 10_{16} = 0010_{16}$$

Finally, the source register number, 1_{16} , is unshifted. The value to be added is 0001_{16} .



To calculate the required sum, the values are added:

| | |
|----------------------------|------|
| Op code of MOV instruction | C000 |
| Destination mode | 0C00 |
| Destination register | 0080 |
| Source mode | 0010 |
| Source register | 0001 |
| Patch value | CC91 |

The sum, $CC91_{16}$, is the object code to be patched. The patch value is the same as the value obtained in the previous example.

When the same instruction format is used repeatedly, the multiplication constants – 400_{16} , 40_{16} and 10_{16} – do not change and become simple to handle with practice.

9.7.3.3 Symbolic Versus Indexed Addressing. The address mode for both symbolic (actual memory address) and register indexed addressing is the same (mode 10_2). The type of addressing is determined by the register field. A register field of zero is symbolic; therefore, no R0 indexing exists. In constructing a patch with a specific address, process it exactly as if it were a register indexed with a register of zero. Refer to the *Model 990 Computer TMS9900 Microprocessor Assembly Language Programmer's Guide*, Manual No. 943441-9701, for further information about symbolic and indexed memory addressing.

9.7.3.4 Branch Distance Calculations for Jump Instructions. The signed displacement in an Unconditional Jump (JMP) instruction is a two's complement eight-bit number which represents the number of words to skip forward or backward from the current PC (the PC points to the instruction *following* the jump instruction).

To calculate the displacement for a jump instruction, evaluate

$$1/2 (\text{target location} - (\text{instruction address} + 2)).$$

If the target address is less than the instruction address, add 10000_{16} to the target address and perform the subtraction. Note that a forward branch must generate a positive displacement and a backward branch must generate a negative displacement to be in range.

Example 1:

Patch location $17A_{16}$ with a jump to location $1FE_{16}$.

The source address is equal to the instruction address +2, which is $17A+2 = 17C$.

The target location minus the source address is $1FE - 17C = 82$. Continuing,

$$1/2 (\text{target location} - \text{source address}) = 41$$

The displacement, 41, is positive. The patch value is therefore 1041_{16} , where 10 is the hexadecimal op code for the JMP instruction and 41 is the displacement value.

Example 2:

Patch Location $1FE_{16}$ with a jump to location $17A_{16}$.



The source address is equal to the instruction address+2, which is $1FE_{16} + 2_{16} = 200_{16}$. The sum of the target location plus 10000_{16} , minus the source address, is $1017A_{16} - 200_{16} = FF7A_{16}$. Continuing

$$1/2 (\text{target location} - \text{source address}) = 7FBD = BD \text{ (dropping the first two digits)}$$

The displacement, BD, is negative. The patch value is therefore $10BD_{16}$, where 10 is the hexadecimal op code for the JMP instruction and BD_{16} is the displacement value, negative in this case.

Note that the 7F is generated from the addition of 2_{16} (10000_{16}) and may be discarded. If the high order eight bits of the destination are not equal to 7F, the branch distance is too great to reach with a JMP instruction.

9.7.3.5 Use of Spin and No-operation. It is sometimes convenient to patch a spin (branch to itself) into a location to intercept control in unexpected situations (the alternate path of a conditional jump, for example). That instruction is a JMP to itself and is a value of $10FF_{16}$. (The corresponding assembly language code is JMP \$.)

Unwanted instructions can be replaced with a No-Operation (NOP) which is a JMP to the next instruction. The value for an NOP is 1000_{16} . Strings of NOPs may also be placed at various locations in the program source to reserve space for temporary debug patches.

9.7.3.6 Out-of-Line Patches. It is often necessary to patch more instructions into a program than there is room, requiring an out-of-line patch. The simplest mechanism is to use a symbolic address branch instruction to a specific location where the patch is placed. After the patch, use a branch instruction back to the original code.

Example:

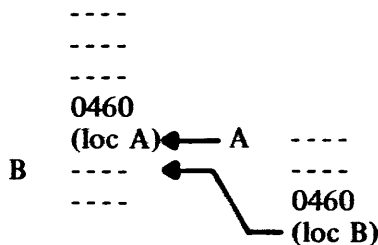

Be careful to see that code which is overlaid is moved to the patch area, that it is not a PC relative jump, and that the return pointer comes to the beginning of an instruction.



9.8 ERROR MESSAGES

TXDBUG may issue any of the following error messages:

| Message | Meaning |
|---------|---|
| MX01 | Unrecoverable I/O error |
| MX06 | Invalid memory address or instruction |
| MS01 | Invalid command |
| MS05 | Required parameter missing |
| MP00 | Parameter specification error |
| DP00 | Invalid hexadecimal number input |
| DP03 | Parameter value is greater than the allowed maximum |
| DP04 | Snapshot is already defined |
| DP10 | Invalid trace region index |
| DP12 | CRU bit width parameter invalid |
| DP13 | Invalid range of registers or memory addresses |
| DP20 | Breakpoint specification error |
| DP23 | Syntax error in trace format character string |
| DP26 | Invalid trace format index number |

In addition, during the initial TXDBUG load, the TX990 program loader may issue the following error messages:

| Message | Meaning |
|---------|--|
| LDFE | Load bias error |
| LDFE | Get common error (system error) |
| LDXX | All other load errors are of the form (LD(XX) where XX is the TXDS I/O error code received |



SECTION X

TXDS PROM (TXPROM) PROGRAMMER UTILITY PROGRAM

10.1 INTRODUCTION

This section describes the TXPROM programmer utility program along with the required hardware and software. In addition, it describes the function and use of control files, bit string mapping of PROMs, and examples of the use of the utility, as well as instructions for loading and operating the utility. For standard operations, refer to the loading and operating procedures contained in paragraphs 10.4 and 10.5, plus the description of standard control files found in paragraph 10.7. The description portion of this section is also helpful for operation of the utility. For custom mapped PROMs or PROMs with nonstandard data configurations, read all the information contained in this section. For further information regarding PROM programming with a 990 Computer System, refer to the following related publications:

| Title | Part Number |
|---|-------------|
| <i>Model 990 Computer TMS9900 Microprocessor Assembly Language Programmer's Guide</i> | 943441-9701 |
| <i>Model 990 Computer PROM Programming Module Installation and Operation</i> | 945258-9701 |
| <i>Model 990 Computer AMPL Microprocessor Prototyping Laboratory Operation Guide</i> | 946244-9701 |

10.2 REQUIRED CONFIGURATION

The TXPROM programmer utility program requires the following configuration for proper operation:

- An FS990 System
- A Model 990 PROM Programming Unit.

The TXPROM programmer utility software is part of the TX990/TXDS system software and is packaged on a diskette. TXPROM includes the following files:

- :TXPROM/ – contains the PROM programming software.
- A set of standard control files – :S288, :S287, :S471, :S472, :E2704B, :E2704, :E2708B, :E2708, :E2716B and :E2716.

10.3 DESCRIPTION

The TXPROM programmer utility is a software module that controls a computer hardware system to create custom Read Only Memories (ROMs). The hardware system can program either Programmable Read Only Memory devices (PROMs) or Erasable Programmable Read Only Memory devices (EPROMs). Throughout this section, the term PROM refers to either of these devices unless it specifically excludes one of them. TXPROM is part of the Terminal Executive Development System that runs under the TX990 Operating System.



Functions performed by TXPROM include:

- Copying data from a file to a PROM
- Storing data from a PROM into memory or a file
- Displaying a disc file in PROM format
- Comparing data contained in a PROM with that contained in a file, and indicating any discrepancies.

TXPROM uses predefined control information to store data in or read data from PROM devices. Included with the utility is a set of standard control files that contain the control information for reading and programming PROMs that employ the memory configuration used in the 990 Computer Family. For other applications, the user can modify these control files or create new files using the information supplied in this section.

10.3.1 PROM BURN AND VERIFY. Three steps are required to transfer data from a data file into a PROM. As illustrated in figure 10-1, these steps are:

- 1) Load control and data information from a diskette into separate areas in computer memory.
- 2) Use the information contained in the control area of memory to direct the transfer of data to the PROM to burn-in the data.
- 3) Use the information in the control area of memory to read the contents of the newly programmed ROM and compare the contents of the ROM with the contents of the data in the memory buffer area in memory.

The TXPROM software performs the second and third steps after having been instructed to do so by the operator. The user must, therefore, adequately prepare both the data file and the control file to ensure that TXPROM accurately transfers the data to the PROM. The requirements of each of these files are explained later in this section of the manual.

10.3.2 PROM READ OPERATION. A PROM read operation requires TXPROM to perform two steps, as illustrated in figure 10-2:

- 1) Use the information contained in a control file to read data from a ROM and store the data in the memory buffer area.
- 2) Store the information from the memory buffer area into a diskette data file as directed by the user.

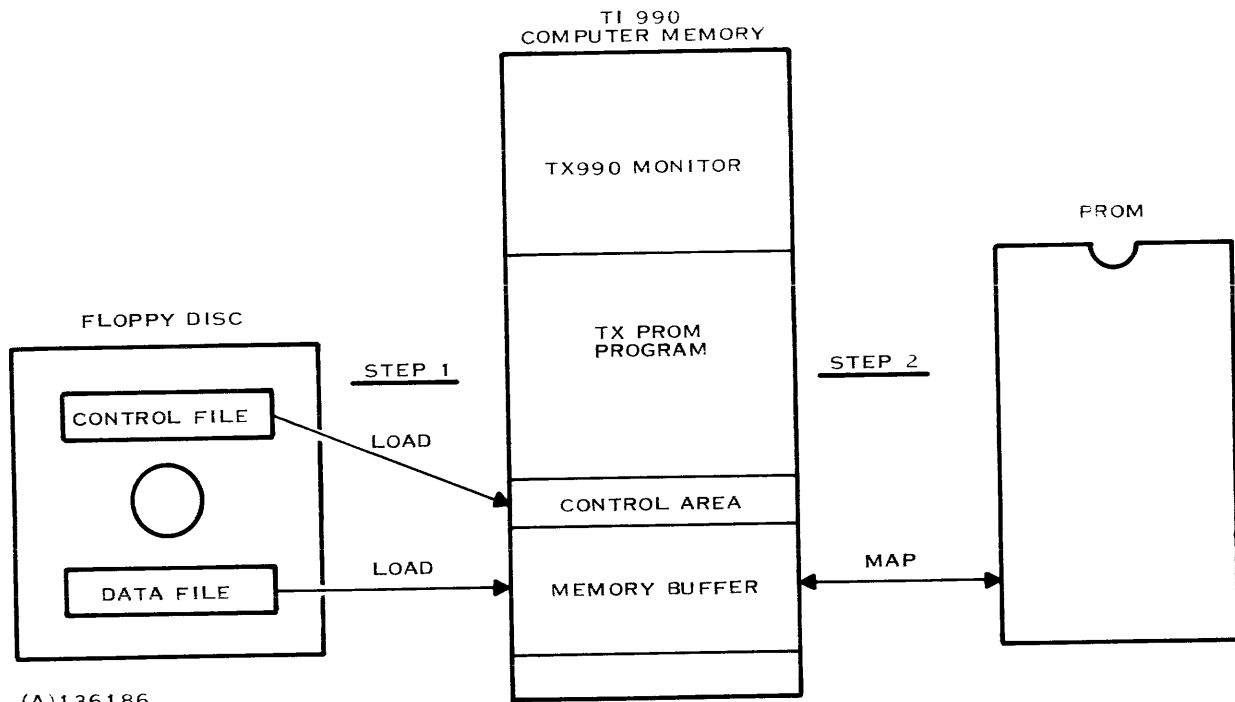

(A)136186

Figure 10-1. PROM Burn, Compare Operation

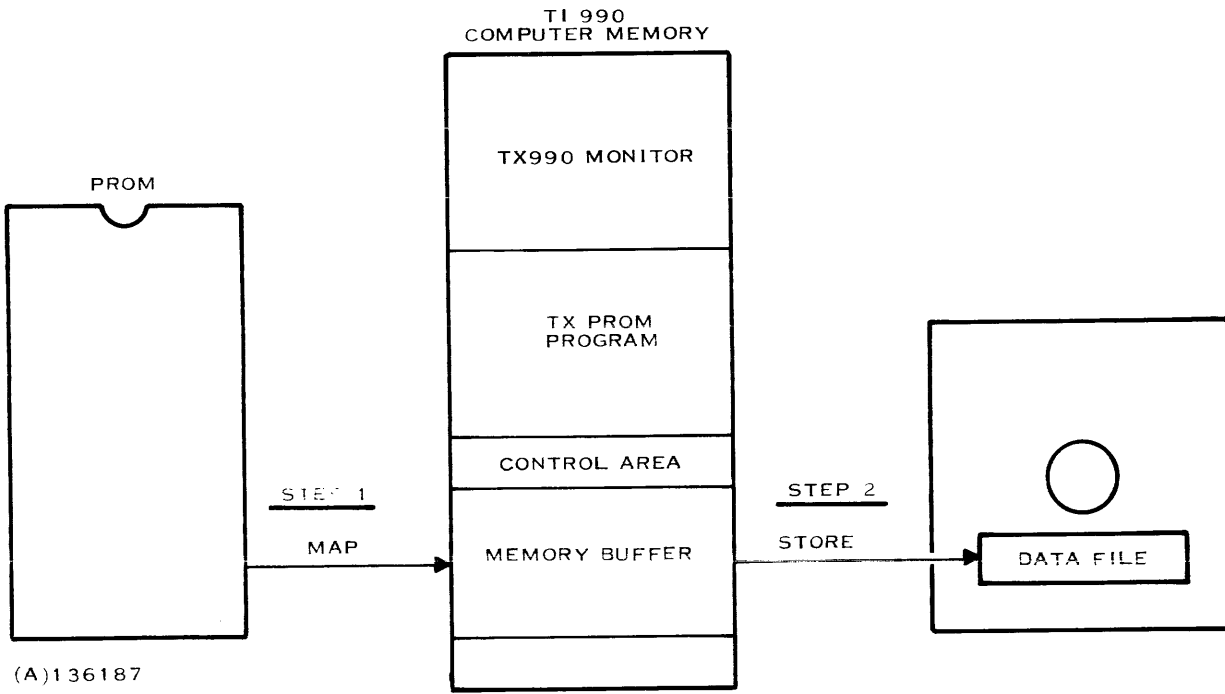

(A)136187

Figure 10-2. PROM Burn, Compare and Read Operation



The transfer of data from the memory buffer to the data file is performed on a word-for-word basis in binary-object format. The previous contents of the data file are lost. The data from the PROM can be read into memory without being stored in an output file by specifying "DUMMY" as the output file. This method can be used for preliminary inspection of ROM data, as well as for data file formatting. For example, to read data from four 4 X 256 PROMs and store it in a 256-word file, the following steps could be used:

- 1) Read the first three half-bytes (4-bit transfers) into the memory buffer using a read operation with DUMMY as the output file. This stores the first twelve bits in memory.
- 2) Read the fourth half-byte into the memory buffer with a read operation that specifies the desired output file. The complete 16-bit word is transferred to the output file.

10.4 LOADING TXPROM

TXPROM is loaded under direction of the TXDS control program. Before loading TXPROM, the diskette containing the software must be inserted into a drive unit and that unit prepared for operation. Since the control program searches all system drives for the requested file, the diskette need not be loaded on a specific drive in multiple drive systems. When initiated, the control program produces the following prompt on the system console:

PROGRAM:

To load TXPROM, respond to this prompt as follows:

PROGRAM: :TXPROM/*<carriage return>

The control program then locates the file containing TXPROM, loads it into memory, and begins execution of TXPROM. Input and output operations will then be directed to the system console during execution of TXPROM. Any other interactive device supported by TXDS may be used. To specify a different device for interaction with TXPROM, respond to the PROGRAM: prompt as follows:

PROGRAM: :TXPROM/*[device]*<carriage return>

10.5 TXPROM OPERATION

When TXPROM is successfully loaded, it prints the following prompt on the selected interactive device:

CONTROL FILE =

The response to this prompt determines which of three modes of operation that TXPROM will enter: control file creation, control file modification, or control file execution. The following paragraphs describe the three modes of operation, provide a general procedure for performing each function, and illustrate each mode with an example.

10.5.1 CONTROL FILE CREATION. The control file creation mode allows the user to create a new control file for a custom application after determining that none of the standard control files satisfies the requirements. The mode is entered by pressing the carriage return key in response to the CONTROL FILE = prompt. In this mode, TXPROM outputs each control file parameter prompt in order, followed by an asterisk (*). The asterisk indicates that the parameter is a variable that must be supplied when the control file is executed. If the parameter is to remain a variable,



press the carriage return key on the terminal to move to the next parameter prompt. If the parameter is to be a predetermined value, type that value and press the carriage return key. The entered value becomes the default value for that parameter. Entered values must be in decimal unless specified otherwise by one of the following prefixes:

- < binary
- ! octal
- > hexadecimal

For example, to enter an octal loop count of 400_8 , the prompt and response appear as:

```
MEM LEV 1 LOOP CNT* !400
```

At any point the remaining parameter prompts may be bypassed, leaving them as variable parameters, by pressing the \wedge (caret) key. TXPROM then proceeds with the file creation mode termination sequence. This sequence is entered either by pressing the caret key or by completing consideration of all parameter prompts. TXPROM then produces the prompt:

```
SAVE UNDER FILE NAME =
```

Entering a floppy disc file name in response to this prompt and then pressing the carriage return causes TXPROM to create a control file with the specified name. That file name can then be used to call the newly created control file for execution. Standard control files are write-protected and cannot be altered. Therefore, choose a file name other than a standard control file name for newly created or modified files. Entering only a carriage return in response to the above prompt creates no new file. The parameters remain in memory until modified, a control file name other than DUMMY is specified, or TXPROM is terminated. The parameters can be accessed by referencing DUMMY as the desired control file for execution or modification.

When the new file name is determined and the carriage return is entered, TXPROM issues the following prompt:

```
EXECUTE, BEGIN OR END
```

The responses to this prompt are as follows (letters in parentheses are optional):

- | | |
|-----------|---|
| EX(ECUTE) | Switch to execution mode and use the newly entered control file parameters for the operation. |
| BE(GIN) | Restart the TXPROM sequence by returning to the CONTROL FILE = prompt. |
| EN(D) | Return to the TXDS control program. |

10.5.2 CONTROL FILE MODIFICATION. The control file modification mode allows the user to modify the contents of a previously created control file. The mode is entered by responding to the CONTROL FILE = prompt with the name of an existing control file without including a parameter list. TXPROM then responds with the prompt:

```
MODIFY OR EXECUTE?
```



Entering the following response places TXPROM in the modification mode (letters in parentheses are optional):

MO(DIFY)

TXPROM then produces the parameter prompts for the control file information as it does in control file creation mode, except that the prompts are followed by the existing values for the parameters. Asterisks indicate variable parameters that must be defined at execution time. The parameters can be changed by typing in the desired value in place of the existing value following each prompt and then pressing a carriage return. The resulting modified control file can replace the original file (if the original file is not a standard control file), can be saved in a new control file, or can be saved in memory only for immediate execution depending upon the response to the SAVE UNDER FILE NAME = prompt. As in the creation mode, pressing the ^ (caret) key at any time skips over the remaining parameters without changing their values. When the SAVE UNDER FILE NAME = prompt has been satisfied and a carriage return entered, TXPROM again produces the following prompt:

EXECUTE, BEGIN OR END

Responses to this prompt are identical to those for creation mode.

10.5.3 CONTROL FILE EXECUTION. The control file execution mode allows the user to program a PROM using the parameters in an existing control file. The control file may be one of the supplied standard control files, or a custom generated file produced using the file creation mode of TXPROM. The execution mode is entered by responding to the CONTROL FILE = prompt with the name of an existing control file, or by responding with the name of an existing control file and its parameter list. If only a control file name is specified (without the parameter list), TXPROM responds with the prompt:

MODIFY OR EXECUTE?

Entering the following response places TXPROM in the execute mode (letters in parentheses are optional):

EX(ECUTE)

A parameter list is not required because TXPROM generates prompts for all missing parameters. However, if parameters are included, they must be in the order specified in table 10-1. The parameter list contains a string of values separated by commas and enclosed in parentheses following the file name. For example, the following reply to the CONTROL FILE = prompt illustrates the parameter list:

DSC:S287(DSC2:DATA, 2, 0, 0, 4, 16)<cr>

control file data file TS FR code mem lev 1 bit step

CM PR after mem start addr mem start bit



Table 10-1. Table of Control File Parameter Prompts

| Parameter Prompt | Possible Value | Description |
|-----------------------|-------------------------|---|
| DATA FILE = | TX990 Pathname | Name of data file |
| DATA BIAS = | * | Value to add to relocatable code in object modules |
| TSFR CODE = | 0 to 2 | Transfer code: 0 nothing, 1 burn PROM, 2 read PROM |
| CMPR AFTER = | 0, 1 | Compare after: 0 nothing, 1 compare PROM and memory |
| MEM DISP = | 0, 1 | Memory display: 0 nothing, 1 display memory |
| PROM DISP = | 0, 1 | PROM display: 0 nothing, 1 display PROM |
| MEM START ADDR = | * | Memory bound low (address) |
| # MEM BYTES = | * | Memory bytes to be transferred |
| MEM START BIT = | * | Memory beginning bit |
| PROM START ADDR = | * | PROM bound low (address) |
| # PROM WORDS = | * | PROM words to be transferred |
| PROM START BIT = | * | PROM beginning bit |
| **MEM MAP LEVELS = | 1 to 3 | Number of memory mapping levels |
| MEM LEV 1 BIT STEP = | 0 to 7FFF ₁₆ | Number of bits skipped between loops |
| LOOP COUNT = | 1 to 32,767 | Number of repetitions of loop 1 |
| 2 BIT STEP = | 0 to 7FFF ₁₆ | |
| LOOP COUNT = | 0 to 32,767 | |
| 3 BIT STEP = | 0 to 7FFF ₁₆ | |
| LOOP COUNT = | 1 to 32,767 | |
| **PROM MAP LEVELS = | 1 to 3 | Number of PROM mapping levels |
| PROM LEV 1 BIT STEP = | 0 to 7FFF ₁₆ | Number of bits skipped between loops |
| LOOP COUNT = | 1 to 32,767 | Number of repetitions of loop 1 |
| 2 BIT STEP = | 0 to 7FFF ₁₆ | |
| LOOP COUNT = | 1 to 32,767 | |
| 3 BIT STEP = | 0 to 7FFF ₁₆ | |
| LOOP COUNT = | 1 to 32,767 | |
| TSFR BIT WIDTH = | 1 to 8 | Transfer bit string width |
| PROM BITS/WORD = | 1 to 8 | |
| PROG 0's OR 1's = | 0, 1 | Program zero's or one's |
| PULSE WIDTH = | 1 to 6 | Programming pulse width |
| DUTY CYCLE = | 0 to 100 | % of time used in program device |
| NO. RETRIES = | 0 to FFFF ₁₆ | Number of retries |
| SIMUL PROG'BLE BITS = | 1 to 8 | Number of simultaneously programmable bits |
| CRU BASE = | 0 to 1FFE ₁₆ | Base CRU address for PROM interface card |

*Any value 0 to 7FFF₁₆; however, some parameters interact with each other to create other limitations. See text.



All numeric parameters are expected to be in decimal notation, but can be in octal, binary or hexadecimal if preceded by the proper prefix as described in the file creation description. When TXPROM enters the execute mode, it scans the contents of the control file and selects the required variable parameters. If a variable parameter list was supplied, the supplied values are filled into the control file data. If additional values are required or if no list was supplied, then TXPROM generates prompts for each required parameter.

TXPROM then checks all parameters for boundary violations. If any value is out of bounds, TXPROM generates a prompt for that value to be changed by the user.

When all parameters have been verified, the control file is executed. All interrupts are disabled during actual data transfer between PROM and memory. When execution is complete, TXPROM generates the following messages:

```
SUCCESSFUL EXECUTION
REPEAT, BEGIN OR END?
```

Proper responses to this message are as follows (letters in parentheses are optional):

```
RE(PEAT)    Repeat the execution process (for burning more than one PROM)
BE(GIN)     Return to the CONTROL FILE = prompt at the start of TXPROM
EN(D)       Return to the TXDS Control program.
```

10.6 DATA FILES

TXPROM uses data files to store formatted data on diskette or in computer memory. The data is in object format as described in the Assembly Language Programmer's Guide. The data in the files may be burned into a PROM or compared to the data already in a PROM. Data files are created either by an assembly, by the link editor, or by reading a PROM and storing the contents in a file. When the data is transferred from the file to a PROM, the data is treated as a series of ascending addressed locations each 16 bits long. Each 16-bit word is selected from the file according to control parameters in the control file (Memory Starting Address Number of Memory Bytes, Memory Start Bit, Memory Level n Bit Step, and Memory n Level Loop Count). The data may then be transferred to the PROM according to other control file parameters so that each bit in the data file can be stored separately in the PROM.

10.7 CONTROL FILES

TXPROM uses control files to determine the pattern that data in data files will be stored in a PROM. The data is not necessarily transferred to the PROM as an exact image of the data file. Instead, the parameters of the control file allow each bit, or group of bits, of the data file to be mapped to a separate location in the PROM. Table 10-1 lists each of the parameters in the control file along with the range of values for each parameter. In the file creation phase, TXPROM produces control file parameter prompts for user response. No default values exist during creation mode. In the file modification phase of a PROM programming sequence, TXPROM allows the user to change the control file parameters after issuing the prompts listed in the table. The user can then select the default value with a carriage return or enter a new value. The default values for each standard control file are listed later in this section. The following paragraphs describe the use and function of each control file parameter.

10.7.1 DATA FILE NAME. The data file name is an alphanumeric parameter that specifies the name of the floppy disc data file to be used during the current operation. The file name may also be the name of an input file from a 733 ASR cassette drive; however, the cassette cannot be used as an output file to store information from a PROM read operation because the output format is not cassette compatible. To indicate that no data file is to be used, enter the file name, DUMY.



This specification allows information to be read from a PROM into memory without being stored in a data file. During the initiation sequence, TXPROM allows the user to enter the data file name after it issues the following prompt:

DATA FILE =

No default value exists for this parameter in the standard control files.

10.7.2 DATA BIAS. The data bias parameter allows a pre-existing object module to be loaded into memory at a simulated load point that is displaced (biased) from the normal load point of zero. The actual load point in memory of the file is unaffected by this parameter. Typically, the data bias is the same as the base address of the data in the target system in which the PROM is to be used. The value of the data bias is added to each word that is marked as relocatable by the assembler or link editor. TXPROM accesses the data as if it were loaded in memory, starting at the data bias value. Therefore, the memory starting address parameter must be consistent with the addressing used in the biased file. For example, a program that is 1000_{16} bytes long and is loaded with a data bias of 500_{16} must have its memory starting address parameter within the range of 500_{16} to $14FF_{16}$. TXPROM allows the user to enter the data bias after it issues the following prompt:

DATA BIAS =

The default value for this parameter in the standard control files is zero (no displacement).

10.7.3 TRANSFER CODE. The transfer code parameter defines the operation to be performed with the PROM device. The code is one of the following three values:

- 0 No operation
- 1 Transfer data from specified data file to PROM
- 2 Read data from PROM and store in specified data file

TXPROM allows the user to enter the transfer code parameter after it issues the following prompt:

TSFR CODE =

The default value for this parameter in control files :E2704B, :E2708B, and :E2716B is 1 (PROM burn operation). There is no default value for the other standard control files.

10.7.4 COMPARE AFTER. The compare after parameter allows the user to enable (1) or disable (0) a comparison of the PROM data with the data file data following either a burn or a read operation. If the comparison is successful, TXPROM proceeds to the next operation. If the comparison fails, TXPROM displays the memory byte address, the PROM address, and the two bit strings in the following format:

>Mxxxx.yy=zz Raaaa.bb=cc

Refer to the description of memory display and PROM display later in this section for an explanation of the display formats. TXPROM allows the user to enter the compare after parameter after it issues the following prompt:

CMPR AFTER =



- The default value for this parameter in control files :E2704B, :E2708B, and :E2716B is 0 (disable comparison). There is no default value for the other standard control files.

10.7.5 MEMORY DISPLAY. The memory display parameter allows the user to select a display of the memory data file on the data terminal being used. This parameter may be either a 1 to enable memory display, or a 0 to inhibit memory display. If the memory display parameter is equal to a 1, the memory region containing the data file is displayed in the following format:

Mxxxx. yy=zz

In this notation, the letters have the following significance:

- M = Designates a memory display
- xxxx = Memory byte address
- yy = Displacement of start of bit string within memory byte ($0 \leq yy \leq 7$)
- zz = The value of the bit string in hexadecimal notation when right-justified within an 8-bit field.

A maximum of four entries are displayed on each output line of the terminal. For example, a memory display value of:

M000B. 00=5A

indicates that the bit string at byte address $000B_{16}$ that begins with the first bit of that byte has a value of $5A_{16}$. TXPROM allows the user to enter the memory display parameter after it issues the following prompt:

MEM DISP =

The default value for this parameter in the standard control files is zero (no display).

10.7.6 PROM DISPLAY. The PROM display parameter allows the user to select a display of the PROM contents being burned or read. The display appears on the data terminal being used to initiate TXPROM during the execution of the program. This parameter may be either a 1 to enable PROM display, or a 0 to inhibit PROM display. If the PROM display parameter is equal to a 1, the PROM region is displayed in the following format:

Raaaa. bb=cc

In this notation, the letters have the following significance:

- R = Designates a ROM or PROM display
- aaaa = PROM/ROM word address
- bb = Displacement of start of bit string within PROM word ($0 \leq bb \leq 7$)
- cc = The value of the bit string in hexadecimal notation when right-justified within an 8-bit field.



A maximum of four entries are displayed on each output line of the terminal. For example, a PROM display of

R00E1.00=7A

indicates that the bit string at PROM word address $00E1_{16}$, that begins the first bit of that byte, has a value of $7A_{16}$. TXPROM allows the user to enter the PROM display parameter after it issues the following prompt:

PROM DISP =

The default value for this parameter in the standard control files is zero (no display).

10.7.7 MEMORY STARTING ADDRESS. The memory starting address parameter indicates the starting address in memory of the first bit string to be transferred to the PROM or to be read from the PROM. If the object module is relocatable, the memory starting address is an absolute memory address. TXPROM allows the user to change the memory starting address parameter by producing the following prompt:

MEM START ADDR =

No default value exists for this parameter in the standard control files.

10.7.8 NUMBER OF MEMORY BYTES. This parameter indicates the number of bytes to be transferred from or to memory during the PROM operation. TXPROM adds this value to the memory starting address to create a range of addresses in memory for the transfer operation. If TXPROM tries to access a bit string outside this range of addresses, an error is indicated. TXPROM allows the user to change the memory bytes parameter by producing the following prompt:

MEM BYTES =

The default value for this parameter varies with the particular standard control file.

10.7.9 MEMORY STARTING BIT. This parameter indicates the starting bit address relative to the starting byte (indicated by memory starting address) of the bit string to be transferred during the operation. The value of this parameter may be any positive magnitude; however, if the value exceeds 7, the starting bit will be located beyond the starting byte indicated by the memory starting address. TXPROM allows the user to enter the memory starting bit after it issues the following prompt:

MEM START BIT =

No default value exists for this parameter in the standard control files.

10.7.10 PROM STARTING ADDRESS. The PROM starting address parameter indicates the starting word address in PROM of the first bit string to be burned or to be read. TXPROM allows the user to enter the PROM starting address after it issues the following prompt:

PROM START ADDR =

The default value for this parameter in the standard control files is 0.



10.7.11 NUMBER OF PROM WORDS. This parameter indicates the number of PROM words that will be processed during the current operation. TXPROM adds this value to the PROM starting address to create a range of addresses in PROM for the transfer operation. If TXPROM tries to access a bit string outside this range of addresses, an error is indicated. TXPROM allows the user to enter the PROM words parameter after it issues the following prompt:

PROM WORDS =

The default value for this parameter varies with the particular standard control file.

10.7.12 PROM STARTING BIT. This parameter indicates the starting bit address relative to the starting word address (indicated by PROM starting address) of the bit string to be processed. The value of this parameter may be any positive magnitude; however, if the value exceeds the word size for the PROM device type being used, the starting bit is located beyond the starting word indicated by the PROM starting address. TXPROM allows the user to enter the PROM starting bit after it issues the following prompt:

PROM START BIT =

The default value for this parameter in the standard control files is 0.

10.7.13 MEMORY MAPPING LEVELS. The memory mapping levels parameter specifies the number of loop levels to be used in mapping data from memory into the PROM device. The number of levels may be 1, 2 or 3. Refer to the discussion of Bit String Mapping later in this section for complete information about the use of this parameter. If this parameter is 1, then the loop count for levels 2 and 3 are automatically set to 1. TXPROM allows the user to enter the memory mapping levels parameter after it issues the following prompt:

**MEM MAP LEVELS =

Enter a value of 1 for all standard control files except :E2704B, :E2708B, and :E2716B. For these files, enter a value of 2.

10.7.14 MEMORY LEVEL n BIT STEP. This parameter determines the number of bits that are skipped between successive bit addresses when performing a level n (n = 1, 2, or 3) mapping loop. For example, to access only the even-numbered bits (or the odd-number bits) this parameter is set to a value of 1. This value causes a skip of one bit between each bit accessed. TXPROM allows the user to enter this parameter for each of the three possible mapping levels after it issues the following prompt(s) (only the prompts for the number of levels selected in the memory mapping levels parameter are produced):

MEM LEV 1 BIT STEP =

or

MEM LEV 2 BIT STEP =

or

MEM LEV 3 BIT STEP =



The default value for the level 2 and 3 parameters in the standard control files is zero. There is no default value for the level 1 parameter in the standard control files.

10.7.15 MEMORY LEVEL *n* LOOP COUNT. This parameter determines the number of iterations that are performed of the level *n* (*n*=1, 2 or 3) mapping loop. The value may be within the range of 0 to FFFF₁₆. TXPROM allows the user to enter this parameter for each of the three possible mapping levels after it issues the following prompts (only the prompts for the number of levels selected in the memory mapping levels parameter are produced; all other levels are set to one:

MEM LEV 1 LOOP COUNT =

or

MEM LEV 2 LOOP COUNT =

or

MEM LEV 3 LOOP COUNT =

The default value for each of these parameters in the standard control files varies with the selected control file.

10.7.16 PROM MAPPING LEVELS. The PROM mapping levels parameter specifies the number of loop levels to be used when mapping data into the PROM. The number of levels may be 1, 2 or 3. Refer to the discussion of Bit String Mapping later in this section for complete information about the use of this parameter. If this parameter is 1, then the loop count for levels 2 and 3 are automatically set to 1. TXPROM allows the user to enter the PROM mapping levels parameter after it issues the following prompt:

**PROM MAP LEVELS =

When responding to this prompt, enter a value of 1 for each standard control file except :E2704B, :E2708B, and :E2716B. These files require a response of 2.

10.7.17 PROM LEVEL *n* BIT STEP. This parameter determines the number of bits that are skipped between successive bit addresses when performing a level *n* (*n* = 1, 2 or 3) mapping loop. For example, to burn every other bit in a PROM (either the odd or even bit addresses) this parameter is set to a value of 1. This value causes a skip of one bit between each bit operated on in the PROM. TXPROM allows the user to enter this parameter for each of the three possible mapping levels after it issues the following prompt(s) (only the prompts for the number of levels selected in the PROM mapping levels parameters are produced):

PROM LEV 1 BIT STEP =

or

PROM LEV 2 BIT STEP =

or

PROM LEV 3 BIT STEP =



The default value for level 1 in the standard control file :S287 is 4; all other standard control files have a default value of 8.

The default value for levels 2 and 3 for this parameter in the standard control files is zero. This value causes TXPROM to access every consecutive bit in the PROM.

10.7.18 PROM LEVEL n LOOP COUNT. This parameter determines the number of iterations that are performed of the level n (n = 1, 2, or 3) mapping loop. The value may be any number from 1 to 32767. TXPROM allows the user to enter this parameter for each of the three possible PROM mapping levels after it issues the following prompt(s) (only the prompts for the number of levels selected in the PROM mapping levels parameter are produced; all other levels are set to one):

PROM LEV 1 LOOP COUNT =

or

PROM LEV 2 LOOP COUNT =

or

PROM LEV 3 LOOP COUNT =

The default value for each of these parameters in the standard control files varies with the selected control file.

10.7.19 TRANSFER BIT WIDTH. The transfer bit width designates the number of bits that are to be transferred in each bit string. This parameter applies to both the memory and the PROM portions of the operation. TXPROM allows the user to change the transfer bit width by producing the following prompt:

TSFR BIT WIDTH =

The default value for this parameter in standard control file :S287 is 4; all other standard control files have a default value of 8.

10.7.20 PROM BITS PER WORD. This parameter specifies the number of bits in each word of the PROM device being used. It should match the architecture of the PROM device. TXPROM allows the user to change this parameter by producing the following prompt:

PROM BITS/WORD =

The default value for this parameter in standard control file :S287 is 4; all other standard control files have a default value of 8.

10.7.21 PROGRAM ZEROS OR ONES. This parameter indicates whether the PROM device begins as all zeros and must be programmed by burning ones, or if it begins as all ones and must be programmed by burning zeros. The *PROM Programmer Installation and Operation Manual* contains a table of initial conditions for all devices that can be programmed with that unit. This parameter should be set to a 1 if a high-level programming pulse (programmed with ones) is required, and to a 0 if a low-level programming pulse (programmed with zeros) is required. TXPROM allows the user to change this parameter by producing the following prompt:

PROG 0'S OR 1'S =



The default value for this parameter in the standard control files varies with the control file selected.

10.7.22 PULSE WIDTH. The pulse width parameter is a code that designates the duration of the programming pulse to be used with the selected PROM device. Table 10-2 lists and defines these codes. Table 10-3 lists the programming pulses required for some commonly used PROM devices. The pulse width is the length of time that power is applied to the PROM device to burn simultaneously programmable bits. TXPROM allows the user to change the value of this parameter by producing the following prompt:

PULSE WIDTH =

The default value for this parameter in the standard control files varies with the control file selected.

Table 10-2. Pulse Widths

| Pulse Width Code | Pulse Width (ms) |
|------------------|------------------|
| 1 | 0.5 |
| 2 | 1.0 |
| 3 | 2.0 |
| 4 | 4.0 |
| 5 | 8.0 |
| 6 | 16.0 |

$$\text{Pulse Width} = 2^{\text{code}} * (.25) \text{ms}$$

Table 10-3. Minimum, Standard and Maximum Pulse Widths and Duty Cycles

| PROM Types | Pulse Width (ms) | | | Duty Cycle | | |
|--|------------------|----------|---------|------------|----------|---------|
| | Minimum | Standard | Maximum | Minimum | Standard | Maximum |
| TTL | | | | | | |
| 188A, S188, S288, S287, S387, S470, S471, S472, S473 | 1 | 2 | 20 | | 25% | 35% |
| EPROMs | | | | | | |
| 2704, 2708, 2716 | 0.1 | 0.1 | 1 | | 50% | 50% |

Note: TTL PROM types have the prefix SN74.



10.7.23 DUTY CYCLE. The duty cycle parameter indicates the percentage of the programming cycle time that it actually used for burning the PROM. The total programming cycle consists of a programming (burn) phase and a rest phase. The duty cycle value (between 0 and 100) represents the maximum percentage of total time that the programming pulse can be active. Table 10-3 lists the duty cycle requirements of some commonly used PROM devices. TXPROM allows the user to change this parameter to match the requirements of the PROM device being used by producing the following prompt:

DUTY CYCLE =

The default value for this parameter in the standard control files is 25 for PROMs and 50 for EPROMs.

10.7.24 NUMBER OF RETRIES. This parameter indicates the number of times that TXPROM will try to program a specific set of bits without success using the normal pulse width. If the first attempt to program a set of bits in a PROM device fails, TXPROM repeats the programming cycle for that set of bits until the correct data is transferred or the number of retries count is depleted. TXPROM allows the user to change this parameter by producing the following prompt:

NO. RETRIES =

The default value for this parameter in the standard control files is zero.

10.7.25 SIMULTANEOUSLY PROGRAMMABLE BITS. This parameter indicates the number of bits in the PROM device that can be programmed with the same programming pulse. This parameter is a physical restriction of the type of PROM device. Bipolar devices require that only one bit be programmed at a time; EPROMs require that an entire EPROM word be programmed simultaneously. TXPROM allows the user to change this parameter by producing the prompt:

SIMUL PROG'BLE BITS =

The default value for this parameter in the standard control files is 1 for PROMs and 8 for EPROMs.

10.7.26 CRU BASE. The CRU base parameter of the control file defines the CRU base address to be used to select the PROM Programmer interface card. For standard applications, the interface card responds to base address 20_{16} . If the interface card is installed in a chassis location other than the standard slot, the CRU base parameter must be changed. TXPROM allows the user to enter the CRU base after it issues the following prompt:

CRU BASE =

The default value for this parameter in the standard control files is 20_{16} .

10.8 BIT STRING MAPPING

The software uses the memory and PROM mapping parameters to determine the addresses of the bit strings to be used in the programming cycle. When specifying mapping parameters, the PROM or memory words within the defined bounds are considered to be a continuous string of bits. The memory file is further divided into 16-bit words, while the PROM string is divided into words whose length is determined by the architecture of the device. Mapping is required so that portions of the 16-bit memory words may be programmed into PROMs that have smaller word widths. The mapping parameters include bit step and loop count, as defined previously in this section.

TXPROM allows three levels of bit string mapping: level 1, level 2 and level 3. Level 1 determines successive bit strings in memory or PROM. When the level 1 loop count is exhausted, the initial bit



is incremented as determined by the level 2 bit step and the level 1 mapping is repeated. Each time that the level 1 loop count is exhausted, the level 2 loop count is decremented, the initial bit incremented, and the mapping repeated until the level 2 loop count is exhausted. At that point, the level 3 increment is added to the beginning address, the level 3 loop count is decremented, the loop counts for levels 1 and 2 are restored, and the entire cycle is repeated. When the level 3 loop count is exhausted, cycling is complete. A map cycle for memory bits is completely independent of a map cycle for PROM bits; however, the total number of bits that are mapped in the memory cycle must be equal to the number of bits mapped to a PROM.

10.8.1 LEVEL 1 MAPPING EXAMPLE. Figure 10-3 illustrates an example of level 1 mapping. In the example, the first four bits of each memory word are mapped into the odd-numbered addresses of a 256×4 PROM, (a 128 half-byte transfer). Table 10-4 lists the mapping parameters for both memory and PROM to accomplish the transfer.

10.8.2 LEVEL 2 MAPPING EXAMPLE. Figure 10-4 illustrates an example of level 2 mapping. In the example, the first and the last four bits of each memory word are mapped into a 256×8 PROM (a 256-byte transfer). Table 10-5 lists the mapping parameters for both memory and PROM to accomplish the transfer. The example combines level 2 memory looping with level 1 PROM looping.

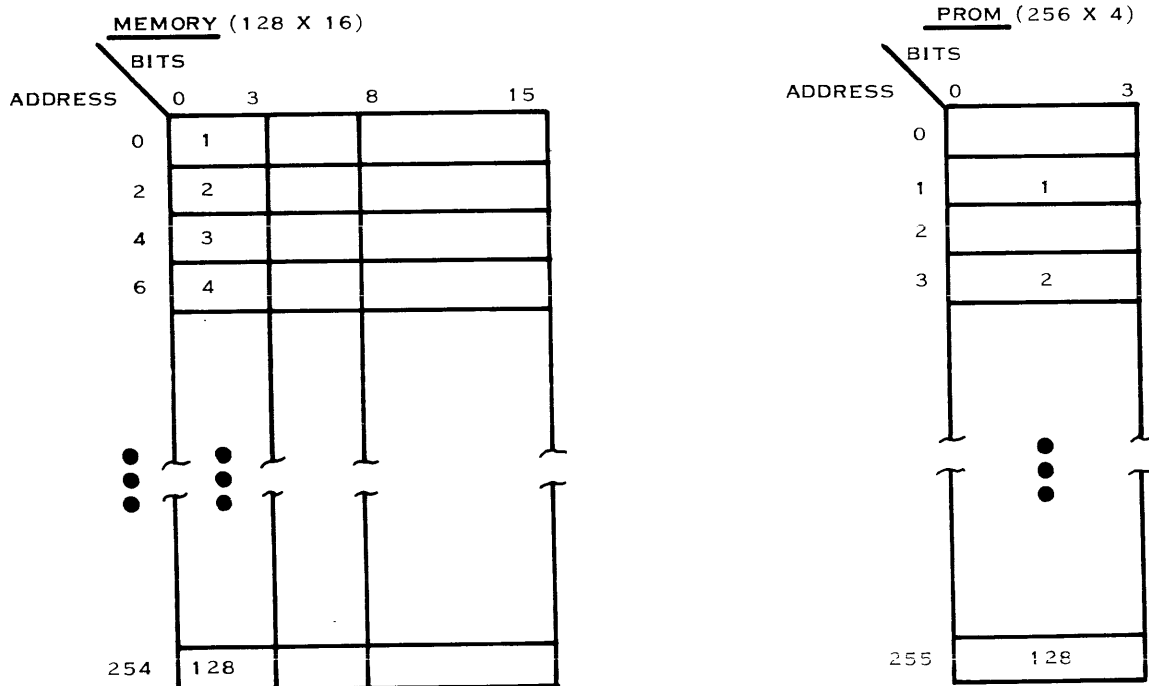

(A)136188

Figure 10-3. Level 1 Mapping Example



Table 10-4. Level 1 Mapping Example Parameters

File (Memory) Mapping Parameters

MEM START ADDR = 0
 # MEM BYTES = 256
 MEM START BIT = 0
 MEM LEV 1 BIT STEP = 16
 MEM LEV 1 LOOP CNT = 128
 MEM LEV 2 BIT STEP = 0
 MEM LEV 2 LOOP CNT = 1
 MEM LEV 3 BIT STEP = 0
 MEM LEV 3 LOOP CNT = 1

PROM Mapping Parameters

PROM START ADDR = 0
 # PROM WORDS = 256
 PROM START BIT = 4
 PROM LEV 1 BIT STEP = 8
 PROM LEV 1 LOOP CNT = 128
 PROM LEV 2 BIT STEP = 0
 PROM LEV 2 LOOP CNT = 1
 PROM LEV 3 BIT STEP = 0
 PROM LEV 3 LOOP CNT = 1

TRANSFER BIT WIDTH = 4

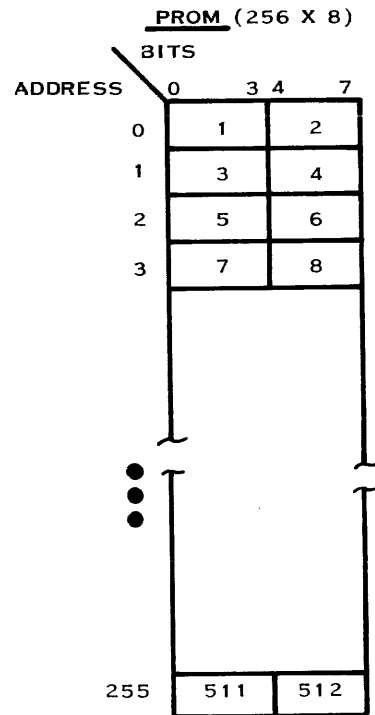
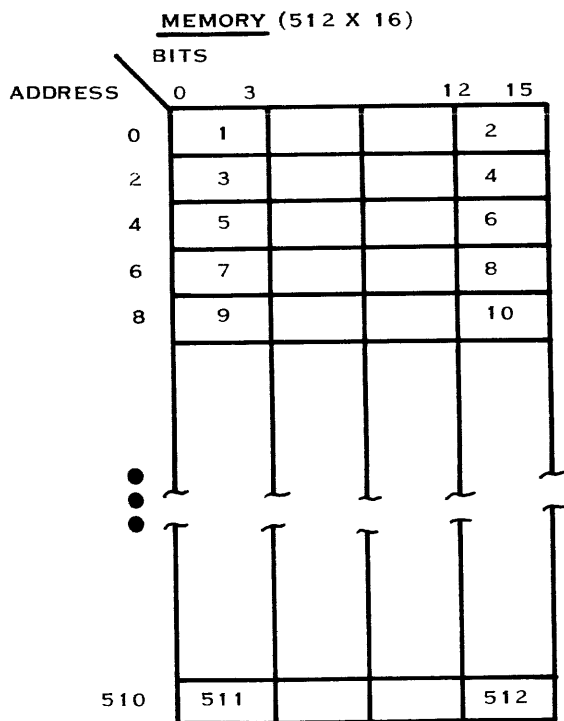

(A)136189

Figure 10-4. Level 2 Mapping Example



Table 10-5. Level 2 Mapping Example Parameters

| File (Memory) Mapping Parameters | PROM Mapping Parameters |
|----------------------------------|---------------------------|
| MEM START ADDR = 0 | PROM START ADDR = 0 |
| #MEM BYTES = 512 | #PROM WORDS = 256 |
| MEM START BIT = 0 | PROM START BIT = 0 |
| MEM LEV 1 BIT STEP = 12 | PROM LEV 1 BIT STEP = 4 |
| MEM LEV 1 LOOP CNT = 2 | PROM LEV 1 LOOP CNT = 512 |
| MEM LEV 2 BIT STEP = 16 | PROM LEV 2 BIT STEP = 0 |
| MEM LEV 2 LOOP CNT = 256 | PROM LEV 2 LOOP CNT = 1 |
| MEM LEV 3 BIT STEP = 0 | PROM LEV 3 BIT STEP = 0 |
| MEM LEV 3 LOOP CNT = 1 | PROM LEV 3 LOOP CNT = 1 |
| TRANSFER BIT WIDTH = 4 | |

10.8.3 LEVEL 3 MAPPING EXAMPLE. Figure 10-5 illustrates an example of level 3 mapping. In the example, the first and the last four bits of each memory word are mapped into the first 256 words of a 1024 X 8 PROM. The mapping of the memory words is then repeated three more times to fill the 1024 words of the PROM. Table 10-6 lists the mapping parameters for both memory and PROM to accomplish the transfer.

10.9 STANDARD CONTROL FILES

The TXPROM software includes a set of standard control files. The files contain parameters that can be used without modification to program most PROM devices commonly used with the PROM programming system. Table 10-7 lists the standard control files along with their contents. For special applications, these files can also be used as the basis for building a custom control file, rather than creating a new file. EPROM devices have two control files: the file with the letter B suffix is for burn cycles and the file with no suffix is for reads. EPROM devices require repeated programming cycles to implant the charge. The EPROM "B" files automatically repeat the programming cycle to allow for this requirement. The standard control files reside on the same diskette as the TXPROM software.

10.10 VARIABLE PARAMETERS

None, any, or all of the parameters in a control file can be made into variable parameters by entering a value of * for each parameter prompt when the control file is created or modified. The values for these parameters are not stored in the control file but must be entered in at execution time (whenever the control file name is requested). Variable parameters allow frequently changed parameters (like DATA FILE name) to be easily inserted, nonpermanently, into control file parameters.

For example, the Standard Control file for 74287 bipolar TTL PROM devices was created with the following variable parameters: DATA FILE, TSFR CODE, CMPR AFTER, MEM START ADDR, MEM START BIT, MEM LEV 1 BIT STEP. To use the standard control file, the user must respond to the control file prompt with:

```
DSC:S287(<data file>,<tsfr code>,<cmpr after>,<mem start addr>,<mem start bit>,<mem lev 1 bit step>).
```

The parameters inside the angle brackets, < >, must be supplied with the desired values. If no parameters are entered, TXPROM generates prompts to ask for the information.

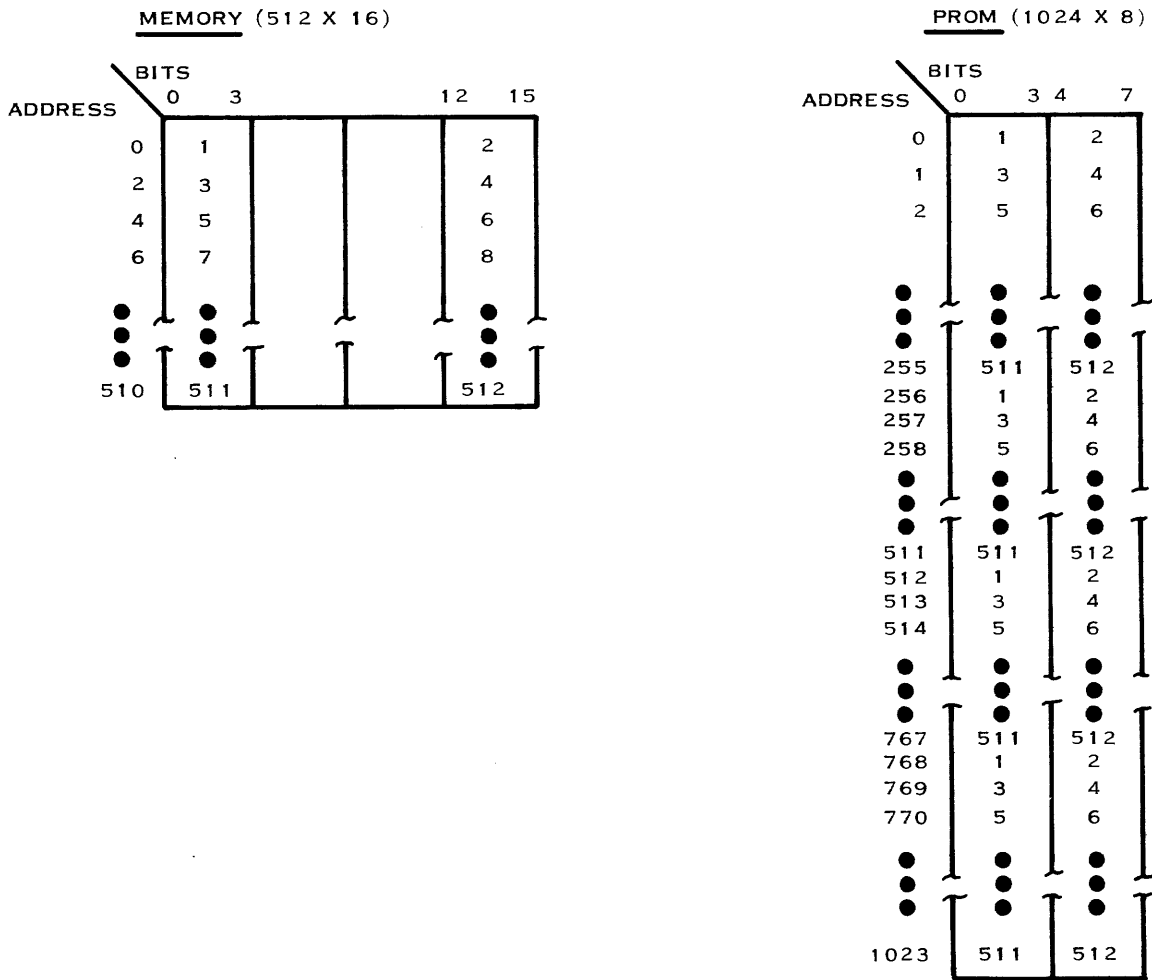

(A)136190

Figure 10-5. Level 3 Mapping Example



Table 10-6. Level 3 Mapping Example Parameters

| File (Memory) Mapping Parameters | PROM Mapping Parameters |
|----------------------------------|----------------------------|
| MEM START ADDR = 0 | PROM START ADDR = 0 |
| # MEM BYTES = 512 | # PROM WORDS = 1024 |
| MEM START BIT = 0 | PROM START BIT = 0 |
| MEM LEV 1 BIT STEP = 12 | PROM LEV 1 BIT STEP = 4 |
| MEM LEV 1 LOOP CNT = 2 | PROM LEV 1 LOOP CNT = 1024 |
| MEM LEV 2 BIT STEP = 16 | PROM LEV 2 BIT STEP = 0 |
| MEM LEV 2 LOOP CNT = 256 | PROM LEV 2 LOOP CNT = 1 |
| MEM LEV 3 BIT STEP = 0 | PROM LEV 3 BIT STEP = 0 |
| MEM LEV 3 LOOP CNT = 4 | PROM LEV 3 LOOP CNT = 1 |

TRANSFER BIT WIDTH = 4

10.11 PROGRAMMING EPROMS

Since EPROMs are metal-oxide-semiconductor (MOS) devices, they must be programmed in a different manner than TTL PROM devices. EPROMs are charge-storage devices that must be programmed by repetitively transferring charge to EPROM bits. This repetition may be accomplished by looping through the programming process defined by the data configurations. The number of required repetitions to transfer sufficient charge to each bit or bit string is defined by the following formula:

$$100 \text{ ms} = \text{pulse width} \times \text{repetitions.}$$

Therefore, using a pulse width of 0.5 ms, 200 repetitions must be used to successfully program the EPROM. A delay must occur after each attempt to program a bit string before trying to program the same bit string again. This delay allows the charge to diffuse into the EPROM device without a buildup of charge on the surface.

Because of this delay, each bit string of the EPROM should be attempted once before repeating the programming cycle. To ensure this delay, the number of retries parameter for programming each bit string (defined in the control file) must be set to zero. Each bit of the EPROM will not appear to have the correct value (0 or 1) until sufficient charge has been transferred to it.

In the early stages of programming, the bits may not have acquired sufficient charge to have the correct value. This appears as a programming failure if the number of retries is set to a nonzero value, and the bit string will be programmed again without the required delay time. For the same reason, the compare after parameter (defined in the control file) should not be set during the programming cycle, since compare errors will be found in the early stages of programming an EPROM.

Since the programming cycle for an EPROM repeats many times, the display parameter (defined by the control file) should not be set during the programming cycle. Setting the display parameters prints the memory or PROM data for each repetition. Therefore, to program, compare and display, the process must be done in two steps. First, the parameters must be set to zero to program, and after completion of EPROM programming, the parameters may be set to enable compare and/or display. The number of repetitions defined must be changed to one before the second step in order to compare and/or display.



Table 10-7. Standard Control Files

| Standard Control File | :S288 | :S287 | :S471 | :S472 | :E2704B | :E2704 | :E2708B | :E2708 | :E2716B | :E2716 |
|-----------------------|-------|-------|-------|-------|---------|--------|---------|--------|---------|--------|
| Data File | * | * | * | * | * | * | * | * | * | * |
| Data Bias | 0 | 0 | 0 | 0 | 0 | 0 | 0 | 0 | 0 | 0 |
| TSFR Code | * | * | * | * | 1 | * | 1 | * | 1 | * |
| CMPR After | * | * | * | * | 0 | * | 0 | * | 0 | * |
| MEM Disp | 0 | 0 | 0 | 0 | 0 | 0 | 0 | 0 | 0 | 0 |
| PROM Disp | 0 | 0 | 0 | 0 | 0 | 0 | 0 | 0 | 0 | 0 |
| MEM Start Addr | * | * | * | * | * | * | * | * | * | * |
| #MEM Bytes | 64 | 512 | 512 | 1024 | 1024 | 1024 | 2048 | 2048 | 4096 | 4096 |
| MEM Start Bit | * | * | * | * | * | * | * | * | * | * |
| PROM Start Addr | 0 | 0 | 0 | 0 | 0 | 0 | 0 | 0 | 0 | 0 |
| #PROM Words | 32 | 256 | 256 | 512 | 512 | 512 | 1024 | 1024 | 2048 | 2048 |
| PROM Start Bit | 0 | 0 | 0 | 0 | 0 | 0 | 0 | 0 | 0 | 0 |
| MEM Map Levels | ‡ | ‡ | ‡ | ‡ | ‡ | ‡ | ‡ | ‡ | ‡ | ‡ |
| MEM LEV 1 BIT STEP | * | * | * | * | * | * | * | * | * | * |
| Loop Count | 32 | 256 | 256 | 512 | 512 | 512 | 1024 | 1024 | 2048 | 2048 |
| MEM LEV 2 BIT STEP | 0 | 0 | 0 | 0 | 0 | 0 | 0 | 0 | 0 | 0 |
| Loop Count | 1 | 1 | 1 | 1 | 200 | 1 | 200 | 1 | 200 | 1 |
| MEM LEV 3 BIT STEP | 0 | 0 | 0 | 0 | 0 | 0 | 0 | 0 | 0 | 0 |
| Loop Count | 1 | 1 | 1 | 1 | 1 | 1 | 1 | 1 | 1 | 1 |
| PROM Map Levels | ‡ | ‡ | ‡ | ‡ | ‡ | ‡ | ‡ | ‡ | ‡ | ‡ |
| PROM LEV 1 BIT STEP | 8 | 4 | 8 | 8 | 8 | 8 | 8 | 8 | 8 | 8 |
| Loop Count | 32 | 256 | 256 | 512 | 512 | 512 | 1024 | 1024 | 2048 | 2048 |
| PROM LEV 2 BIT STEP | 0 | 0 | 0 | 0 | 0 | 0 | 0 | 0 | 0 | 0 |
| Loop Count | 1 | 1 | 1 | 1 | 200 | 1 | 200 | 1 | 200 | 1 |
| PROM LEV 3 BIT STEP | 0 | 0 | 0 | 0 | 0 | 0 | 0 | 0 | 0 | 0 |
| Loop Count | 1 | 1 | 1 | 1 | 1 | 1 | 1 | 1 | 1 | 1 |
| TSFR Bit Width | 8 | 4 | 8 | 8 | 8 | 8 | 8 | 8 | 8 | 8 |
| PROM Bits/Words | 8 | 4 | 8 | 8 | 8 | 8 | 8 | 8 | 8 | 8 |
| PROG 0's, PROG 1's | 1 | 0 | 1 | 1 | 0 | 0 | 0 | 0 | 0 | 0 |
| Pulse Width | 2 | 2 | 2 | 2 | 1 | 1 | 1 | 1 | 1 | 1 |
| Duty Cycle | 25 | 25 | 25 | 25 | 50 | 50 | 50 | 50 | 50 | 50 |
| Number Retries | 0 | 0 | 0 | 0 | 0 | 0 | 0 | 0 | 0 | 0 |
| SIMUL Prog'ble Bits | 1 | 1 | 1 | 1 | 8 | 8 | 8 | 8 | 8 | 8 |
| CRU Base | >20 | >20 | >20 | >20 | >20 | >20 | >20 | >20 | >20 | >20 |

*Indicates variable parameters; i.e., value must be entered at execution time.

‡A response is required. Enter 2 for :E27048B, :E2708B, and :E2716B. Enter 1 for all other standard control files.



If level n bit string mapping is used to burn an EPROM, the level $(n+1)$'s bit step should be set to 0 and the loop count set to the desired number of repetitions. Note that the standard control files for EPROM burns have level 2 loop counts of 200.

10.12 PROGRAMMING EXAMPLES

The following paragraphs illustrate the control file requirements to successfully program a PROM or EPROM using TXPROM.

10.12.1 EPROM EXAMPLE. The following example programs an 8-word data file vertically to the first 16 locations of a 512×8 EPROM (2704) as illustrated in figure 10-6.

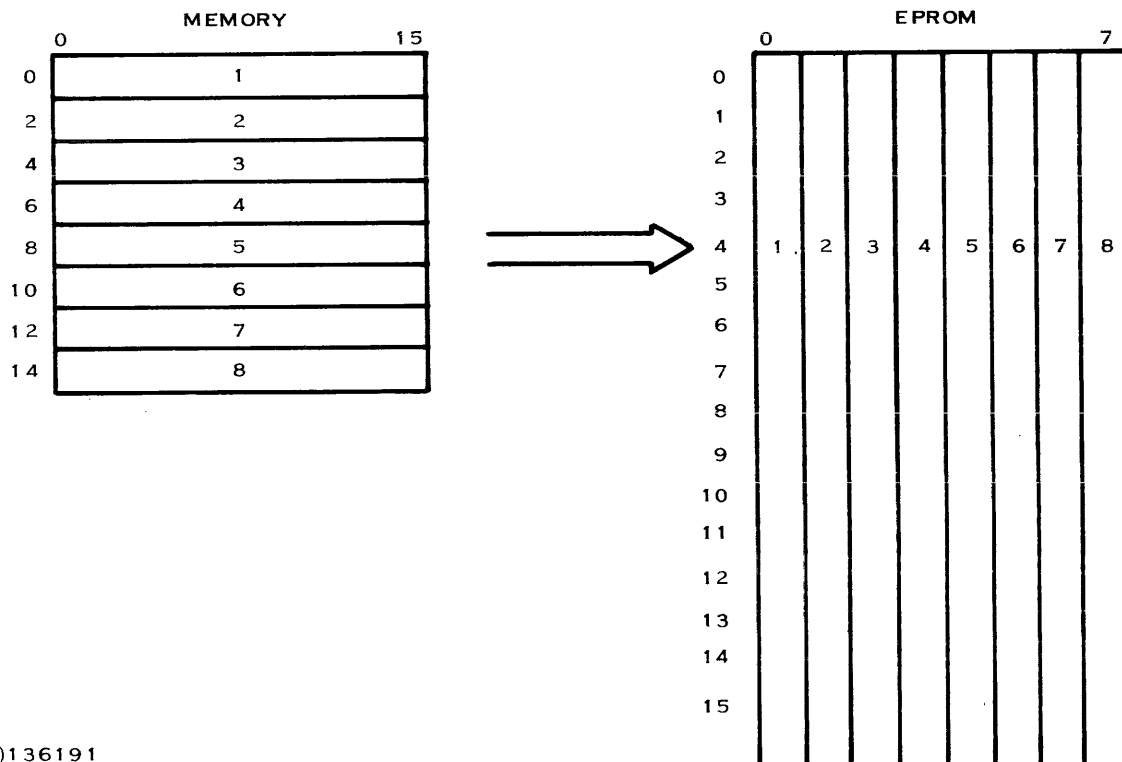

(A)136191

Figure 10-6. EPROM Programming Example



Bits are transferred one at a time from memory to the EPROM. The user creates a control file by modifying the E2704B standard control file. The following parameters are modified:

```

MEM MAP LEVELS = 2
MEM START ADDR = 0
# MEM BYTES = 16
MEM START BIT = 0
MEM LEV 1      BIT STEP = 1
                LOOP COUNT = 256
MEM LEV 2      BIT STEP = 0
                LOOP COUNT = 200
PROM LEVELS = 3
PROM START ADDR = 0
# PROM WORDS = 16
PROM START BIT = 0
PROM LEV 1     BIT STEP = 8           Burns 1 word of memory vertically
                LOOP COUNT = 16
PROM LEV 2     BIT STEP = 1           Positions to next column
                LOOP COUNT = 16
PROM LEV 3     BIT STEP = 0           200 repetitions since EPROM
                LOOP COUNT = 200

```

TRANSFER BIT WIDTH = 1

10.12.2 PROM PROGRAMMING EXAMPLE. Twenty-four 4-bit fields are arranged in 16-bit words of a data file, as shown in figure 10-7. These 24 fields are to be programmed repetitively in the first 384 four-bit words of a 512 X 4 PROM with characteristics similar to a TI SN74S287 (two 287s with a programming adaptor card to make them appear as a 512 X 4 device) as illustrated in figure 10-7.

The user starts with the S287 standard control file and makes the following modifications:

File (Memory) Mapping Parameters

```

MEM START ADDR = 0
# MEM BYTES = 16
MEM START BIT = 0
MEM MAP LEVELS = 3
MEM LEV 1      BIT STEP = 6
MEM LEV 1      LOOP COUNT = 3
MEM LEV 2      BIT STEP = 16
MEM LEV 2      LOOP COUNT = 8
MEM LEV 3      BIT STEP = 0
MEM LEV 3      LOOP COUNT = 16

```

PROM Mapping Parameters

```

PROM START ADDR = 0
# PROM WORDS = 384
PROM START BIT = 0
PROM LEVELS = 1
PROM LEV 1     BIT STEP = 4
PROM LEV 1     LOOP COUNT = 384

```

TRANSFER BIT WIDTH = 4

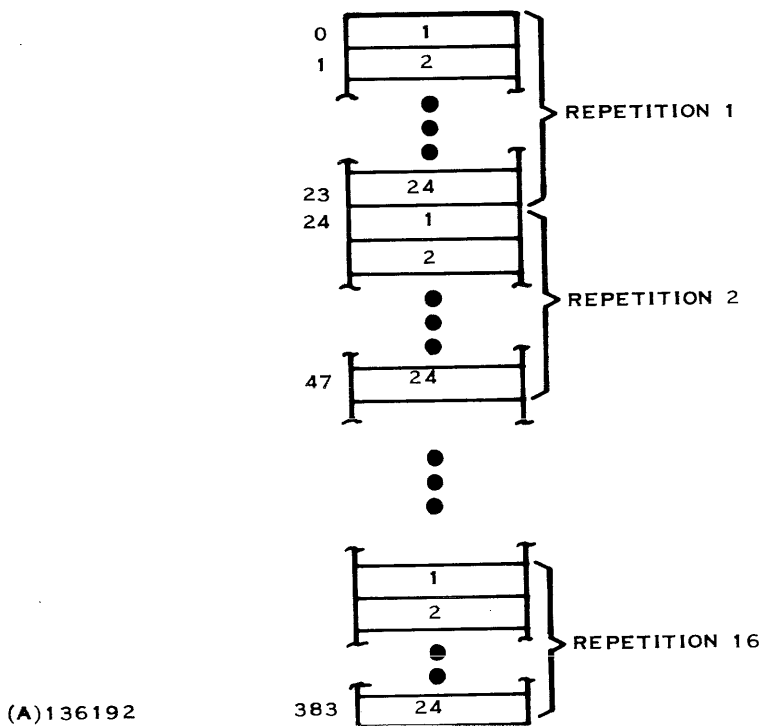
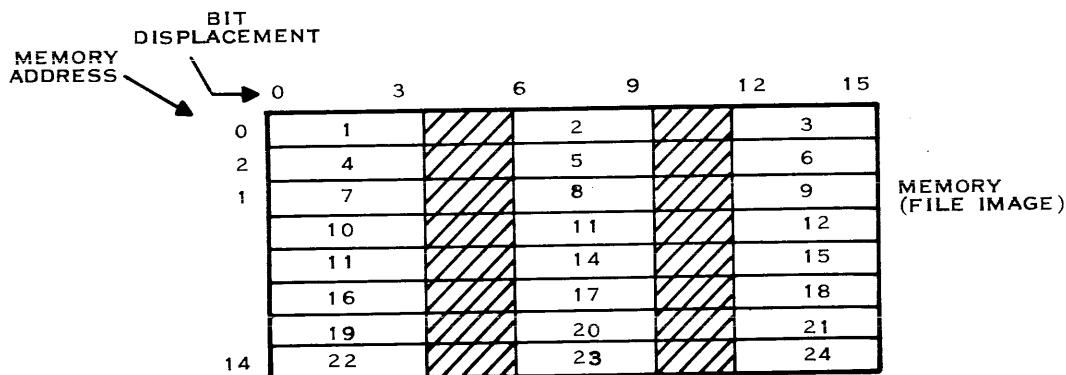

Figure 10-7. PROM Programming Example

10.12.3 CONTROL FILE CHANGE EXAMPLE. The user wishes to change the S471 standard control file so that the parameter DATA BIAS is a variable parameter. The user does the following:

```
CONTROL FILE = DSC:S471<cr>
MODIFY OR EXECUTE? MO<cr>
MODIFICATION MODE
```

```
DATA FILE = *<cr>
DATA BIAS = 0 * <^cr>
```

The user updates the 0 value to "*" and uses the shift ^ to skip the remaining prompts.

```
SAVE UNDER CONTROL FILE NAME=DSC:S471/MOD <cr>
EXECUTE, BEGIN or END? END
```



The modified control file DSC:S471/MOD can now be used instead of the standard control file. The parameters that need be entered for its use are now: DATA FILE, DATA BIAS, TSFR CODE, CMPR AFTER, MEM START ADDR, MEM START BIT, MEM LEV 1 BIT STEP.

10.12.4 EXECUTING A CONTROL FILE EXAMPLE. This example uses the control file created in the previous example to burn a pair of S471 ROMS (256 X 8) from a 256-word relocatable object module named DATA on the disc in drive 2. The ROMS eventually will be stationed at address F000 on a computer memory card.

```
CONTROL FILE =  
DSC:S471/MOD(DSC2:DATA, F000, 1, 1, 0, 0, 16)  
DSC:S471/MOD(DUMY, F000, 1, 1, 0, 8, 16)
```

10.13 NONRECOVERABLE ERROR MESSAGES

The following is a list of nonrecoverable error messages issued by TXPROM. These errors cause abortion of all action and return to the CONTROL FILE = prompt:

```
DATA FILE OPEN ERROR  
DATA FILE I/O ERROR  
CONTROL FILE OPEN ERROR  
CONTROL FILE I/O ERROR  
HARDWARE MALFUNCTION  
HARDWARE OFFLINE  
NO. STRING COUNT ERROR  
STRING ADDRESS OUT OF BOUNDS  
CAN'T GET MEMORY
```



SECTION XI

TXDS BNPf AND HIGH-LOW (BNPfhL) DUMP UTILITY PROGRAM

11.1 INTRODUCTION

The BNPfhL utility program provides the capability of converting a 990 Computer module in standard object code format (i.e., in compressed or noncompressed format) to a module in BNPf format (figures 11-1 and 11-2) or to a module in High-Low format. The conversion from standard object code format to BNPf format is presented in figure 11-1.

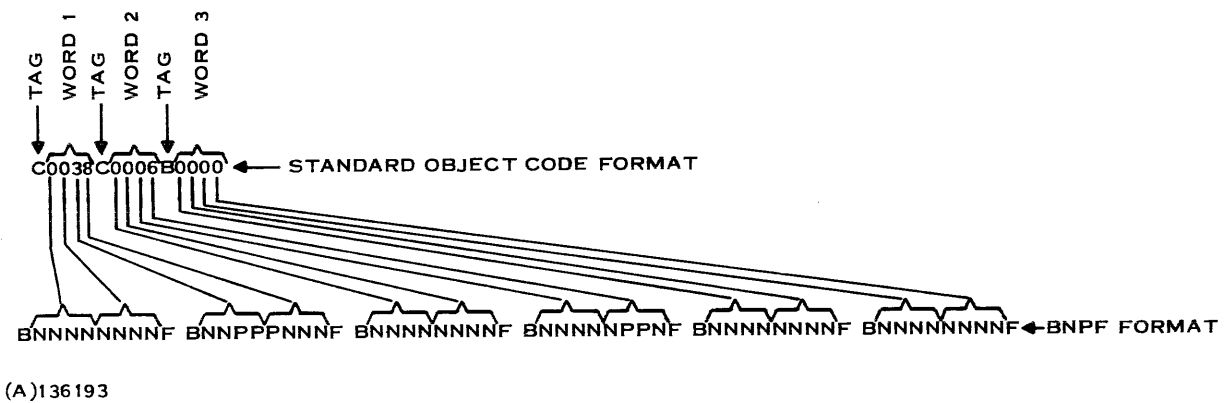

Figure 11-1. Standard Object Code Format to BNPf Format Conversion

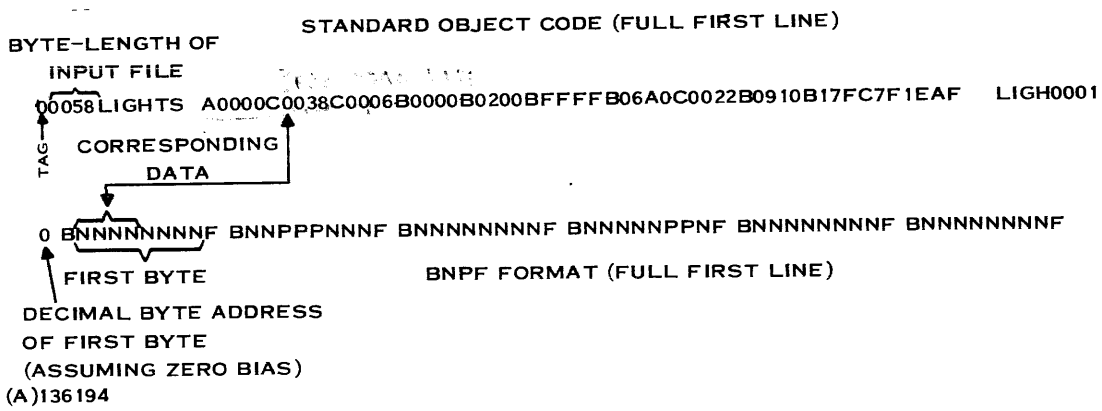

Figure 11-2. Standard Object Code Format to BNPf Format, Full First Line Conversion



Figure 11-3. Standard Object Code Format to High-Low Format Conversion

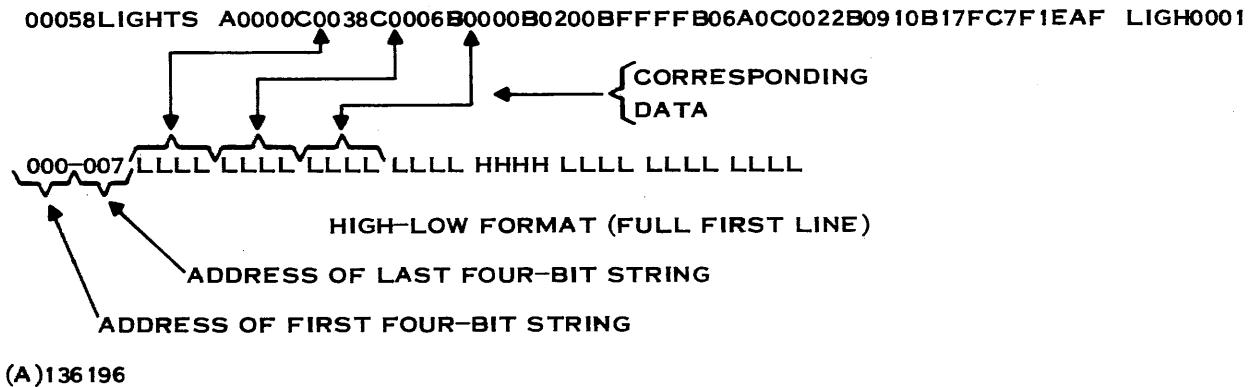

Figure 11-4. Standard Object Code Format to High-Low Format, Full First Line Conversion

When a module in standard object code format is converted to BNPF format, each byte of the standard object code is converted into a string of Ns and Ps (as shown above) preceded by a B (denoting the beginning of the byte) and followed by an F (denoting the end or finish of the byte). Each N corresponds to a negative or zero bit value and each P corresponds to a positive or one bit value. The output module in the BNPF format begins with the decimal byte address (up to five digits) of the first byte contained on the line (as presented in figure 11-2). This decimal byte address has no leading zeros and begins in column one. Each of the lines in the BNPF formatted module contains no more than six bytes of information. An example of a full first line of standard object code is presented in figure 11-2 with the full first line of a converted module in BNPF format. The numbers being converted in figure 11-2 are identical to those shown in figure 11-1.

The conversion from standard object code format to High-Low format is presented in figure 11-3.



When a module in standard object code format is converted to High-Low format, one of the four hexadecimal numbers in each word of the standard object code is converted into a four-bit string of Hs and Ls (where each H corresponds to a high or one-bit value and each L corresponds to a low or zero bit value). The hexadecimal number in each word to be converted is selected by use of the Position option entry. (Refer to paragraph 11.3.3.5 for a description of the Position option entry function.) This Position option entry may be used to specify a 0, 4, 8, or 12, respectively, for the first, second, third, or fourth hexadecimal numbers in the word. The conversion of the hexadecimal number in the first word, into a four-bit string of Hs and Ls, is followed by a conversion of the corresponding hexadecimal number in the same position of the second word (of the standard object code). The process is continued for each corresponding hexadecimal number in each of the words specified in the response to the MEMORY: prompt. (Refer to paragraph 11.3.4 below for a description of the response to the MEMORY: prompt). The Position option entry may also be used to enter any one of the numbers from 0 through 12 and thereby, specify the bit position in the 16-bit word at which the four-bit conversion is to begin. This means, for example, that specifying a 3 would result in converting bits 3, 4, 5, and 6 of the 16-bit word (which is represented in hexadecimal standard object code format) to a four-string of Hs and Ls. The output module in the High-Low format begins each line with the beginning and end address (in decimal) of each of the four-bit strings presented on the line, using three digits for the address of the first four-bit string on the line and another three digits for the address of the last four-bit string on the line. (See figure 11-4.) Each of the lines contains no more than eight four-bit strings. An example of full first line of standard object code is presented in figure 11-4 with the full first line of converted module in High-Low format. The numbers being converted are identical to those shown in figure 11-3.

NOTE

All HILO conversions begin on a word boundary. Therefore, the response to the MEMORY: prompt requires an even-numbered address entry for the beginning and end address.

The following paragraphs describe how to employ this utility program.

11.2 LUNOs

The BNPFL utility program uses LUNOs 10 and 11, which are assigned to the input and output pathnames, respectively.

11.3 LOADING THE BNPFL UTILITY PROGRAM

Proceed as follows:

1. Load the TXDS Control Program in accordance with the step-by-step procedure presented in Section II in this manual.
2. Place the TXDS diskette containing the BNPFL utility program in an available disc drive.
3. Respond to the PROGRAM:, INPUT:, OUTPUT:, and OPTIONS: prompts as follows:

```
PROGRAM: :BNPFL/SYS
INPUT:  Input Pathname
OUTPUT: Output Pathname
OPTIONS: {BNPF} , {DUMP
          {HILO} , {COMPARE} } [,B<bias>,I<init>,P<pos>]
          {LOAD}
```

(where a number is entered for <bias>, <init>, or <pos>)

```
MEMORY: <beg addr>,<end addr>
```



(The MEMORY: prompt is printed or displayed on the system console after the BNPFHL utility program is loaded as described in paragraph 11.3.4.)

The responses to the INPUT:, OUTPUT:, OPTIONS:, and MEMORY: prompts are described in the following subparagraphs.

NOTE

All numerical input values in response to any of the prompts are assumed to be decimal. However, another base may be specified by using the following prefixes:

| Prefix | Base | Example |
|--------|-------------|-------------------------|
| ! | Octal | !23 (equals decimal 19) |
| > | Hexadecimal | >23 (equals decimal 35) |

11.3.1 RESPONSE TO THE INPUT: PROMPT. The response to the INPUT: prompt is either the pathname of a file or the pathname of a device. One of these two responses must be specified. When a DUMP or COMPARE option is specified, the file or device should contain a standard object code module. When a LOAD option is specified, the input file or device should contain either a BNPF or High-Low formatted module to correspond with the BNPF or HILO response to the OPTIONS: prompt.

11.3.2 RESPONSE TO THE OUTPUT: PROMPT. The response to the OUTPUT: prompt is either the pathname of a file or the pathname of a device. One of these two responses must be specified. When the COMPARE option is specified, the response to the OUTPUT: prompt should be a file which contains a BNPF or a HILO formatted module, depending upon whether a BNPF or a HILO file is to be compared to the input standard object code. The output device should not be a hard copy device because no carriage control is included in the output.

11.3.3 RESPONSE TO THE OPTIONS: PROMPT. The response to the OPTIONS: prompt is described in the following subparagraphs.

NOTE

All options must be separated by commas. The Bias, Initialization, and Position options can be defaulted as explained below, but, when used, must be specified in the following sequence: Bias, Initialization, and Position.

11.3.3.1 BNPF and HILO Options. The BNPF option specifies a BNPF formatted input or output module and the HILO option specifies a High-Low formatted input or output module. Either the BNPF or HILO option must be specified. The abbreviations BN and HI may be used, respectively, instead of the full four characters. When neither the BNPF option or the High-Low option is specified, an error results.

11.3.3.2 DUMP, COMPARE, and LOAD Options. The use of these options is described in the following subparagraphs.

NOTE

1. One of these options must be specified or an error will result.
2. Each of the option names may be abbreviated by using the first two letters in the option name



DUMP (DU) Option. The DUMP option causes the input file in 990 standard object code to be dumped to the output file in the specified BNPF or High-Low format.

COMPARE (CO) Option. The COMPARE option is used to verify the results of a DUMP by comparing the output BNPF or HILO formatted file to the input file in standard object code format.

When there is no discrepancy in a BNPF COMPARE, the beginning and end address of the compared information or data are printed on the system console. The following printout is an example of a BNPF COMPARE without errors:

```
TXDS  936215  *A      1/ 0    00:02

PROGRAM:  :BNPFHL/SYS
  INPUT:  DSC2:LIGHTS/OBJ
  OUTPUT: DSC2:TEMP/OBJ
OPTIONS:  BN,CO
MEMORY:  0,24
BEG ADDR=0000
END ADDR=0018
TXDS  936215  *A      1/ 0    00:03
```

PROGRAM:

When there is no discrepancy in a HILO COMPARE, no printout or display is presented on the system console.

When a BNPF COMPARE is discrepant, a presentation of the discrepancy is printed out or displayed on the system console. An example of a typical printout or display of a discrepancy is:

```
T0064=9C    M0064=38
```

where:

T represents the BNPF output file; 0064 represents the decimal address of the byte; and 9C represents the hexadecimal value of the byte, and

where:

M represents the input file in standard object code; 0064 represents the decimal address of the byte; and 38 represents the hexadecimal value of the byte.

The discrepancy is noted by the difference in hexadecimal byte-values 9C and 38. When there exists no discrepancy, both hexadecimal byte-values are 38 and, as a result, are not printed out or displayed on the system console.

When a HILO COMPARE is discrepant, a presentation of the discrepancy is printed out or displayed on the system console. An example of a typical printout or display of a discrepancy is:

```
M0003.<0,3>=0000    T0003.<0,3>=2000
```



where:

M represents the input file in standard object code; 003 represents the decimal address of the input file word; 0,3 represents the beginning and ending bit positions of the four-bit string in the input object file; and 0000 represents the hexadecimal value of the input file word; and

where:

T represents the HILO output file; 0003 represents the decimal address of the output file word; 0,3 represents the beginning and ending bit positions of the discrepant four-bit string in the output file; and 2000 represents the hexadecimal value of the output file word.

The discrepant output is presented in hexadecimal word format but, nevertheless, represents the High-Low formatted output from the HILO DUMP program execution. In addition, the discrepancy is noted by the difference in hexadecimal word-values 0000 and 2000. When there exists no discrepancy, both hexadecimal word-values are 0000 and, as a result, are not printed out or displayed on the system console.

LOAD (LO) Option. Selection of the LOAD option causes a previously created BNPF or High-Low formatted file to be converted into an output file which can be used to program PROMs using the PROM Programming Module (i.e. the hardware module). Refer to the TXDS (TXPROM) Programmer Utility Program section in the TXDS Programmer's Guide, manual number 946258-9701.

11.3.3.3 Bias (B<bias>) Option. The Bias option supplements the DUMP and COMPARE options. It defines the number to be added to the address of the relocatable data in the input file as well as to the relocatable data itself for the purpose of producing the output file or for the purpose of comparing the input file to the output file. The BIAS option has no effect on nonrelocatable object module data. The default-substitute produced by the utility program is 0. An example of the use of the Bias option is presented in paragraph 11.5.5.

11.3.3.4 Initialization (I<init>) Option. The Initialization option is used to initialize the buffer area into which the input file's standard object code is to be read. This initialization is done prior to converting the input file to the BNPF or HILO format so that each bit position initially contains a 1 or 0. Unused sections of the buffer are also initialized. The default substitute provided by the utility program for the Initialization option is a 0. Whenever a number other than 0 or 1 is specified, an error results. An example of the use of the Initialization option is presented in paragraphs 11.5.3 and 11.5.4.

11.3.3.5 Position (P<pos>) Option. The Position option specifies the first bit of the four-bit string from each of the input-file-words (which are in the format of standard object code) that are to be converted to the HILO format. A Position option number from 0 through 12 is selected by the operator to supplement the HILO option selection. The selected number specifies the position number of the start-bit of the four-bit string of the 16-bit word from the input file's standard object code. An example of the use of the Position option is presented in paragraph 11.5.3.

11.3.4 RESPONSE TO MEMORY: PROMPT. The operator's response to the MEMORY: prompt is used to specify the address of the first and last bytes (on a word boundary) of the section of the input file's standard object code that is to be converted to the BNPF or High-Low format. The address of the first byte is the beginning address and the address of the last byte is the end address. When the entire file is to be formatted, the beginning address must be 0 and the end address must be the number representing the byte-length (on a word boundary) of the input file or a number greater than the byte length of the input file. The byte-length (on a word boundary) of the input file is specified in hexadecimal in the first word of the input file's standard object code following the zero (0) tag. In the event the end address entered in response to the MEMORY prompt, exceeds



the capacity of memory, the CANNOT GET MEMORY error message is printed or displayed on the system console.

NOTE

1. The HILO option produces an error message when a nonword boundary is specified, but the BNPF option does not produce an error message when a nonword boundary is specified. This is because the BNPF option operates on byte strings rather than on word strings.
2. The MEMORY: prompt is not issued when the LOAD option is used.

11.4 ERROR MESSAGES

The error messages that result from misuse of the BNPFHL utility are listed in table 11-1 with an explanation of the cause of each error.

11.5 EXAMPLES OF USAGE OF THE BNPFHL UTILITY PROGRAM

Six examples of usage of the BNPFHL utility program are presented in the following subparagraphs. The standard object code used in each of the examples is presented below.

```
TX990 SYSTEM
MEMORY SIZE (WORDS): 24576 AVAILABLE: 12844
!
```

```
. EX,16,TE.
TXDS 936215 +A 1 / 0 00:01
```

```
PROGRAM: :TXCCAT/SYS
INPUT: DSC2:LIGHTS/OBJ
OUTPUT: L05
OPTIONS: SL01,LF55
TXCCAT 937543 **
```

```
0005SLIGHTS A0000C0039C0006B0000B0200BFFFFFB06A0C0022B0910B17FC7F1EAF LIGH0001
B06A0C0022B0A10B17FCB16F7B06A0C0022B10F2B020CB1FE0B3200B06C0B32007F193F LIGH0002
B06C0B0201B1000B0601B16FEB045BA00387F840F LIGH0003
50006LIGHS7FD03F LIGH0004
: LIGHS 02/25/77 07:23:01 SDSMAC 947075 +D LIGH0005
```



Table 11-1. BNPFL Error Messages

| Message | Cause |
|--|---|
| UNABLE TO OPEN FILE | The specified input file does not exist. |
| I/O ERROR ON INPUT FILE | The input file cannot be read. |
| I/O ERROR ON OUTPUT FILE | The output file cannot be opened and/or written to. |
| BIT VALUE TOO LARGE. MUST BE > C OR LESS | The position parameter exceeds C_{16} . |
| ILLEGAL FUNCTION COMMAND | The first parameter after the OPTIONS: prompt is not HILO or BNPF . |
| REQUIRED PARAMETER MISSING | The second parameter after the OPTIONS: prompt is not DUMP , COMPARE , or LOAD . |
| INIT VALUE GREATER THAN 1 | The initialization parameter is not 0 or 1. |
| UNABLE TO OPEN OUTPUT FILE | The specified output file does not exist. |
| ILLEGAL NUMBER INPUT | One of the numeric parameters is not a legal number. |
| ADDRESS WAS NOT ON WORD BOUNDARY | One of the addresses after the MEMORY: prompt does not begin on a word boundary. This error occurs only with the HILO option. |
| BAD OBJECT FORMAT | The input files does not contain legal object code. |
| ABORT; SYSTEM ERROR FROM XOP | A system error flag was returned from an XOP. The flag value is printed above the error. |
| START ADDRESS GREATER THAN END ADDRESS | The first memory parameter is larger than the second memory parameter. |
| CANNOT GET MEMORY | Cannot get memory to run. |
| START GREATER THAN END OR LENGTH > 256 WORDS | The starting address after the memory: prompt is larger than the ending address or the difference between the two is greater than 256. (This applies only to HILO format.) |



11.5.1 EXAMPLE OF BNPF FORMATTED DUMP USING DEFAULT SUBSTITUTE PARAMETERS

TXDS 936215 ♦A 1/ 0 00:01

PROGRAM: :BNPFHL/SYS
INPUT: DSC2:LIGHTS/OBJ
OUTPUT: DSC2:TEMP/OBJ
OPTIONS: BN,DU
MEMORY: 0, >53
TXDS 936215 ♦A 1/ 0 00:02

PROGRAM: :TXCCAT/SYS
INPUT: DSC2:TEMP/OBJ
OUTPUT: LOG
OPTIONS: 3L01,LF55
TXCCAT 937543 ♦♦

```

0 BNNNNNNNNF BNNPPNNNF BNNNNNNNNF BNNNNNNPNF BNNNNNNNNF BNNNNNNNNF
6 BNNNNNNNNF BNNNNNNNNF BPPPPPPPPF BPPPPPPPPF BNNNNNNPNF BPNPNNNNNF
12 BNNNNNNNNF BNNPNNNNNF BNNNNNNNNF BNNNNNNNNF BNNNNNNPNF BPPPPPPNNF
18 BNNNNNNPNF BPNPNNNNNF BNNNNNNNNF BNNNNNNPNF BNNNNNNPNF BNNNNNNNNF
24 BNNNNPPPPF BPPPPPPNNF BNNNNPPPNF BPPPPPPPPF BNNNNNNPNF BPNPNNNNNF
30 BNNNNNNNNF BNNPNNNNNF BNNNNNNNNF BPPPPNNNF BNNNNNNNNF BNNNNPPNNF
36 BNNPPPPPPF BPPNNNNNNF BNNPPNNNF BNNNNNNNNF BNNNNNNPNF BPPNNNNNNF
42 BNNPPNNNF BNNNNNNNNF BNNNNPPNF BPPNNNNNNF BNNNNNNNF BNNNNNNPNF
48 BNNPPNNNF BNNNNNNNNF BNNNNPPNF BNNNNNNNNF BNNNNNNPNF BPPPPPPPNF
54 BNNNNNNNF BNNNNNNNNF BNNNNPPNF BNNNNNNNNF BNNNNNNPNF BNNNNNNNNF
60 BNNNNNNNF BNNNNNNNNF BNNNNPPNF BNNNNNNNNF BNNNNNNPNF BNNNNNNNNF
66 BNNNNNNNF BNNNNNNNNF BNNNNPPNF BNNNNNNNNF BNNNNNNPNF BNNNNNNNNF
72 BNNNNNNNF BNNNNNNNNF BNNNNPPNF BNNNNNNNNF BNNNNNNPNF BNNNNNNNNF
78 BNNNNNNNF BNNNNNNNNF BNNNNPPNF BNNNNNNNNF BNNNNNNPNF BNNNNNNNNF
84 BNNNNNNNF BNNNNNNNNF BNNNNPPNF BNNNNNNNNF BNNNNNNPNF BNNNNNNNNF

```



11.5.2 EXAMPLE OF HILO FORMATTED DUMP USING DEFAULT-SUBSTITUTE

TXDS 936215 *A 1/ 0 00:04

PROGRAM: :BNPFHL/SYS
INPUT: DSC2:LIGHTS/OBJ
OUTPUT: DSC2:TEMP/OBJ
OPTIONS: HI,DU
MEMORY: 0, >58
TXDS 936215 *A 1/ 0 00:05

PROGRAM: :TXCCAT/SYS
INPUT: DSC2:TEMP/OBJ
OUTPUT: LOS
OPTIONS: SL01,LF55
TXCCAT 937543 **

```

000-007  LLLL LLLL LLLL LLLL HHHH LLLL LLLL LLLL
008-015  LLLH LLLL LLLL LLLL LLLH LLLH LLLL LLLL
016-023  LLLH LLLL LLLH LLHH LLLL LLHH LLLL LLLL
024-031  LLLH LLLL LLLH LLLL LLLL LLLL LLLL LLLL
032-039  LLLL LLLL LLLL LLLL LLLL LLLL LLLL LLLL
040-047  LLLL LLLL LLLL LLLL LLLL LLLL LLLL LLLL
048-055  LLLL LLLL LLLL LLLL LLLL LLLL LLLL LLLL
056-063  LLLL LLLL LLLL LLLL LLLL LLLL LLLL LLLL
064-071  LLLL LLLL LLLL LLLL LLLL LLLL LLLL LLLL
072-079  LLLL LLLL LLLL LLLL LLLL LLLL LLLL LLLL
080-087  LLLL LLLL LLLL LLLL LLLL LLLL LLLL LLLL
088-095  LLLL LLLL LLLL LLLL LLLL LLLL LLLL LLLL
096-103  LLLL LLLL LLLL LLLL LLLL LLLL LLLL LLLL
104-111  LLLL LLLL LLLL LLLL LLLL LLLL LLLL LLLL
112-119  LLLL LLLL LLLL LLLL LLLL LLLL LLLL LLLL
120-127  LLLL LLLL LLLL LLLL LLLL LLLL LLLL LLLL
128-135  LLLL LLLL LLLL LLLL LLLL LLLL LLLL LLLL
136-143  LLLL LLLL LLLL LLLL LLLL LLLL LLLL LLLL
144-151  LLLL LLLL LLLL LLLL LLLL LLLL LLLL LLLL
152-159  LLLL LLLL LLLL LLLL LLLL LLLL LLLL LLLL
160-167  LLLL LLLL LLLL LLLL LLLL LLLL LLLL LLLL
168-175  LLLL LLLL LLLL LLLL LLLL LLLL LLLL LLLL
176-183  LLLL LLLL LLLL LLLL LLLL LLLL LLLL LLLL
184-191  LLLL LLLL LLLL LLLL LLLL LLLL LLLL LLLL
192-199  LLLL LLLL LLLL LLLL LLLL LLLL LLLL LLLL
200-207  LLLL LLLL LLLL LLLL LLLL LLLL LLLL LLLL
208-215  LLLL LLLL LLLL LLLL LLLL LLLL LLLL LLLL
216-223  LLLL LLLL LLLL LLLL LLLL LLLL LLLL LLLL
224-231  LLLL LLLL LLLL LLLL LLLL LLLL LLLL LLLL
232-239  LLLL LLLL LLLL LLLL LLLL LLLL LLLL LLLL
240-247  LLLL LLLL LLLL LLLL LLLL LLLL LLLL LLLL
248-255  LLLL LLLL LLLL LLLL LLLL LLLL LLLL LLLL

```



11.5.3 EXAMPLE OF HILO FORMATTED DUMP BEGINNING AT POSITION 4 AND OF INITIALIZING THE BUFFER TO ALL BINARY ONES

TXDS 936215 ♦A 1/ 0 00:06

PROGRAM: :BNPFHL/SYS
INPUT: DSC2:LIGHTS/OBJ
OUTPUT: DSC2:TEMP/OBJ
OPTIONS: HI,DU,I1,P4
MEMORY:0,>58

TXDS 936215 ♦A 1/ 0 00:07

PROGRAM: :TXCCAT/SYS
INPUT: DSC2:TEMP/OBJ
OUTPUT: LOG
OPTIONS: SL01,LF55
TXCCAT 937543 ♦♦

```

000-007 LLLL LLLL LLLL LLHL HHHH LHLH LLLL HLLH
008-015 LHHH LHLH LLLL HLHL LHHH LHLH LHLH LLLL
016-023 LLLL LLHL HHHH LLHL LHLH LLHL LHLH LLHL
024-031 LLLL LHLH LHLH LHLH HHHH HHHH HHHH HHHH
032-039 HHHH HHHH HHHH HHHH HHHH HHHH HHHH HHHH
040-047 HHHH HHHH HHHH HHHH HHHH HHHH HHHH HHHH
048-055 HHHH HHHH HHHH HHHH HHHH HHHH HHHH HHHH
056-063 HHHH HHHH HHHH HHHH HHHH HHHH HHHH HHHH
064-071 HHHH HHHH HHHH HHHH HHHH HHHH HHHH HHHH
072-079 HHHH HHHH HHHH HHHH HHHH HHHH HHHH HHHH
080-087 HHHH HHHH HHHH HHHH HHHH HHHH HHHH HHHH
088-095 HHHH HHHH HHHH HHHH HHHH HHHH HHHH HHHH
096-103 HHHH HHHH HHHH HHHH HHHH HHHH HHHH HHHH
104-111 HHHH HHHH HHHH HHHH HHHH HHHH HHHH HHHH
112-119 HHHH HHHH HHHH HHHH HHHH HHHH HHHH HHHH
120-127 HHHH HHHH HHHH HHHH HHHH HHHH HHHH HHHH
128-135 HHHH HHHH HHHH HHHH HHHH HHHH HHHH HHHH
136-143 HHHH HHHH HHHH HHHH HHHH HHHH HHHH HHHH
144-151 HHHH HHHH HHHH HHHH HHHH HHHH HHHH HHHH
152-159 HHHH HHHH HHHH HHHH HHHH HHHH HHHH HHHH
160-167 HHHH HHHH HHHH HHHH HHHH HHHH HHHH HHHH
168-175 HHHH HHHH HHHH HHHH HHHH HHHH HHHH HHHH
176-183 HHHH HHHH HHHH HHHH HHHH HHHH HHHH HHHH
184-191 HHHH HHHH HHHH HHHH HHHH HHHH HHHH HHHH
192-199 HHHH HHHH HHHH HHHH HHHH HHHH HHHH HHHH
200-207 HHHH HHHH HHHH HHHH HHHH HHHH HHHH HHHH
208-215 HHHH HHHH HHHH HHHH HHHH HHHH HHHH HHHH
216-223 HHHH HHHH HHHH HHHH HHHH HHHH HHHH HHHH
224-231 HHHH HHHH HHHH HHHH HHHH HHHH HHHH HHHH
232-239 HHHH HHHH HHHH HHHH HHHH HHHH HHHH HHHH
240-247 HHHH HHHH HHHH HHHH HHHH HHHH HHHH HHHH
248-255 HHHH HHHH HHHH HHHH HHHH HHHH HHHH HHHH

```



11.5.4 EXAMPLE OF A HILO COMPARE WITH DISCREPANT DATA. The file generated in the example in 11.5.3 is compared to the first hexadecimal number in the words of the standard object code file (positions 0-3) instead of the second hexadecimal number in the words of the standard object code file (positions 4-7) that was used in generating the file presented in paragraph 11.5.3.

```
TXDS 936215 *A      1/ 0      00:11
```

```
PROGRAM: :BNPFHL/SYS  
  INPUT: DSC2:LIGHTS/OBJ  
  OUTPUT: DSC2:TEMP/OBJ  
OPTIONS: HI,CO,I1  
MEMORY: 0,<58  
ILLEGAL NUMBER INPUT
```

```
TXDS 936215 *A      1/ 0      00:15
```

```
PROGRAM: :BNPFHL/SYS  
  INPUT: DSC2:LIGHTS/OBJ  
  OUTPUT: DSC2:TEMP/OBJ  
OPTIONS: HI,CO,I1  
MEMORY: 0,>58
```

```
M0003.(0,3)=0000  T0003.(0,3)=2000  M0005.(0,3)=0000  T0005.(0,3)=6000  
M0007.(0,3)=0000  T0007.(0,3)=9000  M0008.(0,3)=1000  T0008.(0,3)=7000  
M0009.(0,3)=0000  T0009.(0,3)=6000  M000E.(0,3)=0000  T000E.(0,3)=A000  
M000C.(0,3)=1000  T000C.(0,3)=7000  M000D.(0,3)=1000  T000D.(0,3)=6000  
M000E.(0,3)=0000  T000E.(0,3)=6000  M0010.(0,3)=1000  T0010.(0,3)=0000  
M0011.(0,3)=0000  T0011.(0,3)=2000  M0012.(0,3)=1000  T0012.(0,3)=F000  
M0013.(0,3)=3000  T0013.(0,3)=2000  M0014.(0,3)=0000  T0014.(0,3)=6000  
M0015.(0,3)=3000  T0015.(0,3)=2000  M0016.(0,3)=0000  T0016.(0,3)=6000  
M0017.(0,3)=0000  T0017.(0,3)=2000  M0018.(0,3)=1000  T0018.(0,3)=0000  
M0019.(0,3)=0000  T0019.(0,3)=6000  M001A.(0,3)=1000  T001A.(0,3)=6000  
M001E.(0,3)=0000  T001E.(0,3)=4000  
TXDS 936215 *A      1/ 0      00:19
```

**11.5.5 EXAMPLE OF A BNPF FORMATTED DUMP WITH BIAS 100**

```

PROGRAM: :BNPFHL/SYS
INPUT: DSC2:LIGHTS/OBJ
OUTPUT: DSC2:TEMP/OBJ
OPTIONS: BN,DU,B100
MEMORY: 0,>58
TXDS 936215 *A 1/ 0 00:20

```

```

PROGRAM: :TXCCAT/SYS
INPUT: DSC2:TEMP/OBJ
OUTPUT: LOG
OPTIONS: 3L01,LF55
TXCCAT 937543 **

```

```

100 BNNNNNNNNF BPNPPPPPNF BNNNNNNNNF BNPPNPNPNF BNNNNNNNNF BNNNNNNNNF
106 BNNNNNNPNF BNNNNNNNNF BPPPPPPPPF BPPPPPPPF BNNNNNPNF BPNPNNNNNF
112 BNNNNNNNNF BPNNNNNPNF BNNNNPNNF BNNNNNNNF BNNNPNPF BPPPPPNNF
118 BNNNNNPNF BPNNNNNNF BNNNNNNNF BPNNNNPNF BNNNNNPNF BNNNNNNNF
124 BNNNPNPF BPPPPPNNF BNNNPNPF BPPPNPPPF BNNNNNPNF BPNNNNNNF
130 BNNNNNNNF BPNNNNPNF BNNNNNNNF BPPPNPNF BNNNNNNNF BNNNNNPNF
136 BNNNPPPF BPPPNNNNF BNNPPNPNF BNNNNNNNF BNNNNNPNF BPPNNNNNF
142 BNNPNPNF BNNNNNNNF BNNNNNPNF BPNNNNNNF BNNNNNPNF BNNNNNNPF
148 BNNPNNNNF BNNNNNNNF BNNNNNPNF BNNNNNNNF BNNNPNPF BPPPPPNF
154 BNNNNPNF BPNPNPNF BNNNNNNNF BNNNNNNNF BNNNNNNNF BNNNNNNNF
160 BNNNNNNNF BNNNNNNNF BNNNNNNNF BNNNNNNNF BNNNNNNNF BNNNNNNNF
166 BNNNNNNNF BNNNNNNNF BNNNNNNNF BNNNNNNNF BNNNNNNNF BNNNNNNNF
172 BNNNNNNNF BNNNNNNNF BNNNNNNNF BNNNNNNNF BNNNNNNNF BNNNNNNNF
178 BNNNNNNNF BNNNNNNNF BNNNNNNNF BNNNNNNNF BNNNNNNNF BNNNNNNNF
184 BNNNNNNNF BNNNNNNNF BNNNNNNNF BNNNNNNNF BNNNNNNNF BNNNNNNNF
$

```

11.5.6 EXAMPLE OF A BNPF COMPARE WITH DISCREPANT DATA. The BNPF file which is used is the one created in paragraph 11.5.5 with Bias option 100; however, the COMPARE was performed without the Bias option.

```

TXDS 936215 *A 1/ 0 00:21
-
PROGRAM: :BNPFHL/SYS
INPUT: DSC2:LIGHTS/OBJ
OUTPUT: DSC2:TEMP/OBJ
OPTIONS: BN,CD
MEMORY: 0,>58
BEG ADDR=0064
T0064=9C M0064=38 T0064=6A M0064=06
T0070=86 M0070=22
T0076=86 M0076=22
T0082=86 M0082=22
END ADDR=0058
TXDS 936215 *A 1/ 0 00:22

PROGRAM:

```



SECTION XII

TXDS IBM CONVERSION UTILITY (IBMUTL) PROGRAM

12.1 INTRODUCTION

The IBM Conversion Utility (IBMUTL) Program provides a means of transferring standard IBM formatted diskette datasets to TX990 files and transferring TX990 files to standard IBM formatted diskette datasets. IBMUTL also provides a means of formatting diskettes to standard IBM specification for a single density diskette as designated in "The IBM Diskette For Standard Data Interchange", GA21-9182-0.

12.2 IBMUTL DESCRIPTION

IBMUTL allows the user to read or write datasets on an IBM formatted diskette in a form that can be read and used by systems and devices that are based on IBM sequentially sectored diskettes using the EBCDIC character set. The IBM formatted diskette may already contain datasets created by another process or may have been newly formatted by this utility or other means. All pre-existing datasets will be preserved.

12.2.1 FORMATTING IBM DISKETTE. The diskette is formatted to IBM format by entering the format command. If more than two bad tracks are found, or if track zero is bad, the diskette is unuseable and another diskette should be used. Track zero contains the dataset headers (sectors 8-26) and other information about the diskette (sectors 1-7). The dataset headers are written to include name, record length, beginning of extent (BOE), end of extent (EOE), and end of data (EOD) fields only. All others are left in the initialized state (blank).

12.2.2 TRANSFERRING TX990 FILES TO IBM DATASETS. TX990 files that are to be converted to IBM format must be specified by the operator with a standard TX990 pathname. The new dataset will begin with the first available label following the last used label in the IBM diskette directory. Empty labels between used labels are skipped by this directory. The name of the new dataset may be the same as an already existing dataset but the existing dataset will not be replaced.

12.2.3 TRANSFERRING IBM DATASETS TO TX990 FILES. The operator must specify the desired dataset label and the TX990 pathname. The dataset labels from the IBM diskette are displayed when the transfer command is entered. If the TX990 file does not already exist, it will be created as a noncontiguous sequential file. If two datasets have the same name, only the first dataset may be accessed by this utility.

12.3 LUNOS AND THEIR USES

This utility uses the console device assigned to LUNO 15 as the interactive device. If LUNO 15 is not assigned, the system console is used.

12.4 LOADING AND EXECUTING

IBMUTL can be executed using OCP or the Terminal Executive Development System (TXDS). If OCP is used, follow the procedure below:

1. Ready the device which contains the object program for IBMUTL.
2. Load the program into memory using OCP. IBMUTL must be loaded as a privileged task.



LP,CS1,3,P. if loading the IBMUTL object program from cassette drive one as a privileged task

LP,:IBMUTL/SYS,3,P if loading the IBMUTL object program from the system diskette drive, file :IBMUTL/SYS, as a priority level 3 privileged task

- 3. Execute the program, and terminate OCP.

EX,10.TE.

If the IBMUTL object program is linked into the system, omit steps 1 and 2 and simply execute the task using the task ID assigned to it at that time.

If the TXDS control program is used, follow the procedure below:

- 1. Ready the device which contains the object program for IBMUTL.
2. Enter the name of the device or file which contains the object program in response to the PROGRAM: prompt. Specify IBMUTL to be loaded as a privileged task by following the device or file name with "P".

PROGRAM: CS1,P* if loading the object program on cassette drive one and executing as a privileged task

PROGRAM::IBMUTL/SYS,P* if the object program in the file :IBMUTL/SYS on the system diskette drive and executing as a privileged task

12.5 OPERATOR INTERACTION

12.5.1 SPECIAL CHARACTERS. There are two special characters recognized by IBMUTL. They are as follows:

- * When entered in response to a prompt and followed by a carriage return, IBMUTL is terminated.
& When entered in response to a prompt and followed by a carriage return, IBMUTL restarts by requesting the IBM diskette drive name.

12.5.2 OPERATOR PROMPTS. When the task has been loaded and executed, the task name and revision level are printed followed by a request for the IBM floppy diskette drive name.

TI FLOPPY DISK IBM CONVERSION TASK. PN 936216 **

IBM DISK DRIVE NAME:

The required service is selected in response to the next query.

SERVICE? F=FORMAT. T=TRANSFER:



When format is selected, no further interaction is necessary. The format process is executed to completion and the following messages are displayed.

FORMAT IN PROGRESS.

FORMAT COMPLETE.

The utility will then request the IBM diskette drive name again.

When one of the transfer services is selected, the IBM diskette is checked for proper format and a list of the labels is displayed. When the IBM format is found to be incorrect, a message is displayed and the diskette name request is repeated. (Operator responses are underlined; (C/R) represents a carriage return). Upon responding with a "T" for the transfer function, the following messages are output:

FILE1 All dataset labels on the IBM format diskette are listed.

FILE2

FILE3

NOTE

While listing the dataset labels of the IBM formatted diskette, blanks are printed when a dataset is encountered in which the label contains all blanks.

or,

** DISKETTE NOT IBM FORMAT ** Specified diskette is not an IBM formatted diskette.

At this point, if the format is correct, the program is ready to perform the transfer operation. The direction of transfer is established by response to the next query.

FUNCTION? F=FILE TO DATASET, D=DATASET TO FILE: F
or D

Whether or not an "F" or a "D" is selected, the next question asked is:

CHARACTERS PER RECORD? 2 MIN. - 128MAX: 80(C/R)

When only a carriage return is entered, the default value is 80 characters per record.

The TX990 user file pathname and IBM dataset names are requested next:

USER FILE PATHNAME: DSC2:SOURCE/ABC(C/R)

DATASET NAME: SOURCE(C/R)

FILE TRANSFER IN PROGRESS. . .



Pathname can be defaulted to the first six characters of the dataset name when transfer is dataset to file; or when transfer is file to dataset, the dataset name can be defaulted to the file name portion of the pathname. The default substitute is specified by a carriage return (C/R) response to the query. Pathnames that are preceded by a colon are defaulted to the system diskette drive.

When the IBM diskette is not filled at the completion of converting the specified file, IBMUTL requests the record size again.

When it is desired to reverse the transfer function or change the drive on which datasets are being accessed, an ampersand (&) symbol reply returns the program to the point where the diskette name is requested:

USER FILE PATHNAME: &(C/R)

Responding with an ampersand (&) returns program control to the initial user prompt:

IBM DISK DRIVE NAME:

If the user enters an asterisk (*), IBMUTL terminates with the following message;

UTILITY SERVICE TERMINATED

12.6 ERROR REPORTING AND RECOVERY

Errors encountered during execution of IBMUTL are reported to the operator in accordance with table 12-1. Whenever recovery from such errors is possible, the program returns to a logical restart point and continues its function.



Table 12-1. IBMUTL Error Messages

| Message | Meaning | Recovery |
|---|--|---|
| ** DISKETTE NOT IBM FORMAT ** | Specified diskette is not an IBM format diskette. | Insert a properly formatted diskette in specified drive, or return to diskette name request (enter "&") and input correct drive name. |
| UNDEFINED PATHNAME | Illegal pathname has been entered. | Validate pathname and reenter. |
| DISKETTE DIRECTORY FULL | An attempt to exceed the maximum number of datasets (19) allowable per IBM formatted diskette. | Program control returns to diskette drive request. Install new IBM format diskette and retry transfer function. |
| TOO MUCH DATA | Data capacity of IBM format diskette has been exceeded. Last file is labeled as an empty dataset and transfer is terminated. | Program control returns to diskette drive request. Install new IBM format diskette and retry transfer function. |
| MORE THAN 2 BAD TRACKS, FORMAT ABORTED | Bad diskette. | Program control returns to diskette drive request. Install new diskette and retry format function. |
| FILE SERVICE ERROR nn | Error encountered while accessing TX990 user file. Refer to Error Appendices for error code nn. | Program control returns to diskette drive request. Respond according to individual error code. |
| FLOPPY DISK ACCESS ERROR nn | Error encountered while accessing IBM dataset. Refer to Error Appendices for error code nn. | Program control returns to diskette drive request. Respond according to individual error code. |
| I/O ERROR nn | I/O error encountered during program execution. Refer to Error Appendices for error code nn. | Program control returns to diskette drive request. Respond according to individual error code. |



946258-9701

APPENDIX A

GLOSSARY



APPENDIX A

GLOSSARY

Boot Program – A program that loads the Operating System into memory and starts the Operating System executing.

COMMON – An area of memory which may be coded by use of the TXDS Control Program and the system console keyboard (e.g., a 733 ASR, a 911 VDT) or by means of a task-specified-code and then made accessible for use by a task through the Get COMMON Data address supervisor call. The size of the system COMMON memory area is determined by a system parameter specified when the system is generated.

Default-substitute – A substitute pathname, or field of a pathname, provided by some utility programs when the program or keyboard-entry does not supply the data.

Device Name Table – A table accessed by the File Management supervisor call to obtain the address of the Physical Device Table (PDT) corresponding to a device name. Contains all device names defined in the system and addresses of the PDTs for the devices.

Device Service Routine – A routine of the TX990 Operating System that controls I/O operations with a device.

DNT – Device Name Table.

DSR – Device Service Routine.

Dynamic Task Area – The area of memory occupied by task 10_{16} . Task 10_{16} can be loaded by using the Operator Communication Package (OCP) or the TXDS control program.

End-of-file – A record in a file (either logically or physically) that marks the end of the file. The character sequences that denote end-of-file for the file-oriented supported devices are shown in Appendix B.

End-of-record – A character of a record that marks the end of the record. The characters that denote end-of-record for supported devices are shown in Appendix B.

EOF – End-of-file.

EOR – End-of-record.

GENTX – The system generation task, which obtains system parameters interactively from the keyboard of the LOG. GENTX builds source statement files from which modules TXDATA and TASKDF are assembled.

IDT – Program identifier of the source module.

Initial Program Load – The loading of a TX990 system placing the module in memory and starting execution of the system.



I/O Supervisor – The portion of TX990 that processes I/O supervisor calls, and passes control to the Device Service Routine (DSR) for the device.

IPL – Initial Program Load.

Keyboard Status Block (KSB) – A data structure in TXDATA used for character mode I/O with a VDT. TXDATA includes a KSB for each VDT.

KSB – Keyboard Status Block.

LDT – Logical Device Table.

Logical Device Table (LDT) – A table in TXDATA that contains a Logical Unit Number (LUNO) and the address of the Physical Device Table (PDT) that corresponds to the device assigned to the LUNO.

Logical Unit Number (LUNO) – A number by which an I/O operation specifies the device for the operation.

LUNO – Logical Unit Number.

OCP – Operator Communication Package.

Operator Communication Package (OCP) – A package of modules that contains the routines for the commands by which the operator or user communicates with TX990.

PC – Program Counter.

PDT – Physical Device Table.

Physical Device Table (PDT) – A table in TXDATA that contains device-related data required by the Device Service Routine (DSR) in an I/O supervisor call for the device.

Program Counter (PC) – A register in the computer hardware that contains the address of the next instruction to be executed.

Status Register – A register in the computer hardware that contains condition bits and the interrupt mask.

Supervisor Call Block – A block of memory that defines a supervisor call, addressed by the supervisor call instruction. The code of the supervisor call is in byte 0 of the supervisor call block. The number of additional bytes (if any) and the content of the additional bytes are defined for each supervisor call.

Supervisor Call Table – A table in TXDATA in which entry points to supervisor call routines are listed in a supervisor call code order.

Task Data Division – One of two logical divisions within a task. The data division contains one or more workspaces, data structures, supervisor call blocks, and data for the task. A data division may or may not be assembled separately from the procedure division of the task, and is not shared with any other task.

Task Management – Task Management maintains a state code for each task. The state codes are listed in Appendix C.



- Task Scheduler** – Initiates execution of a user task. When the currently executing task completes a time slice, the task scheduler passes control to the oldest task on the active list for the highest priority (0). If there is no task on the active list for priority 0, the oldest task on the active list for the next highest priority receives control.
- Task Status Block (TSB)** – A data structure in TXDATA used by the TX990 Operating System to control execution of the task.
- Task Time Delay** – The result of a task executing a Time Delay supervisor call. The Time Delay supervisor call suspends the calling task for a specified number of 50 ms periods.
- Task Time Slice** – A period of execution of a task having a maximum length defined when the system is generated. A task time slice begins when the task scheduler passes control to the task. A task time slice ends: (1) when the system suspends the task upon expiration of the maximum time period allowed for a task time slice; (2) when the task executes a supervisor call that suspends the task; (3) when the system suspends the task to await completion of an I/O operation. To avoid completely locking out low priority tasks, there is a maximum number of consecutive time slices (weighting factor) for each priority level. When the number of time slices has been used by a priority level, the oldest task on the active list for the next lower priority is allowed a time slice before the higher level again has control. The maximum number of time slices for each priority level are system parameters defined when the system is generated. The maximum period of a time slice may be extended by execution of a Do Not Suspend supervisor call. The time slice is less than the maximum time period when the task suspends itself, or is suspended awaiting completion of an I/O operation.
- Task Weighting Factor** – A count of task time slices for a priority level. When the number of task time slices specified as the weighting factor for priority level has been used by tasks at that priority level after a task at a lower level has had control, a task at a lower priority level receives control for a time slice.
- Task Area, Dynamic** – Memory area where task 10 resides (see Dynamic Task Area and Task, Uses, Loading of).
- Task, Bid** – To start execution of a task causing the TX990 Operating System to enter the task on the active list according to its priority level.
- Task, Debugging of a** – The process of removing errors from a task.
- Task, Diagnostic (DTASK)** – A system task that terminates a task when fatal errors occur in the task, and prints an error message.
- Task, Executing a** – Controlling the processor and the resources of the computer.
- Task, Linked** – Consists of separately assembled modules that have been combined by resolving external references and definitions in the modules to form a single executable module.
- Task, LIST8080** – A utility task that copies 80-character records from one device to another.
- Task, Loaded** – A task copied from an external storage medium into the memory of the computer in preparation for execution.
- Tasks, Multiple** – Two or more tasks concurrently active in an operating system.



Task, Procedure Division – One of two logical divisions within a task. The procedure division contains the executable code for the task. A procedure division may or may not be assembled separately from the data division of the task and may be shared with other tasks.

Task, Suspended – A task temporarily removed from the active list and from execution as a result of a supervisor call or during an I/O operation.

Task, Terminated – A task removed from execution and from the active list either at normal completion or at an abnormal termination initiated by the operator or by the diagnostic task when a fatal error is detected.

Task, User, Loading of – The task loaded into the dynamic task area using the OCP LPROG command.

Task, Waiting – A task waiting for completion of an I/O operation or for a system function or resource.

Workspace – A 16-word area of memory addressed as workspace registers 0 through 15. The active workspace is defined by the contents of the workspace pointer register.

Workspace Pointer (WP) – A register that contains the address of workspace register 0.

Workspace Register – A memory word accessible to an instruction of the computer as a general purpose register. It may be used as an accumulator, a data register, an index register, or an address register.

WP – Workspace pointer register.



APPENDIX B
COMPRESSED OBJECT CODE FORMAT

APPENDIX B

COMPRESSED OBJECT CODE FORMAT

The standard object code format under the TX990 Operating System is comprised basically of an ASCII tag character followed by one or two ASCII fields. The first field is numeric in value and the optional second field contains a symbol. (For additional familiarity with standard object code format, refer to the *Model 990 Computer Assembly Language Programmer's Guide*, part number 943441-9701). The first ASCII field in standard object code format is four characters (i.e., four bytes) in length which, when converted to compressed object code format, is changed to binary, two bytes in length. The second field in standard object code format is left unchanged when converting to compressed object code format. Records are terminated with the standard end-of-record tag character, only. The beginning-of-module-tag-character is an ASCII zero in standard object code format and a binary one in compressed object code format. This is used to distinguish between compressed and uncompressed modules. The end-of-module colon record, identified by the colon at the beginning of the last line of the module, is unchanged. The diskette is the only device capable of supporting compressed object code format.

ASCII Standard Object Code Format (e.g., from punched cards)

```
00008TASK          A0000B000AB02000000B00007F7EEF
:      TASK                021/77      12:32:54
```

Hexadecimal Representation of Standard Format

```
3030  3030  3854  4153  4B20  2020  2041  3030
3030  4230  3030  4142  3032  3030  4330  3030
3042  4330  3030  3746  3745  4546  2020  2020
```

Hexadecimal Representation of Compressed Format

```
0100  0854  4153  4B20  2020  2041  0000  4200
0A42  0200  4300  0042  C000  4600  0000  0000
```

Colon Record for Both Formats Hexadecimal Representation

```
3A20  2020  2020  2054  4153  4B20  2020  2020
2030  3231  2F37  3720  2020  2031  323A  3332
3A35  3420  2020
```

ASCII Representation of Standard Format

```
00 00 8T AS K      A 00
00 B0 00 AB 02 00 C0 00
0B C0 00 7F 7E EF
```

ASCII Representation of Compressed Format

```
.. .T AS K      A .. B.
.B .. C. .B .. F. .. ..
```

ASCII Representation

```
:      T AS K
0 21 /77      1 2: 32
:5 4 .
```





946258-9701

APPENDIX C
TASK STATE CODES





APPENDIX C
TASK STATE CODES

The user-task supervisor calls which return one of the task state codes listed in table G-1 to byte 1 of the supervisor call block are:

- Bid Task Supervisor Call
- Activate Suspended Task Supervisor Call
- Activate Time Delay Task Supervisor Call

The user may code his program to read out the task state code to an output device or, using the OCP STate (ST) command, the user can cause a terminal to print out the task state codes.

Table C-1. List of Task State Codes

| Code (Hexadecimal) | Significance |
|-----------------------|---|
| 00 | Active task, priority level 0 |
| 01 | Active task, priority level 1 |
| 02 | Active task, priority level 2 |
| 03 | Active task, priority level 3 |
| 04 | Terminated task |
| 05 | Task in time delay |
| 06 | Suspended task |
| 07 | Currently executing task |
| 08 | Task awaiting VDT character input |
| 09 | Task awaiting completion of I/O |
| 0A | Task queued for I/O |
| 0B | Task queued for file utility routine |
| 0C | Task on the diagnostic queue |
| 0D | Task waiting for file management completion |
| 10 | Task queued for file management |



APPENDIX D
I/O ERROR CODES





APPENDIX D
I/O ERROR CODES

| Code (Hexadecimal) | Description |
|-------------------------------|--------------------------------------|
| DSR ERRORS | |
| 00 | NO ERROR |
| 01 | ILLEGAL LUNO |
| 02 | ILLEGAL OPERATION CODE |
| 03 | LUNO IS NOT YET OPENED |
| 04 | RECORD LOST DUE TO POWER FAILURE |
| 05 | ILLEGAL MEMORY ADDRESS |
| 06 | TIME OUT, OR ABORT |
| 07 | ILLEGAL DEVICE |
| 11 | DEVICE ERROR |
| 12 | NO ADDRESS MARK FOUND |
| 15 | DATA CHECK ERROR |
| 19 | DISKETTE NOT READY |
| 1A | WRITE PROTECT |
| 1B | EQUIPMENT CHECK ERROR |
| 1C | INVALID TRACK OR SECTOR |
| 1D | SEEK ERROR OR ID NOT FOUND |
| 1E | DELETED SECTOR DETECTED |
| FILE MANAGEMENT ERRORS | |
| 20 | LUNO IS IN USE |
| 21 | BAD DISC NAME |
| 22 | PATHNAME HAS A SYNTAX ERROR |
| 23 | ILLEGAL FUR OPCODE |
| 24 | BAD PARAMETER IN PRB |
| 25 | DISKETTE IS FULL |
| 26 | DUPLICATE FILE NAME |
| 27 | FILE NAME IS UNDEFINED |
| 28 | ILLEGAL LUNO |
| 29 | SYSTEM BUFFER AREA FULL |
| 2A | SYSTEM CAN'T GET MEMORY |
| 2B | FILE MANAGEMENT ERROR |
| 2C | CAN'T RELEASE SYSTEM LUNO |
| 2D | FILE IS PROTECTED |
| 2E | ABNORMAL FUR TERMINATION |
| 2F | FILE UTILITY DOESN'T EXIST IN SYSTEM |
| 30 | NON-EXISTENT RECORD |
| 3B | INVALID ACCESS PRIVILEGE |
| 3E | FILE CONTROL BLOCK ERROR |
| 3F | FILE DIRECTORY FULL |



I/O ERROR CODES (Continued)

| Code (Hexadecimal) | Description |
|-------------------------------|---|
| TASK LOADER ERROR | |
| 60 | I/O ERROR, LOAD NOT COMPLETE |
| 61 | OBJECT MODULE CONTAINS NONRELOCATABLE OBJECT CODE |
| 62 | CHECKSUM ERROR LOAD ABORTED |
| 63 | LOADER RAN OUT OF MEMORY |
| 64 | TASK 10 IS BUSY |
| VDT ERRORS | |
| 80 | DEVICE NOT AVAILABLE VDT STATION NOT FOUND |

Note:

Error Code >FF is a general error code.



946258-9701

ALPHABETICAL INDEX



ALPHABETICAL INDEX

INTRODUCTION

The following index lists key words and concepts from the subject material of the manual together with the area(s) in the manual that supply major coverage of the listed concept. The numbers along the right side of the listing reference the following manual areas:

- Sections - References to Sections of the manual appear as “Section x” with the symbol x representing any numeric quantity.
- Appendixes - References to Appendixes of the manual appear as “Appendix y” with the symbol y representing any capital letter.
- Paragraphs - References to paragraphs of the manual appear as a series of alphanumeric or numeric characters punctuated with decimal points. Only the first character of the string may be a letter; all subsequent characters are numbers. The first character refers to the section or appendix of the manual in which the paragraph is found.
- Tables - References to tables in the manual are represented by the capital letter T followed immediately by another alphanumeric character (representing the section or appendix of the manual containing the table). The second character is followed by a dash (-) and a number:

Tx-yy

- Figures - References to figures in the manual are represented by the capital letter F followed immediately by another alphanumeric character (representing the section or appendix of the manual containing the figure). The second character is followed by a dash (-) and a number:

Fx-yy

- Other entries in the Index - References to other entries in the index are preceded by the word “See” followed by the referenced entry.



| | | | |
|---|-------------|--|---------------|
| Assembler | See TXMIRA | TXCCAT | Section 8 |
| BNPFHL | Section 11 | TXCCAT Errors | T8-3 |
| CB Command | 9.6.6.2 | TXCCAT Operator Interaction | 8.3 |
| Code Format, Compressed Object | Appendix B | TXCCAT Options | T8-2, 8.4 |
| Copy/Concatenate | See TXCCAT | TXDEBUG | Section 9 |
| CP Command | 9.6.13.2 | TXDEBUG Command Codes | 9.5.1 |
| CR Command | 9.6.12.3 | TXDEBUG Command Combinations | T9-1 |
| Cross Reference Utility | See TXXREF | TXDEBUG Command Descriptions | 9.6 |
| CS Command | 9.6.11.3 | TXDEBUG Command Entry | 9.5.3 |
| Debug Monitor | See TXDEBUG | TXDEBUG Command Structures | 9.5 |
| EX Command | 9.6.1 | TXDEBUG Debug Modes | 9.4 |
| Execute User Program | 9.6.1 | TXDEBUG Debugging Techniques | 9.7 |
| Execute User Program (SIE or Trace) | 9.6.2 | TXDEBUG Error Messages | 9.8 |
| FB Command | 9.6.4 | TXDEBUG Keyboard Commands | T9-2 |
| FW Command | 9.6.5 | TXDEBUG Loading | 9.3 |
| Glossary | Appendix A | TXDEBUG Memory Configuration | F9-1 |
| HA Command | 9.6.3 | TXDS Components | 1.1 |
| IBM Conversion | See IBMUTL | TXDS Control Paths | F1-1 |
| IBMUTL | Section 12 | TXDS Minimum Configuration | F1-2 |
| IBMUTL Error Messages | T12-1 | TXEDIT | Section 4 |
| IBMUTL Loading | 12.4 | TXEDIT Commands | 4.4, T4-2 |
| IBMUTL LUNOs | 12.3 | TXEDIT Default Substitutes | T4-1 |
| IBMUTL Operator Interaction | 12.5 | TXEDIT Edit Commands | 4.4.7 |
| IC Command | 9.6.7.1 | TXEDIT Error Messages | T4-3 |
| IM Command | 9.6.8.1 | TXEDIT Example | 4.6, 4.7, 4.8 |
| I/O Error Codes | Appendix D | TXEDIT Loading | 4.3 |
| IR Command | 9.6.9.1 | TXEDIT LUNOs | 4.2 |
| IS Command | 9.6.11.2 | TXEDIT Output Commands | 4.4.9 |
| IW Command | 9.6.10.1 | TXEDIT Pointer Movement Commands | 4.4.6 |
| Linked Object Module | 7.5 | TXEDIT Print Commands | 4.4.8 |
| Linking | See TXLINK | TXEDIT Setup Commands | 4.4.5 |
| MC Command | 9.6.7.2 | TXEDIT Special Keys | 4.4.4 |
| MM Command | 9.6.8.2 | TXEDIT Terminate Sequence Commands | 4.4.10 |
| MR Command | 9.6.9.2 | TXLINK | Section 7 |
| MW Command | 9.6.10.2 | TXLINK Error Messages | T7-3 |
| Notation Conventions | 9.5.4 | TXLINK Example | 7.7 |
| Operation, Verification of | Section 3 | TXLINK Execution | 7.3 |
| RU Command | 9.6.2 | TXLINK File Structures | 7.2 |
| SB Command | 9.6.6.1 | TXLINK Load Map Listing | F7-2 |
| SP Command | 9.6.13.1 | TXLINK Options | 7.4, T7-2 |
| SR Command | 9.6.12.2 | TXLINK Pathname Defaults | T7-1 |
| SS Command | 9.6.11.1 | TXMIRA | Section 5 |
| ST Command | 9.6.12.1 | TXMIRA Errors | 5.5 |
| Task State Codes | Appendix C | TXMIRA Fatal Errors | T5-3 |
| Text Editor | See TXEDIT | TXMIRA LUNOs | 5.2 |
| | | TXMIRA Nonfatal Errors | T5-4 |
| | | TXMIRA Operator Interaction | 5.3 |
| | | TXMIRA Options | 5.4, T5-2 |
| | | TXMIRA Pathname Defaults | T5-1 |
| | | TXMIRA Sample Listing | F3-1 |
| | | TXPROM | Section 10 |
| | | TXXREF | Section 6 |
| | | TXXREF Error Messages | 6.6, T6-2 |
| | | TXXREF Listing Format | 6.4 |
| | | TXXREF LUNOs | 6.2 |
| | | TXXREF Operating Procedure | 6.3 |
| | | TXXREF Options | 6.5 |
| | | TXXREF Pathname Defaults | T6-1 |
| | | TXXREF Sample Listing | F6-1 |

FOLD

FIRST CLASS
PERMIT NO. 7284
DALLAS, TEXAS

BUSINESS REPLY MAIL
NO POSTAGE NECESSARY IF MAILED IN THE UNITED STATES

POSTAGE WILL BE PAID BY

TEXAS INSTRUMENTS INCORPORATED
DIGITAL SYSTEMS DIVISION

P.O. BOX 2909 · AUSTIN, TEXAS 78769

ATTN: TECHNICAL PUBLICATIONS
MS 2146

FOLD



TEXAS INSTRUMENTS
INCORPORATED

DIGITAL SYSTEMS DIVISION
POST OFFICE BOX 2909 AUSTIN, TEXAS 78769