

Panasonic[®]

5.25" Flexible Disk Drives

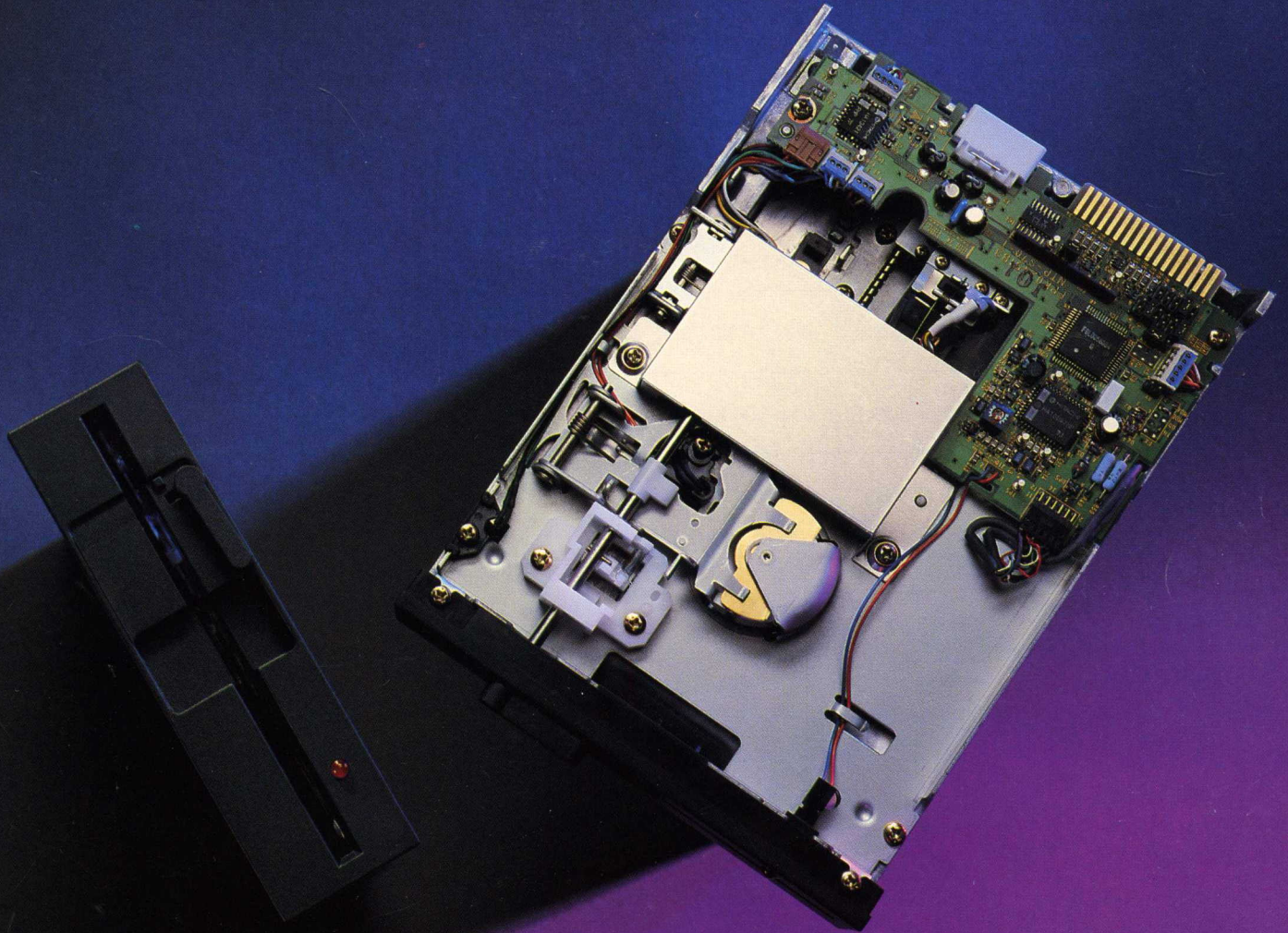

**Panasonic Industrial Co.
Memory Systems Division**

Key Features JU-455

- Compact size — half-height
- 48 tracks-per inch
- Brushless direct drive DC motor
- Minifloppy interface and media compatibility
- Low power consumption
- 10,000 hours MTBF
- Reliable LSI electronics
- Dynamic vertical clamping
- UL/CSA approved

Key Features JU-475

- Compact size — half-height
- 1.6 Mbytes capacity
- Variable compatibility — reads 96 or 48 TPI
- 3 msec track-to-track access time
- Brushless direct drive DC motor
- Low power consumption
- 10,000 hours MTBF
- Reliable LSI electronics
- Dynamic vertical clamping
- UL/CSA approved

Specifications

Performance

		JU-455	JU-475
TYPE		Single/Double Density	
CAPACITY UNFORMATTED	Per Disk	250/500 Kbytes	0.8/1.6 Mbytes
	Per Surface	125/250 Kbytes	400/800 Kbytes
	Per Track	3.1/6.2 Kbytes	5.2/10.4 Kbytes
TRANSFER RATE		125/250 Kbits/sec	200/500 Kbits/sec
LATENCY (avg)		100 msec	83 msec
ACCESS TIME	Track to Track	4 msec	3 msec
	Settling Time	15 msec	
	Motor Start Time	500 msec max.	

Physical

		JU-455/475	
ENVIRONMENTAL LIMITS	Ambient Temperature (operating)	50°F to 115°F (10°C to 46.1°C)	
	Relative Humidity (non-condensing)	20% to 80%	
	Maximum Wet Bulb	85°F (29.4°C)	
DC VOLTAGE REQUIREMENTS	+12V DC ±10% Ripple 100 mVp-p (max)	0.19A typical, 0.55A max. (JU-455)	0.26A typical, 0.8A max. (JU-475)
	+5V DC ±5% Ripple 50 mVp-p (max)	0.37A typical, 0.4A max. (JU-455)	0.44A typical, 0.5A max. (JU-475)
MECHANICAL DIMENSIONS (Exclusive of Faceplate)	Height	1.63 in. (41.5 mm)	
	Width	5.75 in. (146.0 mm)	
	Depth	7.74 in. (196.5 mm)	
	Weight	2.87 lbs (1.3 kg) nominal	
POWER DISSIPATION	JU-455	4.13 watts operating (typical)	
		1.47 watts standby (typical)	
	JU-475	5.4 watts operating (typical)	
		1.8 watts standby (typical)	

Functional

	JU-455	JU-475
ROTATIONAL SPEED	300 RPM	360/300 RPM
RECORDING DENSITY (Inside Track)	2938/5876 BPI	4935/9870 BPI
FLUX DENSITY	5876 FCI	9870 FCI
TRACK DENSITY	48 TPI	96 TPI
TRACKS (Per Surface)	40	80
INDEX	1	1
READ/WRITE HEADS	2	2
ENCODING METHOD	FM/MFM	

Reliability

MTBF	10,000 POH under typical usage	
PM	Not required	
MTTR	30 minutes	
COMPONENT LIFE	15,000 POH or 5 years	
ERROR RATES	Soft Read Errors	1 per 10 ⁹ bits read
	Hard Read Errors	1 per 10 ¹² bits read
	Seek Errors	1 per 10 ⁶ seeks

Electrical Interface

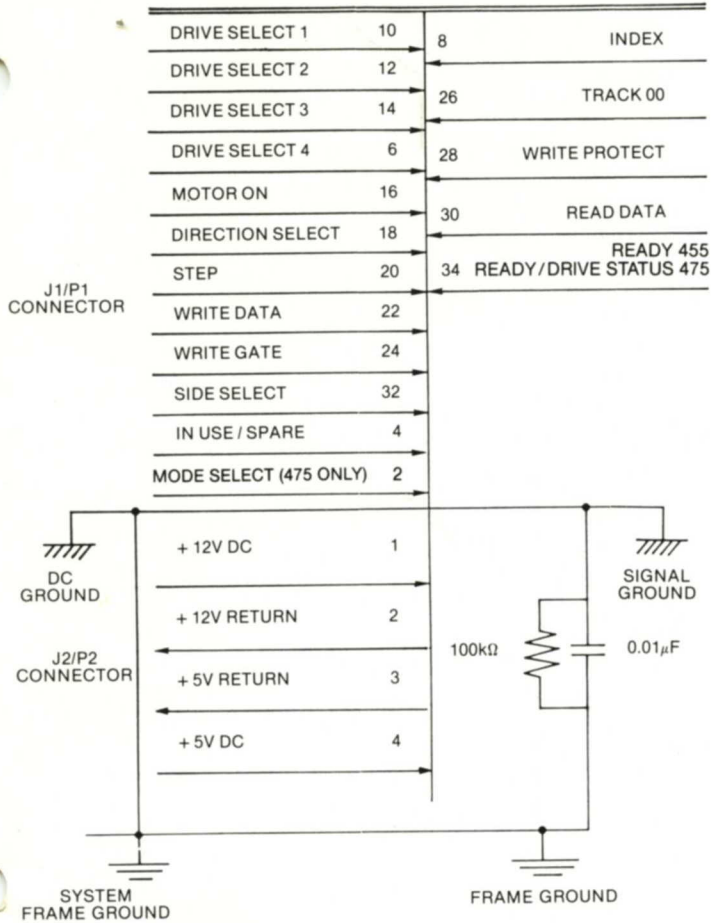

Interface Signal Driver/Receiver

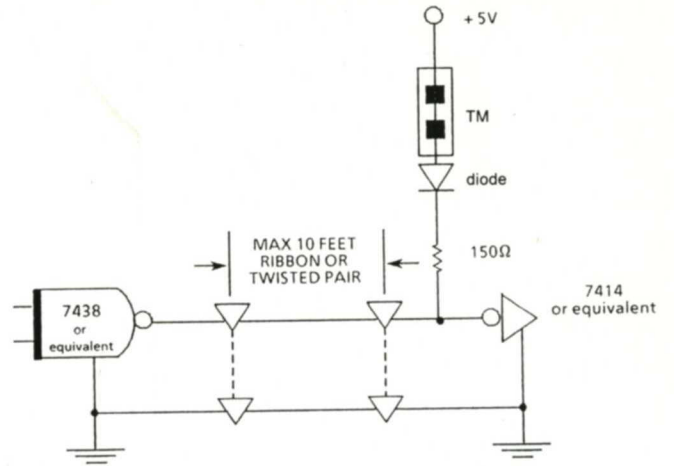

Physical Interface

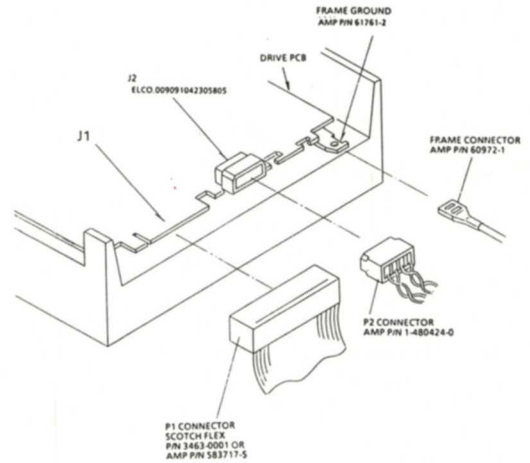

Power Consumption

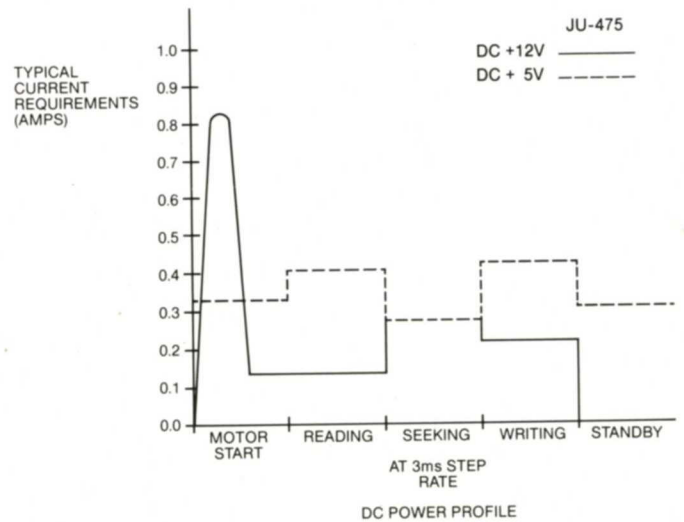
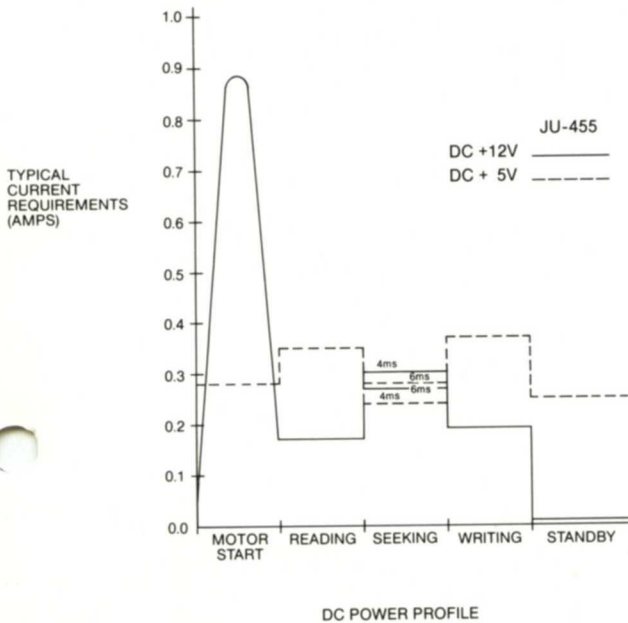

Mechanical Dimensions

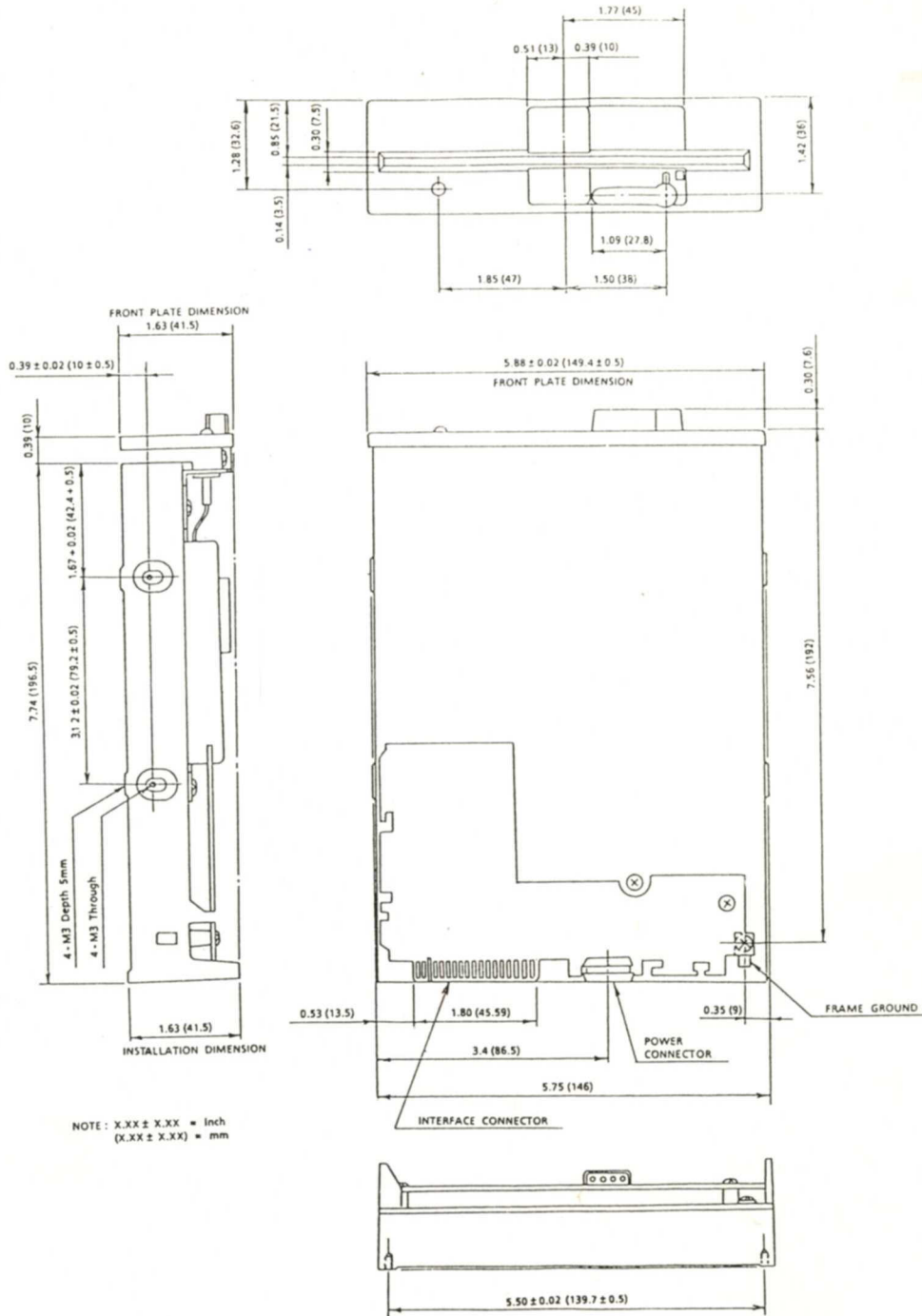

Panasonic Industrial Co. Memory Systems Division

Headquarters
1600 McCandless Drive
Milpitas, CA 95035
408-262-2200

Southwest Sales Office
6550 Katella Avenue
Cypress, CA 90630
714-895-7379

North Central Sales Office
425 E. Algonquin Road
Arlington Heights, IL 60005
312-981-7327

South Central Sales Office
1825 Walnut Hill Lane
Irving, TX 75038
214-580-0518

Northeast Sales Office
Lakeside Office Park, Door # 16
Wakefield, MA 01880
617-246-6200

Southeast Sales Office
1854 Shackleford Court, #210
Norcross, GA 30093
404-925-6848