

**MIT/CS/TR-373**

**Boston Community Information System**

**User's Manual**

**(Version 8.17)**

**David A. Segal, David K. Gillard,  
John M. Lucassen, James B. Henderson,  
Stephen T. Baska, and David S. Bernstein**

*This blank page was inserted to preserve pagination.*

**MIT/LCS/TR-373**

**Boston Community Information System**

**User's Manual**

**(Version 8.17)**

**David A. Segal, David K. Gifford,  
John M. Lucassen, James B. Henderson,  
Stephen T. Berlin, and David E. Burmaster**

**This research was supported by the Defense Advanced Research Projects Agency of the Department of Defense and was monitored by the Office of Naval Research under contract number N00014-83-K-0125.**

**September, 1986**

**© 1984, 1985, 1986 Massachusetts Institute of  
Technology**

*This empty page was substituted for a  
blank page in the original document.*

## Table of Contents

Section 1 — Introduction	1
Section 2 — Using the CommInS Software	4
2.1 — The Filter Window	7
2.2 — The Summary Window	12
2.3 — The Article Window	14
2.4 — The Diagnostic Window	16
2.5 — The Options Window	18
Section: 3 — Databases and Services	20
3.1 — Fields	20
3.2 — Categories	21
3.3 — Subjects	22
3.4 — Useful Queries	26
Section 4 — The Query Language	27
Appendix I — Getting Started	30
I.1 — Unpacking the Equipment	30
I.2 — Installing the Hardware	31
I.3 — Installing the software	33
I.3.1 — Installing the Software on a Hard Disk	34
I.3.2 — Installing the Software with Two Floppy Disk Drives	35
I.3.3 — Installing the Software with One Floppy Disk Drive	36
I.4 — Running the CommInS Program	37
I.5 — Starting and Stopping the CommInS Program	37
I.5.1 — Starting the CommInS Program	37
I.5.2 — Stopping the CommInS Program	38
I.6 — Restarting after a Crash or Accidental Shutdown	38
Appendix II — Setting Up The Remote System	39
II.1 — Hayes Modems	39
II.2 — Non-Hayes Modem	39
Appendix III — Trouble-shooting Guide	40
Appendix IV — Differences from Version 6.0 (7)	43
IV.1 — Keystroke Changes	43
IV.2 — Remote Queries	44
IV.3 — Screen Dimming	44
IV.4 — Printer Support	44
Appendix V — Summary of Commands	45
V.1 — Special Function Keys	45
V.2 — Scroll Keys	45
V.3 — Editing Keys	46
V.4 — Alphabetical Listing of Commands	46
Appendix VI — Files used by the system	48
VI.1 — The CommInS Directory File	48
VI.2 — The Filter File	48
VI.3 — The Help File	48
VI.4 — The Configuration File	48
VI.5 — The Error File	48
VI.6 — Article Files	49
Appendix VII — Your Responsibilities	50
VII.1 — Your Responsibilities to the Boston CommInS Project	50
VII.2 — Your Responsibilities Regarding Use of the Information Received	50

*This empty page was substituted for a  
blank page in the original document.*

## List of Figures

Figure 2-1: The Screen Layout and the Window Selection Menu	4
Figure 2-2: The Filter Window and its Command Menu	7
Figure 2-3: The Filter Window with the Remote Query Routing Menu	10
Figure 2-4: The Summary Window and its Command Menu	12
Figure 2-5: The Article Window and its Command Menu	14
Figure 2-6: The Diagnostic Window and its Command Menu	16
Figure 2-7: The Options Window and its Command Menu	18
Figure I-1: Installation Diagram	31
Figure VII-1: Text of Agreement	51

*This empty page was substituted for a  
blank page in the original document.*



## Section 1 — Introduction

Welcome to the Boston Community Information System — the Boston CommlnS! We are pleased to welcome you as a participant. This experiment is a test of a new way of distributing world news and features from the *New York Times* (NYT) and the Associated Press (AP) wire service directly to people's personal computers via radio waves. With our software and a special radio receiver connected to your IBM (or compatible) personal computer, you can receive up-to-the-minute information on the myriad topics carried by the *New York Times* and AP wire services, including world news, local events, financial reports (and some closing stock prices), business news, editorials, commentaries, features on the arts, and weather forecasts. With the Boston CommlnS, you may even receive information on these topics before its announcement on the radio or its publication in a newspaper!

The Boston CommlnS turns your computer into a personal information assistant that monitors the news as it happens. Acting on your instructions, your computer will "filter" this flow of information, saving the stories that match your list of interests. Thus, you can walk up to the system at any time, and browse through the stories that the system has saved for you. Because your personal computer can receive and filter much more information than you could read yourself, it can help you focus and enlarge your awareness of the world. You will probably find that the system consistently finds more articles of interest on certain subjects than you do.

Additionally, users with a modem may access a full database of New York Times articles that is stored on several database servers at MIT. The commands used to access this database are exactly the same as those which allow you to access the articles saved on your system.

For best results, we recommend that you leave your personal computer running with the Boston CommlnS software running whenever you are not using your personal computer for another task. The radio station that carries our transmissions is on the air 20 hours per day. If you leave your system running overnight, it will be ready the next day with the latest news. Most news is transmitted several times a day, so you can use your personal computer for other tasks without fear that you will miss an important article. Additionally, the program can be used in a background mode with programs like DesqView (TM) and Double-Dos (TM) with only 256K devoted to the software.

This User's Manual is designed to tell you everything you need to know to set up and operate the equipment and software loaned to you. We have prepared this manual for new and experienced PC users alike. We hope the manual will answer all your questions about connecting our special digital receiver to your PC, about using the software for the first time, and about customizing the software for your personal use. If you have difficulties, try re-reading this manual, especially the appendix on trouble-shooting, but if the difficulties persist, do call us for assistance at the Boston CommlnS 'HOTLINE', (617)-253-0007.

Because this is an experiment, we are very much interested in your thoughtful evaluation of the Boston CommlnS. Not only do we want your first impressions of the system, *i.e.* your ideas on making the system easier to use during the first few hours, but we also want your later impressions, *i.e.* your suggestions and advice (on all aspects of the system) from the perspective of an experienced user. To this end, we will send you a Questionnaire each month, which you should return to us promptly. In

truth, we hope that you will send us additional information as the spirit moves you; we want to know your full thoughts on the system, not just your responses to the monthly questionnaire. In a sense, the monthly questionnaires represent a minimum of feedback and evaluation from you; please do send more if you wish.

As a participant in this experiment, you have signed an agreement concerning your responsibilities. Note that you must abide by this agreement, in spirit and in letter, or you will be asked to return all loaned equipment and software to us immediately.

We welcome you to this experiment to test the Boston CommInS, and we are looking forward to working with you in the coming months.

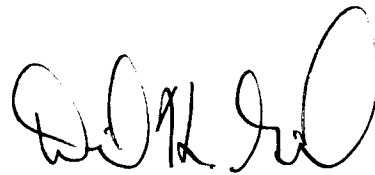

Professor David K. Gifford  
Massachusetts Institute of Technology  
Cambridge, Massachusetts  
September, 1986

## Organization of this Manual

This introduction is followed by three more sections, which describe, in turn:

- the capabilities of the CommInS software, and how to use it;
- the information services provided by the Boston CommInS; and
- how to put together your own personalized 'news filter'.

There are seven appendices. Appendix I is the most important one for new users: it describes how to connect the receiver to your PC, and how to install and run the software. Appendix II is a guide to help users set up their modem for use with the remote system.

Appendix III is a trouble-shooting guide, and contains descriptions of common problems and their solutions.

Appendix IV is designed for users experienced with previous versions of our software. It describes the basic changes in the current program.

Appendix V is the reference section: all the commands are listed here. Appendix VI describes the files used by the system, and finally, Appendix VII contains a few words about the responsibilities of participants in the Boston CommInS experiment.

## How to Use this Manual

First-time users should proceed in the following order:

- First, you should read *Appendix I — Getting Started* and follow the instructions for unpacking the equipment, installing it, and installing the software.
- After you install the hardware and software, you should read Section 2. It includes instructions for first-time users that you should follow. These instructions guide you through the section quickly and superficially, to give you a general idea of how to use the CommInS software.
- Next, you should skim Sections 3 and 4, to learn about the information services that are available, and to learn how to put together your own news filter.
- Finally, you should turn back to Section 2, read the parts that you were asked to skip on first reading, and try out all the different commands.

Start with "Appendix I — Getting Started". *Good luck!*

## Section 2 — Using the CommlnS Software

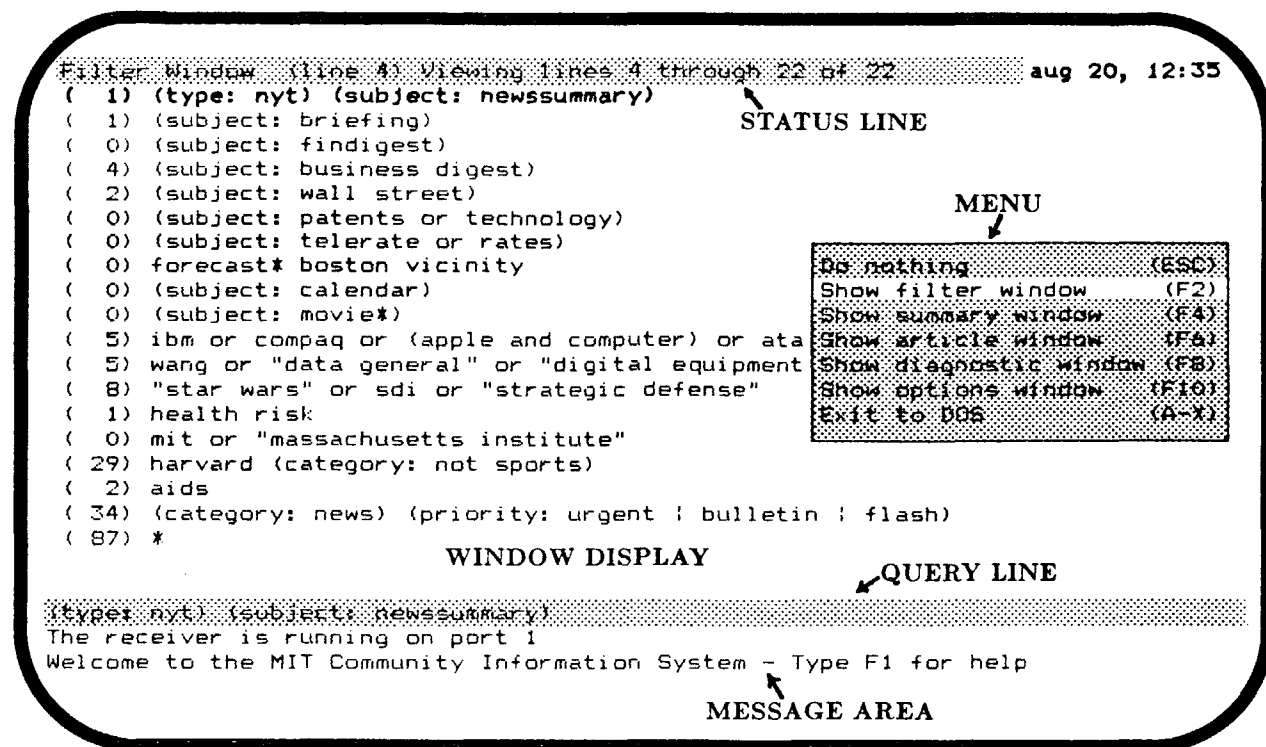

Figure 2-1: The Screen Layout and the Window Selection Menu

As shown in Figure 2-1, the CommlnS software divides the screen of your PC into four separate areas:

- The *status line* is the highlighted line at the top of the screen. In addition to the date and time, the status line indicates which window is displayed below, which line or summary in the window is selected (if any), which lines or summaries are shown, and how many lines or summaries the window contains.
- The *query line*, also highlighted, is the third line from the bottom. The purpose of the query line is described in Section 2.1.
- The *message area* occupies the bottom two lines of the screen. Messages from the system (such as acknowledgments and error messages) are displayed here.
- The *window display* occupies the remainder of the screen. It is used to display the following five windows:
  - the *filter window*, which contains your news filter,
  - the *summary window*, which contains article summaries,
  - the *article window*, which contains articles,
  - the *diagnostic window*, which contains details about the system's operation, and
  - the *options window*, which contains the setting of various controls that you can change.

When the system starts up, it displays the filter window. To find out how to ask the system to display

the other windows, press F3<sup>1</sup>: this instructs the system to show the *window selection menu* (see Figure 2-1).<sup>2</sup> A *menu* is a highlighted box containing a list of *commands*, one of which (the *selected* command) appears on a contrasting background. You can use the ↓ and ↑ keys to select any command in a menu; when you press <Enter>, the selected command is *executed*. If you do not want to execute a command, you can select *DO NOTHING*, or you can press the shorthand key <Esc>. If you press a key other than ↓, ↑ or <Enter>, the system will remove the menu and then act upon the key you pressed.<sup>3</sup>

You can use the window selection menu (see Figure 2-1) to instruct the system to display any of the five windows. As an alternative, you can simply press the corresponding *shorthand key* shown in the menu (F2 for the filter window, F4 for the summary window, and so forth). The status line (at the top of the screen) always indicates which window is being shown. The shorthand keys work whether or not there is a menu on the screen; thus, you can *always* ask the system to display any of the five windows by pressing F2, F4, F6, F8 or F10. If this is your first time using the system, you should take a look at the other windows before you read on.

If a window contains more than one screenful of text, this is indicated in the status line. To see whole text of the window, use the *scroll keys*:

- <PgDn> Show the next page.
- <PgUp> Show the previous page.
- <Home> Show the first page of the window.
- <End> Show the last page of the window.

In the filter window and the summary window, you can also use the the following keys:

- Shift-↓ Move forward one line (or summary)
- Shift-↑ Move back one line (or summary)
- ↓ Select the next line (or summary)
- ↑ Select the previous line (or summary)

The shift key used in conjunction with ↑ and ↓ has the same effect as using the numeric lock key. That is, use of this feature causes the screen to shift as opposed to only cursor movement.

Each of the five windows has its own set of commands: for example, the filter window has a command for adding new filter lines, the article window has a command for going to the next article, and so on. The commands for each window are listed in the *command menu* for that window. When you are looking at a window, press / to see the corresponding command menu. You can display all five command menus in turn by pressing F2 /, F4 /, F6 /, and so forth. Note that every command has a shorthand key, which is listed to the right of the command in the menu.

For your protection, some commands (such as DELETE ALL MATCHING ARTICLES) ask for *confirmation*

---

<sup>1</sup>"F3" refers to the gray function key on the left side (or top for some compatibles) of the keyboard labeled F3. Similarly, F1, F2, etc. refer to the other function keys.

<sup>2</sup>When you press a key, the system usually responds right away. However, when the system is writing a new article on the disk, it responds only after the whole article has been written.

<sup>3</sup>Thus, you can also remove a menu by pressing the space bar.

before they do anything. When you execute such a command, a *confirmation box* appears on the screen. A confirmation box is a tiny menu with only two options: DO NOTHING and EXECUTE. Select EXECUTE and press <Enter> if you wish to go ahead, or use the shorthand A-E.<sup>4</sup> If you wish to cancel the command, execute the DO NOTHING command or use the shorthand <Esc>.

A help file is provided with the system which contains an overview of some basic commands. If this is your first time using the system, you should press F1 and look through this help file. It also contains some information not yet covered. You can view this file any time by pressing F1.

---

<sup>4</sup>The prefix "A-" refers to the <Alt> key: for example, A-E means "hold down the <Alt> key and press e". Similarly, the prefix "C-" refers to the <Ctrl> key: for example, C-D means "hold down the <Ctrl> key and press d".

## 2.1 — The Filter Window

```

Filter Window (line 4) Viewing lines 1 through 22 of 22      aug 20, 12:36
( 1) (type: nyt) (subject: newssummary)
( 1) (subject: briefing)
( 0) (subject: findigest)
( 4) (subject: business digest)
( 2) (subject: wall street)
( 0) (subject: patents or technology)
( 0) (subject: telerate or rates)
( 0) forecast* boston vicinity
( 0) (subject: calendar)
( 0) (subject: movie*)
( 5) ibm or compaq or (apple and compute
( 5) wang or "data general" or "digital
( 8) "star wars" or sdi or "strategic de
( 1) health risk
( 0) mit or "massachusetts institute"
( 29) harvard (category: not sports)
( 2) aids
( 34) (category: news) (priority: urgent
( 87) *

Do nothing (ESC)
Show the window selection menu (F3)
Show summaries (Enter)
Show remote summaries (C-Enter)
Show first article (A-R)
Delete all matching articles (A-K)
Print all matching articles (A-P)
Change budget of current line (A-B)
Insert a new line (A-I)
Remove current line (A-W)
Move current line up (A-U)
Move current line down (A-N)
Turn beep-on-arrival on/off (A-1)
Turn print-on-arrival on/off (A-2)
Exit to DOS (A-X)

(type: nyt) (subject: newssummary)
The receiver is running on port 1
Welcome to the MIT Community Information System - Type F1 for help

```

Figure 2-2: The Filter Window and its Command Menu

The CommInS software monitors the information that comes in via the receiver, and “filters in” the articles that match your interests, based on the *filter*. Thus, the filter serves as your personal “interest profile”. The filter on the distribution disk serves only as an example to get you started — you will soon learn how to customize the filter for your personal use.

Press F2 to see the filter window (see Figure 2-2). Each line in the filter corresponds to a specific topic. Each filter line is preceded by a number in parentheses, which indicates how many articles matching that line are on the disk.<sup>5</sup>

One of the filter lines is highlighted: it is called the *selected line*.<sup>6</sup> You can *select* any line in the filter by means of the *scroll keys*, i.e. ↑, ↓, <PgDn>, etc. When you select a particular line, the contents of that line appears on the *query line* so that you can use it as a *query*. If this is your first time using the system, select a line for which the number of matching articles is not zero, and press <Enter>.<sup>7</sup> When you press <Enter>, the system *processes* the query on the query line, and displays summaries of the

<sup>5</sup>If there are two numbers in front of each filter line, as is the case in Figure 2-2, the number *before* the “/” is the number of matching articles. The second number is the *budget* for that filter line; budgets will be discussed shortly.

<sup>6</sup>If none of the filter lines appear brighter than the rest, press <Home> and adjust the brightness and contrast controls on your PC until the first filter line appears brighter than the rest.

<sup>7</sup>If none of the filter lines have any matching articles, turn to the Appendix on trouble-shooting.

articles that match the query. The *summary window* is described in the next subsection. If this is your first time using the system, turn to the next subsection after you have pressed <Enter>.

Because disk space and memory are limited, the system does not save all matching articles permanently. When the system runs out of space, it deletes old articles to make room for new ones. You can tell the system how many matching articles you would like to keep for each filter line by specifying a *budget* for each line. If this is your first time using the system, press F2 to see the filter list; then press A-S to display the budgets if they are not visible. For each filter line, the system will try to keep *at least* as many articles as the budget indicates, and perhaps more if there is enough room. You can change the budget of any filter line by selecting that filter line, and pressing ">" to increase the budget, or "<" to decrease it.

When the system needs to delete an article to make room for a new one, it will first attempt to delete one from a filter line that is "over budget". If *several* lines are over budget, an article will be deleted from the last such line in the filter. If all the filter lines are *within* their budgets, an article will be deleted from the last line in the filter that has matching articles. Because the system deletes articles from the bottom of the filter first, you should arrange your filter so that the topics that interest you most appear near the top. You can rearrange the lines in the filter by pressing A-U (or A-N) to move the selected line up (or down) in the filter. This is better than deleting the line and re-inserting it elsewhere, because when you delete the line, articles that match only that line will be deleted.

To find out what you can do in the filter window, press F2 (to see the filter window), and press / to see the corresponding *command menu* (see Figure 2-2). You can execute any command in the menu by selecting it (using ↓ and ↑) and pressing <Enter>, or you can use the shorthand keys. Most of the command names are self-explanatory; if this is your first time using the system, please go ahead and try out the various commands. The commands are briefly explained below, with more detail about several of the commands below.

- DO NOTHING (with shorthand <Esc>) — this command removes the menu.
- SHOW WINDOW SELECTION MENU (F3) — this command shows the *window selection menu*; it is listed primarily to remind you of the shorthand key, F3.
- SHOW SUMMARIES (Enter) — this command shows brief *summaries* of all articles matching the current query that are saved on disk.
- SHOW REMOTE SUMMARIES (Control-Enter) — this command will send the query to our *New York Times* database and show brief summaries of all articles matching the current query that are found in the data at MIT.
- SHOW FIRST ARTICLE (A-R) — this command display the first article on disk that matches the current filter line.
- DELETE ALL ARTICLES IN LIST (A-K) — this command deletes all the articles on the disk that match the current filter line. Articles that match more than one line are not removed. This command will ask for confirmation first.
- PRINT ALL ARTICLES IN LIST (A-A) — this command prints all the articles that match the current filter line.
- CHANCE BUDGET OF CURRENT LINE (A-B) — this command puts the cursor in the budget field of the current filter line and lets you change the budget. This command requires you to press <Enter> when you have finished entering the budget.



- INSERT A NEW LINE (A-I) — this command inserts a new filter line, puts the cursor in it, and lets you edit the new line. This command requires you to press <Enter> when you have finished entering the filter line.
- REMOVE CURRENT LINE (A-W) — this command removes the current line from the filter list and deletes all matching articles.
- MOVE CURRENT LINE UP (A-U) — this command moves the current filter line up in the filter list. See the preceding paragraph about filter line priority.
- MOVE CURRENT LINE DOWN (A-D) — this command moves the current filter line down in the filter list. See the preceding paragraph about filter line priority.
- TURN BEEP-ON-ARRIVAL ON/OFF (A-1) — this command toggles the feature that rings the bell upon arrival of an article matching the current filter line. This feature is described below.
- TURN PRINT-ON-ARRIVAL ON/OFF (A-2) — this command toggles the feature that prints all articles that match the current filter line upon arrival. This feature is described below.
- EXIT TO DOS (A-X) — use this command if you want to turn off the PC or if you want to use the PC for something else. This command requires confirmation.

The SHOW SUMMARIES command, with shorthand <Enter><sup>8</sup>, instructs the system to process the query on the query line. Usually, the query line contains a copy of the current filter line. However, you can submit any query you like by editing the query line before you press <Enter>.<sup>9</sup> The *query language* is described in Section 4. Note that while *any* valid query is permitted as a filter line, you can *locally process* only queries that contain only words and phrases that occur in the filter.

Queries which contain words or phrases which do not already appear in your filter will be automatically submitted to the remote database if the program was started with the -d option. If a query is not specific enough to process at the remote database, the program will, if possible, a menu of terms which may be added to the query in order to process the query remotely. You may choose a term from the menu, or select DO NOTHING to cancel the query (see Figure 2-3).

A query which can be answered locally (on your PC) may be submitted to the remote database: select SHOW SUMMARIES FROM REMOTE SYSTEM from the menu, or press <C-Enter> instead of <Enter>.

You can customize the filter by adding and removing lines, by re-ordering lines, and by changing their budgets (see *Section 4 — The Query Language*). To add a new line to the filter, select a line at the point where you want to insert the new line, and select the INSERT A NEW LINE command or press (A-I). The system will create a new filter line, containing a copy of the query line and place the cursor in it. You can use the edit keys to edit the new filter line if you wish. After editing the new filter line, press the <Enter> key to install it in the filter. If you change your mind and you decide that you do not want to add a line after all, press <Esc>.

When you *delete* a filter line, the matching articles are also deleted.<sup>10</sup> For this reason, the REMOVE CURRENT LINE (A-W) command requires confirmation.

---

<sup>8</sup>Since <Enter> is also used to initiate processing on menus, it can only be used as shorthand when there is no menu on the screen.

<sup>9</sup>The editing keys are described in *Appendix V.3 — Editing Keys*.

<sup>10</sup>Except for articles that match one or more other lines as well.

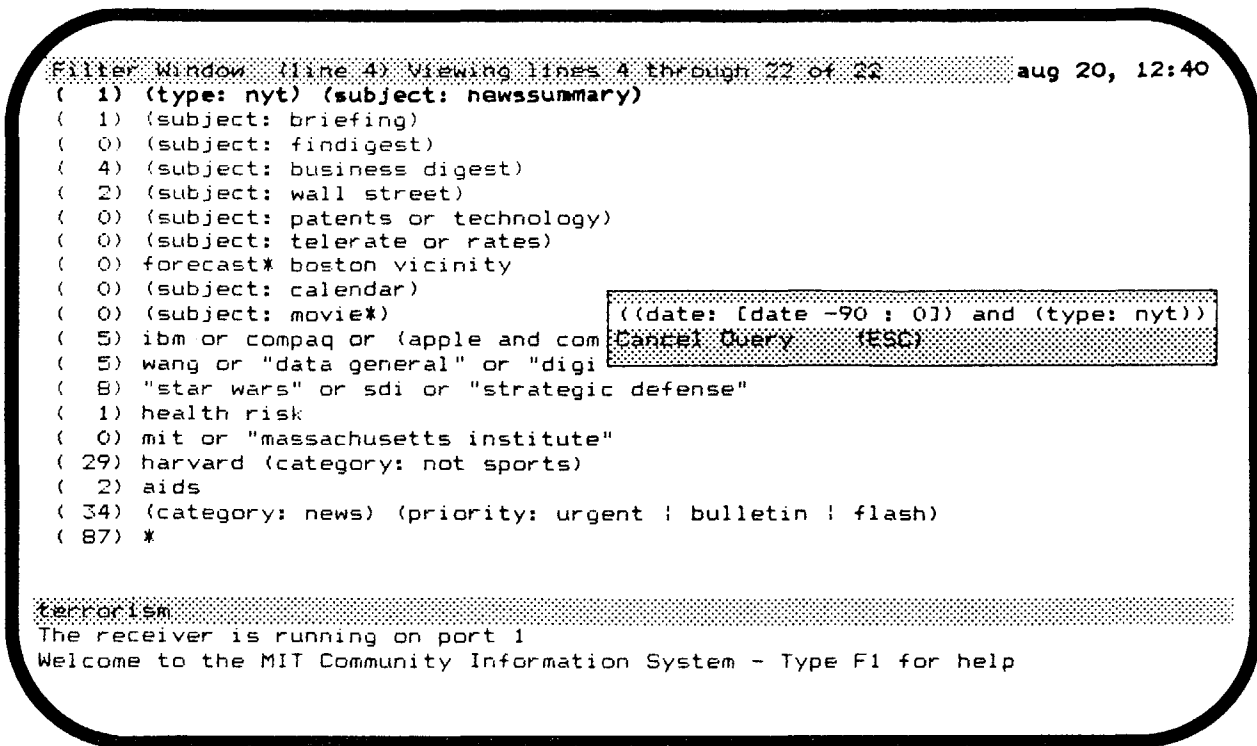

Figure 2-3: The Filter Window with the Remote Query Routing Menu

You can 'mark' a filter line so that the system will ring the bell when a matching article arrives. This is called "beep-on-arrival", and you can turn it on and off (for the selected filter line) by pressing A-1. Filter lines that have "beep-on-arrival" set are identified by a musical note in the margin. You can also mark a filter line so that the system will print all articles matching that line as they arrive. This is called "print-on-arrival", and you can turn it on and off (for the selected filter line) by pressing A-2. Filter lines that have "print-on-arrival" set are identified by the symbol **Pt** in the margin. If a line has both "beep" and "print" set, only the **Pt** symbol appears.

The last line of the filter, displayed as an asterisk (\*), is not really a filter line; it matches every article on the disk, and the number of articles matching it indicates how many articles are on the disk. The *budget* of this line is called the *system budget*, and it indicates the *maximum* number of articles that the system will keep. You can change the system budget just as you change the budget of a filter line, by pressing 'D' or 'L' or by executing the command CHANGE BUDGET OF CURRENT LINE. If you have a hard disk, you can limit the size of the \news directory by setting the system budget to, say, 100 articles. The system budget is limited by the amount of free memory: when the system runs out of memory, it reduces the system budget accordingly.



2.2 — The Summary Window

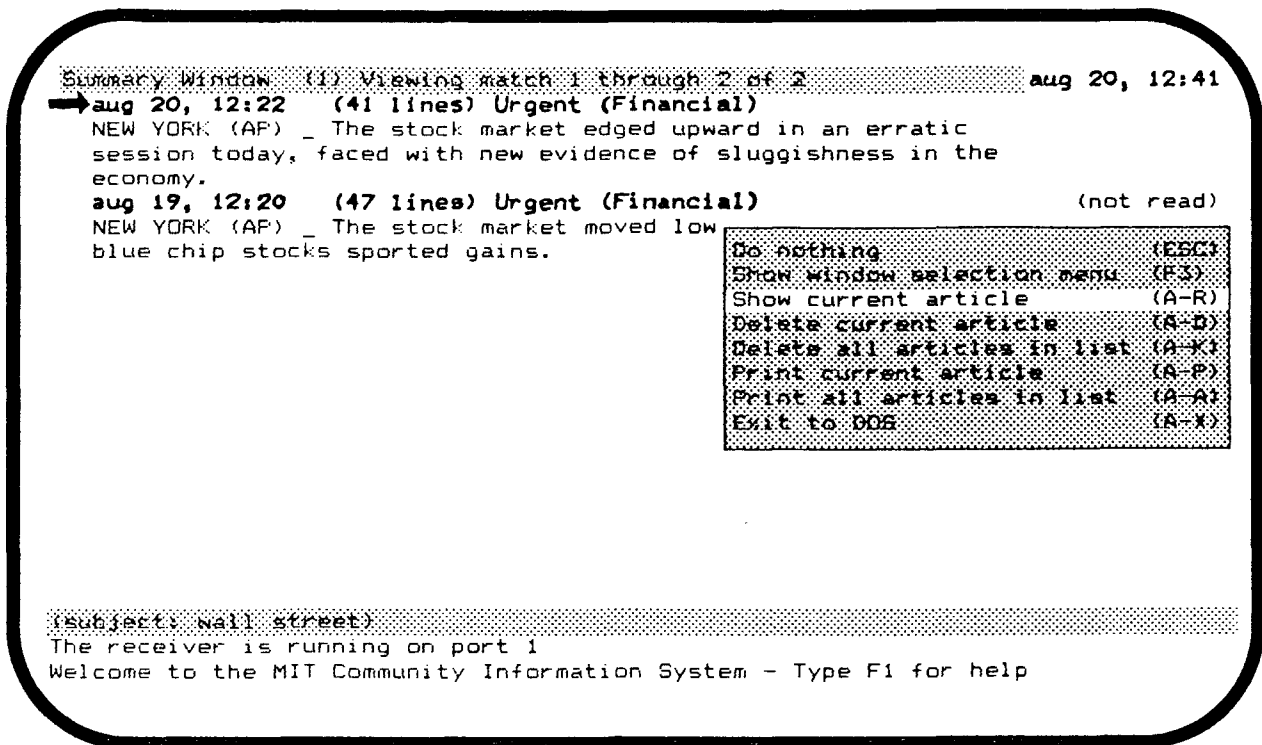

Figure 2-4: The Summary Window and its Command Menu

The summary window (see Figure 2-4) contains summaries of the articles that match a particular query or filter line. If this is your first time using the system, press F4 to see the summary window.

Each article summary is preceded by a highlighted line containing:

- the date (and time) of the article,
- the number of lines in the article,
- the priority of the article, and
- the general subject area of the article.

If the article has not yet been displayed, the header line also contains the words (not read). The header line is followed by a brief "summary" of the article.<sup>11</sup> The summaries are listed in reverse chronological order, *i.e.* the summary of the most recent article is listed first.

The arrow to the left of the summaries points to the selected summary. You can select any summary in the summary window using the *scroll keys*.<sup>12</sup>

<sup>11</sup>We do not employ someone to read the articles and write summaries. Instead, the system automatically extracts the first sentence of each article to display as the summary. In most news articles, the first sentence provides a reasonably good summary. Sometimes, as you will discover, it doesn't. And sometimes our automatic procedure for finding the first sentence doesn't work.

<sup>12</sup>When you use the scroll keys, the system will select a different summary if this is necessary to ensure that the arrow remains visible on the screen.

To learn what you can do in the summary window, press / to see the command menu (see Figure 2-4). The command menu contains the following commands:

- DO NOTHING (with shorthand <Esc>) — this command removes the menu.
- SHOW WINDOW SELECTION MENU (F3) — this command shows the *window selection menu*; it is listed primarily to remind you of the shorthand key, F3.
- SHOW CURRENT ARTICLE (A-R) — use this command if you wish to read the article corresponding to the selected summary. If this is your first time using the system, you should select this command, press <Enter>, and turn to the next subsection.
- DELETE CURRENT ARTICLE (A-D) -- this command deletes the article corresponding to the selected summary. It does not ask for confirmation.

**Note:** Articles which have been received from the remote system can not be deleted.

- DELETE ALL ARTICLES IN LIST (A-K) — this command deletes all the articles whose summaries are in the summary window. It will ask for confirmation first. The number of articles in the summary window is listed on the status line.
- PRINT CURRENT ARTICLE (A-P) — this command prints the article corresponding to the selected summary. It works only if your PC is equipped with a printer and the printer is turned on.
- PRINT ALL ARTICLES IN LIST (A-A) — this command prints all the articles whose summaries are in the summary window. The number of articles in the summary window is listed on the status line.

**Note:** Remote articles cannot be printed from the summary window. To print a remote article, retrieve the article (using the SHOW CURRENT ARTICLE command), and print it from the article window (as described in Section 2.3).

- EXIT TO DOS (A-X) — use this command if you want to turn off the PC or if you want to use the PC for something else. This command requires confirmation.

**Note:** The summary window always contains the summaries from the last query *processed*. Thus, even if you change the query line and press F4 again, the contents of the summary window will remain the same. The following two commands, which are listed in *Section 2.1 — The Filter Window*, are the only ones that create a new list of summaries:

- SHOW SUMMARIES
- SHOW FIRST ARTICLE
- SHOW REMOTE SUMMARIES

2.3 — The Article Window

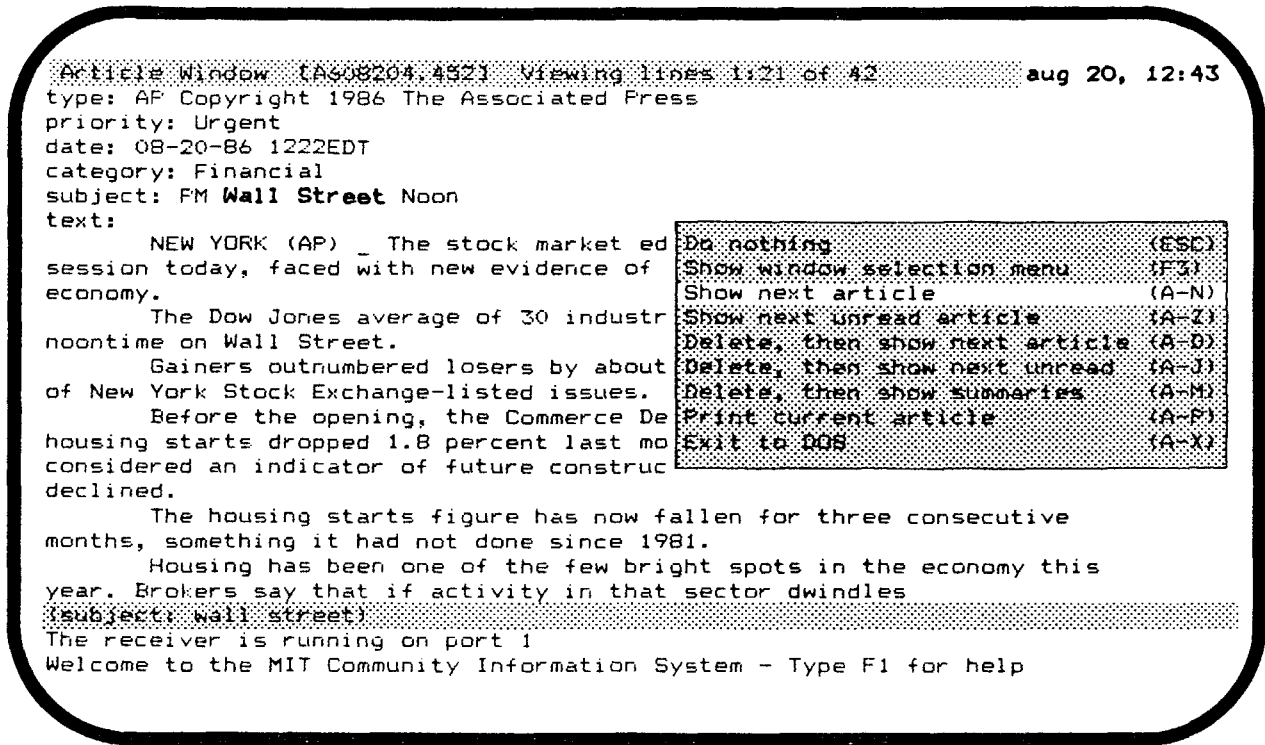

Figure 2-5: The Article Window and its Command Menu

The article window (see Figure 2-5) is used to display articles. You can move up and down through the article using the *scroll* keys.<sup>13</sup> If this is your first time using the system, press F6 to see the article window.

Most articles contain several words that matched your filter. The *first* occurrence of each such word is highlighted, so you can scan an article quickly and determine why it matched the filter.<sup>14</sup> This is useful because filter lines sometimes match out of context, filtering in articles that do not interest you at all. If a particular filter line matches a lot of articles that do not interest you, you may wish to make that filter line more 'specific' — this is explained in Section 4.

To find out what you can do in the article window, press F6 (to see the article window), and press / to see the corresponding command menu (see Figure 2-5).

SHOW NEXT ARTICLE is probably the most useful command. It instructs the system to display the article corresponding to the next summary in the summary window. If there are no more articles, the system puts a message in the message area, and displays the filter window.

The CommInS software remembers which articles it has displayed. If you don't want to see the same article twice, you can use the command SHOW NEXT UNREAD ARTICLE instead of SHOW NEXT ARTICLE.

<sup>13</sup> <PgDn>, <PgUp>, <Home>, <End>, etc.

<sup>14</sup> There is no highlighting in articles received from the remote database.

When you have read an article, you can delete it (to make room for new articles). Depending on what you want to do next, you can use the command `DELETE, THEN SHOW NEXT ARTICLE`, the command `DELETE, THEN SHOW NEXT UNREAD (ARTICLE)`, or the command `DELETE, THEN SHOW SUMMARIES`.

**Note:** Remote articles cannot be deleted.

If your PC is equipped with a printer, you can *print* the article using the command `PRINT CURRENT ARTICLE`. If only a portion of a remote article has been received when a print command is issued, only that portion will be printed; in order to ensure that the complete article has been received before printing, wait for the `** End of Article **` line to appear at the end of the article.

As always, you can use the command `EXIT TO DOS` if you want to turn off the PC or if you want to use the PC for something else.

---

***Note for first-time users:***

If this is your first time using the system, we recommend that you:

- turn to *Section 3 — Databases and Services*, and skim it to learn about the information services that are available through the Boston ComInS;
  - skim *Section 4 — The Query Language*, to find out how to put together a news filter that filters in the information you are interested in;
  - after that, turn back to the beginning of this section (Section 2), read the parts that you were asked to skip on first reading, and try out all the different commands.
-

2.4 — The Diagnostic Window

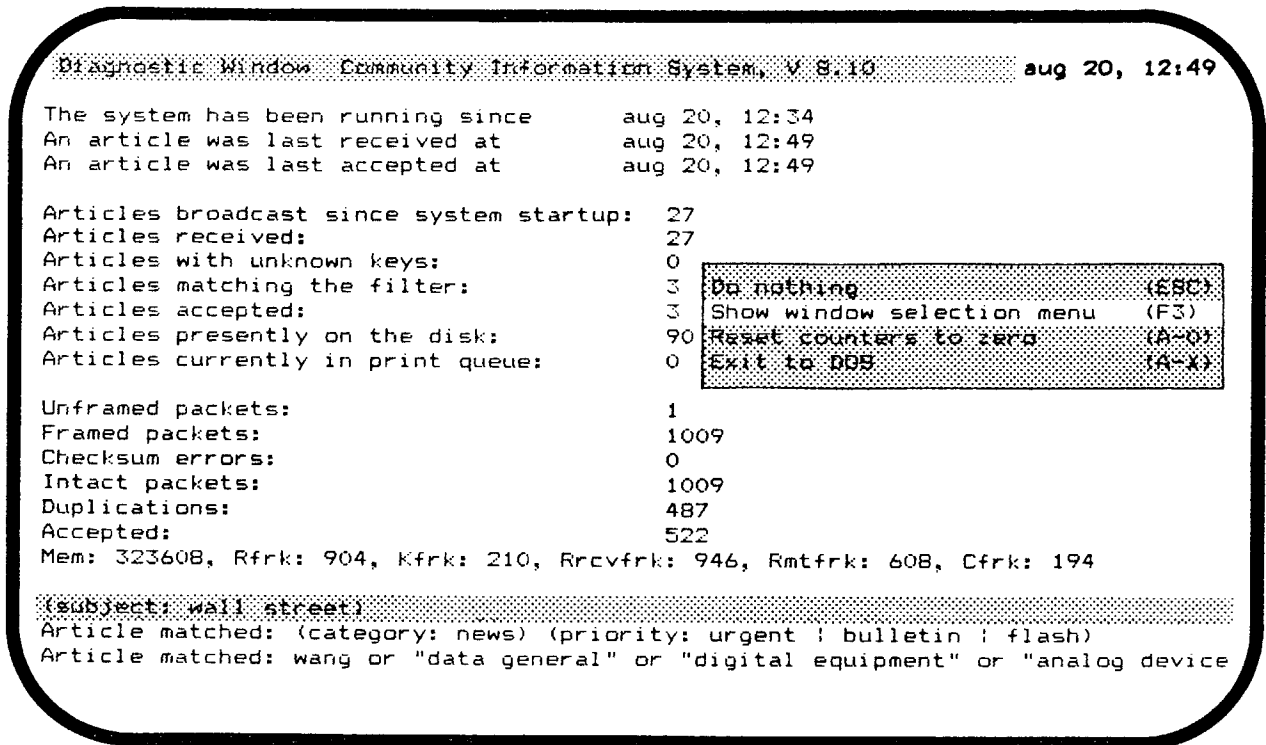

Figure 2-6: The Diagnostic Window and its Command Menu

The *diagnostic window* contains information about the operation of the Boston Commlns software. This information is updated continually. If your system is working correctly, you should have no need for this window at all. If this is your first time using the system, press F8 to see the diagnostic window.

In the Boston Commlns radio transmissions, each article is divided into "packets" that are transmitted separately. Each packet is 'checksummed' to permit error detection, and broadcast twice to permit error recovery. The Commlns software receives packets, verifies the checksum, and discards duplicate packets. The most important indicator of system performance is the number of "intact packets" received. During normal operation, the number of "intact packets" received should be increasing steadily, at a rate of about three per second, occasionally interrupted by brief pauses that are followed by rapid catching up. If the number of "intact packets" is not increasing, turn to the trouble-shooting guide in Appendix III.

All "intact packets" are "accepted", unless they are "duplications" of packets received earlier. Since every packet is transmitted twice, the number of "duplications" should be approximately equal to the number of "accepted" packets.

If a packet is "unframed", or contains a "checksum error", it is not received "intact". These numbers are an indication of reception quality. If your receiver is functioning well, the number of "unframed"



packets and 'checksum errors' should be very small, probably less than ten per day.<sup>15</sup> When the radio station is off the air (usually from 2 am to 6 am) the number of bad packets will increase.

You can get a sense of the percentage of articles that actually match your filter by comparing the number of "articles matching the filter" with the number of "articles broadcast since system startup". The number of matching articles that are actually written to the disk is listed as "Articles accepted". The number of "Articles presently on disk" is the number of articles on the disk.

You may reset all of the statistics counters by selecting the RESET COUNTERS TO ZERO (A-0) command.

For legal and policy reasons, all our information broadcasts are digitally encrypted. Different kinds of information are encrypted using different keys. The software distributed for this experiment contains keys for the *New York Times* and AP articles, as well as for system announcements. Articles that are intended for a limited audience (for example, personal mail) are encrypted using keys that are not distributed to the general public; when such articles are received, they are counted as "articles with unknown keys".

If you instruct the system to *print* one or more articles, in the background, the number of "Articles currently in print queue" indicates how many articles remain to be printed. You can stop printing and clear the print queue at any time using the shorthand key A-Q.

The bottom line in the Diagnostic window indicates the amount of free memory, and the amount of unused stack space in each of the 'forks' (internal processes) of the program.<sup>16</sup> *Mem* is the total amount of memory that is not allocated. Memory is allocated for each filter line, and for each article on the disk.

*Rfrk* is the amount of unused stack space in the receiver fork. The receiver fork receives data, checks packets, assembles them into articles, decrypts the articles, matches them against the filter, and writes new information to disk.

*Kfrk* is the amount of unused stack space in the keyboard fork. The keyboard fork processes all keystrokes and commands.

*Cfrk* is the amount of unused space in the clock fork. The clock fork is responsible for periodic processing, such as updating the clock in the upper right corner of the screen.

*Rmtfrk* is the amount of unused space in the remote processing fork. The remote fork manages communications with the remote database server. This will only appear if the duplex system is selected when the CIS program is started.

*Rrcvfrk* is the amount of unused space in the remote receiver fork. This fork receives and processes information from the remote database server. This will only appear if the duplex system is selected when the CIS program is started.

---

<sup>15</sup>There will usually be at least one "unframed" packet, because when you start up the Boston CommInS program, odds are that it will receive the end of a packet before it begins to receive whole packets.

<sup>16</sup>This information is provided primarily for the system implementors; there are no "user-serviceable parts" within the Boston CommInS software. However, if the amount of free memory gets very small (under 100 for the forks, under 1000 for the free memory) you may encounter unexpected problems. This should not happen during normal operation of the system.

## 2.5 — The Options Window

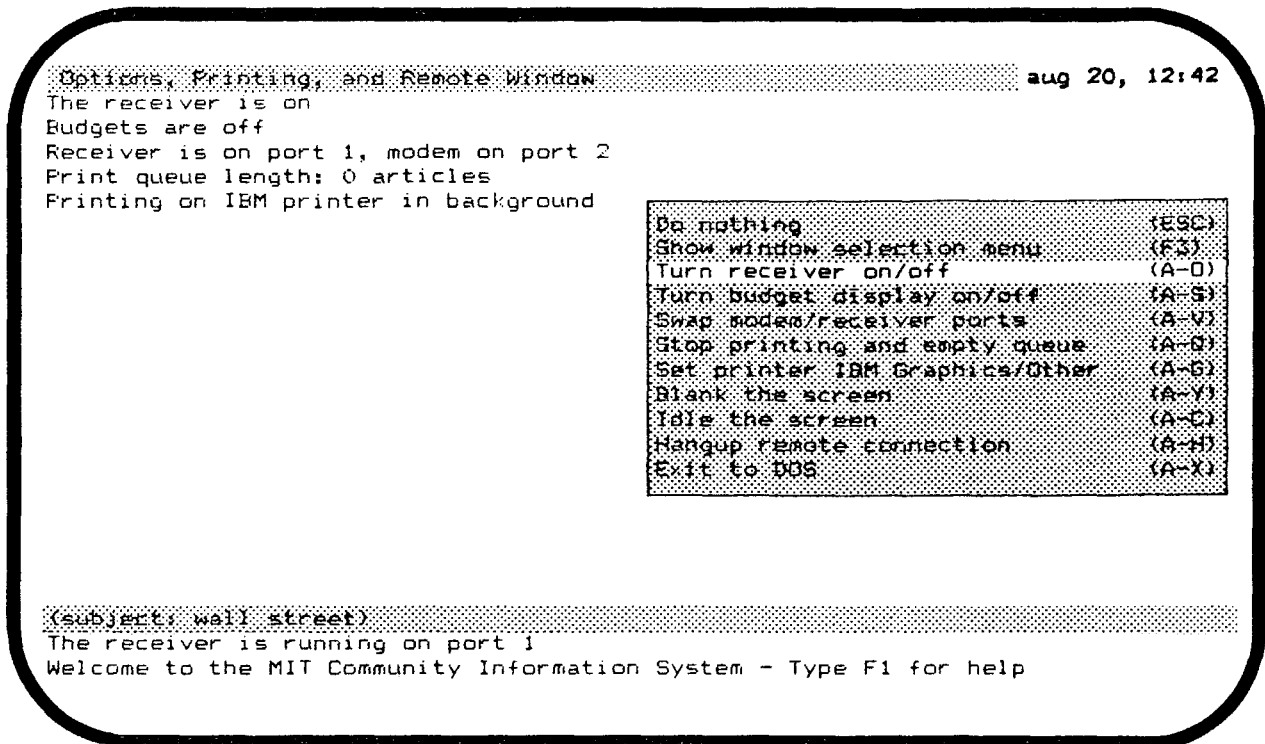

Figure 2-7: The Options Window and its Command Menu

The *options window* shows the setting of various controls that you can change. If this is your first time using the system, press F10 to see the options window.

- The first line in the options window indicates whether the receiver is on or off. You can turn the receiver on or off with the command `TURN RECEIVER ON/OFF`, or with the shorthand `A-O`. When you shut the receiver off, the system will respond to your commands more promptly, because it won't be writing articles to the disk. On the other hand, you won't receive any new articles. If you decide to turn the receiver off so you can read articles without being interrupted, don't forget to turn the receiver back on when you're done.
- Line two of the options window indicates whether or not the *budgets* are being displayed in the filter window. You can turn the budget display on or off with the command `TURN BUDGET DISPLAY ON/OFF`, or with the shorthand `A-S`.
- Line three indicates whether the program is listening for articles on port 1 or on port 2. The modem which allows communication with a remote database server is assumed to be on the other port. If you have two serial ports, you can switch the program to the other port with the command `SWAP MODEM/RECEIVER PORTS` (or with the shorthand `A-V`).<sup>17</sup>
- Line four indicates how many articles are waiting to be printed. To stop printing and empty the print queue, use the command `STOP PRINTING AND EMPTY QUEUE` or press `A-Q`.

<sup>17</sup>You can also select a port when you start up the program: see *Appendix I.5.1 — Starting the CommIns Program*.

- Line five indicates whether the program is expecting to print articles in the foreground or background. Background printing is more convenient because it allows other commands to be processed concurrently. However, the CIS program is designed to print in background on IBM Graphics printers only. In order to use other printers, select the PRINT FOREGROUND command from the menu.

Note that even though this command menu is only available in the options window, the shorthand keys described here may be pressed at any time.

There are several additional commands available in the menu.

- **BLANK THE SCREEN (A-Y)** Causes the screen to become completely blank until any key is pressed. This may be particularly useful in conjunction with multi-processing systems such as DesqView (TM) or Double-Dos (TM) which allow the CIS program to operate in the background while other programs are running on the computer.
- **IDLE THE SCREEN (A-C)** Similar to **BLANK THE SCREEN**, this command causes a message to be displayed on the screen. The message is displayed in different places on the screen every few seconds, so as not to permanently burn the phosphors in the display.
- **HANGUP CONNECTION (A-H)** Terminates any connection to a remote database. This frees the database server for other users, and hangs up the telephone connection.

## Section 3 — Databases and Services

The Boston CommInS provides you with access to two major databases:

- the text of the *New York Times*, and
- the *Associated Press* (AP) news wire.

The *New York Times* service includes the complete text of the articles that appear in that newspaper. The AP service provides articles on a wide variety of topics. Because the *New York Times* is a New York paper, it does not carry local news for the Boston area. However, the AP service provides extensive Boston and New England coverage.

The *New York Times* and AP databases are founded on different philosophies. The *New York Times* provides highly polished and readable news stories, corresponding to the printed version of the *New York Times*. Developing news stories are usually updated once a day by their editors. The AP service, on the other hand, provides up to the minute reports on breaking news stories, as well as corrections, updates, and occasional retractions of previous stories. Thus, you can expect to get different kinds of information from these different sources.

### 3.1 — Fields

All news articles follow the same standard format: an article consists of several *fields*, including the TEXT field. Section 4 describes how to take advantage of the information in the various fields when you put together your personal news filter.

The set of fields is fixed; the use of the various fields is described below. For an example of how the fields are used, just look at any article.

TYPE	The TYPE field of an article identifies the source of the article. There are three types of articles: "nyt" ( <i>New York Times</i> ), "ap" ( <i>Associated Press</i> ), and "cis" (announcements from the Boston Community Information System). As we expand our information services, new article types may appear.	
DATE	The DATE field indicates the date and time at which article was written.	
CATEGORY	The CATEGORY field identifies the general subject area of an article. The categories used by the <i>New York Times</i> and AP editors are described in the next subsection.	
AUTHOR	The AUTHOR field identifies the author of an article. This field is sometimes left blank by the originating information source. Occasionally, the author of an article is identified by a by-line in the TEXT field of the article.	
PRIORITY	The PRIORITY field indicates the priority of the article, as classified by the originating information source. The PRIORITY field of an article contains one the following words or phrases:	
	flash	the highest priority; it is seldom used
	bulletin	the priority level of prime news; it is also used for corrections, updates, and occasional retractions of previous stories
	urgent	the priority level of important news
	regular	the priority level of routine news

	deferred	the lowest priority level; used for delayed sending of a completed story
	Weekday advance	material for a future weekday
	Sunday advance	material for a future Sunday
	reruns	reruns
SUBJECT	The SUBJECT field contains a subject identifier that is assigned by the originating information source. Certain subject identifiers are used consistently; some of these are listed in Section 3.3. Some articles are actually listings of upcoming articles, and they give the subject identifier for each upcoming article (for example, "REAGAN SPEECH"). If you are interested in such an article, add a filter line of the form ( subject: "reagan speech" ) to your filter and your system will catch the article.	
TITLE	The TITLE field contains the title of the article, if any. Most articles do not have titles.	
TEXT	The TEXT field contains the text of the article itself.	

### 3.2 — Categories

As will be explained in *Section 4 — The Query Language*, a filter line or query of the form ( category: <something> ) matches articles whose CATEGORY field contains <something>. The CATEGORY field is very useful, because the *New York Times* and AP editors put every article in an appropriate category. The following is a list of the categories used. Unfortunately, the categories do tend to change with time, so this list is not complete.

Advisories	Listing of the subject lines of stories on the news wire
Domestic	Domestic news, except for news from Washington D.C.
Washington News	News concerning national politics, the United States government, actions of the President, and congressional decisions
International News	News about foreign events, including articles originating at the United Nations headquarters
State and Regional News	News concerning the local Massachusetts area
Financial	Business news, financial indicators, and some stock market information
Features	Feature stories
Lifestyle	Social news
Entertainment and Culture	Articles on entertainment, culture, and the arts, including reviews of movies, plays, books, and television programs
Racing Results and Entries	Upcoming horse races as well as results
Sports	Sports features and scores
Individual Sports Scores	Selected box scores
Commentary	Editorials and columns
Travel	Travel information and human interest stories involving travel
Multiple Categories	Articles consisting of segments that belong in different categories; frequently used for announcements of upcoming

articles  
 Presidential Election Election coverage (when applicable)

**3.3 — Subjects**

Our information sources provide a variety of information, such as news summaries, on a regular basis. Information of this kind is identified using the SUBJECT field; for example, the query (subject: newssummary) matches the *New York Times* news summary, as well as various kinds of AP news summaries. In the descriptions below, (NYT) refers to material from the *New York Times*, (AP) refers to material from the Associated Press. The following subject identifiers are used consistently by our information sources, but note that they do change occasionally and new subjects may be added for events occurring at a particular time, i.e. elections, sport seasons, etc.:

anderson column	Dave Anderson's column (NYT)
architecture	Articles about architecture (NYT)
arts	News about the arts (AP)
60 minute gourmet	What to do for dinner in one hour (NYT)
baker column	Russell Baker's editorial (NYT)
bba	American League Baseball (AP)
bbn	National League Baseball (AP)
bbo	Combined League Baseball stories (AP)
berkow column	Sports commentary (NYT)
bestsellers	Hardcover bestseller list (NYT)
biztalk	Business news summaries (NYT)
bizweek	Weekly business story (NYT)
bkc	College Basketball (AP)
bonds	Bond prices (AP)
book review	Reviews of new books (NYT)
booktalk	Column about books (NYT)
box*	Box scores of baseball games (AP)
briefing	Briefing on washington news and political events (NYT)
broadway	Stories about Broadway openings/closings/reviews (NYT)
business digest	Business news digest (AP)
business highlights	Business news highlights (AP)
business mirror	Column on business (AP)
calendar	Calendar of political events or of crafts, performing arts, and openings in the New England area (AP)
candidates	Close-up on political candidates (when applicable) (NYT)
capitol ideas	Column from Washington (AP)
careers	Features on interesting careers (NYT)
cheese eggs	Cheese and egg prices (AP)
chess	Articles on chess (NYT)
claiborne	Cooking with Craig Claiborne (NYT)

colleges	Stories on college sports (NYT)
column	Columns from the <i>New York Times</i>
comput*	Various columns about computers, computing etc. (NYT)
congress	Stories on Congress' actions (NYT)
consumer column	Consumer advocacy column (NYT)
consumer rates	Consumer credit rates (NYT)
court	Important court rulings (NYT)
credit	Reports on commercial credit markets (NYT)
credit rates	Present commercial credit rates (NYT)
databank	National economic indicators (NYT)
deaths	Obituaries (AP)
digest briefs	Well-edited news summaries (AP)
dollar	Information on the exchange rates (AP)
economy	Information and articles about the US economy (AP)
eco	Various economic stories (NYT)
edit*	Editorials from the <i>New York Times</i>
editorial rndp	Editorials from New England papers (AP)
education	Stories on education (NYT)
elections	Various election results (when applicable) (AP)
extendeds	Three-day extended weather forecasts (AP)
fashion*	Articles about fashion (NYT)
fhc	College football (AP)
fn	Professional football (National league) (AP)
fbo	Combined league football stories (AP)
finbriefs	Collections of short news items about business and finance (NYT)
findigest	A daily digest of top financial news from the <i>New York Times</i> . This digest is identical to the business digest on the front page of the <i>New York Times</i> business section.
followups	Follow up on the news (NYT)
food fitness	Nutrition articles (NYT)
football qa	Football question column (NYT)
forecasts	Forecasts for around the country (AP)
foreign affairs	Foreign affairs column (NYT)
foreign briefs	Foreign news briefs (NYT)
foreign exchange	Foreign exchange rates (AP)
frontpage	A daily description of the layout of the front page of the <i>New York Times</i>
global temps	Temperatures around the world (AP)
gov finances	Figures on Government spending and debt (AP)
hkn	National Hockey (AP)
hko	American League Hockey (AP)
homevideo	Recent home videotape releases (NYT)
indexes	New York and American Stock Exchange indexes (AP)
industry news	Business news briefs (AP)

interview	Various interviews (AP)
investing	Various stories on investments (NYT)
kitchen	A column on kitchen equipment (NYT)
kisselgoff dance	A weekly column on dance (NYT)
kremlin	Political events in Russia (NYT)
lewis column	Anthony Lewis' column (NYT)
lpga	Ladies' professional golf stories (AP)
mail order	Mail order suggestions (NYT)
market	A daily report on the stock market (NYT)
marketplace	Wall street news (NYT)
mass digest	Massachusetts news digest (AP)
mass* lottery	Massachusetts daily lottery results (AP)
mass* news*	Massachusetts News summaries (AP)
mass* nightcap	Massachusetts News summaries (AP)
matchups	Pre-game analysis of upcoming sporting events (NYT)
megabucks	Massachusetts Megabucks lottery stories (AP)
mortgage	Articles about mortgages (NYT)
movie*	Movie reviews and features about movies, including columns by Maslin and Canby (NYT)
movie notes	Movie column (NYT)
movie review	Movie reviews (NYT)
names news	People in the news (AP)
nasdaq	Selected over-the-counter stock prices (AP)
news digest	A capsule summary of top national news stories from the AP.
newssummary	A capsule summary of top news stories from either the AP or the <i>New York Times</i> . The <i>New York Times</i> news summary comes out once a day around midnight, and is identical to the news summary that appears on the first page of the B section of the printed paper. Use the query ( type: nyt ) ( subject: newssummary ) for this summary. The AP summarizes local news many times a day.
obits	Obituaries (NYT)
oly	Olympics coverage (AP)
on language	Column by William Safire on the English language (NYT)
outdoors	Column on outdoor activities (NYT)
patents	Patents of special interest that have recently issued (NYT)
paperbacks	Paperback bestseller list (NYT)
people	Column on people in the news (AP)
personal finance	Column on personal finance (NYT)
personal health	Column on personal health (NYT)
pga	Professional golf stories (AP)
pop	Articles on popular music (NYT)
practical traveler	Travel advice (NYT)
produce	Boston wholesale produce prices (AP)



prospects	Financial prospects for particular business sectors (NYT)
questionbox	Sports questions and answers (NYT)
quotes	Notable quotations (AP)
racing	Horse racing news (NYT)
records	Recent classical record releases (NYT)
reston column	James Reston's column (NYT)
russell art	John Russell's art column (NYT)
safire column	Column by William Safire that is not "On Language" (NYT)
science q a	Science questions and answers (NYT)
science watch	Short summaries of recent scientific news (NYT)
scotus	Supreme Court (of the United States) news (AP)
scouting	Stories on sports players (NYT)
silk column	Financial commentary by Leonard Silk (NYT)
ski	Column on skiing (NYT)
sports briefs	Brief stories about sports (AP)
sports minute	Latest sports stories (AP)
sports watch	Time tables for sporting events (AP)
stocks	Articles on the stock market (NYT)
tabletalk	Food column (NYT)
tech*	Reports on new and interesting technologies (NYT)
telerate	Interest rates, including T-bills, Eurodollar, Federal discount rate etc. (AP)
theater	Articles about and reviews of the theater (NYT)
transactions	New York Stock Exchange trading volume (AP)
travel	Various travel stories (AP)
travel notes	Vacation ideas (NYT)
travelers forecast*	Weather forecasts for selected cities (AP)
tv review	Reviews of upcoming television programs (NYT)
tv tonight	Tonight's TV programs; sent three days in advance (NYT)
tv weekend	Weekend television (NYT)
vacation	Vacation notes and ideas (NYT)
vecsey column	Sports column (NYT)
video	Column on home videotapes (NYT)
wall street	Reports on Wall Street trading (AP)
washington brief	Short news items from Washington D.C. (AP)
watch	Upcoming business events to watch (NYT)
wea temps	Temperatures and weather from major cities around the country (AP)
weatherpage	Summary of weather around the country (NYT)
wicker column	Tom Wicker's column (NYT)
wine*	Column on wine (NYT)

### 3.4 — Useful Queries

In addition to the subject specifiers above, the following queries will provide you with useful information.

boston vicinity forecast*	Local weather forecast (AP)
massachusetts daybook	Newsworthy upcoming events in Massachusetts (AP)
ski conditions	Ski conditions at all local ski resorts (AP)
(title: week review)	Articles from the <i>New York Times</i> "week in review" section
(subject: mass* digest)	Latest Massachusetts news capsules (AP)

## Section 4 — The Query Language

The ComminS software lets you describe articles that interest you using a simple language, called the *query language*. The query language is used primarily for *filter lines*, but you can also type queries directly into the *query line*. As described in Section 2, the system uses your filter to determine which articles to save for you. Using the query language, you can tell the system what articles interest you, in terms of their contents, source, author, subject, and a variety of other attributes. In this section, we explain the query language, starting with the simplest possible queries.

The simplest possible query is a single word. Imagine, for example, that you are interested in all articles that contain the word "peace". The corresponding query is the word `peace`. If you are interested in all articles that contain the words "war" and "peace", the corresponding query could be `war and peace`, `war & peace`, or simply `war peace`. Thus, you can combine two simple queries into a more specific query by means of `and`, `&`, or concatenation.

Next, imagine that you are interested in all articles that mentioned the Supreme Court. You could use the query `supreme court`, but this query matches all articles that contain the words "supreme" and "court", regardless of whether they appear consecutively. To indicate that the words "supreme" and "court" must appear consecutively as a *phrase*, simply put them in quotes: `"Supreme Court"`. A phrase may contain any number of words. The remote system cannot handle phrases, therefore typing `"new york mets"` has the same effect as typing the three words as explained in the preceding paragraph.

Next, imagine that you are interested in all articles about computers, computing, computation, and so on. To catch all these articles, use the query `comput*`: it matches all articles that contain one or more words beginning with the letters "comput". These queries are called *stem queries*, because they match any word that begins with a specified *stem*. There are two restrictions on stem queries: a stem query may not appear inside a phrase, and the stem must be at least two characters long.

The following convention applies to all queries: uppercase and lowercase letters are considered the same, and all punctuation characters in articles are treated as spaces, except for apostrophes, which are ignored. The system will not accept queries that contain punctuation characters, except for hyphens, which are treated as spaces. Thus, the query `rogers` matches the following words: "rogers", "Rogers", "Roger's", "Rogers'", and so forth. The queries `"space cadet"` and `"space-cadet"` match the following phrases: "space-cadet", "Space Cadet", etc.

Next, imagine that you are interested in articles by a certain author, say John Smith. You could use the query `Smith`, but it matches every article that *contains* the word "smith", regardless of the context in which it appears. To rule out all these extra articles, use the query `(author: smith)`; it matches all articles that have an `AUTHOR` field containing the word "smith". Queries of this kind are called *field-specific queries*; the possible fields (besides `AUTHOR`) are listed in Section 3.1. Other examples of field-specific queries include `(subject: newssummary)` and `(type: cis)`.

Above, we showed how to combine two queries into a more specific query by means of `and`, `&`, or concatenation. In combination with field-specific queries, this combining rule is very useful; for example, the query `ibm (category: financial)` matches all articles that contain the word "ibm" and have a `CATEGORY` field containing the word "financial".

In some situations, the *date* of an article is important. The query language permits you to specify a date using a special format: dates are recognized when enclosed in square brackets with the special key word DATE.

```
[date jun 12 1986]
```

Dates may be specified as a number of days in the past:

```
[date -1]
```

Dates may also be specified as ranges:

```
[date jun 12 : jun 16]
```

Note that the year will default to the current year.

The date on which an article was written appears in the "date" field of the article. For example, to find all articles containing the word juggling that appeared in yesterday's New York Times, use the following query:

```
juggling & (type: nyt) & (date: [date -1])
```

Queries issued to remote database servers must be narrowed to specific dates, i.e. (date: [date -30 : -1]), and sources, i.e. (type: nyt). The CIS program will assist in this by suggesting what sources and dates are available, based on information read in from the configuration file.

The examples on the next page illustrate the different kinds of queries, and the various ways in which they can be combined using and, or and not.

The Query	Matches Articles that...
peace	..contain the word "peace"
"War and Peace"	..contain the phrase "war and peace"
comput*	..contain a word that begins with "comput", such as "computer", "computation" or "computability"
ski*	..contain a word that begins with "ski", such as "ski", "skiing", "skid", "skin" or "skiascope"
war and peace	..contain the words "war" and "peace". The three queries shown to the left are equivalent.
war & peace	
war peace	
war "and" peace	..contain the words "war", "and", and "peace"
war or peace	..contain either the word "war" or the word "peace". The two queries shown to the left are equivalent.
war   peace	
not war	..do not contain the word "war". The two queries shown to the left are equivalent.
~ war	
peace and (quiet or talks)	..contain the word "peace" and either the word "quiet" or the word "talks"
(peace and quiet) or talks	..contain the words "peace" and "quiet" or the word "talks"
(subject: movie*)	..have a SUBJECT field containing a word that begins with "movie"
(author: smith (not john))	..have an AUTHOR field containing the word "smith" but not the word "john"
harvard (not (subject: football))	..contain the word "harvard" but do not have a SUBJECT field containing the word "football". The two queries shown to the left are equivalent.
harvard (subject: (not football))	

The following are some examples of *invalid* queries, along with the reasons why they are invalid:

The Query	Is Invalid Because...
"comput* languages"	..a stem query may not appear within a phrase
(author: (subject: smith))	..a field-specific query may not be nested inside another field-specific query
Mr. Rogers' neighborhood	..punctuation (such as periods and apostrophes) cannot be entered in queries
(topic: reagan)	..TOPIC is not a valid field name. The valid field names are listed in Section 3.1.
(a or (b) or c	..parentheses must be balanced

## Appendix I — Getting Started

### Important

---

The Boston CommInS hardware and software have been designed for use with an IBM PC™, XT™, or AT™ personal computer with the following *minimal* configuration:

- a monochrome or graphics display card and monitor,
- version 2.1 or 3.1 of the MS DOS™ operating system, or a corresponding version of PC-DOS™,
- one floppy disk drive,
- 256 K (kilobytes) of RAM, and
- one RS-232 serial port.
- one 1200-baud modem to retrieve articles from our *New York Times* database (optional)

The Boston CommInS hardware and software *may* also work with 100-percent compatible machines made by other manufacturers, provided that they have at least the configuration listed above.

---

### Introduction

This appendix explains how to unpack the equipment and how to start using the hardware and software for the Boston CommInS. It covers the following topics:

- unpacking the equipment,
- installing the hardware,
- installing the software,
- running the CommInS program, and
- stopping the CommInS program.

Please read and follow these steps in order, even though you may have years of experience with microcomputers and/or communications.

#### I.1 — Unpacking the Equipment

All the equipment, software and documentation for the Boston CommInS is packaged together. Each package should contain the following:

- One receiver (wrapped in bubble wrap) — an grey box with a signal strength meter, three connectors, and an MIT equipment tag
- power supply (AC adaptor) — a black object with prongs that can be plugged into an ordinary outlet (110 volt AC)
- One antenna — a flat, white ribbon cable in the shape of a large "T", with a special connector at the bottom of the "T"
- One RS-232 cable — a gray, 20-foot cable with a 25-pin connector at one end and a "phono" plug at the other end

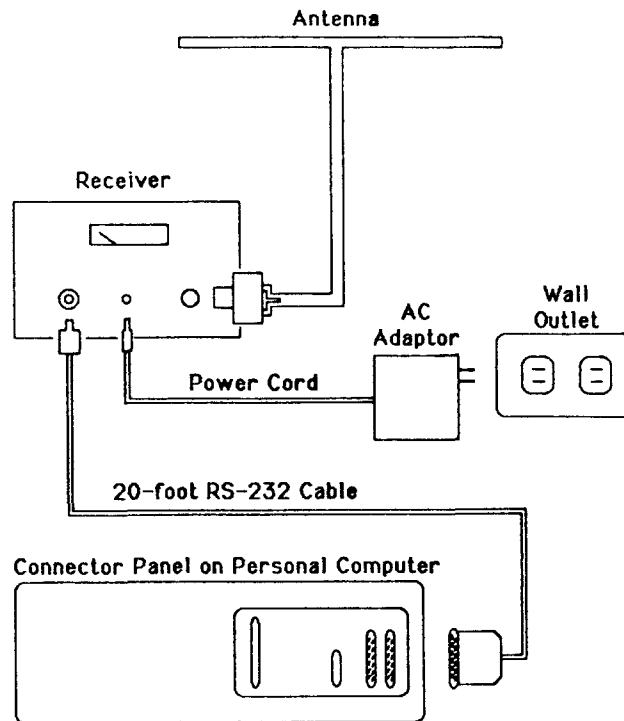

Figure I-1: Installation Diagram

- One distribution disk — a standard 5¼ inch (360K format) floppy disk, packed inside the user's manual
- One user's manual — you're reading it.

Place the contents of the distribution package on a table, and make sure you have received all of the above items. If one or more items are missing, call the Boston CommInS 'HOTLINE' at (617)-253-0007.

Please save the box and packing materials for when you return the equipment to us at the end of this experiment.

## 1.2 — Installing the Hardware

**Note:** Please read this section once *before* you begin to put the equipment together.

### Positioning the Equipment

The receiver, power supply, antenna, and cables can be arranged in any way that suits you, provided that they can be plugged into each other (see Figure I-1). Place the antenna near a window, preferably on the side of your building nearest Boston's Back Bay neighborhood (the Prudential Tower, to be exact). Referring to Figure I-1, position the receiver so that (i) it can be plugged into the antenna, (ii) the 6-foot power cable can reach an ordinary outlet (110 volt AC) and (iii) the 20-foot RS-232 signal cable can reach your personal computer.

### Power

Plug the power supply (AC adaptor) cable into an ordinary outlet (110 volt AC). Plug the other end of

the power cord into the matching connector on the receiver.

### RS-232 Cable

Plug the gray "phono" plug at the end of the 20-foot RS-232 cable into the matching connector on the receiver. Then plug the 25-pin RS-232 connector at the other end of this cable into the RS-232 serial port of your computer. For most installations, this description suffices. However, two unusual situations may apply to you:

- If you have more than one RS-232 serial port on your personal computer, you must know which is port 1 and which is port 2. Normally, the Commins software expects the receiver to be connected to port 1, but either port 1 or port 2 may be used.
- If you have an IBM AT™ computer with a 9-pin serial port connector, you will need an adaptor cable that lets you connect the 25-pin RS-232 connector to the socket on the AT's rear panel.
- If a modem is connected to either serial port one or two, the CIS program may be instructed to use it to retrieve information from a remote database server.

### Receiver

Plug the antenna into the receiver. If you place the receiver near a window, be sure to protect it from rain and snow if you keep the window open.

### Antenna and Orientation

Positioning the antenna properly is the most important part of installing the system. If the antenna is not in a good position, you may not get good reception. As discussed earlier, try to position the antenna near a window on the side of your building closest to Boston's Back Bay. Our transmitter is located atop of the Prudential Building.

Note that the antenna looks like a large "T" (about four feet wide) — keep the top part of the T straight and taut. We have found that in most locations the best results are achieved when the top of the "T" is kept horizontal. While keeping the top of the antenna horizontal, rotate the antenna until you find the orientation that *maximizes* the reading on the receiver's *signal strength meter*. For best results, do not hold the antenna while you read the signal strength meter. Once you have found the orientation that maximizes the meter reading, fix the antenna in this position.

If you are returning to this section because of poor reception, try one of the following:

- Tape the antenna to your window — remember to keep the top of the "T" fully extended — and check your reception.
- Stand facing the Prudential Building and hold the antenna fully extended between your hands. Now lay the fully extended antenna down, fix it in this position, and check your reception.
- Instead of using the antenna supplied in the package, you can use another antenna; antennas designed for VHF TV will work very well. If the antenna does not have a plug that fits the socket on the receiver, connect it to the two screw terminals on the black connector (balun) provided with the antenna in the package. The antenna should be pointed towards the Prudential building for best results.

If neither of these suggestions help, call the Boston Commins 'HOTLINE' at (617)-253-0007.



### 1.3 — Installing the software

**Note:** Before you install the software, make sure that you are using version 2.1 or 3.1 of the MS-DOS<sup>™</sup> operating system, or a corresponding version of PC-DOS<sup>™</sup>,

Locate the Distribution Disk in the distribution package. Use the DOS "DIR" command to list the directory of the Distribution Disk. The disk should contain four files:

- CIS.EXE
- FILTER.TXT
- HELP.TXT
- CONFIG.TXT

The instructions for installing the software depend on whether you have a hard-disk drive, two floppy disk drives, or only one floppy disk drive. Determine which of the following three sections is appropriate, and follow the instructions in that section.

### 1.3.1 — Installing the Software on a Hard Disk

1. Insert the distribution disk into drive A.
2. Make the hard disk the default drive:

```
c: <Enter>
```

Most hard disk systems use drive C to refer to the hard disk. If you have multiple hard disks, or your disk is known by a different drive letter, replace C in the instructions by the drive of your choice.

3. Build a directory for the Boston CommInS program, and change the current directory to be this new directory:

```
mkdir \news <Enter>  
cd \news <Enter>
```

Because the DOS file system limits the root directory to 112 files, the Boston CommInS data should be stored in a subdirectory. We recommend using a directory called \news.

4. Copy the CommInS files from the distribution disk:

```
copy a:*. * <Enter>
```

This command will copy four files: CIS.EXE, FILTER.TXT, HELP.TXT and CONFIG.TXT.

5. Remove the distribution disk from the floppy disk drive, and store it in a safe place. Keep the distribution disk as a backup.

6. Start the Community Information System program:

```
cis <Enter>
```

7. Turn to *Appendix 1.4 -- Running the CommInS Program*.

### 1.3.2 — Installing the Software with Two Floppy Disk Drives

1. Take a blank disk that has been formatted with the /S option.  
If you do not have a blank system disk handy, format a new disk now. Make sure the new disk is not write-protected: remove the piece of tape covering the write-protect notch on the side of the disk if necessary.
2. Label this blank system disk "Boston CommInS Program".  
From now on, we will refer to this disk as the "program disk".
3. Take another blank disk, this one formatted without the /S option.  
Use a disk formatted *without* the /S option, because it has more space for data storage.
4. Label this second blank disk "Boston CommInS Data".  
By keeping the data on a separate disk from the program, you will be able to store more information. From now on, we will refer to this disk as the "data disk".
5. Insert the distribution disk in drive A.
6. Insert the *program disk* in drive B.
7. Copy the file CIS.EXE from the distribution disk onto the program disk:  

```
copy a:cis.exe b: <Enter>
```
8. Remove the program disk from drive B, and insert the *data disk* in drive B.
9. Make drive B the default drive:  

```
b: <Enter>
```
10. Build a directory for the Boston CommInS data, and change the current directory to be this new directory:  

```
mkdir \news <Enter>
cd \news <Enter>
```

Because the DOS file system limits the root directory to 112 files, the Boston CommInS data should be stored in a subdirectory. We recommend using a directory called \news.
11. Copy the CommInS text files from the distribution disk into the \news directory:  

```
copy a:*.txt <Enter>
```

This command will copy three files: FILTER.TXT, HELP.TXT and CONFIG.TXT.
12. Remove the distribution disk from floppy disk drive A, and store it in a safe place.  
Keep the distribution disk as a backup.
13. Insert the *program disk* in drive A.  
When you run the CommInS program, the program disk should be in drive A, and the data disk in drive B.
14. Start the Community Information System program:  

```
a:cis <Enter>
```

The program is on drive A, and the \news directory containing the data is on drive B.
15. Turn to *Appendix I.4 — Running the CommInS Program*.

### I.3.3 — Installing the Software with One Floppy Disk Drive

1. Take a blank disk, formatted with the /S option.

If you do not have a blank system disk handy, format a new disk now. Make sure the new disk is not write-protected: remove the piece of tape covering the write protect notch on the side of the disk if necessary.

2. Label the blank system disk "Boston CommInS".

From now on, we will refer to this disk as the "program disk".

3. Insert the program disk in the floppy disk drive.

4. Build a directory for the Boston CommInS data, and change the current directory to be this new directory:

```
mkdir \news  
<Enter>  
cd \news <Enter>
```

Because the DOS file system limits the root directory to 112 files the Boston CommInS data should be stored in a subdirectory. We recommend using a directory called \news.

5. Copy the CommInS files from the distribution disk:

```
copy b:*. * <Enter>
```

You will be asked to remove the program disk and insert the distribution disk. This command will copy four files: CIS.EXE, FILTER.TXT, HELP.TXT and CONFIG.TXT. You may need to swap the two disks several times.

6. Remove the distribution disk from the floppy disk drive, and store it in a safe place.

Keep the distribution disk as a backup.

7. Re-insert the program disk in the floppy disk drive.

8. Start the Community Information System program:

```
cis <Enter>
```

9. Turn to *Appendix I.4 — Running the CommInS Program*.

### 1.4 — Running the CommlnS Program

At this point, the Boston CommlnS program should be running on your PC. Normally, the program assumes the receiver is connected to port 1. If your receiver is connected to port 2, hold down the <Alt> key and press V to switch the system to port 2.

You should now be "on the air". News articles received by the system will be stored in the \news directory. To verify that the system is working, press F8 and wait until the highlighted line at the top of the screen displays the words "Diagnostic Window". If the system is working, it should be receiving "intact packets" at a rate of about three packets per second. Find the number of "intact packets" on the screen: it is displayed five lines above the highlighted line near the bottom of the screen. The number should be increasing steadily, at a rate of about three per second, occasionally interrupted by brief pauses that are followed by rapid catching up. If this is the case, everything is working; please turn to *Section 2 — Using the Commlns Software* and follow the instructions for first-time users.

If the number of intact packets is not changing, refer to the trouble-shooting guide in Appendix III.

### 1.5 — Starting and Stopping the CommlnS Program

#### 1.5.1 — Starting the Commlns Program

The procedure for normal start-up depends on the hardware configuration of your personal computer:

- If you have either a hard disk or a single floppy disk drive, use the cd command to change the current directory to the \news directory, and start the program by typing `c i s`.
- If you have two floppy disk drives, place the CommlnS program disk in drive A, the CommlnS data disk in drive B, use the `b :` and `cd` commands to change the current directory to the \news directory on the data disk, and start the program by typing `a : c i s`.

If your receiver is connected to port 2, you can use the "`-2`" option to tell the program to listen to port 2 right from the start:

```
c i s -2    <Enter>
  or
a : c i s -2    <Enter>
```

If you want the ability to use a modem to retrieve information from remote databases, you must start the CIS program with the "`-d`" option to enable duplex operation:

```
c i s -d    <Enter>
  or
a : c i s -d    <Enter>
```

You may configure the program to print articles in the foreground (necessary if you do not have an IBM Graphics printer) by specifying the "`-p`" option:

```
c i s -p    <Enter>
  or
a : c i s -p    <Enter>
```

Of course, options may be combined, for example:

```
cis -2 -p <Enter>  
or  
a:cis 2 -p <Enter>
```

When you start the CommlnS program, it begins to receive data immediately. You should verify this by pressing the F8 key and checking to see that the number of "intact packets" is increasing. If the system is not receiving data, refer to trouble-shooting guide in Appendix III.

### 1.5.2 — Stopping the CommlnS Program

To stop the CommlnS program, you should hold down the <Alt> key and press X, or execute the EXIT command that appears in every menu. This instructs the system to save its article directory on the disk and return to DOS.

---

#### **Warning:**

*Do not stop the CommlnS program by turning off the power or by re-booting your PC.*  
If you interrupt the program in this way, the files used by the system may be left in an inconsistent state. When this happens, the program must be re-started using the " -r" option (described below).

---

### 1.6 — Restarting after a Crash or Accidental Shutdown

If the hardware or software running the Boston CommlnS fails or is inadvertently shut down without using the EXIT command, the files used by the system may be left in an inconsistent state. Depending on the cause of the problem, you may wish to consult the trouble-shooting guide in Appendix III.

If the system crashes or is accidentally shut down, you should reboot the DOS operating system in one of the two standard ways — either (i) by turning your personal computer off for 30 seconds and turning it back on, or (ii) by simultaneously holding down the <Ctrl> and <Alt> keys and then pressing the <Del> key. We recommend the latter method, to minimize wear of the computer hardware.

To restart the CommlnS program, follow the instructions for normal start-up in Appendix 1.5.1, but invoke the CommlnS program with the " -r" option:

```
cis -r <Enter>  
or, if you are using Port 2:  
cis -2 -r <Enter>
```

The " -r" option instructs the CommlnS program to re-build the CommlnS directory file, CIS-DIR.TXT, by reading all the article files on the disk and comparing them with the filter in the filter file. During the rebuilding process, the system displays the names of the files as it reads them; when this is finished, the system starts up as usual. Because of the large amount of disk reading and indexing that is required, the rebuilding process takes a large amount of time to execute.

As always, the system should begin to receive data immediately. You should verify this by pressing the F8 key and checking to see that the number of "intact packets" is increasing. If the number of "intact packets" is not changing, refer to trouble-shooting guide in Appendix III.

## Appendix II — Setting Up The Remote System

### **Note:**

If you do not have a modem that is capable of using a 1200 baud communications, you cannot use the remote access feature of the Boston ComminS program. Please check that your modem has 1200 baud capabilities before continuing.

If you have only one serial port, the program cannot listen to broadcast articles and access the *New York Times* database simultaneously. However, you can do one or the other at any time, provided that you connect the modem or receiver to the serial port and swap the ports within the program.

### **II.1 — Hayes Modems**

If you have a Hayes or Hayes compatible modem, the Boston ComminS software does not need any additional set up, beyond starting the program with the `-d` option. (See Appendix I.5.1)

### **II.2 — Non-Hayes Modem**

If your modem is not Hayes compatible you will have to first establish a connection to the remote server prior to issuing remote queries to the Boston ComminS software. The following procedure must be executed with a modem communications program:

- Reset the modem to its initial state.
- Set the modem for 1200 baud mode, if applicable.
- Dial the remote server at (617) 258-7161. If you get a busy signal, continue to attempt to make a connection. Once a connection is established, you should receive a 'login:' prompt. If you did not receive this prompt, you may not have a 1200 baud modem. Check your manual.
- Exit your modem communications program, without severing the connection.
- Enter the Boston ComminS software with the `-d` option (See Appendix I.5.1)
- The software will check if the modem is connected, prior to sending a query.
- If there is a problem with the connection and the Boston ComminS program needs to redial the modem, you will have to exit the program and execute the above steps again. The program cannot reestablish a connection on non-Hayes or compatible modems.
- **NOTE:** If you are running the Boston ComminS software in the background, you do not have to exit the program each time to establish a modem connection. Simply make the connection with the modem program with the Boston ComminS software in the background.

If you are still having difficulties, contact the Boston ComminS 'HOTLINE' at (617) 253-0007.

### Appendix III — Trouble-shooting Guide

If you are having trouble installing or using the system, check this list of common problems, symptoms, and solutions. If you cannot resolve the problem, call the Boston CommInS 'HOTLINE' at (617)-253-0007. If none of the consultants are available, please leave a message on the answering machine and someone will call you back.

Please report 'crashes' (defined below) to the Boston CommInS 'HOTLINE'; try to describe as many of the keystrokes and system actions leading up to the crash as you remember.

Symptom	Possible Problems	Solution
The program does not start up, and does not respond to the keyboard.	Not enough memory in your PC. (You need at least 256 K of RAM in order to run the Boston CommInS program.)	Install more memory.
The program 'freezes' while starting up, and does not respond to the keyboard.	Some previous program left the PC in an unusable state (probably because of disorderly termination).	Re-boot the PC and re-start the program.
The program stops responding to the keyboard.	The program has crashed.	Re-boot the PC and restart the program using the command "c is -r". Please report the crash to the Boston CommInS 'HOTLINE'.
The program prints a "Fatal Error" message when starting up.	The system files are in an inconsistent state (perhaps because of a previous crash or accidental shutdown).	Re-start the program using the command "c is -r" (See Appendix I.6).
The program exits to DOS unexpectedly.	The program got into a situation that was considered impossible, and crashed.	The file STDOUT.TXT will contain an error message. Please record this message, and when you report the crash to the Boston CommInS 'HOTLINE', report the error message as well. Re-boot the PC and restart the program using the command "c is -r".

*(continued)*



Symptom	Possible Problem	Solution
The number of "intact packets" (in the diagnostic window) does not change.	The receiver is not connected.	Make sure that the receiver is plugged in, and that the cable between the receiver and the personal computer is connected.
	The program is listening to the wrong serial port.	<i>Either</i> type A-V to instruct the program to listen to the other port, <i>or</i> connect the receiver to the other port.
	The radio station is off the air.	Our data transmissions are carried by WERS Boston, FM 88.9. WERS is generally off the air from 2:00 until 6:00 am. Listen to WERS on a regular FM radio, and wait until it comes back on the air.
The number of "articles received" (in the diagnostic window) does not change. The number of "unframed packets" and/or the number of "checksum errors" are increasing.	Poor reception.	Refer to the discussion on "Antenna and Orientation" in <i>Appendix 1.2 — Installing The Hardware</i> .
	The leads on the antenna connector are touching.	Move the leads on the antenna connector so they no longer touch.
The number of "articles received" (in the diagnostic window) is increasing, but the number of "matching articles" does not change.	The program does not have a filter.	<i>Either</i> re-start the program in a directory that has a filter file (FILTER.TXT), <i>or</i> insert one or more filter lines into the <i>filter window</i> .
The number of "matching articles" (in the diagnostic window) does not change. The number of "articles received" and the number of "articles with unknown keys" are increasing at the same rate.	The program does not have any keys loaded.	Copy the CONFIG.TXT file from the distribution disk into the \news directory, and re-start the program.

(continued)

Symptom	Possible Problem	Solution
Occasional periods of poor reception.	Radio interference.	Move the receiver, antenna, and PC away from other electrical equipment.
Difficulty establishing a connection to a remote database server.	Not using a Hayes-compatible 1200 baud modem.	Use a standard terminal or modem program to establish a connection to the remote server and wait until you receive a LOGIN: prompt before starting the CIS program.
	Various connection problems.	Press <A-H> to reset the connection from within the CIS program, then turn the modem power off and on, and attempt a remote query again. Or, attempt to "strobe" the modem, ie. press <A-V> twice.

## Appendix IV — Differences from Version 6.0 (7)

### IV.1 — Keystroke Changes

In an attempt to make the program easier to use, we have changed some of our keystroke bindings to a "more standard" form:

Old Key	Explanation
?	The F1 key replaces ? and instructs the system to display the <i>help</i> file. It contains an overview of commands and queries.
F10	The F3 key replaces F10 and instructs the system to display the <i>window selection menu</i> .
<Esc>	The / key replaces the <Esc> to display the <i>command menu</i> for the current window (see <i>Section 2 — Using the CommlnS Software</i> ). Additionally, <Esc> no longer is used to process menu items, see <Enter> below.
<C-C>	The <Esc> key replaces the <C-C> and (shorthand for the command DO NOTHING) instructs the system to <i>exit</i> the current menu or <i>cancel</i> inserting a filter line. If neither of these cases apply, <Esc> still does nothing.
<Enter>	The <Enter> key instructs the system to <i>process</i> whatever is currently being done. Therefore, when there is a menu on the screen, the <Enter> key instructs the system to <i>execute</i> the selected command. When inserting a filter line, <Enter> instructs the system to finish inserting the edited line. Any other time the <Enter> key (shorthand for the command SHOW SUMMARIES) instructs the system to process the query on the query line and to display summaries of the matching articles (see <i>Section 2.1 — The Filter Window</i> ).
<A-Y>	The <A-E> key is now used for confirmation to execute commands (when applicable) and the <A-Y> is used to blank the screen.
F2	The <A-S> key replaces the F2 key and instructs the system to toggle between displaying and turning of the budget display.
F1	The F2 key replaces the F1 key and instructs the system to SHOW FILTER WINDOW.
F3	The F4 key replaces the F3 key and instructs the system to SHOW SUMMARY WINDOW.
F5	The F6 key replaces the F5 key and instructs the system to SHOW ARTICLE WINDOW.
F7	The F8 key replaces the F7 key and instructs the system to SHOW DIAGNOSTIC WINDOW.
F9	The F10 key replaces the F9 key and instructs the system to SHOW OPTIONS WINDOW.

#### IV.2 — Remote Queries

A brand new feature of the current software is the ability to access a complete database of *New York Times* articles. This database is stored on several database servers at MIT. Users must have a 1200 baud modem to use this feature.

The service is invoked by using the `-d` option at startup (see *Appendix I.5.1 -- Starting the CommlnS Program*) and issuing queries with `<C-Enter>`, instead of `<Enter>` (see *Section 2.1 -- The Filter Window and Figure 2.3*). Also, Appendix II will help set up your modem for use with the software.

#### IV.3 — Screen Dimming

If no keys are pressed for ten minutes, the CIS program now enters a 'screen protect' mode. In this mode, the screen is blanked, and a message ("Bounce") is printed. This message is moved randomly to different places on the screen. The screen-dimming mode prevents the CIS display from becoming permanently burned into the screen. Typing any keys restores the screen, then executes the command indicated by the key that was pressed. The menu item "Idle the screen (A-C)" in the options window immediately blanks the screen and displays the message.

If you prefer not to see any message when the screen is blanked, select "Blank the screen (A-Y)" from the options menu. This is particularly useful if you run the CIS program under a multi-tasker such as Double-Dos (TM) or DesqView (TM), because it prevents any output from appearing on the screen.

#### IV.4 — Printer Support

The CIS system now supports several different printer models.

IBM printers may be run in the default (background) mode. In this mode, additional CIS commands can be processed while the article is being printed. Also, relevant words and phrases are highlighted when articles are printed on the IBM printer. In background mode, the CIS program sends characters directly to the printer, bypassing print spoolers and all DOS calls.

Other printers may be used in 'foreground'. No additional CIS commands can be entered until printing is complete. In foreground mode, the CIS system sends characters to the printer by issuing DOS calls. Special printer drivers and spoolers may be used.

The foreground mode may be invoked using the shorthand (A-G) (see *Section 2.5 -- The Options Window*) or at startup using the `-p` option (see *Appendix I.5.1 -- Starting the CommlnS Program*).

## Appendix V — Summary of Commands

### V.1 — Special Function Keys

The following keys on the PC keyboard have special meaning to the Commlns software:

F1	The F1 key instructs the system to display the <i>help</i> file. It contains an overview of commands and queries.
F3	The F3 key (shorthand for the command SHOW WINDOW SELECTION MENU) instructs the system to display the <i>window selection menu</i> .
/	The / key instructs the system to display the <i>command menu</i> for the current window (see <i>Section 2 — Using the Commlns Software</i> ).
<Esc>	The <Esc> key (shorthand for the command DO NOTHING) instructs the system to <i>exit</i> the current menu or <i>cancel</i> inserting a filter line. If neither of these cases apply <Esc> still does nothing.
<Enter>	The <Enter> key instructs the system to <i>process</i> whatever is currently being done. When there is a menu on the screen, the <Enter> key instructs the system to <i>execute</i> the selected command. When inserting a filter line (or editing a budget), <Enter> instructs the system to insert the edited line (or budget). Any other time the <Enter> key (shorthand for the command SHOW SUMMARIES) instructs the system to process the query on the query line and to display summaries of the matching articles (see <i>Section 2.1 — The Filter Window</i> ).
<C-Enter>	The <Control-Enter> key (shorthand for the command SHOW SUMMARIES FROM REMOTE SYSTEM) instructs the system to <i>submit</i> the query on the query line to a remote database server and to display summaries of the matching articles (see <i>Section 2.1 — The Filter Window</i> ).

### V.2 — Scroll Keys

The following keys can be used to scroll through a window:

<PgDn>	Show the next page
<PgUp>	Show the previous page
<Home>	Show the first page of the window
<End>	Show the last page of the window
↓	Select the next line (or summary)
↑	Select the previous line (or summary)
Shift-↓	Move forward one line (or summary)
Shift-↑	Move back one line (or summary)

### V.3 — Editing Keys

The following keys can be used to edit the query line. They can also be used in the 'edit boxes' created by the commands CHANGE BUDGET OF CURRENT LINE and INSERT A NEW LINE. **Note:** the <Backspace> key is the key with a left arrow (←) on a gray background.

<Backspace>	delete the character before the cursor
C-W	delete the word before the cursor
C-D	delete the character after the cursor
C-K	delete everything after the cursor
<Del>	delete the entire line
← or C-B	move the cursor to the left
→ or C-F	move the cursor to the right
C-A	move the cursor to the beginning of the line
C-E	move the cursor to the end of the line

### V.4 — Alphabetical Listing of Commands

The next page contains an alphabetical listing of the commands recognized by the CommInS software, along with their shorthand keys and the menu(s) in which each command is listed.<sup>18</sup> The shorthand keys for the commands listed in the *window selection menu* and the *options window command menu* are available in every window; these keys are marked with an asterisk. All other shorthand keys are available in a given window only if the corresponding command is listed in the command menu for that window.

---

<sup>18</sup>The prefix "A-" refers to the <Alt> key: for example, A-B means "hold down the <Alt> key and press b". Similarly, the prefix "C-" refers to the <Ctrl> key: for example, C-D means "hold down the <Ctrl> key and press d".

Name of Command	Shorthand	Listed in:
BLANK THE SCREEN	A-Y *	options window command menu
CHANGE BUDGET OF CURRENT LINE	A-B	filter window command menu
DELETE ALL ARTICLES IN LIST	A-K	summary window command menu
DELETE ALL MATCHING ARTICLES	A-K	filter window command menu
DELETE CURRENT ARTICLE	A-D	summary window command menu
DELETE, THEN SHOW NEXT ARTICLE	A-D	article window command menu
DELETE, THEN SHOW NEXT UNREAD	A-J	article window command menu
DELETE, THEN SHOW SUMMARIES	A-M	article window command menu
DO NOTHING	<Esc> *	every menu
EXIT TO DOS	A-X *	every menu
HANGUP REMOTE CONNECTION	A-H *	options window command menu
IDLE THE SCREEN	A-C *	options window command menu
INSERT A NEW LINE	A-I	filter window command menu
MOVE CURRENT LINE DOWN	A-N	filter window command menu
MOVE CURRENT LINE UP	A-U	filter window command menu
PRINT ALL ARTICLES IN LIST	A-A	summary window command menu
PRINT ALL MATCHING ARTICLES	A-A	filter window command menu
PRINT CURRENT ARTICLE	A-P	filter window command menu
PRINT CURRENT ARTICLE	A-P	summary window command menu
PRINT IN BACKGROUND/FOREGROUND	A-G *	options window command menu
REMOVE CURRENT LINE	A-W	filter window command menu
RESET COUNTERS TO ZERO	A-0	diagnostic window command menu
SHOW ARTICLE WINDOW	F6 *	window selection menu
SHOW CURRENT ARTICLE	A-R	summary window command menu
SHOW DIAGNOSTIC WINDOW	F8 *	window selection menu
SHOW FILTER WINDOW	F2 *	window selection menu
SHOW FIRST ARTICLE	A-R	filter window command menu
SHOW HELP FILE	F1	startup message
SHOW NEXT ARTICLE	A-N	article window command menu
SHOW NEXT UNREAD ARTICLE	A-Z	article window command menu
SHOW OPTIONS WINDOW	F10 *	window selection menu
SHOW REMOTE SUMMARIES	<C-Enter> *	filter window command menu
SHOW SUMMARIES	<Enter> *	filter window command menu
SHOW SUMMARY WINDOW	F4 *	window selection menu
SHOW (THE) WINDOW SELECTION MENU	F3 *	every menu
STOP PRINTING AND EMPTY QUEUE	A-Q *	options window command menu
SWAP MODEM/RECEIVER PORTS	A-V *	options window command menu
TURN BEEP-ON-ARRIVAL ON/OFF	A-1	filter window command menu
TURN BUDGET DISPLAY ON/OFF	A-S *	options window command menu
TURN PRINT-ON-ARRIVAL ON/OFF	A-2	filter window command menu
TURN RECEIVER ON/OFF	A-O *	options window command menu

## Appendix VI — Files used by the system

### VI.1 — The CommlnS Directory File

The CommlnS directory file, CIS - DIR.TXT, contains information about the articles on the disk: it contains an *index*, which is used to speed up the processing of queries, and it contains *summaries* of the articles, so that these can be displayed without delay. It also contains a list of articles that you have deleted, so that these articles can be filtered out if they are received again.

When the program is running, the contents of the directory file is stored in memory; it is saved on the disk *only* when you exit from the program. This explains why the program should always be stopped using the EXIT command. If the directory file is missing, the program should be started with the " -r" option (see *Appendix I.6 — Restarting after a Crash or Accidental Shutdown*).

### VI.2 — The Filter File

The filter file, FILTER.TXT, contains your personal filter. In this file, each filter line is stored as a separate line, along with two numbers: the first number is the budget for that line, and the second number indicates whether "beep" or "print" is turned on for that filter line (see *Section 2.1 — The Filter Window*).

### VI.3 — The Help File

The help file, HELP.TXT, contains a brief description of how to use the system. The system displays the tutorial when you press F1.

### VI.4 — The Configuration File

The configuration file, CONFIG.TXT, contains information that is used by the CIS program, but may change at a future date. Currently, there are entries for two kinds of information, decryption keys and remote database descriptors.

An entry for a decryption key includes a key number and the hexadecimal representation of the key:

```
k 17001 131b3df7ea8f5b20
```

An entry for a remote database includes the telephone number used to access the database and a description of the contents of the database:

```
d 2587161 ((type: nyt) & (date: [date -90 : 0]))
```

### VI.5 — The Error File

The error file, STDOUT.TXT, is written whenever the program exits. It normally does not contain any useful information; however, when the program exits to DOS unexpectedly, it leaves an error message in this file. Please record this message, and report it to the Boston CommlnS 'HOTLINE' at (617)-253-0007.



**VI.6 — Article Files**

Article files have names of the form TYMMDDN.NNN, where T indicates the *type* of the article (A for Associated Press, N for *New York Times*, or C for *ComminS* announcements); Y is the last digit of the year, MM is the month, DD is the date, and N.NNN is a four-digit serial number. Each article file contains a number indicating the number of lines of text, followed by a set of numbers that indicate which words in the article should be highlighted for display (see *Section 2.3 — The Article Window*), followed by the text of the article. yes

## Appendix VII — Your Responsibilities

As a volunteer in the experiment to test the Boston Community Information System, you have several responsibilities. A copy of the agreement that you have signed is reproduced on the next page as Figure V-1.

### VII.1 — Your Responsibilities to the Boston CommInS Project

We at the Boston CommInS project want and need your active participation in the evaluation and testing of the CommInS hardware, software and documentation. This means that we would like you to

- use the system to the fullest extent of its features,
- give us your thoughtful appraisal of the existing features, and
- give us your suggestions for possible improvements.

You may express these ideas, suggestions, and questions to us in many ways — in writing or by telephone — as often as you wish. However, at a minimum, and even if you have provided feedback in other forms, you must fill out a Questionnaire once a month. This is the minimal requirement for your continued participation in the experiment.

### VII.2 — Your Responsibilities Regarding Use of the Information Received

To conduct this unique experiment in the digital broadcast of news and information, MIT has entered into understandings and legal agreements with the Associated Press, the New York Times Company and Mead Data Central, Inc. As a volunteer in this experiment, you have agreed

1. not to make more than one copy — in any form — of any information received;
2. not to retain copies — in any form — of more than an “insubstantial part” of the information received;
3. not to transfer any of the information received — in any form — to third parties, whether or not for profit; and
4. not to retain any of the information received from the *New York Times* — in any form — for more than 90 days.
5. to return all the equipment to MIT upon request.

In view of the unique nature of this experiment, we feel that the responsibilities outlines above are reasonable. If you do not act in keeping with the letter and the spirit of the agreement, we will request that you return all loaned equipment and software to us immediately.

**BostonComminS** 253-0007  
 c/o MIT Laboratory for Computer Science, Room NE43-403  
 545 Technology Square, Cambridge, MA 02139

Revised 29 September 1986

Full Name (printed): \_\_\_\_\_

Legal Agreement with Mead Data Central, Inc.

The above designated "Recipient" agrees that it will not retain any copies of data from the New York Times in any form, whether print, machine readable or otherwise for a period of more than 90 days, and that any such data retained will be 1) limited to single copies, 2) never consist of more than an insubstantial part of the entire database made available to MIT, and 3) will not be transferred, whether or not for profit to any third party. It is agreed that all copies of such data will be returned or destroyed earlier than the 90-day maximum retention period upon written request from MIT, The New York Times Company, or Mead Data Central, Inc.

Agreed

\_\_\_\_\_  
 Signature of Recipient

\_\_\_\_\_  
 Date

Understanding and Agreement with MIT

Whether or not for profit, I understand and agree not to transfer in printed or electronic form any information received via the Boston ComminS project to any third party.

I understand and agree that I must complete and return a questionnaire provided for that purpose to the Boston ComminS Project once a month or else have to return the receiver and software to the project.

I understand and agree that the software and hardware will remain the property of MIT and that I must return all the materials used in this test of the Boston ComminS system either (i) at the end of the experiment in approximately 12 months or (ii) upon written notice from the project -- whichever comes first.

I understand and agree that MIT has made no expressed nor implied guarantees to provide this information service without interruption throughout the duration of the experimental test.

Agreed

\_\_\_\_\_  
 Signature of Recipient

\_\_\_\_\_  
 Date

---

Copies of this signed agreement will be held by (i) the Recipient, (ii) the Boston ComminS Project at MIT, and Mead Data Central, Inc.

Figure VII-1: Text of Agreement

REPORT DOCUMENTATION PAGE

1a. REPORT SECURITY CLASSIFICATION Unclassified		1b. RESTRICTIVE MARKINGS	
2a. SECURITY CLASSIFICATION AUTHORITY		3. DISTRIBUTION/AVAILABILITY OF REPORT Approved for public release; distribution is unlimited.	
2b. DECLASSIFICATION/DOWNGRADING SCHEDULE		4. PERFORMING ORGANIZATION REPORT NUMBER(S) MIT/LCS/TR-373	
5. MONITORING ORGANIZATION REPORT NUMBER(S) N00014-83-K-0125		6a. NAME OF PERFORMING ORGANIZATION Laboratory for Computer Science	
6b. OFFICE SYMBOL (If applicable)		7a. NAME OF MONITORING ORGANIZATION Office of Naval Research/Department of Navy	
6c. ADDRESS (City, State, and ZIP Code) 545 Technology Square Cambridge, MA 02139		7b. ADDRESS (City, State, and ZIP Code) Information Systems Program Arlington, VA 22217	
8a. NAME OF FUNDING/SPONSORING ORGANIZATION DARPA/DOD		8b. OFFICE SYMBOL (If applicable)	
9. PROCUREMENT INSTRUMENT IDENTIFICATION NUMBER		8c. ADDRESS (City, State, and ZIP Code) 1400 Wilson Blvd. Arlington, VA 22217	
10. SOURCE OF FUNDING NUMBERS		11. TITLE (Include Security Classification) Boston Community Information System User's Manual (Version 8.17)	
PROGRAM ELEMENT NO.	PROJECT NO.	TASK NO.	WORK UNIT ACCESSION NO.
12. PERSONAL AUTHOR(S) Segal, D., Gifford, D., Lucassen, J., Henderson, J., Berlin, S., and Burmaster, D.		14. DATE OF REPORT (Year, Month, Day) 1987 October	
13a. TYPE OF REPORT Technical	13b. TIME COVERED FROM _____ TO _____	15. PAGE COUNT 51	
16. SUPPLEMENTARY NOTATION			
17. COSATI CODES		18. SUBJECT TERMS (Continue on reverse if necessary and identify by block number)	
FIELD	GROUP	SUB-GROUP	community information system, personal computer, programming systems
19. ABSTRACT (Continue on reverse if necessary and identify by block number) The Boston Community Information System turns your computer into a personal information assistant that monitors the news as it happens. This experiment, CommInS, tests a new way of distributing world news as it happens and features from the <u>New York Times</u> and the <u>Associate Press</u> wire service directly to personal computers via radio waves. Acting on your instructions, your computer will "filter" this flow of information, saving the stories that match your list of interests. Thus, you can walk up to the system at any time, and browse through the stories that the system has saved for you. Because your personal computer can receive and filter much more information that you could read yourself, it can help you focus and enlarge your awareness of the world. You will probably find that the system consistently finds more articles of interest on certain subjects than you do.			
20. DISTRIBUTION/AVAILABILITY OF ABSTRACT <input checked="" type="checkbox"/> UNCLASSIFIED/UNLIMITED <input type="checkbox"/> SAME AS RPT <input type="checkbox"/> DTIC USERS		21. ABSTRACT SECURITY CLASSIFICATION Unclassified	
22a. NAME OF RESPONSIBLE INDIVIDUAL Judy Little, Publications Coordinator		22b. TELEPHONE (Include Area Code) (617) 253-5894	22c. OFFICE SYMBOL