

The IBM logo consists of the letters "IBM" in a bold, white, sans-serif font, centered within a solid black square.**Systems Reference Library**

IBM System/360 Principles of Operation

This manual is a comprehensive presentation of the characteristics, functions, and features of the IBM System/360. The material is presented in a direct manner, assuming that the reader has a basic knowledge of IBM data processing systems and has read the IBM System/360 Systems Summary, Form A22-6810. The manual is useful for individual study, as an instruction aid, and as a machine reference manual.

The manual defines System/360 operating principles, central processing unit, instructions, system control panel, branching, status switching, interruption system, and input/output operations.

Descriptions of specific input/output devices used with System/360 appear in separate publications. Also, details unique to each model of the System/360 appear in separate publications.



Copies of this and other IBM publications can be obtained through IBM Branch Offices.
Address comments concerning the contents of this publication to:
IBM Corporation, Customer Manuals, Dept. B98, PO Box 390, Poughkeepsie, N. Y. 12602

Contents

IBM System/360	5	Decimal Arithmetic	34
General-Purpose Design	5	Data Format	34
Compatibility	5	Number Representation	34
System Program	5	Condition Code	35
System Alerts	6	Instruction Format	35
Multisystem Operation	6	Instructions	35
Input/Output	6	Add Decimal	35
Technology	6	Subtract Decimal	36
System Structure	7	Zero and Add	36
Main Storage	7	Compare Decimal	37
Information Formats	7	Multiply Decimal	37
Addressing	8	Divide Decimal	37
Information Positioning	8	Pack	38
Central Processing Unit	8	Unpack	38
General Registers	9	Move with Offset	38
Floating-Point Registers	9	Decimal Arithmetic Exceptions	39
Arithmetic and Logical Unit	9	Floating-Point Arithmetic	40
Fixed-Point Arithmetic	10	Data Format	40
Decimal Arithmetic	10	Number Representation	40
Floating Point Arithmetic	11	Normalization	41
Logical Operations	11	Condition Code	41
Program Execution	12	Instruction Format	41
Instruction Format	12	Instructions	42
Address Generation	13	Load	43
Sequential Instruction Execution	15	Load and Test	43
Branching	15	Load Complement	43
Program Status Word	15	Load Positive	43
Interruption	16	Load Negative	44
Protection Feature	18	Add Normalized	44
Timer Feature	18	Add Unnormalized	45
Direct Control Feature	18	Subtract Normalized	45
Multisystem Feature	18	Subtract Unnormalized	46
Input/Output	19	Compare	46
Input/Output Devices and Control Units	19	Halve	47
Input/Output Interface	19	Multiply	47
Channels	19	Divide	48
Input/Output Instructions	19	Store	49
Input/Output Operation Initiation	20	Floating-Point Arithmetic Exceptions	49
Input/Output Commands	20	Logical Operations	50
Input/Output Termination	21	Data Format	50
Input/Output Interruptions	21	Condition Code	51
System Control Panel	21	Instruction Format	51
System Control Panel Functions	21	Instructions	52
Operation Control Section	22	Move	52
Operation Intervention Section	22	Move Numerics	53
Customer Engineering Section	22	Move Zones	53
Fixed-Point Arithmetic	23	Compare Logical	53
Data Format	23	AND	54
Number Representation	23	OR	54
Condition Code	24	Exclusive OR	55
Instruction Format	24	Test Under Mask	55
Instructions	25	Insert Character	55
Load	25	Store Character	55
Load Halfword	25	Load Address	56
Load and Test	25	Translate	56
Load Complement	26	Translate and Test	56
Load Positive	26	Edit	57
Load Negative	26	Edit and Mark	58
Load Multiple	26	Shift Left Single	59
Add	27	Shift Right Single	59
Add Halfword	27	Shift Left Double	59
Add Logical	27	Shift Right Double	60
Subtract	28	Logical Operation Exceptions	60
Subtract Halfword	28	Branching	61
Subtract Logical	28	Normal Sequential Operation	61
Compare	29	Sequential Operation Exceptions	62
Compare Halfword	29	Decision-Making	62
Multiply	29	Instruction Formats	62
Multiply Halfword	30	Branching Instructions	63
Divide	30	Branch On Condition	63
Convert to Binary	30	Branch and Link	64
Convert to Decimal	31	Branch On Count	64
Store	31	Branch On Index High	64
Store Halfword	31	Branch On Index Low or Equal	65
Store Multiple	31	Execute	65
Shift Left Single	32	Branching Exceptions	65
Shift Right Single	32	Decimal Arithmetic	34
Shift Left Double	32	Data Format	34
Shift Right Double	33	Number Representation	34
Fixed-Point Arithmetic Exceptions	33	Condition Code	35
		Instruction Format	35
		Instructions	35
		Add Decimal	35
		Subtract Decimal	36
		Zero and Add	36
		Compare Decimal	37
		Multiply Decimal	37
		Divide Decimal	37
		Pack	38
		Unpack	38
		Move with Offset	38
		Decimal Arithmetic Exceptions	39
		Floating-Point Arithmetic	40
		Data Format	40
		Number Representation	40
		Normalization	41
		Condition Code	41
		Instruction Format	41
		Instructions	42
		Load	43
		Load and Test	43
		Load Complement	43
		Load Positive	43
		Load Negative	44
		Add Normalized	44
		Add Unnormalized	45
		Subtract Normalized	45
		Subtract Unnormalized	46
		Compare	46
		Halve	47
		Multiply	47
		Divide	48
		Store	49
		Floating-Point Arithmetic Exceptions	49
		Logical Operations	50
		Data Format	50
		Condition Code	51
		Instruction Format	51
		Instructions	52
		Move	52
		Move Numerics	53
		Move Zones	53
		Compare Logical	53
		AND	54
		OR	54
		Exclusive OR	55
		Test Under Mask	55
		Insert Character	55
		Store Character	55
		Load Address	56
		Translate	56
		Translate and Test	56
		Edit	57
		Edit and Mark	58
		Shift Left Single	59
		Shift Right Single	59
		Shift Left Double	59
		Shift Right Double	60
		Logical Operation Exceptions	60
		Branching	61
		Normal Sequential Operation	61
		Sequential Operation Exceptions	62
		Decision-Making	62
		Instruction Formats	62
		Branching Instructions	63
		Branch On Condition	63
		Branch and Link	64
		Branch On Count	64
		Branch On Index High	64
		Branch On Index Low or Equal	65
		Execute	65
		Branching Exceptions	65

Status-Switching	67	Blocking of Data	96
Program States	67	Channel Address Word	96
Problem State	67	Channel Command Word	96
Wait State	67	Command Code	97
Masked States	68	Definition of Storage Area	97
Stopped State	68	Chaining	98
Storage Protection	69	Skipping	100
Area Identification	69	Program-Controlled Interruption	100
Protection Action	69	Commands	101
Locations Protected	69	Termination of Input/Output Operations	104
Program Status Word	69	Types of Termination	104
Multisystem Operation	70	Input/Output Interruptions	105
Direct Address Relocation	70	Channel Status Word	108
Malfunction Indication	71	Unit Status Conditions	109
System Initialization	71	Channel Status Conditions	112
Instruction Format	71	Content of Channel Status Word	114
Instructions	71	System Control Panel	117
Load PSW	72	System Control Functions	117
Set Program Mask	72	System Reset	117
Set System Mask	72	Store and Display	117
Supervisor Call	72	Initial Program Loading	118
Set Storage Key	73	Operator Control Section	118
Insert Storage Key	73	Emergency Pull Switch	119
Write Direct	73	Power-On Key	119
Read Direct	74	Power-Off Key	119
Diagnose	74	Interrupt Key	119
Status-Switching Exceptions	74	Wait Light	119
Interruptions	76	Manual Light	119
Interruption Action	76	System Light	119
Instruction Execution	77	Test Light	119
Source Identification	77	Load Light	119
Location Determination	77	Load-Unit Switches	119
Input/Output Interruption	78	Load Key	120
Program Interruption	78	Prefix-Select Key Switch	120
Operation Exception	78	Operator Intervention Section	120
Privileged-Operation Exception	78	System-Reset Key	120
Execute Exception	78	Stop Key	120
Protection Exception	78	Rate Switch	120
Addressing Exception	78	Start Key	120
Specification Exception	79	Storage-Select Switch	121
Data Exception	79	Address Switches	121
Fixed-Point-Overflow Exception	79	Data Switches	121
Fixed-Point-Divide Exception	79	Store Key	121
Decimal-Overflow Exception	79	Display Key	121
Decimal-Divide Exception	79	Set IC Key	121
Exponent-Overflow Exception	79	Address-Compare Switches	121
Exponent-Underflow Exception	79	Alternate-Prefix Light	121
Significance Exception	79	Customer Engineering Section	121
Floating-Point-Divide Exception	79	Appendix	122
Supervisor-Call Interruption	79	A. Instruction Use Examples	122
External Interruption	80	Assembly Language Examples	128
Timer	80	B. Fixed-Point and Two's Complement Notation	132
Interrupt Key	80	C. Floating-Point Arithmetic	133
External Signal	81	D. Powers of Two Table	135
Priority of Interruptions	81	E. Hexadecimal-Decimal Conversion Table	136
Interruption Exceptions	82	F. EBCDIC and ASCII (Extended) Charts	141
Input/Output Operations	83	G. Instructions	142
Attachment of Input/Output Devices	83	Data Formats	142
Input/Output Devices	83	Hexadecimal Representation	142
Control Units	83	Instructions by Format Type	142
Channels	84	Control Word Formats	144
System Operation	85	Operation Codes	145
Compatibility of Operation	86	Permanent Storage Assignment	147
Control of Input/Output Devices	87	Condition Code Setting	147
Input/Output Device Addressing	87	Interruption Action	148
Instruction Exception Handling	88	Instruction Length Recording	148
States of the Input/Output System	88	Program Interruptions	148
Resetting of the Input/Output System	90	Editing	153
Condition Code	90	System Control Panel	153
Instruction Format	92	Input/Output Operations	153
Instructions	92	Time and Method of Creating and Storing Status	
Start I/O	92	Indications	155
Test I/O	93	Functions That May Differ Among Models	156
Halt I/O	94	Alphabetic List of Instructions	159
Test Channel	95	List of Instructions by Set and Feature	160
Execution of Input/Output Operations	96	Index of Instruction Formats by Mnemonic	162

The IBM System/360 is a solid-state, program compatible, data processing system providing the speed, precision, and data manipulating versatility demanded by the challenge of commerce, science, and industry. System/360, with advanced logical design implemented by microminiature technology, provides a new dimension of performance, flexibility, and reliability. This dimension makes possible a new, more efficient systems approach to all areas of information processing, with economy of implementation and ease of use. System/360 is a single, coordinated set of new data processing components intended to replace the old logical structure with an advanced creative design for present and future application.

The logical design of System/360 permits efficient use at several levels of performance with the preservation of upward and downward program compatibility. Extremely high performance and reliability requirements are met by combining several models into one multisystem using the multisystem feature.

General-Purpose Design

System/360 is a general-purpose system designed to be tailored for commercial, scientific, communications, or control applications. A *Standard* instruction set provides the basic computing function of the system. To this set a decimal feature may be added to provide a *Commercial* instruction set or a floating-point feature may be added to provide a *Scientific* instruction set. When the storage protection feature is added to the commercial and scientific features, a *Universal* set is obtained. Direct control and timer features may be added to satisfy requirements for TELE-PROCESSING® systems to allow load-sharing or to satisfy real-time needs.

System/360 can accommodate large quantities of addressable storage. The markedly increased capacities over other present storage is provided by the combined use of high-speed storage of medium size and large-capacity storage of medium speed. Thus, the requirements for both performance and size are satisfied in one system by incorporating a hierarchy of storage units. The design also anticipates future development of even greater storage capacities. System/360 incorporates a standard method for attaching input/output devices differing in function, data rate,

and access time. An individual System/360 is obtained by selecting the system components most suited to the applications from a wide variety of alternatives in internal performance, functional ability, and input/output (I/O).

Models of System/360 differ in storage speed, width (the amount of data obtained in each instruction access), register width, and capability of simultaneous processing. Yet these differences do not affect the logical appearance of System/360 to the programmer. Several CPU's permit a wide choice in internal performance. The range is such that the ratio of internal performances between the largest and the smallest model is approximately 50 for scientific computation and 15 for commercial processing.

Compatibility

All models of System/360 are upward and downward program compatible, that is, any program gives identical results on any model. Compatibility allows for ease in systems growth, convenience in systems back-up, and simplicity in education.

The compatibility rule has three limitations.

1. The systems facilities used by a program should be the same in each case. Thus, the optional CPU features and the storage capacity, as well as the quantity, type, and priority of I/O equipment, should be equivalent.

2. The program should be independent of the relation of instruction execution times and of I/O data rates, access times, and command execution times.

3. The compatibility rule does not apply to detail functions for which neither frequency of occurrence nor usefulness of result warrants identical action in all models. These functions, all explicitly identified in this manual, are concerned with the handling of invalid programs and machine malfunctions.

System Program

Interplay of equipment and program is an essential consideration in System/360. The system is designed to operate with a supervisory program that coordinates and executes all I/O instructions, handles exceptional conditions, and supervises scheduling and execution of multiple programs. System/360 provides for

efficient switching from one program to another, as well as for the relocation of programs in storage. To the problem programmer, the supervisory program and the equipment are indistinguishable.

System Alerts

The interruption system permits the CPU automatically to change state as a result of conditions arising outside of the system, in I/O units, or in the CPU itself. Interruption switches the CPU from one program to another by changing not only the instruction address but all essential machine-status information.

A storage protection feature permits one program to be preserved when another program erroneously attempts to store information in the area assigned to the first program. Protection does not cause any loss of performance. Storage operations initiated from the CPU, as well as those initiated from a channel, are subject to the protection procedure.

Programs are checked for correct instructions and data as they are executed. This policing-action identifies and separates program errors and machine errors. Thus, program errors cannot create machine checks since each type of error causes a unique interruption. In addition to an interruption due to machine malfunction, the information necessary to identify the error is recorded automatically in a predetermined storage location. This procedure appreciably reduces the mean-time to repair a machine fault. Moreover, operator errors are reduced by minimizing the active manual controls. To reduce accidental operator errors, operator consoles are I/O devices and function under control of the system program.

Multisystem Operation

Several models of System/360 can be combined into one multisystem configuration. Three levels of communication between CPU's are available. Largest in capacity, and moderately fast in response, is communications by means of shared I/O device, for example,

a disk file. Faster transmission is obtained by direct connection between the channels of two individual systems. Finally, storage may be shared on some models between two CPU's, making information exchange possible at storage speeds. These modes of communication are supplemented by allowing one CPU to be interrupted by another CPU and by making direct status information available from one CPU to another.

Input/Output

Channels provide the data path and control for I/O devices as they communicate with the CPU. In general, channels operate asynchronously with the CPU and, in some cases, a single data path is made up of several subchannels. When this is the case, the single data path is shared by several low-speed devices, for example, card readers, punches, printers, and terminals. This channel is called a multiplexor channel. Channels that are not made up of several such subchannels can operate at higher speed than the multiplexor channels and are called selector channels. In every case, the amount of data that comes into the channel in parallel from an I/O device is a byte. All channels or subchannels operate the same and respond to the same I/O instructions and commands.

Each I/O device is connected to one or more channels by an I/O interface. This I/O interface allows attachment of present and future I/O devices without altering the instruction set or channel function. Control units are used where necessary to match the internal connections of the I/O device to the interface. Flexibility is enhanced by optional access to a control unit or device from either of two channels.

Technology

System/360 employs solid-logic integrated components, which in themselves provide advanced equipment reliability. These components are also faster and smaller than previous components and lend themselves to automated fabrication.

The basic structure of a System/360 consists of main storage, a central processing unit (CPU), the selector and multiplexor channels, and the input/output devices attached to the channels through control units. It is possible for systems to communicate with each other by means of shared I/O devices, a channel, or shared storage. Figure 1 shows the basic organization of a single system.

Main Storage

Storage units may be either physically integrated with the CPU or constructed as stand-alone units. The storage cycle is not directly related to the internal cycling of the CPU, thus permitting selection of optimum storage speed for a given word size. The physical differences in the various main-storage units do not affect the logical structure of the system.

Fetching and storing of data by the CPU are not affected by any concurrent I/O data transfer. If an I/O operation refers to the same storage location as the CPU operation, the accesses are granted in the sequence in which they are requested. If the first reference changes the contents of the location, any subsequent storage fetches obtain the new contents. Concurrent I/O and CPU references to the same storage location never cause a machine-check indication.

Information Formats

The system transmits information between main storage and the CPU in units of eight bits, or a multiple of eight bits at a time. An eight-bit unit of information is called a *byte*, the basic building block of all formats. A ninth bit, the parity or check bit, is transmitted with each byte and carries parity on the bytes. The parity bit cannot be affected by the program; its only effect is to cause an interruption when a parity error is detected. References to the size of data fields and registers, therefore, exclude the associated parity bits. All storage capacities are expressed in number of bytes provided, regardless of the physical word size actually used.

Bytes may be handled separately or grouped together in fields. A *halfword* is a group of two consecutive bytes and is the basic building block of instructions. A *word* is a group of four consecutive bytes; a *double word* is a field consisting of two words (Figure 2). The location of any field or group of bytes is specified by the address of its leftmost byte.

The length of fields is either implied by the operation to be performed or stated explicitly as part of the instruction. When the length is implied, the information is said to have a fixed length, which can be either one, two, four, or eight bytes.

When the length of a field is not implied by the

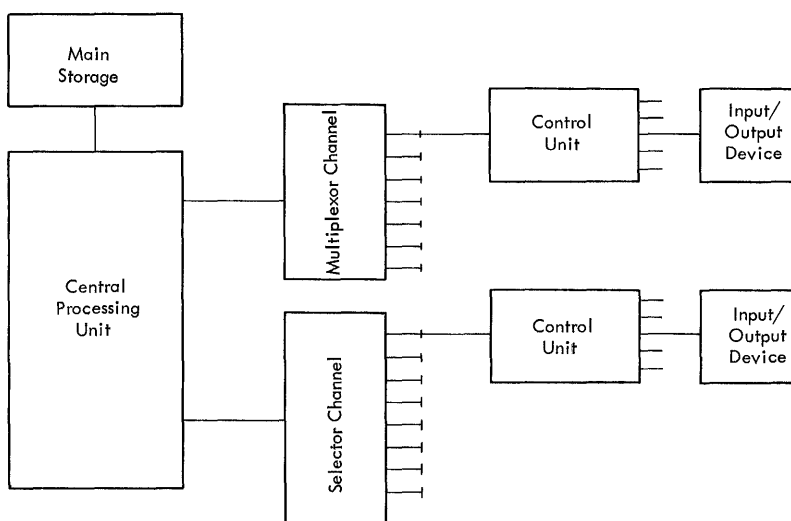

Figure 1. IBM System/360 Basic Logical Structure

operation code, but is stated explicitly, the information is said to have variable field length. Variable-length operands are variable in length by increments of one byte.

Within any program format or any fixed-length operand format, the bits making up the format are consecutively numbered from left to right starting with the number 0.

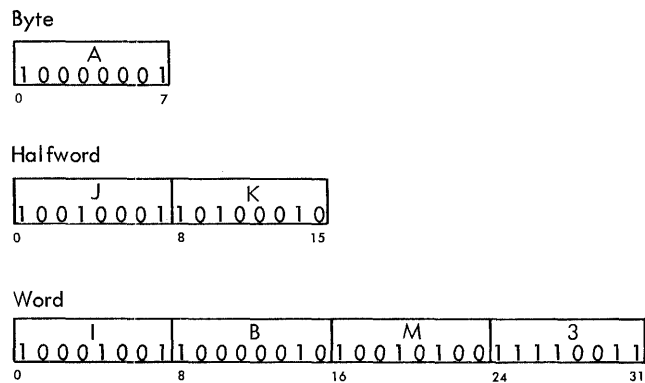

Figure 2. Sample Information Formats

Addressing

Byte locations in storage are consecutively numbered starting with 0; each number is considered the address of the corresponding byte. A group of bytes in storage is addressed by the leftmost byte of the group. The addressing capability permits a maximum of 16,777,216 bytes, using a 24-bit binary address. This set of main-storage addresses includes some locations reserved for special purposes.

Storage addressing wraps around from the maximum byte address, 16,777,215, to address 0. Variable-length operands may be located partially in the last and partially in the first location of storage, and are processed without any special indication.

When only a part of the maximum storage capacity is available in a given installation, the available storage is normally contiguously addressable, starting at address 0. An addressing exception is recognized when any part of an operand is located beyond the maximum available capacity of an installation.

In some models main storage may be shared by more than one CPU. In that case, the address of a byte location is normally the same for each CPU.

Information Positioning

Fixed-length fields, such as halfwords and double words, must be located in main storage on an *integral boundary* for that unit of information. A boundary is called integral for a unit of information when its stor-

age address is a multiple of the length of the unit in bytes. For example, words (four bytes) must be located in storage so that their address is a multiple of the number 4. A halfword (two bytes) must have an address that is a multiple of the number 2, and double words (eight bytes) must have an address that is a multiple of the number 8.

Storage addresses are expressed in binary form. In binary, integral boundaries for halfwords, words, and double words can be specified only by the binary addresses in which one, two, or three of the low-order bits, respectively, are zero. (Figure 3). For example, the integral boundary for a word is a binary address in which the two low-order positions are zero.

Variable fields are not limited to integral boundaries, but may start on any byte location.

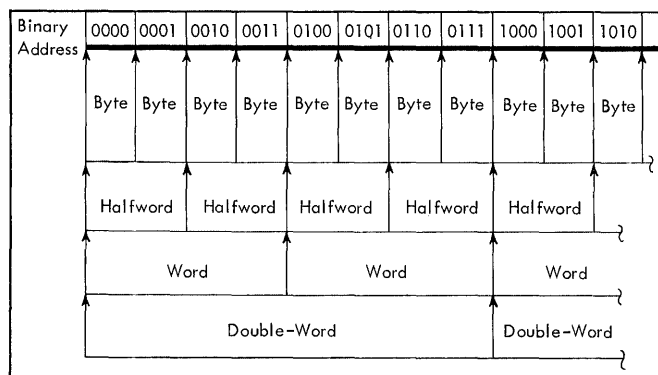

Figure 3. Integral Boundaries for Halfwords, Words, and Doublewords

Central Processing Unit

The central processing unit (Figure 4) contains the facilities for addressing main storage, for fetching or storing information, for arithmetic and logical processing of data, for sequencing instructions in the desired order, and for initiating the communication between storage and external devices.

The system control section provides the normal CPU control that guides the CPU through the operation necessary to execute the instructions. While the physical make-up of the control section in the various models of the Systems/360 may be different, the logical function remains the same.

The CPU provides 16 *general registers* for fixed-point operands and four *floating-point registers* for floating-point operands. Implementation of these registers may be in active elements, in a local storage unit, or in a separate area of main storage. In each case, the address and functions of these registers are identical.

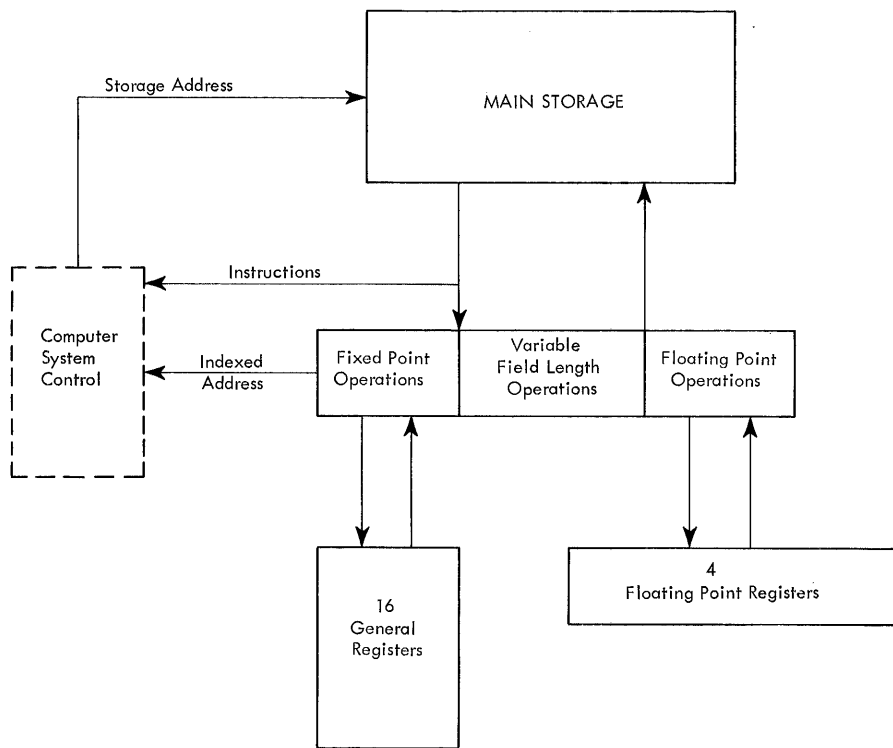

Figure 4. Central Processing Unit

General Registers

The CPU can address information in 16 general registers. The general registers can be used as index registers, in address arithmetic and indexing, and as accumulators in fixed-point arithmetic and logical operations. The registers have a capacity of one word (32 bits). The general registers are identified by numbers 0-15 and are selected by a four-bit field in the instruction called the R field (Figure 5).

R Field	Reg No.	General Registers	Floating Point Registers
0000	0		
0001	1		
0010	2		
0011	3		
0100	4		
0101	5		
0110	6		
0111	7		
1000	8		
1001	9		
1010	10		
1011	11		
1100	12		
1101	13		
1110	14		
1111	15		

Figure 5. General and Floating-Point Registers

For some operations, two adjacent registers can be coupled together, providing a two-word capacity. In these operations, the addressed register contains the high-order operand bits and must have an even address, while the implied register, containing the low-order operand bits, has the next higher address.

Floating-Point Registers

Four floating-point registers are available for floating-point operations. These registers are two words (64 bits) in length and can contain either a short (one word) or a long (two word) floating-point operand. A short operand occupies the high-order bits of a floating-point register. The low-order portion of the register is ignored and remains unchanged in short-precision arithmetic. The floating-point registers are identified by the numbers 0, 2, 4, and 6 (Figure 5). The operation code determines which type of register is to be used in an operation.

Arithmetic and Logical Unit

The arithmetic and logical unit can process binary integers and floating-point fractions of fixed length, decimal integers of variable length, and logical information of either fixed or variable length. Processing may be in

parallel or in series; the width of the arithmetic unit, the multiplicity of the shifting paths, and the degree of simultaneity in performing the different types of arithmetic differ from one CPU to another without affecting the logical appearance of the design.

Arithmetic and logical operations performed by the CPU fall into four classes: fixed-point arithmetic, decimal arithmetic, floating-point arithmetic, and logical operations. These classes differ in the data formats used, the registers involved, the operations provided, and the way the field length is stated.

Fixed-Point Arithmetic

The basic arithmetic operand is the 32-bit fixed-point binary word. Sixteen-bit halfword operands may be specified in most operations for improved performance or storage utilization. See Figure 6. To preserve precision, some products and all dividends are 64 bits long.

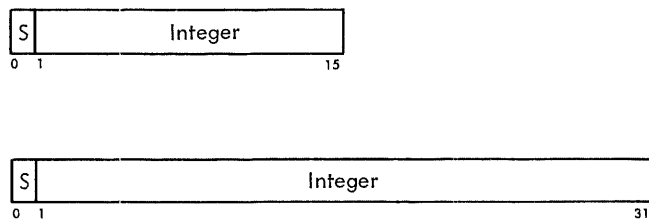

Figure 6. Fixed-Point Number Formats

Because the 32-bit word size conveniently accommodates a 24-bit address, fixed-point arithmetic can be used both for integer operand arithmetic and for address arithmetic. This combined usage provides economy and permits the entire fixed-point instruction set and several logical operations to be used in address computation. Thus, multiplication, shifting, and logical manipulation of address components are possible.

The absence of recomplementation and the ease of extension and truncation make two's-complement notation desirable for address components and fixed-point operands. Since integer and addressing algorithms often require repeated reference to operands or intermediate results, the use of multiple registers is advantageous in arithmetic sequences and address calculations.

Additions, subtractions, multiplications, divisions, and comparisons are performed upon one operand in a register and another operand either in a register or from storage. Multiple-precision operation is made convenient by the two's-complement notation and by recognition of the carry from one word to another. A

word in one register or a double word in a pair of adjacent registers may be shifted left or right. A pair of conversion instructions — CONVERT TO BINARY and CONVERT TO DECIMAL — provides transition between decimal and binary radix (number base) without the use of tables. Multiple-register loading and storing instructions facilitate subroutine switching.

Decimal Arithmetic

Decimal arithmetic is designed for processes requiring few computational steps between the source input and the documented output. This type of processing is frequently found in commercial applications, particularly when use is made of problem-oriented languages. Because of the limited number of arithmetic operations performed on each item of data, radix conversion from decimal to binary and back to decimal is not justified, and the use of registers for intermediate results yields no advantage over storage-to-storage processing. Hence, decimal arithmetic is provided, and both operands and results are located in storage. Decimal arithmetic includes addition, subtraction, multiplication, division, and comparison.

Decimal numbers are treated as signed integers with a variable-field-length format from one to 16 bytes long. Negative numbers are carried in true form.

The decimal digits 0-9 are represented in the four-bit binary-coded-decimal form by 0000-1001, respectively. The codes 1010-1111 are not valid as digits and are reserved for sign codes; 1011 and 1101 represent a minus; the other four codes are interpreted as plus. The sign codes generated in decimal arithmetic depend upon the character set preferred (Figure 7). When the expanded binary coded decimal interchange code (EBCDIC) is preferred, the codes are 1100 and 1101. When the ASCII set, expanded to eight bits, is preferred, the codes are 1010 and 1011. The choice between the two code sets is determined by a mode bit.

Decimal operands are represented by four-bit binary-coded-decimal digits packed two to a byte. They appear in fields of variable length and are accompanied by a sign in the rightmost four bits of the low-

Digit Code	Sign Code
0 0000	+ 1010
1 0001	- 1011
2 0010	+ 1100
3 0011	- 1101
4 0100	+ 1110
5 0101	+ 1111
6 0110	
7 0111	
8 1000	
9 1001	

Figure 7. Bit Codes for Digits and Signs

order byte. Operand fields may be located on any byte boundary, and may have length up to 31 digits and sign. Operands participating in an operation have independent lengths. Packing of digits within a byte (Figure 8) and of variable-length fields within storage results in efficient use of storage, in increased arithmetic performance, and in an improved rate of data transmission between storage and files.

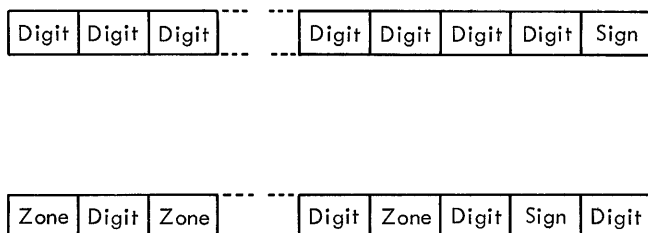

Figure 8. Packed and Zoned Decimal Number Formats

Decimal numbers may also appear in a zoned format as a subset of the eight-bit alphameric character set (Figure 8). This representation is required for character-set sensitive I/O devices. The zoned format is not used in decimal arithmetic operations. Instructions are provided for packing and unpacking decimal numbers so that they may be changed from the zoned to the packed format and vice versa.

Floating-Point Arithmetic

Floating-point numbers occur in either of two fixed-length formats — short or long. These formats differ only in the length of the fractions (Figure 9).

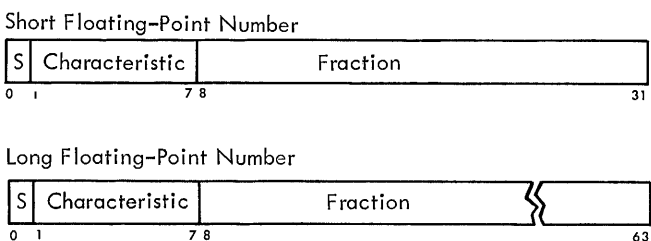

Figure 9. Short and Long Floating-Point Number Formats

Operands are either 32 or 64 bits long. The short length, equivalent to seven decimal places of precision, permits a maximum number of operands to be placed in storage and gives the shortest execution times. The long length, used when higher precision is desired, gives up to 17 decimal places of precision, thus eliminating most requirements for double-precision arithmetic.

The operand lengths, being powers of two, permit maximum efficiency in the use of binary addressing and in matching the physical word sizes of storage. Floating-point arithmetic is designed to allow easy transition between the two formats.

The fraction of a floating-point number is expressed in hexadecimal (base 16) digits, each consisting of four binary bits and having the values 0-15. In the short format, the fraction consists of six hexadecimal digits occupying bits 8-31. In the long format the fraction has 14 hexadecimal digits occupying bits 8-63.

The radix point of the fraction is assumed to be immediately to the left of the high-order fraction digit. To provide the proper magnitude for the floating-point number, the fraction is considered to be multiplied by a power of 16. The characteristic portion, bits 1-7 of both formats, is used to indicate this power. The characteristic is treated as an excess 64 number with a range from -64 through $+63$, and permits representation of decimal numbers with magnitudes in the range of 10^{-78} to 10^{75} .

Bit position 0 in either format is the sign (S) of the fraction. The fraction of negative numbers is carried in true form.

Four 64-bit floating-point registers are provided. Arithmetic operations are performed with one operand in a register and another either in a register or from storage. The result, developed in a register, is generally of the same length as the operands. The availability of several floating-point registers eliminates much storing and loading of intermediate results.

Logical Operations

Logical information is handled as fixed-length and variable-length data. It is subject to such operations as comparison, translation, editing, bit testing, and bit setting.

When used as a fixed-length operand, logical information can consist of either one, four, or eight bytes and is processed in the general registers.

A large portion of logical information consists of alphabetic or numeric character codes, called *alphameric data*, and is used for communication with character-set sensitive I/O devices. This information has the variable-field-length format and can consist of up to 256 bytes (Figure 10). It is processed in storage, left to right, an eight-bit byte at a time.

The CPU can handle any eight-bit character set, although certain restrictions are assumed in the decimal arithmetic and editing operations. However, all character-set sensitive I/O equipment will assume either the extended binary-coded-decimal interchange code

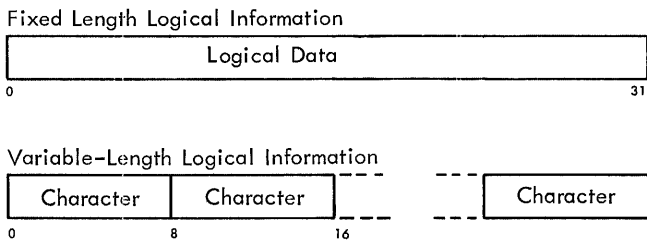

Figure 10. Fixed-Length and Variable-Length Logical Information

(EBCDIC) (Figure 11) or the American Standard Code for Information Interchange (ASCII) extended to eight bits (Figure 12).

The preferred codes do not have a graphic defined for all 256 eight-bit codes. When it is desirable to represent all possible bit patterns, a hexadecimal representation may be used instead of the preferred eight-bit code. The hexadecimal representation uses one graphic for a four-bit code, and therefore, two graphics for an eight-bit byte. The graphics 0-9 are used for codes 0000-1001; the graphics A-F are used for codes 1010-1111.

Program Execution

The CPU program consists of instructions, index words, and control words specifying the operations to be performed. This information resides in main storage and general registers, and may be operated upon as data.

Instruction Format

The length of an instruction format can be one, two, or three halfwords. It is related to the number of storage addresses necessary for the operation. An instruction consisting of only one halfword causes no reference to main storage. A two-halfword instruction provides one storage-address specification; a three-halfword instruction provides two storage-address specifications. All instructions must be located in storage on integral boundaries for halfwords. Figure 13 shows five basic instruction formats.

The five basic instruction formats are denoted by the format codes RR, RX, RS, SI, and SS. The format codes express, in general terms, the operation to be performed. RR denotes a register-to-register operation; RX, a register-to-indexed-storage operation; RS, a regis-

Bit Positions	01				01				10				11			
	00	01	10	11	00	01	10	11	00	01	10	11	00	01	10	11
0000	NUL				BLANK	&	-						>	<	±	0
0001							/		a	i			A	J		1
0010									b	k	s		B	K	S	2
0011									c	l	t		C	L	T	3
0100	PF	RES	BYP	PN					d	m	u		D	M	U	4
0101	HT	NL	LF	RS					e	n	v		E	N	V	5
0110	LC	BS	EOB	UC					f	o	w		F	O	W	6
0111	DEL	IDL	PRE	EOT					g	p	x		G	P	X	7
1000									h	q	y		H	Q	Y	8
1001					.		,	"	i	r	z		I	R	Z	9
1010					?	!	:									
1011					.	\$,	#								
1100					←	*	%	@								
1101					()	~	'								
1110					+	;	-	=								
1111					‡	∅	±	✓								

Figure 11. Extended Binary-Coded-Decimal Interchange Code

Bit Positions		00				01				10				11			
4321		00	01	10	11	00	01	10	11	00	01	10	11	00	01	10	11
0000	NULL	DC ₀				␣	0					@	P				P
0001	SOM	DC ₁				!	1					A	Q			a	q
0010	EOA	DC ₂				"	2					B	R			b	r
0011	EOM	DC ₃				#	3					C	S			c	s
0100	EOT	DC ₄ STOP				§	4					D	T			d	t
0101	WRU	ERR				%	5					E	U			e	u
0110	RU	SYNC				&	6					F	V			f	v
0111	BELL	LEM				'	7					G	W			g	w
1000	BKSP	S ₀				(8					H	X			h	x
1001	HT	S ₁)	9					I	Y			i	y
1010	LF	S ₂				*	:					J	Z			j	z
1011	VT	S ₃				+	;					K	⌈			k	
1100	FF	S ₄				,	<					L	\			l	
1101	CR	S ₅				-	=					M	⌋			m	
1110	SO	S ₆				.	>					N	↑			n	ESC
1111	SI	S ₇				/	?					O	←			o	DEL

Figure 12. Eight-Bit Representation for American Standard Code for Information Interchange for Use in Eight-Bit Environment

ter-to-storage operation; si, a storage and immediate-operand operation; and ss, a storage-to-storage operation.

For purposes of describing the execution of instructions, operands are designated as first and second operands and, in the case of BRANCH ON INDEX, third operands. These names refer to the manner in which the operands participate. The operand to which a field in an instruction format applies is generally denoted by the number following the code name of the field, for example, R₁, B₁, L₂, D₂.

In each format, the first instruction halfword consists of two parts. The first byte contains the operation code (op code). The length and format of an instruction are specified by the first two bits of the operation code.

INSTRUCTION LENGTH RECORDING		
BIT POSITIONS (0-1)	INSTRUCTION LENGTH	INSTRUCTION FORMAT
00	One halfword	RR
01	Two halfwords	RX
10	Two halfwords	RS or SI
11	Three halfwords	SS

The second byte is used either as two 4-bit fields or as a single eight-bit field. This byte can contain the following information:

- Four-bit operand register specification (R₁, R₂, or R₃)
- Four-bit index register specification (X₂)
- Four-bit mask (M₁)
- Four-bit operand length specification (L₁ or L₂)
- Eight-bit operand length specification (L)
- Eight-bit byte of immediate data (I₂)

In some instructions a four-bit field or the whole second byte of the first halfword is ignored.

The second and third halfwords always have the same format:

- Four-bit base register designator (B₁ or B₂), followed by a 12-bit displacement (D₁ or D₂).

Address Generation

For addressing purposes, operands can be grouped in three classes: explicitly addressed operands in main storage, immediate operands placed as part of the in-

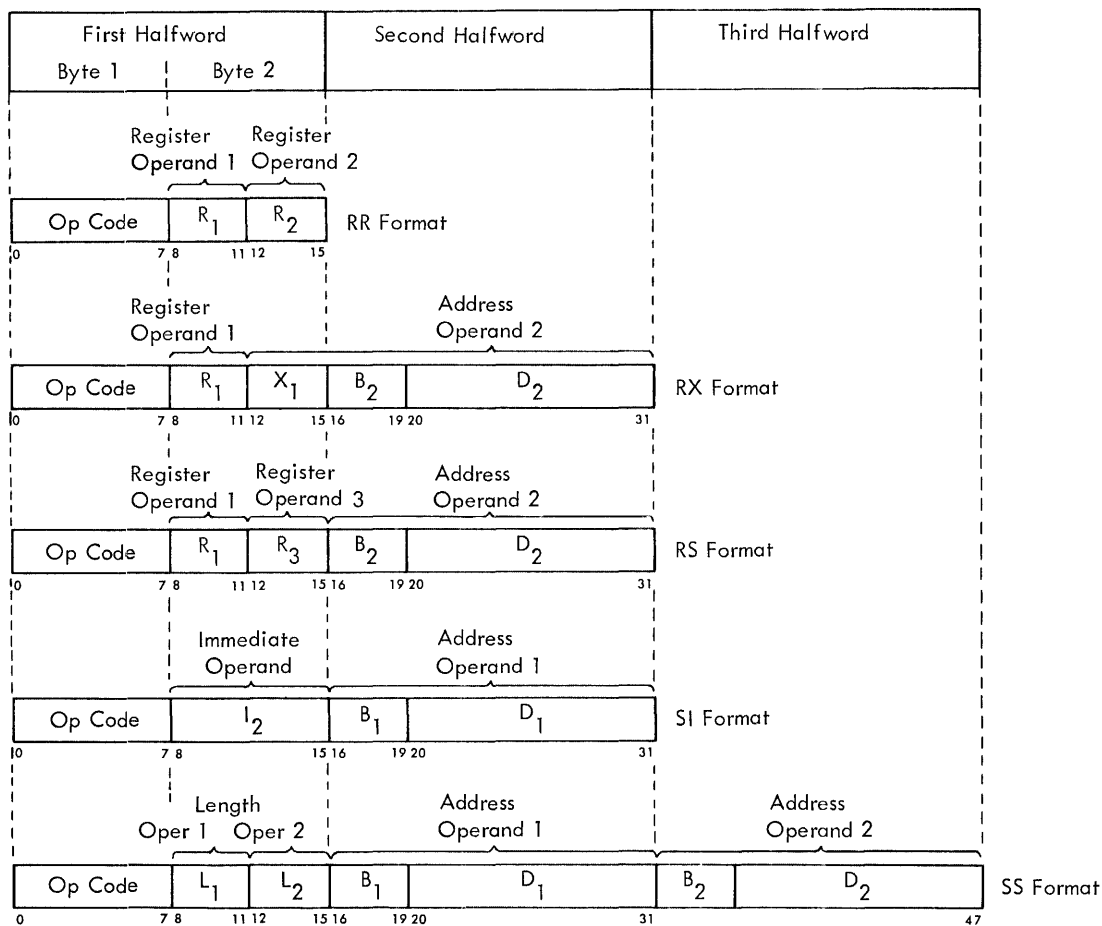

Figure 13. Five Basic Instruction Formats

struction stream in main storage, and operands located in the general or floating-point registers.

To permit the ready relocation of program segments and to provide for the flexible specifications of input, output, and working areas, all instructions referring to main storage have been given the capacity of employing a full address.

The address used to refer to main storage is generated from the following three binary numbers:

Base Address (B) is a 24-bit number contained in a general register specified by the program in the B field of the instruction. The B field is included in every address specification. The base address can be used as a means of static relocation of programs and data. In array-type calculations, it can specify the location of an array and, in record-type processing, it can identify the record. The base address provides for addressing the entire main storage. The base address may also be used for indexing purposes.

Index (X) is a 24-bit number contained in a general register specified by the program in the X field of the instruction. It is included only in the address speci-

fied by the rx instruction format. The index can be used to provide the address of an element within an array. Thus, the rx format instructions permit double indexing.

Displacement (D) is a 12-bit number contained in the instruction format. It is included in every address computation. The displacement provides for relative addressing up to 4095 bytes beyond the element or base address. In array-type calculations the displacement can be used to specify one of many items associated with an element. In the processing of records, the displacement can be used to identify items within a record.

In forming the address, the base address and index are treated as unsigned 24-bit positive binary integers. The displacement is similarly treated as a 12-bit positive binary integer. The three are added as 24-bit binary numbers, ignoring overflow. Since every address includes a base, the sum is always 24 bits long. The address bits are numbered 8-31 corresponding to the numbering of the base address and index bits in the general register.

The program may have zeros in the base address, index, or displacement fields. A zero is used to indicate the absence of the corresponding address component. A base or index of zero implies that a zero quantity is to be used in forming the address, regardless of the contents of general register 0. A displacement of zero has no special significance. Initialization, modification, and testing of base addresses and indexes can be carried out by fixed-point instructions, or by `BRANCH AND LINK`, `BRANCH ON COUNT`, or `BRANCH ON INDEX` instructions.

As an aid in describing the logic of the instruction format, examples of two instructions and their related instruction formats follow.

RR Format

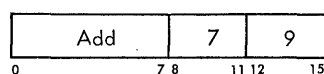

Execution of the `ADD` instruction adds the contents of general register 9 to the contents of general register 7 and the sum of the addition is placed in general register 7.

RX Format

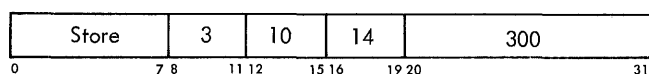

Execution of the `STORE` instruction stores the contents of general register 3 at a main-storage location addressed by the sum of 300 and the low-order 24 bits of general registers 14 and 10.

Sequential Instruction Execution

Normally, the operation of the CPU is controlled by instructions taken in sequence. An instruction is fetched from a location specified by the current instruction address. The instruction address is then increased by the number of bytes in the instruction to address the next instruction in sequence. The instruction is then executed and the same steps are repeated using the new value of the instruction address.

Conceptually, all halfwords of an instruction are fetched from storage after the preceding operation is completed and before execution of the current operation, even though physical storage word size and overlap of instruction execution with storage access may cause actual instruction fetching to be different. Thus, it is possible to modify an instruction in storage by the immediately preceding instruction.

A change from sequential operation may be caused by branching, status switching, interruptions, or manual intervention.

Branching

The normal sequence of instructions is changed when reference is made to a subroutine, when a two-way choice is encountered, or when a segment of coding, such as a loop, is to be repeated. All these tasks can be accomplished with branching instructions.

Subroutine linkage permits not only the introduction of a new instruction address but also the preservation of the return address and associated information.

Decision-making is generally and symmetrically provided by the `BRANCH ON CONDITION` instruction. This instruction inspects a two-bit *condition code* that reflects the result of a majority of the arithmetic, logical, and I/O operations. Each of these operations can set the code in any one of four states, and the conditional branch can specify any selection of these four states as the criterion for branching. For example, the condition code reflects such conditions as nonzero, first operand high, equal, overflow, channel busy, zero, etc. Once set, the condition code remains unchanged until modified by an instruction that reflects a different condition code.

The two bits of the condition code provide for four possible condition code settings: 0, 1, 2, and 3. The specific meaning of any setting is significant only to the operation setting the condition code.

Loop control can be performed by the conditional branch when it tests the outcome of address arithmetic and counting operations. For some particularly frequent combinations of arithmetic and tests, the instructions `BRANCH ON COUNT` and `BRANCH ON INDEX` are provided. These branches, being specialized, provide increased performance for these tasks.

Program Status Word

A double word, the program status word (*psw*), contains the information required for proper program execution. The *psw* includes the instruction address, condition code, and other fields to be discussed. In general, the *psw* is used to control instruction sequencing and to hold and indicate the status of the system in relation to the program being executed. The active or controlling *psw* is called the "current *psw*." By storing the current *psw* during an interruption, the status of the CPU can be preserved for subsequent inspection. By loading a new *psw* or part of a *psw*, the state of the CPU can be initialized or changed. Figure 14 shows the *psw* format.

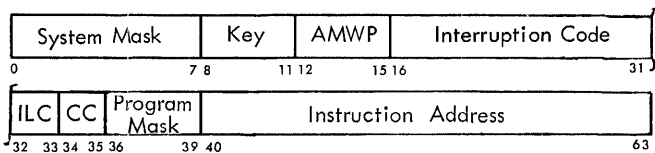

- 0-7 System mask
- 0 Multiplexor channel mask
- 1 Selector channel 1 mask
- 2 Selector channel 2 mask
- 3 Selector channel 3 mask
- 4 Selector channel 4 mask
- 5 Selector channel 5 mask
- 6 Selector channel 6 mask
- 7 External mask
- 8-11 Protection key
- 12 ASCII mode (A)
- 13 Machine check mask (M)
- 14 Wait state (W)
- 15 Problem state (P)
- 16-31 Interruption code
- 32-33 Instruction Length code (ILC)
- 34-35 Condition code (CC)
- 36-39 Program mask
- 36 Fixed-point overflow mask
- 37 Decimal overflow mask
- 38 Exponent underflow mask
- 39 Significance mask
- 40-63 Instruction address

Figure 14. Program Status Word Format

Interruption

The interruption system permits the CPU to change state as a result of conditions external to the system, in input/output (I/O) units or in the CPU itself. Five classes of interruption conditions are possible: I/O, program, supervisor call, external, and machine check.

Each class has two related PSW's called "old" and "new" in unique main-storage locations (Figure 15). In all classes, an interruption involves merely storing the current PSW in its "old" position and making the PSW at the "new" position the current PSW. The "old" PSW holds all necessary status information of the system existing at the time of the interruption. If, at the conclusion of the interruption routine, there is an instruction to make the old PSW the current PSW, the system is restored to the state prior to the interruption and the interrupted routine continues.

Address	Length	Purpose
0 0000 0000	double word	Initial program Loading PSW
8 0000 1000	double word	Initial program Loading CCW1
16 0001 0000	double word	Initial program Loading CCW2
24 0001 1000	double word	External old PSW
32 0010 0000	double word	Supervisor call old PSW
40 0010 1000	double word	Program old PSW
48 0011 0000	double word	Machine check old PSW
56 0011 1000	double word	Input/output old PSW
64 0100 0000	double word	Channel status word
72 0100 1000	word	Channel address word
76 0100 1100	word	Unused
80 0101 0000	word	Timer
84 0101 0100	word	Unused
88 0101 1000	double word	External new PSW
96 0110 0000	double word	Supervisor call new PSW
104 0110 1000	double word	Program new PSW
112 0111 0000	double word	Machine check new PSW
120 0111 1000	double word	Input/output new PSW
128 1000 0000	double word	Diagnostic scan-out area *

* The size of the diagnostic scan-out area depends upon the particular system's CPU and I/O channels.

Figure 15. Permanent Storage Assignments

Interruptions are taken only when the CPU is interruptible for the interruption source. The system mask, program mask, and machine check mask bits in the PSW may be used to mask certain interruptions. When masked off, an interruption either remains pending or is ignored. The system mask may keep I/O and external interruptions pending, the program mask may cause four of the 15 program interruptions to be ignored, and the machine-check mask may cause machine-check interruptions to be ignored. Other interruptions cannot be masked off.

An interruption always takes place after one instruction execution is finished and before a new instruction execution is started. However, the occurrence of an interruption may affect the execution of the current instruction. To permit proper programmed action following an interruption, the cause of the interruption is identified and provision is made to locate the last executed instruction.

Input/Output Interruption

An I/O interruption provides a means by which the CPU responds to conditions in the channels and I/O units.

An I/O interruption can occur only when the related channel is not masked. The address of the channel and I/O unit involved are recorded in the old PSW. Further information concerning the I/O action is preserved in the channel status word (CSW) that is stored during the interruption.

Program Interruption

Unusual conditions encountered in a program create program interruptions. These conditions include incorrect operands and operand specifications, as well as exceptional results. The interruption code identifies the interruption cause. Figure 16 shows the different causes that may occur.

Interruption Code	Program Interruption Cause
1 00000001	Operation
2 00000010	Privileged operation
3 00000011	Execute
4 00000100	Protection
5 00000101	Addressing
6 00000110	Specification
7 00000111	Date
8 00001000	Fixed-point overflow
9 00001001	Fixed-point divide
10 00001010	Decimal overflow
11 00001011	Decimal divide
12 00001100	Exponent overflow
13 00001101	Exponent underflow
14 00001110	Significance
15 00001111	Floating-point divide

Figure 16. Interruption Code for Program Interruption

Supervisor-Call Interruption

This interruption occurs as a result of execution of the instruction SUPERVISOR CALL. Eight bits from the instruction format are placed in the interruption code of the old psw, permitting a message to be associated with the interruptions. A major use for the instruction SUPERVISOR CALL is to switch from the problem-state to the supervisor state. This interruption may also be used for other modes of status-switching.

External Interruption

The external interruption provides the means by which the CPU responds to signals from the interruption key on the system control panel, the timer, and the external signals of the direct control feature (Figure 17).

Interruption Code Bit	External Interruption Cause	Mask Bit
24	Timer	
25	Interrupt key	7
26	External signal 6	7
27	External signal 5	7
28	External signal 4	7
29	External signal 3	7
30	External signal 2	7
31	External signal 1	7

Figure 17. Interruption Code for External Interruption

An external interruption can occur only when the system mask bit 7 is one.

The source of the interruption is identified by the interruption code in bits 24-31 of the psw. Bits 16-23 of the interruption code are made zero.

Machine-Check Interruption

The occurrence of a machine check (if not masked off) terminates the current instruction, initiates a diagnostic procedure, and subsequently causes the machine-check interruption. A machine check cannot be caused by invalid data or instructions. The diagnostic scan is performed into the scan area starting at location 128. Proper execution of these steps depends on the nature of the machine check.

Priority of Interruptions

During execution of an instruction, several interruption requests may occur simultaneously. Simultaneous interruption requests are honored in the following predetermined order:

- Machine Check
- Program or Supervisor Call
- External
- Input/Output

The program and supervisor-call interruptions are

mutually exclusive and cannot occur at the same time.

When more than one interruption cause requests service, the action consists of storing the old psw and fetching the new psw belonging to the interruption which is taken first. This new psw subsequently is stored without any instruction execution and the next interruption psw is fetched. This process continues until no more interruptions are to be serviced. When the last interruption request has been serviced, instruction execution is resumed using the psw last fetched. The order of execution of the interruption subroutines is, therefore, the reverse of the order in which the psw's are fetched.

Thus, the most important interruptions — I/O, external, program or supervisor call — are actually serviced first. Machine check, when it occurs, does not allow any other interruptions to be taken.

Program States

Over-all CPU status is determined by four types of program-state alternatives, each of which can be changed independently to its opposite and most of which are indicated by a bit or bits in the psw. The program-state alternatives are named stopped or operating, running or waiting, masked or interruptable, and supervisor or problem state. These states differ in the way they affect the CPU functions and the manner in which their status is indicated and switched. All program states are independent of each other in their functions, indication, and status-switching.

Stopped or Operating States: The stopped state is entered and left by manual procedure. Instructions are not executed, interruptions are not accepted, and the timer is not updated. In the operating state, the CPU is capable of executing instructions and being interrupted.

Running or Waiting State: In the running state, instruction fetching execution proceeds in the normal manner. The wait state is normally entered by the program to await an interruption, for example, an I/O interruption or operator intervention from the console. In the wait state, no instructions are processed, the timer is updated, and I/O and external interruptions are accepted, unless masked. Running or waiting state is determined by the setting of bit 14 in the psw.

Masked or Interruptable State: The CPU may be interruptable or masked for the system, program, and machine interruptions. When the CPU is interruptable for a class of interruptions, these interruptions are accepted. When the CPU is masked, the system interruptions remain pending, while the program and machine-check interruptions are ignored. The interruptable states of the CPU are changed by changing the mask bits of the psw.

Supervisor or Problem State: In the problem state, all I/O instructions and a group of control instructions are invalid. In the supervisor state, all instructions are valid. The choice of problem or supervisor state is determined by bit 15 of the psw.

Protection Feature

The Protection Feature protects the contents of certain areas of storage from destruction due to erroneous storing of information during the execution of a program. This protection is achieved by identifying blocks of storage with a storage key and comparing this key with a protection key supplied with the data to be stored. The detection of a mismatch results in a protection interruption.

For protection purposes, main storage is divided into blocks of 2,048 bytes. A four-bit storage key is associated with each block. When data are stored in a storage block, the storage key is compared with the protection key. When storing is specified by an instruction, the protection key of the current psw is used as the comparand. When storing is specified by a channel operation, a protection key supplied by the channel is used as the comparand. The keys are said to match when they are equal or when either one is zero.

The storage key is not part of addressable storage. The key is changed by SET STORAGE KEY and is inspected by INSERT STORAGE KEY. The protection key in the psw occupies bits 8-11 of that control word. The protection key of a channel is recorded in bits 0-3 of the csw, which is stored as a result of the channel operation. When a protection mismatch due to an instruction is detected, the execution of this instruction is suppressed or terminated, and the program execution is altered by an interruption. The protected storage location always remains unchanged. Protection mismatch due to an I/O operation causes the data transmission to be terminated in such a way that the protected storage location remains unchanged. The mismatch is indicated in the csw stored as a result of the operation.

Timer Feature

The timer is provided as an interval timer and may be programmed to maintain the time of day. The timer consists of a full word in main storage location 80. The timer word is counted down at a rate of 50 or 60 cycles per second, depending on line frequency. The timer word is treated as a signed integer following the rules of fixed-point arithmetic. An external interruption condition is signaled when the value of the

timer word goes from positive to negative. The full cycle time of the timer is 15.5 hours.

An updated timer value is available at the end of each instruction execution but is not updated in the stopped state. The timer is changed by addressing storage location 80. As an interval timer, the timer is used to measure elapsed time over relatively short intervals. It can be set to any value at any time.

Direct Control Feature

The direct control feature provides two instructions, READ DIRECT and WRITE DIRECT, and six external interruption lines. The read and write instructions provide for the transfer of a single byte of information between an external device and the main storage of the system. It is usually most desirable to use the data channels of the system to handle the transfer of any volume of information and use the direct data control feature to pass controlling and synchronizing information between the CPU and special external devices.

Each of the six external signal lines, when pulsed, sets up the conditions for an external interruption.

Multisystem Feature

The design of System/360 permits communication between individual CPU's at several transmission rates. The communication is possible through shared control units, through a channel connector and through shared storage. These features are further augmented by the direct control feature and the multisystem feature. The direct control feature, described in the previous section, can be used to signal from one CPU to another. The multisystem feature provides direct address relocation, malfunction indications, and electronic CPU initialization.

The relocation procedure applies to the first 4,096 bytes of storage. This area contains all permanent storage assignments and, generally, has special significance to supervisory programs. The relocation is accomplished by inserting a 12-bit prefix in each address which has the high-order 12 bits set to zero and hence, pertains to location 0-4095. Two manually set prefixes are available to permit the use of an alternative area when storage malfunction occurs. The choice between the prefixes is determined by a prefix trigger set during initial program loading.

To alert one CPU to the possible malfunction of another CPU, a machine check-out signal is provided, which can serve as an external interruption to another CPU.

Finally, the feature includes provision for initial program loading initiated by a signal from another CPU.

Input/Output

Input/Output Devices and Control Units

Input/output operations involve the transfer of information to or from main storage and an I/O device. Input/output devices include such equipment as card read punches, magnetic tape units, disk storage, drum storage, typewriter-keyboard devices, printers, TELE-PROCESSING® devices, and process control equipment.

Many I/O devices function with an external document, such as a punched card or a reel of magnetic tape. Some I/O devices handle only electrical signals, such as those found in process-control networks. In either case, I/O device operation is regulated by a control unit. The control-unit function may be housed with the I/O device, as is the case with a printer, or a separate control unit may be used. In all cases, the control-unit function provides the logical and buffering capabilities necessary to operate the associated I/O device. From the programming point of view, most control-unit functions merge with I/O device functions.

Each control unit functions only with the I/O device for which it is designed, but each control unit has standard-signal connections with regard to the channel to which it is attached.

Input/Output Interface

So that the CPU may control a wide variety of I/O devices, all control units are designed to respond to a standard set of signals from the channel. This control-unit-to-channel connection is called the I/O interface. It enables the CPU to handle all I/O operations with only four instructions.

Channels

Channels connect with the CPU and main storage and, via the I/O interface, with control units. Each channel has facilities for:

- Accepting I/O instructions from the CPU
- Addressing devices specified by I/O instructions
- Fetching channel control information from main storage
- Decoding control information
- Testing control information for validity
- Executing control information
- Providing control signals to the I/O interface
- Accepting control-response signals from the I/O interface
- Buffering data transfers
- Checking parity of bytes transferred
- Counting the number of bytes transferred
- Accepting status information from I/O devices
- Maintaining channel-status information
- Sending requested status information to main storage
- Sequencing interruption requests from I/O devices
- Signaling interruptions to the CPU

A channel may be an independent unit, complete with necessary logical and storage capabilities, or it may share CPU facilities and be physically integrated with the CPU. In either case, channel functions are identical.

The System/360 has two types of channels: multiplexor and selector. The channel facility necessary to sustain an operation with an I/O device is called a subchannel. The selector channel has one subchannel; the multiplexor channel has multiple subchannels.

Channels have two modes of operation: burst and multiplex.

In the burst mode, all channel facilities are monopolized for the duration of data transfer to or from a particular I/O device. The selector channel functions only in the burst mode.

The multiplexor channel functions in both the burst mode and in the multiplex mode. In the latter mode, the multiplexor channel sustains simultaneous I/O operations on several subchannels. Bytes of data are interleaved together and then routed to or from the selected I/O devices and to or from the desired locations in main storage.

Input/Output Instructions

The System/360 uses only four I/O instructions:

```
START I/O
TEST CHANNEL
TEST I/O
HALT I/O
```

Input/output instructions can be executed only while the CPU is in the supervisor state.

Start I/O

The START I/O initiates an I/O operation. The address part of the instruction specifies the channel and I/O device.

Test Channel

The TEST CHANNEL sets the condition code in the PSW to indicate the state of the channel addressed by the instruction. The condition code then indicates channel available, interruption condition in channel, channel working, or channel not operational.

Test I/O

The TEST I/O causes a CSW to be stored in location 64 of main storage, if the device addressed by TEST I/O has specified conditions for interruption. The CSW provides information on the status of the channel and I/O devices.

Halt I/O

The HALT I/O terminates a channel operation.

Input/Output Operation Initiation

All I/O operations are initiated by START I/O. If the channel facilities are free, START I/O is accepted and the CPU continues its program. The channel independently selects the I/O device specified by the instruction.

Channel Address Word

Successful execution of START I/O causes the channel to fetch a channel address word (CAW) from the main-storage location 72. The CAW specifies the byte location in main storage where the channel program begins.

Figure 18 shows the format for the CAW. Bits 0-3 specify the storage-protection key that will govern the I/O operation. Bits 4-7 must contain zeros. Bits 8-31 specify the location of the first channel command word (CCW).

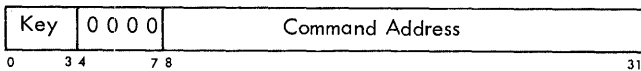

Figure 18. Channel Address Word Format

Channel Command Word

The byte location specified by the CAW is the first of eight bytes of information that the channel fetches from main storage. These 64 bits of information are called a channel command word (CCW).

One or more CCW's make up the channel program that directs channel operations. If more than one CCW is to be used, each CCW points to the next CCW to be fetched, except for the last CCW in the chain, which identifies itself as the last in the chain. Figure 19 shows the format for CCW's.

Six channel commands are provided:

- Read
- Write
- Read Backward
- Control
- Sense
- Transfer In Channel

Input/Output Commands

Read

The read command causes a read operation from the selected I/O device and defines the area in main storage to be used.

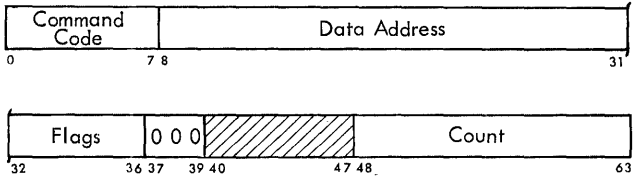

- Bits 0-7 specify the command code.
- Bits 8-31 specify the location of a byte in main storage.
- Bits 32-36 are flag bits.
 - Bit 32 causes the address portion of the next CCW to be used.
 - Bit 33 causes the command code and data address in the next CCW to be used.
 - Bit 34 causes a possible incorrect length indication to be suppressed.
 - Bit 35 suppresses the transfer of information to main storage.
 - Bit 36 causes an interruption as
- Bits 37-39 must contain zeros.
- Bits 40-47 are ignored
- Bits 48-63 specify the number of bytes in the operation.

Figure 19. Channel Command Word Format

Write

The write command causes a write operation on the selected I/O device and defines the data in main storage to be written.

Read Backward

The read-backward command causes a read operation in which the external document is moved in a backward direction. Bytes read backward are placed in descending main storage locations.

Control

The control command contains information used to control the selected I/O device. This control information is called an order. Orders are peculiar to the particular I/O device in use; orders can specify such functions as rewinding a tape unit, searching for a particular track in disk storage, or line skipping on a printer. The relationship of I/O instructions, commands, and orders is shown in Figure 20.

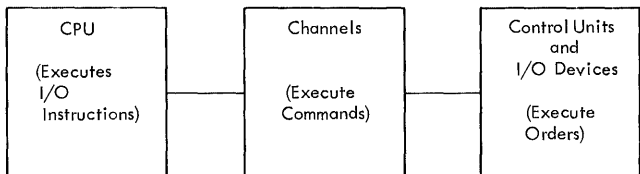

Figure 20. Relationship of I/O Instructions, Commands, and Orders

Sense

The sense command specifies the beginning main storage location to which status information is trans-

ferred from the selected control unit. This sense data may be one or more bytes long. It provides detailed information concerning the selected I/O device, such as a stacker-full condition of a card reader or a file-protected condition of a reel of magnetic tape on a tape unit. Sense data have a significance peculiar to the I/O device involved.

Transfer In Channel

The transfer-in-channel command specifies the location of the next ccw to be used by the channel whenever the programmer desires to break the existing chain of ccw's and cause the channel to begin fetching a new chain of ccw's from a different area in main storage.

External documents, such as punched cards or magnetic tape, may carry ccw's that the channel can use to govern reading of the external document being read.

Input/Output Termination

Input/output operations normally terminate with device-end signal and channel-end conditions and an interruption signal to the CPU.

A command can be rejected during execution of START I/O, however, by a busy condition, program check, etc. The rejection of the command is indicated in the condition code in the PSW, and the details of the conditions that precluded initiation of the I/O operation are provided in the channel status word stored when the command is rejected.

Channel Status Word

The channel status word (CSW) provides information about the termination of an I/O operation. It is formed or reformed by START I/O, TEST I/O, or by an I/O interruption. Figure 21 shows the CSW format.

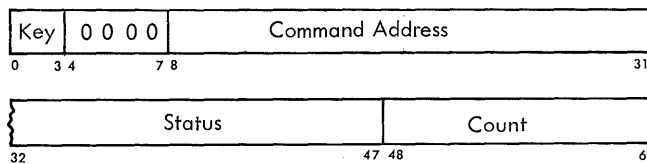

- Bits 0-3 contains the storage-protection key used in the operation.
- Bit 4-7 contain zeros.
- Bits 8-31 specify the location of the last CCW used.
- Bits 32-47 contain an I/O device-status byte and a channel-status byte. The status bytes provide such information as data-check, chaining check, control-unit end, etc.
- Bits 48-63 contain the residual count of the last CCW used.

Figure 21. Channel Status Word Format

Input/Output Interruptions

Input/output interruptions are caused by termination of an I/O operation or by operator intervention at the

I/O device. Input/output interruptions enable the CPU to provide appropriate programmed response to conditions that occur in I/O devices or channels.

Input/output interruptions have two priority sequences, one for the I/O devices attached to a channel, and another for channel interruptions. A channel establishes interruption priority for its associated I/O devices before initiating an I/O interruption signal to the CPU. Conditions responsible for I/O interruption requests are preserved in the I/O devices or channels until they are accepted by the CPU.

System Control Panel

The system control panel provides the switches, keys, and lights necessary to operate and control the system. The need for operator manipulation of manual controls is held to a minimum by the system design and the governing supervisory program. The result is fewer and less serious operator errors.

System Control Panel Functions

The main functions provided by the system control panel are the ability to: reset the system; store and display information in main storage, in registers, and in the PSW; and load initial program information.

System Reset

The system-reset function resets the CPU, the channels, and online control units and I/O devices. In general, the system is placed in such a state that processing can be initiated without the occurrence of machine checks, except those caused by subsequent machine malfunction.

Store and Display

The store-and-display function permits manual intervention in the progress of a program. The function may be provided by a supervisory program in conjunction with proper I/O equipment and the interrupt key. Or, the system-control-panel facilities may be used to place the CPU in the stopped state, and then to store and display information in main storage, in general and floating-point registers, and in instruction-address portion of the PSW.

Initial Program Loading

The initial-program-loading (IPL) procedure is used to begin or renew system operation. The load key is pressed after an input device is selected with the load-unit switches. This causes a read operation at the selected input device. Six words of information are

read into main storage and used as channel control words and as a PSW that controls subsequent system operation.

The system controls are divided into three sections: operator control, operator intervention, and customer engineering control.

Operator Control Section

This section of the system control panel contains the operator controls required when the CPU is operating under supervisory program control.

The main functions provided are the control and indication of power, the indication of system status, and operator-to-machine communication. These include:

- Emergency power-off pull switch
- Power-on back-lighted key
- Power-off key
- Interrupt key
- Wait light
- Manual light
- System light
- Test light

- Load light
- Load-unit switches
- Load key

Operator Intervention Section

This section of the system control panel provides controls required for operator intervention into normal programmed operation. These include:

- System reset key
- Stop key
- Start key
- Rate switch (single cycle or normal processing)
- Storage-select switches
- Address switches
- Data switches
- Store key
- Display key
- Set IC key
- Address compare switches

Customer Engineering Section

This section of the system control panel provides the controls intended only for customer engineering use. Customer engineering controls are also available on some storage, channel, and control-unit equipment.

The fixed-point instruction set performs binary arithmetic on operands serving as addresses, index quantities, and counts, as well as fixed-point data. In general, both operands are signed and 32 bits long. Negative quantities are held in two's-complement form. One operand is always in one of the 16 general registers; the other operand may be in main storage or in a general register.

The instruction set provides for loading, adding, subtracting, comparing, multiplying, dividing, and storing, as well as for the sign control, radix conversion, and shifting of fixed-point operands. The entire instruction set is included in the standard instruction set.

The condition code is set as a result of all sign-control, add, subtract, compare, and shift operations.

Data Format

Fixed-point numbers occupy a fixed-length format consisting of a one-bit sign followed by the integer field. When held in one of the general registers, a fixed-point quantity has a 31-bit integer field and occupies all 32 bits of the register. Some multiply, divide, and shift operations use an operand consisting of 64 bits with a 63-bit integer field. These operands are located in a pair of adjacent general registers and are addressed by an even address referring to the leftmost register of the pair. The sign-bit position of the rightmost register contains part of the integer. In register-to-register operations the same register may be specified for both operand locations.

Fullword Fixed-Point Number

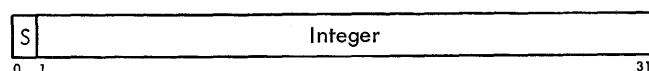

Halfword Fixed-Point Number

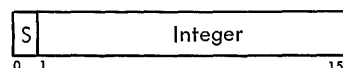

Fixed-point data in main storage occupy a 32-bit word or a 16-bit halfword, with a binary integer field of 31 or 15 bits, respectively. The conversion instructions

use a 64-bit decimal field. These data must be located on integral storage boundaries for these units of information, that is, double-word, fullword, or halfword operands must be addressed with three, two, or one low-order address bit(s) set to zero.

A halfword operand in main storage is extended to a fullword as the operand is fetched from storage. Subsequently, the operand participates as a fullword operand.

Number Representation

All fixed-point operands are treated as signed integers. Positive numbers are represented in true binary notation with the sign bit set to zero. Negative numbers are represented in two's-complement notation with a one in the sign bit. The two's complement of a number is obtained by inverting each bit of the number and adding a one in the low-order bit position.

This type of number representation can be considered the low-order portion of an infinitely long representation of the number. When the number is positive, all bits to the left of the most significant bit of the number, including the sign bit, are zeros. When the number is negative, all these bits, including the sign bit, are ones. Therefore, when an operand must be extended with high-order bits, the expansion is achieved by prefixing a field in which each bit is set equal to the high-order bit of the operand.

Two's-complement notation does not include a negative zero. It has a number range in which the set of negative numbers is one larger than the set of positive numbers. The maximum positive number consists of an all-one integer field with a sign bit of zero, whereas the maximum negative number consists of an all-zero integer field with a one-bit for sign.

The CPU cannot represent the complement of the maximum negative number. When an operation, such as a subtraction from zero, produces the complement of the maximum negative number, the number remains unchanged, and a fixed-point overflow exception is recognized. An overflow does not result, however, when the number is complemented and the final result is within the representable range. An example of this case is a subtraction from minus one. The product of two maximum negative numbers is representable as a double-length positive number.

The sign bit is leftmost in a number. An overflow carries into the sign-bit position and changes the sign. However, in algebraic shifting the sign bit does not change even if significant high-order bits are shifted out.

Programming Notes

Two's-complement notation is particularly suited to address computation and multiple-precision arithmetic.

The two's-complement representation of a negative number may be considered the sum of the integer part of the field, taken as a positive number, and the maximum negative number. Hence, in multiple-precision arithmetic the low-order fields should be treated as positive numbers. Also, when negative numbers are shifted to the right, the resulting rounding, if any, is toward minus infinity and not toward zero.

Condition Code

The results of fixed-point sign-control, add, subtract, compare, and shift operations are used to set the condition code in the program status word (psw). All other fixed-point operations leave this code undisturbed. The condition code can be used for decision-making by subsequent branch-on-condition instructions.

The condition code can be set to reflect three types of results for fixed-point arithmetic. For most operations, the states 0, 1, or 2 indicate a zero, less than zero, or greater than zero content of the result register, while the state 3 is used when the result overflows.

For a comparison, the states 0, 1, or 2 indicate that the first operand is equal, low, or high.

For ADD LOGICAL and SUBTRACT LOGICAL, the codes 0 and 1 indicate a zero or nonzero result register content in the absence of a logical carry out of the sign position; the codes 2 and 3 indicate a zero or nonzero result register content with a logical carry out of the sign position.

CONDITION CODE SETTINGS FOR FIXED-POINT ARITHMETIC

	0	1	2	3
Add H/F	zero	< zero	> zero	overflow
Add Logical	zero	not zero	zero, carry	carry
Compare H/F	equal	low	high	--
Load and Test	zero	< zero	> zero	--
Load Complement	zero	< zero	> zero	overflow
Load Negative	zero	< zero	--	--
Load Positive	zero	--	> zero	overflow
Shift Left Double	zero	< zero	> zero	overflow
Shift Left Single	zero	< zero	> zero	overflow
Shift Right Double	zero	< zero	> zero	--
Shift Right Single	zero	< zero	> zero	--
Subtract H/F	zero	< zero	> zero	overflow
Subtract Logical	--	not zero	zero, carry	carry

Instruction Format

Fixed-point instructions use the following three formats:

RR Format

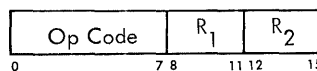

RX Format

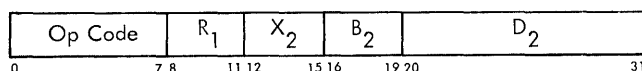

RS Format

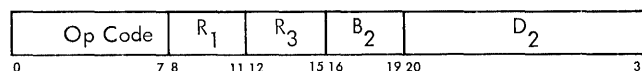

In these formats, R₁ specifies the address of the general register containing the first operand. The second operand location, if any, is defined differently for each format.

In the RR format, the R₂ field specifies the address of the general register containing the second operand. The same register may be specified for the first and second operand.

In the RX format, the contents of the general registers specified by the X₂ and B₂ fields are added to the content of the D₂ field to form an address designating the storage location of the second operand.

In the RS format, the content of the general register specified by the B₂ field is added to the content of the D₂ field to form an address. This address designates the storage location of the second operand in LOAD MULTIPLE and STORE MULTIPLE. In the shift operations, the address specifies the amount of shift. The R₃ field specifies the address of a general register in LOAD MULTIPLE and STORE MULTIPLE and is ignored in the shift operations.

A zero in an X₂ or B₂ field indicates the absence of the corresponding address component.

An instruction can specify the same general register both for address modification and for operand location. Address modification is always completed before operation execution.

Results replace the first operand, except for STORE and CONVERT TO DECIMAL, where the result replaces the second operand.

The contents of all general registers and storage locations participating in the addressing or execution part of an operation remain unchanged, except for the storing of the final result.

Instructions

The fixed-point arithmetic instructions and their mnemonics, formats, and operation codes are listed in the following table. The table also indicates which instructions are not included in the small binary instruction set, when the condition code is set, and the exceptional conditions that cause a program interruption.

NAME	MNEMONIC	TYPE	EXCEPTIONS	CODE		
Load	LR	RR		18		
Load	L	RX	A,S	58		
Load Halfword	LH	RX	A,S	48		
Load and Test	LTR	RR	C	12		
Load Complement	LCR	RR	C	IF	13	
Load Positive	LPR	RR	C	IF	10	
Load Negative	LNR	RR	C		11	
Load Multiple	LM	RS	A,S		98	
Add	AR	RR	C	IF	1A	
Add	A	RX	C	A,S, IF	5A	
Add Halfword	AH	RX	C	A,S, IF	4A	
Add Logical	ALR	RR	C		1E	
Add Logical	AL	RX	C	A,S	5E	
Subtract	SR	RR	C	IF	1B	
Subtract	S	RX	C	A,S, IF	5B	
Subtract Halfword	SH	RX	C	A,S, IF	4B	
Subtract Logical	SLR	RR	C		1F	
Subtract Logical	SL	RX	C	A,S	5F	
Compare	CR	RR	C		19	
Compare	C	RX	C	A,S	59	
Compare Halfword	CH	RX	C	A,S	49	
Multiply	MR	RR		S	1C	
Multiply	M	RX		A,S	5C	
Multiply Halfword	MH	RX		A,S	4C	
Divide	DR	RR		S, IK	1D	
Divide	D	RX		A,S, IK	5D	
Convert to Binary	CVB	RX		A,S,D,IK	4F	
Convert to Decimal	CVD	RX		P,A,S	4E	
Store	ST	RX		P,A,S	50	
Store Halfword	STH	RX		P,A,S	40	
Store Multiple	STM	RS		P,A,S	90	
Shift Left Single	SLA	RS	C		IF	8B
Shift Right Single	SRA	RS	C			8A
Shift Left Double	SLDA	RS	C	S, IF		8F
Shift Right Double	SRDA	RS	C	S		8E

NOTES

A	Addressing exception
C	Condition code is set
D	Data exception
IF	Fixed-Point overflow exception
IK	Fixed-point divide exception
P	Protection exception
S	Specification exception

Programming Note

The logical comparisons, shifts, and connectives, as well as LOAD ADDRESS, BRANCH ON COUNT, BRANCH ON INDEX HIGH, and BRANCH ON INDEX LOW OR EQUAL, also may be used in fixed-point calculations.

Load

LR RR

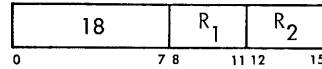

L RX

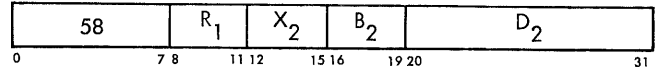

The second operand is placed in the first operand location. The second operand is not changed.

Condition Code: The code remains unchanged.

Program Interruptions:

Addressing (L only)
Specification (L only)

Load Halfword

LH RX

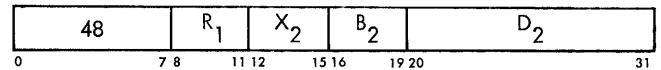

The halfword second operand is placed in the first operand location.

The halfword second operand is expanded to a fullword by propagating the sign-bit value through the 16 high-order bit positions. Expansion occurs after the operand is obtained from storage and before insertion in the register.

Program Interruptions:

Addressing
Specification

Load and Test

LTR RR

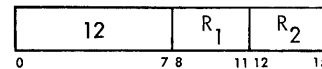

The second operand is placed in the first operand location, and the sign and magnitude of the second operand determine the condition code. The second operand is not changed.

Resulting Condition Code:

- 0 Result is zero
- 1 Result is less than zero
- 2 Result is greater than zero
- 3 --

Program Interruptions: None.

Programming Note

When the same register is specified as first and second operand location, the operation is equivalent to a test without data movement.

Load Complement

LCR RR

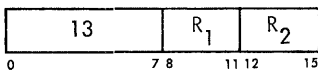

The two's complement of the second operand is placed in the first operand location.

An overflow condition occurs when the maximum negative number is complemented; the number remains unchanged. The overflow causes a program interruption when the fixed-point overflow mask bit is one.

Resulting Condition Code:

- 0 Result is zero
- 1 Result is less than zero
- 2 Result is greater than zero
- 3 Overflow

Program Interruptions:

Fixed-point overflow

Programming Note

Zero remains invariant under complementation.

Load Positive

LPR RR

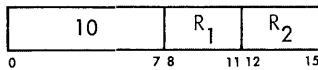

The absolute value of the second operand is placed in the first operand location.

The operation includes complementation of negative numbers; positive numbers remain unchanged.

An overflow condition occurs when the maximum negative number is complemented; the number remains unchanged. The overflow causes a program interruption when the fixed-point overflow mask bit is one.

Resulting Condition Code:

- 0 Result is zero
- 1 --
- 2 Result is greater than zero
- 3 Overflow

Program Interruptions:

Fixed-point overflow

Load Negative

LNR RR

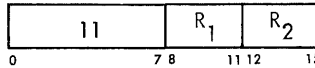

The two's complement of the absolute value of the second operand is placed in the first operand location. The operation complements positive numbers; negative numbers remain unchanged. The number zero remains unchanged with positive sign.

Resulting Condition Code:

- 0 Result is zero
- 1 Result is less than zero
- 2 --
- 3 --

Program Interruptions: None.

Load Multiple

LM RS

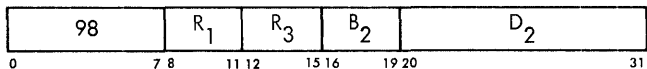

The set of general registers starting with the register specified by R₁ and ending with the register specified by R₃ is loaded from the locations designated by the second operand address.

The storage area from which the contents of the general registers are obtained starts at the location designated by the second operand address and continues through as many words as needed. The general registers are loaded in the ascending order of their addresses, starting with the register specified by R₁ and continuing up to and including the register specified by R₃, with register 0 following register 15.

The second operand remains unchanged.

Condition Code: The code remains unchanged.

Program Interruptions:

Addressing
Specification

Programming Note

All combinations of register addresses specified by R₁ and R₃ are valid. When the register addresses are equal, only one word is transmitted. When the address specified by R₃ is less than the address specified by R₁, the register addresses wrap around from 15 to 0.

Add

AR RR

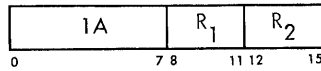

A RX

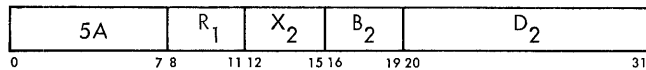

The second operand is added to the first operand, and the sum is placed in the first operand location.

Addition is performed by adding all 32 bits of both operands. If the carries out of the sign-bit position and the high-order numeric bit position agree, the sum is satisfactory; if they disagree, an overflow occurs. The sign bit is not changed after the overflow. A positive overflow yields a negative final sum, and a negative overflow results in a positive sum. The overflow causes a program interruption when the fixed-point overflow mask bit is one.

Resulting Condition Code:

- 0 Sum is zero
- 1 Sum is less than zero
- 2 Sum is greater than zero
- 3 Overflow

Program Interruptions:

- Addressing (A only)
- Specification (A only)
- Fixed-point overflow

Programming Note

In two's-complement notation, a zero result is always positive.

Add Halfword

AH RX

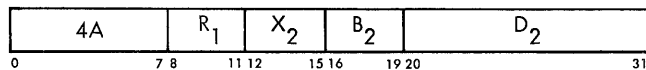

The halfword second operand is added to the first operand and the sum is placed in the first operand location.

The halfword second operand is expanded to a full-

word before the addition by propagating the sign-bit value through the 16 high-order bit positions.

Addition is performed by adding all 32 bits of both operands. If the carries out of the sign-bit position and the high-order numeric bit position agree, the sum is satisfactory; if they disagree, an overflow occurs. The sign bit is not changed after the overflow. A positive overflow yields a negative final sum, and a negative overflow results in a positive sum. The overflow causes a program interruption when the fixed-point overflow mask bit is one.

Resulting Condition Code:

- 0 Sum is zero
- 1 Sum is less than zero
- 2 Sum is greater than zero
- 3 Overflow

Program Interruptions:

- Addressing
- Specification
- Fixed-point overflow

Add Logical

ALR RR

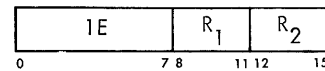

AL RX

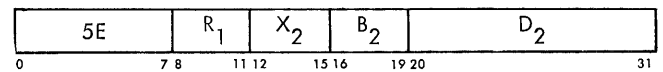

The second operand is added to the first operand, and the sum is placed in the first operand location. The occurrence of a carry out of the sign position is recorded in the condition code.

Logical addition is performed by adding all 32 bits of both operands without further change to the resulting sign bit. The instruction differs from ADD in the meaning of the condition code and in the absence of the interruption for overflow.

If a carry out of the sign position occurs, the leftmost bit of the condition code (psw bit 34) is made one. In the absence of a carry, bit 34 is made zero. When the sum is zero, the rightmost bit of the condition code (psw bit 35) is made zero. A nonzero sum is indicated by a one in bit 35.

Resulting Condition Code:

- 0 Sum is zero (no carry)
- 1 Sum is not zero (no carry)
- 2 Sum is zero (carry)
- 3 Sum is not zero (carry)

Program Interruptions:
 Addressing (AL only)
 Specification (AL only)

Subtract

SR RR

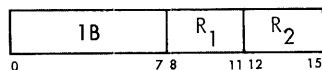

S RX

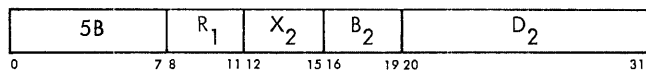

The second operand is subtracted from the first operand, and the difference is placed in the first operand location.

Subtraction is performed by adding the one's complement of the second operand and a low-order one to the first operand. All 32 bits of both operands participate, as in ADD. If the carries out of the sign-bit position and the high-order numeric bit position agree, the difference is satisfactory; if they disagree, an overflow occurs. The overflow causes a program interruption when the fixed-point overflow mask bit is one.

Resulting Condition Code:

- 0 Difference is zero
- 1 Difference is less than zero
- 2 Difference is greater than zero
- 3 Overflow

Program Interruptions:

Addressing (S only)
 Specifications (S only)
 Fixed-point overflow

Programming Note

When the same register is specified as first and second operand location, subtracting is equivalent to clearing the register.

Subtracting a maximum negative number from another maximum negative number gives a zero result and no overflow.

Subtract Halfword

SH RX

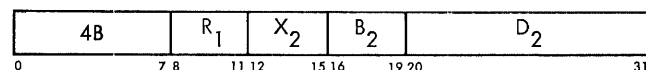

The halfword second operand is subtracted from the first operand, and the difference is placed in the first operand location.

The halfword second operand is expanded to a fullword before the subtraction by propagating the sign-bit value through 16 high-order bit positions.

Subtraction is performed by adding the one's complement of the expanded second operand and a low-order one to the first operand. All 32 bits of both operands participate, as in ADD. If the carries out of the sign-bit position and the high-order numeric bit position agree, the difference is satisfactory; if they disagree, an overflow occurs. The overflow causes a program interruption when the fixed-point overflow mask bit is one.

Resulting Condition Code:

- 0 Difference is zero
- 1 Difference is less than zero
- 2 Difference is greater than zero
- 3 Overflow

Program Interruptions:

Addressing
 Specification
 Fixed-point overflow

Subtract Logical

SLR RR

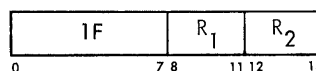

SL RX

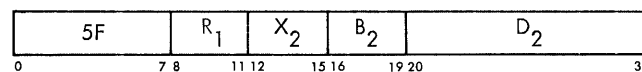

The second operand is subtracted from the first operand, and the difference is placed in the first operand location. The occurrence of a carry out of the sign position is recorded in the condition code.

Logical subtraction is performed by adding the one's complement of the second operand and a low-order one to the first operand. All 32 bits of both operands participate, without further change to the resulting sign bit. The instruction differs from SUBTRACT in the meaning of the condition code and in the absence of the interruption for overflow.

If a carry out of the sign position occurs, the leftmost bit of the condition code (psw bit 34) is made one. In the absence of a carry, bit 34 is made zero. When the sum is zero, the rightmost bit of the condition code (psw bit 35) is made zero. A nonzero sum is indicated by a one in bit 35.

Resulting Condition Code:

- 0 --
- 1 Difference is not zero (no carry)
- 2 Difference is zero (carry)
- 3 Difference is not zero (carry)

Program Interruptions:

- Addressing (SL only)
- Specification (SL only)

Programming Note

A zero difference cannot be obtained without a carry out of the sign position.

Compare

CR RR

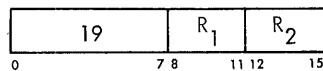

C RX

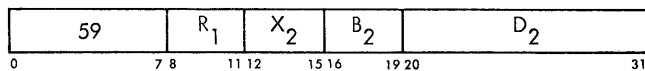

The first operand is compared with the second operand, and the result determines the setting of the condition code.

Comparison is algebraic, treating both comparands as 32-bit signed integers. Operands in registers or storage are not changed.

Resulting Condition Code:

- 0 Operands are equal
- 1 First operand is low
- 2 First operand is high
- 3 --

Program Interruptions:

- Addressing (C only)
- Specification (C only)

Compare Halfword

CH RX

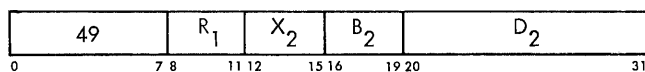

The first operand is compared with the halfword second operand, and the result determines the setting of the condition code.

The halfword second operand is expanded to a fullword before the comparison by propagating the sign-bit value through the 16 high-order bit positions.

Comparison is algebraic, treating both comparands as 32-bit signed integers. Operands in registers or storage are not changed.

Resulting Condition Code:

- 0 Operands are equal
- 1 First operand is low
- 2 First operand is high
- 3 --

Program Interruptions:

- Addressing
- Specification

Multiply

MR RR

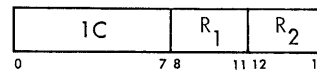

M RX

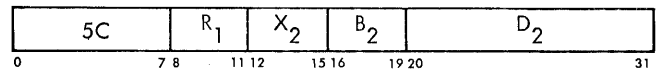

The product of the multiplier (the second operand) and the multiplicand (the first operand) replaces the multiplicand.

Both multiplier and multiplicand are 32-bit signed integers. The product is always a 64-bit signed integer and occupies an even/odd register pair. Because the multiplicand is replaced by the product, the R₁ field of the instruction must refer to an even-numbered register. A specification exception occurs when R₁ is odd. The multiplicand is taken from the odd register of the pair. The content of the even-numbered register replaced by the product is ignored, unless the register contains the multiplier. An overflow cannot occur.

The sign of the product is determined by the rules of algebra from the multiplier and multiplicand sign, except that a zero result is always positive.

Condition Code: The code remains unchanged.

Program Interruptions:

- Addressing (M only)
- Specification

Programming Note

The significant part of the product usually occupies 62 bits or fewer. Only when two maximum negative numbers are multiplied are 63 significant product bits formed. Since two's-complement notation is used, the sign bit is extended right until the first significant product digit is encountered.

Multiply Halfword

MH RX

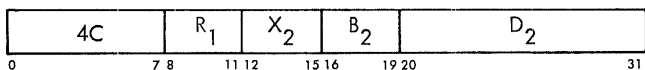

The product of the halfword multiplier (second operand) and multiplicand (first operand) replaces the multiplicand.

Both multiplicand and product are 32-bit signed integers and may be located in any general register. The halfword multiplier is expanded to a fullword before multiplication by propagating the sign-bit value through the 16 high-order bit positions. The multiplicand is replaced by the low-order part of the product. The bits to the left of the 32 low-order bits are not tested for significance; no overflow indication is given.

The sign of the product is determined by the rules of algebra from the multiplier and multiplicand sign, except that a zero result is always positive.

Condition Code: The code remains unchanged.

Program Interruptions:

Addressing
Specification

Programming Note

The significant part of the product usually occupies 46 bits or fewer, the exception being 47 bits when both operands are maximum negative. Since the low-order 32 bits of the product are stored unchanged, ignoring all bits to the left, the sign bit of the result may differ from the true sign of the product in the case of overflow.

Divide

DR RR

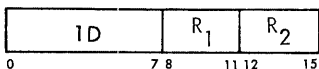

D RX

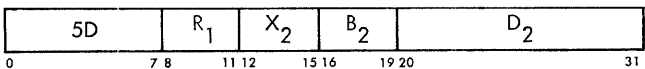

The dividend (first operand) is divided by the divisor (second operand) and replaced by the quotient and remainder.

The dividend is a 64-bit signed integer and occupies the even/odd pair of registers specified by the R₁ field of the instruction. A specification exception occurs

when R₁ is odd. A 32-bit signed remainder and a 32-bit signed quotient replace the dividend in the even-numbered and odd-numbered registers, respectively. The divisor is a 32-bit signed integer.

The sign of the quotient is determined by the rules of algebra. The remainder has the same sign as the dividend, except that a zero quotient or a zero remainder is always positive. All operands and results are treated as signed integers. When the relative magnitude of dividend and divisor is such that the quotient cannot be expressed by a 32-bit signed integer, a fixed-point divide exception is recognized (a program interruption occurs, no division takes place, and the dividend remains unchanged in the general registers).

Condition Code: The code remains unchanged.

Program Interruptions:

Addressing (D only)
Specification
Fixed-point divide

Programming Note

Division applies to fullword operands in storage only.

Convert to Binary

CVB RX

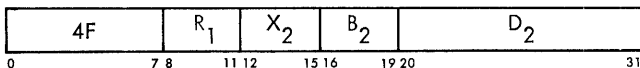

The radix of the second operand is changed from decimal to binary, and the result is placed in the first operand location. The number is treated as a right-aligned signed integer both before and after conversion.

The second operand has the packed decimal data format and is checked for valid sign and digit codes. Improper codes are a data exception and cause a program interruption. The decimal operand occupies a double-word storage field, which must be located on an integral boundary. The low-order four bits of the field represent the sign. The remaining 60 bits contain 15 binary-coded-decimal digits in true notation. The packed decimal data format is described under "Decimal Arithmetic."

The result of the conversion is placed in the general register specified by R₁. The maximum number that can be converted and still be contained in a 32-bit register is 2,147,483,647; the minimum number is -2,147,483,648. For any decimal number outside this range, the operation is completed by placing the 32 low-order binary bits in the register; a fixed-point

divide exception exists, and a program interruption follows. In the case of a negative second operand, the low-order part is in two's-complement notation.

Condition Code: The code remains unchanged.

Program Interruptions:

- Addressing
- Specification
- Data
- Fixed-point divide

Convert to Decimal

CVD RX

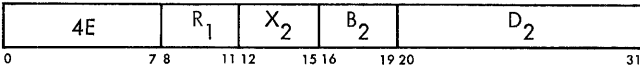

The radix of the first operand is changed from binary to decimal, and the result is stored in the second operand location. The number is treated as a right-aligned signed integer both before and after conversion.

The result is placed in the storage location designated by the second operand and has the packed decimal format, as described in "Decimal Arithmetic." The result occupies a double-word in storage and must be located on an integral boundary. The low-order four bits of the field represent the sign. A positive sign is encoded as 1100 or 1010; a negative sign is encoded as 1101 or 1011. The choice between the two sign representations is determined by the state of rsw bit 12. The remaining 60 bits contain 15 binary-coded-decimal digits in true notation.

The number to be converted is obtained as a 32-bit signed integer from a general register. Since 15 decimal digits are available for the decimal equivalent of 31 bits, an overflow cannot occur.

Condition Code: The code remains unchanged.

Resulting Condition Code:

- Protection
- Addressing
- Specification

Store

ST RX

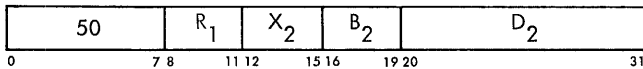

The first operand is stored at the second operand location.

The 32 bits in the general register are placed unchanged at the second operand location.

Condition Code: The code remains unchanged.

Program Interruptions:

- Protection
- Addressing
- Specification

Store Halfword

STH RX

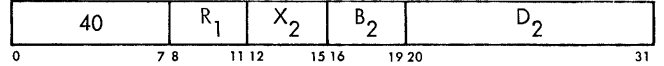

The first operand is stored at the halfword second operand location.

The 16 low-order bits in the general register are placed unchanged at the second operand location. The 16 high-order bits of the first operand do not participate and are not tested.

Condition Code: The code remains unchanged.

Program Interruptions:

- Protection
- Addressing
- Specification

Store Multiple

STM RS

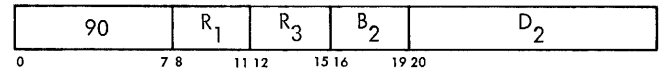

The set of general registers starting with the register specified by R₁ and ending with the register specified by R₃ is stored at the locations designated by the second operand address.

The storage area where the contents of the general registers are placed starts at the location designated by the second operand address and continues through as many words as needed. The general registers are stored in the ascending order of their addresses, starting with the register specified by R₁ and continuing up to and including the register specified by R₃, with register 0 following register 15. The first operands remain unchanged.

Condition Code: The code remains unchanged.

Program Interruptions:

- Protection
- Addressing
- Specification

Shift Left Single

SLA RS

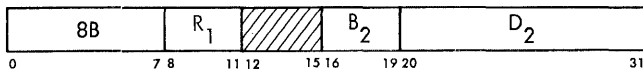

The integer part of the first operand is shifted left the number of bits specified by the second operand address.

The second operand address is not used to address data; its low-order six bits indicate the number of bit positions to be shifted. The remainder of the address is ignored.

The sign of the first operand remains unchanged. All 31 integer bits of the operand participate in the left shift. Zeros are supplied to the vacated low-order register positions.

If a bit unlike the sign bit is shifted out of position 1, an overflow occurs. The overflow causes a program interruption when the fixed-point overflow mask bit is one.

Resulting Condition Code:

- 0 Result is zero
- 1 Result is less than zero
- 2 Result is greater than zero
- 3 Overflow

Program Interruptions: Fixed-point overflow.

Programming Note

The base register participating in the generation of the second operand address permits indirect specification of the shift amount. A zero in the B₂ field indicates the absence of indirect shift specification.

Shift Right Single

SRA RS

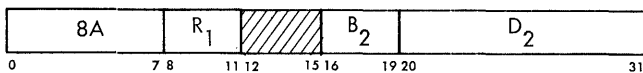

The integer part of the first operand is shifted right the number of bits specified by the second operand address.

The second operand address is not used to address data; its low-order six bits indicate the number of bit positions to be shifted. The remainder of the address is ignored.

The sign of the first operand remains unchanged. All 31 integer bits of the operand participate in the right shift. Bits equal to the sign are supplied to the vacated high-order bit positions. Low-order bits are shifted out without inspection and are lost.

Resulting Condition Code:

- 0 Result is zero
- 1 Result is less than zero
- 2 Result is greater than zero
- 3 --

Program Interruptions: None.

Programming Note

Right-shifting is similar to division by powers of two and to low-order truncation. Since negative numbers are kept in two's-complement notation, truncation is in the negative direction for both positive and negative numbers, rather than toward zero as in decimal arithmetic.

Shift amounts from 32 through 63 cause all significant digits to be shifted out of the register. They give a zero result for positive numbers and a minus one result for negative numbers.

Shift Left Double

SLDA RS

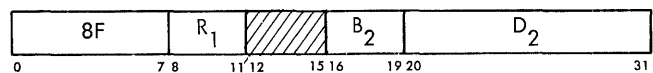

The double-length integer part of the first operand is shifted left the number of bits specified by the second operand address.

The R₁ field of the instruction specifies an even/odd pair of registers and must contain an even register address. A specification exception occurs when R₁ is odd.

The second operand address is not used to address data; its low-order 6-bits indicate the number of bit positions to be shifted. The remainder of the address is ignored.

The operand is treated as a number with 63 integer bits and a sign in the sign position of the even register. The sign remains unchanged. The high-order position of the odd register contains an integer bit, and the content of the odd register participates in the shift in the same manner as the other integer bits. Zeros are supplied to the vacated low-order positions of the registers.

If a bit unlike the sign bit is shifted out of bit position 1 of the even register, an overflow occurs. The overflow causes a program interruption when the fixed-point overflow mask bit is one.

Resulting Condition Code:

- 0 Result is zero
- 1 Result is less than zero
- 2 Result is greater than zero
- 3 Overflow

Program Interruptions:
 Specification
 Fixed-point overflow

Shift Right Double

SRDA RS

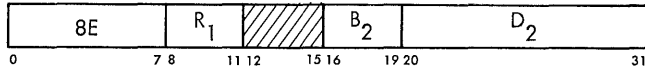

The double-length integer part of the first operand is shifted right the number of places specified by the second operand address.

The R_1 field of the instruction specifies an even/odd pair of registers and must contain an even register address. A specification exception occurs when R_1 is odd.

The second operand address is not used to address data; its low-order six bits indicate the number of bit positions to be shifted. The remainder of the address is ignored.

The sign of the first operand, which is leftmost in the even register, remains unchanged. Bits equal to the sign are supplied to the vacated high-order positions of both registers. Low-order bits are shifted out without inspection and are lost.

Resulting Condition Code:

- 0 Result is zero
- 1 Result is less than zero
- 2 Result is greater than zero
- 3 --

Program Interruptions:
 Specification

Programming Note

A zero shift amount in the double-shift operations provides a double-length sign and magnitude test.

Fixed-Point Arithmetic Exceptions

Exceptional instructions, data, or results cause a program interruption. When a program interruption occurs, the current psw is stored as an old psw, and a new psw is obtained. The interruption code in the old psw identifies the cause of the interruption. The

following exceptions cause a program interruption in fixed-point arithmetic.

Protection: The storage key of a result location does not match the protection key in the psw. The operation is suppressed. Therefore, the condition code and data in registers and storage remain unchanged. The only exception is STORE MULTIPLE, which is terminated; the amount of data stored is unpredictable and should not be used for further computation.

Addressing: An address designates a location outside the available storage for a particular installation. The operation is terminated. Therefore, the result data are unpredictable and should not be used for further computation. Operand addresses are tested only when used to address storage. Addresses used as a shift amount are not tested. The address restrictions do not apply to the components from which an address is generated — the content of the D_2 field and the contents of the registers specified by X_2 and B_2 .

Specification: A double-word operand is not located on a 64-bit boundary, a fullword operand is not located on a 32-bit boundary, a halfword operand is not located on a 16-bit boundary, or an instruction specifies an odd register address for a pair of general registers containing a 64-bit operand. The operation is suppressed. Therefore, the condition code and data in registers and storage remain unchanged.

Data: A sign or a digit code of the decimal operand in CONVERT TO BINARY is incorrect. The operation is suppressed. Therefore, the condition code and data in register and storage remain unchanged.

Fixed-Point Overflow: The result of a sign-control, add, subtract, or shift operation overflows. The interruption occurs only when the fixed-point overflow mask bit is one. The operation is completed by placing the truncated low-order result in the register and setting the condition code to 3. The overflow bits are lost. In add-type operations the sign stored in the register is the opposite of the sign of the sum or difference. In shift operations the sign of the shifted number remains unchanged. The state of the mask bit does not affect the result.

Fixed-Point Divide: The quotient of a division exceeds the register size, including division by zero, or the result in CONVERT TO BINARY exceeds 31 bits. Division is suppressed. Therefore, data in the registers remain unchanged. The conversion is completed by recording the truncated low-order result in the register.

Decimal Arithmetic

Decimal arithmetic operates on data in the packed format. In this format, two decimal digits are placed in one eight-bit byte. Since data are often communicated to or from external devices in the zoned format (which has one digit in an eight-bit byte), the necessary format-conversion operations are also provided in this instruction group.

Data are interpreted as integers, right-aligned in their fields. They are kept in true notation with a sign in the low-order eight-bit byte.

Processing takes place right to left between main-storage locations. All decimal arithmetic instructions use a two-address format. Each address specifies the leftmost byte of an operand. Associated with this address is a length field, indicating the number of additional bytes that the operand extends beyond the first byte.

The decimal arithmetic instruction set provides for adding, subtracting, comparing, multiplying, and dividing, as well as the format conversion of variable-length operands. Most decimal instructions are part of the decimal feature.

The condition code is set as a result of all add-type and comparison operations.

Data Format

Decimal operands reside in main storage only. They occupy fields that may start at any byte address and are composed of one to 16 eight-bit bytes.

Lengths of the two operands specified in an instruction need not be the same. If necessary they are considered to be extended with zeros to the left of the high-order digits. Results never exceed the limits set by address and length specification. Lost carries or lost digits from arithmetic operations are signaled as a decimal overflow exception. Operands are either in the packed or zoned format.

Packed Decimal Number

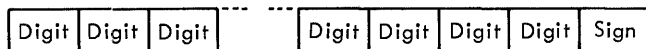

In the packed format, two decimal digits normally are placed adjacent in a byte, except for the rightmost byte of the field. In the rightmost byte a sign is placed

to the right of decimal digit. Both digits and a sign are encoded and occupy four bits each.

Zoned Decimal Number



In the zoned format the low-order four bits of a byte, the *numeric*, are normally occupied by a decimal digit. The four high-order bits of a byte are called the *zone*, except for the rightmost byte of the field, where normally the sign occupies the zone position.

Arithmetic is performed with operands and results in the packed format. In the zoned format, the digits are represented as part of an alphanumeric character set. A `PACK` instruction is provided to transform zoned data into packed data, an `UNPACK` instruction performs the reverse transformation. Moreover, the editing instructions may be used to change data from packed to zoned.

The fields specified in decimal arithmetic other than in `PACK`, `UNPACK`, and `MOVE WITH OFFSET` either should not overlap at all or should have coincident rightmost bytes. In `ZERO AND ADD`, the destination field may also overlap to the right of the source field. Because the code configurations for digits and sign are verified during arithmetic, improper overlapping fields are recognized as data exceptions. In move-type operations, the operand digits and signs are not checked, and the operand fields may overlap without any restrictions.

The rules for overlapped fields are established for the case where operands are fetched right to left from storage, eight bits at a time, just before they are processed. Similarly, the results are placed in storage, eight bits at a time, as soon as they are generated. Actual processing procedure may be considerably different because of the use of preferred storage for intermediate results. Nevertheless, the same rules are observed.

Number Representation

Numbers are represented as right-aligned true integers with a plus or minus sign.

The digits 0-9 have the binary encoding 0000-1001. The codes 1010-1111 are invalid as digits. This set of

codes is interpreted as sign codes, with 1010, 1100, 1110, and 1111 recognized as plus and with 1011 and 1101 recognized as minus. The codes 0000-1001 are invalid as sign codes. The zones are not tested for valid codes as they are eliminated in changing data from the zoned to the packed format.

The sign and zone codes generated for all decimal arithmetic results differ for the extended binary-coded-decimal interchange code (EBCDIC) and the American Standard code for information interchange (ASCII). The choice between the two codes is determined by bit 12 of the PSW. When bit 12 is zero, the preferred EBCDIC codes are generated; these are plus, 1100; minus, 1101; and zone, 1111. When bit 12 is one, the preferred ASCII codes are generated; these are plus, 1010; minus, 1011; and zone, 0101.

Condition Code

The results of all add-type and comparison operations are used to set the condition code. All other decimal arithmetic operations leave the code unchanged. The condition code can be used for decision-making by subsequent branch-on-condition instructions.

The condition code can be set to reflect two types of results for decimal arithmetic. For most operations the states 0, 1, and 2 indicate a zero, less than zero, and greater than zero content of the result field; the state 3 is used when the result of the operations overflows.

For the comparison operation, the states 0, 1, and 2 indicate that the first operand compared equal, low, or high.

CONDITION CODE SETTING FOR DECIMAL ARITHMETIC

	0	1	2	3
Add Decimal	zero	< zero	> zero	overflow
Compare Decimal	equal	low	high	--
Subtract Decimal	zero	< zero	> zero	overflow
Zero and Add	zero	< zero	> zero	overflow

Instruction Format

Decimal instructions use the following format:

SS Format

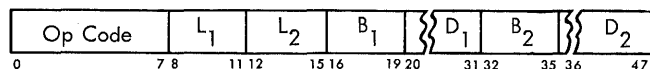

For this format, the contents of the general register specified by B₁ is added to the content of the D₁ field to form an address. This address specifies the leftmost byte of the first operand field. The number of operand bytes to the right of this byte is specified by the L₁ field of the instruction. Therefore, the length in bytes of the first operand field is 1-16, corresponding to a

length code in L₁ of 0000-1111. The second operand field is specified similarly by the L₂, B₂, and D₂ instruction fields.

A zero in the B₁ or B₂ field indicates the absence of the corresponding address component.

Results of operations are always placed in the first operand field. The result is never stored outside the field specified by the address and length. In the event the first operand is longer than the second, the second operand is extended with high-order zeros up to the length of the first operand. Such extension never modifies storage. The second operand field and the contents of all general registers remain unchanged.

Instructions

The decimal arithmetic instructions and their mnemonics and operation codes follow. All instructions use the SS format and assume packed operands and results. The only exceptions are PACK, which has a zoned operand, and UNPACK, which has a zoned result. The table indicates the feature to which each instruction belongs, when the condition code is set, and the exception that causes a program interruption.

NAME	MNEMONIC	TYPE	EXCEPTIONS	CODE
Add Decimal	AP	SS T,C	P,A, D,DF	FA
Subtract Decimal	SP	SS T,C	P,A, D,DF	FB
Zero and Add	ZAP	SS T,C	P,A, D,DF	F8
Compare Decimal	CP	SS T,C	A, D	F9
Multiply Decimal	MP	SS T	P,A,S,D	FC
Divide Decimal	DP	SS T	P,A,S,D,DK	FD
Pack	PACK	SS	P,A	F2
Unpack	UNPK	SS	P,A	F3
Move with Offset	MVO	SS	P,A	F1

NOTES

- A Addressing exception
- C Condition code is set
- D Data exception
- DF Decimal-overflow exception
- DK Decimal-divide exception
- P Protection exception
- S Specification exception
- T Decimal feature

Programming Note

The moving, editing, and logical comparing instructions may also be used in decimal calculations.

Add Decimal

AP SS

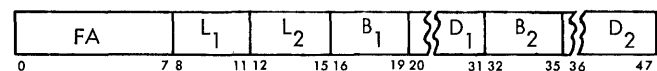

The second operand is added to the first operand, and the sum is placed in the first operand location.

Addition is algebraic, taking into account sign and all digits of both operands. All signs and digits are checked for validity. If necessary, high-order zeros are supplied for either operand. When the first operand field is too short to contain all significant digits of the sum, a decimal overflow occurs, and a program interruption is taken provided that the corresponding mask bit is one.

Overflow has two possible causes. The first is the loss of a carry out of the high-order digit position of the result field. The second cause is an oversized result, which occurs when the second operand field is larger than the first operand field and significant result digits are lost. The field sizes alone are not an indication of overflow.

The first and second operand fields may overlap when their low-order bytes coincide; therefore, it is possible to add a number to itself.

The sign of the result is determined by the rules of algebra. A zero sum is always positive. When high-order digits are lost because of overflow, a zero result has the sign of the correct sum.

Resulting Condition Code:

- 0 Sum is zero
- 1 Sum is less than zero
- 2 Sum is greater than zero
- 3 Overflow

Program Interruptions:

- Operation (if decimal feature is not installed)
- Protection
- Addressing
- Data
- Overflow

Subtract Decimal

SP SS

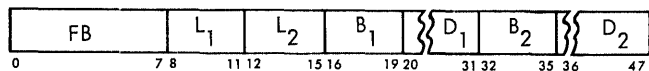

The second operand is subtracted from the first operand, and the difference is placed in the first operand location.

Subtraction is algebraic, taking into account sign and all digits of both operands. The SUBTRACT DECIMAL is similar to ADD DECIMAL, except that the sign of the second operand is changed from positive to negative or from negative to positive after the operand is obtained from storage and before the arithmetic.

The sign of the result is determined by the rules of algebra. A zero difference is always positive. When

high-order digits are lost because of overflow, a zero result has the sign of the correct difference.

Resulting Condition Code:

- 0 Difference is zero
- 1 Difference is less than zero
- 2 Difference is greater than zero
- 3 Overflow

Program Interruptions:

- Operation (if decimal feature is not installed)
- Protection
- Addressing
- Data
- Decimal overflow

Programming Note

The operands of SUBTRACT DECIMAL may overlap when their low-order bytes coincide, even when their lengths are unequal. This property may be used to set to zero an entire field or the low-order part of a field.

Zero and Add

ZAP SS

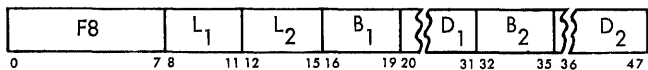

The second operand is placed in the first operand location.

The operation is equivalent to an addition to zero. A zero result is positive. When high-order digits are lost because of overflow, a zero result has the sign of the second operand.

Only the second operand is checked for valid sign and digit codes. Extra high-order zeros are supplied if needed. When the first operand field is too short to contain all significant digits of the second operand, a decimal overflow occurs and results in a program interruption, provided that the decimal overflow mask bit is one. The first and second operand fields may overlap when the rightmost byte of the first operand field is coincident with or to the right of the rightmost byte of the second operand.

Resulting Condition Code:

- 0 Result is zero
- 1 Result is less than zero
- 2 Result is greater than zero
- 3 Overflow

Program Interruptions:

- Operation (if decimal feature is not installed)
- Addressing
- Data
- Decimal overflow
- Protection

Compare Decimal

CP SS

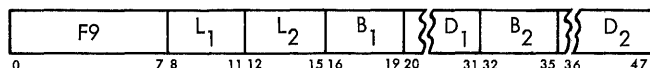

The first operand is compared with the second, and the condition code indicates the comparison result.

Comparison is right to left, taking into account the sign and all digits of both operands. All signs and digits are checked for validity. If the fields are unequal in length, the shorter is extended with high-order zeros. A positive zero compares equal to a negative zero. Neither operand is changed as a result of the operation. Overflow cannot occur in this operation.

The first and second fields may overlap when their low-order bytes coincide. It is possible, therefore, to compare a number to itself.

Resulting Condition Code:

- 0 Operands equal
- 1 First operand is low
- 2 First operand is high
- 3 --

Program Interruptions:

- Operation (if decimal feature is not installed)
- Addressing
- Data

Programming Note

The COMPARE DECIMAL is unique in processing from right to left; taking signs, zeros, and invalid characters into account; and extending variable-length fields when they are unequal in length.

Multiply Decimal

MP SS

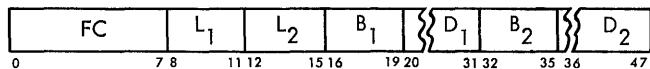

The product of the multiplier (the second operand) and the multiplicand (the first operand) replaces the multiplicand.

The multiplier size is limited to 15 digits and sign and must be less than the multiplicand size. Length code L₂, larger than seven, or larger than or equal to the length code L₁, is recognized as a specification exception. The operation is suppressed and a program interruption occurs.

Since the number of digits in the product is the sum of the number of digits in the operands, the multiplicand must have high-order zero digits for at least a field size that equals the multiplier field size; other-

wise, a data exception is recognized, and a program interruption occurs. This definition of the multiplicand field ensures that no product overflow can occur. The maximum product size is 31 digits. At least one high-order digit of the product field is zero.

All operands and results are treated as signed integers, right-aligned in their field. The sign of the product is determined by the rules of algebra from the multiplier and multiplicand signs, even if one or both operands are zero.

The multiplier and product fields may overlap when their low-order bytes coincide.

Condition Code: The code remains unchanged.

Program Interruptions:

- Operation (if decimal feature is not installed)
- Addressing
- Protection
- Specification
- Data

Programming Note

When the multiplicand does not have the desired number of leading zeros, multiplication may be preceded by a ZERO AND ADD into a larger field.

Divide Decimal

DP SS

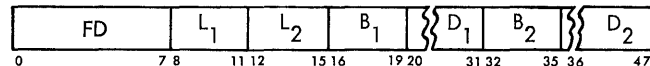

The dividend (the first operand) is divided by the divisor (the second operand) and replaced by the quotient and remainder.

The quotient field is placed leftmost in the first operand field. The remainder field is placed rightmost in the first operand field and has a size equal to the divisor size. Together, the quotient and remainder occupy the entire dividend field; therefore, the address of the quotient field is the address of the first operand. The size of the quotient field in eight-bit bytes is L₁ - L₂, and the length code for this field is one less (L₁ - L₂ - 1). When the divisor length code is larger than seven (15 digits and sign) or larger than or equal to the dividend length code, a specification exception is recognized. The operation is suppressed, and a program interruption occurs.

The dividend, divisor, quotient, and remainder are all signed integers, right-aligned in their fields. The sign of the quotient is determined by the rules of algebra from dividend and divisor signs. The sign of the remainder has the same value as the dividend sign. These rules are true even when quotient or remainder is zero.

Overflow cannot occur. A quotient larger than the number of digits allowed is recognized as a decimal-divide exception. The operation is suppressed, and a program interruption occurs. Divisor and dividend remain unchanged in their storage locations.

The divisor and dividend fields may overlap only if their low-order bytes coincide.

Condition Code: The code remains unchanged.

Program Interruptions:

- Operation (if decimal feature is not installed)
- Addressing
- Protection
- Specification
- Data
- Decimal divide

Programming Note

The maximum dividend size is 31 digits and sign. Since the smallest remainder size is one digit and sign, the maximum quotient size is 29 digits and sign.

The condition for a divide exception can be determined by a trial subtraction. The leftmost digit of the divisor field is aligned with the leftmost-less-one digit of the dividend field. When the divisor, so aligned, is less than or equal to the dividend, a divide exception is indicated.

A decimal-divide exception occurs if the dividend does not have at least one leading zero.

Pack

PACK SS

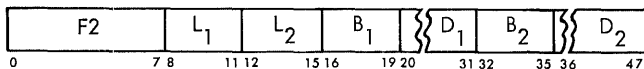

The format of the second operand is changed from zoned to packed, and the result is placed in the first operand location.

The second operand is assumed to have the zoned format. All zones are ignored, except the zone over the low-order digit, which is assumed to represent a sign. The sign is placed in the right four bits of the low-order byte, and the digits are placed adjacent to the sign and to each other in the remainder of the result field. The sign and digits are moved unchanged to the first operand field and are not checked for valid codes.

The fields are processed right to left. If necessary, the second operand is extended with high-order zeros. If the first operand field is too short to contain all significant digits of the second operand field, the remaining digits are ignored. Overlapping fields may occur and are processed by storing each result byte immediately after the necessary operand bytes are fetched.

Condition Code: The code remains unchanged.

Program Interruptions:

- Protection
- Addressing

Unpack

UNPK SS

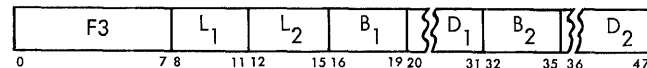

The format of the second operand is changed from packed to zoned, and the result is placed in the first operand location.

The digits and sign of the packed operand are placed unchanged in the first operand location, using the zoned format. Zones with coding 1111 in the binary-coded-decimal mode and coding 0101 in the ASCII mode are supplied for all bytes, except the low-order byte, which receives the sign of the packed operand. The operand sign and digits are not checked for valid codes.

The fields are processed right to left. The second operand is extended with zero digits before unpacking, if necessary. If the first operand field is too short to contain all significant digits of the second operand, the remaining digits are ignored. The first and second operand fields may overlap and are processed by storing a result byte immediately after the necessary operand bytes are fetched.

Condition Code: The code remains unchanged.

Program Interruptions:

- Addressing
- Protection

Move with Offset

MVO SS

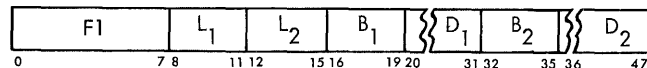

The second operand is placed to the left of and adjacent to the low-order four bits of the first operand.

The low-order four bits of the first operand are attached as low-order bits to the second operand, the second operand bits are offset by four bit positions, and the result is placed in the first operand location. The first and second operand bytes are not checked for valid codes.

The fields are processed right to left. If necessary, the second operand is extended with high-order zeros.

If the first operand field is too short to contain all bytes of the second operand, the remaining information is ignored. Overlapping fields may occur and are processed by storing a result byte as soon as the necessary operand bytes are fetched.

Condition Code: The code remains unchanged.

Program Interruptions:

Protection
Addressing

Programming Note

The instruction set for decimal arithmetic includes no shift instructions since the equivalent of a shift can be obtained by programming. Programs for right or left shift and for an even or odd shift amount may be written with MOVE WITH OFFSET and the logical move instructions.

Decimal Arithmetic Exceptions

Exceptional instructions, data, or results cause a program interruption. When the interruption occurs, the current PSW is stored as an old PSW, and a new PSW is obtained. The interruption code in the old PSW identifies the cause of the interruption. The following exceptions cause a program interruption in decimal arithmetic.

Operation: The decimal feature is not installed and the instruction is ADD DECIMAL, SUBTRACT DECIMAL, ZERO AND ADD, COMPARE DECIMAL, MULTIPLY DECIMAL, or DIVIDE DECIMAL. The instruction is suppressed. Therefore, the condition code and data in storage and registers remain unchanged.

Protection: The storage key of a result location does not match the protection key in the PSW.

Addressing: An address designates a location outside the available storage for the installed system.

In the two preceding exceptions, the operation is terminated. The result data and the condition code are unpredictable and should not be used for further computation.

These address exceptions do not apply to the components from which an address is generated — the contents of the D₁ and D₂ fields and the contents of the registers specified by B₁ and B₂.

Specifications: A multiplier or a divisor size exceeds 15 digits and sign or exceeds the multiplicand or dividend size. The instruction is suppressed; therefore, the condition code and data in storage and registers remain unchanged.

Data: A sign or digit code of an operand in ADD DECIMAL, SUBTRACT DECIMAL, ZERO AND ADD, COMPARE DECIMAL, MULTIPLY DECIMAL, or DIVIDE DECIMAL is incorrect, a multiplicand has insufficient high-order zeros, or the operand fields in these operations overlap incorrectly. The operation is terminated. The result data and the condition code are unpredictable and should not be used for further computation.

Decimal Overflow: The result of ADD DECIMAL, SUBTRACT DECIMAL, or ZERO AND ADD overflows. The program interruption occurs only when the decimal-overflow mask bit is one. The operation is completed by placing the truncated low-order result in the result field and setting the condition code to 3. The sign and low-order digits contained in the result field are the same as they would have been for an infinitely long result field.

Decimal Divide Check: The quotient exceeds the specified data field, including division by zero. Division is suppressed. Therefore, the dividend and divisor remain unchanged in storage.

Floating-Point Arithmetic

The purpose of the floating-point instruction set is to perform calculations using operands with a wide range of magnitude and yielding results scaled to preserve precision.

A floating-point number consists of a signed exponent and a signed fraction. The quantity expressed by this number is the product of the fraction and the number 16 raised to the power of the exponent. The exponent is expressed in excess 64 binary notation; the fraction is expressed as a hexadecimal number having a radix point to the left of the high-order digit.

To avoid unnecessary storing and loading operations for results and operands, four floating-point registers are provided. The floating-point instruction set provides for loading, adding, subtracting, comparing, multiplying, dividing, and storing, as well as the sign control of short or long operands. Short operands generally provide faster processing and require less storage than long operands. On the other hand, long operands provide greater accuracy of computation. Operations may be either register to register or storage to register. All floating-point instructions and registers are part of the floating-point feature.

To preserve maximum precision, addition, subtraction, multiplication, and division are performed with normalized results. Addition and subtraction may also be performed with unnormalized results. Normalized and unnormalized operands may be used in any floating-point operation.

The condition code is set as a result of all sign control, add, subtract, and compare operations.

Data Format

Floating-point data occupy a fixed-length format, which may be either a fullword short format or a double-word long format. Both formats may be used in main storage and in the floating-point registers. The four floating-point registers are numbered 0, 2, 4, and 6.

Short Floating-Point Number

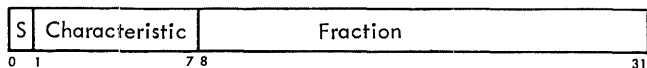

Long Floating-Point Number

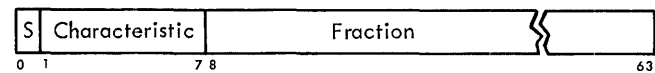

The first bit in either format is the sign bit (S). The subsequent seven bit positions are occupied by the characteristic. The fraction field may have either six or 14 hexadecimal digits.

The entire set of floating-point instructions is available for both short and long operands. When short-precision is specified, all operands and results are 32-bit floating-point words, and the rightmost 32 bits of the floating-point registers do not participate in the operations and remain unchanged. An exception is the product in `MULTIPLY`, which is a 64-bit word and occupies a full register. When long-precision is specified, all operands and results are 64-bit floating-point words.

Although final results in short-precision have six fraction digits, intermediate results in addition, subtraction, and division may extend to seven fraction digits. The low-order digit of a seven-digit fraction is called the *guard digit* and serves to increase the precision of the final result. Intermediate results in long-precision do not exceed 14 fraction digits.

Number Representation

The fraction of a floating-point number is expressed in hexadecimal digits. The radix point of the fraction is assumed to be immediately to the left of the high-order fraction digit. To provide the proper magnitude for the floating-point number, the fraction is considered to be multiplied by a power of 16. The characteristic portion, bits 1-7 of both floating-point formats, indicates this power. The characteristic is treated as an excess 64 number with a range from -64 through +63, corresponding to the binary values 0-127.

Both positive and negative quantities have a true fraction, the difference in sign being indicated by the sign bit. The number is positive or negative accordingly as the sign bit is zero or one.

The range covered by the magnitude (M) of a normalized floating-point number is in short precision $16^{-65} \leq M \leq (1 - 16^{-6}) \cdot 16^{63}$, and in long precision $16^{-65} \leq M \leq (1 - 16^{-14}) \cdot 16^{63}$, or approximately $2.4 \cdot 10^{-78} \leq M \leq 7.2 \cdot 10^{75}$ in either precision.

A number with zero characteristic, zero fraction, and plus sign is called a true zero. A true zero may arise as the result of an arithmetic operation because of the particular magnitude of the operands. A result is forced to be true zero when an exponent underflow occurs or when a result fraction is zero and no program interruption due to significance exception is taken. When the program interruption is taken, the true zero is not forced, and the characteristic and sign of the result remain unchanged. Whenever a result has a zero fraction, the exponent overflow and underflow exceptions do not cause a program interruption. When a divisor has a zero fraction, division is omitted, a floating-point divide exception exists, and a program interruption occurs. Otherwise, zero fractions and zero characteristics participate as normal numbers in all arithmetic operations.

The sign of a sum, difference, product, or quotient with zero fraction is positive. The sign of a zero fraction resulting from other operations is established by the rules of algebra from the operand signs.

Normalization

A quantity can be represented with the greatest precision by a floating-point number of given fraction length when that number is normalized. A normalized floating-point number has a nonzero high-order hexadecimal fraction digit. If one or more high-order fraction digits are zero, the number is said to be unnormalized. The process of normalization consists of shifting the fraction left until the high-order hexadecimal digit is nonzero and reducing the characteristic by the number of hexadecimal digits shifted. A zero fraction can not be normalized, and its associated characteristic therefore remains unchanged when normalization is called for.

Normalization usually takes place when the intermediate arithmetic result is changed to the final result. This function is called *postnormalization*. In performing multiplication and division, the operands are normalized prior to the arithmetic process. This function is called *prenormalization*.

Floating-point operations may be performed with or without normalization. Most operations are performed in only one of these two ways. Addition and subtraction may be specified either way.

When an operation is performed without normalization, high-order zeros in the result fraction are not eliminated. The result may or may not be normalized, depending upon the original operands.

In both normalized and unnormalized operations, the initial operands need not be in normalized form. Also, intermediate fraction results are shifted right

when an overflow occurs, and the intermediate fraction result is truncated to the final result length after the shifting, if any.

Programming Note

Since normalization applies to hexadecimal digits, the three high-order bits of a normalized number may be zero.

Condition Code

The results of floating-point sign-control, add, subtract, and compare operations are used to set the condition code. Multiplication, division, loading, and storing leave the code unchanged. The condition code can be used for decision-making by subsequent branch-on-condition instructions.

The condition code can be set to reflect two types of results for floating-point arithmetic. For most operations, the states 0, 1, or 2 indicate the content of the result register is zero, less than zero, or greater than zero. A zero result is indicated whenever the result fraction is zero, including a forced zero. State 3 is used when the exponent of the result overflows.

For comparison, the states 0, 1, or 2 indicate that the first operand is equal, low, or high.

CONDITION CODE SETTING FOR FLOATING-POINT ARITHMETIC

	0	1	2	3
Add Normalized s/L	zero	< zero	> zero	overflow
Add Unnormalized s/L	zero	< zero	> zero	overflow
Compare s/L	equal	low	high	--
Load and Test s/L	zero	< zero	> zero	--
Load Complement s/L	zero	< zero	> zero	--
Load Negative s/L	zero	< zero	--	--
Load Positive s/L	zero	--	> zero	--
Subtract				
Normalized s/L	zero	< zero	> zero	overflow
Subtract				
Unnormalized s/L	zero	< zero	> zero	overflow

Instruction Format

Floating-point instructions use the following two formats:

RR Format

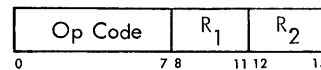

RX Format

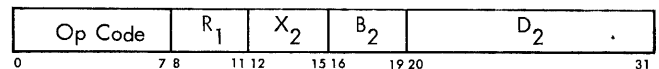

In these formats, R₁ designates the address of a floating-point register. The contents of this register will be

called the first operand. The second operand location is defined differently for two formats.

In the RR format, the R₂ field specifies the address of a floating-point register containing the second operand. The same register may be specified for the first and second operand.

In the RX format, the contents of the general register specified by X₂ and B₂ are added to the content of the D₂ field to form an address designating the location of the second operand.

A zero in an X₂ or B₂ field indicates the absence of the corresponding address component.

The register address specified by the R₁ and R₂ fields should be 0, 2, 4 or 6. Otherwise, a specification exception is recognized, and a program interruption is caused.

The storage address of the second operand should designate word boundaries for short operands and double-word boundaries for long operands. Otherwise, a specification exception is recognized, and a program interruption is caused.

Results replace the first operand, except for the storing operations, where the second operand is replaced.

Except for the storing of the final result, the contents of all floating-point or general registers and storage locations participating in the addressing or execution part of an operation remain unchanged.

The floating-point instructions are the only instructions using the floating-point registers.

Instructions

The floating-point arithmetic instructions and their mnemonics, formats, and operation codes follow. All operations can be specified in short and long precision and are part of the floating-point feature. The following table indicates when normalization occurs, when the condition code is set, and the exceptions that cause a program interruption.

NAME	MNEMONIC	TYPE	EXCEPTIONS	CODE
Load (Long)	LDR	RR F	S	28
Load (Long)	LD	RX F	A,S	68
Load (Short)	LER	RR F	S	38
Load (Short)	LE	RX F	A,S	78
Load and Test (Long)	LTDR	RR F,C	S	22
Load and Test (Short)	LTER	RR F,C	S	32
Load Complement (Long)	LCDR	RR F,C	S	23
Load Complement (Short)	LCER	RR F,C	S	33

NAME	MNEMONIC	TYPE	EXCEPTIONS	CODE
Load Positive (Long)	LPDR	RR F,C	S	20
Load Positive (Short)	LPER	RR F,C	S	30
Load Negative (Long)	LNDR	RR F,C	S	21
Load Negative (Short)	LNER	RR F,C	S	31
Add Normalized (Long)	N ADR	RR F,C	S,U,E,LS	2A
Add Normalized (Long)	N AD	RX F,C	A,S,U,E,LS	6A
Add Normalized (Short)	N AER	RR F,C	S,U,E,LS	3A
Add Normalized (Short)	N AE	RX F,C	A,S,U,E,LS	7A
Add Unnormalized (Long)	AWR	RR F,C	S, E,LS	2E
Add Unnormalized (Long)	AW	RX F,C	A,S, E,LS	6E
Add Unnormalized (Short)	AUR	RR F,C	S, E,LS	3E
Add Unnormalized (Short)	AU	RR F,C	A,S, E,LS	7E
Subtract Normalized (Long)	N SDR	RR F,C	S,U,E,LS	2B
Subtract Normalized (Long)	N SD	RX F,C	A,S,U,E,LS	6B
Subtract Normalized (Short)	N SER	RR F,C	S,U,E,LS	3B
Subtract Normalized (Short)	N SE	RX F,C	A,S,U,E,LS	7B
Subtract Unnormalized (Long)	SWR	RR F,C	S, E,LS	2F
Subtract Unnormalized (Long)	SW	RX F,C	A,S, E,LS	6F
Subtract Unnormalized (Short)	SUR	RR F,C	S, E,LS	3F
Subtract Unnormalized (Short)	SU	RX F,C	A,S, E,LS	7F
Compare (Long)	CDR	RR F,C	S	29
Compare (Long)	CD	RX F,C	A,S	69
Compare (Short)	CER	RR F,C	S	39
Compare (Short)	CE	RX F,C	A,S	79
Halve (Long)	HDR	RR F	S	24
Halve (Short)	HER	RR F	S	34
Multiply (Long)	N MDR	RR F	S,U,E	2C
Multiply (Long)	N MD	RX F	A,S,U,E	6C
Multiply (Short)	N MER	RR F	S,U,E	3C
Multiply (Short)	N ME	RX F	A,S,U,E	7C
Divide (Long)	N DDR	RR F	S,U,E,FK	2D
Divide (Long)	N DD	RX F	A,S,U,E,FK	6D
Divide (Short)	N DER	RR F	S,U,E,FK	3D
Divide (Short)	N DE	RX F	A,S,U,E,FK	7D
Store (Long)	STD	RX F	P,A,S	60
Store (Short)	STE	RX F	P,A,S	70

NOTES

- A Addressing exception
- C Condition code is set
- E Exponent-overflow exception
- F Floating-point feature
- FK Floating-point divide exception
- LS Significance exception
- N Normalized operation
- P Protection exception
- S Specification exception
- U Exponent-underflow exception

Load

LER RR (Short Operands)

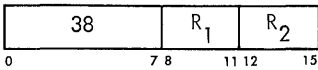

LE RX (Short Operands)

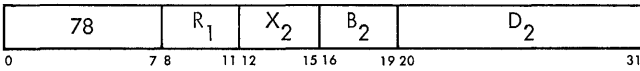

LDR RR (Long Operands)

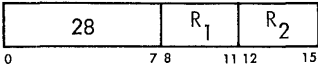

LD RX (Long Operands)

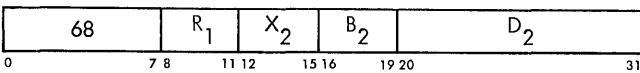

The second operand is placed in the first operand location.

The second operand is not changed. In short-precision the low-order half of the result register remains unchanged. Exponent overflow, exponent underflow, or lost significance cannot occur.

Condition Code: The code remains unchanged.

Program Interruptions:

Operation (if floating-point feature is not installed)

Addressing (LE, LD only)
Specification

Load and Test

LTER RR (Short Operands)

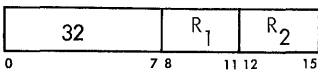

LTDR RR (Long Operands)

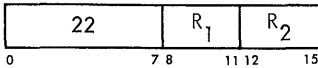

The second operand is placed in the first operand location, and its sign and magnitude determine the condition code.

The second operand is not changed. In short-precision the low-order half of the result register remains unchanged and is not tested.

Resulting Condition Code:

- 0 Result fraction is zero
- 1 Result is less than zero
- 2 Result is greater than zero
- 3 --

Program Interruptions:

Operation (if floating-point feature is not installed)

Specification

Programming Note

When the same register is specified as first and second operand location, the operation is equivalent to a test without data movement.

Load Complement

LCER RR (Short Operands)

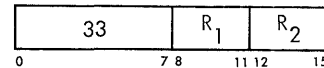

LCDR RR (Long Operands)

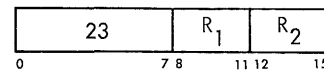

The second operand is placed in the first operand location with the sign changed to the opposite value.

The sign bit of the second operand is inverted, while characteristic and fraction are not changed. In short-precision the low-order half of the result register remains unchanged and is not tested.

Resulting Condition Code:

- 0 Result fraction is zero
- 1 Result is less than zero
- 2 Result is greater than zero
- 3 --

Program Interruptions:

Operation (if floating-point feature is not installed)

Specification

Load Positive

LPER RR (Short Operands)

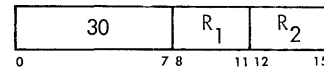

LPDR RR (Long Operands)

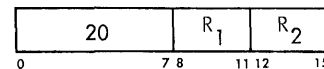

The second operand is placed in the first operand location with the sign made plus.

The sign bit of the second operand is made zero, while characteristic and fraction are not changed. In short-precision, the low-order half of the result register remains unchanged and is not tested.

Resulting Condition Code:

- 0 Result fraction is zero
- 1 --
- 2 Result is greater than zero
- 3 --

Program Interruptions:

Operation (if floating-point feature is not installed)
Specification

Load Negative

LNER RR (Short Operands)

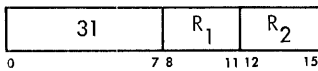

LNDR RR (Long Operands)

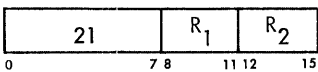

The second operand is placed in the first operand location with the sign made minus.

The sign bit of the second operand is made one, even if the fraction is zero. Characteristic and fraction are not changed. In short-precision, the low-order half of the result register remains unchanged and is not tested.

Resulting Condition Code:

- 0 Result fraction is zero
- 1 Result is less than zero
- 2 --
- 3 --

Program Interruptions:

Operation (if floating-point feature is not installed)
Specification

Add Normalized

AER RR (Short Operands)

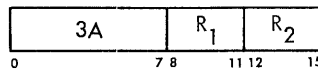

AE RX (Short Operands)

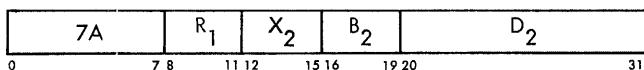

ADR RR (Long Operands)

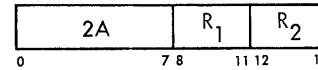

AD RX (Long Operands)

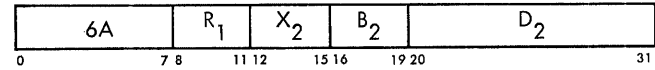

The second operand is added to the first operand, and the normalized sum is placed in the first operand location.

In short-precision the low-order halves of the floating-point registers are ignored and remain unchanged.

Addition of two floating-point numbers consists of a characteristic comparison and a fraction addition. The characteristics of the two operands are compared, and the fraction with the smaller characteristic is right-shifted; its characteristic is increased by one for each hexadecimal digit of shift, until the two characteristics agree. The fractions are then added algebraically to form an intermediate sum. If an overflow carry occurs, the intermediate sum is right-shifted one digit, and the characteristic is increased by one. If this increase causes a characteristic overflow, an exponent-overflow exception is signaled, and a program interruption occurs.

The short intermediate sum consists of seven hexadecimal digits and possible carry. The low-order digit is a guard digit retained from the fraction which is shifted right. Only one guard digit participates in the fraction addition. The guard digit is zero if no shift occurs. The long intermediate sum consists of 14 hexadecimal digits and a possible carry. No guard digit is retained.

After the addition, the intermediate sum is left-shifted as necessary to form a normalized fraction; vacated low-order digit positions are filled with zeros and the characteristic is reduced by the amount of shift.

If normalization causes the characteristic to underflow, characteristic and fraction are made zero, an exponent-underflow exception exists, and a program interruption occurs if the corresponding mask bit is one. If no left shift takes place the intermediate sum is truncated to the proper fraction length.

When the intermediate sum is zero and the significance mask bit is one, a significance exception exists, and a program interruption takes place. No normalization occurs; the intermediate sum characteristic remains unchanged. When the intermediate sum is zero and the significance mask bit is zero, the program

interruption for the significance exception does not occur; rather, the characteristic is made zero, yielding a true zero result. Exponent underflow does not occur for a zero fraction.

The sign of the sum is derived by the rules of algebra. The sign of a sum with zero result fraction is always positive.

Resulting Condition Code:

- 0 Result fraction is zero
- 1 Result is less than zero
- 2 Result is greater than zero
- 3 Result exponent overflows

Program Interruptions:

- Operation (if floating-point feature is not installed)
- Addressing (AE and AD only)
- Specification
- Significance
- Exponent overflow
- Exponent underflow

Programming Note

Interchanging the two operands in a floating-point addition does not affect the value of the sum.

Add Unnormalized

AUR RR (Short Operands)

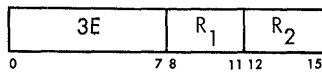

AU RX (Short Operands)

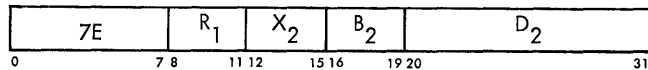

AWR RR (Long Operands)

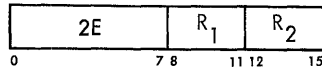

AW RX (Long Operands)

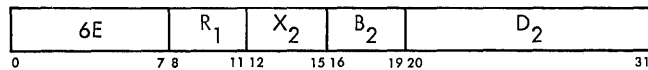

The second operand is added to the first operand, and the unnormalized sum is placed in the first operand location.

In short-precision, the low-order halves of the floating-point registers are ignored and remain unchanged.

After the addition the intermediate sum is truncated to the proper fraction length.

When the resulting fraction is zero and the significance mask bit is one, a significance exception exists and a program interruption takes place. When the resulting fraction is zero and the significance mask bit is zero, the program interruption for the significance exception does not occur; rather, the characteristic is made zero, yielding a true zero result.

Leading zeros in the result are not eliminated by normalization, and an exponent underflow cannot occur.

The sign of the sum is derived by the rules of algebra. The sign of a sum with zero result fraction is always positive.

Resulting Condition Code:

- 0 Result fraction is zero
- 1 Result is less than zero
- 2 Result is greater than zero
- 3 Result exponent overflows

Program Interruptions:

- Operation (if floating-point feature is not installed)
- Addressing (AU and AW only)
- Specification
- Significance
- Exponent overflow

Subtract Normalized

SER RR (Short Operands)

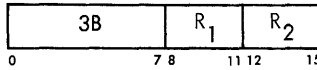

SE RX (Short Operands)

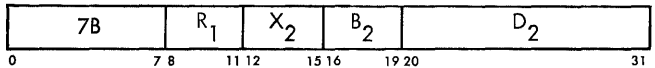

SDR RR (Long Operands)

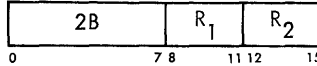

SD RX (Long Operands)

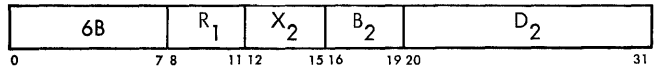

The second operand is subtracted from the first operand, and the normalized difference is placed in the first operand location.

In short-precision, the low-order halves of the floating-point registers are ignored and remain unchanged.

The **SUBTRACT NORMALIZED** is similar to **ADD NORMALIZED**, except that the sign of the second operand is inverted before addition.

The sign of the difference is derived by the rules of algebra. The sign of a difference with zero result fraction is always positive.

Resulting Condition Code:

- 0 Result fraction is zero
- 1 Result is less than zero
- 2 Result is greater than zero
- 3 Result exponent overflows

Program Interruptions:

- Operation (if floating-point feature is not installed)
- Addressing (SD and SE only)
- Specification
- Significance
- Exponent overflow
- Exponent underflow

Subtract Unnormalized

SUR RR (Short Operands)

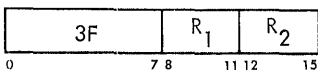

SU RX (Short Operands)

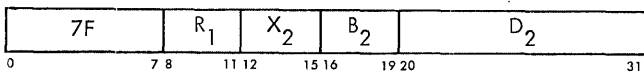

SWR RR (Long Operands)

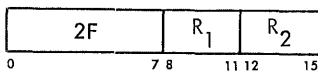

SW RX (Long Operands)

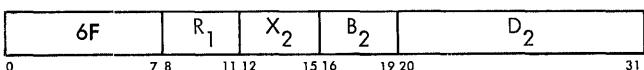

The second operand is subtracted from the first operand, and the unnormalized difference is placed in the first operand location.

In short-precision, the low-order halves of the floating-point register are ignored and remain unchanged.

The **SUBTRACT UNNORMALIZED** is similar to **ADD UNNORMALIZED**, except for the inversion of the sign of the second operand before addition.

The sign of the difference is derived by the rules of algebra. The sign of a difference with zero result fraction is always positive.

Resulting Condition Code:

- 0 Result fraction is zero
- 1 Result is less than zero
- 2 Result is greater than zero
- 3 Result exponent overflows

Program Interruptions:

- Operation (if floating-point feature is not installed)
- Addressing (sw and su only)
- Specification
- Significance
- Exponent overflow

Compare

CER RR (Short Operands)

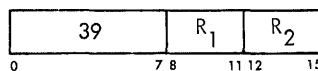

CE RX (Short Operands)

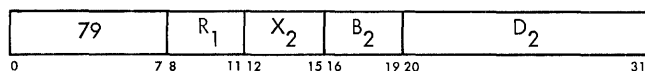

CDR RR (Long Operands)

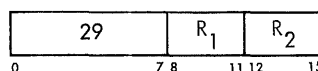

CD RX (Long Operands)

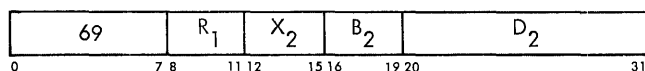

The first operand is compared with the second operand, and the condition code indicates the result.

In short-precision, the low-order halves of the floating-point registers are ignored.

Comparison is algebraic, taking into account the sign, fraction, and exponent of each number. An exponent inequality is not decisive for magnitude determination since the fractions may have different numbers of leading zeros. An equality is established by following the rules for normalized floating-point subtraction. When the intermediate sum, including a possible

guard digit, is zero, the operands are equal. Neither operand is changed as a result of the operation.

Exponent overflow, exponent underflow, or lost significance cannot occur.

Resulting Condition Code:

- 0 Operands are equal
- 1 First operand is low
- 2 First operand is high
- 3 --

Program Interruptions:

- Operation (if floating-point feature is not installed)
- Addressing (CD and CE only)
- Significance

Programming Note

Numbers with zero fraction compare equal even when they differ in sign or characteristic.

Halve

HER RR (Short Operands)

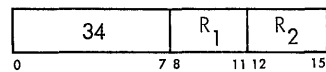

HDR RR (Long Operands)

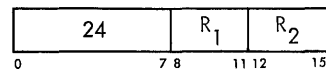

The second operand is divided by two, and the quotient is placed in the first operand location.

In short-precision, the low-order half of the result register remains unchanged.

The operation shifts the fraction right one bit; the sign and characteristic are not changed. No normalization or test for zero fraction takes place.

Condition Code: The code remains unchanged.

Program Interruptions:

- Operation (if floating-point feature is not installed)
- Specification

Programming Note

The halve operation differs from a divide operation with the number two as divisor in the absence of pre-normalization and postnormalization and in the absence of a zero-fraction test.

Multiply

MER RR (Short Operands)

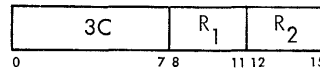

ME RX (Short Operands)

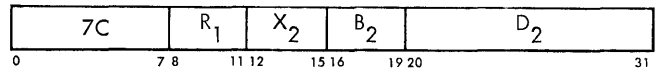

MDR RR (Long Operands)

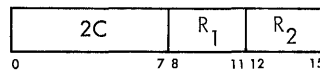

MD RX (Long Operands)

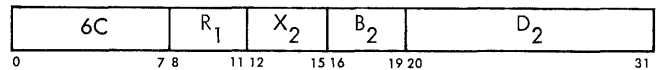

The normalized product of multiplier (the second operand) and multiplicand (the first operand) replaces the multiplicand.

The multiplication of two floating-point numbers consists of a characteristic addition and a fraction multiplication. The sum of the characteristics less 64 is used as the characteristic of an intermediate product. The sign of the product is determined by the rules of algebra.

The product fraction is normalized by prenormalizing the operands and postnormalizing the intermediate product, if necessary. The intermediate product characteristic is reduced by the number of left-shifts. For long operands, the intermediate product fraction is truncated before the left-shifting, if any. For short operands (six-digit fractions), the product fraction has the full 14 digits of the long format, and the two low-order fraction digits are accordingly always zero.

Exponent overflow occurs if the final product characteristic exceeds 127. The operation is terminated, and a program interruption occurs. The overflow exception does not occur for an intermediate product characteristic exceeding 127 when the final characteristic is brought within range because of normalization.

Exponent underflow occurs if the final product char-

acteristic is less than zero. The characteristic and fraction are made zero, and a program interruption occurs if the corresponding mask bit is one. Underflow is not signaled when an operand's characteristics become less than zero during prenormalization, and the correct characteristic and fraction value are used in the multiplication.

When all 14 result fraction digits are zero, the product sign and characteristic are made zero, yielding a true zero result without exponent underflow and exponent overflow causing a program interruption. The program interruption for lost significance is never taken for multiplication.

Condition Code: The code remains unchanged.

Program Interruptions:

- Operation (if floating-point feature is not installed)
- Addressing (MD and ME only)
- Specification
- Exponent overflow
- Exponent underflow

Programming Note

Interchanging the two operands in a floating-point multiplication does not affect the value of the product.

Divide

DER RR (Short Operands)

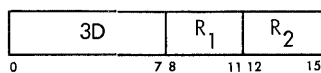

DE RX (Short Operands)

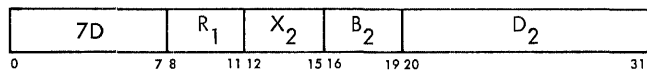

DDR RR (Long Operands)

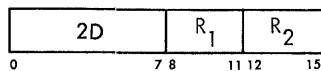

DD RX (Long Operands)

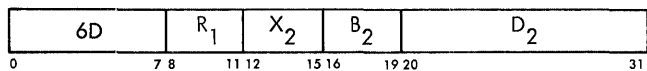

The dividend (the first operand) is divided by the divisor (the second operand) and replaced by the quotient. No remainder is preserved.

In short-precision, the low-order halves of the floating-point register are ignored and remain unchanged.

A floating-point division consists of a characteristic subtraction and a fraction division. The difference between the dividend and divisor characteristics plus 64 is used as an intermediate quotient characteristic. The sign of the quotient is determined by the rules of algebra.

The quotient fraction is normalized by prenormalizing the operands. Postnormalizing the intermediate quotient is never necessary, but a right-shift may be called for. The intermediate-quotient characteristic is adjusted for the shifts. All dividend fraction digits participate in forming the quotient, even if the normalized dividend fraction is larger than the normalized divisor fraction. The quotient fraction is truncated to the desired number of digits.

A program interruption for exponent overflow occurs when the final-quotient characteristic exceeds 127. The operation is terminated.

A program interruption for exponent underflow occurs if the final-quotient characteristic is less than zero. The characteristic, sign, and fraction are made zero, and the interruption occurs if the corresponding mask bit is one. Underflow is not signaled for the intermediate quotient or for the operand characteristics during prenormalization.

When division by a divisor with zero fraction is attempted, the operation is suppressed. The dividend remains unchanged, and a program interruption for floating-point divide occurs. When the dividend fraction is zero, the quotient fraction will be zero. The quotient sign and characteristic are made zero, yielding a true zero result without taking the program interruption for exponent underflow and exponent overflow. The program interruption for significance is never taken for division.

Condition Code: The code remains unchanged.

Program Interruptions:

- Operation (if floating-point feature is not installed)
- Addressing (DD and DE only)
- Specification
- Exponent overflow
- Exponent underflow
- Floating-point divide

Store

STE **RX** (**Short Operands**)

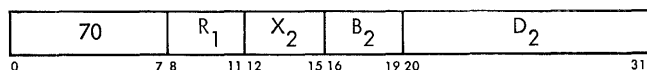

STD **RX** (**Long Operands**)

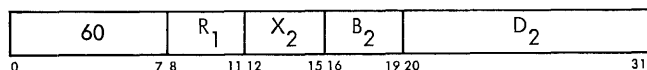

The first operand is stored at the second operand location.

In short-precision, the low-order half of the first operand register is ignored. The first operand remains unchanged.

Condition Code: The code remains unchanged.

Program Interruptions:

- Operation (if floating-point feature is not installed)
- Addressing
- Protection
- Specification

Floating-Point Arithmetic Exceptions

Exceptional instructions, data, or results cause a program interruption. When the interruption occurs, the current PSW is stored as an old PSW, and a new PSW is obtained. The interruption code in the old PSW identifies the cause of the interruption. The following exceptions cause a program interruption in floating-point arithmetic.

Operation: The Floating-Point Feature is not installed, and an attempt is made to execute a floating-point instruction. The instruction is suppressed. The condition code and data in registers and storage remain unchanged.

Protection: The storage key of a result location does not match the protection key in the PSW. The operation is suppressed. Therefore, the condition code and data in registers and storage remain unchanged.

Addressing: An address designates a location outside the available storage for the installed system. The operation is terminated. The result data and the condition code, if affected, are unpredictable and should not be used for further computation.

Specification: A short operand is not located on a 32-bit boundary or a long operand is not located on a 64-bit boundary; or, a floating-point register address other than 0, 2, 4, or 6 is specified. The instruction is suppressed. Therefore, the condition code and data in registers and storage remain unchanged. The address restrictions do not apply to the components from which an address is generated — the content of the D₂ field and the contents of the registers specified by X₂ and B₂.

Exponent Overflow: The result exponent of an addition, subtraction, multiplication, or division overflows, and the result fraction is not zero. The operation is terminated; the result data are unpredictable and should not be used for further computation. The condition code is set to 3 for addition and subtraction and remains unchanged for multiplication and division.

Exponent Underflow: The result of an addition, subtraction, multiplication, or division underflows, and the result fraction is not zero. A program interruption occurs if the exponent-underflow mask bit is one. The operation is completed by replacing the result with a true zero. The condition code is set to 0 for addition and subtraction and remains unchanged for multiplication and division. The state of the mask bit does not affect the result.

Significance: The result fraction of an addition or subtraction is zero. A program interruption occurs if the significance mask bit is one. The mask bit affects also the result of the operation. When the significance mask bit is a zero, the operation is completed by replacing the result with a true zero. When the significance mask bit is one, the operation is completed without further change to the characteristic of the result. In either case, the condition code is set to 0.

Floating-Point Divide: Division by a number with zero fraction is attempted. The division is suppressed; therefore, the condition code and data in registers and storage remain unchanged.

Logical Operations

A set of instructions is provided for the logical manipulation of data. Generally, the operands are treated as eight-bit bytes. In a few cases the left or right four bits of a byte are treated separately or operands are shifted a bit at a time. The operands are either in storage or in the general register. Some operands are introduced from the instruction stream.

Processing of data in storage proceeds left to right through fields which may start at any byte position. In the general registers, the processing, as a rule, involves the entire register contents.

Except for the editing instructions, data are not treated as numbers. Editing provides a transformation from packed decimal digits to alphanumeric characters.

The set of logical operations includes moving, comparing, bit connecting, bit testing, translating, editing, and shift operations. All logical operations other than editing are part of the standard instruction set. Editing instructions are part of the decimal feature.

The condition code is set as a result of all logical comparing, connecting, testing, and editing operations.

Data Format

Data reside in general registers or in storage or are introduced from the instruction stream. The data size may be a single or double word, a single character, or variable in length. When two operands participate they have equal length, except in the editing instructions.

Fixed-Length Logical Information

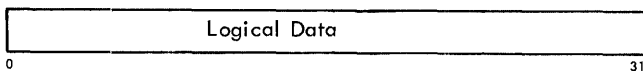

Data in general registers normally occupy all 32 bits. Bits are treated uniformly, and no distinction is made between sign and numeric bits. In a few operations, only the low-order eight bits of a register participate, leaving the remaining 24 bits unchanged. In some shift operations, 64 bits of an even/odd pair of registers participate.

The **LOAD ADDRESS** introduces a 24-bit address into a general register. The high-order eight bits of the register are made zero.

In storage-to-register operations, the storage data occupy either a word of 32 bits or a byte of eight bits. The word must be located on word boundaries, that is, its address must have the two low-order bits zero.

Variable-Length Logical Information

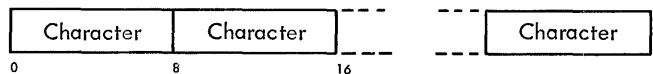

In storage-to-storage operations, data have a variable field-length format, starting at any byte address and continuing for up to a total of 256 bytes. Processing is left to right.

Operations introducing data from the instruction stream into storage, as immediate data, are restricted to an eight-bit byte. Only one byte is introduced from the instruction stream, and only one byte in storage participates.

Use of general register 1 is implied in **TRANSLATE AND TEST** and **EDIT AND MARK**. A 24-bit address may be placed in this register during these operations. The **TRANSLATE AND TEST** also implies general register 2. The low-order eight bits of register 2 may be replaced by a function byte during a translate-and-test operation.

Editing requires a packed decimal field and generates zoned decimal digits. The digits, signs, and zones are recognized and generated as for decimal arithmetic. Otherwise, no internal data structure is required, and all bit configurations are considered valid.

The translating operations use a list of arbitrary values. A list provides a relation between an argument (the quantity used to reference the list) and the function (the content of the location related to the argument). The purpose of the translation may be to convert data from one code to another code or to perform a control function.

A list is specified by an initial address — the address designating the leftmost byte location of the list. The byte from the operand to be translated is the argument. The actual address used to address the list is obtained by adding the argument to the low-order po-

sitions of the initial address. As a consequence, the list contains 256 eight-bit function bytes. In cases where it is known that not all eight-bit argument values will occur, it may be possible to reduce the size of the list.

In a storage-to-storage operation, the operand fields may be defined in such a way that they overlap. The effect of this overlap depends upon the operation. When the operands remain unchanged, as in COMPARE or TRANSLATE AND TEST, overlapping does not affect the execution of the operation. In the case of MOVE, EDIT, and TRANSLATE, one operand is replaced by new data, and the execution of the operation may be affected by the amount of overlap and the manner in which data are fetched or stored. For purposes of evaluating the effect of overlapped operands, consider that data are handled one eight-bit byte at a time. All overlapping fields are considered valid but, in editing, overlapping fields give unpredictable results.

Condition Code

The results of most logical operations are used to set the condition code in the PSW. The LOAD ADDRESS, INSERT CHARACTERS, STORE CHARACTER, TRANSLATE, and the moving and shift operations leave this code unchanged. The condition code can be used for decision-making by subsequent branch-on-condition instructions.

The condition code can be set to reflect five types of results for logical operations: For COMPARE LOGICAL the states 0, 1, or 2 indicate that the first operand is equal, low, or high.

For the logical-connectives, the states 0 or 1 indicate a zero or nonzero result field.

For TEST UNDER MASK, the states 0, 1, or 3 indicate that the selected bits are all-zero, mixed zero and one, or all-one.

For TRANSLATE AND TEST, the states 0, 1, or 2 indicate an all-zero function byte, a nonzero function byte with the operand incompletely tested, or a last function byte nonzero.

For editing the states 0, 1, or 2 indicate a zero, less than zero, or greater than zero content of the last result field.

CONDITION CODE SETTING FOR LOGICAL OPERATIONS

	0	1	2	3
And	zero	not zero	--	--
Compare Logical	equal	low	high	--
Edit	zero	< zero	> zero	--
Edit and Mark	zero	< zero	> zero	--
Exclusive Or	zero	not zero	--	--
Or	zero	not zero	--	--
Test Under Mask	zero	mixed	--	one
Translate and Test	zero	incomplete	complete	--

Instruction Format

Logical instructions use the following five formats:

RR Format

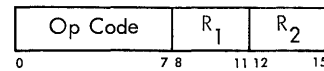

RX Format

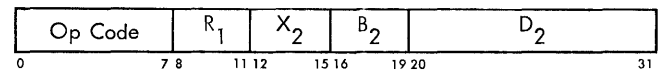

RS Format

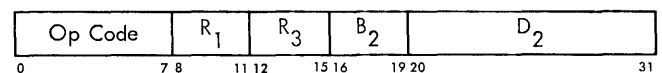

SI Format

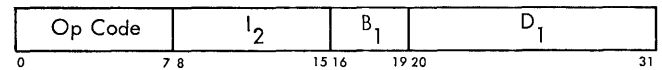

SS Format

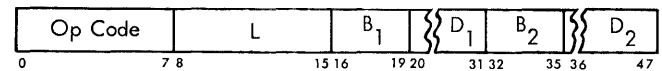

In the RR, RX, and RS formats, the content of the register specified by R₁ is called the first operand.

In the SI and SS formats, the content of the general register specified by B₁ is added to the content of the D₁ field to form an address. This address designates the leftmost byte of the first operand field. The number of bytes to the right of this first byte is specified by the L field in the SS format. In the SI format the operand size is one byte.

In the RR format, the R₂ field specifies the register containing the second operand. The same register may be specified for the first and second operand.

In the RX format, the contents of the general registers specified by the X₂ and B₂ fields are added to the content of the D₂ field to form the address of the second operand.

In the RS format, used for shift operations, the content of the general register specified by the B₂ field is added to the content of the D₂ field. This sum is not used as an address but specifies the number of bits of the shift. The R₃ field is ignored in the shift operations.

In the *si* format, the second operand is the eight-bit immediate data field, I_2 , of the instruction.

In the *ss* format, the content of the general register specified by B_2 is added to the content of the D_2 field to form the address of the second operand. The second operand field has the same length as the first operand field.

A zero in any of the X_2 , B_1 , or B_2 fields indicates the absence of the corresponding address or shift-amount component. An instruction can specify the same general register both for address modification and for operand location. Address modification is always completed prior to operation execution.

Results replace the first operand, except in *STORE CHARACTER*, where the result replaces the second operand. A variable-length result is never stored outside the field specified by the address and length.

The contents of all general registers and storage locations participating in the addressing or execution of an operation generally remain unchanged. Exceptions are the result locations, general register 1 in *EDIT AND MARK*, and general registers 1 and 2 in *TRANSLATE AND TEST*.

Instructions

The logical instructions, their mnemonics, formats, and operation codes follow. The table also indicates the feature to which the instruction belongs, when the condition code is set, and the exceptions that cause a program interruption.

NAME	MNEMONIC	TYPE	EXCEPTIONS	CODE
Move	MVI	SI	P,A	92
Move	MVC	SS	P,A	D2
Move Numerics	MVN	SS	P,A	D1
Move Zones	MVZ	SS	P,A	D3
Compare Logical	CLR	RR	C	15
Compare Logical	CL	RX	C A,S	55
Compare Logical	CLI	SI	C A	95
Compare Logical	CLC	SS	X,C A	D5
AND	NR	RR	C	14
AND	N	RX	C A,S	54
AND	NI	SI	C P,A	94
AND	NC	SS	C P,A	D4
OR	OR	RR	C	16
OR	O	RX	C A,S	56
OR	OI	SI	C P,A	96
OR	OC	SS	C P,A	D6
Exclusive OR	XR	RR	C	17
Exclusive OR	X	RX	C A,S	57
Exclusive OR	XI	SI	C P,A	97
Exclusive OR	XC	SS	C P,A	D7
Test Under Mask	TM	SI	C A	91
Insert Character	IC	RX	A	43
Store Character	STC	RX	P,A	42
Load Address	LA	RX		41
Translate	TR	SS	P,A	DC
Translate and Test	TRT	SS	C A	DD
Edit	ED	SS, T,C	P,A, D	DE
Edit and Mark	EDMK	SS, T,C	P,A, D	DF

NAME	MNEMONIC	TYPE	EXCEPTIONS	CODE
Shift Left Single				
Logical	SLL	RS		89
Shift Right Single				
Logical	SRL	RS		88
Shift Left Double				
Logical	SLDL	RS, X	S	8D
Shift Right Double				
Logical	SRDL	RS, X	S	8C

NOTES

A	Addressing exception
C	Condition code is set
D	Data exception
P	Protection exception
S	Specification exception
T	Decimal feature

Programming Note

The fixed-point loading and storing instructions also may be used for logical operations.

Move

MVI SI

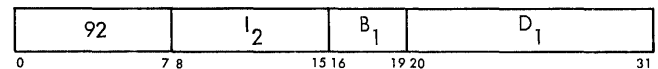

MVC SS

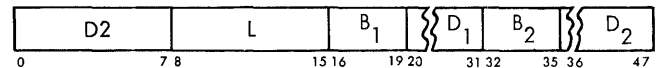

The second operand is placed in the first operand location.

The *ss* format is used for a storage-to-storage move. The *si* format introduces one 8-bit byte from the instruction stream.

In storage-to-storage movement the fields may overlap in any desired way. Movement is left to right through each field a byte at a time.

The bytes to be moved are not changed or inspected.

Condition Code: The code remains unchanged.

Program Interruptions:

- Protection
- Addressing

Programming Note

It is possible to propagate one character through an entire field by having the first operand field start one character to the right of the second operand field.

Move Numerics

MVN SS

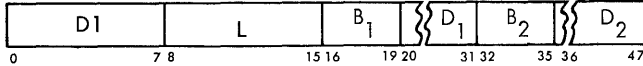

The low-order four bits of each byte in the second operand field, the numerics, are placed in the low-order bit positions of the corresponding bytes in the first operand fields.

The instruction is storage to storage. Movement is left to right through each field one byte at a time, and the fields may overlap in any desired way.

The numerics are not changed or checked for validity. The high-order four bits of each byte, the zones, remain unchanged in both operand fields.

Condition Code: The code remains unchanged.

Program Interruptions:

- Protection
- Addressing

Move Zones

MVZ SS

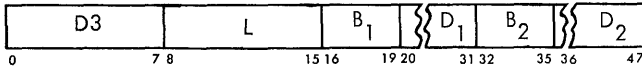

The high-order four bits of each byte in the second operand field, the zones, are placed in the high-order four bit positions of the corresponding bytes in the first operand field.

The instruction is storage to storage. Movement is left to right through each field one byte at a time, and the fields may overlap in any desired way.

The zones are not changed or checked for validity. The low-order four bits of each byte, the numerics, remain unchanged in both operand fields.

Condition Code: The code remains unchanged.

Program Interruptions:

- Addressing
- Protection

Compare Logical

CLR RR

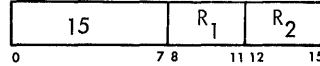

CL RX

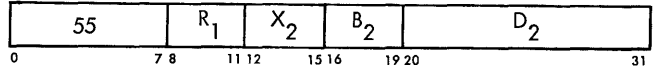

CLI SI

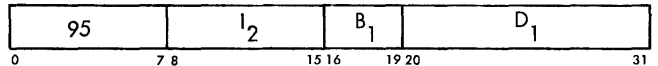

CLC SS

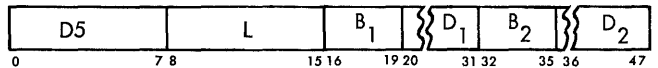

The first operand is compared with the second operand, and the result is indicated in the condition code.

The instructions allow comparisons that are register to register, storage to register, instruction to storage, and storage to storage.

Comparison is binary, and all codes are valid. The operation proceeds left to right and terminates as soon as an inequality is found.

Resulting Condition Code:

- 0 Operands are equal
- 1 First operand is low
- 2 First operand is high
- 3 --

Program Interruptions:

- Addressing (CL, CLI, CLC only)
- Specification (CL only)

Programming Note

The COMPARE LOGICAL is unique in treating all bits alike as part of an unsigned binary quantity. In variable-length operation, comparison is left to right and may extend to field lengths of 256 bytes. The operation may be used for alphameric comparisons.

AND

NR RR

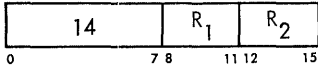

N RX

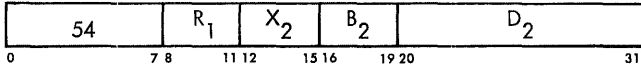

NI SI

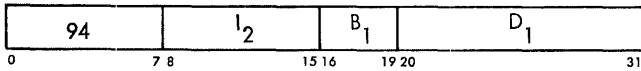

NC SS

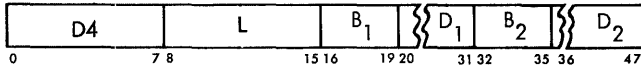

The logical product (AND) of the bits of the first and second operand is placed in the first operand location.

Operands are treated as unstructured logical quantities, and the connective AND is applied bit by bit. All operands and results are valid.

Resulting Condition Code:

- 0 Result is zero
- 1 Result not zero
- 2 --
- 3 --

Program Interruptions:

- Protection (NI, NC only)
- Addressing (N, NI, NC only)
- Specification (N only)

Programming Note

The AND may be used to set a bit to zero.

OR

OR RR

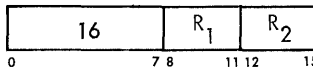

O RX

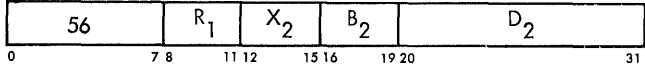

OI SI

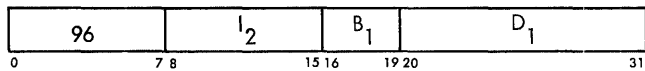

OC SS

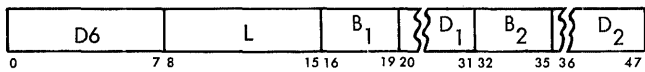

The logical sum (OR) of the bits of the first and second operand is placed in the first operand location.

Operands are treated as unstructured logical quantities, and the connective *inclusive* OR is applied bit by bit. All operands and results are valid.

Resulting Condition Code:

- 0 Result is zero
- 1 Result not zero
- 2 --
- 3 --

Program Interruptions:

- Protection (OI, OC only)
- Addressing (O, OI, OC only)
- Specification (O only)

Programming Note

The OR may be used to set a bit to one.

Exclusive OR

XR RR

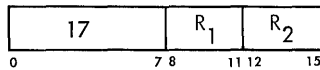

X RX

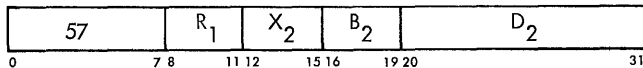

XI SI

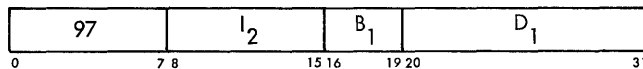

XC SS



The modulo-two sum (*exclusive OR*) of the bits of the first and second operand is placed in the first operand location.

Operands are treated as instructed logical quantities, and the connective *exclusive OR* is applied bit by bit. All operands and results are valid.

The instruction differs from **AND** and **OR** only in the connective applied.

Resulting Condition Code:

- 0 Result is zero
- 1 Result not zero
- 2 --
- 3 --

Program Interruptions:

- Protection (**xI**, **xC** only)
- Addressing (**x**, **xI**, **xC** only)
- Specification (**x** only)

Programming Note

The *exclusive OR* may be used to invert a bit.

Test Under Mask

TM SI

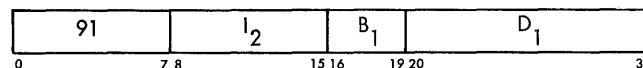

The state of the first operand bits selected by a mask is used to set the condition code.

The byte of immediate data, I₂, is used as an eight-bit mask. The bits of the mask are made to correspond one for one with the bits of the character in storage specified by the first operand address.

A mask bit of one indicates that the storage bit is selected. When the mask bit is zero, the storage bit is ignored. When all storage bits thus selected are zero, the condition code is made 0. The code is also made 0 when the mask is all-zero. When the selected bits are all-one, the code is made 3; otherwise, the code is made 1. The character in storage is not changed.

Resulting Condition Code:

- 0 Selected bits all-zero; mask is all-zero
- 1 Selected bits mixed zero and one
- 2 --
- 3 Selected bits all-one

Program Interruptions:

Addressing.

Insert Character

IC RX

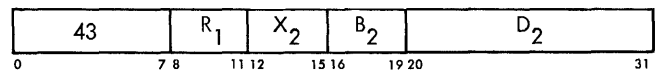

The eight-bit character at the second operand address is inserted into bit positions 24-31 of the register specified as the first operand location. The remaining bits of the register remain unchanged.

The instruction is storage to general register. The byte to be inserted is not changed or inspected.

Condition Code: The code remains unchanged.

Program Interruptions: Addressing.

Store Character

STC RX

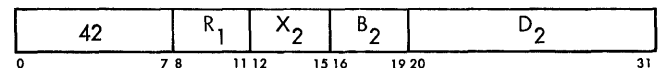

Bit positions 24-31 of the register designated as the first operand are placed at the second operand address.

The instruction is general register to storage. The byte to be stored is not changed or inspected.

Condition Code: The code remains unchanged.

Program Interruptions:

- Protection
- Addressing

Load Address

LA RX

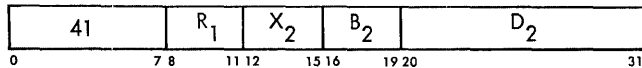

The address of the second operand is inserted in the low-order 24 bits of the general register specified by R₁. The remaining bits of the general register are made zero. No storage references for operands take place.

The address specified by the X₂, B₂, and D₂ fields is inserted in bits 8-31 of the general register specified by R₁. Bits 0-7 are set to zero. The address is not inspected for availability, protection, or resolution.

The address computation follows the rules for address arithmetic. Any carries beyond the 24th bit are ignored.

Condition Code: The code remains unchanged.

Program Interruptions: None.

Programming Note

The same general register may be specified by the R₁, X₂, and B₂ instruction field, except that general register 0 can be specified only by the R₁ field. In this manner, it is possible to increment the low-order 24 bits of a general register, other than 0, by the contents of the D₂ field of the instruction. The register to be incremented should be specified by R₁ and by either X₂ (with B₂ set to zero) or B₂ (with X₂ set to zero).

Translate

TR SS

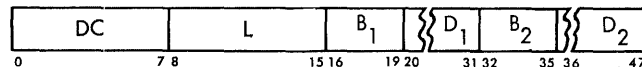

The eight-bit bytes of the first operand are used as arguments to reference the list designated by the second operand address. Each eight-bit function byte selected from the list replaces the corresponding argument in the first operand.

The bytes of the first operand are selected one by one for translation, proceeding left to right. Each argument byte is added to the entire initial address, the second operand address, in the low-order bit positions. The sum is used as the address of the function byte, which then replaces the original argument byte.

All data are valid. The operation proceeds until the first operand field is exhausted. The list is not altered unless an overlap occurs.

Condition Code: The code remains unchanged.

Program Interruptions:

Protection

Addressing

Translate and Test

TRT SS

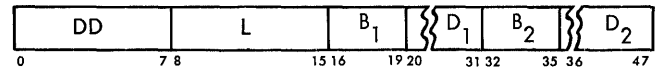

The eight-bit bytes of the first operand are used as arguments to reference the list designated by the second operand address. Each eight-bit function byte thus selected from the list is used to determine the continuation of the operation. When the function byte is a zero, the operation proceeds by fetching and translating the next argument byte. When the function byte is nonzero, the operation is completed by inserting the related argument address in general register 1, and by inserting the function byte in general register 2.

The bytes of the first operand are selected one by one for translation, proceeding from left to right. The first operand remains unchanged in storage. Fetching of the function byte from the list is performed as in TRANSLATE. The function byte retrieved from the list is inspected for the all-zero combination.

When the function byte is zero, the operation proceeds with the next operand byte. When the first operand field is exhausted before a nonzero function byte is encountered, the operation is completed by setting the condition code to 0. The contents of general register 1 and 2 remain unchanged.

When the function byte is nonzero, the related argument address is inserted in the low-order 24 bits of general register 1. This address points to the argument last translated. The high-order eight bits of register 1 remain unchanged. The function byte is inserted in the low-order eight bits of general register 2. Bits 0-23 of register 2 remain unchanged. The condition code is set to 1 when the one or more argument bytes have not been translated. The condition code is set to 2 if the last function byte is nonzero.

Resulting Condition Code:

- 0 All function bytes are zero
- 1 Nonzero function byte before the first operand field is exhausted
- 2 Last function byte is nonzero
- 3 --

Program Interruptions:

Addressing

Programming Note

The TRANSLATE AND TEST is useful for scanning an input stream and locating delimiters. The stream can thus be rapidly broken into statements or data fields for further processing.

Edit

ED SS

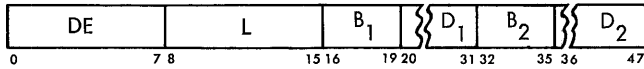

The format of the source (the second operand) is changed from packed to zoned and is edited under control of the pattern (the first operand). The edited result replaces the pattern.

Editing includes sign and punctuation control and the suppressing and protecting of leading zeros. It also facilitates programmed blanking of all-zero fields. Several numbers may be edited in one operation, and numeric information may be combined with text.

The length field applies to the pattern (the first operand). The pattern has the unpacked format and may contain any character. The source (the second operand) has the packed format and must contain valid decimal digit and sign codes. The left four bits of a byte must be 0000-1001; the codes 1010-1111 are recognized as a data exception and cause a program interruption. The right four bits are recognized as either a sign or a digit.

Both operands are processed left to right one character at a time. Overlapping pattern and source fields give unpredictable results.

The character to be stored in the first operand field is determined by three things: the digit obtained from the source field, the pattern character, and the state of a trigger, called the S trigger. One of three actions may be taken:

1. The source digit is expanded to zoned format and is stored.
2. The pattern character is left unchanged.
3. A fill character is stored.

S Trigger: The S trigger is used to control the storing or replacing of source digits and pattern characters. Source digits are replaced when zero suppression or protection is desired. Digits to be stored in the result, whether zero or not, are termed significant. Pattern characters are replaced or stored when they are

significance-dependent (such as punctuation) or sign-dependent (such as credit symbols). The S trigger also is used to record the sign of the source number and set the condition code accordingly.

The S trigger is set to the zero state at the start of the operation and is subsequently changed depending upon the source number and the pattern characters.

Pattern Character: Three pattern characters have a special use in editing. They are the digit-select character, the significance-start character, and the field-separation character. These three characters are replaced, either by a source digit or by a fill character; their encoding is shown in the next table.

1. The digit-select character causes either a source digit or the fill character to be inserted in the result field.

2. The significance-start character has the same function but also indicates, by setting the S trigger, that the following digits are significant.

3. The field-separator character identifies individual fields in a multiple-field editing operation. The character is replaced by the fill character. The S trigger is set to zero, and testing for a zero-field is then re-initiated.

4. All other pattern characters are treated in a common way: If the S trigger is one, the pattern character is left unchanged; if the S trigger is zero, the pattern character is replaced by the fill character.

If the pattern character is either a digit-select or a significance-start character, the source digit is examined. The source digit replaces the pattern character if the S trigger is one or if the source digit is nonzero. If the nonzero digit is inserted when the S trigger is zero, the S trigger is set to one to indicate that the subsequent digits are significant. If the S trigger and the source digit are both zero, the fill character is substituted for the pattern character.

Source Digit: When the source digit is stored in the result, its code is expanded from the packed to the zoned format by attaching a zone. When P_{SW} bit 12 is zero, the preferred EBCDIC zone code 1111 is generated. When P_{SW} bit 12 is one, the preferred ASCII zone code 0101 is generated.

The source digits are examined only once during an editing operation. They are selected eight bits at a time from the second operand field. The leftmost four bits are examined first, and the rightmost four bits remain available for the next pattern character which calls for a digit examination. However, the rightmost

four bits are inspected for a sign code immediately after the leftmost four bits are examined.

Any of the plus-sign codes 1010, 1100, 1110, or 1111 will set the S trigger to zero after the digit is inspected, whereas the minus-sign codes 1011 and 1101 will leave the S trigger unchanged. When one of these sign codes is encountered in the four rightmost bits, these bits no longer are treated as a digit, and a new character is fetched from storage for the next digit to be examined.

A plus sign sets the S trigger to zero even if the trigger was set to one for a nonzero digit in the same source byte or by a significance-start character for that digit.

Fill Character: The fill character is obtained from the pattern as part of the editing operation. The first character of the pattern is used as a fill character and is left unchanged in the result field, except when it is the digit-select or significance-start character. In the latter cases a digit is examined and, when nonzero, inserted.

Result Condition: To facilitate the blanking of all-zero fields, the condition code is used to indicate the sign and zero status of the last field edited. All digits examined are tested for the code 0000. The presence or absence of an all-zero source field is recorded in the condition code at the termination of the editing operation.

1. The condition code is made 0 for a zero source field, regardless of the state of the S trigger.

2. For a nonzero source field and an S trigger of one, the code is made 1 to indicate less than zero.

3. For a nonzero source field and an S trigger of zero, the code is made 2 to indicate greater than zero.

The condition-code setting pertains to fields as specified by the field-separator characters, regardless of the number of signs encountered.

For the multiple-field editing operations the condition-code setting reflects only the field following the last field-separator character. When the last character of the pattern is a field-separator character, the condition code is made 0.

The following table gives the details of the edit operation. The leftmost columns give the pattern character and its code. The next columns show the states of the digit and the S trigger used to determine the resulting action. The rightmost column shows the new setting of the S trigger.

CHARACTER CODE	NAME AND PURPOSE	EXAM-INE DIGIT	TRIG-GER STATUS	DIGIT STATUS	RESULT CHARACTER	TRIG-GER SET
0010 0000	digit select	yes	s=1 s=0	d not 0 d=0	digit digit fill	s=1
0010 0001	significance start	yes	s=1 s=0	d not 0 d=0	digit digit fill	s=1 s=1 s=0
0010 0010	field separator	no			fill	s=0
other	message insertion	no	s=1 s=0		leave fill	

NOTES

- d Source digit
- s S trigger (1: minus sign, digits, or pattern used; 0: plus sign, fill used)
- digit A source digit replaces the pattern character.
- fill The fill character replaces the pattern character.
- leave The pattern character remains unchanged.

Resulting Condition Code:

- 0 Result field is zero
- 1 Result field is less than zero
- 2 Result field is greater than zero
- 3 --

Program Interruptions:

- Operation (if decimal feature is not installed)
- Protection
- Addressing
- Data

Programming Note

As a rule the source operand is shorter than the pattern since it yields two digits or a digit and a sign for each source number.

When a single instruction is used to edit several numbers, the zero-field identification is provided only for the last field.

Edit and Mark

EDMK SS

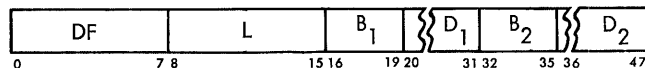

The format of the source (the second operand) is changed from packed to zoned and is edited under control of the pattern (the first operand). The address of each first significant result digit is recorded in general register 1. The edited result replaces the pattern.

The operation is identical to `EDIT`, except for the additional function of inserting a byte address in general register 1. The use of general register 1 is implied. The byte address is inserted in bits 8-31 of this register. The byte address is inserted each time the S trigger is in the zero state and a nonzero digit is inserted in the result field. The address is not inserted when significance is forced by the significance-start character of the pattern. Bits 0-7 are not changed.

Resulting Condition Code:

- 0 Result field is zero
- 1 Result field is less than zero
- 2 Result field is greater than zero
- 3 --

Program Interruptions:

- Operation (if decimal feature is not installed)
- Protection
- Addressing
- Data

Programming Notes

The `EDIT AND MARK` facilitates the programming of floating currency-symbol insertion. The character address inserted in register 1 is one more than the address where a floating currency-sign would be inserted. The `BRANCH ON COUNT`, with zero in the R_2 field, may be used to reduce the inserted address by one.

The character address is not stored when significance is forced. Therefore, the address of the character following the significance-start character should be placed in register 1 prior to `EDIT AND MARK`.

When a single instruction is used to edit several numbers, the address of the first significant digit of each number is inserted in general register 1. Only the last address will be available after the instruction is completed.

Shift Left Single

SLL RS

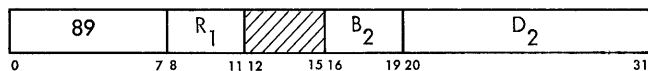

The first operand is shifted left the number of bits specified by the second operand address.

The second operand address is not used to address data; its low-order six bits indicate the number of bit positions to be shifted. The remainder of the address is ignored.

All 32 bits of the general register specified by R_1 participate in the shift. High-order bits are shifted out

without inspection and are lost. Zeros are supplied to the vacated low-order register positions.

Condition Code: The code remains unchanged.

Program Interruptions: None.

Shift Right Single

SRL RS

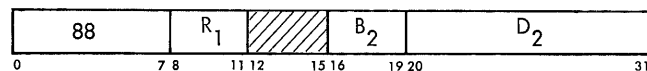

The first operand is shifted right the number of bits specified by the second operand address.

The second operand address is not used to address data; its low-order six bits indicate the number of bit positions to be shifted. The remainder of the address is ignored.

All 32 bits of the general register specified by R_1 participate in the shift. Low-order bits are shifted out without inspection and are lost. Zeros are supplied to the vacated high-order register positions.

Condition Code: The code remains unchanged.

Program Interruptions: None.

Shift Left Double

SIDL RS

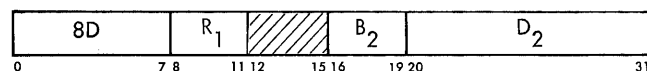

The double-length first operand is shifted left the number of bits specified by the second operand address.

The R_1 field of the instruction specifies an even/odd pair of registers and must contain an even register address. An odd value for R_1 is a specification exception and causes a program interruption. The second operand address is not used to address data; its low-order six bits indicate the number of bit positions to be shifted. The remainder of the address is ignored.

All 64 bits of the even/odd register pair specified by R_1 participate in the shift. High-order bits are shifted out of the even-numbered register without inspection and are lost. Zeros are supplied to the vacated low-order positions of the odd-numbered registers.

Condition Code: The code remains unchanged.

Program Interruptions:

Specification

Shift Right Double

SRDL RS

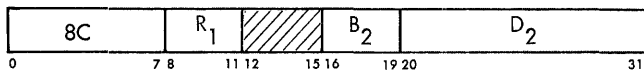

The double-length first operand is shifted right the number of bits specified by the second operand address.

The R_1 field of the instruction specifies an even/odd pair of registers and must contain an even register address. An odd value for R_1 is a specification exception and causes a program interruption. The second operand address is not used to address data; its low-order six bits indicate the number of bit positions to be shifted. The remainder of the address is ignored.

All 64 bits of the even/odd register pair specified by R_1 participate in the shift. Low-order bits are shifted out of the odd-numbered register without inspection and are lost. Zeros are supplied to the vacated high-order positions of the registers.

Condition Code: The code remains unchanged.

Program Interruptions:

Specification

Programming Note

The logical shifts differ from the arithmetic shifts in that the high-order bit participates in the shift and is not propagated, the condition code is not changed, and no overflow occurs.

Logical Operation Exceptions

Exceptional instructions, data, or results cause a program interruption. When the interruption occurs, the current *psw* is stored as an old *psw* and a new *psw*

is obtained. The interruption code in the old *psw* identifies the cause of the interruption. The following exceptions cause a program interruption in logical operations.

Operation: The decimal feature is not installed, and the instruction is *EDIT* or *EDIT AND MARK*. The operation is suppressed. Therefore, the condition code and data in registers and storage remain unchanged.

Protection: The storage key of a result location in storage does not match the protection key in the *psw*. The operation is suppressed. Therefore, the condition code and data in registers and storage remain unchanged. The only exceptions are the variable-length storage-to-storage operations, which are terminated. For terminated operations, the result data and condition code, if affected, are unpredictable and should not be used for further computation.

Addressing: An address designates a location outside the available storage for the installed system. The operation is terminated. The result data and the condition code, if affected, are unpredictable and should not be used for further computation.

Specification: A fullword operand in a storage-to-register operation is not located on a 32-bit boundary or an odd register address is specified for a pair of general registers containing a 64-bit operand. The operation is suppressed. Therefore, the condition code and data in registers and storage remain unchanged.

Data: A digit code of the second operand in *EDIT* or *EDIT AND MARK* is invalid. The operation is terminated. The result data and the condition code are unpredictable and should not be used for further computation.

Operand addresses are tested only when used to address storage. Addresses used as a shift amount are not tested. Similarly, the address generated by the use of *LOAD ADDRESS* is not tested. The address restrictions do not apply to the components from which an address is generated — the contents of the D_1 and D_2 fields, and the contents of the registers specified by X_2 , B_1 , and B_2 .

Instructions are performed by the central processing unit primarily in the sequential order of their locations. A departure from this normal sequential operation may occur when branching is performed. The branching instructions provide a means for making a two-way choice, to reference a subroutine, or to repeat a segment of coding, such as a loop.

Branching is performed by introducing a branch address as a new instruction address.

The branch address may be obtained from one of the general registers or it may be the address specified by the instruction. The branch address is independent of the updated instruction address.

The detailed operation of branching is determined by the condition code which is part of the program status word (PSW) or by the results in the general registers which are specified in the loop-closing operations.

During a branching operation, the rightmost half of the PSW, including the updated instruction address, may be stored before the instruction address is replaced by the branch address. The stored information may be used to link the new instruction sequence with the preceding sequence.

The instruction EXECUTE is grouped with the branching instructions. The branch address of EXECUTE designates a single instruction to be inserted in the instruction sequence. The updated instruction address normally is not changed in this operation, and only the instruction located at the branch address is executed.

All branching operations are provided in the standard instruction set.

Normal Sequential Operation

Normally, operation of the CPU is controlled by instructions taken in sequence. An instruction is fetched from a location specified by the instruction-address field of the PSW. The instruction address is increased by the number of bytes of the instruction to address the next instruction in sequence. This new instruction-address value, called the updated instruction address, replaces the previous contents of the instruction-address field in the PSW. The current instruction is executed, and the same steps are repeated, using the updated instruction address to fetch the next instruction.

Instructions occupy a halfword or a multiple thereof. An instruction may have up to three halfwords. The number of halfwords in an instruction is specified by the first two instruction bits. A 00 code indicates a halfword instruction, codes 01 and 10 indicate a two-halfword instruction, and code 11 indicates a three-halfword instruction.

Halfword Format

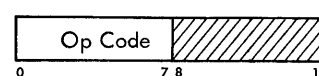

Two-Halfword Format

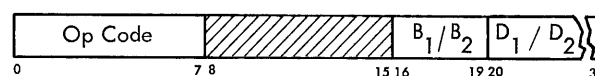

Three-Halfword Format

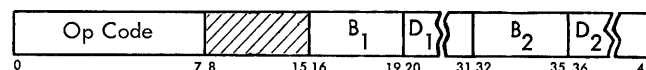

Storage wraps around from the maximum addressable storage location, byte location 16,777,215, to byte location 0. An instruction having its last halfword at the maximum storage location is followed by the instruction at address 0. Also, a multiple-halfword instruction may straddle the upper storage boundary; no special indication is given in these cases.

Conceptually, an instruction is fetched from storage after the preceding operation is completed and before execution of the current operation, even though physical storage word size and overlap of instruction execution with storage access may cause actual instruction fetching to be different.

A change in the sequential operation may be caused by branching, status-switching, interruption, or manual intervention. Sequential operation is initiated and terminated from the system control panel.

Programming Note

It is possible to modify an instruction in storage by means of the immediately preceding instructions.

Sequential Operation Exceptions

Exceptional instruction addresses or operation codes cause a program interruption. When the interruption occurs, the current Psw is stored as an old Psw, and a new Psw is obtained. The interruption code in the old Psw identifies the cause of the interruption. (In this manual, part of the description of each class of instructions is a list of the program interruptions that may occur for these instructions.) The following program interruptions may occur in normal instruction sequencing, independently of the instruction performed.

Operation: The operation code is not assigned.

Addressing: An instruction halfword is located outside the available storage for the particular installation.

Specification: The low-order bit of the instruction address is one.

In each case, the operation is suppressed; therefore, the condition code and data in storage and registers remain unchanged. The instruction address stored as part of the old Psw has been updated by the number of halfwords indicated by the instruction length code in the old Psw.

Programming Notes

An unavailable instruction address may occur when normal instruction sequencing proceeds from a valid storage region into an unavailable region or following a branching or status-switching operation.

The odd instruction address can occur only following branching or status-switching operations.

When the last location in available storage contains an instruction that again introduces a valid instruction address, no program interruption is caused, even though the updated instruction address designates an unavailable location.

The main-storage or register address specification of an instruction with unassigned operation code may cause an addressing or specification interruption when the requirements for the particular instruction class are not met.

Decision-Making

Branching may be conditional or unconditional. Unconditional branches replace the updated instruction address with the branch address. Conditional branches may use the branch address or may leave the updated instruction address unchanged. When branching takes place, the instruction is called successful; otherwise, it is called unsuccessful.

Whether a conditional branch is successful depends on the result of operations concurrent with the branch or preceding the branch. The former case is represented by BRANCH ON COUNT and the branch-on-index instructions. The latter case is represented by BRANCH ON CONDITION, which inspects the condition code that reflects the result of a previous arithmetic, logical, or I/O operation.

The condition code provides a means for data-dependent decision-making. The code is inspected to qualify the execution of the conditional-branch instructions. The code is set by some operations to reflect the result of the operation, independently of the previous setting of the code. The code remains unchanged for all other operations.

The condition code occupies bit positions 34 and 35 of the Psw. When the Psw is stored during status-switching, the condition code is preserved as part of the Psw. Similarly, the condition code is stored as part of the rightmost half of the Psw in a branch-and-link operation. A new condition code is obtained by a LOAD Psw or SET PROGRAM MASK or by the new Psw loaded as a result of an interruption.

The condition code indicates the outcome of some of the arithmetic, logical, or I/O operations. It is not changed for any branching operation, except for EXECUTE. In the case of EXECUTE, the condition code is set or left unchanged by the subject instruction, as would have been the case had the subject instruction been in the normal instruction stream.

The table at the end of this section lists all instructions capable of altering the condition code and the meaning of the codes for these instructions.

Instruction Formats

Branching instructions use the following three formats:

RR Format

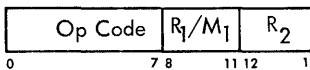

RX Format

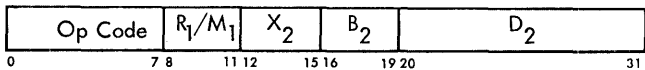

RS Format

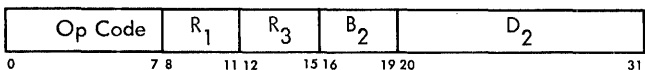

In these formats R_1 specifies the address of a general register. In **BRANCH ON CONDITION** a mask field (M_1) identifies the bit values of the condition code. The branch address is defined differently for the three formats.

In the **RR** format, the R_2 field specifies the address of a general register containing the branch address, except when R_2 is zero, which indicates no branching. The same register may be specified by R_1 and R_2 .

In the **RX** format, the contents of the general registers specified by the X_2 and B_2 fields are added to the content of the D_2 field to form the branch address.

In the **RS** format, the content of the general register specified by the B_2 field is added to the content of the D_2 field to form the branch address. The R_3 field in this format specifies the location of the second operand and implies the location of the third operand. The first operand is specified by the R_1 field. The third operand location is always odd. If the R_3 field specifies an even register, the third operand is obtained from the next higher addressed register. If the R_3 field specifies an odd register, the third operand location coincides with the second operand location.

A zero in a B_2 or X_2 field indicates the absence of the corresponding address component.

An instruction can specify the same general register for both address modification and operand location. The order in which the contents of the general registers are used for the different parts of an operation is:

1. Address computation.
2. Arithmetic or link information storage.
3. Replacement of the instruction address by the branch address obtained under step 1.

Results are placed in the general register specified by R_1 . Except for the storing of the final results, the contents of all general registers and storage locations participating in the addressing or execution part of an operation remain unchanged.

Programming Note

In several instructions the branch address may be specified in two ways: in the **RX** format, the branch address is the address specified by X_2 , B_2 , and D_2 , in the **RR** format, the branch address is the contents of the register specified by R_2 . Note that the relation of the two formats in branch-address specification is not the same as in operand-address specification. For operands, the address specified by X_2 , B_2 , and D_2 is the operand address, but the register specified by R_2 contains the operand itself.

Branching Instructions

The branching instructions and their mnemonics, formats, and operation codes follow. The table also shows which instructions are not part of the small binary instruction set and the exceptions that cause a program interruption. The subject instruction of **EXECUTE** follows its own rules for interruptions. The condition code is never changed for branching instructions.

NAME	MNEMONIC	TYPE	EXCEPTIONS	CODE
Branch on Condition	BCR	RR		07
Branch on Condition	BC	RX		47
Branch and Link	BALR	RR		05
Branch and Link	BAL	RX		45
Branch on Count	BCTR	RR		06
Branch on Count	BCT	RX		46
Branch on Index High	BXH	RS		86
Branch on Index Low or Equal	BXLE	RS		87
Execute	EX	RX	A,S, EX	44

- NOTES
- A Addressing exception
 - EX Execute exception
 - S Specification exception

Branch On Condition

BCR RR

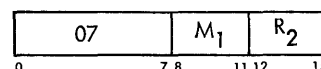

BC RX

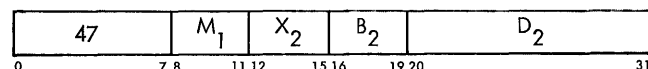

The updated instruction address is replaced by the branch address if the state of the condition code is as specified by M_1 ; otherwise, normal instruction sequencing proceeds with the updated instruction address.

The M_1 field is used as a four-bit mask. The four bits of the mask correspond, left to right, with the four condition codes (0, 1, 2, and 3) as follows:

CONDITION CODE	INSTRUCTION BIT
0	8
1	9
2	10
3	11

The branch is successful whenever the condition code has a corresponding mask bit of one.

Condition Code: The code remains unchanged.
Program Interruptions: None.

Programming Note

When all four mask bits are ones, the branch is unconditional. When all four mask bits are zero or when the R_2 field in the RR format contains zero, the branch instruction is equivalent to a no-operation.

Branch and Link

BALR RR

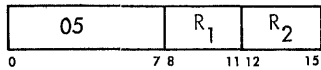

BAL RX

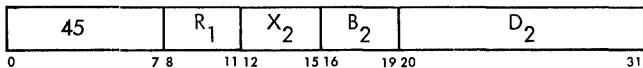

The rightmost 32 bits of the psw, including the updated instruction address, are stored as link information in the general register specified by R_1 . Subsequently, the instruction address is replaced by the branch address.

The branch address is determined before the link information is stored. The link information contains the instruction length code, the condition code, and the program mask bits, as well as the updated instruction address. The instruction-length code is 1 or 2, depending on the format of the BRANCH AND LINK.

Condition Code: The code remains unchanged.

Program Interruptions: None.

Programming Note

The link information is stored without branching when in the RR format the R_2 field contains zero.

When BRANCH AND LINK is the subject instruction of EXECUTE, the instruction-length code is 2.

Branch On Count

BCTR RR



BCT RX

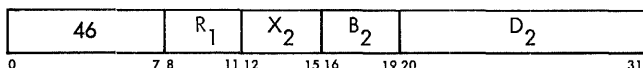

The content of the general register specified by R_1 is algebraically reduced by one. When the result is zero, normal instruction sequencing proceeds with the up-

dated instruction address. When the result is not zero, the instruction address is replaced by the branch address.

The branch address is determined prior to the counting operation. Counting does not change the condition code. The overflow occurring on transition from the maximum negative number to the maximum positive number is ignored. Otherwise, the subtraction proceeds as in fixed-point arithmetic, and all 32 bits of the general register participate in the operation.

Condition Code: The code remains unchanged.

Program Interruptions: None.

Programming Notes

Counting is performed without branching when the R_2 field in the RR format contains zero.

An initial count of zero is not a special case. It results in minus one and causes branching to be executed.

Branch On Index High

BXH RS

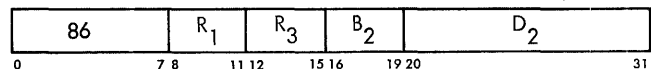

The second operand is added to the first operand; and the sum is compared algebraically with the third operand. Subsequently, the sum is placed in the first operand location, regardless of whether the branch is taken. When the sum is high, the instruction address is replaced by the branch address. When the sum is low or equal, instruction sequencing proceeds with the updated instruction address.

The first and the second operands are in the registers specified by R_1 and R_3 . The third operand register address is odd and is either one larger than R_3 or equal to R_3 . The branch address is determined prior to the addition and comparison.

Overflow caused by the addition is ignored and does not affect the comparison. Otherwise, the addition and comparison proceed as in fixed-point arithmetic. All 32 bits of the general registers participate in the operations, and negative quantities are expressed in two's-complement notation. When the first and third operand locations coincide, the original register contents are used as third operand.

Condition Code: The code remains unchanged.

Program Interruptions: None.

Programming Note

The name "branch on index high" indicates that one of the major purposes of this instruction is the incre-

menting and testing of an index value. The increment may be algebraic and of any magnitude.

Branch On Index Low or Equal

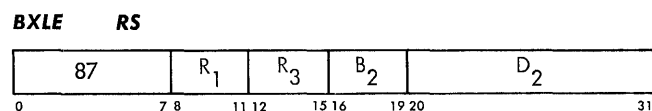

The second operand is added to the first operand, and the sum is compared algebraically with the third operand. Subsequently, the sum is placed in the first operand location, regardless of whether the branch is taken. When the sum is low or equal, the instruction address is replaced by the branch address. When the sum is high, normal instruction sequencing proceeds with the updated instruction address.

The first and the second operands are in the registers specified by R_1 and R_3 . The third operand register address is odd and is either one larger than R_3 or equal to R_3 . The branch address is determined prior to the addition and comparison.

This instruction is similar to **BRANCH ON INDEX HIGH**, except that the branch is successful when the sum is low or equal compared to the third operand.

Condition Code: The code remains unchanged.

Program Interruptions: None.

Execute

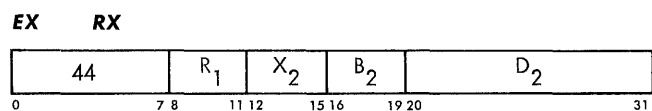

The single instruction at the branch address is modified by the content of the general register specified by R_1 , and the resulting subject instruction is executed.

Bits 8-15 of the instruction designated by the branch address are OR'ed with bits 24-31 of the register specified by R_1 , except when register 0 is specified, which indicates that no modification takes place. The subject instruction may be 16, 32, or 48 bits in length. The OR'ing does not change either the content of the register specified by R_1 or the instruction in storage and is effective only for the interpretation of the instruction to be executed.

The execution and exception handling of the subject instruction are exactly as if the subject instruction were obtained in normal sequential operation, except for instruction address and instruction-length recording.

The instruction address of the PSW is increased by the length of **EXECUTE**. This updated address and the length code (2) of **EXECUTE** are stored in the PSW in the event of a branch-and-link subject instruction or in the event of an interruption.

When the subject instruction is a successful branching instruction, the updated instruction address of the PSW is replaced by the branch address of the subject instruction. When the subject instruction in turn is an **EXECUTE**, an execute exception occurs and results in a program interruption. The effective address of **EXECUTE** must be even; if not, a specification exception will cause a program interruption.

Condition Code: The code may be set by the subject instruction.

Program Interruptions:

Execute
Addressing
Specification

Programming Notes

The OR'ing of eight bits from the general register with the designated instruction permits indirect length, index, mask, immediate data, and arithmetic-register specification.

If the subject instruction is a successful branch, the length code still stands at 2.

An addressing or specification exception may be caused by **EXECUTE** or by the subject instruction.

Branching Exceptions

Exceptional instructions cause a program interruption. When the interruption occurs, the current PSW is stored as an old PSW, and a new PSW is obtained. The interruption code in the old PSW identifies the cause. Exceptions that cause a program interruption in branching are:

Execute: An **EXECUTE** instruction has as its subject instruction another **EXECUTE**.

Addressing: The branch address of **EXECUTE** designates an instruction-halfword location outside the available storage for the particular installation.

Specification: The branch address of **EXECUTE** is odd.

The last three exceptions occur only for **EXECUTE**. The instruction is suppressed. Therefore, the condition code and data in registers and storage remain unchanged.

Exceptions arising for the subject instruction of **EXECUTE** are the same as would have arisen had the subject instruction been in the normal instruction stream. However, the instruction address stored in the old

PSW is the address of the instruction following EXECUTE. Similarly, the instruction-length code in the old PSW is the instruction-length code (2) of EXECUTE.

The address restrictions do not apply to the components from which an address is generated — the content of the D₁ field and the content of the register specified by B₁.

Programming Note

An unavailable or odd branch address of a successful branch is detected during the execution of the next instruction and not as part of the branch.

	CONDITION CODE SETTING			
	0	1	2	3
<i>Fixed-Point Arithmetic</i>				
Add H/F	zero	< zero	> zero	overflow
Add Logical	zero	not zero	zero, carry	carry
Compare H/F	equal	low	high	--
Load and Test	zero	< zero	> zero	carry
Load Complement	zero	< zero	> zero	overflow
Load Negative	zero	< zero	--	--
Load Positive	zero	--	> zero	overflow
Shift Left Double	zero	< zero	> zero	overflow
Shift Left Single	zero	< zero	> zero	overflow
Shift Right Double	zero	< zero	> zero	--
Shift Right Single	zero	< zero	> zero	--
Subtract H/F	zero	< zero	> zero	overflow
Subtract Logical	--	not zero	zero, carry	carry
<i>Decimal Arithmetic</i>				
Add Decimal	zero	< zero	> zero	overflow
Compare Decimal	equal	low	high	--
Subtract Decimal	zero	< zero	> zero	overflow
Zero and Add	zero	< zero	> zero	overflow
<i>Floating-Point Arithmetic</i>				
Add Normalized S/L	zero	< zero	> zero	overflow
Add Unnormalized S/L	zero	< zero	> zero	overflow
Compare S/L	equal	low	high	--
Load and Test S/L	zero	< zero	> zero	--
Load Complement S/L	zero	< zero	> zero	--
Load Negative S/L	zero	< zero	--	--
Load Positive S/L	zero	--	> zero	--
Subtract Normalized S/L	zero	< zero	> zero	overflow
Subtract Unnormalized S/L	zero	< zero	> zero	overflow

Logical Operations

And	zero	not zero	--	--
Compare Logical	equal	low	high	--
Edit	zero	< zero	> zero	--
Edit and Mark	zero	< zero	> zero	--
Exclusive Or	zero	not zero	--	--
Or	zero	not zero	--	--
Test Under Mask	zero	mixed	--	one
Translate and Test	zero	incomplete	complete	--

Input-Output Operations

Halt I/O	not working	halted	stopped	not oper
Start I/O	available	CSW stored	busy	not oper
Test Channel	not working	CSW ready	working	not oper
Test I/O	available	CSW stored	working	not oper

NOTES

available	Unit and channel available
busy	Unit or channel busy
carry	A carryout of the sign position occurs
complete	Last result byte nonzero
CSW ready	Channel status word ready for test or interruption
CSW stored	Channel status word stored
equal	Operands compare equal
F	Fullword
> zero	Result is greater than zero
H	Halfword
halted	Data transmission stopped. Unit in halt-reset mode
high	First operand compares high
incomplete	Nonzero result byte; not last
L	Long precision
< zero	Result is less than zero
low	First operand compares low
mixed	Selected bits are both zero and one
not oper	Unit or channel not operational
not working	Unit or channel not working
not zero	Result is not all zero
one	Selected bits are one
overflow	Result overflows
S	Short precision
stopped	Data transmission stopped
working	Unit or channel working
zero	Result or selected bits are zero

NOTE: The condition code also may be changed by LOAD PSW, SET SYSTEM MASK, and DIAGNOSE and by an interruption.

A set of operations is provided to switch the status of the CPU, of storage, and of communication between systems.

The over-all CPU status is determined by several program-state alternatives, each of which can be changed independently to its opposite and most of which are indicated by a bit in the program status word (PSW). The CPU status is further defined by the instruction address, the condition code, the instruction-length code, the storage-protection key, and the interruption code. These all occupy fields in the PSW.

Storage is protected by storage keys, which are matched with a protection key in the PSW or in a channel. The protection status of storage may be changed by introducing new storage keys, using `SET STORAGE KEY`. The storage keys may be inspected by using `INSERT STORAGE KEY`.

The system formed by CPU, storage, and I/O can communicate with other systems by means of the signals of the direct control feature and the multisystem feature. The `READ DIRECT` makes signals available to the CPU; `WRITE DIRECT` provides signals to other systems.

All status-switching instructions, other than those of the protection feature or direct control feature, are provided in the standard instruction set.

Program States

The four types of program-state alternatives, which determine the over-all CPU status, are named Problem/Supervisor, Wait/Running, Masked/Interruptable, and Stopped/Operating. These states differ in the way they affect the CPU functions and in the way their status is indicated and switched. Each state, except masked, has one alternative.

All program states are independent of each other in their function, indication, and status-switching. Status-switching does not affect the contents of the arithmetic registers or the execution of I/O operations but may affect the timer operation.

Problem State

The choice between supervisor and problem state determines whether the full set of instructions is valid. The names of these states reflect their normal use.

In the problem state all I/O, protection, and direct-

control instructions are invalid, as well as `LOAD PSW`, `SET SYSTEM MASK`, and `DIAGNOSE`. These are called privileged instructions. A privileged instruction encountered in the problem state constitutes a privileged-operation exception and causes a program interruption. In the supervisor state all instructions are valid.

When bit 15 of the PSW is zero, the CPU is in the supervisor state. When bit 15 is one, the CPU is in the problem state. The supervisor state is not indicated on the operator sections of the system control panel.

The CPU is switched between problem and supervisor state by changing bit 15 of the PSW. This bit can be changed only by introducing a new PSW. Thus status-switching may be performed by `LOAD PSW`, using a new PSW with the desired value for bit 15. Since `LOAD PSW` is a privileged instruction, the CPU must be in the supervisor state prior to the switch. A new PSW is also introduced when the CPU is interrupted. The `SUPERVISOR CALL` causes an interruption and thus may change the CPU state. Similarly, initial program loading introduces a new PSW and with it a new CPU state. The new PSW may introduce the problem or supervisor state regardless of the preceding state. No explicit operator control is provided for changing the supervisor state.

Timer updating is not affected by the choice between supervisor and problem state.

Programming Note

To allow return from an interruption-handling routine to a preceding program by a `LOAD PSW`, the PSW for the interruption routine should specify the supervisor state.

Wait State

In the wait state no instructions are processed, and storage is not addressed repeatedly for this purpose, whereas in the running state, instruction fetching and execution proceed in the normal manner.

When bit 14 of the PSW, is one, the CPU is waiting. When bit 14 is zero, the CPU is in the running state. The wait state is indicated on the operator control section of the system control panel by the wait light.

The CPU is switched between wait and running state by changing bit 14 of the PSW. This bit can be changed only by introducing an entire new PSW, as is the case with the problem-state bit. Thus, switching from the

running state may be achieved by the privileged instruction `LOAD PSW`, by an interruption such as for `SUPERVISOR CALL`, or by initial program loading. Switching from the wait state may be achieved by an I/O or external interruption or, again, by initial program loading. The new `PSW` may introduce the wait or running state regardless of the preceding state. No explicit operator control is provided for changing the wait state.

Timer updating is not affected by the choice between running and wait state.

Programming Note

To leave the wait state without manual intervention, the CPU should remain interruptible for some active I/O or external interruption source.

Masked States

The CPU may be masked or interruptible for all systems and machine-check interruptions and for some program interruptions. When the CPU is interruptible for a class of interruptions, these interruptions are accepted. When the CPU is masked, the system interruptions remain pending, while the program and machine-check interruptions are ignored.

The system mask bits (`PSW` bits 0-7), the program mask bits (`PSW` bits 36-39), and the machine-check mask bit (`PSW` bit 13) indicate as a group the masked state of the CPU. When a mask bit is one, the CPU is interruptible for the corresponding interruptions. When the mask bit is zero, these interruptions are masked off. The system mask bits indicate the masked state of the CPU for the multiplexor channel, the six selector channels, and the external signals. The program mask bits indicate the masked state for four of the 15 types of program exceptions. The machine-check mask bit pertains to all machine checks. Program interruptions not maskable, as well as the supervisor-call interruption, are always taken. The masked states are not indicated on the operator sections of the system control panel.

Most mask bits do not affect the execution of CPU operations. The only exception is the significance mask bit, which determines the manner in which a floating-point operation is completed when a significance exception occurs.

The interruptible state of the CPU is switched by changing the mask bits in the `PSW`. The program mask may be changed separately by `SET PROGRAM MASK`, and the system mask may be changed separately by the privileged instruction `SET SYSTEM MASK`. The machine-check mask bit can be changed only by introducing an entire new `PSW`, as is the case with the problem-state and wait-state bits. Thus, a change in the entire

masked status may be achieved by the privileged instruction `LOAD PSW`, by an interruption such as for `SUPERVISOR CALL`, or by initial program loading. The new `PSW` may introduce a new masked state regardless of the preceding state. No explicit operator control is provided for changing the masked state.

Timer updating is not affected by the choice between masked or interruptible states.

Programming Note

To prevent an interruption-handling routine from being interrupted before necessary housekeeping steps are performed, the new `PSW` for that interruption should mask the CPU for further interruptions of the kind that caused the interruption.

Stopped State

When the CPU is in the stopped state, instructions and interruptions are not executed. In the operating state, the CPU executes instructions (if not waiting) and interruptions (if not masked off).

The stopped state is indicated on the operator control section of the system control panel by the manual light. The stopped state is not identified by a bit in the `PSW`.

A change in the stopped or operating state can be effected only by manual intervention or by machine malfunction. No instructions or interruptions can stop or start the CPU. The CPU is commanded to stop when the stop key on the operator intervention section of the system control panel is pressed, when an address comparison indicates equality, and when the rate switch is set to `INSTRUCTION STEP`. In addition, the CPU is placed in the stopped state after power is turned on or following a system reset, except during initial program loading. The CPU is placed in the operating state when the start key on the operator intervention panel is pressed. The CPU is also placed in the operating state when initial program loading is commenced.

The transition from operating to stopped state occurs at the end of instruction execution and prior to starting the next instruction execution. When the CPU is in the wait state, the transition takes place immediately. All interruptions pending and not masked off are taken while the CPU is still in the operating state. They cause an old `PSW` to be stored and a new `PSW` to be fetched before entering the stopped state. Once the CPU is in the stopped state, interruptions are no longer taken but remain pending.

The timer is not updated in the stopped state.

Programming Notes

Except for timing considerations, execution of a program is not affected by stopping the CPU.

When because of machine malfunction the CPU is unable to end an instruction, the stop key is not effective, and initial program loading or system reset should be used.

Input/output operations continue to completion while the CPU is in the problem, wait, masked, or stopped state. However, no new I/O operations can be initiated while the CPU is stopped, waiting, or in the problem state. Also, the interruption caused by I/O completion remains pending when masked off or when the CPU is in the stopped state.

Storage Protection

Storage protection is provided to protect the contents of certain areas of storage from destruction caused by erroneous storing of information during the execution of a program. This protection is achieved by identifying blocks of storage with a storage key and comparing this key with a protection key supplied with the data to be stored. The detection of a mismatch is a protection exception and results in a program interruption.

Area Identification

For protection purposes, main storage is divided into blocks of 2,048 bytes, each block having an address that is a multiple of 2,048. A four-bit storage key is associated with each block. When data are stored in a storage block, the storage key is compared with the protection key. The protection key of the current PSW is used as the comparand when storing is specified by an instruction. When storing is specified by a channel operation, the protection key supplied to the channel by the command address word is used as the comparand. The keys are said to match when they are equal or when either one is zero.

The storage key is not part of addressable storage. The key is changed by SET STORAGE KEY and is inspected by INSERT STORAGE KEY. The protection key in the PSW occupies bits 8-11 of that control word. The protection key of a channel is recorded in bits 0-3 of the channel status word, which is stored as a result of the channel operation.

Protection Action

The storage-protection system is always active. It is independent of the problem, supervisor, or masked state of the CPU and of the type of instruction or I/O command being executed.

When an instruction causes a protection mismatch, execution of the instruction is suppressed or terminated, and program execution is altered by a program

interruption. The protected storage location always remains unchanged.

In general, the detection of a protected location causes the instruction specifying this location to be suppressed, that is to be omitted entirely. In operations using multiple words or variable-length fields, part of the operation may already have been completed when the protected area is referenced. In these operations the instruction cannot be suppressed and, hence, is terminated.

Protection mismatch due to an I/O operation causes data transmission to be terminated in such a way that the protected storage location remains unchanged. The mismatch is indicated in the channel status word stored as a result of the operation.

Storage protection is optional in some models. When protection is not installed, the protection key in the PSW and the protection key of the channels must be zero; otherwise, a program interruption or program-check I/O termination occurs.

Locations Protected

All main-storage locations where information is stored in the course of an operation are subject to protection. A location not actually used does not cause protection action.

Locations whose addresses are generated by the CPU for updating or interruption purposes, such as the timer, channel status word, or PSW addresses, are not protected. However, when the program specifies these locations, they are subject to protection.

Program Status Word

The PSW contains all information not contained in storage or registers but required for proper program execution. By storing the PSW, the program can preserve the detailed status of the CPU for subsequent inspection. By loading a new PSW or part of a PSW, the state of the CPU may be changed.

In certain circumstances all of the PSW is stored or loaded; in others, only part of it. The entire PSW is stored, and a new PSW is introduced when the CPU is interrupted. The rightmost 32 bits are stored in BRANCH AND LINK. The LOAD PSW introduces a new PSW; SET PROGRAM mask introduces a new condition code and program-mask field in the PSW; SET SYSTEM MASK introduces a new system-mask field.

The PSW has the following format:

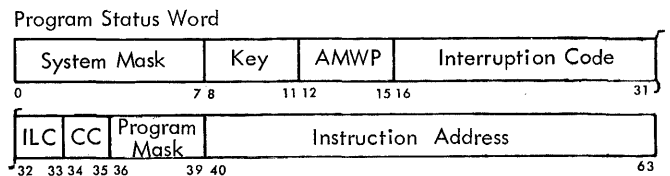

The following is a summary of the purposes of the psw fields:

System Mask: Bits 0-7 of the psw are associated with i/o channels and external signals as specified in the following table. When a mask bit is one, the source can interrupt the CPU. When a mask bit is zero, the corresponding source can not interrupt the CPU and interruptions remain pending.

SYSTEM MASK BIT	INTERRUPTION SOURCE
0	Multiplexor channel
1	Selector channel 1
2	Selector channel 2
3	Selector channel 3
4	Selector channel 4
5	Selector channel 5
6	Selector channel 6
7	Timer
7	Interrupt key
7	External signal

Protection Key: Bits 8-11 of the psw form the CPU protection key. The key is matched with a storage key whenever a result is stored. When the protection feature is not implemented, bits 8-11 must be zero when loaded and are zero when stored.

ASCII(A): When bit 12 of the psw is one, the codes preferred for the extended ASCII code are generated for decimal results. When psw 12 is zero, the codes preferred for the extended binary-coded-decimal interchange code are generated.

Machine-Check Mask (M): When psw bit 13 is one, the machine-check interruption, machine check out-signal, and diagnostics occur upon malfunction detection. When bit 13 of the psw is zero, the CPU is masked for machine-check interruptions, and any associated signals and diagnostic procedures do not take place. The interruption does not remain pending.

Wait State (W): When bit 14 of the psw is one, the CPU is in the wait state. When psw bit 14 is zero, the CPU is in the running state.

Problem State (P): When bit 15 of the psw is one, the CPU is in the problem state. When psw bit 15 is zero, the CPU is in the supervisor state.

Interruption Code: Bits 16-31 of the psw identify the cause of an i/o, program, supervisor call, or external interruption. The code is zero when a machine-check interruption occurs. Use of the code for all five interruption types is shown in a table appearing in the "Interruptions" section.

Instruction Length Code (ILC): The code in psw bits 32 and 33 indicates the length, in halfwords, of the last-interpreted instruction when a program or supervisor-call interruption occurs. The code is unpredictable for i/o, external, or machine-check interruptions. Encoding of these bits is summarized in a table appearing in the "Interruptions" sections.

Condition Code (CC): Bits 34 and 35 of the psw are the two bits of the condition code. The condition codes for all instructions are summarized in a table appearing in the "Branching" section.

Program Mask: Bits 36-39 of the psw are the four program mask bits. Each bit is associated with a program exception, as specified in the following table. When the mask bit is one, the exception results in an interruption. When the mask bit is zero, no interruption occurs. The significance mask bit also determines the manner in which floating-point addition and subtraction are completed.

PROGRAM MASK BIT	PROGRAM EXCEPTION
36	Fixed-point overflow
37	Decimal overflow
38	Exponent underflow
39	Significance

Instruction Address: Bits 40-63 of the psw are the instruction address. This address specifies the leftmost eight-bit byte position of the next instruction.

Multisystem Operation

Various features are provided to permit communication between individual systems. Messages may be transmitted by means of a shared i/o device, a channel connector, or a shared storage unit. Signaling may be accomplished when the direct control feature is installed by WRITE DIRECT and READ DIRECT and by the signal-in lines of the external interruption.

The multisystem feature adds to these facilities the ability to relocate direct addressed locations, to signal the machine malfunction of one system to another, and to initiate system operation from another system.

Direct Address Relocation

Addresses 0-4095 can be generated without a base address or index. This property is important when the psw and general register contents must be preserved and restored during program-switching. These addresses further include all addresses generated by the CPU for fixed locations, such as old psw, new psw, channel address word, channel status word, and timer.

This set of addresses can be relocated by means of a main prefix to permit more than one CPU to use one uniquely addressed storage. Furthermore, an alternate prefix is provided to permit a change in relocation in case storage malfunction occurs or reconfiguration becomes otherwise desirable.

A prefix is used whenever an address has the high-order 12 bits all-zero. The use of the prefix is independent of the manner in which the address is generated and does not apply to the components, such as the

base or index registers, from which the address is generated. The use of the prefix applies both to addresses obtained from the program (CPU or I/O), and to fixed addresses generated by the CPU for updating or interruption purposes.

Both main prefix and alternate prefix occupy 12 bits. One or the other replaces the 12 high-order address bits when these are found to be zero.

The choice of main or alternate prefix is determined by the prefix trigger. This trigger is set during initial program loading (IPL) and remains unchanged until the next initial program loading occurs. Manual IPL sets the prefix trigger to the state of the prefix-select switch on the operator control section of the system control panel. Electronic IPL sets the prefix trigger to the state indicated by the signal line used. The state of the prefix is indicated by the alternate-prefix light on the operator intervention section of the system control panel.

The prefixes can be changed by hand within 5 minutes from one prewired encoding to another. The low-order four bits of a prefix always have even parity, and the total number of one-bits in a prefix cannot exceed seven.

Malfunction Indication

A machine check out-signal occurs whenever a machine check is recognized and the machine-check mask bit is one. The signal has 0.5-microsecond to 1.0-microsecond duration and is identical in electronic characteristics to the signals on the signal-out lines of the direct control feature.

The machine check out-signal is given during machine-check handling and has a high probability of being issued in the presence of machine malfunction.

System Initialization

A main IPL in-line and an alternate IPL in-line respond to 0.5-microsecond to 1.0-microsecond pulses. Either line, when pulsed, sets the prefix trigger to the state indicated by its name and subsequently starts initial program loading. Thus, these lines permit electronic initiation of IPL.

The definition of the signal to which these lines respond is identical in electronic characteristic to the definition for the signal-in lines of the external interruption.

Instruction Format

Status-switching instructions use the following two formats:

RR Format

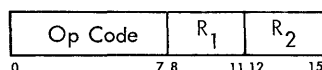

SI Format



In the RR format, the R₁ field specifies a general register, except for SUPERVISOR CALL. The R₂ field specifies a general register in SET STORAGE KEY and INSERT STORAGE KEY. The R₁ and R₂ fields in SUPERVISOR CALL contain an identification code. In SET PROGRAM MASK the R₂ field is ignored.

In the SI format the eight-bit immediate field (I₂) of the instruction contains an identification code. The I₂ field is ignored in LOAD PSW and SET SYSTEM MASK. The content of the general register specified by B₁ is added to the content of the D₁ field to form an address designating the location of an operand in storage. Only one operand location is required in status-switching operations.

A zero in the B₁ field indicates the absence of the corresponding address component.

Instructions

The status-switching instructions and their mnemonics, formats, and operation codes follow. The table also indicates the feature to which an instruction belongs and the exceptions that cause a program interruption.

NAME	MNEMONIC	TYPE	EXCEPTIONS	CODE
Load PSW	LPSW	SI L	M, A,S	82
Set Program Mask	SPM	RR L		04
Set System Mask	SSM	SI	M, A	80
Supervisor Call	SVC	RR		0A
Set Storage Key	SSK	RR Z	M, A,S	08
Insert Storage Key	ISK	RR Z	M, A,S	09
Write Direct	WRD	SI Y	M, A	84
Read Direct	RDD	SI Y	M,P,A	85
Diagnose		SI	M, A,S	83

NOTES

- A Addressing exception
- L New condition code loaded
- M Privileged-operation exception
- P Protection exception
- S Specification exception
- Y Direct control feature
- Z Protection feature

Programming Note

The program status is also switched by interruptions, initial program loading, and manual control.

Load PSW

LPSW SI

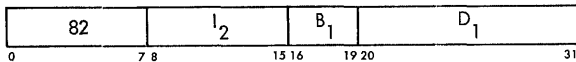

The double word at the location designated by the operand address replaces the PSW.

The operand address must have its three low-order bits zero to designate a double word; otherwise, a specification exception results in a program interruption.

The double word which is loaded becomes the PSW for the next sequence of instructions. Bits 40-63 of the double word become the new instruction address. The new instruction address is not checked for available storage or for an even byte address during a load PSW operation. These checks occur as part of the execution of the next instructions.

Bits 8-11 of the double word become the new protection key. The protection key must be zero when the protection feature is not installed; otherwise, the key is made zero, and a specification exception causes a program interruption.

The interruption code in bit positions 16-31 of the new PSW is not retained as the PSW is loaded. When the PSW is subsequently stored because of an interruption, these bit positions contain a new code. Similarly, bits 32 and 33 of the PSW are not retained upon loading. They will contain the instruction-length code for the last-interpreted instruction when the PSW is stored during a branch-and-link operation or during a program or supervisor-call interruption.

Condition Code: The code is set according to bits 34 and 35 of the new PSW loaded.

Program Interruptions:

- Privileged operation
- Addressing
- Specification

Programming Note

The CPU enters the problem state when LOAD PSW loads a double word with a one in bit position 15 and similarly enters the wait state if bit position 14 is one. The LOAD PSW is the only instruction available for entering the problem state or the wait state.

Set Program Mask

SPM RR

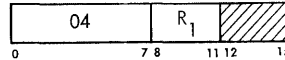

Bits 2-7 of the general register specified by the R₁ field replace the condition code and the program mask bits of the current PSW.

Bits 0, 1, and 8-31 of the register specified by the R₁ field are ignored. The contents of the register specified by the R₁ field remain unchanged.

The instruction permits setting of the condition code and the mask bits in either the problem or supervisor state.

Condition Code: The code is set according to bits 2 and 3 of the register specified by R₁.

Program Interruptions: None.

Programming Note

Bits 2-7 of the general register may have been loaded from the PSW by BRANCH AND LINK.

Set System Mask

SSM SI

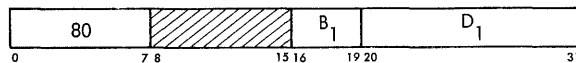

The byte at the location designated by the operand address replaces the system mask bits of the current PSW.

Condition Code: The code remains unchanged.

Program Interruptions:

- Privileged operation
- Addressing

Supervisor Call

SVC RR

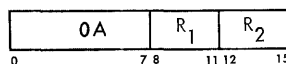

The instruction causes a supervisor-call interruption, with the R₁ and R₂ field of the instruction providing the interruption code.

The contents of bit positions 8-15 of the instruction are placed in bit positions 24-31 of the old *psw* which is stored in the course of the interruption. Bit positions 16-23 of the old *psw* are made zero. The old *psw* is stored at location 32, and a new *psw* is obtained from location 96. The instruction is valid in both problem and supervisor state.

Condition Code: The code remains unchanged in the old *psw*.

Program Interruptions: None.

Set Storage Key

SSK RR

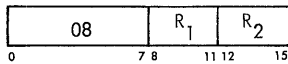

The key of the storage block addressed by the register designated by R₂ is set according to the key in the register designated by R₁.

The storage block of 2,048 bytes, located on a multiple of the block length, is addressed by bits 8-20 of the register designated by the R₂ field. Bits 0-7 and 21-27 of this register are ignored. Bits 28-31 of the register must be zero; otherwise, a specification exception causes a program interruption.

The four-bit storage key is obtained from bits 24-27 of the register designated by the R₁ field. Bits 0-23 and 28-31 of this register are ignored.

Condition Code: The code remains unchanged.

Program Interruptions:

- Operation (if protection feature is not installed)
- Privileged operation
- Addressing
- Specification

Insert Storage Key

ISK RR

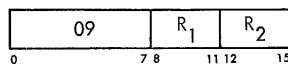

The key of the storage block addressed by the register designated by R₂ is inserted in the register designated by R₁.

The storage block 2,048 bytes, located on a multiple of the block length, is addressed by bits 8-20 of the register designated by the R₂ field. Bits 0-7 and

21-27 of this register are ignored. Bits 28-31 of the register must be zero; otherwise, a specification exception causes a program interruption. The four-bit storage key is inserted in bits 24-27 of the register specified by the R₁ field. Bits 0-23 of this register remain unchanged, and bits 28-31 are set to zero.

Condition Code: The code remains unchanged.

Program Interruptions:

- Operation (if protection feature is not installed)
- Privileged operation
- Addressing
- Specification

Write Direct

WRD SI

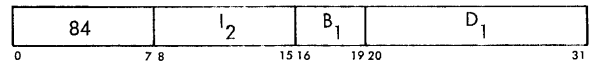

The byte at the location designated by the operand address is made available as a set of direct-out static signals. Eight instruction bits are made available as signal-out timing signals.

The eight data bits of the byte fetched from storage are presented on a set of eight direct-out lines as static signals. These signals remain until the next WRITE DIRECT is executed. No parity is presented with the eight data bits.

Instruction bits 8-15, the I₂ field, are made available simultaneously on a set of eight signal-out lines as 0.5-microsecond to 1.0-microsecond timing signals. On a ninth line (write out) a 0.5-microsecond to 1.0-microsecond timing signal is made available coincident with these timing signals. The leading edge of the timing signals coincides with the leading edge of the data signals. The eight signal-out lines are also used in READ DIRECT. No parity is made available with the eight instruction bits.

Condition Code: The code remains unchanged.

Program Interruptions:

- Operation (if direct control feature is not installed)
- Privileged operation
- Addressing

Programming Note

The timing signals and the write-out signal may be used to alert the equipment to which the data are sent. When data are sent to another CPU, the external signal interruption may be used to alert that CPU.

Read Direct

RDD SI

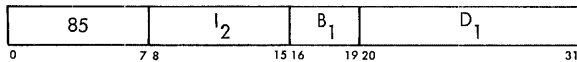

Eight instruction bits are made available as signal-out timing signals. A direct-in data byte is accepted from an external device in the absence of a hold signal and is placed in the location designated by the operand address.

Instruction bits 8-15, the I₂ field, are made available on a set of eight signal-out lines as 0.5-microsecond to 1.0-microsecond timing signals. These signal-out lines are also used in WRITE DIRECT. On a ninth line (Read Out) a 0.5-microsecond to 1.0-microsecond timing signal is made available coincident with these timing signals. The read-out line is distinct from the write-out line in WRITE DIRECT. No parity is made available with the eight instruction bits.

Eight data bits are accepted from a set of eight direct-in lines when the hold signal on the hold-in line is absent. The hold signal is sampled after the read-out signal has been completed and should be absent for at least 0.5-microsecond. No parity is accepted with data signals, but a parity bit is generated as the data are placed in storage. When the hold signal is not removed, the CPU does not complete the instruction. Excessive duration of this instruction may result in incomplete updating of the timer.

Condition Code: The code remains unchanged.

Program Interruptions:

- Operation (if direct control feature is not installed)
- Privileged operation
- Protection
- Addressing

Programming Note

The direct-out lines of one CPU may be connected to the direct-in lines of another CPU, providing CPU-to-CPU static signaling. Further, the write-out signal of the sending CPU may serve as the hold signal for the receiving CPU, temporarily inhibiting a READ DIRECT when the signals are in transition.

Equipment connected to the hold-in line should be so constructed that the hold signal is removed when READ DIRECT is performed. Absence of the hold signal should correspond to absence of current in such a fashion that the CPU can proceed when power is removed from the source of the hold signal.

Diagnose

SI

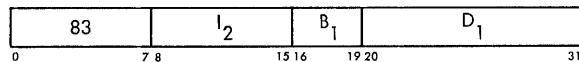

The CPU performs built-in diagnostic functions.

The purpose of the I₂ field and the operand address may be defined in greater detail for a particular CPU and its appropriate diagnostic procedures. Similarly, the number of low-order address bits which must be zero is further specified for a particular CPU. When the address does not have the required number of low-order zeros, a specification exception causes a program interruption.

The purpose of the diagnostic functions is verification of proper functioning of the CPU equipment and locating faulty components.

The DIAGNOSE is completed either by taking the next sequential instruction or by obtaining a new PSW from location 112. The diagnostic procedure may affect the problem, supervisor, and interruptible status of the CPU, the condition code, and the contents of storage, registers, and timer, as well as the progress of I/O operations.

Some diagnostic functions turn on the test light on the operator control section of the system control panel.

Since the instruction is not intended for problem-program or supervisor-program use, DIAGNOSE has no mnemonic.

Condition Code: The code is unpredictable.

Program Interruptions:

- Privileged operation
- Specification
- Addressing

Status-Switching Exceptions

Exceptional instructions or data cause a program interruption. When the interruption occurs, the current PSW is stored as an old PSW, and a new PSW is obtained. The interruption code inserted in the old PSW identifies the cause of the interruption. The following exception conditions cause a program interruption in status-switching operations.

Operation: The direct control feature is not installed, and the instruction is READ DIRECT or WRITE DIRECT; or,

the protection feature is not installed and the instruction is SET STORAGE KEY or INSERT STORAGE KEY.

Privileged Operation: A LOAD PSW, SET SYSTEM MASK, SET STORAGE KEY, INSERT STORAGE KEY, WRITE DIRECT, READ DIRECT, or DIAGNOSE is encountered while the processor is in the problem state.

Protection: The storage key of the location designated by READ DIRECT does not match the protection key in the PSW.

Addressing: An address designates a location outside the available storage for the installed model.

Specification: The operand address of a LOAD PSW does not have all three low-order bits zero; the operand address of DIAGNOSE does not have as many low-order zero bits as required for the particular CPU; the block address specified by SET STORAGE KEY or INSERT STORAGE KEY does not have the four low-order bits all-zero; or the protection feature is not installed and a

PSW with two nonzero protection keys is introduced.

In most of the above interruption conditions, the instruction is suppressed. Therefore, storage and external signals remain unchanged, and the PSW is not changed by information from storage. The only exception is READ DIRECT, which is terminated when a protection or addressing violation is detected. Although storage remains unchanged, a timing signal may have been made available.

When an interruption is taken, the instruction address stored as part of the old PSW has been updated by the number of halfwords indicated by the instruction-length code in the old PSW.

Operand addresses are tested only when used to address storage. The address restrictions do not apply to the components from which an address is generated: the content of the D_1 field and the content of the register specified by B_1 .

Interruptions

The interruption system permits the CPU to change its state as a result of conditions external to the system, in I/O units, or in the CPU itself. The five classes of these conditions are input/output, program, supervisor-call, external, and machine-check interruptions.

Interruption Action

An interruption consists of storing the current PSW as an old PSW and fetching a new PSW.

Processing resumes in the state indicated by the new PSW. The old PSW contains the address of the instruction that would have been executed next if an interruption had not occurred and the instruction-length code of the last-interpreted instruction.

Interruptions are taken only when the CPU is interruptable for the interruption source. Input/output and external interruptions may be masked by the system mask, four of the 15 program interruptions may be masked by the program mask, and the machine-check interruptions may be masked by the machine-check mask.

An interruption always takes place after one instruction interpretation is finished and before a new instruction interpretation is started. However, the occurrence of an interruption may affect the execution of the current instruction. To permit proper programmed action following an interruption, the cause of the interruption is identified and provision is made to locate the last-interpreted instruction.

When the CPU is commanded to stop, the current instruction is finished, and all interruptions that are pending or become pending before the end of the instruction, and which are not masked, are taken.

The details of instruction execution, source identification, and location determination are explained in later sections and are summarized in the following table.

Programming Note

A pending interruption will be taken even if the CPU becomes interruptable during only one instruction.

INTERRUPTION SOURCE IDENTIFICATION	INTERRUPTION CODE PSW BITS 16-31	MASK BITS	ILC SET	INSTRUCTION EXECUTION
<i>Input/Output</i> (old PSW 56, new PSW 120, priority 4)				
Multiplexor channel	00000000 aaaaaaaa	0	x	complete
Selector channel 1	00000001 aaaaaaaa	1	x	complete
Selector channel 2	00000010 aaaaaaaa	2	x	complete
Selector channel 3	00000011 aaaaaaaa	3	x	complete
Selector channel 4	00000100 aaaaaaaa	4	x	complete
Selector channel 5	00000101 aaaaaaaa	5	x	complete
Selector channel 6	00000110 aaaaaaaa	6	x	complete
<i>Program</i> (old PSW 40, new PSW 104, priority 2)				
Operation	00000000 00000001		1,2,3	suppress
Privileged operation	00000000 00000010		1,2	suppress
Execute	00000000 00000011		2	suppress
Protection	00000000 00000100		0,2,3	suppress/terminate
Addressing	00000000 00000101		1,2,3	suppress/terminate
Specification	00000000 00000110		1,2,3	suppress
Data	00000000 00000111		2,3	terminate
Fixed-point overflow	00000000 00001000	36	1,2	complete
Fixed-point divide	00000000 00001001		1,2	suppress/complete
Decimal overflow	00000000 00001010	37	3	complete
Decimal divide	00000000 00001011		3	suppress
Exponent overflow	00000000 00001100		1,2	terminate
Exponent underflow	00000000 00001101	38	1,2	complete
Significance	00000000 00001110	39	1,2	complete
Floating-point divide	00000000 00001111		1,2	suppress
<i>Supervisor Call</i> (old PSW 32, new PSW 96, priority 2)				
Instruction bits	00000000 rrrrrrrr		1	complete
<i>External</i> (old PSW 24, new PSW 88, priority 3)				
External signal 1	00000000 xxxxxx1	7	x	complete
External signal 2	00000000 xxxxxx1x	7	x	complete
External signal 3	00000000 xxxxxx1xx	7	x	complete
External signal 4	00000000 xxxxxx1xxx	7	x	complete
External signal 5	00000000 xxxxxx1xxxx	7	x	complete
External signal 6	00000000 xxxxxx1xxxxx	7	x	complete
Interrupt key	00000000 x1xxxxxx	7	x	complete
Timer	00000000 1xxxxxxx	7	x	complete
<i>Machine Check</i> (old PSW 48, new PSW 112, priority 1)				
Machine malfunction	00000000 00000000	13	x	terminate

NOTES

- a Device address bits
- r Bits of R₁ and R₂ field of SUPERVISOR CALL
- x Unpredictable

Instruction Execution

An interruption occurs when the preceding instruction is finished and the next instruction is not yet started. The manner in which the preceding instruction is finished may be influenced by the cause of the interruption. The instruction is said to have been completed, terminated, or suppressed.

In the case of instruction completion, results are stored and the condition code is set as for normal instruction operation, although the result may be influenced by the exception which has occurred.

In the case of instruction termination, all, part, or none of the result may be stored. Therefore, the result data are unpredictable. The setting of the condition code, if called for, may also be unpredictable. In general, the results should not be used for further computation.

In the case of instruction suppression, the execution proceeds as if no operation were specified. Results are not stored, and the condition code is not changed.

Source Identification

The five classes of interruptions are distinguished by the storage locations in which the old PSW is stored and from which the new PSW is fetched. The detailed causes are further distinguished by the interruption code of the old PSW, except for the machine-check interruption. The bits of the interruption code are numbered 16-31, according to their position in the PSW.

For I/O interruptions, additional information is provided by the contents of the channel status word stored as part of the I/O interruption.

For machine-check interruptions, additional information is provided by the diagnostic procedure, which is part of the interruption.

The following table lists the permanently allocated main-storage locations.

ADDRESS	LENGTH	PURPOSE
0 0000 0000	Double word	Initial program loading PSW
8 0000 1000	Double word	Initial program loading CCW1
16 0001 0000	Double word	Initial program loading CCW2
24 0001 1000	Double word	External old PSW
32 0010 0000	Double word	Supervisor call old PSW
40 0010 1000	Double word	Program old PSW
48 0011 0000	Double word	Machine old PSW
56 0011 1000	Double word	Input/output old PSW
64 0100 0000	Double word	Channel status word
72 0100 1000	Word	Channel address word
76 0100 1100	Word	Unused
80 0101 0000	Word	Timer
84 0101 0100	Word	Unused
88 0101 1000	Double word	External new PSW
96 0110 0000	Double word	Supervisor call new PSW
104 0110 1000	Double word	Program new PSW
112 0111 0000	Double word	Machine-check new PSW
120 0111 1000	Double word	Input/output new PSW
128 1000 0000		Diagnostic scan-out area*

*The size of the diagnostic scan-out area depends on the particular model and I/O channels.

Location Determination

For some interruptions, it is desirable to locate the instruction being interpreted when the interruption occurred. Since the instruction address in the old PSW designates the instruction to be executed next, it is necessary to know the length of the preceding instruction. This length is recorded in bit positions 32 and 33 of the PSW as the instruction-length code.

The instruction-length code is predictable only for program and supervisor-call interruptions. For I/O and external interruptions, the interruption is not caused by the last-interpreted instruction, and the code is not predictable for these instructions. For machine-check interruptions, the setting of the code may be affected by the malfunction and, therefore, is unpredictable.

For the supervisor-call interruption, the instruction-length code is 1, indicating the halfword length of SUPERVISOR CALL. For program interruptions, the codes 1, 2, and 3 indicate the instruction length in halfwords. The code 0 is reserved for program interruptions where the length of the instruction is not available because of certain overlapping conditions in instruction fetching. In code-0 cases, the instruction address in the old PSW does not represent the next instruction address. Instruction-length code 0 can occur for a program interruption only when the interruption is caused by a protected or an unavailable data address. The following table shows the states of the instruction-length code.

INSTRUCTION LENGTH CODE	PSW BITS 32-33	INSTRUCTION BITS 0-1	INSTRUCTION LENGTH	INSTRUCTION FORMAT
0	00		Not available	
1	01	00	One halfword	RR
2	10	01	Two halfwords	RX
2	10	10	Two halfwords	RS or SI
3	11	11	Three halfwords	SS

Programming Notes

When a program interruption is due to an incorrect branch address, the location determined from the instruction address and instruction-length code is the branch address and not the location of the branch instruction.

When an interruption occurs while the CPU is in the wait state, the instruction-length code is always unpredictable.

The instruction EXECUTE represents upon interruption an instruction-length code which does not reflect the length of the instruction executed, but is 2, the length of EXECUTES.

Input/Output Interruption

The I/O interruption provides a means by which the CPU responds to signals from I/O devices.

A request for an I/O interruption may occur at any time, and more than one request may occur at the same time. The requests are preserved in the I/O section until accepted by the CPU. Priority is established among requests so that only one interruption request is processed at a time.

An I/O interruption can occur only after execution of the current instruction is completed and while the CPU is interruptable for the channel presenting the request. Channels are masked by system mask bits 0-6. Interruptions masked off remain pending.

The I/O interruption causes the old PSW to be stored at location 56 and causes the channel status word associated with the interruption to be stored at location 64. Subsequently, a new PSW is loaded from location 120.

The interruption code in the old PSW identifies the channel and device causing the interruption in bits 21-23 and 24-31, respectively. Bits 16-20 of the old PSW are made zero. The instruction-length code is unpredictable.

Program Interruption

Exceptions resulting from improper specification or use of instructions and data cause a program interruption.

The current instruction is completed, terminated, or suppressed. Only one program interruption occurs for a given instruction and is identified in the old PSW. The occurrence of a program interruption does not preclude the simultaneous occurrence of other program-interruption causes. Which of several causes is identified may vary from one occasion to the next and from one model to another.

A program interruption can occur only when the corresponding mask bit, if any, is one. When the mask bit is zero, the interruption is ignored. Program interruptions do not remain pending. Program mask bits 36-39 permit masking of four of the 15 interruption causes.

The program interruption causes the old PSW to be stored at location 40 and a new PSW to be fetched from location 104.

The cause of the interruption is identified by interruption-code bits 28-31. The remainder of the interruption code, bits 16-27 of the PSW, are made zero. The instruction-length code indicates the length of the preceding instruction in halfwords. For a few cases,

the instruction length is not available. These cases are indicated by code 0.

A description of the individual program exceptions follows. The application of these rules to each class of instructions is further described in the applicable sections. Some of the exceptions listed may also occur in operations executed by I/O channels. In that event, the exception is indicated in the channel status word stored with the I/O interruption (as explained under "Input/Output Operations").

Operation Exception

When an operation code is not assigned or the assigned operation is not available on the particular model, an operation exception is recognized. The operation is suppressed.

The instruction-length code is 1, 2, or 3.

Privileged-Operation Exception

When a privileged instruction is encountered in the problem state, a privileged-operation exception is recognized. The operation is suppressed.

The instruction-length code is 1 or 2.

Execute Exception

When the subject instruction of EXECUTE is another EXECUTE, an execute exception is recognized. The operation is suppressed.

The instruction-length code is 2.

Protection Exception

When the storage key of a result location does not match the protection key in the PSW, a protection exception is recognized.

The operation is suppressed, except in the case of STORE MULTIPLY, READ DIRECT, and variable-length operations, which are terminated.

The instruction-length code is 0, 2, or 3.

Addressing Exception

When an address specifies any part of data, an instruction, or a control word outside the available storage for the particular installation, an addressing exception is recognized.

The operation is terminated for an invalid data address. Data in storage remain unchanged, except when designated by valid addresses. The operation is suppressed for an invalid instruction address.

The instruction-length code normally is 1, 2 or 3; but may be 0 in the case of a data address.

Specification Exception

A specification exception is recognized when:

1. A data, instruction, or control-word address does not specify an integral boundary for the unit of information.
2. The R_1 field of an instruction specifies an odd register address for a pair of general registers that contains a 64-bit operand.
3. A floating-point register address other than 0, 2, 4, or 6 is specified.
4. The multiplier or divisor in decimal arithmetic exceeds 15 digits and sign.
5. The first operand field is shorter than or equal to the second operand field in decimal multiplication or division.
6. The block address specified in SET STORAGE KEY or INSERT STORAGE KEY has the four low-order bits not all zero.
7. A PSW with nonzero protection key is loaded and the protection feature is not installed.

The operation is suppressed. The instruction-length code is 1, 2, or 3.

Data Exception

A data exception is recognized when:

1. The sign or digit codes of operands in decimal arithmetic or editing operations or in CONVERT TO BINARY are incorrect.
2. Fields in decimal arithmetic overlap incorrectly.
3. The decimal multiplicand has too many high-order significant digits.

The operation is terminated. The instruction-length code is 2 or 3.

Fixed-Point-Overflow Exception

When a high-order carry occurs or high-order significant bits are lost in fixed-point add, subtract, shift, or sign-control operations, a fixed-point-overflow exception is recognized.

The operation is completed by ignoring the information placed outside the register. The interruption may be masked by rsw bit 36.

The instruction-length code is 1 or 2.

Fixed-Point-Divide Exception

A fixed-point-divide exception is recognized when a quotient exceeds the register size in fixed-point division, including division by zero, or the result of CONVERT TO BINARY exceeds 31 bits.

Division is suppressed. Conversion is completed by ignoring the information placed outside the register.

The instruction-length code is 1 or 2.

Decimal-Overflow Exception

When the destination field is too small to contain the result field in a decimal operation, a decimal-overflow exception is recognized.

The operation is completed by ignoring the overflow information. The interruption may be masked by rsw bit 37.

The instruction-length code is 3.

Decimal-Divide Exception

When a quotient exceeds the specified data field size, a decimal-divide exception is recognized. The operation is suppressed.

The instruction-length code is 3.

Exponent-Overflow Exception

When the result characteristic exceeds 127 in floating-point addition, subtraction, multiplication, or division, an exponent-overflow exception is recognized. The operation is terminated.

The instruction-length code is 1 or 2.

Exponent-Underflow Exception

When the result characteristic is less than zero in floating-point addition, subtraction, multiplication, or division, an exponent-underflow exception is recognized.

The operation is completed by making the result a true zero. The interruption may be masked by rsw bit 38.

The instruction-length code is 1 or 2.

Significance Exception

When the result of a floating-point addition or subtraction has an all-zero fraction, a significance exception is recognized.

The operation is completed. The interruption may be masked by rsw bit 39. The manner in which the operation is completed is determined by the mask bit.

The instruction-length code is 1 or 2.

Floating-Point-Divide Exception

When division by a floating-point number with zero fraction is attempted, a floating-point divide exception is recognized. The operation is suppressed.

The instruction-length code is 1 or 2.

Supervisor-Call Interruption

The supervisor-call interruption occurs as a result of the execution of SUPERVISOR CALL.

The supervisor-call interruption causes the old rsw to be stored at location 32 and a new rsw to be fetched from location 96.

The contents of bit positions 8-15 of the SUPERVISOR CALL become bits 24-31 in the interruption code of the old PSW. Bits 16-23 of the interruption code are made zero. The instruction-length code is 1, indicating the halfword length of SUPERVISOR CALL.

Programming Notes

The name "supervisor call" indicates that one of the major purposes of the interruption is the switching from problem to supervisor state. This major purpose does not preclude the use of this interruption for other types of status-switching.

The interruption code may be used to convey a message from the calling program to the supervisor.

When SUPERVISOR CALL is performed as the subject instruction of EXECUTE, the instruction-length code is 2.

External Interruption

The external interruption provides a means by which the CPU responds to signals from the timer, from the interrupt key, and from external units.

A request for an external interruption may occur at any time, and requests from different sources may occur at the same time. Requests are preserved until honored by the CPU. All pending requests are presented simultaneously when an external interruption occurs. Each request is presented only once. When several requests from one source are made before the interruption is taken, only one interruption occurs.

An external interruption can occur only when system mask bit 7 is one and after execution of the current instruction is completed. The interruption causes the old PSW to be stored at location 24 and a new PSW to be fetched from location 88.

The source of the interruption is identified by interruption-code bits 24-31. The remainder of the interruption code, PSW bits 16-23, is made zero. The instruction-length code is unpredictable for external interruptions.

Timer

A timer value changing from positive to negative causes an external interruption with bit 24 of the interruption code turned on.

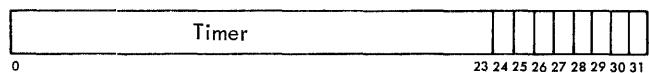

The timer occupies a 32-bit word at storage location 80. In the standard form, the contents of the timer are reduced by a one in bit position 21 and in bit position

23 every 1/60th of a second or the timer contents are reduced by one in bit position 21 and in bit position 22 every 1/50th of a second. The choice is determined by the available line frequency. The gross result in either case is equivalent to reducing the timer by one in bit position 23 every 1/300th of a second.

Higher resolution may be obtained in some models by counting with higher frequency in one of the positions 24 through 31. In each case, the frequency is adjusted to give counting at 300 cycles per second in bit 23, as shown in the table. The full cycle of the timer is 15.5 hours.

BIT POSITION	FREQUENCY	RESOLUTION
23	300 cps	3.33 ms
24	600 cps	1.67 ms
25	1.2 kc	833 μs
26	2.4 kc	417 μs
27	4.8 kc	208 μs
28	9.6 kc	104 μs
29	19.2 kc	52 μs
30	38.4 kc	26 μs
31	76.8 kc	13 μs

The count is treated as a signed integer by following the rules for fixed-point arithmetic. The negative overflow, occurring as the timer is counted from a large negative number to a large positive number, is ignored. The interruption is initiated as the count proceeds from a positive number, including zero, to a negative number.

The timer is updated whenever access to storage permits. An updated timer value is normally available at the end of each instruction execution; thus, a real-time count can be maintained. Timer updating may be omitted when I/O data transmission approaches the limit of storage capability and when the instruction time for READ DIRECT is excessive.

After an interruption is initiated, the timer may have been updated several times before the CPU is actually interrupted, depending upon instruction execution time.

The timer remains unchanged when the CPU is in the stopped state or when the rate switch on the operator intervention panel is set to INSTRUCTION STEP. The timer value may be changed at any time by storing a new value in storage location 80 (except when this location is protected).

The timer is an optional feature on some models.

Programming Note

The timer in association with a program can serve both as a real-time clock and as an interval timer.

Interrupt Key

Pressing the interrupt key on the operator control section of the system control panel causes an external

interruption with bit 25 of the interruption code turned on.

The key is active while power is on.

External Signal

An external signal causes an external interruption, with the corresponding bit in the interruption code turned on.

A total of six signal-in lines may be connected to the CPU for receiving external signals. The pattern presented in interruption-code bits 26-31 depends upon the pattern received before the interruption is taken.

The external signals are part of the direct control feature.

Programming Note

The signal-in lines of one CPU may be connected to the signal-out timing lines of the direct control feature or the machine check out-line of the multisystem feature of another CPU. An interconnection of this kind allows one CPU to interrupt another. Also, the direct-out lines of one CPU may be connected to the direct-in lines of the other, and vice versa.

Machine-Check Interruption

The machine-check interruption provides a means for recovery from and fault location of machine malfunction.

When the machine-check mask bit is one, occurrence of a machine check terminates the current instruction, initiates a diagnostic procedure, issues a signal on the machine check out-line, and subsequently causes the machine-check interruption.

The old PSW is stored at location 48 with an interruption code of zero. The state of the CPU is scanned out into the storage area, starting with location 128 and extending through as many words as the given CPU requires. The new PSW is fetched from location 112. Proper execution of these steps depends on the nature of the machine check.

The machine check out-signal is provided as part of the multisystem feature. The signal is a 0.5-microsecond to 1.0-microsecond timing signal that follows the I/O interface line-driving and terminating specifications. The signal is designed so that it has a high probability of being issued in the presence of machine malfunction.

When the machine-check mask bit is zero, an attempt is made to complete the current instruction upon the occurrence of a machine check and to proceed with the next sequential instruction. No diagnostic procedure, signal, or interruption occurs.

A change in the machine-check mask bit due to the loading of a new PSW results in a change in the treatment of machine checks. Depending on the nature of a machine check, the earlier treatment may still be in force for several cycles.

Following emergency power turn-off and turn-on or system reset, incorrect parity may exist in storage or registers. Unless new information is loaded, a machine check may occur erroneously. Once storage and registers are cleared, a machine check can be caused only by machine malfunction and never by data or instructions.

Machine checks occurring in operations executed by I/O channels either cause a machine-check interruption or are recorded in the channel status word for that operation.

Priority of Interruptions

During execution of an instruction, several interruption-causing events may occur simultaneously. The instruction may give rise to a program interruption, an external interruption may occur, a machine check may occur, and an I/O interruption request may be made. Instead of the program interruption, a supervisor-call interruption might occur; however, both cannot occur since these two interruptions are mutually exclusive. Simultaneous interruption requests are honored in a predetermined order.

The machine-check interruption has highest priority. When it occurs, the current operation is terminated. Program and supervisor-call interruptions that would have occurred as a result of the current instruction are eliminated. Every reasonable attempt is made to limit the side-effects of a machine check. Normally, I/O and external interruptions, as well as the progress of the I/O data transfer and the updating of the timer, remain unaffected.

When no machine check occurs, the program interruption or supervisor-call interruption is taken first, the external interruption is taken next, and the I/O interruption is taken last. The action consists of storing the old PSW and fetching the new PSW belonging to the interruption first taken. This new PSW is subsequently stored without any instruction execution, and the next interruption PSW is fetched. This storing and fetching continues until no more interruptions are to be serviced. The external and I/O interruptions are taken only if the immediately preceding PSW indicates that the CPU is interruptible for these causes.

Instruction execution is resumed using the last-fetched PSW. The order of executing interruption sub-routines is therefore the reverse of the order in which the PSW's are fetched.

The interruption code of a new psw is not loaded since a new interruption code is always stored. The instruction-length code in a new psw is similarly ignored since it is unpredictable for all interruptions other than program or supervisor call. The protection key of a new psw is stored unchanged when the protection feature is installed. When the feature is not installed, the protection key is made zero upon storing.

Programming Note

When interruption sources are not masked off, the order of priority in handling the interruption sub-routines is machine check, i/o, external, and program or supervisor call. This order can be changed to some extent by masking. The priority rule applies to interruption requests made simultaneously. An interruption request made after some interruptions have already been taken is honored according to the priority prevailing at the moment of request.

Interruption Exceptions

The only exception that can cause a program interruption during an interruption is a specification exception.

Specification: The protection feature is not installed, and a new psw with nonzero protection key is loaded.

A program interruption is taken immediately upon

loading the new psw, regardless of the type of interruption introducing the erroneous protection key and prior to any other pending interruptions. The protection key is made zero when the psw is stored.

If the new psw for the program interruption has a nonzero protection key, another program interruption occurs. Since this second program interruption introduces the same unacceptable protection key in the new psw, the process is repeated with the CPU caught in a string of program interruptions. This string can be broken only by initial program loading or system reset.

The instruction address in a new psw is not tested for availability or resolution as the psw is fetched during an interruption. However, an unavailable or odd instruction address is detected as soon as the instruction address is used to fetch an instruction. These exceptions are described in the section on normal sequential operation.

If the new psw for the program interruption has an unacceptable instruction address, another program interruption occurs. Since this second program interruption introduces the same unacceptable instruction address, a string of program interruptions is established. This string may be broken by an external or i/o interruption. If these interruptions also have an unacceptable new psw, new supervisor information must be introduced by initial program loading or by manual intervention.

Transfer of information to and from main storage, other than to or from the central processing unit or via the direct control path, is referred to as input and output operation. An input/output (I/O) operation involves the use of an input/output device. Input/output devices perform I/O operations under control of control units, which are attached to the central processing unit (CPU) by means of channels.

This portion of the manual describes, from the programming point of view, the control of I/O devices by the channels and the CPU. The programmed control procedures apply to all I/O operations and are independent of the type of I/O device, its speed, or its mode of operation.

Attachment of Input/Output Devices

Input/Output Devices

Input/output devices provide external storage and a means of communication between data processing systems or between a system and the external world. Input/output devices include such equipment as card read-punches, magnetic tape units, direct-access-storage devices (disk or drum), typewriter-keyboard devices, printers, TELE-PROCESSING devices, and process control equipment.

Most types of I/O devices, such as printers, card equipment, or tape devices, deal directly with external documents, and these devices are physically distinguishable and identifiable. Other types consist only of electronic equipment and do not directly handle physical recording media. The channel-to-channel adapter, for example, provides a channel-to-channel data transfer path, and the data never reach a physical recording medium outside main storage; the IBM 2702 Transmission Control handles transmission of information between the data processing system and a remote station, and its input and output are signals on a transmission line. Furthermore, the equipment in this case may be time-shared for a number of concurrent operations, and it is denoted as a particular I/O device only during the time period associated with the operation on the corresponding remote station.

Input/output devices may be accessible from one or more channels. Devices accessible from one channel normally are attached to one control unit only. A device can be made accessible to two or more channels by switching it between two or more control units,

each attached to a different channel, or by switching the control unit between two or more channels.

Control Units

The control unit provides the logical capability necessary to operate and control an I/O device and adapts the characteristics of each device to the standard form of control provided by the channel.

All communications between the control unit and the channel take place over the I/O interface. The control unit accepts control signals from the channel, controls the timing of data transfer over the I/O interface, and provides indications concerning the status of the device.

The I/O interface provides an information format and a signal sequence common to all I/O devices. The interface consists of a set of lines that can connect a number of control units to the channel. Except for the signal used to establish priority among control units, all communications to and from the channel occur over a common bus, and any signal provided by the channel is available to all control units. At any one instant, however, only one control unit is logically connected to the channel. The selection of a control unit for communication with the channel is controlled by a signal that passes serially through all control units and permits, sequentially, each control unit to respond to the signals provided by the channel. A control unit remains logically connected on the interface until it has transferred the information it needs or has, or until the channel signals it to disconnect, whichever occurs earlier.

The I/O device attached to the control unit may be designed to perform only certain limited operations. A typical operation is moving the recording medium and recording data. To accomplish these functions, the device needs detailed signal sequences peculiar to the type of device. The control unit decodes the commands received from the channel, interprets them for the particular type of device, and provides the signal sequence required for execution of the operation.

A control unit may be housed separately or it may be physically and logically integral with the I/O device. In the case of most electromechanical devices, a well-defined interface exists between the device and the control unit because of the difference in the type of equipment the control unit and the device contain. These electromechanical devices often are of a type where only one device of a group is required to op-

erate at a time (magnetic tape units and disk access mechanisms, for example), and the control unit is shared among a number of I/O devices. On the other hand, in electronic I/O devices such as the channel-to-channel adapter, the control unit does not have an identity of its own.

From the user's point of view, most functions performed by the control unit can be merged with those performed by the I/O device. In view of this, the control unit normally is not identified, and execution of I/O operations is described in this manual as if the I/O devices communicated directly with the channel. Reference is made to the control unit only when a function performed by it is emphasized or when sharing of the control unit among a number of devices affects the execution of I/O operations.

Channels

The channel directs the flow of information between I/O devices and main storage. It relieves the CPU of the task of communicating directly with the devices and permits data processing to proceed concurrently with I/O operations.

The channel provides a standard interface for connecting different types of I/O devices to the CPU and to main storage. It accepts control information from the CPU in the format supplied by the program and changes it into a sequence of signals acceptable to a control unit. After the operation with the device has been initiated, the channel assembles or disassembles data and synchronizes the transfer of data bytes over the interface with main-storage cycles. To accomplish this, the channel maintains and updates an address and a count that describe the destination or source of data in main storage. When an I/O device provides signals that should be brought to the attention of the program, the channel again converts the signals to a format compatible to that used in the CPU.

The channel contains all the common facilities for the control of I/O operations. When these facilities are provided in the form of separate autonomous equipment designed specifically to control I/O devices, I/O operations are completely overlapped with the activity in the CPU. The only main-storage cycles required during I/O operations in such channels are those needed to transfer data and control information to or from the final locations in main storage. These cycles do not interfere with the CPU program, except when both the CPU and the channel concurrently attempt to refer to the same main storage.

Alternatively, the system may use to a greater or lesser extent the facilities of the CPU for controlling I/O devices. When the CPU and the channel share common

equipment, interference varies from delaying the CPU by occasional cycles to a complete lockout of CPU activity, depending on the extent of sharing and on the I/O data rate. The sharing of the equipment, however, is accomplished automatically, and the program is not aware of CPU delays, except for an increase in execution time.

Modes of Operation

Data can be transferred between main storage and an I/O device in two modes: burst and multiplex.

In burst mode, the I/O device monopolizes all channel controls and stays logically connected on the I/O interface for the transfer of a burst of information. Only one device can be communicating with the channel during the time a burst is transferred. The burst can consist of a few bytes, a whole block of data, or a sequence of blocks with associated control and status information.

In multiplex mode, the facilities in the channel may be shared by a number of concurrent I/O operations. The multiplex mode causes all I/O operations to be split into short intervals of time during which only a segment of information is transferred over the interface. The intervals associated with different operations are intermixed in response to demands from the I/O devices. The channel controls are occupied with any one operation only for the time required to transfer a segment of information. The segment can consist of a single byte of data, a few bytes of data, or a control sequence such as initiation of a new operation or a status report from the device.

Short bursts of data can appear in both the burst and multiplex modes of operation. The distinction between a short burst occurring in the multiplex mode and an operation in the burst mode is in the length of the bursts. Whenever the burst causes the device to be connected to the channel for more than approximately 100 microseconds, the channel is considered to be operating in the burst mode.

Operation in burst and multiplex modes is differentiated because of the way the channels respond to I/O instructions. A channel operating in the burst mode appears busy to new I/O instructions, whereas a channel operating in the multiplex mode is available for initiation of new operations. A channel that can operate in both modes determines its mode of operation by time-out. If such a channel happens to be communicating with an I/O device at the instant a new I/O instruction is issued, action on the instruction is delayed until the current mode of operation is established. New I/O operations are initiated only after the channel has serviced all outstanding requests for data transfer for previously initiated operations.

Types of Channels

A system can be equipped with two types of channels: selector and multiplexor. Channels are classified according to the modes of operation they can sustain.

The channel facilities required for sustaining a single I/O operation are termed a *subchannel*. The subchannel consists of the channel storage used for recording the addresses, count, and any status and control information associated with the I/O operation. The mode in which a channel can operate depends upon whether it has one or more subchannels.

The selector channel has only one subchannel and operates only in the burst mode. The burst always extend over the whole block of data, or, when command chaining is specified, over the whole sequence of blocks. The selector channel cannot perform any multiplexing and therefore can be involved in only one data transfer operation at a time. In the meantime, other I/O devices attached to the channel can execute operations not involving communication with the channel. When the selector channel is not executing an operation or a chain of operations and is not processing an interruption, it scans the attached devices for status information.

The multiplexor channel contains multiple subchannels and can operate in either multiplex or burst mode. It can switch between the two modes at any time, and an operation on any one subchannel can occur partially in the multiplex and partially in the burst mode.

When the multiplexor channel operates in multiplex mode, it can sustain concurrently one I/O operation per subchannel, provided that the total load on the channel does not exceed its capacity. To the program, each subchannel appears as an independent selector channel. When the multiplexor channel is not servicing an I/O device, it scans its devices for data and for interruption conditions.

When the multiplexor channel operates in burst mode, the subchannel associated with the burst operation monopolizes all channel facilities and appears to the program as a single selector channel.

The remaining subchannels on the multiplexor channel must remain dormant and cannot respond to devices until the burst is completed.

System Operation

Input/output operations are initiated and controlled by information with three types of formats: instructions, commands, and orders. Instructions are decoded and executed by the CPU and are part of the CPU program. Commands are decoded and executed by the channels, and initiate I/O operations, such as reading and writing. Both instructions and commands are

fetched from main storage and are common to all types of I/O devices.

Functions peculiar to a device, such as rewinding tape or spacing a line on the printer, are specified by orders. Orders are decoded and executed by I/O devices. The execution of orders is initiated by a control command, and the associated control information is transferred to the device as data during the control operation or is specified in the modifier bits of the command code.

The CPU program initiates I/O operations with the instruction *START I/O*. This instruction identifies the device and causes the channel to fetch the channel address word (CAW) from a fixed location in main storage. The CAW contains the protection key and designates the location in main storage from which the channel subsequently fetches the first channel command word (CCW). The CCW specifies the command to be executed and the storage area, if any, to be used.

If the channel is not operating in burst mode and if the subchannel associated with the address I/O device is not busy, the channel attempts to select the device by sending the address of the device to all attached control units. A control unit that recognizes the address connects itself logically to the channel and responds to the selection by returning the address. The channel subsequently sends the command code over the interface, and the device responds with a status byte indicating whether it can execute the command.

At this time, the execution of *START I/O* is terminated. The results of the attempt to initiate the execution of the command are indicated by setting the condition code in the program status word (PSW), and, under certain conditions, by storing a portion of the channel status word (CSW).

If the operation is initiated at the device and its execution involves transfer of data, the subchannel is set up to respond to service requests from the device and assumes further control of the operation. In the case of operations that do not require any data to be transferred to or from the device, the device may signal the end of the operation immediately on receipt of the command code.

An I/O operation may involve transfer of data to one storage area, designated by a single CCW, or, when data chaining is specified, to a number of noncontiguous storage areas. In the latter case, a chain of CCW's is used, in which each CCW designates an area in main storage for the original operation. The program can be notified of the progress of chaining by specifying that the channel interrupt the program upon fetching a new CCW.

Termination of the I/O operation normally is indicated by two conditions: channel end and device end. The channel-end condition indicates that the I/O device has received or provided all information associated with the operation and no longer needs channel facilities. The device-end signal indicates that the I/O device has terminated execution of the operation. The device-end condition can occur concurrently with the channel-end condition or later.

Operations that tie up the control unit after releasing channel facilities may, under certain conditions, cause a third type of signal. This signal, called control unit end, may occur only after channel end and indicates that the control unit is available for initiation of another operation.

The conditions signaling the termination of an I/O operation can be brought to the attention of the program by I/O interruptions or, when the channel is masked, by programmed interrogation of the I/O device. In either case, these conditions cause storing the csw, which contains additional information concerning the execution of the operation. At the time the channel-end condition is generated, the channel provides an address and a count that indicate the extent of main storage used. Both the channel and the device can provide indications of unusual conditions. The device-end and control-unit-end conditions can be accompanied by error indications from the device.

Facilities are provided for the program to initiate execution of a chain of commands with a single START I/O. When command chaining is specified, the receipt of the device-end signal causes the channel to fetch a new ccw and to initiate a new command at the device. A chained command is initiated by means of the same sequence of signals over the I/O interface as the first command specified by START I/O. The conditions signaling the termination of an operation are not made available to the program when command chaining occurs.

Conditions that initiate I/O interruptions are asynchronous to the activity in the CPU, and more than one condition can occur at the same time. The channel and the CPU establish priority among the conditions so that only one interruption request is processed at a time. The conditions are preserved in the I/O devices and subchannels until accepted by the CPU.

Execution of an I/O operation or chain of operations thus involves up to four levels of participation. Except for the effects of shared equipment, the CPU is tied up for the duration of execution of START I/O, which

lasts at most until the addressed I/O device responds to the first command. The subchannel is busy with the execution from the time the operation is initiated at the I/O device until the channel-end condition for the last operation of the command chain is accepted by the CPU. The control unit may remain busy after the subchannel has been released and may generate the control-unit-end condition when it becomes free. Finally, the I/O device is busy from the initiation of the first command until the device-end condition associated with the last operation is cleared. A pending device-end condition causes the associated device to appear busy, but does not affect the state of any other part of the system. A pending control unit end blocks communications through the control unit to any device attached to it, while a pending channel end normally blocks all communications through the subchannel.

Compatibility of Operation

The organization of the I/O system provides for a uniform method of controlling I/O operations. The capacity of a channel, however, depends on its use and on the model to which it belongs. Channels are provided with different data-transfer capabilities, and an I/O device designed to transfer data only at a specific rate (a magnetic tape unit or a disk storage for example) can operate only on a channel that can accommodate at least this data rate.

The data rate a channel can accommodate depends also on the way the I/O operation is programmed. The channel can sustain its highest data rate when no data chaining is specified. Data chaining reduces the maximum allowable rate, and the extent of the reduction depends on the frequency at which new ccw's are fetched and on the address resolution of the first byte in the new area. Furthermore, since the channel may share main storage with the CPU and other channels, activity in the rest of the system affects the accessibility of main storage and, hence, the instantaneous load the channel can sustain.

In view of the dependence of channel capacity on programming and on activity in the rest of the system, an evaluation of the ability of a specific I/O configuration to function concurrently must be based on a consideration of both the data rate and the way the I/O operations are programmed. Two systems employing identical complements of I/O devices may be able to execute certain programs in common, but it is possible that other programs requiring, for example, data chaining, may not run on one of the systems.

Control of Input/Output Devices

The CPU controls I/O operations by means of four I/O instructions: START I/O, TEST I/O, HALT I/O, and TEST CHANNEL.

The instruction TEST CHANNEL addresses a channel; it does not address an I/O device. The other three I/O instructions address a channel and a device on that channel.

Input/Output Device Addressing

An I/O device is designated by an I/O address. Each I/O address corresponds to a unique I/O device and is specified by means of an 11-bit binary number in the I/O instruction. The address identifies, for example, a particular magnetic tape drive, disk access mechanism, or transmission line.

The I/O address consists of two parts: *channel address* in the three high-order bit positions, and a *device address* in the eight low-order bit positions. The channel address specifies the channel to which the instruction applies; the device address identifies the particular I/O device in that channel. Any number in the range 0-255 can be used as a device address, providing facilities for addressing 256 devices per channel. The assignment of I/O addresses is:

ADDRESS	ASSIGNMENT
000 xxxx xxxx	Devices on the multiplexor channel
001 xxxx xxxx	Devices on selector channel 1
010 xxxx xxxx	Devices on selector channel 2
011 xxxx xxxx	Devices on selector channel 3
100 xxxx xxxx	Devices on selector channel 4
101 xxxx xxxx	Devices on selector channel 5
110 xxxx xxxx	Devices on selector channel 6
111 xxxx xxxx	Invalid

On the multiplexor channel the device address identifies the subchannel as well as the I/O device. A subchannel can be assigned a unique device address, or it can be referred to by a group of addresses. When more than one device address designates the same subchannel, the subchannel is called shared.

The following table lists the basic assignment of device addresses on the multiplexor channel. Addresses with a zero in the high-order bit position pertain to subchannels that are not shared. The seven low-order bit positions of an address in this set identify one of 128 distinct subchannels. The presence of a one in the high-order bit position of the address indicates that the address refers to a shared subchannel. There are eight such shared subchannels, each of which may be shared by as many as 16 I/O devices. In addresses that designate shared subchannels, the four low-order bit positions identify the I/O device on the subchannel.

ADDRESS	ASSIGNMENT
0000 0000 to 0111 1111	Devices that do not share a subchannel
1000 xxxx	Devices on shared subchannel 0
1001 xxxx	Devices on shared subchannel 1
1010 xxxx	Devices on shared subchannel 2
1011 xxxx	Devices on shared subchannel 3
1100 xxxx	Devices on shared subchannel 4
1101 xxxx	Devices on shared subchannel 5
1110 xxxx	Devices on shared subchannel 6
1111 xxxx	Devices on shared subchannel 7

Physically, the shared subchannels are the same as the first eight non-shared subchannels. In particular, the set of addresses 1000 xxxx refers to the same subchannel as the address 0000 0000, the set 1001 xxxx refers to the same subchannel as the address 0000 0001, etc, while the set 1111 xxxx refers to the same subchannel as the address 0000 0111. Thus, the installation of all eight sets of devices on the shared subchannels reduces the maximum possible number of devices that do not share a subchannel to 120.

For devices sharing a control unit (for example, magnetic tape units and the 2702 Transmission Control), the high-order bit positions of the device address identify the control unit. The number of bit positions in the common field depends upon the number of devices installed but is designed to accommodate 16 or the high-order bits of all addresses are common. Control units with more than 16 devices may be assigned noncontiguous sets of 16 addresses. The low-order bit positions of the address identify the device on the control unit.

When the control unit is designed to accommodate fewer devices than can be addressed with the common field, the control unit does not recognize the addresses not assigned to it. For example, if a control unit is designed to control devices having only bits 0000-1001 in the low-order positions, it does not recognize addresses containing 1010-1111 in these bit positions. However, when a control unit has fewer than 16 devices installed but is designed to accommodate 1 or more, it may respond to all 16 addresses and may indicate unit check for the invalid addresses.

Devices sharing both a control unit and a subchannel (magnetic tape units, disk access mechanism) are always assigned as sets of 16 addresses, with four high-order bits common. These addresses refer to the same subchannel even if the control unit does not recognize the whole set.

Input/output devices accessible through more than one channel have a distinct address for each path of communications. This address identifies the channel, subchannel, and the control unit. For devices sharing a control unit, the position of the address identifying

the device on the control unit is fixed and does not depend on the path of communications.

In models in which more than 128 subchannels are available, the shared subchannels can optionally be replaced by sets of unshared subchannels. When the option is implemented, the additional unshared subchannels are assigned sequential addresses starting at 128.

Except for the rules described, the assignment of device addresses is arbitrary. The assignment is made at the time of installation and normally is fixed.

Programming Notes

Shared subchannels are used with devices, such as magnetic tape units and disk access mechanisms, that share a control unit. For such devices, the sharing of the subchannel does not restrict the concurrency of I/O operations since the control unit permits only one device to be involved in a data transfer operation at a time.

The program can refer to a shared subchannel by addresses 0-7 or by one of the addresses assigned to the subchannel. No restrictions are imposed on the use of a shared subchannel. If the subchannel is available, the addressed device is selected, and the specified operation is performed, regardless of the control unit to which the device is attached.

Instruction Exception Handling

Before the channel is signaled to execute an I/O instruction, the instruction is tested for validity by the CPU. Exceptional conditions detected at this time cause a program interruption. When the interruption occurs, the current PSW is stored as the old PSW and is replaced by a new PSW. The interruption code in the old PSW identifies the cause of the interruption.

The following exception may cause a program interruption:

Privileged Operation: An I/O instruction is encountered when the CPU is in the problem state. The instruction is suppressed before the channel has been signaled to execute it. The CSW, the condition code in the PSW, and the state of the addressed subchannel and I/O device remain unchanged.

States of the Input/Output System

The state of the I/O system identified by an I/O address depends on the collective state of the channel, subchannel, and I/O device. Each of these components of the I/O system can have up to four states, as far as the response to an I/O instruction is concerned. These states are listed in the following table. The name of the state is followed by its abbreviation and a brief definition.

I/O DEVICE	ABBREV	DEFINITION
Available	A	None of the following states
Interruption pending	I	Interruption condition pending in
Working	W	Device executing an operation
Not operational	N	Device not operational

SUBCHANNEL	ABBREV	DEFINITION
Available	A	None of the following states
Interruption pending	I	Information for CSW available in subchannel
Working	W	Subchannel executing an operation
Not operational	N	Subchannel not operational

CHANNEL	ABBREV	DEFINITION
Available	A	None of the following states
Interruption pending	I	Interruption immediately available from channel
Working	W	Channel operating in burst mode
Not operational	N	Channel not operational

A channel, subchannel, or I/O device that is available, that contains a pending interruption condition, or that is working, is said to be operational. The states of containing an interruption condition, working, or being not operational are collectively referred to as "not available."

In the case of the multiplexor channel, the channel and subchannel are easily distinguishable and, if the channel is operational, any combination of channel and subchannel states are possible. Since the selector channel can have only one subchannel, the channel and subchannel are functionally coupled, and certain states of the channel are related to those of the subchannel. In particular, the working state can occur only concurrently in both the channel and subchannel and, whenever an interruption condition is pending in the subchannel, the channel also is in the same state. The channel and subchannel, however, are not synonymous, and an interruption condition not associated with data transfer, such as attention or device end, does not affect the state of the subchannel. Thus, the subchannel may be available when the channel has an interruption condition pending. Consistent distinction between the subchannel and channel permits both types of channels to be covered uniformly by a single description.

The device referred to in the preceding table includes both the device proper and its control unit. For some types of devices, such as magnetic tape units, the working and the interruption-pending states can be caused by activity in the addressed device or control unit. A shared control unit imposes its state on all devices attached to the control unit. The states of the devices are not related to those of the channel and subchannel.

When the response to an I/O instruction is determined on the basis of the states of the channel and subchannel, the components further removed are not interrogated. Thus, ten composite states are identified

as conditions for the execution of the I/O instruction. Each composite state is identified in the following discussion by three alphabetic characters; the first character position identifies the state of the channel, the second identifies the state of the subchannel, and the third refers to the state of the device. Each character position can contain A, I, W, or N, denoting the state of the component. The symbol x in place of a letter indicates that the state of the corresponding component is not significant for the execution of the instruction.

Available (AAA): The addressed channel, subchannel, control unit, and I/O device are operational, are not engaged in the execution of any previously initiated operations, and do not contain any pending interruption conditions.

Interruption Pending in Device (AAI) or Device Working (AAW): The addressed I/O device or control unit is executing a previously initiated operation or contains a pending interruption condition. The addressed subchannel and channel are available. These situations are possible:

1. The device is executing an operation after signaling the channel-end condition, such as rewinding tape or seeking on a disk file.

2. The control unit associated with the device is executing an operation after signaling the channel-end condition, such as backspacing file on a magnetic tape unit.

3. The device or control unit is executing an operation on another subchannel or channel.

4. The device or control unit contains the device-end, control-unit-end, or attention condition or, on the selector channel, the channel-end condition associated with an operation terminated by HALT I/O.

Device Not Operational (AAN): The addressed I/O device is not operational. A device appears not operational when no control unit recognizes the address. This occurs when the control unit is not provided in the system, when power is off in the control unit, or when the control unit has been logically switched off the I/O interface. For some types of devices, the not-operational state is indicated also when the addressed device is not installed on the control unit. The addressed subchannel and channel are available.

For devices such as magnetic tape units, the device appears operational as long as the control unit associated with the addressed device is operational. If the device is not installed or has been logically removed from the control unit, selection of the device for TEST I/O or a command other than sense causes the unit-check indication.

Interruption Pending in Subchannel (AIX): An interruption condition is pending in the addressed sub-

channel because of the termination of the portion of the operation involving the use of channel facilities. The subchannel has information for a complete csw. The interruption condition can indicate termination of an operation at the addressed I/O device or at another device on the subchannel. In the case of the multiplexor channel, the channel is available. The state of the addressed device is not significant, except when TEST I/O is addressed to the device associated with the terminated operation. The device associated with the terminated operation normally is in the interruption pending state.

On the selector channel the existence of an interruption condition in the subchannel immediately causes the channel to assign to this condition the highest priority for I/O interruptions and, hence, leads to the state IIX.

Subchannel Working (AWX): The addressed subchannel is executing a previously initiated operation or chain of operations in the multiplex mode and has not yet reached the channel end for the last operation. All devices sharing the currently operating control unit appear in the working state but, for shared subchannels, the states of devices not attached to the control unit are not known. The addressed channel is available.

The subchannel-working state does not occur on the selector channel since all operations on the selector channel are executed in the burst mode and cause the channel to be in the working state (wwx).

Subchannel Not Operational (ANX): The addressed subchannel on the multiplexor channel is not operational. A subchannel is not operational when it is not provided in the system. The channel is available. This state cannot occur on the selector channel.

Interruption Pending in Channel (IXX): The addressed channel has established which device will cause the next I/O interruption from this channel. The state where the channel contains a pending interruption condition is distinguished only by the instruction TEST CHANNEL. This instruction does not cause the subchannel and I/O device to be interrogated. The other I/O instructions consider the channel available when it contains a pending interruption condition.

Channel Working (WXX): The addressed channel is operating in the burst mode. In the case of the multiplexor channel, a burst of bytes is currently being handled. In the case of the selector channel, an operation or a chain of operations is currently being executed, and the channel end for the last operation has not yet been reached. The states of the addressed device and, in the case of the multiplexor channel, of the subchannel are not significant.

Channel Not Operational (NXX): The addressed channel is not operational, or the channel address in the instruction is invalid. A channel is not operational when it is not provided in the system or when it has been switched to the test mode. The states of the addressed I/O device and subchannel are not significant.

Resetting of the Input/Output System

Two types of resetting can occur in the I/O system. The reset states overlap the hierarchy of states distinguished for the purpose of responding to the CPU during the execution of I/O instructions. Resetting terminates the current operation, disconnects the device from the channel, and may place the device in certain modes of operation. The meaning of the two reset states for each type of I/O device is specified in the Systems Reference Library (SRL) publication for the device.

System Reset

The system-reset function is performed when the system-reset key is pushed, when initial program loading is performed, or when a system power-on sequence is completed.

System reset causes the channel to terminate operations on all subchannels. Status information and interruption conditions in the subchannels are reset, and all operational subchannels are placed in the available state. The channel sends the system-reset signal to all I/O devices attached to it.

If the device is currently communicating over the I/O interface, the device immediately disconnects from the channel. Data transfer and any operation using the facilities of the control unit are immediately terminated, and the I/O device is not necessarily positioned at the beginning of a block. Mechanical motion not involving the use of the control unit, such as rewinding magnetic tape or positioning a disk access mechanism, proceeds to the normal stopping point, if possible. The device remains unavailable until the termination of mechanical motion or the inherent cycle of operation, if any, whereupon it becomes available. Status information in the device and control unit is reset, and no interruption condition is generated upon completing the operation.

A control unit accessible by more than one channel is reset if it is currently associated with a channel on the CPU generating the reset.

Malfunction Reset

The malfunction-reset function is performed when the channel detects equipment malfunctioning.

Execution of malfunction reset in the channel depends on the type of error and the model. It may cause all operations in the channel to be terminated and all operational subchannels to be reset to the available state. The channel may send either the malfunction-reset signal to the device connected to the channel at the time the malfunctioning is detected, or channels sharing common equipment with the CPU may send the system-reset signal to all devices attached to the channel.

When the channel signals malfunction reset over the interface, the device immediately disconnects from the channel. Data transfer and any operation using the facilities of the control unit are immediately terminated, and the I/O device is not necessarily positioned at the beginning of a block. Mechanical motion not involving the control unit, such as rewinding magnetic tape or positioning a disk access mechanism, proceeds to the normal stopping point, if possible. The device remains unavailable until the termination of mechanical motion or the inherent cycle of operation, if any, whereupon it becomes available. Status information associated with the addressed device is reset, but an interruption condition may be generated upon completing any mechanical operation.

When a malfunction reset occurs, the program is alerted by an I/O interruption or, when the malfunction is detected during the execution of an I/O instruction, by the setting of the condition code. In either case the CSW identifies the condition. The device addressed by the I/O instruction or the device identified by the I/O interruption, however, is not necessarily the one placed in the malfunction-reset state. In channels sharing common equipment with the CPU, malfunctioning detected by the channel may be indicated by a machine-check interruption, in which case a CSW is not stored and a device is not identified. The method of identifying malfunctioning depends upon the model.

Condition Code

The results of certain tests by the channel and device, and the original state of the addressed part of the I/O system are used during the execution of an I/O instruction to set one of four condition codes in bit positions 34 and 35 of the PSW. The condition code is set at the time the execution of the instruction is completed, that is, the time the CPU is released to proceed with the next instruction. The condition code indicates whether or not the channel has performed the function specified by the instruction and, if not, the reason for the rejection. The code can be used for decision-making by subsequent branch-on-condition operations.

The following table lists the conditions that are identified and the corresponding condition codes for each instruction. The states of the system and their abbreviations are defined in "States of the Input/Output System." The digits in the table represent the numeric value of the code. The instruction START I/O can set code 0 or 1 for the AAA state, depending on the type of operation that is initiated.

CONDITIONS		CONDITION CODE FOR			
		START I/O	TEST I/O	HALT I/O	TEST CHAN
Available	AAA	0,1*	0	0	0
Interruption pend. in device	AAI	1*	1*	0	0
Device working	AAW	1*	1*	0	0
Device not operational	AAN	3	3	0	0
Interruption pend. in subchannel	AIX
For the addressed device		2	1*	0	0
For another device		2	2	0	0
Subchannel working	AWX	2	2	1*	0
Subchannel not operational	ANX	3	3	3	0
Interruption pend. in channel	IXX	see note below			1
Channel working	WXX	2	2	2	2
Channel not operational	NXX	3	3	3	3
Error					
Channel equipment error		1*	1*	1*	—
Channel programming error		1*	—	—	—
Device error		1*	1*	—	—

*The CSW or its status portion is stored at location 64 during execution of the instruction.

—The condition cannot be identified during execution of the instruction.

NOTE: For the purpose of executing START I/O, TEST I/O, and HALT I/O, a channel containing a pending interruption condition appears the same as an available channel, and the condition codes for the IXX state are the same as for the AXX state, where the X's represent the states of the subchannel and the device. As an example, the condition code for the IAA state is the same as for the AAA state.

The available condition is indicated only when no errors are detected during the execution of the I/O instruction. When a programming error occurs in the information placed in the CAW or CCW and the addressed channel or subchannel is working, either condition code 1 or 2 may be set, depending upon the model. Similarly, either code 1 or 3 may be set when a programming error occurs and a part of the addressed I/O system is not operational.

When a subchannel on the multiplexor channel contains a pending interruption condition (state AIX), the I/O device associated with the terminated operation normally is in the interruption-pending state. When the channel detects during execution of TEST I/O that the device is not operational, condition code 3 is set. Similarly, condition code 3 is set when HALT I/O is addressed to a subchannel in the working state and operating in the multiplex mode (state AWX), but the device turns out to be not operational. The not-operational state in both situations can be caused

by operator intervention or by equipment malfunction and, for HALT I/O, may occur when the instruction is addressed to a control unit other than the one currently operating.

The error conditions listed in the preceding table include all equipment or programming errors detected by the channel or the I/O device during execution of the I/O instruction. Except for channel equipment errors, in which case no CSW may be stored, the status portion of the CSW identifies the error. Three types of errors can occur:

Channel Equipment Error: The channel can detect the following equipment errors during execution of START I/O, TEST I/O, and HALT I/O:

1. The device address that the channel received on the interface during initial selection either has a parity error or is not the same as the one the channel sent out. Some device other than the one addressed may be malfunctioning.

2. The unit-status byte that the channel received on the interface during initial selection has a parity error.

3. A signal from the I/O device occurred during initial selection at an invalid time or had invalid duration.

4. The channel detected an error in its control equipment.

The channel may perform the malfunction-reset function, depending on the type of error and the model. If a CSW is stored, channel control check or interface control check is indicated, depending on the type of error.

Channel Programming Error: The channel can detect the following programming errors during execution of START I/O:

1. Invalid CCW address in CAW
2. Invalid CCW address specification in CAW
3. Invalid storage protection key in CAW
4. Invalid CAW format
5. First CCW specifies transfer in channel
6. Invalid command code in first CCW
7. Initial data address exceeds addressing capacity of model
8. Invalid count in first CCW
9. Invalid format of first CCW

The CSW indicates program check.

Device Error: Programming or equipment errors detected by the device during the execution of START I/O are indicated by unit check or unit exception in the CSW. The instruction TEST I/O can cause unit check to be generated.

The conditions responsible for unit check and unit exception for each type of I/O device are detailed in the SRL publication for the device.

Instruction Format

All I/O instructions use the following *SI* format:

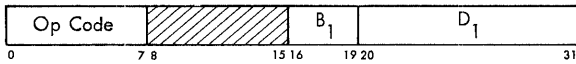

Bit positions 8-15 of the instruction are ignored. The content of the B_1 field designates a register. The sum obtained by the addition of the content of register B_1 and content of the D_1 field identifies the channel and the I/O device. This sum has the format:

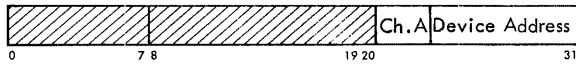

Bit positions 0-7 are not part of the address. Bit positions 8-20, which constitute the high-order portion of the address, are ignored. Bit positions 21-23 of the sum contain the channel address, while bit positions 24-31 identify the device on the channel and, on the multiplexor channel, the subchannel.

Instructions

The mnemonics, format, and operation codes of the I/O instructions follow. The table also indicates that all I/O instructions cause program interruption when they are encountered in the problem state, and that all I/O instructions set the condition code.

NAME	MNEMONIC	TYPE	EXCEPTION	CODE
Start I/O	SIO	SI, C	M	9C
Test I/O	TIO	SI, C	M	9D
Halt I/O	HIO	SI, C	M	9E
Test Channel	TCH	SI, C	M	9F

NOTES

C	Condition code is set
M	Privileged-operation exception

Programming Note

The instructions *START I/O*, *TEST I/O*, and *HALT I/O* may cause a *CSW* to be stored. To prevent the contents of the *CSW* stored by the instruction from being destroyed by an immediately following I/O interruption, all channels must be masked before issuing *START I/O*, *TEST I/O*, or *HALT I/O* and must remain masked until the information in the *CSW* provided by the instruction has been acted upon or stored elsewhere for later use.

Start I/O

SIO SI

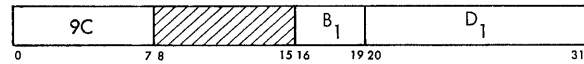

A write, read, read backward, control or sense operation is initiated at the addressed I/O device and subchannel. The instruction *START I/O* is executed only when the CPU is in the supervisor state.

Bit positions 21-31 of the sum formed by the addition of the content of register B_1 and the content of the D_1 field identify the channel, subchannel, and I/O device to which the instruction applies. The *CAW* at location 72 contains the protection key for the subchannel and the address of the first *CCW*. The *CCW* so designated specifies the operation to be performed, the main-storage area to be used, and the action to be taken when the operation is completed.

The I/O operation specified by *START I/O* is initiated if the addressed I/O device and subchannel are available, the channel is available or is in the interruption-pending state, and errors or exceptional conditions have not been detected. When the addressed part of the I/O system is in any other state or when the channel or device detect any error or exceptional condition during execution of the instruction, the I/O operation is not initiated.

When any of the following conditions occurs, *START I/O* causes the status portion, bit positions 32-47, of the *CSW* at location 64 to be replaced by a new set of status bits. The status bits pertain to the device addressed by the instruction. The contents of the other fields of the *CSW* at location 64 are not changed.

1. An immediate operation was executed, and no command chaining is taking place. An operation is called immediate when the I/O device signals the channel-end condition immediately on receipt of the command code. The *CSW* contains the channel-end bit and any other indications provided by the channel or the device. The busy bit is off. The I/O operation has been initiated, but no information has been transferred to or from the storage area designated by the *CCW*. No interruption conditions are generated at the device or subchannel, and the subchannel is available for a new I/O operation.

2. The I/O device contains a pending interruption condition due to device end or attention, or the con-

trol unit contains a pending channel end or control unit end for the addressed device. The csw unit-status field contains the busy bit, identifies the interruption condition, and may contain other bits provided by the device or control unit. The interruption condition is cleared. The channel-status field contains zeros.

3. The I/O device or the control unit is executing a previously initiated operation, or the control unit has pending channel end or control unit end for a device other than the one addressed. The csw unit-status field contains the busy bit or, if the control unit is busy, the busy and status-modifier bits. The channel-status field contains zeros.

4. The I/O device or channel detected an equipment or programming error during execution of the instruction. The channel-end and busy bits are off, unless the error was detected after the device was selected and was found to be busy, in which case the busy bit, as well as any bits indicating pending interruption conditions, are on. The interruption conditions indicated in the csw have been cleared at the device. The csw identifies the error condition. The I/O operation has not been initiated. No interruption conditions are generated at the I/O device or subchannel.

Resulting Condition Code:

- 0 I/O operation initiated and channel proceeding with its execution
- 1 csw stored
- 2 Channel or subchannel busy
- 3 Not operational

Program Interruptions: Privileged operation.

Programming Note

When a programming error occurs and the addressed device contains an interruption condition, with the channel and subchannel in the available state, START I/O may or may not clear the interruption condition, depending on the type of error and the model. If the instruction has caused the device to be interrogated, as indicated by the presence of the busy bit in the csw, the interruption condition has been cleared, and the csw contains program check, as well as the status from the device.

Test I/O

TIO SI



The state of the addressed channel, subchannel, and device is indicated by setting the condition code in the rsw and, under certain conditions, by storing the csw. Pending interruption conditions may be cleared.

The instruction TEST I/O is executed only when the CPU is in the supervisor state.

Bit positions 21-31 of the sum formed by the addition of the content of register B₁ and the content of the D₁ field identify the channel, subchannel, and I/O device to which the instruction applies.

When any of the following conditions is detected, TEST I/O causes the csw at location 64 to be stored. The content of the csw pertains to the I/O device addressed by the instruction.

1. The subchannel contains a pending interruption condition due to a terminated operation at the addressed device. The interruption condition is cleared. The protection key, command address, and count fields contain the final values for the I/O operation, and the status may include other bits provided by the channel and the device. The interruption condition in the subchannel is not cleared, and the csw is not stored if the interruption condition is associated with an operation on a device other than the one addressed.

2. The I/O device contains a pending interruption condition due to device end or attention, or the control unit contains a pending channel end or control unit end for the addressed device. The csw unit-status field identifies the interruption condition and may contain other bits provided by the device or control unit. The interruption condition is cleared. The busy bit in the csw is off. The other fields of the csw contain zeros.

3. The I/O device or the control unit is executing a previously initiated operation or the control unit has pending channel end or control unit end for a device other than the one addressed. The csw unit-status field contains the busy bit or, if the control unit is busy, the busy and status-modifier bits. Other fields of the csw contain zeros.

4. The I/O device or channel detected an equipment error during execution of the instruction. The csw identifies the error condition. No interruption conditions are generated at the I/O device or the subchannel.

When TEST I/O is used to clear an interruption condition from the subchannel and the channel has not yet accepted the condition from the device, the instruction causes the device to be selected and the interruption condition in the device to be reset. During certain I/O operations, some types of devices cannot provide their current status in response to TEST I/O. The tape control unit, for example, is in such a state when it has provided the channel-end condition and is executing the backspace-file operation. When TEST I/O is issued to a control unit in such a state, the unit-status field of the csw contains the busy and

status-modifier bits, with zeros in the other csw fields. The interruption condition in the device and in the subchannel is not cleared.

On some types of devices, such as the 2702 Transmission Control, the device never provides its current status in response to TEST I/O, and an interruption condition can be cleared only by permitting an I/O interruption. When TEST I/O is issued to such a device, the unit-status field contains the status-modifier bit. The interruption condition in the device and in the subchannel, if any, is not cleared.

However, at the time the channel assigns the highest priority for interruptions to a condition associated with an operation at the subchannel, the channel accepts the status from the device and clears the corresponding condition at the device. When TEST I/O is addressed to a device for which the channel has already accepted the interruption condition, the device is not selected, and the condition in the subchannel is cleared regardless of the type of device and its present state. The csw contains unit status and other information associated with the interruption condition.

Resulting Condition Code:

- 0 Available
- 1 csw stored
- 2 Channel or subchannel busy
- 3 Not operational

Program Interruptions: Privileged operation.

Programming Notes

Masking of channels provides the program a means of controlling the priority of I/O interruptions selectively by channels. The priority of devices attached on a channel is fixed and cannot be controlled by the program. The instruction TEST I/O permits the program to clear interruption conditions selectively by I/O device.

When a csw is stored by TEST I/O, the interface-control-check and channel-control-check indications may be due to a condition already existing in the channel or due to a condition created by TEST I/O. Similarly, presence of the unit-check bit in the absence of channel-end, control-unit-end or device-end bits may be due to either a condition created by the preceding operation or an equipment error detected during the execution of TEST I/O.

Halt I/O

HIO SI

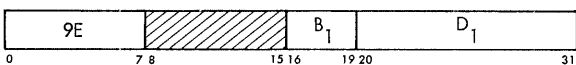

Execution of the current I/O operation at the addressed subchannel or channel is terminated. The subse-

quent state of the subchannel depends on the type of channel. The csw may be stored. The instruction HALT I/O is executed only when the CPU is in the supervisor state.

Bit positions 21-31 of the sum formed by the addition of the content of register B₁ and the content of the D₁ field identify the I/O device to whose subchannel or channel the instruction applies.

When HALT I/O is issued to a channel operating in the burst mode, data transfer for the burst operation is terminated and the device performing the burst operation is immediately disconnected from the channel. The subchannel and I/O device address in the instruction is ignored. When the instruction is issued to the multiplexor channel operating in the multiplex mode and the addressed subchannel is working, data transfer for the current operation on the subchannel is terminated. In this case the channel uses the device address appearing in the instruction to identify the subchannel and select the device on the I/O interface. The address of the device on the subchannel is not significant, providing the control unit responds to the address.

The termination of an operation by HALT I/O on the selector channel causes the channel and subchannel to be placed in the interruption-pending state. The interruption condition is generated without receiving the channel-end signal from the device. When HALT I/O causes an operation on the multiplexor channel to be terminated, the subchannel remains in the working state until the device provides the next status byte, whereupon the subchannel is placed in the interruption-pending state.

The control unit associated with the terminated operation remains unavailable for a new I/O operation until the data-handling portion of the operation in the control unit is terminated, whereupon it generates the channel-end condition. Channel end may be generated at the normal time for the operation, earlier, or later, depending upon the operation and type of device. The I/O device executing the terminated operation remains in the working state until termination of the inherent cycle of the operation, at which time device end is generated. If blocks of data at the device are defined, such as reading on magnetic tape, the recording medium is advanced to the beginning of the next block.

If the control unit is shared, all devices attached to the control unit appear in the working state until the channel-end condition is accepted by the CPU. The states of the other devices, however, are not permanently affected. Operations such as rewinding magnetic tape or positioning a disk access mechanism are

not interrupted, and any pending attention and device-end conditions in these devices are not reset.

When any of the following conditions occurs, HALT I/O causes the status portion, bit positions 32-47, of the CSW at location 64 to be replaced by a new set of status bits. The status bits pertain to the device addressed by instruction. The contents of the other fields of the CSW at location 64 are not changed. The extent of data transfer and the conditions of termination of the operation at the subchannel are provided in the CSW associated with the termination.

1. The device on the addressed subchannel currently involved in data transfer in the multiplex mode has been signaled to terminate the operation. The CSW contains zeros in the status field.

2. The addressed subchannel on the multiplexor channel is working, and no burst operation is in progress, but the control unit or the I/O device is executing a type of operation or is in such a state that it cannot accept the halt-I/O signal. The device has not been signaled to terminate the operation, but the subchannel has been set up to signal termination to the device the next time the device requests or offers a byte of data. The CSW unit-status field contains the busy and status-modifier bits. The channel-status field contains zeros.

3. The channel detected an equipment malfunction during the execution of HALT I/O. The status bits in the CSW identify the error condition. The state of the channel and the progress of the I/O operation are unpredictable.

When the subchannel on the multiplexor channel is shared and no burst operation is in progress, HALT I/O causes the operation to be terminated as long as the instruction is addressed to a device on the currently working control unit. If another device is addressed, a malfunction has occurred, or the operator has changed the state of the operating control unit, no device may recognize the address. If the device appears not operational during execution of HALT I/O, condition code 3 is set, and the subchannel is set up to signal termination to the device the next time the device offers or requests a byte of data.

Resulting Condition Code:

- 0 Channel and subchannel not working
- 1 CSW stored

- 2 Burst operation terminated
- 3 Not operational

Program Interruptions: Privileged operation.

Programming Note

The instruction HALT I/O provides the program a means of terminating an I/O operation before all data specified in the operation have been transferred. It permits the program to immediately free the selector channel for an operation of higher priority. On the multiplexor channel, HALT I/O provides a means of controlling real-time operations and permits the program to terminate data transmission on a communication line.

Test Channel

TCH SI

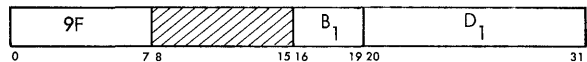

The condition code in the PSW is set to indicate the state of the addressed channel. The state of the channel is not affected, and no action is caused. The instruction TEST CHANNEL is executed only when the CPU is in the supervisor state.

Bit positions 21-23 of the sum formed by the addition of the content of register B₁ and the content of the D₁ field identify the channel to which the instruction applies. Bit positions 24-31 of the address are ignored.

The instruction TEST CHANNEL inspects only the state of the addressed channel. It tests whether the channel is operating in the burst mode, is aware of any outstanding interruption conditions from its devices, or is not operational. When none of these conditions exists, the available state is indicated. No device is selected, and, on the multiplexor channel, the subchannels are not interrogated.

Resulting Condition Code:

- 0 Channel available
- 1 Interruption pending in channel
- 2 Channel operating in burst mode
- 3 Channel not operational

Execution of Input/Output Operations

The channel can execute six commands:

- Write
- Read
- Read backward
- Control
- Sense
- Transfer in channel

Each command except transfer in channel initiates a corresponding I/O operation. The term "I/O operation" refers to the activity initiated by a command in the I/O device and subchannel. The subchannel is involved with the execution of the operation from the initiation of the command until the channel-end signal is received or, in the case of command chaining, until the device-end signal is received. The operation in the device lasts until device end occurs.

Blocking of Data

Data recorded on an external document may be divided into blocks. A block of data is defined for each type of I/O device as the amount of information recorded in the interval between adjacent starting and stopping points of the device. The length of a block depends on the documents; for example, a block can be a card, a line of printing, or the information recorded between two consecutive gaps on tape.

The maximum amount of information that can be transferred in one I/O operation is one block. An I/O operation is terminated when the associated storage area is exhausted or the end of the block is reached, whichever occurs first. For some operations, such as writing on a magnetic tape unit or on an inquiry station, blocks are not defined, and the amount of information transferred is controlled only by the program.

Channel Address Word

The channel address word (CAW) specifies the storage protection key and the address of the first ccw associated with START I/O. It appears at location 72. The channel refers to the CAW only during the execution of START I/O. The pertinent information thereafter is stored in the channel, and the program is free to change the content of the CAW. Fetching of the CAW by the channel does not affect the contents of location 72.

The CAW has the following format:



The fields in the CAW are allocated for the following purposes:

Protection Key: Bits 0-3 form the storage protection key for all commands associated with START I/O. This key is matched with a storage key whenever data are placed in storage.

Command Address: Bits 8-31 designate the location of the first ccw in main storage.

Bit positions 4-7 of the CAW must contain zeros. When the protection feature is not implemented, the protection key must be zero. The three low-order bits of the command address must be zero to specify the ccw on integral boundaries for double words. If any of these restrictions is violated or if the command address specifies a location outside the main storage of the particular installation, START I/O causes the status portion of the CSW to be stored with the program-check bit on. In this event, the I/O operation is not initiated.

Channel Command Word

The channel command word (ccw) specifies the command to be executed and, for commands initiating I/O operations, it designates the storage area associated with the operation and the action to be taken whenever transfer to or from the area is completed. The ccw's can be located anywhere in main storage, and more than one can be associated with a START I/O. The channel refers to a ccw in main storage only once, whereupon the pertinent information is stored in the channel.

The first ccw is fetched during the execution of START I/O. Each additional ccw in the chain is obtained when the operation has progressed to the point where the additional ccw is needed. Fetching of the ccw's by the channel does not affect the contents of the location in main storage.

The ccw has the following format:

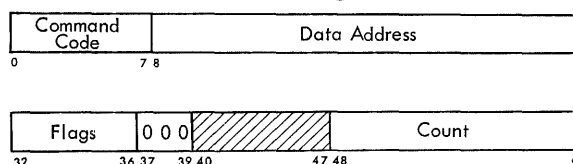

The fields in the ccw are allocated for the following purposes:

Command Code: Bits 0-7 specify the operation to be performed.

Data Address: Bits 8-31 specify the location of an eight-bit byte in main storage. It is the first location referred to in the area designated by the ccw.

Chain-Data Flag: Bit 32, when one, specifies chaining of data. It causes the storage area designated by the next ccw to be used with the current operation. When bit 32 is zero, the current control word is the last one for the operation.

Chain-Command Flag: Bit 33, when one and when the chain-data flag is off, specifies chaining of commands. It causes the operation specified by the command code in the next ccw to be initiated on normal completion of the current operation. When bit 33 is zero or when the *CD* flag is one, the next ccw does not specify a new command.

Suppress-Length-Indication Flag: Bit 34 controls whether an incorrect length condition is to be indicated to the program. When this bit is one and the *CD* flag is off in the last ccw used, the incorrect-length indication is suppressed. If the ccw has the *CC* flag on, command chaining takes place. Absence of the *SLI* flag or the presence of the *CD* flag causes the program to be notified of the incorrect-length condition when it occurs.

Skip Flag: Bit 35, when one, specifies suppression of transfer of information to storage during a read, read-backward, or sense operation. When bit 35 is zero, normal transfer of data takes place.

Program-Controlled-Interruption Flag: Bit 36, when one, causes the channel to generate an interruption condition upon fetching the ccw. When bit 36 is zero, normal operation takes place.

Count: Bits 48-63 specify the number of eight-bit byte locations in the storage area designated by the ccw.

Bit positions 37-39 of every ccw other than one specifying transfer in channel must contain zeros. Violation of this restriction generates the program-check condition. When the first ccw designated by the *CAW* does not contain the required zeros, the *I/O* operation is not initiated, and the status portion of the *CSW* with the program-check indication is stored during execution of *START I/O*. Detection of this condition during data chaining causes the *I/O* device to be signaled to terminate the operation. When the absence of these zeros is detected during command chaining, the new operation is not initiated, and no interruption condition is generated.

The content of bit positions 40-47 of the ccw is ignored.

Command Code

The command code in the ccw specifies to the channel and the *I/O* device the operation to be performed.

The two low-order bits or, when these bits are 00, the four low-order bits of the command code identify the operation to the channel. The channel distinguishes among the following four operations:

- Output forward (write, control)
- Input forward (read, sense)
- Input backward (read backward)
- Branching (transfer in channel)

The channel ignores the high-order bits of the command code.

Commands that initiate *I/O* operations (write, read, read backward, control, and sense) cause all eight bits of the command code to be transferred to the *I/O* device. In these command codes, the high-order bit positions contain modifier bits. The modifier bits specify to the device how the command is to be executed. They may cause, for example, the device to compare data received during a write operation with data previously recorded, and they may specify such conditions as recording density and parity. For the control command, the modifier bits may contain the order code specifying the control function to be performed. The meaning of the modifier bits depends on the type of *I/O* device and is specified in the *SRL* publication for the device.

The command code assignment is listed in the following table. The symbol *x* indicates that the bit position is ignored; *m* identifies a modifier bit.

CODE	COMMAND
<i>x x x x</i> 0 000	Invalid
<i>MMMM</i> 0 100	Sense
<i>x x x x</i> 1 000	Transfer in channel
<i>MMMM</i> 1 100	Read backward
<i>MMMM</i> <i>MM</i> 01	Write
<i>MMMM</i> <i>MM</i> 10	Read
<i>MMMM</i> <i>MM</i> 11	Control

Whenever the channel detects an invalid command code during the initiation of a command, the program-check condition is generated. When the first ccw designated by the *CAW* contains an invalid command code, the status portion of the *CSW* with the program-check indication is stored during execution of *START I/O*. When the invalid code is detected during command chaining, the new operation is not initiated, and an interruption condition is generated. The command code is ignored during data chaining, unless it specifies transfer in channel.

Definition of Storage Area

The main-storage area associated with an *I/O* operation is defined by ccw's. A ccw defines an area by specifying the address of the first eight-bit byte to be transferred and the number of consecutive eight-bit bytes contained in the area. The address of the first byte appears in the data-address field of the ccw. The number of bytes contained in the storage area is specified in the count field.

In write, read, control, and sense operations storage locations are used in ascending order of addresses. As information is transferred to or from main storage, the content of the address field is incremented, and the content of the count field is decremented. The read-backward operation causes data to be placed in stor-

age in a descending order of addresses, and both the count and the address are stepped down. When the count in any operation reaches zero, the storage area defined by the ccw is exhausted.

Any main-storage location provided in the system can be used to transfer data to or from an I/O device, provided that during an input operation the location is not protected. Similarly, the ccw's can be specified in any part of available main storage. When the channel attempts to store data at a protected location, the protection-check condition is generated, and the device is signaled to terminate the operation.

When the channel refers to a location not provided in the system, the program-check condition is generated. When this condition occurs because the first ccw designated by the CAW contains a data address exceeding the addressing capacity of the model, the I/O operation is not initiated, and the status portion of the csw with the program-check indication is stored during execution of START I/O. Invalid data addresses detected after initiation of the operation or detection of an invalid ccw address during chaining is indicated to the program with the interruption conditions at the termination of the operation or chain of operations.

During an output operation, the channel may fetch data from main storage ahead of the time the I/O device requests the data. As many as 16 bytes may be prefetched and buffered. Similarly, on data chaining during an output operation, the channel may fetch the new ccw when as many as 16 bytes remain to be transferred under the control of the current ccw. When the I/O operation uses data and ccw's from locations near the end of the available storage, such prefetching may cause the channel to refer to locations that do not exist. Invalid addresses detected during prefetching of data or ccw's do not affect the execution of the operation and do not cause error indications until the I/O operation actually attempts to use the information. If the operation is terminated by the I/O device or by HALT I/O before the invalid information is needed, the condition is not brought to the attention of the program.

Storage addresses do not wrap around to location 0 unless the system has the maximum addressable storage (16,777,216 bytes). When the maximum addressable storage is provided, location 0 follows location 16,777,215 and, on reading backward, location 16,777,215 follows location 0.

The count field in the ccw can specify any number of bytes up to 65,535. Except for a ccw specifying transfer in channel, it may not contain the value zero. Whenever the count field in the ccw initially contains a zero, the program-check condition is generated. When this occurs in the first ccw designated by the

CAW, the operation is not initiated, and the status portion of the csw with the program-check indication is stored during execution of START I/O. When a count of zero is detected during data chaining, the I/O device is signaled to terminate the operation. Detection of a count of zero during command chaining suppresses initiation of the new operation and generates an interruption condition.

Chaining

When the channel has performed the transfer of information specified by a ccw, it can continue the activity initiated by START I/O by fetching a new ccw. The fetching of a new ccw upon the exhaustion of the current ccw is called *chaining* and the ccw's belonging to such a sequence are said to be chained.

Chaining takes place only between ccw's located in successive double-word locations in storage. It proceeds in an ascending order of addresses; that is, the address of the new ccw is obtained by adding eight to the address of the current ccw. Two chains of ccw's located in noncontiguous storage areas can be coupled for chaining purposes by a transfer in channel command. All ccw's in a chain apply to the I/O device specified in the original START I/O.

Two types of chaining are provided: chaining of data and chaining of commands. Chaining is controlled by the chain-data (CD) and chain-command (CC) flags in the ccw. These flags specify the action to be taken by the channel upon the exhaustion of the current ccw. The following code is used:

CD	CC	ACTION
0	0	No chaining. The current CCW is the last.
0	1	Command chaining
1	0	Data chaining
1	1	Data chaining

The specification of chaining is effectively propagated through a transfer in channel command. When in the process of chaining a transfer-in-channel command is fetched, the ccw designated by the transfer in channel is used for the type of chaining specified in the ccw preceding the transfer in channel.

The CD and CC flags are ignored in the transfer-in-channel command.

Data Chaining

During data chaining, the new ccw fetched by the channel defines a new storage area for the original I/O operation. Execution of the operation at the I/O device is not affected. Data chaining occurs only when all data designated by the current ccw have been transferred to or from the device and causes the operation to continue, using the storage area designated by the new

ccw. The content of the command-code field of the new ccw is ignored, unless it specifies transfer in channel.

Data chaining is considered to occur immediately after the last byte of data designated by the current ccw has been transferred to or from the device. When the last byte has been placed in main storage or accepted by the device, the new ccw takes over the control of the operation and replaces the pertinent information in the subchannel. If the device sends channel end after exhausting the count of the current ccw but before transferring any data to or from the storage area designated by the new ccw, the csw associated with the termination identifies the new ccw.

If programming errors are detected in the new ccw or during its fetching, the program-check condition is generated, and the device is signaled to terminate the operation when it attempts to transfer data designated by the new ccw. If the device signals the channel-end condition before transferring any data designated by the new ccw, program check is indicated in the csw associated with the termination. Unless the address of the new ccw is invalid or programming errors are detected in an intervening transfer-in-channel command, the content of the csw pertains to the new ccw. A data address referring to a nonexistent area or, on reading, to a protected area causes an error indication only after the I/O device has attempted to transfer data to or from the invalid location, but an address exceeding the addressing capacity of the model is detected immediately upon fetching the ccw.

Data chaining during an input operation causes the new ccw to be fetched when all data designated by the current ccw have been placed in main storage. On an output operation, the channel may fetch the new ccw from main storage ahead of the time data chaining occurs. The earliest such prefetching may occur is when 16 bytes still remain to be transferred under the control of the current ccw. Any programming errors in the prefetched ccw, however, do not affect the execution of the operation until all data designated by the current ccw have been transferred to the I/O device. If the device terminates the operation before all data designated by the current ccw have been transferred, the conditions associated with the prefetched ccw are not indicated to the program.

Only one ccw describing a data area may be prefetched and buffered in the channel. If the prefetched ccw specifies transfer in channel, only one more ccw is fetched before the exhaustion of the current ccw.

Programming Notes

Data chaining permits information to be rearranged as it is transferred between main storage and the I/O

device. Data chaining also permits a block of information to be transferred to or from noncontiguous areas of storage, and, when used in conjunction with the skipping function, it permits the program to place in storage selected portions of a block of data.

When during an input operation, the program specifies data chaining to a location into which data have been placed under the control of the current ccw, the channel fetches the new contents of the location, even if the location contains the last byte transferred under the control of the current ccw. The program, therefore, can use self-describing records; that is, it can chain to a ccw that has been read under the control of the current ccw. However, since the program is not notified of any data errors until the end of the operation, there is no assurance that the ccw is correct. The ccw in main storage may be invalid even though its parity is good.

Command Chaining

During command chaining, the new ccw fetched by the channel specifies a new I/O operation. The channel fetches the new ccw and initiates the new operation upon the receipt of the device-end signal for the current operation. When command chaining takes place, the completion of the current operation does not cause an I/O interruption, and the count indicating the amount of data transferred during the current operation is not made available to the program. For operations involving data transfer, the new command always applies to the next block at the device.

Command chaining takes place and the new operation is initiated only if no unusual conditions have been detected in the current operation. If a condition such as unit check, unit exception, or incorrect length has occurred, the sequence of operations is terminated, and the status associated with the current operation causes an interruption condition to be generated. The new ccw in this case is not fetched. The incorrect-length condition does not suppress command chaining if the current ccw has the SLI flag on.

An exception to sequential chaining of ccw's occurs when the I/O device presents the status-modifier condition with the device-end signal. When command chaining is specified and no unusual conditions have been detected, the combination of status-modifier and device-end bits causes the channel to fetch and chain to the ccw whose main-storage address is 16 higher than that of the current ccw.

When both command and data chaining are used, the first ccw associated with the operation specifies the operation to be executed, and the last ccw indicates whether another operation follows.

Programming Note

Command chaining makes it possible for the program to initiate transfer of multiple blocks of data by means of a single `START I/O`. It also permits a subchannel to be set up for execution of auxiliary functions, such as positioning the disk access mechanism, and for data transfer operations without interference by the program at the end of each operation. Command chaining, in conjunction with the status-modifier condition, permits the channel to modify the normal sequence of operations in response to signals provided by the `I/O` device.

Skipping

Skipping is the suppression of main-storage references during an `I/O` operation. It is defined only for read, read backward, and sense operations and is controlled by the skip flag, which can be specified individually for each `ccw`. When the skip flag is one, skipping occurs; when zero, normal operation takes place. The setting of the skip flag is ignored in all other operations.

Skipping affects only the handling of information by the channel. The operation at the `I/O` device proceeds normally, and information is transferred to the channel. The channel keeps updating the count but does not place the information in main storage. If the chain-command or chain-data flag is one, a new `ccw` is obtained when the count reaches zero. In the case of data chaining, normal operation is resumed if the skip flag in the new `ccw` is zero.

No checking for invalid or protected data addresses takes place during skipping, except that the initial data address in the `ccw` cannot exceed the addressing capacity of the model.

Programming Note

Skipping, when combined with data chaining, permits the program to place in main storage selected portions of a block of information from an `I/O` device.

Program-Controlled Interruption

The program-controlled interruption (`PCI`) function permits the program to cause an `I/O` interruption during execution of an `I/O` operation. The function is controlled by the `PCI` flag in the `ccw`. The flag can be on either in the first `ccw` specified by `START I/O` or in a `ccw` fetched during chaining. Neither the `PCI` flag nor the associated interruption affects the execution of the current operation.

Whenever the `PCI` flag in the `ccw` is on, the channel attempts to interrupt the program. When the first `ccw` associated with an operation contains the `PCI` flag,

either initially or upon command chaining, the interruption may occur as early as immediately upon the initiation of the operation. The `PCI` flag in a `ccw` fetched on data chaining causes the interruption to occur after all data designated by the preceding `ccw` have been transferred. The time of the interruption, however, depends on the model and the current activity in the system and may be delayed even if the channel is not masked. No predictable relation exists between the time the interruption due to the `PCI` flag occurs and the progress of data transfer to or from the area designated by the `ccw`.

If chaining occurs before the interruption due to the `PCI` flag has taken place, the `PCI` condition is carried over to the new `ccw`. This carryover occurs both on data and command chaining and, in either case, the condition is propagated through the transfer-in-channel command. The `PCI` conditions are not stacked; that is, if another `ccw` is fetched with a `PCI` flag before the interruption due to the `PCI` flag of the previous `ccw` has occurred, only one interruption takes place.

A `csw` containing the `PCI` bit may be stored by an interruption while the operation is still proceeding or upon the termination of the operation.

When the `csw` is stored by an interruption before the operation or chain of operations has been terminated, the command address is eight higher than the address of the current `ccw`, and the count is unpredictable. All unit-status bits in the `csw` are off. If the channel has detected any unusual conditions, such as channel data check, program check, or protection check by the time the interruption occurs, the corresponding channel-status bit is on, although the condition in the channel is not reset and is indicated again upon the termination of the operation.

Presence of any unit-status bit in the `csw` indicates that the operation or chain of operations has been terminated. The `csw` in this case has its regular format with the `PCI` bit added.

The setting of the `PCI` flag is inspected in every `ccw` except those specifying transfer in channel. In a `ccw` specifying transfer in channel, the setting of the flag is ignored. The `PCI` flag is ignored also during initial program loading.

Programming Notes

Since no unit-status bits are placed in the `csw` associated with the termination of an operation on the selector channel by `HALT I/O`, the presence of a unit-status bit with the `PCI` bit is not a necessary condition for the operation to be terminated. When the selector channel contains the `PCI` bit at the time the operation is terminated by `HALT I/O`, the `csw` associated with the termination is indistinguishable from the `csw` pro-

vided by an interruption during execution of the operation.

Program-controlled interruption provides a means of alerting the program of the progress of chaining during an I/O operation. It permits programmed dynamic main-storage allocation.

Commands

The following table lists the command codes for the six commands and indicates which flags are defined for each command. The flags are ignored for all commands for which they are not defined.

NAME	FLAG	CODE
Write	CD CC SLI PCI	MMMM MM01
Read	CD CC SLI SKIP PCI	MMMM MM10
Read backward	CD CC SLI SKIP PCI	MMMM 1 100
Control	CD CC SLI PCI	MMMM MM11
Sense	CD CC SLI SKIP PCI	MMMM 0 100
Transfer in channel		x x x x 1 000

NOTES

CD	Chain data
CC	Chain command
SLI	Suppress incorrect length
SKIP	Skip
PCI	Program-controlled interruption

All flags have individual significance, except that the CC and SLI flags are ignored when the CD flag is on. The SLI flag is ignored on immediate operations, in which case the incorrect-length indication is suppressed regardless of the setting of the flag. The PCI flag is ignored during initial program loading.

Write

A write operation is initiated at the I/O device, and the subchannel is set up to transfer data from main storage to the I/O device. Data in storage are fetched in an ascending order of addresses, starting with the address specified in the ccw.

A ccw used in a write operation is inspected for the CD, CC, SLI, and the PCI flags. The setting of the skip flag is ignored. Bit positions 0-5 of the ccw contain modifier bits.

Programming Note

On writing magnetic tape, block-length is not defined, and the amount of data written is controlled only by the count in the ccw. Every operation terminated under count control causes the incorrect-length indication, unless the indication is suppressed by the SLI flag.

Read

A read operation is initiated at the I/O device, and the subchannel is set up to transfer data from the device to main storage. For devices such as magnetic tape units, disk storage, and card equipment, the bytes of data within a block are provided in the same sequence

as written by means of a write command. Data in storage are placed in an ascending order of addresses, starting with the address specified in the ccw.

A ccw used in a read operation is inspected for every one of the five flags — CD, CC, SLI, skip, and PCI. Bit positions 0-5 of the ccw contain modifier bits.

Read Backward

A read-backward operation is initiated at the I/O device, and the subchannel is set up to transfer data from the device to main storage. On magnetic tape units, read backward causes reading to be performed with the tape moving backwards. The bytes of data within a block are sent to the channel in a sequence opposite to that on writing. The channel places the bytes in storage in a descending order of address, starting with the address specified in the ccw. The bits within an eight-bit byte are in the same order as sent to the device on writing.

A ccw used in a read-backward operation is inspected for every one of the five flags — CD, CC, SLI, skip, and PCI. Bit positions 0-3 of the ccw contain modifier bits.

Programming Note

When data chaining is used during a read-backward operation, the channel places data in storage in a descending sequence but fetches ccw's in an ascending sequence. Consequently, if a magnetic tape is to be written so that it can be read in either the forward or backward direction as a self-describing record, the ccw must be written at both the beginning and the end of the physical record. If more than one ccw is to be used, the order of the ccw's must be reversed at the end of the record since the storage areas associated with the ccw's are used in reverse sequence. Furthermore, a ccw used for reading backward must describe the associated storage area by specifying the highest address of the area, whereas it normally contains the lowest address.

Control

A control operation is initiated at the I/O device, and the subchannel is set up to transfer data from main storage to the device. The device interprets the data as control information. The control information, if any, is fetched from storage in an ascending order of addresses, starting with the address specified in the ccw. A control command is used to initiate at the I/O device an operation not involving transfer of data — such as backspacing or rewinding magnetic tape or positioning a disk access mechanism.

For most control functions, the entire operation is specified by the modifier bits in the command code,

and the function is performed over the I/O interface as an immediate operation (see "Immediate Operations"). If the command code does not specify the entire control function, the data-address field of the CCW designates the required additional information for the operation. This control information may include an order code further specifying the operation to be performed or an address, such as the disk address for the seek function, and is transferred in response to requests by the device.

A control command code containing zeros for the six modifier bits is defined as no operation. The no-operation order causes the addressed device to respond with channel end and device end without causing any action at the device. The order can be executed as an immediate operation, or the device can delay the status until after the initiation sequence is completed. Other operations that can be initiated by means of the control command depend on the type of I/O device. These operations and their codes are specified in the SRL publication for the device.

A CCW used in a control operation is inspected for the CD, CC, SLI, and the PCI flags. The setting of the skip flag is ignored. Bit positions 0-5 of the CCW contain modifier bits.

Programming Note

Since a count of zero is invalid, the program cannot use the CCW count field to specify that no data be transferred to the I/O device. Any operation terminated before data have been transferred causes the incorrect-length indication, provided the operation is not immediate and has not been rejected during the initiation sequence. The incorrect-length indication is suppressed when the SLI flag is on.

Sense

A sense operation is initiated at the I/O device, and the subchannel is set up to transfer data from the device to main storage. The data are placed in storage in an ascending order of addresses, starting with the address specified in the CCW.

Data transferred during a sense operation provide information concerning both unusual conditions detected in the last operation and the status of the device. The status information provided by the sense command is more detailed than that supplied by the unit-status byte and may describe reasons for the unit-check indication. It may also indicate, for example, if the device is in the not-ready state, if the tape unit is in the file-protected state, or if magnetic tape is positioned beyond the end-of-tape mark.

For most devices, the first six bits of the sense data describe conditions detected during the last opera-

tion. These bits are common to all devices having this type of information and are designated as follows:

BIT	DESIGNATION
0	Command reject
1	Intervention required
2	Bus-out check
3	Equipment check
4	Data check
5	Overrun

The following is the meaning of the first six bits:

Command Reject: The device has detected a programming error. A command has been received which the device is not designed to execute, such as read issued to a printer, or which the device cannot execute because of its present state, such as backspace issued to a tape unit with the tape at load point.

Intervention Required: The last operation could not be executed because of a condition requiring some type of intervention at the device. This bit indicates conditions such as an empty hopper in a card punch or the printer being out of paper. It is also turned on when the addressed device is in the not-ready state, is in test mode, or is not provided on the control unit.

Bus-Out Check: The device or the control unit has received a data byte or a command code with an invalid parity over the I/O interface. During writing, bus-out check indicates that incorrect data have been recorded at the device, but the condition does not cause the operation to be terminated prematurely. Errors on command codes and control information cause the operation to be immediately terminated.

Equipment Check: During the last operation, the device or the control unit has detected equipment malfunctioning, such as an invalid card hole count or printer buffer parity error.

Data Check: The device or the control unit has detected a data error other than those included in bus-out check. Data check identifies errors associated with the recording medium and includes conditions such as reading an invalid card code or detecting invalid parity on data recorded on magnetic tape.

On an input operation, data check indicates that incorrect data may have been placed in main storage. The control unit forces correct parity on data sent to the channel. On writing, this condition indicates that incorrect data may have been recorded at the device. Data errors on reading and writing do not cause the operation to be terminated prematurely.

Overrun: The channel has failed to respond on time to a request for service from the device. Overrun can occur when data are transferred to or from a non-buffered control unit operating with a synchronous medium, and the total activity initiated by the program exceeds the capability of the channel. When the chan-

nel fails to accept a byte on an input operation, the following data in main storage are shifted to fill the gap. On an output operation, overrun indicates that data recorded at the device may be invalid. The overrun bit is also turned on when the device receives the new command too late during command chaining.

All information significant to the use of the device normally is provided in the first two bytes. Any bit positions following those used for programming information contain diagnostic information, which may extend to as many bytes as needed. The amount and the meaning of the status information are peculiar to the type of I/O device and are specified in the *SRL* publication for the device.

The sense information pertaining to the last I/O operation is reset by the next command, other than sense, addressed to the control unit. The sense command cannot cause the command-reject, intervention-required, data-check, or overrun bits to be turned on. If the control unit detects an equipment error or invalid parity of the sense command code, the equipment-check or bus-out-check bits are turned on, and unit check is sent with the channel end.

A ccw used in a sense operation is inspected for every one of the five flags — *CD*, *CC*, *SLI*, *skip*, and *PCI*. Bit positions 0-3 of the ccw contain modifier bits.

Transfer In Channel

The next ccw is fetched from the location designated by the data-address field of the ccw specifying trans-

fer in channel. The transfer-in-channel command does not initiate any I/O operation at the channel, and the I/O device is not signaled of the execution of the command. The purpose of the transfer in channel command is to provide chaining between ccw's not located in adjacent double-word locations in an ascending order of addresses. The command can occur in both data and command chaining.

The first ccw designated by the *CAW* may not specify transfer in channel. When this restriction is violated, no I/O operation is initiated, and the program-check condition is generated. The error causes the status portion of the *CSW* with the program-check indication to be stored during the execution of *START I/O*.

To address a ccw on integral boundaries for double words, a ccw specifying transfer in channel must contain zeros in bit positions 29-31. Furthermore, a ccw specifying a transfer in channel may not be fetched from a location designated by an immediately preceding transfer in channel. When either of these errors is detected or when an invalid address is specified in transfer in channel, the program-check condition is generated. Detection of these errors during data chaining causes the operation at the I/O device to be terminated, whereas during command chaining they cause an interruption condition to be generated.

The contents of the second half of the ccw, bit positions 32-63, are ignored. Similarly, the contents of bit positions 0-3 of the ccw are ignored.

Termination of Input/Output Operations

When the operation or sequence of operations initiated by START I/O is terminated, the channel and the device generate status conditions. These conditions can be brought to the attention of the program by the I/O interruption mechanism, by TEST I/O, or, in certain cases, by START I/O. The status conditions, as well as an address and a count indicating the extent of the operation sequence, are presented to the program in the form of a CSW.

Types of Termination

Normally an I/O operation at the subchannel lasts until the device signals channel end. The channel-end condition can be signaled during the sequence initiating the operation, or later. When the channel detects equipment malfunctioning or a system reset is performed, the channel disconnects the device without receiving channel end. The program can force a device on the selector channel to be disconnected prematurely by issuing HALT I/O.

Termination at Operation Initiation

After the addressed channel and subchannel have been verified to be in a state where START I/O can be executed, certain tests are performed on the validity of the information specified by the program and on the availability of the addressed control unit and I/O device. This testing occurs both during the execution of START I/O and during command chaining.

A data-transfer operation is initiated at the subchannel and device only when no programming or equipment errors are detected by the channel and when the device responds with zero status during the initiation sequence. When the channel detects or the device signals any unusual condition during the initiation of an operation, but channel end is off, the command is said to be rejected.

Rejection of the command during the execution of START I/O is indicated by the setting of the condition code in the PSW. Unless the device is not operational, the conditions that precluded the initiation are detailed by the portion of the CSW stored by START I/O. The device is not started, no interruption conditions are generated, and the subchannel is not tied up beyond the initiation sequence. The device is immediately available for the initiation of another operation,

provided the command was not rejected because of the busy or non-operational condition.

When an unusual condition causes a command to be rejected during initiation of an I/O operation by command chaining, an interruption condition is generated, and the subchannel is not available until the condition is cleared. The not-operational state on command chaining is indicated by means of interface control check; the other conditions are identified by the corresponding status bits in the associated CSW. The new operation at the I/O device is not started.

Immediate Operations

Instead of accepting or rejecting a command, the I/O device can signal the channel-end condition immediately upon receipt of the command code. An I/O operation causing the channel-end condition to be signaled during the initiation sequence is called an "immediate operation."

When the first CCW designated by the CAW initiates an immediate operation, no interruption condition is generated. If no command chaining occurs, the channel-end condition is brought to the attention of the program by causing START I/O to store the CSW status portion, and the subchannel is immediately made available to the program. The I/O operation, however, is initiated, and, if channel-end is not accompanied by device end, the device remains busy. Device end, when subsequently provided by the device, causes an interruption condition to be generated.

When command chaining is specified after an immediate operation and no unusual conditions have been detected during the execution, START I/O does not cause storing of CSW status. The subsequent commands in the chain are handled normally, and the channel-end condition for the last operation generates an interruption condition even if the device provides the signal immediately upon receipt of the command code.

Whenever immediate completion of an I/O operation is signaled, no data have been transferred to or from the device. The data address in the CCW is not checked for validity, except that it may not exceed the addressing capacity of the model.

Since a count of zero is not valid, any CCW specifying an immediate operation must contain a nonzero count. When an immediate operation is executed, however, incorrect length is not indicated to the program, and command chaining is not suppressed.

Input/Output Interruptions

Input/output interruptions provide a means for the CPU to change its state in response to conditions that occur in I/O devices or channels. These conditions can be caused by the program or by an external event at the device.

Interruption Conditions

The conditions causing requests for I/O interruptions to be initiated are called interruption conditions. An interruption condition can be brought to the attention of the program only once and is cleared when it causes an interruption. Alternatively, an interruption condition can be cleared by TEST I/O, and conditions generated by the I/O device following the termination of the operation at the subchannel can be cleared by START I/O. The latter include the attention, device-end, and control-unit-end conditions, and the channel-end condition when provided by a device on the selector channel after termination of the operation by HALT I/O.

The device initiates a request to the channel for an interruption whenever it detects any of the following conditions:

- Channel end
- Control unit end
- Device end
- Attention
- Unit check
- Unit exception

When command chaining is specified and is not suppressed because of error conditions, channel end and device end do not cause interruption conditions and are not made available to the program. Unit-check and unit-exception conditions cause interruption to be requested only when the conditions are detected during the initiation of a chained command. Once the command has been accepted by the device, unit check and unit exception do not occur in the absence of channel end, control unit end, or device end.

When the channel detects any of the following conditions, it initiates a request for an I/O interruption without having received the status byte from the device:

- PCI flag in a CCW.
- Execution of HALT I/O on selector channel.

The interruption conditions from the channel can be accompanied by other channel status indications, but none of the device status bits is on when the channel initiates the interruption.

A request for an I/O interruption due to a program-check condition detected during command chaining (such as invalid command code, count of zero, or two sequential transfer-in-channel commands) may be initiated either by the I/O device or by the channel, de-

pending on the type of channel. To stack the interruption condition in the device, as occurs on the multiplexor channel, the channel signals the device to respond with a unit-status byte consisting of all zeros on a subsequent scan for interruption conditions. The error indication is preserved in the subchannel.

The method of processing a request for interruption due to equipment malfunctioning, as indicated by the presence of the channel-control-check and interface-control-check conditions, depends on the model.

More than one interruption condition can be cleared concurrently. As an example, when the PCI condition exists in the subchannel at the termination of an operation, the PCI condition is indicated with channel end and only one I/O interruption occurs, or only one TEST I/O is needed. Similarly, if the channel-end condition is not cleared until device end is generated, both conditions may be indicated in the CSW and cleared at the device concurrently.

However, at the time the channel assigns highest priority for interruptions to a condition associated with an operation at the subchannel, the channel accepts the status from the device and clears the condition at the device. The interruption condition is subsequently preserved in the subchannel. Any subsequent status generated by the device is not included with the condition at the subchannel, even if the status is generated before the CPU accepts the condition.

Priority of Interruptions

All requests for I/O interruption are asynchronous to the activity in the CPU, and interruption conditions associated with more than one I/O device can exist at the same time. The priority among requests is controlled by two types of mechanisms — one establishes the priority among interruption conditions associated with devices attached to the same channel, and another establishes priority among requests from different channels. A channel requests an I/O interruption only after it has established priority among requests from its devices. The conditions responsible for the requests are preserved in the devices or channels until accepted by the CPU.

Assignment of priority to requests for interruption associated with devices on any one channel is a function of the type of interruption condition and the position of the device on the I/O interface cable.

The selector channel assigns the highest priority to conditions associated with the portion of the operation in which the channel is involved. These conditions include channel end, program-controlled interruptions, errors detected or command chaining, and execution of HALT I/O in the channel. The channel cannot handle

ceipt of the signal from the device. The channel-end indication in this case is not made available to the program.

Termination by HALT I/O

The instruction HALT I/O causes the current operation at the addressed channel or subchannel to be terminated immediately. The method of termination differs from that used upon exhaustion of count or upon detection of programming errors to the extent that termination by HALT I/O is not contingent on the receipt of a service request from the device.

When HALT I/O is issued to a channel operating in the burst mode, the channel issues the halt-I/O signal to the device regardless of the current activity in the channel and on the interface. If the channel is involved in the data-transfer portion of an operation, data transfer is immediately terminated, and the device is disconnected from the channel. If HALT I/O is addressed to a selector channel executing a chain of operations and the device has already provided channel end for the current operation, the instruction causes the device to be disconnected and the chain-command flag to be removed.

When HALT I/O is issued to the multiplexor channel and the channel is not operating in the burst mode, the halt-I/O signal is sent to the device whenever the addressed subchannel is in the working state. The subchannel may be transferring data, or it may have already received channel end for the current operation and may be waiting for device end to initiate a new operation by command chaining. In either case, HALT I/O causes the device to be selected, and the halt-I/O signal is issued as the device responds. When command chaining is indicated in the subchannel, HALT I/O causes the chain-command flag to be turned off.

Termination of an operation by HALT I/O on the selector channel results in up to four distinct interruption conditions. The first one is generated by the channel upon execution of the instruction and is not contingent on the receipt of status from the device. The command address and count in the associated csw indicate how much data have been transferred, and the channel-status bits reflect the unusual conditions, if any, detected during the operation. If HALT I/O is issued before all data specified for the operation have been transferred, incorrect length is indicated, subject to the control of the SLI flag in the current ccw. The execution of HALT I/O itself is not reflected in csw status, and all status bits in a csw due to this interruption condition can be zero. The channel is available for the initiation of a new I/O operation as soon as the interruption condition is cleared.

The second interruption condition on the selector

channel occurs when the control unit generates the channel-end condition. The selector channel handles this condition as any other interruption condition from the device with the subchannel available and provides zeros in the protection key, command address, count, and channel status fields of the associated csw. The channel-end condition is not made available to the program when HALT I/O is issued to a channel executing a chain of operations and the device has already provided channel end for the current operation.

Finally, the third and fourth interruption conditions occur when control unit end, if any, and device end are generated. These conditions are handled as for any other I/O operation.

Termination of an operation by HALT I/O on the multiplexor channel causes the normal interruption conditions to be generated. If the instruction is issued when the subchannel is in the data-transfer portion of an operation, the subchannel remains in the working state until channel end is signaled by the device, at which time the subchannel is placed in the interruption-pending state. If HALT I/O is issued after the device has signaled channel end and the subchannel is executing a chain of operations, the channel-end condition is not made available to the program, and the subchannel remains in the working state until the next status byte from the device is received. Receipt of a status byte subsequently places the subchannel in the interruption-pending state.

The csw associated with the interruption condition in the subchannel contains the status bytes provided by the device and the channel, and indicates at what point data transfer was terminated. If HALT I/O is issued before all data areas associated with the current operation have been exhausted or filled, incorrect length is indicated, subject to the control of the SLI flag in the current ccw. The interruption condition is processed as for any other type of termination.

Termination Due to Equipment Malfunction

When channel equipment malfunctioning is detected or invalid signals are received over the I/O interface, the recovery procedure and the subsequent states of the subchannels and devices on the channel depend on the type of error and on the model. Normally, the program is alerted of the termination by an I/O interruption, and the associated csw indicates the channel-control-check or interface-control-check condition. In channels sharing common equipment with the CPU, malfunctioning detected by the channel may be indicated by a machine-check interruption, in which case no csw is stored. Equipment malfunctioning may cause the channel to perform the malfunction-reset function.

Programming Note

Control operations for which the entire operation is specified in the command code may be executed as immediate operations. Whether the control function is executed as an immediate operation depends on the operation and type of device and is specified in the SRL publication for the device.

Termination of Data Transfer

When the device accepts a command, the subchannel is set up for data transfer. The subchannel is said to be working during this period. Unless the channel detects equipment malfunctioning or, on the selector channel, the operation is terminated by HALT I/O, the working state lasts until the channel receives the channel-end signal from the device. When no command chaining is specified or when chaining is suppressed because of unusual conditions, the channel-end condition causes the operation at the subchannel to be terminated and an interruption condition to be generated. The status bits in the associated csw indicate channel end and the unusual conditions, if any. The device can signal channel end at any time after initiation of the operation, and the signal may occur before any data have been transferred.

For operations not involving data transfer, the device normally controls the timing of the channel-end condition. The duration of data transfer operations may be variable and may be controlled by the device or the channel.

Excluding equipment errors and HALT I/O, the channel signals the device to terminate data transfer whenever any of the following conditions occurs:

- The storage areas specified for the operation are exhausted or filled.
- Program-check condition is detected.
- Protection-check condition is detected.
- Chaining-check condition is detected.

The first of these conditions occurs when the channel has stepped the count in the last ccw associated with the operation to zero. A count of zero indicates that the channel has transferred all information specified by the program. The other three conditions are due to errors and cause premature termination of data transfer. In either case, the termination is signaled in response to a service request from the device and causes data transfer to cease. If the device has no blocks defined for the operation (such as writing on magnetic tape), it terminates the operation and generates the channel-end condition.

The device can control the duration of an operation and the timing of channel end by blocking of data. On certain operations for which blocks are defined (such as reading on magnetic tape), the device does not

provide the channel-end signal until the end of the block is reached, regardless of whether or not the device has been previously signaled to terminate data transfer.

The channel suppresses initiation of an I/O operation when the data address in the first ccw associated with the operation exceeds the addressing capacity of the model. Complete check for the validity of the data address is performed only as data are transferred to or from main storage. When the initial data address in the ccw is invalid, no data are transferred during the operation, and the device is signaled to terminate the operation in response to the first service request. On writing, devices such as magnetic tape units request the first byte of data before any mechanical motion is started and, if the initial data address is invalid, the operation is terminated before the recording medium has been advanced. However, since the operation has been initiated, the device provides channel end, and an interruption condition is generated. Whether a block at the device is advanced when no data are transferred depends on the type of device and is specified in the SRL publication for the device.

When command chaining takes place, the subchannel appears in the working state from the time the first operation is initiated until the device signals the channel-end condition of the last operation of the chain. On the selector channel, the device executing the operation stays connected to the channel and the whole channel appears to be in the working state for the duration of the execution of the chain of operations. On the multiplexor channel an operation in the burst mode causes the channel to appear to be in the working state only for the duration of the transfer of the burst of data. If channel end and device end do not occur concurrently, the device disconnects from the channel after providing channel end, and the channel can in the meantime communicate with other devices on the interface.

Any unusual conditions cause command chaining to be suppressed and an interruption condition to be generated. The unusual conditions can be detected by either the channel or the device, and the device can provide the indications with channel end, control unit end, or device end. When the channel is aware of the unusual condition by the time the channel-end signal for the operation is received, the chain is terminated as if the operation during which the condition occurred were the last operation of the chain. The device-end signal subsequently is processed as an interruption condition. When the device signals unit check or unit exception with control unit end or device end, the subchannel terminates the working state upon re-

any interruption conditions while an operation is in progress.

As soon as the selector channel has cleared the interruption conditions associated with data transfer, it starts scanning devices for attention, control-unit-end, and device-end conditions and for the channel-end condition associated with operations terminated by HALT I/O. The highest priority is assigned to the I/O device that first identifies itself on the interface.

On the multiplexor channel the priority among requests for interruption is based only on the response to scanning. The multiplexor channel continuously scans its I/O devices. The highest priority is assigned to the device that first responds with an interruption condition or that requests service for data transfer and contains the PCI condition in the subchannel. The PCI, as well as any other condition in the subchannel, cannot cause an I/O interruption unless the device initiates a reference to the subchannel.

Except for conditions associated with termination of data transfer, the current assignment of priority for interruption among devices on a channel may be canceled when START I/O or TEST I/O is issued to the channel. Whenever the assignment is canceled, the channel resumes scanning for interruption conditions and re-assigns the priority on completion of the activity associated with the I/O instruction.

The assignment of priority among requests for interruption from channels is based on the type of channel. The priorities of selector channels are in the order of their addresses, with channel 1 having the highest priority. The interruption priority of the multiplexor channel is not fixed and depends on the model and on the current activity in the channel. Its priority may be above, below, or between those of the selector channels.

Interruption Action

An I/O interruption can occur only when the channel accommodating the device is not masked and after the execution of the current instruction in the CPU has been terminated. If a channel has established the priority among requests for interruption from devices while it is masked, the interruption occurs immediately after the termination of the instruction removing the mask and before the next instruction is executed. This interruption is associated with the highest priority condition on the channel. If more than one channel is unmasked concurrently, the interruption occurs from the channel having the highest priority among those requesting interruption.

If the priority among interruption conditions has not yet been established in the channel by the time the mask is removed, the interruption does not necessarily

occur immediately after the termination of the instruction removing the mask. This delay can occur regardless of how long the interruption condition has existed in the device or the subchannel.

The interruption causes the current program status word (PSW) to be stored as the old PSW at location 56 and causes the CSW associated with the interruption to be stored at location 64. Subsequently, a new PSW is loaded from location 120, and processing resumes in the state indicated by this PSW. The I/O device causing the interruption is identified by the channel address in bit positions 21-23 and by the device address in bit positions 24-31 of the old PSW. The CSW associated with the interruption identifies the condition responsible for the interruption and provides further details about the progress of the operation and the status of the device.

Programming Note

When a number of I/O devices on a shared control unit are concurrently executing operations such as rewinding tape or positioning a disk access mechanism, the initial device-end signals generated on completion of the operations are provided in the order of generation, unless command chaining is specified for the operation last initiated. In the latter case, the control unit provides the device-end signal for the last initiated operation first, and the other signals are delayed until the subchannel is freed. Whenever interruptions due to the device-end signals are delayed either because the channel is masked or the subchannel is busy, the original order of the signals is destroyed.

Channel Status Word

The channel status word (CSW) provides to the program the status of an I/O device or the conditions under which an I/O operation has been terminated. The CSW is formed, or parts of it are replaced, in the process of I/O interruptions and during execution of START I/O, TEST I/O, and HALT I/O. The CSW is placed in main storage at location 64 and is available to the program at this location until the time the next I/O interruption occurs or until another I/O instruction causes its content to be replaced, whichever occurs first.

When the CSW is stored as a result of an I/O interruption, the I/O device is identified by the I/O address in the old PSW. The information placed in the CSW by START I/O, TEST I/O, or HALT I/O pertains to the device addressed by the instruction.

The CSW has the following format:

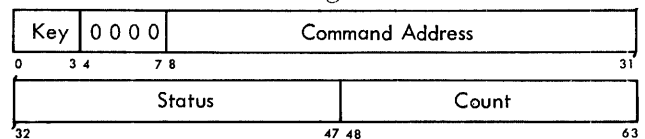

The fields in the csw are allocated for the following purposes:

Protection Key: Bits 0-3 form the storage protection key used in the chain of operations initiated by the last START I/O.

Command Address: Bits 8-31 form an address that is eight higher than the address of the last ccw used.

Status: Bits 32-47 identify the conditions in the device and the channel that caused the storing of the csw. Bits 32-39 are obtained over the I/O interface and indicate conditions detected by the device or the control unit. Bits 40-47 are provided by the channel and indicate conditions associated with the subchannel. Each of the 16 bits represents one type of condition, as follows:

BIT	DESIGNATION	BIT	DESIGNATION
32	Attention	40	Program-controlled interruption
33	Status modifier	41	Incorrect length
34	Control unit end	42	Program check
35	Busy	43	Protection check
36	Channel end	44	Channel data check
37	Device end	45	Channel control check
38	Unit check	46	Interface control check
39	Unit exception	47	Chaining check

Count: Bits 48-63 form the residual count for the last ccw used.

Unit Status Conditions

The following conditions are detected by the I/O device or control unit and are indicated to the channel over the I/O interface. The timing and causes of these conditions for each type of device are specified in the SRL publication for the device.

When the I/O device is accessible from more than one subchannel, status is signaled to the subchannel that initiated the associated I/O operation. The handling of conditions not associated with I/O operations depends on the type of device and condition and is specified in the SRL publication for the device.

The channel does not modify the status bits received from the I/O device. These bits appear in the csw as received over the interface.

Attention

Attention is caused upon the generation of the attention signal at the I/O device. The attention signal can be generated at any time and is interpreted by the program. Attention is not associated with the initiation, execution, or termination of any I/O operation.

The attention condition cannot be indicated to the program while an operation is in progress at the I/O device, control unit, or subchannel. Otherwise, the handling and presentation of the condition to the channel depend on the type of device.

Status Modifier

Status modifier is generated by the device when the normal sequence of commands has to be modified or when the control unit detects during the selection sequence that it cannot execute the command or instruction as specified.

When the status-modifier condition is provided in response to TEST I/O, presence of the bit indicates that the device cannot execute the instruction and that no bits pertaining to the current status of the device have been provided. The status of the device and subchannel is not changed, and the csw stored by TEST I/O contains zeros in the key, command address, channel status, and count fields. The 2702 Transmission Control is an example of a type of device that cannot execute TEST I/O.

When the status-modifier bit appears in the csw together with the busy bit, it indicates that the busy condition pertains to the control unit associated with the addressed I/O device. The control unit appears busy when it is executing a type of operation or is in a state that precludes the acceptance of any command or the instruction TEST I/O and HALT I/O. This occurs for operations such as backspace tape file, in which case the control unit remains busy after providing channel end, and for operations terminated on the selector channel by HALT I/O. The combination of busy and status modifier can be provided in response to any command as well as TEST I/O and HALT I/O. Presence of both busy and status modifier in response to TEST I/O is handled the same way as when status modifier alone is on.

Once the execution of a command has been initiated, the status-modifier indication can be provided only together with device end. The handling of this set of bits by the channel depends on the operation. If command chaining is specified in the current ccw and no unusual conditions have been detected, presence of the bit causes the channel to fetch and chain to the ccw whose main-storage address is 16 higher than that of the current ccw. If the I/O device signals the status-modifier condition at a time when the chain-command flag is off or when any unusual conditions have been detected, no action is taken in the channel, and the status-modifier bit is placed in the csw.

Programming Note

When the multiplexor channel detects a programming error during command chaining, the interruption condition is queued at the I/O device. On devices such as the 2702 Transmission Control, queuing of the condition may generate the status-modifier indication, which subsequently appears in the csw associated with the termination of the operation.

Control Unit End

Control unit end indicates that the control unit has become available for use for another operation.

The control-unit-end condition is provided only by control units shared by I/O devices and only when one or both of the following conditions has occurred:

1. The program has caused the control unit to be interrogated while the control unit was executing an operation. The control unit is considered to have been interrogated when START I/O, TEST I/O, or HALT I/O has been issued to a device on the control unit, and the control unit had responded with busy and status modifier in the unit status byte. START I/O and TEST I/O cause interrogation of the control unit when the control unit is still executing a previously initiated operation, but the subchannel is available or, for TEST I/O, the subchannel on the multiplexor channel contains an interruption condition for the addressed device. The instruction HALT I/O can cause the control unit to be interrogated when issued to a device sharing a control unit and operating in the multiplex mode.

2. The control unit detected an unusual condition during the portion of the operation after channel end had been signaled to the channel.

If the control unit remains busy with the execution of an operation after signaling channel end but has not been interrogated by the program, control unit end is not generated. Similarly, control unit end is not provided when the control unit has been interrogated and could perform the indicated function. The latter case is indicated by the absence of busy and status modifier in the response to the instruction causing the interrogation.

When the busy state of the control unit is temporary, control unit end is included with busy and status modifier in response to the interrogation even though the control unit has not yet been freed. The busy condition is considered to be temporary if its duration is short with respect to the program time required to handle an I/O interruption. The 2702 Transmission Control is an example of a device in which the control unit may be busy temporarily and which includes control unit end with busy and status modifier.

The device address associated with control unit end depends on the type of I/O device. The address can be fixed for the control unit, may identify the device on which the terminated operation was executed, or may be the device address specified in the instruction causing the control unit to be interrogated.

The control-unit-end condition can be signaled with channel end, device end, or between the two. A pend-

ing control unit end causes the control unit to appear busy for initiation of new operations.

Busy

Busy indicates that the I/O device or control unit cannot execute the command or instruction because it is executing a previously initiated operation or because it contains an interruption condition. The interruption condition for the addressed device, if any, accompanies the busy indication. If the busy condition applies to the control unit, busy is accompanied by status modifier.

The following table lists the conditions when the busy bit (B) appears in the CSW and when it is accompanied by the status-modifier bit (SM). A double hyphen (--) indicates that the busy bit is off; an asterisk (*) indicates that CSW status is not stored or an I/O interruption cannot occur; and the (cl) indicates that the interruption condition is cleared and the status appears in the CSW. The abbreviation DE stands for device end, while CU stands for control unit.

CONDITION	CSW STATUS STORED BY:			
	START I/O	TEST I/O	HALT I/O	I/O INT.
Subchannel available				
DE or attention in device	B,cl	--,cl	*	--,cl
Device working, CU available	B	B	*	*
CU end or channel end in CU:				
for the addressed device	B,cl	--,cl	*	--,cl
for another device	B,SM	B,SM	*	--,cl
CU working	B,SM	B,SM	*	*
Interruption pend. in subchannel for the addressed device				
because of:				
chaining terminated by				
attention	*	,cl	*	B,cl
other type of termination	*	--,cl	*	--,cl
Subchannel working				
CU available	*	*	-	*
CU working	*	*	B,SM	*

The busy bit is included in the status associated with a pending interruption condition from the subchannel only when a chain of commands has been prematurely terminated because of attention and no interruption was pending in the channel at the time of chaining.

Channel End

Channel end is caused by the completion of the portion of an I/O operation involving transfer of data or control information between the I/O device and the channel. The condition indicates that the subchannel has become available for use for another operation.

Each I/O operation causes a channel-end condition to be generated, and there is only one channel end for an operation. When command chaining takes place, only the channel end of the last operation of the chain is made available to the program. The channel-end

condition, however, is not made available to the program when a chain of commands is prematurely terminated because of an unusual condition indicated with control unit end or device end. The channel-end condition is not generated when programming or equipment errors are detected during initiation of the operation.

The instant within an I/O operation when channel end is generated depends on the operation and the type of device. For operations such as writing on magnetic tape, the channel-end condition occurs when the block has been written. On devices that verify the writing, channel end may or may not be delayed until verification is performed, depending on the device. When magnetic tape is being read, the channel-end condition occurs when the gap on tape reaches the read-write head. On devices equipped with buffers, such as a line printer, the channel-end condition occurs upon completion of data transfer between the channel and the buffer. During control operations, channel end is generated when the control information has been transferred to the devices, although for short operations the condition may be delayed until completion of the operation. Operations that do not cause any data to be transferred can provide the channel-end condition during the initiation sequence.

A channel-end condition pending in the control unit causes the control unit to appear busy for initiation of new operations. Unless the operation has been performed on the selector channel and has been terminated by HALT I/O, channel end causes the subchannel to be in the interruption-pending state.

Device End

Device end is caused by the completion of an I/O operation at the device or, on some devices, by manually changing the device from the not-ready to the ready state. The condition indicates that the I/O device has become available for use for another operation.

Each I/O operation causes a device-end condition, and there is only one device end to an operation. When command chaining takes place, only the device end of the last operation of the chain is made available to the program. The device-end condition is not generated when any programming or equipment errors are detected during initiation of the operation.

The device-end condition associated with an I/O operation is generated either simultaneously with the channel-end condition or later. On data transfer operations on devices such as magnetic tape units, the device terminates the operation at the time channel end is generated, and both device end and channel end occur together. On buffered devices, such as a line printer, the device-end condition occurs upon

completion of the mechanical operation. For control operations, device end is generated at the completion of the operation at the device. The operation may be completed at the time channel end is generated or later.

When command chaining in the current ccw is specified, receipt of the device-end signal, in the absence of any unusual conditions, causes the channel to initiate a new I/O operation.

Unit Check

Unit check is caused by any programming or equipment errors detected by the I/O device or control unit. The errors responsible for the unit check are detailed by the information available to a sense command. The unit-check bit provides a summary indication of the errors identified by sense data.

The unit-check condition is generated only when the error is detected during the execution of TEST I/O or a command. The device does not alert the program of any equipment malfunction occurring at a time when the device is not executing an operation and does not have a pending interruption condition. Malfunctioning detected at this time may cause the device to become not ready; unit check in this case is signaled to the program the next time the device is selected.

If the device detects during the initiation sequence that the command cannot be executed, unit check is presented to the channel and appears in the csw without channel end, control unit end, or device end. Such unit status indicates that no action has been taken at the device in response to the command. If the condition precluding proper execution of the operation occurs after execution has been started, unit check is accompanied by channel end, control unit end, or device end, depending on when the condition was detected.

Termination of an operation with the unit-check indication causes command chaining to be suppressed.

Unit Exception

Unit exception is caused when the I/O device detects a condition that usually does not occur. The condition includes conditions such as recognition of a tape mark and does not necessarily indicate an error. It has only one meaning for any particular command and type of device.

The unit-exception condition can be generated only when the device is executing an I/O operation. If the device detects during the initiation sequence that the operation cannot be executed, unit exception is presented to the channel and appears in the csw without

channel end, control end, or device end. Such unit status indicates that no action has been taken at the device in response to the command. If the condition precluding normal execution of the operation occurs after the execution has been started, unit exception is accompanied by channel end, control unit end, or device end, depending on when the condition was detected.

Termination of an operation with the unit-exception indication causes command chaining to be suppressed.

Channel Status Conditions

The following conditions are detected and indicated by the channel. Except for the conditions caused by equipment malfunctioning, they can occur only while the subchannel is involved with the execution of an I/O operation.

Program-Controlled Interruption

The program-controlled-interruption condition is generated when the channel fetches a ccw with the program-controlled-interruption (PCI) flag on. The interruption due to the PCI flag takes place as soon as possible after fetching the ccw but may be delayed an unpredictable amount of time because of masking of the channel or other activity in the system.

Detection of the PCI condition does not affect the progress of the I/O operation.

Incorrect Length

Incorrect length occurs when the number of bytes contained in the storage areas assigned for the I/O operation is not equal to the number of bytes requested or offered by the I/O device. Incorrect length is indicated for one of the following reasons:

Long Block on Input: During a read, read-backward, or sense operation, the device attempted to transfer one or more bytes to storage after the assigned storage areas were filled. The extra bytes have not been placed in main storage. The count in the csw is zero.

Long Block on Output: During a write or control operation the device requested one or more bytes from the channel after the assigned main-storage areas were exhausted. The count in the csw is zero.

Short Block on Input: The number of bytes transferred during a read, read backward, or sense operation is insufficient to fill the storage areas assigned to the operation. The count in the csw is not zero.

Short Block on Output: The device terminated a write or control operation before all information contained in the assigned storage areas was transferred to the device. The count in the csw is not zero.

The incorrect-length indication is suppressed when

the current ccw has the SLI flag and does not have the CD flag. The indication does not occur for immediate operations and for operations rejected during the initiation sequence.

Presence of the incorrect-length condition suppresses command chaining unless the SLI flag in the ccw is on or unless the condition occurs in an immediate operation.

The following table lists the effect of the incorrect-length condition for all combinations of the CD, CC, and SLI flags. It indicates for the two types of operations when the operation at the subchannel is terminated (stop) and when the command chaining takes place. The entry "incorrect length" (IL) means that the indication is made available to the program; a double hyphen (--) means that the indication is suppressed. For all entries, the current operation is assumed to have caused the incorrect-length condition.

FLAGS			ACTION AND INDICATION	
CD	CC	SLI	REGULAR OPERATION	IMMEDIATE OPERATION
0	0	0	Stop, IL	Stop, --
0	0	1	Stop, --	Stop, --
0	1	0	Stop, IL	Chain command
0	1	1	Chain command	Chain command
1	0	0	Stop, IL	Stop, --
1	0	1	Stop, IL	Stop, --
1	1	0	Stop, IL	Stop, --
1	1	1	Stop, IL	Stop, --

Program Check

Program check occurs when programming errors are detected by the channel. The condition can be due to the following causes:

Invalid CCW Address Specification: The CAW or the transfer-in-channel command does not designate the ccw on integral boundaries for double words. The three low-order bits of the ccw address are not zero.

Invalid CCW Address: The channel has attempted to fetch a ccw from a location outside the main storage of the particular installation. An invalid ccw address can occur in the channel because the program has specified an invalid address in the CAW or in the transfer-in-channel command or because on chaining the channel has stepped the address above the highest available location.

Invalid Command Code: The command code in the first ccw designated by the CAW or in a ccw fetched on command chaining has four low-order zeros. The command code is not tested for validity during data chaining.

Invalid Count: A ccw other than a ccw specifying transfer in channel contains the value zero in bit positions 48-63.

Invalid Data Address: The channel has attempted to transfer data to or from a location outside the main storage of the particular installation. An invalid data

address can occur in the channel because the program has specified an invalid address in the ccw or because the channel has stepped the address above the highest available address or, on reading backward, below zero.

Invalid Key: The CAW contains a nonzero storage protection key in a model not having the protection feature installed.

Invalid CAW Format: The CAW does not contain zeros in bit positions 4-7.

Invalid CCW Format: A ccw other than a ccw specifying transfer in channel does not contain zeros in bit positions 37-39.

Invalid Sequence: The first ccw designated by the CAW specifies transfer in channel or the channel has fetched two successive ccw's both of which specify transfer in channel.

Detection of the program-check condition during the initiation of an operation causes execution of the operation to be suppressed. When the condition is detected after the device has been started, the device is signaled to terminate the operation. The program-check condition causes command chaining to be suppressed.

Protection Check

Protection check occurs when the channel attempts to place data in a portion of main storage that is protected for the current operation on the subchannel. The protection key associated with the I/O operation does not match the key of the addressed main-storage location, and neither of the keys is zero.

Detection of the protection-check condition causes the device to be signaled to terminate the operation; command chaining is suppressed.

The protection-check condition can be generated only on models having the protection feature installed.

Channel Data Check

Channel data check is caused by data errors detected in the channel or in main storage. The condition covers all data transferred to or from an I/O device, including sense and control information. It includes any parity errors detected on I/O data in main storage, in the channel, or as received from the device over the I/O interface.

The channel attempts to force correct parity on data placed in main storage. On output operations, the parity of data sent to the device is not changed.

Parity errors on data cause command chaining to be suppressed and, depending on model, may cause the current operation to be terminated. When the channel and the CPU share common equipment, parity errors on data may cause malfunction reset to be performed. The

recovery procedure in the channel and the subsequent state of the subchannel upon a malfunction reset depend on the model.

Channel Control Check

Channel control check is caused by any machine malfunctioning affecting channel controls. The condition includes parity errors on ccw and data addresses and parity errors on the contents of the ccw. Conditions responsible for channel control check usually cause the contents of the csw to be invalid and conflicting.

The csw as generated by the channel has correct parity. The channel either forces correct parity on the csw fields or sets the invalid fields to zero.

Detection of the channel-control-check condition causes the current operation, if any, to be immediately terminated and may cause the channel to perform the malfunction-reset function. The recovery procedure in the channel and the subsequent state of the subchannel upon a malfunction reset depend upon the model.

Interface Control Check

Interface control check is caused by any invalid signal on the I/O interface. The condition is detected by the channel and usually indicates malfunctioning of an I/O device. It can be due to the following reasons:

1. The address or status byte received from a device has invalid parity.
2. A device responded with an address other than the address specified by the channel during initiation of an operation.
3. During command chaining the device appeared not operational or indicated the busy condition without providing any other status bits.
4. A signal from a device occurred at an invalid time or had invalid duration.

Detection of the interface-control-check condition causes the current operation, if any, to be immediately terminated and may cause the channel to perform the malfunction-reset function. The recovery procedure in the channel and the subsequent state of the subchannel upon a malfunction reset depends on the model.

Chaining Check

Chaining check is caused by channel overrun during data chaining on input operations. The condition occurs when the I/O data rate is too high for the particular resolution of data addresses. Chaining check cannot occur on output operations.

Detection of the chaining-check condition causes the I/O device to be signaled to terminate the operation. It causes command chaining to be suppressed.

Content of Channel Status Word

The content of the csw depends on the condition causing the storing of the csw and on the programming method by which the information is obtained. The status portion always identifies the condition that caused storing of the csw. The protection key, command address, and count fields may contain information pertaining to the last operation or may be set to zero, or the original contents of these fields at location 64 may be left unchanged.

Information Provided by Channel Status Word

Conditions associated with the execution or termination of an operation at the subchannel cause the whole csw to be replaced.

Such a csw can be stored only by an I/O interruption or by TEST I/O. Except for conditions associated with command chaining, the storing can be caused by the PCI or channel-end condition, by the execution of HALT I/O on the selector channel, or by equipment malfunction. The contents of the csw are related to the current values of the corresponding quantities, although the count is unpredictable after programming errors and after an interruption due to the PCI flag.

A csw stored upon the execution of a chain of operation pertains to the last operation the channel executed or attempted to initiate. Information concerning the preceding operations is not preserved and is not made available to the program.

When an unusual condition causes command chaining to be suppressed, the premature termination of the chain is not explicitly indicated in the csw. A csw associated with a termination due to a condition occurring at channel-end time contains the channel-end bit and identifies the unusual condition. When the device signals the unusual condition with control unit end or device end, the channel-end indication is not made available to the program, and the channel provides the current protection key, command address, and count, as well as the unusual indication, with the control-unit-end or device-end bit in the csw. The command address and count fields pertain to the operation that was executed.

When the execution of a chain of commands is terminated by an error detected during initiation of a new operation, the command address and count fields pertain to the rejected command. Termination at initiation time can occur because of attention, unit check, unit exception, program check, or equipment malfunctioning and causes both the channel-end and device-end bits in the csw to be off.

A csw associated with conditions occurring after the operation at the subchannel has been terminated contains zeros in the protection key, command address, and count fields, provided the conditions are not cleared by START I/O. These conditions include attention, control unit end, and device end (and channel end when it occurs after termination of an operation on the selector channel by HALT I/O).

When the above conditions are cleared by START I/O, only the status portion of the csw is stored, and the original contents of the protection key, command address, and count fields in location 64 are preserved. Similarly, only the status bits of the csw are changed when the command is rejected or the operation at the subchannel is terminated during the execution of START I/O or whenever HALT I/O causes csw status to be stored.

Errors detected during execution of the I/O operation do not affect the validity of the csw unless the channel-control-check or interface-control-check conditions are indicated. Channel control check indicates that equipment errors have been detected, which can cause any part of the csw, as well as the address in the rsw identifying the I/O device, to be invalid. Interface control check indicates that the address identifying the device or the status bits received from the device may be invalid. The channel forces correct parity on invalid csw fields.

Protection Key

A csw stored to reflect the progress of an operation at the subchannel contains the protection key used in that operation. The content of this field is not affected by programming errors detected by the channel or by the condition causing termination of the operation.

Models in which the protection feature is not implemented cause an all-zero key to be stored.

Command Address

When the csw is formed to reflect the progress of the I/O operation at the subchannel, the command address is normally eight higher than the address of the last ccw used in the operation.

The following table lists the contents of the command address field for all conditions that can cause the csw to be stored. The conditions are listed in order of priority; that is, if two conditions are indicated or occur, the csw appears as indicated for the condition higher on the list. The programming errors listed in the table refer to conditions included in program check.

CONDITION	CONTENT
Channel control check	Unpredictable
Status stored by START I/O	Unchanged
Status stored by HALT I/O	Unchanged
Invalid CCW address spec. in TIC	Address of TIC + 8
Invalid CCW address in TIC	Address of TIC + 8
Invalid CCW address generated	Address first invalid CCW + 8
Invalid command code	Address of invalid CCW + 8
Invalid count	Address of invalid CCW + 8
Invalid data address	Address of invalid CCW + 8
Invalid CCW format	Address of invalid CCW + 8
Invalid sequence — 2 TIC's	Address of second TIC + 8
Protection check	Address of invalid CCW + 8
Chaining check	Address of last-used CCW + 8
Termination under count control	Address of last-used CCW + 8
Termination by I/O device	Address of last-used CCW + 8
Termination by HALT I/O	Address of last-used CCW + 8
Suppression of command chaining due to unit check or unit exception with device end or control unit end	Address of last CCW used in the completed operation + 8
Termination on command chaining by attention, unit check, or unit exception	Address of CCW specifying the new operation + 8
Program-controlled interruption	Address of last-used CCW + 8
Interface control check	Address of last-used CCW + 8
Ch. end after HIO on sel. ch.	Zero
Control unit end	Zero
Device end	Zero
Attention	Zero
Busy	Zero
Status modifier	Zero

Count

The residual count, in conjunction with the original count specified in the last ccw used, indicates the number of bytes transferred to or from the area designated by the ccw. When an input operation is terminated, the difference between the original count in the ccw and the residual count in the csw is equal to the number of bytes transferred to main storage; on an output operation, the difference is equal to the number of bytes transferred to the I/O device.

The following table lists the contents of the count field for all conditions that can cause the csw to be stored. The conditions are listed in the order of priority; that is, if two conditions are indicated or occur, the csw appears as for the condition higher on the list.

CONDITION	CONTENT
Channel control check	Unpredictable
Status stored by START I/O	Unchanged
Status stored by HALT I/O	Unchanged
Program check	Unpredictable
Protection check	Unpredictable
Chaining check	Correct
Termination under count control	Correct
Termination by I/O device	Correct
Termination by HALT I/O	Correct
Suppression of command chaining due to unit check, unit exception with device end, or control unit end	Correct. Residual count of last CCW used in the completed operation.
Termination on command chaining by attention, by unit check, or unit exception	Correct. Original count of CCW specifying the new operation.
Program-controlled interruption	Unpredictable
Interface control check	Correct
Ch. end after HIO on sel. ch.	Zero
Control unit end	Zero
Device end	Zero
Attention	Zero
Busy	Zero
Status Modifier	Zero

Status

The status bits identify the conditions that have been detected during the I/O operation, that have caused a command to be rejected, or that have been generated by external events.

The csw contains at least one status bit, unless it is stored by HALT I/O issued to the multiplexor channel or the interruption condition responsible for the storing is caused by HALT I/O issued to the selector channel. In both of the latter cases, all status bits may be off.

When the channel detects several error conditions, all conditions may be indicated or only one may appear in the csw, depending on the condition and model. Conditions associated with equipment malfunctioning have precedence, and whenever malfunctioning causes an operation to be terminated, channel control check, interface control check, or channel data check is indicated, depending on the condition. When an operation is terminated by program check, protection check, or chaining check, the channel identifies

the condition responsible for the termination and may or may not indicate incorrect length. When a data error has been detected before termination due to program check, protection check, or chaining check, both data check and the programming error are identified.

If the CSW fetched on command chaining contains the PCI flag but a programming error in the contents of the CSW or an unusual condition signaled by the device precludes the initiation of the operation, the PCI bit appears in the CSW associated with the interruption condition. Similarly, if device status or a programming error in the contents of the CCW causes the command

to be rejected during execution of START I/O, the CSW stored by START I/O contains the PCI flag. The I/O flag, however, is not included in the CSW if a programming error in the contents of the CAW prevents the operation from being initiated.

Conditions detected by the channel are not related to those identified by the I/O device.

The following table summarizes the handling of status bits. The table lists the states and activities that can cause status indications to be created and the methods by which these indications can be placed in the CSW.

TIME AND METHOD OF CREATING AND STORING STATUS INDICATIONS

STATUS	WHEN	WHEN	UPON TERMINATION OF OPERATION			DURING	BY	BY	BY	BY I/O
	I/O IS IDLE	SUBCHANNEL WORKING	AT SUBCHANNEL	AT CONTROL UNIT	AT DEVICE	COMMAND CHAINING	START I/O	TEST I/O	HALT I/O	INTER- RUPTION
Attention	C*				C	C*	S	S		S
Status modifier					C	C	CS	CS	CS	S
Control unit end				C*			CS	CS	CS	S
Busy						C	CS	CS	CS	S
Channel end			C*	C* H		C* †	C† S	S		S
Device end	C*				C*	C †	C† S	S		S
Unit check			C	C	C	C*	CS	CS		CS
Unit exception			C	C	C	C*	CS	S		S
Program-controlled interruption		C*	C			C	CS	S		S
Incorrect length		C	C					S		S
Program check		C	C			C*	CS	S		S
Protection check		C	C					S		S
Channel data check		C*	C					S		S
Channel control check	C*	C*	C*	C*	C*	C*	CS	CS	CS	CS
Interface control check	C*	C*	C*	C*	C*	C*	CS	CS	CS	CS
Chaining check		C	C					S		S

NOTES

C—The channel or the device can create or present the status condition at the indicated time. A CSW or its status portion is not necessarily stored at this time.

Condition such as channel end and device end are created at the indicated time. Other conditions may have been created previously, but are made accessible to the program only at the indicated time. Examples of such conditions are program check and channel data check, which are detected while data are transferred, but are made available to the program only with channel end, unless the PCI flag or equipment malfunctioning have caused an interruption condition to be generated earlier.

S—The status indication is stored in the CSW at the indicated time.

An S appearing alone indicates that the condition has been created previously. The letter C appearing with the S indicates that the status condition did not necessarily exist previously in the form that causes the program to be alerted, and may have

been created by the I/O instruction or I/O interruption. For example, equipment malfunctioning may be detected during an I/O interruption, causing channel control check or interface control check to be indicated; or a device such as the 2702 Transmission Control Unit may signal the control-unit-busy condition in response to interrogation by an I/O instruction, causing status modifier, busy, and control unit end to be indicated in the CSW.

*—The status condition generates or, in the case of channel data check, may generate an interruption condition.

Channel end and device end do not result in interruption conditions when command chaining is specified and no unusual conditions have been detected.

†—This status indication can be created at the indicated time only by an immediate operation.

H—When an operation on the selector channel has been terminated by HALT I/O, channel end indicates the termination of the data-handling portion of the operation at the control unit.

The system control panel contains the switches and lights necessary to operate and control the system. The system consists of the CPU, storage, channels, on-line control units, and I/O devices. Off-line control units and I/O devices, although part of the system environment, are not considered part of the system proper.

System controls are divided into three sections: operator control, operator intervention, and customer engineering control. Customer engineering controls are also available on some storage, channel, and control-unit frames.

No provision is made for locking out any section of the system control panel. The conditions under which individual controls are active are described for each case.

System Control Functions

The system-reset function resets the CPU, the channels, panel are the ability to reset the system; to store and display information in storage, in registers and in the PSW; and to load initial program information.

System Reset

The system-reset function resets the CPU, the channels, and on-line, nonshared control units and I/O devices.

The CPU is placed in the stopped state and all pending interruptions are eliminated. The parity of general and floating-point registers, as well as the parity of the PSW, may be corrected. All error-status indicators are reset to zero.

In general, the system is placed in such a state that processing can be initiated without the occurrence of machine checks, except those caused by subsequent machine malfunction.

The reset state for a control unit or device is described in the appropriate System Reference Library (SRL) publication. Off-line control units are not reset. A system-reset signal from a CPU resets only the functions in a shared control unit or device belonging to that CPU. Any function pertaining to another CPU remains undisturbed.

The system-reset function is performed when the system-reset key is pressed, when initial program

loading is initiated, or when a power-on sequence is performed.

Programming Notes

Because the system reset may occur in the middle of an operation, the contents of the PSW and of result registers or storage locations are unpredictable. If the CPU is in the wait state when the system reset is performed, and I/O is not operating this uncertainty is eliminated.

Following a system reset, incorrect parity may exist in storage in all models and in the registers in some models. Since a machine check occurs when information with incorrect parity is used, the incorrect information should be replaced by loading new information.

Store and Display

The store-and-display function permits manual intervention in the progress of a program. The store-and-display function may be provided by a supervisor program in conjunction with proper I/O equipment and the interrupt key.

In the absence of an appropriate supervisor program, the controls on the operator intervention panel permit the CPU to be placed in the stopped state and subsequently to store and display information in main storage, in general and floating-point registers, and in the instruction-address part of the PSW. The stopped state is achieved at the end of the current instruction when the stop key is pressed, when single instruction execution is specified, or when a preset address is reached. Once the desired intervention is completed, the CPU can be started again.

All basic store-and-display functions can be simulated by a supervisor program. The stopping and starting of the CPU in itself does not cause any alteration in program execution other than the time element involved (the transition from operating to stopped state is described under "Stopped State" in "Status-Switching").

Interruption checks occurring during store-and-display functions do not interrupt or log immediately but may, in some cases, create a pending interruption. This interruption request can be removed by a system reset. Otherwise, the interruption, when not masked off, is taken when the CPU is again in the operating state.

Initial Program Loading

Initial program loading (IPL) is provided for the initiation of processing when the contents of storage or the PSW are not suitable for further processing.

Initial program loading is initiated manually by selecting an input device with the load-unit switches and subsequently pressing the load key. When the multisystem feature is installed, initial program loading may be initiated electronically by a signal received on one of the IPL in-lines.

Depressing the load key causes a system reset, turns on the load light, turns off the manual light, sets the prefix trigger (if present), and subsequently initiates a read operation from the selected input device. When reading is completed satisfactorily, a new PSW is obtained, the CPU starts operating, and the load light is turned off.

When a signal is received on one of the IPL in-lines, the same sequence of events takes place, except that the read operation is omitted.

System reset suspends all instruction processing, interruptions, and timer updating and also resets all channels, on-line nonshared control units, and I/O devices. The contents of general and floating-point registers remain unchanged, except that the reset procedure may introduce correct parity.

The prefix trigger is set after system reset. In manually initiated IPL, the trigger is set according to the state of the prefix-select key switch. When IPL is initiated by a signal on one of the two IPL in-lines, the trigger is set according to the identity of each line. The prefix trigger is part of the multisystem feature.

If IPL is initiated manually, the select input device starts reading. The first 24 bytes read are placed in storage locations 0-23. Storage protection, program-controlled interruption, and a possible incorrect length indication are ignored. The double-word read into location 8 is used as the channel command word (CCW) for a subsequent input command. When chaining is specified in this CCW, the operation proceeds with the CCW in location 16.

After the input operation is performed, the I/O address is stored in bits 21-31 of the first word in storage. Bits 16-20 are made zero. Bits 0-15 remain unchanged. The input operation and the storing of the I/O address are not performed when IPL is initiated by means of the IPL in-lines.

The CPU subsequently fetches the double word in location 0 as a new PSW and proceeds under control of the new PSW. The load light is turned off. When the

I/O operations and PSW loading are not completed satisfactorily, the CPU stops, and the load light remains on.

Programming Notes

Initial program loading resembles a START I/O that specifies the I/O device selected in the load-unit switches and a zero protection key. The CCW for this START I/O has a read command, zero data address, a byte count of 24, command-chain flag on, suppress-length-indication flag on, program-controlled-interruption flag off, and a virtual command address of zero.

Initial program loading reads new information into the first six words of storage. Since the remainder of the IPL program may be placed in any desired section of storage, it is possible to preserve such areas of storage as the timer and PSW locations, which may be helpful in program debugging.

If the selected input device is a disk, the IPL information is read from track 0.

The selected input device may be the channel-to-channel adapter involving two CPU's. A system reset on this adapter causes an attention signal to be sent to the addressed CPU. That CPU then should issue the write command necessary to load a program into main storage of the requesting CPU.

When the PSW in location 0 has bit 14 set to one, the CPU is in the wait state after the IPL procedure (the manual, the system, and the load lights are off, and the wait light is on). Interruptions that become pending during IPL are taken before instruction execution.

Operator Control Section

This section of the system control panel contains only the controls required by the operator when the CPU is operating under full supervisor control. Under supervisor control, a minimum of direct manual intervention is required since the supervisor performs operations like store and display.

The main functions provided by the operator control section are the control and indication of power, the indication of system status, operator to machine communication, and initial program loading.

The operator control section, with the exception of the emergency pull switch, may be duplicated once as a remote panel on a console.

The following table lists all operator controls by the names on the panel or controls and describes them.

NAME	IMPLEMENTATION
Emergency Pull	Pull switch
Power On	Key, backlighted
Power Off	Key
Interrupt	Key
Wait	Light
Manual	Light
System	Light
Test	Light
Load	Light
Load Unit	Three rotary switches
Load	Key
Prefix Select*	Key switch

* Multisystem feature

Emergency Pull Switch

Pulling this switch turns off all power beyond the power-entry terminal on every unit that is part of the system or that can be switched onto the system. Therefore, the switch controls the system proper and all off-line and shared control units and I/O devices.

The switch latches in the out position and can be restored to its in position by maintenance personnel only.

When the emergency pull switch is in the out position, the power-on key is ineffective.

Power-On Key

This key is pressed to initiate the power-on sequence of the system.

As part of the power-on sequence, a system reset is performed in such a way that the system performs no instructions or I/O operations until explicitly directed. The contents of main storage, including its protection keys, remain preserved.

The power-on key is backlighted to indicate when the power-on sequence is completed. The key is effective only when the emergency pull switch is in its in position.

Power-Off Key

The power-off key is pressed to initiate the power-off sequence of the system.

The contents of main storage and its protection keys are preserved.

Interrupt Key

The interrupt key is pressed to request an external interruption.

The interruption is taken when not masked off and when the CPU is not stopped. Otherwise, the interruption request remains pending. Bit 25 in the interruption-code portion of the current PSW is made one to indicate that the interrupt key is the source of the external interruption.

Wait Light

The wait light is on when the CPU is in the wait state.

Manual Light

The manual light is on when the CPU is in the stopped state. Several of the manual controls are effective only when the CPU is stopped, that is, when the manual light is on.

System Light

The system light is on when the CPU cluster meter or customer-engineering meter is running.

Programming Note

The states indicated by the wait and manual lights are independent of each other; however, the state of the system light is not independent of the state of these two lights because of the definition of the running condition for the meters. The following table shows possible conditions.

SYSTEM LIGHT	MANUAL LIGHT	WAIT LIGHT	CPU STATE	I/O STATE
off	off	off	Not allowed	when power is on
off	off	on	Waiting	Not operating
off	on	off	Stopped	Not operating
off	on	on	Stopped, waiting	Not operating
on	off	off	Running	Undetermined
on	off	on	Waiting	Operating
on	on	off	Stopped	Operating
on	on	on	Stopped, waiting	Operating

Test Light

The test light is on when a manual control is not in its normal position or when a maintenance function is being performed for CPU, channels, or storage.

Any abnormal switch setting on the system control panel or on any separate maintenance panel for the CPU, storage, or channels that can affect the normal operation of a program causes the test light to be on.

The test light may be on when one or more diagnostic functions under control of DIAGNOSE are activated or when certain abnormal circuit breaker or thermal conditions occur.

The test light does not reflect the state of marginal voltage controls.

Load Light

The load light is on during initial program loading; it is turned on when the load key is pressed and is turned off after the loading of the new PSW is completed successfully.

Load-Unit Switches

Three rotary switches provide the 11-bit address of the device to be used for initial program loading.

The leftmost rotary switch has eight positions labeled 0-7. The other two are 16-position rotary switches labeled with the hexadecimal characters 0-9, A-F.

Load Key

The load key is pressed to start initial program loading, and is effective while power is on the system.

Prefix-Select Key Switch

The prefix-select key switch provides the choice between main prefix and alternate prefix during manually initiated initial program loading.

The setting of the switch determines the state of the prefix trigger following the system reset after the load key is pressed.

The switch is part of the multisystem feature.

Operator Intervention Section

This section of the system control panel contains the controls required for the operator to intervene in normal programming operation. These controls may be intermixed with the customer engineering controls, and additional switch positions and nomenclature may be included, depending on the model.

Operator intervention provides the system-reset and the store-and-display functions. Compatibility in performing these functions is maintained, except that the word size used for store and display depends on the physical word size of storage for the model. Switches for display of the instruction address are absent on models that continuously display the instruction address.

The following table lists all intervention controls by the names on the panel or controls and describes them.

NAME	IMPLEMENTATION
System Reset	Key
Stop	Key
Rate	Rotary switch
Start	Key
Storage Select	Rotary or key switch
Address	Rotary or key switches
Data	Rotary or key switches
Store	Key
Display	Key
Set IC	Key
Address Compare	Rotary or key switches
Alternate Prefix*	Light

* Multisystem feature

System-Reset Key

The system-reset key is pressed to cause a system reset; it is effective while power is on the system. The reset function does not affect any off-line or shared device.

Stop Key

The stop key is pressed to cause the CPU to enter the stopped state; it is effective while power is on the system.

Programming Note

Pressing the stop key has no effect when a continuous string of interruptions is performed or when the CPU is unable to complete an instruction because of machine malfunction. The effect of pressing the key is indicated by the turn-on of the manual light as the CPU enters the stopped state.

Rate Switch

This rotary switch indicates the way in which instructions are to be performed.

The switch has two or more positions, depending on model. The vertical position is marked PROCESS. In this position, the system starts operating at normal speed when the start key is pressed. The position left of vertical is marked INSTRUCTION STEP. When the start key is pressed with the rate switch in this position, one complete instruction is performed, and all pending, not masked interruptions are subsequently taken. The CPU next returns to the stopped state.

Any instruction can be executed with the rate switch set to INSTRUCTION STEP. Input/output operations are completed to the interruption point. When the CPU is in the wait state, no instruction is performed, but pending interruptions, if any, are taken before the CPU returns to the stopped state. Initial program loading is completed with the loading of the new PSW before any instruction is performed. The timer is not updated while the rate switch is set to INSTRUCTION STEP.

The test light is on when the rate switch is not set to PROCESS.

The position of the rate switch should be changed only while the CPU is in the stopped state. Otherwise unpredictable results occur.

Start Key

The start key is pressed to start instruction execution in the manner defined by the rate switch.

Pressing the start key after a normal stop causes instruction processing to continue as if no stop had occurred, provided that the rate switch is in the PROCESS or INSTRUCTION-STEP position. If the key is pressed after a system reset, the instruction designated by the instruction address in the PSW is the first instruction executed. In some models, the start key cannot be pressed after a system reset until a new instruction address or PSW is introduced by pressing the set IC or load switch.

The key is effective only while the CPU is in the stopped state.

Storage-Select Switch

The storage area to be addressed by the address switches is selected by the storage-select switches.

The switch can select main storage, the general registers, the floating-point registers and, in some cases, the instruction-address part of the rsw.

When the general or floating-point registers are not addressed directly but must be addressed by using another address such as a local-store location, information is included on the panel to enable an operator to compute the required address.

The switch can be manipulated without disrupting CPU operations.

Address Switches

The address switches address a location in a storage area and can be manipulated without disrupting CPU operation. The address switches, with the storage-select switch, permit access to any addressable location. Correct address parity is generated.

Data Switches

The data switches specify the data to be stored in the location specified by the storage-select switch and address switches.

The number of data switches is sufficient to allow storing of a full physical storage word. Correct data parity is generated. Some models generate either correct or incorrect parity under switch control.

Store Key

The store key is pressed to store information in the location specified by the storage-select switch and address switches.

The contents of the data switches are placed in the main storage, general register, or floating-point register location specified. Storage protection is ignored. When the location designated by the address switches and storage-select switch is not available, data are not stored.

The key is effective only while the CPU is in the stopped state.

Display Key

The display key is pressed to display information in the location specified by the storage-select switch and address switches.

The data in the main storage, general register, or floating-point register location, or in the instruction-

address part of the rsw specified by the address switches and the storage-select switch, are displayed. When the designated location is not available, the displayed information is unpredictable. In some models, the current instruction address is continuously displayed and hence is not explicitly selected.

The key is effective only while the CPU is in the stopped state.

Set IC Key

This key is pressed to enter an address into the instruction-address part of the current rsw.

The key is effective only while the CPU is in the stopped state.

The address in the address switches is entered in bits 40-63 of the current rsw. In some models the address is obtained from the data switches.

Address-Compare Switches

These rotary or key switches provide a means of stopping the CPU on a successful address comparison.

When these switches are set to the stop position, the address in the address switches is compared against the value of the instruction address on all models and against all addresses on some models. An equal comparison causes the CPU to enter the stopped state. Comparison includes only the part of the instruction address that addresses the physical word size of storage.

Comparison of the entire halfword instruction address is provided in some models, as is the ability to compare data addresses.

The address-compare switches can be manipulated without disrupting CPU operation other than by causing the address-comparison stop. When they are set to any position but normal, the test light is on.

Programming Note

When an address not used in the program is selected in the address switches, the CPU runs as if the address-compare switches were set to normal, except for the reduction in performance which may be caused by the address comparison.

Alternate-Prefix Light

The alternate-prefix light is on when the prefix trigger is in its alternate state. The light is part of the multi-system feature.

Customer Engineering Section

This section of the system control panel contains controls intended only for customer-engineering use.

Appendix A. Instruction Use Examples

The following examples illustrate the use of many System/360 instructions. Note that these examples closely approximate machine language to best illustrate the operation of the system. For clarity, the mnemonic for each operation code is used instead of the actual machine code. In addition, whenever possible, the contents of registers, storage locations, and so on, are given in decimal notation rather than the actual binary formats. When binary formats are used, they are segmented into bytes (eight bits) for ease of visual comparison.

Included at the end of this Appendix are programming examples that utilize the assembly language symbols and formats.

Load Complement

The two's complement of general register 4 is to be placed into general register 2.

Assume:

Condition code = 2; greater than zero
 Reg 2 (before) 00000000 00000000 00000010 11010110
 Reg 4 00000000 00000000 01001001 11010101

The instruction is:

Op Code	R ₁	R ₂
LCR	2	4

Reg 2 (after) 11111111 11111111 10110110 00101011
 Reg 2 contains the two's complement of Reg 4.
 Condition code setting = 1; less than zero.

Load Multiple

General registers 5, 6, and 7 are to be loaded from consecutive words starting at 3200.

Assume:

Reg 5 (before) 00 00 75 63
 Reg 6 (before) 00 00 01 26
 Reg 7 (before) 00 32 76 45
 Reg 12 00 00 30 00
 Loc 3200-3203 00 12 57 27
 Loc 3204-3207 00 00 25 63
 Loc 3208-3211 73 26 00 12

The instruction is:

Op Code	R ₁	R ₂	B ₂	D ₂
LM	5	7	12	200

Reg 5 (after) 00 12 57 27
 Reg 6 (after) 00 00 25 63
 Reg 7 (after) 73 26 00 12
 Condition code: unchanged.

Compare

The contents of register 4 are to be algebraically compared with the contents of register 2.

Assume:

Reg 2 00 00 03 92
 Reg 4 00 00 03 47

The instruction is:

Op Code	R ₁	R ₂
CR	4	2

Condition code = 1; first operand low.

Divide (Fixed Point)

The contents of the even/odd pair of general registers 6 and 7 are to be divided by the contents of general register 4.

Assume:

Reg 6 (before) 00000000 00000000 00000000 00000000 (1st Word)
 Reg 7 (before) 00000000 00000000 00001000 11011110 = +2270 (2nd Word)
 Reg 4 00000000 00000000 00000000 00110010 = +50

The instruction is:

Op Code	R ₁	R ₂
DR	6	4

Reg 6 (after) 00000000 00000000 00000000 00010100(remainder) = +20
 Reg 7 (after) 00000000 00000000 00000000 00101101(quotient) = +45
 Condition code: unchanged.

The instruction divides the contents of registers 6 and 7 by the content of register 4. The quotient replaces the content of register 7, and the remainder replaces the content of register 6.

Convert to Binary

The signed, packed decimal field at double-word location 1000-1007 is to be converted into a binary integer and placed in general register 7.

Assume:

Reg 5 00 00 00 50
 Reg 6 00 00 09 00
 Loc 1000-1007 00 00 00 00 00 25 59 4+
 Reg 7 (before) 11111111 11100000 11110111 10111111

The instruction is:

Op Code	R ₁	X ₂	B ₂	D ₂
CVB	7	5	6	50

Reg 7 (after) 00000000 00000000 01100011 11111010
Condition code: unchanged.

Convert to Decimal

The binary contents of general register 3 are to be converted into a packed decimal integer of 15 digits and sign and stored in double-word location 2000.

Assume:

Reg 4 00 00 00 40
Reg 15 00 00 18 60
Reg 3 00000000 00000000 01011011 01000001
Loc 2000 (before) 01 47 63 27 42 73 21 17

The instruction is:

Op Code	R ₁	X ₂	B ₂	D ₂
CVD	3	4	15	100

Loc 2000 (after) 00 00 00 00 00 23 36 1+
Condition code: unchanged.

Store Multiple

The contents of general registers 14, 15, 0, and 1 are to be stored in consecutive words starting with 4050.

Assume:

Reg 14 00 00 25 63
Reg 15 00 01 27 36
Reg 0 12 43 00 62
Reg 1 73 26 12 57
Reg 6 00 00 40 00
Loc 4050-4053 (before) 63 25 41 32
Loc 4054-4057 (before) 17 25 63 42
Loc 4058-4061 (before) 07 16 32 71
Loc 4062-4065 (before) 98 67 45 21

The instruction is:

Op Code	R ₁	R ₂	B ₂	D ₂
STM	14	1	6	50

Loc 4050-4053 (after) 00 00 25 63
Loc 4054-4057 (after) 00 01 27 36
Loc 4058-4061 (after) 12 43 00 62
Loc 4062-4065 (after) 73 26 12 57
Condition code: unchanged

Decimal Add

The signed, packed decimal field at location 500-503 is to be added to the signed, packed decimal field at location 2000-2002.

Assume:

Reg 12 00 00 20 00
Reg 13 00 00 04 80
Loc 2000-2002 (before) 38 46 0-
Loc 500-503 01 12 34 5+

The instruction is:

Op Code	L ₁	L ₂	B ₁	D ₁	B ₂	D ₂
AP	2	3	12	0	13	20

Loc 2000-2002 (after) 73 88 5+
Condition code = 2; sum is greater than zero.

Zero and Add

The signed, packed decimal field at location 4500-4502 is to be moved to location 4000-4004 with four leading zeros in the result field.

Assume:

Reg 9 00 00 40 00
Loc 4000-4004 (before) 12 34 56 78 90
Loc 4500-4502 38 46 0-

The instruction is:

Op Code	L ₁	L ₂	B ₁	D ₁	B ₂	D ₂
ZAP	4	2	9	0	9	500

Loc 4000-4004 (after) 00 00 38 46 0-
Condition code = 1; sum is less than zero.

Compare Decimal

The contents of location 700-703 are to be compared algebraically with the contents of location 500-503.

Assume:

Reg 12 00 00 05 50
Reg 13 00 00 04 00
Loc 700-703 17 25 35 6+
Loc 500-503 06 72 14 2+

The instruction is:

Op Code	L ₁	L ₂	B ₁	D ₁	B ₂	D ₂
CP	3	3	12	150	13	100

Condition code = 2; first operand is high.

Multiply Decimal

The signed, packed decimal field in location 1200-1204 is to be multiplied by the signed, packed decimal field in location 500-501, and the product is to be placed in location 1200-1204.

Assume:

Reg 4 00 00 12 00
Reg 6 00 00 02 50
Loc 1200-1204 (before) 00 00 38 46 0-
Loc 500-501 32 1-

The instruction is:

Op Code	L ₁	L ₂	B ₁	D ₁	B ₂	D ₂
MP	4	1	4	0	6	250

Loc 1200-1204 (after) 01 23 45 66 0+
Condition code: unchanged.

Divide Decimal

The signed, packed decimal field at location 2000-2004 is to be divided by the packed decimal field at location 3000-3001.

Assume:

Reg 12 00 00 18 00
 Reg 13 00 00 25 00
 Loc 2000-2004 (before) 01 23 45 67 8+
 Loc 3000-3001 32 1-

The instruction is:

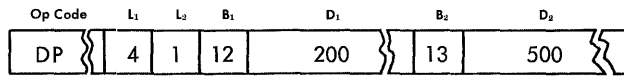

Loc 2000-2004 (after) 38 46 0- 01 8+
 where the quotient is 38460- and the remainder is 018+.
 Condition code: unchanged.

Pack

Assume locations 1000-1004 contain the following:

Z1 Z2 Z3 Z4 S5
 where Z = four-bit zone code
 S = four-bit sign code

The field is to be in packed format with two leading zeros and placed in location 2500-2503.

Reg 12 00 00 10 00
 Reg 13 00 00 25 00
 Loc 1000-1004 Z1 Z2 Z3 Z4 S5
 Loc 2500-2503 (before) A B C D

The instruction is:

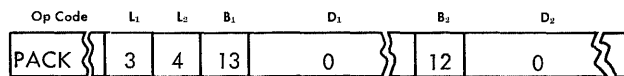

Loc 2500-2503 (after) 00 12 34 5S
 Condition code: unchanged.

Unpack

Assume locations 2501-2503 contains the following fields:

12 34 5S

This field is to be put into zoned format and placed in the locations 1000-1004 where: S is a four bit sign code.

Reg 12 00 00 10 00
 Reg 13 00 00 25 00
 Loc 2501-2503 12 34 5S
 Loc 1000-1004 (before) A B C D E

The instruction is:

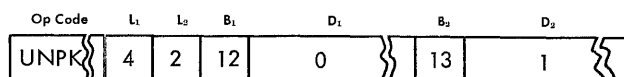

and results in
 Loc 1000-1004 (after) Z1 Z2 Z3 Z4 S5
 where Z is a four-bit zone code.
 Condition code: unchanged.

Move with Offset

The unsigned three-byte field at location 4500-4502 is to be moved to location 5600-5603 and given the sign of the one byte field located at 5603.

Assume:

Reg 12 00 00 50 00
 Reg 15 00 00 40 00
 Loc 5600-5603 (before) 77 88 99 0+
 Loc 4500-4502 12 34 56

The instruction is:

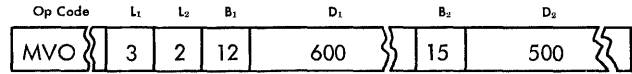

Loc 5600-5603 (after) 01 23 45 6+
 Condition code: unchanged.

Move Immediate

A dollar sign (\$) is to be placed in location 2100, leaving locations 2101-2105 unchanged. Let Z represent a four-bit zone.

Assume:

Reg 12 00 00 20 00
 Loc 2100-2105 (before) Z0 Z1 Z2 Z3 Z5 Z0

The instruction is:

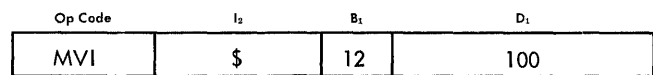

Loc 2100-2105 (after) \$ Z1 Z2 Z3 Z5 Z0
 Condition code: unchanged.

Move Numeric

Let Z and Y represent four-bit zones. The numeric parts of the eight-bit characters in the field at locations 6070-6074 are to be replaced by the numeric parts of eight-bit characters at locations 8080-8084.

Assume:

Reg 12 00 00 60 00
 Reg 15 00 00 80 00
 Loc 6070-6074 (before) Y1 Y2 Y3 Y4 Y5
 Loc 8080-8084 Z3 Z6 Z9 Z7 Z8

The instruction is:

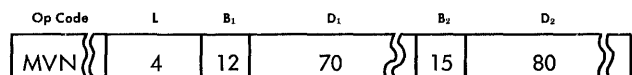

Loc 6070-6074 (after) Y3 Y6 Y9 Y7 Y8
 Condition code: unchanged.

Move Zones

Let Z and Y represent four-bit zones in the eight-bit characters making up the fields at location 2006-2010 and 3007-3011, respectively. The zones of the field at 2006-2010 are to be replaced by the zones from location 3007-3011.

Assume:

Reg 12 00 00 20 00
 Reg 15 00 00 30 00
 Loc 2006-2010 (before) Z1 Z4 Z7 Z8 Z5
 Loc 3007-3011 Y8 Y7 Y4 Y6 Y8

The instruction is:

Op Code	L	B ₁	D ₁	B ₂	D ₂
MVZ	4	12	6	15	7

Loc 2006-2010 (after) Y1 Y4 Y7 Y8 Y5
 Condition code: unchanged.

AND (Register to Register)

When two operands are combined by an AND, they are matched bit for bit. If corresponding bits are both 1, the result is 1. If either is 0, the result is 0. For example, if the logical AND of register 5 and 6 is to be taken,

Assume:

Reg 6 00000000 00000000 00000000 01011011
 Reg 5 (before) 00000000 00000000 00000000 01110110

The instruction is:

Op Code	R ₁	R ₂
NR	5	6

Reg 5 00000000 00000000 00000000 01010010
 Condition code = 1; not all-zero result.

OR

When two operands are combined by an OR, they are matched bit-for-bit. If either of the corresponding bits is 1, the result is 1. If both are 0, the result is 0. For example, if the logical OR of register 5 and 6 is to be taken,

Assume:

Reg 6 00000000 00000000 00000000 10110111
 Reg 5 (before) 00000000 00000000 00000000 11101101

The instruction is:

Op Code	R ₁	R ₂
OR	5	6

Reg 5 (after) 00000000 00000000 00000000 11111111
 Condition code = 1; not all-zero result.

Exclusive OR

When two operands are combined by an EXCLUSIVE OR, they are matched bit-for-bit. If the corresponding bits match (both 0 or both 1), the result is 0. If they differ, the result is 1. For example, if the EXCLUSIVE OR of register 5 and 6 is to be taken,

Assume:

Reg 6 00000000 00000000 00000000 10110111
 Reg 5 (before) 00000000 00000000 00000000 11101101

The instruction is:

Op Code	R ₁	R ₂
XR	5	6

Reg 5 (after) 00000000 00000000 00000000 01011010
 Condition code = 1; not all-zero result.

Test Under Mask

Test bit positions 0, 2, 3, and 6 of a given byte in storage to determine if all of these bit positions contain ones. A TEST UNDER MASK with a mask of 10110010 = 178₁₀ is used. The byte to be tested is stored at location 1250 and contains 01101101.

Assume:

Reg 10 00 00 12 00

The instruction is:

Op Code	I ₂	B ₁	D ₁
TM	178	10	50

Mask from TM 10110010
 Byte tested 01101101
 Selected result 0- 10 -- 0-
 Condition code = 1; some selected bits are 0, some selected bits are 1.

Insert Character

The character at location 4200 is to be inserted into the low-order eight bits of register 7.

Assume:

Reg 7 (before) 00000000 10110110 11000101 01101101
 Reg 4 00 00 02 00
 Reg 5 00 00 30 00
 Loc 4200 00001011

The instruction is:

Op Code	R ₁	X ₂	B ₂	D ₂
IC	7	4	5	1000

Reg 7 (after) 00000000 10110110 11000101 00001011
 Condition code: unchanged.

Load Address

The effective address obtained by adding 1000 to the low-order 24 bits of general registers 3 and 2, is to be placed in general register 4.

Assume:

Reg 4 (before) 73 16 00 12
 Reg 3 00 03 00 10
 Reg 2 00 00 02 00

The instruction is:

Op Code	R ₁	X ₂	B ₂	D ₂
LA	4	3	2	1000

Reg 4 (after) 00 03 12 10
 Condition code: unchanged.

Edit and Edit and Mark

The following examples show the step-by-step editing of a packed field with a length specification of four against a pattern 13 bytes long. The following symbols are used:

SYMBOL	MEANING
b	blank character
(significance start character
)	field separator character
d	digit-select character

Assume:

Loc 1000-1012 (first operand) bdd,dd(.ddbCR
 Loc 120-1203 (second operand) 02 57 42 6+
 Reg 120 00 00 10 00

The instruction is:

Op Code	L	B ₁	D ₁	B ₂	D ₂
ED	12	12	0	12	200

and provides the following:

PATTERN DIGIT	S TRIGGER	RULE	LOCATION 1000-1012
b	0	leave ⁽¹⁾	bdd, dd(. ddbCR
d	0	fill	bbd, dd(. ddbCR
d	2	digit	bb2, dd(. ddbCR ⁽²⁾
,	1	leave	same
d	5	digit	bb2, 5d(. ddbCR
d	7	digit	bb2, 57(. ddbCR
(4	digit	bb2, 574. ddbCR
.	1	leave	same
d	2	digit	bb2, 574. 2bdCR
d	6+	digit	bb2, 574. 26bCR ⁽³⁾
b	0	fill	same
C	0	fill	bb2, 574, 26bbR
R	0	fill	bb2, 574, 26bbb

Thus:

Loc 1000-1012 (after) bb2,574. 26bCR

NOTES

1. This character is saved as the fill character.
 2. First nonzero digit sets S trigger to 1.
 3. Plus sign in this same byte sets S trigger to zero.
- Condition code = 2; result greater than zero.

If the second operand in location 1200-1203 is 00 00 02 6-, the following results are obtained:

Loc 1000-1012 (before) bdd, dd(. ddbCR
 Loc 1000-1012 (after) bbbbbb. 26bCR
 Condition code = 1; result less than zero.

In this case the significance-start character in the pattern causes the decimal point to be left unchanged. The minus sign does not reset the S trigger so that the CR symbol is also preserved.

In the edit examples above, if the initial character of the pattern was an asterisk, then asterisk-protection would be achieved.

In the same example, if EDIT AND MARK was used:

Reg 1 (before) 00 12 34 56
 Reg 1 (after) 00 00 10 02

Branch On Condition

Assume a prior operation has been performed which resulted in setting the condition code in the Psw. The program is to branch if the result of the previous operation is nonzero.

The BRANCH ON CONDITION with a mask of 0111 = 7₁₀ in the M₁ field becomes a branch-on-nonzero instruction.

Reg 5 00 00 01 00
 Reg 12 00 04 00 00

The instruction is:

Op Code	M ₁	X ₂	B ₂	D ₂
BC	7	5	12	100

and causes a branch to location 40,200, provided the condition code is not zero. Condition code setting is unchanged.

Execute

The ADD instruction at location 350 is to be executed by means of EXECUTE:

Assume:

Reg 3 00 00 00 10
 Reg 12 00 00 03 30
 Loc 350 AR 4,6

The instruction is:

Op Code	R ₁	X ₂	B ₂	D ₂
EX	0	3	12	10

The CPU executes the ADD instruction and takes the next sequential instruction after EXECUTE.

The move character instruction MVC at location 1200 is to be executed, and the number of characters to be moved is computed in register 5.

Assume:

Reg 5 (rightmost 8 bits) 01110000 = 112₁₀
 Reg 7 00 00 00 50
 Reg 13 00 00 10 50
 Loc 1200 MVC 0, 15, 100, 12, 1000
 Length field (8 bits) = 0000 0000

The instruction is:

Op Code	R ₁	X ₂	B ₂	D ₂
EX	5	7	13	100

The rightmost eight bits of R5 are or'ed with the length portion (positions 8-15) of the instruction being executed, at location 1200 prior to execution of MOVE. However, the actual instruction at location 1200 re-

mains unchanged, and the instruction actually executed by EXECUTE is

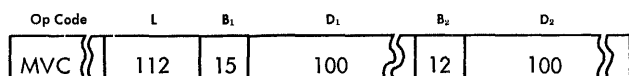

to provide a move with a length of 112 bytes and thus move 113 bytes.

Assembly Language Examples

These programming examples use the System/360 assembly-language format and mnemonics. In general, the operands are shown symbolically with indexing or length specification following the symbol and enclosed in parentheses. Lengths are given as the total number of bytes in the field. This differs from the machine definition regarding lengths which states that the length is the number of bytes to be added to the field address to obtain the address of the last byte of the field. Thus the machine length is one less than the assembly-language length. The assembly language automatically subtracts one from the length specified when the instruction is assembled.

Examples

1. Decimal right shift — even number of places.

Assume symbolic location "Source" is:

Source: 12 34 56 78 9S

and we wish to drop two places.

MOVE NUMERICS (MVN) can be used to accomplish this

MVN Source + 3 (1), Source + 4 Source
12 34 56 7S 9S

By using a length of 4 instead of 5 in operations using symbolic location Source, the result is accomplished.

2. Decimal right shift — odd number of places.

Source: 12 34 56 78 9S

Assume we wish to drop three places.

The move with offset (MVO) instruction is used.

MVO Source (5), Source (3) Source
00 01 23 45 6S

3. Decimal left shift — even number of places.

Assume the following at symbolic location "ZERO."

Zero: 00 00

Source: 12 34 56 78 9S

A left shift of four places can be performed as follows:

MVC Source + 5 (2), Zero Source
12 34 56 78 9S 00 00

MVN Source + 6 (1), Source + 4 12 34 56 78 9S 00 0S

NI Source + 4, 240 12 34 56 78 90 00 0S

Note the number 240₁₀ in the AND IMMEDIATE instruction provides a mask of 11110000 which is to be used to make the old sign positions zero.

4. Decimal left shift — odd number of places.

Zero: 00 00

Source: 12 34 56 78 9S

Assume the shift to be three places.

	Source
MVC Source + 5 (2), Zero	12 34 56 78 9S 00 00
MVN Source + 6 (1), Source + 4	12 34 56 78 9S 00 0S
NI Source + 4, 240	12 34 56 78 90 00 0S
MVO Source (6), Source (5)	01 23 45 67 89 00 0S

5. A master inventory file is to be updated by issue and receipt transactions. There may be multiple transactions pertaining to a master record. Both inactive and updated master records are to be rewritten. The following calculations are performed to update the master:

Receipts

1. Receipt quantity \times unit cost = receipt cost
2. Receipt cost + total cost = new total cost
3. Receipt quantity + quantity on hand = new quantity
4. New total cost \div new quantity = new average unit cost

Issues

1. Quantity on hand — issue quantity = new quantity (if quantity on hand is less than issue quantity, go to an exception routine).
2. Issue quantity \times average unit cost = issue cost
3. Total cost — issue cost = new total cost
4. If new quantity is not greater than the reorder level, go to an exception routine.

Record Description

Master Record:

Item #: 6 alphameric characters

Description: 20 alphabetic characters

Quantity: 7 digits plus sign

Total cost: 11 digits plus sign (2 decimal places)

Average unit cost: 7 digits plus sign (3 decimal places)

Reorder level: 5 digits plus sign

Transaction Record:

Type code: 1 digit plus sign

(plus 1 = receipt)

(plus 2 = issue)

Item #: 6 alphameric characters

Quantity: 5 digits plus sign

Receipt unit cost: 6 digits plus sign (2 decimal places)

6. Assume that record read into defined storage contains a field labeled "date." This field is stored in six character positions as follows:

- Day – two characters
- Month – two characters
- Year – two characters

Place the date an item is ordered (year, month, day) into a record field labeled "key."

Name		Operation	Operand										Comments										Identification- Sequence		
1	10	12	16	18	25	30	35	40	45	50	55	60	65	71	73	80									
PROGRAM <i>REORDER ACTIVITY—TRANSLATE INSTRUCTION</i>				PUNCHING INSTRUCTIONS										PAGE OF											
PROGRAMMER				DATE										PUNCH		CARD ELECTRO NUMBER									
		MVC		KEY, STREAM										PLACE TABLE VALUE INTO SORT KEY											
		TR		KEY, DATE										TRANSLATE DATE INTO PROPER SEQ.											
STREAM		BC		XL6'050603040102'																					

7. Assume two streams of bytes, N bytes separated ($N \leq 4095$) and a 256 byte table.

In stream 1 locate the first nonzero bit of each byte. On finding the first nonzero bit in stream 1, set the corresponding bit position in stream 2 to zero. Continue this process to the end of the stream. A 256-byte translate-and-test table is constructed in storage such that:

Byte from 00000000 fetches 00000000 from the table. (0_{10})
 Byte from 1xxxxxxx fetches 01111111 from the table. (127_{10})
 Byte from 01xxxxxx fetches 10111111 from the table. (191_{10})
 Byte from 001xxxxx fetches 11011111 from the table. (223_{10})
 Byte from 0001xxxx fetches 11101111 from the table. (239_{10})
 Byte from 00001xxx fetches 11110111 from the table. (247_{10})
 Byte from 000001xx fetches 11111011 from the table. (251_{10})
 Byte from 0000001x fetches 11111101 from the table. (253_{10})
 Byte from 00000001 fetches 11111110 from the table. (254_{10})

Translate and Test Table

	0	1	2	3	4	5	6	7	8	9	10	11	12	13	14	15
0	0	254	253	253	251	251	251	251	247	247	247	247	247	247	247	247
16	239	239	239	239	239	239	239	239	239	239	239	239	239	239	239	239
32	223	223	223	223	223	223	223	223	223	223	223	223	223	223	223	223
48	223	223	223	223	223	223	223	223	223	223	223	223	223	223	223	223
64	191	191	191	191	191	191	191	191	191	191	191	191	191	191	191	191
80	191	191	191	191	191	191	191	191	191	191	191	191	191	191	191	191
96	191	191	191	191	191	191	191	191	191	191	191	191	191	191	191	191
112	191	191	191	191	191	191	191	191	191	191	191	191	191	191	191	191
128	127	127	127	127	127	127	127	127	127	127	127	127	127	127	127	127
144	127	127	127	127	127	127	127	127	127	127	127	127	127	127	127	127
160	127	127	127	127	127	127	127	127	127	127	127	127	127	127	127	127
176	127	127	127	127	127	127	127	127	127	127	127	127	127	127	127	127
192	127	127	127	127	127	127	127	127	127	127	127	127	127	127	127	127
208	127	127	127	127	127	127	127	127	127	127	127	127	127	127	127	127
224	127	127	127	127	127	127	127	127	127	127	127	127	127	127	127	127
240	127	127	127	127	127	127	127	127	127	127	127	127	127	127	127	127
	240	241	242	243	244	245	246	247	248	249	250	251	252	253	254	255

All Decimal Numbers Represent an 8-Bit Binary Value

IBM IBM System/360 Assembler Coding Form X78-6597
Printed in U.S.A.

PROGRAM *TEST AND CHANGE BIT STREAMS* PUNCHING INSTRUCTIONS PAGE OF

GRAPHIC CARD ELECTRO NUMBER

PROGRAMMER DATE PUNCH

Name		Operation	Operand		Comments		Identification-Sequence									
1	10	12	16	18	25	30	35	40	45	50	55	60	65	71	73	80
<i>FIRST</i>		<i>ORG</i>		<i>4096</i>				<i>PROGRAM</i>	<i>ORIGIN</i>	<i>POINT</i>						
		<i>BALR</i>		<i>150</i>				<i>LOAD</i>	<i>REG</i>	<i>15</i>						
		<i>USING</i>		<i>*15</i>				<i>DEFINE</i>	<i>BASE</i>	<i>REG</i>	<i>15</i>					
		<i>START</i>		<i>START</i>				<i>START</i>	<i>PGM</i>							
<i>CONST1</i>		<i>DC</i>		<i>F'249'</i>				<i>STREAM</i>	<i>LENGTH</i>							
<i>CONST2</i>		<i>DC</i>		<i>A(STREAM-1)</i>				<i>CONSTANT</i>	<i>ADDR</i>							
<i>TABLE1</i>		<i>DC</i>		<i>XL256'</i>				<i>TRANSLATE</i>	<i>TABLE</i>							
<i>STREAM</i>		<i>DS</i>		<i>750C</i>				<i>STREAM</i>	<i>STORAGE</i>	<i>AREA</i>						
<i>START</i>		<i>L</i>		<i>0,CONST1</i>				<i>STREAM</i>	<i>LGTH</i>	<i>TO</i>	<i>RO</i>					
		<i>AR</i>		<i>1,CONST2</i>				<i>STREAM</i>	<i>START</i>	<i>ADDR</i>	<i>-1</i>	<i>TO</i>	<i>RI</i>			
<i>LOOP</i>		<i>LR</i>		<i>0,1</i>				<i>END</i>	<i>OF</i>	<i>STREAM</i>	<i>-1</i>	<i>TO</i>	<i>RO</i>			
		<i>SR</i>		<i>4,0</i>				<i>END</i>	<i>OF</i>	<i>STREAM</i>	<i>-1</i>	<i>TO</i>	<i>RH</i>			
		<i>EX</i>		<i>4,TRANS</i>				<i>LENGTH</i>	<i>OF</i>	<i>STREAM</i>	<i>TO</i>	<i>RH</i>				
		<i>BC</i>		<i>8,OUT</i>				<i>EXECUTE</i>	<i>TRT</i>	<i>INST</i>						
		<i>EX</i>		<i>2,AND</i>				<i>END</i>	<i>OF</i>	<i>STREAM</i>	<i>BRANCH</i>					
		<i>CR</i>		<i>0,1</i>				<i>EXECUTE</i>	<i>AND</i>							
		<i>BL</i>		<i>0,1</i>				<i>END</i>	<i>OF</i>	<i>STREAM</i>	<i>-1</i>	<i>VS</i>	<i>TEST</i>	<i>POS</i>		
		<i>LB</i>		<i>0,1</i>				<i>OUT</i>	<i>LAST</i>	<i>STREAM</i>	<i>ITEM</i>					
		<i>BL</i>		<i>LOOP</i>				<i>CONTINUE</i>								
<i>TRANS</i>		<i>TRT</i>		<i>1(,1),TABLE</i>				<i>TRANSLATE</i>	<i>*TEST</i>	<i>STREAM</i>	<i>1</i>					
<i>AND</i>		<i>NI</i>		<i>500(,1),0</i>				<i>SET</i>	<i>STREAM</i>	<i>2</i>	<i>POSITION</i>					

Appendix B. Fixed-Point and Two's Complement Notation

A fixed-point number is a signed value, recorded as a binary integer. It is called fixed point because the programmer determines the fixed positioning of the binary point.

Fixed-point operands may be recorded in halfword (16 bits) or word (32 bits) lengths. In both lengths, the first bit position (0) holds the sign of the number, with the remaining bit positions (1-15 for halfwords and 1-31 for fullwords) used to designate the magnitude of the number.

Positive fixed-point numbers are represented in true binary form with a zero sign bit. Negative fixed-point numbers are represented in two's complement notation with a one bit in the sign position. In all cases, the bits between the sign bit and the leftmost significant bit of the integer are the same as the sign bit (i.e. all zeros for positive numbers, all ones for negative numbers).

Negative fixed-point numbers are formed in two's complement notation by inverting each bit of the positive binary number and adding one. For example, the true binary form of the decimal value (plus 26) is made negative (minus 26) in the following manner:

	S	INTEGER	
+26	0	0000000 00011010	
Invert	1	1111111 11100101	
Add 1		1	
-26	1	1111111 11100110	(Two's complement form)

This is equivalent to subtracting the number: 00000000 00011010 from 1 00000000 00000000.

The following addition examples illustrate two's complement arithmetic. Only eight bit positions are used. All negative numbers are in two's complement form.

		COMMENTS
+57	= 00111001	
+35	= 00100011	
<hr/>		
+92	= 01011100	
+57	= 00111001	
-35	= 11011101	No overflow
<hr/>		
+22	= 00010110	Ignore carry — carry into high order position and carry out.
+35	= 00100011	
-57	= 11000111	
<hr/>		
-22	= 11101010	Sign change only; no carry.
-57	= 11000111	
-35	= 11011101	No overflow
<hr/>		
-92	= 10100100	Ignore carry — carry into high order position and carry out.
-57	= 11000111	
-92	= 10100100	
<hr/>		
-149	= *01101011	*Overflow — no carry into high order position but carry out.
+57	= 00111001	
+92	= 01011100	
<hr/>		
149	= *10010101	*Overflow — carry into high order position, no carry out.

The following are 16-bit fixed-point numbers. The first is the largest positive number and the last, the largest negative number.

NUMBER	DECIMAL	S	INTEGER
2 ¹⁵ -1	= 32,767	=0	1111111 11111111
2 ⁰	= 1	=0	0000000 00000001
0	= 0	=0	0000000 00000000
-2 ⁰	= -1	=1	1111111 11111111
-2 ¹⁵	= -32,768	=1	0000000 00000000

The following are 32 bit fixed-point numbers. The first is the largest positive number that can be represented by 32 bits, and the last is the largest negative number.

NUMBER	DECIMAL	S	INTEGER
2 ³¹ -1	= 2 147 483 647	=0	1111111 11111111 11111111 11111111
2 ¹⁶	= 65 536	=0	0000000 00000001 00000000 00000000
2 ⁰	= 1	=0	0000000 00000000 00000000 00000001
0	= 0	=0	0000000 00000000 00000000 00000000
-2 ⁰	= -1	=1	1111111 11111111 11111111 11111111
-2 ¹	= -2	=1	1111111 11111111 11111111 11111110
-2 ¹⁶	= -65 536	=1	1111111 11111111 00000000 00000000
-2 ³¹ +1	= -2 147 483 647	=1	0000000 00000000 00000000 00000001
-2 ³¹	= -2 147 483 648	=1	0000000 00000000 00000000 00000000

Appendix C. Floating-Point Arithmetic

Floating-point arithmetic simplifies programming by automatically maintaining binary point placement (scaling) during computations in which the range of values used vary widely or are unpredictable.

The key to floating-point data representation is the separation of the significant digits of a number from the size (scale) of the number. Thus, the number is expressed as a fraction times a power of 16.

A floating-point number has two associated sets of values. One set represents the significant digits of the number and is called the fraction. The second set specifies the power (exponent) to which 16 is raised and indicates the location of the binary point of the number.

These two numbers (the fraction and exponent) are recorded in a single word or double-word.

Since each of these two numbers is signed, some method must be employed to express two signs in an area that provides for a single sign. This is accomplished by having the fraction sign use the sign associated with the word (or double word) and expressing the exponent in excess 64 arithmetic; that is, the exponent is added as a signed number to 64. The resulting number is called the characteristic. Since 64 uses 7 bits, the characteristic can vary from 0 to 127, permitting the exponent to vary from -64 through 0 to +63. This provides a decimal range of $n \times 10^{75}$ to $n \times 10^{-78}$.

Floating-point data in the System/360 may be recorded in short or long formats, depending on the precision required. Both formats use a sign bit in bit position 0, followed by a characteristic in bit positions 1-7. Short-precision floating-point data operands contain the fraction in bit positions 8-31; long-precision operands have the fraction in bit positions 8-63.

Short-Precision Floating-Point Format

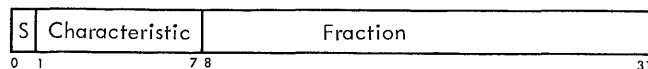

Long-Precision Floating-Point Format

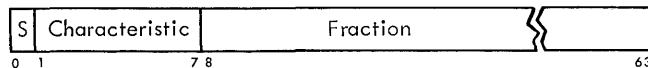

The sign of the fraction is indicated by a zero or one bit in bit position 0 to denote a positive or negative fraction, respectively.

Within a given fraction length (24 or 56 bits), a floating-point operation will provide the greatest precision if the fraction is normalized. A fraction is normalized when the high-order digit (bit positions 8, 9, 10 and 11) is not zero. It is unnormalized if the high-order digit contains all zeros.

If normalization of the operand is desired, the floating-point instructions that provide automatic normalization are used. This automatic normalization is accomplished by left-shifting the fraction (four bits per shift) until a nonzero digit occupies the high-order digit position. The characteristic is reduced by one for each digit shifted.

Conversion Example

Convert the decimal number 149.25 to a short-precision floating-point operand.

1. The number is decomposed into a decimal integer and a decimal fraction.

$$149.25 = 149 \text{ plus } 0.25$$

2. The decimal integer is converted to its hexadecimal representation.

$$149_{10} = 95_{16}$$

3. The decimal fraction is converted to its hexadecimal representation.

$$0.25_{10} = 0.4_{16}$$

4. Combine the integral and fractional parts and express as a fraction times a power of 16 (exponent).

$$95.4_{16} = (0.954 \times 16^2)_{16}$$

5. The characteristic is developed from the exponent and converted to binary.

$$\begin{array}{rcl} \text{base} + \text{exponent} & = & \text{characteristic} \\ 64 + 2 & = & 66 = 1000010 \end{array}$$

6. The fraction is converted to binary and grouped hexadecimally.

$$.954_{16} = .100101010100$$

7. The characteristic and the fraction are stored in short precision format. The sign position contains the sign of the fraction.

S	Char	Fraction
0	1000010	100101010100000000000000

The following are sample normalized short floating-point numbers. The last two numbers represent the smallest and the largest positive normalized numbers.

NUMBER	POWERS OF 16	S	CHAR	FRACTION
1.0	$= +1/16 \times 16^1$	=0	1000001	0001 0000 0000 0000 0000 0000
0.5	$= +8/16 \times 16^0$	=0	1000000	1000 0000 0000 0000 0000 0000
1/64	$= +4/16 \times 16^{-1}$	=0	01111111	0100 0000 0000 0000 0000 0000
0.0	$= +0 \times 16^{-64}$	=0	0000000	0000 0000 0000 0000 0000 0000
-15.0	$= -15/16 \times 16^1$	=1	1000001	1111 0000 0000 0000 0000 0000
2×10^{-78}	$= +1/16 \times 16^{-64}$	=0	0000000	0001 0000 0000 0000 0000 0000
7×10^{75}	$= (1-16^{-9}) \times 16^{63}$	=0	11111111	1111 1111 1111 1111 1111 1111

Appendix D. Powers of Two Table

2^n	n	2^{-n}
1	0	1.0
2	1	0.5
4	2	0.25
8	3	0.125
16	4	0.062 5
32	5	0.031 25
64	6	0.015 625
128	7	0.007 812 5
256	8	0.003 906 25
512	9	0.001 953 125
1 024	10	0.000 976 562 5
2 048	11	0.000 488 281 25
4 096	12	0.000 244 140 625
8 192	13	0.000 122 070 312 5
16 384	14	0.000 061 035 156 25
32 768	15	0.000 030 517 578 125
65 536	16	0.000 015 258 789 062 5
131 072	17	0.000 007 629 394 531 25
262 144	18	0.000 003 814 697 265 625
524 288	19	0.000 001 907 348 632 812 5
1 048 576	20	0.000 000 953 674 316 406 25
2 097 152	21	0.000 000 476 837 158 203 125
4 194 304	22	0.000 000 238 418 579 101 562 5
8 388 608	23	0.000 000 119 209 289 550 781 25
16 777 216	24	0.000 000 059 604 644 775 390 625
33 554 432	25	0.000 000 029 802 322 387 695 312 5
67 108 864	26	0.000 000 014 901 161 193 847 656 25
134 217 728	27	0.000 000 007 450 580 596 923 828 125
268 435 456	28	0.000 000 003 725 290 298 461 914 062 5
536 870 912	29	0.000 000 001 862 645 149 230 957 031 25
1 073 741 824	30	0.000 000 000 931 322 574 615 478 515 625
2 147 483 648	31	0.000 000 000 465 661 287 307 739 257 812 5
4 294 967 296	32	0.000 000 000 232 830 643 653 869 628 906 25
8 589 934 592	33	0.000 000 000 116 415 321 826 934 814 453 125
17 179 869 184	34	0.000 000 000 058 207 660 913 467 407 226 562 5
34 359 738 368	35	0.000 000 000 029 103 830 456 733 703 613 281 25
68 719 476 736	36	0.000 000 000 014 551 915 228 366 851 806 640 625
137 438 953 472	37	0.000 000 000 007 275 957 614 183 425 903 320 312 5
274 877 906 944	38	0.000 000 000 003 637 978 807 091 712 951 660 156 25
549 755 813 888	39	0.000 000 000 001 818 989 403 545 856 475 830 078 125

Appendix E. Hexadecimal-Decimal Conversion Table

The table in this appendix provides for direct conversion of decimal and hexadecimal numbers in these ranges:

HEXADECIMAL 000 to FFF	DECIMAL 0000 to 4095
---------------------------	-------------------------

For numbers outside the range of the table, add the following values to the table figures:

HEXADECIMAL	DECIMAL
1000	4096
2000	8192
3000	12288

HEXADECIMAL	DECIMAL
4000	16384
5000	20484
6000	24576
7000	28672
8000	32768
9000	36864
A000	40960
B000	45056
C000	49152
D000	53248
E000	57344
F000	61440

	0	1	2	3	4	5	6	7	8	9	A	B	C	D	E	F
000	0000	0001	0002	0003	0004	0005	0006	0007	0008	0009	0010	0011	0012	0013	0014	0015
010	0016	0017	0018	0019	0020	0021	0022	0023	0024	0025	0026	0027	0028	0029	0030	0031
020	0032	0033	0034	0035	0036	0037	0038	0039	0040	0041	0042	0043	0044	0045	0046	0047
030	0048	0049	0050	0051	0052	0053	0054	0055	0056	0057	0058	0059	0060	0061	0062	0063
040	0064	0065	0066	0067	0068	0069	0070	0071	0072	0073	0074	0075	0076	0077	0078	0079
050	0080	0081	0082	0083	0084	0085	0086	0087	0088	0089	0090	0091	0092	0093	0094	0095
060	0096	0097	0098	0099	0100	0101	0102	0103	0104	0105	0106	0107	0108	0109	0110	0111
070	0112	0113	0114	0115	0116	0117	0118	0119	0120	0121	0122	0123	0124	0125	0126	0127
080	0128	0129	0130	0131	0132	0133	0134	0135	0136	0137	0138	0139	0140	0141	0142	0143
090	0144	0145	0146	0147	0148	0149	0150	0151	0152	0153	0154	0155	0156	0157	0158	0159
0A0	0160	0161	0162	0163	0164	0165	0166	0167	0168	0169	0170	0171	0172	0173	0174	0175
0B0	0176	0177	0178	0179	0180	0181	0182	0183	0184	0185	0186	0187	0188	0189	0190	0191
0C0	0192	0193	0194	0195	0196	0197	0198	0199	0200	0201	0202	0203	0204	0205	0206	0207
0D0	0208	0209	0210	0211	0212	0213	0214	0215	0216	0217	0218	0219	0220	0221	0222	0223
0E0	0224	0225	0226	0227	0228	0229	0230	0231	0232	0233	0234	0235	0236	0237	0238	0239
0F0	0240	0241	0242	0243	0244	0245	0246	0247	0248	0249	0250	0251	0252	0253	0254	0255
100	0256	0257	0258	0259	0260	0261	0262	0263	0264	0265	0266	0267	0268	0269	0270	0271
110	0272	0273	0274	0275	0276	0277	0278	0279	0280	0281	0282	0283	0284	0285	0286	0287
120	0288	0289	0290	0291	0292	0293	0294	0295	0296	0297	0298	0299	0300	0301	0302	0303
130	0304	0305	0306	0307	0308	0309	0310	0311	0312	0313	0314	0315	0316	0317	0318	0319
140	0320	0321	0322	0323	0324	0325	0326	0327	0328	0329	0330	0331	0332	0333	0334	0335
150	0336	0337	0338	0339	0340	0341	0342	0343	0344	0345	0346	0347	0348	0349	0350	0351
160	0352	0353	0354	0355	0356	0357	0358	0359	0360	0361	0362	0363	0364	0365	0366	0367
170	0368	0369	0370	0371	0372	0373	0374	0375	0376	0377	0378	0379	0380	0381	0382	0383
180	0384	0385	0386	0387	0388	0389	0390	0391	0392	0393	0394	0395	0396	0397	0398	0399
190	0400	0401	0402	0403	0404	0405	0406	0407	0408	0409	0410	0411	0412	0413	0414	0415
1A0	0416	0417	0418	0419	0420	0421	0422	0423	0424	0425	0426	0427	0428	0429	0430	0431
1B0	0432	0433	0434	0435	0436	0437	0438	0439	0440	0441	0442	0443	0444	0445	0446	0447
1C0	0448	0449	0450	0451	0452	0453	0454	0455	0456	0457	0458	0459	0460	0461	0462	0463
1D0	0464	0465	0466	0467	0468	0469	0470	0471	0472	0473	0474	0475	0476	0477	0478	0479
1E0	0480	0481	0482	0483	0484	0485	0486	0487	0488	0489	0490	0491	0492	0493	0494	0495
1F0	0496	0497	0498	0499	0500	0501	0502	0503	0504	0505	0506	0507	0508	0509	0510	0511

	0	1	2	3	4	5	6	7	8	9	A	B	C	D	E	F
200	0512	0513	0514	0515	0516	0517	0518	0519	0520	0521	0522	0523	0524	0525	0526	0527
210	0528	0529	0530	0531	0532	0533	0534	0535	0536	0537	0538	0539	0540	0541	0542	0543
220	0544	0545	0546	0547	0548	0549	0550	0551	0552	0553	0554	0555	0556	0557	0558	0559
230	0560	0561	0562	0563	0564	0565	0566	0567	0568	0569	0570	0571	0572	0573	0574	0575
240	0576	0577	0578	0579	0580	0581	0582	0583	0584	0585	0586	0587	0588	0589	0590	0591
250	0592	0593	0594	0595	0596	0597	0598	0599	0600	0601	0602	0603	0604	0605	0606	0607
260	0608	0609	0610	0611	0612	0613	0614	0615	0616	0617	0618	0619	0620	0621	0622	0623
270	0624	0625	0626	0627	0628	0629	0630	0631	0632	0633	0634	0635	0636	0637	0638	0639
280	0640	0641	0642	0643	0644	0645	0646	0647	0648	0649	0650	0651	0652	0653	0654	0655
290	0656	0657	0658	0659	0660	0661	0662	0663	0664	0665	0666	0667	0668	0669	0670	0671
2A0	0672	0673	0674	0675	0676	0677	0678	0679	0680	0681	0682	0683	0684	0685	0686	0687
2B0	0688	0689	0690	0691	0692	0693	0694	0695	0696	0697	0698	0699	0700	0701	0702	0703
2C0	0704	0705	0706	0707	0708	0709	0710	0711	0712	0713	0714	0715	0716	0717	0718	0719
2D0	0720	0721	0722	0723	0724	0725	0726	0727	0728	0729	0730	0731	0732	0733	0734	0735
2E0	0736	0737	0738	0739	0740	0741	0742	0743	0744	0745	0746	0747	0748	0749	0750	0751
2F0	0752	0753	0754	0755	0756	0757	0758	0759	0760	0761	0762	0763	0764	0765	0766	0767
300	0768	0769	0770	0771	0772	0773	0774	0775	0776	0777	0778	0779	0780	0781	0782	0783
310	0784	0785	0786	0787	0788	0789	0790	0791	0792	0793	0794	0795	0796	0797	0798	0799
320	0800	0801	0802	0803	0804	0805	0806	0807	0808	0809	0810	0811	0812	0813	0814	0815
330	0816	0817	0818	0819	0820	0821	0822	0823	0824	0825	0826	0827	0828	0829	0830	0831
340	0832	0833	0834	0835	0836	0837	0838	0839	0840	0841	0842	0843	0844	0845	0846	0847
350	0848	0849	0850	0851	0852	0853	0854	0855	0856	0857	0858	0859	0860	0861	0862	0863
360	0864	0865	0866	0867	0868	0869	0870	0871	0872	0873	0874	0875	0876	0877	0878	0879
370	0880	0881	0882	0883	0884	0885	0886	0887	0888	0889	0890	0891	0892	0893	0894	0895
380	0896	0897	0898	0899	0900	0901	0902	0903	0904	0905	0906	0907	0908	0909	0910	0911
390	0912	0913	0914	0915	0916	0917	0918	0919	0920	0921	0922	0923	0924	0925	0926	0927
3A0	0928	0929	0930	0931	0932	0933	0934	0935	0936	0937	0938	0939	0940	0941	0942	0943
3B0	0944	0945	0946	0947	0948	0949	0950	0951	0952	0953	0954	0955	0956	0957	0958	0959
3C0	0960	0961	0962	0963	0964	0965	0966	0967	0968	0969	0970	0971	0972	0973	0974	0975
3D0	0976	0977	0978	0979	0980	0981	0982	0983	0984	0985	0986	0987	0988	0989	0990	0991
3E0	0992	0993	0994	0995	0996	0997	0998	0999	1000	1001	1002	1003	1004	1005	1006	1007
3F0	1008	1009	1010	1011	1012	1013	1014	1015	1016	1017	1018	1019	1020	1021	1022	1023

	0	1	2	3	4	5	6	7	8	9	A	B	C	D	E	F
400	1024	1025	1026	1027	1028	1029	1030	1031	1032	1033	1034	1035	1036	1037	1038	1039
410	1040	1041	1042	1043	1044	1045	1046	1047	1048	1049	1050	1051	1052	1053	1054	1055
420	1056	1057	1058	1059	1060	1061	1062	1063	1064	1065	1066	1067	1068	1069	1070	1071
430	1072	1073	1074	1075	1076	1077	1078	1079	1080	1081	1082	1083	1084	1085	1086	1087
440	1088	1089	1090	1091	1092	1093	1094	1095	1096	1097	1098	1099	1100	1101	1102	1103
450	1104	1105	1106	1107	1108	1109	1110	1111	1112	1113	1114	1115	1116	1117	1118	1119
460	1120	1121	1122	1123	1124	1125	1126	1127	1128	1129	1130	1131	1132	1133	1134	1135
470	1136	1137	1138	1139	1140	1141	1142	1143	1144	1145	1146	1147	1148	1149	1150	1151
480	1152	1153	1154	1155	1156	1157	1158	1159	1160	1161	1162	1163	1164	1165	1166	1167
490	1168	1169	1170	1171	1172	1173	1174	1175	1176	1177	1178	1179	1180	1181	1182	1183
4A0	1184	1185	1186	1187	1188	1189	1190	1191	1192	1193	1194	1195	1196	1197	1198	1199
4B0	1200	1201	1202	1203	1204	1205	1206	1207	1208	1209	1210	1211	1212	1213	1214	1215
4C0	1216	1217	1218	1219	1220	1221	1222	1223	1224	1225	1226	1227	1228	1229	1230	1231
4D0	1232	1233	1234	1235	1236	1237	1238	1239	1240	1241	1242	1243	1244	1245	1246	1247
4E0	1248	1249	1250	1251	1252	1253	1254	1255	1256	1257	1258	1259	1260	1261	1262	1263
4F0	1264	1265	1266	1267	1268	1269	1270	1271	1272	1273	1274	1275	1276	1277	1278	1279
500	1280	1281	1282	1283	1284	1285	1286	1287	1288	1289	1290	1291	1292	1293	1294	1295
510	1296	1297	1298	1299	1300	1301	1302	1303	1304	1305	1306	1307	1308	1309	1310	1311
520	1312	1313	1314	1315	1316	1317	1318	1319	1320	1321	1322	1323	1324	1325	1326	1327
530	1328	1329	1330	1331	1332	1333	1334	1335	1336	1337	1338	1339	1340	1341	1342	1343
540	1344	1345	1346	1347	1348	1349	1350	1351	1352	1353	1354	1355	1356	1357	1358	1359
550	1360	1361	1362	1363	1364	1365	1366	1367	1368	1369	1370	1371	1372	1373	1374	1375
560	1376	1377	1378	1379	1380	1381	1382	1383	1384	1385	1386	1387	1388	1389	1390	1391
570	1392	1393	1394	1395	1396	1397	1398	1399	1400	1401	1402	1403	1404	1405	1406	1407
580	1408	1409	1410	1411	1412	1413	1414	1415	1416	1417	1418	1419	1420	1421	1422	1423
590	1424	1425	1426	1427	1428	1429	1430	1431	1432	1433	1434	1435	1436	1437	1438	1439
5A0	1440	1441	1442	1443	1444	1445	1446	1447	1448	1449	1450	1451	1452	1453	1454	1455
5B0	1456	1457	1458	1459	1460	1461	1462	1463	1464	1465	1466	1467	1468	1469	1470	1471
5C0	1472	1473	1474	1475	1476	1477	1478	1479	1480	1481	1482	1483	1484	1485	1486	1487
5D0	1488	1489	1490	1491	1492	1493	1494	1495	1496	1497	1498	1499	1500	1501	1502	1503
5E0	1504	1505	1506	1507	1508	1509	1510	1511	1512	1513	1514	1515	1516	1517	1518	1519
5F0	1520	1521	1522	1523	1524	1525	1526	1527	1528	1529	1530	1531	1532	1533	1534	1535

	0	1	2	3	4	5	6	7	8	9	A	B	C	D	E	F
600	1536	1537	1538	1539	1540	1541	1542	1543	1544	1545	1546	1547	1548	1549	1550	1551
610	1552	1553	1554	1555	1556	1557	1558	1559	1560	1561	1562	1563	1564	1565	1566	1567
620	1568	1569	1570	1571	1572	1573	1574	1575	1576	1577	1578	1579	1580	1581	1582	1583
630	1584	1585	1586	1587	1588	1589	1590	1591	1592	1593	1594	1595	1596	1597	1598	1599
640	1600	1601	1602	1603	1604	1605	1606	1607	1608	1609	1610	1611	1612	1613	1614	1615
650	1616	1617	1618	1619	1620	1621	1622	1623	1624	1625	1626	1627	1628	1629	1630	1631
660	1632	1633	1634	1635	1636	1637	1638	1639	1640	1641	1642	1643	1644	1645	1646	1647
670	1648	1649	1650	1651	1652	1653	1654	1655	1656	1657	1658	1659	1660	1661	1662	1663
680	1664	1665	1666	1667	1668	1669	1670	1671	1672	1673	1674	1675	1676	1677	1678	1679
690	1680	1681	1682	1683	1684	1685	1686	1687	1688	1689	1690	1691	1692	1693	1694	1695
6A0	1696	1697	1698	1699	1700	1701	1702	1703	1704	1705	1706	1707	1708	1709	1710	1711
6B0	1712	1713	1714	1715	1716	1717	1718	1719	1720	1721	1722	1723	1724	1725	1726	1727
6C0	1728	1729	1730	1731	1732	1733	1734	1735	1736	1737	1738	1739	1740	1741	1742	1743
6D0	1744	1745	1746	1747	1748	1749	1750	1751	1752	1753	1754	1755	1756	1757	1758	1759
6E0	1760	1761	1762	1763	1764	1765	1766	1767	1768	1769	1770	1771	1772	1773	1774	1775
6F0	1776	1777	1778	1779	1780	1781	1782	1783	1784	1785	1786	1787	1788	1789	1790	1791
700	1792	1793	1794	1795	1796	1797	1798	1799	1800	1801	1802	1803	1804	1805	1806	1807
710	1808	1809	1810	1811	1812	1813	1814	1815	1816	1817	1818	1819	1820	1821	1822	1823
720	1824	1825	1826	1827	1828	1829	1830	1831	1832	1833	1834	1835	1836	1837	1838	1839
730	1840	1841	1842	1843	1844	1845	1846	1847	1848	1849	1850	1851	1852	1853	1854	1855
740	1856	1857	1858	1859	1860	1861	1862	1863	1864	1865	1866	1867	1868	1869	1870	1871
750	1872	1873	1874	1875	1876	1877	1878	1879	1880	1881	1882	1883	1884	1885	1886	1887
760	1888	1889	1890	1891	1892	1893	1894	1895	1896	1897	1898	1899	1900	1901	1902	1903
770	1904	1905	1906	1907	1908	1909	1910	1911	1912	1913	1914	1915	1916	1917	1918	1919
780	1920	1921	1922	1923	1924	1925	1926	1927	1928	1929	1930	1931	1932	1933	1934	1935
790	1936	1937	1938	1939	1940	1941	1942	1943	1944	1945	1946	1947	1948	1949	1950	1951
7A0	1952	1953	1954	1955	1956	1957	1958	1959	1960	1961	1962	1963	1964	1965	1966	1967
7B0	1968	1969	1970	1971	1972	1973	1974	1975	1976	1977	1978	1979	1980	1981	1982	1983
7C0	1984	1985	1986	1987	1988	1989	1990	1991	1992	1993	1994	1995	1996	1997	1998	1999
7D0	2000	2001	2002	2003	2004	2005	2006	2007	2008	2009	2010	2011	2012	2013	2014	2015
7E0	2016	2017	2018	2019	2020	2021	2022	2023	2024	2025	2026	2027	2028	2029	2030	2031
7F0	2032	2033	2034	2035	2036	2037	2038	2039	2040	2041	2042	2043	2044	2045	2046	2047

	0	1	2	3	4	5	6	7	8	9	A	B	C	D	E	F
800	2048	2049	2050	2051	2052	2053	2054	2055	2056	2057	2058	2059	2060	2061	2062	2063
810	2064	2065	2066	2067	2068	2069	2070	2071	2072	2073	2074	2075	2076	2077	2078	2079
820	2080	2081	2082	2083	2084	2085	2086	2087	2088	2089	2090	2091	2092	2093	2094	2095
830	2096	2097	2098	2099	2100	2101	2102	2103	2104	2105	2106	2107	2108	2109	2110	2111
840	2112	2113	2114	2115	2116	2117	2118	2119	2120	2121	2122	2123	2124	2125	2126	2127
850	2128	2129	2130	2131	2132	2133	2134	2135	2136	2137	2138	2139	2140	2141	2142	2143
860	2144	2145	2146	2147	2148	2149	2150	2151	2152	2153	2154	2155	2156	2157	2158	2159
870	2160	2161	2162	2163	2164	2165	2166	2167	2168	2169	2170	2171	2172	2173	2174	2175
880	2176	2177	2178	2179	2180	2181	2182	2183	2184	2185	2186	2187	2188	2189	2190	2191
890	2192	2193	2194	2195	2196	2197	2198	2199	2200	2201	2202	2203	2204	2205	2206	2207
8A0	2208	2209	2210	2211	2212	2213	2214	2215	2216	2217	2218	2219	2220	2221	2222	2223
8B0	2224	2225	2226	2227	2228	2229	2230	2231	2232	2233	2234	2235	2236	2237	2238	2239
8C0	2240	2241	2242	2243	2244	2245	2246	2247	2248	2249	2250	2251	2252	2253	2254	2255
8D0	2256	2257	2258	2259	2260	2261	2262	2263	2264	2265	2266	2267	2268	2269	2270	2271
8E0	2272	2273	2274	2275	2276	2277	2278	2279	2280	2281	2282	2283	2284	2285	2286	2287
8F0	2288	2289	2290	2291	2292	2293	2294	2295	2296	2297	2298	2299	2300	2301	2302	2303
900	2304	2305	2306	2307	2308	2309	2310	2311	2312	2313	2314	2315	2316	2317	2318	2319
910	2320	2321	2322	2323	2324	2325	2326	2327	2328	2329	2330	2331	2332	2333	2334	2335
920	2336	2337	2338	2339	2340	2341	2342	2343	2344	2345	2346	2347	2348	2349	2350	2351
930	2352	2353	2354	2355	2356	2357	2358	2359	2360	2361	2362	2363	2364	2365	2366	2367
940	2368	2369	2370	2371	2372	2373	2374	2375	2376	2377	2378	2379	2380	2381	2382	2383
950	2384	2385	2386	2387	2388	2389	2390	2391	2392	2393	2394	2395	2396	2397	2398	2399
960	2400	2401	2402	2403	2404	2405	2406	2407	2408	2409	2410	2411	2412	2413	2414	2415
970	2416	2417	2418	2419	2420	2421	2422	2423	2424	2425	2426	2427	2428	2429	2430	2431
980	2432	2433	2434	2435	2436	2437	2438	2439	2440	2441	2442	2443	2444	2445	2446	2447
990	2448	2449	2450	2451	2452	2453	2454	2455	2456	2457	2458	2459	2460	2461	2462	2463
9A0	2464	2465	2466	2467	2468	2469	2470	2471	2472	2473	2474	2475	2476	2477	2478	2479
9B0	2480	2481	2482	2483	2484	2485	2486	2487	2488	2489	2490	2491	2492	2493	2494	2495
9C0	2496	2497	2498	2499	2500	2501	2502	2503	2504	2505	2506	2507	2508	2509	2510	2511
9D0	2512	2513	2514	2515	2516	2517	2518	2519	2520	2521	2522	2523	2524	2525	2526	2527
9E0	2528	2529	2530	2531	2532	2533	2534	2535	2536	2537	2538	2539	2540	2541	2542	2543
9F0	2544	2545	2546	2547	2548	2549	2550	2551	2552	2553	2554	2555	2556	2557	2558	2559

	0	1	2	3	4	5	6	7	8	9	A	B	C	D	E	F
A00	2560	2561	2562	2563	2564	2565	2566	2567	2568	2569	2570	2571	2572	2573	2574	2575
A10	2576	2577	2578	2579	2580	2581	2582	2583	2584	2585	2586	2587	2588	2589	2590	2591
A20	2592	2593	2594	2595	2596	2597	2598	2599	2600	2601	2602	2603	2604	2605	2606	2607
A30	2608	2609	2610	2611	2612	2613	2614	2615	2616	2617	2618	2619	2620	2621	2622	2623
A40	2624	2625	2626	2627	2628	2629	2630	2631	2632	2633	2634	2635	2636	2637	2638	2639
A50	2640	2641	2642	2643	2644	2645	2646	2647	2648	2649	2650	2651	2652	2653	2654	2655
A60	2656	2657	2658	2659	2660	2661	2662	2663	2664	2665	2666	2667	2668	2669	2670	2671
A70	2672	2673	2674	2675	2676	2677	2678	2679	2680	2681	2682	2683	2684	2685	2686	2687
A80	2688	2689	2690	2691	2692	2693	2694	2695	2696	2697	2698	2699	2700	2701	2702	2703
A90	2704	2705	2706	2707	2708	2709	2710	2711	2712	2713	2714	2715	2716	2717	2718	2719
AA0	2720	2721	2722	2723	2724	2725	2726	2727	2728	2729	2730	2731	2732	2733	2734	2735
AB0	2736	2737	2738	2739	2740	2741	2742	2743	2744	2745	2746	2747	2748	2749	2750	2751
AC0	2752	2753	2754	2755	2756	2757	2758	2759	2760	2761	2762	2763	2764	2765	2766	2767
AD0	2768	2769	2770	2771	2772	2773	2774	2775	2776	2777	2778	2779	2780	2781	2782	2783
AE0	2784	2785	2786	2787	2788	2789	2790	2791	2792	2793	2794	2795	2796	2797	2798	2799
AF0	2800	2801	2802	2803	2804	2805	2806	2807	2808	2809	2810	2811	2812	2813	2814	2815
B00	2816	2817	2818	2819	2820	2821	2822	2823	2824	2825	2826	2827	2828	2829	2830	2831
B10	2832	2833	2834	2835	2836	2837	2838	2839	2840	2841	2842	2843	2844	2845	2846	2847
B20	2848	2849	2850	2851	2852	2853	2854	2855	2856	2857	2858	2859	2860	2861	2862	2863
B30	2864	2865	2866	2867	2868	2869	2870	2871	2872	2873	2874	2875	2876	2877	2878	2879
B40	2880	2881	2882	2883	2884	2885	2886	2887	2888	2889	2890	2891	2892	2893	2894	2895
B50	2896	2897	2898	2899	2900	2901	2902	2903	2904	2905	2906	2907	2908	2909	2910	2911
B60	2912	2913	2914	2915	2916	2917	2918	2919	2920	2921	2922	2923	2924	2925	2926	2927
B70	2928	2929	2930	2931	2932	2933	2934	2935	2936	2937	2938	2939	2940	2941	2942	2943
B80	2944	2945	2946	2947	2948	2949	2950	2951	2952	2953	2954	2955	2956	2957	2958	2959
B90	2960	2961	2962	2963	2964	2965	2966	2967	2968	2969	2970	2971	2972	2973	2974	2975
BA0	2976	2977	2978	2979	2980	2981	2982	2983	2984	2985	2986	2987	2988	2989	2990	2991
BB0	2992	2993	2994	2995	2996	2997	2998	2999	3000	3001	3002	3003	3004	3005	3006	3007
BC0	3008	3009	3010	3011	3012	3013	3014	3015	3016	3017	3018	3019	3020	3021	3022	3023
BD0	3024	3025	3026	3027	3028	3029	3030	3031	3032	3033	3034	3035	3036	3037	3038	3039
BE0	3040	3041	3042	3043	3044	3045	3046	3047	3048	3049	3050	3051	3052	3053	3054	3055
BF0	3056	3057	3058	3059	3060	3061	3062	3063	3064	3065	3066	3067	3068	3069	3070	3071

	0	1	2	3	4	5	6	7	8	9	A	B	C	D	E	F
C00	3072	3073	3074	3075	3076	3077	3078	3079	3080	3081	3082	3083	3084	3085	3086	3087
C10	3088	3089	3090	3091	3092	3093	3094	3095	3096	3097	3098	3099	3100	3101	3102	3103
C20	3104	3105	3106	3107	3108	3109	3110	3111	3112	3113	3114	3115	3116	3117	3118	3119
C30	3120	3121	3122	3123	3124	3125	3126	3127	3128	3129	3130	3131	3132	3133	3134	3135
C40	3136	3137	3138	3139	3140	3141	3142	3143	3144	3145	3146	3147	3148	3149	3150	3151
C50	3152	3153	3154	3155	3156	3157	3158	3159	3160	3161	3162	3163	3164	3165	3166	3167
C60	3168	3169	3170	3171	3172	3173	3174	3175	3176	3177	3178	3179	3180	3181	3182	3183
C70	3184	3185	3186	3187	3188	3189	3190	3191	3192	3193	3194	3195	3196	3197	3198	3199
C80	3200	3201	3202	3203	3204	3205	3206	3207	3208	3209	3210	3211	3212	3213	3214	3215
C90	3216	3217	3218	3219	3220	3221	3222	3223	3224	3225	3226	3227	3228	3229	3230	3231
CA0	3232	3233	3234	3235	3236	3237	3238	3239	3240	3241	3242	3243	3244	3245	3246	3247
CB0	3248	3249	3250	3251	3252	3253	3254	3255	3256	3257	3258	3259	3260	3261	3262	3263
CC0	3264	3265	3266	3267	3268	3269	3270	3271	3272	3273	3274	3275	3276	3277	3278	3279
CD0	3280	3281	3282	3283	3284	3285	3286	3287	3288	3289	3290	3291	3292	3293	3294	3295
CE0	3296	3297	3298	3299	3300	3301	3302	3303	3304	3305	3306	3307	3308	3309	3310	3311
CF0	3312	3313	3314	3315	3316	3317	3318	3319	3320	3321	3322	3323	3324	3325	3326	3327
D00	3328	3329	3330	3331	3332	3333	3334	3335	3336	3337	3338	3339	3340	3341	3342	3343
D10	3344	3345	3346	3347	3348	3349	3350	3351	3352	3353	3354	3355	3356	3357	3358	3359
D20	3360	3361	3362	3363	3364	3365	3366	3367	3368	3369	3370	3371	3372	3373	3374	3375
D30	3376	3377	3378	3379	3380	3381	3382	3383	3384	3385	3386	3387	3388	3389	3390	3391
D40	3392	3393	3394	3395	3396	3397	3398	3399	3400	3401	3402	3403	3404	3405	3406	3407
D50	3408	3409	3410	3411	3412	3413	3414	3415	3416	3417	3418	3419	3420	3421	3422	3423
D60	3424	3425	3426	3427	3428	3429	3430	3431	3432	3433	3434	3435	3436	3437	3438	3439
D70	3440	3441	3442	3443	3444	3445	3446	3447	3448	3449	3450	3451	3452	3453	3454	3455
D80	3456	3457	3458	3459	3460	3461	3462	3463	3464	3465	3466	3467	3468	3469	3470	3471
D90	3472	3473	3474	3475	3476	3477	3478	3479	3480	3481	3482	3483	3484	3485	3486	3487
DA0	3488	3489	3490	3491	3492	3493	3494	3495	3496	3497	3498	3499	3500	3501	3502	3503
DB0	3504	3505	3506	3507	3508	3509	3510	3511	3512	3513	3514	3515	3516	3517	3518	3519
DC0	3520	3521	3522	3523	3524	3525	3526	3527	3528	3529	3530	3531	3532	3533	3534	3535
DD0	3536	3537	3538	3539	3540	3541	3542	3543	3544	3545	3546	3547	3548	3549	3550	3551
DE0	3552	3553	3554	3555	3556	3557	3558	3559	3560	3561	3562	3563	3564	3565	3566	3567
DF0	3568	3569	3570	3571	3572	3573	3574	3575	3576	3577	3578	3579	3580	3581	3582	3583

	0	1	2	3	4	5	6	7	8	9	A	B	C	D	E	F
E00	3584	3585	3586	3587	3583	3589	3590	3591	3592	3593	3594	3595	3596	3597	3598	3599
E10	3600	3601	3602	3603	3604	3605	3606	3607	3608	3609	3610	3611	3612	3613	3614	3615
E20	3616	3617	3618	3619	3620	3621	3622	3623	3624	3625	3626	3627	3628	3629	3630	3631
E30	3632	3633	3634	3635	3636	3637	3638	3639	3640	3641	3642	3643	3644	3645	3646	3647
E40	3648	3649	3650	3651	3652	3653	3654	3655	3656	3657	3658	3659	3660	3661	3662	3663
E50	3664	3665	3666	3667	3668	3669	3670	3671	3672	3673	3674	3675	3676	3677	3678	3679
E60	3680	3681	3682	3683	3684	3685	3686	3687	3688	3689	3690	3691	3692	3693	3694	3695
E70	3696	3697	3698	3699	3700	3701	3702	3703	3704	3705	3706	3707	3708	3709	3710	3711
E80	3712	3713	3714	3715	3716	3717	3718	3719	3720	3721	3722	3723	3724	3725	3726	3727
E90	3728	3729	3730	3731	3732	3733	3734	3735	3736	3737	3738	3739	3740	3741	3742	3743
EA0	3744	3745	3746	3747	3748	3749	3750	3751	3752	3753	3754	3755	3756	3757	3758	3759
EB0	3760	3761	3762	3763	3764	3765	3766	3767	3768	3769	3770	3771	3772	3773	3774	3775
EC0	3776	3777	3778	3779	3780	3781	3782	3783	3784	3785	3786	3787	3788	3789	3790	3791
ED0	3792	3793	3794	3795	3796	3797	3798	3799	3800	3801	3802	3803	3804	3805	3806	3807
EE0	3808	3809	3810	3811	3812	3813	3814	3815	3816	3817	3818	3819	3820	3821	3822	3823
EF0	3824	3825	3826	3827	3828	3829	3830	3831	3832	3833	3834	3835	3836	3837	3838	3839
F00	3840	3841	3842	3843	3844	3845	3846	3847	3848	3849	3850	3851	3852	3853	3854	3855
F10	3856	3857	3858	3859	3860	3861	3862	3863	3864	3865	3866	3867	3868	3869	3870	3871
F20	3872	3873	3874	3875	3876	3877	3878	3879	3880	3881	3882	3883	3884	3885	3886	3887
F30	3888	3889	3890	3891	3892	3893	3894	3895	3896	3897	3898	3899	3900	3901	3902	3903
F40	3904	3905	3906	3907	3908	3909	3910	3911	3912	3913	3914	3915	3916	3917	3918	3919
F50	3920	3921	3922	3923	3924	3925	3926	3927	3928	3929	3930	3931	3932	3933	3934	3935
F60	3936	3937	3938	3939	3940	3941	3942	3943	3944	3945	3946	3947	3948	3949	3950	3951
F70	3952	3953	3954	3955	3956	3957	3958	3959	3960	3961	3962	3963	3964	3965	3966	3967
F80	3968	3969	3970	3971	3972	3973	3974	3975	3976	3977	3978	3979	3980	3981	3982	3983
F90	3984	3985	3986	3987	3988	3989	3990	3991	3992	3993	3994	3995	3996	3997	3998	3999
FA0	4000	4001	4002	4003	4004	4005	4006	4007	4008	4009	4010	4011	4012	4013	4014	4015
FB0	4016	4017	4018	4019	4020	4021	4022	4023	4024	4025	4026	4027	4028	4029	4030	4031
FC0	4032	4033	4034	4035	4036	4037	4038	4039	4040	4041	4042	4043	4044	4045	4046	4047
FD0	4048	4049	4050	4051	4052	4053	4054	4055	4056	4057	4058	4059	4060	4061	4062	4063
FE0	4064	4065	4066	4067	4068	4069	4070	4071	4072	4073	4074	4075	4076	4077	4078	4079
FF0	4080	4081	4082	4083	4084	4085	4086	4087	4088	4089	4090	4091	4092	4093	4094	4095

Appendix F. EBCDIC and ASCII Charts

Extended Binary-Coded-Decimal Interchange Code (EBCDIC)

Bit Positions		01				01				10				11				
4567		23	00	01	10	11	00	01	10	11	00	01	10	11	00	01	10	11
0000	NUL					BLANK	&	-							>	<	‡	0
0001								/		a	i				A	J		1
0010										b	k	s			B	K	S	2
0011										c	l	t			C	L	T	3
0100	PF	RES	BYP	PN						d	m	u			D	M	U	4
0101	HT	NL	LF	RS						e	n	v			E	N	V	5
0110	LC	BS	EOB	UC						f	o	w			F	O	W	6
0111	DEL	IDL	PRE	EOT						g	p	x			G	P	X	7
1000										h	q	y			H	Q	Y	8
1001						.		,	"	i	r	z			I	R	Z	9
1010						?	!		:									
1011						.	\$,	#									
1100						←	*	%	@									
1101						()	~	'									
1110						+	;	-	=									
1111						‡	∅	+ ₋	✓									

American Standard Code for Information Interchange (ASCII) Extended to Eight Bits

Bit Positions		76				01				10				11				
4321		X5	00	01	10	11	00	01	10	11	00	01	10	11	00	01	10	11
0000	NULL	DC ₀				␣	0			@	P							P
0001	SOM	DC ₁				!	1			A	Q						a	q
0010	EOA	DC ₂				"	2			B	R						b	r
0011	EOM	DC ₃				#	3			C	S						c	s
0100	EOT	DC ₄ STOP				§	4			D	T						d	t
0101	WRU	ERR				%	5			E	U						e	u
0110	RU	SYNC				&	6			F	V						f	v
0111	BELL	LEM				'	7			G	W						g	w
1000	BKSP	S ₀				(8			H	X						h	x
1001	HT	S ₁)	9			I	Y						i	y
1010	LF	S ₂				*	:			J	Z						j	z
1011	VT	S ₃				+	;			K	␣						k	
1100	FF	S ₄				,	<			L	\						l	
1101	CR	S ₅				-	=			M	␣						m	
1110	SO	S ₆				.	>			N	↑						n	ESC
1111	SI	S ₇				/	?			O	←						o	DEL

Appendix G. Instructions

Data Formats

Fixed-Point Numbers

Fullword Fixed-Point Number

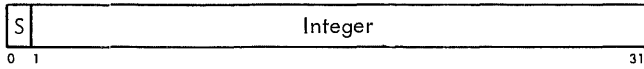

Halfword Fixed-Point Number

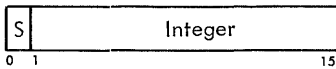

Floating-Point Numbers

Short Floating-Point Number

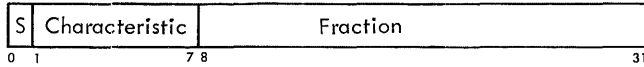

Long Floating-Point Number

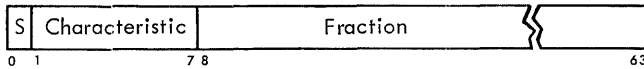

Decimal Numbers

Packed Decimal Number

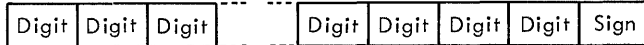

Zoned Decimal Number

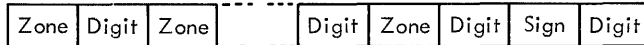

Logical Information

Fixed-Length Logical Information

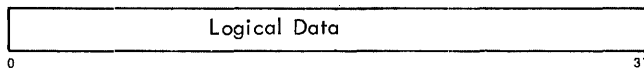

Variable-Length Logical Information

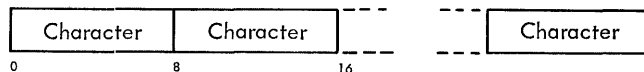

Hexadecimal Representation

HEXADECIMAL CODE	PRINTED GRAPHIC	EBCDIC* CODE	ASCII† CODE
0000	0	1111 0000	0101 0000
0001	1	1111 0001	0101 0001
0010	2	1111 0010	0101 0010
0011	3	1111 0011	0101 0011
0100	4	1111 0100	0101 0100
0101	5	1111 0101	0101 0101
0110	6	1111 0110	0101 0110
0111	7	1111 0111	0101 0111
1000	8	1111 1000	0101 1000
1001	9	1111 1001	0101 1001
1010	A	1100 0001	1010 0001
1011	B	1100 0010	1010 0010
1100	C	1100 0011	1010 0011
1101	D	1100 0100	1010 0100
1110	E	1100 0101	1010 0101
1111	F	1100 0110	1010 0110

*Extended Binary-Coded-Decimal Interchange Code.

†An eight-bit representation for American Standard Code for Information Interchange for use in eight-bit environments.

Instructions by Format Type

RR Format

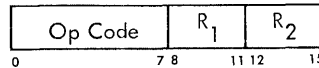

Fixed Point

- Load
- Load and Test
- Load Complement
- Load Positive
- Load Negative
- Add
- Add Logical
- Subtract
- Subtract Logical
- Compare
- Multiply
- Divide

E
E

Floating Point

- Load S/L
- Load and Test S/L
- Load Complement S/L
- Load Positive S/L
- Load Negative S/L
- Add Normalized S/L
- Add Unnormalized S/L
- Subtract Normalized S/L
- Subtract Unnormalized S/L
- Compare S/L
- Halve S/L
- Multiply S/L
- Divide S/L

Logical

- Compare
- AND
- OR
- Exclusive OR

1

Status Switching

- Set Program Mask 2
- Supervisor Call 3
- Set Storage Key Z
- Insert Storage Key Z

RX Format

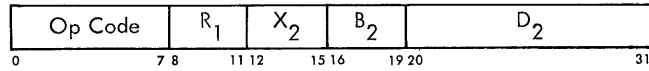

Fixed Point

Load H/F
 Add H/F
 Add Logical
 Subtract H/F
 Subtract Logical
 Compare H/F
 Multiply H
 Multiply F
 Divide F
 Convert to Binary
 Convert to Decimal
 Store H/F

E
 E

Floating Point

Load S/L
 Add Normalized S/L
 Add Unnormalized S/L
 Subtract Normalized S/L
 Subtract Unnormalized S/L
 Compare S/L
 Multiply S/L
 Store S/L
 Divide S/L

Logical

Compare
 Load Address
 Insert Character
 Store Character
 AND
 OR
 Exclusive OR

Branching

Branch on Condition 1
 Branch and Link
 Branch on Count
 Execute

RS Format

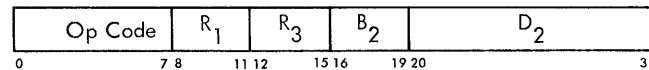

Fixed Point

Load Multiple
 Store Multiple
 Shift Left Single 2
 Shift Right Single 2
 Shift Left Double E,2
 Shift Right Double E,2

Logical

Shift Left Single 2
 Shift Right Single 2
 Shift Left Double E,2
 Shift Right Double E,2

Branching

Branch on High
 Branch on Low-Eq

SI Format

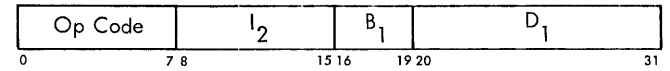

Input/Output

Start I/O 4
 Test I/O 4
 Halt I/O 4
 Test Channel 4

Status Switching

Load PSW 4
 Set System Mask 4
 Write Direct Y
 Read Direct Y
 Diagnose

Logical

Move
 Compare
 AND
 OR
 Exclusive OR
 Test Under Mask

SS Format

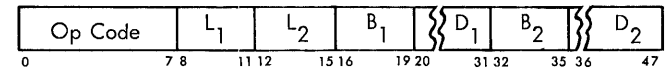

Decimal

Pack
 Unpack
 Move With Offset
 Zero and Add T
 Add T
 Subtract T
 Compare T
 Multiply T
 Divide T

Logical

Move 5
 Move Numeric 5
 Move Zone 5
 Compare 5
 AND 5
 OR 5
 Exclusive OR 5
 Translate 5
 Translate and Test 5
 Edit T,5
 Edit and Mark T,5

FORMAT NOTES

- E R₁ must be even
- F Fullword
- H Halfword
- L Long
- S Short
- T Decimal feature
- Y Direct control feature
- Z Protection feature
- 1 R₁ used as mask M₁
- 2 R₂ or R₃ ignored
- 3 R₁ and R₂ used as immediate information
- 4 L₂ ignored
- 5 L₁ and L₂ used as eight-bit L field

All floating-point instructions are part of the floating-point feature.

Control Word Formats

Base and Index Registers

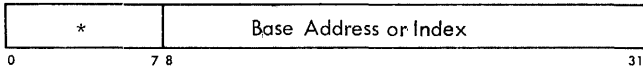

0-7 Ignored
8-31 Base address or index

Program Status Word

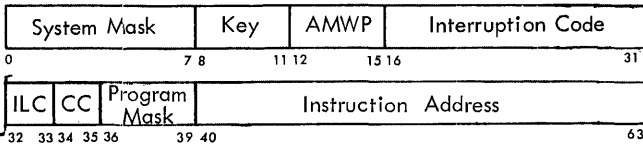

0-7 System mask	13 Machine check mask (M)
0 Multiplexor channel mask	14 Wait state (W)
1 Selector channel 1 mask	15 Problem state (P)
2 Selector channel 2 mask	16-31 Interruption code
3 Selector channel 3 mask	32-33 Instruction length code (ILC)
4 Selector channel 4 mask	34-35 Condition code (CC)
5 Selector channel 5 mask	36-39 Program mask
6 Selector channel 6 mask	36 Fixed-point overflow mask
7 External mask	37 Decimal overflow mask
8-11 Protection key	38 Exponent underflow mask
12 ASCII mode (A)	39 Significance mask
	40-63 Instruction address

Channel Command Word

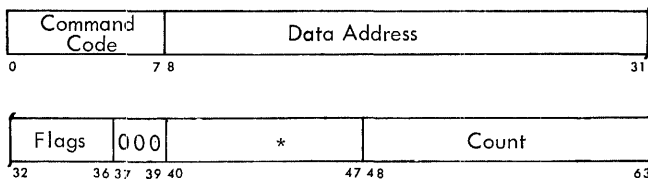

0-7 Command code	35 Skip flag
8-31 Data address	36 Program-controlled interruption flag
32-36 Command flags	37-39 Zero
32 Chain data flag	40-47 Ignored
33 Chain command flag	48-63 Count
34 Suppress length indication flag	

Command Code Assignment

NAMES	FLAGS	CODE
Write	CD CC SLI PCI	MMMM MM01
Read	CD CC SLI SKIP PCI	MMMM MM10
Read Backward	CD CC SLI SKIP PCI	MMMM 1 100
Control	CD CC SLI PCI	MMMM MM11
Sense	CD CC SLI SKIP PCI	MMMM 0 100
Transfer in Channel		x x x x 1 000

CD = Chain data	SKIP = Skip
CC = Chain command	PCI = Program-controlled interruption
SLI = Suppress length indication	

Channel Address Word

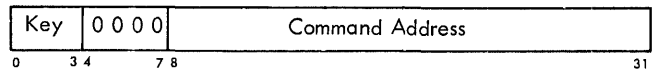

0-3 Protection key
4-7 Zero
8-31 Command address

Channel Status Word

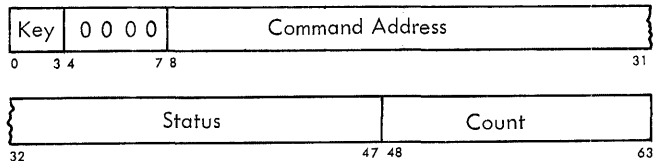

0-3 Protection key	40 Program-controlled interruption
4-7 Zero	41 Incorrect length
8-31 Command address	42 Program check
32-47 Status	43 Protection check
32 Attention	44 Channel data check
33 Status modifier	45 Channel control check
34 Control unit end	46 Interface control check
35 Busy	47 Chaining check
36 Channel end	48-63 Count
37 Device end	
38 Unit check	
39 Unit exception	

Operation Codes

RR Format

CLASS				
	BRANCHING AND STATUS SWITCHING	FIXED-POINT FULLWORD AND LOGICAL	FLOATING-POINT LONG	FLOATING-POINT SHORT
xxxx	0000xxxx	0001xxxx	0010xxxx	0011xxxx
0000		Load Positive	Load Positive	Load Positive
0001		Load Negative	Load Negative	Load Negative
0010		Load and Test	Load and Test	Load and Test
0011		Load Complement	Load Complement	Load Complement
0100	Set Program Mask	AND	Halve	Halve
0101	Branch and Link	Compare Logical		
0110	Branch on Count	OR		
0111	Branch/Condition	Exclusive OR		
1000	Set Key	Load	Load	Load
1001	Insert Key	Compare	Compare	Compare
1010	Supervisor Call	Add	Add N	Add N
1011		Subtract	Subtract N	Subtract N
1100		Multiply	Multiply	Multiply
1101		Divide	Divide	Divide
1110		Add Logical	Add U	Add U
1111		Subtract Logical	Subtract U	Subtract U

RX Format

CLASS				
	FIXED-POINT HALFWORD AND BRANCHING	FIXED-POINT FULLWORD AND LOGICAL	FLOATING-POINT LONG	FLOATING-POINT SHORT
xxxx	0100xxxx	0101xxxx	0110xxxx	0111xxxx
0000	Store	Store	Store	Store
0001	Load Address			
0010	Store Character			
0011	Insert Character			
0100	Execute	AND		
0101	Branch and Link	Compare Logical		
0110	Branch on Count	OR		
0111	Branch/Condition	Exclusive OR		
1000	Load	Load	Load	Load
1001	Compare	Compare	Compare	Compare
1010	Add	Add	Add N	Add N
1011	Subtract	Subtract	Subtract N	Subtract N
1100	Multiply	Multiply	Multiply	Multiply
1101		Divide	Divide	Divide
1110	Convert-Decimal	Add Logical	Add U	Add U
1111	Convert-Binary	Subtract Logical	Subtract U	Subtract U

RS, SI Format

CLASS				
	BRANCHING STATUS SWITCHING AND SHIFTING	FIXED-POINT LOGICAL AND INPUT/OUTPUT		
xxxx	1000xxxx	1001xxxx	1010xxxx	1011xxxx
0000	Set System Mask	Store Multiple		
0001		Test Under Mask		
0010	Load PSW	Move		
0011	Diagnose			
0100	Write Direct	AND		
0101	Read Direct	Compare Logical		
0110	Branch/High	OR		
0111	Branch/Low-Equal	Exclusive OR		
1000	Shift Right SL	Load Multiple		
1001	Shift Left SL			
1010	Shift Right S			
1011	Shift Left S			
1100	Shift Right DL	Start I/O		
1101	Shift Left DL	Test I/O		
1110	Shift Right D	Halt I/O		
1111	Shift Left D	Test Channel		

SS Format

CLASS				
		LOGICAL		DECIMAL
xxxx	1100xxxx	1101xxxx	1110xxxx	1111xxxx
0000				
0001		Move Numeric		Move With Offset
0010		Move		Pack
0011		Move Zone		Unpack
0100		AND		
0101		Compare Logical		
0110		OR		
0111		Exclusive OR		
1000				Zero and Add
1001				Compare
1010				Add
1011				Subtract
1100		Translate		Multiply
1101		Translate and Test		Divide
1110		Edit		
1111		Edit and Mark		

OPERATION CODE NOTES

N	= Normalized	U	= Unnormalized
SL	= Single logical	S	= Single
DL	= Double logical	D	= Double

Permanent Storage Assignment

ADDRESS	LENGTH	PURPOSE
0 0000 0000	double-word	Initial program loading PSW
8 0000 1000	double-word	Initial program loading CCW1
16 0001 0000	double-word	Initial program loading CCW2
24 0001 1000	double-word	External old PSW
32 0010 0000	double-word	Supervisor call old PSW
40 0010 1000	double-word	Program old PSW
48 0011 0000	double-word	Machine-check old PSW
56 0011 1000	double-word	Input/output old PSW
64 0100 0000	double-word	Channel status word
72 0100 1000	word	Channel address word
76 0100 1100	word	Unused
80 0101 0000	word	Timer
84 0101 0100	word	Unused
88 0101 1000	double-word	External new PSW
96 0110 0000	double-word	Supervisor call new PSW
104 0110 1000	double-word	Program new PSW
112 0111 0000	double-word	Machine-check new PSW
120 0111 1000	double-word	Input/output new PSW
128 1000 0000		Diagnostic scan-out area*

* The size of the diagnostic scan-out area depends on the particular model and I/O channels.

Condition Code Setting

Fixed-Point Arithmetic

	0	1	2	3
Add H/F	zero	< zero	> zero	overflow
Add Logical	zero	not zero	zero, carry	carry
Compare H/F	equal	low	high	--
Load and Test	zero	< zero	> zero	--
Load Complement	zero	< zero	> zero	overflow
Load Negative	zero	< zero	--	--
Load Positive	zero	--	> zero	overflow
Shift Left Double	zero	< zero	> zero	overflow
Shift Left Single	zero	< zero	> zero	overflow
Shift Right Double	zero	< zero	> zero	--
Shift Right Single	zero	< zero	> zero	--
Subtract H/F	zero	< zero	> zero	overflow
Subtract Logical	--	not zero	zero, carry	carry

Decimal Arithmetic

Add Decimal	zero	< zero	> zero	overflow
Compare Decimal	equal	low	high	--
Subtract Decimal	zero	< zero	> zero	overflow
Zero and Add	zero	< zero	> zero	overflow

Floating-Point Arithmetic

Add Normalized S/L	zero	< zero	> zero	overflow
Add Unnormalized S/L	zero	< zero	> zero	overflow
Compare S/L	equal	low	high	--
Load and Test S/L	zero	< zero	> zero	--

Load Complement S/L	zero	< zero	> zero	--
Load Negative S/L	zero	< zero	--	--
Load Positive S/L	zero	--	> zero	--
Subtract Normalized S/L	zero	< zero	> zero	overflow
Subtract Unnormalized S/L	zero	< zero	> zero	overflow

Logical Operations

AND	zero	not zero	--	--
Compare Logical	equal	low	high	--
Edit	zero	< zero	> zero	--
Edit and Mark	zero	< zero	> zero	--
Exclusive OR	zero	not zero	--	--
OR	zero	not zero	--	--
Test Under Mask	zero	mixed	--	one
Translate and Test	zero	incomplete	complete	--

Input/Output Operations

Halt I/O	not working	halted	stopped	not oper
Start I/O	available	CSW stored	busy	not oper
Test Channel	not working	CSW ready	working	not oper
Test I/O	available	CSW stored	working	not oper

CONDITION CODE SETTING NOTES

available	Unit and channel available
busy	Unit or channel busy
carry	A carry out of the sign position occurred
complete	Last result byte nonzero
CSW ready	Channel status word ready for test or interruption
CSW stored	Channel status word stored
equal	Operands compare equal
F	Fullword
> zero	Result is greater than zero
H	Halfword
halted	Data transmission stopped. Unit in halt-reset mode
high	First operand compares high
incomplete	Nonzero result byte; not last
L	Long precision
< zero	Result is less than zero
low	First operand compares low
mixed	Selected bits are both zero and one
not oper	Unit or channel not operational
not working	Unit or channel not working
not zero	Result is not all zero
one	Selected bits are one
overflow	Result overflows
S	Short precision
stopped	Data transmission stopped
working	Unit or channel working
zero	Result or selected bits are zero

The condition code also may be changed by LOAD PSW, SET SYSTEM MASK, DIAGNOSE, and by an interruption.

Interrupt Action

INTERRUPTION SOURCE IDENTIFICATION	INTERRUPTION CODE PSW BITS 16-31	MASK BITS	ILC SET	INSTRUCTION EXECUTION
Input/Output (old PSW 56, new PSW 120, priority 4)				
Multiplexor channel	00000000 aaaaaaaa	0	x	complete
Selector channel 1	00000001 aaaaaaaa	1	x	complete
Selector channel 2	00000010 aaaaaaaa	2	x	complete
Selector channel 3	00000011 aaaaaaaa	3	x	complete
Selector channel 4	00000100 aaaaaaaa	4	x	complete
Selector channel 5	00000101 aaaaaaaa	5	x	complete
Selector channel 6	00000110 aaaaaaaa	6	x	complete

Program (old PSW 40, new PSW 104, priority 2)

Operation	00000000 00000001		1,2,3	suppress
Privileged operation	00000000 00000010		1,2	suppress
Execute	00000000 00000011		2	suppress
Protection	00000000 00000100		0,2,3	suppress/terminate
Addressing	00000000 00000101		1,2,3	suppress/terminate
Specification	00000000 00000110		1,2,3	suppress
Data	00000000 00000111		2,3	terminate
Fixed-point overflow	00000000 00001000	36	1,2	complete
Fixed-point divide	00000000 00001001		1,2	suppress/complete
Decimal overflow	00000000 00001010	37	3	complete
Decimal divide	00000000 00001011		3	suppress
Exponent overflow	00000000 00001100		1,2	terminate
Exponent underflow	00000000 00001101	38	1,2	complete
Significance	00000000 00001110	39	1,2	complete
Floating-point divide	00000000 00001111		1,2	suppress

Supervisor Call (old PSW 32, new PSW 96, priority 2)

Instruction bits	00000000 rrrrrrrr		1	complete
------------------	-------------------	--	---	----------

External (old PSW 24, new PSW 88, priority 3)

External signal 1	00000000 xxxxxxx1	7	x	complete
External signal 2	00000000 xxxxxx1x	7	x	complete
External signal 3	00000000 xxxxx1xx	7	x	complete
External signal 4	00000000 xxxx1xxx	7	x	complete
External signal 5	00000000 xxxlxxxx	7	x	complete
External signal 6	00000000 xxlxxxxx	7	x	complete
Interrupt key	00000000 xlxxxxxx	7	x	complete
Timer	00000000 lxxxxxxx	7	x	complete

Machine Check (old PSW 48, new PSW 112, priority 1)

Machine malfunction	00000000 00000000	13	x	terminate
---------------------	-------------------	----	---	-----------

NOTES

- a Device address bits
- r Bits of R₁ and R₂ field of SUPERVISOR CALL
- x Unpredictable

Instruction Length Recording

INSTRUCTION LENGTH CODE	PSW BITS 32-33	INSTRUCTION BITS 0-1	INSTRUCTION LENGTH	INSTRUCTION FORMAT
0	00		Not available	
1	01	00	One halfword	RR
2	10	01	Two halfwords	RX
2	10	10	Two halfwords	RS or SI
3	11	11	Three halfwords	SS

Program Interruptions

The listings in the "Type" and "Exceptions" columns of the tables in this section mean:

A	Addressing exception
C	Condition code is set
D	Data exception
DF	Decimal-overflow exception
DK	Decimal-divide exception
E	Exponent-overflow exception
EX	Execute exception
F	Floating-point feature
FK	Floating-point divide exception
IF	Fixed-point overflow exception
IK	Fixed-point divide exception
L	New condition code loaded
LS	Significance exception
M	Privileged-operation exception
N	Normalized operation
P	Protection exception
S	Specification exception
T	Decimal feature
U	Exponent-underflow exception
Y	Direct control feature
Z	Protection feature

Operation (OP)

The operation code is not assigned or the assigned operation is not available on the particular CPU.

The operation is suppressed.

The instruction-length code is 1, 2, or 3.

Privileged Operation (M)

A privileged instruction is encountered in the problem state.

The operation is suppressed.

The instruction-length code is 1 or 2.

NAME	MNEMONIC	TYPE	EXCEPTIONS	CODE
Diagnose		SI	M, A,S	83
Halt I/O	HIO	SI C	M,	9E
Insert Storage Key	ISK	RR Z	M, A,S	09
Load PSW	LPSW	SI L	M, A,S	82
Read Direct	RDD	SI Y	M,P,A	85
Set Storage Key	SSK	RR Z	M, A,S	08
Set System Mask	SSM	SI C	M, A	80
Start I/O	SIO	SI C	M,	9C
Test Channel	TCH	SI C	M,	9F
Test I/O	TIO	SI C	M,	9D
Write Direct	WRD	SI Y	M, A	84

Execute (EX)

The subject instruction of EXECUTE is another EXECUTE.

The operation is suppressed.

The instruction-length code is 2.

NAME	MNEMONIC	TYPE	EXCEPTIONS	CODE
Execute	EX	RX	A,S, EX	44

Protection (P)

The storage key of a result location does not match the protection key in the PSW.

The operation is suppressed, except in the case of STORE MULTIPLE, READ DIRECT, and variable-length operations, which are terminated.

The instruction-length code is 0, 2, or 3.

NAME	MNEMONIC	TYPE	EXCEPTIONS	CODE	NOTE
Add Decimal	AP	SS T,C	P,A, D, DF	FA	TRM
AND	NI	SI C	P,A	94	SPR
AND	NC	SS C	P,A	D4	TRM
Convert to Decimal	CVD	RX	P,A,S	4E	SPR
Divide Decimal	DP	SS T	P,A,S,D, DK	FD	TRM
Edit	ED	SS T,C	P,A, D	DE	TRM
Edit and Mark	EDMK	SS T,C	P,A, D	DF	TRM
Exclusive OR	XI	SI C	P,A	97	SPR
Exclusive OR	XC	SS C	P,A	D7	TRM
Move	MVI	SI	P,A	92	SPR
Move	MVC	SS	P,A	D2	TRM
Move Numerics	MVN	SS	P,A	D1	TRM
Move with Offset	MVO	SS	P,A	F1	TRM
Move Zones	MVZ	SS	P,A	D3	TRM
Multiply Decimal	MP	SS T	P,A,S,D	FC	TRM
OR	OI	SI C	P,A	96	SPR
OR	OC	SS C	P,A	D6	TRM
Pack	PACK	SS	P,A	F2	TRM
Read Direct	RDD	SI Y	M,P,A	85	TRM
Store	ST	RX	P,A,S	50	SPR
Store Character	STC	RX	P,A	42	SPR
Store Halfword	STH	RX	P,A,S	40	SPR
Store Long	STD	RX F	P,A,S	60	SPR
Store Multiple	STM	RX F	P,A,S	90	TRM
Store Short	STE	RX F	P,A,S	70	SPR
Subtract Decimal	SP	SS T,C	P,A, D, DF	FB	TRM
Translate	TR	SS	P,A	DC	TRM
Unpack	UNPK	SS	P,A	F3	TRM
Zero and Add	ZAP	SS T,C	P,A, D, DF	F8	TRM

PROTECTION INTERRUPTION NOTES

SPR = Operation suppressed

TRM = Operation terminated

Addressing (A)

An address specifies any part of data, instructions, or control words outside the available storage for the particular installation.

The operation is terminated. Data in storage remain unchanged, except when designated by valid addresses.

The instruction-length code normally is 2 or 3; but may be 0, in the case of a data address.

NAME	MNEMONIC	TYPE	EXCEPTIONS	CODE	NOTE
Add	A	RX C	A,S, IF	5A	TRM
Add Decimal	AP	SS T,C	P,A D, DF	FA	TRM
Add Halfword	AH	RX C	A,S, IF	4A	TRM
Add Logical	AL	RX C	A,S,	5E	TRM
Add Normalized (Long)	N AD	RX F,C	A,S,U,E,LS	6A	TRM
Add Normalized (Short)	N AE	RX F,C	A,S,U,E,LS	7A	TRM
Add Unnorm- alized (Long)	AW	RX F,C	A,S, E,LS	6E	TRM
Add Unnorm- alized (Short)	AU	RX F,C	A,S, E,LS	7E	TRM
AND	N	RX C	A,S,	54	TRM

NAME	MNEMONIC	TYPE	EXCEPTIONS	CODE	NOTE
AND	NI	SI C	P,A,	94	SPR
AND	NC	SS C	P,A	D4	TRM
Compare	C	RX C	A,S,	59	TRM
Compare Decimal	CP	SS T,C	A, D	F9	TRM
Compare Halfword	CH	RX C	A,S,	49	TRM
Compare Logical	CL	RX C	A,S,	55	TRM
Compare Logical	CLI	SI C	A	95	TRM
Compare Logical	CLC	SS C	A	D5	TRM
Compare (Long)	CD	RX F,C	A,S,	69	TRM
Compare (Short)	CE	RX F,C	A,S,	79	TRM
Convert to Binary	CVB	RX	A,S,D, IK	4F	TRM
Convert to Decimal	CVD	RX	P,A,S,	4E	SPR
Diagnose		SI	M, A,S,	83	SPR
Divide	D	RX	A,S, IK	5D	TRM
Divide Decimal	DP	SS T	P,A,S,D, DK	FD	TRM
Divide (Long)	N DD	RX F	A,S,U,E,FK	6D	TRM
Divide (Short)	N DE	RX F	A,S,U,E,FK	7D	TRM
Edit	ED	SS T,C	P,A, D	DE	TRM
Edit and Mark	EDMK	SS T,C	P,A, D	DF	TRM
Exclusive OR	X	RX C	A,S,	57	TRM
Exclusive OR	XI	SI C	P,A,	97	SPR
Exclusive OR	XC	SS C	P,A,	D7	TRM
Execute	EX	RX	A,S, EX	44	SPR
Insert Character	IC	RX	A	43	TRM
Insert Storage Key	ISK	RR Z	M, A,S	09	
Load	L	RX	A,S,	58	TRM
Load Halfword	LH	RX	A,S,	48	TRM
Load (Long)	LD	RX F	A,S,	68	TRM
Load Multiple	LM	RS	A,S,	98	TRM
Load PSW	LPSW	SI	LM, A,S	82	TRM
Load (Short)	LE	RX F	A,S,	78	TRM
Move	MVI	SI	P,A	92	SPR
Move	MVC	SS	P,A	D2	TRM
Move Numerics	MVN	SS	P,A	D1	TRM
Move with Offset	MVO	SS	P,A	F1	TRM
Move Zones	MVZ	SS	P,A	D3	TRM
Multiply	M	RX	A,S	5C	TRM
Multiply Decimal	MP	SS T	P,A,S,D	FC	TRM
Multiply Halfword	MH	RX	A,S	4C	TRM
Multiply (Long)	N MD	RX F	A,S,U,E	6C	TRM
Multiply (Short)	N ME	RX F	A,S,U,E	7C	TRM
OR	O	RX C	A,S,	56	TRM
OR	OI	SI C	P,A	96	SPR
OR	OC	SS C	P,A	D6	TRM
Pack	PACK	SS	P,A	F2	TRM
Read Direct	RDD	SI Y	M,P,A,	85	TRM
Set Storage Key	SSK	RR Z	M, A,S	08	
Set System Mask	SSM	SI	M, A	80	TRM
Store	ST	RX	P,A,S	50	SPR
Store Character	STC	RX	P,A	42	SPR
Store Halfword	STH	RX	P,A,S	40	SPR
Store (Long)	STD	RX F	P,A,S	60	SPR
Store Multiple	STM	RS	P,A,S	90	TRM
Store (Short)	STE	RX F	P,A,S	70	SPR
Subtract	S	RX C	A,S, IF	5B	TRM
Subtract Decimal	SP	SS T,C	P,A, D, DF	FB	TRM
Subtract Halfword	SH	RX C	A,S, IF	4B	TRM

NAME	MNEMONIC	TYPE	EXCEPTIONS	CODE	NOTE
Subtract Logical	SL	RX C	A,S	5F	TRM
Subtract Normalized (Long)	N SD	RX F,C	A,S,U,E,LS	6B	TRM
Subtract Normalized (Short)	N SE	RX F,C	A,S,U,E,LS	7B	TRM
Subtract Unnormalized (Long)	SW	RX F,C	A,S, E,LS	6F	TRM
Subtract Unnormalized (Short)	SU	RX F,C	A,S, E,LS	7F	TRM
Test Under Mask	TM	SI C	A	91	TRM
Translate	TR	SS	P,A	DC	TRM
Translate and Test	TRT	SS C	A	DD	TRM
Unpack	UNPK	SS	P,A	F3	TRM
Write Direct	WRD	SI Y	M, A	84	TRM
Zero and Add	ZAP	SS T,C	P,A, D,	DF F8	TRM

The addressing interruption can occur in normal sequential operation following branching, LOAD PSW, interruption, or manual operation.

Instruction execution is suppressed.

ADDRESSING INTERRUPTION NOTES

SPR = Operation suppressed

TRM = Operation terminated

Specification (S)

1. A data, instruction, or control-word address does not specify an integral boundary for the unit of information.

2. The R₁ field of an instruction specifies an odd register address for a pair of general registers that contain a 64-bit operand.

3. A floating-point register address other than 0, 2, 4, or 6 is specified.

4. The multiplier or divisor in decimal arithmetic exceeds 15 digits and sign.

5. The first operand field is shorter than or equal to the second operand field in decimal multiplication or division.

6. The block address specified in SET STORAGE KEY or INSERT STORAGE KEY has the four low-order bits not all zero.

7. A PSW with nonzero protection key is loaded when the protection feature is not installed.

In all of these cases the operation is suppressed.

The instruction-length code is 1, 2, or 3.

NAME	MNEMONIC	TYPE	EXCEPTIONS	CODE	NOTE
Add	A	RX C	A,S,	IF 5A	4
Add Halfword	AH	RX C	A,S,	IF 4A	2
Add Logical	AL	RX C	A,S	5E	4
Add Normalized (Long)	N ADR	RR F,C	S,U,E,LS	2A	3
Add Normalized (Long)	N AD	RX F,C	A,S,U,E,LS	6A	3,8
Add Normalized (Short)	N AER	RR F,C	S,U,E,LS	3A	3
Add Normalized (Short)	N AE	RX F,C	A,S,U,E,LS	7A	3,4

NAME	MNEMONIC	TYPE	EXCEPTIONS	CODE	NOTE
Add Unnormalized (Long)	AWR	RR F,C	S, E,LS	2E	3
Add Unnormalized (Long)	AW	RX,F,C	A,S, E,LS	6E	3,8
Add Unnormalized (Short)	AUR	RR F,C	S, E,LS	3E	3
Add Unnormalized (Short)	AU	RX F,C	A,S, E,LS	7E	3,4
AND	N	RX C	A,S	54	4
Compare	C	RX C	A,S	59	4
Compare Halfword	CH	RX C	A,S	49	2
Compare Logical	CL	RX C	A,S	55	4
Compare (Long)	CDR	RR,F,C	S	29	3
Compare (Long)	CD	RX,F,C	A,S	69	3,8
Compare (Short)	CER	RR,F,C	S	39	3
Compare (Short)	CE	RX,F,C	A,S	79	3,4
Convert to Binary	CVB	RX	A,S,D,	IK 4F	8
Convert to Decimal	CVD	RX	P,A,S	4E	8
Diagnose	SI	M, A,S		83	
Divide	DR	RR	S,	IK 1D	1
Divide	D	RX	A,S,	IK 5D	1,4
Divide Decimal	DP	SS T	P,A,S,D,	DK FD	5
Divide (Long)	N DDR	RR F	S,U,E,FK	2D	3
Divide (Long)	N DD	RX F	A,S,U,E,FK	6D	3,8
Divide (Short)	N DER	RR F	S,U,E,FK	3D	3
Divide (Short)	N DE	RX F	A,S,U,E,FK	7D	3,4
Exclusive OR	X	RX C	A,S	57	4
Execute	EX	RX	A,S,	EX 44	2
Halve (Long)	HDR	RR F	S	24	3
Halve (Short)	HER	RR F	S	34	3
Insert Storage Key	ISK	RR Z	M, A,S	09	7
Load	L	RX	A,S	58	4
Load and Test (Long)	LTDR	RR F,C	S	22	3
Load and Test (Short)	LTER	RR F,C	S	32	3
Load Complement (Long)	LCDR	RR F,C	S	23	3
Load Complement (Short)	LCER	RR F,C	S	33	3
Load Halfword	LH	RX	A,S,	48	2
Load (Long)	LDR	RR F	S	28	3
Load (Long)	LD	RX F	A,S	68	3,8
Load Multiple	LM	RS	A,S	98	4
Load Negative (Long)	LNDR	RR F,C	S	21	3
Load Negative (Short)	LNER	RR F,C	S	31	3
Load Positive (Long)	LPDR	RR F,C	S	20	3
Load Positive (Short)	LPER	RR F,C	S	30	3
Load PSW	LPSW	SI L M,	A,S	82	6,8
Load (Short)	LER	RR F	S	38	3
Load (Short)	LE	RX F	A,S	78	3,4
Multiply	MR	RR	S	1C	1
Multiply	M	RX	A,S	5C	1,4

NAME	MNEMONIC	TYPE	EXCEPTIONS	CODE	NOTE
Multiply					
Decimal	MP	SS T	P,A,S,D	FC	5
Multiply					
Halfword	MH	RX	A,S	4C	2
Multiply (Long)	N MDR	RR F	S,U,E	2C	3
Multiply (Long)	N MD	RX F	A,S,U,E	6C	3,8
Multiply (Short)	N MER	RR F	S,U,E	3C	3
Multiply (Short)	N ME	RX F	A,S,U,E	7C	3,4
OR	O	RX C	A,S	56	4
Set Storage					
Key	SSK	RR Z	M, A,S	08	7
Shift Left					
Double	SLDA	RS C	S, IF	8F	1
Shift Left					
Double					
Logical	SLDL	RS	S	8D	1
Shift Right					
Double	SRDA	RS C	S	8E	1
Shift Right					
Double					
Logical	SRDL	RS	S	8C	1
Store	ST	RX	P,A,S	50	4
Store Halfword	STH	RX	P,A,S	40	2
Store (Long)	STD	RX F	P,A,S	60	3,8
Store Multiple	STM	RS	P,A,S	90	4
Store (Short)	STE	RX F	P,A,S	70	3,4
Subtract	S	RX C	A,S, IF	5B	4
Subtract					
Halfword	SH	RX C	A,S, IF	4B	2
Subtract					
Logical	SL	RX C	A,S	5F	4
Subtract Norm-					
alized (Long)	N SDR	RR F,C	S,U,E,LS	2B	3
Subtract Norm-					
alized (Long)	N SD	RX F,C	A,S,U,E,LS	6B	3,8
Subtract Norm-					
alized (Short)	N SER	RR F,C	S,U,E,LS	3B	3
Subtract Norm-					
alized (Short)	N SE	RX F,C	A,S,U,E,LS	7B	3,4
Subtract Un-					
normalized					
(Long)	SWR	RR F,C	S, E,LS	2F	3
Subtract Un-					
normalized					
(Long)	SW	RX F,C	A,S, E,LS	6F	3,8
Subtract Un-					
normalized					
(Short)	SUR	RR F,C	S, E,LS	3F	3
Subtract Un-					
normalized					
(Short)	SU	RX F,C	A,S, E,LS	7F	3,4

The specification interruption can occur in normal sequential operation following branching, LOAD PSW, interruption, or manual operation (Note 1).
The specification interruption can occur during an interruption (Note 6).

SPECIFICATION INTERRUPTION NOTES

- 1 Even register specification
- 2 Two-byte unit of information specification
- 3 Floating-point register specification
- 4 Four-byte unit of information specification
- 5 Decimal multiplier or divisor size specification
- 6 Zero protection key specification
- 7 Block address specification
- 8 Eight-byte unit of information specification

Data (D)

1. The sign or digit codes of operands in decimal arithmetic, or editing operations, or CONVERT TO BINARY, are incorrect.

2. Fields in decimal arithmetic overlap incorrectly.

3. The decimal multiplicand has too many high-order significant digits.

The operation is terminated in all three cases.

The instruction-length code is 2 or 3.

NAME	MNEMONIC	TYPE	EXCEPTIONS	CODE	NOTE
Add Decimal	AP	SS T,C	P,A, D, DF	FA	1
Compare					
Decimal	CP	SS T,C	A, D	F9	1
Convert to					
Binary	CVB	RX	A,S,D	IK	4F
Divide Decimal	DP	SS T	P,A,S,D, DK	FD	1
Edit	ED	SS T,C	P,A, D	DE	
Edit and Mark	EDMK	SS T,C	P,A, D	DF	
Multiply					
Decimal	MP	SS T	P,A,S,D	FC	1,2
Subtract					
Decimal	SP	SS T,C	P,A, D, DF	FB	1
Zero and Add	ZAP	SS T,C	P,A, D, DF	F8	1

All instructions listed may have incorrect codes.

DATA INTERRUPTION NOTES

- 1 Overlapping fields
- 2 Multiplicand length

Fixed-Point Overflow (IF)

A high-order carry occurs or high-order significant bits are lost in fixed-point addition, subtraction, shifting, or sign-control operations.

The operation is completed by ignoring the information placed outside the register. The interruption may be masked by psw bit 36.

The instruction-length code is 1 or 2.

NAME	MNEMONIC	TYPE	EXCEPTIONS	CODE
Add	AR	RR C		IF 1A
Add	A	RX C	A,S,	IF 5A
Add Halfword	AH	RX C	A,S,	IF 4A
Load Complement	LCR	RR C		IF 13
Load Positive	LPR	RR C		IF 10
Shift Left Double	SLDA	RS C	S,	IF 8F
Shift Left Single	SLA	RS C		IF 8B
Subtract	SR	RR C		IF 1B
Subtract	S	RX C	A,S,	IF 5B
Subtract Halfword	SH	RX C	A,S,	IF 4B

Fixed-Point Divide (IK)

1. The quotient exceeds the register size in fixed-point division, including division by zero.

2. The result of CONVERT TO BINARY exceeds 31 bits.

Division is suppressed. Conversion is completed by ignoring the information placed outside the register.

The instruction-length code is 1 or 2.

NAME	MNEMONIC	TYPE	EXCEPTIONS	CODE
Convert to Binary	CVB	RX	A,S,D,	IK 4F
Divide	DR	RR	S,	IK 1D
Divide	D	RX	A,S,	IK 5D

Decimal Overflow (DF)

The destination field is too small to contain the result field in decimal operations.

The operation is completed by ignoring the overflow information. The interruption may be masked by psw bit 37.

The interruption-length code is 3.

NAME	MNEMONIC	TYPE	EXCEPTIONS	CODE
Add Decimal	AP	SS T,C	P,A, D, DF	FA
Subtract Decimal	SP	SS T,C	P,A, D, DF	FB
Zero and Add	ZAP	SS T,C	P,A, D, DF	F8

Decimal Divide (DK)

The quotient exceeds the specified data field.

The operation is suppressed.

The instruction-length code is 3.

NAME	MNEMONIC	TYPE	EXCEPTIONS	CODE
Divide Decimal	DP	SS T	P,A,S,D, DK	FD

Exponent Overflow (E)

The result characteristic exceeds 127 in floating-point addition, subtraction, multiplication, or division.

The operation is terminated.

The instruction-length code is 1 or 2.

NAME	MNEMONIC	TYPE	EXCEPTIONS	CODE
Add Normalized (Long)	N ADR	RR F,C	S,U,E,LS	2A
Add Normalized (Long)	N AD	RX F,C	A,S,U,E,LS	6A
Add Normalized (Short)	N AER	RR F,C	S,U,E,LS	3A
Add Normalized (Short)	N AE	RX F,C	A,S,U,E,LS	7A
Add Unnormalized (Long)	AWR	RR F,C	S, E,LS	2E
Add Unnormalized (Long)	AW	RX F,C	A,S, E,LS	6E
Add Unnormalized (Short)	AUR	RR F,C	S, E,LS	3E
Add Unnormalized (Short)	AU	RX F,C	A,S, E,LS	7E
Divide (Long)	N DDR	RR F	S,U,E,FK	2D
Divide (Long)	N DD	RX F	A,S,U,E,FK	6D
Divide (Short)	N DER	RR F	S,U,E,FK	3D
Divide (Short)	N DE	RX F	A,S,U,E,FK	7D
Multiply (Long)	N MDR	RR F	S,U,E	2C
Multiply (Long)	N MD	RX F	A,S,U,E	6C
Multiply (Short)	N MER	RR F	S,U,E	3C
Multiply (Short)	N ME	RX F	A,S,U,E	7C
Subtract Normalized (Long)	N SDR	RR F,C	S,U,E,LS	2B
Subtract Normalized (Long)	N SD	RX F,C	A,S,U,E,LS	6B
Subtract Normalized (Short)	N SER	RR F,C	S,U,E,LS	3B
Subtract Normalized (Short)	N SE	RX F,C	A,S,U,E,LS	7B
Subtract Unnormalized (Long)	SWR	RR F,C	S, E,LS	2F
Subtract Unnormalized (Long)	SW	RX F,C	A,S, E,LS	6F
Subtract Unnormalized (Short)	SUR	RR F,C	S, E,LS	3F
Subtract Unnormalized (Short)	SU	RX F,C	A,S, E,LS	7F

Exponent Underflow (U)

The result characteristic is less than zero in floating-point addition, subtraction, multiplication, or division.

The operation is completed by making the result of the operation a true zero. The interruption may be masked by psw bit 38.

The instruction-length code is 1 or 2.

NAME	MNEMONIC	TYPE	EXCEPTIONS	CODE
Add Normalized (Long)	N ADR	RR F,C	S,U,E,LS	2A
Add Normalized (Long)	N AD	RX F,C	A,S,U,E,LS	6A
Add Normalized (Short)	N AER	RR F,C	S,U,E,LS	3A
Add Normalized (Short)	N AE	RX F,C	A,S,U,E,LS	7A
Divide (Long)	N DDR	RR F	S,U,E,FK	2D
Divide (Long)	N DD	RX F	A,S,U,E,FK	6D
Divide (Short)	N DER	RR F	S,U,E,FK	3D
Divide (Short)	N DE	RX F	A,S,U,E,FK	7D
Multiply (Long)	N MDR	RR F	S,U,E	2C
Multiply (Long)	N MD	RX F	A,S,U,E	6C
Multiply (Short)	N MER	RR F	S,U,E	3C
Multiply (Short)	N ME	RX F	A,S,U,E	7C
Subtract Normalized (Long)	N SDR	RR F,C	S,U,E,LS	2B
Subtract Normalized (Long)	N SD	RX F,C	A,S,U,E,LS	6B
Subtract Normalized (Short)	N SER	RR F,C	S,U,E,LS	3B
Subtract Normalized (Short)	N SE	RX F,C	A,S,U,E,LS	7B

Significance (LS)

The result of a floating-point addition or subtraction has an all-zero fraction.

The operation is completed. The interruption may be masked by psw bit 39. The manner in which the operation is completed is determined by the mask bit.

The instruction-length code is 1 or 2.

NAME	MNEMONIC	TYPE	EXCEPTIONS	CODE
Add Normalized (Long)	N ADR	RR F,C	S,U,E,LS	2A
Add Normalized (Long)	N AD	RX F,C	A,S,U,E,LS	6A
Add Normalized (Short)	N AER	RR F,C	S,U,E,LS	3A
Add Normalized (Short)	N AE	RX F,C	A,S,U,E,LS	7A
Add Unnormalized (Long)	AWR	RR F,C	S, E,LS	2E
Add Unnormalized (Long)	AW	RX F,C	A,S, E,LS	6E
Add Unnormalized (Short)	AUR	RR F,C	S, E,LS	3E
Add Unnormalized (Short)	AU	RX F,C	A,S, E,LS	7E
Subtract Normalized (Long)	N SDR	RR F,C	S,U,E,LS	2B
Subtract Normalized (Long)	N SD	RX F,C	A,S,U,E,LS	6B
Subtract Normalized (Short)	N SER	RR F,C	S,U,E,LS	3B
Subtract Normalized (Short)	N SE	RX F,C	A,S,U,E,LS	7B

Channel

Available	A	None of the following states
Interruption pending	I	Interruption immediately available from channel
Working	W	Channel operating in burst mode
Not operational	N	Channel not operational

Subchannel

Available	A	None of the following states
Interruption pending	I	Information for CSW available in subchannel
Working	W	Subchannel executing an operation
Not operational	N	Subchannel not operational

Condition Code Setting for Input/Output Instructions

CONDITIONS	CONDITION CODE FOR			
	START I/O	TEST I/O	HALT I/O	TEST CHAN
Available	AAA	0,1*	0	0
Interruption pend. in device	AAI	1*	1*	0
Device working	AAW	1*	1*	0
Device not operational	AAN	3	3	0
Interruption pend. in subchannel	AIX			
For the addressed device		2	1*	0
For another device		2	2	0
Subchannel working	AWX	2	2	1*
Subchannel not operational	ANX	3	3	3
Interruption pend. in channel	IXX	see note below		1
Channel working	WXX	2	2	2
Channel not operational	NXX	3	3	3
Error				
Channel equipment error		1*	1*	1*
Channel programming error		1*	-	-
Device error		1*	1*	-

NOTE: For the purpose of executing START I/O, TEST I/O, and HALT I/O, a channel containing a pending interruption condition appears the same as an available channel, and the condition codes for the IXX state are the same as for the AXX state, where the X's represent the states of the subchannel and the device. As an example, the condition code for the IAA state is the same as for the AAA state.

*The CSW or its status portion is stored at location 64 during execution of the instruction.

-The condition cannot be identified during execution of the instruction.

Flag Setting for Chaining Operations

CD	CC	ACTION
0	0	No chaining. The current CCW is the last. The operation is terminated
0	1	Command chaining
1	0	Data chaining
1	1	Data chaining

Content of Channel Status Word Address Field

CONDITION	CONTENT
Channel control check	Unpredictable
Status stored by START I/O	Unchanged
Status stored by HALT I/O	Unchanged
Invalid CCW address spec. in TIC	Address of TIC + 8
Invalid CCW address in TIC	Address of TIC + 8
Invalid CCW address generated	Address of first invalid CCW + 8
Invalid command code	Address of invalid CCW + 8
Invalid count	Address of invalid CCW + 8
Invalid data address	Address of invalid CCW + 8

CONDITION

CONTENT

Invalid CCW format	Address of invalid CCW + 8
Invalid sequence - 2 TIC's	Address of second TIC + 8
Protection check	Address of invalid CCW + 8
Chaining check	Address of last-used CCW + 8
Termination under count control	Address of last-used CCW + 8
Termination by I/O device	Address of last-used CCW + 8
Termination by HALT I/O	Address of last-used CCW + 8
Suppression of command chaining due to unit check or unit exception with device end or control unit end	Address of last CCW used in the completed operation + 8
Termination on command chaining by attention, unit check, or unit exception	Address of CCW specifying the new operation + 8
Program-controlled interruption	Address of last-used CCW + 8
Interface control check	Address of last-used CCW + 8
Ch. end after HIO on sel. ch.	Zero
Control unit end	Zero
Device end	Zero
Attention	Zero
Busy	Zero
Status modifier	Zero

Content of Channel Status Word Count Field

CONDITION	CONTENT
Channel control check	Unpredictable
Status stored by START I/O	Unchanged
Status stored by HALT I/O	Unchanged
Program check	Unpredictable
Protection check	Unpredictable
Chaining check	Correct
Termination under count control	Correct
Termination by I/O device	Correct
Termination by HALT I/O	Correct
Suppression of command chaining due to unit check or unit exception with device end or control unit end	Correct. Residual count of last CCW used in the completed operation.
Termination on command chaining by attention, by unit check, or unit exception	Correct. Original count of CCW specifying the new operation.
Program-controlled interruption	Unpredictable
Interface control check	Correct
Ch. end after HIO on sel. ch.	Zero
Control unit end	Zero
Device end	Zero
Attention	Zero
Busy	Zero
Status Modifier	Zero

Indication of Busy Condition in Channel Status Word

The table lists the conditions when the busy bit (B) appears in the csw and when it is accompanied by the status-modifier bit (SM). Two hyphens (--) indicate that the busy bit is off; an asterisk (*) indicates that csw status is not stored or an I/O interruption cannot occur; the (cl) indicates that the interruption condition is cleared and the status appears in the csw. The abbreviation DE stands for device end, and CU stands for control unit.

CONDITION	CSW STATUS STORED BY:				HANDLING OF INCORRECT LENGTH			ACTION AND INDICATION	
	START	TEST	HALT	I/O	FLAGS			REGULAR OPERATION	IMMEDIATE OPERATION
	I/O	I/O	I/O	INT.	CD	CC	SLI		
Subchannel available					0	0	0	Stop, IL	Stop, --
DE or attention in device	B,cl	--,cl	*	--,cl	0	0	1	Stop, --	Stop, --
Device working, CU available	B	B	*	*	0	1	0	Stop, IL	Chain command
CU end or channel end in CU:					0	1	1	Chain command	Chain command
for the addressed device	B,cl	--,cl	*	--,cl	1	0	0	Stop, IL	Stop, --
for another device	B,SM	B,SM	*	--,cl	1	0	1	Stop, IL	Stop, --
CU working	B,SM	B,SM	*	*	1	1	0	Stop, IL	Stop, --
Interruption pend. in subchannel					1	1	1	Stop, IL	Stop, --
for the addressed device									
because of:									
chaining terminated by									
attention	*	B,cl	*	B,cl					
other type of termination	*	--,cl	*	--,cl					
Subchannel working									
CU available	*	*	--	*					
CU working	*	*	B,SM	*					

Time and Method of Creating and Storing Status Indications

STATUS	WHEN	WHEN	UPON TERMINATION OF OPERATION		DURING	BY	BY	BY	BY I/O
	I/O IS	SUBCHANNEL	AT	AT CONTROL	COMMAND	START	TEST	HALT	INTER-
	IDLE	WORKING	SUBCHANNEL	UNIT	DEVICE	CHAINING	I/O	I/O	RUPTION
Attention	C*				C	C*	S	S	S
Status modifier					C	C	CS	CS	CS
Control unit end				C*			CS	CS	CS
Busy						C	CS	CS	CS
Channel end			C*	C* H		C* †	C† S	S	S
Device end	C*				C*	C †	C† S	S	S
Unit check			C	C	C	C*	CS	CS	CS
Unit exception			C	C	C	C*	CS	S	S
Program-controlled interruption		C*	C			C	CS	S	S
Incorrect length		C	C					S	S
Program check		C	C			C*	CS	S	S
Protection check		C	C					S	S
Channel data check		C*	C					S	S
Channel control check	C*	C*	C*	C*	C*	C*	CS	CS	CS
Interface control check	C*	C*	C*	C*	C*	C*	CS	CS	CS
Chaining check		C	C					S	S

NOTES

C—The channel or the device can create or present the status condition at the indicated time. A CSW or its status portion is not necessarily stored at this time.

Conditions such as channel end and device end are created at the indicated time. Other conditions may have been created previously, but are made accessible to the program only at the indicated time. Examples of such conditions are program check and channel data check, which are detected while data are transferred, but are made available to the program only with channel end, unless the PCI flag or equipment malfunctioning have caused an interruption condition to be generated earlier.

S—The status indication is stored in the CSW at the indicated time.

An S appearing alone indicates that the condition has been created previously. The letter C appearing with the S indicates that the status condition did not necessarily exist previously in the form that causes the program to be alerted, and may have

been created by the I/O instruction or I/O interruption. For example, equipment malfunctioning may be detected during an I/O interruption, causing channel control check or interface control check to be indicated; or a device such as the 2702 Transmission Control Unit may signal the control-unit-busy condition in response to interrogation by an I/O instruction, causing status modifier, busy, and control unit end to be indicated in the CSW.

*—The status condition generates or, in the case of channel data check, may generate an interruption condition.

Channel end and device end do not result in interruption conditions when command chaining is specified and no unusual conditions have been detected.

†—This status indication can be created at the indicated time only by an immediate operation.

H—When an operation on the selector channel has been terminated by HALT I/O, channel end indicates the termination of the data-handling portion of the operation at the control unit.

Functions that May Differ Among Models

Instruction Execution

In the editing operations, overlapping fields give unpredictable results.

Equipment connected to the hold-in line of READ DIRECT should be so constructed that the hold signal will be removed when READ DIRECT is performed. Excessive duration of this instruction may result in incomplete updating of the timer.

The purpose of the I_2 field and the operand address in the SI format of DIAGNOSE may be further defined for a particular CPU and its appropriate diagnostic procedures. Similarly the number of low-order address bits that must be zero is further specified for a particular CPU. When the address does not have the required number of low-order zeros, a specification exception is recognized and causes a program interruption.

The diagnose operation is completed either by taking the next sequential instruction or by obtaining a new PSW from location 112. The diagnostic procedure may affect the problem, supervisor, and interruptible states of the CPU, and the contents of storage registers and timer, as well as the progress of I/O operations.

Instruction Termination

Only one program interruption occurs for a given instruction. The old PSW always identifies a valid cause. This does not preclude simultaneous occurrence of any other causes. Which of several causes is identified may vary from one occasion to the next and from one model to another.

When instruction execution is terminated by an interruption, all, part, or none of the result may be stored. The result data, therefore, are unpredictable. The setting of the condition code, if called for, may also be unpredictable. In general, the results of the operation should not be used for further computation.

Cases of instruction termination for a program interruption are:

Protection: The storage key of a result location does not match the protection key in the PSW. The operation is terminated in the case of STORE MULTIPLE, READ DIRECT, and variable-length operations. Protected storage remains unchanged. The timing signals of READ DIRECT may have been made available.

Addressing: An address specifies any part of data, instruction, or control word outside the available storage for the particular installation. The operation is terminated. Data in storage remain unchanged, except when designated by valid addresses.

Data: The sign or digit codes of operands in decimal arithmetic, CONVERT TO BINARY, or editing operations are incorrect, or fields in decimal arithmetic overlap incorrectly, or the decimal multiplicand has too many high-order significant digits. The operation is terminated in all three cases. The condition code setting, if called for, is unpredictable for protection, addressing, and data exceptions.

Exponent Overflow: The result exponent of an ADD, SUBTRACT, MULTIPLY, or DIVIDE overflows and the result fraction is not zero. The operation is terminated. The condition code is set to 3 for ADD and SUBTRACT, and remains unchanged for MULTIPLY and DIVIDE.

Machine-Check Interruption

For a machine-check interruption, the old PSW is stored at location 48 with a zero interruption code. The state of the CPU is scanned out into the storage area starting with location 128 and extending through as many words as are required by the given CPU. The new PSW is fetched from location 112. Proper execution of these steps depends on the nature of the machine check. A change in the machine-check mask bit due to the loading of a new PSW results in a change in the treatment of machine checks. Depending upon the nature of a machine check, the old treatment may still be in force for several cycles. Machine checks that occur in operations executed by I/O channels may either cause a machine-check interruption or are recorded in the CSW for that operation.

Instruction-Length Code

The instruction-length code is predictable only for program and supervisor-call interruptions. For I/O and external interruptions, the interruption is not caused by the last interpreted instruction, and the code is not predictable for these classes of interruptions. For machine-check interruptions, the setting of the code is a function of the malfunction and therefore unpredictable.

For the supervisor-call interruption the instruction-length code is 1, indicating the halfword length of SUPERVISOR CALL; for the program interruptions, the codes 1, 2, and 3 indicate the instruction length in halfwords. The code 0 is reserved for program interruptions where the length of the instruction is not available because of certain overlap conditions in instruction fetching. In those cases, the instruction address in the old PSW does not represent the next instruction address. The instruction-length code 0 can occur only for a program interruption caused by a protected or unavailable data address.

Timer

Updating of the timer may be omitted when I/O data transmission approaches the limit of storage capability.

System Control Panel

The system-reset function may correct the parity of general and floating-point registers, as well as the parity of the PSW.

The number of data switches is sufficient to allow storing of a full physical storage word. Correct parity generation is provided. In some models, either correct or incorrect parity is generated under switch control.

The data in the storage, general register or floating-point register location, or the instruction-address part of the PSW as specified by the address switches and the storage-select switch can be displayed by the display key. When the location designated by the address switches and storage-select switch is not available, the displayed information is unpredictable. In some models, the instruction address is permanently displayed and hence is not explicitly selected.

When the address-comparison switches are set to the stop position, the address in the address switches is compared against the value of the instruction address on some models, and against all addresses on others. Comparison includes only that part of the instruction address corresponding to the physical word size of storage.

Comparison of the entire halfword instruction address is provided in some models, as is the ability to compare data addresses.

The test light may be on when one or more diagnostic functions under control of DIAGNOSE are activated, or when certain abnormal circuit breaker or thermal conditions occur.

Normal Channel Operation

Channel capacity depends on the way I/O operations are programmed and the activity in the rest of the system. In view of this, an evaluation of the ability of a specific I/O configuration to function concurrently must be based on the application. Two systems employing identical complements of I/O devices may be able to execute certain programs in common, but it is possible that other programs requiring, for example, data chaining may not run on one of the systems.

The time when the interruption due to the PCI flag occurs depends on the model and the current activity. The channel may cause the interruption an unpredictable time after control of the operation is taken over by the CSW containing the PCI flag.

The content of the count field in a CSW associated

with an interruption due to the PCI flag is unpredictable. The content of the count field depends upon the model and its current activity.

When the channel has established which device on the channel will cause the next I/O interruption, the identity of the device is preserved in the channel. Except for conditions associated with termination of an operation at the subchannel, the current assignment of priority for interruptions among devices may or may not be canceled when START I/O or TEST I/O is issued to the channel, depending upon the model.

The assignment of priority among requests for interruption from channels is based on the type of channel. The priorities of selector channels are in the order of their addresses, with channel 1 having the highest priority. The interruption priority of the multiplexor channel is not fixed, and depends on the model and the current activity in the channel.

Channel Programming Errors

A data address referring to a location not provided in the model normally causes program check when the device offers a byte of data to be placed at the non-existent location or requests a byte from that location. Models in which the channel does not have the capacity to address 16,777,216 bytes of storage cause program check whenever the address is found to exceed the addressing capacity of the channel.

In the following cases, action depends on the addressing capacity of the model.

1. When the data address in the CCW designated by the CAW exceeds the addressing capacity of the model, the I/O operation is not initiated and the CSW is stored during the execution of START I/O. Normally an invalid data address does not preclude the initiation of the operation.

2. When the data address in a CCW fetched during command chaining exceeds the addressing capacity of the model, the I/O operation is not initiated.

3. When a CCW fetched on data chaining contains an address exceeding the addressing capacity of the model and the device signals channel end immediately upon transferring the last byte designated by the preceding CCW, program check is indicated to the program. Normally, program check is not indicated unless the device attempts to transfer one more byte of data.

4. Data addresses are not checked for validity during skipping, except that the initial data address in the CCW cannot exceed the addressing capacity of the model.

When the channel detects program check or protection check, the content of the count field in the associated CSW is unpredictable.

When a programming error occurs in the information placed in the CAW or CCW and the addressed channel or subchannel is working, either condition code 1 or 2 may be set, depending on the model. Similarly, either code 1 or 3 may be set when a programming error occurs and a part of the addressed I/O system is not operational.

When a programming error occurs and the addressed device contains an interruption condition, with the channel and subchannel in the available state, START I/O may or may not clear the interruption condition, depending on the type of error and the model. If the instruction has caused the device to be interrogated, as indicated by the presence of the busy bit in the CSW, the interruption condition has been cleared, and the CSW contains program check, as well as the status from the device.

When the channel detects several error conditions, all conditions may be indicated or only one may appear in the CSW, depending on the condition and the model.

Channel Equipment Errors

Parity errors detected by the channel on data sent to or received from the I/O device on some models cause the current operation to be terminated. When the channel and the CPU share common equipment, parity errors on data may cause malfunction reset to be performed. The recovery procedure in the channel and

subsequent state of the subchannel upon a malfunction reset depend on the model.

Detection of channel control check or interface control check causes the current operation, if any, to be immediately terminated and causes the channel to perform the malfunction-reset function. The recovery procedure in the channel and the subsequent state of the subchannel upon a malfunction reset depend on the model.

The contents of the CSW, as well as the address in the PSW identifying the I/O device, are unpredictable upon the detection of a channel-control-check condition.

Execution of malfunction reset in the channel depends on the type of error and model. It may cause all operations in the channel to be terminated and all operational subchannels to be reset to the available state. The channel may send the malfunction-reset signal to the device connected to the channel at the time the malfunctioning is detected, or a channel sharing common equipment with the CPU may send the system-reset signal to all devices attached to the channel.

The method of processing a request for interruption due to equipment malfunctioning, as indicated by the presence of the channel-data-check, channel-control-check, and interface-control-check conditions, depends on the model. In channels sharing common equipment with the CPU, malfunctioning detected by the channel may be indicated by the machine-check interruption.

Alphabetic List of Instructions

The listings in the TYPE and EXCEPTIONS columns mean:

A	Addressing exception
C	Condition code is set
D	Data exception
DF	Decimal-overflow exception
DK	Decimal-divide exception
E	Exponent-overflow exception
EX	Execute exception
F	Floating-point feature
FK	Floating-point divide exception
IF	Fixed-point overflow exception
IK	Fixed-point divide exception
L	New condition code loaded
LS	Significance exception
M	Privileged-operation exception
N	Normalized operation
P	Protection exception
S	Specification exception
T	Decimal feature
U	Exponent-underflow exception
Y	Direct control feature
Z	Protection feature

NAME	MNEMONIC	TYPE	EXCEPTIONS	CODE
Add	AR	RR C	IF	1A
Add	A	RX C	A,S, IF	5A
Add Decimal	AP	SS T,C	P,A, D, DF	FA
Add Halfword	AH	RX C	A,S, IF	4A
Add Logical	ALR	RR C		1E
Add Logical	AL	RX C	A,S,	5E
Add Normalized (Long)	N ADR	RR F,C	S,U,E,LS	2A
Add Normalized (Long)	N AD	RX F,C	A,S,U,E,LS	6A
Add Normalized (Short)	N AER	RR F,C	S,U,E,LS	3A
Add Normalized (Short)	N AE	RX F,C	A,S,U,E,LS	7A
Add Unnorm- alized (Long)	AWR	RR F,C	S, E,LS	2E
Add Unnorm- alized (Long)	AW	RX F,C	A,S, E,LS	6E
Add Unnorm- alized (Short)	AUR	RR F,C	S, E,LS	3E
Add Unnorm- alized (Short)	AU	RX F,C	A,S, E,LS	7E
AND	NR	RR C		14
AND	N	RX C	A,S	54
AND	NI	SI C	P,A	94
AND	NC	SS C	P,A	D4
Branch and Link	BALR	RR		05
Branch and Link	BAL	RX		45
Branch on Condition	BCR	RR		07
Branch on Condition	BC	RX		47
Branch on Count	BCTR	RR		06
Branch on Count	BCT	RX		46
Branch on Index High	BXH	RS		86
Branch on Index Low or Equal	BXLE	RS		87
Compare	CR	RR C		19
Compare	C	RX C	A,S	59
Compare Decimal	CP	SS T,C	A, D	F9

NAME	MNEMONIC	TYPE	EXCEPTIONS	CODE
Compare Halfword	CH	RX C	A,S	49
Compare Logical	CLR	RR C		15
Compare Logical	CL	RX C	A,S	55
Compare Logical	CLI	SI C	A	95
Compare Logical	CLC	SS C	A	D5
Compare (Long)	CDR	RR F,C	S	29
Compare (Long)	CD	RX F,C	A,S	69
Compare (Short)	CER	RR F,C	S	39
Compare (Short)	CE	RX F,C	A,S	79
Convert to Binary	CVB	RX	A,S,D, IK	4F
Convert to Decimal	CVD	RX	P,A,S	4E
Diagnose		SI	M, A,S	83
Divide	DR	RR	S, IK	1D
Divide	D	RX	A,S, IK	5D
Divide Decimal	DP	SS T	P,A,S,D, DK	FD
Divide (Long)	N DDR	RR F	S,U,E,FK	2D
Divide (Long)	N DD	RX F	A,S,U,E,FK	6D
Divide (Short)	N DER	RR F	S,U,E,FK	3D
Divide (Short)	N DE	RX F	A,S,U,E,FK	7D
Edit	ED	SS T,C	P,A, D,	DE
Edit and Mark	EDMK	SS T,C	P,A, D,	DF
Exclusive OR	XR	RR C		17
Exclusive OR	X	RX C	A,S	57
Exclusive OR	XI	SI C	P,A	97
Exclusive OR	XC	SS C	P,A	D7
Execute	EX	RX	A,S, EX	44
Halt I/O	HIO	SI	CM	9E
Halve (Long)	HDR	RR F	S	24
Halve (Short)	HER	RR F	S	34
Insert Character	IC	RX	A	43
Insert Storage Key	ISK	RR Z	M, A,S	09
Load	LR	RR		18
Load	L	RX	A,S	58
Load Address	LA	RX		41
Load and Test	LTR	RR C		12
Load and Test (Long)	LTDR	RR F,C	S	22
Load and Test (Short)	LTER	RR F,C	S	32
Load Complement	LCR	RR C	IF	13
Load Complement (Long)	LCDR	RR F,C	S	23
Load Complement (Short)	LCER	RR F,C	S	33
Load Halfword	LH	RX	A,S	48
Load (Long)	LDR	RR F	S	28
Load (Long)	LD	RX F	A,S	68
Load Multiple	LM	RS	A,S	98
Load Negative	LNR	RR C		11
Load Negative (Long)	LNDR	RR F,C	S	21
Load Negative (Short)	LNER	RR F,C	S	31
Load Positive	LPR	RR C	IF	10
Load Positive (Long)	LPDR	RR F,C	S	20
Load Positive (Short)	LPER	RR F,C	S	30
Load PSW	LPSW	SI	L M, A,S	82
Load (Short)	LER	RR F	S	38
Load (Short)	LE	RX F	A,S	78
Move	MVI	SI	P,A	92
Move	MVC	SS	P,A	D2
Move Numerics	MVN	SS	P,A	D1
Move with Offset	MVO	SS	P,A	F1

NAME	MNEMONIC	TYPE	EXCEPTIONS	CODE
Move Zones	MVZ	SS	P,A	D3
Multiply	MR	RR	S	1C
Multiply	M	RX	A,S	5C
Multiply Decimal	MP	SS T	P,A,S,D	FC
Multiply Halfword	MH	RX	A,S	4C
Multiply (Long)	N MDR	RR F	S,U,E	2C
Multiply (Long)	N MD	RX F	A,S,U,E	6C
Multiply (Short)	N MER	RR F	S,U,E	3C
Multiply (Short)	N ME	RX F	A,S,U,E	7C
OR	OR	RR C		16
OR	O	RX C	A,S	56
OR	OI	SI C	P,A	96
OR	OC	SS C	P,A	D6
Pack	PACK	SS	P,A	F2
Read Direct	RDD	SI Y	M,P,A	85
Set Program Mask	SPM	RR L		04
Set Storage Key	SSK	RR Z	M, A,S	08
Set System Mask	SSM	SI	M, A	80
Shift Left Double	SLDA	RS C	S, IF	8F
Shift Left Double Logical	SLDL	RS	S	8D
Shift Left Single	SLA	RS C	IF	8B
Shift Left Single Logical	SLL	RS		89
Shift Right Double	SRDA	RS C	S	8E
Shift Right Double Logical	SRDL	RS	S	8C
Shift Right Single	SRA	RS C		8A
Shift Right Single Logical	SRL	RS		88
Start I/O	SIO	SI	C M	9C
Store	ST	RX	P,A,S	50
Store Character	STC	RX	P,A	42
Store Halfword	STH	RX	P,A,S	40
Store (Long)	STD	RX F	P,A,S	60
Store Multiple	STM	RS	P,A,S	90
Store (Short)	STE	RX F	P,A,S	70
Subtract	SR	RR C	IF	1B
Subtract	S	RX C	A,S, IF	5B
Subtract Decimal	SP	SS T,C	P,A, D, DF	FB
Subtract Halfword	SH	RR C	A,S, IF	4B
Subtract Logical	SLR	RR C		1F
Subtract Logical	SL	RX C	A,S	5F
Subtract Normal- alized (Long)	N SDR	RR F,C	S,U,E,LS	2B
Subtract Normal- alized (Long)	N SD	RX F,C	A,S,U,E,LS	6B
Subtract Normal- alized (Short)	N SER	RR F,C	S,U,E,LS	3B
Subtract Normal- alized (Short)	N SE	RX F,C	A,S,U,E,LS	7B
Subtract Unnorm- alized (Long)	SWR	RR F,C	S, E,LS	2F
Subtract Unnorm- alized (Long)	SW	RX F,C	A,S, E,LS	6F
Subtract Unnorm- alized (Short)	SUR	RR F,C	S, E,LS	3F
Subtract Unnorm- alized (Short)	SU	RX F,C	A,S, E,LS	7F
Supervisor Call	SVC	RR		0A
Test Channel	TCH	SI	CM	9F
Test I/O	TIO	SI	CM	9D
Test Under Mask	TM	SI C	A	91
Translate	TR	SS	P,A	DC
Translate and Test	TRT	SS C	A	DD
Unpack	UNPK	SS	P,A	F3
Write Direct	WRD	SI Y	M, A	84
Zero and Add	ZAP	SS T,C	P,A, D, DF	F8

List of Instructions by Set and Feature

Standard Instruction Set

NAME	MNEMONIC	TYPE	EXCEPTIONS	CODE
Add	AR	RR C	IF	1A
Add	A	RX C	A,S, IF	5A
Add Halfword	AH	RX C	A,S, IF	4A
Add Logical	ALR	RR C		1E
Add Logical	AL	RX C	A,S,	5E
AND	NR	RR C		14
AND	N	RX C	A,S	54
AND	NI	SI C	P,A	94
AND	NC	SS C	P,A	D4
Branch and Link	BALR	RR		05
Branch and Link	BAL	RX		45
Branch on Condition	BCR	RR		07
Branch on Condition	BC	RX		47
Branch on Count	BCTR	RR		06
Branch on Count	BCT	RX		46
Branch on Index High	BXH	RS		86
Branch on Index Low or Equal	BXLE	RS		87
Compare	CR	RR C		19
Compare	C	RX C	A,S	59
Compare Halfword	CH	RX C	A,S	49
Compare Logical	CLR	RR C		15
Compare Logical	CL	RX C	A,S	55
Compare Logical	CLC	SS C	A	D5
Compare Logical	CLI	SI C	A	95
Convert to Binary	CVB	RX	A,S,D, IK	4F
Convert to Decimal	CVD	RX	P,A,S	4E
Diagnose		SI	M, A,S	83
Divide	DR	RR	S, IK	1D
Divide	D	RX	A,S, IK	5D
Exclusive OR	XR	RR C		17
Exclusive OR	X	RX C	A,S	57
Exclusive OR	XI	SI C	P,A	97
Exclusive OR	XC	SS C	P,A	D7
Execute	EX	RX	A,S, EX	44
Halt I/O	HIO	SI	CM	9E
Insert Character	IC	RX	A	43
Load	LR	RR		18
Load	L	RX	A,S	58
Load Address	LA	RX		41
Load and Test	LTR	RR C		12
Load Complement	LCR	RR C	IF	13
Load Halfword	LH	RX	A,S	48
Load Multiple	LM	RS	A,S	98
Load Negative	LNR	RR C		11
Load Positive	LPR	RR C	IF	10
Load PSW	LPSW	SI	L M, A,S	82
Move	MVI	SI	P,A	92
Move	MVC	SS	P,A	D2
Move Numerics	MVN	SS	P,A	D1
Move with Offset	MVO	SS	P,A	F1
Move Zones	MVZ	SS	P,A	D3
Multiply	MR	RR	S	1C
Multiply	M	RX	A,S	5C
Multiply Halfword	MH	RX	A,S	4C
OR	OR	RR C		16
OR	O	RX C	A,S	56
OR	OI	SI C	P,A	96
OR	OC	SS C	P,A	D6
Pack	PACK	SS	P,A	F2

Set Program Mask	SPM	RR	L		04
Set System Mask	SSM	SI	M, A		80
Shift Left Double	SLDA	RS	C	S, IF	8F
Shift Left Single	SLA	RS	C	IF	8B
Shift Left Double Logical	SLDL	RS		S	8D
Shift Left Single Logical	SLL	RS			89
Shift Right Double	SRDA	RS	C	S	8E
Shift Right Single	SRA	RS	C		8A
Shift Right Double Logical	SRDL	RS		S	8C
Shift Right Single Logical	SRL	RS			88
Start I/O	SIO	SI	CM		9C
Store	ST	RX		P,A,S	50
Store Character	STC	RX		P,A	42
Store Halfword	STH	RX		P,A,S	40
Store Multiple	STM	RS		P,A,S	90
Subtract	SR	RR	C	IF	1B
Subtract	S	RX	C	A,S, IF	5B
Subtract Halfword	SH	RX	C	A,S, IF	4B
Subtract Logical	SLR	RR	C		1F
Subtract Logical	SL	RX	C	A,S	5F
Supervisor Call	SVC	RR			0A
Test Channel	TCH	SI	CM		9F
Test I/O	TIO	SI	CM		9D
Test Under Mask	TM	SI	C	A	91
Translate	TR	SS		P,A	DC
Translate and Test	TRT	SS	C	A	DD
Unpack	UNPK	SS		P,A	F3

Load (Long)	LDR	RR	F	S	28
Load (Long)	LD	RX	F	A,S	68
Load Negative (Long)	LNDR	RR	F,C	S	21
Load Negative (Short)	LNER	RR	F,C	S	31
Load Positive (Long)	LPDR	RR	F,C	S	20
Load Positive (Short)	LPER	RR	F,C	S	30
Load (Short)	LER	RR	F	S	38
Load (Short)	LE	RX	F	A,S	78
Multiply (Long)	N MDR	RR	F	S,U,E	2C
Multiply (Long)	N MD	RX	F	A,S,U,E	6C
Multiply (Short)	N MER	RR	F	S,U,E	3C
Multiply (Short)	N ME	RX	F	A,S,U,E	7C
Store (Long)	STD	RX	F	P,A,S	60
Store (Short)	STE	RX	F	P,A,S	70
Subtract Normalized (Long)	N SDR	RR	F,C	S,U,E,LS	2B
Subtract Normalized (Long)	N SD	RX	F,C	A,S,U,E,LS	6B
Subtract Normalized (Short)	N SER	RR	F,C	S,U,E,LS	3B
Subtract Normalized (Short)	N SE	RX	F,C	A,S,U,E,LS	7B
Subtract Unnormalized (Long)	SWR	RR	F,C	S, E,LS	2F
Subtract Unnormalized (Long)	SW	RX	F,C	A,S, E,LS	6F
Subtract Unnormalized (Short)	SUR	RR	F,C	S, E,LS	3F
Subtract Unnormalized (Short)	SU	RX	F,C	A,S, E,LS	7F

Floating-Point Feature Instructions

NAME	MNEMONIC	TYPE	EXCEPTIONS	CODE
Add Normalized (Long)	N ADR	RR F,C	S,U,E,LS	2A
Add Normalized (Long)	N AD	RX F,C	A,S,U,E,LS	6A
Add Normalized (Short)	N AER	RR F,C	S,U,E,LS	3A
Add Normalized (Short)	N AE	RX F,C	A,S,U,E,LS	7A
Add Unnormalized (Long)	AWR	RR F,C	S, E,LS	2E
Add Unnormalized (Long)	AW	RX F,C	A,S, E,LS	6E
Add Unnormalized (Short)	AUR	RR F,C	S, E,LS	3E
Add Unnormalized (Short)	AU	RX F,C	A,S, E,LS	7E
Compare (Long)	CDR	RR F,C	S	29
Compare (Long)	CD	RX F,C	A,S	69
Compare (Short)	CER	RR F,C	S	39
Compare (Short)	CE	RX F,C	A,S	79
Divide (Long)	N DDR	RR F	S,U,E,FK	2D
Divide (Long)	N DD	RX F	A,S,U,E,FK	6D
Divide (Short)	N DER	RR F	S,U,E,FK	3D
Divide (Short)	N DE	RX F	A,S,U,E,FK	7D
Halve Long	HDR	RR F	S	24
Halve (Short)	HER	RR F	S	34
Load and Test (Long)	LTDR	RR F,C	S	22
Load and Test (Short)	LTER	RR F,C	S	32
Load Complement (Long)	LCDR	RR F,C	S	23
Load Complement (Short)	LCER	RR F,C	S	33

The scientific instruction set includes the instructions of both the standard instruction set and the floating-point feature.

Decimal Feature Instructions

NAME	MNEMONIC	TYPE	EXCEPTIONS	CODE
Add Decimal	AP	SS T,C	P,A, D, DF	FA
Compare Decimal	CP	SS T,C	A, D	F9
Divide Decimal	DP	SS T	P,A,S,D, DK	FD
Edit	ED	SS T,C	P,A, D	DE
Edit and Mark	EDMK	SS T,C	P,A, D	DF
Multiply Decimal	MP	SS T	P,A,S,D	FC
Subtract Decimal	SP	SS T,C	P,A, D, DF	FB
Zero and Add	ZAP	SS T,C	P,A, D, DF	F8

Commercial Instruction Set

The commercial instruction set includes the instructions of both the standard instruction set and the decimal feature.

Universal Instruction Set

The universal instruction set includes the instructions of the standard instruction set, the floating-point feature, and the decimal feature.

Direct Control Feature Instructions

NAME	MNEMONIC	TYPE	EXCEPTIONS	CODE
Read Direct	RDD	SI Y	M,P,A	85
Write Direct	WRD	SI Y	M, A	84

Protection Feature Instructions

NAME	MNEMONIC	TYPE	EXCEPTIONS	CODE
Insert Storage Key	ISK	RR Z	M, A,S	09
Set Storage Key	SSK	RR Z	M, A,S	08

Instruction Formats by Mnemonic

A RX 27

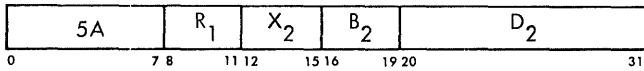

AD RX (Long Operands) 44

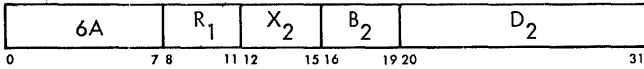

ADR RR (Long Operands) 44

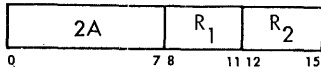

AE RX (Short Operands) 44

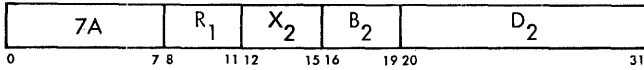

AER RR (Short Operands) 44

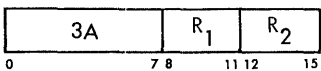

AH RX 27

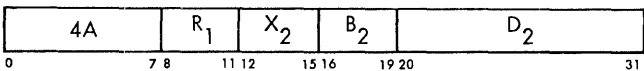

AL RX 27

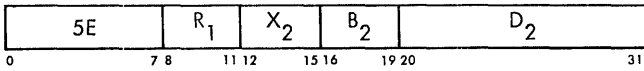

ALR RR 27

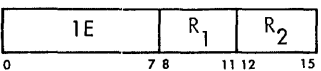

AP SS 35

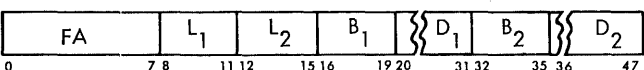

AR RR 27

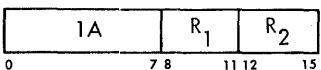

AU RX (Short Operands) 45

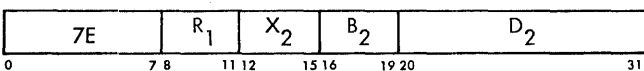

AUR RR (Short Operands) 45

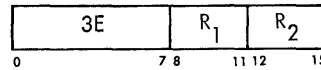

AW RX (Long Operands) 45

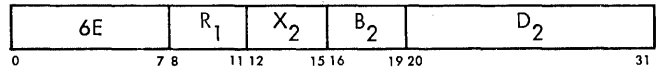

AWR RR (Long Operands) 45

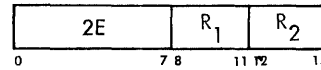

BAL RX 64

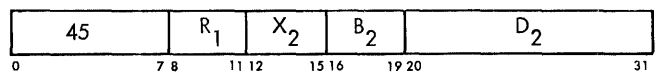

BALR RR 64

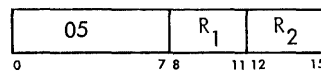

BC RX 63

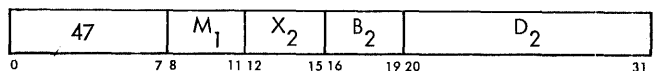

BCR RR 63

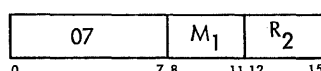

BCT RX 64

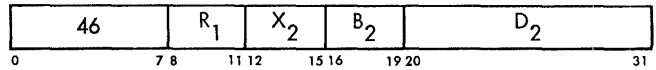

BCTR RR 64

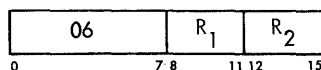

BXH RS 64

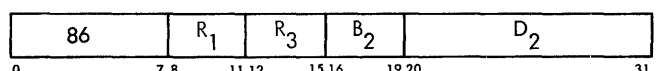

BXLE RS 65

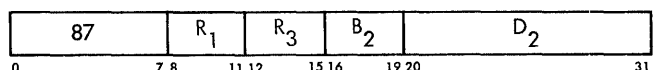

C RX 29

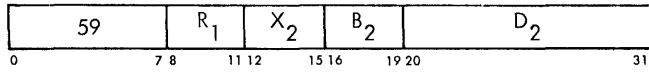

CD RX (Long Operands) 46

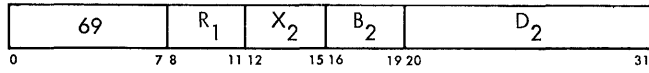

CDR RR (Long Operands) 46

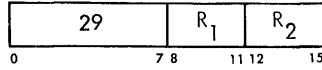

CE RX (Short Operands) 46

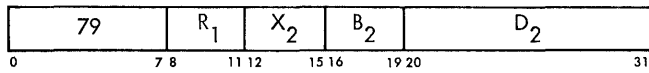

CER RR (Short Operands) 46

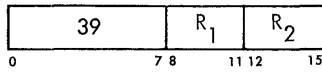

CH RX 29

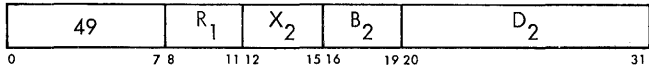

CL RX 53

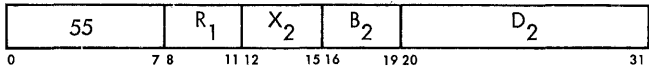

CLC SS 53

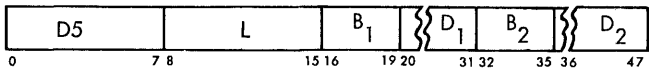

CLI SI 53

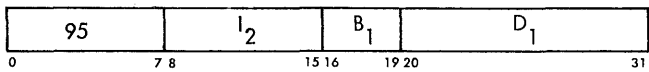

CLR RR 53

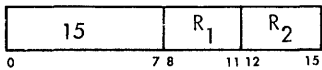

CP SS 37

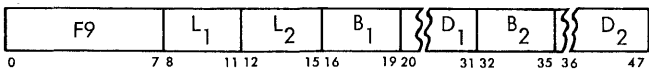

CR RR 29

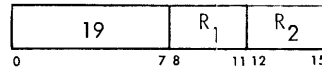

CVB RX 30

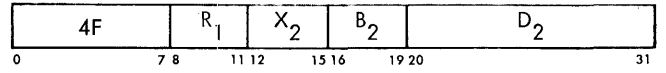

CVD RX 31

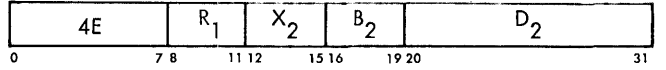

D RX 30

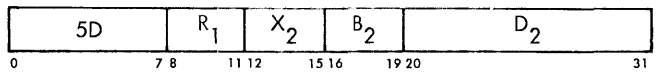

DD RX (Long Operands) 48

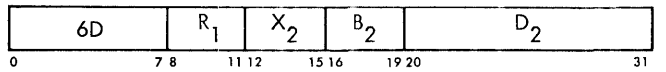

DDR RR (Long Operands) 48

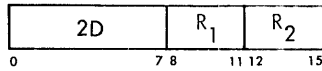

DE RX (Short Operands) 48

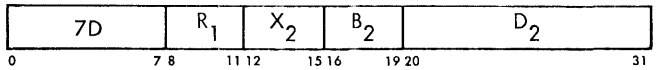

DER RR (Short Operands) 48



DP SS 37

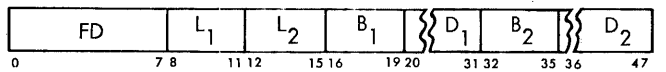

DR RR 30

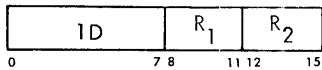

ED SS 57

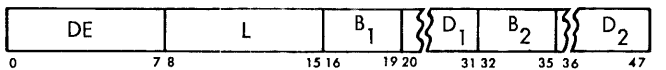

EDMK SS

58

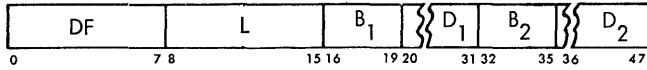

LCR RR

26

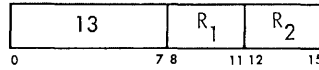

EX RX

65

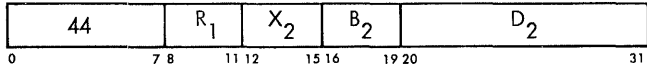

LD RX (Long Operands)

43

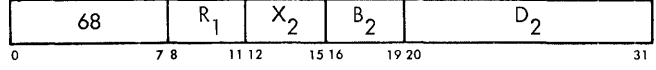

HDR RR (Long Operands)

47

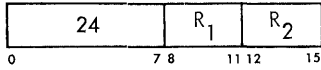

LDR RR (Long Operands)

43

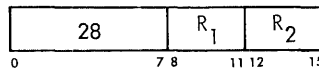

HER RR (Short Operands)

47

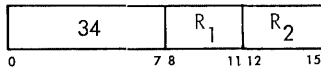

LE RX (Short Operands)

43

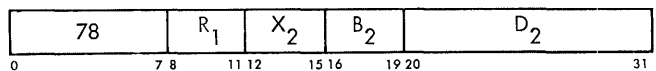

HIO SI

94

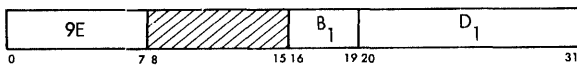

LER RR (Short Operands)

43

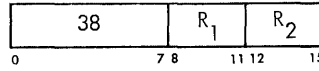

IC RX

55

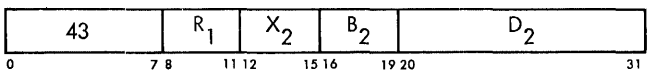

LH RX

25

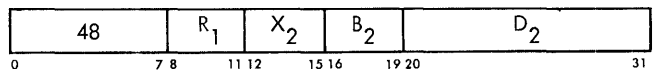

ISK RR

73

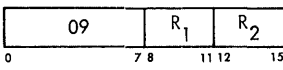

LM RS

26

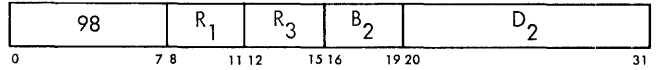

L RX

25

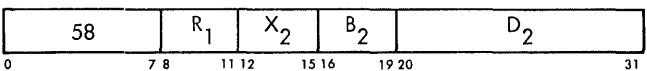

LNDR RR (Long Operands)

44

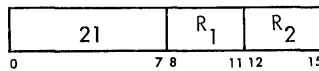

LA RX

56

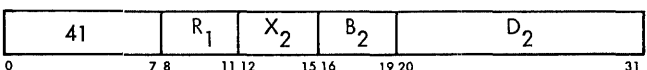

LNER RR (Short Operands)

44

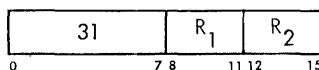

LCDR RR (Long Operands)

43

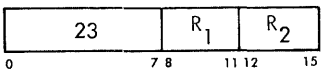

LNR RR

26

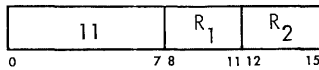

LCER RR (Short Operands)

43

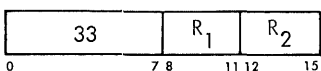

LPDR RR (Long Operands)

43

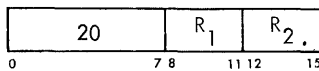

LPER RR (Short Operands)



43

MER RR (Short Operands)

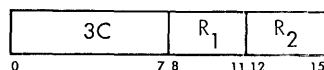

47

LPR RR

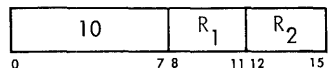

26

MH RX

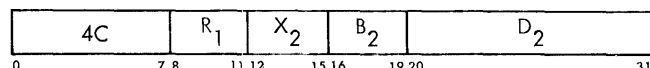

30

LPSW SI



72

MP SS

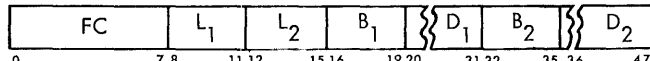

37

LR RR

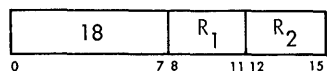

25

MR RR

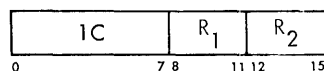

29

LTDR RR (Long Operands)

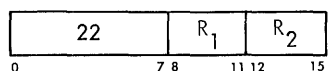

43

MVC SS

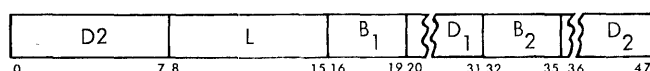

52

LTER RR (Short Operands)

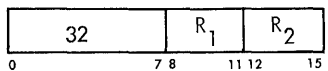

43

MVI SI

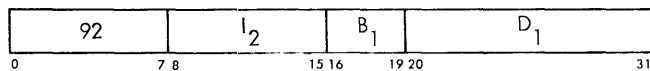

52

LTR RR

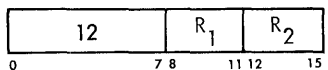

25

MVN SS



53

M RX

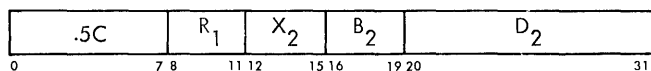

29

MVO SS

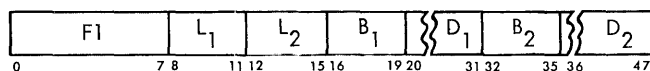

38

MD RX (Long Operands)

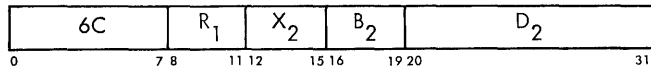

47

MVZ SS

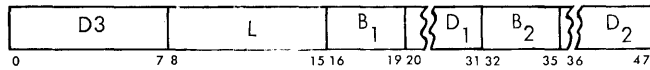

53

MDR RR (Long Operands)

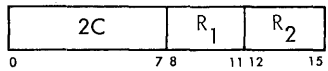

47

N RX

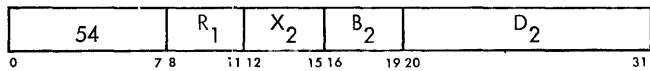

54

ME RX (Short Operands)

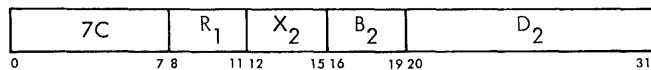

47

NC SS

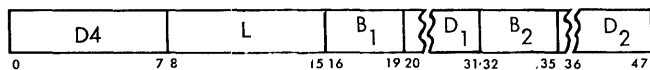

54

NI SI 54

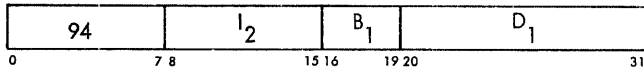

NR RR 54

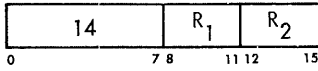

O RX 54

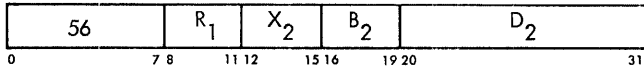

OC SS 54

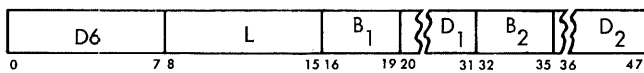

OI SI 54

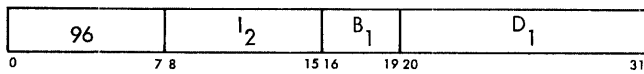

OR RR 54

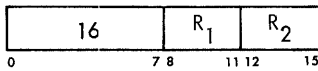

PACK SS 38

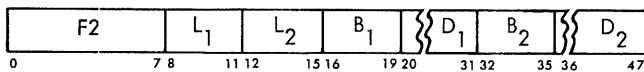

RDD SI 74

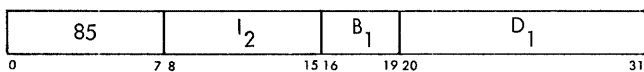

S RX 28

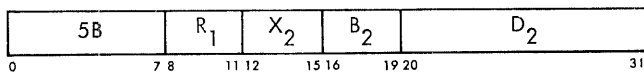

SD RX (Long Operands) 45

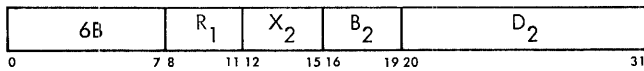

SDR RR (Long Operands) 45

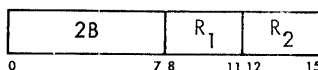

SE RX (Short Operands) 45

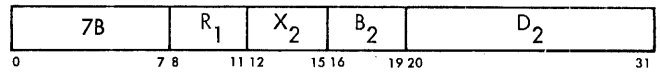

SER RR (Short Operands) 45

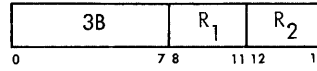

SH RX 28

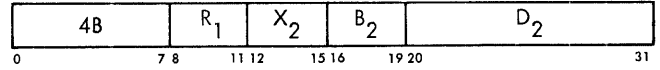

SIO SI 92

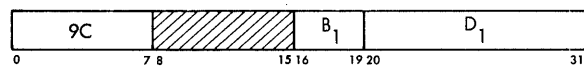

SL RX 28

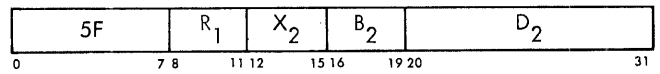

SLA RS 32

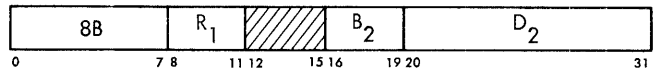

SLDA RS 32

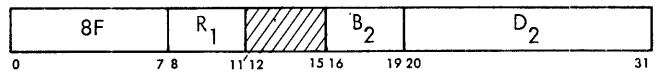

SLDL RS 59

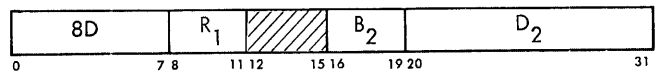

SLL RS 59

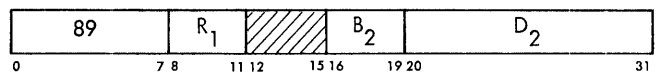

SLR RR 28

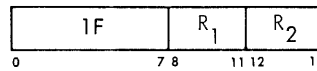

SP SS 36

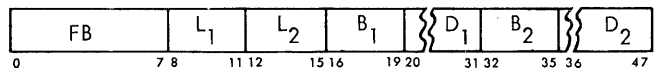

SPM RR

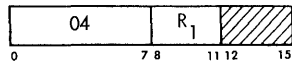

72

STE RX (Short Operands)

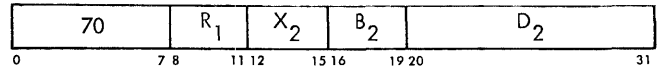

49

SR RR

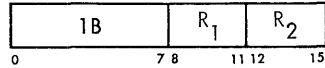

28

STH RX

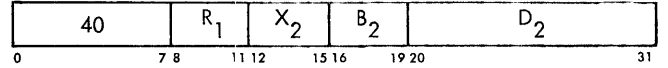

31

SRA RS

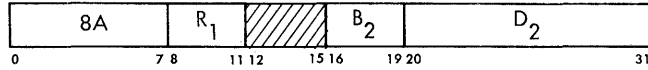

32

STM RS

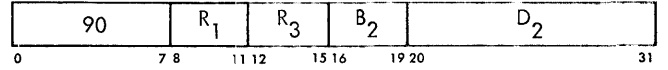

31

SRDA RS

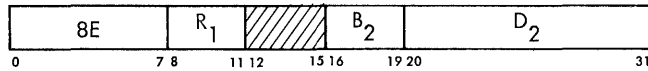

33

SU RX (Short Operands)

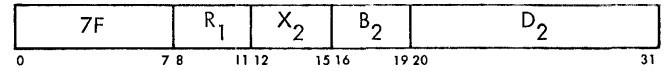

46

SRDL RS

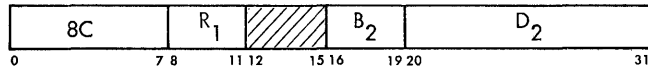

60

SUR RR (Short Operands)

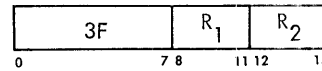

46

SRL RS

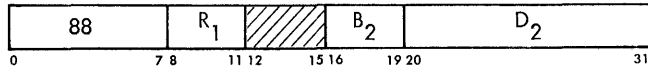

59

SVC RR

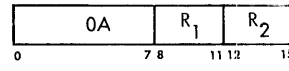

72

SSK RR

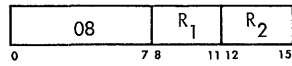

73

SW RX (Long Operands)

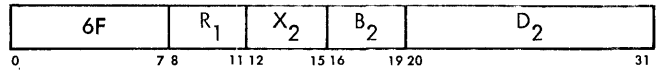

46

SSM SI

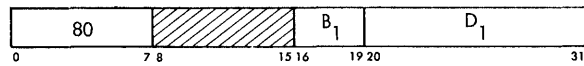

72

SWR RR (Long Operands)

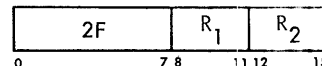

46

ST RX

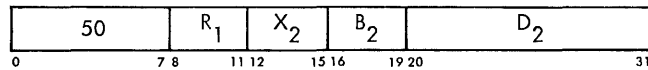

31

TCH SI

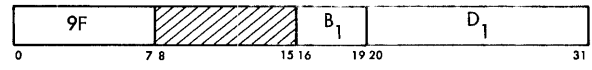

95

STC RX

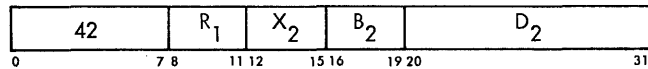

55

TIO SI

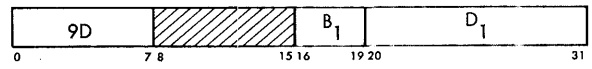

93

STD RX (Long Operands)

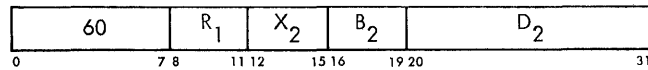

49

TM SI

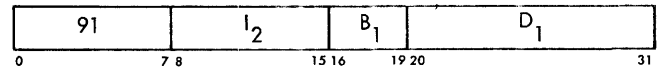

55

TR SS 56

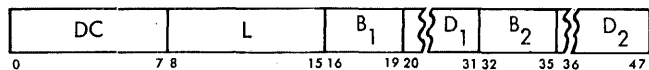

XC SS 55

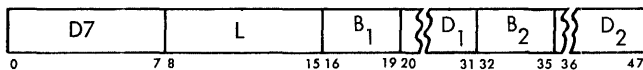

TRT SS 56

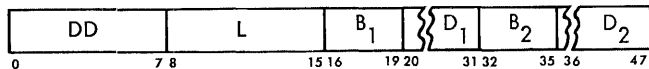

XI SI 55

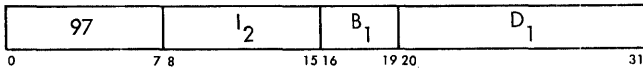

UNPK SS 38

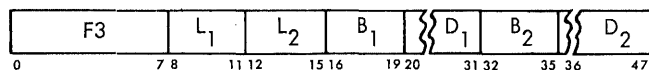

XR RR 55

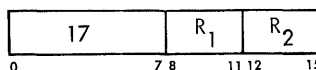

WRD SI 73

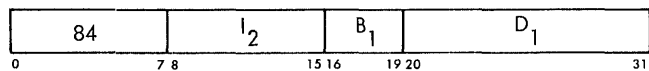

ZAP SS 36

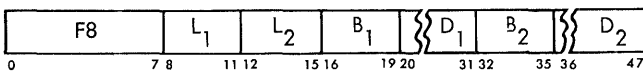

X RX 55

