



HEWLETT
PACKARD

HP-86B

ASSEMBLY LEVEL
SERVICE MANUAL

Reorder Number
00086-90080

© HEWLETT-PACKARD COMPANY

Printed May 1983

Personal Computer Division
1010 N.E. Circle Blvd.
Corvallis, OR 97330 U.S.A.

Contents

Section	Page
I	GENERAL INFORMATION
1.1	Introduction 1-1
1.2	Product Description 1-1
1.3	Identification 1-3
1.4	Safety Considerations 1-4
1.5	Servicing the HP-86B 1-4
1.6	Using This Manual 1-5
II	TROUBLESHOOTING AND REPAIR
2.1	Introduction 2-1
2.2	Safety Considerations 2-1
2.3	System Overview 2-2
2.4	Troubleshooting Overview 2-4
2.5	Troubleshooting Tips 2-5
2.6	Setup 2-5
2.7	Initial Troubleshooting 2-7
2.8	No Turn-On 2-9
2.9	Service ROMs 2-11
2.10	Self-Test 2-12
2.11	Running a Service ROM Test 2-13
2.12	Error Messages 2-15
2.13	Troubleshooting With the System Test 2-16
2.14	Results of the System Test 2-16
2.15	RAM Test Diagnosis 2-16
2.16	ROM Test Diagnosis 2-17
2.17	Beeper Test Diagnosis 2-17
2.18	CRT Test Diagnosis 2-17
2.19	Timer Test Diagnosis 2-17
2.20	Keyboard Test Diagnosis 2-18
2.21	HP-IB Test Diagnosis 2-18
2.22	Troubleshooting With the Cycle Test 2-18
2.23	How to Run the Cycle Test 2-18
2.24	Completion of the System Test..... 2-18
2.25	Troubleshooting With the HP-IB Interface Test 2-19
2.26	Results of the Short HP-IB Test 2-19
2.27	Troubleshooting With the Long HP-IB Test 2-20
2.28	Results of the Long HP-IB Test 2-21

2.29	Using the Heat Test	2-22
2.30	How to Run the Heat Test	2-22
2.31	Results of the Heat Test	2-22
2.32	Troubleshooting With the CPU Test	2-23
2.33	How to Run the CPU Test	2-23
2.34	Results of the CPU Test	2-23
2.35	Troubleshooting With the RAM Test	2-24
2.36	How to Run the RAM Test	2-24
2.37	Results of the RAM Test	2-24
2.38	Troubleshooting with the External RAM Test	2-25
2.39	How to Run the External RAM Test	2-25
2.40	Results of the External RAM Test	2-25
2.41	Troubleshooting With the ROM Test	2-26
2.42	How to Run the External ROM Test	2-26
2.43	Results of the External ROM Test	2-26
2.44	Troubleshooting With the External ROM Test	2-26
2.45	How to Run the External ROM Test	2-26
2.46	Results of the External ROM Test	2-27
2.47	Keyboard Troubleshooting	2-28
2.48	How to Run the Keyboard Test	2-28
2.49	Results of the Keyboard Test	2-28
2.50	No Key Entry	2-34
2.51	Wrong Character Entered	2-35
2.52	Wrong Character Entered; [SHIFT], [CAPS LOCK], and [CTRL] OK	2-35
2.53	Wrong Character Entered; [SHIFT], [CAPS LOCK], or [CTRL] Apparently Down	2-36
2.54	Wrong Character Entered; [SHIFT], [CAPS LOCK], or [CTRL] Apparently Up	2-36
2.55	Key Stuck	2-37
2.56	Troubleshooting With the Timer Test	2-47
2.57	How to Run the Timer Test	2-47
2.58	Results of the Timer Test	2-47
2.59	Troubleshooting the Video Monitor	2-47
2.60	How to Run the CRT Test	2-48
2.61	Results of the CRT Test	2-48
2.62	Troubleshooting the Control and Bus Lines	2-52
2.63	Power Supply Troubleshooting	2-53
2.64	PWO and Clock Failure Isolation	2-54
2.65	Troubleshooting With the Beeper Test	2-55
2.66	How to Run the Beeper Test	2-55
2.67	Results of the Beeper Test	2-55
2.68	Using the QA Test	2-56
2.69	How to Run the QA Test	2-56
2.70	Results of the QA Test	2-56

III. DISASSEMBLY AND REASSEMBLY

3.1	Introduction	3-1
3.2	Safety Considerations	3-1
3.3	Removing and Tightening Screws	3-1
3.4	Cable Interconnections	3-2
3.5	Special Handling for Keyboard Assembly Cables	3-2
3.6	Connecting a Cable	3-2
3.7	Removing a Trapped Cable	3-2
3.8	Replacing Assemblies and Case Parts	3-5
	Separating the Top Case from the Bottom Case	3-6
	Replacing the Keyboard Assembly	3-7
	Replacing a Key Cap	3-9
	Replacing the Space Bar	3-10
	Replacing a Plunger and Spring	3-12
	Replacing the [CAPS LOCK] Key Mechanism	3-13
	Replacing Key Contacts	3-16
	Replacing a Keyboard Hinge	3-18
	Cleaning Key Contacts	3-18
	Replacing the Logic PCA	3-19
	Replacing the Logic PCA Shield and Insulator	3-21
	Replacing the Power Supply Assembly	3-22
	Replacing the I/O PCA	3-22
	Replacing the HP-IB Connector	3-23
	Replacing the Back Panel Assembly	3-24
	Replacing Parts of the Bottom Case Assembly	3-25
	Replacing Parts of the Back Panel Assembly	3-28
	Attaching the Top Case to the Bottom Case	3-29

IV REPLACEABLE PARTS

V SCHEMATIC DIAGRAMS

Illustrations

Figure	Title	Page
1-1.	HP-86B	1-5
2-1.	HP-86B Block Diagram	2-3
2-2.	System Self-Test Results	2-12
2-3.	HP-IB Switch Settings	2-19
2-4.	SI Setting on the HP 82937A PCA	2-21
2-5.	Key Sequence for the Keyboard Test	2-29
2-6.	CRT Test Pattern 1	2-49
2-7.	CRT Test Pattern 2	2-50
2-8.	CRT Test Pattern 3	2-50
2-9.	CRT Test Pattern 4	2-51
2-10.	CRT Test Pattern 5	2-51
2-11.	Clock Waveforms	2-54
3-1.	Aligning Cable Contacts	3-3
3-2.	Cable Connected Properly	3-3
3-3.	Cable Misaligned	3-3
3-4.	Cable Connected With Edge Folded Over	3-4
3-5.	Removing a Trapped Cable	3-4
4-1.	Keyboard Assembly Exploded View	4-12
4-2.	English Version Keyboard Layout	4-13
4-3.	Italian Version Keyboard Layout	4-13
4-4.	Spanish Version Keyboard Layout	4-14
4-5.	French Version Keyboard Layout	4-14
4-6.	Danish/Norwegian Version Keyboard Layout	4-15
4-7.	German Version Keyboard Layout	4-15
4-8.	Swedish Version Keyboard Layout	4-16
4-9.	Dutch Version Keyboard Layout	4-16
4-10.	Swiss German Keyboard Layout	4-17
4-11.	Swiss French Keyboard Layout	4-17
4-12.	Back Panel Exploded View	4-22
4-13.	HP-86B Exploded View	4-23
5-1.	Logic PCA Component Location Diagram	5-2
5-2.	Logic PCA Schematic Diagram (Sheet 1)	5-3
5-3.	Logic PCA Schematic Diagram (Sheet 2)	5-5
5-4.	Power Supply PCA Schematic Diagram	5-7
5-5.	Power Supply PCA Component Location Diagram	5-8
5-6.	I/O PCA Schematic Diagram	5-9
5-7.	I/O PCA Component Location Diagram	5-9

Tables

Table	Title	Page
1-1.	HP-86B Specifications	1-2
1-2.	Recommended Tools	1-6
2-1.	Power Supply and PWO Test Point Voltages	2-9
2-2.	Service ROM Tests for the HP-86B	2-15
2-3.	Enhancement ROM Codes	2-27
2-4.	Keyboard Test	2-30
2-5.	Keyboard Test Diagnosis	2-31
2-6.	Mnemonics and Key Lines for Keys Expected	2-38
2-7.	Key(s) Corresponding to Character Entered	2-43
2-8.	Control and Bus Line Failure Isolation	2-52
2-9.	Power Supply Troubleshooting	2-53
2-10.	PWO and Clock Failure Isolation	2-55
2-11.	Keyboard Test (Non-English Keyboards)	2-57
2-12.	Keyboard Test Diagnosis (Non-English Keyboards)	2-58
4-1.	Keyboard Assembly Part Numbers	4-1
4-2.	Keyboard Assembly Replaceable Parts	4-2
4-3.	HP-86B Replaceable Parts	4-18
4-4.	Language Switch Settings of Logic PCA	4-24

General Information

1.1 INTRODUCTION

This manual contains the necessary information to allow you to test and service the HP-86B Personal Computer, which is shown in figure 1-1. For ease of reference, this manual has been divided into five sections:

Section I	General Information
Section II	Troubleshooting and Repair
Section III	Disassembly and Reassembly
Section IV	Replaceable Parts
Section V	Schematic Diagrams

Before using this manual in an actual repair, first read all of this section to become familiar with the computer and the organization of this manual, then read through the rest of the manual to become familiar with the service procedures.

Additional information related to service is included in appendix C of the HP-86/87 Operating and BASIC Programming Manual.

1.2 PRODUCT DESCRIPTION

The HP-86B is an integrated system that features:

- Enhanced ANSI BASIC language.
- 128K user read/write memory, expandable to 640K.
- Built-in HP-IB interface.
- Typewriter keyboard and numeric keypad.
- Built-in composite video driver for use with an external monitor.
- Graphics capability standard.
- Ten different language options.

Section I: General Information

- Four I/O ports.
- Programmable tone output.

Table 1-1. HP-86B Specifications

Size

- Width: 41.9 cm (16.5 in.).
- Depth: 45.2 cm (17.8 in.).
- Height: 19.7 cm (7.75 in.).
- Weight: 7.5 kg (16.5 lb, 28.0 lb shipping).

Power Requirements

- AC Line Voltage: 90 to 127V, 200 to 254V.
- Line Frequency: 50 to 60 Hz.
- Power Consumption: 14 watts (nominal).

Environmental Limits

- Operating Temperature: 0 to 55 degrees C (32 to 131 degrees F).
- Storage Temperature: -40 to 75 degrees C (-40 to 167 degrees F).
- Operating Humidity: 0% to 95% relative humidity at 40 degrees C (104 degrees F).

Video Monitor Output:

- Capacity: 16 or 24 lines, 80 characters per line (alphanumeric mode); 240 dots by 544 dots (graphall mode).
- Refresh Rate: 60 Hz.

Keyboard

- 91 keys.
- Typewriter keyboard and numeric keypad.
- Fourteen special function keys.

Section I: General Information

1.3 IDENTIFICATION

The serial number of the computer is used for identification and determination of warranty status. It is located at the top of the back panel, above the video connector. Its format is shown below:

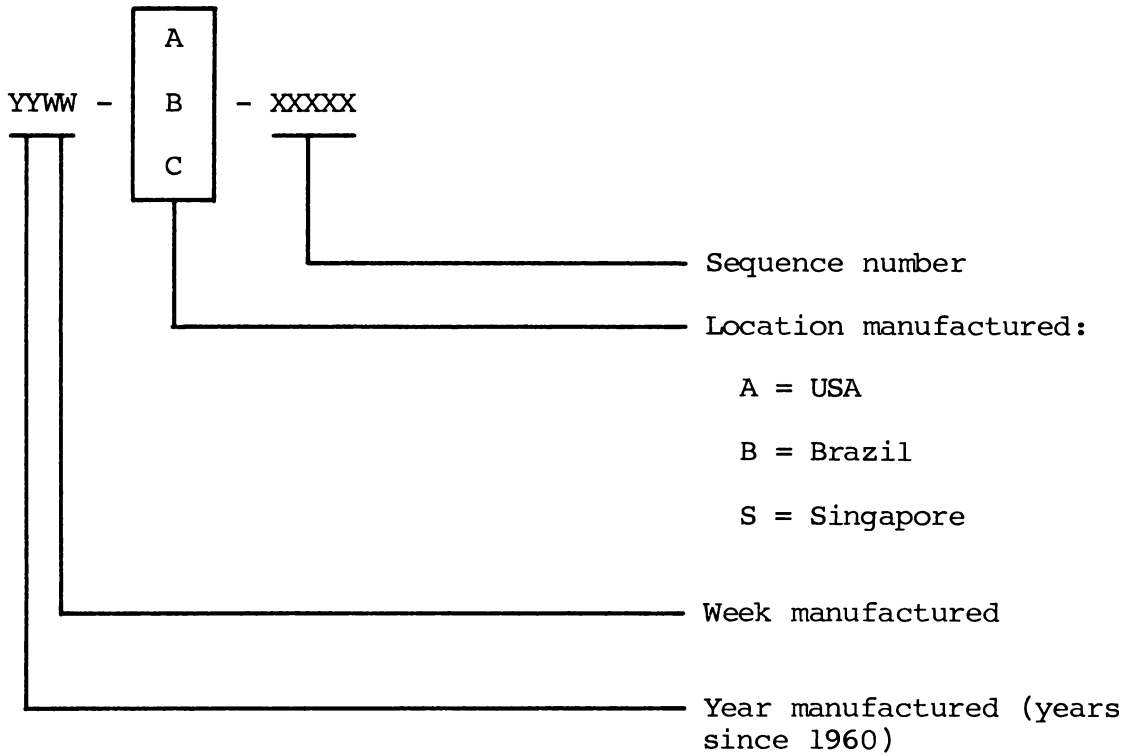

1.4 SAFETY CONSIDERATIONS

WARNING

Line voltages may be exposed when the top case of the HP-86B is removed. Electrical and mechanical failures may cause dangerous voltages to be present at points that normally are safe. For your own safety, read and heed the safety guidelines listed below.

Observe the following safety guidelines while working on an HP-86B:

- Do all possible operations with the computer turned off.
- NEVER WORK ALONE. Be familiar with the location of power switches in your service area and what they control.
- In case of an accident, know where to obtain respiratory resuscitation and/or cardiac pulmonary resuscitation (CPR).
- Keep your work area neat and free of any nonessential conducting material or sharp objects. Remember that reaction to an electrical shock can make you strike nearby objects, which could result in serious injury.
- Do not exceed the rated specifications of test instruments.

Associated with certain procedures throughout this manual you will see a warning. Enclosed within a box like the one in section 1-4, these warnings caution you about possible dangers while you perform the service procedures.

1.5 SERVICING THE HP-86B

The HP-86B is designed to be easy to service. Most parts are included in the following assemblies (see figure 1-1):

- Logic PCA (printed-circuit assembly).
- Power Supply PCA.
- Keyboard assembly.
- Back panel assembly, with HP-IB interface connector.
- Top case assembly.
- Bottom case assembly.

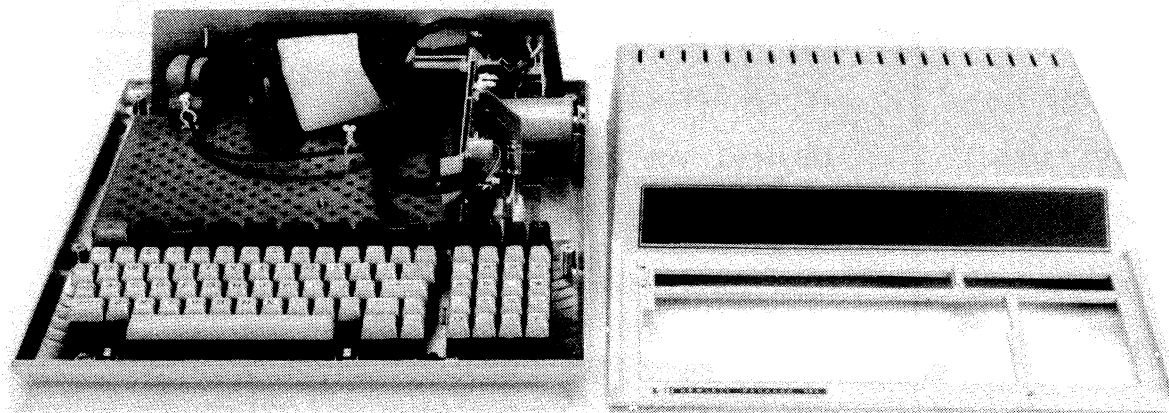

Figure 1-1. HP-86B

Troubleshooting the HP-86B is facilitated by the use of the service ROMs. Tests provided in these ROMs tell you if any IC is bad and enable you to check operation of the HP-IB interface. The test provided in the service ROM goes much further than the self-test performed by the computer when the power is switched on or when the [TEST] key is pressed.

1.6 USING THIS MANUAL

Here is an outline of how you might use this manual in servicing an HP-86B:

- a. Follow the procedures in section II. They will help isolate a problem to one of the major HP-86B assemblies and then give specific troubleshooting and repair procedures for that assembly.
- b. If it is necessary to disassemble the computer in order to access a bad assembly, refer to the procedures in section III.
- c. To order replacement parts or assemblies, obtain the HP part numbers from the list of replaceable parts in section IV.

Section I: General Information

Table 1-2 lists the tools recommended for servicing the HP-86B.

Table 1-2. Recommended Tools

HP PART NUMBER	DESCRIPTION
HP 82937A	HP-IB Interface Module (known good)
HP 3465/3466	Digital Voltmeter
HP 1220A	Oscilloscope
0960-0062	Continuity Tester
8500-0232	FREON TF
8710-1254	Key Contact Insertion Tool
8710-0002	Nut Driver, 1/4 inch
8710-0007	Nut Driver, 1/2 inch
8100-1217	Nut Driver, 7 mm (or 9/32 inch)
8710-1107	Pliers, long-nose, serrated tip
8710-0945	Screwdriver, holding
8710-0899	Screwdriver, Pozidriv, #1
8710-0900	Screwdriver, Pozidriv, #2
8730-0008	Screwdriver, small flat-blade
00087-60912	System Service ROM (English Version)
00086-60922	System Service ROM (Foreign Versions)
00087-60913	HP-IB Service ROM
00086-90060	Introduction to the HP-86B
00087-90017	HP-86/87 Operating and BASIC Programming Manual
00086-90080	HP-86B Assembly-Level Service Manual
00086-60910	HP-86 Power Supply Test Tool

Troubleshooting and Repair

2.1 INTRODUCTION

This section helps isolate the cause of a problem to a part or assembly that you can replace without soldering.

Frequently a computer is received for repair with a message from the customer describing the problem. This information can be very helpful in troubleshooting. Nevertheless, because of the complexity of the HP-86B, you should always begin troubleshooting any HP-86B problem by using the procedures described in paragraph 2.7.

CAUTION

Ensure that the bench setup for troubleshooting and repair has adequate electrostatic protection; otherwise, ICs may be damaged.

2.2 SAFETY CONSIDERATIONS

WARNING

Line voltages are exposed when the top case of the HP-86B is removed. For your own safety, read and heed the safety precautions in section I.

2.3 SYSTEM OVERVIEW

The HP-86B (see figure 2-1) consists of:

- The CPU (central processing unit), an 8-bit microprocessor.
- Read-only memory (ROM) containing microprogrammed instructions. The English version of the HP-86B has 56K bytes of ROM distributed among seven ICs. All foreign language versions have an additional 8K bytes.
- Random access memory (RAM) for storage of user programs and data and the BASIC operating system. The HP-86B has 128K bytes of RAM, which are distributed among 16 ICs and accessed through the RAM controller. Approximately 4K of RAM are used for the BASIC operating system.
- A 91 character keyboard which is controlled by the CPU via the keyboard controller. The keyboard controller also provides four timers for use by the operating system and the user.
- Language options with language ROM, and different keyboards. There are two different keyboard controllers; one for the HP-86A and the HP-86B English version, and one for all HP-86B foreign versions.
- A video output capable of driving a high-quality monitor to display the program statements and output from running programs. This output is governed by a separate microprocessor, the CRT controller, with 16K bytes of RAM.
- A built-in HP-IB interface that conforms to IEEE Standard 488-1978. An industry standard HP-IB connector is provided on the rear panel of the computer. A switch to set the select code and address of the interface is included internally.
- Four I/O ports for plug-in modules that provide additional memory and functional capabilities; for connecting non-HP-IB peripheral devices. An I/O buffer IC provides the interface between the CPU and modules or devices plugged into the I/O ports.
- A 1-3/4-inch speaker, controlled by the CPU to produce audible tones ("beeps") of variable frequency and duration.
- An 8-bit bus that transfers instructions and addresses between the CPU and the various controllers, the I/O buffer, and the ROMs.
- Power supply circuitry.

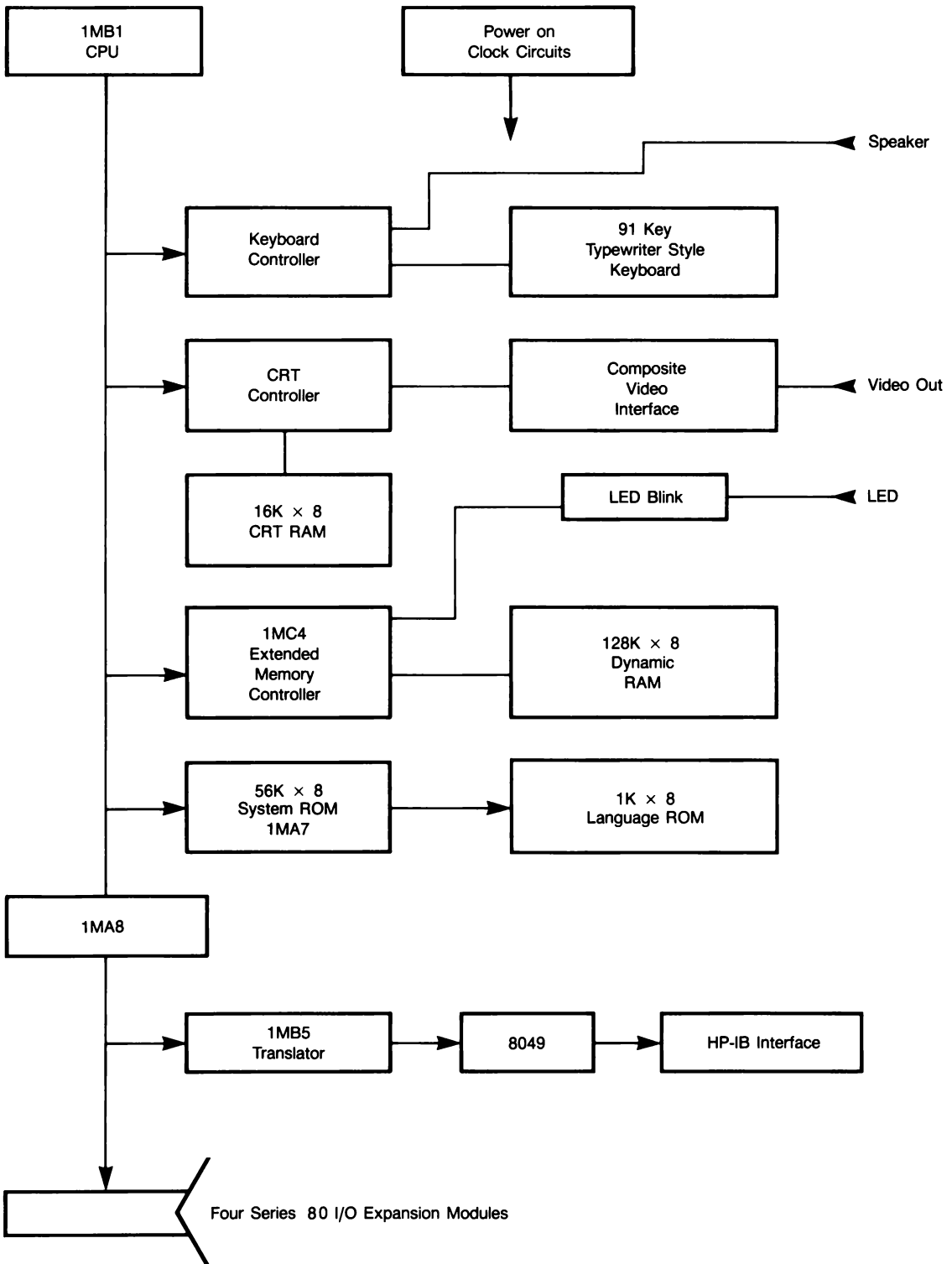

Figure 2-1. HP-86B Block Diagram

2.4 TROUBLESHOOTING OVERVIEW

Troubleshooting the HP-86B is facilitated by the use of two service ROMs provided for the HP-86B: the System Service ROM (HP part number 00087-60912 for the English version and 00086-60922 for the foreign language versions) and the HP-IB Service ROM (HP part number 00087-60913).

The service ROMs identify bad ICs and enable you to further check the interface and keyboard assemblies. Paragraph 2.9 gives a general description of the service ROMs.

In order to troubleshoot an HP-86B:

- a. Set up the computer as described in paragraph 2.6. If the computer does not turn on properly, troubleshoot it as described in paragraph 2.8.
- b. Run the System Test from the service ROMs as described in paragraph 2.13.
- c. Replace the logic assembly if that is indicated and rerun the system test to verify that the problem has been corrected.
- d. In many cases it will be necessary to run the XRAM test (not included in the system test). Paragraph 2.38 describes this test.
- e. For some problems, the service ROMs will not identify a possible cause. In such cases, an IC or part of an assembly may nevertheless be bad. First, check the power supply voltages according to table 2-1. If they are within specified limits, replace the logic PCA. After replacing any part or assembly, run the appropriate tests from the service ROMs to verify that the repair has corrected the problem.
- f. After correcting all problems and installing the top case, run the System Test again to make sure that the computer is working properly before returning it to the customer.
- g. If the customer reported an intermittent problem, you can attempt to reproduce it in either of two ways:
 - Run the Cycle Test. (Refer to paragraph 2.22.)
 - Write and run a BASIC program containing a continuous loop of a test or tests from the service ROMs. (For more information about running service ROM tests under control of the BASIC operating system, refer to paragraph 2.11; for assistance in programming, refer to the HP-86/87 Operating and BASIC Programming Manual.)

2.5 TROUBLESHOOTING TIPS

CAUTION

Always switch the power off before disconnecting or connecting an assembly or cable. If power is on while this is done, ICs may be damaged.

Do not attempt to leave the keyboard PCA connected with its short ribbon cables while the keyboard hinge pins are disengaged from their retainers in the bottom case. If this is done, the strain on the ribbon cable connectors may open the connection between a connector pin and the keyboard PCA.

If ribbon cables are not inserted properly into their connectors, components could be damaged. Refer to paragraph 3.5 for information about connecting cables.

2.6 SETUP

To set up an HP-86B for checkout and troubleshooting:

- a. Disconnect the power cord and ensure that the ON-OFF switch on the back panel is set to OFF.
- b. Make sure that the line voltage selector switch on the back panel is set to the nominal line voltage in the customer's area.

CAUTION

The computer will be damaged if the switch is set to 115V and the computer is switched on while connected to a 230V supply.

- c. Ensure that an intact fuse of the proper rating is installed in the fuse receptacle on the back panel. Use a 750 mA fuse for 115V operation; use a time-delayed 315 mA fuse for 230V operation.

Section II: Troubleshooting and Repair

- d. Connect the power cord to its receptacle on the back panel. Plug the other end of the cord into an ac power source of the proper voltage.

CAUTION

The computer must be switched off when the ROM drawer (as well as any other plug-in module) is inserted into a module port. If the power were on, ICs could be damaged.

- e. Install the service ROMs in a ROM drawer, and insert the ROM drawer into one of the I/O ports in the back panel assembly.
- f. Install the known-good HP-IB interface into an I/O port and attach the cable. See section 2.25 for switch settings.
- g. Connect the computer to a suitable video monitor with a phono plug cable. Turn on the video monitor.
- h. Switch the computer on.

2.7 INITIAL TROUBLESHOOTING

Immediately after the power is switched on, the power LED should blink on and off. If not, refer to paragraph 2.8.

Within 10 to 15 seconds after you switch the computer on, the following message should be displayed:

{SERVICE ROM: SELECT TEST A-V}*

This message will be preceded by other messages indicating tests of the CPU, RAM, the four system ROMs, external ROMs, and the HP-IB interface. These messages may identify bad ICs; they will be repeated during the System Test (if the System Test can be run). Watch the display for these messages.

If the {SERVICE ROM} message appears correctly on the monitor, run the System Test from the System Service ROM, as described in paragraph 2.13.

Note: If the computer has a keyboard problem, the System Test may not run. In this situation:

- If the message {NO KEY!} appears, refer to No Key Entry, paragraph 2.50.
- If the message {KEY STUCK!} appears, refer to Key Stuck, paragraph 2.55.
- If a service ROM test other than the System Test is run, look up the key entered in table 2-10, then refer to paragraph 2.52.
- If only the message {RETURN TO BASIC SYSTEM} appears, refer to paragraph 2.51 if the character following the message is one of the first 61 characters listed in table 2-9; otherwise, refer to paragraph 2.52.
- If there is no response to pressing any key (that is, no test is run and no message appears), check keyboard cables and then replace the logic PCA.

*Throughout the rest of this manual, this message is referred to simply as "the {SERVICE ROM} message."

Note: The foreign language service ROM requires the correct key to be pressed, according to an English version keyboard. Therefore, when the TEST `A` is selected to be run from a French keyboard, for example, the key appearing at the location of `A` on an English keyboard must be pressed. On the French keyboard, this is the `Q` key. Refer to the English and foreign keyboard layouts in the Replaceable Parts List for the correct key to press when troubleshooting a foreign-keyboard option HP-86B.

Section II: Troubleshooting and Repair

If no message appears within 15 seconds after you switch the computer on, the power LED does not blink, and the computer does not beep, the computer is not turning on properly; refer to paragraph 2.8.

If no message appears but the computer beeps once, watch the monitor display while you switch the computer off and immediately on again. If still no message appears, refer to paragraph 2.8.

If the {SERVICE ROM} message does not appear on the display but a {CPU BAD!}, {RAM BIT n BAD!}, {EMC BAD!}, {ROM n BAD!}, or {XROM nnn BAD!} message appears, replace the logic PCA.

If the {SERVICE ROM} message does not appear on the display but the message {CPU BAD! or n RAM BAD!} appears, replace the logic PCA.

2.8 NO TURN-ON

If the computer does not beep, messages do not appear, and the power LED does not blink when the computer is switched on with the service ROMs installed, the HP-86B is not "turning on" properly. This condition could be caused by any of the following:

- The power supply, PWO, or clock circuitry is not operating properly.
- An output of one of these three circuits is being pulled low by a failure of another circuit.
- The CPU is bad.
- One of the bus lines or control lines is being pulled low by a failure on another assembly.
- ROM 0 is bad. This IC is necessary for turn-on.
- The RAM controller or any of the RAM ICs (U81-U88) is bad. A portion of RAM is used by the service ROMs and the CPU.
- The I/O buffer is bad. This IC is necessary to interface between the service ROMs and the CPU.
- One of the power supply, PWO, clock, bus, or control lines to an IC is open.
- The connector on the I/O PCA is bad.
- The connection between the I/O PCA and the logic PCA is bad.
- The service ROMs are bad.

Note: Always check the power supply voltages when first trying to isolate a no-turn on condition.

To isolate a no turn-on condition to a socketed IC or an assembly, perform the following steps until the computer turns on:

- a. Check the voltage on the power supply lines at the power supply connector on the logic PCA. Refer to table 2-1 for the test point and acceptable voltage range for each supply line. If any line is out of range, refer to paragraph 2.65.
- b. Check the PWO and clock lines. If any line is not correct, refer to paragraph 2.66, and table 2-12.

Section II: Troubleshooting and Repair

- c. Check the control and bus lines at the pins of the CPU with an oscilloscope. Each line should be switching between 0 and 6 volts. Since these lines are asynchronous, with an oscilloscope you can only verify that they are switching. If any line is not observed to be active, refer to paragraph 2.64.
- d. Replace the logic PCA.
- e. Check continuity through the ribbon cable from the logic PCA to the I/O PCA. Replace PCA that is found to have a bad connector.
- f. Try different service ROMs.

Table 2-1. Power Supply and PWO Test Points

LINES	TEST ASSEMBLY	CHECK		ACCEPTABLE
		SIGNAL	PIN	
Power Supply	Power Supply PCA	+12	(J2) 1	11.4V to 12.6V
		+6	3	5.70V to 6.30V
		+5	2	4.75V to 5.25V
		-12	4	-10.8V to -13.2V
		-5	5	-4.75V to -5.25V
PWO	Logic PCA	PWO	(U25) 13	4.4V, minimum

2.9 SERVICE ROMS

Troubleshooting the HP-86B is greatly facilitated by the use of the service ROMs. Tests provided in these ROMs tell you if a socketed IC is bad and enable you to check for proper operation of the interfaces.

The System Service ROM contains the following tests:

System	[A]*
CPU	[B]
RAM	[C]
ROM	[D]
Beeper	[E]
CRT	[F]
Timer	[J]
Key	[K]
External RAM	[L]
External ROM	[M]*
Heat	[N]
Focus Pattern	[O]
Pincushion Pattern	[P]
QA	[Q]*
Raster Screen	[R]
Cycle	[V]

- * The actual key to press varies from keyboard to keyboard, depending on the language version. On the French keyboard, the [A] test is run by pressing [Q], and the [Q] test is run by pressing [A]. On both French and Italian versions the [M] test is run by pressing the [,] key, located just to the right of the [N] key, where the [M] would be on any other language version of the HP-86B keyboard.

The HP-IB Service ROM contains two tests: Short HP-IB [H] and Long HP-IB [I] interface tests.

Although any of the tests in a service ROM can be run individually, most of the tests are run automatically as part of the System Test.

The System Test, which incorporates seven individual tests, is the basic test you should use to begin assembly-level troubleshooting of an entire computer. Even when you know that there is a problem in a particular assembly checked by an individual test, you should first run the entire System Test. The first few tests in the System Test check components that could cause operating problems in the assemblies checked by subsequent tests. You may run an individual test alone in the following circumstance:

- You have replaced a component or assembly that the System Test indicated was bad, and you want to verify, without running the entire System Test again, that replacing the component or assembly has corrected the problem.

2.10 SELF-TEST

The HP-86B system performs a self-test each time it is switched on. This test does a simplified version of the ROM Test and portions of the RAM and Keyboard Tests. The CPU, CRT, and timers are not checked. If the computer is switched on with the System Service ROM installed, the ROM takes control immediately, and the self-test is not done until control is returned to the BASIC system. Then--if a problem is found, the computer beeps twice, and a message {ERROR 23: SELF TEST} is displayed. If the self-test is completed successfully, the cursor alone reappears. The self-test executed by pressing the [TEST] key is identical to that performed when the computer is switched on, except that if the test is completed successfully, the complete character set shown in figure 2-2 is shown at the end. The characters displayed should match the results shown below for the option that corresponds to the HP-86 version.

English version:

```
◀ ▶ ↑ ↓ ← → + - * / = < > [ ] ; : ' " # $ % & ' ( ) * + , - . / 0 1 2 3 4 5 6 7 8 9 : ; < = > @ A B C D E F G H I J K L M N O  
P Q R S T U V W X Y Z [ \ ] ^ _ ` a b c d e f g h i j k l m n o p q r s t u v w x y z { | } ~ * [
```

Foreign versions:

```
! @ # $ % & ' ( ) * + , - . / 0 1 2 3 4 5 6 7 8 9 : ; < = > @ A B C D E F G H I J K L M N O  
P Q R S T U V W X Y Z [ \ ] ^ _ ` a b c d e f g h i j k l m n o p q r s t u v w x y z { | } ~ * [
```

Figure 2-2. System Self-Test Results

2.11 RUNNING A SERVICE ROM TEST

When an HP-86B with the service ROMs installed is turned on, control is passed to the service ROMs (the foreign version System Service ROM must be used with all foreign versions of the HP-86B; the English version of the System Service ROM is also used on the HP-86A). This message will then be displayed.

```

{CPU OK}
{RAM OK}
{2RAM OK}
{EMC OK}
{ROM 0 OK}
{ROM 1 OK}
{ROM 2 OK}
{ROM 3 OK}
{XROM 001 0K}
{XROM 024 OK}      (not appearing in English version)
{XROM 208 OK}
{XROM 209 OK}
{XROM 224 OK}
{XROM 225 OK}
{HP-IB SHORT TEST OK}
{SERVICE ROM: SELECT TEST A-V}

```

If you press one of the keys [A] through [V] within 15 seconds after the messages appear, the service ROMs should perform the corresponding test listed in table 2-2. By pressing the [W] key, you can command the computer to remain in the 'auto' mode (wait), beyond the usual 15 seconds.

Note: Refer to paragraph 2.7 for troubleshooting procedures in any of the following circumstances:

- The {SERVICE ROM} message does not appear within 15 seconds after the computer is switched on.
- A {NO KEY!} or {KEY STUCK!} message appears 15 seconds after the {SERVICE ROM} message appears.
- Pressing a key has no result within 15 seconds after the {SERVICE ROM} message appears.
- Pressing a key results in the wrong test.

When the selected test is completed, the {SERVICE ROM} message appears again, and you can then run any Service ROM test by pressing the corresponding key.

It is recommended that you install the HP 82937A HP-IB Interface into a plug-in port in the back of the computer under test and connect the HP 82937A connector to the HP-IB connector on the back of the HP-86B before beginning the testing process, since this will be required for the System Test, which is usually run first. See figure 2-4 for the required switch settings.

Section II: Troubleshooting and Repair

Note: If you press [W] within 15 seconds after the {SERVICE ROM} message appears, the computer will wait indefinitely for you to press another key.

If you press any key other than those listed in table 2-2, control will be passed to the BASIC system. (The space bar is a convenient key to press if you want to return to the BASIC system.) When this happens, the message {RETURN TO BASIC SYSTEM} is momentarily displayed, then the cursor appears in the display. The message is followed by a character that indicates which key was entered. The cursor signifies that the BASIC system is in control.

If no key is pressed within 15 seconds after the {SERVICE ROM} message appears, the computer will beep, the messages {NO KEY!} and {RETURN TO BASIC SYSTEM} are momentarily displayed, then the cursor appears in the display. If a key is not released (or a key is struck) within 15 seconds after the {SERVICE ROM} message appears, the messages {KEY STUCK!} and {RETURN TO BASIC SYSTEM} are momentarily displayed, then the cursor appears in the display.

Whenever the BASIC system is in control (as signified by the presence of the cursor on the CRT), you can select any test by typing in the corresponding BASIC command listed in table 2-2, followed by [END LINE].

This capability enables you to write and run a BASIC program that automatically runs and repeats a test or group of tests from the service ROMs. For normal testing and troubleshooting it is more convenient to run the test under the direct control of the service ROMs.

Running a BASIC program--including a program that contains BASIC commands from the service ROMs--requires that the CPU, ROM, and RAM are OK. Therefore, do not run a test using a BASIC command until you have control of the service ROMs.

If you want to run a BASIC program that automatically runs and repeats a test or group of tests from the Service ROM, do not include the Keyboard Test or the System Test, which incorporates this test, in your program. This test requires interaction from the user.

2.12 ERROR MESSAGES

Most messages that result when a component or assembly is not operating properly are followed on the same line by a letter designating the nature of the failure. If a message on a computer under repair contains one of the letters shown next to the message in a troubleshooting procedure, proceed as directed in the procedure; otherwise ignore the letter

Table 2-2. Service ROM Tests for the HP-86

TEST	KEY	COMMAND	PARAGRAPH NUMBER
System	[A]*	{SYSTEM}	2.13
CPU	[B]	{CPU}	2.31
RAM	[C]	{RAM}	2.35, 2.38
ROM	[D]	{ROM}	2.41
Beeper	[E]	{BEEPER}	2.67
CRT (Video Mon.)	[F]	{DISPLAY}	2.59
HP-IB Short	[H]	{HP-IB x}	2.62
		(x is odd)	
HP-IB Long	[I]	{HP-IB s}	2.26
		(s is even)	
Timer	[J]	{TIMER}	2.56
Keyboard	[K]	{KBD}	2.47
External RAM	[L]	{XRAM}	2.38
External ROM	[M]**	{XROM}	2.44
Heat	[N]	{HEAT x}	2.28
Focus Pattern	[O]	{FOCUS}	2.59
Test Pattern	[P]	{PATTERN}	2.59
QA	[Q]*	{QA x}	2.70
Raster Pattern	[R]	{RASTER}	2.59
Cycle	[V]	{CYCLE}	2.21

* On the French version, replace the [Q] key with the [A] key.

** On the French and Italian versions, press the [,] key for test [M].

2.13 TROUBLESHOOTING WITH THE SYSTEM TEST

The System Test automatically runs the following tests from the service ROMs:

- a. CPU Test
- b. RAM Test
- c. ROM Test
- d. External ROM Test
- e. Beeper Test
- f. CRT Test
- g. Timer Test
- h. Keyboard Test
- i. HP-IB Long Test

To run the System Test, press [A]* if the service ROMs are in control, or type in {SYSTEM} if the BASIC system is in control.

After running the System Test, run the XRAM test. The XRAM test is ??? needed to check the rest of the internal RAM.

2.14 Results of the System Test

- The message {SYSTEM TEST BEGINS} is displayed, then the nine individual tests are run in the order listed in paragraph 2.13.
- If a problem is found during any of the tests in the System Test, the appropriate message appears, the individual test is terminated, and the next test is begun.
- The message {SYSTEM TEST ENDS} appears after all tests are run.

If the service ROMs find a bad IC during the System Test, they display a message identifying the IC, then skip to the next test. If a bad IC is identified, replace the logic PCA.

Note: The service ROMs may indicate that more than one IC is bad. If so, replace the logic PCA, and run the System Test after replacement.

If the computer appears to "die" during any test, replace the logic PCA. For assistance in troubleshooting problems that the steps above do not correct, refer to paragraphs 2.7 and 2.8.

2.15 RAM Test Diagnosis

If the message {RAM n BAD! or {2 RAM n BAD!} appears, replace the logic PCA.

* On the French keyboard, press [Q] for the SYSTEM test.

Section II: Troubleshooting and Repair

2.16 ROM Test Diagnosis

If the {ROM n BAD!} message appears replace the logic PCA.

2.17 Beeper Test Diagnosis

If the beeper is not operating properly, try replacing the logic PCA. If this does not result in proper operation, replace the speaker.

2.18 CRT Test Diagnosis

If any of the following occur, troubleshoot the video monitor:

- The monitor screen does not go blank at step (d) of the CRT Test.
- The monitor does not go entirely white at step (i) of the CRT Test.
- Test pattern 4 is not displayed as shown in figure 2-10.

If the monitor seems to function correctly, or CRT test pattern 5 is not displayed correctly, replace the logic PCA.

2.19 Timer Test Diagnosis

If the message {TIMER BAD!} appears, replace the logic PCA.

2.20 Keyboard Test Diagnosis

If one of the following messages appears, refer to paragraph 2-47:

- {NO KEY!}
- {KEY BAD!}
- {KEY STUCK!}

2.21 HP-IB Test Diagnosis

If any error messages occur, refer to paragraph 2.26 and troubleshoot the HP-IB Interface.

2.22 TROUBLESHOOTING WITH THE CYCLE TEST

The Cycle Test runs and automatically repeats the System Test (refer to paragraph 2.14) continuously.

2.23 HOW TO RUN THE CYCLE TEST

To run the Cycle Test, press [V] if the Service ROM is in control, or type in {CYCLE} if the BASIC system is in control.

To terminate the Cycle Test, press any key within 3 seconds after the message {SYSTEM TEST ENDS} appears.

The results of the Cycle Test are the same as the results of the System Test, but any messages are repeated until the test is terminated.

2.24 COMPLETION OF THE SYSTEM TEST

The System Test does not actually check the entire HP-86 system. It is therefore recommended that you perform the External RAM Test along with the System Test to finish testing the HP-86. The External RAM Test checks the operation of the upper internal RAM, (even though it is called external) as well as any plug-in RAM which may be present. See the appropriate paragraph for details on the running of this test.

2.25 TROUBLESHOOTING WITH THE HP-IB INTERFACE TEST

The HP-IB test checks the built-in HP-IB interface.

The HP-IB switch located at the back of the computer on the Logic PCA consists of 10 elements serving three functions:

- Segments 8, 9, and 10 (SC0, SC1, and SC2) are used to set the interface select code for the HP-IB interface.
- Segments 3 through 7 (A0, A1, A2, A3, and A4) are used to set the computer's talk/listen address.
- Segment 2 (CTRL) is used to change the computer's normal status as system controller.
- Segment 1 is not used.

Before running the short HP-IB test, make sure that the HP-IB Service ROM is installed in the computer and that the HP-IB switches (internal to the computer) are set to controller, select code 7, address 21 (see figure 2-3). Press [H] if the Service ROM is in control or type in {HPIB x} if the BASIC system is in control. The parameter x must be an odd integer.

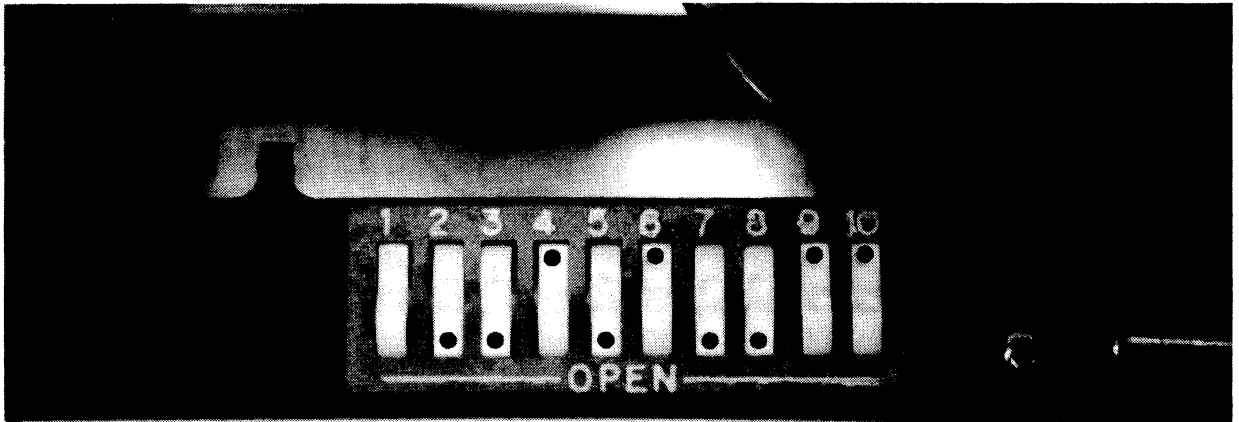

Figure 2-3. HP-IB Switch Settings

2.26 Results of the Short HP-IB Test

One of the following messages appears:

- {HPIB SHORT TEST DONE} indicates that the HP-IB circuitry is probably OK.

Section II: Troubleshooting and Repair

- {HPIB BAD #} indicates that the HP-IB select code is not set to 7 if #=a. Any other value for # indicates that either the translator IC or the processor IC may be bad. Replace the logic PCA.
- {CONTROL LINE BAD} indicates that the either the translator IC or the processor IC may be bad. Replace the logic PCA.
- {DATA LINE BAD} indicates the either the translator IC or the processor IC may be bad. Replace the logic PCA.
- {SWITCHES BAD} indicates that the HP-IB switch internal to the HP-86B may be bad. Recheck the switch settings. Replace the logic PCA.

2.27 Troubleshooting With the Long HP-IB Test

The long version of the HP-IB test contains all of the tests of the short version. It also exercises most of the functions of the interface to provide a very thorough test.

Before running the long HP-IB test, perform the following steps:

- a. Set the segments of S1 on the HP 82937A HP-IB Interface module PCA to non-controller, select code 6, address 20 (see figure 2-4).
- b. Install the HP 82937A HP-IB Interface module into one of the module ports on the HP-86B back panel.
- c. Connect the HP 82937A HP-IB Interface module cable to the HP-IB connector on the backpanel of the computer.

To run the long HP-IB test, press [I] if the service ROM is in control or type in {HPIB s} if the BASIC system is in control. The parameter "s" must be an even integer to access this test.

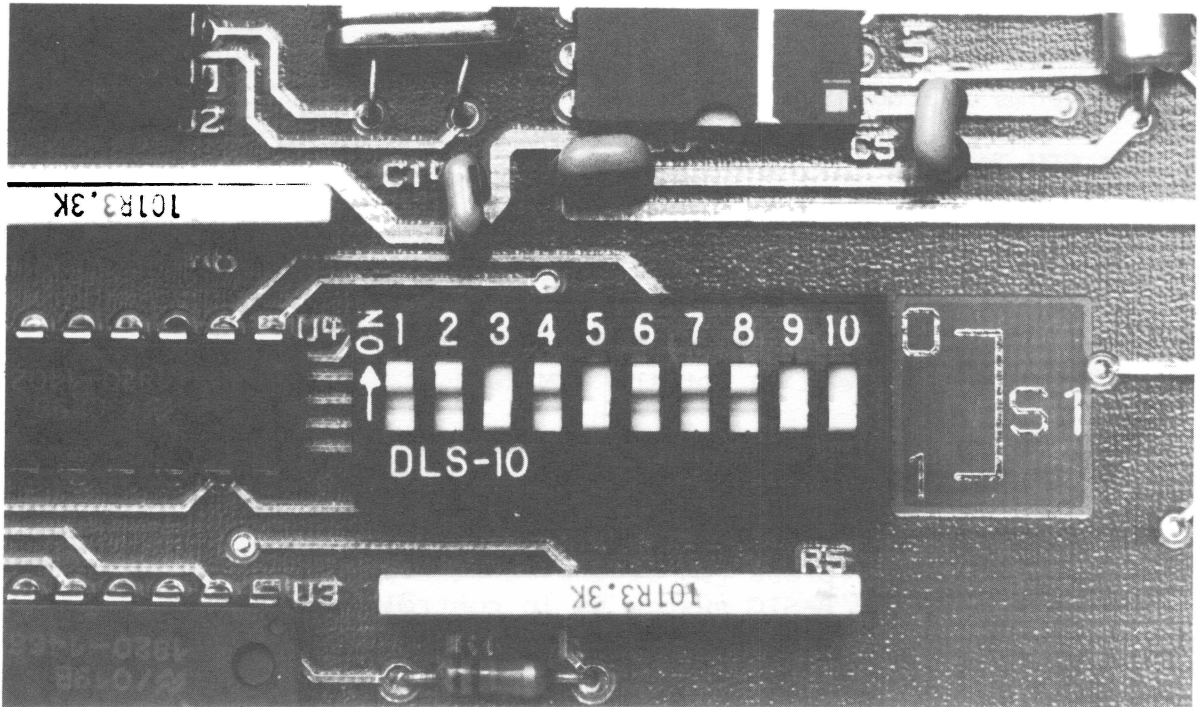

Figure 2-4. S1 Setting on the HP 82937A PCA

2.28 Results of the Long HP-IB Test

One of the following messages will be displayed:

- {HP-IB LONG TEST DONE} indicates that the HP-IB circuitry is probably OK.
- {HP-IB BAD A} indicates that the HP 82937A select code is not set to 6.
- The other messages are identical to the short test messages except for various letters. However, for the purposes of assembly-level service they can be ignored and you should respond as described in paragraph 2-27.

2.29 USING THE HEAT TEST

The Heat Test turns the monitor on full so that the entire screen is lighted and simultaneously runs a continuous and repeating series of IC checks. The Heat Test runs the specified number of hours (default is 48 hours) or until any key is pressed.

The IC checks include the following:

- a. The CPU Test.
- b. The status bits in the CRT controller and keyboard controller ICs.
- c. The RAM Test.
- d. A checksum of the ROM ICs. (The checksum is a simplified signature analysis; this check is not the ROM Test.)

2.30 How to Run the Heat Test

To run the Heat Test, press [N] if the service ROM is in control, or type in {HEAT} if the BASIC system is in control. To terminate the test, press any key.

2.31 Results of the Heat Test

- When the Heat Test is begun, the message {HEAT TEST BEGINS} is displayed and the monitor is turned on full.
- Each time one cycle of the test is completed (about every 25 seconds), the monitor momentarily goes blank.
- If a problem is found in any IC during the test, the monitor goes blank, the appropriate message indicating the bad IC is displayed, and the test is terminated.
- If no problem is found, the Heat Test runs until you terminate it. To do so, press any key; the message {HEAT TEST ENDS} and the elapsed time in hours will be displayed within 21 seconds after you press the key.

2.32 TROUBLESHOOTING WITH THE CPU TEST

The CPU Test checks the CPU by performing machine level instructions and comparing the results to what they should be. Note that since most of the CPU must be OK in order to obtain the {SERVICE ROM} message, in effect the CPU Test checks only a portion of the CPU.

2.33 How to Run the CPU Test

To run the CPU Test, press [B] if the Service ROM is in control, or type in {CPU} if the BASIC system is in control.

2.34 Results of the CPU Test

One of the following messages appears:

- {CPU OK} indicates that the CPU is probably OK.
- {CPU BAD!} indicates that the CPU is probably bad.
- {CPU BAD!} or {n RAM BAD! (character)} indicates that a failure has been found during an attempt by the CPU to store data into RAM. When this message appears, either the CPU or the RAM controller or a RAM IC may be bad. Replace the logic PCA.

2.35 TROUBLESHOOTING WITH THE RAM TEST

The RAM Test checks the RAM controller IC and the first 32K addresses of RAM ICs by filling them with alternate 1s and 0s and reading back the results to see if the contents have been changed. If an error is found in one bit or only a few bits at a particular address, the message will indicate that the corresponding RAM IC is bad. If an error is found in all eight bits at a particular address, the message will indicate that the RAM controller is bad.

The RAM test also checks the extended memory controller (EMC) and an error message is displayed if it is bad.

In order to check all 128K locations, the XRAM test must also be run.

When run under the control of the service ROMs, this test checks the address register in the RAM controller. When run under the control of the BASIC system, the address register is not checked since doing so would not allow you to continue using the BASIC system.

2.36 How to Run the RAM Test

To run the RAM Test, press [C] if the service ROMs are in control, or type in {RAM} if the BASIC system is in control.

2.37 Results of the RAM Test

Any of the following messages may appear:

- {RAM OK} indicates that the RAM controller and the RAM ICs are probably OK.
- {2RAM OK} indicates that the RAM controller and the RAM ICs are probably OK.
- {RAM CONTROL BAD!} indicates that the RAM controller, on the logic PCA, is probably bad.
- {RAM n BAD!} indicates that a RAM IC (on the logic PCA) is probably bad.
- {2RAM n BAD!} indicates that a RAM IC (on the logic PCA) is probably bad.
- {EMC OK!} indicates that the extended memory controller is probably OK.
- {EMC BAD!} indicates that the extended memory controller (on the logic PCA) is probably bad.

2.38 TROUBLESHOOTING WITH THE EXTERNAL RAM TEST

The External RAM Test checks the RAM controller IC, the higher-address internal RAM chips (from 32K to 128K), and the RAM chips contained in the HP 82907A/8A/9A Memory Modules. The check is performed in the same way that the RAM Test checks the internal RAM controller and ICs.

When run under the control of the service ROMs, this test checks the address register in the RAM controller. When run under the control of the BASIC system, the address register is not checked. Therefore, running the External RAM Test under control of the service ROMs provides a more complete check than running the test under the control of the BASIC system.

2.39 How to Run the External RAM Test

- a. With the power to the computer off, insert the memory module into the module ports in the back of the computer. (This need not be done to check the internal RAM above the first 96K.)
- b. Switch the computer on.
- c. When the {SERVICE ROM} message appears, press [L]. If the BASIC system is in control, you can run the External RAM Test by typing in {XRAM}.

2.40 Results of the External RAM Test

Any of the following messages may appear:

- {XRAM OK THRU 00096} indicates that the internal RAMs are OK; no memory module is plugged in.
- {XRAM CONTROL BAD!} indicates that the RAM controller in the memory module is probably bad.
- {XRAM BAD THRU 000nn} indicates that a RAM IC in the memory module is bad provided that nn is greater than 96. The test procedure starts in the memory module in the topmost I/O port and checks blocks of 32K at a time.

2.41 TROUBLESHOOTING WITH THE ROM TEST

The ROM Test checks the system ROMs by performing a signature analysis on their contents. The ROM contents are treated as data; the test manipulates this data and checks for the correct results.

2.42 How to Run the ROM Test

To run the ROM Test, press [D] if the service ROMs are in control, or type in {ROM} if the BASIC system is in control.

2.43 Results of the ROM Test

For each of the four System ROM ICs, one of the following messages will be displayed.

{ROM n OK} or {ROM n BAD!}

The particular ROM IC checked is designated by the number n: ROM 0-3 correspond to ICs U32-35.

Note: If the message {RAM BAD! ROM TEST ABORTED!} appears, the ROM Test has been aborted because the RAM controller or a RAM IC is bad. Replace the logic PCA.

2.44 TROUBLESHOOTING WITH THE EXTERNAL ROM TEST

The External ROM Test checks the internal mass storage, electronic disc, graphics, and language ROMs and any plug-in enhancement ROMs by performing a signature analysis on their contents. This check is performed in the same way that the ROM test checks the system ROMs.

Since the External ROM Test uses the computer's RAM, run the System Test (or at least the RAM Test) before running the External ROM Test to make sure that the internal lowest 32K of RAM is OK.

2.45 How to Run the External ROM Test

- a. If you are checking the internal enhancement ROMs, turn the power to the computer off, remove all ROMs except the service ROMs from the ROM drawer, and insert the ROM drawer into one of the module ports on the back panel. However, if you are checking an external ROM, install it in the ROM drawer along with the service ROMs.

- b. Switch the computer on.
- c. When the {SERVICE ROM} message appears, press [M]. If the BASIC system is already in control, you can run the External ROM Test by typing in {XROM}.

2.46 Results of the External ROM Test

One of the messages shown below will appear for the internal enhancement ROMs and for any external ROM present in the ROM drawer. The number {nnn} appearing in the message designates which ROM has been checked. To identify the particular ROM from the code, refer to table 2-3.

- {XROM nnn OK} indicates that the designated ROM is probably OK.
- {XROM nnn BAD!} indicates that the designated ROM is probably bad.

Note: If the message {RAM BAD! XROM TEST ABORTED!} appears, the External ROM Test has been aborted because the RAM controller or a RAM IC is bad. Replace the logic PCA and rerun the XROM test.

Table 2-3. Enhancement ROM Codes

nnn	ROM	Location
001	Graphics	Logic PCA
024	Language	Logic PCA
208	Mass Storage	Logic PCA
209	Electronic Disc	Logic PCA
224	System Service	ROM drawer
225	HP-IB Service	ROM drawer
231	Advanced Programming 1	ROM drawer
232	Advanced Programming 2	ROM drawer
040	Assembler	ROM drawer
192	I/O	ROM drawer
175	Matrix 1	ROM drawer
176	Matrix 2	ROM drawer
240	Plotter	ROM drawer

2.47 KEYBOARD TROUBLESHOOTING

To help determine what may be wrong with the keyboard (if anything), run the System Test from the System Service ROM. It is essential that you run at least the CPU, RAM, and ROM Tests before running the Keyboard Test, since the Keyboard Test uses the computer's ROM and RAM. If one of those tests indicates a bad IC, replace the logic PCA, and run the System Test once again. After all three tests have been passed, you need run only the Keyboard Test to check whether replacing a part has corrected a keyboard problem.

2.48 How to Run the Keyboard Test

The Keyboard Test requires you to press certain keys. In particular, at certain times you will press and hold the [CTRL] [SHIFT] key while the next key or keys are pressed. The same is true for the [CAPS LOCK] key, except that you need not hold it down, since it locks in position. To release the [CAPS LOCK] key, press it again. These keys act differently, as noted, with [CAPS LOCK] only on the English language version. The service ROM will prompt you with messages indicating whether these are to be down or up while pressing the next keys.

Since the Keyboard Test uses the computer ROM and RAM, do not run the Keyboard Test alone unless the computer has already passed the CPU, ROM, and RAM Tests. If the Keyboard Test is run with a bad ROM or RAM IC, the computer may appear to "go dead" during the test.

To begin the Keyboard Test, press [K] if the Service ROM is in control, or type in {KBD} if the BASIC system is in control. The keys to be pressed are indicated next to their prompting messages in table 2-4.

Note 1: The Keyboard Test was designed around the English language keyboard layout. Some prompt messages will ask for the wrong key according to a foreign language version, since the same key position corresponds to a different displayed character. Follow the instructions of the test, but substitute the correct key to enter by referring to the Key Sequence for Keyboard Test, figure 2-5.

Note 2: At the beginning of the test, make sure that the [CTRL], [CAPS] and [SHIFT] keys are not pressed and that the [CAPS LOCK] key is released to the same level as the other keys. If this is not done, the results of the test will be invalid.

In steps 4 through 7 and 9, each key is entered when it is pressed. In steps 1 through 3 and 8, each key is entered when it is released.

2.49 Results of the Keyboard Test

The following messages appear if no problem is found:

- {OK} following steps 1 through 9 indicates that the keys expected have been entered.
- {KEY TEST ENDS} indicates that the Keyboard Test has been completed.

If a problem is found, the test is terminated and one of the following messages appears:

- {KEY CONTROL BAD!} indicates that the keyboard controller is probably bad. Replace the logic PCA.
- {NO KEY!} indicates that no key has been entered. This message appears about 30 seconds after the key is first expected.
- {KEY STUCK!} indicates that a key appears to be stuck in the pressed position. This message appears about 30 seconds after the key is pressed.
- {KEY BAD!} indicates that the key entered is not the key expected. This message appears after an incorrect key has been entered eight times.

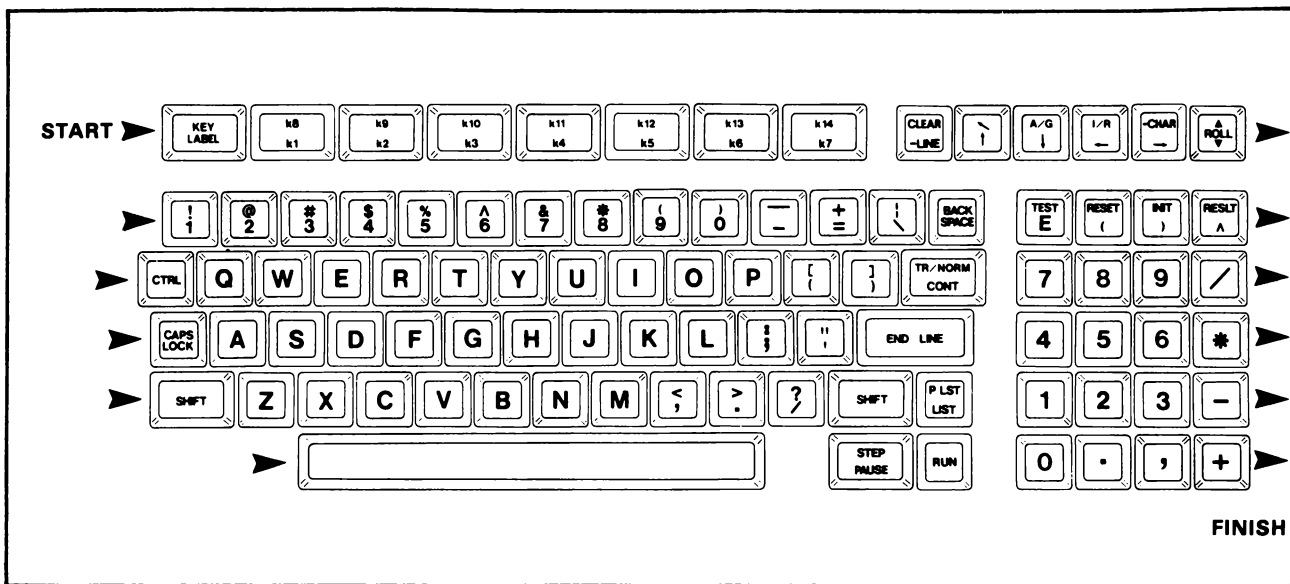

Figure 2-5. Key Sequence for Keyboard Test

Table 2-4. Keyboard Test*

STEP	PROMPTING MESSAGE	ACTION
1	{KEY TEST: {CTRL, CAPS, SHIFT UP; PRESS A}	Until otherwise indicated in subsequent prompting message, the [CTRL] and [SHIFT] keys should not be pressed, and the [CAPS LOCK] key should be released to the same level as the other keys. Press [A].
2	{PRESS A K1}	Press [A] [K1].
3	{PRESS A K1}	Press [A] [K1] again.
4	{CAPS DOWN; PRESS A K1}	Press and lock the [CAPS LOCK] key, then press [A] [K1].
5	{CAPS UP; PRESS A K1}	Press and unlock the [CAPS LOCK] key, then press [A] [K1].
6	{CTRL DOWN; PRESS A K1}	While holding down the [CTRL] key, press [A] [K1].
7	{CTRL UP; PRESS A K1}	Release the [CTRL] key, then press [A] [K1] again.
8	{SHIFT DOWN; PRESS KEYS}	While holding down the [SHIFT] key press each of the keys in the order shown in figure 2-5. Do not press the [CTRL] or [CAPS LOCK] key during this sequence test.
9	{SHIFT UP; PRESS KEYS}	Release the [SHIFT] key, then again press each of the keys in the order shown in figure 2-5. Do not press the [CTRL], [CAPS LOCK], or [SHIFT] key during this sequence test.

* This table and table 2-5 are for the English version of the Service ROM and differ for the foreign version. Tables 2-11 and 2-12 at the end of this section are the corresponding tables for foreign keyboards.

If the keyboard is not working properly, one of the messages listed in table 2-5 will be displayed when the computer is switched on (with

the service ROMs installed) or during the Keyboard Test. For each message, the table shows the reason for the message and the recommended action to correct the problem. To determine the key(s) corresponding to the character entered following a {KEY STUCK!} or {KEY BAD!} message, refer to table 2-7. To determine the key expected from the mnemonic following certain other messages, refer to table 2-6.

Note: Remember that some keys (digits, for example) are duplicated.

Table 2-5. Keyboard Test Diagnosis*

MESSAGE	REASON	DIAGNOSIS/REPAIR
{KEY CONTROL BAD!}	Bad controller.	Replace logic PCA.
{PRESS KEY}	Service ROM does not recognize that you have pressed a key within 15 seconds after prompt.	Press the key again.
{NO KEY!}	Service ROM does not recognize a pressed key within 15 seconds after a {PRESS KEY} message.	Refer to No Key Entry paragraph 2.50.
{RELEASE KEY!}	Service ROM does not recognize that you have released a key within 15 seconds after you pressed it.	Release key.
{KEY STUCK! (character entered)}	Service ROM does not recognize that a key was released within 15 seconds after the {RELEASE KEY} message.	Refer to Key Stuck paragraph 2.55.
{KEY BAD! (character entered)}	Character entered different from character expected.	If message occurred in key sequence test see No Key Entry, paragraph 2.50; else refer to Wrong Character Entered, 2.51.

*See note for table 2-4.

Table 2-5. Keyboard Test Diagnosis (Continued)

MESSAGE	REASON	DIAGNOSIS/REPAIR
{(key expected)}	Character entered does not correspond to key expected.	<ol style="list-style-type: none"> 1. Press expected key. If message appears again, refer to Wrong Character Entered, paragraph 2.51; if not, proceed with step 2 below. 2. Press next key in sequence. If message appears again, proceed with step 3 below; if not, continue with key sequence. 3. Press expected key twice. If no message appears, refer to No Key Entry, paragraph 2.50; if message appears, indicating next key in sequence, press that key and continue with key sequence.

Table 2-5. Keyboard Test Diagnosis (Continued)

MESSAGE	REASON	DIAGNOSIS/REPAIR
{SHIFT UP} {(key expected)}	[SHIFT] key appears to be down.	Press expected key again with [SHIFT] key up.
{SHIFT DOWN} {(key expected)}	[SHIFT] key appears to be up.	Press expected key again with [SHIFT] key down.
{CAPS UP} {(key expected)}	[CAPS LOCK] key appears to be down.	Press expected key again with [CAPS LOCK] key up.
{CAPS DOWN} {(key expected)}	[CAPS LOCK] key appears to be up.	Press expected key again with [CAPS LOCK] key down.
{CTRL UP} {(key expected)}	[CTRL] key appears to be down.	Press expected key again with [CTRL] key up.
{CTRL DOWN} {(key expected)}	[CTRL] key appears to be up.	Press expected key again with [CTRL] key down.

2.50 No Key Entry

To locate the problem when pressing a key has no effect:

- a. Make sure that both ribbon cables are properly aligned in their connectors on the keyboard PCA.
- b. Make sure that both ribbon cables are properly aligned in their connectors on the logic PCA.
- c. Look up the row and column lines for the bad key in table 2-8.
- d. With the key pressed, check for continuity between the row and column pins for the bad key at the keyboard controller. (See the logic PCA schematic diagram to determine the pin locations of the row and column lines at the keyboard controller.) If continuity is OK, replace the logic PCA.
- e. Check for continuity along the row line for the bad key between the keyboard controller and the pins of J1 on the bottom of the keyboard PCA. Check for continuity along the column line for the bad key between the keyboard controller and the pins of J2 on the bottom of the keyboard PCA. If no continuity exists on either line, check the cable connectors on the keyboard PCA. If either is bad, replace the keyboard assembly; otherwise, replace the logic PCA.

Note: If the connectors have been bent, a connector pin may be broken or making intermittent contact.

- f. Disconnect the keyboard PCA from the logic PCA and remove the keyboard assembly from the computer. Check for continuity between the key contact pins (on the back of the keyboard PCA) for the bad key while the key is pressed.
 - If continuity OK, replace the keyboard assembly.
 - If no continuity, remove the key cap (refer to section III), and inspect the key plunger and the key contacts.
 - i) If at least three of the four fingers of the slotted key contact appear to close against the solid key contact when the plunger is pressed, clean the key contacts. (Refer to section III.)
 - ii) If the key contacts do not appear to close, or if cleaning the key contacts does not result in continuity between them, replace the plunger and/or the key contacts. (Refer to section III.)

2.51 Wrong Character Entered

Note: If the [SHIFT], [CAPS LOCK], and [CTRL] keys were not all released before step 1 of the Keyboard Test, the results of the test are not valid.

If pressing a key results in entering the wrong character:

- If a {KEY BAD!} message was preceded by a {SHIFT UP}, {CAPS UP}, or {CTRL UP} message, refer to paragraph 2.53.
- If a {KEY BAD!} message was preceded by a {SHIFT DOWN}, {CAPS DOWN}, or {CTRL DOWN} message, refer to paragraph 2.54.
- If a {KEY BAD!} message was preceded only by a mnemonic for the key expected, refer to paragraph 2.52.
- If only a {(key expected)} mnemonic appears, refer to paragraph 2.52.

2.52 Wrong Character Entered; [SHIFT], [CAPS LOCK], and [CTRL] OK.

To locate the problem when pressing a key results in entering the wrong character:

- a. Make sure that the ribbon cables are properly aligned in their connectors on the logic PCA. Refer to section III, paragraph 3.5.
- b. Try replacing the logic PCA.
- c. Try replacing the keyboard assembly.

Section II: Troubleshooting and Repair

2.53 Wrong Character Entered; [SHIFT], [CAPS LOCK], or [CTRL] Apparently Down

To locate the problem when pressing a key results in entering the wrong character because the [SHIFT], [CAPS LOCK], or [CTRL] key appears to be down:

- a. Make sure that both ribbon cables are properly aligned in their connectors on the logic PCA. (Refer to section III, paragraph 3-5.)
- b. Disconnect the keyboard PCA from the logic PCA and check for a short between pin 11 of J1 (GRD) on the bottom of the keyboard PCA and pin 11 ([SHIFT]), pin 10 ([CAPS LOCK]), or pin 4 ([CTRL]) of J2 on the bottom of the keyboard PCA. If not shorted, install a new logic PCA in the computer.
- c. Check for continuity between the key contact pins (on the back of the keyboard PCA) for the bad key.

Note: Remember that there are two [SHIFT] keys.

- If shorted, replace the key plunger and/or the key contacts. (Refer to section III.)
- If not shorted, replace the keyboard assembly.

2.54 Wrong Character Entered; [SHIFT], [CAPS LOCK], or [CTRL] Apparently Up

To locate the problem when pressing a key results in entering the wrong character because the [SHIFT], [CAPS LOCK], or [CTRL] key appears to be up:

- a. Make sure that both ribbon cables are properly aligned in their connectors on the logic PCA.
- b. Check for continuity between the pin at the controller (refer to step c for the pin number) and pin 11 ([SHIFT]), pin 10 ([CAPS LOCK]), or pin 4 ([CTRL]) of J2 on the bottom of the keyboard PCA. If no continuity, check J1. If bad, replace the keyboard assembly; otherwise, replace the logic PCA.

- c. Disconnect the keyboard from the logic PCA and remove the keyboard assembly from the computer. With the key down, check for continuity between the key contact pins (on the back of the keyboard PCA) of the bad key.
 - If continuity OK, replace the keyboard assembly.
 - If no continuity, remove the key cap (refer to section III), and inspect the key plunger and key contacts.
 - If at least three of the four fingers of the slotted key contact appear to close against the solid key contact when the plunger is pressed, clean the key contacts.
 - If the key contacts do not appear to close, or if cleaning the key contacts does not result in continuity between them, replace the plunger and/or the key contacts.

2.55 Key Stuck

To locate the problem when a key appears to be stuck:

- a. Disconnect the keyboard PCA from the logic PCA and check for a short between the pin of J1 (on the bottom of the keyboard PCA) for the row line of the bad key and the pin of J2 for the column line of the bad key. If not shorted, replace the logic PCA.
- b. Check for continuity between the key contact pins (on the back of the keyboard PCA) for the bad key.
 - If shorted, replace the key plunger and/or the key contacts.
 - If not shorted, replace the keyboard assembly.

Table 2-6. Mnemonics and Key Lines for Keys Expected *

SERVICE ROM MNEMONIC	KEY EXPECTED	ROW LINE	COLUMN LINE
{'}	[' "]	R6	C2
{(}	[([]	R7	C2
{(}	[(RESET]	R8	C6
{)}	[) INIT]	R7	C6
{)}	[)]]	R7	C3
{*}	[*]	R6	C6
{+}	[+]	R5	C5
{,}	[,] or [, <]	R5	C0
{-L}	[-LINE CLEAR]	R9	C1
{-}	[-]	R8	C2
{-}	[-]	R5	C6
{.}	[.] or [.] >]	R5	C1
{/}	[/ ?]	R5	C2
{/}	[/]	R6	C7
{0}	[0] or [0)]	R8	C1
{1}	[1] or [1 !]	R1	C7
{2}	[2] or [2@]	R1	C6

* In this table, as in the keyboard test, reference has been made specifically to the English language version keys. Thus, when troubleshooting a foreign version keyboard, refer to the English version keyboard, shown in figure 2-5, for the location of the key expected, according to the service ROMs message, and then look that mnemonic up in this and the following tables to find the correct row/column location for a faulty key or for the correct key to press for a particular test.

**Table 2-6. Mnemonics and Key Lines for Keys Expected
(Continued) ***

SERVICE ROM MNEMONIC	KEY EXPECTED	ROW LINE	COLUMN LINE
{3}	[3] or [3 #]	R1	C5
{4}	[4] or [4 \$]	R1	C4
{5}	[5] or [5 %]	R1	C3
{6}	[6] or [6 ^]	R1	C2
{7}	[7] or [7 &]	R1	C1
{8}	[8] or [8 *]	R1	C0
{9}	[9] or [9 (]	R8	C0
{;}	[; :]	R6	C1
{=}	[= +]	R8	C3
{A}	[A]	R3	C7
{BS}	[BACK SPACE]	R8	C5
{B}	[B]	R4	C2
{C>}	[> -CHAR]	R9	C5
{CN}	[CONT]/[TR/NORM]	R7	C4
{C^}	[↑\]	R9	C2
{Cv}	[↓ A/G]	R9	C3

* See footnote on page 2-38.

**Table 2-6. Mnemonics and Key Lines for Keys Expected
(Continued) ***

SERVICE ROM MNEMONIC	KEY EXPECTED	ROW LINE	COLUMN LINE
{Cv}	[←I/R]	R9	C4
{C}	[C]	R4	C4
{D}	[D]	R3	C5
{EN}	[END LINE]	R6	C3
{E}	[E]	R2	C5
{E}	[E TEST]	R7	C5
{F}	[F]	R3	C4
{G}	[G]	R3	C3
{H}	[H]	R3	C2
{I}	[I]	R2	C0
{J}	[J]	R3	C1
{K}	[K]	R3	C0
{LA}	[LABEL KEY]	R0	C6
{LI}	[LIST PLST]	R6	C4
{L}	[L]	R6	C0
{M}	[M]	R4	C0
{N}	[N]	R4	C1

* See footnote on page 2-38.

**Table 2-6. Mnemonics and Key Lines for Keys Expected
(Continued) ***

SERVICE ROM MNEMONIC	KEY EXPECTED	ROW LINE	COLUMN LINE
{O}	[O]	R7	C0
{PS}	[PAUSE STEP]	R5	C3
{P}	[P]	R7	C1
{Q}	[Q]	R2	C7
{RU}	[RUN]	R5	C4
{Rv}	[ROLL]	R9	C6
{R}	[R]	R2	C4
{S}	[S]	R3	C6
{T}	[T]	R2	C3
{U}	[U]	R2	C1
{V}	[V]	R4	C3
{W}	[W]	R2	C6
{X}	[X]	R4	C5
{Y}	[Y]	R2	C2

* See footnote on page 2-38.

Table 2-6. Mnemonics and Key Lines for Keys Expected (Continued) *

SERVICE ROM MNEMONIC	KEY EXPECTED	ROW LINE	COLUMN LINE
{Z}	[Z]	R4	C6
{\}	[\]]	R8	C4
{^}	[^ RESLT]	R8	C7
(blank)	[(space bar)]	R4	C7
{k1}	[k1 k8]	R0	C5
{k2}	[k2 k9]	R0	C4
{k3}	[k3 k10]	R0	C3
{k4}	[k4 k11]	R0	C2
{k5}	[k5 k12]	R0	C1
{k6}	[k6 k13]	R0	C0
{k7}	[k7 k14]	R9	C0

* This table is intended to be used with the English language keyboard. To use it with the other language version keyboards, refer to figure 2-5, and figure 2-2 to translate particular characters into those demanded by the (English version) service tests, or to determine the key location of any particular key.

Table 2-7. Key(s) Corresponding to Character Entered *

CHARACTER ENTERED	CORRESPONDING KEY(S)	CHARACTER ENTERED	CORRESPONDING KEY(S)
◀	{ [CTRL] [SHIFT] [2@] or [CTRL] [SHIFT] [2]	π	[CTRL] [O]
◊	[CTRL] [A]	θ	[CTRL] [P]
⊗	[CTRL] [B]	ϵ	[CTRL] [Q]
⊘	[CTRL] [C]	⊖	[CTRL] [R]
◊	[CTRL] [D]	⊗	[CTRL] [S]
⊖	[CTRL] [E]	⊘	[CTRL] [T]
⊗	[CTRL] [F]	⊖	[CTRL] [U]
⊘	[CTRL] [G]	⊗	[CTRL] [V]
⊖	[CTRL] [H]	⊘	[CTRL] [W]
⊗	[CTRL] [I]	⊖	[CTRL] [X]
⊘	[CTRL] [J]	⊗	[CTRL] [Y]
⊖	[CTRL] [K]	⊘	[CTRL] [Z]
⊗	[CTRL] [L]	⊖	[CTRL] [SHIFT] [([]
(blank)	[CTRL] [M]		[CTRL] [\]
τ	[CTRL] [N]	£	[CTRL] [SHIFT] [)]]
			[CTRL] [^ RESULT]

* The character entered column contains the correct character only for the English language version. Refer to figures 2-2 and 2-5 for aid in translating these characters to the proper display characters for each language version.

Table 2-7. Keys(s) Corresponding to Character Entered (Continued) *

CHARACTER ENTERED	CORRESPONDING KEY(S)	CHARACTER ENTERED	CORRESPONDING KEY(S)
+	[CTRL] [SHIFT] [- _]	*	{ [SHIFT] [8 *] or [SHIFT] [8] or [*]
(blank)	[(space bar)]	+	[SHIFT] [= +] or [+]
!	[SHIFT] [1 !] or [SHIFT] [1]	,	[,] or [,]
"	[SHIFT] [' "]	-	[- =] or [-]
#	[SHIFT] [3 #] or [SHIFT] [3]	.	[. >] or [.]
\$	[SHIFT] [4 \$] or [SHIFT] [4]	/	[/ ?] or [/]
%	[SHIFT] [5 %] or [SHIFT] [5]	0	[0)] or [0]
&	[SHIFT] [7 &] or [SHIFT] [7]	1	[1 !] or [1]
'	[' "]	2	[2] or [2]
({ [SHIFT] [9 (] or [SHIFT] [9] or [(RESET]	3	[3 #] or [3]
)	{ [SHIFT] [0)] or [SHIFT] [0] or [) INIT]	4	[4 \$] or [4]
5	[5 %] or [5]	6	[6 ^] or [6]

* See the footnote on page 2-43.

Table 2-7. Key(s) Corresponding to Character Entered (Continued) *

CHARACTER ENTERED	CORRESPONDING KEY(S)	CHARACTER ENTERED	CORRESPONDING KEY(S)
7	[7 &] or [7]	H	[H]
8	[8 *] or [8]	I	[I]
9	[9)] or [9]	J	[J]
:	[SHIFT] [; :]	K	[K]
;	[; :]	L	[L]
	[SHIFT] [,<] or [SHIFT] [']	M	[M]
	[=]	N	[N]
	[SHIFT] [.>] or [SHIFT] [.]	O	[O]
?	[SHIFT] [/ ?]	P	[P]
@	[SHIFT] [2@] or [SHIFT] [2]	Q	[Q]
A	[A]	R	[R]
B	[B]	S	[S]
C	[C]	T	[T]
D	[D]	W	[W]
E	[E]	X	[X]
F	[F]	Y	[Y]
G	[G]	Z	[Z]

* See the footnote on page 2-43.

Table 2-7. Key(s) Corresponding to Character Entered (Continued) *

CHARACTER ENTERED	CORRESPONDING KEY(S)	CHARACTER ENTERED	CORRESPONDING KEY(S)
€	[SHIFT] [([]	o	[SHIFT] [O]
	[\]]	p	[SHIFT] [P]
]]	[SHIFT] [)]]	q	[SHIFT] [Q]
	[^ RESULT]	r	[SHIFT] [R]
-	[SHIFT] [- _]	s	[SHIFT] [S]
a	[SHIFT] [A]	t	[SHIFT] [T]
b	[SHIFT] [B]	u	[SHIFT] [U]
c	[SHIFT] [C]	v	[SHIFT] [V]
d	[SHIFT] [D]	t	[SHIFT] [T]
e	[SHIFT] [E]	v	[SHIFT] [V]
f	[SHIFT] [F]	w	[SHIFT] [W]
g	[SHIFT] [G]	x	[SHIFT] [X]
h	[SHIFT] [H]	y	[SHIFT] [Y]
i	[SHIFT] [I]	z	[SHIFT] [Z]
j	[SHIFT] [J]		[SHIFT] [/]
k	[SHIFT] [K]	:	[SHIFT] [\]]
l	[SHIFT] [L]	}	[SHIFT] [-]
m	[SHIFT] [M]		[SHIFT] [*]
n	[SHIFT] [N]	■	[SHIFT] [+]

* See the footnote on page 2-43.

2.56 TROUBLESHOOTING WITH THE TIMER TEST

The Timer Test activates the test mode in the keyboard controller, which contains the four timers.

2-57. How to Run the Timer Test

To run the Timer Test, press [J] if the service ROMs are in control, or type in {TIMER} if the BASIC system is in control. Since the Timer Test uses the computer's ROM and RAM, do not run the Timer Test alone unless the computer has already passed the CPU, ROM, and RAM Tests. If the Timer Test is run with a bad ROM or RAM IC, the computer may appear to "die" during the test.

In test mode, the keyboard controller uses the keyboard scan to run the timers. Because of this, pressing a key during the Timer Test aborts the test. The Timer Test is begun about 3 seconds after it is selected--that is, after you press [J] (if the Service ROM is in control) or [END LINE] (if the BASIC system is in control). Therefore, be sure that all keys are released by that time.

2.58 Results of the Timer Test

One of the following messages appears:

- {TIMER OK} indicates that the timer is probably OK.
- {TIMER BAD!} indicates that the timer is probably bad.
- {TIMER TEST ABORTED!} indicates that a key was apparently pressed during the Timer Test.

2.59 TROUBLESHOOTING THE VIDEO DRIVER

The service ROMs contain four tests that can be used to troubleshoot the video driver circuitry: the CRT Test; the Focus Pattern; Pincushion, and the Raster Test. You will need to refer to the monitor's service manual for specific troubleshooting and repair procedures.

The CRT test is a combined test: it checks the CRT controller IC and the CRT RAM ICs, and also causes the monitor to display various test patterns. By checking whether each pattern is displayed correctly, you can determine whether the rest of the circuitry is operating properly.

The Focus Pattern, Pincushion Pattern, and Raster tests are subsets of the CRT Test and merely display the focus, pincushion patterns, and a full white screen, respectively. Therefore, only the CRT Test will be described in detail.

2.60 How to Run the CRT Test

To run the CRT Test, press [F] if the service ROMs are in control, or type in {DISPLAY} if the BASIC system is in control.

2.61 Results of the CRT Test

The monitor should display the following patterns:

Note: While the patterns of steps e, g, and i are in the display, you can cause the pattern to remain there indefinitely by pressing any key. Pressing any key again will cause the next pattern to appear.

- a. Vertical bars (CRT test pattern 1), as shown in figure 2-4. These bars remain on the screen for about 15 seconds.

Note: When the CRT Test is first run after turning on the computer, the display may appear garbled before the vertical bars are rolled onto the screen.

- b. A new set of vertical bars, shifted from the previous bars. These bars also remain on the screen for about 15 seconds.
- c. The pattern (CRT test pattern 2) shown in figure 2-5. This pattern remains on the screen for about 15 seconds.
- d. Blank screen (signaled by a beep). This remains for about 1 second.
- e. The focus pattern {B}s and {J}s (CRT test pattern 3) shown in figure 2-6. This remains for about 3 seconds.
- f. Blank screen (signaled by a beep). This remains for about 3 seconds.
- g. The pincushion test pattern (CRT test pattern 4) shown in figure 2-7. This remains for about 3 seconds.

- h. Blank screen (signaled by a beep). This remains for about 3 seconds.
- i. Entirely white screen (signaled by a beep). This remains for about 3 seconds.
- j. Blank screen (signaled by a beep). This remains for about 3 seconds.
- k. Four lines containing two copies of the HP-86B character set, as shown in figure 2-10: one in standard video, the other in inverse video. The actual characters presented will be dependent on the language version of the HP-86B. This is a quick way to ensure that the language ROM is selecting the proper version, by matching the display with the known display format for the version under test. Refer to figure 2-2.

If no problems are found during the CRT Test, the message {CRT TEST ENDS} appears. Otherwise, one of the following messages is (possibly) displayed:

- {CRT RAM n BAD!} indicates that the CRT RAM designated by the number n is probably bad or that the CRT RAM designated by the number n + 4 is probably bad. Replace the logic PCA.
- {CRT CONTROL BAD!} indicates that the CRT controller is probably bad. Replace the logic PCA.

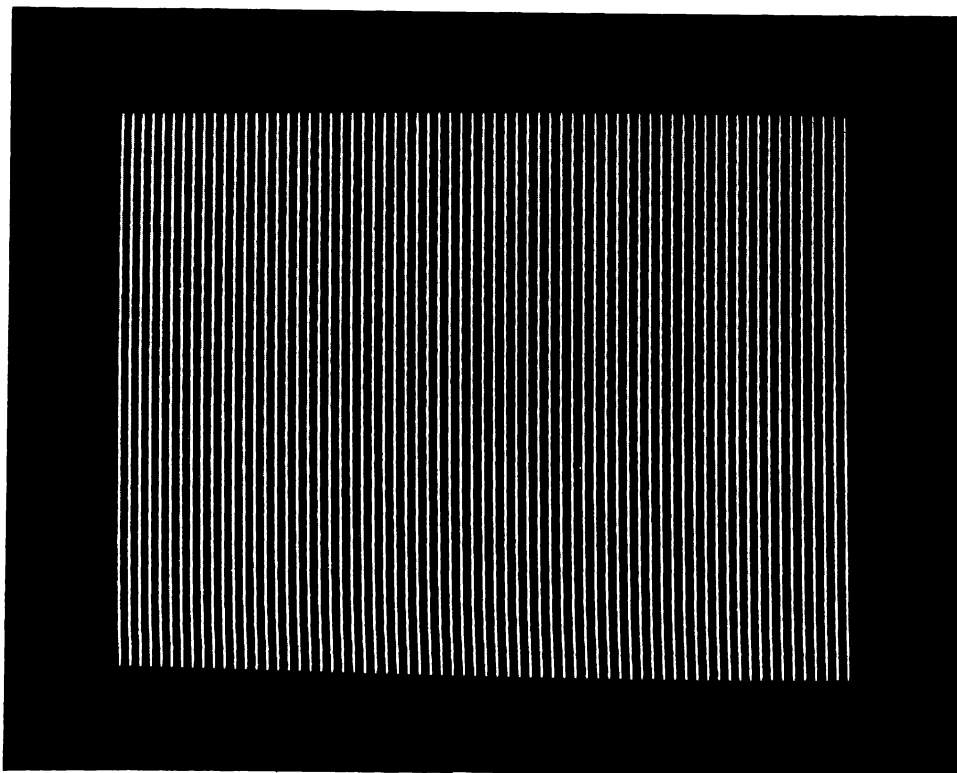

Figure 2-6. CRT Test Pattern 1

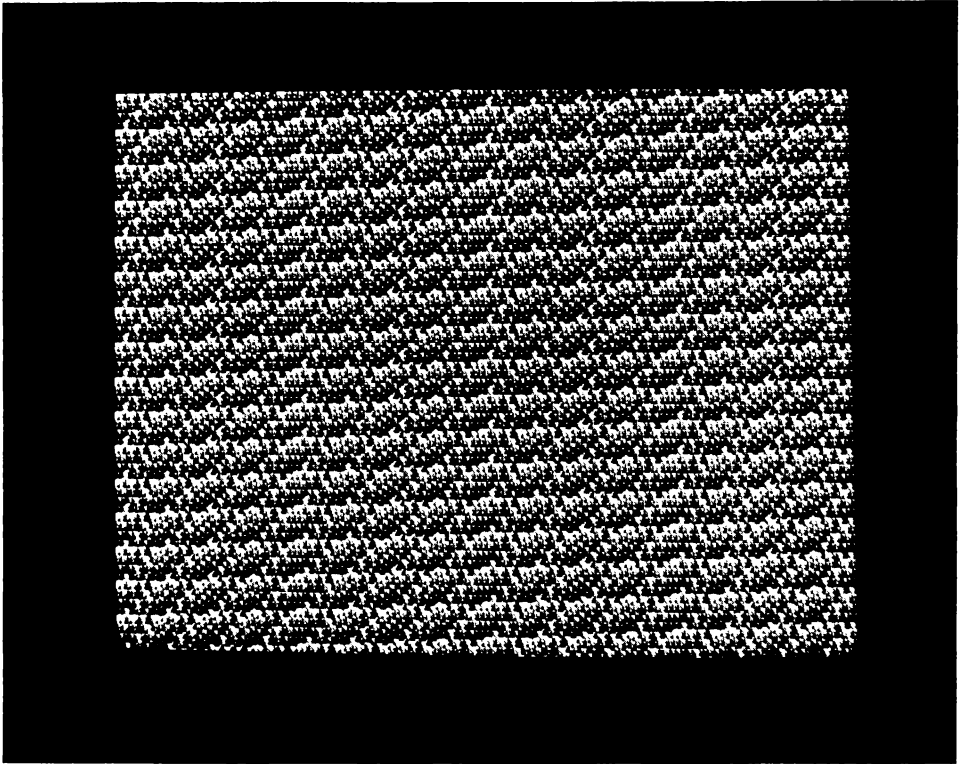

Figure 2-7. CRT Test Pattern 2

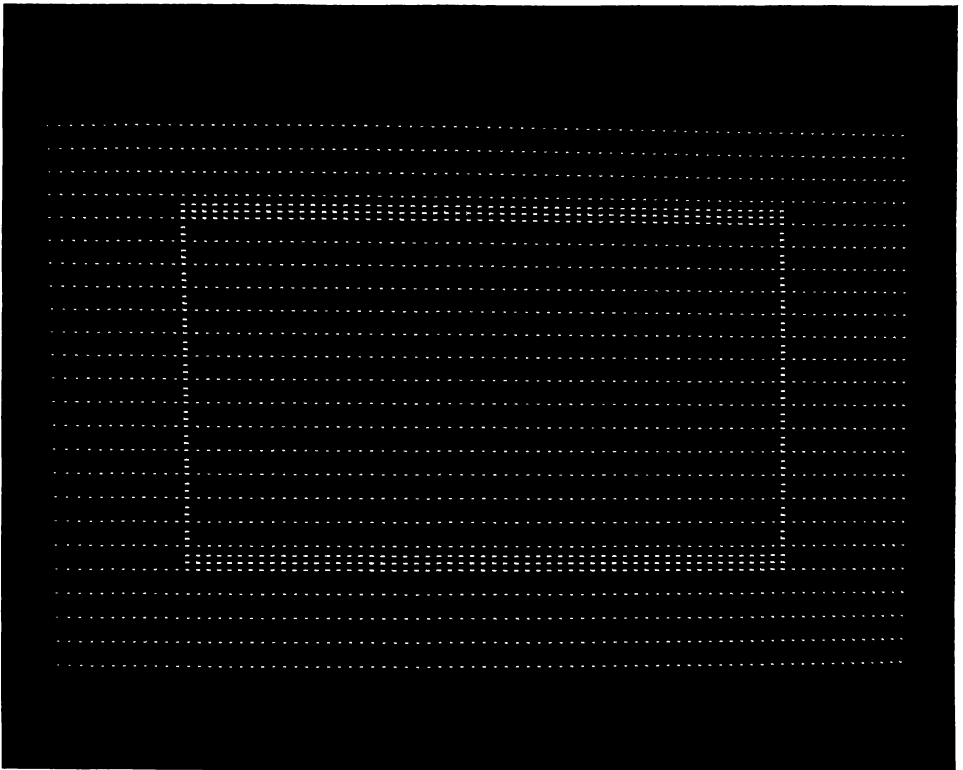

Figure 2-8. CRT Test Pattern 3

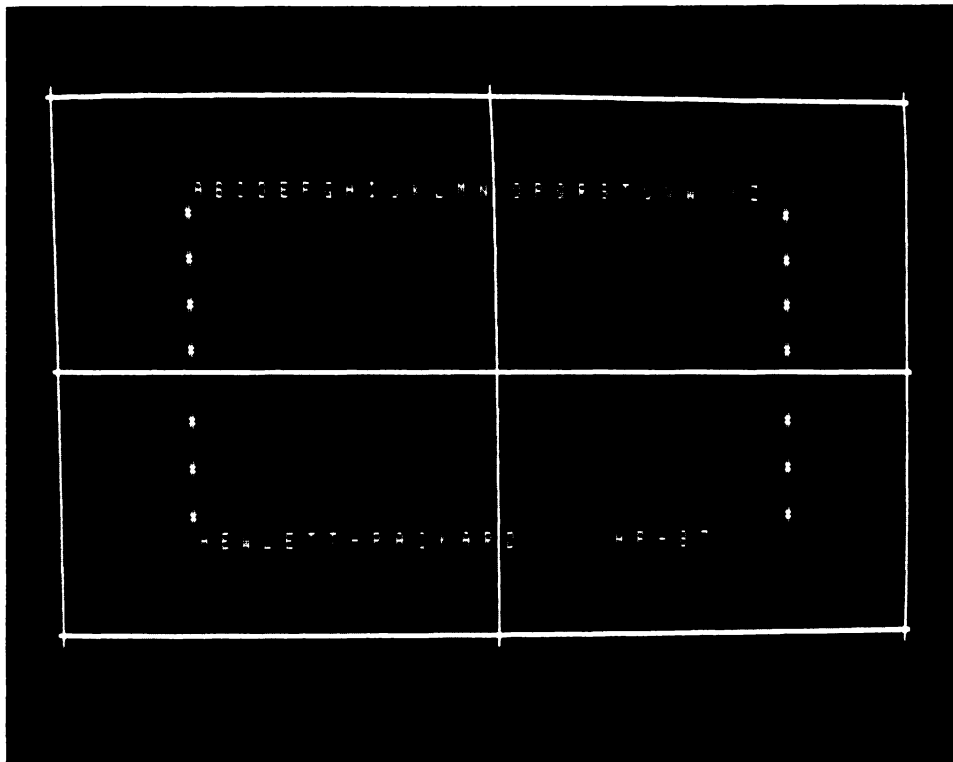

Figure 2-9. CRT Test Pattern 4

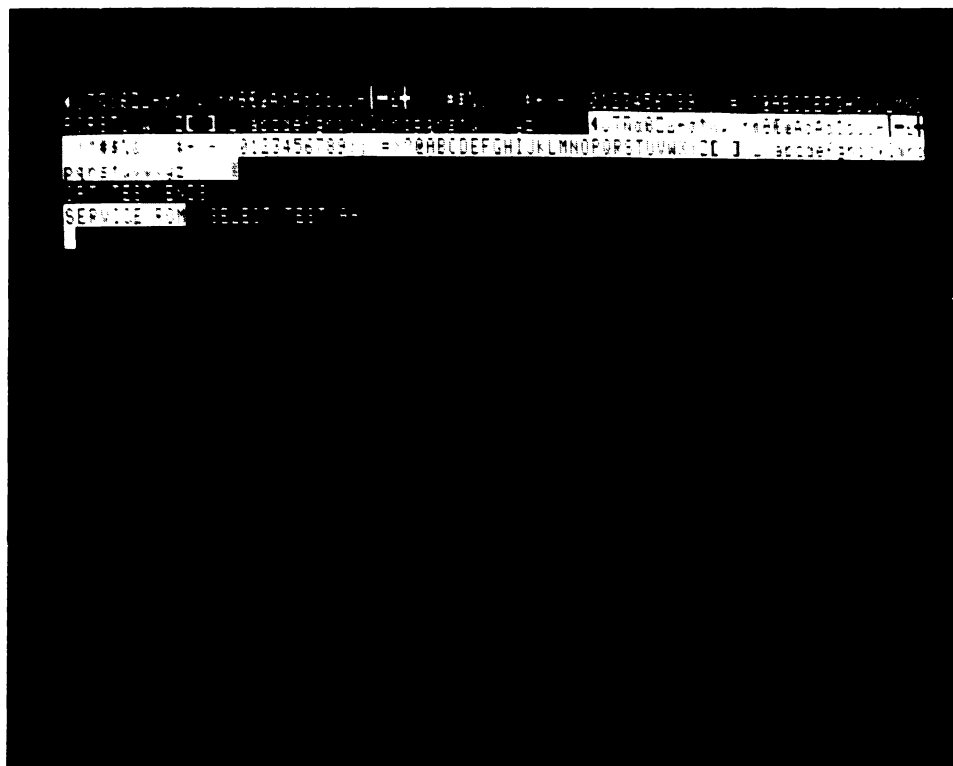

Figure 2-10. CRT Test Pattern 5

Note: This pattern will vary for different language versions.

2.62 TROUBLESHOOTING THE CONTROL AND BUS LINES

The three control lines (LMA, RD, and WR) and the eight bus lines (B0 through B7) should be switching between 0V and 6V. Since these lines are asynchronous (their waveforms do not have a regular period), with an oscilloscope, you can only verify that they are active (switching).

If one of the bus or control lines is not active, either an IC is holding the line constant or the line is shorted somewhere in the in the system. To isolate the failure, refer to table 2-8.

Table 2-8. Control and Bus Line Failure Isolation

STEP	ACTION	DIAGNOSIS/ REPAIR	
		LINE OK	LINE BAD
1	Remove all plug-in modules from the I/O port.	One of the modules is bad.	Proceed with step 2.
2	Substitute new logic PCA for original. Check lines.	Install new logic PCA in computer.	

2.63 POWER SUPPLY TROUBLESHOOTING

If you suspect that the power supply may be bad, follow the troubleshooting procedure outlined in table 2-9.

Table 2-9. Power Supply Troubleshooting

STEP	ACTION	DIAGNOSIS/REPAIR	
		SUPPLIES OK	SUPPLIES BAD
1	Check fuse; replace if blown.		Check if AC power is present at connector J1 of the power supply PCA. If so, replace the power supply PCA; otherwise, replace the back panel assembly.
2	Connect Test Connector (00086-60910).	Proceed with step 3.	
3	Reconnect power supply cable to logic PCA. Disconnect I/O PCA from logic PCA. Check supply voltages.	Reconnect I/O PCA and proceed with step 4.	Replace logic PCA.
4	Remove modules from I/O ports. Check supplies.	Replace modules in I/O port one at a time. Check supplies; determine which is pulling supplies low.	Replace I/O PCA.

For power supply voltage limits, refer to table 2-1.

2.64 PWO AND CLOCK FAILURE ISOLATION

PWO should reach at least 4.4 Vdc a fraction of a second after you switch the power on, but not instantly.

- If PWO reaches at least 4.4 Vdc instantly, the PWO circuitry on the logic PCA is bad. Refer to table 2-1 for PWO test point.
- If PWO never reaches 4.4 Vdc, either the PWO circuitry on the logic PCA is bad, an IC somewhere in the system is holding the line low, or the line is shorted somewhere in the system. To isolate the failure, refer to table 2-10.

Note: For this procedure to be valid, all power supply voltages must be within their acceptable ranges as specified in table 2-1.

All four clock waveforms should be pulse trains swinging between 0V and at least 10V (see figure 2-11). A clock signal is bad if it does not reach 10V, its duty cycle is incorrect, or if it is always constant.

- If the duty cycle is incorrect, the clock circuitry on the logic PCA is bad.
- If a clock signal does not reach 10V or is always constant, either the clock circuitry on the logic PCA is bad, an IC somewhere in the computer is holding the line low or constant, or the line is shorted somewhere in the computer. To isolate the failure, refer to table 2-10.

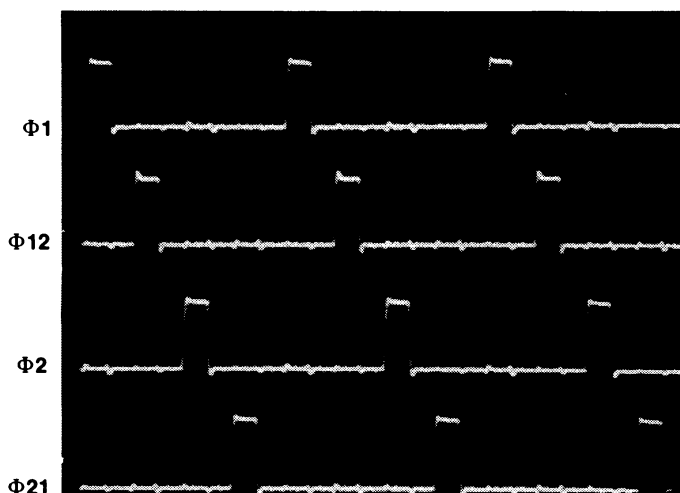

Figure 2-11. Clock Waveforms

Table 2-10. PWO and Clock Failure Isolation

STEP	ACTION	DIAGNOSIS/REPAIR	
		LINE OK	LINE BAD
1	Disconnect I/O PCA from logic PCA. Check line on logic PCA.	Reconnect I/O PCA and proceed with step 2.	Replace the logic PCA.
2	Remove modules from I/O ports. Check lines.	Replace modules, one at a time to determine which is pulling line low.	Replace the I/O PCA.

2.65 TROUBLESHOOTING WITH THE BEEPER TEST

The Beeper Test causes the beeper to sound three short tones of the same frequency followed by a scale of eight longer tones of increasing frequency. The test performs no internal checks.

2.66 How to Run the Beeper Test

To run the Beeper Test, press [E] if the Service ROM is in control, or type in {BEEPER} if the BASIC system is in control.

2.67 Results of the Beeper Test

After sounding the three short tones and the scale, the message {BEEPER TEST ENDS} appears. If the beeper is not functioning properly, replace the logic PCA. If this does not solve the problem, replace the speaker.

2.68 USING THE QA TEST

The QA Test is similar to the Heat Test (refer to paragraph 2.29). It executes all the IC checks of the Heat Test and then loads RAM with known data. After x seconds have elapsed, the data is read out of RAM and compared with the original data.

2.69 How to Run the QA Test

To run the QA Test, press [Q] if the service ROM is in control, or type in {QA x} if the BASIC system is in control. To terminate the test press any key.

2.70 Results of the QA Test

- When the QA Test is begun, the message {QA TEST BEGINS} is displayed and the CRT is turned on full.
- If a problem is found during the IC checks, the monitor goes blank, an appropriate message indicating the bad IC is displayed, and the test is terminated.
- If the data read from RAM is not the same as the known data read into RAM, the message {RAM REFRESH BAD} is displayed and the test is terminated. This message indicates that the RAM controller is probably bad.
- If no problem is found, the QA Test runs until you terminate it or for four hours (default). To terminate the test press any key. The message {QA TEST ENDS} will be displayed.

Table 2-11. Keyboard Test (Non-English Keyboards)

STEP	PROMPTING MESSAGE	ACTION
1	{KEY TEST:} {CNTL, SHIFT UP-PRESS K1}	Until otherwise indicated in subsequent prompting message, the [CNTL] and [SHIFT] keys should not be pressed. Press [K1].
2	{CNTL UP, SHIFT DOWN-PRESS K1}	While holding down the [SHIFT] key, press [K1].
3	{CNTL DOWN, SHIFT UP-PRESS K1}	While holding down the [CNTL] key press [K1].
4	{CNTL, SHIFT DOWN-PRESS K1}	While holding both the [CNTL] and [SHIFT] keys down, press [K1].
5	{SHIFT UP; PRESS KEY}	Press each of the keys in the order shown in figure 2-5. Be sure to include the [CAPS] key in the sequence, but do not press it until its turn in the order. Do not press the [CNTL] or the [SHIFT] key at any time in the sequence.

Table 2-12. Keyboard Test Diagnosis (Non-English Keyboards)

MESSAGE	REASON	DIAGNOSIS/REPAIR
{KEY CONTROL BAD!}	Bad controller.	Replace logic PCA.
{PRESS KEY}	Service ROM does not recognize that you have pressed a key within 15 seconds after prompt.	Press the key again.
{NO KEY!}	Service ROM does not recognize a pressed key within 15 seconds after a {PRESS KEY} message.	Refer to No Key Entry paragraph 2.50.
{RELEASE KEY!}	Service ROM does not recognize that you have released a key within 15 seconds after you pressed it.	Release key.
{KEY STUCK! (character entered)}	Service ROM does not recognize that a key was released within 15 seconds after the {RELEASE KEY} message.	Refer to Key Stuck paragraph 2.55.
{KEY BAD! (character entered)}	Character entered different from character expected.	If message occurred in key sequence test see No Key Entry, paragraph 2.50; else refer to Wrong Character Entered, 2.51.

Table 2-12. Keyboard Test Diagnosis (Non-English Keyboards)
(Continued)

MESSAGE	REASON	DIAGNOSIS/REPAIR
<p>{SHIFT-UP PRESS} {key expected}</p>	<p>Character entered does not correspond to key expected.</p>	<ol style="list-style-type: none"> 1. Press expected key. If message appears again, refer to Wrong Character Entered, paragraph 2.51; if not, proceed with step 2 below. 2. Press next key in sequence. If message appears again, proceed with step 3 below; if not, continue with key sequence. 3. Press expected key twice. If no message appears, refer to No Key Entry, paragraph 2.50; if message appears, indicating next key in sequence, press that key and continue with key sequence.

Table 2-12. Keyboard Test Diagnosis (Non-English Keyboards)
(Continued)

MESSAGE	REASON	DIAGNOSIS/REPAIR
{CNTL BAD!}	Control key is bad.	If this message occurs during steps 1 or 2 of table 2-11, refer to paragraph 2.53; else refer to paragraph 2.54.
{SHIFT BAD!} {(key expected)}	One of the shift keys is bad.	If this message occurs during steps 1 or 3 of table 2-11, refer to paragraph 2.53; else refer to paragraph 2.54.
{CNTL, SHIFT BAD!} {(key expected)}	Bothj the [CNTL] and [SHIFT] keys are bad.	If the message occurs during step 1 of table 2-11, refer to paragraph 2.53; else refer to paragraph 2.54.

Disassembly and Reassembly

3.1 INTRODUCTION

This section describes how to access, remove, and replace the major assemblies of an HP-86B and the parts of the top and bottom cases. These assemblies are identified in figure 1-1--which shows the inside of an HP-86B with the top case removed--and in the exploded view in the Replaceable Parts section. The exploded view also identifies the parts of the bottom case and keyboard assemblies.

3.2 SAFETY CONSIDERATIONS

WARNING

Line voltages are exposed when the top case of the HP-86B is removed. Electrical and mechanical failures may cause dangerous voltages to be present at points that normally are safe. For your own safety, read and heed the precautions in section I.

3.3 REMOVING AND TIGHTENING SCREWS

The main tools you will need to remove and replace HP-86B assemblies are two Pozidriv screwdrivers, #1 and #2, and a 1/4-inch nut driver. All screws used in the HP-86B have Pozidriv heads, not Phillips heads. Although Phillips screwdrivers will work, they can easily strip the screw heads. Pozidriv screwdrivers require much less effort to remove and insert screws.

Due to the nature of the plastic used in HP-86B parts, the threads in screw holes can easily be stripped if you overtighten the screws. All screws should be tightened only until they feel snug; if you strip the threads by overtightening the screws, you will have to replace the part. Also, try to engage screws--especially small screws--in the original threads; if a screw cuts new threads, they can easily be stripped.

3.4 CABLE INTERCONNECTIONS

HP-86B assemblies are electrically connected with two types of ribbon cable. The first type is used to connect the keyboard assembly to the logic PCA and has thin metallized-film connectors that must be handled as described in paragraphs 3.5 through 3.7. The second type of cable is terminated in pin connectors that require no more than normal careful handling.

3.5 SPECIAL HANDLING FOR KEYBOARD ASSEMBLY CABLES

These ribbon cables can be connected and disconnected with your fingers; no special tool is required. However, if you insert a cable into its connector without properly aligning it first, it will not make the proper electrical connection. Furthermore, it will be very difficult to remove the cable, and doing so may damage it.

3.6 Connecting a Cable

Note: When the contacts of a cable are split, have come loose from their backing, or otherwise deteriorated, use a new cable when reassembling the computer.

To connect a cable properly:

- a. Carefully align the contacts of the cable with the contacts of its connector, as shown in figure 3-1. The cable contacts must face the connector contacts.
- b. Press the end of the cable into the connector gently but firmly.
- c. Make sure that the cable contacts are properly aligned with the connector contacts and that neither edge of the cable is folded over. Figure 3-2 shows a cable connected properly. Figure 3-3 shows a cable misaligned, and figure 3-4 shows a cable connected with an edge folded over.

3.7 Removing a Trapped Cable

To remove an improperly connected cable from its connector:

- a. Insert a spare cable of the same type and width into the connector between the trapped cable and the connector contacts. (See figure 3-5.) The contacts of the spare cable should face the contacts of the trapped cable, not the contacts of the connector.
- b. Pull the two cables together out of the connector.

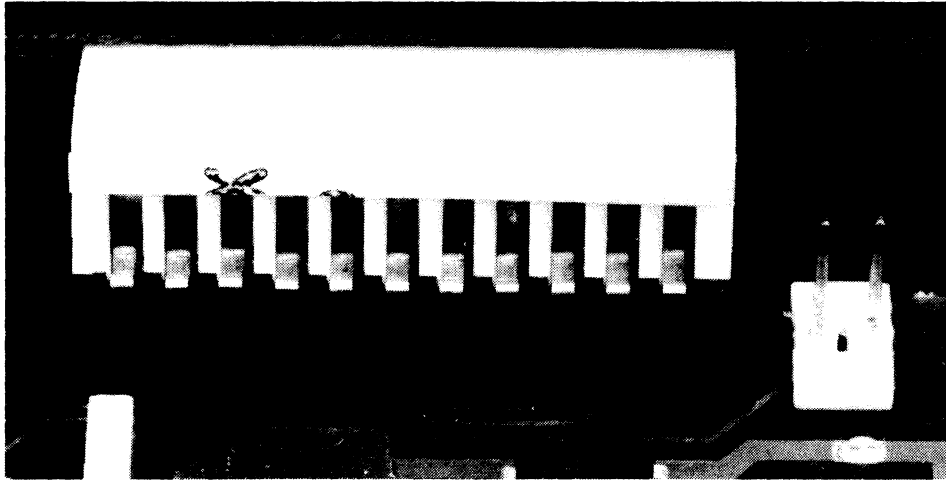

Figure 3-1. Aligning Cable Contacts

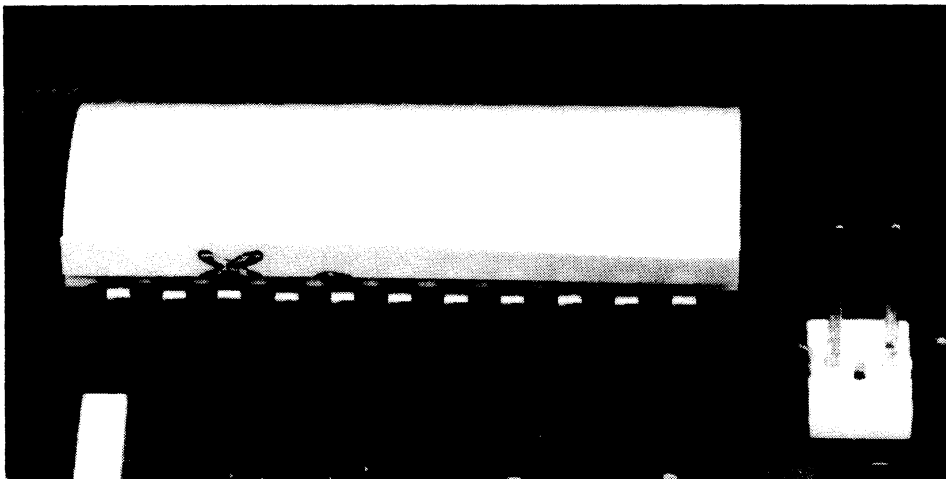

Figure 3-2. Cable Connected Properly

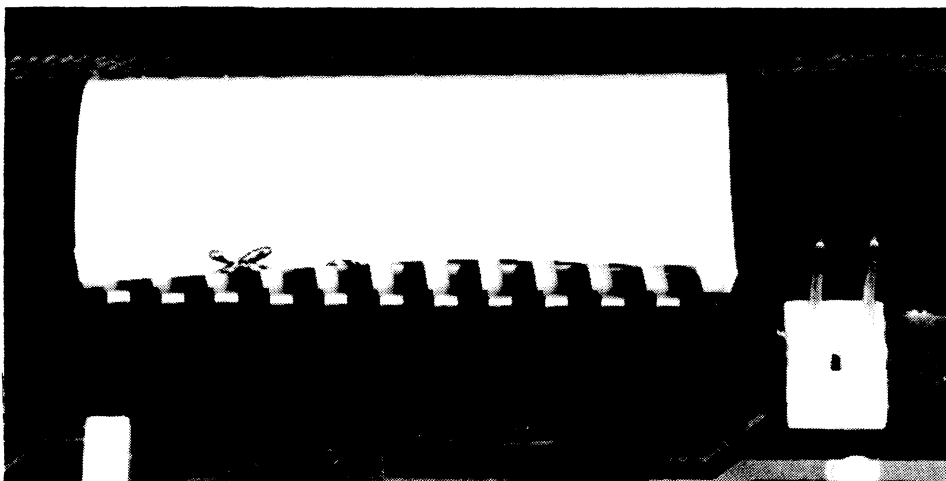

Figure 3-3. Cable Misaligned

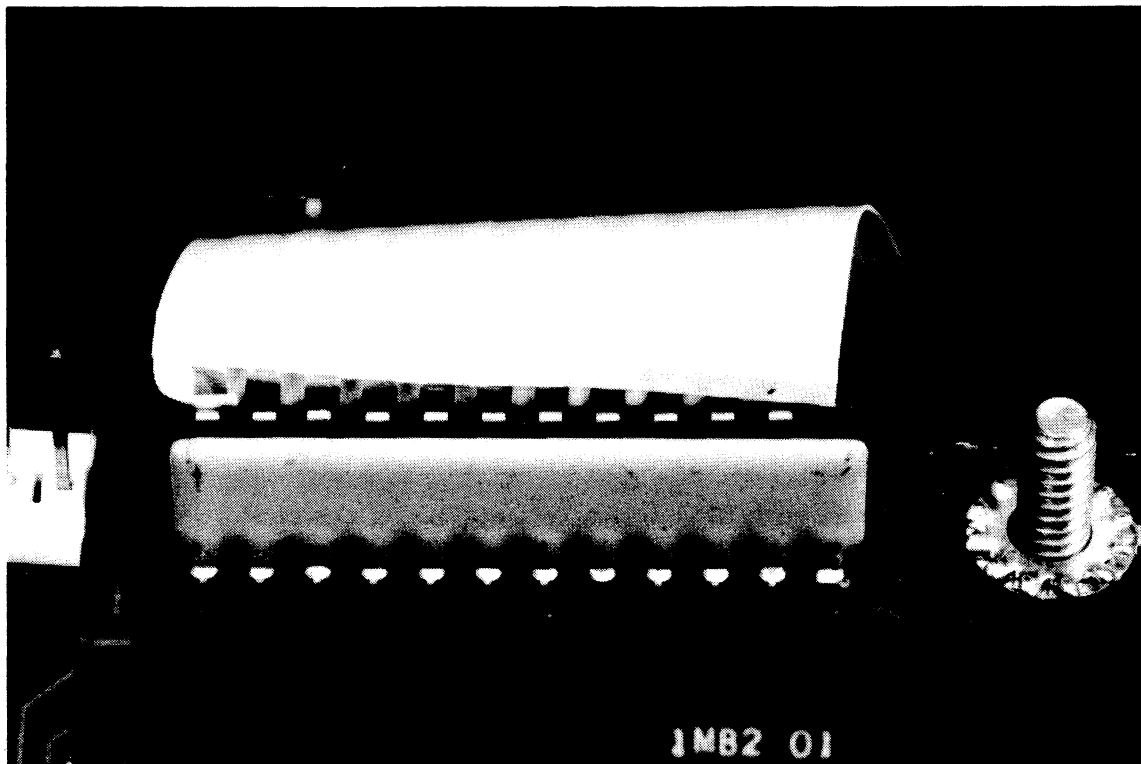

Figure 3-4. Cable Connected With Edge Folded Over



Figure 3-5. Removing a Trapped Cable

3.8 REPLACING ASSEMBLIES AND CASE PARTS

The disassembly and reassembly procedures are grouped as follows:

1. Separating the top case from the bottom case.
2. Replacing the keyboard assembly.
3. Replacing a key cap.
4. Replacing the space bar.
5. Replacing a plunger and a spring.
6. Replacing the [CAPS LOCK] key mechanism.
7. Replacing key contacts.
8. Replacing a keyboard hinge.
9. Cleaning key contacts.
10. Replacing the logic PCA.
11. Replacing the logic PCA shield and insulator.
12. Replacing the power supply PCA.
13. Replacing the I/O PCA.
14. Replacing the HP-IB connector.
15. Replacing the back panel assembly.
16. Replacing parts of the bottom case assembly.
17. Replacing parts of the back panel assembly.
18. Attaching the top case to the bottom case.

Section III: Disassembly and Reassembly

1. SEPARATING THE TOP CASE FROM THE BOTTOM CASE

- a. Disconnect the power cord from the back panel.
- b. Remove any plug-in modules from the I/O ports.
- c. Remove the six screws in the bottom case after turning the computer over on its topcase. Be careful not to damage the video connector if you need to set the computer on its back panel.
- d. Separate the front of the top case from the front of the bottom case. To do so, turn the computer back over and place your thumbs on the front edge of the top case. Push upward until the cases separate slightly.
- e. Lift the top case off of the computer. To do so, place your hands on the sides of the computer near the back. Press inward on the sides of the top case and lift it straight up.

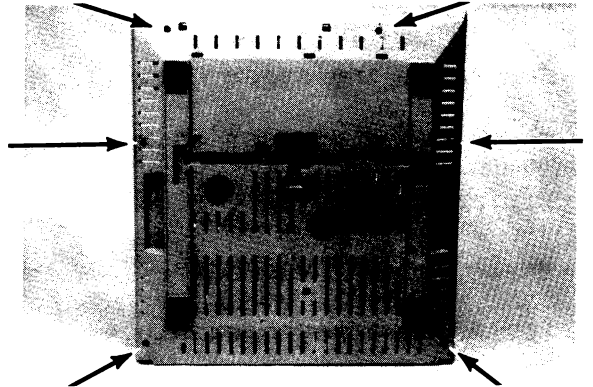

Section III: Disassembly and Reassembly

2. REPLACING THE KEYBOARD ASSEMBLY

- a. Remove the nut at the left back of the keyboard and the two screws securing the keyboard to the bottom case.
- b. Rotate the back of the keyboard forward and up.
- c. Lift the keyboard out of the bottom case. To do so, grasp its ends and lift up and slightly forward until the keyboard hinge pins snap out of their retainers in the bottom case. With the keyboard still inclined, lift it straight up until the two cables disconnect from the logic PCA.
- d. Disconnect the two cables from the keyboard assembly, and connect them to the new keyboard assembly.
- e. Connect the other ends of the cables to the logic PCA.
- f. Snap the keyboard hinge pins into the retainers in the bottom case.
- g. Rotate the back of the keyboard down.

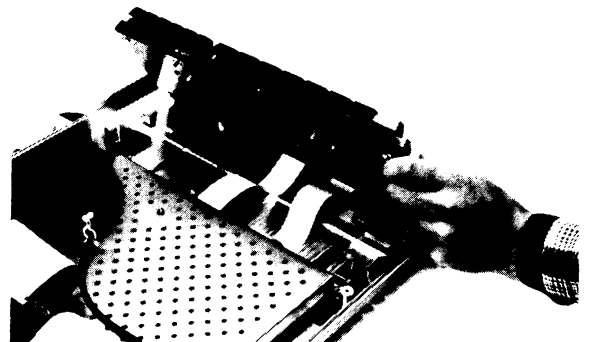
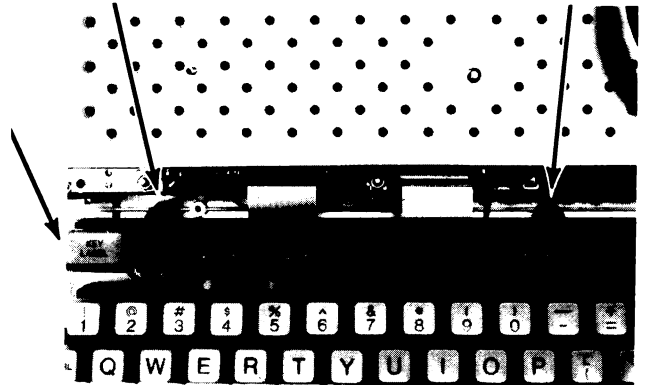

Section III: Disassembly and Reassembly

- h. Insert and tighten the two screws securing keyboard to the bottom case. Insert and tighten the nut at the left back of the keyboard.

Note: Be sure to run the System Test (or at least the Keyboard Test) from the System Service ROM after installing the top case. If any key catches on the top case, loosen the four screws securing the keyboard hinges to the keyboard PCA and adjust the position of the keyboard.

3. REPLACING A KEYCAP

Note: Make a tool to remove key caps by bending a paper clip as shown in the photograph.

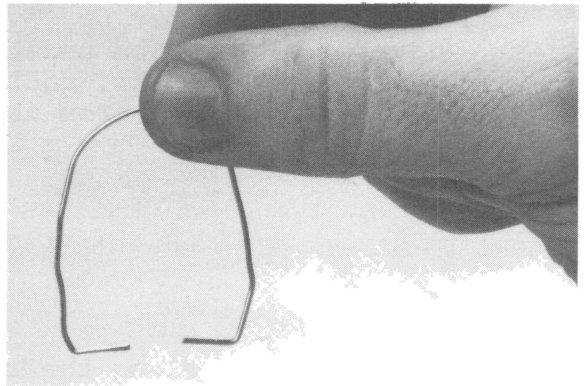

- a. Insert the paper clip over the key and hook the clip in the corners of the key cap.
- b. Pull firmly upward to remove the key cap.
- c. Install the new key cap by pressing it firmly into place. It is a press fit; it will not snap. Try not to remove more key caps at a time than necessary, to avoid inserting them into incorrect key positions.

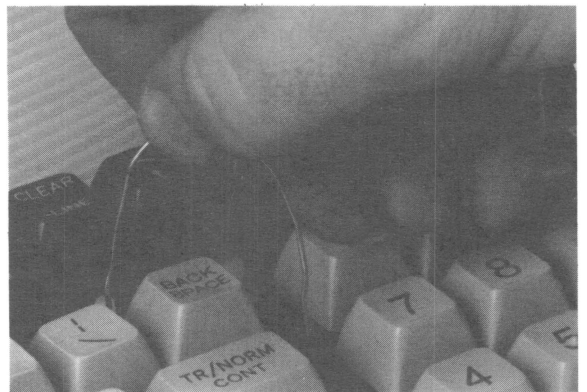

Refer to the diagrams in the Replaceable Parts section (figures 4-2 through 4-11) for the correct position for each keycap.

4. REPLACING THE SPACE BAR

- a. Pull the space bar up, by hooking your thumbs under the ends of the bar, until the bar separates from its plunger.
- b. Slide the bar along the hinge rod and gently press the bracket inward until it clears the rod.
- c. If the adapter from the space bar remained in the plunger instead of in the space bar:

- (1) Pull the adapter out of the plunger with your fingers.
- (2) Insert the adapter into the boss in the space bar. The adapter should be positioned so that it angles toward the edge of the space bar away from the brackets.
- (3) Press the adapter firmly into place with your thumb.

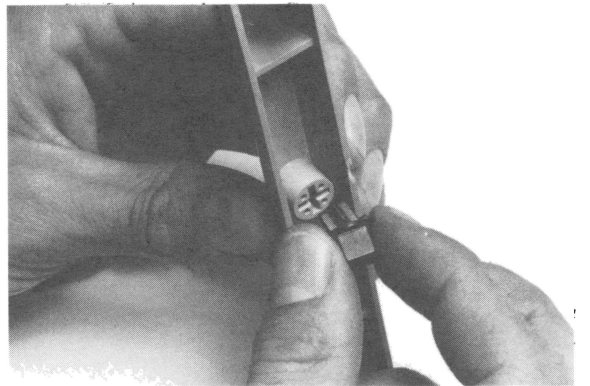

Section III: Disassembly and Reassembly

- d. Position the space bar over the keyboard. It should be oriented with the brackets toward the front.

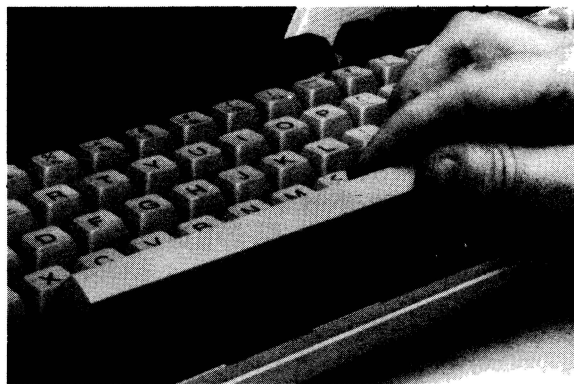

- e. Hook one end of the hinge rod in the hole in the bracket.

- f. Hook the other end in the rear hole of the bracket after sliding the bar along the rod.

- g. Position the space bar with its adapter over its plunger, then press down on the center of the bar as far as it will go. It is a press fit; it will not snap.



5. REPLACING A PLUNGER AND SPRING

Note: After the plunger has been removed, it should not be reinserted. Discard it and install a new plunger.

This procedure does not apply to the plunger and spring for the [CAPS LOCK] key. To replace them, see procedure 6.

- a. Remove the key cap or space bar as described above.
- b. Grasp the plunger firmly using long-nose pliers with serrated tips.

CAUTION

In the next step, be sure to pull the plunger straight up. If you pull it up at an angle, the plunger housing could be damaged.

- c. Pull up to remove the plunger.
- d. Remove the old key spring and replace it with a new one. For all keys except the space bar, insert a short spring (28 mm; 1.1 in.). For the space bar, insert a long spring (35 mm; 1.4 in.).

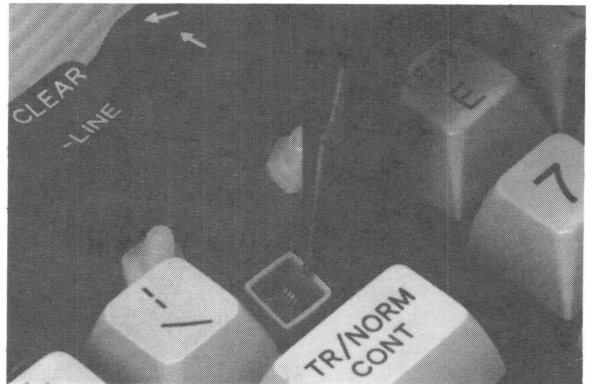

Section III: Disassembly and Reassembly

e. Place a new plunger over the spring. The plunger should be oriented such that the slots in its sides face the left and right of the keyboard and the bar inside points toward the front and back of the keyboard.

f. Press the plunger down with your finger until it snaps into place.

Section III: Disassembly and Reassembly

6. REPLACING THE [CAPS LOCK] KEY MECHANISM

- a. Remove the key cap as described in step 3.
- b. Place your finger over the plunger, and pry the wire away from plunger using a small flat-blade screwdriver.
- c. Lift off and discard the plunger and spring.
- d. Remove the straight retaining wire from the bottom of the plunger housing using needle-nose pliers. You may have to release the wire from beneath the plunger housing by prying it toward the rear of the keyboard.
- e. Remove the C-shaped wire from the plunger housing.
- f. Insert a new C-shaped wire into the plunger housing. The long arm should be down and located in the shallow channel in the base of the housing.
- g. Insert a new straight retaining wire between the arms of the other wire, then release it so that it drops to the bottom of the plunger housing.

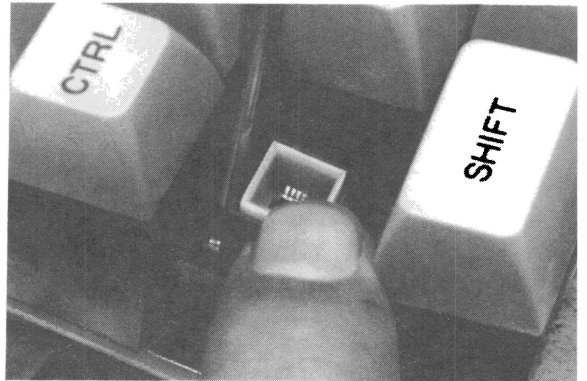

Section III: Disassembly and Reassembly

- h. Pry both ends of the straight wire under the corners of the plunger housing.
- i. Place a new, long spring around the contacts in the plunger housing.
- j. Place a new plunger over the spring. The plunger should be oriented such that the raised area on one of its sides faces the rear of the keyboard.
- k. Press the plunger down into the housing while prying the C-shaped wire away from the plunger using a small, flat-blade screwdriver.
- l. Release the wire so that it engages in the slot in the side of the plunger. Press down on the plunger a few times to make sure that the mechanism is working properly.

7. REPLACING KEY CONTACTS

- a. Remove the key cap, plunger, and spring as described above.
- b. Unsolder the key contacts from the back of the keyboard PCA.

CAUTION

In the next step, be sure to pull the contacts straight up. If you pull them up at an angle, the plunger housing could be damaged.

- c. Remove the key contacts, one at a time, by pulling them straight up using needle-nose pliers with serrated tips.
- d. Remove all solder from the two holes in the keyboard PCA.
- e. Remove any bits of plastic, loose solder, or other particles from the inside of the plunger housing.

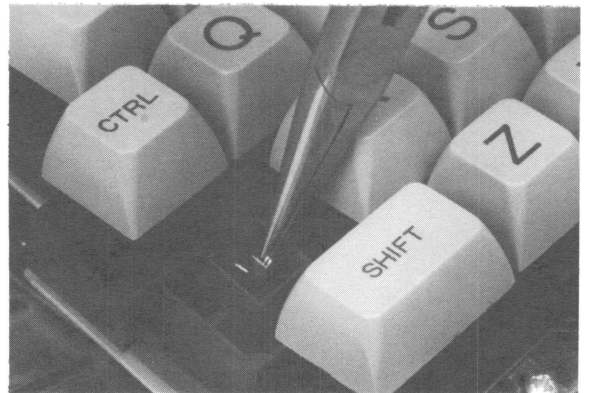

CAUTION

Wear white gloves while handling the key contacts in the next two steps. If key contacts are contaminated with dirt or oils, they might not make proper electrical contact when closed.

Section III: Disassembly and Reassembly

- f. Insert a solid key contact into one of the rectangular holes next to the plunger in the bottom of the key contact insertion tool. The contact should be inserted so that it is bent toward the plunger in the tool.

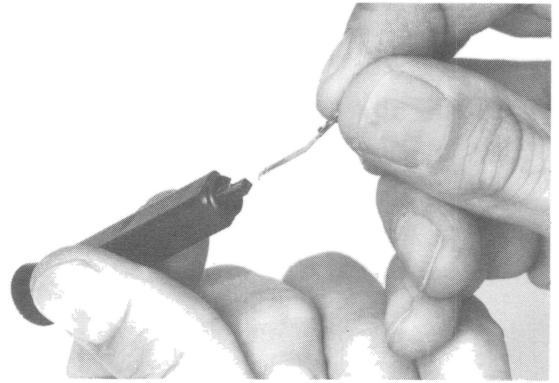

- g. Push the contact into the tool as far as it will go. When fully inserted, the solder tail of the contact will reach the end of the plunger in the tool.

- h. Insert a slotted key contact into the other rectangular hole in the tool. Again, the contact should be inserted so that it is bent toward the plunger. Push the contact into the tool as far as it will go.

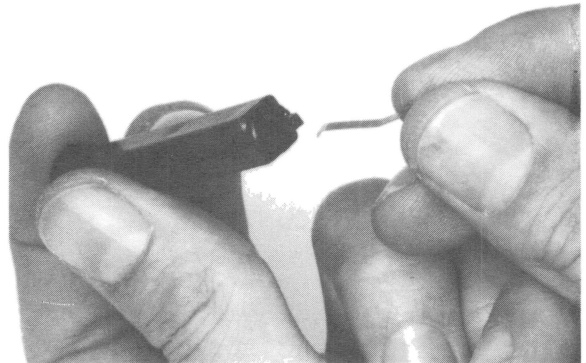

- i. Insert the tool into the plunger housing. The tool should be oriented so that the contacts are facing the left and right of the keyboard, not the front and rear.
- j. Press the tool down until it bottoms out in the plunger housing.
- k. Solder the contacts to the keyboard PCA.

8. REPLACING A KEYBOARD HINGE

- a. Remove the two screws securing the hinge to the keyboard PCA.
- b. Position a new hinge beneath the keyboard PCA. The pin in the middle of the hinge should be engaged in the hole in the keyboard PCA.
- c. Insert and tighten the screws.
- d. Be sure to run the keyboard test from the service ROM to make sure that no key sticks.

9. CLEANING KEY CONTACTS

- a. Remove the key cap, plunger, and spring as described in procedures 3 and 5.
- b. Dampen the corner of a thin cardboard sheet (such as a business card) with Freon TE, TF, or TMS PLUS.
- c. Insert the dampened corner between the key contacts, and move it up and down a few times.

10. REPLACING THE LOGIC PCA

- a. Disconnect the cables from the logic PCA to the power supply, the I/O PCA, and the disc/printer PCA. Remove the video cable from the two twistlocks and disconnect it from the logic PCA. With keyboard propped forward, remove the cables from the keyboard, the power light, and the speaker where they attach to the logic PCA.
- b. Remove the six nuts, with a one-quarter inch nut driver, that hold the EMI box in place.
- c. Lift the EMI box straight up and off. Do not bend the mounting tabs since there is a chance of shorting to PCA traces if the solder mask is damaged and the tabs are angled incorrectly or sharp-edged.
- d. Remove the two nuts holding the board down in the center. Remove the six lockwashers from each stud. The logic board may now be lifted up and off the studs. (This is accomplished most easily by lifting the PCA off the back studs, then off the front.)
- e. Place the new logic PCA in the bottom case over the mounting studs. Be sure not to trap any of the cables underneath the PCA.

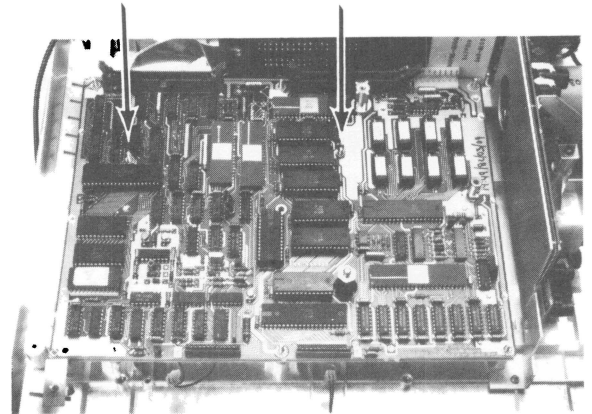
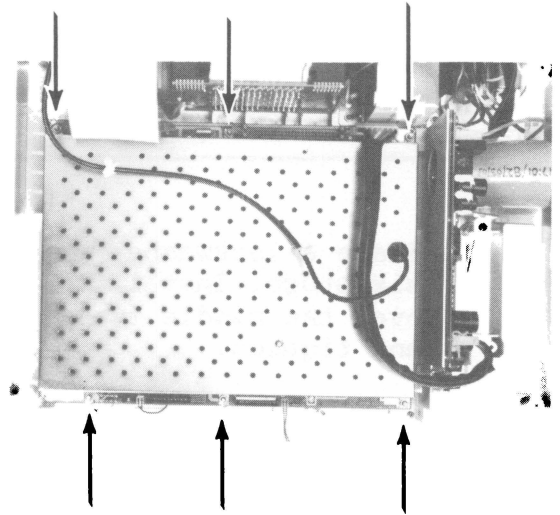

CAUTION

In the next step, be sure all washers are in place. Otherwise, the EMI box may short traces on the board causing the power supply to fail.

- f. Place a lockwasher over all six studs. Install the nuts over the middle two studs and tighten.
- g. Connect the two small plugs to the logic PCA. Be sure that the wires to the speaker do not get caught in the studs. Also be sure that the plug from the power light is connected so that the wires come out of the plug toward the front of the computer. The power light will not turn on if the plug is connected backwards. Reconnect the keyboard cables (see the precautions in paragraphs 3.5 through 3.7).
- h. Arrange the power light wires down against the logic PCA and the bottom case, and lower the EMI box over the six studs.
- i. Connect to the logic PCA the cables from the I/O PCA, the power supply, and the disc/printer PCA. Reconnect the video cable and tie down this cable with the twist-locks.
- j. Install and tighten the six nuts which secure the EMI box.
- k. Lower the keyboard into place and tighten screws and the nut at the left-back corner.

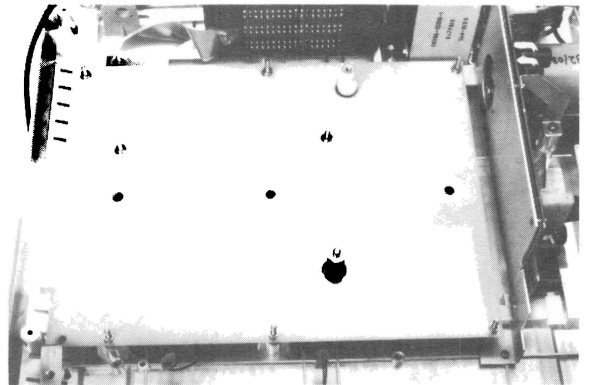

Section III: Disassembly and Reassembly

11. REPLACING THE LOGIC PCA SHIELD AND INSULATOR

With the logic PCA removed;

- a. Remove the screw which secures the I/O PCA ground strap to the back panel assembly, also on the left side.
- b. Remove the brass spacers from the eight studs.
- c. The insulator and shield may now be removed.
- d. Replace the shield, then the insulator by reversing the above procedures.

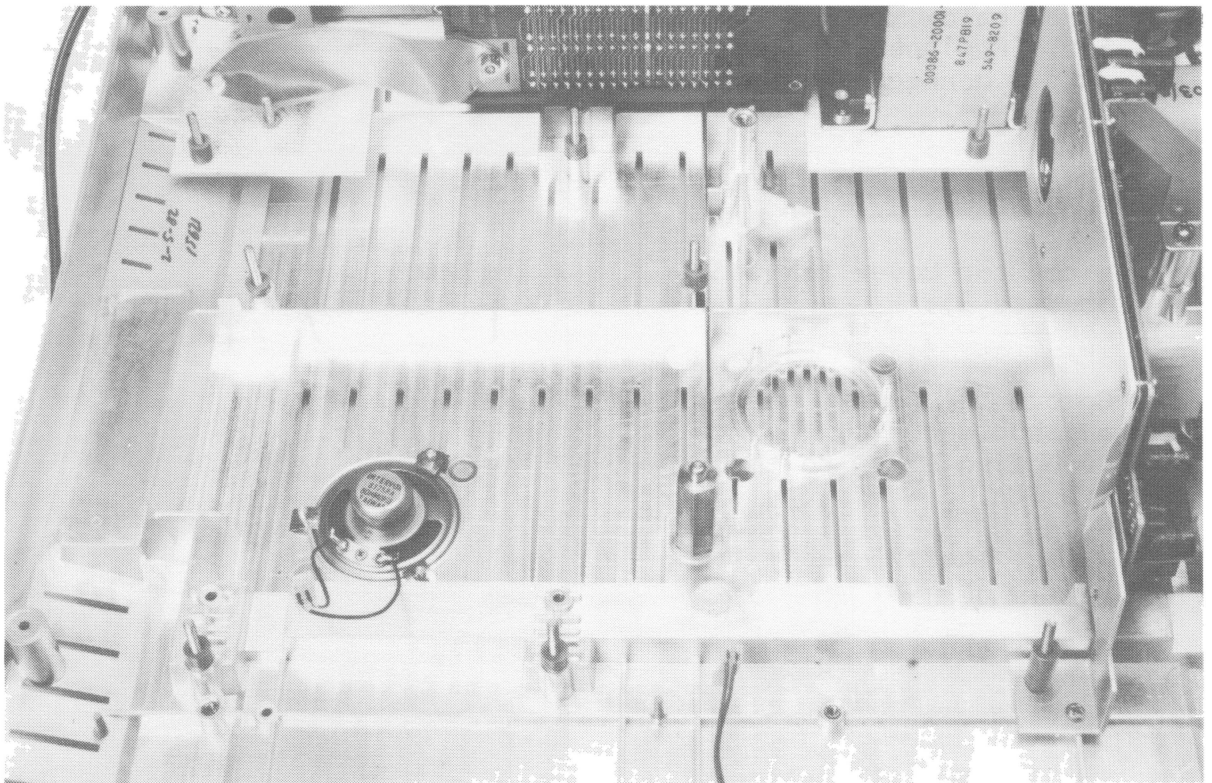

12. REPLACING THE POWER SUPPLY ASSEMBLY

- a. Remove the screw which secures the power supply bracket to the post in the bottom case.
- b. Remove both power supply connectors and the six screws securing the PCA to the power supply mount.
- c. The power supply PCA may now be lifted straight up and out.
- d. Replace by inserting and tightening the four corner screws before installing the two screws which retain the power supply bracket and the screw below the large capacitor. Replace both power supply connectors.

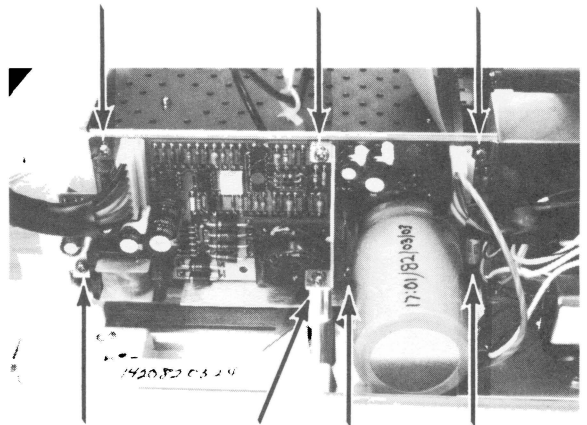

13. REPLACING THE I/O PCA

With the top cover removed (procedure 1):

- a. Remove the screw, washer, and nut securing the grounding strap to the I/O PCA.
- b. Remove the I/O cable from the logic PCA.
- c. Remove the two screws which fasten the PCA to the I/O box.
- d. The I/O PCA will slide straight up, out of the I/O receptacle.
- e. To reinstall the I/O PCA, simply reverse the above steps.

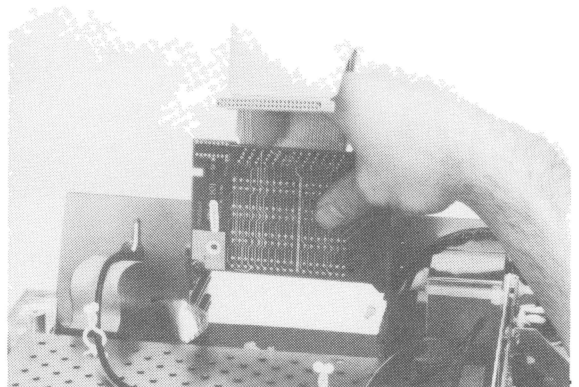

14. REPLACING THE HP-IB CONNECTOR

- a. Remove the two jack posts securing the HP-IB PCA to the back panel. Disconnect the connector on the logic PCA and remove the cable by pressing the locking ears outward to release the cable from the header.
- b. Push the protrusion in the bottom case away from the back panel and rotate the HP-IB connector up to remove it from the back panel assembly.
- c. Reinstall the HP-IB connector by pushing the bottom case protrusion forward (gently) and slipping the connector down and into the hole in the back panel assembly.
- d. Reconnect the cable into the header by positioning it carefully above and then pushing down until the retaining ears lock. Retighten the jack posts.

15. REPLACING THE BACK PANEL ASSEMBLY

With the top case removed (procedure 1), the keyboard (procedure 2), and logic PCA removed (procedure 10), the logic shield removed (procedure 11), and the I/O PCA removed (procedure 13):

- a. Turn the computer around so that the back panel is facing you.
- b. Disconnect the power plug from the power supply PCA.
- c. Remove the power supply PCA with its mount by removing the screw at the front, the screw which holds the bracket to the bottom case, and the nut at the back by the line fuse.
- d. Remove the four screws securing the I/O box to the back panel.
- e. Remove the I/O box.
- f. Remove the video cable jack from the back panel. Be careful not to scratch the back panel.
- g. Remove the three screws securing the back panel assembly to the bottom case.
- h. The back panel may now be removed by rotating up and back.
- i. To replace the back panel assembly, reverse the above procedures. Be careful not to trap any cables when reinstalling.

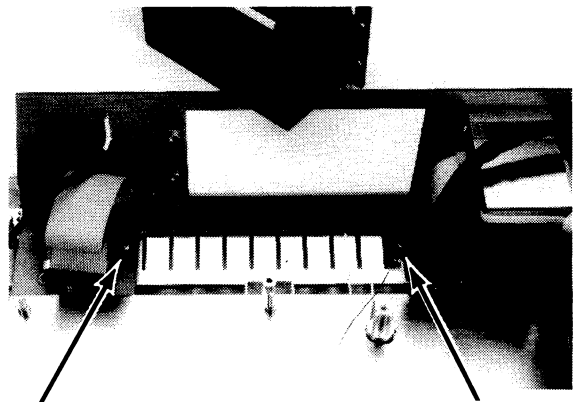
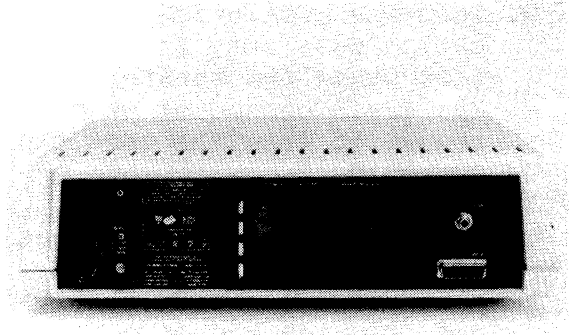

16. REPLACING PARTS OF THE BOTTOM CASE ASSEMBLY

With the top case assembly removed (procedure 1), the logic PCA and the logic shield removed (procedures 10 and 11):

- To replace the speaker:
 - a. Break each of the three retaining clips off of the pins using pliers or diagonal cutters, being careful not to break the pins.
 - b. Place the new speaker in the bottom case with the speaker's terminals toward the channel in the bottom case.
 - c. Insert a new retaining clip over each pin and press them all the way down using a small nutdriver.
 - d. Reconnect the speaker plug to the logic PCA when the PCA is installed.

- To replace a foot:
 - a. Tilt the computer on its back making sure not to damage the video jack, and peel off the old foot with a pair of needle-nose pliers.
 - b. Press a new foot into place.

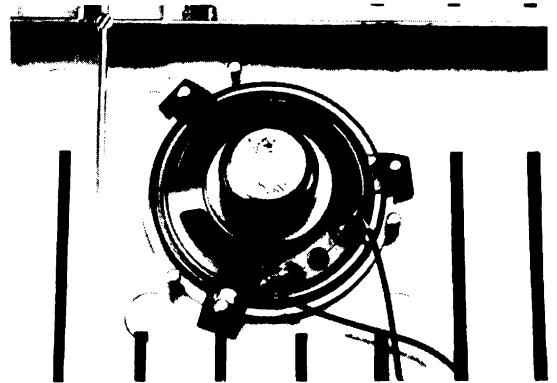

Section III: Disassembly and Reassembly

- To replace the power light:
 - a. Remove the keyboard assembly as described in procedure 2.
 - b. Disconnect the power light plug from the logic PCA.
 - c. Remove the screw securing the power light holder to the bottom case.
 - d. Lift out the power light holder and pull the plug off the LED.
 - e. Pull the LED out of the holder using pliers.
 - f. Insert a new LED into the holder. The flat on the LED should be aligned with the flat on the base of the holder.

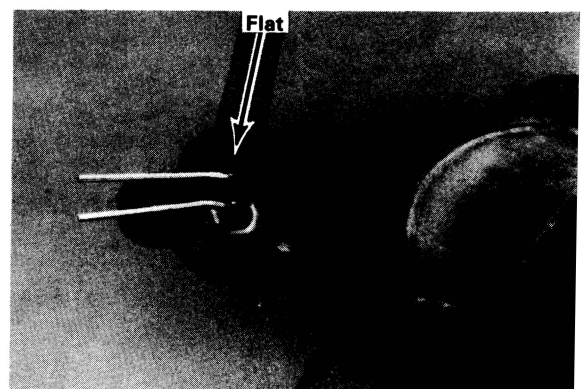
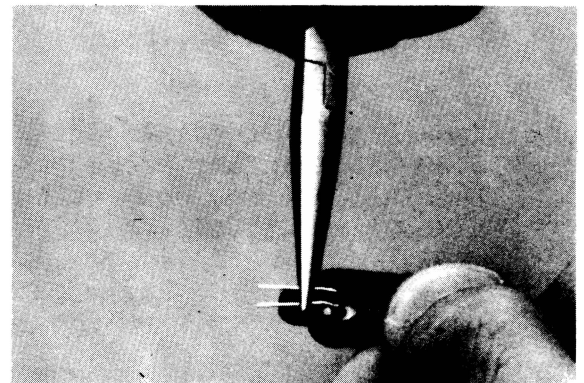
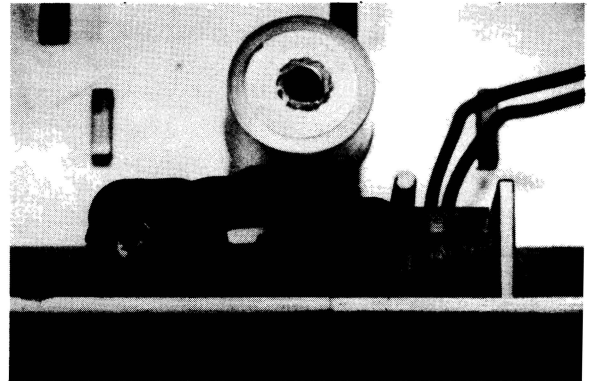

Section III: Disassembly and Reassembly

- g. Push the LED in until its base is flush with the base of the holder.
- h. Insert about 3/4 of the length of the LED leads into either of the plugs. Bend the plug away from the screw hole in the holder. The plug should be positioned so that when the holder is in position the wires will come down out of the holder, not up.
- i. Position the holder in the bottom case and insert the screw. Before tightening it, orient the holder so that the plug is positioned between the two ribs in the bottom case. Tighten the screw.
- j. Connect the other plug to the logic PCA. The plug should be positioned so that the wires come out of the plug toward the front of the computer. The power light will not turn on if the plug is connected backwards.
- k. Arrange the power light wires down against the logic PCA and the bottom case.

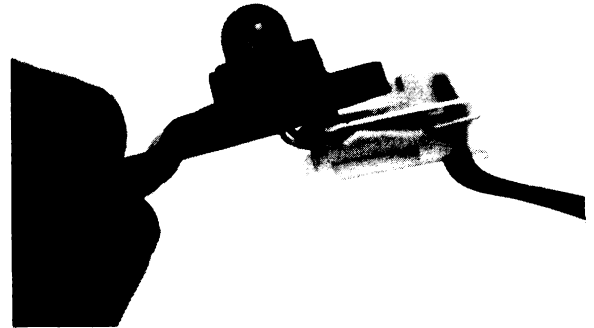

Section III: Disassembly and Reassembly

17. REPLACING PARTS OF THE BACK PANEL ASSEMBLY

With the back panel assembly removed (procedure 15):

- To replace the on/off switch:
 - a. Remove the power switch by squeezing the locking tabs on the switch body and pulling the switch out the back panel. The wires will extend through the case. Remove the lug connectors from the switch terminals and immediately connect each to the terminal on the new switch (being sure that the new switch is oriented correctly) so that none of the wires are misplaced.
 - b. Install the new switch.

- To replace the transformer assembly (with back panel removed):
 - a. Remove the two nuts securing the power supply ground lugs to the back panel assembly.
 - b. Remove the four screws from the bottom of the back panel and swing the transformer out of the way. Place the new transformer on the back panel and replace the lugs on the line voltage selector and power switch one at a time so that no wires are misplaced.
 - c. Insert and tighten the four screws and the nut with the the ground lugs.

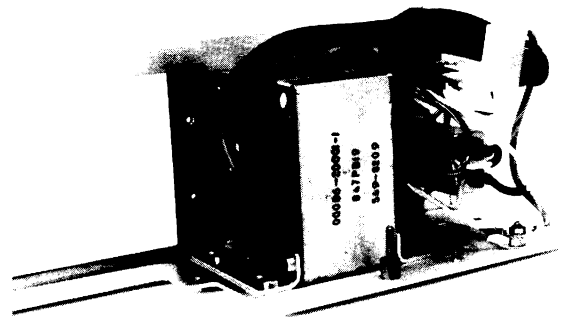

Section III: Disassembly and Reassembly

18. ATTACHING THE TOP CASE TO THE BOTTOM CASE

- a. Make sure the power cord is disconnected from the back panel.
- b. Place the top case in position on the bottom case. Make sure that the back panel is just inside the top case, not outside.
- c. Wiggle the top case and gently press it down until the cases close together. When closed properly, there should be a gap of about 1.6 mm (1/16 in.) between the edges of the cases.
- d. Insert and tighten the six screws in the bottom case after tilting the computer onto its back panel.

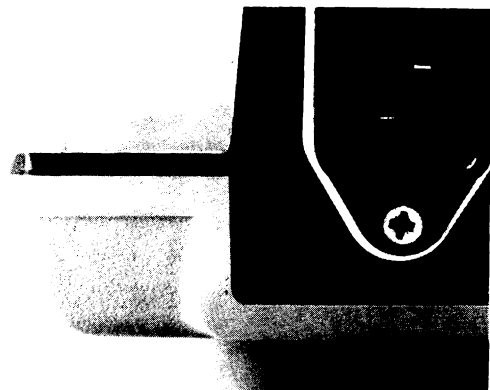

Replaceable Parts

This section lists the replaceable parts and assemblies of the HP-86B. This section also contains exploded view drawings of the HP-86B, the keyboard assembly, and the back panel assembly.

Assemblies or parts listed without an HP part number are identified for reference only and cannot be ordered as named. Such items are either supplied as part of the assemblies under which they are listed, or can be obtained by ordering the indicated parts included in the assembly.

Note that since there are 10 different language options for the HP-86B, there are 10 different keyboard assemblies. These are illustrated in figures 4-2 through 4-11. The following table lists the option numbers for the HP-86B foreign language versions along with the keyboard assembly part numbers.

Table 4-1. Keyboard Assembly Part Numbers

HP-86B OPTION	LANGUAGE VERSION	KEYBOARD ASSEMBLY PART NUMBER
Standard	English	00086-60906
001	Swedish	00086-60920
002	Norwegian/ Danish	00086-60919
003	German	00086-60912
004	Spanish	00086-60918
005	French	00086-60913
006	Italian	00086-60914
007	Dutch	00086-60915
008	Swiss German	00086-60916
009	Swiss French	00086-60917

Table 4-2. Keyboard Assembly Replaceable Parts

FIGURE AND INDEX NUMBER	HP PART NUMBER	DESCRIPTION	QTY
4-13-1	(table 4-1)	ASSEMBLY, keyboard	1
4-13-2	8120-3705	CABLE, ribbon	2
4-13-3	2200-0143	SCREW, machine, 4-40 x .375 inch	2
	00085-40031	HINGE, keyboard	2
	0624-0314	SCREW, tapping, 4-20 x 0.375 inch	4
	0380-1462	SUPPORT, PC board	4
	0371-2369	CAP, key, [LABEL KEY]	1
	0371-2370	CAP, key, [k1 k8]	1
	0371-2371	CAP, key, [k2 k9]	1
	0371-2372	CAP, key, [k3 k10]	1
	0371-2373	CAP, key, [k4 k11]	1
	0371-2374	CAP, key, [k5 k12]	1
	0371-2375	CAP, key, [k6 k13]	1
	0371-2376	CAP, key, [k7 k14]	1
	0371-0092	CAP, key, [↑↘]	1
	0371-2381	CAP, key, [↓A/G]	1
	0371-2378	CAP, key, [← I/R]	1
	0371-2379	CAP, key, [→ -CHAR]	1

Table 4-2. Keyboard Assembly Replaceable Parts (Continued)

FIGURE AND, INDEX NUMBER	HP PART NUMBER	DESCRIPTION	QTY
	0371-0137	CAP, key, [ROLL]	1
	0371-2377	CAP, key, [-LINE CLEAR]	1
	0371-0119	CAP, key, [1 !]	1
	0371-0103	CAP, key, [2 @]	1
	0371-0104	CAP, key, [3 #]	1
	0371-0105	CAP, key, [4 \$]	1
	0371-0106	CAP, key, [5 %]	1
	0371-0063	CAP, key, [6 -]	1
	0371-0130	CAP, key, [7 &]	1
	0371-0070	CAP, key, [8 *]	1
	0371-0071	CAP, key, [9 (]	1
	0371-0072	CAP, key, [0)]	1
	0371-0073	CAP, key, [- _]	1
	0371-0074	CAP, key, [= +]	1
	0371-0075	CAP, key, [\]	1
	0371-0076	CAP, key, [BACK SPACE]	1
	0371-2380	CAP, key, [E TEST]	1
	0371-0141	CAP, key, [(RESET]	1
	0371-0140	CAP, key, [) INIT]	1

Table 4-2. Keyboard Assembly Replaceable Parts (Continued)

FIGURE AND INDEX NUMBER	HP PART NUMBER	DESCRIPTION	QTY
	0371-0097	CAP, key, [{ RESULT]	1
	0371-0131	CAP, key, [CTRL]	1
	0371-0101	CAP, key, [Q]	1
	0371-0090	CAP, key, [W]	1
	0371-0120	CAP, key, [E]	1
	0371-0100	CAP, key, [R]	1
	0371-0079	CAP, key, [T]	1
	0371-0108	CAP, key, [Y]	1
	0371-0080	CAP, key, [U]	1
	0371-0085	CAP, key, [I]	1
	0371-0125	CAP, key, [O]	1
	0371-0123	CAP, key, [P]	1
	0371-0143	CAP, key, [[[]	1
	0371-0065	CAP, key, []]]	1
	0371-2368	CAP, key, [CONT TR/NORMAL]	1
	0371-0124	CAP, key, [7]	1
	0371-0117	CAP, key, [8]	1
	0371-0118	CAP, key, [9]	1
	0371-0078	CAP, key, [/]	1

Table 4-2. Keyboard Assembly Replaceable Parts (Continued)

FIGURE AND INDEX NUMBER	HP PART NUMBER	DESCRIPTION	QTY
	0371-0127	CAP, key, [CAPS LOCK]	1
	0371-0142	CAP, key, [A]	1
	0371-0099	CAP, key, [S]	1
	0371-0121	CAP, key, [D]	1
	0371-0088	CAP, key, [F]	1
	0371-0087	CAP, key, [G]	1
	0371-0086	CAP, key, [H]	1
	0371-0084	CAP, key, [J]	1
	0371-0083	CAP, key, [K]	1
	0371-0082	CAP, key, [L]	1
	0371-0132	CAP, key, [; :]	1
	0371-0128	CAP, key, [' "]	1
	0371-0153	CAP, key, [END LINE]	1
	0371-0114	CAP, key, [4]	1
	0371-0115	CAP, key, [5]	1
	0371-0116	CAP, key, [6]	1
	0371-0077	CAP, key, [*]	1
	0371-0147	CAP, key, [SHIFT], right offset stem	1

Table 4-2. Keyboard Assembly Replaceable Parts (Continued)

FIGURE AND INDEX NUMBER	HP PART NUMBER	DESCRIPTION	QTY
	0371-0107	CAP, key, [Z]	1
	0371-0089	CAP, key, [X]	1
	0371-0122	CAP, key, [C]	1
	0371-0091	CAP, key, [V]	1
	0371-0064	CAP, key, [B]	1
	0371-0126	CAP, key, [N]	1
	0371-0081	CAP, key, [M]	1
	0371-0066	CAP, key, [, <]	1
	0371-0067	CAP, key, [. >]	1
	0371-0068	CAP, key, [/ ?]	1
	0371-0146	CAP, key, [SHIFT], left offset stem	1
	0371-0134	CAP, key, [LIST PLST]	1
	0371-0111	CAP, key, [1]	1
	0371-0112	CAP, key, [2]	1
	0371-0113	CAP, key, [3]	1
	0371-0133	CAP, key, [-]	1
	0371-0154	CAP, key, [SPACE BAR] (HI-TEK)	1
	0371-2738	CAP, key, [SPACE BAR], (STACKPOLE)	

Table 4-2. Keyboard Assembly Replaceable Parts (Continued)

FIGURE AND INDEX NUMBER	HP PART NUMBER	DESCRIPTION	QTY
	00086-40001	CAP, key, [1 &]	1
	00086-40002	CAP, key, [2 e]	1
	00086-40003	CAP, key, [3 "]	1
	00086-40004	CAP, key, [4 `]	1
	00086-40005	CAP, key, [5 (]	1
	00086-40006	CAP, key, [6 §]	1
	00086-40007	CAP, key, [7 e]	1
	00086-40008	CAP, key, [8 !]	1
	00086-40009	CAP, key, [9 ç]	1
	00086-40010	CAP, key, [0 a]	1
	00086-40011	CAP, key, [°)]	1
	00086-40012	CAP, key, [· ^]	1
	00086-40013	CAP, key, [£ \$]	1
	00086-40014	CAP, key, [% u]	1
	00086-40015	CAP, key, [? ,]	1
	00086-40016	CAP, key, [. ;]	1
	00086-40017	CAP, key, [/ :]	1
	00086-40018	CAP, key, [CAPS]	1
	00086-40019	CAP, key, [~ 1]	1
	00086-40020	CAP, key, [! 4]	1

Table 4-2. Keyboard Assembly Replaceable Parts (Continued)

FIGURE AND INDEX NUMBER	HP PART NUMBER	DESCRIPTION	QTY
	00086-40021	CAP, key, [{ 5]	1
	00086-40022	CAP, key, [} 6]	1
	00086-40023	CAP, key, [\ 7]	1
	00086-40024	CAP, key, [[8]	1
	00086-40025	CAP, key, [] 9]	1
	00086-40026	CAP, key, [= 0]	1
	00086-40027	CAP, key, [" 2]	1
	00086-40028	CAP, key, [\$ 3]	1
	00086-40029	CAP, key, [& 6]	1
	00086-40030	CAP, key, [/ 7]	1
	00086-40031	CAP, key, [(8]	1
	00086-40032	CAP, key, [) 9]	1
	00086-40033	CAP, key, [? β]	1
	00086-40034	CAP, key, [' ']	1
	00086-40035	CAP, key, [' °]	1
	00086-40036	CAP, key, [* +]	1
	00086-40037	CAP, key, [A]	1
	00086-40038	CAP, key, [O]	1
	00086-40039	CAP, key, [U]	1
	00086-40040	CAP, key, [; ,]	1

Table 4-2. Keyboard Assembly Replaceable Parts (Continued)

FIGURE AND INDEX NUMBER	HP PART NUMBER	DESCRIPTION	QTY
	00086-40041	CAP, key, [: .]	1
	00086-40042	CAP, key, [i l]	1
	00086-40043	CAP, key, [i 2]	1
	00086-40044	CAP, key, [l £]	1
	00086-40045	CAP, key, [\$ ``]	1
	00086-40046	CAP, key, [° ']	1
	00086-40047	CAP, key, [N]	1
	00086-40048	CAP, key, [& \$]	1
	00086-40049	CAP, key, [6 _]	1
	00086-40050	CAP, key, [8 *]	1
	00086-40051	CAP, key, [+ -]	1
	00086-40052	CAP, key, [= i]	1
	00086-40053	CAP, key, [! o]	1
	00086-40054	CAP, key, [+ l]	1
	00086-40055	CAP, key, [* 3]	1
	00086-40056	CAP, key, [4]	1
	00086-40057	CAP, key, [? ']	1
	00086-40058	CAP, key, [' ^]	1
	00086-40059	CAP, key, [! ``]	1
	00086-40060	CAP, key, [è ü]	1

Table 4-2. Keyboard Assembly Replaceable Parts (Continued)

FIGURE AND INDEX NUMBER	HP PART NUMBER	DESCRIPTION	QTY
	00086-40061	CAP, key, [à ä]	1
	00086-40062	CAP, key, [é ö]	1
	00086-40063	CAP, key, [? +]	1
	00086-40064	CAP, key, [É]	1
	00086-40065	CAP, key, [* ']	1
	00086-40066	CAP, key, [A]	1
	00086-40067	CAP, key, [O]	1
	00086-40068	CAP, key, [Æ]	1
	00086-40069	CAP, key, [ç #]	1
	00086-40070	CAP, key, [§ :]	1
	00086-40071	CAP, key, [. .]	1
	00086-40072	CAP, key, [ü è]	1
	00086-40073	CAP, key, [ö é]	1
	00086-40074	CAP, key, [ä à]	1
	00086-40075	CAP, key, [£ 3]	1
	00086-40076	CAP, key, [! 7]	1
	00086-40077	CAP, key, [/ 0]	1
	00086-40078	CAP, key, [? ']	1
	00086-40079	CAP, key, [@ °]	1
	00086-40080	CAP, key, [# *]	1

Table 4-2. Keyboard Assembly Replaceable Parts (Continued)

FIGURE AND INDEX NUMBER	HP PART NUMBER	DESCRIPTION	QTY
	0371-0148	CAP, key, [PAUSE STEP]	1
	0371-0135	CAP, key, [RUN]	1
	0371-0110	CAP, key, [0]	1
	0371-0129	CAP, key, [.]	1
	0371-0109	CAP, key, [,]	1
	0371-0102	CAP, key, [+]	1
4-1-3	1535-4040	CONTACT, key, slotted (HI-TEK)	92
4-1-4	1535-4041	CONTACT, key (HI-TEK)	92
	3131-0458	CONTACT, key (STACKPOLE)	
4-1-5	1535-4043	PLUNGER, key (HI-TEK)	91
	4040-2020	PLUNGER, key (STACKPOLE)	
4-1-6	1535-4042	PLUNGER, key, [CAPS LOCK] (HI-TEK)	1
	4040-2021	PLUNGER, key, [CAPS LOCK] (STACKPOLE)	
4-1-7	1150-1415	SPRING, key, 28 mm (HI-TEK)	90
	1460-2012	SPRING, key, 28 mm (STACKPOLE)	
4-1-8	1150-1416	SPRING, key, 35 mm (HI-TEK)	2
	1460-2014	SPRING, key, 35 mm (STACKPOLE)	
4-1-9	1460-1782	WIRE, cam, [CAPS LOCK] plunger	1
4-1-10	1460-1783	WIRE, retaining, [CAPS LOCK] plunger	1

Section IV: Replaceable Parts

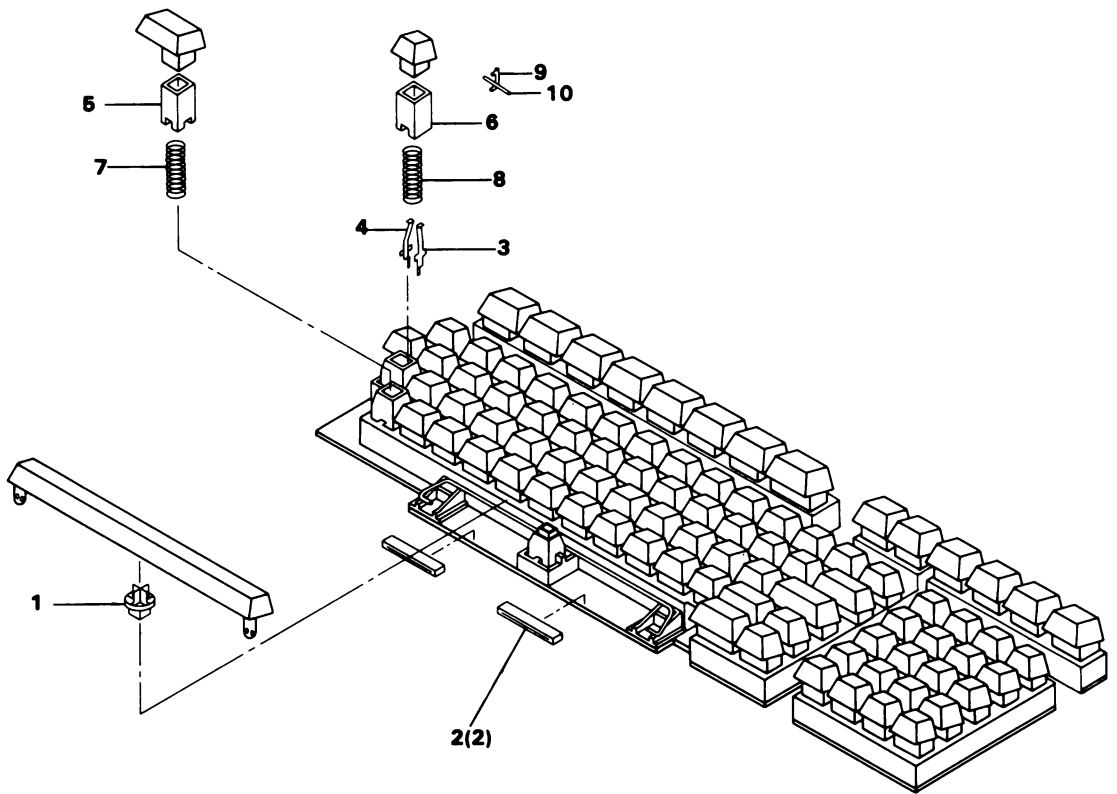

Figure 4-1. Keyboard Assembly Exploded View

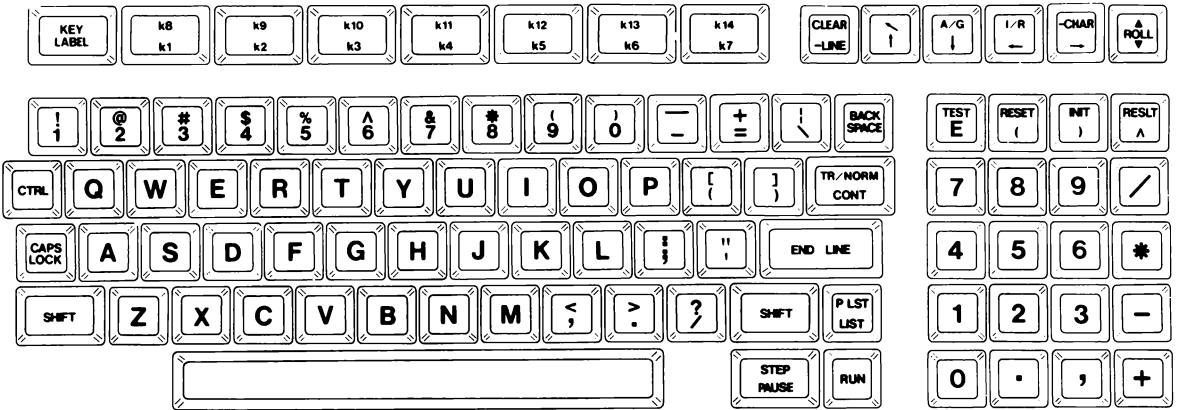

Figure 4-2. English Version Keyboard Layout

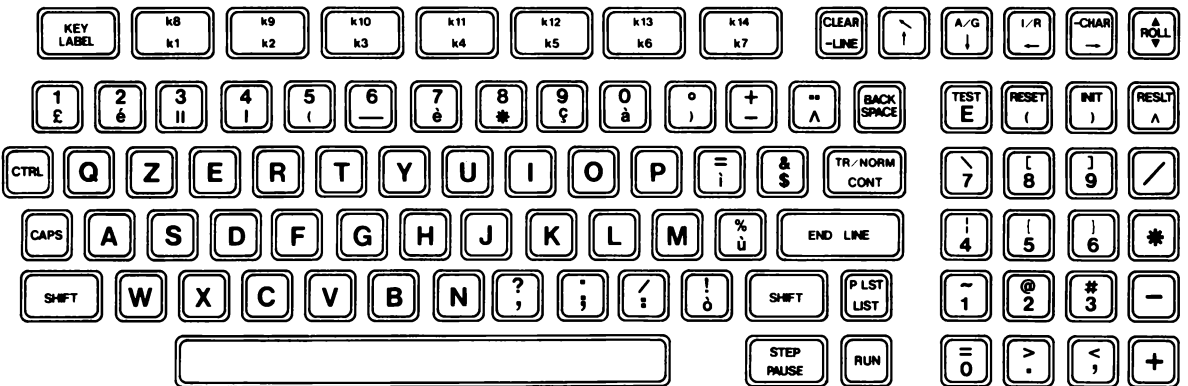

Figure 4-3. Italian Version Keyboard Layout

Section IV: Replaceable Parts

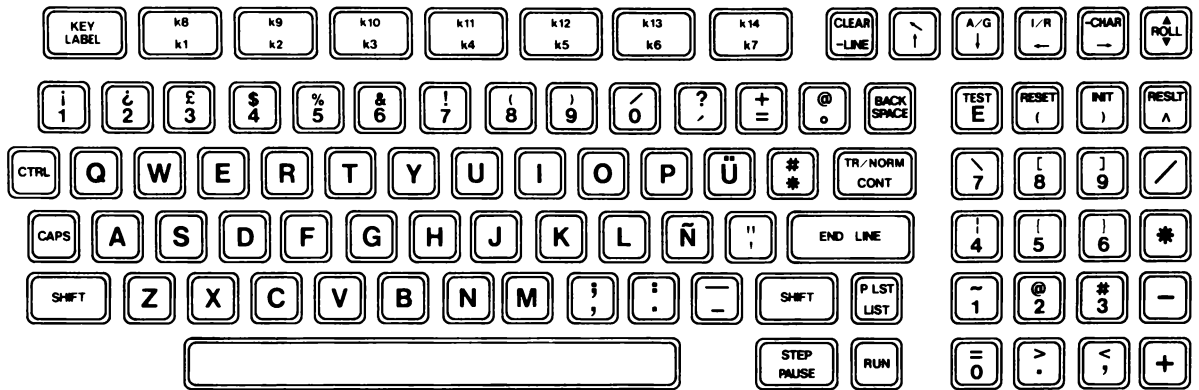

Figure 4-4. Spanish Version Keyboard Layout

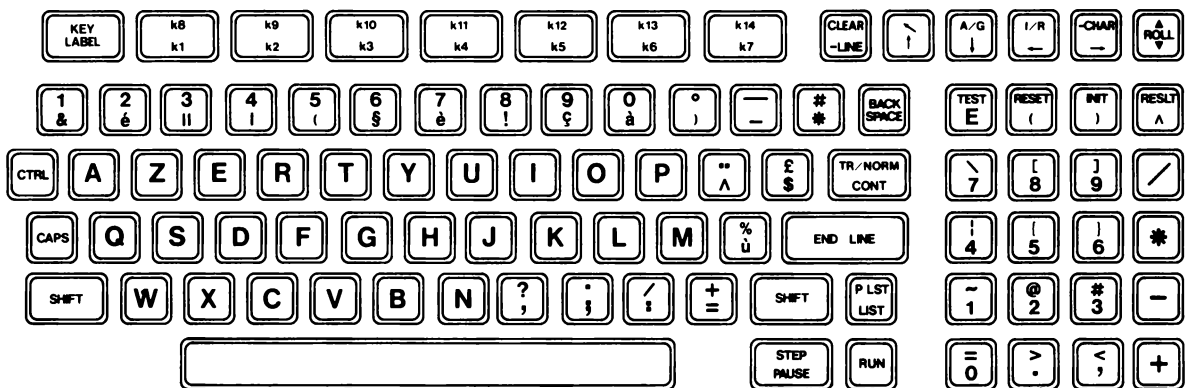

Figure 4-5. French Version Keyboard Layout

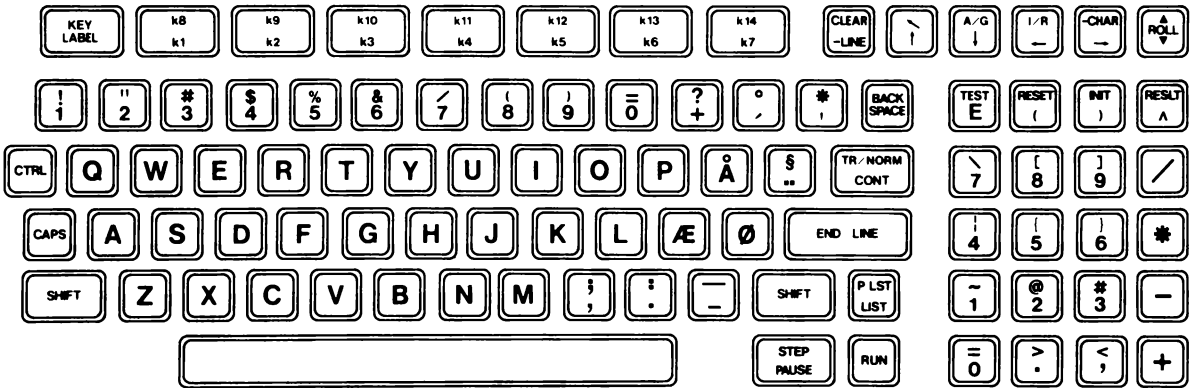

Figure 4-6. Danish/Norwegian Version Keyboard Layout

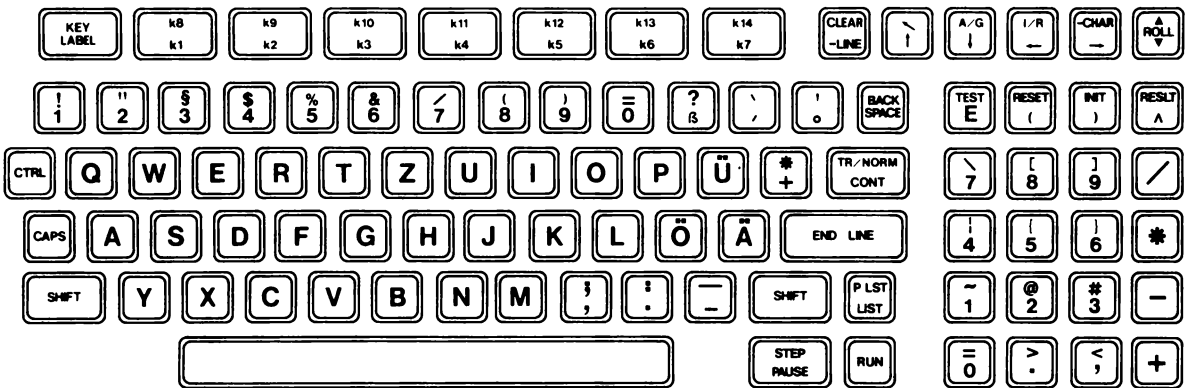

Figure 4-7. German Version Keyboard Layout

Section IV: Replaceable Parts

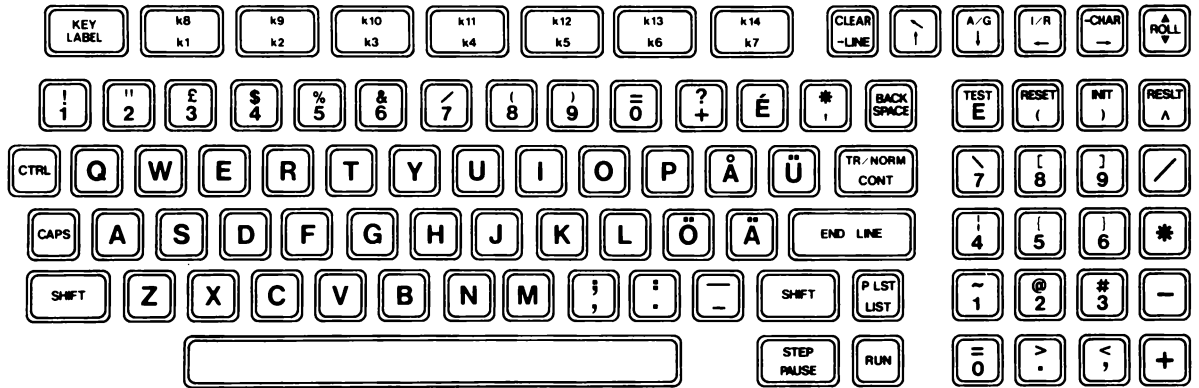

Figure 4-8. Swedish Version Keyboard Layout

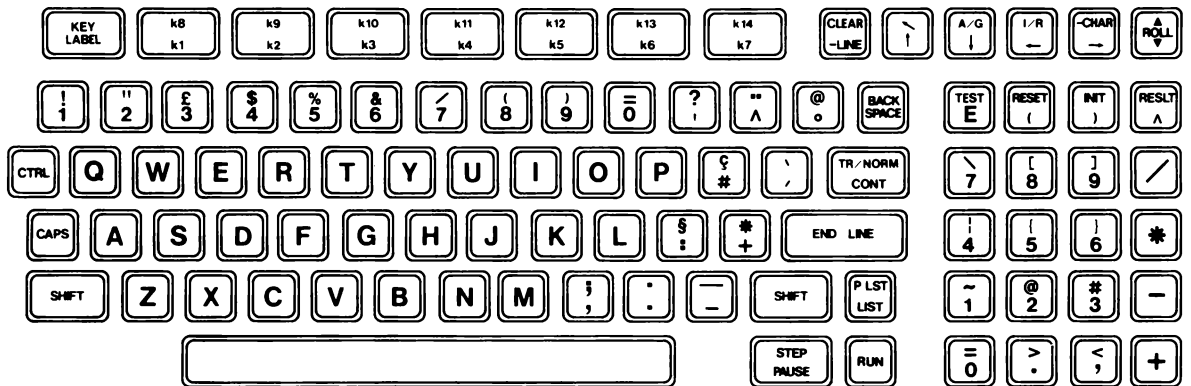

Figure 4-9. Dutch Version Keyboard Layout

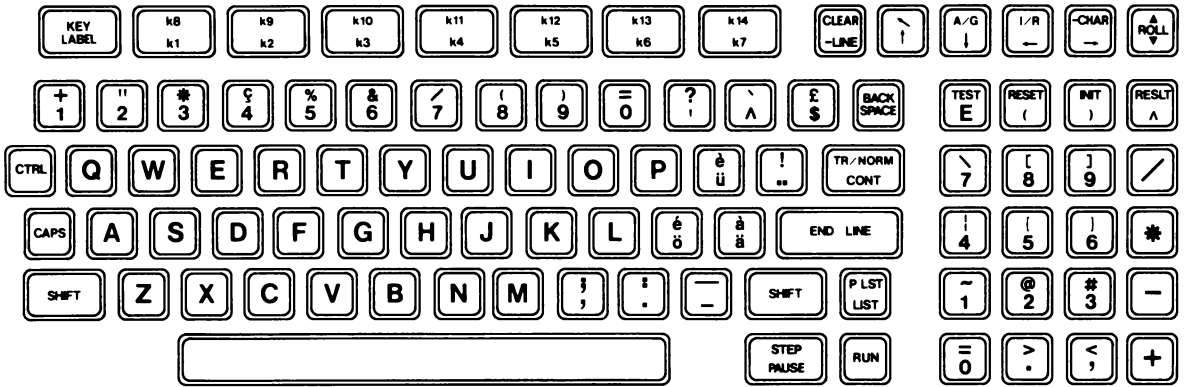

Figure 4-10. Swiss German Version Keyboard Layout

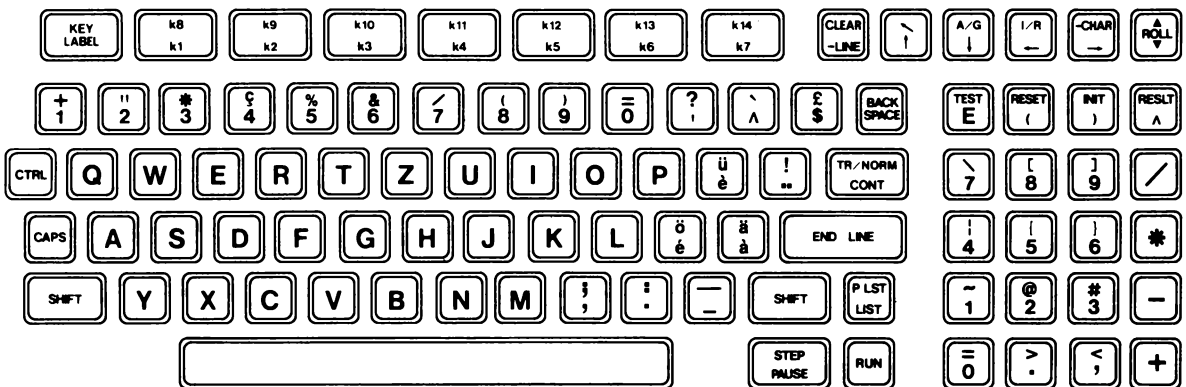

Figure 4-11. Swiss French Keyboard Layout

Table 4-3. HP-86B Replaceable Parts

FIGURE AND INDEX NUMBER	HP PART NUMBER	DESCRIPTION	QTY
4-13-4	00086-60038	WIRE, LED	1
	0624-0289	SCREW, tapping, 2-28 x .312	1
	00085-40019	HOLDER	1
	1990-0524	LED	1
	00086-60080	ASSEMBLY, topcase	1
4-13-5	2200-0147	SCREW, machine, 4-40 x 0.500 inch	6
	00086-90041	OVERLAY, keyboard	1
4-13-6	1600-1328	SHIELD, logic PCA	1
4-13-7	0340-1059	INSULATOR, logic	1
4-13-8	00086-69003	ASSEMBLY, logic PC (English)	1
4-13-8	*00086-69005	ASSEMBLY, logic PC (German, French, Dutch Italian, Swiss/German Swiss/French)	1
4-13-8	*00086-69007	ASSEMBLY, logic PC (Spanish, Swedish, Finnish Norwegian/Danish)	1
4-13-9	2190-0563	WASHER, #6 locking	8
4-13-10	1600-1321	EMI BOX	1
4-13-11	0590-0305	NUT, 6-32 w/lockwasher	12

*These assemblies contain a switch that configures them to a single language. See table 4-4 for the switch setting required for each language.

Section IV: Replaceable Parts

Table 4-3. HP-86B Replaceable Parts (Continued)

FIGURE AND INDEX NUMBER	HP PART NUMBER	DESCRIPTION	QTY
	1251-8060	CONNECTOR, video jack	1
4-13-12	8120-4023	CABLE, video	1
4-13-13	2190-0163	WASHER, locking	1
	3050-0646	WASHER, flat	2
	2950-0001	NUT, hex, video connector	1
4-13-15	0380-1014	SPACER, 0.125 inch	8
4-13-16	0380-1552	STANDOFF, 0.664 inch	1
4-13-17	0380-1553	STANDOFF, 0.195 inch	3
4-13-18	0380-1554	STANDOFF, 0.093 inch	1
4-13-19	0380-1555	STANDOFF, 0.268 inch	1
4-13-20	0380-1556	STANDOFF, 0.286 inch	2
4-13-21	00086-60903	ASSEMBLY, I/O PC	1
4-13-22	2360-0113	SCREW, 6-32 w/lckwshr	1
	2190-0757	WASHER, flat, #6	1
4-13-23	0624-0403	SCREW, tapping 19 x 0.375 inch	2
4-13-24	2360-0481	SCREW, 6-32 x 0.25	4
4-13-25	00085-40010	RECEPTACLE, I/O	
4-13-26	00086-60907	ASSEMBLY, backpanel	1
4-13-27	0624-0314	SCREW, tap, #4	3
4-13-14	8160-0335	STRIP, conducting	1

Table 4-3. HP-86B Replaceable Parts (Continued)

FIGURE AND INDEX NUMBER	HP PART NUMBER	DESCRIPTION	QTY
4-13-28	1400-1174	TWIST LOCK	2
4-13-29	8120-4031	CABLE, power supply	1
4-13-30	0624-0314	SCREW, #4 tapping w/lockwasher	1
4-13-31	7101-0718	MOUNT, power supply	1
4-13-32	00086-60902	ASSY, power supply	1
4-13-33	1600-1332	BRACKET, power supp.	1
4-13-34	2360-0115	SCREW, machine, 6-32 x 0.25 inch	9
4-13-35	0340-1057	INSULATOR, pwr supp.	1
4-13-36	00085-60023	ASSEMBLY, speaker	1
	0510-0062	CLIP, retaining, speaker	3
4-13-37	7101-0719	CASE, bottom	1
4-13-38	1531-0265	POST, support	1
4-13-39	3050-0716	WASHER, flat, shim	2
4-13-41	0570-1246	STUD, logic mount	5

Section IV: Replaceable Parts

Table 4-3. HP-86B Replaceable Parts (Continued)

FIGURE AND INDEX NUMBER	HP PART NUMBER	DESCRIPTION	QTY
	0403-0291	FOOT	1
4-12-1	2360-0480	SCREW, 6-32 w/lckw.	4
4-12-2	0905-0090	O-ring	1
4-12-3	2110-0569	NUT, fuseholder	1
4-12-6	00086-60005	ASSEMBLY, transformer	1
4-12-7	3101-0402	SWITCH, on/off	1
4-12-8	9135-0038	FILTER, line	1
4-12-9	2200-0778	SCREW, 4-40 x 0.25	2
4-12-10	2110-0610	FUSEHOLDER	1
4-12-11	2190-0411	WASHER, lock, ext. teeth, #4	2
4-12-12	00086-60053	ASSEMBLY, HP-IB connector	1
	0380-1625	POST, jack	2
4-12-15	3050-1144	WASHER, rectangular	2
	0590-0305	NUT, hex	2

Section IV: Replaceable Parts

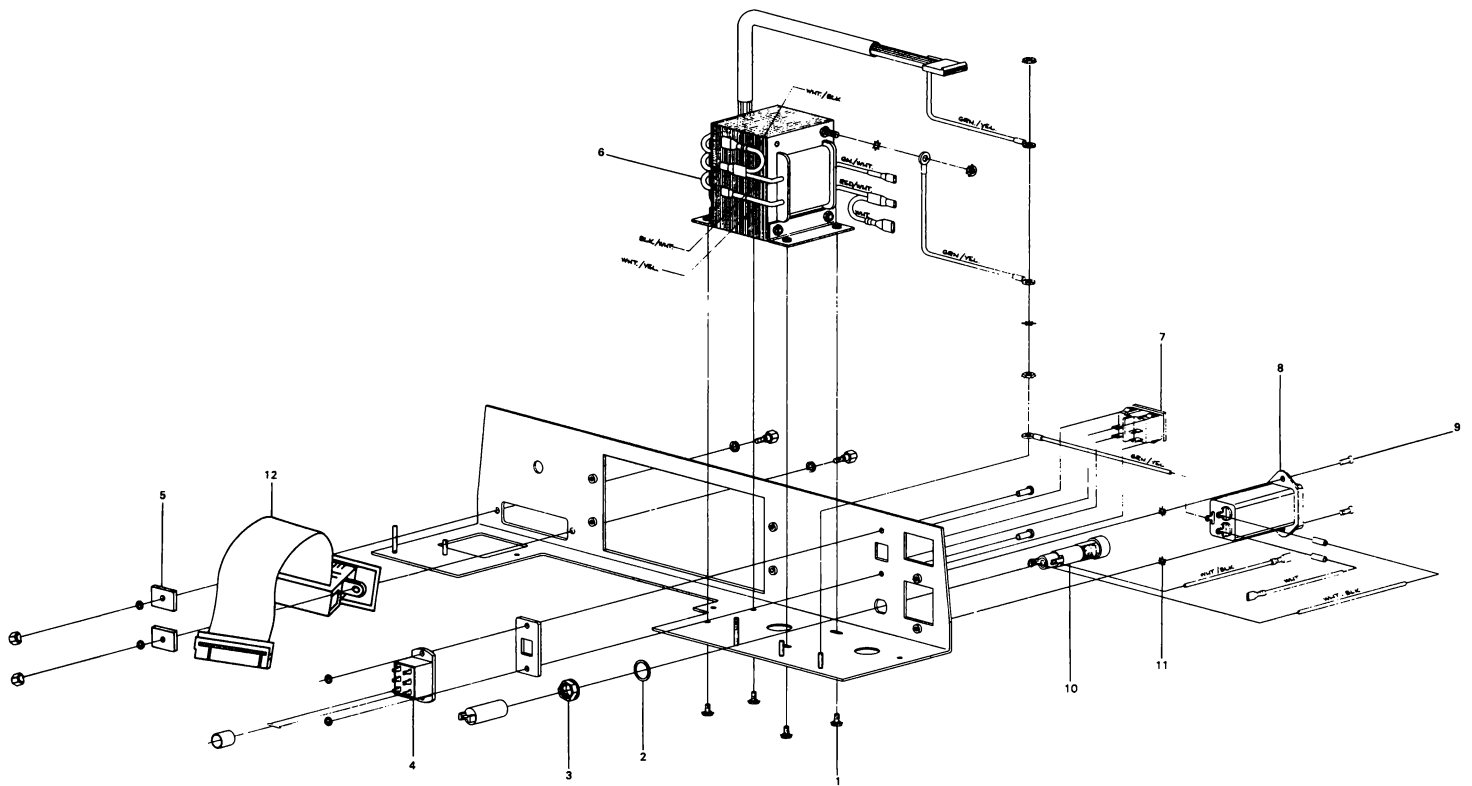

Figure 4-12. Back Panel Assembly Exploded View

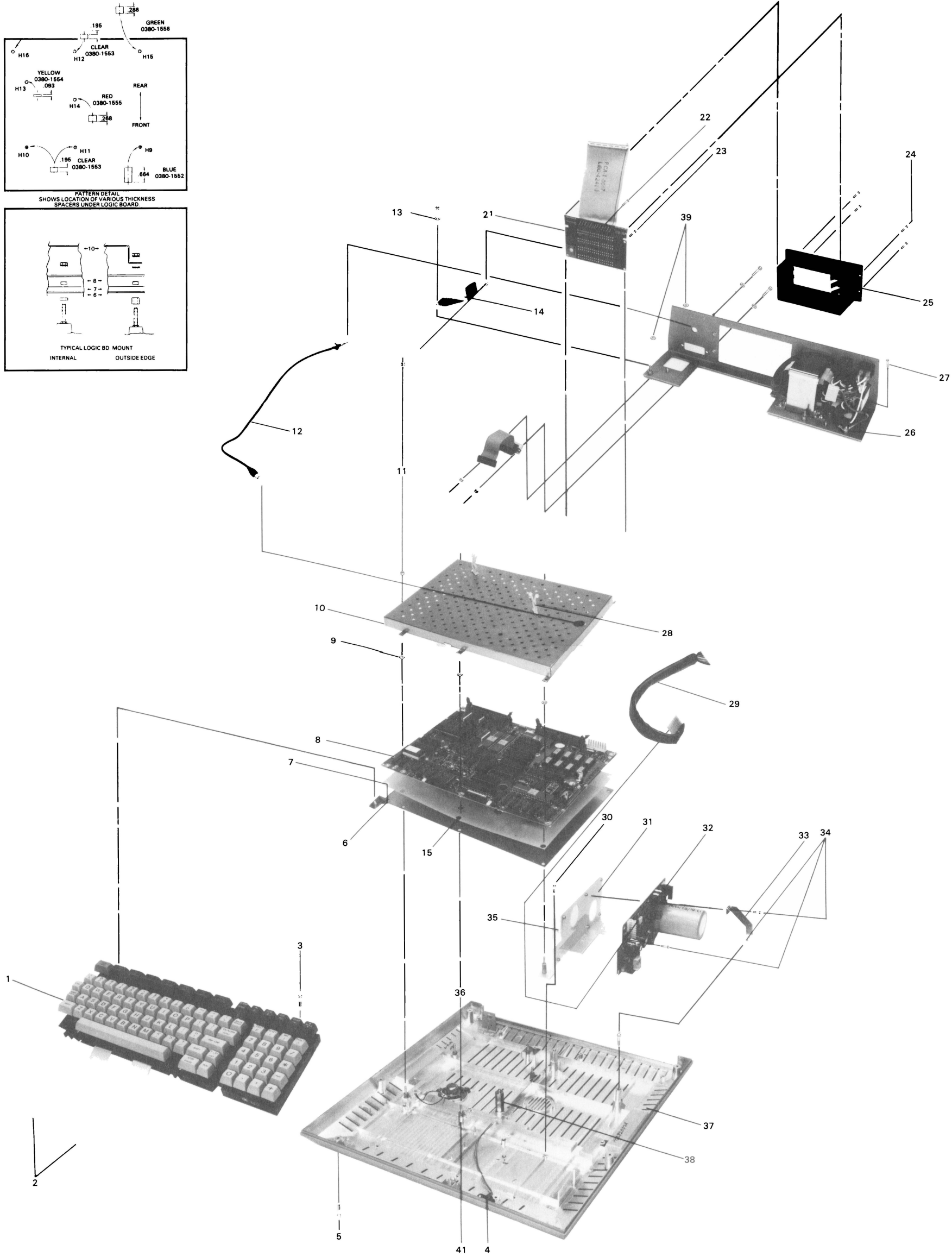
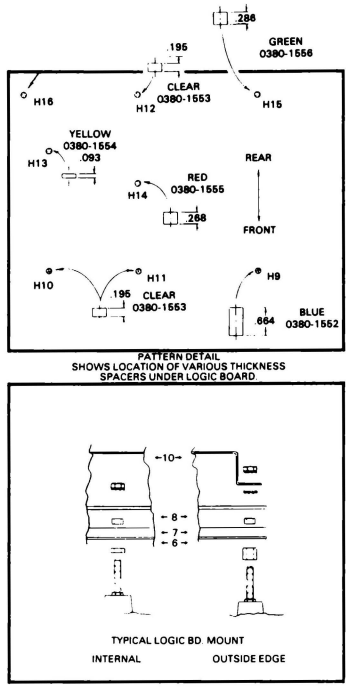

Figure 4-13.
HP-86B Exploded View

Table 4-4. Language Switch Settings on Logic PCA

ASSEMBLY PART NUMBER	LANGUAGE	SWITCH: S2 SEGMENT: 7 6 5 4 3 2 1
00086-69005	English	0 0 0 0 0 0 X
	German	0 0 0 1 0 0 X
	French	0 0 1 0 0 0 X
	Dutch	0 0 1 0 1 0 X
	Italian	0 0 1 0 0 1 X
	Swiss/German	0 1 0 1 0 0 X
	Swiss/French	0 1 0 1 0 1 X
00086-69007	English	0 0 0 0 0 0 X
	Spanish	0 0 0 1 1 0 X
	Swedish	0 0 0 0 0 1 X
	Finnish	0 0 0 0 0 1 X
	Norwegian/Danish	0 0 0 0 1 0 X

Schematic Diagrams

This section contains the schematic diagrams for the printed-circuit assemblies of the HP-86B.

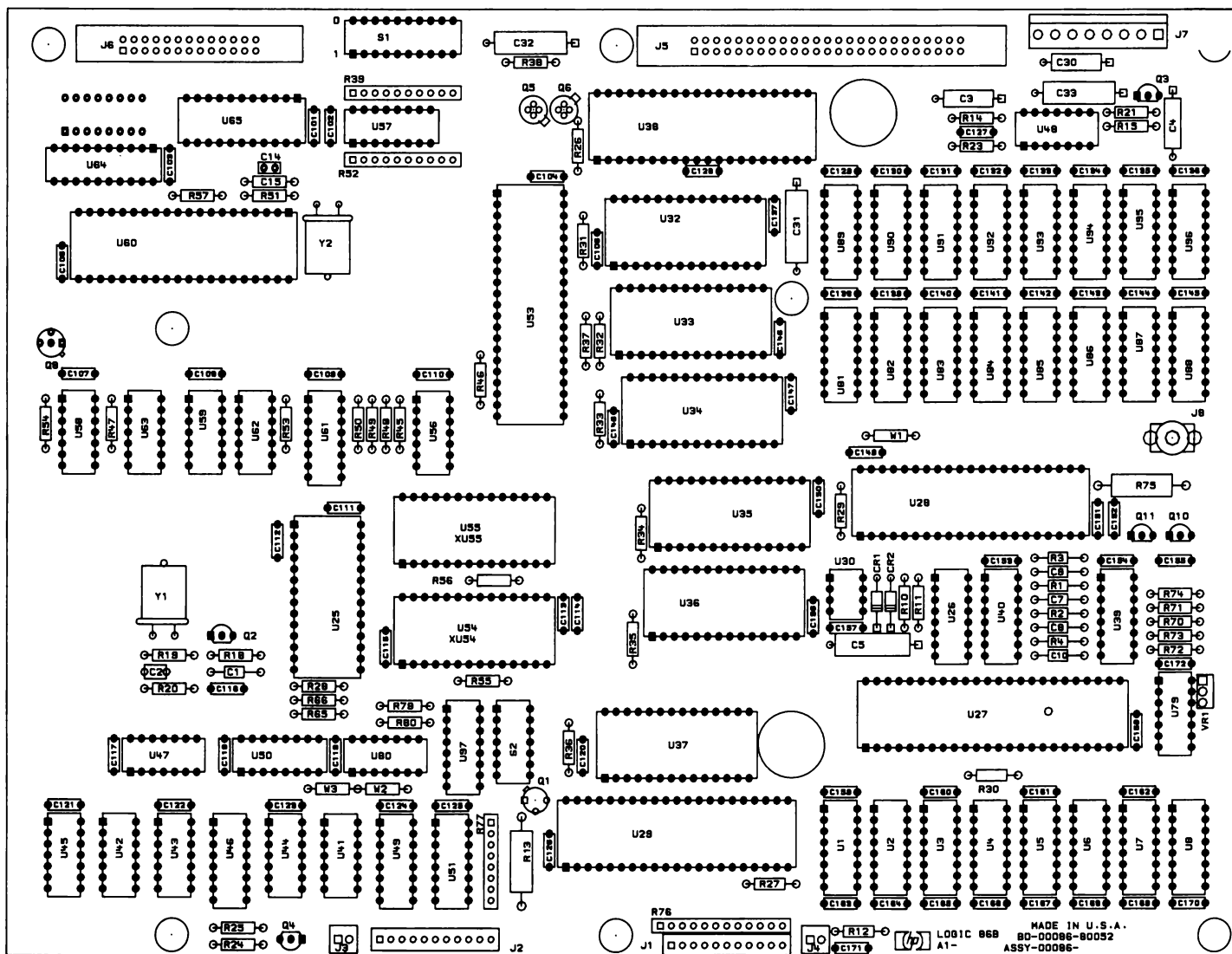

Figure 5-1. Logic PCA Component Location Diagram

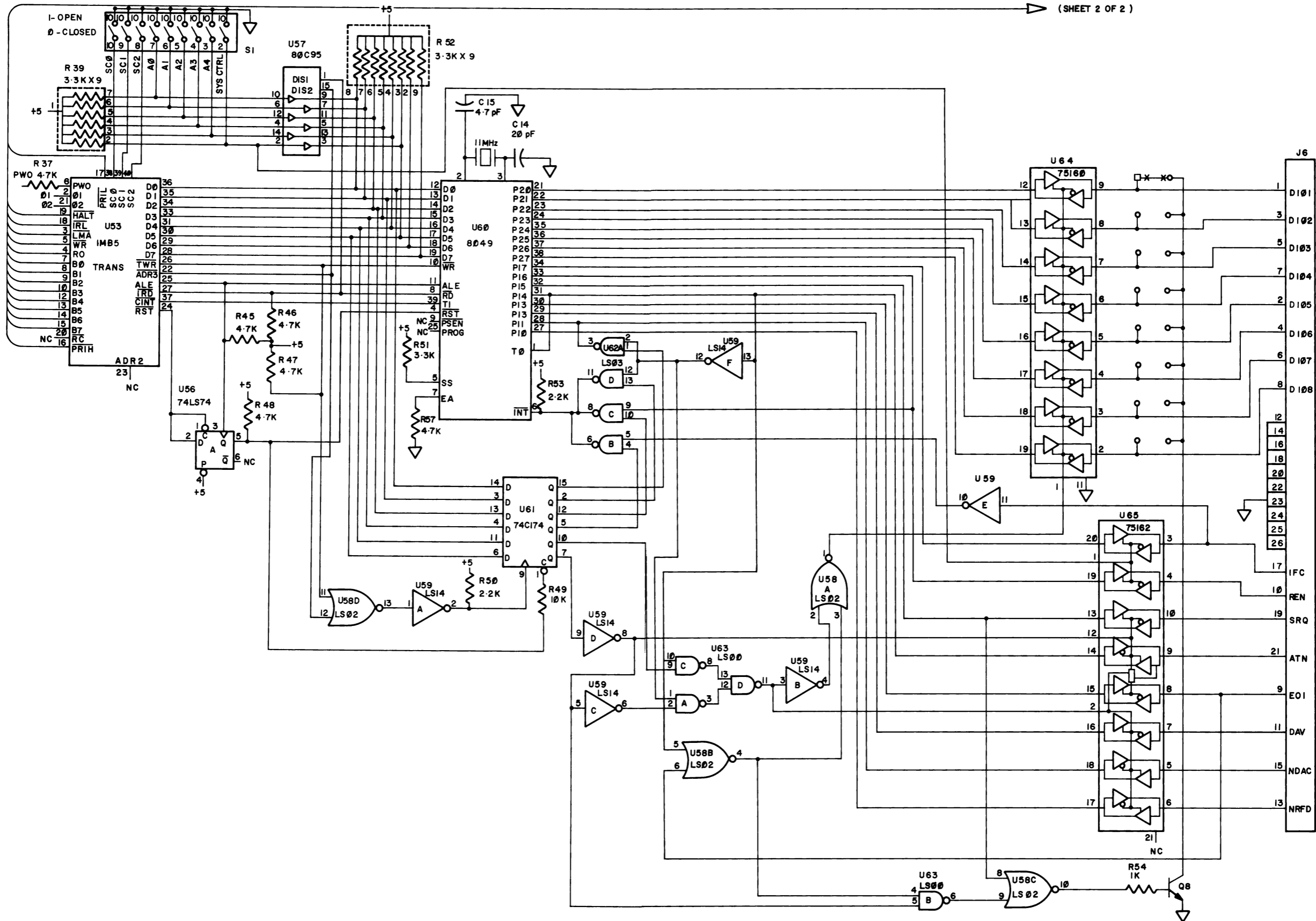

Figure 5-2. Logic PCA Schematic Diagram (Sheet 1) 5-3/5-4

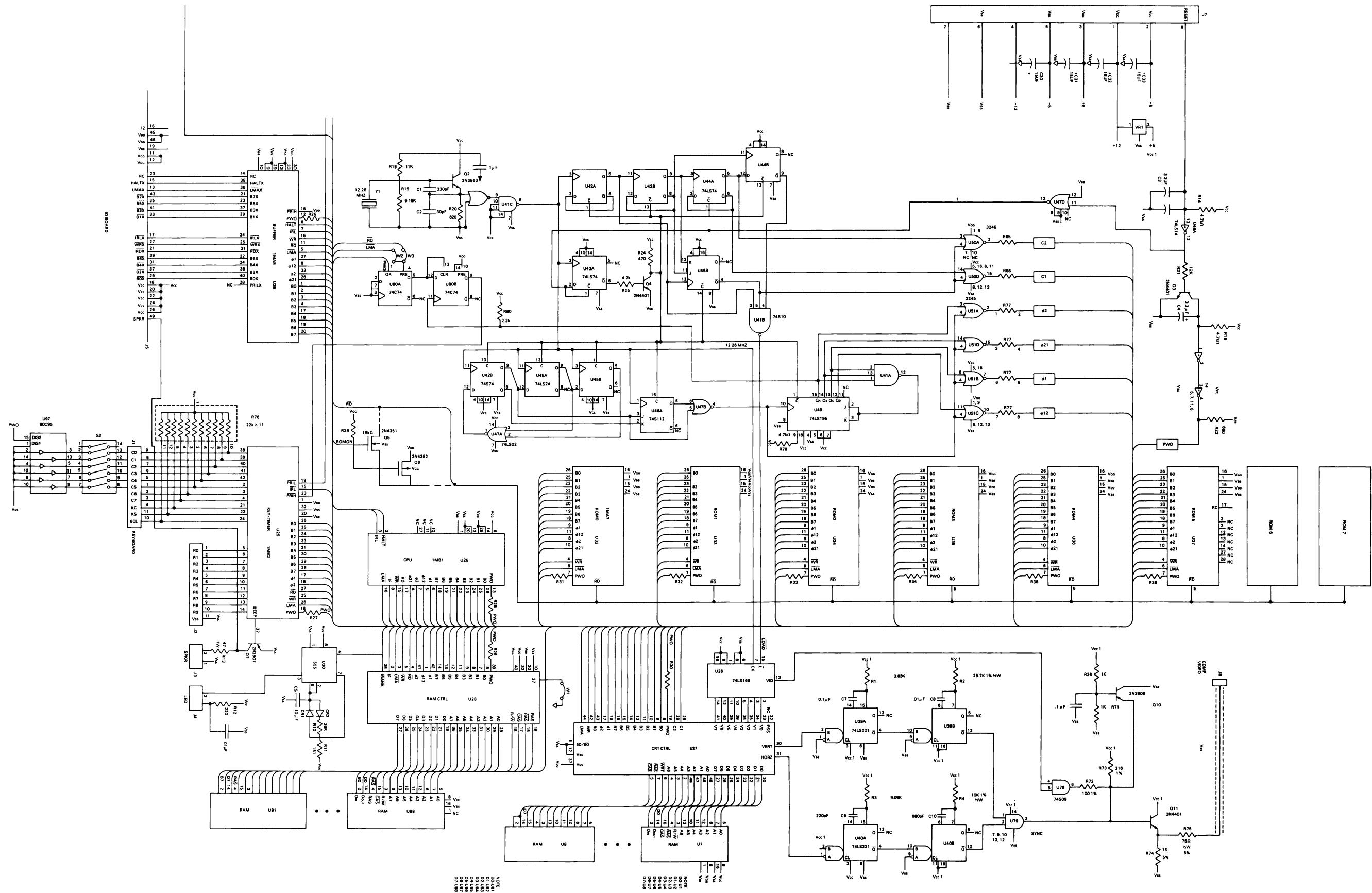

Figure 5-3. Logic PCA Schematic Diagram (Sheet 2) 5-5/5-6

Section V: Schematic Diagrams

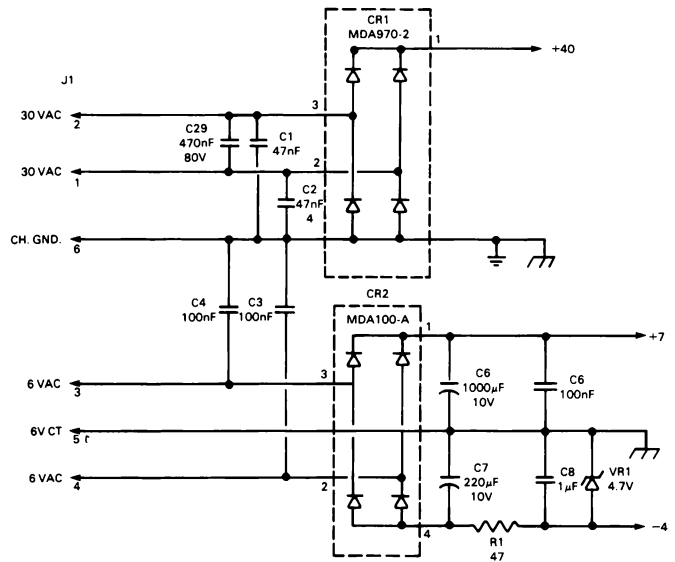
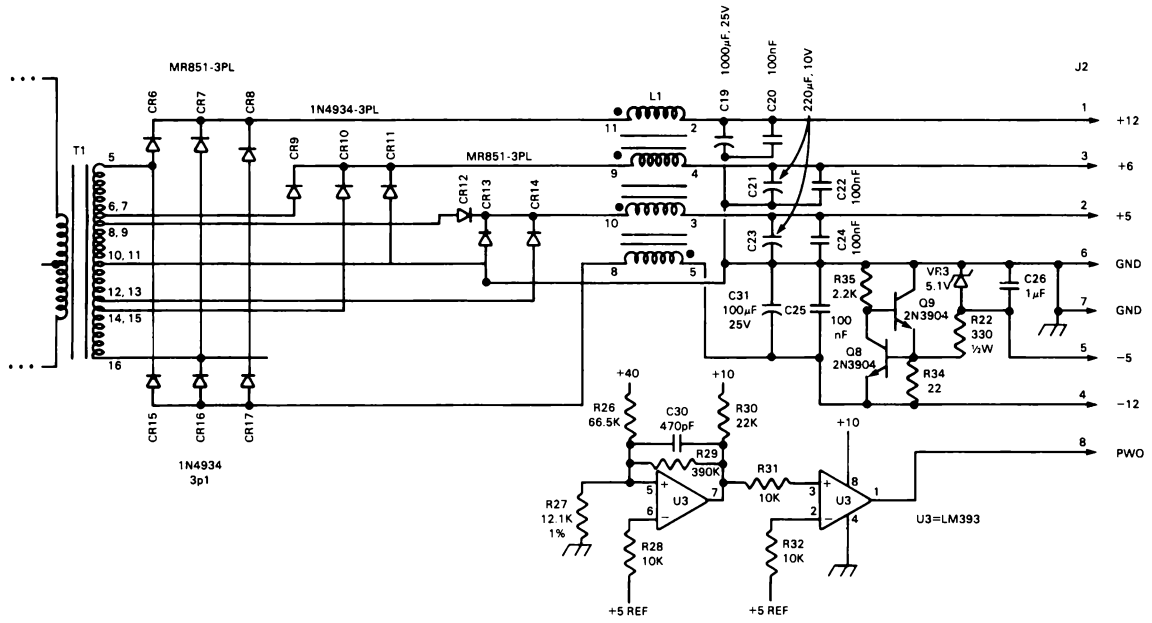
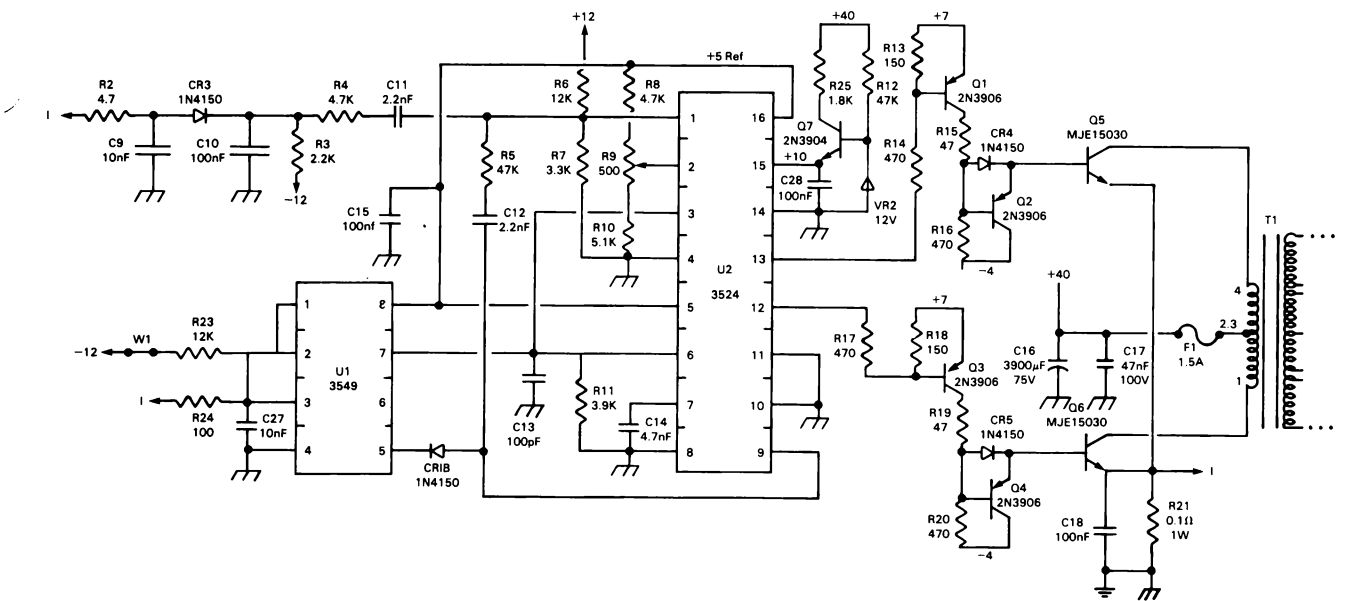

Figure 5-4. Power Supply PCA Schematic Diagram

Section V: Reference Diagrams

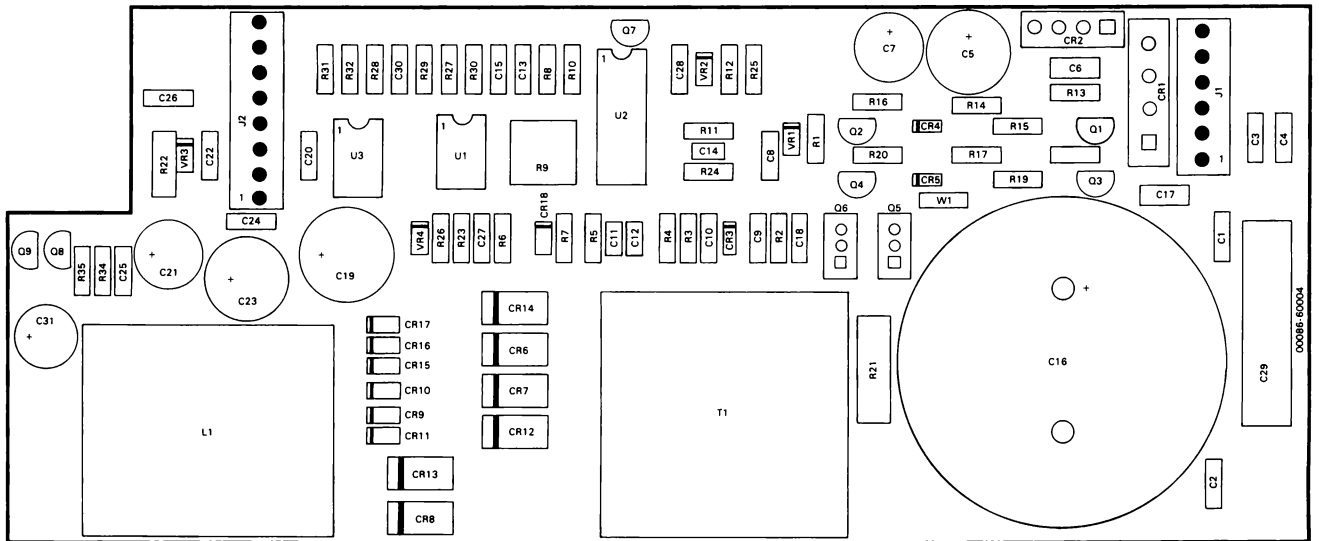

Figure 5-5. Power Supply PCA
Component Location Diagram

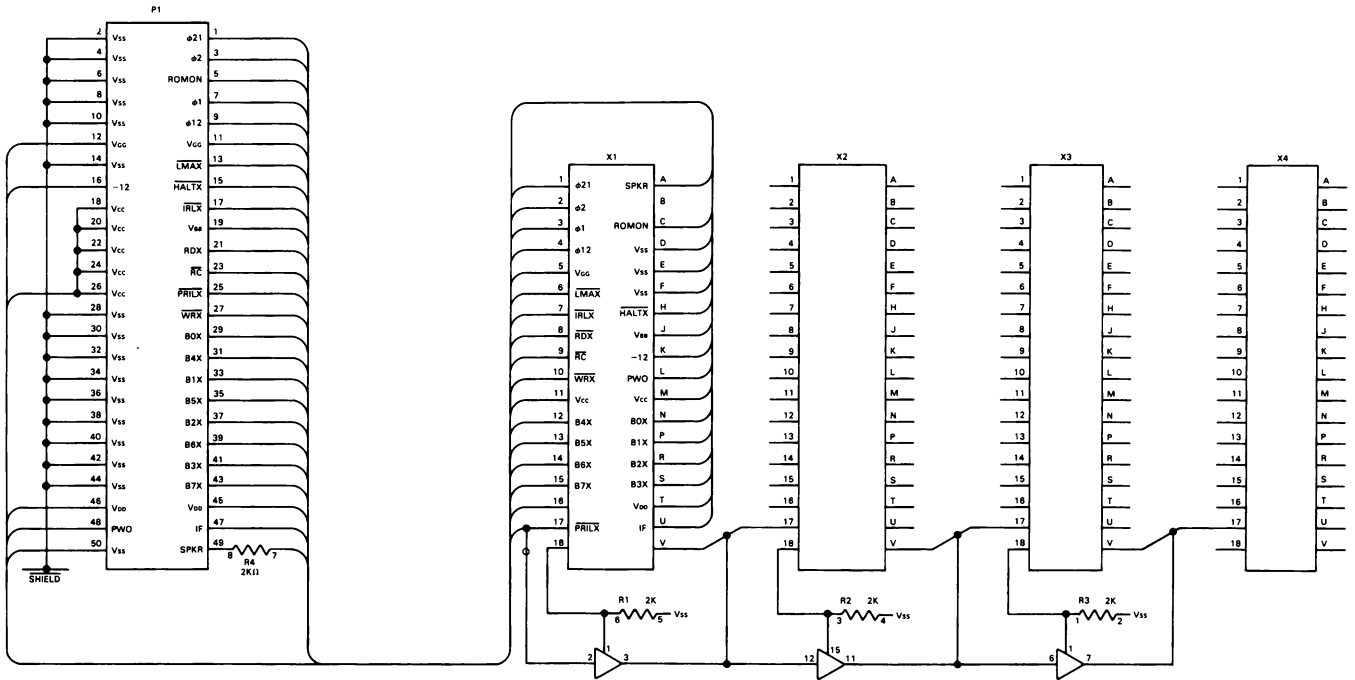

Figure 5-6. I/O PCA Schematic Diagram

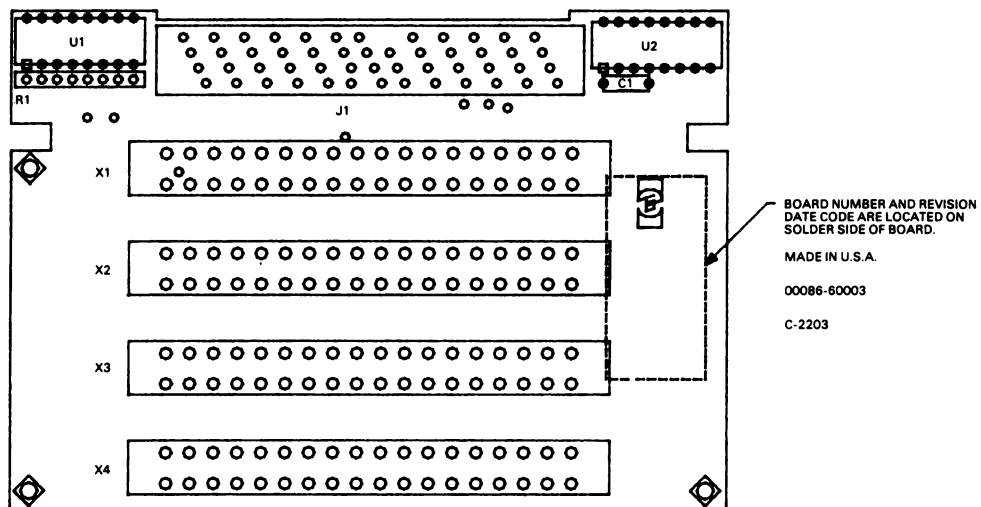

Figure 5-7. I/O PCA Component Location Diagram

