

Installation Reference

**HP 9000 Series 300 Computers
Model 375**

HP Part Number 98574-90604



Hewlett-Packard Company

3404 East Harmony Road, Fort Collins, Colorado 80525

NOTICE

The information contained in this document is subject to change without notice.

HEWLETT-PACKARD MAKES NO WARRANTY OF ANY KIND WITH REGARD TO THIS MANUAL, INCLUDING, BUT NOT LIMITED TO, THE IMPLIED WARRANTIES OF MERCHANTABILITY AND FITNESS FOR A PARTICULAR PURPOSE. Hewlett-Packard shall not be liable for errors contained herein or direct, indirect, special, incidental or consequential damages in connection with the furnishing, performance, or use of this material.

WARRANTY

A copy of the specific warranty terms applicable to your Hewlett-Packard product and replacement parts can be obtained from your local Sales and Service Office.

Copyright © Hewlett-Packard Company 1990

This document contains information which is protected by copyright. All rights are reserved. Reproduction, adaptation, or translation without prior written permission is prohibited, except as allowed under the copyright laws.

Restricted Rights Legend

Use, duplication or disclosure by the U.S. Government Department of Defense is subject to restrictions as set forth in paragraph (b)(3)(ii) of the Rights in Technical Data and Software clause in FAR 52.227-7013.

Printing History

New editions of this manual will incorporate all material updated since the previous edition. Update packages may be issued between editions and contain replacement and additional pages to be merged into the manual by the user. Each updated page will be indicated by a revision date at the bottom of the page. A vertical bar in the margin indicates the changes on each page. Note that pages which are rearranged due to changes on a previous page are not considered revised.

The manual printing date and part number indicate its current edition. The printing date changes when a new edition is printed. (Minor corrections and updates which are incorporated at reprint do not cause the date to change.) The manual part number changes when extensive technical changes are incorporated.

May 1990...Edition 1

Notices

Radio Frequency Interference Statements

FCC Statement

**Federal Communications Commission
Radio Frequency Interference Statement
(U.S.A. Only)**

The Federal Communications Commission (in Subpart J of Part 15, Docket 20780) has specified that the following notice be brought to the attention of the users of this product.

Warning: This equipment generates, uses, and can radiate radio frequency energy and if not installed and used in accordance with the instructions manual, may cause interference to radio communications. It has been tested and found to comply with the limits for a Class A computing device pursuant to Subpart J of Part 15 of FCC rules, which are designed to provide reasonable protection against such interference when operated in a commercial environment. Operation of this equipment in a residential area is likely to cause interference in which case the user at his own expense will be required to take whatever measures may be required to correct the interference.

VCCI Statement (Japan Only)

この装置は、第一種情報装置(商工業地域において使用されるべき情報装置)で商工業地域での電波障害防止を目的とした情報処理装置等電波障害自主規制協議会(VCCI)基準に適合しております。

従って、住宅地域またはその隣接した地域で使用すると、ラジオ、テレビジョン受信機等に受信障害を与えることがあります。

取扱説明書に従って正しい取り扱いをして下さい。

Manufacturer's Declaration (Germany Only)

Herstellerbescheinigung

Hiermit wird bescheinigt, daß dieses Gerät in Übereinstimmung mit den Bestimmungen der Postverfügung 1046/84 funkentstört ist. Der Deutschen Bundespost wurde das Inverkehrbringen dieses Gerätes angezeigt und die Berechtigung zur Überprüfung der Serie auf Einhaltung der Bestimmungen eingeräumt.

Table of Contents

Chapter 1: Introduction

How This Reference Is Organized	1
Your Computer's Parts	3
Interfaces	4
Interface Configuration	5
LAN Interfaces	7
RS-232 Interface	9
Connecting a Terminal	10
HP-HIL	11
SCSI	11
Miscellaneous Model 375 Hardware Information	12
Replacing the Fuse	12
Voltage Select Switch	13
Booting a System in Attended Mode	13
Where to Go Next	13
Additional References	13

Chapter 2: Reading the Self-Test

Self-Test Messages	16
Status Messages	17
Where to Go Next	18
Error Messages	18
Boot ROM Beeper	19
Boot ROM Errors	19
Running an Extended Memory Test	20
What To Do When Errors Occur	20
Where To Get Help	21
Boot ROM Error Messages	21

Chapter 1

Installing Your System

Introduction

This manual covers the installation of all Series 300 computers, as well as their monitors and keyboards.

For the purpose of consistency, the computers will be referred to by their product number only. The term, “the computer” will be used when referring to any of the various models.

Getting Started

Your new computer has just arrived. You're looking for some easy instructions to get it set up and running, and you've turned to this reference for help. You've come to the right place.

Before you proceed, we want to address a few preconceptions you may have about computer documentation. Yes, we know that you may be less than enthusiastic about reading this reference. You're concerned that you'll have to read for hours before you can finally put the book down and actually *do something* with your computer. Or perhaps you're afraid that we'll presume you have a Ph.D. in electrical engineering, give you a schematic of the computer, and tell you to figure it out for yourself.

Forget it. That's not going to happen here. This reference tells you how to put your computer system together and turn it on. When you're finished with this manual, you'll be ready to load and use your operating system or applications program.

How This Reference Is Organized

This reference has two chapters. Please read them in order, performing the installation procedures as you go.

Chapter 1 – Installing Your System. The section you're now reading tells you how your installation guide is organized. The rest of the chapter explains how to install your system. It expands on the procedure in the Installation Card, and deals with any problems.

Chapter 2 – Reading The Self-Test. This chapter tells you how to turn on your computer system and read and interpret the self-test messages.

Reference. This section contains information that you don't normally need for installation, but that may be valuable at a later date or for tutorial purposes. You are referred to this section from the main body of the guide where appropriate.

Glossary. This section contains definitions of terms used in this reference.

Index. This section contains an alphabetical list of the subjects in this reference and the corresponding pages where the subjects are discussed.

Add-on Accessories. If you purchase add-on accessories after your system is installed, you will install them yourself. Store the installation instructions in this section. Those accessories which you purchase with the system will be installed at the factory.

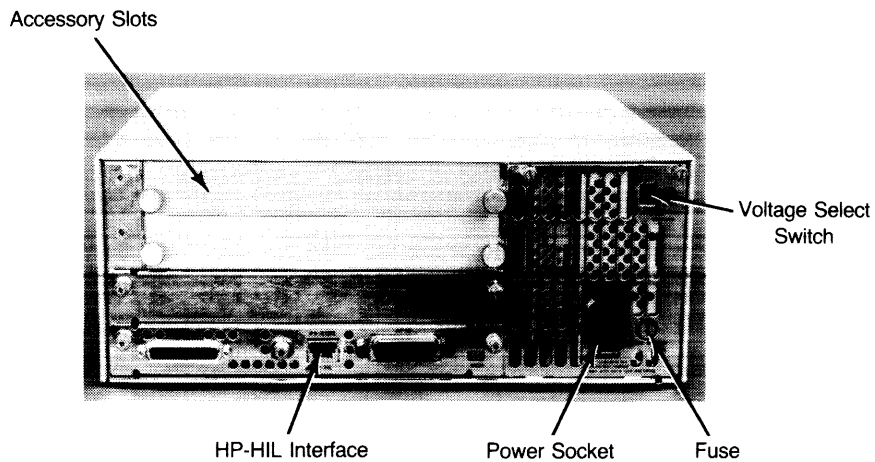
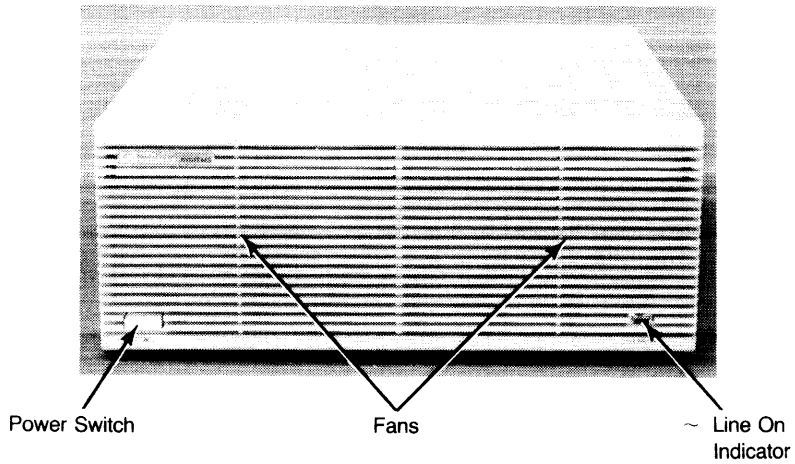

Your Computer's Parts

4 Installing Your System

Your Computer's Parts

The Figures on the facing page show the various parts of the computer which are referred to in this Reference. Note that due to the large number of different configurations, some of the items pointed out may be in a different place than in these Figures. They will, however, look the same.

Power Switch - This is the switch you use to turn power on and off. When power is on, the switch is "in" or flush with the front of the computer; the switch is "out" when power is off.

~LINE ON Indicator - This green indicator is lit when power is turned on. When power is off, the indicator is off.

Accessory Slots - Remove these covers to install memory cards, interface cards, and other accessories.

Fans - The computer has two small built-in fans to keep it cool. The fans should always be running when the computer is on. If either fan ever goes off while the computer is powered on, switch the computer off and call your HP Service Representative.

Power Socket - The three-pronged power socket is especially designed for an HP power cord. The power cord is shipped in the carton this reference came in.

Voltage Select Switch - The computer is designed to run at either 85-129 Vac or 187-250 Vac. The line frequency range is 48-66 Hz. The voltage select switch sets the computer to run at the lower (120 Vac) or upper (240 Vac) range.

Fuse - A fuse rated at 250V, 8A, must be in place for your computer to run safely.

HP-HIL Interface - You will plug your HP-HIL cable into this receptacle.

Installing Your Computer

This section explains how to install your system. It expands on the procedure presented in the *Installation Picture-guide*, and deals with any problems which you may encounter.

The computer comes in several versions. Each version has a different *Installation Picture-guide* due to differences in the hardware. However, the versions will be covered together here except for the monitors, which are quite different.

Before you move on to the first step, look at the photo at the beginning of this chapter and familiarize yourself with the computer parts. Find each part on your own computer as you look over the list.

There are four sections to the installation procedure: the Computer section, the Monitor section, the Keyboard section and the Video Display section.

The Computer Section

This section covers unpacking and installing the computer mainframe.

Remove the computer from this carton.

The computer is packed in a large carton together with a box containing accessory items.

Go ahead and remove the computer from the large box.

Place it on your desk.

Place the computer on any convenient surface. It need not be at your work area, as the computer is designed for remote operation. Be sure that there is at least 50 mm (2 inches) of space at the front and back for ventilation. The fans draw cooling air through the grill in the front panel and out the back. Do not operate the computer in areas with excessive dust or smoke.

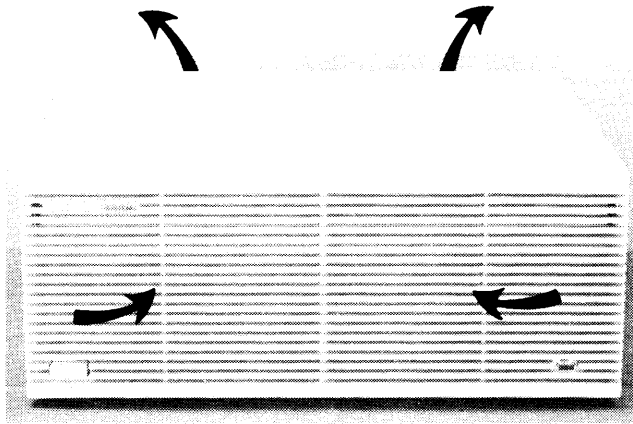

Position the Computer to Allow Free Air Flow

Leave enough clearance at the back of the computer for any cables that will be connected. If pressure is exerted against the computer-end of these cables, the connector could be damaged.

Open the long box and remove the power cord.

The long box is called the Localization Kit, and contains items such as power cords, keyboard cables, and this manual.

Compare the voltage setting to the power cord.

Your computer can be set to operate at nominal line voltages of 120 or 240 Vac. It was set at the factory to the line voltage in your area. However, it is a good idea to check the setting and change it if it is incorrect.

CAUTION

**THE COMPUTER CAN BE DAMAGED IF SET FOR 120 VAC
AND PLUGGED INTO A HIGHER VOLTAGE.**

The best way to check for correct setting is to determine whether you have the correct power cord, then use the furnished chart to determine the correct setting for the power cord.

Note: These drawings represent the **wall connector** end of the cord.

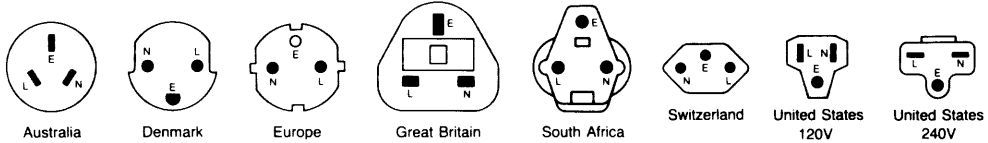

Country	Part Number	Opt.	Voltage
Australia	8120-1369	901	250V, 6A
Denmark	8120-2956	912	250V, 6A
Europe	8120-1689	902	250V, 6A
Great Britain	8120-1351	900	250V, 6A
South Africa	8120-4211	917	250V, 10A
Switzerland	8120-2104	906	250V, 6A
United States	8120-1378	903	120V, 10A
United States	8120-0698	904	240V, 10A

Power cords supplied by HP have polarities matched to the power-input socket on the computer:

- L = Line or Active Conductor (also called "live" or "hot")
- N = Neutral or Identified Conductor
- E = Earth or Safety Ground

NOTE: Plugs are viewed from connector end. Shape of molded plug may vary within country.

Available Power Cords

Check the voltage setting.

Now compare the voltage figure from the previous step with the setting on the rear panel of the computer.

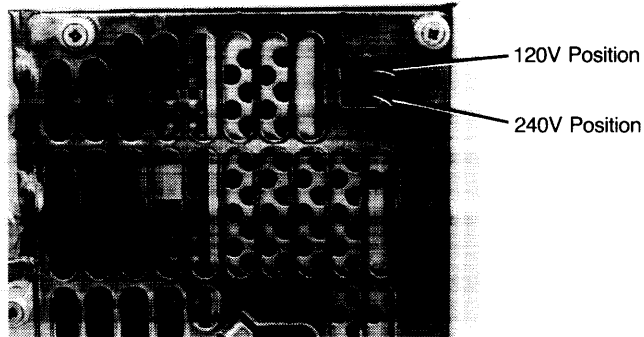

Voltage Select Switch

The switch should be in the **up** position if you have a United States 120V power cord, and in the **down** position otherwise.

Connect power to the computer.

Locate the power switch and press it in and out a few times to get the feel of it. Now set it to the off position (that is, the switch is “out”).

Find the power cord in the small box and connect it to the power socket. Then connect the other end to the wall socket.

WARNING

IF A REPLACEMENT POWER CORD IS NEEDED, MAKE SURE YOU ORDER AN HP POWER CORD THAT IS IDENTICAL TO THE ORIGINAL. OTHERWISE, ELECTRICAL SHOCK OR EQUIPMENT DAMAGE MAY RESULT.

The Monitor Section

This section covers installing your video display monitor and connecting it to the computer mainframe. The monitors are not similar enough to cover together, so they are separated by resolution and whether monochrome or color, and covered individually.

Medium-resolution Monochrome

This section covers installing a medium-resolution monochrome monitor.

Find and unpack the video board.

If you ordered an unbundled system or are upgrading your system, the video board may have come separately. Locate the video board carton. It will have the number 98542A stamped on it.

Install the video board in the computer.

The video board must be installed in the bottom slot in the computer. If a board is already located there, it must be removed and positioned elsewhere.

Find the video display monitor carton.

The monitor furnished with your computer is the HP 35731A/B 12-inch Monochrome Video Monitor.

Find the carton containing your monitor. It will have HP 35731 printed on it. Go ahead and unpack the monitor and place it on a convenient surface at your work area.

CAUTION

TURN YOUR COMPUTER OFF BEFORE INSTALLING THE MONITOR.

CAUTION

DO NOT OBSTRUCT THE AIR VENTS AT THE TOP AND SIDES OF THE MONITOR.

Check the voltage select setting to be the same as the computer.

Your monitor has a voltage select switch. Make sure that the monitor is set to the same voltage range as the computer.

Find the audio/video cable.

A two-conductor cable is furnished for audio and video. One conductor is marked "Video" at each end and the other is marked "SPKR".

Connect the audio/video cable.

Connect one end of the "Video" cable to the Video Out connector on the computer. Connect one end of the "SPKR" cable to the Audio Out connector on the computer.

Then connect the other ends to the monitor.

Install the HP-HIL cable.

The HP-HIL cable is keyed. It has a black dot at one end and two black dots at the other.

Locate the two-dot end of the HP-HIL cable. It is marked with two black dots.

Connect the two-dot end of the HP-HIL cable to the computer. The computer socket is also coded with **two dots**.

Connect the one-dot end of the HP-HIL cable to the monitor. The monitor receptacle is also coded with **one dot**.

Connect power to the monitor.

The power cord is located in the carton containing the monitor. Connect it to the power socket. Then connect the other end to the wall socket.

Turn the monitor on. This allows the monitor to warm up while you are installing the keyboard.

Your system should now look like this:

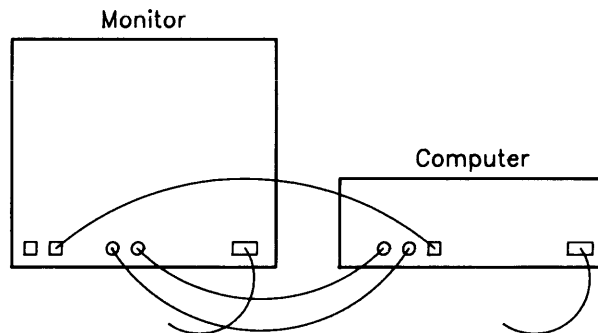

Computer with Medium-resolution Monochrome Monitor

Medium-resolution Color

This section covers installing a medium-resolution color monitor.

Find and unpack the video board.

If you ordered an unbundled system or are upgrading your system, the video board may have come separately. Locate the video board carton. It will have the number 98543A stamped on it.

Install the video board in the computer.

The video board must be installed in the bottom slot in the computer. If a board is already located there, it must be removed and positioned elsewhere.

Find the video display monitor carton.

The monitor furnished with your computer is the HP 35741A 12-inch Color Video Monitor.

Find the carton containing your monitor. It will have HP 35741 printed on it. Go ahead and unpack the monitor and place it on a convenient surface at your work area.

CAUTION

TURN YOUR COMPUTER OFF BEFORE INSTALLING THE MONITOR.

CAUTION

DO NOT OBSTRUCT THE AIR VENTS AT THE TOP AND SIDES OF THE MONITOR.

Check the voltage select setting.

Your monitor has a voltage select switch. Make sure that the monitor is set to the same voltage range as the computer.

Find the video cables.

The video cable carries video signals from the computer to the monitor. Your monitor has three separate video cables for red, blue and green. The cables are identical and may be used for any color.

Connect the video cables.

The video cables are color-coded Red, Blue and Green. The monitor output connectors are labelled R, B and G. Connect each video cable connector to the appropriate video connector on the computer. Then connect the other ends of the cables to the Monitor.

Install the audio cable.

Now find and install the audio cable. It has an RCA connector on each end. Install it between the computer and the monitor.

Install the HP-HIL cable.

The HP-HIL cable is keyed. It has a black dot at one end and two black dots at the other.

Locate the two-dot end of the HP-HIL cable. It is marked with two black dots.

Connect the two-dot end of the HP-HIL cable to the computer. The computer socket is also coded with **two dots**.

Connect the one-dot end of the HP-HIL cable to the monitor. The monitor receptacle is also coded with **one dot**.

Connect power to the monitor.

The power cord is located in the carton containing the monitor. Connect it to the power socket. Then connect the other end to the wall socket.

Turn the monitor on. This allows the monitor to warm up while you are installing the keyboard.

Your system should now look like this:

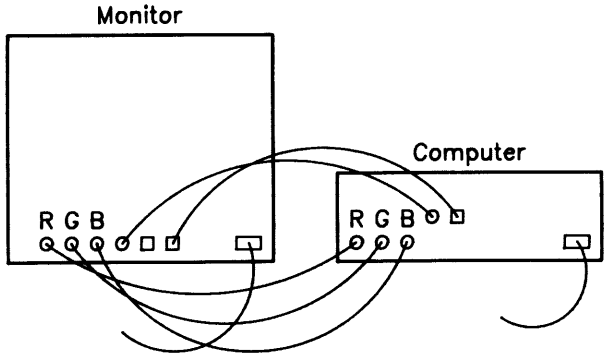

Computer with Medium-resolution Color Monitor

High-resolution Monochrome

This section covers installing a high-resolution monochrome monitor.

Find and unpack the video board.

If you ordered an unbundled system or are upgrading your system, the video board may have come separately. Locate the video board carton. It will have the number 98544A stamped on it.

Install the video board in the computer.

The video board must be installed in the bottom slot in the computer. If a board is already located there, it must be removed and positioned elsewhere.

Find the video display monitor carton.

The monitor furnished with your computer is an HP 98781A/B/C or an HP 98786A 17-inch high-resolution monochrome Video Monitor.

Find the carton containing your monitor. It will have HP 98781 or HP 98786 printed on it. Go ahead and unpack the monitor and place it on a convenient surface at your work area.

CAUTION

TURN YOUR COMPUTER OFF BEFORE INSTALLING THE MONITOR.

CAUTION

DO NOT OBSTRUCT THE AIR VENTS AT THE TOP AND SIDES OF THE MONITOR.

Check the voltage select setting to be the same as the computer.

Your monitor has a voltage select switch. Make sure that the monitor is set to the same voltage range as the computer.

Install the video cable.

The video cable is black and has an RCA connector on one end and a BNC connector on the other.

Connect the end with the RCA connector to the video output jack on the computer and the other end to the monitor.

Install the audio cable.

The audio cable is black and has an RCA connector on both ends.

Connect one end to the audio output jack on the computer and the other end to the monitor.

Install the HP-HIL cable.

Now locate the HP-HIL connector. It has two black dots on it. The socket on the computer also has two dots. Install the HP-HIL connector into the two-dot socket on the computer.

Now locate the phono-to-RCA adapter and connect it to the remaining connector on the monitor cable. Then connect it to the RCA connector on the computer.

Connect power to the monitor.

The power cord is located in the carton containing the monitor. Connect it to the power socket. Then connect the other end to the wall socket.

Your system should now look like this:

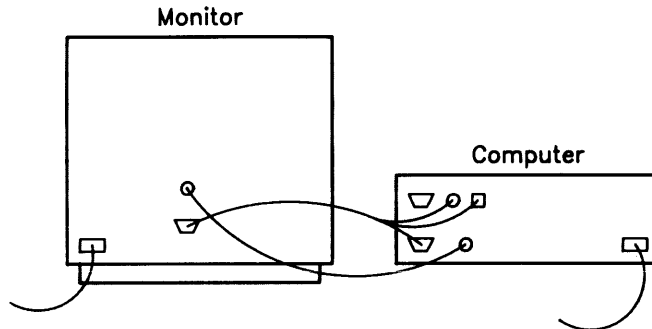

Computer with High-resolution Monochrome Monitor

High-resolution Color

This section covers installing a high-resolution color monitor.

Find and unpack the video board.

If you ordered an unbundled system or are upgrading your system, the video board may have come separately. Locate the video board carton. It will have the number 98547A stamped on it.

Install the video board in the computer.

The video board must be installed in the bottom slot in the computer. If a board is already located there, it must be removed and positioned elsewhere.

Find the video display monitor carton.

The monitor furnished with your computer is an HP 98782A/B/C or an HP 98784A 19-inch high-resolution Color Video Monitor.

Find the carton containing your monitor. It will have HP 98782 or HP 98784 printed on it. Go ahead and unpack the monitor and place it on a convenient surface at your work area.

CAUTION

TURN YOUR COMPUTER OFF BEFORE INSTALLING THE MONITOR.

CAUTION

DO NOT OBSTRUCT THE AIR VENTS AT THE TOP AND SIDES OF THE MONITOR.

Check the voltage select setting.

Your monitor has a voltage select switch. Make sure that the monitor is set to the same voltage range as the computer.

Locate the video cables.

The video cables carry video signals from the computer to the monitor. Your monitor has a three-conductor video cable—one conductor for red, blue and green.

Connect the video cables.

The video cables are color-coded Red, Blue and Green. The video output connectors are labelled R, B and G. Connect each video cable connector to the appropriate video connector on the computer. Then connect the other ends of the cables to the monitor.

Install the Speaker Module.

HP 98782A/B/C monitors do not have an internal speaker or HP-HIL circuitry, so you will need to install a Speaker Module.

Installation involves selecting a location for the module, installing a fastener pad and attaching the module to the pad.

The fastener pad has a pressure-sensitive adhesive backing. The backing must be placed on a clean, dry and oil-free surface. It should be flat, smooth and non-porous.

Suggested locations are the back or side of the monitor or the edge of a desk. Avoid any location which interferes with equipment ventilation grilles.

Select a suitable mounting location and remove the paper covering from the back of the fastener pad. Place the pad at the location and press down firmly for a few seconds. Now attach the module to the fastener pad.

Install the audio cable.

Now find the audio cable and connect one end to the speaker module.

Now locate the phono-to-RCA adapter and connect it to the other end of the audio cable. Then connect it to the RCA connector on the computer.

Install the HP-HIL cable.

The HP-HIL cable is keyed. It has a black dot at one end and two black dots at the other.

Locate the two-dot end of the HP-HIL cable. It is marked with two black dots.

Connect the two-dot end of the HP-HIL cable to the computer. The computer socket is also coded with **two dots**.

Connect the one-dot end of the HP-HIL cable to the speaker module. The speaker module receptacle is also coded with **one dot**.

Connect power to the monitor.

The power cord is located in the carton containing the monitor. Connect it to the power socket. Then connect the other end to the wall socket.

Turn the monitor on.

This allows the monitor to warm up while you are installing the keyboard.

Your system should now look like this:

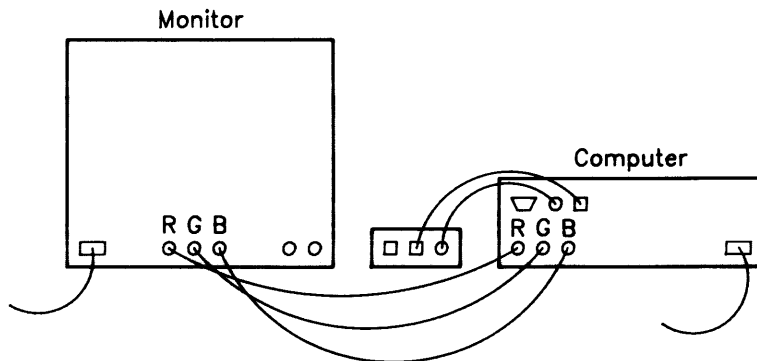

Computer with High-resolution Color Monitor

The Keyboard Section

This section covers installing the keyboard.

Find and unpack the keyboard.

The keyboard is packed in a flat box with a picture of a keyboard on the top.

CAUTION

THE KEYBOARD CABLE PLUGS AND SOCKETS ARE NOT ALIKE. IF YOU FORCE A PLUG INTO THE WRONG SOCKET ON THE COMPUTER OR KEYBOARD, YOU CAN DAMAGE THE EQUIPMENT. CAREFULLY FOLLOW INSTALLATION INSTRUCTIONS.

Locate the keyboard cable.

The keyboard cable is similar to the HP-HIL cable, except that it is coiled. It is keyed like the HP-HIL cable, with the one-dot end going to the keyboard and the two-dot end going to the monitor. It is located in the small box in the large, outer carton containing the computer.

Locate the two-dot end of the keyboard cable.

It is marked with two black dots.

Connect the two-dot end of the keyboard cable to the monitor.

Install the keyboard cable plug with **two dots** in the socket on the monitor or speaker module. The monitor or speaker module socket is also coded with **two dots**.

Connect the one-dot end of the keyboard cable to the keyboard.

Install the keyboard cable plug with **one dot** in the right-hand socket of the keyboard (as viewed from the back). The right-hand keyboard socket is also coded with **one dot**.

Slide the keyboard cable into the cable run on the keyboard. Fold the keyboard stand up or down as you like.

Your system should now look like this:

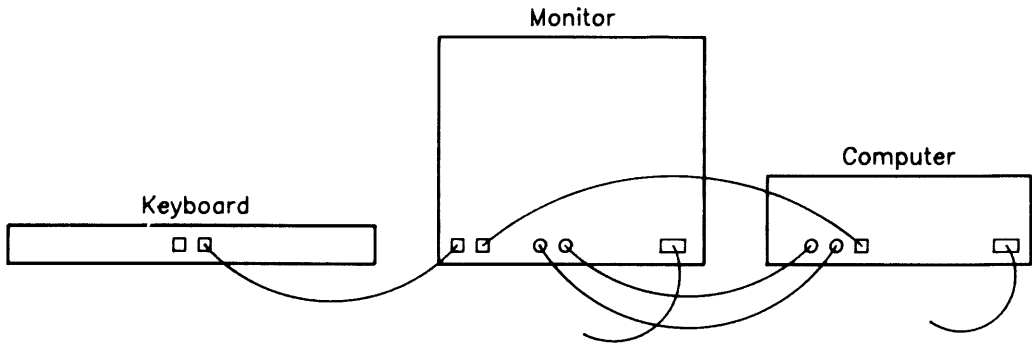

Computer with Medium-resolution Monochrome Monitor and Keyboard

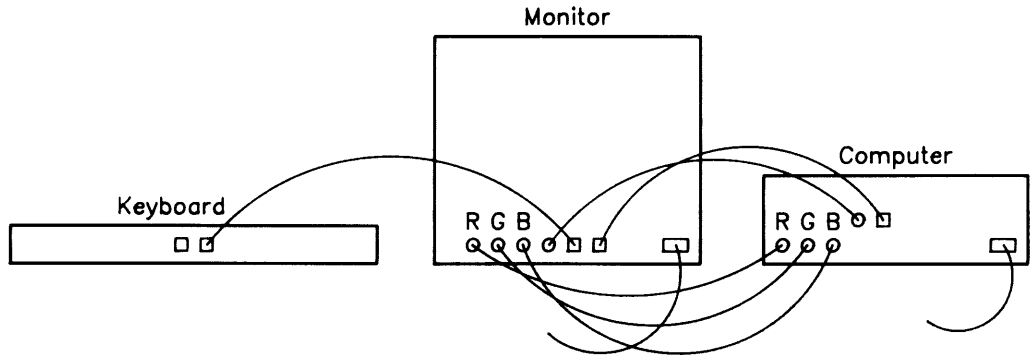

Computer with Medium-resolution Color Monitor and Keyboard

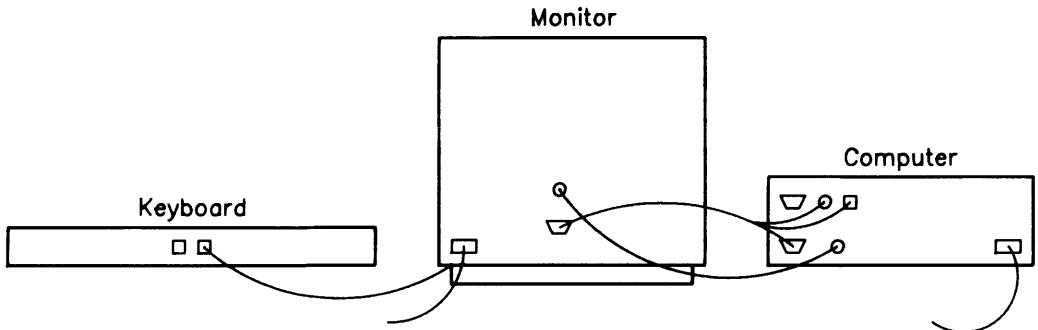

Computer with High-resolution Monochrome Monitor and Keyboard

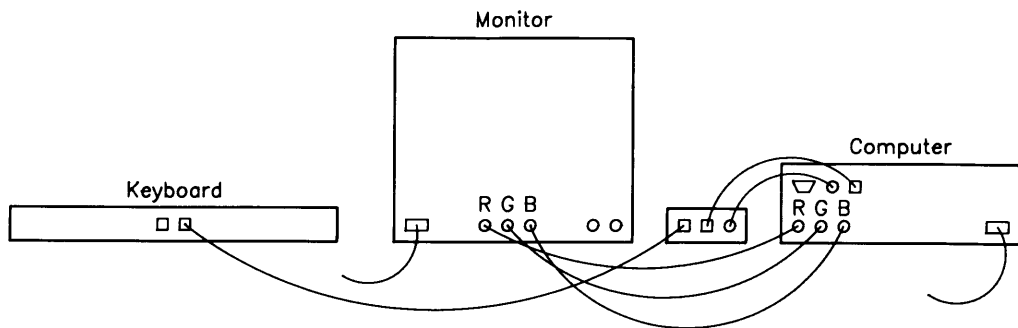

Computer with High-resolution Color Monitor and Keyboard

The Video Display Section

This section covers turning the computer on and checking the video display to see if the computer is functioning properly.

Turn the computer on.

Press in the power switch at the left front of the computer. You should immediately hear the fans running. The green $\bar{\text{LINE ON}}$ indicator should light.

Any problems?

If your computer does not turn on, check the following:

1. Is the power switch on the front of the computer set to the “on” position? The switch should be “in”, flush with the front of the computer.
2. Is the power cord firmly plugged into the computer’s power socket and into the power outlet?
3. Is power present at the power outlet?

If you answered “yes” to all three questions, replace the fuse according to the instructions in the Reference section at the back of this guide and again try to turn on your computer. If it still doesn’t turn on, call your HP Service Representative.

Compare the display to this picture.

If the display is incorrect, proceed to Chapter 2.

If you do not see a display, but hear a series of beeps, make sure that you have correctly installed your system. If you have, refer the problem to your HP Service Representative. A list of HP Sales and Support Offices is packed with your computer.

If you do not see a display and don't hear any beeps either, make sure that you have correctly installed the video display monitor. Areas to check are:

- Is the monitor plugged in and turned on?
- Are the video cables correctly installed?

If the display is correct, you have installed your computer. If you have an HP 98568A or an HP 98570A eight-slot backplane expander to install, do so now. Use the instructions included with the expander or those in the *Peripheral Installation Guide*.

If you do not have an expander to install, proceed to the *Peripheral Installation Guide* to install your peripherals.

Chapter 2

Reading the Self-Test

Computers can be valuable time-savers, but only if they are operating reliably. If a problem goes undetected and your computer fails in the middle of a job, data can be lost and hours of your labor may be wasted.

Your computer minimizes this risk by performing a self-test every time you turn it on. In this way, most problems are caught before you start to work, sparing you the frustration of a mid-session failure.

In this chapter, we describe how to interpret the self-test messages and suggest what you should do in case of a failure.

Self-Test Messages

Turn your monitor on, and turn your computer on or press **Shift** **Reset** if it is already on. If you have one or more operating systems on-line, tap the space bar a couple times after the word **Keyboard** appears. This inhibits the boot ROM from loading a system. Notice the messages appearing along the left-hand side of the screen. Compare your display to the appropriate one below. Adjust your monitor if necessary.

```
Copyright 1985,  
Hewlett-Packard Company.  
All Rights Reserved.
```

```
BOOTROM Rev. A
```

```
MC68010 Processor
```

```
Bit Mapped Display
```

```
Keyboard
```

```
MC68881 Co-processor
```

```
HP-IB
```

```
HP98626 at 9
```

```
XXXXXX Bytes
```

These items listed only
if installed.



```
SEARCHING FOR A SYSTEM (Press RETURN To Pause)  
RESET To Power-Up
```

Model 310 Display

Copyright 1985,
Hewlett-Packard Company.
All Rights Reserved.

BOOTROM Rev. A

MC68020 Processor

Bit Mapped Display

Keyboard

MC68881 Co-processor

HP-IB

HP98626 at 9

XXXXXX Bytes

These items listed only
if installed.

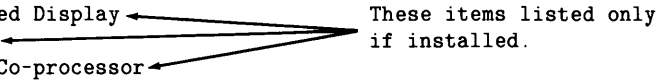

SEARCHING FOR A SYSTEM (Press RETURN To Pause)

RESET To Power-Up

Model 320 Display

Copyright 1985,
Hewlett-Packard Company.
All Rights Reserved.

BOOTROM Rev. A2
MC68020 Processor
MC68881 Co-processor
Bit Mapped Display
Keyboard
HP-IB
DMA-CO
HP98644 at 9
HP98625 at 14
HP98643 at 20
XXXXXX Bytes

← This item listed only
if installed.

SEARCHING FOR A SYSTEM (Press RETURN To Pause)
RESET To Power-Up

Models 330 and 350 Display

The lines under the **BOOTROM Rev.** A message tell you that each major component in your computer has just been tested. If the component passed the test, a **status message** is displayed; if the component failed the test, an **error message** will appear.

Status Messages

Usually, each component will pass its test and only status messages will be displayed. The first status message is either **MC68010** or **68020 Processor**, and tells you that the computer's central processor is functioning properly.

The next three status messages, **Bit Mapped Display**, **Keyboard**, and **MC68881 Coprocessor**, tell you that the the monitor's bit-mapped display, the keyboard and the floating-point coprocessor, respectively, are working properly.

The next message reports that your computer's built-in **HP-IB** interface is functional. Below that is the message **HP98644 at 9**, which indicates that your built-in Data Communications interface is working. The message, **HP98643 at 20**, indicates that your built-in Local Area Net interface is working. If you have another interface in your computer, its name and select code would be listed, also.

The final status message in the self-test list (**XXXXXX Bytes**) shows that memory has passed its test. This figure will be different for the various models. You may check it by adding up your amount of RAM and subtracting 174 bytes.

While the memory test is in progress, the message:

```
TESTING MEMORY
```

appears at the bottom of the screen. Press **Shift**—**Reset** if you want to re-start the self-test and see this message. When the memory test is finished, the number of bytes of RAM is reported in the self-test list (e.g., **524114 Bytes**).

Where to Go Next

You have completed the installation of your computer, keyboard and monitor. You are now ready to install peripheral devices, such as printers and mass storage devices. The *Peripheral Installation Guide* (part number 97005-90000) is the place to go for this information. It is located in the carton containing your software or operating system.

Error Messages

If a component fails its test, an error message is displayed in place of the usual status message. There are a few types of error messages; we'll discuss one of them here and list the rest in the Boot ROM Error Messages list which follows in this chapter.

You might get the message:

Keyboard Failed

This means that the computer found the keyboard's electronics, but it wasn't happy with what it found. This message indicates a problem that an HP Service Representative should look at.

After displaying an error message, the computer moves on to the next component in the self-test list. After all components are tested, the computer either looks for software to load, or displays the message:

WAITING 1 MINUTE (Press RETURN To Abort Wait)

This message tells you that the computer found at least one error and it's giving you a minute to read the error message(s) on the screen. You can press **Return** to terminate the waiting period.

Boot ROM Beeper

In addition to displaying an error and waiting a minute, the boot ROM sounds a pattern of beeps. The boot ROM is actually sending an error message to a service person. If this error pattern is sounded, check the display for an error message. Refer to the Boot ROM Error Messages list which follows in this chapter. If the message indicates something you cannot correct, or if the display is not working, you should call HP for service. Your service representative may ask you to restart the self-test so he can listen to the error code sounded.

After the error pattern has sounded, the boot ROM searches for a system to load. If you want to cancel the one-minute delay and the beeps, you can press **Return**. The boot ROM will then display any operating systems found and wait for you to specify which system you want loaded.

Boot ROM Errors

If the computer detects a problem with the boot ROM (that is, it failed checksum), it displays the message:

```
BOOTROM Rev. A Failed
```

instead of the BOOTROM Rev. A message displayed when powerup is successful. It also displays the message:

```
CONTINUE AT OWN RISK (Press RETURN To Continue)
```

The computer will do nothing further until you press the key. Your computer is somewhat unpredictable in this state and could alter the programs that you want to load from a disc. Therefore, if you decide to continue, make sure you have extra copies of any discs or programs that the boot ROM might access.

Running an Extended Memory Test

If you wish to run a more complete test of all RAM in the computer, turn on the computer or press **Shift**—**Reset**, and press these keys while the computer is self-testing:

CTRL — **C**

When the Configure menu appears, press:

T

The boot ROM will restart the self-test and run a longer RAM test. This test may catch intermittent problems not seen by the power-up self-test.

What To Do When Errors Occur

Very few self-test errors are serious enough to require service. When an error is reported, always run the self-test again and see if the error is repeated.

If the same error is reported a second time, look up the message in the Boot ROM Error Messages list which follows. You can often correct the problem yourself. Make the recommended adjustment and run the self-test again. If the same error is reported, or if the error message you get doesn't appear in the Boot ROM Error Messages list, call your HP Service Representative for help.

Where To Get Help

When your computer develops a problem that you cannot correct yourself, call your HP Service Representative. A number of service contracts are available. Refer to the Sales and Support Offices list which was packed with your computer.

Boot ROM Error Messages

This section lists error messages sent by the boot ROM. The boot ROM stores instructions that tell the computer to test the computer, display status messages, and search for a system program. We have tried to anticipate some errors you might receive that indicate a hardware mis-configuration rather than a failure. If you still receive the error after making the recommended adjustment, it means that there is a real problem; call HP for service.

Error Message	Description and Recovery Action
WAITING 1 MINUTE	The self-test found a failure. After evaluating the message, either press Return to begin the booting process or call HP for service.
HP-IB Failed	Either more than half of the devices on the HP-IB interface are turned OFF or a device on the HP-IB has failed the self-test. First turn each device on or disconnect it. Then run the self-test again. If the message is repeated, call for service.
CONTINUE AT OWN RISK	Errors detected in the boot ROM. Press Return to continue the self-test. Ensure you have a copy of every file the boot ROM may access. If the error persists, call HP for service.
UNEXPECTED USE OF xxxxxx	Indicates a system failure. Call HP for service.

Where to Go Next

You have completed the installation of your computer, keyboard and monitor. You are now ready to install peripheral devices, such as printers and mass storage devices. The *Peripheral Installation Guide* is the place to go for this information. It is located in the carton containing your software or operating system.

Notes

Reference

This section contains the following reference and tutorial information:

- Replacing the Fuse
- Processor Board Switches
- Human Interface Card Switches
- System Interface Board Switches

Replacing the Fuse

New fuses are available at Hewlett-Packard Sales and Service Centers.

1. Turn off the computer's power switch.
2. Unplug the power cord from the outlet and then unplug it from the power socket on the computer.
3. The fuse is located just beside the power cord.

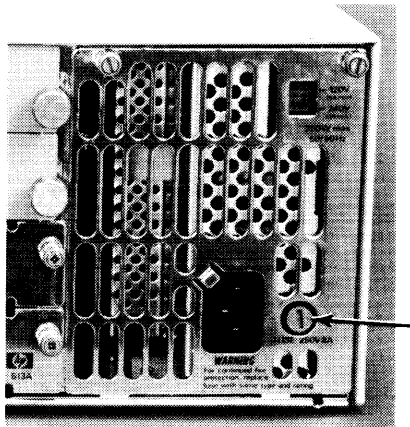

Fuse Location

4. Open the fuse cover by turning it counter-clockwise with a screwdriver.
5. Remove the fuse cover. It should contain a 250V, 8A fuse. Remove the fuse.
6. Install the replacement fuse that was shipped with your computer into the fuse cover, and slide the cover into the computer.
7. Close the cover by turning it clockwise with a screwdriver.
8. Plug the power cord into the computer's power socket and into the power outlet.
9. Press in the power switch on the computer.

Processor Board Switches

Processor boards with the part number 98561-66511, 98561-66512 and 98561-66513 contain communications functions with switch-selected attributes. This section tells how to set the switches for desired operation. Processor boards with the part number 98561-66519 do not contain any switches.

The following illustration shows the processor board switches. All switches are shown in their default positions. Switch descriptions follow the illustration. Check the switches and change them as required.

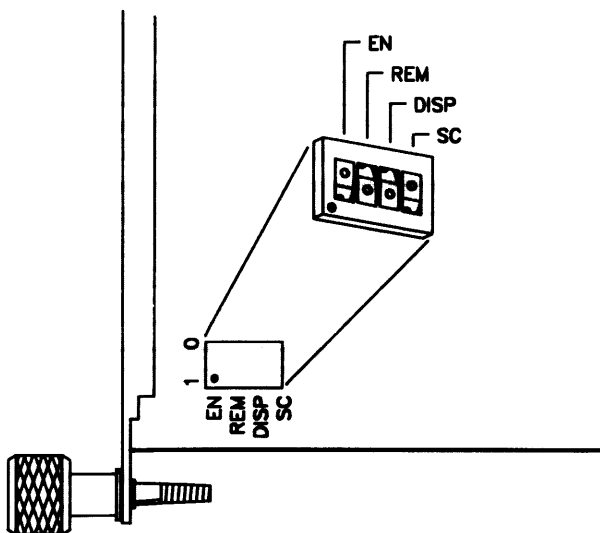

Processor Board Switches

Setting Processor Board Switches

Switch Label	Function/How It's Used
SC	Internal HP-IB System Controller 1 = System Controller (Shipped setting) 0 = Not System Controller
DIS	Display Disable 0 = Enabled(Shipped setting) 1 = Disabled
REM	Remote Terminal Enable 0 = Local Mode (Shipped setting) 1 = Remote Mode
EN	RS-232 Control Line Defeat 0 = Control Lines Defeated 1 = Control Lines Defeated (Shipped setting)

Human Interface Card Switches

The 98561-66530 and 98561-66531 human interface cards contains communications functions with switch-selected attributes. This section tells how to set the switches for desired operation.

The following illustration shows the interface card switches. All switches are shown in their default positions. Switch descriptions follow the illustration. Check the switches and change them as required.

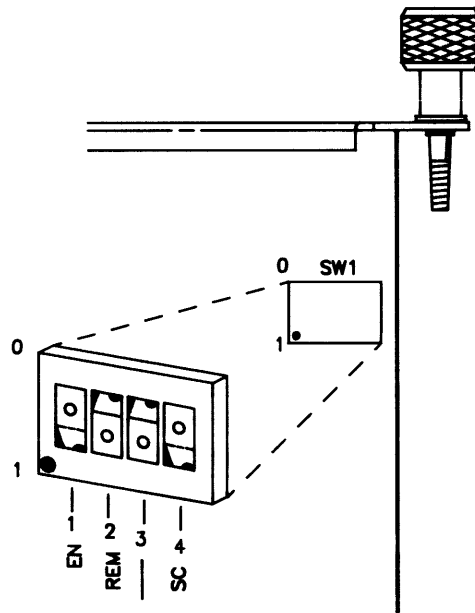

Human Interface Card Switches

Human Interface Card Switches

Switch Label	Function/How It's Used
SC	Internal HP-IB System Controller 1 = System Controller (Shipped setting) 0 = Not System Controller
REM	Remote Terminal Enable 0 = Local Mode (Shipped setting) 1 = Remote Mode
EN	RS-232 Control Line Defeat 0 = Control Lines Defeated 1 = Control Lines Defeated (Shipped setting)

System Interface Board Switches

The 98237-66530 system interface board contains communications functions with switch-selected attributes. This section tells how to set the switches for desired operation.

The following illustration shows the system interface board switches. All switches are shown in their default positions. Switch descriptions follow the illustration. Check the switches and change them as required.

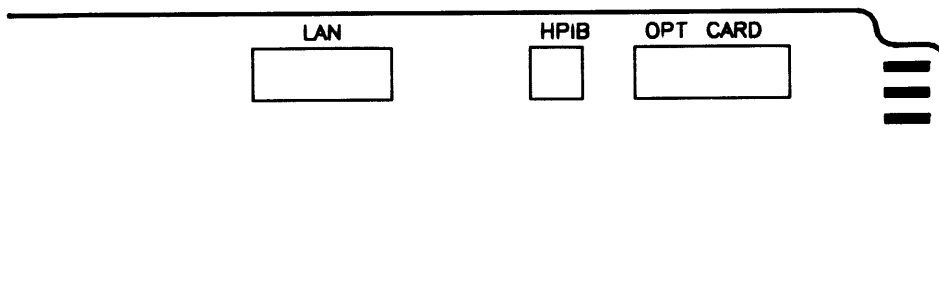

System Interface Board Switches

HP-IB and RS-232 Switches

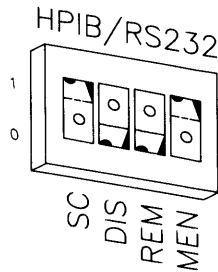

HP-IB and RS-232 Configuration Switches

Switch Label	Function/How It's Used
SC	Internal HP-IB System Controller 1 = System Controller (Shipped setting) 0 = Not System Controller
DIS	RS-232 Disable 0 = Enabled(Shipped setting) 1 = Disabled
REM	Remote Terminal Enable 1 = Remote Mode 0 = Local Mode (Shipped setting)
MEN	Modem Enable 1 = Modem lines enabled (Shipped setting) 0 = Modem lines disabled

Optional Disc Interface Switches

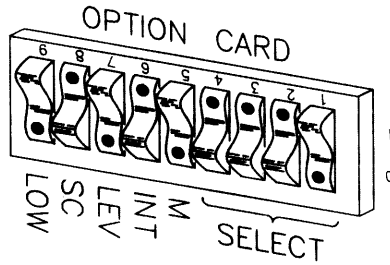

Optional Disc Interface Configuration Switches

Switch Label	Function/How It's Used
LOW (9)	Low/High Speed 0 = High Speed (Shipped setting) 1 = Low Speed
SC (8)	System Controller 1 = System Controller (Shipped setting) 0 = Not System Controller
INT (6) LEV (7)	Interrupt Level: LEV (7) is MSB 7 6 - - 0 0 = Level 3 0 1 = Level 4 (Shipped setting) 1 0 = Level 5 1 1 = Level 6
SELECT (1 - 5)	Select Code: 5 (M) is MSB. Shipped set at Select Code 14 (01110)

LAN Switches

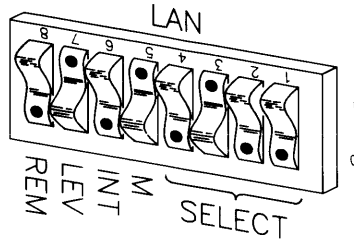

LAN Configuration Switches

Switch Label	Function/How It's Used
REM (8)	Local/Remote 0 = Local (Shipped setting) 1 = Remote
INT (6) LEV (7)	Interrupt Level: LEV (7) is MSB 7 6 -- 0 0 = Level 3 0 1 = Level 4 1 0 = Level 5 (Shipped setting) 1 1 = Level 6
SELECT (1 - 5)	Select Code: 5 (M) is MSB. Shipped set at Select Code 20 (10100)

Glossary

Bit: A binary digit (1 or 0).

Boot ROM: The boot ROM stores instructions that tell the computer how to search for a system program. They basically keep the computer running until a system program can take over.

Byte: The unit of memory used on your computer. One byte equals eight bits and is generally equivalent to one character, like “A”.

Character Code: A numeric code which is used to represent a character inside the computer.

CRT: The computer’s screen (cathode ray tube).

Cursor: The blinking underline character that marks the position on the screen where the next character will be typed.

Disc: Similar to a phonograph record, except that it stores programs and data instead of music.

Disc Drive: An input/output device that transfers programs and data between a disc and the computer’s memory.

Hardware: All of the electrical and mechanical components of the computer.

K bytes: 1 024 bytes.

Language System: A large program which performs all of the functions of a system program, plus supports a programming language like BASIC or Pascal.

Language-dependent Program: A program which requires a language system in order to run. Language-dependent programs are always loaded into memory *after* a language system has been booted.

M bytes: 1 048 576 bytes.

Memory: The area of the computer where programs and data are stored. The processor cannot run a program unless it is in memory.

Memory Address: A number which uniquely identifies one byte of memory.

Processor: This is the “brain” of the computer that runs programs and regulates most other computer functions.

Program: A set of instructions that tell the processor how to perform a particular task. Most programs are written in a high-level programming language like BASIC or Pascal.

RAM: Random Access Memory. This is erasable program memory. Programs and data are usually copied into RAM from a disc drive or other mass storage device, executed by the processor, and then erased from RAM. When the power is turned off, RAM is erased.

ROM: Read-Only Memory. This is permanent program memory, used primarily for storing essential programs. Programs in ROM are never erased, so ROM is not reusable.

Software: A synonym for program.

System Program: A program which handles all of the overhead functions of computing, such as defining the keyboard, managing the peripherals, refreshing the display, etc. When the computer is turned on and passes its self-test, it immediately begins searching for a system program to boot.

Stand-alone Program: A program that has a “built-in” system program and can run without any underlying language support.

Index

a

Accessory slots	6
Air flow	6

b

Beeper, boot ROM	29
Boot ROM:	
beeper	29
error messages	26, 31
errors	29
general	26, 43
Byte	43

c

Changing voltage select settings	8
Chapter contents	3
Checking memory	27, 30
Clearance, computer	6
Computer:	
clearance	6
installation	6
position	6
ventilation	6
Connecting power cord	9
Control line defeat, RS-232	34 41
Cooling fans	5, 6
Cord, power	9

d

Display, typical power-up	26
Display, video	21

e

Error messages	26, 28, 29
Error messages, boot ROM	26, 31
Errors:	
boot ROM	29
self-test	28
Expander, eight-slot	22
Extended memory test	30

f

Fans	5
Fuse	5, 33
Fuse replacement	33

g

Glossary	43
Guide organization	3

h

HP-HIL	11, 13, 15, 18
HP-IB system controller	34-39

i

Indicator, LINE ON	5, 21
Installation:	
computer	6
keyboard	19-22
monitor	10-19
power cord	9
Interface:	
data communications	34-39
HP-IB	34-39

k

K byte	43
Keyboard:	
installation	19-21
remote status	34-39

I

LINE ON indicator 5, 21

m

M byte 43

Memory test, extended 30

Memory:

 general 27

 random access 44

 read-only 44

 testing 27

Messages:

 boot ROM error 29

 error 26, 28

 self-test 26

 status 26, 27

Monitor 10–19

o

Organization, guide 3

p

Position, computer 6

Power cord installation 8

Power cords 8

Power socket 5

Power switch 5, 9

Power-up display, typical 26

Processor 44

Processor board switches 34

Program 44

r

RAM 27, 44

Random access memory 27, 44

Read-only memory 44

Remote keyboard status 34–39

Replacement, fuse 33

ROM 44

ROM, boot	28, 29, 44
RS-232:	
control line defeat	34-39
switches	34-39

S

Self-test:	
errors	26, 28
messages	26, 28
reading the	25
Settings, voltage select	7
Slots, accessory	5
Socket, power	5
Software	44
Status message	26, 27
Switch, power	5
Switches:	
human interface card	36
processor board	34
system interface board	38
System controller, HP-IB	34

t

Test, extended memory	30
Testing memory	27, 30

u

Unpacking	6
-----------------	---

v

Ventilation, computer	6
Video:	
display	21
display disable	34
Voltage select settings	7
Voltage select switch	8

Installing Add-on Accessories

Add-on accessories are devices that attach to your computer. They include backplane expanders, video output cards, interfaces, and other enhancements. If you ordered any at the time you purchased the computer, they will be assembled at the factory. If you purchased an accessory at a later date, you will have to install it yourself.

When finished with the installation on an accessory, place the *Installation Note* behind this page.

HP 9000 System Support Log

Introduction

Hello—Let me tell you a few things about this document.

Place this document behind the installation document that came with your system and keep the binder close to the system it is associated with. Use the spine that came with this system support log for the binder title. It contains information that will make your system more useful and productive with less down time if your system should ever require service.

This document has information about where and how to obtain service for hardware and/or software problems. It also contains information about your systems configuration, options, modifications, and repair/maintenance required. In other words, this is an historical document that contains information about the system it is prepared for and no other system.

Certain entries are left for you to make and maintain. Careful and accurate entries will save you time and frustration if service is required.

A system information page is shipped with the Computer for your system. Its color is blue and has some white labels affixed to it. These labels record the model and serial number for the computer and/or expander, plus it identifies the boards that were installed in the backplane at the factory. Be sure to enter the HP Maintenance Agreement Numbers on this page if you have an agreement with Hewlett-Packard. Place this page in the LOG book in front of the blue Peripheral page at the front of the Installation section.

The Peripheral page has spaces for you to enter some important information. Record the model number and serial number for each:

- Monitor
- Disc drive
- Graphics Hardware

And other Accessories that make up your system.

Notes

Available Services

Introduction

Available Services provides you, in one section, information that you will require if your system ever needs service, or you need assistance with your operating system software.

This section has information about where and how to obtain service for hardware and/or software problems. The Local HEWLETT-PACKARD Representative card page has been cut so you can insert business cards in an appropriate slot. You then have a ready reference in case of need.

Notes

Installation Record

Introduction

Installation Records contain the information about your computer system configuration and options at time of installation. Certain entries are left for you to make and maintain. Careful and accurate entries will save you time and frustration if service is required.

A system information page is shipped with the Computer for your system. Its color is blue and has some white labels affixed to it. These labels record:

- The model and serial number for the computer and/or expander, plus
- The boards that were installed at the factory.

Be sure to enter the HP Maintenance Agreement Numbers on this page if you have an agreement with Hewlett-Packard. Place this page in the LOG book in front of the blue Accessory and Peripheral page and behind the Introduction page for the Available Services section.

The Accessory and Peripheral page has spaces for you to enter some important information. Record the model number and serial number for each:

- Monitor
- Disc drive
- Graphics Hardware

And other Accessories that make up your system.

Notes

Peripheral Information

Introduction

This page contains space for you to document additional information about the Computer system that you have just received. We at Hewlett-Packard believe this information will assist you if you ever require service or assistance.

Here are spaces for you to record the Model and Serial numbers of the peripherals that make up your system.

Monitor

Model Number _____

Serial Number _____

Peripherals

Keyboard: _____ Graphics Device: _____

Printer: _____ Device: _____

HP-HIL Device: _____ Device: _____

Disc Drive: _____ Device: _____

Notes

Software Information

Introduction

This page contains space for you to document additional information about your computer system. This information will be helpful if your computer system requires service or you need assistance.

Software

HP Operating System: _____

HP Application Program: _____

Third Party Software: _____

- Supported By: _____

Locally Developed Software: _____

- Supported By: _____

Additional

Notes

Maintenance Record

Introduction

Maintenance records are an important link in the maintenance and troubleshooting of computer products. Time and effort are saved whenever service or repair are required if records are kept of up-dates, modifications, and service performed. Careful Log entries will maintain the usefulness of this section.

Periodic Maintenance is not required on HP 9000 series computers, however, peripherals such as disc drives, printers, and plotters may need to be serviced periodically. With the help of your Hewlett-Packard CE, you can establish a periodic maintenance program using the Field Preventive Maintenance Procedure included here.

Included in this section is an instruction page that explains how to use the system historical record. Also included are several copies of the historical record sheet. This record sheet may be copied as needed.

Another form included here is the HP PICS Historical Record. Use this when you need assistance with a problem. Briefly describe the problem on the upper half of the form and call your nearest HP Sales and Service Office for assistance. The lower half will be filled out by your Hewlett-Packard CE. This will be a permanent record of that service. Again, you may copy this page as often as required.

FIELD PREVENTIVE MAINTENANCE PROCEDURE

INTRODUCTION

Often, the most common denominator associated with poorly performing systems is the lack of a sound preventive maintenance program. This section provides a convenient means of scheduling and logging P.M. activities.

"P.M.'s" are essential in obtaining a high on-the-air yield from complex systems and should be performed on a regularly scheduled basis. Specific instructions and methods of preventive maintenance may be found in the installation and service manual of each device. Blank "worksheets" have been provided that will enable you to consolidate each P.M. procedure into a yearly schedule of system maintenance. Your local HP Customer Engineer will assist you in planning and performing a P.M. program suited to your system.

Preventive Maintenance schedules must take into consideration the hours of operation and the environment of the system. Where conditions are more harsh, maintenance must be performed more frequently.

MATERIALS COMMONLY NEEDED FOR PM

HP Products		
Description	HP Part No.	
1. Aerosol De-greaser	8500-0232	
2. Andero Gear Lubricant	6040-0222	
3. Applicators, Cotton Tipped	8520-0023	
4. Brush, Acid	8520-0015	
5. Freon Head Cleaner	8500-1251	
6. Glass Cleaner, Anti Static	8500-0039	
7. Hypodermic Syringe	9301-0171	
8. Hypodermic Needle	9301-0172	
9. Isopropyl Alcohol, Filtered	8500-0559	
10. Lubricating Oil, Light	560A-95N-3	
11. Slidewire Cleaner	5080-3605	
12. Slidewire Lubricant	5080-3635	
Commercial (Non-HP) Products		
Description	Trade Name	Mfg. No. or Address
1. Cleaner/Degreaser	"Chemisol Formula 409"	Harrell Corp. "A" Div. So. Norwalk, Conn.
2. Detergent, Mild	"Spray-White"	Kelite Chemical Corp. 261 Hamilton Avenue Palo Alto, Calif.
3. Forced Air	"Aero Dust" (MS-220)	Miller Stevenson Co. 1001 East 1st Street Los Angeles, Calif.
4. Tissues	"Kim Wipe" (900-S) SN 3415	Kimberly-Clark Corp. Neenah, Wisconsin
5. Tissues, Soft Facial	"Crown Chiffon" (No. 482)	Crown Zellerbach Corp. 1 Bush Street San Francisco, Calif.

Filling Out The System Maintenance Record Customer Entry

HP notified	Enter date and time Hewlett-Packard was notified of the problem.
Found By	Enter name of person observing the symptom(s).
HP Contact	Enter the name of HP person contacted.
Symptom	Enter the symptom(s) observed. Be as specific as possible. If only happened once, so state. If a reoccurring problem give times and dates.

Hewlett-Packard Entry

On Site	Enter Date and Time of arrival on site.
CE/Tech	Enter initials of Person performing the repair.
CSO#	Enter Customer Service Order number.
Product#	Enter Product number.
Serial#	Enter Serial number of product.
Completed	Enter Date and Time repair is accomplished. If not accomplished, enter a note, or indicate time of next visit.
Problem	Give a description of the problem(s) found. Be as specific as Possible. Include what action was taken to eliminate problem(s). If not able to complete repair this visit, make a note of it.
Parts	Enter part numbers of all parts used in accomplishing the repair.

Appendix

Introduction

An appendix is a place to add supplementary or additional information that is useful. Use this section for keeping notes about this computer system, update notes, and other useful information.

Notes

System Maintenance Record

Customer Entry	H.P. Entry	
HP Notified_____	On Site_____	Time_____
Found by_____	CE/Tech#_____	CSO #_____
HP Contact_____	Product_____	S/N_____
Symptom_____	Completed_____	Problem_____
_____	_____	_____
_____	_____	_____
_____	_____	_____
_____	_____	_____
_____	_____	_____
_____	Parts	_____
_____	P/N_____	P/N_____
_____	P/N_____	P/N_____
_____	P/N_____	P/N_____

System Maintenance Record

Customer Entry	H.P. Entry	
HP Notified_____	On Site_____	Time_____
Found by_____	CE/Tech#_____	CSO #_____
HP Contact_____	Product_____	S/N_____
Symptom_____	Completed_____	Problem_____
_____	_____	_____
_____	_____	_____
_____	_____	_____
_____	_____	_____
_____	Parts	
_____	P/N_____	P/N_____
_____	P/N_____	P/N_____
_____	P/N_____	P/N_____

HP Pics Historical Record

Date _____ Time _____ Pics ID # _____

Problem Description: _____

HP Response: Date _____ Time _____ HP Contact _____

Problem Resolution: _____

HP Pics Historical Record

Date _____ Time _____ Pics ID # _____

Problem Description: _____

HP Response: Date _____ Time _____ HP Contact _____

Problem Resolution: _____

MANUAL COMMENT CARD
Installation Reference
for HP 9000 Series 300 Computers

HP Part No.98561-90000

Name: _____

Company: _____

Address: _____

Phone No: _____

Thank you for taking the time to respond.

Please note the latest printing date from the Printing History (page iii) of this manual and any applicable update(s) so we know which material you are commenting on

NO POSTAGE
NECESSARY
IF MAILED
IN THE
UNITED STATES

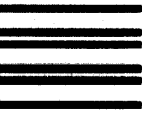
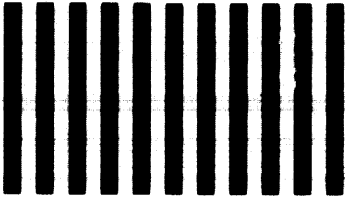

BUSINESS REPLY MAIL
FIRST CLASS PERMIT NO. 37 LOVELAND, COLORADO

POSTAGE WILL BE PAID BY ADDRESSEE

Hewlett-Packard Company
Attn: Customer Documentation
3404 East Harmony Road
Fort Collins, Colorado 80525



HP Part Number
98561-90000

Microfiche No. 98561-99000
Printed in U.S.A. 12/86



98561-90612

For Internal Use Only