

---

User's Guide for the  
Graphical User Interface

---

HP 64782  
MC6833x Emulation/Analysis

---

# Notice

Hewlett-Packard makes no warranty of any kind with regard to this material, including, but not limited to, the implied warranties of merchantability and fitness for a particular purpose. Hewlett-Packard shall not be liable for errors contained herein or for incidental or consequential damages in connection with the furnishing, performance, or use of this material.

Hewlett-Packard assumes no responsibility for the use or reliability of its software on equipment that is not furnished by Hewlett-Packard.

© Copyright 1994 Hewlett-Packard Company.

This document contains proprietary information, which is protected by copyright. All rights are reserved. No part of this document may be photocopied, reproduced or translated to another language without the prior written consent of Hewlett-Packard Company. The information contained in this document is subject to change without notice.

HP is a trademark of Hewlett-Packard Company.

OSF/Motif and Motif are trademarks of the Open Software Foundation in the U.S. and other countries.

SunOS, SPARCsystem, OpenWindows, and SunView are trademarks of Sun Microsystems, Inc.

UNIX® is a registered trademark in the United States and other countries, licensed exclusively through X/Open Company Limited.

## **Hewlett-Packard**

**P.O. Box 2197**

**1900 Garden of the Gods Road**

**Colorado Springs, CO 80901-2197, U.S.A.**

**RESTRICTED RIGHTS LEGEND** Use, duplication, or disclosure by the U.S. Government is subject to restrictions as set forth in subparagraph (c) (1)(ii) of the Rights in Technical Data and Computer Software Clause at DFARS 252.227-7013. Hewlett-Packard Company, 3000 Hanover Street, Palo Alto, CA 94304 U.S.A. Rights for non-DOD U.S. Government Departments and Agencies are as set forth in FAR 52.227-19(c)(1,2).

---

## Printing History

New editions are complete revisions of the manual. The date on the title page changes only when a new edition is published.

A software code may be printed before the date; this indicates the version level of the software product at the time the manual was issued. Many product updates and fixes do not require manual changes, and manual corrections may be done without accompanying product changes. Therefore, do not expect a one-to-one correspondence between product updates and manual revisions.

### **Edition 1**

B3092-97000, July 1994

---

## Safety, Certification and Warranty

Safety and certification and warranty information can be found at the end of this manual on the pages before the back cover.

The HP 64782 6833x emulators replace the microprocessor in your embedded microprocessor system, also called the *target system*, so that you can control execution and view or modify processor and target system resources.

The emulator requires an *emulation analyzer* that captures 64 channels of emulation processor bus cycle information synchronously with the processor's clock signal. The HP 64703 Emulation Bus Analyzer meets this requirement.

The HP 64703 Emulation Bus Analyzer also has an *external analyzer* that captures up to 16 channels of data external to the emulator. You can also use the HP 64704 or HP 64794 Emulation Bus Analyzer which has 80 channels; however, these analyzers do not have external analysis channels.

### **With the Emulator, You Can ...**

- Plug into 6833x target systems.
- Download programs into emulation memory or target system RAM.
- Display or modify the contents of processor registers and memory resources.
- Run programs, set up software breakpoints, step through programs, and reset the emulation processor. For information about your emulator clock speed, refer to the *6833x Installation/Service/Terminal Interface Guide*.

### **With the Analyzer, You Can ...**

- Trigger the analyzer when a particular bus cycle state is captured. States are stored relative to the trigger state.
- Qualify which states get stored in the trace.
- Prestore certain states that occur before each normal store state.
- Trigger the analyzer after a sequence of up to 8 events have occurred.
- Capture data on signals of interest in the target system with the external analyzer.
- Cause emulator execution to break when the analyzer finds its trigger condition.

### **With the HP 64700 Card Cage, You Can ...**

- Use the RS-422 capability of the serial port and an RS-422 interface card on the host computer (HP 98659 for the HP 9000 Series 300) to provide upload/download rates of up to 230.4K baud.
- Easily access and use the emulator over a Local Area Network by connecting it to the LAN.
- Easily upgrade HP 64700 firmware by downloading to flash memory.

### **With Multiple HP 64700s, You Can ...**

- Start and stop up to 16 emulators at the same time (up to 32 if modifications are made).
- Use the analyzer in one HP 64700 to arm (that is, activate) the analyzers in other HP 64700 card cages or to cause emulator execution in other HP 64700 card cages to break.
- Use the HP 64700's BNC connector to trigger an external instrument (for example, a logic analyzer or oscilloscope) when the analyzer finds its trigger condition, or you can allow an external instrument to arm the analyzer or break emulator execution.

### **With the Graphical User Interface, You Can ...**

- Use the emulator and analyzer under an X Window System that supports OSF/Motif interfaces.
- Enter commands using pull-down or pop-up menus.
- Enter, recall, and edit commands using the command line pushbuttons.
- Enter file names, recalled commands, recalled values, etc., using dialog boxes.
- Set breakpoints by pointing the mouse cursor on a line in the mnemonic memory display and clicking.
- Create action keys for commonly used commands or command files.

### **With the Softkey Interface, You Can ...**

- Use the emulator and analyzer with a terminal or terminal emulator.
- Quickly enter commands using softkeys, command recall, and command editing.

---

## In This Book

This book documents the Graphical User Interface and the Softkey Interface when used with the HP 64782 6833x emulators and the HP 64703/4 analyzer. It is organized into five parts whose chapters are described below.

### Part 1. Quick Start Guide

Chapter 1 presents an overview of emulation and analysis and quickly shows you how to use the emulator and analyzer.

### Part 2. User's Guide

Chapter 2 tells where to find information about plugging the emulator into a target system.

Chapter 3 shows you how to start and exit the HP 64700 interfaces.

Chapter 4 shows you how to enter commands.

Chapter 5 shows how to configure the emulator.

Chapter 6 shows how to use the emulator.

Chapter 7 shows how to use the analyzer.

Chapter 8 shows how to use the Software Performance Measurement Tool (SPMT) with the analyzer.

Chapter 9 shows how to use the external state analyzer.

Chapter 10 shows how to make coordinated measurements.

Chapter 11 shows how to change X resource settings.

### Part 3. Reference

Chapter 12 describes emulator/analyzer interface commands.

Chapter 13 lists the error messages that can occur.

### Part 4. Concept Guide

Chapter 14 contains conceptual information on various topics.

### Part 5. Installation Guide

Chapter 15 outlines the installation of the Graphical User Interface.

Chapter 16 shows you how to install or update emulator firmware.

Follow these instructions if you have ordered the HP 64782 emulator and the HP 64700 Card Cage separately.

## **Part 1 Quick Start Guide**

### **1 Getting Started**

The Emulator/Analyzer Interface — At a Glance 24

The Getting Started Tutorial 31

Step 1: Start the demo 32

Step 2: Display the program in memory 33

Step 3: Run from the transfer address 34

Step 4: Step high-level source lines 35

Step 5: Display the previous mnemonic display 36

Step 6: Run until an address 37

Step 7: Display data values 38

Step 8: Display registers 39

Step 9: Step assembly-level instructions 40

Step 10: Trace the program 41

Step 11: Display memory at an address in a register 43

Step 12: Patch assembly language code 44

Step 13: Exit the emulator/analyzer interface 48

## **Part 2 User's Guide**

### **2 Plugging into a Target System**

Plugging the Emulator into a Target System 52

### **3 Starting and Exiting HP 64700 Interfaces**

Starting and Exiting HP 64700 Interfaces 54

Starting the Emulator/Analyzer Interface 55

To start the emulator/analyzer interface 55

To start the interface using the default configuration 57

To run a command file on interface startup 57

To display the status of emulators	57
To unlock an interface that was left locked by another user	58
Opening Other HP 64700 Interface Windows 59	
To open additional emulator/analyzer windows	59
To open the high-level debugger interface window	60
To open the software performance analyzer (SPA) interface window	60
Exiting HP 64700 Interfaces 61	
To close an interface window	61
To exit a debug/emulation session	62

## 4 Entering Commands

Entering Commands	64
Using Menus, the Entry Buffer, and Action Keys 65	
To choose a pulldown menu item using the mouse (method 1)	65
To choose a pulldown menu item using the mouse (method 2)	66
To choose a pulldown menu item using the keyboard	66
To choose popup menu items	68
To place values into the entry buffer using the keyboard	68
To copy-and-paste to the entry buffer	68
To recall entry buffer values	71
To use the entry buffer	71
To copy-and-paste from the entry buffer to the command line entry area	72
To use the action keys	72
To use dialog boxes	73
To access help information	76
Using the Command Line with the Mouse 77	
To turn the command line on or off	77
To enter a command	78
To edit the command line using the command line pushbuttons	79
To edit the command line using the command line popup menu	79



- To recall commands 80
- To get help about the command line 81
  
- Using the Command Line with the Keyboard 82
  - To enter multiple commands on one command line 82
  - To recall commands 83
  - To edit commands 83
  - To access on-line help information 84
  
- Using Command Files 85
  - To start logging commands to a command file 88
  - To stop logging commands to a command file 88
  - To playback (execute) a command file 88
  
- Using Pod Commands 89
  - To display the pod commands screen 90
  - To use pod commands 90
  
- Forwarding Commands to Other HP 64700 Interfaces 91
  - To forward commands to the high-level debugger 92
  - To forward commands to the software performance analyzer 92

## **5 Configuring the Emulator**

- Configuring the Emulator 94
  - Using the Configuration Interface 95
    - To start the configuration interface 96
    - To modify a configuration section 98
    - To apply configuration changes to the emulator 98
    - If apply to emulator fails 99
    - To store configuration changes to a file 100
    - To change the configuration directory context 101
    - To display the configuration context 101
    - To access help topics 102

To access context sensitive (f1) help	103
To exit the configuration interface	103
To load an existing configuration file	103
Modifying the General Items and Monitor Setup	104
When Modifying the Microprocessor Clock Source	105
When Restricting the Emulator to Real-time Runs	105
Reconfiguring the Emulator Copy of the SIM Registers	107
To define values for the emulator copy of the SIM registers	108
Mapping Memory	109
To add memory map entries	111
To modify memory map entries	115
To delete memory map entries	116
To characterize unmapped ranges	116
To map memory ranges that use function codes	117
Setting the Debug/Trace Options	120
When Configuring Breaks on Writes to ROM	120
When Configuring the Trace Mode	121
Setting Simulated I/O	122
Verifying the Emulator Configuration	123
To display information about chip selects	123
To display information about bus interface ports	125
To display information about the memory map	126
To display information about the reset mode configuration	128
To display assembly language instructions for setting up the SIM	129
To check for configuration inconsistencies	130

## 6 Using the Emulator

Using the Emulator 134

Using the EMSIM Registers 135

To view the SIM register differences 138

To synchronize to the 6833x SIM registers 139

To synchronize to the EMSIM registers 139

To restore default values in the EMSIM registers 139

Loading and Storing Absolute Files 140

To load absolute files 140

To load absolute files without symbols 141

To store memory contents into absolute files 142

Using Symbols 143

To load symbols 143

To display global symbols 144

To display local symbols 145

To display a symbol's parent symbol 149

To copy-and-paste a full symbol name to the entry buffer 150

Using Context Commands 151

To display the current directory and symbol context 152

To change the directory context 152

To change the current working symbol context 153

Executing User Programs 154

To run programs from the current PC 154

To run programs from an address 155

To run programs from the transfer address 155

To run programs from reset 155

To run programs until an address 156

To stop (break from) user program execution 157

To step high-level source lines 157

To step assembly-level instructions	158
To reset the emulation processor	159
Using Execution Breakpoints	160
Setting execution breakpoints in RAM	161
Using temporary and permanent breakpoints	161
To enable execution breakpoints	162
To disable an execution breakpoint	163
To set a permanent breakpoint	164
To set a temporary breakpoint	165
To clear an execution breakpoint	166
To clear all execution breakpoints	168
To display the status of all execution breakpoints	168
Displaying and Modifying Registers	170
To display register contents	170
To modify register contents	171
Displaying and Modifying Memory	172
To display memory	172
To display memory in mnemonic format	173
To return to the previous mnemonic display	173
To display memory in hexadecimal format	174
To display memory in real number format	175
To display memory at an address	176
To display memory repetitively	177
To modify memory	177
Displaying Data Values	178
To display data values	178
To clear the data values display and add a new item	179
To add items to the data values display	179
Changing the Interface Settings	180
To set the source/symbol modes	180

To set the display modes 181

Using System Commands 183

To set UNIX environment variables 183

To display the name of the emulation module 183

To display the event log 184

To display the error log 184

To edit files 185

To copy information to a file or printer 188

To open a terminal emulation window 189

Using Simulated I/O 190

To display the simulated I/O screen 190

To use simulated I/O keyboard input 191

Using Basis Branch Analysis 192

To store BBA data to a file 192

## **7 Using the Emulation Analyzer**

Using the Emulation Analyzer 194

The Basics of Starting, Stopping, and Displaying Traces 195

To start a trace measurement 196

To stop a trace measurement 197

To display the trace list 197

To display the trace status 199

To change the trace depth 201

To modify the last trace command entered 202

To repeat the previous trace command 202

To position the trace display on screen 203

Qualifying Trigger and Store Conditions 204

To specify a trigger and set the trigger position 209

To use address, data, and status values in trace expressions 211

- To enter a range in a trace expression 212
- To trigger on a number of occurrences of some state 213
- To break emulator execution on the analyzer trigger 214
- To count states or time 214
- To define a storage qualifier 216
- To define a prestore qualifier 217
- To trace activity leading up to a program halt 219
- To capture a continuous stream of program execution no matter how large your program 219

### Using the Sequencer 223

- To trigger after a sequence of states 224
- To specify a global restart state 226
- To trace "windows" of program execution 228
- To specify both sequencing and windowing 230

### Displaying the Trace List 231

- To display the trace about a line number 234
- To move through the trace list 235
- To disassemble the trace list 235
- To specify trace disassembly options 237
- To specify trace dequeuing options 238
- To display the trace without disassembly 240
- To display symbols in the trace list 242
- To display source lines in the trace list 243
- To change the column width 244
- To select the type of count information in the trace list 245
- To offset addresses in the trace list 247
- To reset the trace display defaults 248
- To change the number of states available for display 248
- To display program memory associated with a trace list line 249
- To open an edit window into the source file associated with a trace list line 249

Saving and Restoring Trace Data and Specifications	250
To store a trace specification	250
To store trace data	251
To load a trace specification	252
To load trace data	253

## **8 Making Software Performance Measurements**

Making Software Performance Measurements	256
Activity Performance Measurements	257
To set up the trace command for activity measurements	260
To initialize activity performance measurements	261
To interpret activity measurement reports	265
Duration Performance Measurements	275
To set up the trace command for duration measurements	276
To initialize duration performance measurements	278
To interpret duration measurement reports	280
Running Measurements and Creating Reports	285
To run performance measurements	285
To end performance measurements	286
To create a performance measurement report	287

## **9 Using the External State Analyzer**

Using the External State Analyzer	290
Setting Up the External Analyzer	291
To connect the external analyzer probe to the target system	291

- Configuring the External Analyzer 294
  - To control the external analyzer with the emulator/analyzer interface 296
  - To specify the threshold voltage 296
  - To specify the external analyzer mode 297
  - To specify the slave clock mode 298
  - To define labels for the external analyzer signals 301

## **10 Making Coordinated Measurements**

- Making Coordinated Measurements 304
  - Setting Up for Coordinated Measurements 307
    - To connect the Coordinated Measurement Bus (CMB) 307
    - To connect to the rear panel BNC 309
  - Starting/Stopping Multiple Emulators 311
    - To enable synchronous measurements 311
    - To start synchronous measurements 312
    - To disable synchronous measurements 312
  - Using Trigger Signals 313
    - To drive the emulation analyzer trigger signal to the CMB 316
    - To drive the emulation analyzer trigger signal to the BNC connector 316
    - To drive the external analyzer trigger signal to the CMB 316
    - To drive the external analyzer trigger signal to the BNC connector 317
    - To break emulator execution on signal from CMB 317
    - To break emulator execution on signal from BNC 317
    - To break emulator execution on external analyzer trigger 317
    - To arm the emulation analyzer on signal from CMB 318
    - To arm the emulation analyzer on signal from BNC 318
    - To arm the emulation analyzer on external analyzer trigger 318
    - To arm the external analyzer on signal from CMB 319
    - To arm the external analyzer on signal from BNC 319
    - To arm the external analyzer on emulation analyzer trigger 319



## 11 Setting X Resources

- Setting X Resources 322
- To modify the Graphical User Interface resources 324
- To use customized scheme files 328
- To set up custom action keys 330
- To set initial recall buffer values 331
- To set up demos or tutorials 332

## Part 3 Reference

### 12 Emulator/Analyzer Interface Commands

- Emulator/Analyzer Interface Commands 338
- Commands 346
- bbaunld 347
- break 348
- cmb\_execute 349
- copy 350
- copy local\_symbols\_in 353
- copy memory 354
- copy registers 356
- copy trace 357
- display 358
- display configuration\_info 360
- display data 363
- display global\_symbols 366
- display local\_symbols\_in 367
- display memory 368
- display registers 372
- display simulated\_io 373
- display software\_breakpoints 374
- display trace 375
- end 379
- EXPR-- 380

## Contents

FCODE 383  
forward 384  
help 385  
load 387  
log\_commands 389  
modify 390  
modify configuration 391  
modify keyboard\_to\_simio 392  
modify memory 393  
modify register 396  
modify SIM registers 397  
performance\_measurement\_end 399  
performance\_measurement\_initialize 400  
performance\_measurement\_run 402  
pod\_command 403  
QUALIFIER 405  
RANGE 407  
reset 409  
run 410  
SEQUENCING 412  
set 414  
specify 419  
STATE 421  
step 423  
stop\_trace 425  
store 426  
--SYMB-- 428  
sync\_sim\_registers 435  
trace 436  
TRIGGER 439  
wait 441  
WINDOW 443

### **13 Error Messages**

Error Messages 446

**Part 4 Concept Guide****14 Concepts**

Concepts 492

X Resources and the Graphical User Interface 493

Concepts of the EMSIM and EMRAM 500

**Part 5 Installation Guide****15 Installation**

Installation 510

Connecting the HP 64700 to a Computer or LAN 512

Installing HP 9000 Software 513

Step 1. Install the software from the media 513

Step 2. Set the necessary environment variables 514

Step 3. Verify the software installation 516

Step 4a. Start the X server and the Motif Window Manager (mwm) 517

Step 4b. Start HP VUE 517

Installing Sun SPARCsystem Software 518

Step 1. Install the software from the media 518

Step 2. Start the X server and OpenWindows 519

Step 3. Set the necessary environment variables 519

Step 4. Verify the software installation 521

Step 5. Map your function keys 521

Verifying the Installation 523

Step 1. Determine the logical name of your emulator 523

Step 2. Start the interface with the emul700 command 524

Step 3. Exit the Graphical User Interface 525

## **16 Installing/Updating Emulator Firmware**

Installing/Updating Emulator Firmware 528

To update emulator firmware with "progflash" 529

To display current firmware version information 532

If there is a power failure during a firmware update 533

---

Quick Start Guide

---



## Part 1

A one-glance overview of the product and a few task instructions to help you get comfortable.





---

# Getting Started

When an X Window System that supports OSF/Motif interfaces is running on the host computer, the emulator/analyzer interface is the Graphical User Interface which provides pull-down and pop-up menus, point and click setting of breakpoints, cut and paste, on-line help, customizable action keys and pop-up recall buffers, etc.

## The Graphical User Interface

**Figure 1**

Menu bar

Action keys

Entry buffer

Entry buffer recall button.

Display area.

Scroll bar.

Status line.

Command line.

Command line entry area.

Softkey pushbuttons

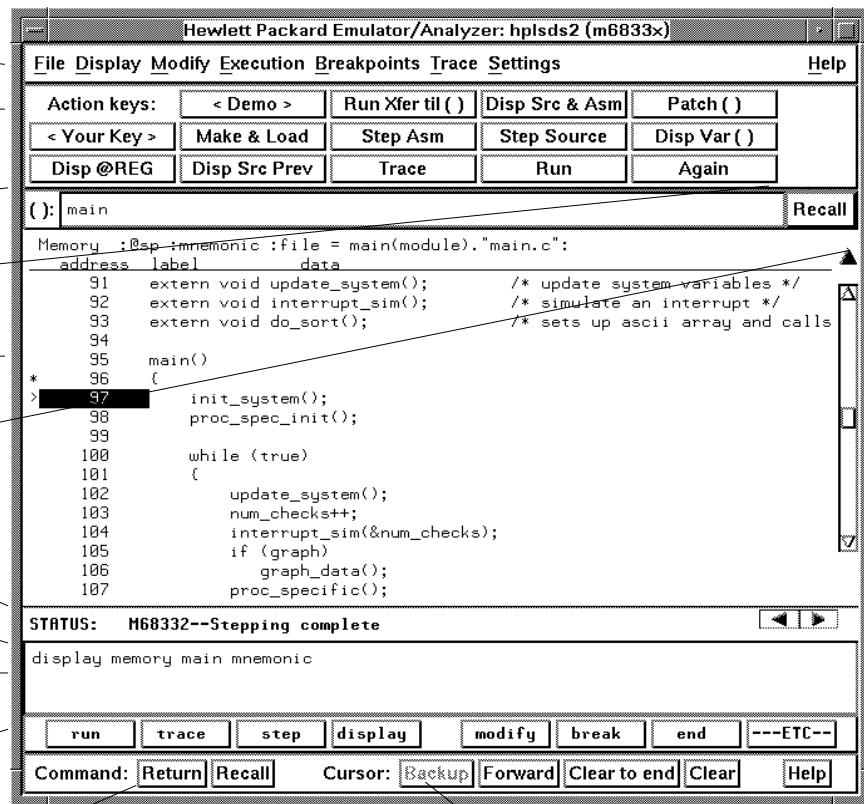

Command buttons. Includes command recall button.

Cursor buttons for command line area control.



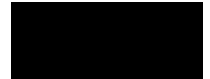

**Menu Bar.** Provides pulldown menus from which you select commands. When menu items are not applicable, they appear half-bright and do not respond to mouse clicks.

**Action Keys.** User-defined pushbuttons. You can label these pushbuttons and define the action to be performed.

**Entry Buffer.** Wherever you see "( )" in a pulldown menu, the contents of the entry buffer are used in that command. You can type values into the entry buffer, or you can cut and paste values into the entry buffer from the display area or from the command line entry area. You can also set up action keys to use the contents of the entry buffer.

**Entry Buffer Recall Button.** Allows you to recall entry buffer values that have been predefined or used in previous commands. When you click on the entry buffer Recall button, a dialog box appears that allows you to select values.

**Display Area.** Can show memory, data values, analyzer traces, registers, breakpoints, status, simulated I/O, global symbols, local symbols, pod commands (the emulator's underlying Terminal Interface), error log, or display log.

Whenever the mouse pointer changes from an arrow to a hand, you can press and hold the *select* mouse button to access popup menus.

**Scroll Bar.** A "sticky slider" that allows navigation in the display area. Click on the upper and lower arrows to scroll to the top (home) and bottom (end) of the window. Click on the inner arrows to scroll one line. Drag the slider handle up or down to cause continuous scrolling. Click between the inner arrows and the slider handle to page up or page down.

**Status Line.** Displays the emulator and analyzer status. Also, when error and status messages occur, they are displayed on the status line in addition to being saved in the error log. You can press and hold the *select* mouse button to access the Status Line popup menu.

**Command Line.** The command line area is similar to the command line in the Softkey Interface; however, the graphical interface lets you use the mouse to enter and edit commands.

- Command line entry area. Allows you to enter commands from the command line.

- Softkey pushbuttons. Clicking on these pushbuttons, or pressing softkeys, places the command in the command line entry area. You can press and hold the *select* mouse button to access the Command Line popup menu.
- Command buttons (includes command recall button). The command Return button is the same as pressing the carriage return key — it sends the command in the command line entry area to the emulator/analyzer. The command Recall button allows you to recall previous or predefined commands. When you click on the command Recall button, a dialog box appears that allows you to select a command.
- Cursor buttons for command line area control. Allow you to move the cursor in the command line entry area forward or backward, clear to the end of the command line, or clear the whole command line entry area.

You can choose not to display the command line area by turning it off. For the most common emulator/analyzer operations, the pulldown menus, popup menus, and action keys provide all the control you need. Choosing menu items that require use of the command line will automatically turn the command line back on.

## Graphical User Interface Conventions

### Choosing Menu Commands

This chapter uses a shorthand notation for indicating that you should choose a particular menu item. For example, the following instruction

#### **Choose File→Load→Configuration**

means to first display the File pulldown menu, then display the Load cascade menu, then select the Configuration item from the Load cascade menu.

Based on this explanation, the general rule for interpreting this notation can be stated as follows:

- The leftmost item in bold is the pulldown menu label.
- If there are more than two items, then cascade menus are involved and all items between the first and last item have cascade menus attached.
- The last item on the right is the actual menu choice to be made.



### Mouse Button and Keyboard Bindings

Because the Graphical User Interface runs on different kinds of computers, which may have different conventions for mouse buttons and key names, the Graphical User Interface supports different bindings and the customization of bindings.

This manual refers to the mouse buttons using general (or "generic") terms. The following table describes the generic mouse button names and shows the default mouse button bindings.

Mouse Button Bindings and Description			
Generic Button Name	Bindings for HP 9000	Bindings for Sun SPARCsystem (SunOS or Solaris)	Description
<i>paste</i>	left	left	Paste from the display area to the entry buffer.
<i>command paste</i>	middle <sup>1</sup>	middle <sup>1</sup>	Paste from the entry buffer to the command line text entry area.
<i>select</i>	right	right	Click selects first item in popup menus. Press and hold displays menus.
<i>command select</i>	left	right	Displays pulldown menus.
<i>pushbutton select</i>	left	left	Actuates pushbuttons outside of the display area.

<sup>1</sup> Middle button on three-button mouse. Both buttons on two-button mouse.

The following tables show the default keyboard bindings.

---

Keyboard Key Bindings

---

Generic Key Name	HP 9000	Sun SPARCsystem (SunOS or Solaris)
menu select	extend char	extend char
insert	insert char	insert char
delete	delete char	delete char
left-arrow	left arrow	left arrow
right-arrow	right arrow	right arrow
up-arrow	up arrow	up arrow
down-arrow	down arrow	down arrow
escape	escape	escape
TAB	TAB	TAB

---

## The Softkey Interface

The emulator/analyzer interface can also be the Softkey Interface which is provided for several types of terminals, terminal emulators, and bitmapped displays. When using the Softkey Interface, commands are entered from the keyboard.

Figure 2

The screenshot shows a window titled "Softkey Interface" with a header "Memory :mnemonic :file = main(module).\"main.c\":". Below the header is a table of memory addresses and their corresponding mnemonics and data. A status line indicates the current file and status, and a command line shows the current command being entered. At the bottom, there are several softkey options: run, trace, step, display, modify, break, end, and ---ETC---

address	mnemonic	data
000FC8	LINK	A6, #00000
000FCC	JSR	00014F0
000FD2	JSR	0001A46
000FD8	NOP	
000FDA	JSR	000159A
000FE0	ADDQ.L	#1, 00076F2
000FE6	PEA.L	00076F2
000FEC	JSR	000101C
000FF2	ADDQ.L	#4, A7
000FF4	TST.B	00076FE
000FFA	BEQ.B	0001004
000FFC	JSR	0001986
001002	NOP	
001004	JSR	0001A6A
00100A	NOP	
00100C	BRA.B	0000FDA

STATUS: cws: main.\"main.c\": ...R....

display memory main mnemonic

run trace step display modify break end ---ETC---

Display area.

Status line.

Command line.

**Display area.**

Can show memory, data values, analyzer traces, registers, breakpoints, status, simulated I/O, global symbols, local symbols, pod commands (the emulator's underlying Terminal Interface), error log, or display log. You can use the UP ARROW, DOWN ARROW, PAGE UP, and PAGE DOWN cursor keys to scroll or page up or down the information in the active window.

**Status line.**

Displays the emulator and analyzer status. Also, when error and status messages occur, they are displayed on the status line in addition to being saved in the error log.

**Command line.**

Commands are entered on the command line by pressing softkeys (or by typing them in) and executed by pressing the Return key. The Tab and Shift-Tab keys allow you to move the cursor on the command line forward or backward. The Clear line key (or CTRL-e) clears from the cursor position to the end of the line. The CTRL-u key clears the whole command line.

**Softkey Interface Conventions**

Example Softkey Interface commands throughout the manual use the following conventions:

<b>bold</b>	Commands, options, and parts of command syntax.
<b><i>bold italic</i></b>	Commands, options, and parts of command syntax which may be entered by pressing softkeys.
normal	User specified parts of a command.
\$	Represents the UNIX prompt. Commands which follow the "\$" are entered at the UNIX prompt.
<RETURN>	The carriage return key.



This tutorial gives you step-by-step instructions on how to perform a few basic tasks using the emulator/analyzer interface. The tutorial examples presented in this chapter make the following assumptions:

- The HP 64782B-H emulator and HP 64703/4 analyzer are installed into the HP 64700 Card Cage, the HP 64700 is connected to the host computer, and the Graphical User Interface software has been installed as outlined in the "Installation" chapter.
- The emulator is operating out-of-circuit (that is, not plugged into a target system).

### **The Demonstration Program**

The demonstration program used in this chapter is a simple environmental control system. The program controls the temperature and humidity of a room requiring accurate environmental control.

---

## Step 1. Start the demo

A demo program and its associated files are provided with the Graphical User Interface.

- 1 Change to the demo directory.

```
$ cd /usr/hp64000/demo/debug_env/hp64749
```

Refer to the README file for more information on the demo program.

- 2 Check that "/usr/hp64000/bin" and "." are in your PATH environment variable. To see the value of PATH:

```
$ echo $PATH
```

- 3 If the Graphical User Interface software is installed on a different type of computer than the computer you are using, edit the "platformScheme" resource setting in the "Xdefaults.emul" file.

For example, if the Graphical User Interface will be run on a HP 9000 computer and displayed on a Sun SPARCsystem computer, change the platform scheme to "SunOS".

- 4 Start the emulator/analyzer demo.

```
$ startemul <logical_emul_name>
```

This script starts the emulator/analyzer interface (with a customized set of action keys), loads a configuration file for the demo program, and then loads the demo program.

The <logical\_emul\_name> in the command above is the logical emulator name given in the HP 64700 emulator device table file (/usr/hp64000/etc/64700tab.net). It may also be the LAN name.



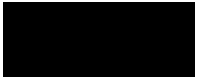

## Step 2: Display the program in memory

- 1 If the symbol "main" is not already in the entry buffer, move the mouse pointer to the entry buffer (notice the flashing I-beam cursor) and type in "main".
- 2 Choose **Display**→**Memory**→**Mnemonic ( )**.  
Or, using the command line, enter:

```
display memory main mnemonic
```

Figure 3

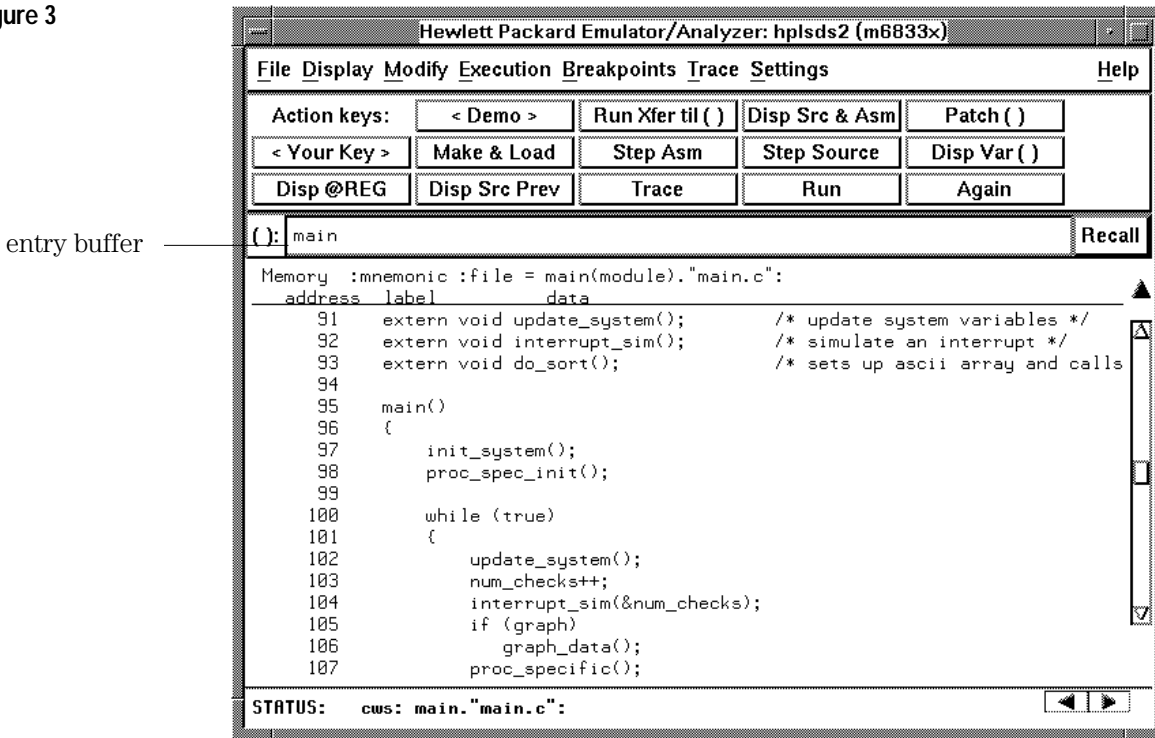

The default display mode settings cause source lines and symbols to appear in displays where appropriate. Notice you can use symbols when specifying expressions. The global symbol "main" is used in the command above to specify the starting address of the memory to be displayed.

### Step 3: Run from the transfer address

The transfer address is the entry address defined by the software development tools and included with the program's symbol information.

- Click on the **Run Xfer til ( )** action key.

Or, using the command line, enter:

*run from transfer\_address until main*

Figure 4

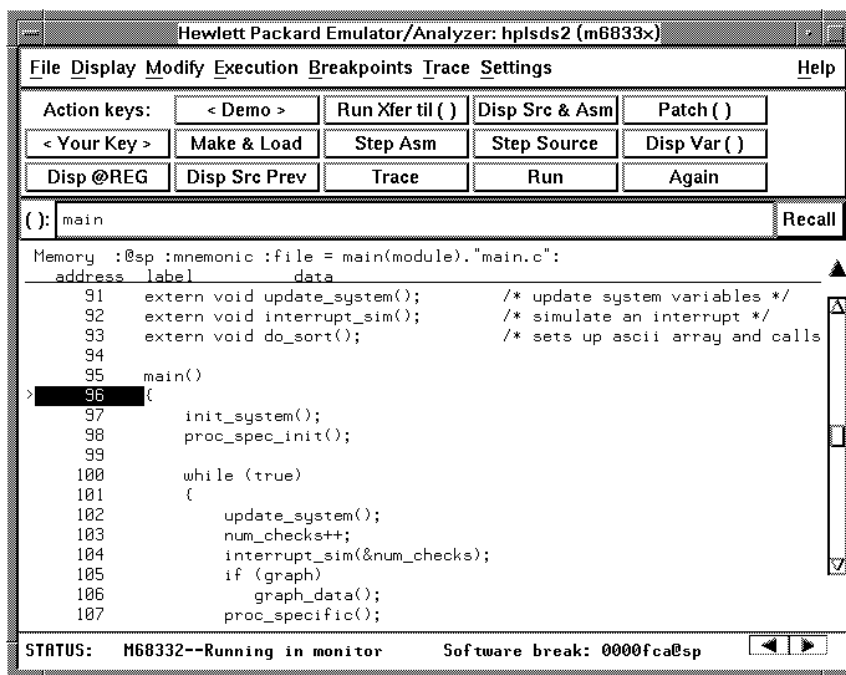

Notice the message "Software break: <address>" is displayed on the status line and that the emulator is "Running in monitor" (you may have to click the *select* mouse button to remove temporary messages from the status line).

When you run until an address, a breakpoint is set at the address before the program is run.

Notice the highlighted bar on the screen; it shows the current program counter.

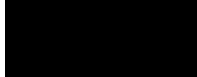

## Step 4: Step high-level source lines

You can step through the program by high-level source lines. The emulator executes as many instructions as are associated with the high-level program source lines.

- 1 To step a source line from the current program counter, click on the **Step Source** action key.

Or, using the command line, enter:

*step source*

Notice that the highlighted bar (the current program counter) moves to the next high-level source line.

- 2 Step into the "init\_system" function by continuing to step source lines, either by clicking on the **Step Source** action key, by clicking on the **Again** action key which repeats the previous command, or by entering the **step source** command on the command line.

Figure 5

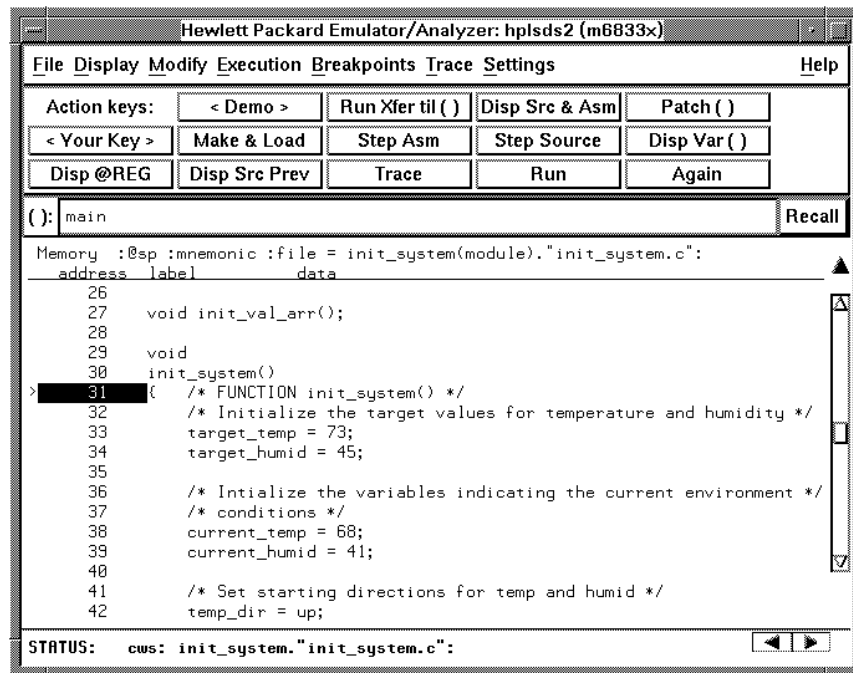

---

## Step 5: Display the previous mnemonic display

- Click on the **Disp Src Prev** action key.  
Or, using the command line, enter:

*display memory mnemonic previous\_display*

This command is useful, for example, when you have stepped into a function that you do not wish to look at—you can display the previous mnemonic display and run until the source line that follows the function call.

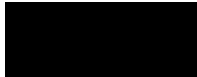

## Step 6: Run until an address

When displaying memory in mnemonic format, a selection in the popup menu lets you run from the current program counter address until a specific source line.

- Position the mouse pointer over the line "proc\_spec\_init();", press and hold the *select* mouse button, and choose **Run Until** from the popup menu. This screen shows the command line turned on.

Figure 6

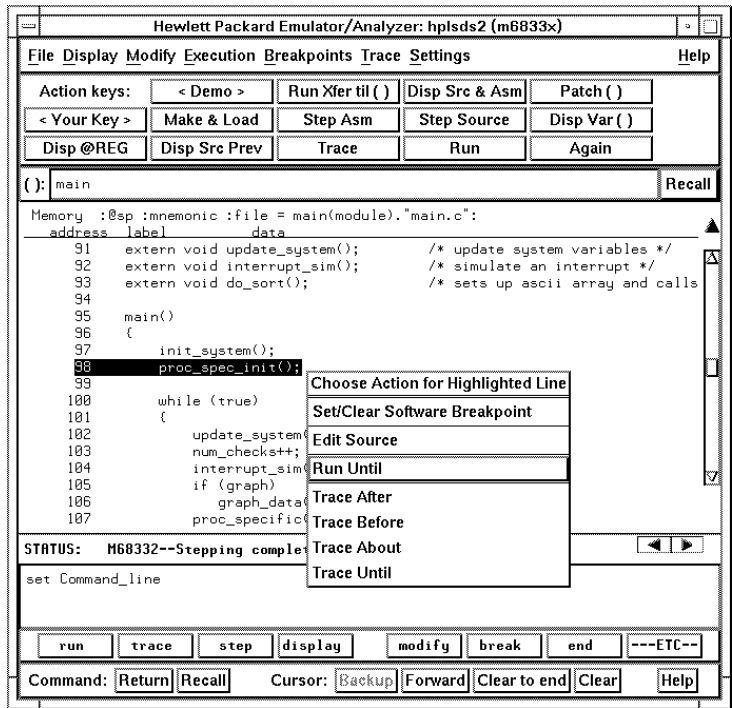

Or, using the command line, enter:

```
run until main."main.c": line 98
```

After the command has executed, notice the highlighted bar indicates the program counter has moved to the specified source line.

## Step 7: Display data values

- 1 Position the mouse pointer over "num\_checks" in the source line that reads "num\_checks++;" and click the *paste* mouse button (notice "num\_checks" is cut and pasted into the entry buffer).
- 2 Click on the **Disp Var ( )** action key.  
Or, using the command line, enter:

```
display data , num_checks int32
```

Figure 7

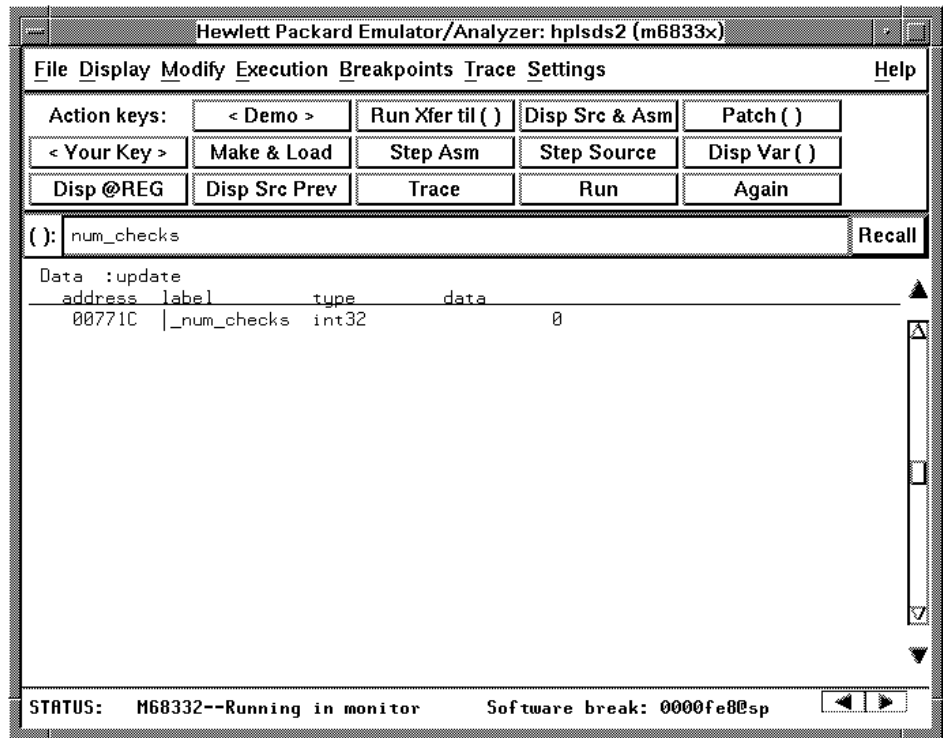

The "num\_checks" variable is added to the data values display and its value is displayed as a 32-bit integer.

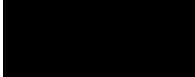

## Step 8: Display registers

You can display the contents of the processor registers.

- Choose **Display**→**Registers**→**BASIC**.

Or, using the command line, enter:

*display registers*

Figure 8

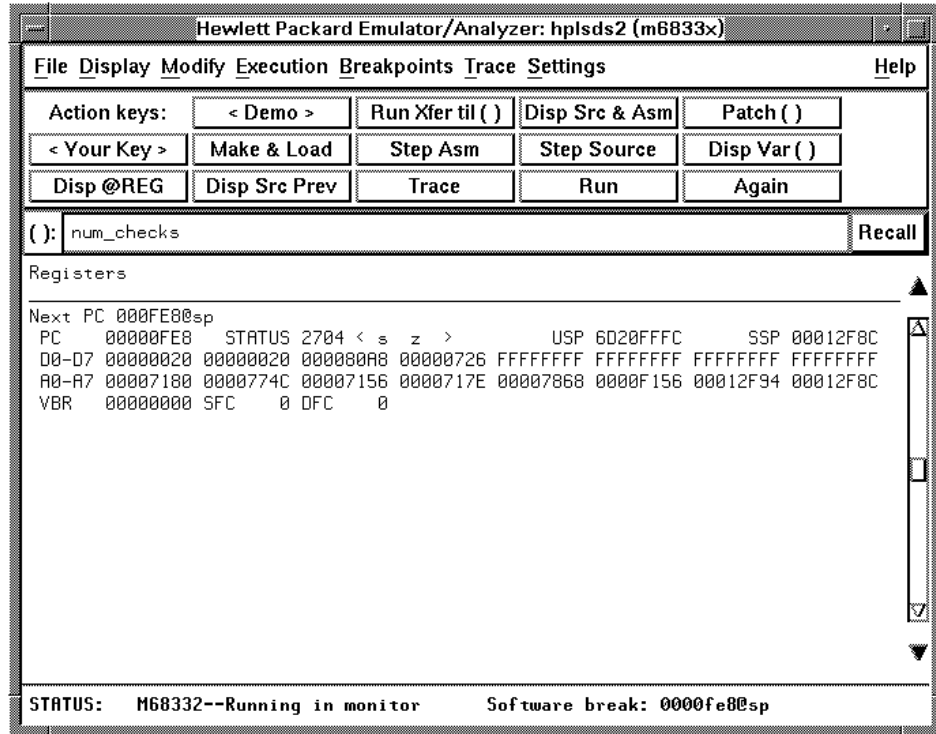

## Step 9: Step assembly-level instructions

You can step through the program one instruction at a time.

- To step one instruction from the current program counter, click on the **Step Asm** action key.

Or, using the command line, enter:

*step*

Figure 9

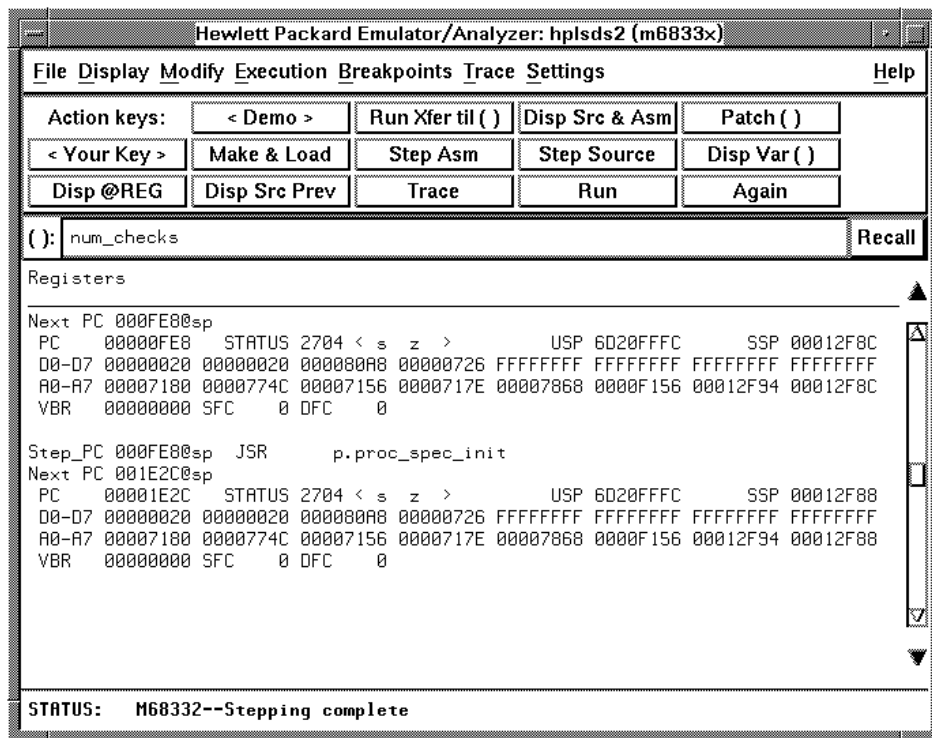

Notice, when registers are displayed, stepping causes the assembly language instruction just executed to be displayed.





---

## Step 10: Trace the program

When the analyzer traces program execution, it looks at the data on the emulation processor's bus and control signals at each clock cycle. The information seen at a particular clock cycle is called a state.

When one of these states matches the "trigger state" you specify, the analyzer stores states in trace memory. When trace memory is filled, the trace is said to be "complete."

**1 Click on the **Recall** button to the right of the entry buffer.**

A selection dialog box appears. You can select from entry buffer values that have been entered previously or that have been predefined.

**2 Click on "main" in the selection dialog box, and click the "OK" pushbutton.**

Notice that the value "main" has been returned to the entry buffer.

**3 To trigger on the address "main" and store states that occur after the trigger, choose **Trace**→**After** ().**

Or, using the command line, enter:

```
trace after main
```

Notice the message "Emulation trace started" appears on the status line. This shows that the analyzer has begun to look for the trigger state which is the address "main" on the processor's address bus.

**4 Run the emulator demo program from its transfer address by choosing **Execution**→**Run**→**from Transfer Address**.**

Or, using the command line, enter:

```
run from transfer_address
```

Notice that now the message on the status line is "Emulation trace complete". This shows the trigger state has been found and the analyzer trace memory has been filled.

- To view the captured states, choose **Display→Trace**.  
 Or, using the command line, enter:

*display trace*

Figure 10

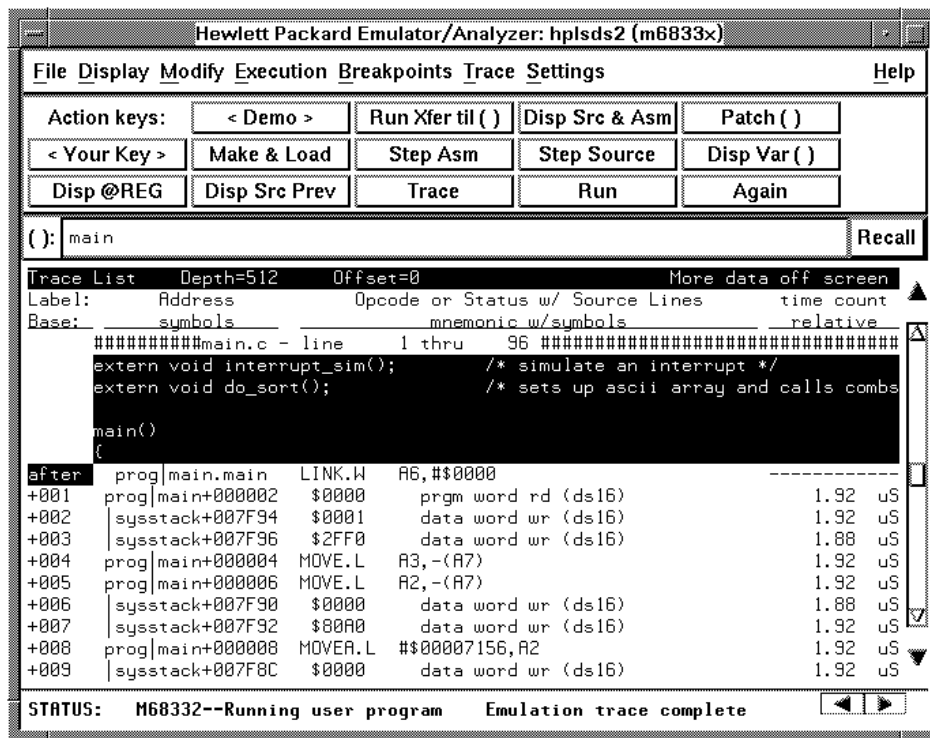

The default display mode settings cause source lines and symbols to appear in the trace list.

Captured states are numbered in the left-hand column of the trace list. Line 0 always contains the state that caused the analyzer to trigger.

Other columns contain address information, data values, opcode or status information, and time count information.

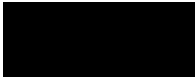

## Step 11: Display memory at an address in a register

- 1 Click on the **Disp @REG** action key.

Or, using the command line, enter the name of the command file:

```
mematreg
```

A command file dialog box appears (or a prompt appears in the command line).

- 2 Move the mouse pointer to the dialog box text entry area, type "A7" (uppercase), and click on the "OK" button.

Or, if the prompt is in the command line:

```
A7
```

Figure 11

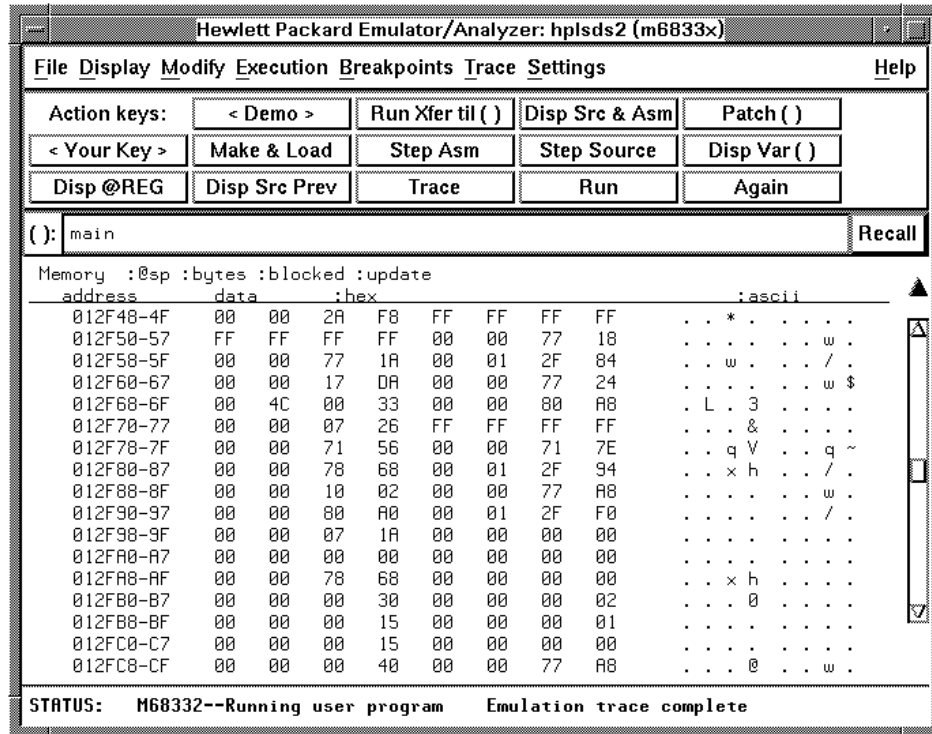

## Step 12: Patch assembly language code

The Patch ( ) action key lets you patch code in your program.

- 1 With "main" still in the entry buffer, click on the **Run Xfer til ( )** action key.
- 2 To display memory with assembly-level instructions intermixed with the high-level source lines, click on the **Disp Src & Asm** action key.

Figure 12

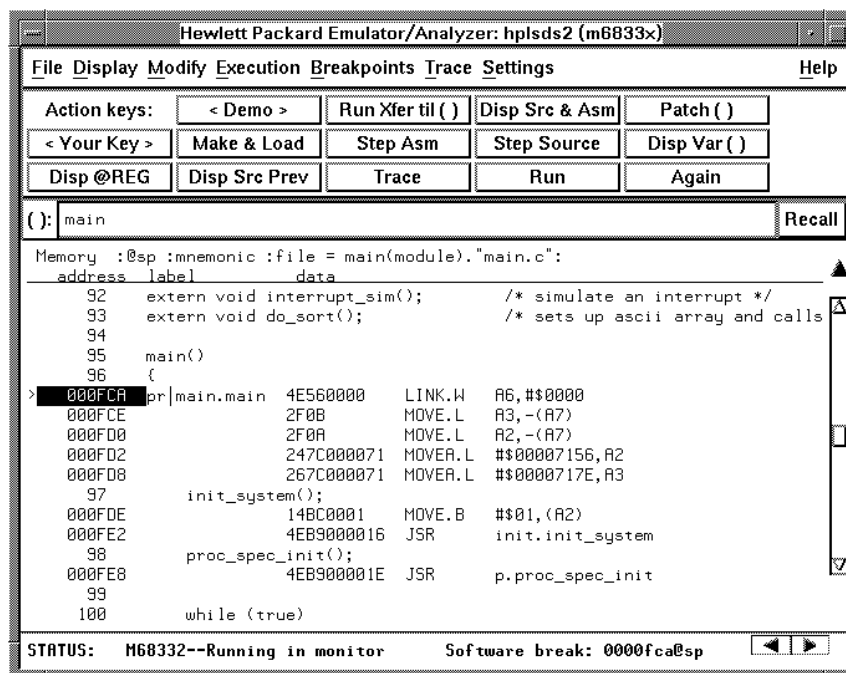

- 3 Click on the address for main in the source display to enter the address into the entry buffer.
- 4 Click on the **Patch ( )** action key.

A window appears and the vi editor is started. Notice that the address for "main" appears in the ORG statement.

- 5 Add the line:

```
LINK A6, #1234h
```

Figure 13

```

cmdscript
; PCHS700 Assembly Patch File: PCH000FCAh.s
;
; Date : Tue Jul  5 11:01:36 MDT 1994
; Dir  : /usr/hp64000/demo/debug_env/hp64749
; Owner: markb
;
INCLUDE PCHSINC.s
ORG 000FCAh ; you may need to change this!

Link A6,#1234h
~
~
~
~
~
~
~
~
~
~
"PCH000FCAh.s" 12 lines, 236 characters
  
```

- 6 Exit out of the editor, saving your changes.  
The file you just edited is assembled, and the patch main menu appears.
- 7 Type "a" and press <RETURN> to apply the patch.

Figure 14

Address	Label	Code	Comment
92		extern void interrupt_sim();	/* simulate an interrupt */
93		extern void do_sort();	/* sets up ascii array and calls
94			
95	main()		
96	{		
> 000FCA	pr main.main	4E561234 LINK.W	A6,#1234
000FCE		2F0B MOVE.L	A3,-(A7)
000FD0		2F0A MOVE.L	A2,-(A7)
000FD2		247C000071	MOVER.L #00007156,A2
000FD8		267C000071	MOVER.L #0000717E,A3
97	init_system();		
000FDE		14BC0001	MOVE.B #01,(A2)
000FE2		4EB9000016	JSR init.init_system
98	proc_spec_init();		
000FE8		4EB900001E	JSR p.proc_spec_init
99			
100	while (true)		

STATUS: H68332--Running in monitor Software break: 0000fca@esp

Notice in the emulator/analyzer interface that the instruction at address "main" has changed.

**8 Click on the Patch ( ) action key again.**

A window running the vi editor again appears, allowing you to modify the patch code that was just created.

**9 Modify the line you added previously to:**

```
LINK A6 , #0
```

**10 Exit out of the editor, saving your changes.**

The file you just edited is assembled, and the patch main menu appears.

**11 Type "a" and press <RETURN> to apply the patch.**

Notice in the emulator/analyzer interface that the instruction at address "main" has been changed back to what it was originally.

When patching a single address, make sure the new instruction takes up the same number of bytes as the old instruction; otherwise, you may inadvertently modify code that follows.

**12 Type "main+4 thru main+15" in the entry buffer.**

By entering an address range in the entry buffer (that is, <address> thru <address>) before clicking on the Patch ( ) action key, you can modify a patch template file which allows you to insert as much or as little code as you wish.

If you make a mistake while editing the patch, then save the changes, when you enter the file again to fix the mistake, a "duplicate symbol" error will appear on the INCLUDE PCHSINC.s" line when the patch is reassembled. Although this message is displayed, it will not affect the new patch assembly.

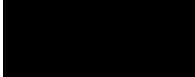

**13** Click on the **Patch ()** action key again.

A window running the vi editor again appears. Suppose you want to patch the demo program so that the `proc_spec_init()` function is called before the `init_system()` function. Suppose also that there is memory available at address 8800H. Edit the patch template file as shown below.

Figure 15

```

cmdscript
; PCHS700 Assembly Patch File: PCH000FCAh+4.s
;
; Date : Tue Jul  5 12:11:11 MDT 1994
; Dir  : /usr/hp64000/demo/debug_env/hp64749
; Owner: markb
;
      INCLUDE PCHSINC.s
      ORG 000FCAh+4 ; you may need to change this!
      BRA patch1 ; You may want to change this name!
      ORG 8800h ; You MUST set this address!
patch1 NOP
; !!!!!!!!! You may need to modify labels and operands of the !!!!!!!!!
; !!!!!!!!! following code to match your assembler syntax !!!!!!!!!
; !!!!!!!!! Patching Range: 000FCAh+4 thru 000FCAh+15 !!!!!!!!!
; !!!!!!!!! Insert new code here !!!!!!!!!
      JSR _proc_spec_init
      JSR _init_system
      BRA 000FCAh+16 ; You MUST set this address also!
~
~
~
~
:

```

Notice that symbols can be used in the patch file.

**14** Exit out of the editor, saving your changes.

The file you just edited is assembled, and the patch main menu appears.

**15** Type "a" and press <RETURN> to apply the patch.

You can step through the program to view execution of the patch.

---

## Step 13: Exit the emulator/analyzer interface

- To exit the emulator/analyzer interface and release the emulator, choose **File**→**Exit**→**Released**.

Or, using the command line, enter:

```
end release_system
```



---

User's Guide

---



## Part 2

A complete set of task instructions and problem-solving guidelines, with a few basic concepts.



---

## Plugging into a Target System

---

---

## Plugging the Emulator into a Target System

For information about plugging the emulator into a target system, refer to the *6833x Installation/Service/Terminal Interface Manual*. That manual describes connecting these emulators to a target system using an AMP 132-pin connector, a PQFP (plastic quad flat pack) cable, or a 132-pin to PQFP adapter.

- M68331—Model HP 64782B
- M68332—Model HP 64782C
- M68334—Model HP 64782E
- M68335—Model HP 64782F

It also describes connecting these emulators to a target system directly using a PQFP cable:

- M68333—Model HP 64782D
- M68336—Model HP 64782G
- M68337—Model HP 64782H

---

### CAUTION

---

**Possible Damage to the Emulator Probe.** The emulator contains devices that are susceptible to damage by static discharge. Therefore, precautionary measures should be taken before handling the emulator probe to avoid damaging the internal components of the emulator by static electricity.



---

## Starting and Exiting HP 64700 Interfaces

---

## Starting and Exiting HP 64700 Interfaces

You can use several types of interfaces to the same emulator at the same time to give yourself different views into the target system.

The strength of the emulator/analyzer interface is that it lets you perform the real-time analysis measurements that are helpful when integrating hardware and software.

The C debugger interface (which is a separate product) lets you view the stack backtrace and high-level data structures, and it lets you use C language expressions and macros. These features are most useful when debugging software.

The Software Performance Analyzer interface (which is also a separate product) lets you make measurements that can help you improve the performance of your software.

These interfaces can operate at the same time with the same emulator. When you perform an action in one of the interfaces, it is reflected in the other interfaces.

Up to 10 interface windows may be started for the same emulator. Only one C debugger interface window and one SPA window are allowed, but you can start multiple emulator/analyzer interface windows.

The tasks associated with starting and exiting HP 64700 interfaces are grouped into the following sections:

- Starting the emulator/analyzer interface.
- Opening other HP 64700 interface windows.
- Exiting HP 64700 interfaces.

---

## Starting the Emulator/Analyzer Interface

Before starting the emulator/analyzer interface, the emulator and interface software must have already been installed as described in the "Installation" chapter.

This section describes how to:

- Start the interface.
- Start the interface using the default configuration.
- Run a command file on interface startup.
- Display the status of emulators defined in the 64700tab.net file.
- Unlock an interface that was left locked by another user.

---

### To start the emulator/analyzer interface

- Use the **emul700 <emul\_name>** command.

If /usr/hp64000/bin is specified in your PATH environment variable (as shown in the "Installation" chapter), you can start the interface with the **emul700 <emul\_name>** command. The "emul\_name" is the logical emulator name given in the HP 64700 emulator device table (/usr/hp64000/etc/64700tab.net). It may also be the LAN address.

If you are running a window system on your host computer (for example, the X Window System), you can run the interface in up to 10 windows. This capability provides you with several views into the emulation system. For example, you can display memory in one window, registers in another, an analyzer trace in a third, and data in the fourth.

---

**Examples**

To start the emulator/analyzer interface for the 6833x emulator:

```
$ emul700 em6833x
```

The "em6833x" in the command above is the logical emulator name given in the HP 64700 emulator device table file (/usr/hp64000/etc/64700tab.net).

```
# Blank lines and the rest of each line after a '#' character are ignored.
# The information in each line must be in the specified order, with one line
# for each HP series 64700 emulator. Use blanks or tabs to separate fields.
#
#-----+-----+-----+-----+-----+-----+-----+-----+-----+-----+
# Channel| Logical   | Processor | Remainder of Information for the Channel
# Type  | Name     | Type     | (IP address for LAN connections)
#-----+-----+-----+-----+-----+-----+-----+-----+-----+-----+
# lan:   em6833x  m6833x   21.17.9.143
serial:  em6833x  m6833x   myhost /dev/emcom23 OFF 9600 NONE XON 2 8
```

If you're currently running the X Window System, the Graphical User Interface starts; otherwise, the Softkey Interface starts.

The status message shows that the default configuration file has been loaded. If the command is not successful, you will be given an error message and returned to the UNIX prompt. Error messages are described in the "Error Messages" chapter.

---



---

## To start the interface using the default configuration

- Use the **emul700 -d <emul\_name>** command.  
In the **emul700 -d <emul\_name>** command, the -d option says to use the default configuration. The -d option is ignored if the interface is already running in another window or on another terminal.

---

## To run a command file on interface startup

- Use the **emul700 -c <cmd\_file> <emul\_name>** command.  
You can cause command files to be run upon starting the interface by using the -c <cmd\_file> option to the **emul700** command.  
Refer to the "Using Command Files" section in the "Entering Commands" chapter for information on creating command files.

---

### Examples

To start the emulator/analyzer interface and run the "startup" command file:

```
$ emul700 -c startup em6833x
```

---

## To display the status of emulators

- Use the **emul700 -l** or **emul700 -lv** command.  
The -l option of the **emul700** command lists the status of all emulators defined in the 64700tab and 64700tab.net files. If a logical emulator name is included in the command, just the status of that emulator is listed.  
You can also use the -v option with the -l option for a verbose listing of the status information.

---

**Examples**

To list, verbosely, the status of the emulator whose logical name is "em6833x":

```
$ emul700 -lv em6833x
```

The information may be similar to:

```
em6833x - m6833x running; user = guest
description:      M6833x emulation, 512K bytes emul mem
user interfaces:  xdebug, xemul, xperf, skemul, sktiming
device channel:  /dev/emcom23
```

Or, the information may be similar to:

```
em6833x - m6833x running; user = guest@myhost
description:      M6833x emulation, 512K bytes emul mem
user interfaces:  xdebug, xemul, xperf, skemul, sktiming
internet address: 21.17.9.143
```

---

---

## To unlock an interface that was left locked by another user

- Use the **emul700 -U <emul\_name>** command.

The -U option to the **emul700** command may be used to unlock the emulators whose logical names are specified. This command will fail if there currently is a session in progress.

---

**Examples**

To unlock the emulator whose logical name is "em6833x":

```
$ emul700 -U em6833x
```

---

---

# Opening Other HP 64700 Interface Windows

The **File→Emul700** menu lets you open additional emulator/analyzer interface windows or other HP 64700 interface windows if those products have been installed (for example, the software performance analyzer (SPA) interface and the high-level debugger interface).

This section shows you how to:

- Open additional emulator/analyzer interface windows.
- Open the high-level debugger interface window.
- Open the software performance analyzer (SPA) interface window.

---

## To open additional emulator/analyzer windows

- To open additional Graphical User Interface windows, choose **File→Emul700→Emulator/Analyzer under Graphic Windows**, or enter the **emul700 <emul\_name>** command in another terminal emulation window.
- To open additional conventional Softkey Interface windows, choose **File→Emul700→Emulator/Analyzer under Terminal Windows**, or enter the **emul700 -u skemul <emul\_name>** command in another terminal emulation window.

You can open additional Graphical User Interface windows, or terminal emulation windows containing the Softkey Interface. When you open an additional window, the status line will show that this session is joining a session already in progress, and the event log is displayed.

You can enter commands in any window in which the interface is running. When you enter commands in different windows, the command entered in the first window must complete before the command entered in the second window can start. The status lines and the event log displays are updated in all windows.

---

### To open the high-level debugger interface window

- Choose **File→Emul700→High-Level Debugger ...** under "Graphic Windows", or enter the **emul700 -u xdebug <emul\_name>** command in another terminal emulation window.

For information on how to use the high-level debugger interface, refer to the debugger/emulator *User's Guide*.

---

### To open the software performance analyzer (SPA) interface window

- Choose **File→Emul700→Performance Analyzer ...** under "Graphic Windows", or enter the **emul700 -u xperf <emul\_name>** command in another terminal emulation window.

For information on how to use the software performance analyzer, refer to the *Software Performance Analyzer User's Guide*.

---

## Exiting HP 64700 Interfaces

There are several options available when exiting the HP 64700 interfaces. You can simply close one of the open interface windows, or you can exit the debug session by closing all the open windows. When exiting the debug session, you can lock the emulator so that you can continue later, or you can release the emulation system so that others may use it. This section describes how to:

- Close an interface window.
- Exit a debug/emulation session.

---

### To close an interface window

- In the interface window you wish to close, choose **File**→**Exit**→**Window**. In the emulator/analyzer interface command line, enter the **end** command with no options.

All other interface windows remain open, and the emulation session continues, unless the window closed is the only one open for the emulation session. In that case, closing the window ends the emulation session, but locks the emulator so that other users cannot access it.

## To exit a debug/emulation session

- To exit the interface, save your configuration to a temporary file, and lock the emulator so that it cannot be accessed by other users, choose **File→Exit→Locked**. In the emulator/analyzer interface command line, enter the **end locked** command.
- To exit the interface and release the emulator for access by other users, choose **File→Exit→Released**. In the emulator/analyzer interface command line, enter the **end release\_system** command.

If you exit the interface locked, the interface saves the current configuration to a temporary file and locks the emulator to prevent other users from accessing it. When you again start the interface with the **emul700** command, the temporary file is reloaded, and therefore, you return to the configuration you were using when you quit the interface locked.

Also saved when you exit the interface locked are the contents of the entry buffer and command recall buffer. These recall buffer values will be present when you restart the interface.

In contrast, if you end released, you must have saved the current configuration to a configuration file (if the configuration has changed), or the changes will be lost.



---

## Entering Commands

---

## Entering Commands



When an X Window System that supports OSF/Motif interfaces is running on the host computer, the emulator/analyzer interface is the Graphical User Interface which provides pull-down and pop-up menus, point and click setting of breakpoints, cut and paste, on-line help, customizable action keys and pop-up recall buffers, etc.

The emulator/analyzer interface also provides the Softkey Interface for several types of terminals, terminal emulators, and bitmapped displays. When using the Softkey Interface, commands are entered from the keyboard.

When using the Graphical User Interface, the *command line* portion of the interface gives you the option of entering commands in the same manner as they are entered in the Softkey Interface. If you are using the Softkey Interface, you can only enter commands from the keyboard using the command line.

The menu commands in the Graphical User Interface are a subset of the commands available when using the command line. While you have a great deal of capability in the menu commands, you have even more in the command line.

This chapter shows you how to enter commands in each type of emulator/analyzer interface. The tasks associated with entering commands are grouped into the following sections:

- Using menus, the entry buffer, and action keys.
- Using the command line with the mouse.
- Using the command line with the keyboard.
- Using command files.
- Using pod commands.
- Forwarding commands to other HP 64700 interfaces.



---

## Using Menus, the Entry Buffer, and Action Keys

This section describes the tasks you perform when using the Graphical User Interface to enter commands. This section describes how to:

- Choose a pulldown menu item using the mouse.
- Choose a pulldown menu item using the keyboard.
- Use the popup menus.
- Use the entry buffer.
- Copy and paste to the entry buffer.
- Use action keys.
- Use dialog boxes.
- Access help information.

---

### To choose a pulldown menu item using the mouse (method 1)

- 1** Position the mouse pointer over the name of the menu on the menu bar.
- 2** Press and hold the *command select* mouse button to display the menu.
- 3** While continuing to hold down the mouse button, move the mouse pointer to the desired menu item. If the menu item has a cascade menu (identified by an arrow on the right edge of the menu button), then continue to hold the mouse button down and move the mouse pointer toward the arrow on the right edge of the menu. The cascade menu will display. Repeat this step for the cascade menu until you find the desired menu item.

**4 Release the mouse button to select the menu choice.**

If you decide not to select a menu item, simply continue to hold the mouse button down, move the mouse pointer off of the menu, and release the mouse button.

Some menu items have an ellipsis ("...") as part of the menu label. An ellipsis indicates that the menu item will display a dialog or message box when the menu item is chosen.

---

**To choose a pulldown menu item using the mouse (method 2)**

**1 Position the mouse pointer over the menu name on the menu bar.**

**2 Click the *command select* mouse button to display the menu.**

**3 Move the mouse pointer to the desired menu item. If the menu item has a cascade menu (identified by an arrow on the right edge of the menu button), then repeat the previous step and then this step until you find the desired item.**

**4 Click the mouse button to select the item.**

If you decide not to select a menu item, simply move the mouse pointer off of the menu and click the mouse button.

Some menu items have an ellipsis ("...") as part of the menu label. An ellipsis indicates that the menu item will display a dialog or other box when the menu item is chosen.

---

**To choose a pulldown menu item using the keyboard**

- To initially display a pulldown menu, press and hold the *menu select* key (for example, the "Extend char" key on a HP 9000 keyboard) and then type the underlined character in the menu label on the menu bar. (For example, "f" for "File". Type the character in lower case only.)
- To move right to another pulldown menu after having initially displayed a menu, press the *right-arrow* key.
- To move left to another pulldown menu after having initially displayed a menu, press the *left-arrow* key.

- To move down one menu item within a menu, press the *down-arrow* key.
- To move up one menu item within a menu, press the *up-arrow* key.
- To choose a menu item, type the character in the menu item label that is underlined. Or, move to the menu item using the arrow keys and then press the *<RETURN>* key on the keyboard.
- To cancel a displayed menu, press the *Escape* key.

The interface supports keyboard mnemonics and the use of the arrow keys to move within or between menus. For each menu or menu item, the underlined character in the menu or menu item label is the keyboard mnemonic character. Notice the keyboard mnemonic is not always the first character of the label. If a menu item has a cascade menu attached to it, then typing the keyboard mnemonic displays the cascade menu.

Some menu items have an ellipsis ("...") as part of the menu label. An ellipsis indicates that the menu item will display a dialog or other box when the menu item is chosen.

Dialog boxes support the use of the keyboard as well. To direct keyboard input to a dialog box, you must position the mouse pointer somewhere inside the boundaries of the dialog box. That is because the interface *keyboard focus policy* is set to *pointer*. That just means that the window containing the mouse pointer receives the keyboard input.

In addition to keyboard mnemonics, you can also specify keyboard accelerators which are keyboard shortcuts for selected menu items. Refer to the "Setting X Resources" chapter and the "Softkey.Input" scheme file for more information about setting the X resources that control defining keyboard accelerators.



---

## To choose popup menu items

- 1 Move the mouse pointer to the area whose popup menu you wish to access. (If a popup menu is available, the mouse pointer changes from an arrow to a hand.)
- 2 Press and hold the *select* mouse button.
- 3 After the popup menu appears (while continuing to hold down the mouse button), move the mouse pointer to the desired menu item.
- 4 Release the mouse button to select the menu choice.

If you decide not to select a menu item, simply continue to hold the mouse button down, move the mouse pointer off of the menu, and release the mouse button.

---

## To place values into the entry buffer using the keyboard

- 1 Position the mouse pointer within the text entry area. (An "I-beam" cursor will appear.)
- 2 Enter the text using the keyboard.

To clear the entry buffer text area from beginning until end, press the <Ctrl>u key combination.

---

## To copy-and-paste to the entry buffer

- To copy and paste a discrete text string as determined by the interface, position the mouse pointer over the text to copy and click the *paste* mouse button.
- To specify the exact text to copy to the entry buffer: press and hold the *paste* mouse button; drag the mouse pointer to highlight the text to copy-and-paste; release the *paste* mouse button.

You can copy-and-paste from the display area, the status line, and from the command line entry area.

When you position the pointer and click the mouse button, the interface expands the highlight to include the most complete text string it considers to be discrete. Discrete here means that the interface will stop expanding the

highlight in a given direction when it discovers a delimiting character not determined to be part of the string. A common delimiter would, of course, be a space.

When you press and hold the mouse button and drag the pointer to highlight text, the interface copies all highlighted text to the entry buffer when you release the mouse button.

Because the interface displays absolute addresses as hex values, any copied and pasted string that can be interpreted as a hexadecimal value (that is, the string contains only numbers 0 through 9 and characters "a" through "f") automatically has an "h" appended.

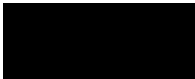

If you have multiple Graphical User Interface windows open, a copy-and-paste action in any window causes the text to appear in all entry buffers in all windows. That is because although there are a number of entry buffers being displayed, there is actually only one entry buffer and it is common to all windows. That means you can copy a symbol or an address from one window and then use it in another window.

On a memory display or trace display, a symbol may not be completely displayed because there are too many characters to fit into the width limit for a particular column of the display. To make a symbol usable for copy-and-paste, you can scroll the screen left or right to display all, or at least more, of the characters from the symbol. The interface displays absolute addresses as hex values.

Text pasted into the entry buffer replaces that which is currently there. You cannot use paste to append text to existing text already in the entry buffer.

See "To copy-and-paste from the entry buffer to the command line entry area" for information about pasting the contents of the entry buffer into the command line entry area.

Entering Commands  
To copy-and-paste to the entry buffer

Example

To paste the symbol "num\_checks" into the entry buffer from the interface display area, position the mouse pointer over the symbol and then click the paste mouse button.

A mouse click causes the interface to expand the highlight to include the symbol "num\_checks" and paste the symbol into the entry buffer.

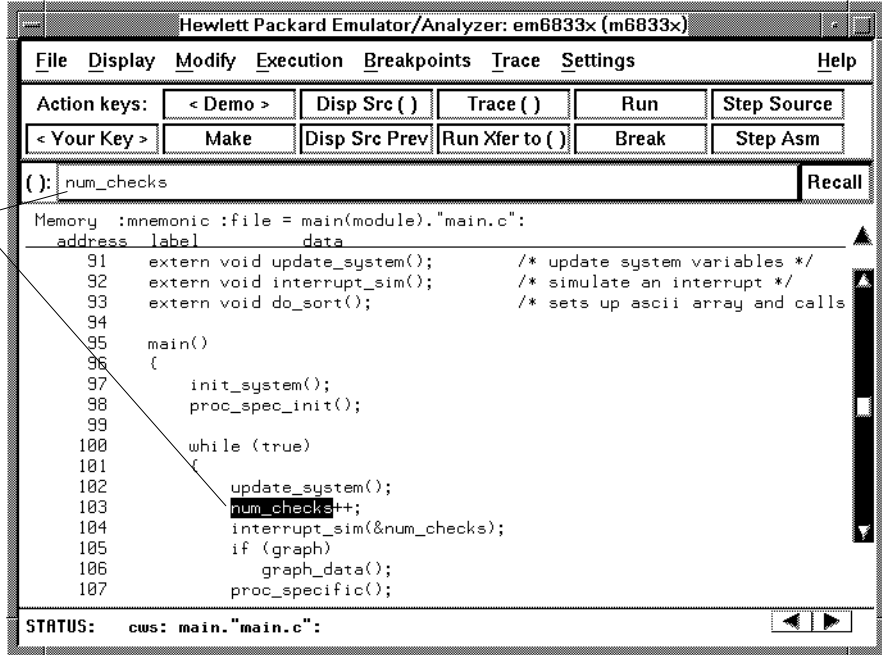

---

## To recall entry buffer values

- Position the mouse pointer over the **Recall** button just to the right of the entry buffer text area, click the mouse button to bring up the Entry Buffer Recall dialog box, and then choose a string from that dialog box.

The Entry Buffer Recall dialog box contains a list of entries gained during the emulation session as well as any predefined entries present at interface startup.

If you exit the emulation/analysis session with the interface "locked", recall buffer values are saved and will be present when you restart the interface.

You can predefine entries for the Entry Buffer Recall dialog box and define the maximum number of entries by setting X resources (refer to the "Setting X Resources" chapter).

See the following "To use dialog boxes" section for information about using dialog boxes.

---

## To use the entry buffer

- 1 Place information into the entry buffer (see the previous "To place values into the entry buffer using the keyboard", "To copy-and-paste to the entry buffer", or "To recall entry buffer values" task descriptions).
- 2 Choose the menu item, or click the action key, that uses the contents of the entry buffer (that is, the menu item or action key that contains "O").

## To copy-and-paste from the entry buffer to the command line entry area

- 1 Place text to be pasted into the command line in the entry buffer text area.

You may do that by:

- Copying the text from the display area using the copy-and-paste feature.
- Enter the text directly by typing it into the entry buffer text area.
- Choose the text from the entry buffer recall dialog box.

- 2 Position the mouse pointer within the command line text entry area.
- 3 If necessary, reposition the cursor to the location where you want to paste the text.
- 4 If necessary, choose the insert or replace mode for the command entry area.
- 5 Click the **command paste** mouse button to paste the text in the command line entry area at the current cursor position.

The entire contents of the entry buffer are pasted into the command line at the current cursor position.

Although a paste from the display area to the entry buffer affects all displayed entry buffers in all open windows, a paste from the entry buffer to the command line only affects the command line of the window in which you are currently working.

See "To copy-and-paste to the entry buffer" for information about pasting information from the display into the entry buffer.

---

## To use the action keys

- 1 If the action key uses the contents of the entry buffer, place the desired information in the entry buffer.
- 2 Position the mouse pointer over the action key and click the action key.

Action keys are user-definable pushbuttons that perform interface or system functions. Action keys can use information from the entry buffer — this makes it possible to create action keys that are more general and flexible.

---



Several action keys are predefined when you first start the Graphical User Interface. You can use the predefined action keys, but you'll really appreciate action keys when you define and use your own.

Action keys are defined by setting an X resource. Refer to the chapter "Setting X Resources" for more information about creating action keys.

---

## To use dialog boxes

- 1 Click on an item in the dialog box list to copy the item to the text entry area.
- 2 Edit the item in the text entry area (if desired).
- 3 Click on the "OK" pushbutton to make the selection and close the dialog box, click on the "Apply" pushbutton to make the selection and leave the dialog box open, or click on the "Cancel" pushbutton to cancel the selection and close the dialog box.

Directory Selection

The graphical interface uses a number of dialog boxes for selection and recall: Selects the working directory. You can change to a previously accessed directory, a predefined directory, or specify a new directory.

File Selection

From the working directory, you can select an existing file name or specify a new file name.

Entry Buffer Recall

You can recall a previously used entry buffer text string, a predefined entry buffer text string, or a newly entered entry buffer string, to the entry buffer text area.

Command Recall

You can recall a previously executed command, a predefined command, or a newly entered command, to the command line.

The dialog boxes share some common properties:

- Most dialog boxes can be left on the screen between uses.
- Dialog boxes can be moved around the screen and do not have to be positioned over the graphical interface window.
- If you iconify the interface window, all dialog boxes are iconified along with the main window.

Except for the File Selection dialog box, predefined entries for each dialog box (and the maximum number of entries) are set via X resources (refer to the "Setting X Resources" chapter).

**Examples**

To use the File Selection dialog box:

The file filter selects specific files.

A list of filter-matching files from the current directory.

A list of files previously accessed during the emulation session.

A single click on a file name from either list highlights the file name and copies it to the text area. A double click chooses the file and closes the dialog box.

Label informs you what kind of file selection you are performing.

Text entry area. Text is either copied here from the recall list, or entered directly.

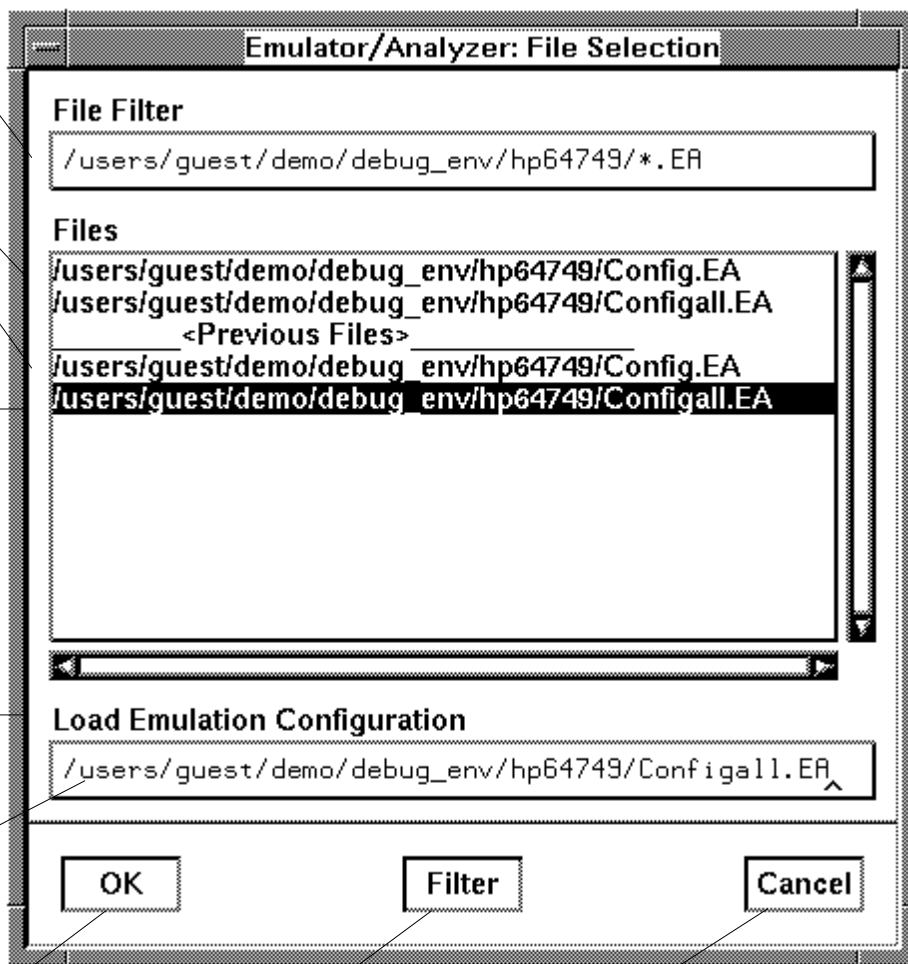

Clicking this button chooses the file name displayed in the text entry area and closes the dialog box.

Entering a new file filter and clicking this button causes a list of files matching the new filter to be read from the directory.

Clicking this button cancels the file selection operation and closes the dialog box.

To use the Directory Selection dialog box:

Label informs you of the type of list displayed.

A list of predefined or previously accessed directories.

A single click on a directory name from the list highlights the name and copies it to the text area. A double click chooses the directory and closes the dialog box.

Text entry area. Directory name is either copied here from the recall list, or entered directly.

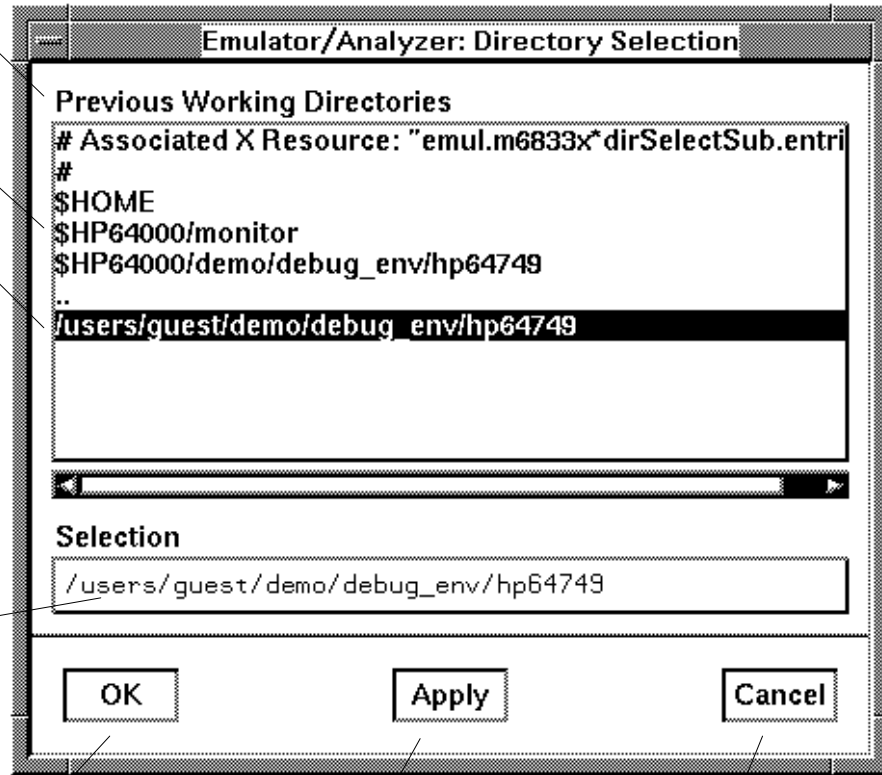

Clicking this button chooses the directory displayed in the text entry area and closes the dialog box.

Clicking this button chooses the directory displayed in the text entry area, but keeps the dialog box on the screen instead of closing it.

Clicking this button cancels the directory selection operation and closes the dialog box.

## To access help information

- 1 Display the Help Index by choosing **Help→General Topic...** or **Help→Command Line...**
- 2 Choose a topic of interest from the Help Index.

The Help Index lists topics covering operation of the interface as well other information about the interface. When you choose a topic from the Help Index, the interface displays a window containing the help information. You may leave the window on the screen while you continue using the interface.

---

## Using the Command Line with the Mouse

When using the Graphical User Interface, the *command line* portion of the interface gives you the option of entering commands in the same manner as they are entered in the Softkey Interface. Additionally, the graphical interface makes the softkey labels pushbuttons so commands may be entered using the mouse.

If you are using the Softkey Interface, using the command line with the keyboard is the only way to enter commands.

This section describes how to:

- Turn the command line off/on.
- Enter commands.
- Edit commands.
- Recall commands.
- Display the help window.

---

### To turn the command line on or off

- To turn the command line on or off using the pulldown menu, choose **Settings**→**Command Line**.
- To turn the command line on or off using the status line popup menu: position the mouse pointer within the status line area, press and hold the *select* mouse button, and choose **Command Line Off** from the menu.
- To turn the command line off using the command line entry area popup menu: position the mouse pointer within the entry area, press and hold the **select** mouse button, and choose **Command Line Off** from the menu.

Turns display of the command line area "on" or "off." On means that the command line is displayed and you can use the softkey label pushbuttons, the command return and recall pushbuttons, and the cursor pushbuttons for command line editing. Off means the command line is not displayed and you use only the pulldown menus and the action keys to control the interface.

The command line area begins just below the status line and continues to the bottom of the emulator/analyzer window. The status line is not part of the command line and continues to be displayed whether the command line is on or off.

Choosing certain pulldown menu items while the command line is off causes the command line to be turned on. That is because the menu item chosen requires some input at the command line that cannot be supplied another way.

---

## To enter a command

- 1 Build a command using the softkey label pushbuttons by successively positioning the mouse pointer on a pushbutton and clicking the *pushbutton select* mouse button until a complete command is formed.
- 2 Execute the completed command by clicking the *Return* pushbutton (found near the bottom of the command line in the "Command" group).

Or:

Execute the completed command using the Command Line entry area popup menu: Position the mouse pointer in the command line entry area; press and hold the *select* mouse button until the Command Line popup menu appears; then, choose the *Execute Command* menu item.

You may need to combine pushbutton and keyboard entry to form a complete command.

A complete command is a string of softkey labels and text entered with the keyboard. You know a command is complete when Return pushbutton is not halfbright. The interface does not check or act on a command, however, until the command is executed. (In contrast, commands resulting from pulldown menu choices and action keys are supplied with the needed carriage return as part of the command.)

## To edit the command line using the command line pushbuttons

- To clear the command line, click the *Clear* pushbutton.
- To clear the command line from the cursor position to the end of the line, click the *Clear to end* pushbutton.
- To move to the right one command word or token, click the *Forward* pushbutton.
- To move to the left one command word or token, click the *Backup* pushbutton.
- To insert characters at the cursor position, press the **insert** key to change to insertion mode, and then type the characters to be inserted.
- To delete characters to the left of the cursor position, press the **<BACKSPACE>** key.

When the cursor arrives at the beginning of a command word or token, the softkey labels change to display the possible choices at that level of the command.

When moving by words left or right, the Forward pushbutton becomes halfbright and unresponsive when the cursor reaches the end of the command string. Similarly, the Backup pushbutton becomes halfbright and unresponsive when the cursor reaches the beginning of the command.

See "To edit the command line using the mouse and the command line popup menu" and "To edit the command line using the keyboard" for information about additional editing operations you can perform.

---

## To edit the command line using the command line popup menu

- To clear the command line: position the mouse pointer within the Command Line entry area; press and hold the *select* mouse button until the Command Line popup menu appears; choose **Clear Entire Line** from the menu.
- To clear the command line from the cursor position to the end of the line: position the mouse pointer at the place where you want the clear-to-end to start; press and hold the *select* mouse button until the

Command Line popup menu appears; choose **Clear to End of Line** from the menu.

- To position the cursor and insert characters at the cursor location: position the mouse pointer in a non-text area of the command line entry area; press and hold the *select* mouse button to display the Command Line popup menu; choose **Position Cursor, Insert Mode** from the menu; type the characters to be inserted.
- To replace characters at the current cursor location: position the mouse pointer in a non-text area of the command line entry area; press and hold the *select* mouse button to display the Command Line popup menu; choose **Position Cursor, Replace Mode** from the menu; type the characters to be inserted.
- To position the cursor and replace characters at the cursor location: position the mouse pointer in a non-text area of the command line entry area; press and hold the *select* mouse button to display the Command Line popup menu; choose **Position Cursor, Replace Mode** from the menu; type the characters to be inserted.

When the cursor arrives at the beginning of a command word or token, the softkey labels change to display the possible choices at that level of the command.

See "To edit the command line using the mouse and the command line pushbuttons" and "To edit the command line using the keyboard" for information about additional editing operations you can perform.

---

## To recall commands

- 1 Click the pushbutton labeled *Recall* in the Command Line to display the dialog box.
- 2 Choose a command from the buffer list. (You can also enter a command directly into the text entry area of the dialog box.)

Because all command entry methods in the interface — pulldown menus, action keys, and command line entries — are echoed to the command line entry area, the contents of the Command Recall dialog box is not restricted to just commands entered directly into the command line entry area.

The Command Recall dialog box contains a list of interface commands executed during the session as well as any predefined commands present at interface startup.



If you exit the emulation/analysis session with the interface "locked", commands in the recall buffer are saved and will be present when you restart the interface.

You can predefine entries for the Command Recall dialog box and define the maximum number of entries by setting X resources (refer to the "Setting X Resources" chapter).

See "To use dialog boxes" for information about using dialog boxes.

---

## To get help about the command line

- To display the help topic explaining the operation of the command line, press the *Help* pushbutton located near the bottom-right corner of the Command Line area.

---

## Using the Command Line with the Keyboard

When using the command line with the keyboard, you enter commands by pressing softkeys whose labels appear at the bottom of the screen. Softkeys provide for quick command entry, and minimize the possibility of errors.

The command line also provides command completion. You can type the first few characters of a command (enough to uniquely identify the command) and then press <Tab>. The interface completes the command word for you.

Entering commands with the keyboard is easy. However, the interface provides other features that make entering commands even easier. For example, you can:

- Enter multiple commands on one line.
- Recall commands.
- Edit commands.
- Access on-line help information.

---

### To enter multiple commands on one command line

- Separate the commands with semicolons (;).

More than one command may be entered in a single command line if the commands are separated by semicolons (;).

---

#### Examples

To reset the emulator and break into the monitor:

```
reset ; break
```

---

---

## To recall commands

- Press <CTRL>r or <CTRL>b.

The most recent 20 commands you enter are stored in a buffer and may be recalled by pressing <CTRL>r. Pressing <CTRL>b cycles forward through the recall buffer.

---

### Examples

For example, to recall and execute the command prior to the last command:

```
<CTRL>r <CTRL>r
```

---

---

## To edit commands

- Use the <Left arrow>, <Right arrow>, <Tab>, <Shift><Tab>, <Insert char>, <Back space>, <Delete char>, <Clear line>, and <CTRL>u keys.

The <Left arrow> and <Right arrow> keys move the cursor single spaces to the left or right.

The <Tab> and <Shift><Tab> keys move the cursor to the next or previous word on the command line.

The <Insert char> key enters the insert editing mode and allows characters or command options to be inserted at the cursor location.

The <Back space> key deletes the character to the left of the cursor.

The <Delete char> key deletes the character to the right of the cursor.

The <Clear line> key deletes the characters from the cursor to the end of the line.

The <CTRL>u key erases the command line.

## To access on-line help information

- Use the **help** or **?** commands.

To access the command line's on-line help information, type either **help** or **?** on the command line. You will notice a new set of softkeys. By pressing one of these softkeys and <RETURN>, you can display information on that topic.

---

### Examples

To display information on the system commands:

```
help system_commands
```

Or:

```
? system_commands
```

The help information is scrolled on to the screen. If there is more than a screen full of information, you will have to press the space bar to see the next screen full, or the <RETURN> key to see the next line, just as you do with the UNIX more command. After all the information on the particular topic has been displayed (or after you press "q" to quit scrolling through information), you are prompted to press <RETURN> to return to the command line.

---

---

# Using Command Files

You can execute a series of commands that have been stored in a command file. You can create command files by logging commands while using the interface or by using an editor on your host computer.

Once you create a command file, you can execute the file in the emulation environment by typing the name of the file on the command line and pressing <RETURN>.

Command files execute until an end-of-file is found or until a syntax error occurs. You can stop a command file by pressing <CTRL>c or the <Break> key.

This section shows you how to:

- Start logging commands to a command file.
- Stop logging commands to a command file.
- Playback (execute) a command file.

## **Nesting Command Files**

You can nest a maximum of eight levels of command files. Nesting command files means one command file calls another.

## **Comments in Command Files**

Text that follows a pound sign (#), up to the end of the line, is interpreted as a comment.

## **Using the wait Command**

When editing command files, you can insert **wait** commands to pause execution of the command file at certain points.

If you press <CTRL>c to stop execution of a command file while the "wait" command is being executed from the command file, the <CTRL>c will terminate the "wait" command, but will not terminate command file execution. To do this, press <CTRL>c again.

Use the **wait measurement complete** command after changing the trace depth. By doing this, when you copy or display the trace after changing the trace depth, the new trace states will be available. Otherwise the new states won't be available.

### Passing Parameters

Command files provide a convenient method for passing parameters by using a parameter declaration line preceding the commands in the command file. When the command file is called, the system will prompt you for current values of the formal parameters listed.

Parameters are defined as:

Passed Parameters - These are ASCII strings passed to a command file. Any continuous set of ASCII characters can be passed. Spaces separate the parameters.

Formal Parameters - These are symbols preceded by an ampersand (&), which are the variables of the command file.

The ASCII string passed (passed parameter) will be substituted for the formal parameter when the command file is executed.

The only way to pass a parameter containing a space is to enclose the parameter in double quotes (") or single quotes ('). Thus, to pass the parameter HP 9000 to a command file, you can use either "HP 9000" or 'HP 9000'.

The special parameter &ArG\_lEft gets set to all the remaining parameters specified when the command file was invoked. This lets you use variable size parameter lists. If no parameters are left, &ArG\_lEft gets set to NULL.

Consider the command file example (named CMDFILE) shown below:

```
PARMS &ADDR &VALUE1
#
# modify a location or list of locations in memory
# and display the result
#
modify memory &ADDR words to &VALUE1 &ArG_lEft
display memory &ADDR blocked words
```

When you execute CMDFILE, you will be prompted with:

```
Define command file parameter [&ADDR]
```

To pass the parameter, enter the address of the first memory location to be modified. You will then be prompted for &VALUE1. If you enter, for example, "0,-1,20, 0ffffh, 4+5\*4", the first parameter "0,-1,20," is passed to &VALUE1 and the remaining parameters "0ffffh," and "4+5\*4" are passed to &ArG\_1EfT.

You can also pass the parameters when you invoke the command file (for example, CMDFILE 1000h 0,-1,20, 0ffffh, 4+5\*4).

### Other Things to Know About Command Files

You should know the following about using command files:

- 1 Command files may contain shell variables. Only those shell variables beginning with "\$" followed by an identifier will be supported. An identifier is a sequence of letters, digits or underscores beginning with a letter or underscore. The identifier may be enclosed by braces "{}" or entered directly following the "\$" symbol. Braces are required when the identifier is followed by a letter, a digit or an underscore that is not interpreted as part of its name.

For example, assume a directory named /users/softkeys and the shell variable "S". The value of "S" is "soft". By specifying the directory as /users/\${S}keys the correct result is obtained. However, if you attempt to specify the directory as /users/\$Skeys, the Softkey Interface looks for the value of the variable "Skeys". This is not the operators intended result. You may not get the intended result unless Skeys is already defined to be "softkeys".

You can examine the current values of all shell variables defined in your environment with the command "env".

- 2 Positional shell variables, such as \$1, \$2, and so on, are not supported. Neither are special shell variables, such as \$@, \$\*, and so on, supported.
- 3 You can continue command file lines. This is done by avoiding the line feed with a backslash (\). A line terminated by "\" is concatenated with any following lines until a line that does not contain a backslash is found. A line constructed in this manner is recognized and executed as one single command line. If the last line in a command file is terminated by "\", it appears on the command line but is not executed. Normally, the line feed is recognized as the command terminator. The UNIX environment recognizes three quoting characters for shell commands which are double quotes ("), single quotes ('), and the backslash symbol (\).

## To start logging commands to a command file

For example, the following three lines are treated as a single shell command. The two hidden line feeds are ignored because they are inside the two single quotes ('):

```
!awk '/$/{ blanks++ }  
END { print blanks }  
' an_unix_file
```

---

## To start logging commands to a command file

- Choose **File**→**Log**→**Record** and use the dialog box to select a command file name.
- Using the command line, enter the **log\_commands to <file>** command.

---

## To stop logging commands to a command file

- Choose **File**→**Log**→**Stop**.
- Using the command line, enter the **log\_commands off** command.

---

## To playback (execute) a command file

- Choose **File**→**Log**→**Playback** and use the dialog box to select the name of the command file you wish to execute.
- Using the command line, enter the name of the command file and press <RETURN>.

If you enter the name of the command file in the command line and the interface cannot find the command file in the current directory, it searches the directories specified in the HP64KPATH environment variable.

To interrupt playback of a command file, press the <CTRL>c key combination. (The mouse pointer must be within the interface window.)

If you press <CTRL>c to stop execution of a command file while the "wait" command is being executed from the command file, the <CTRL>c will terminate the "wait" command, but will not terminate command file execution. To do this, press <CTRL>c again.



---

## Using Pod Commands

Pod commands are Terminal Interface commands. The Terminal Interface is the low-level interface that resides in the firmware of the emulator.

A pod command used in the Graphical User Interface bypasses the interface and goes directly to the emulator. Because some pod commands can cause the interface to become out-of-sync with the emulator, or even cause the interface to terminate abnormally, they must be used with care.

For example, if you change configuration items, the actual state of the emulator will no longer match the internal record the interface keeps about the state of the emulator.

Issuing certain communications-related commands can prevent the interface from communicating with the emulator and cause abnormal termination of the interface.

However, it is sometimes necessary to use pod commands. For example, you must use a pod command to execute the emulator's *performance verification (pv)* routine. Performance verification is an internal self-test procedure for the emulator.

Remember that pod commands can cause trouble for the high-level interface if they are used indiscriminately.

This section shows you how to:

- Display the pod commands screen.
- Use pod commands.

---

## To display the pod commands screen

- Choose **Display→Pod Commands**.

The pod commands screen displays the results of pod (Terminal Interface) commands. To set the interface to use pod commands, choose

**Settings→Pod Command Keyboard**.

---

## To use pod commands

- To begin using pod commands, choose **Settings→Pod Command Keyboard**.
- To end using pod commands, click the **suspend** pushbutton softkey.

The **Settings→Pod Command Keyboard** command displays the pod commands screen and activates the keyboard for entering pod command on the command line.

---

### Examples

To see a list of pod command categories available, choose **Settings→Pod Command Keyboard**, and on the command line, type: **help**.

To see a list of pod commands that control the emulator, type: **help emul**.

To see details of the emulator "r" (run user code) command, type: **help r**.

---

---

## Forwarding Commands to Other HP 64700 Interfaces

To allow the emulator/analyzer interface to run concurrently with other HP 64700 interfaces like the high-level debugger and software performance analyzer, a background "daemon" process is necessary to coordinate actions in the interfaces.

This background process also allows commands to be forwarded from one interface to another. Commands are forwarded using the forward command available in the command line. The general syntax is:

```
forward <interface_name> "<command_string>"
```

This section shows you how to:

- Forward commands to the high-level debugger.
- Forward commands to the software performance analyzer.

---

## To forward commands to the high-level debugger

- Enter the **forward debug "<command string>"** command using the command line.

---

**Examples**

To send the "Program Run" command to the debugger:

```
forward debug "Program Run"
```

Or, since only the capitalized key is required:

```
forward debug "P R"
```

---

---

## To forward commands to the software performance analyzer

- Enter the **forward perf "<command string>"** command using the command line.

---

**Examples**

To send the "profile" command to the software performance analyzer:

```
forward perf "profile"
```

---



---

## Configuring the Emulator

---

---

# Configuring the Emulator

This chapter describes how to configure the emulator. You must map memory whenever you use the emulator. When you plug the emulator into a target system, you must configure the emulator so that it operates correctly in the target system. The configuration tasks are grouped into the following sections:

- Using the configuration interface.
- Modifying the general items and monitor setup.
- Reconfiguring the emulator copy of the SIM registers.
- Mapping memory.
- Setting the debug/trace options.
- Setting Simulated I/O
- Verifying the emulator configuration.

The simulated I/O feature and configuration questions are described in the *Simulated I/O User's Guide*.

The external analyzer configuration options are described in the "Using the External State Analyzer" chapter.

The interactive measurement configuration options are described in the "Making Coordinated Measurements" chapter.

---

## Using the Configuration Interface

This section shows you how to modify, store, and load configurations using the emulator configuration interface.

This section shows you how to:

- Start the configuration interface.
- Modify a configuration section.
- Apply configuration changes to the emulator.
- Display information if the "apply" didn't work.
- Store configuration changes to a file.
- Change the configuration directory context.
- Display the configuration context.
- Access help topics.
- Access context sensitive (f1) help.
- Exit the configuration interface.
- Load an existing configuration file.

This section describes emulator configuration in general. The remaining sections in this chapter describe the specific configuration options for your emulator.



## To start the configuration interface

- Choose **Modify→Emulator Config...** from the emulator/analyzer interface pulldown menu.
- Using the command line, enter the *modify configuration* command. The configuration interface top-level dialog box (see the following example) is displayed.

The configuration sections that are presented depend on the hardware and the features of your particular emulator.

The configuration interface may be left running while you are using the emulator/analyzer interface.

If you're using the Softkey Interface from a terminal or terminal emulation window, you don't get a dialog box from which to choose configuration sections; however, you have access to the same configuration options through a series of configuration questions.



**Examples**

The 6833x emulator configuration interface top-level dialog box is shown below.

The menu bar.

Clicking on one of these lines selects a particular configuration section.

Clicking this button loads configuration changes into the emulator.

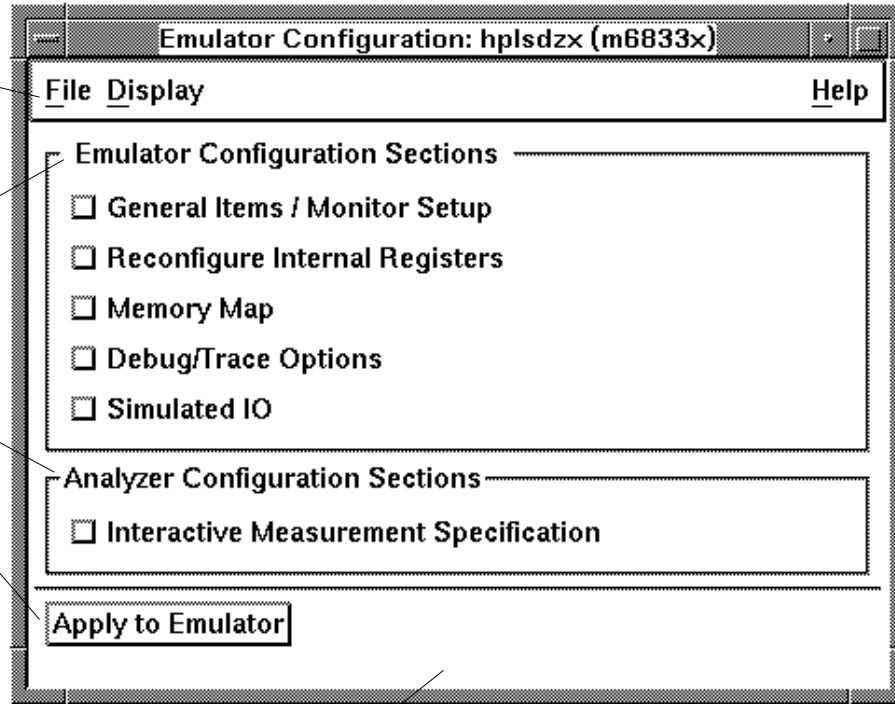

This portion of the dialog box displays configuration status information.

## To modify a configuration section

- 1 Start the emulator configuration interface.
- 2 Click on a section name in the configuration interface top-level dialog box.
- 3 Use the section dialog box to make changes to the configuration.

As soon as you change a configuration option, the change is recorded (as seen by the "Changes Not Loaded" message in the top level dialog).

If you're using the Softkey Interface:

The configuration questions in the "General Items" section are the first to be asked.

To access the questions in the "Reconfigure Internal Registers" section, answer "yes" to the "Reconfigure internal registers?" question.

To access the questions in the "Memory Map" section, answer "yes" to the "Modify memory configuration?" question.

To access the questions in the "Emulator Pod Settings" section, answer "yes" to the "Modify emulator pod configuration?" question.

To access the questions in the "Debug/Trace Options" section, answer "yes" to the "Modify debug/trace options?" question.

- 4 Apply the configuration changes to the emulator.

---

## To apply configuration changes to the emulator

- Click the "Apply to Emulator" button in the top-level dialog box.

Loads the configuration changes into the emulator. Status text to the right shows whether the load was successful.

You can apply configuration changes to the emulator at any time (even while section dialog boxes are open). This lets you verify changes without closing section dialog boxes.

The "Apply to Emulator" button does not store configuration changes to a file.

When you exit the configuration interface and there are configuration changes that have not been stored, you are asked whether you want to store the changes, exit without storing, or cancel the exit.

---

## If apply to emulator fails

- Choose **Display→Failed Apply Info** from the pulldown menu in the top-level configuration interface window.

A window containing the following information about the failed configuration is opened:

- Chip select information from the emsim (emulator) register set.
- Bus interface port information from the emsim (emulator) register set.
- The expanded memory map.
- Reset mode configuration information.
- A complete list of the configuration inconsistencies. This list is not limited to 16 messages as is the **Display→Configuration Info→Diagnostics** command.

This information is shown in the same format as output from the various **Display→Configuration Info→** commands.

Because the old configuration is reloaded when an apply to emulator fails, the information displayed in this window is different than the information displayed by the **Display→Configuration Info→** commands (which display information about the configuration currently loaded).

Refer to the "Verifying the Emulator Configuration" section later in this chapter for details on these types of configuration information displays.



## To store configuration changes to a file

- Choose **File**→**Store...** from the pulldown menu in the top-level configuration interface window, and use the file selection dialog box to name the configuration file.
- If you're using the Softkey Interface, the last configuration question, "Configuration file name?", lets you name the file to which configuration information is stored. If you don't enter a name, configuration information is saved to a temporary file (which is deleted when you exit the interface and release the emulation system).

When modifying a configuration using the graphical interface, you can store your answers at any time.

Configuration information is saved in a file with the extension ".EA". This file is the "source", ASCII format copy of the file. (The interface will create a temporary file with the extension ".EB" which is the "binary" or loadable copy of the file.)

---

**CAUTION**

---

Do not modify configurations by editing the ".EA" files. Use the configuration interface to modify and save configurations.

For more information on how to use dialog boxes, refer to the "To use dialog boxes" description in the "Using Menus, the Entry Buffer, and Action Keys" section of the "Entering Commands" chapter.

---

## To change the configuration directory context

- Choose **File**→**Directory...** from the pulldown menu in the top-level configuration interface window, and use the directory selection dialog box to specify the new directory.

The directory context specifies the directory to which configuration files are stored and from which they are loaded.

For more information on how to use dialog boxes, refer to the "To use dialog boxes" description in the "Using Menus, the Entry Buffer, and Action Keys" section of the "Entering Commands" chapter.

---

## To display the configuration context

- Choose **Display**→**Context...** from the pulldown menu in the top-level configuration interface window.

The current directory context and the current configuration files are displayed in a window. Click the "Done" pushbutton when you wish to close the window.

Figure 16

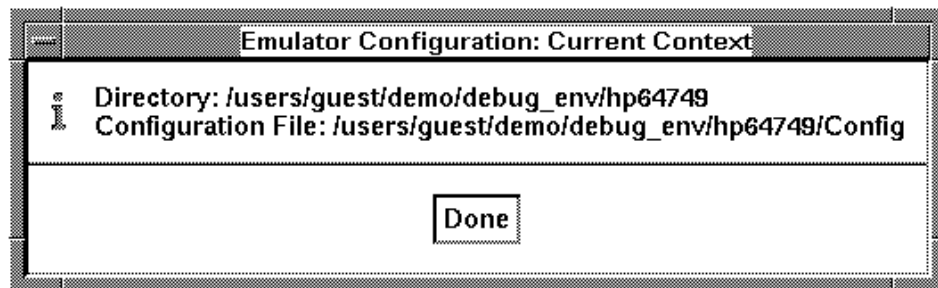

---

## To access help topics

- Choose **Help**→**General Topic...** from the pulldown menu in the top-level configuration interface window, click on a topic in the selection dialog box, and click the "OK" button.

Figure 17



Displays help on main items.

Displays context-sensitive help. Place mouse pointer over item and press f1.

Displays help about the specific topic.

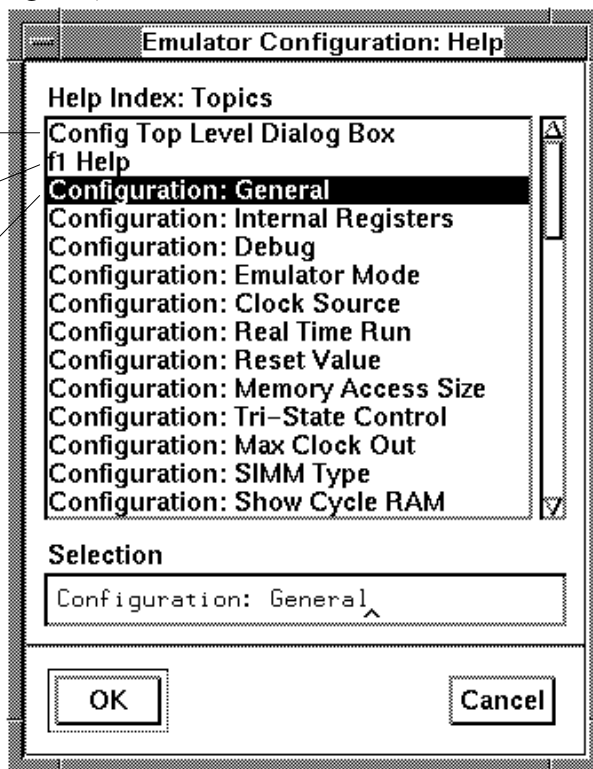

---

## To access context sensitive (f1) help

- Place the mouse pointer over the item you're interested in, and press the f1 key.
- Choose **Help**→**On Item...** from the pulldown menu in the top-level configuration interface window. Notice that the mouse pointer changes from an arrow to a question mark. Move the question mark mouse pointer over the item you're interested in, and click any mouse button.

The configuration interface provides context sensitive help in the top level dialog box and throughout the configuration section dialog boxes.

---

## To exit the configuration interface

- Choose **File**→**Exit...** from the pulldown menu in the top-level configuration interface window (or type <CTRL>x).

If configuration changes have not been stored to a file, a confirmation dialog box appears, giving you the options of: storing, exiting without storing, or canceling the exit.

---

## To load an existing configuration file

- In the emulator/analyzer interface, choose **File**→**Load**→**Emulator Config...** from the pulldown menu, and use the file selection dialog box to specify the configuration file to be loaded.
- Using the command line, enter the *load configuration <FILE>* command.

This command loads previously created and stored configuration files. You cannot load a configuration while the configuration interface is running.

---

## Modifying the General Items and Monitor Setup

To modify the general configuration items, first start the configuration interface and access the "General Items/Monitor Setup" configuration section (refer to the previous "Using the Configuration Interface" section).

Figure 18

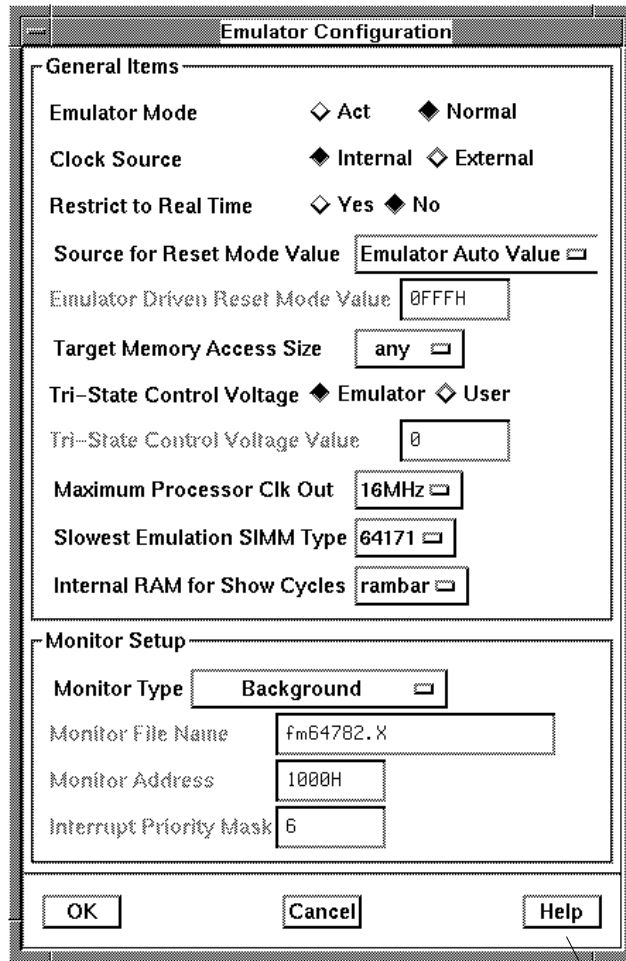

The screenshot shows the "Emulator Configuration" dialog box. It is divided into two main sections: "General Items" and "Monitor Setup".

**General Items:**

- Emulator Mode:  Act  Normal
- Clock Source:  Internal  External
- Restrict to Real Time:  Yes  No
- Source for Reset Mode Value:
- Emulator Driven Reset Mode Value:
- Target Memory Access Size:
- Tri-State Control Voltage:  Emulator  User
- Tri-State Control Voltage Value:
- Maximum Processor Clk Out:
- Slowest Emulation SIMM Type:
- Internal RAM for Show Cycles:

**Monitor Setup:**

- Monitor Type:
- Monitor File Name:
- Monitor Address:
- Interrupt Priority Mask:

At the bottom of the dialog box are three buttons: "OK", "Cancel", and "Help". A line points from the "Help" button to the text below.

To access information about the configuration items, use the online help button or press f1 to show context-sensitive help on an individual item.



---

## When Modifying the Microprocessor Clock Source

In normal mode, if you are using the emulator in ACT mode, you must use an external target system clock. The external target system clock must be an oscillator unless you are using the emulator in ACT mode, in which case the external target system clock may be a crystal.

Information about plugging the emulator into a target system is included in the *6833x Installation/Service/Terminal Interface Guide*.

---

## When Restricting the Emulator to Real-time Runs

---

### CAUTION

If your target system circuitry is dependent on constant execution of program code, you should restrict the emulator to real-time runs. This will help insure that target system damage does not occur. However, remember you can still execute the **reset**, **break**, and **step** commands; you should use caution in executing these commands.

The default configuration does not restrict the emulator to real-time runs. Therefore, the emulator might make temporary breaks into the monitor to complete certain commands. However, you may wish to restrict runs to real-time to prevent temporary breaks that might cause target system problems.

When runs are restricted to real-time and the emulator is running the user program, all commands that cause a break (except **reset**, **break**, **run**, and **step** are refused.

The following commands are not allowed when runs are restricted to real-time and the emulator is running the user program:

- Display/modify registers.
- Display/modify target system memory.
- Load/store target system memory.
- Modify SIM registers.
- Display emulator SIM configuration info.

If you want to enter one of these commands, you must first make an explicit break into the monitor using the break command.

Because the emulator contains dual-port emulation memory, commands that access emulation memory are allowed while runs are restricted to real-time.

When the restriction to real-time runs is turned off, all commands, regardless of whether or not they require a break to the emulation monitor, are accepted by the emulator.

# Reconfiguring the Emulator Copy of the SIM Registers

To modify the general configuration items, first start the configuration interface and access the "Reconfigure Internal Registers" configuration section (refer to the previous "Using the Configuration Interface" section).

Figure 19

Emulator Configuration: Reconfigure Internal Registers							
<b>Emulator Copy of General Registers</b>							
SIM_MCR	060CFh	PICR	0000Fh	SYPCR	0h		
SYNCR	03F08h	PITR	00000h				
<b>Emulator Copy of Bus Interface Port Registers</b>							
PORTE	0FFh	DDRE	000h	PEPAR	0FFh	CSPDR	07Fh
PORTF	0FFh	DDRF	000h	PFPAR	0FFh		
<b>Emulator Copy of Chip Select Pin Assignment Registers</b>							
CSPAR0	03FFFh	CSPAR1	003FFh				
<b>Emulator Copy of Chip Select Registers (CSxxxx)</b>							
BRBT	00007h	BR2	0	BR5	0	BR8	0
ORBT	07B70h	OR2	0	OR5	0	OR8	0
BR0	0	BR3	0	BR6	0	BR9	0
OR0	0	OR3	0	OR6	0	OR9	0
BR1	0	BR4	0	BR7	0	BR10	0
OR1	0	OR4	0	OR7	0	OR10	0
<b>Emulator Copy of Ram Registers</b>							
RAMMCR	0100h	RAMBAR	0001h				
SRAMMCR	8300h	SRAMBAH	0000h	SRAMBAL	0000h		
OK                      Cancel                      Help							

To access information about the configuration items, use the online help button or press f1 to show context-sensitive help on an individual item.

## To define values for the emulator copy of the SIM registers

- Click on the register field and enter the desired value. Then apply the changes to the emulator.

Refer to the "Using the EMSIM Registers" section in the "Using the Emulator" chapter for information on how these registers are used. Refer to the "Concepts" chapter for conceptual information about these registers.

---

# Mapping Memory

If you are using the emulator in ACT mode, emulation memory cannot be used; therefore, this section is not applicable.

Because the emulator can use target system memory or emulation memory (or both) in Normal mode, it is necessary to map ranges of memory so that the emulator knows where to direct its accesses.

Up to 8 ranges of memory can be mapped, and the resolution of mapped ranges is 256 bytes (that is, the memory ranges must begin on 256-byte boundaries and must be at least 256 bytes in length).

Emulation memory is made available to the mapper in 64-Kbyte blocks.

When you map an address range to emulation memory, at least one block is assigned to the range. When a block of emulation memory is assigned to a range, it is no longer available, even though part of the block may be unused.

Direct memory access (DMA) to emulation memory is not permitted.

You should map all memory ranges used by your programs before loading programs into memory.

In order to map memory, you must first start the configuration interface and access the "Memory Map" configuration section (refer to the previous "Using the Configuration Interface" section).



Figure 20

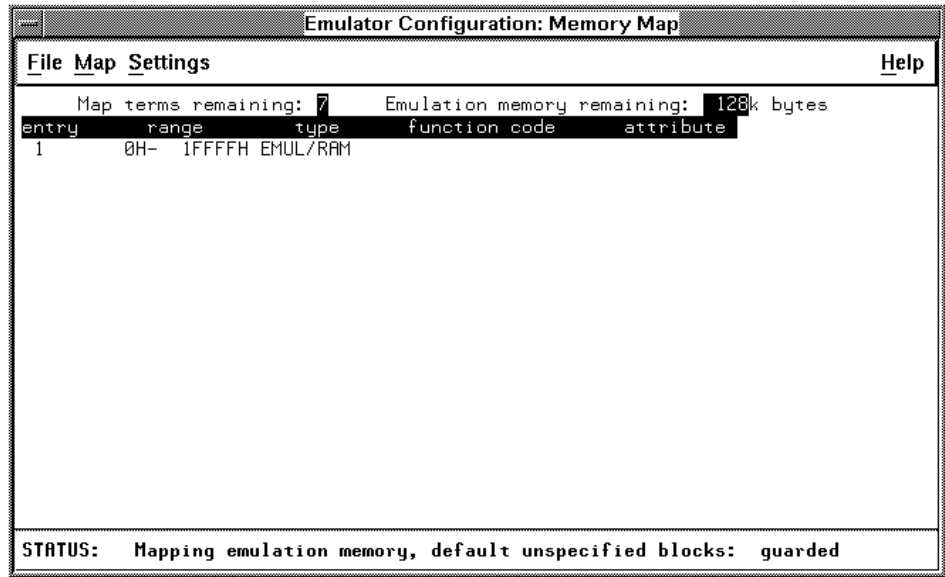

This section shows you how to:

- Add memory map entries.
- Modify memory map entries.
- Delete memory map entries.
- Characterize unmapped ranges.
- Map memory ranges that use function codes.
- Map memory ranges that use chip selects.

### Using Emulation Memory to Substitute for 8-Bit Memory

Emulation memory is 16-bit wide memory. However, you can use emulation memory to substitute for 8-bit memory.

---

## To add memory map entries

- Choose **Map**→**Add New Entry** from the pulldown menu in the memory map window.
- Press and hold the *select* mouse button and choose **Add New Entry** from the popup menu.
- Using the command line (**Settings**→**Command Line**), enter the address range, memory type, and possibly a blk1-blk6 attribute for emulation memory ranges.

You can characterize memory ranges as emulation RAM, emulation ROM, target system RAM, target system ROM, or as guarded memory.

Guarded memory accesses will cause emulator execution to break into the monitor program.

Writes to locations characterized as ROM will cause emulator execution to break into the monitor program if the "Break processor on write to ROM" trace/debug configuration option is enabled.

Writes to emulation ROM will be inhibited. Writes by user code to target system memory locations mapped as ROM or guarded memory will result in a break to the monitor but are not inhibited (that is, the write still occurs).



## Configuring the Emulator To add memory map entries

The first two methods of mapping memory ranges give you the following dialog box.

**Figure 21**

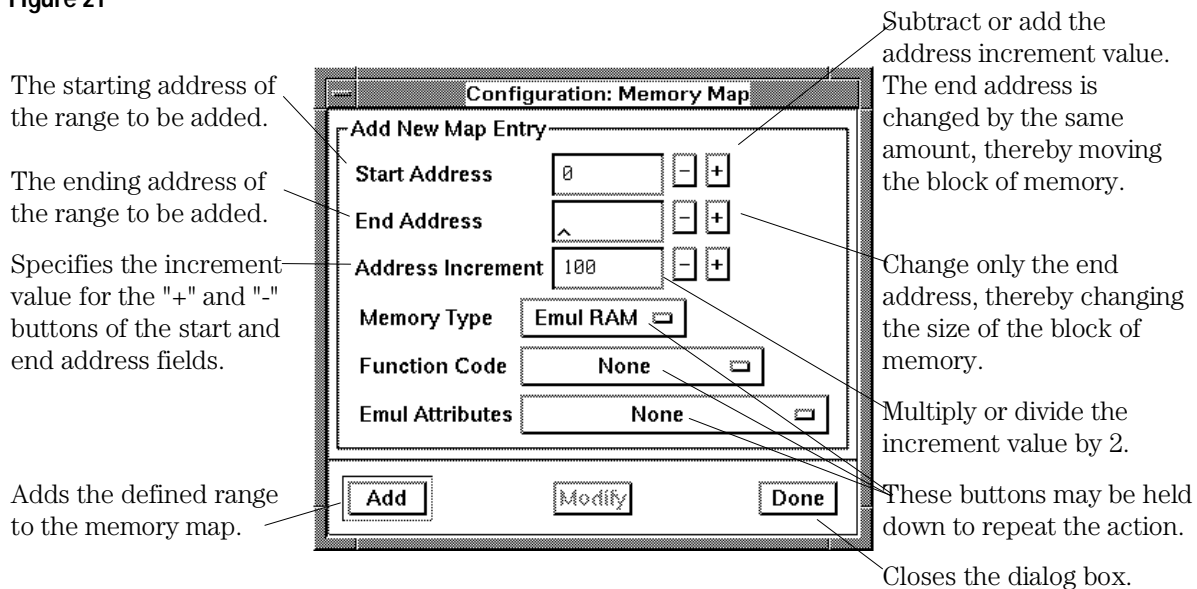



**Examples**

Consider the following section summary from the linker load map output listing.

SECTION SUMMARY

-----

SECTION	ATTRIBUTE	START	END	LENGTH	ALIGN
	ABSOLUTE DATA	00000000	0000002F	00000030	0 (BYTE)
0	NORMAL	00000030	00000030	00000000	2 (WORD)
env	NORMAL CODE	00000400	00000FC0	00000BC1	2 (WORD)
prog	NORMAL CODE	00000FC2	00001A89	00000AC8	2 (WORD)
const	NORMAL ROM	00001A8A	00001ACF	00000046	2 (WORD)
lib	NORMAL CODE	00001AD0	00002663	00000B94	2 (WORD)
libc	NORMAL CODE	00002664	00004881	0000221E	2 (WORD)
libm	NORMAL CODE	00004882	00004882	00000000	0 (BYTE)
mon	NORMAL CODE	00004882	000049CB	0000014A	2 (WORD)
envdata	NORMAL DATA	00007000	00007155	00000156	4 (LONG)
data	NORMAL DATA	00007156	00007721	000005CC	2 (WORD)
idata		00007722	00007722	00000000	0 (BYTE)
udata		00007722	00007722	00000000	0 (BYTE)
libdata	NORMAL DATA	00007724	00007727	00000004	4 (LONG)
libcdata	NORMAL DATA	00007728	00008153	00000A2C	2 (WORD)
monddata	NORMAL DATA	00008154	00008177	00000024	2 (WORD)
stack	NORMAL DATA	0000B000	00012FFF	00008000	4 (LONG)
heap	NORMAL DATA	00013000	00016FFD	00003FFE	4 (LONG)

Notice the ABSOLUTE DATA, CODE, and ROM sections occupy locations 0 through 49CBH. Because the contents of these sections will eventually reside in target system ROM, this area should be characterized as ROM when mapped. This will prevent these locations from being written over accidentally. If breaks on writes to ROM are enabled, instructions that attempt to write to these locations will cause emulator execution to break into the monitor.

Also, notice the DATA sections occupy locations 7000H through 8177H and 0B000H through 16FFDH. Since these sections are written to, they should be characterized as RAM when mapped.

Configuring the Emulator  
To add memory map entries

Using the command line (choose **Settings**→**Command Line** from the pulldown menu in the memory map window), enter the following commands to map memory for the above program.

```
delete all  
<addr> 0 thru 4fffh emulation rom  
7000h thru 8fffh emulation ram  
0b000h thru 16fffh emulation ram
```

The resulting memory mapper screen is shown below.

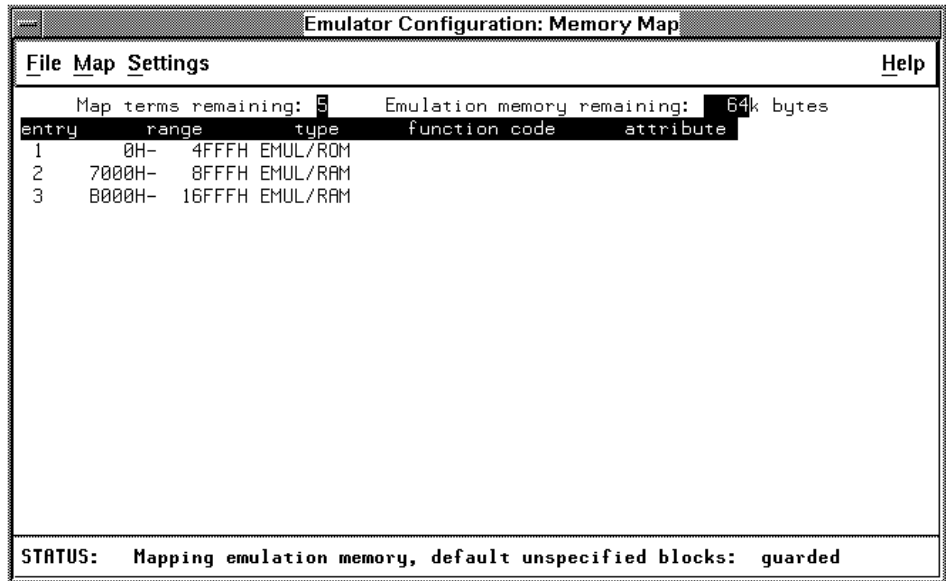

To exit out of the memory mapper, enter:

```
end
```

---

## To modify memory map entries

- Choose **Map**→**Modify Entry** from the pulldown menu in the memory map window and select the entry number from the cascade menu.
- Position the mouse pointer over the entry you wish to modify, press and hold the *select* mouse button and choose **Modify Entry** from the popup menu.

These commands open the same dialog box that is used for adding memory map entries, except it lets you modify the current settings for the entry.

In order to modify an entry when using the command line, you must delete the entry and add a new entry.

---

### Examples

To modify a memory map entry using the popup menu:

Click and hold the mouse select button to bring up the menu. Then choose the Modify Entry item to modify the highlighted memory map entry.

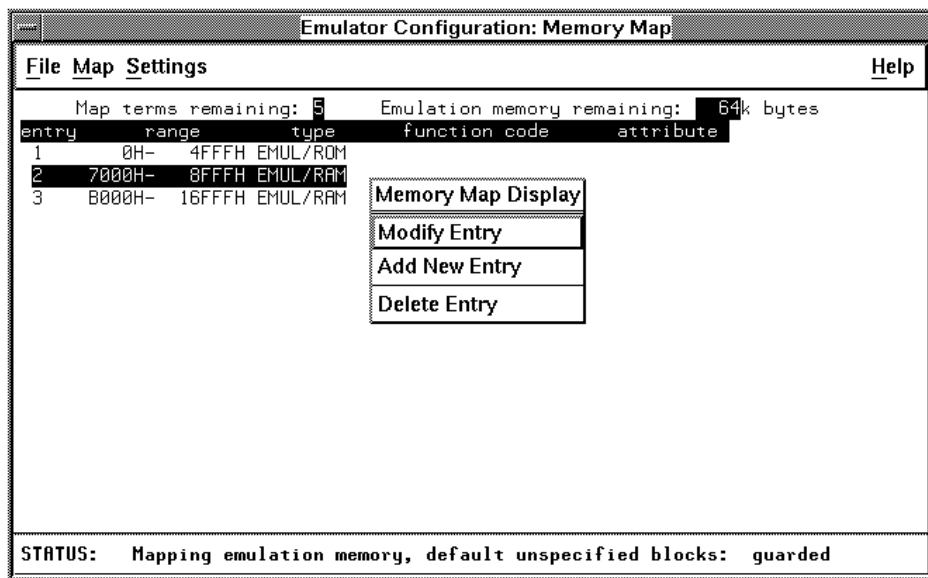

Use the dialog box to modify the entry, and click the "Modify" button to add the modified range to the memory map.

### To delete memory map entries

- Choose **Map→Delete Entry** from the pulldown menu in the memory map window and select the entry number from the cascade menu.
  - Position the mouse pointer over the entry you wish to delete, press and hold the *select* mouse button and choose **Delete Entry** from the popup menu.
  - Using the command line, enter the *delete <ENTRY#>* command.  
Note that programs should be reloaded after deleting mapper terms. The memory mapper may re-assign blocks of emulation memory after the insertion or deletion of mapper terms.
- 

### To characterize unmapped ranges

- Choose **Map→Default Memory Type** from the pulldown menu in the memory map window and select the memory type from the cascade menu.
- Using the command line, enter the *default <memory\_type>* command.  
Unmapped memory ranges are treated as target system RAM by default. Unmapped memory ranges cannot be characterized as emulation memory.

---

## To map memory ranges that use function codes

- Specify function codes with address ranges when mapping memory.

The function code can be:

- None
- supervisor
- supervisor program
- supervisor data
- user
- user program
- user data
- program
- data

Function code information lets you further characterize memory blocks as supervisor, user, supervisor program, supervisor data, user program, or user data space. When you specify function codes with mapper ranges, the 6833x function code outputs (FC0, FC1, FC2) are decoded to select particular blocks of memory. Function codes let you overlay address ranges. When you specify function codes as part of the address, the emulator memory mapper knows that overlaid blocks are different memory regions and will define them separately.

If you specify a function code when mapping a range of memory, you must include the function code when referring to locations in that range. If you don't include the function code, an "ambiguous address" error message is displayed.

If you use different function codes, it's possible to map address ranges that overlap. When address ranges with different function codes overlap, you must load a separately linked module for the space associated with each function code. The modules are linked separately because linker errors occur when address ranges overlap.

When address ranges are mapped with different function codes, and there are no overlapping ranges, your program modules may exist in one absolute file. However, you have to use multiple **load** commands—one for each function code specifier. This is necessary to load the various sections of the absolute file into the appropriate function code qualified memory ranges.

When you do this, be sure that all address ranges not mapped (that is, the "other" memory mapper term) are mapped as target RAM. When "other" is mapped as guarded, guarded memory access errors (from the attempt to load the absolute file sections that are outside the specified function code range) can prevent the absolute file sections that are inside the specified function range from being loaded.

Attributes include:

- Interlock to target DSACK—locking emulation memory timing to target system memory timing.
- Emulate 8 bit wide memory—setting the memory to 8 bits for processors that cannot handle the 16-bit emulation memory width.
- Combined—combining both attributes listed above.

---

### Examples

Suppose you're developing a system with the following characteristics:

- Input port at 100 hex.
- Output port at 400 hex.
- Supervisor program from 1000 through 1fff hex.
- Supervisor data from 2000 through 2fff hex.
- User program from 3000 through 3fff hex.
- User data from 3000 through 3fff hex.

The last two terms have address ranges that overlap. You can use function codes to cause these terms to be mapped to different blocks of memory.

Suppose also that the only things that exist in your target system at this time are the input and output ports and some control logic; no memory is available. You can reflect this by mapping the I/O ports to target system memory space and the rest of memory to emulation memory space by entering the following mapper commands using the command line (**Settings**→**Command Line**):

```
0h thru 0fffh target ram  
1000h thru 1ffffh supervisor program emulation rom  
2000h thru 2ffffh supervisor data emulation ram  
3000h thru 3ffffh user program emulation ram  
3000h thru 3ffffh user data emulation ram
```

After the configuration is saved, display memory at 1000H by entering the following command (using the command line):

```
display memory 1000h blocked bytes
```

Notice that an "ambiguous address" error occurs because the "sp" function code was not included with the address. The following command should have been entered instead:

```
display memory fcode sp 1000h blocked bytes
```

---



---

## Setting the Debug/Trace Options

To set the debug/trace options, you must start the configuration interface and access the "Debug/Trace Options" configuration section (refer to the "Using the Configuration Interface" section).

Figure 22

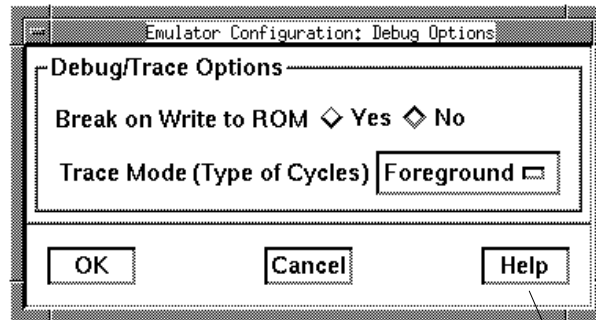

To access information about the configuration items, use the online help button or press f1 to show context-sensitive help on an individual item.

---

### When Configuring Breaks on Writes to ROM

When breaks on writes to ROM are enabled, the emulator will break into the emulation monitor whenever the user program attempts to write to a memory region mapped as ROM. The emulator will prevent the processor from actually writing to memory mapped as emulation ROM; however, it cannot prevent writes to target system RAM locations which are mapped as ROM, even though the write to ROM break is enabled.

When breaks on writes to ROM are disabled, the emulator will not break to the monitor upon a write to ROM. The emulator will not modify the memory location if it is in emulation ROM.



## When Configuring the Trace Mode

"Background" specifies that the analyzer trace only background cycles. This is rarely a useful setting for user program debugging.

"Both" specifies that the analyzer trace both foreground and background cycles. You may wish to specify this option so that all emulation processor cycles may be viewed in the trace display.

"Foreground" specifies that the analyzer trace only foreground cycles.



---

## Setting Simulated I/O

To set the debug/trace options, you must start the configuration interface and access the "Simulated I/O " configuration section (refer to the "Using the Configuration Interface" section).

Figure 23

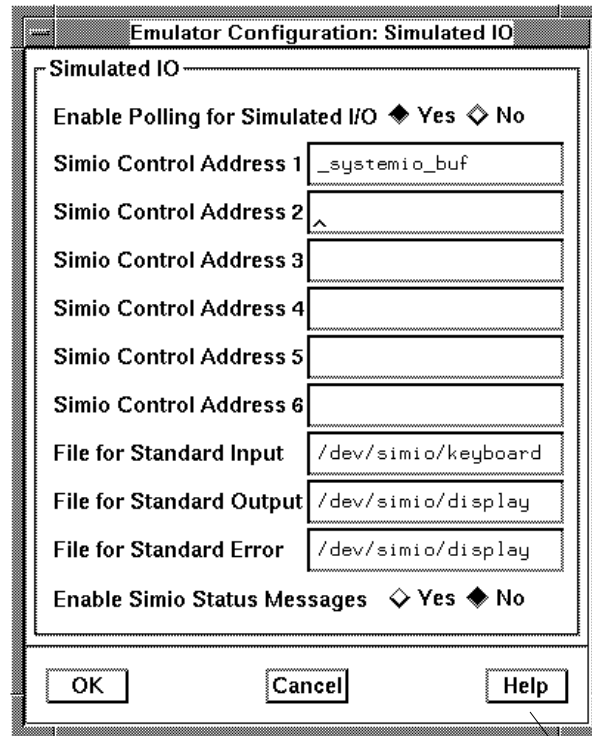

To access information about the configuration items, use the online help button or press f1 to show context-sensitive help on an individual item.

---

# Verifying the Emulator Configuration

The 6833x emulator lets you display information about emulator configuration and processor SIM programming. You can also display information about inconsistencies found in the emulator configuration.

This section shows you how to:

- Display information about chip selects.
- Display information about bus interface ports.
- Display information about the memory map.
- Display information about the reset mode configuration.
- Display assembly language instructions for setting up the SIM.
- Check for configuration inconsistencies.

---

## To display information about chip selects

- Choose **Display→Configuration Info→Chip Selects (SIM)** or **Display→Configuration Info→Chip Selects (Emulator SIM)** from either the configuration interface the emulator/analyser interface pulldown menu.
- Using the emulator/analyser interface command line, enter the *display configuration\_info sim\_chip\_selects* or *display configuration\_info emsim\_chip\_selects* command.

These commands let you display chip select information from the sim (processor) register set or the emsim (emulator) register set.

The resulting display shows how the chip select is assigned, the base address, the block size, and other information from the option register.

---

### Examples

To display information about chip selects from the sim (processor) register set, choose **Display→Configuration Info→Chip Selects (SIM)** from either the configuration interface the emulator/analyser interface pulldown menu.

Configuring the Emulator  
To display information about chip selects

The following table reflects the current values in the sim (processor) register set.

Select	Assign	Base	Size	Mode	Byte	R/W	Strb	DSACK	Space	IPL	AVEC
CSBOOT	16-bit	000000H	1M	async	both	both	AS	13wait	s/u	all	off
CS0	16-bit	000000H	2K	async	off	rsvd	AS	0wait	cpu	all	off
CS1	16-bit	000000H	2K	async	off	rsvd	AS	0wait	cpu	all	off
CS2	16-bit	000000H	2K	async	off	rsvd	AS	0wait	cpu	all	off
CS3	16-bit	000000H	2K	async	off	rsvd	AS	0wait	cpu	all	off
CS4	16-bit	000000H	2K	async	off	rsvd	AS	0wait	cpu	all	off
CS5	16-bit	000000H	2K	async	off	rsvd	AS	0wait	cpu	all	off
CS6	16-bit	000000H	2K	async	off	rsvd	AS	0wait	cpu	all	off
CS7	16-bit	000000H	2K	async	off	rsvd	AS	0wait	cpu	all	off
CS8	16-bit	000000H	2K	async	off	rsvd	AS	0wait	cpu	all	off
CS9	16-bit	000000H	2K	async	off	rsvd	AS	0wait	cpu	all	off
CS10	16-bit	000000H	2K	async	off	rsvd	AS	0wait	cpu	all	off

To display information about chip selects from the emsim (emulator) register set, choose **Display→Configuration Info→Chip Selects (Emulator SIM)** from either the configuration interface the emulator/analyzer interface pulldown menu.

The following table reflects the current values in the emsim register set. These values will be loaded into the processor when the monitor is entered from emulation reset.

Select	Assign	Base	Size	Mode	Byte	R/W	Strb	DSACK	Space	IPL	AVEC
CSBOOT	16-bit	060000H	128K	async	both	read	AS	2wait	s/u	all	off
CS0	16-bit	000000H	64K	async	upper	write	AS	0wait	s/u	level4	off
CS1	16-bit	000000H	64K	async	lower	write	AS	0wait	s/u	level7	off
CS2	16-bit	000000H	64K	async	both	read	AS	0wait	s/u	level7	off
CS3	16-bit	000000H	2K	async	off	rsvd	AS	0wait	cpu	all	off
CS4	16-bit	000000H	2K	async	off	rsvd	AS	0wait	cpu	all	off
CS5	16-bit	FFE800H	64K	async	both	both	AS	0wait	s/u	level7	on
CS6	16-bit	080000H	128K	async	lower	both	AS	3wait	s/u	all	off
CS7	16-bit	080000H	128K	async	upper	both	AS	3wait	s/u	all	off
CS8	16-bit	010000H	64K	async	both	read	AS	1wait	s/u	all	off
CS9	16-bit	010000H	64K	async	lower	write	AS	0wait	s/u	all	off
CS10	16-bit	010000H	64K	async	upper	write	AS	0wait	s/u	all	off

## To display information about bus interface ports

- Choose **Display**→**Configuration Info**→**Bus Interface Ports (SIM)** or **Display**→**Configuration Info**→**Bus Interface Ports (Emulator SIM)** from either the configuration interface the emulator/analyzer interface pull-down menu.
- Using the emulator/analyzer interface command line, enter the ***display configuration info bus interface ports*** or ***display configuration info embus interface ports*** command.

These commands let you display chip select information from the sim (processor) register set or the emsim (emulator) register set.

The resulting display shows the pin assignments for the C, E, and F ports.

### Examples

To display information about bus interface ports from the sim (processor) register set, choose **Display**→**Configuration Info**→**Bus Interface Ports (SIM)** from either the configuration interface the emulator/analyzer interface pull-down menu.

The following table reflects the current values in the sim (processor) register set that relate to the external bus interface.

	Bit 7	Bit 6	Bit 5	Bit 4	Bit 3	Bit 2	Bit 1	Bit 0
	-----	-----	-----	-----	-----	-----	-----	-----
Port C assign data = 7FH	CS10	CS9	CS8	CS7	CS6	CS5	CS4	CS3
Port E assign data = FFH	SIZ1	SIZ0	AS	DS	RMC	AVEC	DSACK1	DSACK0
Port F assign data = FFH	IRQ7	IRQ6	IRQ5	IRQ4	IRQ3	IRQ2	IRQ1	MODCK

## Configuring the Emulator To display information about the memory map

To display information about bus interface ports from the emsim (emulator) register set, choose **Display**→**Configuration Info**→**Bus Interface Ports (Emulator SIM)** from either the configuration interface the emulator/analyzer interface pulldown menu.

The following table reflects the current values in the emsim register set that relate to the external bus interface. These values will be loaded into the processor when the monitor is entered from emulation reset.

	Bit 7	Bit 6	Bit 5	Bit 4	Bit 3	Bit 2	Bit 1	Bit 0
	-----	-----	-----	-----	-----	-----	-----	-----
Port C assign data = 00H	CS10	CS9	CS8	CS7	CS6	CS5	CS4	CS3
Port E assign data = FFH	SIZ1	SIZ0	AS	DS	RMC	AVEC	DSACK1	DSACK0
Port F assign data = FFH	IRQ7	IRQ6	IRQ5	IRQ4	IRQ3	IRQ2	IRQ1	MODCK

---

## To display information about the memory map

- Choose **Display**→**Configuration Info**→**Memory Map** from either the configuration interface the emulator/analyzer interface pulldown menu.
- Using the emulator/analyzer interface command line, enter the ***display configuration\_info memory\_map*** command.

When in the memory map section of the emulator configuration, the ranges of memory that have been mapped are displayed.

The memory map configuration information shows detailed information about the memory map and how actual mapper resources are allocated due to the current programming of the chip selects in the EMSIM and EMRAM register sets.

When the emulator automatically expands the memory map to assign actual mapper resources, it looks at ranges that have been mapped during emulator configuration.

Examples

To display information about the memory map and its correlation with RAM, choose **Display**→**Configuration Info**→**Memory Map** from either the configuration interface the emulator/analyzer interface pulldown menu.

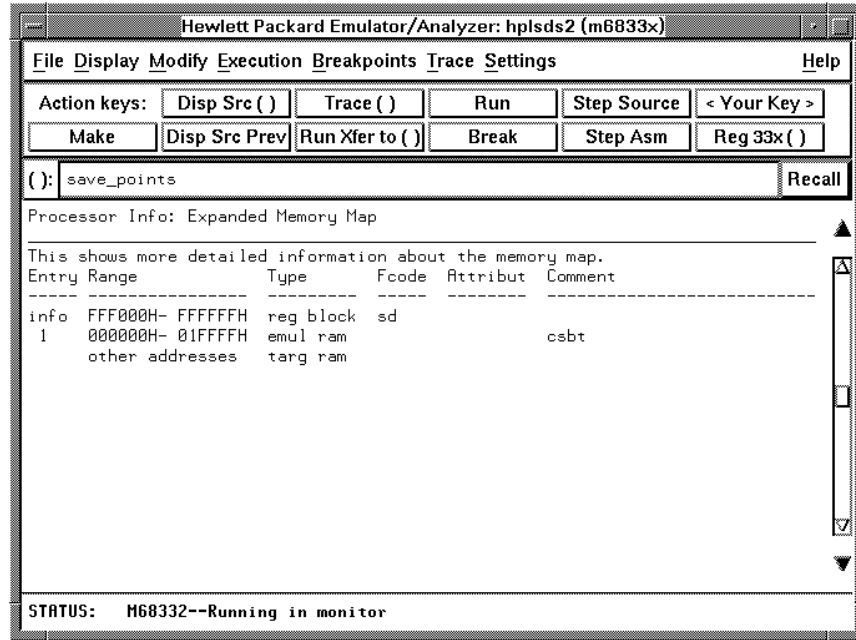

Notice the entry labeled "info". Ranges with this label do not take up mapper resources; they just show information about the processor's address space. Another "info" entry will be listed if the internal RAM is enabled with the EMRAMBAR register.

---

## To display information about the reset mode configuration

- Choose **Display**→**Configuration Info**→**Reset Mode Value** from either the configuration interface the emulator/analyzer interface pulldown menu.
- Using the emulator/analyzer interface command line, enter the *display configuration\_info reset\_mode* command.

### Examples

To display information about the reset mode configuration, choose **Display**→**Configuration Info**→**Reset Mode Value** from either the configuration interface the emulator/analyzer interface pulldown menu.

The reset mode configuration value will be driven by the emulator. The value of 0FFFH was generated automatically by the emulator to be compatible with the current values in the emsim register set. It will be regenerated if any values in that register set change.

Data Bit	Value	Selects	Comment
0	1	CSBOOT 16-bit	
1	1	CS0, CS1, CS2	
2	1	CS3, CS4, CS5	
3	1	CS6	
4	1	CS7	
5	1	CS8	
6	1	CS9	
7	1	CS10	
8	1	Bus Control Lines	
9	1	IRQ7-1, MODCK	
11	1	Slave Mode Disabled	



---

## To display assembly language instructions for setting up the SIM

- Choose **Display**→**Configuration Info**→**Initialization Source Code** from either the configuration interface the emulator/analyzer interface pulldown menu.
- Using the emulator/analyzer interface command line, enter the ***display configuration\_info init\_source\_code*** command.  
This command displays the assembly language program that will initialize the processor as defined by the current EMSIM register contents.

---

### Examples

To display assembly language instructions for setting up the SIM, choose **Display**→**Configuration Info**→**Initialization Source Code** from either the configuration interface the emulator/analyzer interface pulldown menu.

```
* Configuration Program for
CHIP 68332
MOVE.L  #$fff000,A0
MOVE.W  #$60cf,($0a00,A0) ;set mcr
MOVE.L  #$fff000,A0 ;set A0 for register location
MOVE.W  #$3f08,($0a04,A0) ;set synchr
MOVE.B  #$ff,($0a11,A0) ;set porte
MOVE.B  #$00,($0a15,A0) ;set ddre
MOVE.B  #$ff,($0a17,A0) ;set pepar
MOVE.B  #$ff,($0a19,A0) ;set portf
MOVE.B  #$00,($0a1d,A0) ;set ddrf
MOVE.B  #$ff,($0a1f,A0) ;set pfpar
MOVE.B  #$80,($0a21,A0) ;set sypcr
MOVE.W  #$0000,($0a24,A0) ;set pitr
MOVE.W  #$000f,($0a22,A0) ;set picr
MOVE.B  #$00,($0a41,A0) ;set portc
MOVE.W  #$3fff,($0a44,A0) ;set cspar0
MOVE.W  #$03ff,($0a46,A0) ;set cspar1
MOVE.W  #$0604,($0a48,A0) ;set csbrbt
MOVE.W  #$68b0,($0a4a,A0) ;set csorbt
MOVE.W  #$0003,($0a4c,A0) ;set csbr0
MOVE.W  #$5038,($0a4e,A0) ;set csor0
MOVE.W  #$0003,($0a50,A0) ;set csbr1
MOVE.W  #$303e,($0a52,A0) ;set csor1
MOVE.W  #$0003,($0a54,A0) ;set csbr2
MOVE.W  #$683e,($0a56,A0) ;set csor2
```

## Configuring the Emulator To check for configuration inconsistencies

```
MOVE.W  #$0000,($0a58,A0) ;set csbr3
MOVE.W  #$0000,($0a5a,A0) ;set csor3
MOVE.W  #$0000,($0a5c,A0) ;set csbr4
MOVE.W  #$0000,($0a5e,A0) ;set csor4
MOVE.W  #$ffeb,($0a60,A0) ;set csbr5
MOVE.W  #$783f,($0a62,A0) ;set csor5
MOVE.W  #$0804,($0a64,A0) ;set csbr6
MOVE.W  #$38f0,($0a66,A0) ;set csor6
MOVE.W  #$0804,($0a68,A0) ;set csbr7
MOVE.W  #$58f0,($0a6a,A0) ;set csor7
MOVE.W  #$0103,($0a6c,A0) ;set csbr8
MOVE.W  #$6870,($0a6e,A0) ;set csor8
MOVE.W  #$0103,($0a70,A0) ;set csbr9
MOVE.W  #$3030,($0a72,A0) ;set csor9
MOVE.W  #$0103,($0a74,A0) ;set csbr10
MOVE.W  #$5030,($0a76,A0) ;set csor10
MOVE.W  #$0100,($0b00,A0) ;set rammc
MOVE.W  #$0001,($0b04,A0) ;set rambar
```

---

---

## To check for configuration inconsistencies

- Choose **Display**→**Configuration Info**→**Diagnostics** from the configuration interface or the emulator interface pulldown menu.
- Using the emulator/analyzer interface command line, enter the ***display configuration\_info diagnostics*** command.

This command:

- Checks for inconsistencies between the mapper and the EMSIM registers.
- Checks for inconsistencies between the reset mode configuration value and the EMSIM registers.
- Compares corresponding values in the SIM and EMSIM register sets.

This command identifies errors that result from inconsistencies between related configuration values. These errors should be resolved in order for the emulator to operate correctly.

This command also provides status and warning messages about expectations and limitations of the emulator of which you should be aware.

If no messages are returned, no inconsistencies are found in the emulator configuration.

---

**Examples**

To check for inconsistencies between the configuration and the EMSIM registers, choose **Display→Configuration Info→Diagnostics** from either the configuration interface the emulator/analyzer interface pulldown menu.

```
!STATUS 170! CS0 is set for block size of 1M byte but A19 is not available
!STATUS 170! CS0 is DS qualified and SIZx not available; max clock is 8 MHz
!STATUS 171! CS1 is configured for fast termination; max clock is 8 MHz
!ERROR 172! CS2 is used in map spec but not defined as a chip select
!ERROR 173! CS3 is used in map spec but not enabled (byte or R/W)
!ERROR 174! Need FC2 or chip select for map entry #3
!ERROR 175! No chip selects programmed for address range of map entry #4
!ERROR 176! CSBOOT width (8/16 bit) in reset config conflicts with emcspar0
!ERROR 178! Need DSACK1 at port E or chip select DSACK for map entry #5
```

Another sample inconsistency check might yield:

```
!STATUS 177! BG at reset config, emulator expects CS1 (emsim value)
!STATUS 177! BGACK at reset config, emulator expects CS2 (emsim value)
!STATUS 177! FC0 at reset config, emulator expects CS3 (emsim value)
!STATUS 177! FC1 at reset config, emulator expects CS4 (emsim value)
!STATUS 177! FC2 at reset config, emulator expects CS5 (emsim value)
!STATUS 177! A19 at reset config, emulator expects CS6 (emsim value)
!STATUS 177! A20 at reset config, emulator expects CS7 (emsim value)
!STATUS 177! A21 at reset config, emulator expects CS8 (emsim value)
!STATUS 177! A22 at reset config, emulator expects CS9 (emsim value)
!STATUS 177! A23 at reset config, emulator expects CS10 (emsim value)
!STATUS 177! PortE0 at reset config, emulator expects DSACK0 (emsim value)
!STATUS 177! PortE1 at reset config, emulator expects DSACK1 (emsim value)
!STATUS 177! PortE4 at reset config, emulator expects DS (emsim value)
!STATUS 177! PortE5 at reset config, emulator expects AS (emsim value)
!STATUS 177! PortE6 at reset config, emulator expects SIZ0 (emsim value)
!STATUS 177! PortE7 at reset config, emulator expects SIZ1 (emsim value)
```





---

## Using the Emulator

---

## Using the Emulator

This chapter describes general tasks you may wish to perform while using the emulator. These tasks are grouped into the following sections:

- Using the emulation copy of the SIM (emsim) registers.
- Loading and storing absolute files.
- Using symbols.
- Using context commands.
- Executing user programs (starting, stopping, stepping, and resetting the emulator).
- Using execution breakpoints.
- Displaying and modifying registers.
- Displaying and modifying memory.
- Displaying data values.
- Changing the interface settings.
- Using system commands.
- Using Simulated I/O.
- Using Basis Branch Analysis.

## Using the EMSIM Registers

The 6833x processor contains a System Integration Module (SIM) which has the external bus interface, 12 chip selects, and other circuitry to reduce external logic in a typical microprocessor system. The SIM can be programmed or configured in a variety of ways to suit the need of various systems.

The HP 64782 emulator contains circuitry that accommodates the flexibility of the SIM and maintains consistent emulation features.

Figure 24

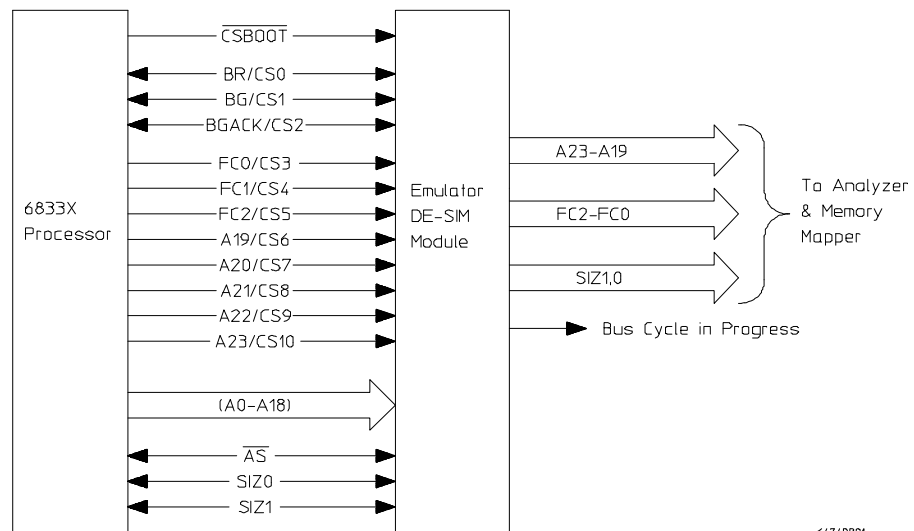

64749801

In the previous figure, there is a block labeled DE-SIM module. It receives as inputs from the 6833x:

- Port C which can be BR, BG, BGACK, FC0-2, and A19-23 or  $\overline{CS0-10}$ .
- CSBOOT.
- SIZ0,1.

The DE-SIM module provides as outputs:

- Address lines A23-A19 and FC2-0 to the memory mapper and the analyzer.
- A "bus cycle in progress" signal based upon  $\overline{AS}$  or chip selects.

The 6833x SIM is configured through the registers in the SIM register class; these registers control how the 6833x uses external signal lines to access memory.

The emulator's DE-SIM module is configured through the registers in the EMSIM register class. The DE-SIM module controls how the emulator interprets the signals from the 6833x when accessing emulation memory and passing information to the analysis trace.

Normally, the SIM and EMSIM registers should be programmed with the same values so they will be working together.

One of the primary functions of the DE-SIM is to provide A23-A19 to the memory mapper and analyzer so they will have the complete 24-bit address bus. This is easy if Port C of the 6833x is programmed as address lines; however, if any of these lines are programmed as chip selects, the corresponding address lines are not available external to the 6833x. The chip selects, however, have access to the full 24-bit address inside the 6833x. You can therefore locate memory using a chip select at an address that is not possible to decode externally. If properly programmed, the DE-SIM can use information in the programming of the chip selects to re-create the upper address lines. This provides the ability to map emulation memory at these addresses and also provides a correct address in the analysis trace so that symbolic debugging is possible.

Normally, the DE-SIM would be programmed through the EMSIM registers to match the programming of the 6833x SIM as it will exist after all of the boot-up configuration is complete. This can be done before the boot-up code is run. In fact, the programming of the EMSIM registers is part of the configuration and will be loaded along with the memory map and other configuration items when a configuration file is loaded.



The default programming of the DE-SIM matches the reset values of the 6833x SIM (refer to the Motorola *MC6833x User's Manual* for specific values).

If desired, the programming of the DE-SIM can be transferred into the 6833x SIM with the ***sync\_sim\_registers\_to\_6833x\_from\_config*** command. This happens automatically each time a break to the monitor from emulation reset occurs. This ensures that the 6833x is prepared to properly access memory when a program is downloaded to the emulator.

Alternatively, the emulator's DE-SIM can be programmed from the 6833x SIM with the ***sync\_sim\_registers\_from\_6833x\_to\_config*** command. This is useful if initialization code that configures the 6833x SIM exists, but you don't know what its values are. In this case, you can use the default configuration, run from reset to execute the initialization code, and use the ***sync\_sim\_registers\_from\_6833x\_to\_config*** command to configure the emulator to match the 6833x SIM.

At any time, you can verify if the SIM and DE-SIM are programmed the same with the ***sync\_sim\_registers\_difference*** command. Any differences between the two register sets will be listed.

It should be noted that the DE-SIM module is programmed solely from the EMSIM register set and is therefore static with respect to the application program. No attempt is made to update the programming of the DE-SIM by tracking instructions that will program the 6833x SIM.

This section shows you how to:

- View the SIM register differences.
- Synchronize to the 6833x SIM registers.
- Synchronize to the EMSIM registers.
- Restore default values in the EMSIM registers.

---

## To view the SIM register differences

- Choose **Display**→**SIM Register Differences** from the emulator/analyzer interface pulldown menu.
  - Using the emulator/analyzer interface command line, enter the ***sync\_sim\_registers difference*** command.
- Note that PORTE and PORTF check only output pins. Any registers that are the same are *not* displayed.

---

### Examples

To display the SIM register differences:

```
SIM_MCR = 618F  EMSIM_MCR = 4321
SYNCR   = 3F08  EMSYNCR   = 1F09
PORTE   = 00    EMPORTE   = 01
DDRE    = 00    EMDDRE    = FF
PEPAR   = FF    EMPEPAR   = 00
PORTF   = 00    EMPORF    = 02
DDRF    = 00    EMDDRF    = FF
PFPAR   = FF    EMPFPAR   = 00
SYPCR   = 80    EMSYPCR   = 41
PICR    = 000F  EMPICR    = 4321
PITR    = 0000  EMPITR    = 1234
PORTC   = 00    EMPORC    = 7F
CSPAR0  = 3FFF  EMCSPAR0  = 15FF
CSPAR1  = 03FF  EMCSPAR1  = 0155
CSBRBT  = 0007  EMCSBRBT  = 0011
CSORBT  = 7B70  EMCSORBT  = 1100
CSBR0   = 0000  EMCSBR0   = 1234
CSOR0   = 0000  EMCSOR0   = 4321
CSBR1   = 0000  EMCSBR1   = 1100
CSOR1   = 0000  EMCSOR1   = 0011
CSBR2   = 0000  EMCSBR2   = 2200
CSOR2   = 0000  EMCSOR2   = 0022
CSBR3   = 0000  EMCSBR3   = 3300
CSOR3   = 0000  EMCSOR3   = 0033
CSBR4   = 0000  EMCSBR4   = 4400
CSOR4   = 0000  EMCSOR4   = 0044
CSBR5   = 0000  EMCSBR5   = 5500
CSOR5   = 0000  EMCSOR5   = 0055
CSBR6   = 0000  EMCSBR6   = 6600
```

---

CSOR6	= 0000	EMCSBR6	= 0066
CSBR7	= 0000	EMCSBR7	= 7700
CSOR7	= 0000	EMCSBR7	= 0077
CSBR8	= 0000	EMCSBR8	= 8800
CSOR8	= 0000	EMCSBR8	= 0088
CSBR9	= 0000	EMCSBR9	= 9900
CSOR9	= 0000	EMCSBR9	= 0099
CSBR10	= 0000	EMCSBR10	= AA00
CSOR10	= 0000	EMCSBR10	= 00AA

---

---

### To synchronize to the 6833x SIM registers

- Choose **Modify**→**SIM Registers**→**Copy Processor SIM to Emulator SIM** from the emulator/analyzer interface pulldown menu.
- Using the emulator/analyzer interface command line, enter the ***sync\_sim\_registers\_from\_6833x\_to\_config*** command.  
The contents of the 6833x SIM registers are copied to the emulation copy of the SIM registers.

---

### To synchronize to the EMSIM registers

- Choose **Modify**→**SIM Registers**→**Copy Emulator SIM to Processor SIM** from the emulator/analyzer interface pulldown menu.
- Using the emulator/analyzer interface command line, enter the ***sync\_sim\_registers\_to\_6833x\_from\_config*** command.  
The contents of the emulation copy of the SIM registers are copied to the 6833x SIM registers.

---

### To restore default values in the EMSIM registers

- Choose **Modify**→**SIM Registers**→**Default Emulator SIM** from the emulator/analyzer interface pulldown menu.
- Using the emulator/analyzer interface command line, enter the ***sync\_sim\_registers\_default\_config*** command.  
The contents of the EMSIM register set are restored to their power-up values.

---

## Loading and Storing Absolute Files

This section describes the tasks related to loading absolute files into the emulator and storing memory contents into absolute files. This section shows you how to:

- Load absolute files into memory.
- Load absolute files without symbols.
- Store memory contents into absolute files.

---

### To load absolute files

- Choose **File**→**Load**→**Executable** and use the dialog box to select the absolute file.
- Using the command line, enter the *load <absolute\_file>* command. You can load absolute files into emulation or target system memory. You can load IEEE-695 format absolute files. You can also load HP format absolute files. The store memory command creates HP format absolute files.

If you wish to load only that portion of the absolute file that resides in memory mapped as emulation RAM or ROM, use the command line's *load emul\_mem* syntax.

If you wish to load only the portion of the absolute file that resides in memory mapped as target RAM, use the command line's *load user\_mem* syntax.

If you want both emulation and target memory to be loaded, do not specify *emul\_mem* or *user\_mem*.

---

**Examples**

To load the demo program absolute file and the configuration file, enter the following commands:

```
load configuration Config.EA  
load ecs.x
```

To load only portions of the absolute file that reside in target system RAM:

```
load user_mem absfile
```

To load only portions of the absolute file that reside in emulation memory:

```
load emul_mem absfile
```

---

---

## To load absolute files without symbols

- Choose **File**→**Load**→**Program Only** and use the dialog box to select the absolute file.
- Using the command line, enter the ***load <absolute\_file> nosymbols*** command.

## To store memory contents into absolute files

- Using the command line, enter the *store memory <expression>* command.

You can store emulation or target system memory contents into HP format absolute files on the host computer. Absolute files are stored in the current directory. If no extension is given for the absolute file name, it is given a ".X" extension.

---

### Examples

To store the contents of memory locations 900H through 9FFH to an absolute file on the host computer named "absfile":

```
store memory 900h thru 9ffh to absfile
```

After the command above, a file named "absfile.X" exists in the current directory on the host computer.

---

---

## Using Symbols

If symbol information is present in the absolute file, it is loaded along with the absolute file (unless you use the `nosymbols` option). Both global symbols and symbols that are local to a program module can be displayed.

Long symbol names can be truncated in the symbols display; however, you can increase the width of the symbols display by starting the interface with more columns (refer to the "Setting X Resources" chapter). This section describes how to:

- Load symbols.
- Display global symbols.
- Display local symbols.
- Display a symbol's parent symbol.
- Copy-and-paste a full symbol name to the entry buffer.

---

### To load symbols

- Choose **File**→**Load**→**Symbols Only** and use the dialog box to select the absolute file.
- Using the command line, enter the *load symbols <absolute\_file>* command.

Unless you use the `nosymbols` option when loading absolute files, symbols are loaded automatically. However, if you did use the `nosymbols` option when loading the absolute file, you can load the symbols without loading the absolute file again.

This option is particularly useful for loading symbols for files located in target ROM so that you can use symbols with that code.

---

#### Examples

To load symbols from the demo program:

```
load symbols ecs.x
```

---

## To display global symbols

- Choose **Display**→**Global Symbols**.
- Using the command line, enter the *display global\_symbols* command.

Listed are: address ranges associated with a symbol, the segment the symbol is associated with, and the offset of that symbol within the segment.

If there is more than a screen full of information, you can use the up arrow, down arrow, <NEXT>, or <PREV> keys to scroll the information up or down on the display.



---

### Examples

To display global symbols in the demo program:

#### *display global\_symbols*

```
Global symbols in ecs.x
Procedure symbols
Procedure name      Address range      Segment      Offset
__fflush           004414 - 0044A0      libc         0000
_bufsync           002CE4 - 002D11      libc         0000
_dbl_to_str        002EF6 - 003398      libc         01E4
_doprnt            003648 - 004379      libc         0036
_exec_funcs        002692 - 0026B1      libc         002C
_findbuf           0044AE - 004541      libc         0000
_startup           000604 - 000723      env          0000
_swrite            004724 - 004759      libc         0000
_wrtchk            00475A - 0047F1      libc         0000
_xflsbuf           0047F2 - 004883      libc         0000
atexit             002666 - 002691      libc         0000
calloc             002BCE - 002BFF      libc         0412
clear_screen       000A06 - 000A3B      env          01CA
close              000806 - 00090B      env          009A
combsort           00124C - 001443      prog         028A
do_sort            00144A - 0014E9      prog         0488
```



---

## To display local symbols

- When displaying symbols, position the mouse pointer over a symbol on the symbol display screen and click the *select* mouse button.
- When displaying symbols, position the mouse pointer over the symbol, press and hold the *select* mouse button, and choose **Display Local Symbols** from the popup menu.
- Position the mouse cursor in the entry buffer and enter the module whose local symbols are to be displayed; then, choose **Display→Local Symbols ()**.
- Using the command line, enter the *display local\_symbols\_in <module>* command.

To display the address ranges associated with the high-level program's source file line numbers, you must display the local symbols in the file.

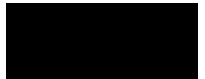

# Using the Emulator To display local symbols

## Examples

To use the Symbols Display popup menu:

View the local symbols associated with the highlighted symbol by choosing this menu item.

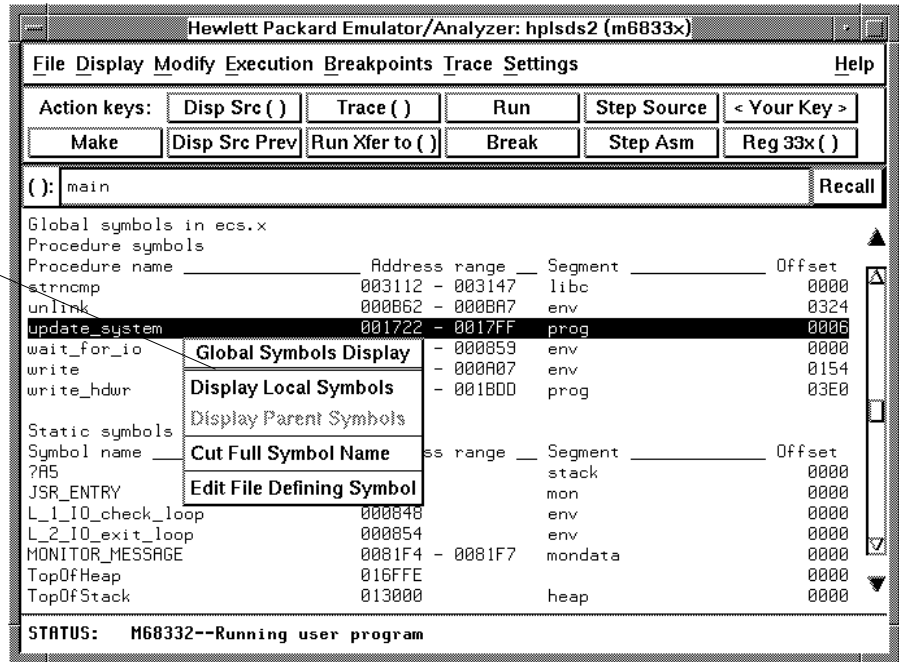

Using the command line:

To display local symbols in a module:

***display local\_symbols\_in*** update\_sys

```
Symbols in update_sys(module)
Procedure symbols
Procedure name _____ Address range __ Segment _____ Offset
get_targetts                00165C - 0016E5  prog                00C8
graph_data                  001986 - 001A3F  prog                03F2
read_conditions             0016EC - 00177B  prog                0158
save_points                 00189A - 00197F  prog                0306
set_outputs                 001782 - 001813  prog                01EE
update_system               00159A - 001655  prog                0006
write_hdwr                  00181A - 001893  prog                0286

Filename symbols
Filename _____
update_sys.c
```

To display local symbols in a procedure:

***display local\_symbols\_in*** update\_sys.save\_points

```
Symbols in update_sys(module).save_points(procedure)
Procedure special symbols
Procedure special name _____ Address range __ Segment _____ Offset
ENTRY                       00189A          prog                0306
EXIT                         00197E          prog                03EA
TEXTRANGE                   00189A - 00197F  prog                0306
```

Using the Emulator  
To display local symbols

To display address ranges associated with the high-level source line numbers:

***display local\_symbols\_in***  
update\_sys."update\_sys.c" :

```
Symbols in update_sys(module)."update_sys.c":  
Source reference symbols
```

Line range	Address range	Segment	Offset
#1-#47	001508 - 0015F7	prog	0006
#48-#53	0015F8 - 001608	prog	0026
#54-#56	00160C - 001617	prog	003A
#57-#59	001618 - 001637	prog	0046
#60-#60	001638 - 001630	prog	0066
#61-#61	00163E - 001640	prog	006C
#62-#63	00164E - 001653	prog	007C
#64-#64	001654 - 001661	prog	0082
#65-#68	001662 - 001673	prog	0090
#69-#72	001674 - 001687	prog	00A2
#73-#75	001688 - 001680	prog	00B6
#76-#77	00168E	prog	00BC
#78-#94	00169E - 0016B9	prog	00CC
#95-#95	0016BA - 0016D1	prog	00E8
#96-#99	0016D2 - 0016D7	prog	0100
#100-#100	0016D8 - 0016D9	prog	0106

---

## To display a symbol's parent symbol

- When displaying symbols, position the mouse pointer over the symbol, press and hold the *select* mouse button, and choose **Display Parent Symbols** from the popup menu.

---

### Examples

View the parent symbol associated with the highlighted symbol by choosing this menu item.

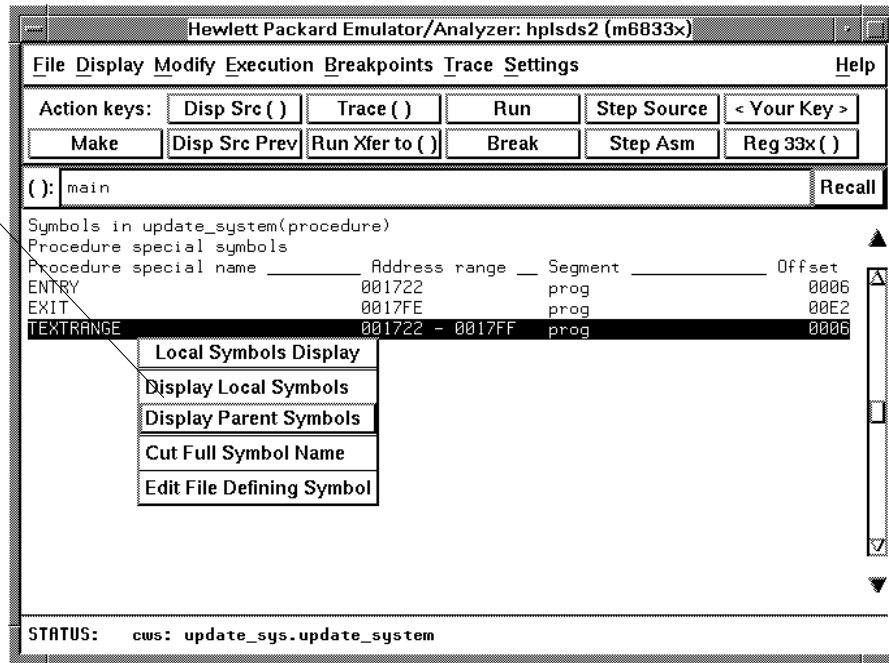

---

## To copy-and-paste a full symbol name to the entry buffer

- When displaying symbols, position the mouse pointer over the symbol, press and hold the *select* mouse button, and choose **Cut Full Symbol Name** from the popup menu.

Once the full symbol name is in the entry buffer, you can use it with pulldown menu items or paste it to the command line area.

By cutting the full symbol name, you get the complete names of symbols that have been truncated. Also, you are guaranteed of specifying the proper scope of the symbol.

---

### Examples

Copy the full name of the highlighted symbol to the entry buffer by choosing this menu item.

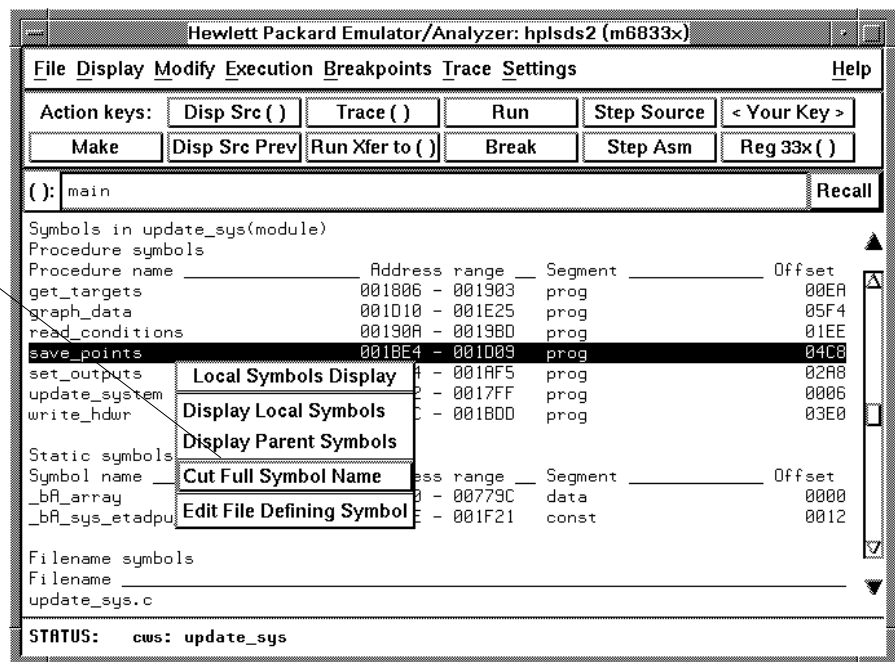

---

## Using Context Commands

The commands in this section display and control the directory and symbol contexts for the interface.

**Directory context.** The current directory context is the directory accessed by all system references for files—primarily load, store, and copy commands—if no explicit directory is mentioned. Unless you have changed directories since beginning the emulation session, the current directory context is that of the directory from which you started the interface.

**Symbol context.** The emulator/analyzer interface and the Symbol Retrieval Utilities (SRU) together support a current working symbol context. The current working symbol represents an enclosing scope for local symbols. If symbols have not been loaded into the interface, you cannot display or change the symbol context.

This section shows you how to:

- Display the current directory and symbol context.
- Change the directory context.
- Change the current working symbol context.

---

## To display the current directory and symbol context

- Choose **Display**→**Context**.
- Using the command line, enter the *pwd* and *pws* commands.  
The current directory and working symbol contexts are displayed, and also the name of the last executable file from which symbols were loaded.

---

### Example

Directory context.

Executable from which symbols were last loaded.

Symbol context.

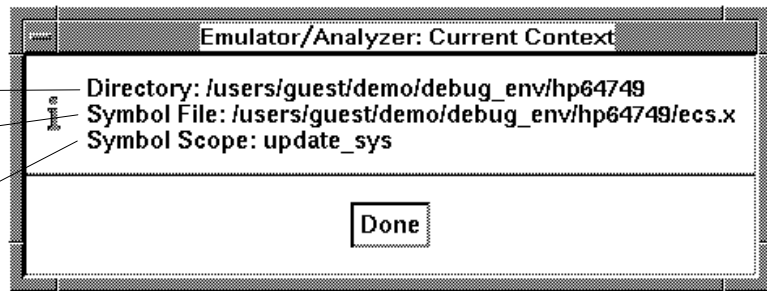

---

## To change the directory context

- Choose **File**→**Context**→**Directory** and use the dialog box to select a new directory.
- Using the command line, enter the **cd <directory>** command.

The Directory Selection dialog box contains a list of directories accessed during the emulation session as well as any predefined directories present at interface startup.

You can predefine directories and set the maximum number of entries for the Directory Selection dialog box by setting X resources (see the "Setting X Resources" chapter).



---

## To change the current working symbol context

- Choose **File**→**Context**→**Symbols** and use the dialog box to select the new working symbol context.
- Using the command line, enter the **cws <symbol\_context>** command. (Because **cws** is a hidden command and doesn't appear on a softkey label, you have to type it in.)

You can predefine symbol contexts and set the maximum number of entries for the Symbol Scope Selection dialog box by setting X resources (see the "Setting X Resources" chapter).

Displaying local symbols or displaying memory in mnemonic format causes the working symbol context to change as well. The new context will be that of the local symbols or memory locations displayed.

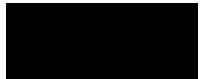

---

## Executing User Programs

You can use the emulator to run programs, break program execution into the monitor, step through the program by high-level source lines or by assembly language instructions, and reset the emulation processor.

When displaying memory in mnemonic format, a highlighted bar shows the current program counter address. When you step, the mnemonic memory display is updated to highlight the new program counter address.

When displaying registers, the register display is updated to show you the contents of the registers after each step.

You can open multiple interface windows to display memory in mnemonic format and registers at the same time. Both windows are updated after stepping.

This section describes how to:

- Start the emulator running the user program.
- Stop (break from) user program execution.
- Step through user programs.
- Reset the emulation processor.

---

### To run programs from the current PC

- Choose **Execution**→**Run**→**from PC**.
- Using the command line, enter the ***run*** command.

When the emulator is executing the user program, the message "Running user program" is displayed on the status line.

---

## To run programs from an address

- Position the mouse pointer in the entry buffer and enter the address you want to run from; then, choose **Execution→Run→from ()**.
- Using the command line, enter the ***run from <address>*** command.

---

### Examples

To run from address 920H:

```
run from 920h
```

---

---

## To run programs from the transfer address

- Choose **Execution→Run→from Transfer Address**.
- Using the command line, enter the ***run from transfer\_address*** command.

Most software development tools allow you to specify a starting or entry address for program execution. That address is included with the absolute file's symbolic information and is known by the interface as the *transfer address*.

---

## To run programs from reset

- Choose **Execution→Run→from Reset**.
- Using the command line, enter the ***run from reset*** command.

The ***run from reset*** command specifies a run from target system reset. It is equivalent to entering a ***reset*** command followed by a ***run*** command. The processor will be reset and then allowed to run.

## To run programs until an address

- When displaying memory in mnemonic format, position the mouse pointer over the line that you want to run until; then press and hold the *select* mouse button and choose **Run Until** from the popup menu.
- Position the mouse pointer in the entry buffer and enter the address you want to run from; then, choose **Execution**→**Run**→**until ()**.
- Using the command line, enter the *run until <address>* command.

When you run until an address, a software breakpoint is set at the address and the program is run from the current program counter.

When using the command line, you can combine the various types of run commands; for example, you can run from the transfer address until another address.

---

### Examples

To run from the transfer address until the address of the global symbol main:

```
run from transfer_address until main
```

---

---

## To stop (break from) user program execution

- Choose **Execution**→**Break**.
- Using the command line, enter the ***break*** command.  
This command generates a break to the background monitor.  
Software breakpoints and the run until command allow you to stop execution at particular points in the user program.

---

### Examples

To break emulator execution from the user program to the monitor:

***break***

---

---

## To step high-level source lines

- Choose **Execution**→**Step Source** and select one of the items from the cascade menu.
- Using the command line, enter the ***step source*** command.  
When stepping through instructions associated with source lines, execution can remain in a loop and the message "Stepping source line 1; Next PC: <address>" is displayed on the status line. In this situation you can abort the step command by pressing <CTRL>c.

---

### Examples

To step through instructions associated with the high-level source lines at the current program counter:

***step source***

---

To step through instructions associated with high-level source lines at address "main":

*step source from* main

---

## To step assembly-level instructions

- Choose **Execution**→**Step Instruction** and select one of the items from the cascade menu.

- Using the command line, enter the *step* command.

The step command allows you to step through program execution an instruction or a number of instructions at a time. Also, you can step from the current program counter or from a specific address.

---

### Examples

To step one instruction from the current program counter:

*step*

To step a number of instructions from the current program counter:

*step* 8

To step a number of instructions from a specified address:

*step* 16 *from* 920h

---

---

## To reset the emulation processor

- Choose **Execution**→**Reset**.
- Using the command line, enter the *reset* command.

The reset command causes the processor to be held in a reset state until a break, run, or step command is entered. A CMB execute signal will also cause the emulator to run if reset.



---

## Using Execution Breakpoints

Breakpoints allow you to stop target program execution at a particular address and transfer control to the emulation monitor. Suppose your system crashes when it executes in a certain area of your program. You can set a breakpoint in your program at a location just before the crash occurs. When the processor executes the breakpoint, the emulator will force a break to the monitor. You can display registers or memory to understand the state of the system before the crash occurs. Then you can step through the program instructions and examine changes in the system registers that lead up to the system crash.

Execution breakpoints are implemented using the BKPT instruction of the MC6833x. You can enable, disable, set, or clear execution breakpoints.

Set execution breakpoints at the first word of program instructions. Otherwise, your BKPT may be interpreted as data and no breakpoint cycle will occur. When the BKPT instruction is executed, target program execution stops immediately (unlike using the analyzer to cause a break into the monitor, which may allow several additional bus cycles to execute before the break finally occurs).

This section shows you how to:

- Set execution breakpoints in RAM.
- Set execution breakpoints in ROM.
- Use temporary and permanent breakpoints.
- Enable and disable execution breakpoints.
- Set a permanent breakpoint.
- Set a ROM breakpoint in RAM.
- Clear execution breakpoints.
- Display status of all execution breakpoints.



---

## Setting execution breakpoints in RAM

When you set an execution breakpoint in RAM, the emulator will place a breakpoint instruction (BKPT) at the address you specified, and then read that address to ensure that the BKPT instruction is there. The program instruction that was replaced by BKPT is saved by the emulator.

When the breakpoint instruction is executed, the BKPT acknowledge cycle is detected by the emulator, and the emulator causes a break to the monitor. At this point, the emulator replaces the BKPT instruction with the original instruction it saved. It also replaces the BKPT instruction with the original instruction whenever you disable or remove the breakpoint.

The emulator allows an unlimited number of breakpoints to be set in RAM.

---

## Using temporary and permanent breakpoints

When you set a temporary execution breakpoint, the emulator creates the breakpoint as described in the preceding paragraphs. When the breakpoint instruction is executed, the emulator breaks to the monitor and removes the breakpoint. Now you can execute that portion of program code as often as you like and the breakpoint will not occur again, unless you enable it again.

When you set a permanent breakpoint, the emulator will process it the same as a temporary breakpoint, but when the breakpoint instruction is executed, the original instruction will only replace the breakpoint instruction during its next execution. This allows you to step through the original instruction one time. After your first step, the BKPT instruction will replace the original instruction again so that the breakpoint will occur the next time the breakpoint address is hit.

Permanent breakpoints remain in effect until you explicitly disable or remove them.

Permanent breakpoints are available when using version A.04.00 or greater of the emulation system firmware.

## To enable execution breakpoints

- Choose **Breakpoints**→**Enable**.
- Inside the breakpoints list display, press and hold the *select* mouse button and then choose **Enable/Disable Software Breakpoints** from the popup menu.
- Using the command line, enable breakpoints with:

*modify software\_breakpoints enable*

You must enable breakpoints before you can set, inactivate, or clear any breakpoints.

Once you have enabled breakpoints, you can enter new ones into the breakpoint table. Note that if you enable breakpoints, add several, and then disable them, they all become inactive. If you reenables the breakpoints feature, you must choose **Breakpoints**→**Set All**, or on the command-line, enter *modify software\_breakpoints set* if you want to set all the existing breakpoint entries.

---

## To disable an execution breakpoint

- Choose **Breakpoints**→**Enable** again. The **Breakpoints**→**Enable** selection is a switch.
- Inside the breakpoints list display, press and hold the *select* mouse button and then choose **Enable/Disable Software Breakpoints** from the popup menu.
- Using the command line, disable breakpoints with:

*modify software\_breakpoints disable*

Sometimes you will want to temporarily disable the execution breakpoints feature without removing the existing breakpoints. Use one of the above commands to do this.

When you disable breakpoints, the emulator replaces the BKPT instructions at all breakpoint locations with the original instructions. It marks the breakpoint table entries as “inactive.” The processor won’t break to monitor when the instructions at inactive locations are executed.

If you later enable breakpoints, the ones in the table are still inactive. To use them, you must set them by choosing **Breakpoints**→**Set All**, or on the command line, entering the *modify software\_breakpoints set* command.

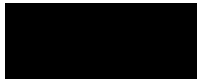

## To set a permanent breakpoint

- When displaying memory in mnemonic format, position the mouse pointer over the program line where you wish to set the breakpoint and click the *select* mouse button. Or, press and hold the *select* mouse button and choose **Set/Clear Software Breakpoint** from the popup menu.
- Place an absolute or symbolic address in the entry buffer; then, choose **Breakpoints**→**Permanent()**.
- Using the command line, enter the command:

```
modify software_breakpoints set <address>  
permanent
```

The breakpoints feature must be enabled before individual breakpoints can be set.

When displaying memory in mnemonic format, asterisks (\*) appear next to breakpoint addresses. An asterisk shows the breakpoint is active. Also, if assembly level code is being displayed, the disassembled instruction mnemonic at the breakpoint address will show the breakpoint instruction.

---

## To set a temporary breakpoint

- Type in the absolute or symbolic address of the breakpoint you want to set in the entry buffer. Then choose **Breakpoints**→**Temporary()**, ( or choose **Breakpoints**→**Set()** if your version of HP 64700 system firmware is less than A.04.00).
- Choose **Breakpoints**→**Set All** to set all existing breakpoints in the breakpoint table.
- Inside the breakpoints list display, press and hold the *select* mouse button and then choose **Set All Breakpoints** from the popup menu.
- Using the command line, enter commands as follows:
  - To set a breakpoint at a location given by <address>, enter:

```
modify software_breakpoints set <address>
```

- To set all existing breakpoints in the breakpoint table, enter:

```
modify software_breakpoints set
```

To add a new breakpoint, you can choose **Breakpoints**→**Temporary()** with the name of the new breakpoint in the entry buffer, or use the *modify software\_breakpoints set* command and specify the address for the breakpoint. You can also use this method to reenble an existing breakpoint at that address.

If you choose **Breakpoints**→**Set All**, or use the *modify software\_breakpoints set* command without an address parameter, all existing breakpoints in the breakpoints table will be enabled. The breakpoints feature must be enabled before individual breakpoints can be set.

When displaying memory in mnemonic format, asterisks (\*) appear next to breakpoint addresses. An asterisk shows the breakpoint is active. Also, if assembly level code is being displayed, the disassembled instruction mnemonic at the breakpoint address will show the breakpoint instruction.

---

**Examples**

Set a new breakpoint at `get_targets`:

```
modify software_breakpoints set  
update_sys.get_targets
```

Reenable all existing breakpoints:

```
modify software_breakpoints set
```

---

## To clear an execution breakpoint

- Type in the name of the breakpoint you want to clear in the entry buffer. Then choose **Breakpoints**→**Clear()**.
- Choose **Breakpoints**→**Clear All** to clear all existing breakpoints in the breakpoint table.
- Inside the breakpoints list display, press and hold the *select* mouse button and then choose **Clear (delete) Breakpoint** from the popup menu to clear the selected breakpoint.
- Using the command line, enter commands as follows:
  - To remove an existing breakpoint at a location given by `<address>`, enter:

```
modify software_breakpoints clear <address>
```

- To remove all existing breakpoints, enter:

```
modify software_breakpoints clear
```

When you're finished using a particular breakpoint, you should clear the breakpoint table entry. The original instruction is restored to memory, and the breakpoint table entry is removed.

**Examples**

To clear a breakpoint using the breakpoints display popup menu:

Bring up the menu and choose this item to clear the highlighted breakpoint.

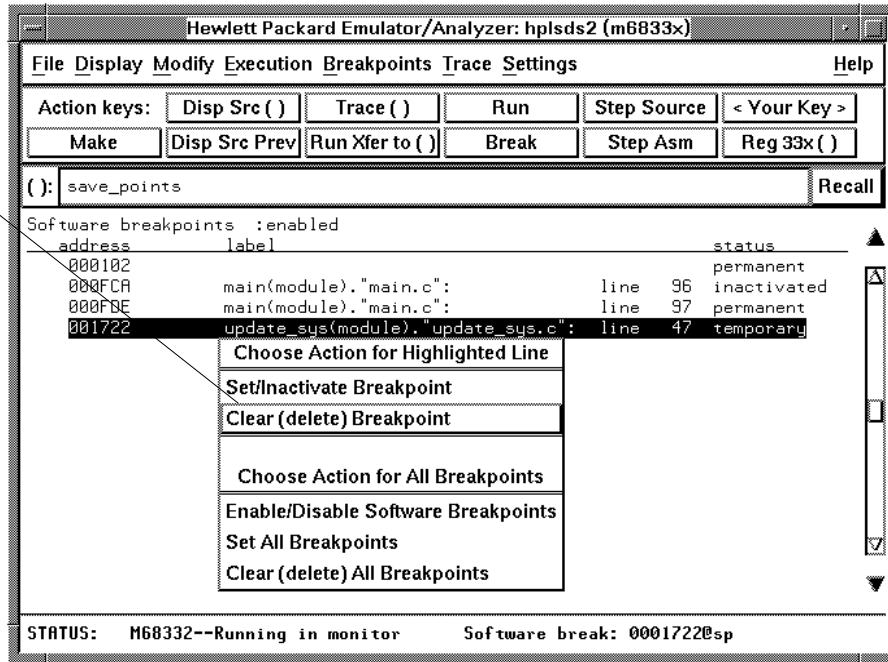

To clear an existing breakpoint at get\_targets:

```
modify software_breakpoints clear  
update_sys.get_targets
```

To clear all existing breakpoints:

```
modify software_breakpoints clear
```

---

## To clear all execution breakpoints

- When displaying breakpoints, position the mouse pointer within the breakpoints display screen, press and hold the *select* mouse button, and choose **Clear (delete) All Breakpoints** from the popup menu.
- Choose **Breakpoints**→**Clear All**.
- Using the command line, enter:

```
modify software_breakpoints clear
```

---

## To display the status of all execution breakpoints

- Choose **Breakpoints**→**Display** or **Display**→**Breakpoints**.
- Using the command line, display the status of all breakpoints by selecting:

```
display software_breakpoints
```

The breakpoints table shows you whether the breakpoints feature is currently enabled or disabled. Also, the status is shown for each breakpoint in memory. If “Pending,” the BKPT instruction is in memory at that location and the breakpoint is set. If “Inactive,” the memory location contains the original instruction, and the breakpoint will not be executed.

Active breakpoints are indicated in the memory mnemonic display by asterisks beside the lines with breakpoints set.



	The status of a breakpoint can be:
temporary	Which means the temporary breakpoint has been set but not encountered during program execution. These breakpoints are removed when the breakpoint is encountered.
permanent	Which means the permanent breakpoint is active. Permanent breakpoints remain active after they are encountered during execution.
inactivated	Which means the breakpoint has been inactivated. Pending breakpoints are inactivated when they are encountered during program execution. Both temporary and permanent breakpoints can be inactivated (and restored) using the breakpoints display popup menu.
pending	Which means the temporary breakpoint has been set but not encountered during program execution. When encountered, these breakpoints are inactivated, but retained in the breakpoints list. Pending breakpoints can only be set using the softkey command line with commands like <b><i>modify software_breakpoints set 1000</i></b> and not selecting the additional options <temporary> or <permanent>. The "pending" breakpoints status is retained for compatibility with older product software versions.  In the breakpoints display, a popup menu is available, obtained by pressing the <i>select</i> mouse button. You can inactivate or restore the status of any breakpoint in the breakpoints list, as well as enable or disable the breakpoints feature, using the popup menu.

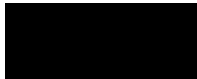

---

# Displaying and Modifying Registers

This section describes tasks related to displaying and modifying emulation processor registers.

Within the interface, related registers are grouped into a class. For example, the <BASIC> register class includes general registers, such as the PC, ST, USP, SSP, and data and address registers. You can display the contents of an individual register, a register class, or all registers.

This section shows you how to:

- Display register contents.
- Modify register contents.

---

## To display register contents

- Choose **Display**→**Registers**→**<register class>**.
- Using the command line, enter the ***display registers <register class>*** command.

When displaying registers, you can display classes of registers and individual registers.

---

## To modify register contents

- Choose **Modify→Register...** and use the dialog box to name the register and specify its value.

Clicking the "Recall" pushbutton lets you select register names and values from predefined or previously specified entries.

Placing the mouse pointer in the text entry area lets you type in the register name and value.

To define the type of value, press and hold the *command select* mouse button and drag the mouse to select the value type.

Clicking this checkbox causes the current value of the named register to be placed in the "Value" text entry area.

Clicking this button modifies the register to the value specified and closes the dialog box.

Clicking this button modifies the register to the value specified and leaves the dialog box open.

Clicking this button cancels modification and closes the dialog box.

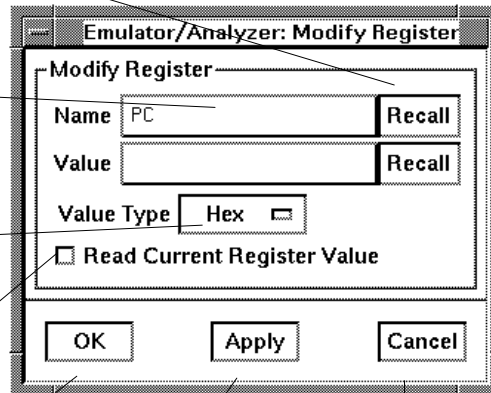

- Using the command line, enter the ***modify register <register> to <value>*** command.

---

## Displaying and Modifying Memory

You can display and modify the contents of memory in hexadecimal formats and in real number formats. You can also display the contents of memory in assembly language mnemonic format.

This section shows you how to:

- Display memory.
- Display memory in mnemonic format.
- Display memory in mnemonic format at the current PC.
- Return to the previous mnemonic display.
- Display memory in hexadecimal format.
- Display memory in real number format.
- Display memory at an address.
- Display memory repetitively.
- Modify memory.
- Modify memory at an address.

---

### To display memory

- Choose **Display**→**Memory**.

This command either re-displays memory in the format specified by the last memory display command, or, if no previous command has been executed, displays memory as hexadecimal bytes beginning at address zero.

---

## To display memory in mnemonic format

- To display memory at a particular address, place an absolute or symbolic address in the entry buffer; then, choose **Display→Memory→Mnemonic ()**, or, using the command line, enter the *display memory <address> mnemonic* command.
- To display memory at the current program counter address, choose **Display→Memory→Mnemonic at PC**, or, using the command line, enter the *display memory mnemonic at\_pc* command.

A highlighted bar shows the location of the current program counter address. This allows you to view the program counter while stepping through user program execution.

Whether source lines, assembly language instructions, or symbols are included in the display depends on the modes you choose with the **Settings→Source/Symbols Modes** or **Settings→Display Modes** pulldown menu items. See the "Changing the Interface Settings" section.

If symbols are loaded into the interface, the default is to display source only.

---

## To return to the previous mnemonic display

- Choose **Display→Memory→Mnemonic Previous**.
- Using the command line, enter the *display memory mnemonic previous\_display* command.

This command is useful for quickly returning to the previous mnemonic memory display.

For example, suppose you are stepping source lines and you step into a function that you would like to step over. You can return to the previous mnemonic memory display, set a breakpoint at the line following the function call, and run the program from the current program counter.

---

## To display memory in hexadecimal format

- Place an absolute or symbolic address in the entry buffer; then, choose **Display**→**Memory**→**Hex ( )** and select the size from the cascade menu.
- Using the command line, enter the *display memory <address> blocked <size>* command.

This command displays memory as hexadecimal values beginning at the address in the entry buffer.

---

### Examples

To display memory in absolute word format:

*display memory* ascii\_old\_data *absolute words*

Memory	:@sp	:words	:absolute	:update	
address	label	data	:hex	:ascii	
0072DA	_ascii_old_d	2020			
0072DC		2020			
0072DE		2034		4	
0072E0		3300		3.	
0072E2		2020			
0072E4		2020			
0072E6		2034		4	
0072E8		3500		5.	
0072EA		2020			
0072EC		2020			
0072EE		2037		7	
0072F0		3700		7.	
0072F2		2020			
0072F4		2020			
0072F6		2035		5	
0072F8		3000		0.	
0072FA		2020			

To display memory in blocked byte format:

***display memory*** *ascii\_old\_data blocked bytes*

Memory	:@sp	:bytes	:blocked	:update						
address	data	hex	hex	hex	hex	hex	hex	hex	hex	:ascii
0072DA-E1	20	20	20	20	20	34	33	00		4 3 .
0072E2-E9	20	20	20	20	20	34	35	00		4 5 .
0072EA-F1	20	20	20	20	20	37	37	00		7 7 .
0072F2-F9	20	20	20	20	20	35	30	00		5 0 .
0072FA-01	20	20	20	20	20	34	34	00		4 4 .
007302-09	20	20	20	20	20	34	35	00		4 5 .
00730A-11	20	20	20	20	20	37	38	00		7 8 .
007312-19	20	20	20	20	20	35	31	00		5 1 .
00731A-21	20	20	20	20	20	34	34	00		4 4 .
007322-29	20	20	20	20	20	34	35	00		4 5 .
00732A-31	20	20	20	20	20	37	39	00		7 9 .
007332-39	20	20	20	20	20	35	32	00		5 2 .
00733A-41	20	20	20	20	20	34	35	00		4 5 .
007342-49	20	20	20	20	20	34	34	00		4 4 .
00734A-51	20	20	37	34	2E	35	33	00	7 4 .	5 3 .
007352-59	20	20	20	20	20	36	39	00		6 9 .
00735A-61	20	20	20	20	20	34	36	00		4 6 .

---

### To display memory in real number format

- Place an absolute or symbolic address in the entry buffer; then, choose **Display→Memory→Real ( )** and select the size from the cascade menu.
- Using the command line, enter the ***display memory <address> real <size>*** command.

Displays memory as a list of real number values beginning at the address in the entry buffer. Short means four-byte real numbers and long means eight-byte real numbers.

---

**Examples**

To display memory in 64-bit real number format:

***display memory real long***

Memory :@sp :long real :update			
address	label	data	:real
0072DA	_ascii_old_d	6.01347001874187E-154	
0072E2		6.01347001874255E-154	
0072EA		6.01347001900370E-154	
0072F2		6.01347001882768E-154	
0072FA		6.01347001874221E-154	
007302		6.01347001874255E-154	
00730A		6.01347001900404E-154	
007312		6.01347001882801E-154	
00731A		6.01347001874221E-154	
007322		6.01347001874255E-154	
00732A		6.01347001900438E-154	
007332		6.01347001882835E-154	
00733A		6.01347001874255E-154	
007342		6.01347001874221E-154	
00734A		6.04708840026633E-154	
007352		6.01347001891755E-154	
00735A		6.01347001874288E-154	

---

**To display memory at an address**

- Place an absolute or symbolic address in the entry buffer; then, choose **Display→Memory→At ( )**.

This command displays memory in the same format as that of the last ***memory display*** command. If no previous command has been issued, memory is displayed as hexadecimal bytes.



---

## To display memory repetitively

- Choose **Display**→**Memory**→**Repetitively**.
- Using the command line, enter the *display memory repetitively* command.

The memory display is constantly updated. The format is specified by the last memory display command.

This command is ignored if the last memory display command was a mnemonic display.

---

## To modify memory

- Choose **Modify**→**Memory** and complete the command using the command line.
- To modify memory at a particular address, place an absolute or symbolic address in the entry buffer; then, choose **Modify**→**Memory at ( )** and complete the command using the command line.
- Using the command line, enter the *modify memory* command.

You can modify the contents of one memory location or a range of memory locations. Options allow you to modify memory in byte, short, word, and real number formats.

---

# Displaying Data Values

The data values display lets you view the contents of memory as data types. You can display data values in the following formats:

- bytes
- 8-bit integers
- unsigned 8-bit integers
- chars
- words
- 16-bit integers
- unsigned 16-bit integers
- long words
- 32-bit integers
- unsigned 32-bit integers

This section shows you how to:

- Display data values.
- Clear the data values display and add a new item.
- Add item to the data values display.

---

## To display data values

- Choose **Display**→**Data Values**.
- Using the command line, enter the *display data* command.

Items must be added to the data values display before you can use this command.

The data display shows the values of simple data types in the user program. When the display mode setting turns ON symbols, a label column that shows symbol values is added to the data display.

Step commands and commands that cause the emulator to enter the monitor (for example, encountering a breakpoint) cause the data values screen to be updated.

---

### To clear the data values display and add a new item

- Place an absolute or symbolic address in the entry buffer; then, choose **Display**→**Data Values**→**New ( )** and select the data type from the cascade menu.
- Using the command line, enter the *display data <address>* *<format>* command.

---

### To add items to the data values display

- Place an absolute or symbolic address in the entry buffer; then, choose **Display**→**Data Values**→**Add ( )** and select the data type from the cascade menu.
- Using the command line, enter the *display data , <address>* *<format>* command.

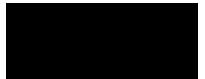

---

## Changing the Interface Settings

This section shows you how to:

- Set the source/symbol modes.
- Set the display modes.

---

### To set the source/symbol modes

- To display assembly language mnemonics with absolute addresses, choose **Settings**→**Source/Symbol Modes**→**Absolute**, or, using the command line, enter the *set source off symbols off* command.
- To display assembly language mnemonics with absolute addresses replaced by global and local symbols where possible, choose **Settings**→**Source/Symbol Modes**→**Symbols**, or, using the command line, enter the *set source off symbols on* command.
- To display assembly language mnemonics intermixed with high-level source lines, choose **Settings**→**Source/Symbol Modes**→**Source Mixed**, or, using the command line, enter the *set source on inverse\_video on symbols on* command.
- To display only high-level source lines, choose **Settings**→**Source/Symbol Modes**→**Source Only**, or, using the command line, enter the *set source only inverse\_video off symbols on* command.

The source/symbol modes affect mnemonic memory displays and trace displays.

Each display mode cascade menu choice is a toggle. Choosing one of these items causes it to be the only one active and toggles all others off. Provided that symbols were loaded, the interface defaults to:

- Source only for mnemonic memory displays.
- Source mixed for trace listing displays.

## To set the display modes

- Choose **Settings**→**Display Modes...** to open the display modes dialog box.

Press and hold the *select* mouse button and drag the mouse to select "Source Only", "Source Mixed", or "Off".

Clicking toggles whether symbolic information is displayed.

Move the mouse pointer to the text entry area and type in the value. Descriptions of the modes follow.

Clicking toggles auto update settings.

Clicking this checkbox changes all display mode settings to their defaults.

Clicking this button saves your changes and closes the dialog box.

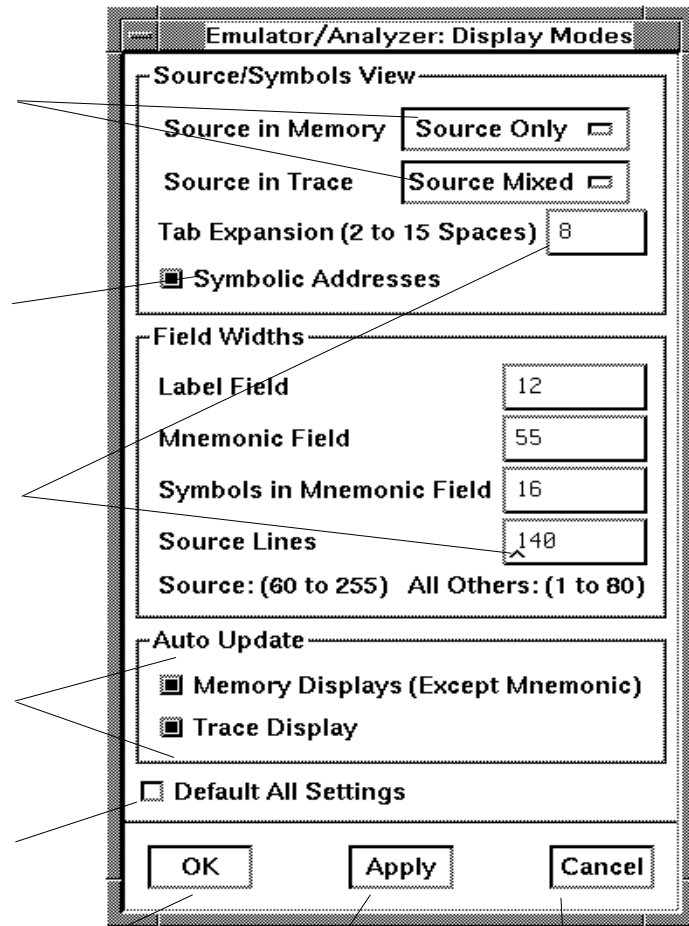

Clicking this button saves your changes and leaves the dialog box open.

Clicking this button cancels your changes and closes the dialog box.

### **Source/Symbols View**

Source in Memory specifies whether source lines are included, mixed with assembly code, or excluded from mnemonic memory displays.

Source in Trace specifies whether source lines are included, mixed with stored states, or excluded from trace displays.

Symbolic Addresses specifies whether symbols are included in displays.

Tab Expansion sets the number of spaces displayed for tabs in source lines.

### **Source/Symbols View**

Label Field sets the width (in characters) of the address field in the trace list or label (symbols) field in any of the other displays.

Mnemonic Field sets the width (in characters) of the mnemonic field in memory mnemonic, trace list, and register step mnemonic displays. It also changes the width of the status field in the trace list.

Symbols in Mnemonic Field sets the maximum width of symbols in the mnemonic field of the trace list, memory mnemonic, and register step mnemonic displays.

Source Lines sets the width (in characters) of the source lines in the memory mnemonic display.

### **Auto Update**

Memory Displays (Except Mnemonic) toggles whether memory displays are automatically updated after commands that change memory contents or whether you must enter memory display commands to update the display. You may wish to turn off memory display updates, for example, when displaying memory mapped I/O.

Memory Mnemonic Auto PC toggles whether memory mnemonic displays automatically jump to the new PC location when the PC changes (such as during stepping or break). You may wish to turn off the automatic update of memory mnemonic displays when you want to examine a specific area of memory regardless of the location of the current PC (such as during stepping).

Trace Displays toggles whether trace displays are automatically updated when trace measurements complete or whether you must enter trace display commands to update the display. You may wish to turn off trace display updates in one emulator/analyzer window in order to compare the display with a new trace display in another emulator/analyzer window.

---

## Using System Commands

With the Softkey Interface system commands, you can:

- Set UNIX environment variables while in the Softkey Interface.
- Display the name of the emulation module.
- Display the event log.
- Display the error log.

---

### To set UNIX environment variables

- Using the command line, enter the **set <VAR>** command.  
You can set UNIX shell environment variables from within the Softkey Interface with the **set <environment\_variable> = <value>** command.

---

#### Examples

To set the PRINTER environment variable to "lp -s":

```
set PRINTER = "lp -s"
```

After you set an environment variable from within the Softkey Interface, you can verify the value of it by entering **!set**.

---

### To display the name of the emulation module

- Using the command line, type the **name\_of\_module** command.  
While operating your emulator, you can verify the name of the emulation module. This is also the logical name of the emulator in the emulator device file.

---

**Examples**

To display the name of your emulation module:

```
name_of_module
```

The name of the emulation module is displayed on the status line.

---

---

### To display the event log

- Choose **Display**→**Event Log**.
- Position the mouse pointer on the status line, press and hold the *select* mouse button, and then choose **Display Event Log** from the popup menu.
- Using the command line, enter the *display event\_log* command.

The last 100 events that have occurred during the emulation session are displayed.

The status of the emulator and analyzer are recorded in the event log, as well as the conditions that cause the status to change (for example, software breakpoints and trace commands).

---

### To display the error log

- Choose **Display**→**Error Log**.
- Position the mouse pointer on the status line, press and hold the *select* mouse button, and then choose **Display Error Log** from the popup menu.
- Using the command line, enter the *display error\_log* command.

The last 100 error messages that have occurred during the emulation session are displayed.

---



---

## To edit files

- Choose **File**→**Edit**→**File** and use the dialog box to specify the file name.
- To edit a file based on an address in the entry buffer, place an address reference (either absolute or symbolic) in the entry buffer; then, choose **File**→**Edit**→**At ( ) Location**.
- To edit a file based on the current program counter, choose **File**→**Edit**→**At PC Location**.
- To edit a file associated with a symbol when you are displaying symbols, position the mouse pointer over the symbol, press and hold the *select* mouse button, and choose **Edit File Defining Symbol** from the popup menu.
- To edit a file when displaying memory in mnemonic format, position the mouse pointer over the line of source where you want to begin the edit, press and hold the *select* mouse button, and choose **Edit Source** from the popup menu.

When editing files at addresses, the interface determines which source file contains the code generated for the address and opens an edit session on the file. The interface will issue an error if it cannot find a source file for the address.

If, upon starting the emulator session, you chose to copy files to a new directory, the file you try to edit will have write permissions. This same file will be "read only" if you did not choose to copy files to a new directory upon starting up the emulator.

The interface will choose the "vi" editor as its default editor, unless you specify another editor by setting an X resource. Refer to the "Setting X Resources" chapter for more information about setting this resource.

You must load symbols before most commands will work because symbol information is needed to be able to locate the files.

Examples

To edit a file that defines a symbol:

Choosing the Edit File Defining Symbol menu item brings up a terminal window with an edit session open on the file where the highlighted symbol is defined.

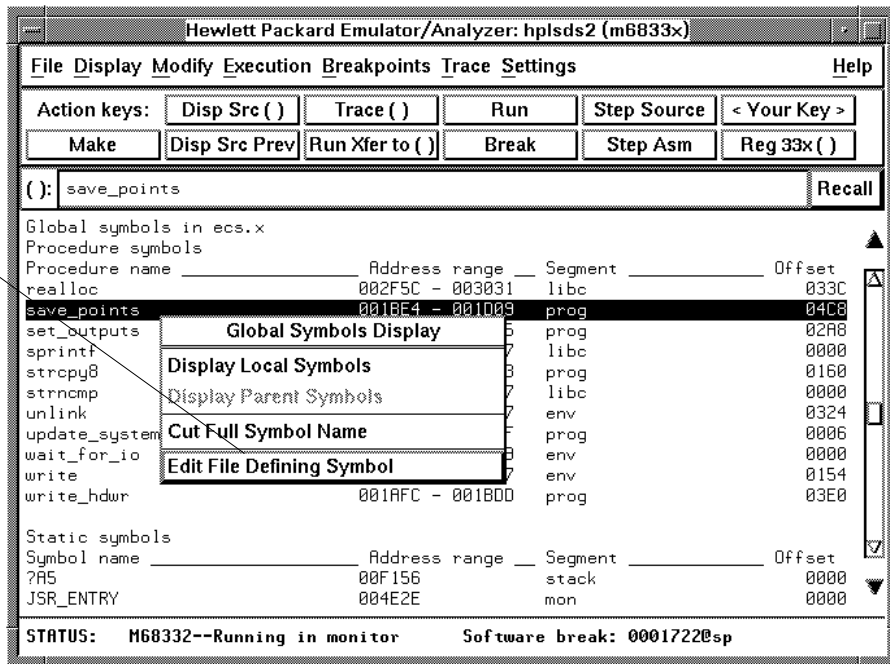

To edit a file at a source line:

Choosing the Edit Source menu item brings up a terminal window with an edit session open on the file where the highlighted source line exists.

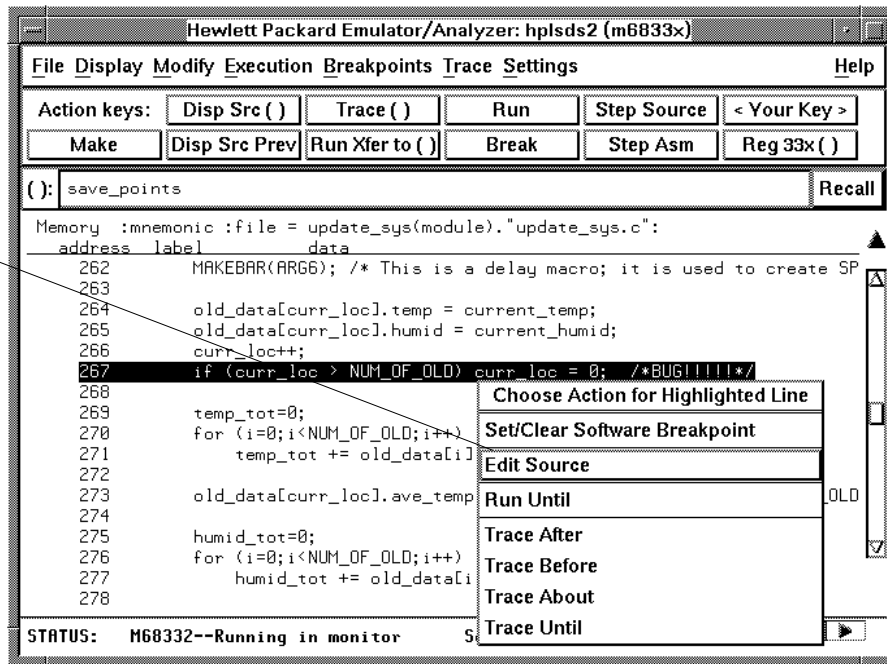

## To copy information to a file or printer

- Choose **File**→**Copy**, select the type of information from the cascade menu, and use the dialog box to select the file or printer.
- Using the command line, enter the *copy* command.

ASCII characters are copied to the file or printer.

If you copy information to an existing file, it will be appended to the file.

Refer to the following paragraphs for details about the different copy options.

**Display ...** Copies information currently in the display area. This option is useful for restricting the number of lines that are copied. Also, this option is useful for copying the contents of register classes other than BASIC.

**Memory ...** Copies the contents of a range of memory. The format is the same as specified in the last display memory command. For example, if you copy memory after displaying a range of memory in mnemonic format, the file would contain the mnemonic memory information. If there is no previous display memory command, the format used is a blocked hex byte format beginning at address zero.

**Data Values ...** Copies the contents of the defined data values last displayed. An error occurs if you try to copy data values to a file if you have not yet displayed data values.

**Configuration Info ...** Copies the contents of the configuration information last displayed. An error occurs if you try to copy configuration information to a file if you have not yet displayed any.

**Trace ...** The most recently captured trace is copied to the file. The copied trace listing is formatted according to the current display mode.

You can set the display mode with the **Settings**→**Source/Symbols Modes** or **Settings**→**Display Modes** pulldown menu items. See the "Changing the Interface Settings" section.

**Registers ...** Copies the current values of the BASIC register class to a file. To copy the contents of the other register classes, first display the registers in that class, and then use the **File**→**Copy**→**Display ...** command.

**Breakpoints ...** Copies the breakpoints list. If no breakpoints are present in the list, only the enable/disable status is copied.

**Status ...** Copies the emulator/analyzer status display.

**Global Symbols ...** Copies the global symbols. If symbols have not been loaded, this menu item is grayed-out and unresponsive.

**Local Symbols ( ) ...** Copies the local symbols from the symbol scope named (by an enclosing symbol) in the entry buffer. If symbols have not been loaded, this menu item is grayed-out and unresponsive.

**Pod Commands ...** Copies the last 100 lines from the pod commands display.

**Error Log ...** Copies the last 100 lines from the error log display.

**Event Log ...** Copies the last 100 lines from event log display.

---

## To open a terminal emulation window

- Choose **File**→**Term...**

This command opens a terminal window into the current working directory context.

---

## Using Simulated I/O

Simulated I/O is a feature of the emulator/analyzer interface that lets you use the same keyboard and display that you use with the interface to provide input to programs and display program output.

To use simulated I/O, your programs must communicate with the simulated I/O control address and the buffer locations that follow it. (The Hewlett-Packard AxLS compilers, if your program uses I/O, automatically link with environment dependent routines that communicate with the simulated I/O control address and buffer.)

Also, before simulated I/O can work, the emulator must be configured to enable polling of the simulated I/O control address and to define the control address location.

This section shows you how to:

- Display the simulated I/O screen.
- Use simulated I/O keyboard input.

Refer to the *Simulated I/O User's Guide* for complete details on how simulated I/O works.

---

### To display the simulated I/O screen

- Choose **Display**→**Simulated IO**.

Before you can display simulated I/O, polling for simulated I/O must be enabled in the emulator configuration.

---

## Examples

```
Simulated I/O display                               Status messages disabled
display is open
54 55 79 90          hH          t          T
54 54 79 89          H          t          T
53 53 78 88          H          t          T
53 52 78 87          Hh         t          T
52 51 77 86          Hh         t          T
52 50 77 85          H h        t          T
51 49 76 84          H h        t          T
51 48 76 83          H h        t          T
50 50 75 75          H          t          T
51 49 71 74          H h        t  T
51 48 71 73          H h        t  T
50 47 70 72          H h        t  T
50 46 70 71          H h        tT
49 45 69 70          H  h        tT
48 44 69 69          H  h        T
48 43 68 68          H  h        T
```

A message tells you whether the display is open or closed. You can modify the configuration to enable status messages.

---

## To use simulated I/O keyboard input

- To begin using simulated I/O input, choose **Settings**→**Simulated IO Keyboard**.
- To end simulated I/O and return to using the interface, use the **suspend** softkey.

For Simulated I/O to work, you must configure the emulator to enable polling of simulated I/O.

The command line entry area is used for simulated input with the keyboard. Therefore, if the command line is turned off, choosing this menu item will turn command line display back on.

If you are planning to use even a modest amount of simulated I/O input during an emulation session, it might be a good idea to open another Emulator/Analyzer window to be used exclusively for simulated I/O input and output.

---

## Using Basis Branch Analysis

Basis branch analysis (BBA) is provided by the HP Branch Validator product. This product is used to analyze the testing of your programs, create more complete test suites, and quantify your level of testing.

The HP Branch Validator records branches executed in a program and generates reports that provide information about program execution during testing. It uses a special C preprocessor to add statements that write to a data array when program branches are taken. After running the program in the emulator (using test input), you can store the BBA information to a file. Then, you can generate reports based on the stored information.

This section shows you how to store BBA data to a file. Refer to the *HP Branch Validator (BBA) User's Guide* for complete details on the BBA product and how it works.

---

### To store BBA data to a file

- Choose **File**→**Store**→**BBA Data** and use the selection dialog box to specify the file name.

The default file name "bbadump.data" can be selected from the dialog box.





---

## Using the Emulation Analyzer

---

## Using the Emulation Analyzer

This chapter describes tasks you may wish to perform while using the emulation analyzer. These tasks are grouped into the following sections:

- The basics of starting, stopping, and displaying traces.
- Qualifying trigger and store conditions.
- Using the sequencer.
- Displaying the trace list.
- Saving and restoring trace data and specifications.

---

# The Basics of Starting, Stopping, and Displaying Traces

This section describes the basic tasks that relate to starting and stopping trace measurements.

When you start a trace measurement, the analyzer begins looking at the data on the emulation processor's bus and control signals on each analyzer clock signal. The information seen on a particular clock is called a state.

When one of these states matches the "trigger state" you specify, the analyzer stores states in trace memory. When trace memory is filled, the trace is said to be "complete." The default trigger state specification is "any state," so when you start a trace measurement after initializing the analyzer, the analyzer will "trigger" on the first state it sees and store the following states in trace memory.

Once you start a trace measurement, you can view the progress of the measurement by displaying the trace status.

In some situations, for example, when the trigger state is never found or when the analyzer hasn't filled trace memory, the trace measurement does not complete. In these situations, you can halt the trace measurement.

Once a trace is displayed, you can use the cursor keys and other keys to position the trace list on the display. To speed up the display of traces, you can reduce the depth of the trace list. Also, when entering trace commands, there is a special command that allows you to recall and modify the last trace command entered.

This section describes how to:

- Start a trace measurement.
- Display the trace list.
- Display the trace status.
- Change the trace depth.
- Modify the last trace command entered.
- Repeat the previous trace command.
- Position the trace display on the screen.

## To start a trace measurement

- Choose **Trace**→**Everything**.
- Using the command line, enter:

***trace***

When you use the ***trace*** command without any options, the analyzer begins recording processor bus cycles immediately, and continues until the trace buffer is filled. In the default trace configuration, the analyzer stores all bus cycles.

If you are using the deep analyzer, the depth of the trace list buffer depends on whether or not you installed memory modules on the analyzer card, and the capacity of the memory modules installed. Refer to the Hewlett-Packard *MC6833x Emulator/Analyzer Installation/Service/Terminal Interface Guide* for details. If you are using the 1K analyzer, the trace list buffer is 512 or 1024 states deep (depending on whether or not you turn on the state/time count). See "To count states or time" in this chapter.)

---

### Example

From the demo directory /usr/hp64000/demo/debug\_env/hp64749, start the demo program and trace from the program start:

```
Startemul
reset
trace
run from transfer_address
```

---

---

## To stop a trace measurement

- Choose **Trace→Stop**.
- Using the command line, enter:

***stop\_trace***

You must use this command to stop a trace started with a **Trace→Until Stop** command (refer to "To trace activity leading up to a program halt" later in this chapter). Several other conditions may occur that will make you want to stop a trace. The analyzer may not record any trace states because your trigger specification isn't correct, or because you have a target system problem. At other times, a valid trace may be capturing data slowly. You can use the ***stop\_trace*** command to prevent the analyzer from storing additional data.

You do not have to stop a trace in order to begin viewing a partial trace because the interface supports incremental trace uploading. After the trigger condition occurs, the interface begins uploading and displaying trace states as they are captured.

---

## To display the trace list

- Choose **Trace→Display** or **Display→Trace**.
- Using the command line, enter the ***display trace*** command.

You can display captured trace data with the ***display trace*** command. The available options to the display trace command are described in the "Modifying the Trace Display" section later in this chapter.

**Examples**

To display the trace:

***display trace***

Trace List	Offset=0	More data off screen		
Label:	Address	Opcode or Status w/ Source Lines	time count	
Base:	symbols	mnemonic w/symbols	relative	
after	update_sy+000066	NOP		
+001	update_sy+000068	CMPL 04,02	360	nS
+002	update_sy+00006A	BLTB p update_system+000062	360	nS
+003	update_sy+00006C	NOP	360	nS
#####update_sys.c - line 61 #####				
counter++;				
+004	update_sy+000062	ADDQL #1,02	720	nS
+005	update_sy+000064	NOP	360	nS
+006	update_sy+000066	NOP	360	nS
+007	update_sy+000068	CMPL 04,02	360	nS
+008	update_sy+00006A	BLTB p update_system+000062	360	nS
+009	update_sy+00006C	NOP	360	nS
#####update_sys.c - line 61 #####				
counter++;				
+010	update_sy+000062	ADDQL #1,02	720	nS
+011	update_sy+000064	NOP	360	nS

The first column in the trace list contains the line number. The trigger is always on line 0.

The second column contains the address information associated with the trace states. Addresses in this column may be locations of instruction opcodes on fetch cycles, or they may be sources or destinations of operand cycles.

The third column shows mnemonic information about the emulation bus cycle.

The next column shows the count information (time is counted by default). "Relative" indicates that each count is relative to the previous state.

If your analyzer card contains external analysis (for example, HP 64703), the next column shows the data captured on the external trace signals.

You can use the <NEXT> and <PREV> keys to scroll through the trace list a page at a time. The <Up arrow> and <Down arrow> keys will scroll through the trace list a line at a time. You can also display the trace list centered around a specific line number (for example, ***display trace 100***). Refer to the "Modifying the Trace Display" section for more information on the trace list display.

Note that when a trigger condition is found but not enough states are captured to fill trace memory, the status line will show the trace is still running. You can display all but the last captured state in this situation; you must halt the trace to display the last captured state.

---

## To display the trace status

- Choose **Display**→**Status**.
- Using the command line, enter the *display status* command.

In addition to the analyzer information shown on the status line (Emulation trace started, Emulation trace complete, etc.), you can display complete analyzer status with the command below.

---

### Examples

To display the trace status:

*display status*

```
Status
-----
Emulator Status

M68332--Running user program

Trace Status

Emulation trace complete
Arm ignored
Trigger in memory
Arm to trigger ?
States 512 (512) 0..511
Sequence term 2
Occurrence left 1
```

The first line of the emulation trace status display shows the user trace has been "completed"; other possibilities are that the trace is still "running" or that the trace has been "halted".

The second line of the trace status display contains information on the arm condition. If the analyzer is always armed, the message "Arm ignored" is displayed. If the analyzer is to be armed by one of the internal signals, either

the message "Arm not received" or "Arm received" is displayed. The display indicates if the arm condition happened any time since the most recent trace started, even if it happened after the trace was halted or became complete. (The "Making Coordinated Measurements" chapter explains arm conditions.)

The "Arm to trigger" line displays the amount of time between the arm condition and the trigger. The time displayed will be from -0.04 microseconds to 41.943 milliseconds, less than -0.04 microseconds, or greater than 41.943 milliseconds. If the arm signal is ignored or the trigger is not in memory, a question mark (?) is displayed.

The "States" line shows the number of states that have been stored (out of the number that is possible to store) and the line numbers that the stored states occupy. (The trigger state is always stored on line 0.)

The "Sequence term" line of the trace status display shows the number of the term the sequencer was in when the trace completed. Because a branch out of the last sequence term constitutes the trigger, the number displayed is what would be the next term (2 in the preceding example) even though that term is not defined. If the trace is halted, the sequence term number just before the halt is displayed; otherwise, the current sequence term number is displayed. If the current sequence term is changing too quickly to be read, a question mark (?) is displayed.

The "Occurrence left" line of the trace status display shows the number of occurrences remaining before the primary branch can be taken out of the current sequence term. If the occurrence left is changing too quickly to be read, a question mark (?) is displayed.



---

## To change the trace depth

- Choose **Trace→Display Options...** and in the dialog box, enter the desired trace unload depth in the field beside Unload Depth. Then click the OK or Apply pushbutton.
- Using the command line, enter:

***display trace depth*** <depth>

Using one of the above command forms, you specify the number of states that will be unloaded for display, copy, or file storage. By reducing the trace unload depth, you shorten the time it takes for the interface to unload the trace information. You can increase the trace unload depth to view more states of the current trace. Regardless of how much or how little unload depth you specify, the entire trace memory will be filled with captured states during a trace.

In the deep analyzer, the maximum number of trace states depends on whether or not you installed memory modules in the analyzer card, and the capacity of the memory modules. Refer to the Hewlett-Packard *MC6833x Emulator/Analyzer Installation/Service/Terminal Interface Guide* for details. In the 1K analyzer, the maximum number of trace states is 1024 when counting is turned off, and 512 otherwise. In either analyzer, the minimum trace depth is 9.

Trace data must be unloaded before it can be displayed, copied, or stored in a file. If you wish to reduce the number of states that are unloaded for display, you must enter the unload depth specification (in one of the two ways shown above) before you enter the trace command. The above commands cannot be used to reduce the number of states displayed in the current trace. You can enter a new unload depth specification after a trace is complete to increase the amount of trace memory that is unloaded, if desired.

## To modify the last **trace** command entered

- Choose **Trace**→**Trace Spec...** and use the dialog box to select and edit a trace command.
- Using the command line, enter the **trace modify\_command** command.

The Trace Specification Selection dialog box lets you recall, edit, and enter trace commands that have been executed during the emulation session or trace commands that have been predefined. If you make an error in a trace command or want to change the measurement slightly, it's often easier to recall the previous trace command and edit it than it is to enter a new trace command.

You can predefine trace specifications and set the maximum number of entries for the dialog box by setting X resources (see the "Setting X Resources" chapter).

The **trace modify\_command** command recalls the last trace command. The advantage of this command over command recall is that you do not have to move forward and backward over other commands to find the last trace command; also, the last trace command is always available, no matter how many commands have since been entered.

---

## To repeat the previous trace command

- Choose **Trace**→**Again**.
- To continually repeat the last trace, choose **Trace**→**Repetitively**.
- Using the command line, repeat the previous trace command (including its complete trace specification) by entering:

**trace again**

The **trace again** command is most useful when you want to repeat a measurement with the same trace specification. It saves you the trouble of reentering the complete trace command specification.

The "repetitively" choice continually repeats the last trace command. Successive traces begin as soon as the results from the just-completed trace are displayed.

---

Also, this command is useful when you load a trace specification from a file.  
(See "To load a trace specification" in this chapter.)

---

## To position the trace display on screen

- Use the scroll bar or the <Up arrow>, <Down arrow>, <PREV>, <NEXT>, <CTRL>f, and <CTRL>g keys.

The trace display command can display more states than can appear on the screen at one time. However, you can reposition the display on the screen with the keys described below.

The <Up arrow> and <Down arrow> (or roll up and roll down) keys move the display up or down on the screen one line at a time.

The <PREV> and <NEXT> (or page up and page down) keys allow you to move the display up or down a page at a time.

The <CTRL>f and <CTRL>g keys allow you to move the display left or right, respectively. These keys are used when the width of the address or mnemonic/absolute columns is increased so that not all the trace display data can be displayed across the screen.



---

# Qualifying Trigger and Store Conditions

This section describes tasks relating to the qualification of trigger and storage states.

You can trigger on, or store, specific states or specific values on a set of trace signals (which are identified by trace labels).

Also, you can *prestore* states. The *prestore* qualifier is a second storage qualifier used for storing states that occur before the normally stored states. *Prestore* is useful for capturing entry points to procedures or for identifying where global variables are accessed from.

This section describes how to:

- Specify a trigger and set the trigger position.
- Use address, data, and status values in trace expressions.
- Enter a range in a trace expression.
- Trigger on a number of occurrences of some state.
- Break emulator on execution on the analyzer trigger.
- Count states or time.
- Define a storage qualifier.
- Define a *prestore* qualifier.
- Trace activity leading up to a program halt.

## Expressions in Trace Commands

When modifying the analysis specification, you can enter expressions which consist of values, symbols, and operators.

**Values** Values are numbers in hexadecimal, decimal, octal, or binary. These number bases are specified by the following characters:

<b>Bb</b>	Binary (example: 10010110b).
<b>QqOo</b>	Octal (example: 377o or 377q).
<b>Dd</b> (default)	Decimal (example: 2048d or 2048).
<b>Hh</b>	Hexadecimal (example: 0a7fh).

You must precede any hexadecimal number that begins with an A, B, C, D, E, or F with a zero.

Don't care digits may be included in binary, octal, or hexadecimal numbers and they are represented by the letters X or x. A zero must precede any numerical value that begins with an "X".

**Symbols** A symbol database is built when the absolute file is loaded into the emulator. Both global and local symbols can be used when entering expressions. Global symbols are entered as they appear in the global symbols display. When specifying a local symbol, you must include the name of the module ("anly.c") as shown below.

```
anly.c:cmp_function
```

**Operators** Analysis specification expressions may contain operators. All operations are carried out on 32-bit, two's complement integers. (Values which are not 32 bits will be sign extended when expression evaluation occurs.)

The available operators are listed below in the order of evaluation precedence. Parentheses are also allowed in expressions to change the order of evaluation.

~, ~

Unary two's complement, unary one's complement. The unary two's complement operator is not allowed on constants containing don't care bits.

\*, /, %

Integer multiply, divide, and modulo. These operators are not allowed on constants containing don't care bits.

+, -

Addition, subtraction. These operators are not allowed on constants containing don't care bits.

&

Bitwise AND.

|

Bitwise inclusive OR.

Values, symbols, and operators may be used together in analysis specification expressions. For example, if the local symbol exists, the following is a valid expression:

```
module.c:symb+0b67dh&0fff00h
```

However, you cannot add two symbols unless one of them is an EQU type symbol.



**Emulation Analyzer Trace Signals**

When you qualify states, you specify values that should be found on the analyzer trace signals. The emulation analyzer trace signals are described in the table that follows.

Emulation Analyzer Trace Signals			
Trace Signals	Analyzer Channel #	Signal Name	Signal Description
0-23	0-23	A0-A15	Address Lines 0-15
32-47	32-47	D0-D15	Data Lines 16-31
bit 0	ch 48	BACKGROUND	0 = in monitor or RESET 1 = not in monitor and not RESET
bit 1 bit 2 bit 3	ch 49 ch 50 ch 51	FC0 FC1 FC2	These are the translation RAM derivation of the processor function codes. If the processor has been configured such that these are FC* signals, the translation RAM will pass the signals directly. If the processor has been configured such that these signals are chip selects, one of three bus values will be driven, based on chip select programming. If the chip select programming does not differentiate between user and supervisor, the FC value will be 011 BIN. If the chip select is supervisor, the FC value will be 100 BIN. If the chip select is user, the FC value will be 000 BIN.
bit 4	ch 52	R/W	0 = write bus cycle 1 = read bus cycle
bit 5 bit 6	ch 53 ch 54	SIZ0 SIZ1	These are processor SIZ signals, which may be configured as I/O pins. If analysis status bits 15:14 are equal to 0:0, the processor has been configured such that these signals are SIZ.
bit 7	ch 55	MAPBYTE	When = 0, the memory mapper has been programmed such that the current emulation memory address is byte wide. When = 1, the memory mapper has been programmed such that the current emulation memory address is word wide.

Emulation Analyzer Trace Signals			
Trace Signals	Analyzer Channel #	Signal Name	Signal Description
bit 8 bit 9	ch 56 ch 57	DSACK0 DSACK1	These are processor DSACK signals, which may be configured as I/O pins.
bit 10	ch 58	BERR	0 = bus error 1 = no bus error
bit 11	ch 59	HALT	0 = processor halt 1 = processor is not halted
bit 12	ch 60	CODE	0 = instruction fetch 1 = data transfer
bit 13	ch 61	FLUSH	0 = first instruction fetch following any program transfer 1 = no program transfer
bit 14 bit 15	ch 62 ch 63	LOWBYTE HIBYTE	These are translation RAM signals which describe the bus cycle. 15:14 0:0 use SIZ1, SIZ0 bits (status bits 6:5) 0:1 low-byte transfer 1:0 high-byte transfer 1:1 word transfer

**State Qualifiers**

Whenever a state can be specified in the trace command (trigger state, storage state, prestore state, etc.), you will see the following softkeys that allow you to qualify the state:

- address      The value following this softkey is searched for on the lines that monitor the emulation processor's address bus.
- data         The value following this softkey is searched for on the lines that monitor the emulation processor's data bus.
- status       The value following this softkey is searched for on the lines that monitor other emulation processor signals.

When a value is specified without one of these softkeys it is assumed to be an address value.

**Predefined Values for Qualifiers** When you specify status qualifiers for analyzer states (by pressing the status softkey), you will be given the following softkeys which are predefined values for the qualifiers.

<u>Qualifier</u>	<u>Status Values</u>	<u>Description</u>
berr	=0xxxxx0xxxxxxxxxxx	BIN - bus cycle bus error
data	=0xxx1xxxxxxxxxxxxx	BIN - bus cycle is a data transfer
flush	=0xx0xxxxxxxxxxxxx	BIN - instruction pipe flush and program transfer
halt	=0xxx0xxxxxxxxxxxxx	BIN - processor halt
hibyte	=0xxxxxxxxxxxxxxxx	BIN - high byte bus transfer
lobyte	=0x0xxxxxxxxxxxxx	BIN - low byte bus transfer
prog	=0xxx0xxxxxxxxxxxxx	BIN - bus cycle is an instruction fetch
read	=0xxxxxxxxxxxx1xxxx	BIN - bus cycle is a read
write	=0xxxxxxxxxxxx0xxxx	BIN - bus cycle is a write

These predefined values may be used as other values would be used.  
 For example:

***trace after status write***

is the same as:

***trace after status 0xxxxxxxxxxxx0xxxxb***



## To specify a trigger and set the trigger position

- Enter a trigger state specification in the entry buffer; then, choose **Trace→After ()**, **Trace→About ()**, or **Trace→Before ()**.
- When displaying memory in mnemonic format, position the mouse pointer over the source line where you want to set the trace trigger, press and hold the *select* mouse button and choose **Trace After**, **Trace Before**, or **Trace About** from the popup menu.
- Using the command line, enter the **trace after**, **trace about**, or **trace before** commands.

Tracing after the trigger state says states that occur after the trigger state should be saved; in other words, the trigger is positioned at the top of the trace.

Tracing before the trigger state says states that occur before the trigger state should be saved; in other words, the trigger is positioned at the bottom of the trace.

Tracing about the trigger state says states that occur before and after the trigger state should be saved; in other words, the trigger is positioned at the center of the trace.

When the analyzer counts time or states, the actual trigger position is within +/- 1 state of the number specified. When counts are turned OFF, the actual trigger position is within +/- 3 states of the number specified.

Usually, when you enter a trace about command, the trigger state (line 0) is labeled "about". However, if there are three or fewer states before the trigger, the trigger state is labeled "after". Likewise, if there are 3 or fewer states after the trigger, the trigger state is labeled "before".

The state you define after trace after, trace about, or trace before is the state that will trigger the analyzer and cause states to be stored.



Using the Emulation Analyzer  
To specify a trigger and set the trigger position

Examples

Suppose you want to look at the execution of the demo program after the call of the "update\_system()" function (main.c: line 102) occurs. To trigger on this address, enter:

*trace after address* main."main.c": line 102

*set source on inverse\_video on symbols on*

*display trace*



Trace List	Offset=0	More data off screen
Label:	Address	Opcode or Status w/ Source Lines
Base:	symbols	mnemonic w/symbols
#####main.c - line 101 thru 102 #####		
{		
update_system();		
after	prog main+000012	JSR up.update_system 720 nS
+001	prog main+000014	0000 pgm word rd (ds16) 360 nS
+002	prog main+000016	159A pgm word rd (ds16) 360 nS
#####main.c - line 103 #####		
num_checks++;		
+003	prog main+000018	ADDQ.L #1,***** 360 nS
+004	sysstack+007F90	0000 data long wr (ds16) 600 nS
+005	sysstack+007F92	0FE0 data word wr (ds16) 360 nS
#####update_sys.c - line 1 thru 47 #####		
#include <stdio.h>		
void		
update_system()		

In the preceding trace list, line 0 (labeled "after") shows the beginning of the program loop.

---

## To use address, data, and status values in trace expressions

- Enter the value(s) desired in the entry buffer (such as **address 1000h**). Then Choose **Trace→After()**, **Trace→Before()**, or **Trace→About()**, as desired.
- Using the command line, enter commands as follows:
  - To specify an address expression, enter:

`<expression> -or- address <expression>`

- To specify a data expression, enter:

`data <expression>`

- To specify a status expression, enter:

`status <expression>`

Many trace commands require that you enter address, data and status expressions to specify the bus state. You can combine multiple expressions on the same command line to build a complete bus state qualifier. You can also use logical operators to build more complex states. Refer to the "Emulator/Analyzer Interface Commands" chapter for details.

The default expression type is address, therefore you don't need to specify the address keyword when you enter an address expression.

---

### Example

Start a trace and store only writes of 0 hex to the graph address in the demo program:

`trace only graph data 0 status write`

---

## To enter a range in a trace expression

- Use the command-line rules (described below) to create your expression in the entry buffer. Then Choose **Trace→After()**, **Trace→Before()**, or **Trace→About()**, as desired.
- Using the command line, enter commands as follows:
  - To specify an address range enter:

```
address range <expression> thru <expression>
```

- To specify a data range, enter:

```
data range <expression> thru <expression>
```

- To specify a status range enter:

```
status range <expression> thru <expression>
```

- To take the logical not of a range, use the not keyword before the range keyword.

Ranges allow you to qualify analyzer actions on a contiguous set of values. Mostly, you'll use address ranges to trigger or store on access to a data block such as a lookup table. But, you can also use data ranges to qualify a trigger or storage on a range of data values.

There is only one range term available in the trace specification. Once it has been used, it cannot be reused. That is, if you specify a range in a trigger specification, you can't duplicate it in the storage specification. (The Terminal Interface does allow this type of measurement, though there is still only one range term. Refer to the Hewlett-Packard *MC6833x Emulator/Analyzer Installation/Service/Terminal Interface Guide* for details.)

Since address is the default range type, you can omit the address keyword. You can't omit the data or status keywords if those are the bus parts you want to qualify.

You can use the logical or operator to combine the range term with several state qualifiers. See the examples.

---

**Examples**

Store only the accesses to the demo program's `current_humid` location:

```
trace only range current_humid thru +1h
```

Store only bus cycles where data is in the range 6h..26h or is 29h:

```
trace only data range 6h thru 26h or data 29h
```

---

---

## To trigger on a number of occurrences of some state

- Use the **occurs <#TIMES>** after specifying the trigger state.  
When specifying a trigger state, you can include an occurrence count. The occurrence count specifies that the analyzer trigger on the Nth occurrence of some state.  
The default base for an occurrence count is decimal. You may specify occurrence counts from 1 to 65535.

---

**Examples**

To trigger on the 20th occurrence of the call of the "update\_system()" function (main.c: line 102):

```
trace after address main."main.c": line 102  
occurs 20
```

---

## To break emulator execution on the analyzer trigger

- Enter a trigger state specification in the entry buffer; then, choose **Trace**→**Until ()**.
- When displaying memory in mnemonic format, position the mouse pointer over the program line which you wish to trace before, press and hold the *select* mouse button and choose **Trace Until** from the popup menu.
- Using the command line, use the **break\_on\_trigger** option to the **trace** command.

The `break_on_trigger` option to the trace command allows you to cause the emulator to break when the analyzer finds the trigger state.

Note that the actual break may be several cycles after the analyzer trigger.



---

### Examples

To trace before source line 102 and cause the emulator to break into the monitor when the analyzer triggers:

```
trace before address main."main.c": line 102  
break_on_trigger
```

---

---

## To count states or time

- Create your first specification form on the command line. That will enter the proper format in the Trace Specification Selection dialog box. Obtain that dialog box by choosing **Trace**→**Trace Spec...** You can click on your specification in the dialog box, edit it if desired, and click OK.
- Using the command line, enter commands as follows:
  - To count occurrences of a particular bus state in the trace, enter:

```
trace counting <bus_state>
```

---

<bus\_state> represents a combination of address, data and status expressions that must be matched to satisfy the trigger qualifier.

- To count all states in the trace, enter:

***trace counting anystate***

- To count time in the trace, enter:

***trace counting time***

- To disable counting in the trace, enter:

***trace counting off***

You can use the analyzer's state/time counter to count time or bus states. If using the deep analyzer, counting imposes no restrictions on memory depth. If using the 1K analyzer, use of the counter restricts the trace memory to a maximum depth of 512 states. If you disable the counter in the 1K analyzer, using the trace counting off command, maximum trace depth is 1024 states. When using the 1K analyzer, the MC6833x emulator defaults to counting off. To count states or time, you must configure the analyzer clocks correctly. See "To configure the analyzer clock" in the "Configuring the Emulator" chapter for more information.

Use the display trace count command to determine how the count is displayed in the trace list. See "To display count information in the trace" for more information.



---

**Examples**

To count occurrences of a particular bus state in the trace (this requires the 1K analyzer speed to be set to "Slow" in configuration):

```
trace counting state address 10h
```

Count all states in the trace:

```
trace counting anystate
```

Count time in the trace:

```
trace counting time
```

Disable counting in the trace:

```
trace counting off
```

---

---

## To define a storage qualifier

- Enter the storage qualifier (such as **status read**) in the entry buffer. Then choose **Trace→Only()**.
- Using the command line, store only certain states in the trace list by entering:

```
trace only <bus_state>
```

<bus\_state> represents a combination of address, data and status expressions that must be matched to satisfy the storage qualifier.

Storage qualifiers can help filter unwanted information from program execution and improve your trace measurement. The analyzer stores only the information specified in the storage qualifier. Note that if you have a



sequencer or trigger specification, any states given there are shown in the trace list even if they don't meet the storage qualifier.

---

**Examples**

Trace only address 10h:

```
trace only address 10h
```

Trace only data value 0ffh:

```
trace only data 0ffh
```

Trace only write operations

```
trace only status write
```

---

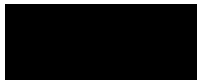

---

## To define a prestore qualifier

- Place your prestore qualification into the entry buffer. Then choose **Trace→Only() Prestore**.
- Using the command line, enter commands as follows:
  - Specify a prestore qualifier by entering:

```
trace prestore <bus_state>
```

<bus\_state> represents a combination of address, data and status expressions that must be matched to satisfy the prestore qualifier.

- Disable prestore qualification by entering:

```
trace prestore anything
```

---

You use the prestore qualifier to save states that are related to other routines that you're tracing. For example, you might be tracing a subprogram, and want to see which program called it. You can specify calls be prestore and that entries to the subprogram be stored. The easiest way to do this is to prestore program reads that are outside the address range of the subprogram being called.

You may have several program modules that write to a variable, and sometime during execution of your program, that variable gets bad data written to it. Using a prestore measurement, you can find out which module is writing the bad data. Store-qualify writes to the variable, and use prestore to capture the instructions that caused those writes to occur (perhaps by prestoreing program reads).

---

**Examples**

Specify a prestore qualifier:

```
trace prestore address not range gen_ascii_data  
thru gen_ascii_data end status program and read  
only gen_ascii_data
```

Disable prestore qualification:

```
trace prestore anything
```

---

## To trace activity leading up to a program halt

- Choose **Trace→Until Stop**.
- Using the command line, trace on a program halt by entering:

*trace on\_halt*

The above commands cause the analyzer to continuously fill the trace buffer until you issue a **Trace→Stop** or *stop\_trace* command.

Sometimes you may have a program failure that can't be attributed to a specific trigger condition. For example, the emulator may access guarded memory and break to the monitor. You want to trace the events leading up to the guarded memory access but you don't know what to specify for a trigger. Use the above command. The analyzer will capture and record states until the break occurs. The trace list will display the last processor states leading up to the break condition.

Note that the *trace until stop* command may not capture the desired information when you are using a foreground monitor (unless the code that causes the break also causes the processor to halt) because the analyzer will continue to capture foreground monitor states after the break. When using a foreground monitor, you can use the command line to enter a trace command that stores only states outside the range of the foreground monitor program (for example, *trace on\_halt only not range <mon\_start\_addr> thru <mon\_end\_addr> on\_halt*).

---

## To capture a continuous stream of program execution no matter how large your program

The following example can be performed in emulation systems using the deep analyzer (it cannot be done with the 1K analyzer). It shows you how to capture all of the execution of your target program. You may wish to capture target program execution for storage, for future reference, and/or for comparison with execution after making program modifications. The execution of a typical target program will require more memory space than is available in the trace memory of an analyzer. This example shows you how to capture all of your target program execution while excluding unwanted execution of the emulation monitor.

**To capture a continuous stream of program execution no matter how large your program**

- 1 Choose **Trace→Display Options ...**, and in the dialog box, enter 0 or the total depth of your deep analyzer trace memory in the entry field beside Unload Depth. Then click OK or Apply. This sets unload depth to maximum.
- 2 For this measurement, the analyzer will drive trig1 and the emulator will receive trig1 from the trigger bus inside the card cage. The trig1 signal is used to cause the emulator to break to its monitor program shortly before the trace memory is filled. This use of trig1 is not supported in workstation interface commands. Therefore, terminal interface commands (accessible through the pod command feature) must be used. Enter the following commands:
  - a. Choose **Settings→Pod Command Keyboard**.
  - b. Enter `tgout trig1 -c <states before end of memory>`  
(trigger output trig1 before trace complete).
  - c. Enter `bc -e trig1` (break conditions enabled on trig1).
  - d. Click the **suspend** softkey.

Note that "tgout trig1 -c <states...>" means generate trig1 as an output when the state that is <states...> before the end of the trace memory is captured in the trace memory; "bc -e trig1" means enable the emulator to break to its monitor program when it receives trig1.

Select a value for <states before end of memory> that allows enough time and/or memory space for the emulator to break to its monitor program before the trace memory is filled. Otherwise, some of your program execution will not be captured in the trace. Many states may be executed before the emulation break occurs, depending on the state of the processor when the trig1 signal arrives. Also, if your program executes critical routines in which interrupts are masked, the occurrence of trig1 may be ignored until the critical routine is completed (when using a foreground monitor).

- 3 If you are using a foreground monitor, enter the following additional pod commands to prevent the trace memory from capturing monitor execution. The following example commands will obtain this result in some emulators:
  - a. Choose **Settings→Pod Command Keyboard**.
  - b. Enter `trng addr=<address range occupied by your monitor>`  
(trigger on range address = <address range>)  
where <address range> is expressed as <first addr>..<last addr>.
  - c. Enter `tsto !r` (trace store not range).
  - d. Click the **suspend** softkey.

**To capture a continuous stream of program execution no matter how large your program**

Note that "trng addr=<addr>..<addr>" means define an address range for the analyzer; "tsto !r" means store all trace activity except activity occurring in the defined address range.

**4 Start the analyzer trace with the command, `Trace→Again`****5 Start your program running using `Execution→Run→from()`, from `Transfer Address`, or from `Reset`, as appropriate.**

The **Trace→Again** (or *trace again*) command starts the analyzer trace with the most recent trace specifications (including the pod\_command specifications you entered). The trace command cannot be used by itself because it defaults the "bc -e trig1", "trng addr=...", and "tsto !r" specifications, returning them to their default values before the trace begins.

You can see the progress of your trace with the command, **Display→Status**. A line in the Trace Status listing will show how many states have been captured.

**6 The notation "trig1 break" usually followed by "Emulation trace complete" will appear on the status line. If "trig1 break" remains on the status line without "Emulation trace complete", manually stop the trace with the command:****Trace→Stop**

You must wait for the notation "trig1 break" and/or "Emulation trace complete" to appear on the status line; this ensures the trace memory is filled during the trace (except for the unfilled space you specified in Step 2 above).

Note that when you set a delay specification using tgout -c or tgout -t (trigger output delay before trace complete/after trigger), the trace will indicate complete as soon as the analyzer has captured the state specified, even though the entire trace memory has not been filled.

If the notation "trig1 break" remains on the status line without being replaced by "Emulation trace complete", it indicates the trace memory is not completely filled, and no more states are being captured.

**7 Store the entire trace memory content in a file with a command like:**

**`wait measurement_complete ; copy trace to` <directory/filename>**

The "wait" command is inserted ahead of the "copy" command to ensure that the unload of trace data is complete before you try to store it. Without "wait", you will get an ERROR message warning that the unload is still in process.

The <filename> is an ASCII filename for a binary file that can be viewed using the load trace command.

**8 Start a new trace with the command: `trace again`**

To capture a continuous stream of program execution no matter how large your program

- 9 Resume the program run from the point where it was interrupted when the emulator broke to the monitor with the command **run**.
- 10 Wait until the notation "trig1 break" and/or "Emulation trace complete" appears on the status line. Then store the new trace memory content in a new file with commands like:

**stop\_trace**

**wait measurement\_complete ; copy trace to** <directory/filename+1>

Note that "filename+1" in the above command suggests use of consecutive filenames to store your execution files, such as FILENAME1, FILENAME2, etc.

Repeat steps 8 through 10 above until all program execution has been captured. Your destination directory will have a set of files that, taken together, contain all of your program execution. Note that if you did not prevent capture of foreground monitor cycles in step 3 above, the last few trace lines in each file may contain monitor cycles.

---

## Using the Sequencer

When you use the analyzer's sequencer, you can specify traces that trigger on a series, or sequence, of states. You can specify a state which, when found, causes the analyzer to restart the search for the sequence of states. Also, the analyzer's sequencer allows you to trace "windows" of code execution.

This section describes how to:

- Trigger after a sequence of states.
- Specify a global restart state.
- Trace "windows" of program execution.
- Specify both sequencing and windowing.

The sequencing and windowing capabilities from within the Softkey Interface are not as powerful or flexible as they are from within the Terminal Interface. For example, in the Terminal Interface, you can specify different restart states for each sequence term and you can set up a windowing trace specification where the trigger does not have to be in the window. If you do not find the sequencing flexibility you need from within Softkey Interface, refer to the *6833x Emulator User's Guide for the Terminal Interface*.



## To trigger after a sequence of states

- Create your first specification form on the command line. That will enter the proper format in the Trace Specification Selection dialog box. Obtain the dialog box by choosing **Trace**→**Trace Spec...** You can click on your specification in the dialog box, edit it if desired, and click OK.
- Using the command line, specify a trace sequence by entering:

```
trace find_sequence <bus_state> occurs <#times>  
then <bus_state> occurs <#times> trigger  
<bus_state>
```

<bus\_state> represents a combination of address, data and status expressions that must be matched to satisfy the trigger or sequence qualifier. <#times> is the number of times that bus state must occur to satisfy the qualifier.

The analyzer's sequencer has several levels (also called *sequence terms*). Each state in the series of states to be found before triggering, as well as the trigger state, is associated with a sequence term.

When triggering using the sequencer, the analyzer searches for the state associated with the first sequence term. When that state is captured, the analyzer starts searching for the state associated with the second term, and so on. The last sequence term used is associated with the trigger state. When the trigger state is captured the analyzer is triggered. Up to seven sequence terms and an optional occurrence count for each term are available.



**Examples**

In the demo program, suppose you wish to trigger on the following sequence of events: the "save\_points" function, the "interrupt\_sim" function, and finally the "do\_sort" function. Also, suppose you wish to store only opcode fetches of the assembly language LINK A6,#0 instruction (data values that equal 4E56H) to show function entry addresses.

To set up the sequencing trace specification, enter the following trace command.

```
trace find_sequence save_points then
interrupt_sim trigger about do_sort only data
4e56h
```

```
set source off
```

Trace List	Address	Offset=0	Opcode or Status	More data off screen
Label:	symbols		mnemonic w/symbols	time count
Base:				relative
-012	upda.set_outputs	4E56	pgm word rd (ds16)	5.22 mS
-011	updat.write_hdr	4E56	pgm word rd (ds16)	27.6 mS
sq adv	upda.save_points	4E56	pgm word rd (ds16)	6.04 mS
sq adv	ma.interrupt_sim	4E56	pgm word rd (ds16)	4.06 mS
-008	pr.proc_specific	4E56	pgm word rd (ds16)	7.06 mS
-007	up.update_system	LINK	A6, #****	3.27 mS
-006	upda.get_targets	LINK	A6, #****	16.6 uS
-005	.read_conditions	LINK	A6, #****	2.04 mS
-004	upda.set_outputs	LINK	A6, #****	5.22 mS
-003	updat.write_hdr	LINK	A6, #****	27.6 mS
-002	upda.save_points	LINK	A6, #****	6.04 mS
-001	ma.interrupt_sim	LINK	A6, #****	4.06 mS
<b>about</b>	pro main.do_sort	LINK	A6, #****	9.25 mS
+001	pro main.strcpy8	LINK	A6, #****	5.65 mS
+002	pro main.strcpy8	LINK	A6, #****	249. uS
+003	pro main.strcpy8	LINK	A6, #****	249. uS

Notice the states that contain "sq adv" in the first column (you may have to press <PREV> in order to see the states captured prior to the trigger). These are the states associated with (or captured for) each sequence term. Just as the trigger state is always stored in trace memory, the states captured in the sequence are always stored if the trace buffer is deep enough.

## To specify a global restart state

- Create your first specification form on the command line. That will enter the proper format in the Trace Specification Selection dialog box. Obtain the dialog box by choosing **Trace**→**Trace Spec...** You can click on your specification in the dialog box, edit it if desired, and click OK.
- Using the command line, restart the search for the trace sequence terms by including the restart parameter in

```
trace find_sequence <bus_state> occurs <#times>  
then <bus_state> occurs <#times> restart  
<bus_state> trigger <bus_state>
```

<bus\_state> represents a combination of address, data and status expressions that must be matched to satisfy the trigger or sequence qualifier. <#times> is the number of times the selected bus state must occur to satisfy the qualifier.

The restart qualifier allows you to restart the trace sequence whenever a certain instruction or data access occurs. For example, you might have a complicated trace sequence that searches for an intermittent failure condition. You could set the restart term to restart the sequence whenever a bus cycle occurred that ensures that the code segment would perform correctly. Thus, the trace will be satisfied only when that restart term never occurs and the code segment fails.

---

### Examples

In the demo program, suppose you wish to trigger on the following sequence of events: the "save\_points" function, the "interrupt\_sim" function, and the "do\_sort" function. However, you only want to trigger when the "interrupt\_sim" calls the "do\_sort" function. In other words, if the "proc\_specific" function is entered before the "do\_sort" function is entered, you know "interrupt\_sim" did not call "do\_sort" this time, and the analyzer should start searching again from the beginning.

Again, suppose you wish to store only opcode fetches of the assembly language LINK A6,#0 instruction (data values that equal 4E56H).

To set up this sequencing trace specification, enter the following trace command.

```
trace find_sequence save_points then
interrupt_sim restart proc_specific trigger about
do_sort only data 4e56h
```

**set source off**

Trace List	Address	Offset=0	Opcode or Status	More data off screen
Label:	symbols		mnemonic w/symbols	time count
Base:				relative
-007	up.update_system	LINK	A6, #****	3.27 mS
-006	upda.get_targets	LINK	A6, #****	16.6 uS
-005	.read_conditions	LINK	A6, #****	2.04 mS
-004	upda.set_outputs	LINK	A6, #****	5.22 mS
-003	updat.write_hdr	LINK	A6, #****	27.6 mS
sq adv	upda.save_points	LINK	A6, #****	6.04 mS
sq adv	ma.interrupt_sim	LINK	A6, #****	4.06 mS
<b>about</b>	pro main.do_sort	LINK	A6, #****	504. uS
+001	pro main.strcpy8	LINK	A6, #****	5.65 mS
+002	pro main.strcpy8	LINK	A6, #****	249. uS
+003	pro main.strcpy8	LINK	A6, #****	249. uS
+004	pro main.strcpy8	LINK	A6, #****	249. uS
+005	pro main.strcpy8	LINK	A6, #****	249. uS
+006	pro main.strcpy8	LINK	A6, #****	249. uS
+007	pro main.strcpy8	LINK	A6, #****	249. uS
+008	pro main.strcpy8	LINK	A6, #****	249. uS

Notice in the preceding trace (you may have to press <PREV> in order to see the states captured prior to the trigger) that, in addition to states captured in the sequence, "sq adv" is also shown next to states which cause a sequencer restart.

## To trace "windows" of program execution

- Create your first specification form on the command line. That will enter the proper format in the Trace Specification Selection dialog box. Obtain the dialog box by choosing **Trace**→**Trace Spec...** You can click on your specification in the dialog box, edit it if desired, and click OK.
- Using the command line, enter commands as follows:
  - To trace only the states occurring after a particular bus cycle, enter:

```
trace enable <bus_state>
```

- To trace only the states occurring between two particular bus cycles, enter:

```
trace enable <bus_state> disable <bus_state>
```

<bus\_state> represents a combination of address, data and status expressions that must be matched to satisfy the windowing qualifier.

Windowing refers to the analyzer feature that allows you to turn on, or enable, the capturing of states after some state occurs then to turn off, or disable, the capturing of states when another state occurs. In effect, windowing allows you capture "windows" of code execution.

Windowing is different than storing states in a range (the only range option in the trace command syntax) because it allows you to capture execution of all states in a window of code whereas storing states in a range won't capture the execution of subroutines that are called in that range or reads and writes to locations outside that range.

When you use the windowing feature of the analyzer, the trigger state must be in the window or else the trigger will never be found.

If you wish to combine the windowing and sequencing functions of the analyzer, there are some restrictions:

- Up to four sequence terms are available when windowing is in effect.
- Global restart is not available when windowing is in effect.
- Occurrence counts are not available.

**Examples**

In the demo program, suppose you are only interested in the execution that occurs within the switch statement of the "combsort" function. You could specify source line number 229 as the window enable state and the source line number of the next statement (line number 241) as the window disable state. Set up the windowing trace specification with the following command.

```
trace enable main."main.c": line 229 disable
main."main.c": line 241
```

```
set source on
```

Trace List	Offset=0	More data off screen	
Label:	Address	Opcode or Status w/ Source Lines	time count
Base:	symbols	mnemonic w/symbols	relative
#####main.c - line 239 thru 241#####			
/* Do the comb sort loop for this comb gap */			
for (top=len-gap,i=0; i < top; i++)			
sq adv	combsort+0000E0	MOVER.L D3,A0	720 nS
#####main.c - line 227 thru 229#####			
/* Force gap to conform to comb11 */			
switch (gap)			
sq adv	combsort+000098	MOVE.L (A3),D0	5.67 mS
+013	combsort+00009A	CMPI.L #0000000B,D0	360 nS
+014	da main.switches	0000 data long wr (ds16)	360 nS
+015	.switches+000002	0000 data word wr (ds16)	360 nS
+016	data main.gap	0000 data long rd (ds16)	360 nS
+017	main.gap+000002	001B data word rd (ds16)	360 nS
+018	combsort+00009C	0000 pgm word rd (ds16)	360 nS

Notice in the resulting trace (you have to press the <NEXT> key) that the enable and disable states have the "sq adv" string in the line number column. This is because the windowing feature uses the analyzer's sequencer.

## To specify both sequencing and windowing

- Create your first specification form on the command line. That will enter the proper format in the Trace Specification Selection dialog box. Obtain that dialog box by choosing **Trace**→**Trace Spec...** You can click on your specification in the dialog box, edit it if desired, and click OK.
- Using the command line, enter commands as follows:
- Specify a trace sequence that starts with a window and ends with a trigger by entering:

```
trace enable <bus_state> disable <bus_state>  
find_sequence <bus_state> then <bus_state>  
trigger <bus_state>
```

<bus\_state> represents a combination of address, data and status expressions that must be matched to satisfy the trigger or sequence qualifier. <#times> is the number of times that bus state must occur to satisfy the qualifier.

You can use the sequencing and windowing specifications together to make specification of complex qualifiers easier. If you use the windowing specification, the sequence specification is limited to four sequence terms. Also, note that when you use a windowing specification, you cannot use a restart term with your sequence specification.

---

### Example

Use the analyzer sequencer to trace states occurring between the start of the example program and the call to the message interpreter, then trigger after access to the variable that stores the value of current humidity, but only if it is accessed after a specific series of events:

```
trace enable main disable proc_spec find_sequence  
update_sys.get_targets then update_sys.write_hdwr  
trigger after current_humid
```

---

## Displaying the Trace List

The *trace list* is your view of the analyzer's record of processor bus activity. You can specify what is shown in the trace list to make it easier to find the information of interest. For example, you can display symbol information where available, or source lines from the high-level languages used to write the target system program. You can also change the column widths and set options for disassembly of the trace list.

This section covers many of the options available for controlling the trace display. Display control is available through the **Trace→Display Options...** dialog box, the trace list popup menu, and the command line. You can combine most options within a single command on the command line to obtain a desired trace display. See the display trace and set command descriptions in the "Emulator/Analyzer Interface Commands" chapter for more information. This section describes how to:

- Use the Trace Options dialog box.
- Use the trace list popup menu.
- Display the trace about a line number.
- Move through the trace list.
- Disassemble the trace list.
- Specify trace disassembly options.
- Specify trace dequeuing options.
- Display the trace without disassembly.
- Display symbols in the trace list.
- Display source lines in the trace list.
- Change the column width.
- Select the type of count information in the trace list.
- Offset addresses in the trace list.
- Reset the trace display defaults.
- Change the number of states available for display.
- Display program memory associated with a trace list line.
- Open an edit window into the source file associated with a trace list line.

**Examples**

To use the Trace Options dialog box:

Click to select the desired format of trace disassembly.

Click to select the way that absolute status information is shown in the trace list.

Click to select count reference: Relative (to preceding state), or Absolute (to trigger).

Click to select trace list dequeuing, if available for your emulator.

Enter the desired depth of the trace memory to be unloaded for display or storage in a file.

Enter a value to be subtracted from addresses and symbol/source-line references shown in the trace list

Enter the desired trace list line number to be placed on screen.

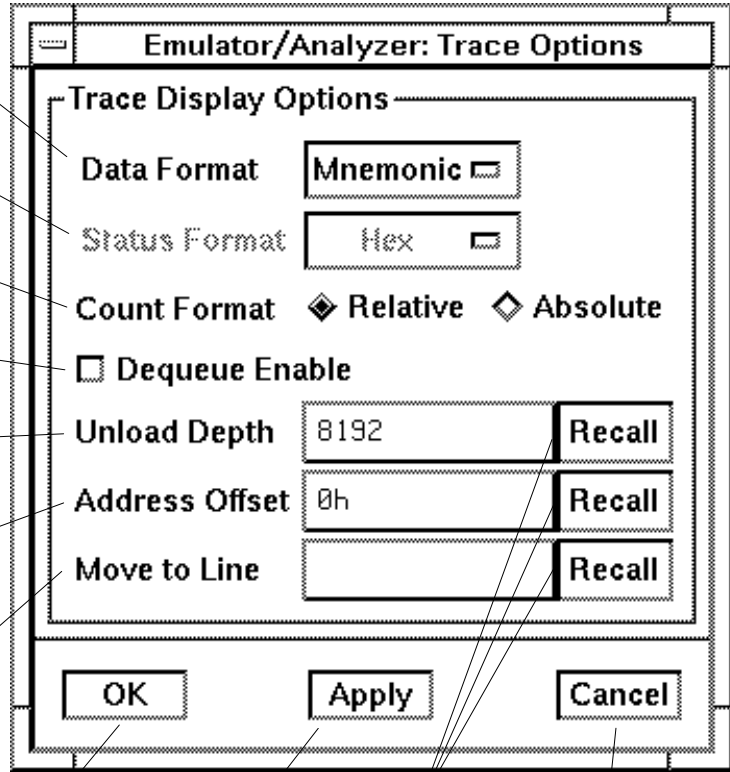

Click OK to specify the trace options and close the dialog box.

Click Apply to specify the trace options and leave the dialog box open.

Click these pushbuttons to select predefined or previously specified entries.

Click this pushbutton to cancel the entries and close the dialog box.



**Examples**

To use the trace list popup menu:

Click to begin trace disassembly from the selected line, moving that line to the top of the display.

Click to open an edit window into the source file that contains the address of the selected line.

Click to open a display window into memory containing the address of the selected line. Note that the format of the memory display will be mnemonic for addresses in the code segment and absolute otherwise.

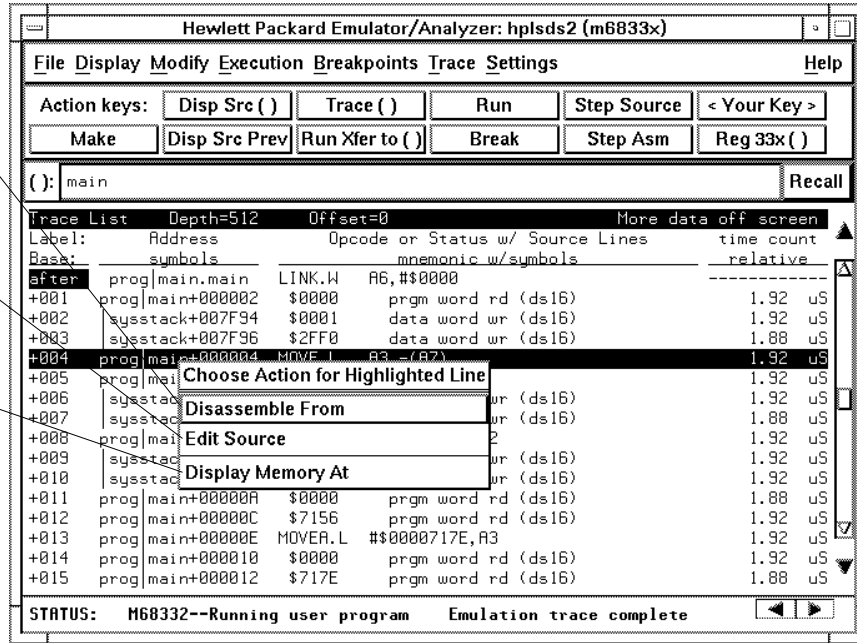

## To display the trace about a line number

- Choose **Trace→Display Options...** and in the dialog box, enter the desired trace list line number in the field beside Move to Line. Then click the OK or Apply pushbutton.
- Center the trace display about a particular state given by <LINE #> by entering

*display trace <LINE #>*

If you need to move to a particular state quickly, you can use this command. The command places the specified state in the center of the current trace display.



---

### Examples

Display the trace about line number 20:

Choose **Trace→Display Options...** and in the dialog box, enter 20 in the field beside Move to Line. Then click the OK or Apply pushbutton.

Enter the following command on the command line to display the trace about line number 256:

*display trace 256*

---

---

## To move through the trace list

- Use the scroll bar at the right of the display to scroll up and down. Use the arrows at the bottom of the display (if any) to scroll left and right.
- Using the command line, enter commands as follows:
  - To roll the trace display to the left, press <Ctrl>f simultaneously.
  - To roll the trace display to the right, press <Ctrl>g simultaneously.
  - To roll the display down one line, press the down arrow key.
  - To roll the display up one line, press the up arrow key.
  - To move to the previous page in the trace list, press the Pg Up or Prev key.
  - To move to the next page in the trace list, press the Pg Dn or Next key.

Though the trace display is set to 256 or more states, only 15 lines may be displayed in the interface window, depending on your terminal type. You can move through the trace list display using various key combinations.

You can roll the display left and right only if the trace list is wider than 80 columns. This may occur if you increased the width of the columns.

---

## To disassemble the trace list

- Choose **Trace→Display Options...** and in the dialog box, select **Data Format Mnemonic**. Then click the OK or Apply pushbutton.
- Use the mouse to place the cursor on a line in the trace list where you want disassembly to begin. Then press the *select* mouse button, and click on **Disassemble From** in the trace list popup menu.
- Using the command line, enter commands as follows:
  - To disassemble instruction data in the trace list, enter:

*display trace mnemonic*

- To control where trace list disassembly starts, enter:

***display trace disassemble\_from\_line\_number***  
<LINE #>

<LINE #> is a line number corresponding to a state in the trace list.

Disassembly of instruction data means that you will see instructions as they would appear in an assembly language program listing. That is, instruction mnemonics and operands are shown instead of hexadecimal instruction data.

The analyzer interface normally disassembles instruction data in the trace list. However, if you specify absolute data display, that mode remains in effect until you select the mnemonic option.

When you identify a particular trace list line where disassembly is to begin, be sure to specify a line number that corresponds to an analyzer state with an opcode fetch. The analyzer interface disassembles and displays the trace starting with the state you specify.

---

### Examples

To disassemble instruction data in the trace list starting at line 40:

Place the cursor on line 40, press the select mouse button, and click on Disassemble From in the popup menu.

Or, using the command line, enter:

***display trace disassemble\_from\_line\_number*** 40

---

---

## To specify trace disassembly options

- Selection of disassembly options is not supported in pull-downs of the Graphical User Interface. By default, the Graphical User Interface selects **high\_word** and **all\_cycles**. Use the command line if you need to specify trace disassembly using other options.
- Using the command line, enter commands as follows:
  - To show only instruction cycles in the trace list, enter:

```
display trace disassemble_from_line_number  
<LINE#> instructions_only
```

- To show all bus cycles in the trace list, enter:

```
display trace disassemble_from_line_number  
<LINE#> all_cycles
```

Normally, the MC6833x presents the trace list data as it was stored by the analyzer. That is, all bus cycles are shown, and disassembly starts with the most significant word of the data.

If you don't want to see operand cycles in the trace list, specify the `instructions_only` option.

The disassembly options remain in effect until you specify a new disassembly option.

Note that although the "high\_word," "low\_word" and "align" options are displayed, these are for 32-bit processors only, and will not perform any action.

---

**Examples**

Show only instruction cycles in the trace list starting at line 40:

```
display trace disassemble_from_line_number 40  
instructions_only
```

Show all bus cycles in the trace list:

```
display trace disassemble_from_line_number 40  
all_cycles
```

---

**To specify trace dequeuing options**

- Choose **Trace→Display Options...** and in the dialog box, select Dequeue Enable. Then click the OK or Apply pushbutton.
- Using the command line, enter commands as follows:
  - To dequeue the trace list, enter:

```
display trace dequeue on
```

- To display the trace list without dequeuing, enter:

```
display trace dequeue off
```

<LINE #> is a line number corresponding to a state in the trace list.  
<STATE#> is the line number of the data operand that is associated with the instruction at <LINE#>.

A dequeued trace list is available through the disassembly options. In a dequeued trace list, unused instruction prefetch cycles are discarded, and operand cycles are placed immediately following the corresponding instruction fetch. If you choose a non-dequeued trace list, instruction and operand fetches are shown exactly as captured by the analyzer.

Once the dequeuer has been started on the correct opcode, it will continue to disassemble correctly unless an unusual condition causes it to misinterpret the data. By specifying the first instruction state for disassembly and the number of the first operand cycle for that instruction, you can resynchronize the disassembly.

You may see TAKEN, NOT TAKEN, or ?TAKEN? beside a branch in your dequeued trace list. TAKEN is shown beside a branch if the dequeuer determines that the branch was taken. NOT TAKEN is shown if the dequeuer determines that the branch was definitely not taken. ?TAKEN? means the dequeuer was not able to determine whether or not the branch was taken. If you read down the trace list and see that the branch was taken, use the ***disassemble\_from\_line\_number*** command to restart disassembly at the trace list line number of the branch destination.

---

**Examples**

Dequeue the trace list:

Choose **Trace→Display Options...** and in the dialog box, select **Dequeue Enable**. Then click the OK or Apply pushbutton.

Or, using the command line, enter:

***display trace dequeue on***

Display the trace list without dequeuing:

***display trace dequeue off***

---



## To display the trace without disassembly

- Choose **Trace→Display Options...** and in the dialog box, select **Data Format Absolute**. You can select Hex, Binary, or Mnemonic format for display of status information. Then click the OK or Apply pushbutton.
- Using the command line, enter commands as follows:
  - To display the trace list without instruction disassembly and with status information in binary format, enter:

*display trace absolute status binary*

- To display the trace list without instruction disassembly and with status information in hexadecimal format, enter:

*display trace absolute status hex*

- To display the trace list without instruction disassembly and with status information in mnemonic format, enter:

*display trace absolute status mnemonic*

For some measurements, it may be more convenient for you to view the trace data without instruction disassembly. The **Data Format Absolute** selection in the **Trace→Display Options...** dialog box, or the *display trace absolute* command allows you to do this. Notice that once you enter this format selection, subsequent trace lists will be displayed in this format until you select the mnemonic format with the dialog box or display trace mnemonic command again.

You can select the display format for the status information when you choose **Data Format Absolute** in the dialog box, or when you use the *display trace absolute* command. The status information can be displayed in binary, hex, or as mnemonics that indicate the nature of the current bus cycle (such as a read or write).



---

**Examples**

Display the trace list without instruction disassembly and with status information in binary format:

Choose **Trace→Display Options...** and in the dialog box, select **Data Format Absolute**. Select **Status Format Binary**. Then click the OK or Apply pushbutton.

Or, using the command line, enter:

*display trace absolute status binary*

Display the trace list without instruction disassembly and with status information in hexadecimal format, make appropriate entries in the **Trace→Display Options...** dialog box, or enter the following command:

*display trace absolute status hex*

Display the trace list without instruction disassembly and with status information in mnemonic format, make appropriate entries in the **Trace→Display Options...** dialog box, or enter the following command:

*display trace absolute status mnemonic*

---

## To display symbols in the trace list

- Choose **Settings**→**Source/Symbol Modes**→**Symbols**, or choose **Settings**→**Display Modes ...**, and in the dialog box, click on **Symbolic Addresses**. In the Field Widths area of the dialog box, you can select the widths of the Label Field and Symbols in Mnemonic Field to control the display space allocated to the symbols. To select symbol types, use the command line, described below.
- Using the command line, enter commands as follows:
  - To display symbols in the trace list, enter:

*set symbols on*

- To display only high level symbols, enter:

*set symbols high*

- To display only low level symbols, enter:

*set symbols low*

- To display all symbols (both high and low level), enter:

*set symbols all*

When you enable symbol display, addresses and operands are replaced by the symbols that correspond to those values. The symbol information is derived from the SRU symbol database for that command file. See Chapter 6, "Using the Emulator" for more information on SRU and symbol handling.

High-level symbols are those that are available only from high-level languages such as a compiler. Low-level symbols are those that are available from assembly language modules (which may include symbols generated internally by a compiler).

The **Settings→Source/Symbol Modes...**, **Settings→Display Modes...**, or **set symbols** command remains in effect until you enter a new **Settings→Source/Symbol Modes...**, **Settings→Display Modes...**, or **set symbols** command with different options.

Refer to Chapter 6, "Using the Emulator", for details of how to set up and use the Display Modes dialog box.

---

## To display source lines in the trace list

- Choose **Settings→Source/Symbol Modes→Source Mixed** or **Settings→Source/Symbol Modes→Source Only**.
- Choose **Settings→Display Modes...**, and in the dialog box, click on **Source in Trace** and select either **Source Mixed** or **Source Only** from the submenu.
- Using the command line, enter commands as follows:
  - To display mixed source and assembly language in the trace list, enter:

**set source on**

- To display only source language statements in the trace list, enter:

**set source only**

- To display only assembly language in the trace list, enter:

**set source off**

If you developed your target programs in a high-level language such as "C," you can display the source code in the trace list with the corresponding assembly language statements. Or, you can choose to display only the source listing without the assembly language information.

The analyzer uses the line-number information in the SRU symbol database for the absolute file to reference between source lines and assembly language information. Refer to Chapter 6, "Using the Emulator" for more information on SRU and symbol handling.

## To change the column width

- Choose **Settings**→**Display Modes...**, and select desired widths for information in the trace list by using the dialog box. Refer to the "Examples" page under "To display symbols in the trace list", earlier in this chapter for details of how to use the dialog box.
- To set the column width for the address column in the trace list, enter:

```
set width label <WIDTH>
```

- To set the column width for the mnemonic column in the trace list, enter:

```
set width mnemonic <WIDTH>
```

- To set the column width for source lines in the trace list, enter:

```
set width source <WIDTH>
```

<WIDTH> is an integer between 1 and 80, specifying the width of the column in characters. (<WIDTH> is restricted to certain values which are shown if you press the <WIDTH> softkey.)

You can display more information by widening a column or ignore the information by narrowing the column. For example, you might want to widen the label column so that you can see the complete names of the symbols in that column.

You can combine multiple options on the command line to set the width for several columns at once.

---

**Example**

Set the width of the address label column to 30 characters and the width of the mnemonic column to 50 characters:

```
set width label 30 mnemonic 50
```

---

---

## To select the type of count information in the trace list

- Choose **Trace→Display Options...** and in the dialog box, select Count Format Relative or Absolute, as desired. Then click the OK or Apply pushbutton.
- To display count information in the trace list relative to the trigger state, enter:

```
display trace count absolute
```

- To display count information in the trace list relative to the previous trace list state, enter:

```
display trace count relative
```

Count information may be displayed two ways: relative (which is the default), or absolute. When relative is selected, count information is displayed relative to the previous state. When absolute is selected, count information is displayed relative to the trigger condition.

The count information in the trace list is always displayed if count display is turned on. To turn on the trace counting function, enter a command beginning with trace counting on the command line. Refer to "To count states or time" later in this manual for details.

When using the 1K analyzer, the trace memory is 512 states deep if counting states or time is turned on and 1024 states deep if counting is turned off. To disable counting in the 1K analyzer, use the command trace counting off. When using the deep analyzer, full memory depth is always available; the depth of the deep analyzer is not affected by the counting selected. See "To count states or time."

---

**Examples**

Count time and store only each iteration of the update\_sys symbol in the demo program (if using the 1K analyzer, make sure the clock speed is set to "Slow" in the configuration):

Specify the trace for the emulator:

```
trace only update_sys counting time
```

Now, start the program run; then display the trace:

```
run from transfer_address
```

```
display trace count relative
```

Count absolute entries into the get\_targets routine of the demo program:

```
trace only address range update_sys thru  
update_sys end counting state get_targets
```

```
run from transfer_address
```

```
display trace count absolute
```

---

---

## To offset addresses in the trace list

- Choose **Trace→Display Options...** and in the dialog box, enter the desired offset value in the field beside Address Offset. Then click the OK or Apply pushbutton.
- Use the **offset\_by** command-line option to the **display trace** command.

The Address Offset or offset\_by trace display options allow you to cause the address information in the trace display to be offset by the amount specified. The offset value is subtracted from the instruction's physical address to yield the address that is displayed.

If code gets relocated and therefore makes symbolic information invalid, you can use the Address Offset or offset\_by option to change the address information so that it again agrees with the symbolic information.

You can also specify an offset to cause the listed addresses to match the addresses in compiler or assembler listings.

---

### Example

Trace execution from entry of the demo program (the main label) then offset by the value of main so that the addresses appear the same as the location counter in the assembler listing:

```
reset  
trace  
run from transfer_address  
display trace offset_by main
```

---

## To reset the trace display defaults

- Choose **Settings**→**Display Modes...** Then in the dialog box, click on Default All Settings, and click the OK pushbutton. This leaves the trace display in the "source intermixed and symbols on" mode.
- Using the command line, enter:

***set default***

This turns off all symbolics and source references in the interface.

---

## To change the number of states available for display

- Choose **Trace**→**Display Options...** and in the dialog box, enter the desired number of states to be made available for display in the field beside Unload Depth. Then click the OK or Apply pushbutton.
- Using the command line, set the depth of the trace list with:

***display trace depth*** <DEPTH#>

<DEPTH#> is the number of states to be available in the trace list for displaying, copying, or storing to a file. If you are using the deep analyzer, the depth of the trace list buffer depends on whether or not you installed memory modules on the analyzer card, and the capacity of the memory modules installed. Refer to the Hewlett-Packard *MC6833x Emulator/Analyzer Installation/Service/Terminal Interface Guide* for details. If you are using the 1K analyzer, the trace list buffer is 512 or 1024 states deep (depending on whether or not you turn on the state/time count). See "To count states or time" in this chapter.)

When you display the trace list, the interface requests the number of states specified by the trace depth from the emulator. If you want faster trace display, you can decrease the trace depth. To display more states, you can increase the trace depth. Notice that the trace depth setting only regulates the number of states sent from the emulation-bus analyzer to the interface. You still need to use the Pg Up and Pg Dn keys to page through the trace list.



---

**Examples**

Set the depth of the trace memory to 256 states:

Choose **Trace**→**Display Options...** and in the dialog box, enter 256 in the field beside Unload Depth. Then click the OK or Apply pushbutton.

Set the depth of the trace to 1024 states:

*display trace depth* 1024

---

---

### To display program memory associated with a trace list line

- Using the mouse, place the cursor on the line in the trace list where you want to see the associated content of program memory. Then press the *select* mouse button, and click on **Display Memory At** in the trace list popup menu.

You will see a display of memory at the location of the program that emitted the selected trace list line. This is the same as placing the program address of the selected trace list line in the entry buffer and choosing **Display**→**Memory**→**At()** in the pulldown menus.

---

### To open an edit window into the source file associated with a trace list line

- Using the mouse, place the cursor on the line in the trace list whose source file you wish to edit. Then press the *select* mouse button, and click on **Edit Source** in the trace list popup menu.

A new window will open. It will show the source file that emitted the line you selected in the trace list. An edit session will be in progress on the source file in the new window. When you complete the desired edit, save the file and close the window.

---

---

# Saving and Restoring Trace Data and Specifications

The emulator/analyzer can save your trace data and trace specifications in a file for later use. This can help you record measurement results that you can use for comparison with other tests, and it is useful to automate measurements.

Suppose you're using the emulator in a manufacturing test application. The target system is your product board. You might build a command file that recalls a trace specification, makes the trace on the target board, and then recalls a previous measurement result (from a working product) and compares it to the new measurement (using the UNIX diff command).

This section describes how to:

- Store a trace specification.
- Store trace data.
- Load a trace specification.
- Load trace data.

---

## To store a trace specification

- Choose **File**→**Store**→**Trace Spec...** In the dialog box, select an existing filename or specify a new filename to contain the present trace specification. Then click OK.
- Using the command line, store the current trace specification by entering:

```
store trace_spec <filename>
```

<filename> is any UNIX file name including paths. The extension .TS is automatically added to the file name.

The trace specification file is a binary file.

The ***store trace\_spec*** command allows you to save a trace specification (effectively the current trace command with all trigger, storage and sequence options) in a file for later use. For example, you might have several trace

commands that you want to make every time your target system program is modified. You can store each trace command in a separate file and recall it later using the **load trace\_spec** command.

---

**Example**

Store a trace specification to a file:

```
store trace_spec tspec.TS
```

---

---

## To store trace data

- Choose **File→Store→Trace Data...** In the dialog box, select an existing filename or specify a new filename to contain the present trace memory content. Then click OK.
- Using the command line, store the current trace data by entering:

```
store trace <filename>
```

<filename> is any UNIX file name including paths. The trace data file is a binary file. The extension .TR is automatically added to the file name. A trace data file can be reloaded into the interface and displayed like any other trace listing.

You can store the trace data resulting from a measurement. This can be useful if you want to compare the results of later measurements with a reference result obtained in an earlier measurement.

---

**Example**

Store a trace to a file:

```
store trace tracel.TR
```

---

## To load a trace specification

- Choose **File→Load→Trace Spec...** In the dialog box, click on the name of the trace specification you want to load (placing it in the Load Trace Specification box). Then click OK.
- Using the command line, load an existing trace specification from a file by entering:

```
load trace_spec <filename>
```

<filename> is any UNIX file name including paths. The extension .TS is assumed.

Once you save a trace specification in a file using the **File→Store→Trace Spec...** or *store trace\_spec* command, you can load it using the appropriate command above. To start a trace with the trace specification that you loaded, use the **Trace→Again** or *trace again* command.

---

### Example

Load a trace specification from a file and start the trace:

```
load trace_spec tspec
```

```
trace again
```

---

---

## To load trace data

- Choose **File**→**Load**→**Trace Data...** In the dialog box, click on the name of the trace data file (file of trace memory content) you want to load (placing it in the Load Trace Data box). Then click OK.
- Using the command line, load trace data from a file by entering:

***load trace*** <filename>

<filename> is any UNIX file name including paths. The extension .TR is assumed.

Loads a previously saved trace from a binary trace data file (with a ".TR" suffix).

Once you save trace data in a file using the **File**→**Store**→**Trace Data...** or ***store trace*** command, you can reload it. To view the data you loaded, use the **Display**→**Trace**, **Trace**→**Display**, or ***display trace*** command. Remember that a new trace measurement will overwrite this trace data (but not the file from which it was loaded).

The interface will try to display the trace listing in the display format active when the trace data was stored. If the interface needs symbols to replace absolute addresses or to find high-level source lines, and symbols are not loaded, an error occurs.

For example, suppose "source-mixed" was the display mode when the trace was captured and the executable file "test1" was the file being executed in the emulator/target system. To reload and display a trace listing saved from that emulation session requires reloading the symbols for "test1".

---

### Example

Load a trace from a file:

***load trace*** tracel

---





---

## Making Software Performance Measurements

---

# Making Software Performance Measurements

The Software Performance Measurement Tool (SPMT) is a feature of the Softkey Interface that allows you to make software performance measurements on your programs.

The SPMT allows you to make some of the measurements that are possible with the HP 64708 Software Performance Analyzer and its Graphical User Interface (HP B1487).

The SPMT post-processes information from the analyzer trace list. When you end a performance measurement, the SPMT dumps the post-processed information to a binary file, which is then read using the perf32 report generator utility.

Two types of software performance measurements can be made with the SPMT: activity measurements, and duration measurements.

This chapter describes tasks you perform while using the Software Performance Measurement Tool (SPMT). These tasks are grouped into the following sections:

- Activity performance measurements.
- Duration performance measurements.
- Running performance measurements and creating reports.



---

# Activity Performance Measurements

Activity measurements are measurements of the number of accesses (reads or writes) within an address range. The SPMT shows you the percentage of analyzer trace states that are in the specified address range, as well as the percentage of time taken by those states. Two types of activity are measured: memory activity, and program activity.

Memory activity is all activity that occurs within the address range.

Program activity is the activity caused by instruction execution in the address range. Program activity includes opcode fetches and the cycles that result from the execution of those instructions (reads and writes to memory, stack pushes, etc.).

For example, suppose an address range being measured for activity contains an opcode that causes a stack push, which results in multiple write operations to the stack area (outside the range). The memory activity measurement will count only the stack push opcode cycle. However, the program activity measurement will count the stack push opcode cycle and the write operations to the stack.

By comparing the program activity and the memory activity in an address range, you can get an idea of how much activity in other areas is caused by the code being measured. An activity measurement report of the code (prog), data, and stack sections of a program is shown below.

```
Label
prog
Address Range      ADEH thru      1261H

Memory Activity
State Percent      Rel =  57.77   Abs =  57.77
                   Mean = 295.80   Sdv =  26.77
Time Percent       Rel =  60.97   Abs =  60.97

Program Activity
State Percent      Rel =  99.82   Abs =  99.82
                   Mean = 511.10   Sdv =   0.88
Time Percent       Rel =  99.84   Abs =  99.84
```

data

Address Range 6007AH thru 603A5H

Memory Activity

State Percent Rel = 30.51 Abs = 30.51  
 Mean = 156.20 Sdv = 31.87  
 Time Percent Rel = 28.09 Abs = 28.09

Program Activity

State Percent Rel = 0.18 Abs = 0.18  
 Mean = 0.90 Sdv = 0.88  
 Time Percent Rel = 0.16 Abs = 0.16

stack

Address Range 40000H thru 43FFFH

Memory Activity

State Percent Rel = 11.72 Abs = 11.72  
 Mean = 60.00 Sdv = 29.24  
 Time Percent Rel = 10.94 Abs = 10.94

Program Activity

State Percent Rel = 0.00 Abs = 0.00  
 Mean = 0.00 Sdv = 0.00  
 Time Percent Rel = 0.00 Abs = 0.00

Graph of Memory Activity relative state percents >= 1

prog 57.77% \*\*\*\*\*  
 data 30.51% \*\*\*\*\*  
 stack 11.72% \*\*\*\*\*

Graph of Memory Activity relative time percents >= 1

prog 60.97% \*\*\*\*\*  
 data 28.09% \*\*\*\*\*  
 stack 10.94% \*\*\*\*\*

Graph of Program Activity relative state percents >= 1

prog 99.82% \*\*\*\*\*

Graph of Program Activity relative time percents >= 1  
 prog 99.84% \*\*\*\*\*

Summary Information for 10 traces

Memory Activity

State count  
 Relative count 5120  
 Mean sample 170.67  
 Mean Standard Dv 29.30  
 95% Confidence 12.28% Error tolerance  
 Time count  
 Relative Time - Us 2221.20

Program Activity

State count  
 Relative count 5120  
 Mean sample 170.67  
 Mean Standard Dv 0.58  
 95% Confidence 0.24% Error tolerance  
 Time count  
 Relative Time - Us 2221.20

Absolute Totals

Absolute count - state 5120  
 Absolute count - time - Us 2221.20

This section describes how to:

- Set up the trace command for activity measurements.
- Initialize activity performance measurements.
- Interpret activity measurement reports.



## To set up the trace command for activity measurements

- 1 Specify a trace display depth of 512.
- 2 Trace after any state, store all states, and count time.

Before you initialize and run performance measurements, the current trace command (in other words, the last trace command entered) must be properly set up.

In general, you want to give the SPMT as many trace states as possible to post-process, so you should increase the trace depth to the maximum number, as shown in the following command.

If you wish to measure activity as a percentage of all activity, the current trace command should be the default (in other words, *trace* <RETURN>). The default trace command triggers on any state, and all captured states are stored. It is important that time be counted by the analyzer; otherwise, the SPMT measurements will not be correct. Also, since states are stored "after" the trigger state, the maximum number of captured states appears in each trace list.

You can qualify trace commands any way you like to obtain specific information. However, when you qualify the states that get stored in the trace memory, your SPMT results will be biased by your qualifications; the percentages shown will be of only those states stored in the trace list.

---

### Examples

To specify a trace depth of 512:

```
display trace depth 512
```

To trace after any state, store all states, and count time:

```
trace counting time
```

---

## To initialize activity performance measurements

- Use the **performance\_measurement\_initialize** command.  
After you set up the trace command, you must tell the SPMT the address ranges on which you wish to make activity measurements. This is done by initializing the performance measurement. You can initialize the performance measurement in the following ways:
  - Default initialization (using global symbols if the symbols database is loaded).
  - Initialize with user-defined files.
  - Initialize with global symbols.
  - Initialize with local symbols.
  - Restore a previous performance measurement (if the emulation system has been exited and re-entered).

### Default Initialization

Entering the **performance\_measurement\_initialize** command with no options specifies an activity measurement. If a valid symbolic database has been loaded, the addresses of all global procedures and static symbols will be used; otherwise, a default set of ranges that cover the entire processor address range will be used.

### Initialization with User Defined Ranges

You can specifically give the SPMT address ranges to use by placing the information in a file and entering the file name in the **performance\_measurement\_initialize** command.

Address range files may contain program symbols (procedure name or static), user defined address ranges, and comments. An example address range file is shown below.

```
# Any line which starts with a # is a comment.
# All user's labels must be preceded by a "|".

|users_label 10H 1000H
program_symbol

# A program symbol can be a procedure name or a static. In the case of a pro-
# cedure name the range of that procedure will be used.

|users_label2 program_symbol1 -> program_symbol2

# "->" means thru. The above will define a range which starts with symbol1
# and goes thru symbol2. If both symbols are procedures then the range will
# be defined as the start of symbol1 thru the end of symbol2.

dirl/dir2/source_file.s:local_symbol

# The above defines a range based on the address of local_symbol.
```

### Initialization with Global Symbols

When the *performance\_measurement\_initialize* command is entered with no options or with the `global_symbols` option, the global symbols in the symbols database become the address ranges for which activity is measured. If the symbols database is not loaded, a default set of ranges that cover the entire processor address range will be used.

The global symbols database contains procedure symbols, which are associated with the address range from the beginning of the procedure to the end, and static symbols, which are associated with the address of the static variable.

### Initialization with Local Symbols

When the *performance\_measurement\_initialize* command is entered with the *local\_symbols\_in* option and a source file name, the symbols associated with that source file become the address ranges for which activity is measured. If the symbols database is not loaded, an error message will occur telling you that the source filename symbol was not found.

You can also use the *local\_symbols\_in* option with procedure symbols; this allows you to measure activity related to the symbols defined in a single function or procedure.

### Restoring the Current Measurement

The *performance\_measurement\_initialize* restore command allows you to restore old performance measurement data from the *perf.out* file in the current directory.

If you have not exited and re-entered emulation, you can add traces to a performance measurement simply by entering another *performance\_measurement\_run* command. However, if you exit and re-enter the emulation system, you must enter the *performance\_measurement\_initialize restore* command before you can add traces to a performance measurement. When you restore a performance measurement, make sure your current trace command is identical to the command used with the restored measurement.

The restore option checks the emulator software version and will only work if the *perf.out* files you are restoring were made with the same software version as is presently running in the emulator. If you ran tests using a former software version and saved *perf.out* files, then updated your software to a new version number, you will not be able to restore old *perf.out* measurement files.

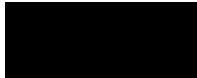

---

**Examples**

Suppose the "addr\_ranges" file contains the names of all the functions in the "ecs" demo program loop:

```
combsort
do_sort
gen_ascii_data
get_targets
graph_data
interrupt_sim
proc_specific
read_conditions
save_points
set_outputs
strcpy8
update_system
write_hdwr
```

Since these labels are program symbols, you do not have to specify the address range associated with each label; the SPMT will search the symbol database for the addresses of each label.

An easy way to create the "addr\_ranges" file is to use the copy global\_symbols command to copy the global symbols to a file named "addr\_ranges"; then, fork a shell to UNIX (by entering "! <RETURN>" on the Softkey Interface command line) and edit the file so that it contains the procedure names shown above. Enter a <CTRL>d at the UNIX prompt to return to the Softkey Interface.

To initialize the activity measurement with a user-defined address range file:

```
performance_measurement_initialize addr_ranges
```



---

## To interpret activity measurement reports

- **View the performance measurement report.**

Activity measurements are measurements of the number of accesses (reads or writes) within an address range. The reports generated for activity measurements show you the percentage of analyzer trace states that are in the specified address range, as well as the percentage of time taken by those states. The performance measurement must include four traces before statistics (mean and standard deviation) appear in the activity report. The information you will see in activity measurement reports is described below.

**Memory Activity** All activity found within the address range.

**Program Activity** All activity caused by instruction execution in the address range. Program activity includes opcode fetches and the cycles that result from the execution of those instructions (reads and writes to memory, stack pushes, etc.).

**Relative** With respect to activity in all ranges defined in the performance measurement.

**Absolute** With respect to all activity, not just activity in those ranges defined in the performance measurement.

**Mean** Average number of states in the range per trace. The following equation is used to calculate the mean:

$$mean = \frac{states\ in\ range}{total\ states}$$

**Standard Deviation** Deviation from the mean of state count. The following equation is used to calculate standard deviation:

$$std\ dev = \sqrt{\frac{1}{N-1} \times \sum_{i=1}^N S_{sumq} - N (mean)^2}$$

N  
mean  
S<sub>sumq</sub>

Where:

Number of traces in the measurement.

Average number of states in the range per trace.

Sum of squares of states in the range per trace.

**Symbols Within Range** Names of other symbols that identify addresses or ranges of addresses within the range of this symbol.

**Additional Symbols for Address** Names of other symbols that also identify this address.

Note that some compilers emit more than one symbol for certain addresses. For example, a compiler may emit "interrupt\_sim" and "\_interrupt\_sim" for the first address in a routine named interrupt\_sim. The analyzer will show the first symbol it finds to represent a range of addresses, or a single address point, and it will show the other symbols under either "Symbols within range" or "Additional symbols for address", as applicable. In the "interrupt\_sim" example, it may show either "interrupt\_sim" or "\_interrupt\_sim" to represent the range, depending on which symbol it finds first. The other symbol will be shown below "Symbols within range" in the report. These conditions appear particularly in default measurements that include all global and local symbols.

**Relative and Absolute Counts** Relative count is the total number of states associated with the address ranges in the performance measurement. Relative time is the total amount of time associated with the address ranges in the performance measurement. The absolute counts are the number of states or amount of time associated with all the states in all the traces.

**Error Tolerance and Confidence Level** An approximate error may exist in displayed information. Error tolerance for a level of confidence is calculated using the mean of the standard deviations and the mean of the means. Error tolerance gives an indication of the stability of the information. For example, if the error is 5% for a confidence level of 95%, then you can be 95% confident that the information has an error of 5% or less.

The Student's "T" distribution is used in these calculations because it improves the accuracy for small samples. As the size of the sample increases, the Student's "T" distribution approaches the normal distribution.

The following equation is used to calculate error tolerance:

$$\text{error pct.} = \frac{O_m \times t}{N \times P_m} \times 100$$

Where:

$O_m$   
 $t$   
 $N$   
 $P_m$

Mean of the standard deviations.  
Table entry in Student's "T" table for a given confidence level.  
Number of traces in the measurement.  
Mean of the means (i.e., mean sample).

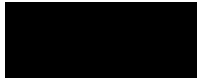

---

**Examples**

Consider the following activity measurement report (generated with the commands shown):

```
display trace depth 512  
trace counting time  
performance_measurement_initialize addr_ranges  
performance_measurement_run 20  
performance_measurement_end  
!perf32 | more
```

Making Software Performance Measurements  
To interpret activity measurement reports

Label

set\_outputs

Address Range 1784H thru 1814H

Memory Activity

State Percent Rel = 30.28 Abs = 25.00  
Mean = 128.00 Sdv = 227.46  
Time Percent Rel = 30.45 Abs = 25.45

Program Activity

State Percent Rel = 28.97 Abs = 25.00  
Mean = 128.00 Sdv = 227.46  
Time Percent Rel = 29.28 Abs = 25.45

update\_system

Address Range 159CH thru 1656H

Memory Activity

State Percent Rel = 30.28 Abs = 25.00  
Mean = 128.00 Sdv = 227.46  
Time Percent Rel = 30.44 Abs = 25.45

Program Activity

State Percent Rel = 28.99 Abs = 25.02  
Mean = 128.10 Sdv = 227.40  
Time Percent Rel = 29.29 Abs = 25.46

read\_conditions

Address Range 16EEH thru 177CH

Memory Activity

State Percent Rel = 12.11 Abs = 10.00  
Mean = 51.20 Sdv = 157.59  
Time Percent Rel = 12.18 Abs = 10.18

Program Activity

State Percent Rel = 11.59 Abs = 10.00  
Mean = 51.20 Sdv = 157.59  
Time Percent Rel = 11.71 Abs = 10.18

strcpy8

Address Range 10B0H thru 110AH

Memory Activity

State Percent	Rel =	9.75	Abs =	8.05
	Mean =	41.20	Sdv =	116.63
Time Percent	Rel =	9.45	Abs =	7.90

Program Activity

State Percent	Rel =	12.39	Abs =	10.69
	Mean =	54.75	Sdv =	149.76
Time Percent	Rel =	11.83	Abs =	10.28

interrupt\_sim

Address Range 101EH thru 10A8H

Memory Activity

State Percent	Rel =	6.15	Abs =	5.08
	Mean =	26.00	Sdv =	114.41
Time Percent	Rel =	5.96	Abs =	4.98

Program Activity

State Percent	Rel =	5.97	Abs =	5.16
	Mean =	26.40	Sdv =	114.35
Time Percent	Rel =	5.81	Abs =	5.05

write\_hdwr

Address Range 181CH thru 1894H

Memory Activity

State Percent	Rel =	6.06	Abs =	5.00
	Mean =	25.60	Sdv =	114.49
Time Percent	Rel =	6.10	Abs =	5.10

Program Activity

State Percent	Rel =	5.79	Abs =	5.00
	Mean =	25.60	Sdv =	114.49
Time Percent	Rel =	5.86	Abs =	5.10

proc\_specific

Address Range 1A6CH thru 1A8CH



Making Software Performance Measurements  
To interpret activity measurement reports

Memory Activity

State Percent Rel = 3.84 Abs = 3.17  
Mean = 16.25 Sdv = 72.67  
Time Percent Rel = 3.86 Abs = 3.23

Program Activity

State Percent Rel = 3.70 Abs = 3.19  
Mean = 16.35 Sdv = 73.12  
Time Percent Rel = 3.73 Abs = 3.24

combsort

Address Range 124EH thru 1444H

Memory Activity

State Percent Rel = 1.06 Abs = 0.88  
Mean = 4.50 Sdv = 20.12  
Time Percent Rel = 1.06 Abs = 0.89

Program Activity

State Percent Rel = 1.90 Abs = 1.64  
Mean = 8.40 Sdv = 37.57  
Time Percent Rel = 1.80 Abs = 1.56

do\_sort

Address Range 144CH thru 14EAH

Memory Activity

State Percent Rel = 0.47 Abs = 0.39  
Mean = 2.00 Sdv = 5.30  
Time Percent Rel = 0.49 Abs = 0.41

Program Activity

State Percent Rel = 0.70 Abs = 0.61  
Mean = 3.10 Sdv = 7.68  
Time Percent Rel = 0.69 Abs = 0.60

gen\_ascii\_data

Address Range 1112H thru 1246H

Memory Activity

State Percent Rel = 0.00 Abs = 0.00

Mean = 0.00 Sdv = 0.00  
Time Percent Rel = 0.00 Abs = 0.00

Program Activity

State Percent Rel = 0.00 Abs = 0.00  
Mean = 0.00 Sdv = 0.00  
Time Percent Rel = 0.00 Abs = 0.00

get\_targets

Address Range 165EH thru 16E6H

Memory Activity

State Percent Rel = 0.00 Abs = 0.00  
Mean = 0.00 Sdv = 0.00  
Time Percent Rel = 0.00 Abs = 0.00

Program Activity

State Percent Rel = 0.00 Abs = 0.00  
Mean = 0.00 Sdv = 0.00  
Time Percent Rel = 0.00 Abs = 0.00

graph\_data

Address Range 1988H thru 1A40H

Memory Activity

State Percent Rel = 0.00 Abs = 0.00  
Mean = 0.00 Sdv = 0.00  
Time Percent Rel = 0.00 Abs = 0.00

Program Activity

State Percent Rel = 0.00 Abs = 0.00  
Mean = 0.00 Sdv = 0.00  
Time Percent Rel = 0.00 Abs = 0.00

proc\_spec\_init

Address Range 1A48H thru 1A64H

Memory Activity

State Percent Rel = 0.00 Abs = 0.00  
Mean = 0.00 Sdv = 0.00  
Time Percent Rel = 0.00 Abs = 0.00



Making Software Performance Measurements  
 To interpret activity measurement reports

```

Program Activity
  State Percent  Rel =  0.00  Abs =  0.00
                    Mean =  0.00  Sdv =  0.00
  Time  Percent  Rel =  0.00  Abs =  0.00
  
```

```

save_points
  Address Range      189CH thru      1980H
  
```

```

Memory Activity
  State Percent  Rel =  0.00  Abs =  0.00
                    Mean =  0.00  Sdv =  0.00
  Time  Percent  Rel =  0.00  Abs =  0.00
  
```

```

Program Activity
  State Percent  Rel =  0.00  Abs =  0.00
                    Mean =  0.00  Sdv =  0.00
  Time  Percent  Rel =  0.00  Abs =  0.00
  
```



Graph of Memory Activity relative state percents >= 1

```

set_outputs      30.28%  *****
update_system    30.28%  *****
read_conditions  12.11%  *****
strcpy8          9.75%   *****
interrupt_sim    6.15%   ***
write_hdwr       6.06%   ***
proc_specific    3.84%   **
combsort         1.06%   *
  
```

Graph of Memory Activity relative time percents >= 1

```

set_outputs      30.45%  *****
update_system    30.44%  *****
read_conditions  12.18%  *****
strcpy8          9.45%   *****
interrupt_sim    5.96%   ***
write_hdwr       6.10%   ***
proc_specific    3.86%   **
combsort         1.06%   *
  
```

Graph of Program Activity relative state percents >= 1



set_outputs	28.97%	*****
update_system	28.99%	*****
read_conditions	11.59%	*****
strcpy8	12.39%	*****
interrupt_sim	5.97%	***
write_hdwr	5.79%	***
proc_specific	3.70%	**
combsort	1.90%	*

Graph of Program Activity relative time percents >= 1

set_outputs	29.28%	*****
update_system	29.29%	*****
read_conditions	11.71%	*****
strcpy8	11.83%	*****
interrupt_sim	5.81%	***
write_hdwr	5.86%	***
proc_specific	3.73%	**
combsort	1.80%	*

Summary Information for 20 traces

Memory Activity

State count

Relative count 8455  
Mean sample 30.20  
Mean Standard Dv 75.44  
95% Confidence 116.98% Error tolerance

Time count

Relative Time - Us 3500.92

Program Activity

State count

Relative count 8838  
Mean sample 31.56  
Mean Standard Dv 79.24  
95% Confidence 117.55% Error tolerance

Time count

Relative Time - Us 3641.08

Absolute Totals

Absolute count - state 10240  
Absolute count - time - Us 4188.56

The measurements for each label are printed in descending order according to the amount of activity. You can see that the `set_outputs` function has the most activity. Also, you can see that no activity is recorded for several of the functions. The histogram portion of the report compares the activity in the functions that account for at least 1% of the activity for all labels defined in the measurement.

---

---

## Duration Performance Measurements

Duration measurements provide a best-case/worst-case characterization of code execution time. These measurements record execution times that fall within a set of specified time ranges. The analyzer trace command is set up to store only the entry and exit states of the module to be measured (for example, a C function or Pascal procedure). The SPMT provides two types of duration measurements: module duration, and module usage.

Module duration measurements record how much time it takes to execute a particular code segment (for example, a function in the source file).

Module usage shows how much of the execution time is spent outside of the module (from exit to entry). This measurement gives an indication of how often the module is being used.

When using the SPMT to perform duration measurements, there should be only two addresses stored in the trace memory: the entry address, and the exit address. Recursion can place several entry addresses before the first exit address, and/or several exit addresses before the first entry address. Duration measurements are made between the last entry address in a series of entry addresses, and the last exit address in a series of exit addresses (see the figure below). All of the entry and exit addresses which precede these last addresses are assumed to be unused prefetches, and are ignored during time measurements.

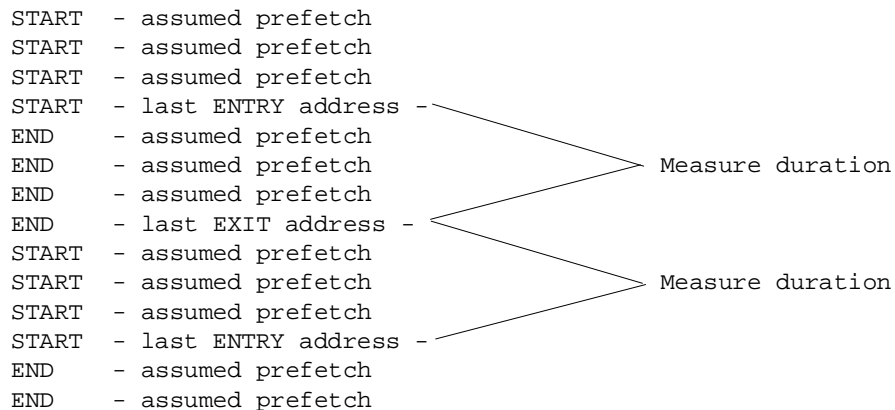

When measuring a recursive function, module duration will be measured between the last recursive call and the true end of the recursive execution. This will affect the accuracy of the measurement.

If a module is entered at the normal point, and then exited by a point other than the defined exit point, the entry point will be ignored. It will be judged the same as any other unused prefetch, and no time-duration measurement will be made. Its time will be included in the measure of time spent outside the procedure or function.

If a module is exited from the normal point, and then re-entered from some other point, the exit will also be assumed to be an unused prefetch of the exit state.

Note that if you are making duration measurements on a function that is recursive, or one that has multiple entry and/or exit points, you may wind up with invalid information.

This section describes how to:

- Set up the trace command for duration measurements.
- Initialize duration performance measurements.
- Interpret duration measurement reports.

---

## To set up the trace command for duration measurements

- 1 Specify a trace display depth of 512.
- 2 Trace after and store only function start and end addresses.

For duration measurements, the trace command must be set up to store only the entry and exit points of the module of interest. Since the trigger state is always stored, you should trigger on the entry or exit points. For example:

```
trace after symbol_entry or symbol_exit only  
symbol_entry or symbol_exit counting time
```

---

### CAUTION

The previous command depends on the generation of correct exit address symbols by the software development tools.

Or:

```
trace after module_name start or module_name end  
only module_name start or module_name end  
counting time
```

Where "symbol\_entry" and "symbol\_exit" are symbols from the user program.  
Or, where "module\_name" is the name of a C function or Pascal procedure  
(and is listed as a procedure symbol in the global symbol display).

---

### Examples

To specify a trace display depth of 512:

```
display trace depth 512
```

To set up the trace command for duration measurements on the  
interrupt\_sim function:

```
trace after interrupt_sim start or interrupt_sim  
end only interrupt_sim start or interrupt_sim end  
counting time
```

The trace specification sets up the analyzer to capture only the states that  
contain the start address of the interrupt\_sim function or the end address of  
the interrupt\_sim function. Since the trigger state is also stored, the analyzer  
is set up to trigger on the entry or exit address of the interrupt\_sim function.  
With these states in memory, the analyzer will derive two measurements:  
time from start to end of interrupt\_sim, and time from end to start of  
interrupt\_sim.

## To initialize duration performance measurements

- Use the **performance\_measurement\_initialize** command with the **duration** option.

After you set up the trace command, you must tell the SPMT the time ranges to be used in the duration measurement. This is done by initializing the performance measurement. You can initialize the performance measurement in the following ways:

- Initialize with user-defined files.
- Restore a previous performance measurement (if the emulation system has been exited and re-entered).

### Initialization with User Defined Ranges

You can specifically give the SPMT time ranges to use by placing the information in a file and entering the file name in the **performance\_measurement\_initialize** command.

Time range files may contain comments and time ranges in units of microseconds (us), milliseconds (ms), or seconds (s). An example time range file is shown below.

```
# Any line which starts with a # is a comment.  
  
1 us 20 us  
10.1 ms 100.6 ms  
3.55 s 6.77 s  
  
# us microseconds  
# ms milliseconds  
# s seconds  
#  
# The above are the only abbreviations allowed. The space between the number  
# and the units abbreviation is required.
```

When no user defined time range file is specified, the following set of default time ranges are used.

```
1 us 10 us
10.1 us 100 us
100.1 us 500 us
500.1 us 1 ms
1.001 ms 5 ms
5.001 ms 10 ms
10.1 ms 20 ms
20.1 ms 40 ms
40.1 ms 80 ms
80.1 ms 160 ms
160.1 ms 320 ms
320.1 ms 640 ms
640.1 ms 1.2 s
```

### Restoring the Current Measurement

The *performance\_measurement\_initialize* restore command allows you to restore old performance measurement data from the perf.out file in the current directory.

If you have not exited and re-entered emulation, you can add traces to a performance measurement simply by entering another *performance\_measurement\_run* command. However, if you exit and re-enter the emulation system, you must enter the *performance\_measurement\_initialize restore* command before you can add traces to a performance measurement. When you restore a performance measurement, make sure your current trace command is identical to the command used with the restored measurement.

The restore option checks the emulator software version and will only work if the perf.out files you are restoring were made with the same software version as is presently running in the emulator. If you ran tests using a former software version and saved perf.out files, then updated your software to a new version number, you will not be able to restore old perf.out measurement files.

---

#### Examples

To initialize the duration measurement:

```
performance_measurement_initialize duration
```

---

## To interpret duration measurement reports

- View the performance measurement report.

Duration measurements provide a best-case/worst-case characterization of code execution time. These measurements record execution times that fall within a set of specified time ranges. The information you will see in duration measurement reports is described below.

**Number of Intervals** Number of "from address" and "to address" pairs (after prefetch correction).

**Maximum Time** The greatest amount of time between the "from address" to the "to address".

**Minimum Time** The shortest amount of time between the "from address" to the "to address".

**Average Time** Average time between the "from address" and the "to address". The following equation is used to calculate the average time:

$$mean = \frac{\text{amount of time for all intervals}}{\text{number of intervals}}$$



**Standard Deviation** Deviation from the mean of time. The following equation is used to calculate standard deviation:

$$std\ dev = \sqrt{\frac{1}{N-1} \times \sum_{i=1}^N S_{sumq} - N (mean)^2}$$

Where:

- N Number of intervals.
- mean Average time.
- S<sub>sumq</sub> Sum of squares of time in the intervals.

**Error Tolerance and Confidence Level** An approximate error may exist in displayed information. Error tolerance for a level of confidence is calculated using the mean of the standard deviations and the mean of the means. Error tolerance gives an indication of the stability of the information. For example, if the error is 5% for a confidence level of 95%, then you can be 95% confident that the information has an error of 5% or less.

The Student's "T" distribution is used in these calculations because it improves the accuracy for small samples. As the size of the sample increases, the Student's "T" distribution approaches the normal distribution.

The following equation is used to calculate error tolerance:

$$error\ pct. = \frac{O_m \times t}{N \times P_m} \times 100$$

Where:

- O<sub>m</sub> Mean of the standard deviations in each time range.
- t Table entry in Student's "T" table for a given confidence level.
- N Number of intervals.
- P<sub>m</sub> Mean of the means (i.e., mean of the average times in each time range).



---

**Examples**

Consider the following duration measurement report (generated with the commands shown):

```
display trace depth 512  
trace after interrupt_sim start or interrupt_sim  
end only interrupt_sim start or interrupt_sim end  
counting time  
performance_measurement_initialize duration  
performance_measurement_run 10  
performance_measurement_end  
!perf32 | more
```

Time Interval Profile

```
From Address      10A8  
                  File main(module)."/users/guest/demo/debug_env/hp64782/main.c"  
                  Symbolic Reference at interrupt_sim+8A  
To Address       101E  
                  File main(module)."/users/guest/demo/debug_env/hp64782/main.c"  
                  Symbolic Reference at main.interrupt_sim  
Number of intervals  2550  
Maximum Time 73297.920 us  
Minimum Time 48230.400 us  
Avg Time      55672.752 us
```

```
Statistical summary - for      10 traces  
Stdv 11442.64  
95% Confidence 0.80% Error tolerance
```

```
Graph of relative percents  
1 us 10 us          0.00%  
10.1 us 100 us     0.00%  
100.1 us 500 us    0.00%  
500.1 us 1 ms      0.00%  
1.001 ms 5 ms      0.00%  
5.001 ms 10 ms     0.00%
```

10.1 ms	20 ms	0.00%
20.1 ms	40 ms	0.00%
40.1 ms	80 ms	100.00%
*****		
80.1 ms	160 ms	0.00%
160.1 ms	320 ms	0.00%
320.1 ms	640 ms	0.00%
640.1 ms	1.2 s	0.00%

From Address 101E  
File main(module)."/users/guest/demo/debug\_env/hp64782/main.c"  
Symbolic Reference at main.interrupt\_sim  
To Address 10A8  
File main(module)."/users/guest/demo/debug\_env/hp64782/main.c"  
Symbolic Reference at interrupt\_sim+8A  
Number of intervals 2550  
Maximum Time 342343.680 us  
Minimum Time 52.320 us  
Avg Time 36987.751 us

Statistical summary - for 10 traces  
Stdv 76924.84  
95% Confidence 8.07% Error tolerance

Graph of relative percents

1 us	10 us	0.00%	
10.1 us	100 us	14.82%	*****
100.1 us	500 us	5.06%	***
500.1 us	1 ms	0.00%	
1.001 ms	5 ms	24.82%	*****
5.001 ms	10 ms	20.27%	*****
10.1 ms	20 ms	10.08%	*****
20.1 ms	40 ms	0.00%	
40.1 ms	80 ms	9.88%	*****
80.1 ms	160 ms	5.02%	***
160.1 ms	320 ms	7.57%	****
320.1 ms	640 ms	2.47%	*
640.1 ms	1.2 s	0.00%	

Two sets of information are given in the duration measurement report: module duration and module usage.

The first set is the "module usage" measurement. Module usage measurements show how much time is spent outside the module of interest; they indicate how often the module is used. The information shown in the first part of the duration report above shows that the average amount of time spent outside the `interrupt_sim` function is about 55.7 milliseconds.

The second set of information in the duration measurement report is the "module duration" measurement. The module duration report shows that the amount of time it takes for the `interrupt_sim` function to execute varies from 52.3 microseconds to 342.3 milliseconds. The average amount of time it takes for the `interrupt_sim` module to execute is roughly 37 milliseconds.

---

---

# Running Measurements and Creating Reports

Several performance measurement tasks are the same whether you are making activity or duration measurements.

This section describes how to:

- Run performance measurements.
- End performance measurements.
- Create a performance measurement report.

---

## To run performance measurements

- Use the **performance\_measurement\_run** command.

The **performance\_measurement\_run** command processes analyzer trace data. When you end the performance measurement, this processed data is dumped to the binary "perf.out" file in the current directory. The perf32 report generator utility is used to read the binary information in the "perf.out" file.

If the **performance\_measurement\_run** command is entered without a count, the current trace data is processed. If a count is specified, the current trace command is executed consecutively the number of times specified. The data that results from each trace command is processed and combined with the existing processed data. The STATUS line will say "Processing trace <NO.>" during the run so you will know how your measurement is progressing. The only way to stop this series of traces is by using <CTRL>c (sig INT).

The more traces you include in your sample, the more accurate will be your results. At least four consecutive traces are required to obtain statistical interpretation of activity measurement results.

---

**Examples**

To run the performance measurement, enter the following command:

```
performance_measurement_run 20
```

The command above causes 20 traces to occur. The SPMT processes the trace information after each trace, and the number of the trace being processed is shown on the status line.

---

---

## To end performance measurements

- Use the ***performance\_measurement\_end*** command.

The ***performance\_measurement\_end*** command takes the data generated by the ***performance\_measurement\_run*** command and places it in a file named perf.out in the current directory. If a file named "perf.out" already exists in the current directory, it will be overwritten. Therefore, if you wish to save a performance measurement, you must rename the perf.out file before performing another measurement.

The ***performance\_measurement\_end*** command does not affect the current performance measurement data which exists within the emulation system. In other words, you can add more traces later to the existing performance measurement by entering another ***performance\_measurement\_run*** command.

Once you have entered the ***performance\_measurement\_end*** command, you can use the perf32 report generator to look at the data saved in the perf.out file.

Note that the "perf.out" file is a binary file. Do not try to read it with the UNIX more or cat commands. The perf32 report generator utility (described in the following section) must be used to read the contents of the "perf.out" file.

---

**Examples**

To cause the processed trace information to be dumped to the "perf.out" file:

***performance\_measurement\_end***

---

---

## To create a performance measurement report

- Use the **perf32** command at the UNIX prompt.

The perf32 report generator utility must be used to read the information in the "perf.out" file and other files dumped by the SPMT (in other words, renamed "perf.out" files). The perf32 utility is run from the UNIX shell. You can fork a shell while in the Softkey Interface and run perf32, or you can exit the Softkey Interface and run perf32.

### Options to "perf32"

A default report, containing all performance measurement information, is generated when the perf32 command is used without any options. The options available with perf32 allow you to limit the information in the generated report. These options are described below.

<b>-h</b>	Produce outputs limited to histograms.
<b>-s</b>	Produce a summary limited to the statistical data.
<b>-p</b>	Produce a summary limited to the program activity.
<b>-m</b>	Produce a summary limited to the memory activity.
<b>-f&lt;file&gt;</b>	Produce a report based on the information contained in <file> instead of the information contained in perf.out.

For example, the following commands save the current performance measurement information in a file called "perf1.out", and produce a histogram showing only the program activity occupied by the functions and variables.

```
mv perf.out perf1.out  
perf32 -hpf perf1.out
```

Options -h, -s, -p, and -m affect the contents of reports generated for activity measurements. These options have no effect on the contents of reports generated for duration (time interval) measurements.

---

**Examples**

Now, to generate a report from the "perf.out" file, type the following on the command line to fork a shell and run the perf32 utility:

```
!perf32 | more
```





---

## Using the External State Analyzer

---

## Using the External State Analyzer

The HP 64703A analyzer provides an external analyzer with 16 external trace channels. These trace channels allow you to capture activity on signals external to the emulator, typically other target system signals. The external analyzer may be configured as an extension to the emulation analyzer, as an independent state analyzer, or as an independent timing analyzer.

When the external analyzer is configured as an independent state analyzer, the emulator/analyzer interface does not control the external analyzer. However, you can use pod commands to control the independent state analyzer via the terminal interface. Refer to the *6833x Emulator User's Guide for the Terminal Interface* for information on using the external analyzer when it is configured as an independent state analyzer.

When the external analyzer is configured as an independent timing analyzer, you must use a special Timing Analyzer Interface program. Refer to the *Timing Analyzer Interface User's Guide* for information on using the external analyzer when it is configured as an independent timing analyzer.

The tasks you perform with the external analyzer are grouped into the following sections:

- Setting up the external analyzer.
- Configuring the external analyzer.

---

## Setting Up the External Analyzer

This section assumes you have already connected the external analyzer probe to the HP 64700 Card Cage.

Before you can use the external analyzer, you must:

- Connect the external analyzer probe to the target system.
- Specify threshold voltages of external trace signals.
- Label the external trace signals.
- Select the external analyzer mode.

---

### To connect the external analyzer probe to the target system

**1 Assemble the Analyzer Probe.** The analyzer probe is a two-piece assembly, consisting of ribbon cable and 18 probe wires (16 data channels and the J and K clock inputs) attached to a connector. Either end of the ribbon cable may be connected to the 18 wire connector, and the connectors are keyed so they may only be attached one way. Align the key of the ribbon cable connector with the slot in the 18 wire connector, and firmly press the connectors together.

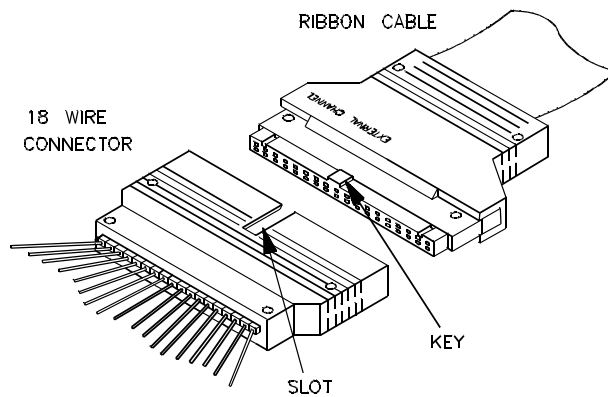

Using the External State Analyzer  
To connect the external analyzer probe to the target system

**2** Attach grabbers to probe wires. Each of the 18 probe wires has a signal and a ground connection. Each probe wire is labeled for easy identification. Thirty-six grabbers are provided for the signal and ground connections of each of the 18 probe wires. The signal and ground connections are attached to the pin in the grabber handle.

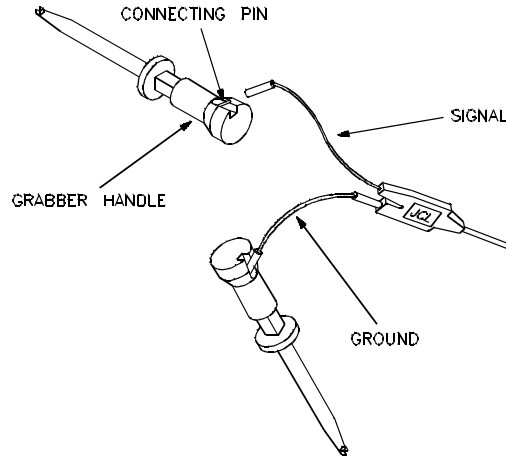

**CAUTION**

Turn OFF target system power before connecting analyzer probe wires to the target system. The probe grabbers are difficult to handle with precision, and it is extremely easy to short the pins of a chip (or other connectors which are close together) with the probe wire while trying to connect it.

**3** You can connect the grabbers to pins, connectors, wires, etc., in the target system. Pull the hilt of the grabber towards the back of the grabber handle to uncover the wire hook. When the wire hook is around the desired pin or connector, release the hilt to allow the grabber spring tension to hold the connection.

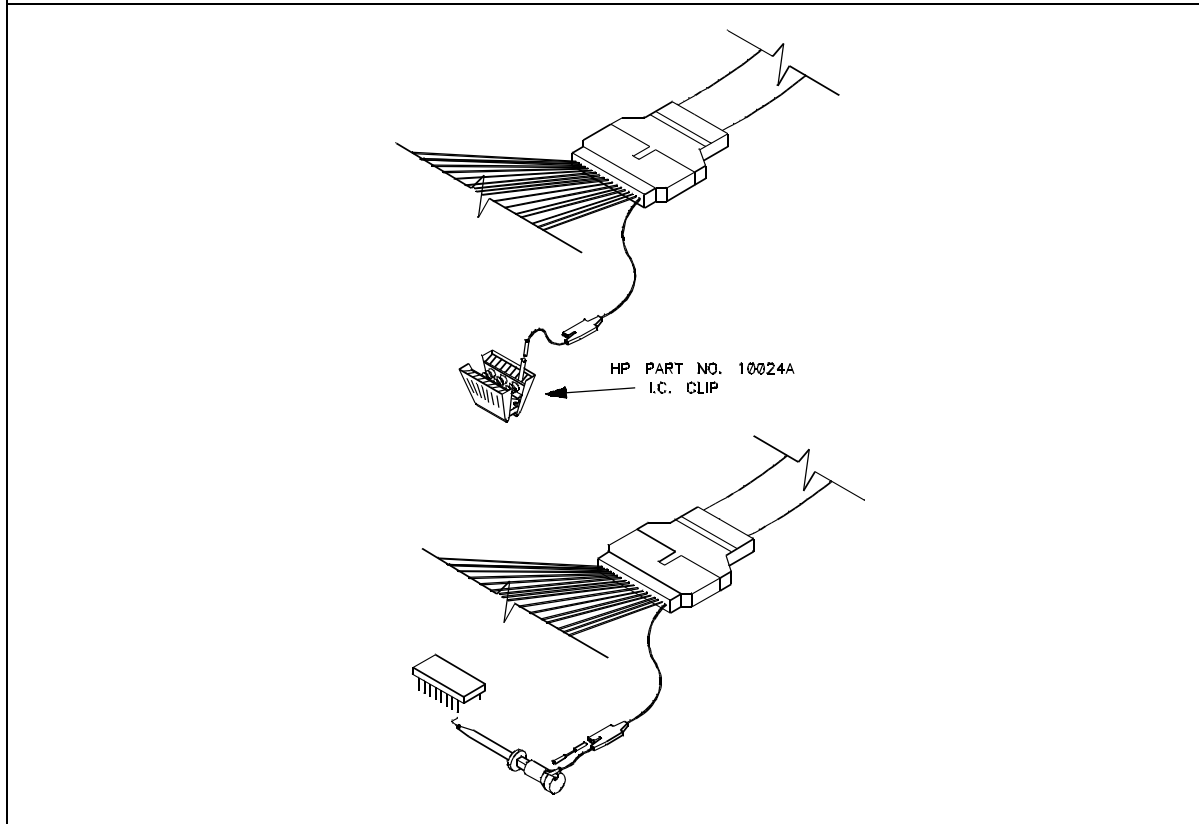

---

## Configuring the External Analyzer

After you have assembled the external analyzer probe and connected it to the emulator and target system, the next step is to configure the external analyzer.

The external analyzer is a versatile instrument, and you can configure it to suit your needs. For example, you can specify threshold voltage levels on the external analyzer channels, and you can operate the external analyzer in several different modes.

The default configuration specifies that the external analyzer is aligned with the emulation analyzer. TTL level threshold voltages are defined, as well as an external label named "xbits" which contains all 16 channels.

In order to configure the external analyzer, you must first start the configuration interface and access the "External Analyzer" configuration section (refer to the "Using the Configuration Interface" section in the "Configuring the Emulator" chapter).

Figure 25

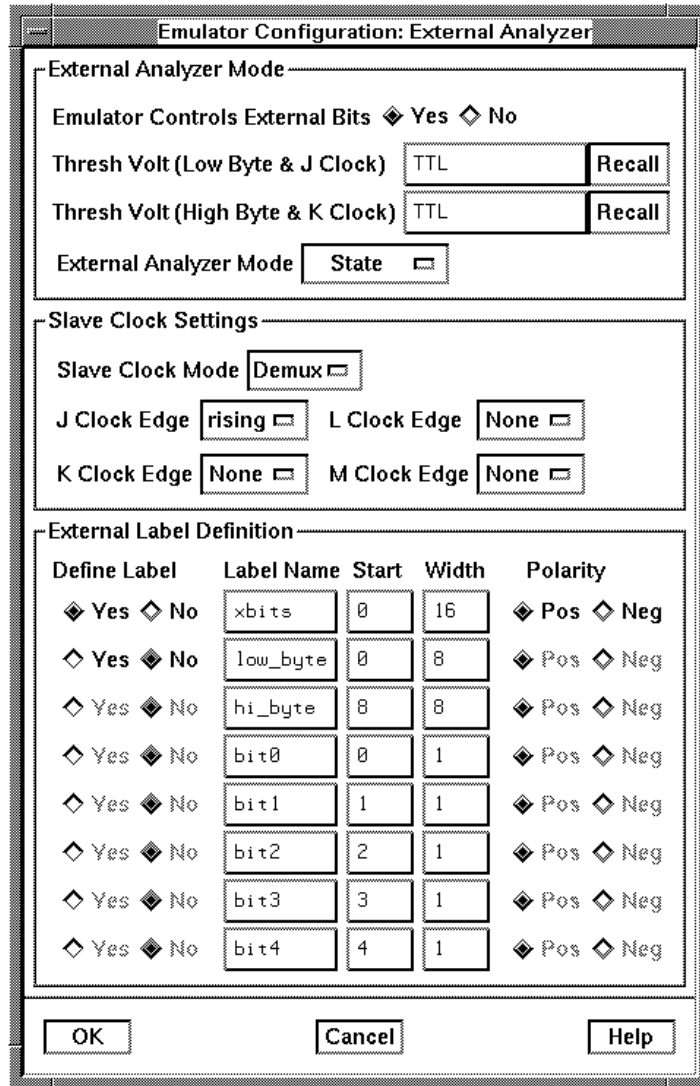

If you're using the Softkey Interface from a terminal or terminal emulation window, you don't get a dialog box from which to choose configuration sections; however, you have access to the same configuration options through a series of configuration questions. To access the questions in the

"External Analyzer" section, answer "yes" to the "Modify external analyzer configuration?" question.

This section describes how to:

- Specify whether the emulation emulator/analyzer interface should control the external analyzer.
- Specify the threshold voltages for the external channels.
- Select the external analyzer mode.
- Specify the slave clock mode when configured as an independent state analyzer.
- Define labels for the external analyzer channels.

---

### To control the external analyzer with the emulator/analyzer interface

- **Choose "yes" or "no" for the "Should emulation control the external bits" configuration option.**

Answer "yes" if the emulation emulator/analyzer interface should control the external analyzer. You must answer "yes" to access the remaining external analyzer configuration questions. At the end of the configuration process the external analyzer mode and threshold voltages will be set; existing labels will be deleted, and only the labels specified in response to the questions below will be defined.

Answer "no" if the emulation emulator/analyzer interface shouldn't control the external analyzer. If emulation does not control the external bits, the external analyzer configuration will not be modified in any way by the emulation interface.

---

### To specify the threshold voltage

- 1 Choose "yes" for the "Should emulation control the external bits" configuration option.**
- 2 Enter the "Threshold voltage for bits 0-7 and J clock" value.**
- 3 Enter the "Threshold voltage for bits 8-15 and K clock" value.**

The external analyzer probe signals are divided into two groups: the lower byte (channels 0 through 7 and the J clock), and the upper byte (channels 8



through 15 and the K clock). You can specify a threshold voltage for each of these groups.

The default threshold voltages are specified as TTL which translates to 1.40 volts.

Voltages may be in the range from -6.40 volts to 6.35 volts (with a 0.05V resolution). You may also specify CMOS (which translates to 2.5 volts), or ECL (which translates to -1.3 volts).

---

## To specify the external analyzer mode

- 1 Choose "yes" for the "Should emulation control the external bits" configuration option.**
- 2 Choose "Emulation", "State", or "Timing" for the "External analyzer mode" configuration option.**

The default configuration selects the "emulation" external analyzer mode. In this mode, you have 16 external trace signals on which data is captured synchronously with the emulation clock.

The external analyzer may also operate as an independent state analyzer, or it may operate as an independent timing analyzer if a host computer interface program is used.

Choose "emulation" to select the emulation mode. In this mode, the external analyzer becomes an extension of the emulation analyzer. In other words, they operate as one analyzer. The external bits are clocked with the emulation clock. External labels may be used in trace commands to qualify trigger, storage, prestore, or count states. External labels may be viewed in the trace display.

Choose "state" to select the independent state mode of the external analyzer. The external bits are not available for use from the emulation interface. You can, however, use pod commands to control the external state analyzer in its independent mode.

Choose "timing" to select the timing mode of the external analyzer. The external bits are not available for use from the emulation interface. Because the pod commands for the timing analyzer dump information in binary format, you will need to use Timing Analyzer Interface, or other interface program, to capture the timing analyzer data.

---

## To specify the slave clock mode

- 1 Choose "yes" for the "Should emulation control the external bits" configuration option.
- 2 Choose "State" for the "External analyzer mode" configuration option.
- 3 Choose "Off", "Mixed", or "Demux" for the "Slave clock mode for external bits" configuration item.

There are two modes of demultiplexing that can be set for the 16 channels of the external analyzer: mixed clocks and true demultiplexing.

Choose "off" to turn slave clocks OFF. If the slave clock is "off", all 16 external bits are clocked with the emulation clock.

Choose "mixed" to specify the mixed clock demultiplexing mode. In this mode, the lower eight external bits (0-7) are latched when the slave clock (as specified by your answers to the next four questions) is received. The upper eight bits and the latched lower eight are then clocked into the analyzer when the emulation clock is received (see the figure below).

Figure 26

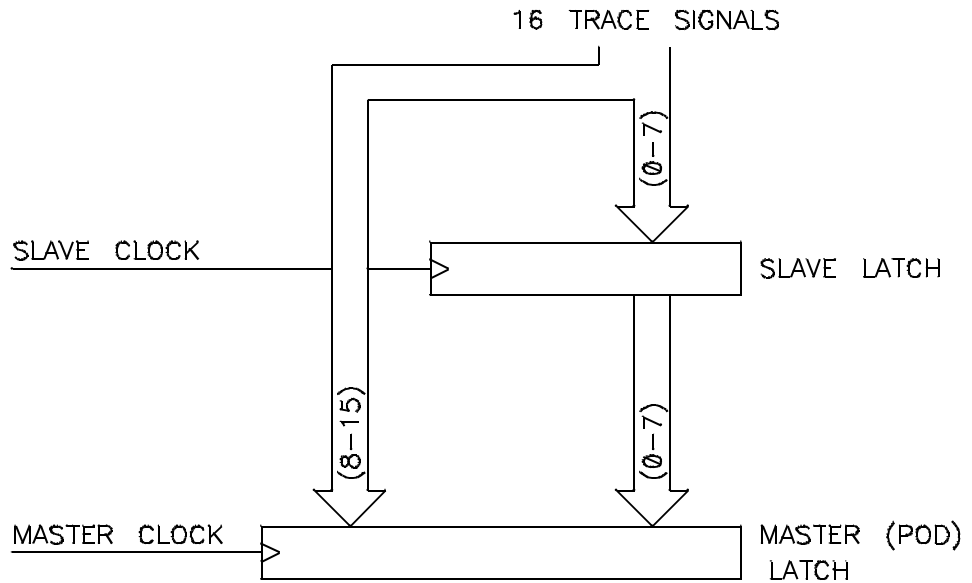

If no slave clock has appeared since the last master clock, the data on the lower 8 bits of the pod will be latched at the same time as the upper 8 bits. If

more than one slave clock has appeared since the last master clock, only the first slave data will be available to the analyzer (see the figure below).

Figure 27

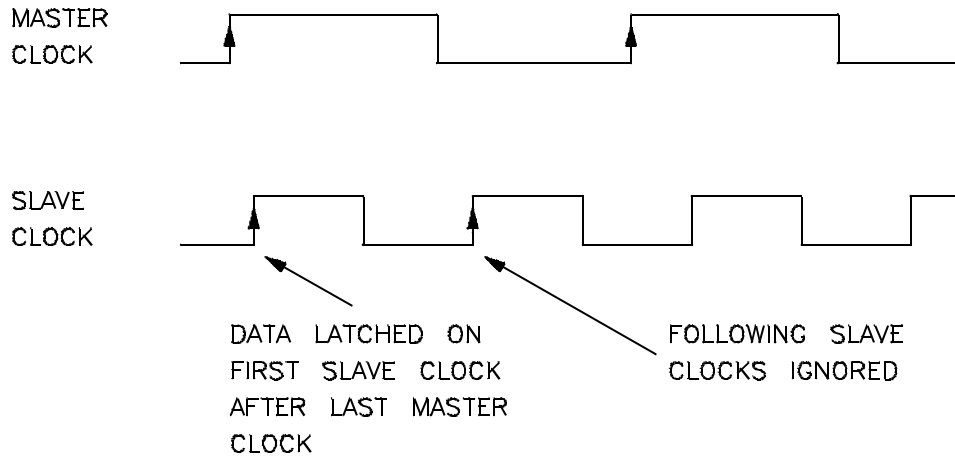

Choose "demux" to specify the true demultiplexing mode. In this mode, only the lower eight external channels (0-7) are used. The slave clock (as specified by your answers to the next four questions) latches these bits and the emulation clock samples the same channels again. The latched bits show up as bits 0-7 in the trace data, and the second sample shows up as bits 8-15 (see the figure below).



Figure 28

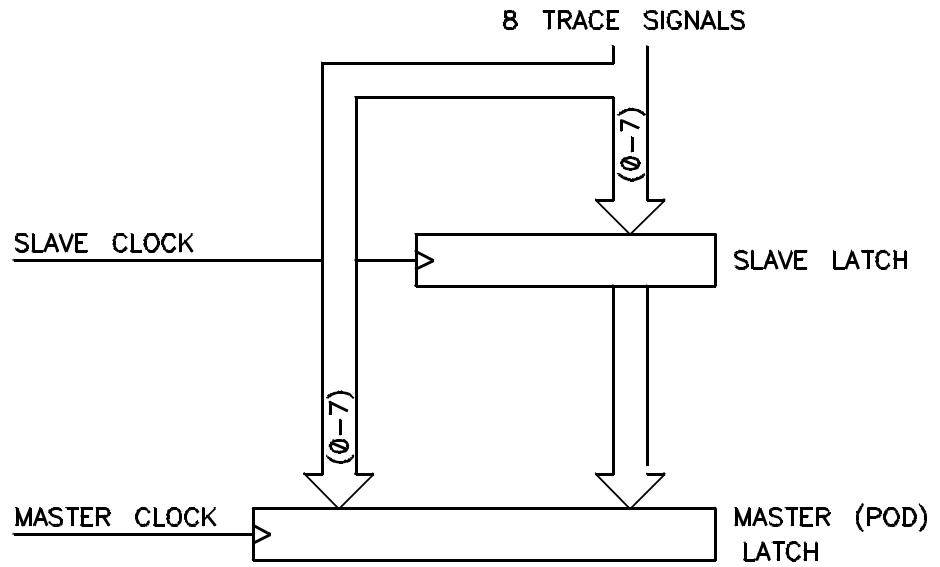

EXAMPLE TIMING:

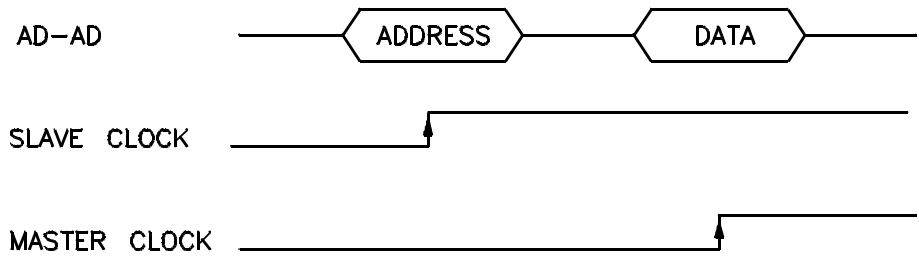

If no slave clock has appeared since the last master clock, the data on the lower 8 bits of the pod will be the same as the upper 8 bits. If more than one slave clock has appeared since the last master clock, only the first slave data will be available to the analyzer.

- 4 If the "mixed" or "true demultiplexing" slave clock modes are selected, choose "None", "rising", "falling", or "Both" for the "Edges of J (K,L,M) clock used for slave clock" configuration options.

Four configuration options are present when you select either the "mixed" or "demux" slave clock mode. They allow you to define the slave clock. You can specify rising, falling, both, or neither (none) edges of the J, K, L, and M clocks. When several clock edges are specified, any one of the edges clocks the trace.

Clocks J and K are the external clock inputs of the external analyzer probe. The L and M clocks are generated by the emulator. Typically, the L clock is the emulation clock derived by the emulator and the M clock is not used.

---

## To define labels for the external analyzer signals

- 1 Choose "yes" for the "Should emulation control the external bits" configuration option.
- 2 For each defined external label (there can be up to 8), choose the "name", "start bit", "width", and "polarity".

You can define up to eight labels for the 16 external data channels in the configuration. These external analyzer labels can be used in trace commands, and the data associated with these labels can be displayed in the trace list. One external analyzer label, "xbits", is defined by the default configuration and is included in the default trace list.

External labels can be defined with bits in the range of 0 through 15. The start bit may be in the range 0 through 15, but the width of the label must not cause the label to extend past bit 15. Thus, the sum of the start bit number plus the width must not exceed 16.

The "polarity" configuration option allows you to specify positive or negative logic for the external bits. In other words, positive means high=1, low=0. Negative means low=1, high=0.

Once external labels are defined, they may be used in trace commands to qualify events (if the emulation controls the external analyzer). Also, you can modify the trace display to include data for the various trace labels.

Note that the Timing Analyzer Interface does not use the external labels defined in the emulator/analyzer interface. You maintain labels for the timing analyzer within the Timing Analyzer Interface itself.





---

## Making Coordinated Measurements

---

## Making Coordinated Measurements

When HP 64700 Card Cages are connected together via the Coordinated Measurement Bus (CMB), you can start and stop up to 32 emulators at the same time.

You can use the analyzer in one HP 64700 to arm (that is, activate) the analyzers in other HP 64700 Card Cages or to cause emulator execution in other HP 64700 Card Cages to break into the monitor.

You can use the HP 64700's BNC connector (labeled TRIGGER IN/OUT on the lower left corner of the HP 64700 rear panel) to trigger an external instrument (for example, a logic analyzer or oscilloscope) when the analyzer finds its trigger condition. Also, you can allow an external instrument to arm the analyzer or break emulator execution into the monitor.

The coordinated measurement tasks you can perform are grouped into the following sections:

- Setting up for coordinated measurements.
- Starting and stopping multiple emulators.
- Driving trigger signals to the CMB or BNC.
- Stopping program execution on trigger signals.
- Arming analyzers on trigger signals.



The location of the CMB and BNC connectors on the HP 64700 rear panel is shown in the following figure.

Figure 29

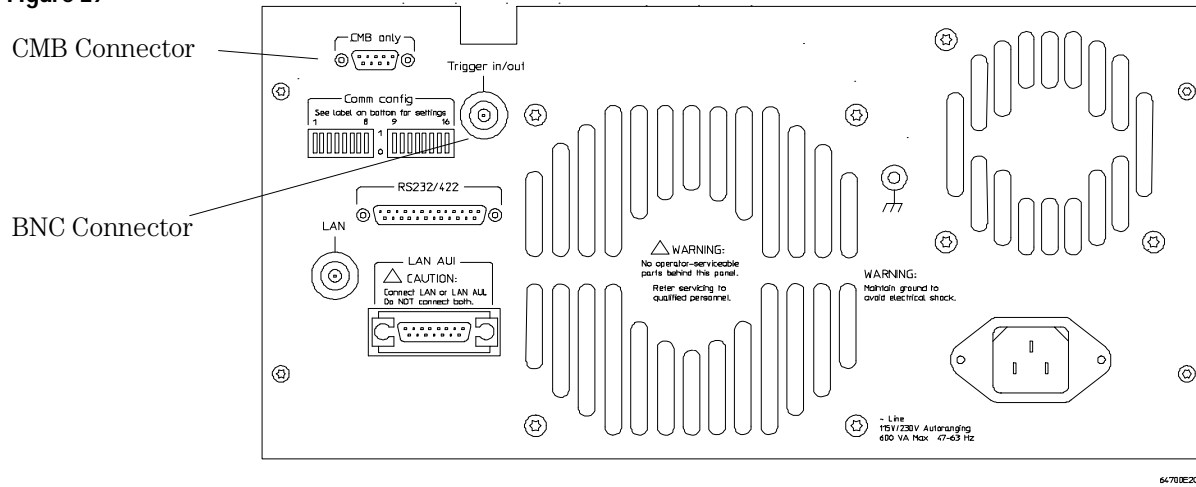

**Signal Lines on the CMB**

There are three bi-directional signal lines on the CMB connector on the rear panel of the emulator. These CMB signals are:

**TRIGGER** The CMB TRIGGER line is low true. This signal can be driven or received by any HP 64700 connected to the CMB. This signal can be used to trigger an analyzer. It can be used as a break source for the emulator.

**READY** The CMB READY line is high true. It is an open collector and performs an ANDing of the ready state of enabled emulators on the CMB. Each emulator on the CMB releases this line when it is ready to run. This line goes true when all enabled emulators are ready to run, providing for a synchronized start.

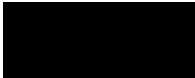

When CMB is enabled, each emulator is required to break to background when CMB READY goes false, and will wait for CMB READY to go true before returning to the run state. When an enabled emulator breaks, it will drive the CMB READY false and will hold it false until it is ready to resume running. When an emulator is reset, it also drives CMB READY false.

**EXECUTE** The CMB EXECUTE line is low true. Any HP 64700 on the CMB can drive this line. It serves as a global interrupt and is processed by both the emulator and the analyzer. This signal causes an emulator to run from a specified address when CMB READY returns true.

### **BNC Trigger Signal**

The BNC trigger signal is a positive rising edge TTL level signal. The BNC trigger line can be used to either drive or receive an analyzer trigger, or receive a break request for the emulator.

**Comparison Between CMB and BNC Triggers** The CMB trigger and BNC trigger lines have the same logical purpose: to provide a means for connecting the internal trigger signals (trig1 and trig2) to external instruments. The CMB and BNC trigger lines are bi-directional. Either signal may be used directly as a break condition.

The CMB trigger is level-sensitive, while the BNC trigger is edge-sensitive. The CMB trigger line puts out a true pulse following receipt of EXECUTE, despite the commands used to configure it. This pulse is internally ignored.

Note that if you use the EXECUTE function, the CMB TRIGGER should not be used to trigger external instruments, because a false trigger will be generated when EXECUTE is activated.

---

## Setting Up for Coordinated Measurements

This section describes how to:

- Connect the Coordinated Measurement Bus.
- Connect the rear panel BNC.

---

### To connect the Coordinated Measurement Bus (CMB)

---

**CAUTION**

---

Be careful not to confuse the 9-pin connector used for CMB with those used by some computer systems for RS-232C communications. Applying RS-232C signals to the CMB connector is likely to result in damage to the HP 64700 Card Cage.

To use the CMB, you will need one CMB cable for the first two emulators and one additional cable for every emulator after the first two. The CMB cable is orderable from HP under product number HP 64023A. The cable is four meters long.

You can build your own compatible CMB cables using standard 9-pin D type subminiature connectors and 26 AWG wire.

Note that Hewlett-Packard does not ensure proper CMB operation if you are using a self-built cable!

Making Coordinated Measurements  
To connect the Coordinated Measurement Bus (CMB)

1 Connect the cables to the HP 64700 CMB ports.

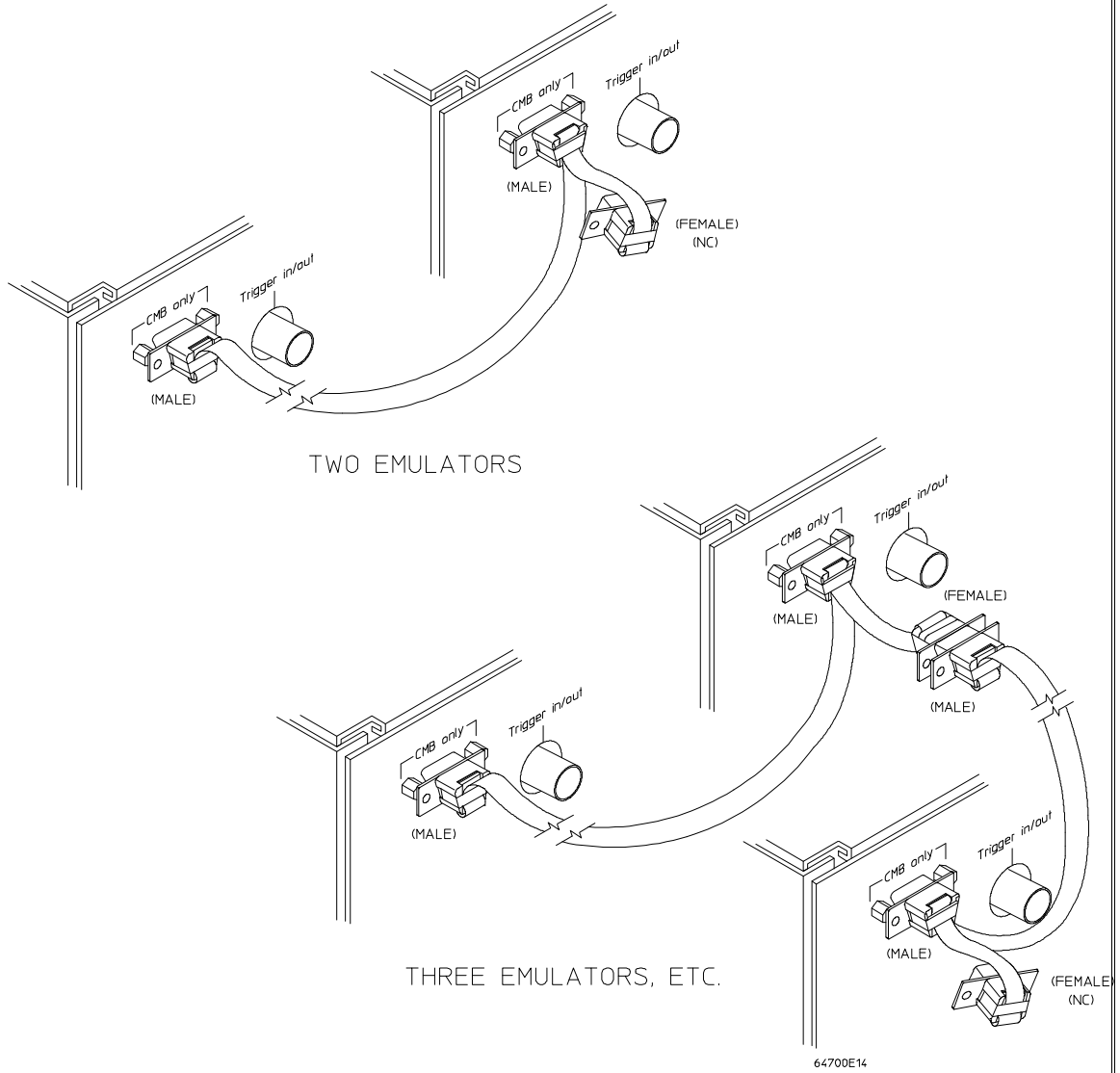

Number of HP 64700 Series Emulators	Maximum Total Length of Cable	Restrictions on the CMB Connection
2 to 8	100 meters	None.
9 to 16	50 meters	None.
9 to 16	100 meters	Only 8 emulators may have rear panel pullups connected. *
17 to 32	50 meters	Only 16 emulators may have rear panel pullups connected. *

\* A modification must be performed by your HP Customer Engineer.  
Emulators using the CMB must use background emulation monitors.  
At least 3/4 of the HP 64700-Series emulators connected to the CMB must be powered up before proper operation of the entire CMB configuration can be assured.

---

### To connect to the rear panel BNC

---

**CAUTION**

The BNC line on the HP 64700 accepts input and output of TTL levels only. (TTL levels should not be less than 0 volts or greater than 5 volts.) Failure to observe these specifications may result in damage to the HP 64700 Card Cage.

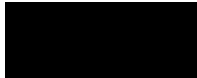

Making Coordinated Measurements  
To connect to the rear panel BNC

1 Connect one end of a 50-ohm coaxial cable with male BNC connectors to the HP 64700 BNC receptacle and the other end to the appropriate BNC receptacle on the other measuring instrument.

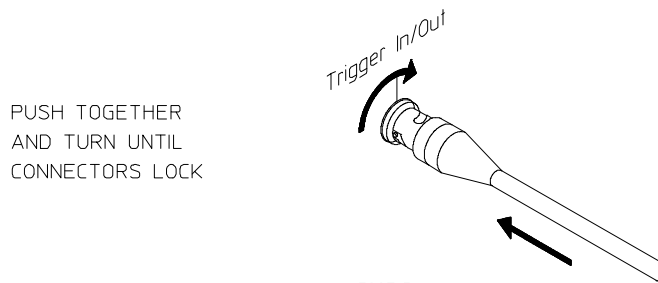
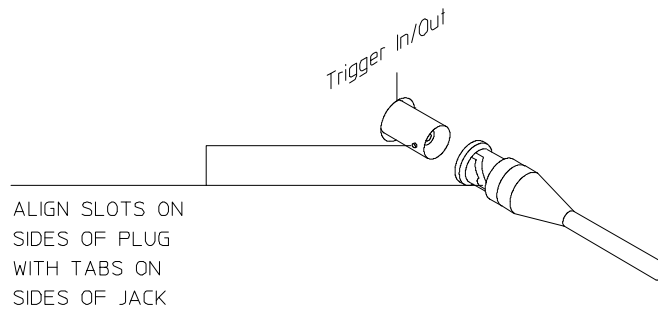

The BNC connector is capable of driving TTL level signals into a 50-ohm load. (A positive rising edge is the trigger signal.) It requires a driver that can supply at least 4 mA at 2 volts when used as a receiver. The BNC connector is configured as an open-emitter structure which allows for multiple drivers to be connected. It can be used for cross-triggering between multiple HP 64700Bs when no other cross-measurements are needed. The output of the BNC connector is short-circuit protected and is protected from TTL level signals when the emulator is powered down.

---

## Starting/Stopping Multiple Emulators

When HP 64700 Card Cages are connected together via the Coordinated Measurement Bus (CMB), you can start and stop up to 32 emulators at the same time. These are called synchronous measurements.

This section describes how to:

- Enable synchronous measurements.
- Start synchronous measurements.
- Disable synchronous measurements.

---

### To enable synchronous measurements

- Enter the **specify run** command.

You can enable the emulator's interaction with the CMB by using the **specify run** command. When the EXECUTE signal is received, the emulator will run at the current program counter address or the address specified in the specify run command.

Note that when the CMB is being actively controlled by another emulator, the step command does not work correctly. The emulator may end up running in user code (NOT stepping). Disable CMB interaction (see "To disable synchronous measurements" below) while stepping the processor.

Note that enabling CMB interaction does not affect the operation of analyzer cross-triggering.

You can use the **specify trace** command to specify that an analyzer measurement begin upon reception of the CMB EXECUTE signal.

The trace measurement defined by the **specify trace** command will be started when the EXECUTE signal becomes active. When the trace measurement begins, you will see the message "CMB execute; emulation trace started".

When you enter a normal **trace** command, trace at execute is disabled, and the analyzer ignores the CMB EXECUTE signal.

---

**Examples**

To enable synchronous measurements:

***specify run from*** 1e8h

To trace when synchronous execution begins:

***specify trace after address*** main

---

---

## To start synchronous measurements

- Enter the **cmb\_execute** command.

The **cmb\_execute** command will cause the EXECUTE line to be pulsed, thereby initiating a synchronous measurement. CMB interaction does not have to be enabled in order to use either of these commands. (When you enable CMB interaction, you only specify how the emulator will react to the CMB EXECUTE signal.)

All emulators whose CMB interaction is enabled will break into the monitor when any one of those emulators breaks into its monitor.

---

## To disable synchronous measurements

- Enter the **specify run disable** command.

You can disable the emulator's interaction with the CMB by using the **specify run disable** command. When interaction is disabled, the emulator ignores the CMB EXECUTE and READY lines.

---



---

## Using Trigger Signals

The HP 64700 contains two internal lines, trig1 and trig2, over which trigger signals can pass from the emulator or analyzer to other HP 64700s on the Coordinated Measurement Bus (CMB) or other instruments connected to the BNC connector.

You can configure the internal lines to make connections between the emulator, analyzer, external analyzer (if its configured as an independent state or timing analyzer), CMB connector, or BNC connector. Measurements that depend on these connections are called *interactive measurements* or *coordinated measurements*.

This figure below illustrates the possible connections between the internal lines (trig1 and trig2) and the emulator, analyzer, and external devices.

Figure 30

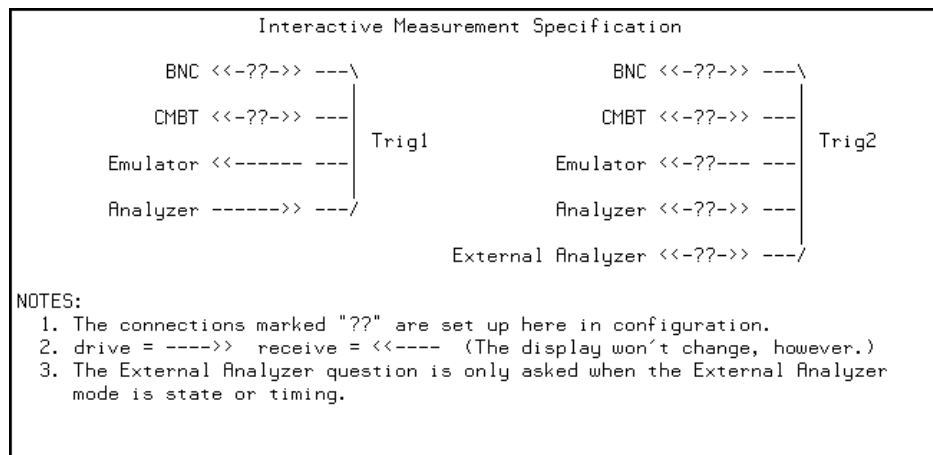

Note that the "External Analyzer" connection for "Trig2" is only available if you have selected "state" or "timing" for the external analyzer mode.

Notice that the analyzer always drives trig1, and the emulator always receives trig1. This provides for the ***break\_on\_trigger*** syntax of the ***trace*** command.

You can use the trig1 or trig2 line to make a connection between the analyzer and the CMB connector or BNC connector so that, when the analyzer finds its trigger condition, a trigger signal is driven on the HP 64700's Coordinated Measurement Bus (CMB) or BNC connector. This can also be done for the external analyzer when it is configured as an independent state or timing analyzer.

You can use the trig1 or trig2 line to make a connection between the emulator break input and the CMB connector, BNC connector, analyzer, (or external analyzer when configured as an independent state or timing analyzer) so that program execution can break when a trigger signal is received from the CMB, BNC, or analyzer.

You can use the trig2 line to make a connection between the analyzer and the CMB connector or BNC connector so that the analyzer can be armed (that is, enabled) when a trigger signal is received from the CMB or BNC connector. This can also be done for the external analyzer when it is configured as an independent state or timing analyzer.

You can use the trig1 and trig2 lines to make several type of connections at the same time. For example, when the analyzer finds its trigger condition, a signal is driven on the trig1 line. This signal may be used to stop user program execution, but the trigger signal may also be driven on the CMB and BNC connectors.

Also, it's possible for signals to be driven and received on the CMB or BNC connectors. So, for example, while the analyzer's trigger signal can be driven on the CMB and BNC connectors, signals can also be received from the CMB and BNC connectors and used to stop user program execution. In this case, the emulator will break into the monitor on either the analyzer trigger or on the reception of a trigger signal from the CMB or BNC.

You can disable connections made by the internal trig1 and trig2 lines by choosing "neither" or "no" to the appropriate interactive measurement configuration options.

In order to modify the interactive measurement specification, you must first start the configuration interface and access the "Interactive Measurement Specification" configuration section (refer to the "Using the Configuration Interface" section in the "Configuring the Emulator" chapter).

Figure 31

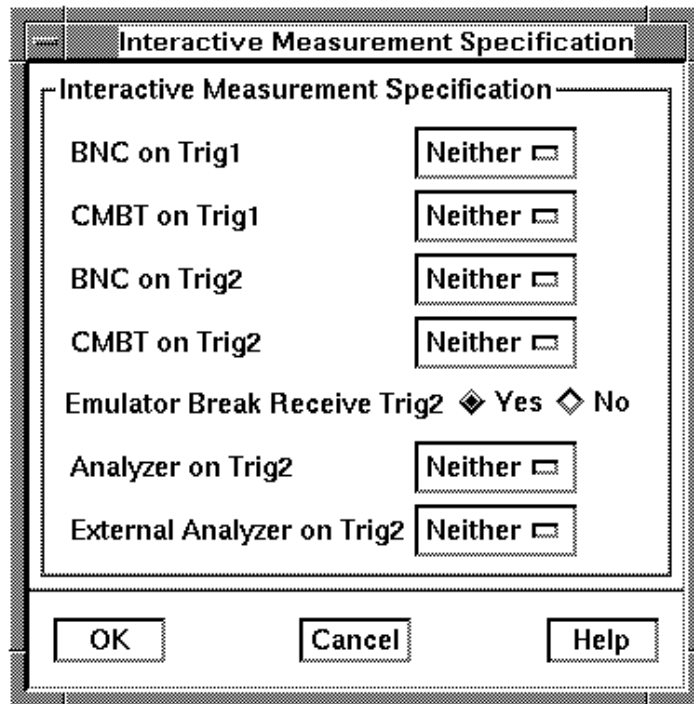

If you're using the Softkey Interface from a terminal or terminal emulation window, you don't get a dialog box from which to choose configuration sections; however, you have access to the same configuration options through a series of configuration questions. To access the questions in the "Interactive Measurement Specification" section, answer "yes" to the "Modify interactive measurement specification?" question.

This section shows you how to:

- Drive the emulation analyzer trigger signal to the CMB.
- Drive the emulation analyzer trigger signal to the BNC connector.
- Drive the external analyzer trigger signal to the CMB.
- Drive the external analyzer trigger signal to the BNC connector.
- Break emulator execution on signal from CMB.
- Break emulator execution on signal from BNC.
- Break emulator execution on external analyzer trigger.

- Arm the emulation analyzer on signal from CMB.
  - Arm the emulation analyzer on signal from BNC.
  - Arm the emulation analyzer on external analyzer trigger.
  - Arm the external analyzer on signal from CMB.
  - Arm the external analyzer on signal from BNC.
  - Arm the external analyzer on emulation analyzer trigger.
- 

### To drive the emulation analyzer trigger signal to the CMB

- Choose "receive" for the "Should CMBT drive or receive Trig1" configuration option.  
You could also drive the emulation analyzer trigger to the CMB over the trig2 internal line by specifying that the CMBT should receive trig2 and that the emulation analyzer should drive trig2.
- 

### To drive the emulation analyzer trigger signal to the BNC connector

- Choose "receive" for the "Should BNC drive or receive Trig1" configuration option.  
You could also drive the emulation analyzer trigger to the BNC over the trig2 internal line by specifying that the BNC should receive trig2 and that the emulation analyzer should drive trig2.
- 

### To drive the external analyzer trigger signal to the CMB

- 1 Choose "receive" for the "Should CMBT drive or receive Trig2" configuration option.
  - 2 Choose "drive" for the "Should External Analyzer drive or receive Trig2" configuration option.
-

---

## To drive the external analyzer trigger signal to the BNC connector

- 1 Choose "receive" for the "Should BNC drive or receive Trig2" configuration option.
- 2 Choose "drive" for the "Should External Analyzer drive or receive Trig2" configuration option.

---

## To break emulator execution on signal from CMB

- Choose "drive" for the "Should CMBT drive or receive Trig1" configuration option.  
You could also break emulator execution on a trigger signal from the CMB over the trig2 internal line by specifying that the CMB should drive trig2 and that the emulator break should receive trig2.

---

## To break emulator execution on signal from BNC

- Choose "drive" for the "Should BNC drive or receive Trig1" configuration option.  
You could also break emulator execution on a trigger signal from the BNC over the trig2 internal line by specifying that the BNC should drive trig2 and that the emulator break should receive trig2.

---

## To break emulator execution on external analyzer trigger

- 1 Choose "yes" for the "Should Emulator break receive Trig2" configuration option.
- 2 Choose "drive" for the "Should External Analyzer drive or receive Trig2" configuration option.

When an emulator break occurs due to the analyzer trigger, the analyzer will stop driving the internal signal that caused the break. Therefore, if trig2 is used both to break and to drive the CMB TRIGGER (for example), TRIGGER will go true when the trigger is found and then will go false after the emulator

breaks. However, if trig1 is used to cause the break and trig2 is used to drive the CMB TRIGGER, TRIGGER will stay true until the trace is halted or until the next trace starts.

---

### To arm the emulation analyzer on signal from CMB

- 1 Choose "drive" for the "Should CMBT drive or receive Trig2" configuration option.
- 2 Choose "receive" for the "Should Analyzer drive or receive Trig2" configuration option.
- 3 Use the **arm\_trig2** option to the **trace** command.

---

### To arm the emulation analyzer on signal from BNC

- 1 Choose "drive" for the "Should BNC drive or receive Trig2" configuration option.
- 2 Choose "receive" for the "Should Analyzer drive or receive Trig2" configuration option.
- 3 Use the **arm\_trig2** option to the **trace** command.

---

### To arm the emulation analyzer on external analyzer trigger

- 1 Choose "receive" for the "Should Analyzer drive or receive Trig2" configuration option.
- 2 Choose "drive" for the "Should External Analyzer drive or receive Trig2" configuration option.
- 3 Use the **arm\_trig2** option to the **trace** command.

---

### To arm the external analyzer on signal from CMB

- 1 Choose "drive" for the "Should CMBT drive or receive Trig2" configuration option.
- 2 Choose "receive" for the "Should External Analyzer drive or receive Trig2" configuration option.

---

### To arm the external analyzer on signal from BNC

- 1 Choose "drive" for the "Should BNC drive or receive Trig2" configuration option.
- 2 Choose "receive" for the "Should External Analyzer drive or receive Trig2" configuration option.

---

### To arm the external analyzer on emulation analyzer trigger

- 1 Choose "drive" for the "Should Analyzer drive or receive Trig2" configuration option.
- 2 Choose "receive" for the "Should External Analyzer drive or receive Trig2" configuration option.

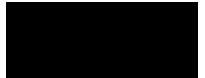







---

## Setting X Resources

---

## Setting X Resources

The Graphical User Interface is an X Window System application which means it is a *client* in the X Window System client-server model.

The X server is a program that controls all access to input devices (typically a mouse and a keyboard) and all output devices (typically a display screen). It is an interface between application programs you run on your system and the system input and output devices.

An X *resource* controls an element of appearance or behavior in an X application. For example, in the graphical interface, one resource controls the text in action key pushbuttons as well as the action performed when the pushbutton is clicked.

By modifying resource settings, you can change the appearance or behavior of certain elements in the graphical interface.

When the graphical interface starts up, it reads resource specifications from a set of configuration files. Resources specifications in later files override those in earlier files. Files are read in the following order:

- 1** The application defaults file. For example, `/usr/lib/X11/app-defaults/HP64_Softkey` in HP-UX or `/usr/openwin/lib/X11/app-defaults/HP64_Softkey` in SunOS.
- 2** The `$XAPPLRESDIR/HP64_Softkey` file. (The `XAPPLRESDIR` environment variable defines a directory containing system-wide custom application defaults.)
- 3** The server's `RESOURCE_MANAGER` property. (The `xrdb` command loads user-defined resource specifications into the `RESOURCE_MANAGER` property.)  
If no `RESOURCE_MANAGER` property exists, user defined resource settings are read from the `$HOME/.Xdefaults` file.
- 4** The file named by the `XENVIRONMENT` environment variable.  
If the `XENVIRONMENT` variable is not set, the `$HOME/.Xdefaults-host` file (typically containing resource specifications for a specific remote host) is read.
- 5** Resource specifications included in the command line with the `-xrm` option.
- 6** System scheme files in directory `/usr/hp64000/lib/X11/HP64_schemes`.

- 7 System-wide custom scheme files located in directory  
\$XAPPLRESDIR/HP64\_schemes.
- 8 User-defined scheme files located in directory  
\$HOME/.HP64\_schemes (note the dot in the directory name).

*Scheme files* group resource specifications for different displays, computing environments, and languages.

This chapter shows you how to:

- Modify the Graphical User Interface resources.
- Use customized scheme files.
- Set up custom action keys.
- Set initial recall buffer values.
- Set up demos or tutorials.

Refer to the "X Resources and the Graphical Interface" section in the "Concepts" chapter for more detailed information.



---

## To modify the Graphical User Interface resources

You can customize the appearance of an X Windows application by modifying its X resources. The following tables describe some of the commonly modified application resources.

Application Resources for Schemes		
Resource	Values	Description
HP64_Softkey.platformScheme	HP-UX SunOS (custom)	Names the subdirectory for platform specific schemes. This resource should be set to the platform on which the X server is running (and displaying the Graphical User Interface) if it is different than the platform where the application is running.
HP64_Softkey.colorScheme	BW Color (custom)	Names the color scheme file.
HP64_Softkey.sizeScheme	Small Large (custom)	Names the size scheme file which defines the fonts and the spacing used.
HP64_Softkey.labelScheme	Label \$LANG (custom)	Names to use for labels and button text. The default uses the \$LANG environment variable if it is set and if a scheme file named Softkey.\$LANG exists in one of the directories searched for scheme files; otherwise, the default is Label.
HP64_Softkey.inputScheme	Input (custom)	Specifies mouse and keyboard operation.

Commonly Modified Application Resources		
Resource	Values	Description
HP64_Softkey.lines	24 (min. 18)	Specifies the number of lines in the main display area.
HP64_Softkey.columns	100 (min. 80)	Specifies the number of columns, in characters, in the main display area.
HP64_Softkey.enableCmdline	True False	Specifies whether the command line area is displayed when you initially enter the Graphical User Interface.
*editFile	(example) vi %s	Specifies the command used to edit files.
*editFileLine	(example) vi +%d %s	Specifies the command used to edit a file at a certain line number.
*<proc>*actionKeysSub.keyDefs	(paired list of strings)	Specifies the text that should appear on the action key push buttons and the commands that should be executed in the command line area when the action key is pushed. Refer to the "To set up custom action keys" section for more information.
*<proc>*dirSelectSub.entries	(list of strings)	Specifies the initial values that are placed in the File→Context→Directory popup recall buffer. Refer to the "To set initial recall buffer values" section for more information.
*<proc>*recallSub.entries	(list of strings)	Specifies the initial values that are placed in the entry buffer (labeled "O:"). Refer to the "To set initial recall buffer values" section for more information.

The following steps show you how to modify the Graphical User Interface's X resources.

**1 Copy part or all of the HP64\_Softkey application defaults file to a temporary file.**

The HP64\_Softkey file contains the default definitions for the graphical interface application's X resources.

For example, on an HP 9000 computer you can use the following command to copy the complete HP64\_Softkey file to HP64\_Softkey.tmp (note that the HP64\_Softkey file is several hundred lines long):

```
cp /usr/lib/X11/app-defaults/HP64_Softkey HP64_Softkey.tmp
```

NOTE: The HP64\_Softkey application defaults file is re-created each time Graphical User Interface software is installed or updated. You can use the UNIX diff command to check for differences between the new HP64\_Softkey application defaults file and the old application defaults file that is saved as /usr/hp64000/lib/X11/HP64\_schemes/old/HP64\_Softkey.

**2 Modify the temporary file.**

Modify the resource that defines the behavior or appearance that you wish to change.

For example, to change the number of lines in the main display area to 36:

```
vi HP64_Softkey.tmp
```

Search for the string "HP64\_Softkey.lines". You should see lines similar to the following.

```
!-----  
! The lines and columns set the vertical and horizontal dimensions of the  
! main display area in characters, respectively. Minimum values are 18 lines  
! and 80 columns. These minimums are silently enforced.  
!  
! Note: The application cannot be resized by using the window manager.  
  
!HP64_Softkey.lines:    24  
!HP64_Softkey.columns: 85
```

Edit the line containing "HP64\_Softkey.lines" so that it is uncommented and is set to the new value:

```
!-----  
! The lines and columns set the vertical and horizontal dimensions of the  
! main display area in characters, respectively. Minimum values are 18 lines  
! and 80 columns. These minimums are silently enforced.  
!  
! Note: The application cannot be resized by using the window manager.  
  
HP64_Softkey.lines:      36  
!HP64_Softkey.columns:  85
```

Save your changes and exit the editor.

- 3** If the `RESOURCE_MANAGER` property exists (as is the case with HP VUE — if you're not sure, you can check by entering the **xrdb -query** command), use the **xrdb** command to add the resources to the `RESOURCE_MANAGER` property. For example:

```
xrdb -merge -nocpp HP64_Softkey.tmp
```

Otherwise, if the `RESOURCE_MANAGER` property does not exist, append the temporary file to your `$HOME/.Xdefaults` file. For example:

```
cat HP64_Softkey.tmp >> $HOME/.Xdefaults
```

- 4** Remove the temporary file.
- 5** Start or restart the Graphical User Interface.

After you have completed the above steps, you must either start, or restart by exiting and starting again, the Graphical User Interface. Starting and exiting the Graphical User Interface is described in the "Starting and Exiting HP 64700 Interfaces" chapter.



## To use customized scheme files

Scheme files are used to set platform specific resources that deal with color, fonts and sizes, mouse and keyboard operation, and labels and titles. You can create and use customized scheme files by following these steps.

**1 Create the `$HOME/.HP64_schemes/<platform>` directory.**

For example:

```
mkdir $HOME/.HP64_schemes
mkdir $HOME/.HP64_schemes/HP-UX
```

**2 Copy the scheme file to be modified to the `$HOME/.HP64_schemes/<platform>` directory.**

Label scheme files are not platform specific; therefore, they should be placed in the `$HOME/.HP64_schemes` directory. All other scheme files should be placed in the `$HOME/.HP64_schemes/<platform>` directory.

For example:

```
cp /usr/hp64000/lib/X11/HP64_schemes/HP-UX/Softkey.Color
$HOME/.HP64_schemes/HP-UX/Softkey.MyColor
```

Note that if your custom scheme file has the same name as the default scheme file, the load order requires resources in the custom file to explicitly override resources in the default file.

**3 Modify the `$HOME/.HP64_schemes/<platform>/Softkey.<scheme>` file.**

For example, you could modify the "`$HOME/.HP64_schemes/HP-UX/Softkey.MyColor`" file to change the defined foreground and background colors. Also, since the scheme file name is different than the default, you could comment out various resource settings to cause general foreground and background color definitions to apply to the Graphical User Interface. At least one resource must be defined in your color scheme file for it to be recognized.



**4 If your custom scheme file has a different name than the default, you must modify the scheme resource definitions.**

The Graphical User Interface application defaults file contains resources that specify which scheme files are used. If your custom scheme files are named differently than the default scheme files, you must modify these resource settings so that your customized scheme files are used instead of the default scheme files.

For example, to use the "\$HOME/.HP64\_schemes/HP-UX/Softkey.MyColor" color scheme file you would set the "HP64\_Softkey.colorScheme" resource to "MyColor":

```
HP64_Softkey.colorScheme: MyColor
```

Refer to the previous "To customize Graphical User Interface resources" section for more detailed information on modifying resources.

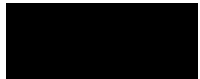

## To set up custom action keys

- **Modify the "actionKeysSub.keyDefs" resource.**

The "actionKeysSub.keyDefs" resource defines a list of paired strings. The first string defines the text that should appear on the action key pushbutton. The second string defines the command that should be sent to the command line area and executed when the action key is pushed.

A pair of parentheses (with no spaces, that is "()") can be used in the command definition to indicate that text from the entry buffer should replace the parentheses when the command is executed.

Action keys that use the entry buffer should always include the entry buffer symbol, "()", in the action key label as a visual cue to remind you to place information in the entry buffer before clicking the action key.

Shell commands can be executed by using an exclamation point prefix. A second exclamation point ends the command string and allows additional options on the command line.

Also, command files can be executed by placing the name of the file in the command definition.

Finally, an empty action ("") means to repeat the previous operation, whether it came from a pulldown, a dialog, a popup, or another action key.

---

### Examples

To set up custom action keys when the graphical interface is used with 6833x emulators, modify the "\*m6833x\*actionKeysSub.keyDefs" resource:

```
*m6833x*actionKeysSub.keyDefs: \  
"Make"                "cd /users/project2/6833x; !make! in_browser" \  
"Load Pgm"            "load configuration config.EA; load program2" \  
"Run Pgm"             "run from reset" \  
"Trace after ( )"     "trace after (); display trace" \  
"Step Source"         "set source on; display memory mnemonic; step source" \  
"Again"               ""
```

---

Refer to the previous "To modify Graphical User Interface resources" section for more detailed information on modifying resources.

## To set initial recall buffer values

- Modify the "entries" resource for the particular recall buffer.

There are six popup recall buffers present in the Graphical User Interface. The resources for these popup recall buffers are listed in the following table. The window manager resource "\*transientDecoration" controls the borders around dialog box windows. The most natural setting for this resource is "title."

Popup Recall Buffer Resources		
Recall Popup	Resources	Description
File→Context→Directory ...	*dirSelect.textColumns *dirSelect.listVisibleItemCount *dirSelectSub.entries	The default number of text columns in the popup is 50.
File→Context→Symbols ...	*symSelect.textColumns *symSelect.listVisibleItemCount *symSelectSub.entries	The default number of visible lines in the popup is 12.
Trace→Trace Spec ...	*modtrace.textColumns *modtrace.listVisibleItemCount *modtraceSub.entries	The "entries" resource is defined as a list of strings (see the following example).
Entry Buffer O:	*recall.textColumns *recall.listVisibleItemCount *recallSub.entries	Up to 40 unique values are saved in each of the recall buffers (as specified by the resource settings "*XcRecall.maxDepth: 40" and "*XcRecall.onlyUnique: True").
Command Line command recall	*recallCmd.textColumns *recallCmd.listVisibleItemCount *recallCmdSub.entries	
Command Line pod/simio recall	*recallKbd.textColumns *recallKbd.listVisibleItemCount *recallKbdSub.entries	

---

**Examples**

To set the initial values for the directory selection dialog box when the Graphical User Interface is used with 6833x emulators, modify the `*m6833x*dirSelectSub.entries` resource:

```
*m6833x*dirSelectSub.entries: \  
    "$HOME" \  
    ".." \  
    "/users/project1" \  
    "/users/project2/6833x"
```

---

Refer to the previous "To modify the Graphical User Interface resources" section for more detailed information on modifying resources.

---

## To set up demos or tutorials

You can add demos or tutorials to the Graphical User Interface by modifying the resources described in the following tables.

Demo Related Component Resources		
Resource	Value	Description
<code>*enableDemo</code>	False True	Specifies whether Help→Demo appears in the pulldown menu.
<code>*demoPopupSub.indexFile</code>	<code>./Xdemo/Index-topics</code>	Specifies the file containing the list of topic and file pairs.
<code>*demoPopup.textColumns</code>	30	Specifies the width, in characters, of the of the demo topic list popup.
<code>*demoPopup.listVisibleItemCount</code>	10	Specifies the length, in lines, of the demo topic list popup.
<code>*demoTopic</code>	About demos	Specifies the default topic in the demo popup selection buffer.

Tutorial Related Component Resources		
Resource	Value	Description
*enableTutorial	False True	Specifies whether Help→Tutorial appears in the pulldown menu.
*tutorialPopupSub.indexFile	./Xtutorial/Index-topics	Specifies the file containing the list of topic and file pairs.
*tutorialPopup.textColumns	30	Specifies the width, in characters, of the of the tutorial topic list popup.
*tutorialPopup.listVisibleItemCount	10	Specifies the length, in lines, of the tutorial topic list popup.
*tutorialTopic	About tutorials	Specifies the default topic in the tutorial popup selection buffer.

The mechanism for providing demos and tutorials in the graphical interface is identical. The following steps show you how to set up demos or tutorials in the Graphical User Interface.

**1 Create the demo or tutorial topic files and the associated command files.**

Topic files are simply ASCII text files. You can use "\I" to produce inverse video in the text, "\U" to produce underlining in the text, and "\N" to restore normal text.

Command files are executed when the "Press to perform demo (or tutorial)" button (in the topic popup dialog) is pushed. A command file must have the same name as the topic file with ".cmd" appended. Also, a command file must be in the same directory as the associated topic file.



## 2 Create the demo or tutorial index file.

Each line in the index file contains first a quoted string that is the name of the topic which appears in the index popup and second the name of the file that is raised when the topic is selected. For example:

```
"About demos"          /users/guest/gui_demos/general  
"Loading programs"    /users/guest/gui_demos/loadprog  
"Running programs"    /users/guest/gui_demos/runprog
```

You can use absolute paths (for example, /users/guest/topic1), paths relative to the directory in which the interface was started (for example, mydir/topic2), or paths relative to the product directory (for example, ./Xdemo/general where the product directory is something like /usr/hp64000/inst/emul/64742A).

## 3 Set the "\*enableDemo" or "\*enableTutorial" resource to "True".

## 4 Define the demo index file by setting the "\*demoPopupSub.indexFile" or "\*tutorialPopupSub.indexFile" resource.

For example:

```
*demoPopupSub.indexFile: /users/guest/gui_demos/index
```

You can use absolute paths (for example, /users/guest/Index), paths relative to the directory in which the interface was started (for example, mydir/indexfile), or paths relative to the product directory (for example, ./Xdemo/Index-topics where the product directory is something like /usr/hp64000/inst/emul/64742A).

## 5 If you wish to define a default topic to be selected, set the "\*demoTopic" or "\*tutorialTopic" resource to the topic string.

For example:

```
*demoTopic: "About demos"
```

Refer to the previous "To customize Graphical User Interface resources" section for more detailed information on modifying resources.

---

Reference

---



Descriptions of the product in a dictionary or encyclopedia format.





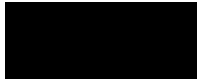

---

## Emulator/Analyzer Interface Commands

---

# Emulator/Analyzer Interface Commands

This chapter describes the emulator/analyzer interface commands in alphabetical order. First, the syntax conventions are described and the commands are summarized.

## How Pulldown Menus Map to the Command Line

Pulldown menu items and corresponding softkey commands are shown below.

---

Pulldown	Command Line
File→Context→Directory	cd
File→Context→Symbols	cws
File→Load→Emulator Config	load configuration
File→Load→Executable	load <abs_file>
File→Load→Program Only	load <abs_file> nosymbols
File→Load→Symbols Only	load symbols
File→Load→Trace Data	load trace <FILE>
File→Load→Trace Spec	load trace <FILE>
File→Store→Trace Data	store trace
File→Store→Trace Spec	store trace_spec
File→Store→BBA Data	bbaunload
File→Copy→Display	copy display to
File→Copy→Memory	copy memory to
File→Copy→Data Values	copy data to
File→Copy→Configuration Info	copy configuration_info to
File→Copy→Trace	copy trace to
File→Copy→Registers	copy registers to
File→Copy→Breakpoints	copy software_breakpoints to
File→Copy→Status	copy status to
File→Copy→Global Symbols	copy global_symbols to
File→Copy→Local Symbols ()	copy local_symbols_in --SYMB-- to
File→Copy→Pod Commands	copy pod_command to
File→Copy→Error Log	copy error_log to
File→Copy→Event Log	copy event_log to

---

Pulldown	Command Line
File→Log→Playback	<command file>
File→Log→Record	log_commands to
File→Log→Stop	log_commands off
File→Emul700→High-Level Debugger	N/A
File→Emul700→Performance Analyzer	N/A
File→Emul700→Emulator/Analyzer	N/A
File→Emul700→Timing Analyzer	N/A
File→Emul700→SPA for VRTXsa	N/A
File→Emul700→SPA for VRTX	N/A
File→Edit→File	! vi <file> ! no_prompt_before_exit
File→Edit→At () Location	! vi +<line> <file> ! no_prompt_before_exit
File→Edit→At PC Location	! vi +<line> <file> ! no_prompt_before_exit
File→Term	!
File→Exit→Window (save session)	end
File→Exit→Locked (all windows, save session)	end locked
File→Exit→Released (all windows, release emulator)	end release_system
Display→Context	pwd, pws
Display→Memory	display memory
Display→Memory→Mnemonic ()	display memory --EXPR-- mnemonic
Display→Memory→Mnemonic at PC	display memory mnemonic at_pc
Display→Memory→Mnemonic Previous	display memory mnemonic previous_display
Display→Memory→Hex ()→bytes	display memory --EXPR-- blocked bytes
Display→Memory→Hex ()→words	display memory --EXPR-- blocked words
Display→Memory→Hex ()→long	display memory --EXPR-- blocked long
Display→Memory→Real ()→short	display memory --EXPR-- real short
Display→Memory→Real ()→long	display memory --EXPR-- real long
Display→Memory→At ()	display memory --EXPR--
Display→Memory→Repetitively	display memory repetitively
Display→Data Values	display data
Display→Data Values→New ()→<type>	display data --EXPR-- <type>
Display→Data Values→Add ()→<type>	display data, --EXPR-- <type>

Pulldown	Command Line
Display→Configuration Info	display configuration_info
Display→Configuration Info→Diagnostics	display configuration_info diagnostics
Display→Configuration Info→Chip Selects (SIM)	display configuration_info sim_chip_selects
Display→Configuration Info→Chip Selects (Emulator SIM)	display configuration_info emsim_chip_selects
Display→Configuration Info→Bus Interface Ports (SIM)	display configuration_info bus_interface_ports
Display→Configuration Info→Bus Interface Ports (Emulator SIM)	display configuration_info embus_interface_ports
Display→Configuration Info→Memory Map	display configuration_info memory_map
Display→Configuration Info→Reset Mode Value	display configuration_info reset_mode
Display→Configuration Info→Initialization Source Code	display configuration_info init_source_code
Display→SIM Register Differences	sync_sim_registers difference
Display→Trace	display trace
Display→Registers	display registers
Display→Breakpoints	display software_breakpoints
Display→Status	display status
Display→Simulated IO	display simulated_io
Display→Global Symbols	display global_symbols
Display→Local Symbols ()	display local_symbols_in --SYMB--
Display→Pod Commands	display pod_command
Display→Error Log	display error_log
Display→Event Log	display event_log
Modify→Emulator Config	modify configuration
Modify→Memory	modify memory
Modify→Memory at ()	modify memory --EXPR--
Modify→Register	modify register
Modify→SIM Registers→Copy Processor SIM to Emulator SIM	sync_sim_registers from_6833x_to_config
Modify→SIM Registers→Copy Emulator SIM to Processor SIM	sync_sim_registers to_6833x_from_config
Modify→SIM Registers→Default Emulator SIM to Reset Values	sync_sym_registers default_emsim

Pulldown	Command Line
Execution→Run→from PC	run
Execution→Run→from ()	run from --EXPR--
Execution→Run→from Transfer Address	run from transfer_address
Execution→Run→from Reset	run from reset
Execution→Run→until ()	run until --EXPR--
Execution→Step Source→from PC	step source
Execution→Step Source→from ()	step source from --EXPR--
Execution→Step Source→from Transfer Address	step source from transfer_address
Execution→Step Instruction→from PC	step
Execution→Step Instruction→from ()	step from --EXPR--
Execution→Step Instruction→from Transfer Address	step from transfer_address
Execution→Break	break
Execution→Reset	reset
Breakpoints→Display	display software_breakpoints
Breakpoints→Enable	modify software_breakpoints enable/disable
Breakpoints→Permanent ()	modify software_breakpoints set --EXPR-- permanent
Breakpoints→Temporary ()	modify software_breakpoints set --EXPR-- temporary
Breakpoints→Set All	modify software_breakpoints set
Breakpoints→Clear ()	modify software_breakpoints clear --EXPR--
Breakpoints→Clear All	modify software_breakpoints clear



Pull-down	Command Line
Trace→Display	display trace
Trace→Display Options	display trace
Trace→Trace Spec	N/A (browses recall buffer for trace commands)
Trace→After ()	trace after STATE
Trace→Before ()	trace before STATE
Trace→About ()	trace about STATE
Trace→Only ()	trace only STATE
Trace→Only () Prestore	trace only STATE prestore anything
Trace→Again	trace again
Trace→Repetitively	<previous trace spec> repetitively
Trace→Everything	trace
Trace→Until ()	trace before STATE break_on_trigger
Trace→Until Stop	trace on_halt
Trace→Stop	stop_trace
Settings→Source/Symbol Modes→Absolute	set source off symbols off
Settings→Source/Symbol Modes→Symbols	set source off symbols on
Settings→Source/Symbol Modes→Source Mixed	set source on inverse_video on symbols on
Settings→Source/Symbol Modes→Source Only	set source only inverse_video off symbols on
Settings→Display Modes	set
Settings→Pod Command Keyboard	display pod_command; pod_command keyboard
Settings→Simulated IO Keyboard	display simulated_io; modify keyboard_to_simio
Settings→Command Line	N/A (toggles the command line)

## How Popup Menus Map to the Command Line

The following tables show the items available in the popup menus and the command line commands to which they map.

Mnemonic Memory Display Popup	Command Line
Set/Clear Software Breakpoint	modify software_breakpoints set/clear --EXPR--
Edit Source	! vi +<line> <file> ! no_prompt_before_exit
Run Until	run until --EXPR--
Trace After	trace after STATE
Trace Before	trace before STATE
Trace About	trace about STATE
Trace Until	trace before STATE break_on_trigger

Breakpoints Display Popup	Command Line
Set/Inactivate Breakpoint	modify software_breakpoints set/deactivate --EXPR--
Clear (delete) Breakpoint	modify software_breakpoints clear --EXPR--
Enable/Disable Software Breakpoints	modify software_breakpoints enable/disable
Set All Breakpoints	modify software_breakpoints set
Clear (delete) All Breakpoints	modify software_breakpoints clear

Symbols Display Popup	Command Line
Display Local Symbols	display local_symbols_in --SYMB--
Display Parent Symbols	display local_symbols_in --SYMB--, display global_symbols
Cut Full Symbol Name	N/A
Edit File Defining Symbol	! vi +<line> <file> ! no_prompt_before_exit

---

Status Line Popup	Command Line
Remove Temporary Message	N/A
Command Line On/Off	(toggles command line)
Display Error Log	display error_log
Display Event Log	display event_log

---

Command Line Popup	Command Line
Position Cursor, Replace Mode	<INSERT CHAR> key (when in insert mode)
Position Cursor, Insert Mode	<INSERT CHAR> key
Execute Command	<RETURN> key
Clear to End of Line	<CTRL>e
Clear Entire Line	<CTRL>u
Command Line Off	(toggles command line)

---



## Syntax Conventions

Conventions used in the command syntax diagrams are defined below.

### Oval-shaped Symbols

Oval-shaped symbols show options available on the softkeys and other commands that are available, but do not appear on softkeys (such as `log_commands` and `wait`). These appear in the syntax diagrams as:

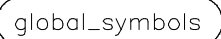

### Rectangular-shaped Symbols

Rectangular-shaped symbols contain prompts or references to other syntax diagrams. Prompts are enclosed with angle brackets (< and >). References to other diagrams are shown in all capital letters. Also, references to expressions are shown in all capital letters, for example `--EXPR--` and `--SYMB--` (see those syntax diagrams). These appear in the following syntax diagrams as:



### Circles

Circles indicate operators and delimiters used in expressions and on the command line as you enter commands. These appear in the syntax diagrams as:



### The -NORMAL- Key

The softkey labeled `-NORMAL-` allows you exit the `--SYMB--` definition, and access softkeys that are not displayed when defining expressions. You can press this key after you have defined an expression to view other available options.

---

## Commands

Emulator/analyzer Softkey Interface commands are summarized in the table below and described in the following pages.

!UNIX_COMMAND	display event_log	modify memory <sup>4</sup>
bbaunload	display global_symbols	modify register <sup>1</sup>
break	display local_symbols_in	modify software_breakpoints <sup>1</sup>
cd (change directory) <sup>3</sup>	display memory <sup>4</sup>	modify tags
cmb_execute	display pod_command	name_of_module <sup>3</sup>
<command file> <sup>3</sup>	display registers <sup>1</sup>	performance_measurement_end
copy configuration_info	display simulated_io <sup>2</sup>	performance_measurement_init
copy data <sup>4</sup>	display software_breakpoints	performance_measurement_run
copy display	display status	pod_command
copy error_log	display trace	pwd (print working directory) <sup>3</sup>
copy event_log	end	pws (print working symbol) <sup>3</sup>
copy global_symbols	forward <sup>3</sup>	reset
copy help	help <sup>3</sup>	run
copy local_symbols_in	load <absolute_file>	set
copy memory <sup>4</sup>	load configuration	specify
copy pod_command	load emul_mem	step
copy registers <sup>1</sup>	load fg_mon	stop_trace
copy software_breakpoints	load trace	store memory
copy status	load trace_spec	store trace
copy trace	load user_memory	store trace_spec
cws(change working symbol) <sup>3</sup>	log_commands <sup>3</sup>	sync_sim_registers <sup>1</sup>
display configuration_info	modify configuration	trace
display data <sup>4</sup>	modify keyboard_to_simio <sup>2</sup>	wait <sup>3</sup>
display error_log		

<sup>1</sup> This option is not available in real-time mode.  
<sup>2</sup> This is only available when simulated I/O is defined.  
<sup>3</sup> These commands are not displayed on softkeys.  
<sup>4</sup> This option is not available in real-time mode if addresses are in user memory.

---

## **bbaunld**

This command is available when the HP Branch Validator product is installed. This basis branch analyzer (BBA) product is used to analyze the testing of your programs, create more complete test suites, and quantify your level of testing.

The HP Branch Validator records branches executed in a program and generates reports that provide information about program execution during testing. It uses a special C preprocessor to add statements that write to a data array when program branches are taken. After running the program in the emulator (using test input), you can use the **bbaunload** command to store the BBA information to a file. Then, you can generate reports based on the stored information.

### **See Also**

Refer to the *HP Branch Validator (BBA) User's Guide* for complete details on the **bbaunload** command syntax.

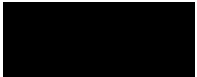

---

## break



This command causes the emulator to leave user program execution and begin executing in the monitor.

The behavior of **break** depends on the state of the emulator:

running

Break diverts the processor from execution of your program to the emulation monitor.

reset

Break releases the processor from reset, and diverts execution to the monitor.

running in monitor

The **break** command does not perform any operation while the emulator is executing in the monitor.

**See Also**

The **reset**, **run**, and **step** commands.

---

## cmb\_execute



The `cmb_execute` command causes the emulator to emit an EXECUTE pulse on its rear panel Coordinated Measurement Bus (CMB) connector. All emulators connected to the CMB (including the one sending the CMB EXECUTE pulse) and configured to respond to this signal will take part in the measurement.

### See Also

The ***specify run*** and ***specify trace*** commands.

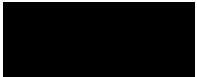

---

**copy**

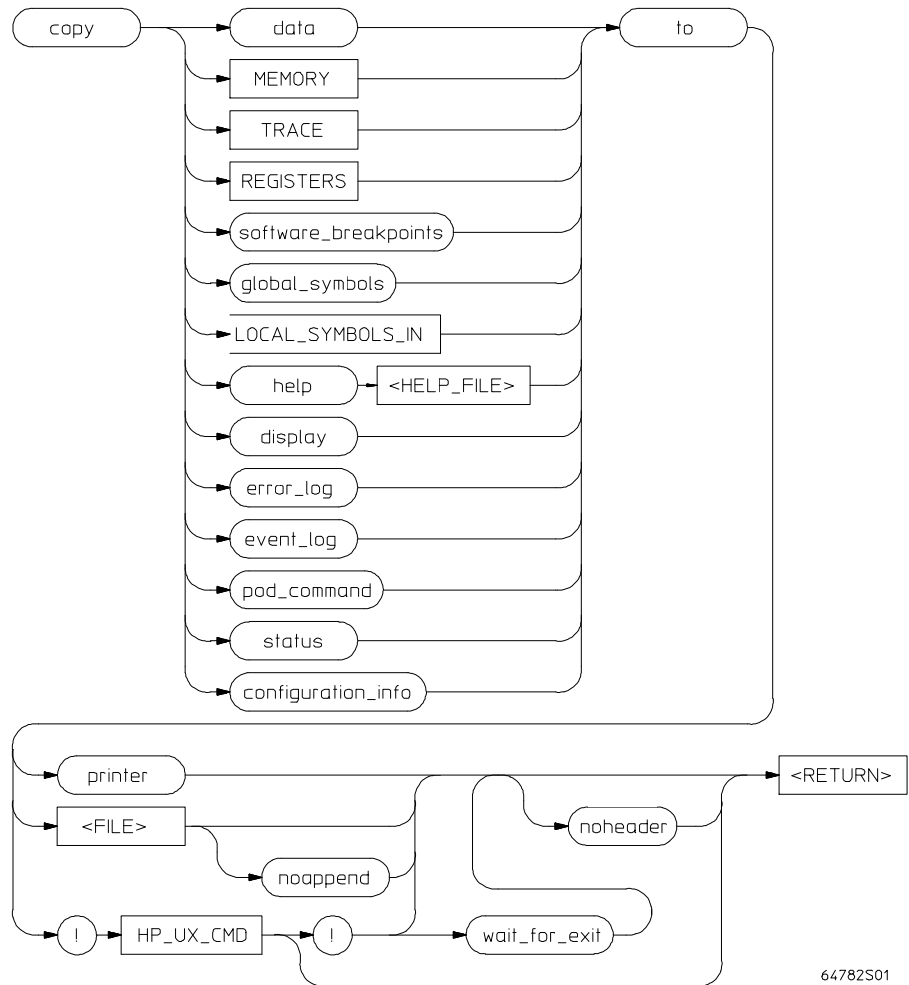

64782S01

Use this command with various parameters to save or print emulation and analysis information.

The **copy** command copies selected information to your system printer or listing file, or directs it to an UNIX process.

Depending on the information you choose to copy, default values may be options selected for the previous execution of the display command. For example, if you display memory locations 10h through 20h, then issue a copy memory to myfile command, myfile will list only memory locations 10h through 20h.

The parameters are as follows:

configuration_info	Copies the last configuration information display.
data	Copies a list of memory contents formatted in various data types (see display data).
display	Copies the display to a selected destination.
error_log	Copies the most recent errors that have occurred.
event_log	Copies the most recent events that have occurred.
<FILE>	This prompts you for the name of a file where you want the specified information to be copied. If you want to specify a file name that begins with a number, you must precede the file name with a backslash. For example: <b>copy display to \12.10.</b>
global_symbols	Copies a list of global symbols to the selected destination.
help	Copies the contents of the emulation help files to the selected destination.
<HELP_FILE>	This represents the name of the help file to be copied. Available help file names are displayed on the softkey labels.
UNIX CMD	This represents an UNIX filter or pipe where you want to route the output of the copy command. UNIX commands must be preceded by an exclamation point (!). An exclamation point following the UNIX command continues command line execution after the UNIX command executes. Emulation is not affected when using an UNIX command that is a shell intrinsic.
local_symbols_in	Copies all the children of a given symbol to the selected destination. See the --SYMB-- syntax page and the <i>Symbolic Retrieval Utilities User's Guide</i> for information on symbol hierarchy.
memory	Copies a list of the contents of memory to the selected destination.
noappend	This causes any copied information to overwrite an existing file with the same name specified by <FILE>. If this option is not selected, the default operation is to append the copied information to the end of an existing file with the same name that you specify.
noheader	Copies the information into a file without headings.
pod_command	This allows you to copy the most recent commands sent to the HP 64700 Series emulator/analyzer.

**copy**

**printer** This option specifies your system printer as the destination device for the copy command. Before you can specify the printer as the destination device, you must define PRINTER as a shell variable. For example, you could enter the text shown below after the "\$" symbol:

```
$ PRINTER=lp
$ export PRINTER
```

If you don't want the print message to overwrite the command line, execute:

```
$ set PRINTER = "lp -s"
```

**registers** Copies a list of the contents of the emulation processor registers to the selected destination.

**software  
\_breakpoints** Copies a list of the current software breakpoints to a selected destination.

**status** Copies emulation and analysis status information.

**to** This allows you to specify a destination for the copied information.

**trace** Copies the current trace listing to the selected destination.

**wait\_for\_exit** Waits for the UNIX command to complete before returning.

**!** An exclamation point specifies the delimiter for UNIX commands. An exclamation point must precede all UNIX commands. A trailing exclamation point should be used if you want to return to the command line and specify noheader. Otherwise, the trailing exclamation point is optional. If an exclamation point is part of the UNIX command, a backslash (\) must precede the exclamation point.

---

**Examples**

---

See the following pages on various **copy** syntax diagrams.

**See Also**

See the following pages on various **copy** syntax diagrams.



## copy local\_symbols\_in

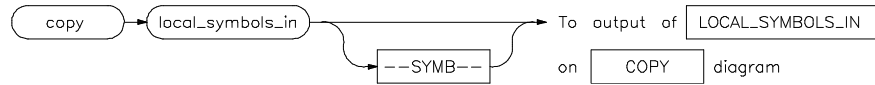

This command lets you copy local symbols contained in a source file and relative segments (program, data, or common) to the selected destination. Local symbols are symbols that are children of the particular file or symbol defined by --SYMB--, that is, they are defined in that file or scope.

For additional information on symbols, refer to the --SYMB-- syntax pages and the *Symbolic Retrieval Utilities User's Guide*.

--SYMB-- is the current working symbol.

The parameters are as follows:

--SYMB--

This option represents the symbol whose children are to be listed. See the --SYMB-- syntax diagram and the *Symbolic Retrieval Utilities User's Guide* for information on symbol hierarchy.

### Examples

***copy local\_symbols\_in*** mod\_name ***to printer***

***copy local\_symbols\_in*** mod\_name: ***to*** linenumfile

### See Also

The ***display local\_symbols\_in*** command.



---

**copy memory**

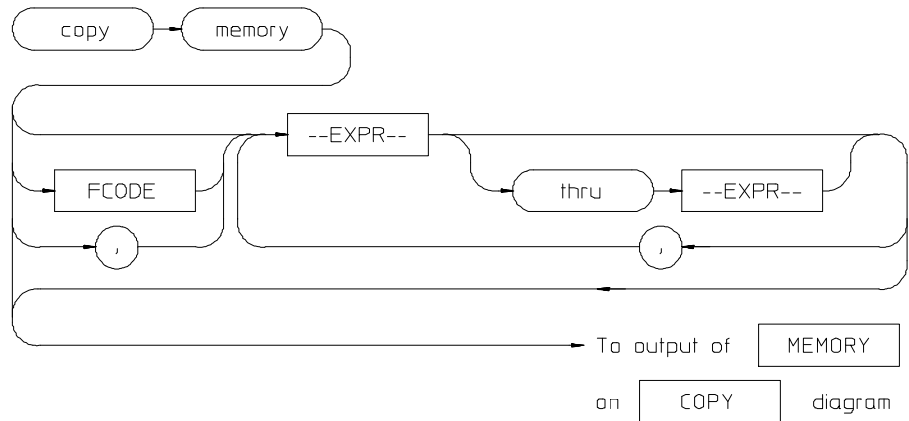

This command copies the contents of a memory location or series of locations to the specified output.

The memory contents are copied in the same format as specified in the last display memory command.

Contents of memory can be displayed if program runs are not restricted to real-time. Memory contents are listed as an asterisk (\*) under the following conditions:

- The address refers to guarded memory.
- Runs are restricted to real-time, the emulator is running a user program, and the address is located in user memory.

Values in emulation memory can always be displayed.

Initial values are the same as those specified by the command **display memory 0 blocked bytes offset\_by 0**.

Defaults are to values specified in the previous **display memory** command.

The parameters are as follows:

--EXPR--

An expression is a combination of numeric values, symbols, operators, and parentheses, specifying a memory address or offset value. See the EXPR syntax diagram.

FCODE

The function code used to define the address space being referenced. See the syntax diagram for FCODE to see a list of the function codes available and for an explanation of those codes.

,

A comma used immediately after memory in the command line appends the current copy memory command to the preceding display memory command. The data specified in both commands is copied to the destination specified in the current command. Data is formatted as specified in the current command. The comma is also used as a delimiter between values when specifying multiple memory addresses.

---

**Examples**

***copy memory*** start ***to printer***

***copy memory*** 0 ***thru*** 100h , start ***thru*** +5 , 500H ,  
target2 ***to*** memlist

***copy memory*** 2000h ***thru*** 204fh ***to*** memlist

---

**See Also**

The ***display memory***, ***modify memory***, and ***store memory*** commands.



---

## copy registers

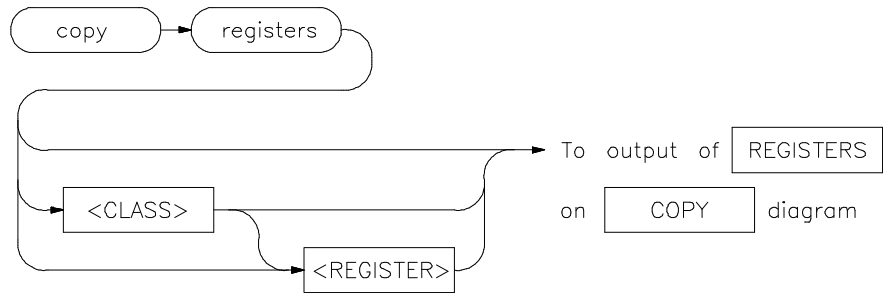

This command copies the contents of the processor registers to a file or printer.

The copy register process does not occur in real-time. The emulation system must be configured for nonreal-time operation to list the registers while the processor is running.

With no options specified, the basic register class is copied. This includes the local and global registers.

The parameters are as follows:

Specifies a particular class of the emulator registers.

<CLASS>  
<REGISTER>

---

### Examples

***copy registers global to printer***

***copy registers to reglist***

---

### See Also

The ***display registers*** and ***modify registers*** commands.

## copy trace

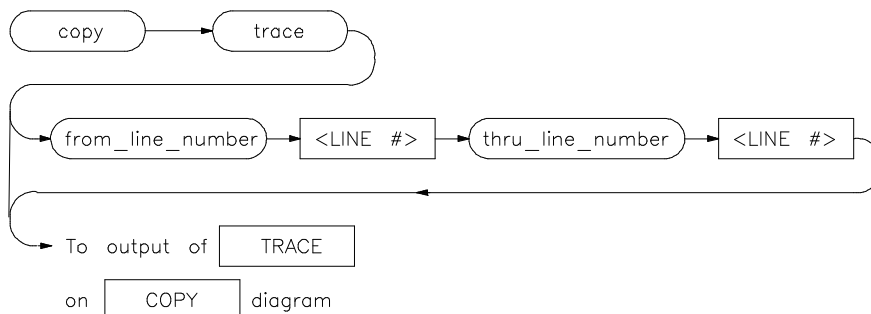

This command copies the contents of the trace buffer to a file or to the printer.

Trace information is copied in the same format as specified in the last display trace command.

Initial values are the same as specified by the last **display trace** command.

The parameters are as follows:

from\_line\_number  
 <LINE#>

This specifies the trace list line number from which copying will begin.

thru\_line\_number

Use this with from\_line\_number and thru\_line\_number to specify the starting and ending trace list lines to be copied.

Specifies the last line number of the trace list to include in the copied range.

### Examples

**copy trace to** tlist

**copy trace from\_line\_number** 0 **thru\_line\_number** 5  
**to** longtrac

### See Also

The **display trace** and **store trace** commands.

---

## display

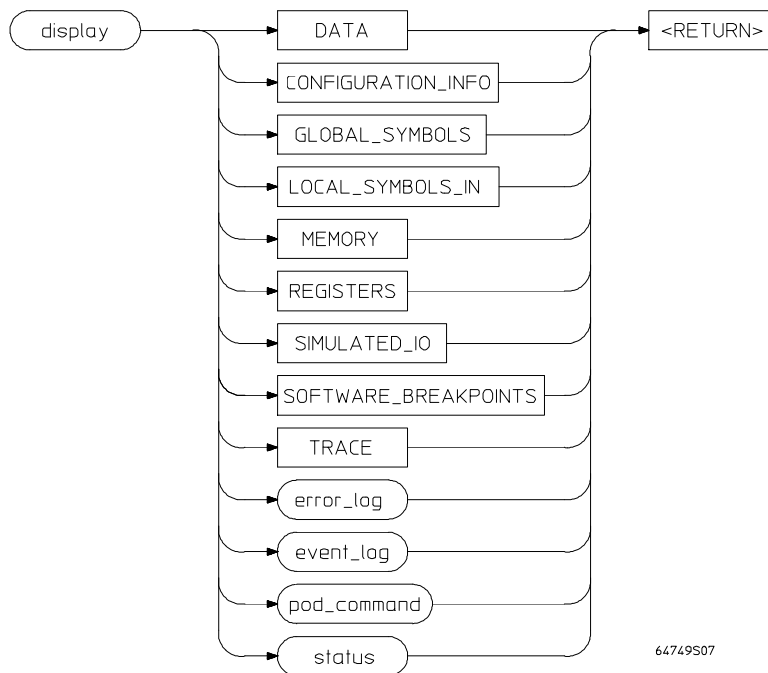

64749S07

This command displays selected information on your screen.

You can use the <Up arrow>, <Down arrow>, <PREV>, and <NEXT> keys to view the displayed information. For software\_breakpoints, data, memory, and trace displays you can use the <CTRL>g and <CTRL>f keys to scroll left and right if the information goes past the edge of the screen.

Depending on the information you select, defaults may be the options selected for the previous execution of the **display** command.

The parameters are as follows:

- data This allows you to display a list of memory contents formatted in various data types (see the display data pages for details).
- error\_log This option displays the recorded list of error messages that occurred during the emulation session.
- event\_log This option displays the recorded list of events.
- global\_symbols This option lets you display a list of all global symbols in memory.

local_symbols_in	This option lets you display all the children of a given symbol. See the --SYMB-- syntax page and the <i>Symbolic Retrieval Utilities User's Guide</i> for details on symbol hierarchy.
memory	This option allows you to display the contents of memory.
pod_command	This option lets you display the output of previously executed emulator pod commands.
registers	This allows you to display the contents of emulation processor registers.
simulated_io	This lets you display data written to the simulated I/O display buffer after you have enabled polling for simulated I/O in the emulation configuration.
software_breakpoints	This option lets you display the current list of software breakpoints.
status	This displays the emulator and trace status.
trace	This displays the current trace list.

---

**Examples**

***display event\_log***

***display local\_symbols\_in*** mod\_name

---

**See Also**

The ***copy*** command description and the following pages which describe the various ***display*** commands.

---

## display configuration\_info

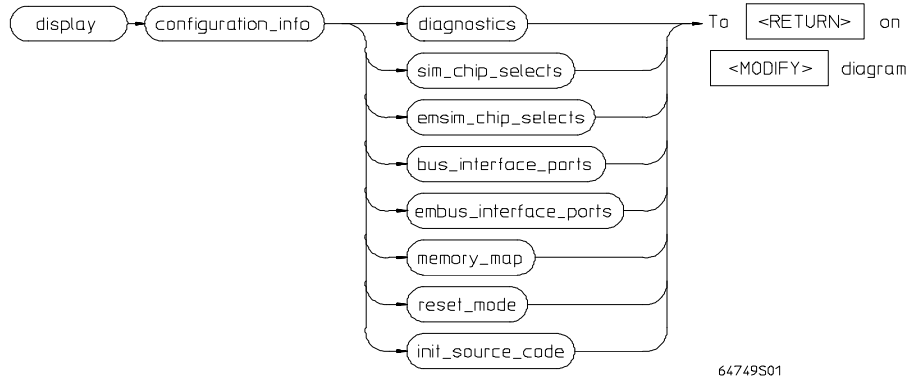

This command displays information about emulator configuration and processor SIM programming. You can also display diagnostic information about inconsistencies found in the emulator configuration.



diagnostics	<p>The parameters are as follows:</p> <p>Checks all parts of the emulator configuration and reports any inconsistencies. It identifies errors that result from inconsistencies between related configuration values. These errors should be resolved in order for the emulator to operate correctly.</p> <p>This option primarily checks for inconsistencies between the mapper and the EMSIM registers, but it also provides status messages about expectations and limitations of the emulator of which you should be aware. (These checks are primarily between the reset mode configuration value and the EMSIM registers.)</p> <p>If no messages are returned, no inconsistencies are found in the emulator configuration.</p>
sim_chip_selects	Display chip select information from the sim (processor) register set or the emsim (emulator) register set. The resulting display shows:
emsim_chip_selects	<ul style="list-style-type: none"><li>How the chip select is assigned.</li><li>The base address.</li><li>The block size.</li><li>Other information from the option register.</li></ul>
bus_interface_ports	Display bus interface information from the sim (processor) register set or the emsim (emulator) register set. The resulting display shows the pin assignments for the C, E, and F ports.
embus_interface_ports	
memory_map	<p>When in the memory map section of the emulator configuration, the ranges of memory that have been mapped are displayed.</p> <p>The memory map configuration information shows detailed information about the memory map and how actual mapper resources are allocated due to the current programming of the chip selects in the EMSIM and EMRAM register sets.</p>
reset_mode	Displays information about the reset mode configuration value, whether it is generated internally by the emulator or externally by the target system.
init_source_code	Displays the assembly language program that will initialize the processor as defined by the current EMSIM register contents.

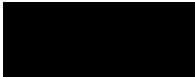

---

**Examples**

*display configuration\_info diagnostics*

*display configuration\_info memory\_map*

---

**See Also**

The *sync\_sim\_registers* and *modify configuration* commands. Also, see the "Verifying the Emulator Configuration" section in the "Configuring the Emulator" chapter.

---

## display data

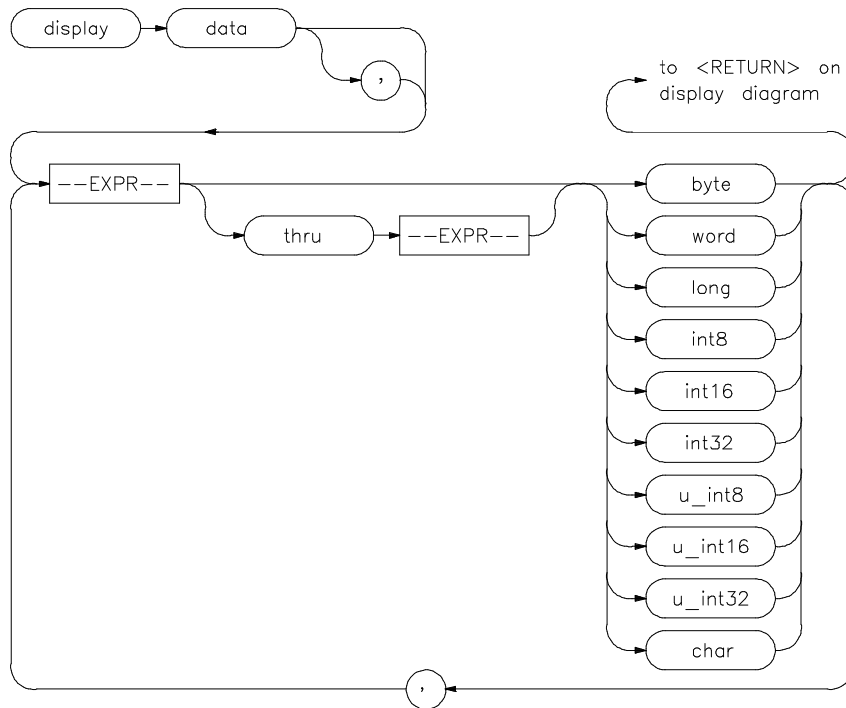

This command can display the values of simple data types in your program. Using this command can save you time; otherwise, you would need to search through memory displays for the location and value of a particular variable.

The address, identifier, and data value of each symbol may be displayed. You must issue the command set symbols on to see the symbol names displayed.

In the first **display data** command after you begin an emulation session, you must supply at least one expression specifying the data item(s) to display.

Thereafter, the **display data** command defaults to the expressions specified in the last **display data** command, unless new expressions are supplied or appended (with a leading comma).

**display data**

Symbols are normally set off until you give the command **set symbols on**. Otherwise, only the address, data type, and value of the data item will be displayed.

The parameters are as follows:

,	A leading comma allows you to append additional expressions to the previous display data command.
--EXPR--	Commas between expression/data type specifications allow you to specify multiple variables and types for display with the current command. Prompts you for an expression specifying the data item to display. The expression can include various math operators and program symbols. See the --EXPR-- and --SYMB-- syntax pages for more information.
thru --EXPR--	Allows you to specify a range of addresses for which you want data display. Typically, you use this to display the contents of an array. You can display both single-dimensioned and multi-dimensioned arrays. Arrays are displayed in the order specified by the language definition, typically row major order for most Algol-like languages.
<TYPE>	Specifies the format in which to display the information. (Data type information is not available from the symbol database, so you must specify.)
byte	Hex display of one 8 bit location.
word	Hex display of one 16 bit location.
long	Hex display of one 32 bit location.
	Note that byte ordering in word and long displays is determined by the conventions of the processor in use.
int8	Display of one 8 bit location as a signed integer using two's complement notation.
int16	Display of two bytes as a signed integer using two's complement notation.
int32	Display of four bytes as a signed integer using two's complement notation.
u_int8	Display of one byte as an unsigned positive integer.
u_int16	Display of two bytes as an unsigned positive integer.
u_int32	Display of four bytes as an unsigned positive integer.
char	Displays one byte as an ASCII character in the range 0 through 127. Control characters and values in the range 128 through 255 are displayed as a period (.).

---

**Examples**

*display data* Msg\_A *thru* +17 *char*, Stack *long*

*set symbols on*

*set width label* 30

*display data* , Msg\_B *thru* +17 *char*, Msg\_Dest *thru*  
+17 *char*

---

**See Also**

The *copy data* and *set* commands.

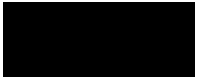

---

## display global\_symbols

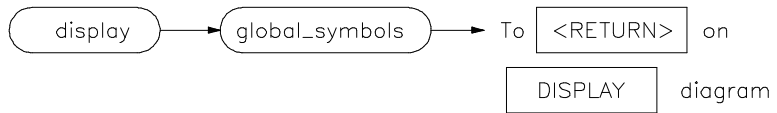

This command displays the global symbols defined for the current absolute file.

Global symbols are symbols declared as global in the source file. They include procedure names, variables, constants, and file names. When the ***display global\_symbols command*** is used, the listing will include the symbol name and its logical address.

### See Also

The ***copy global\_symbols*** command.

## display local\_symbols\_in

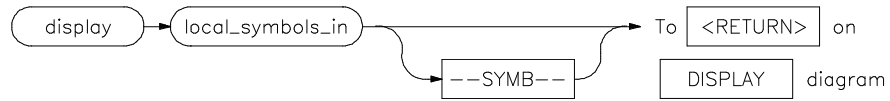

This command displays the local symbols in a specified source file and their relative segment (program, data, or common).

Local symbols of --SYMB-- are the ones which are children of the file and/or scope specified by --SYMB--. That is, they are defined in that file or scope.

See the --SYMB-- syntax pages and the *Symbolic Retrieval Utilities User's Guide* for further explanation of symbols.

Displaying the local symbols sets the current working symbol to the one specified.

The parameters are as follows:

--SYMB--

This option represents the symbol whose children are to be listed. See the --SYMB-- syntax diagram and the *Symbolic Retrieval Utilities User's Guide* for more information on symbol hierarchy and representation.

### Examples

***display local\_symbols\_in*** mod\_name

***display local\_symbols\_in*** mod\_name:main

### See Also

The ***copy local\_symbols\_in*** command.

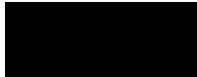

---

**display memory**

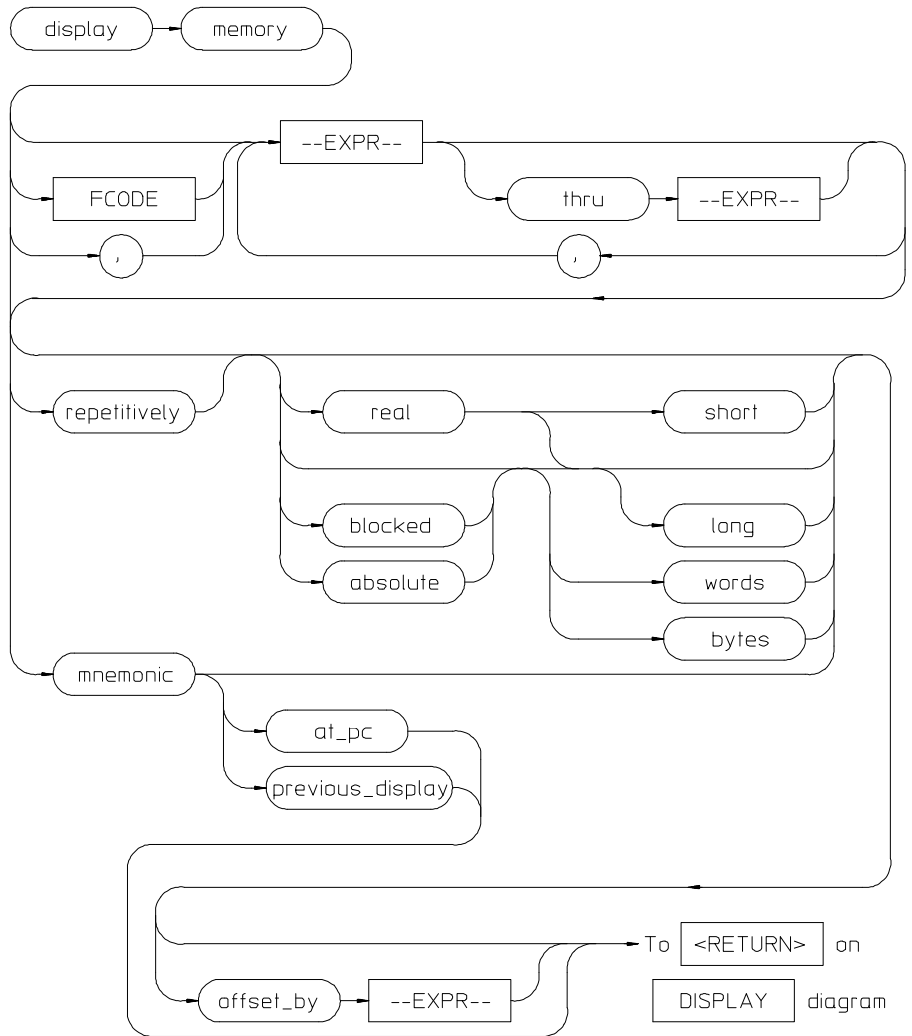

This command displays the contents of the specified memory location or series of locations.

The memory contents can be displayed in mnemonic, hexadecimal, or real number format. In addition, the memory addresses can be listed offset by a



value, which allows the information to be easily compared to the program listing.

When displaying memory mnemonic and stepping, the next instruction that will step is highlighted. The memory mnemonic display autopages to the new address if the next PC goes outside the currently displayed address range. This feature works even if stepping is performed in a different emulation window than the one displaying memory mnemonic.

Pending software breakpoints are shown in the memory mnemonic display by an asterisk (\*) in the leftmost column of the assembly instruction or source line that has a pending breakpoint.

A label column (symbols) may be displayed for all memory displays except blocked mode. Memory mnemonic may be displayed with source and assembly code intermixed, or with source code only. Symbols also can be displayed in the memory mnemonic string. (See the **set** command.)

Initial values are the same as specified by the command:

***display memory 0 blocked bytes offset\_by 0***

Defaults are values specified in a previous ***display memory*** command.

The symbols and source defaults are:

***set source off symbols off***

The parameters are as follows:

absolute	Formats the memory listing in a single column.
at_pc	Displays the memory at the address pointed to by the current program counter value.
blocked	Formats the memory listing in multiple columns.
bytes	Displays the absolute or blocked memory listing as byte values.
--EXPR--	An expression is a combination of numeric values, symbols, operators, and parentheses, specifying a memory address or memory offset value. See the EXPR syntax diagram.
FCODE	The function code used to define the address space being referenced. See the syntax diagram for FCODE to see a list of the function codes available and for an explanation of those codes.
long	Displays memory in a 64-bit real number format or 32-bit long words when preceded by blocked or absolute.

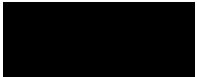

**display memory**

mnemonic	This causes the memory listing to be formatted in assembly language instruction mnemonics with associated operands. When specifying mnemonic format, you should include a starting address that corresponds to the first byte of an operand to ensure that the listed mnemonics are correct. If set source only is on, you will see only the high level language statements and corresponding line numbers.
offset_by	This option lets you specify an offset that is subtracted from each of the absolute addresses before the addresses and corresponding memory contents are listed. You might select the offset value so that each module appears to start at address 0000H. The memory contents listing will then appear similar to the assembler or compiler listing.  This option is also useful for displaying symbols and source lines in dynamically relocated programs.
previous_display	Returns to display associated with the previous mnemonic memory display command.
real	Formats memory values in the listing as real numbers. (NaN in the display list means "Not a Number.")
repetitively	Updates the memory listing display continuously. You should only use this to monitor memory while running user code, since it is very CPU intensive. To allow updates to the current memory display whenever memory is modified, a file is loaded, software breakpoint is set, etc., use the set update command.
short	Formats the memory list as 32-bit real numbers.
thru	This option lets you specify a range of memory locations to be displayed. Use the <Up arrow>, <Down arrow>, <NEXT>, and <PREV> keys to view additional memory locations.
words	Displays the absolute or blocked memory listing as 16-bit word values.
,	A comma after memory in the command line appends the current display memory command to the preceding display memory command. The data specified in both commands is displayed. The data will be formatted as specified in the current command. The comma is also a delimiter between values when specifying multiple addresses.

---

**Examples**

You can display memory in real number and mnemonic formats:

```
display memory 2000h thru 202fh , 2100h real long
```

```
display memory 400h mnemonic
```

```
set symbols on
```

```
set source on
```

```
display memory main mnemonic
```

---

**See Also**

The *copy memory*, *modify memory*, *set*, and *store memory* commands.

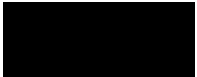

---

## display registers

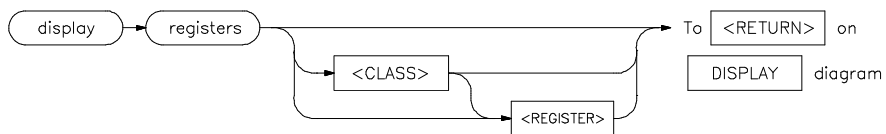

This command displays the current contents of the emulation processor registers.

If a **step** command just executed, the mnemonic representation of the last instruction is also displayed, if the current display is the register display. This process does not occur in real-time. The emulation system must be configured for nonreal-time operation to display registers while the processor is running. Symbols also may be displayed in the register step mnemonic string (see **set symbols**).

With no options specified, the basic register class is displayed as the default. This includes the local and global registers.

The parameters are as follows:

<CLASS>

This allows you to display a particular class of emulation processor registers.

<REGISTER>

This displays an individual register or control register field.

---

### Examples

**display registers**

**display registers** BASIC D2

---

### See Also

The **copy registers**, **modify registers**, **set**, and **step** commands.

---

## display simulated\_io

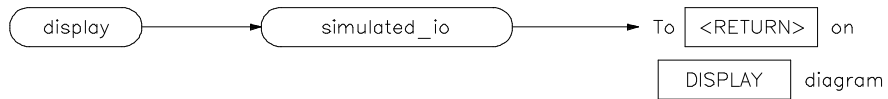

This command displays information written to the simulated I/O display buffer.

After you have enabled polling for simulated I/O during the emulation configuration process, six simulated I/O addresses can be defined. You then define files used for standard input, standard output, and standard error.

For details about setting up simulated I/O, refer to the *Simulated I/O User's Guide*.

---

### Examples

***display simulated\_io***

### See Also

The ***modify configuration*** and ***modify keyboard\_to\_simio*** commands.

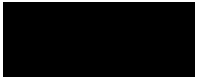

---

## display software\_breakpoints

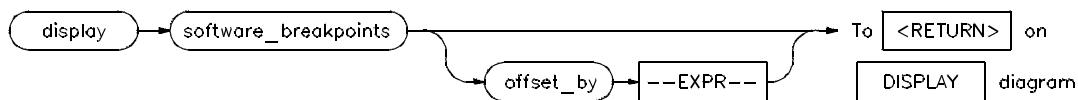

This command displays the currently defined software breakpoints and their status.

If the emulation session is continued from a previous session, the listing will include any previously defined breakpoints. The column marked "status" shows whether the breakpoint is pending, inactivated, or unknown.

A pending breakpoint causes the processor to enter the emulation monitor upon execution of that breakpoint. Executed breakpoints are listed as inactivated. Entries that show an inactive status can be reactivated by executing the **modify software\_breakpoints set** command.

A label column also may be displayed for addresses that correspond to a symbol. See the **set** command for details.

The parameters are as follows:

--EXPR--

An expression is a combination of numeric values, symbols, operators, and parentheses, specifying an offset value for the breakpoint address. See the --EXPR-- syntax diagram.

offset\_by

This option allows you to offset the listed software breakpoint address value from the actual address of the breakpoint. By subtracting the offset value from the breakpoint address, the system can cause the listed address to match that given in the assembler or compiler listing.

---

### Examples

**display software\_breakpoints**

**display software\_breakpoints offset\_by 1000H**

---

### See Also

The **copy software\_breakpoints**, **modify software\_breakpoints**, and **set** commands.

## display trace

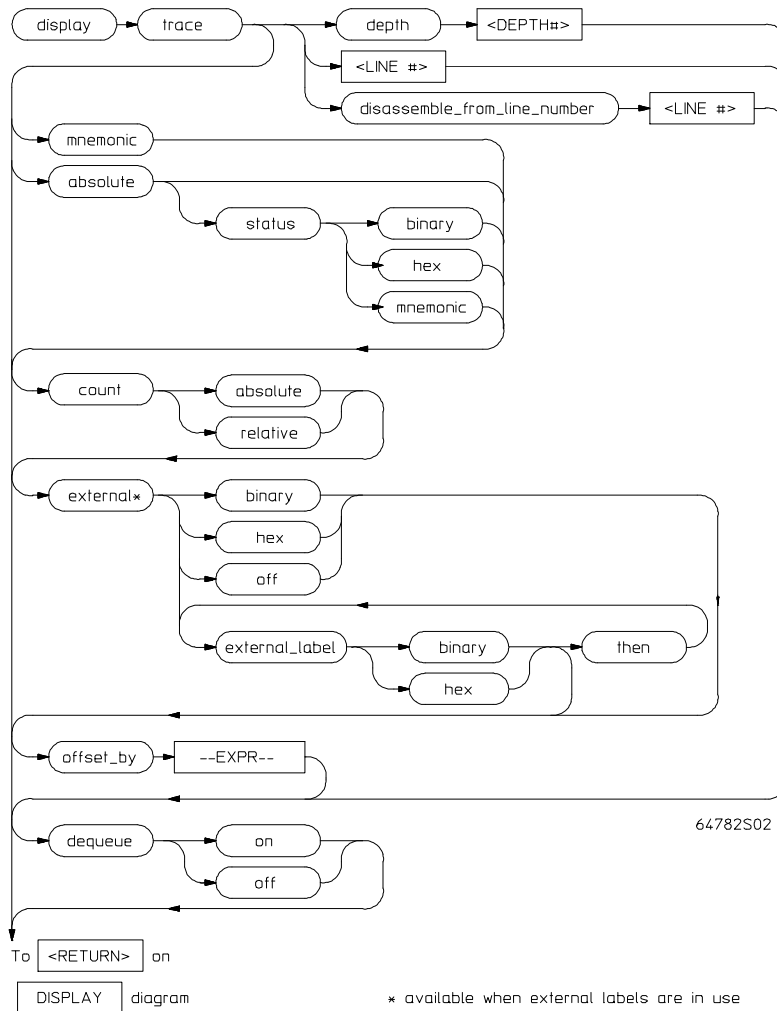

This command displays the contents of the trace buffer.

Captured information can be presented as absolute hexadecimal values or in mnemonic form. The processor status values captured by the analyzer can be listed mnemonically or in hexadecimal or binary form.

**display trace**

Addresses captured by the analyzer are physical addresses.

The `offset_by` option subtracts the specified offset from the addresses of the executed instructions before listing the trace. With an appropriate entry for `offset`, each instruction in the listed trace will appear as it does in the assembled or compiled program listing.

The `count` parameter lists the time associated with a trace event either relative to the previous event in the trace list or as an absolute count measured from the trigger event.

The `source` parameter allows display of source program lines in the trace listing, enabling you to quickly correlate the trace list with your source program.

Initial values are the same as specified by the command:

***display trace mnemonic count relative offset\_by 0***

The parameters are as follows:

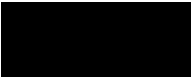
- absolute Lists trace information in hexadecimal format, rather than mnemonic opcodes.
- count
  - absolute This lists the time count for each event of the trace as the total time measured from the trigger event.
  - relative This lists the time count for each event of the trace as the time measured relative to the previous event.
- depth
  - <DEPTH#> This defines the number of states to be uploaded by the interface. Note that after you have changed the trace depth, execute the command `wait measurement_complete` before displaying the trace. Otherwise the new trace states will not be available.
-  dequeue Displays the trace list with or without dequeuing. A dequeued trace list is available through the disassembly options. In a dequeued trace list, unused instruction prefetch cycles are discarded, and operand cycles are placed immediately following the corresponding instruction fetch. If you choose a non-dequeued trace list, instruction and operand fetches are shown exactly as captured by the analyzer.
- disassemble
  - \_from\_line Displays the trace at a certain line number and disassembles instruction
  - \_number opcodes.



--EXPR-- An expression is a combination of numeric values, symbols, operators, and parentheses, specifying an offset value to be subtracted from the addresses traced by the emulation analyzer. See the EXPR syntax diagram.

external  
 binary Displays the external analyzer trace list in binary format.  
 <external  
 \_label> This option displays a defined external analyzer label.  
 hex Displays the external analyzer trace list in hexadecimal format.  
 off Use this option to turn off the external trace list display.  
 then This allows you to display multiple external analysis labels. This option appears when more than one external analyzer label is in use.

<LINE#> This prompts you for the trace list line number to be centered in the display. Also, you can use <LINE#> with disassemble\_from\_line\_number. <LINE#> prompts you for the line number from which the inverse assembler attempts to disassemble data in the trace list.

mnemonic Lists trace information with opcodes in mnemonic format.

offset\_by This option allows you to offset the listed address value from the address of the instruction. By subtracting the offset value from the physical address of the instruction, the system makes the listed address match that given in the assembler or compiler listing.  
 This option is also useful for displaying symbols and source lines in dynamically relocated programs.  
 Note that when using the set source only command, the analyzer may operate more slowly than when using the set source on command. This is an operating characteristic of the analyzer:  
 When you use the command set source on, and are executing only assembly language code (not high-level language code), no source lines are displayed. The trace list will then fill immediately with the captured assembly language instructions.  
 When using set source only, no inverse assembled code is displayed. Therefore, the emulation software will try to fill the display with high-level source code. This requires the emulation software to search for any captured analysis data generated by a high-level language statement.

In conclusion, you should not set the trace list to set source only when tracing assembly code. This will result in optimum analyzer performance.

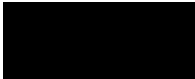

status	
binary	Lists absolute status information in binary form.
hex	Lists absolute status information in hexadecimal form.
mnemonic	Lists absolute status information in mnemonic form.

---

**Examples**

*display trace count absolute*

*display trace absolute status binary*

*display trace mnemonic*

---

**See Also**

The *copy trace*, *store trace*, and *set* commands.

---

end

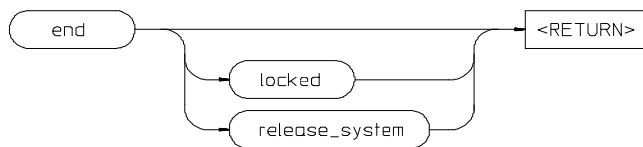

This command terminates the current emulation session.

You can end the emulation session and keep the emulator in a locked state. The current emulation configuration is stored, so that you can continue the emulation session on reentry to the emulator. You also can release the emulation system when ending the session so that others may use the emulator.

Note that pressing <CTRL>d performs the same operation as pressing **end** <RETURN>. Pressing <CTRL>\ or <CTRL>| performs the same as **end release\_system** <RETURN>.

When the emulation session ends, control returns to the UNIX shell without releasing the emulator.

The parameters are as follows:

locked

This option allows you to stop all active instances of an emulator/analyzer interface session in one or more windows and/or terminals. This option is not available when operating the emulator in the measurement system.

release\_system

This option stops all instances of the emulator/analyzer interface in one or more windows or terminals. The emulation system is released for other users. If you do not release the emulation system when ending, others cannot access it.

---

Examples

**end**

**end release\_system**

---

See Also

The "Exiting the Emulator/Analyzer Interface" section in the "Starting and Exiting HP 64700 Interfaces" chapter.

--EXPR--

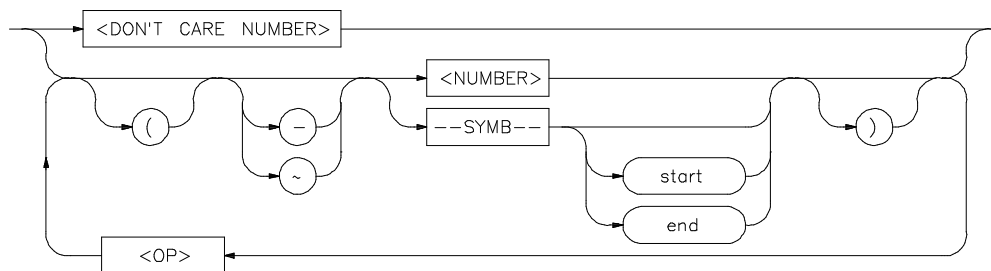

An expression is a combination of numeric values, symbols, operators, and parentheses used to specify address, data, status, executed address, or any other value used in the emulation commands.

The function of an expression (--EXPR--) is to let you define the address, data, status, or executed address expression that fits your needs. You can combine multiple values to define the expression.

Certain emulation commands will allow the option of <+EXPR> after pressing a thru softkey. This allows you to enter a range without retyping the original base address or symbol. For example, you could specify the address range

```
disp_buf thru disp_buf + 25
```

as

```
disp_buf thru +25
```

The parameters are as follows:

DON'T CARE  
NUMBER

You can include "don't care numbers" in expressions. These are indicated by a number containing an "x." These numbers may be defined as binary, octal, decimal, or hexadecimal. For example: 1fxxh, 17x7o, and 011xxx10b are valid.

--NORMAL--

Note that "Don't care numbers" are not valid for all commands.

This appears as a softkey label to enable you to return to the --EXPR-- key. The --NORMAL-- label can be accessed whenever defining an expression, but

is only valid when "C" appears on the status line, which indicates a valid expression has been defined.

<NUMBER> This can be an integer in any base (binary, octal, decimal, or hexadecimal), or can be a string of characters enclosed with quotation marks.

<OP> This represents an algebraic or logical operand and may be any of the following (in order of precedence):

mod	modulo
*	multiplication
/	division
&	logical AND
+	addition
-	subtraction
	logical OR

--SYMB-- This allows you to define symbolic information for an address, range of addresses, or a file. See the --SYMB-- syntax pages and the *Symbolic Retrieval Utilities User's Guide* for more information on symbols.

end This displays the last location where the symbol information may be located. For example, if a particular symbol is associated with a range of addresses, end will represent the last address in that range.

start This displays first memory location where the symbol you specify may be located. For example, if a particular symbol is associated with a range of addresses, start will represent the first address in that range.

<UNARY> This defines either the algebraic negation (minus) sign (-) or the logical negation (NOT) sign (~).

( ) Parentheses may be used in expressions to enclose numbers. For every opening parenthesis, a closing parenthesis must exist.

Note that when "C" appears on the right side of the status line, a valid expression exists. The --NORMAL-- key can be accessed at any time, but is only valid when "C" is on the command line.

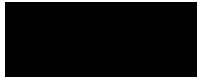

Note that when a thru softkey has been entered, a <+ EXPR> prompt appears. This saves you from tedious repeated entry of long symbols and expressions. For example:

```
disp_buf thru +25
```

is the same as

```
disp_buf thru disp_buf + 25
```

---

**Examples**

```
05fxh
```

```
0ffffh
```

```
disp_buf + 5
```

```
symb_tbl + (offset / 2)
```

```
start
```

```
mod_name: line 15 end
```

---

**See Also**

The SYMB syntax description.

## FCODE

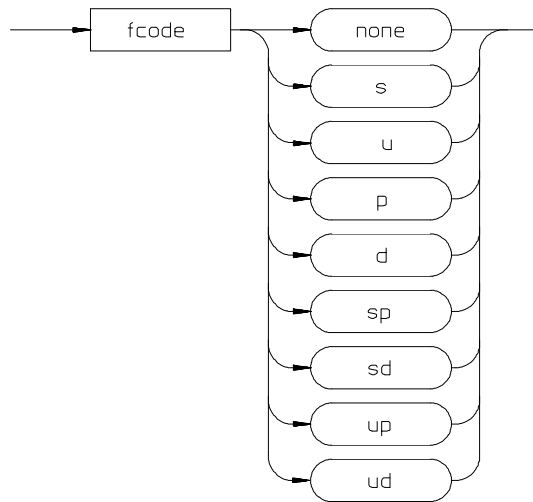

The function code is used to define the address space being referenced. Select the appropriate function code from those listed below.

- d Data space.
- none Causes the emulator to ignore the function code bits.
- p Program space.
- s Supervisor space.
- sd Supervisor data space.
- sp Supervisor program space.
- u User space.
- ud User data space.
- up User program space.

### Examples

To copy a portion of user data memory to a file:

***copy memory fcode ud 1000H thru 1fffH to mymem***

To modify a location in program memory:

***modify memory fcode p 5000h long to 12345678h***

---

## forward

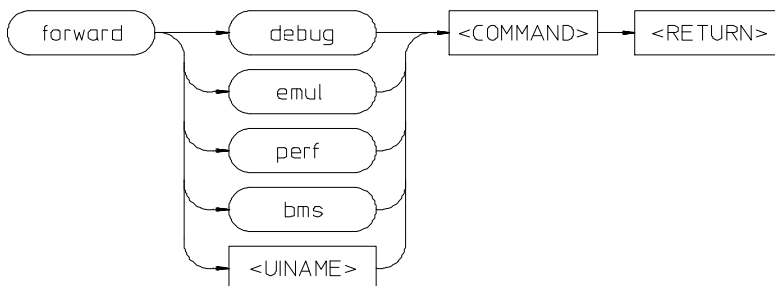

This command lets you forward commands to other HP 64700 interfaces that use the "emul700dmn" daemon process to coordinate actions between the interfaces.

bms  
<COMMAND>

Sends messages to the Broadcast Message Server or BMS.  
An ASCII string, enclosed in quotes, that is the command to be forwarded to the named interface.

debug  
emul  
perf  
<UINAME>

Forwards command to the high-level debugger interface.  
Forwards command to the emulator/analyzer interface.  
Forwards commands to the software performance analyzer interface.  
Forwards commands to a user interface name other than those available on the softkeys.

---

### Examples

To send the "Program Run" command to the debugger:

```
forward debug "Program Run"
```

To send the "profile" command to the software performance analyzer:

```
forward debug "profile"
```

---

### See Also

The *User's Guide* for the interface to which you are forwarding commands.



---

## help



Displays information about system and emulation features during an emulation session.

Typing help or ? displays softkey labels that list the options on which you may receive help. When you select an option, the system will list the information to the screen.

The help command is not displayed on the softkeys. You must enter it into the keyboard. You may use a question mark in place of help to access the help information.

The parameters are as follows:

<HELP\_FILE>

This represents one of the available options on the softkey labels. You can either press a softkey representing the help file, or type in the help file name. If you are typing in the help file name, make sure you use the complete syntax. Not all of the softkey labels reflect the complete file name.

---

### Examples

help *system\_commands*

? *run*

This is a summary of the commands that appear on the softkey labels when you type help or press ?:

```

system_commands
run
trace
step
break
display
modify
load
store
copy
reset
  
```

**help**

stop\_trace  
end  
software\_breakpoints  
registers  
expressions (--EXPR--)  
symbols (--SYMB--)  
specify  
cmb  
cmb\_execute  
map  
set  
wait  
pod\_command  
bbaunload  
coverage  
performance\_measurement\_initialize  
performance\_measurement\_run  
performance\_measurement\_end

---

## load

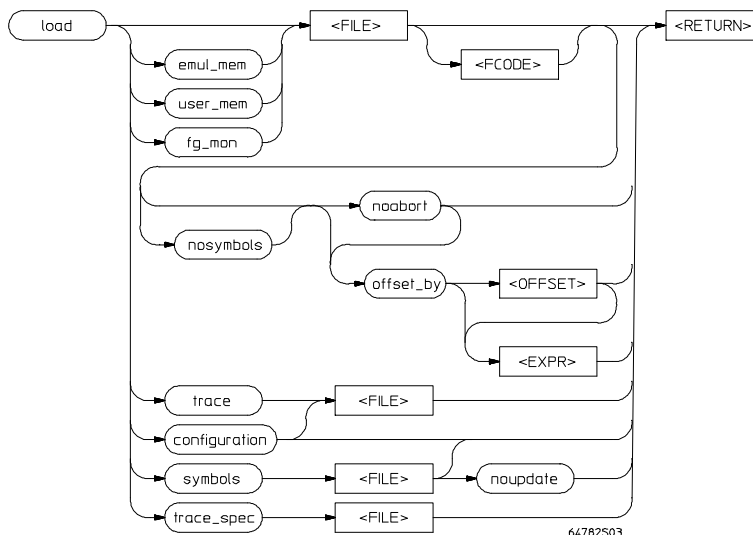

This command transfers absolute files from the host computer into emulation or target system RAM. With other parameters, the **load** command can load emulator configuration files, trace records, trace specifications, or symbol files.

The absolute file contains information about where the file is stored. The memory map specifies that the locations of the file are in user (target system) memory or emulation memory. This command also allows you to access and display previously stored trace data, load a previously created configuration file, and load absolute files with symbols.

Note that any file specified by <FILE> cannot be named "configuration", "emul\_mem", "user\_mem", "symbols", "trace", or "trace\_spec" because these are reserved words, and are not recognized by the emulator/analyzer interface as ordinary file names.

The absolute file is loaded into emulation memory by default.

The parameters are as follows:

### configuration

This option specifies that a previously created emulation configuration file will be loaded into the emulator. You can follow this option with a file name. Otherwise the previously loaded configuration will be reloaded.

**load**

emul_mem	Loads only those portions of the absolute file that reside in memory ranges mapped as emulation memory.
FCODE	Specifies the address space where the file will be loaded.
fg_mon	Loads a foreground monitor.
<FILE>	This represents the absolute file to be loaded into either target system memory, emulation memory (.X files are assumed), or the trace memory (.TR files are assumed).
offset_by	Specifies an offset value that is subtracted from the address before the foreground monitor file is loaded.
<OFFSET>	
noabort	This option allows you to load a file even if part of the file is located at memory mapped as "guarded" or "target ROM" (trom).
nosymbols	This option causes the file specified to be loaded without symbols.
noupdate	This option suppresses rebuilding of the symbol data base when you load an absolute file. If you load an absolute file, end emulation, then modify the file (and relink it), the symbol database will not be updated upon reentering emulation and reloading the file. The default is to rebuild the database.
symbols	This option causes the file specified to be loaded with symbols.
trace	This option allows you to load a previously generated trace file.
trace_spec	This option allows you to load a previously generated trace specification. Note that the current trace specification will be modified, but a new trace will not be started. To start a trace with the newly loaded trace specification, enter trace again or specify trace again (not trace). If you specify trace, a new trace will begin with the default trace specification, not the one you loaded.
user_mem	Loads only those portions of the absolute file that reside in memory ranges mapped as target memory.

---

**Examples****load** sort1**load configuration** config3

---

**See Also**The **display trace** command.

---

## log\_commands

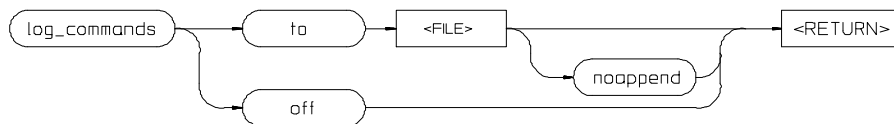

This command allows you to record commands that are executed during an emulation session.

Commands executed during an emulation session are stored in a file until this feature is turned off. This is a handy method for creating command files.

To execute the saved commands after the file is closed, type the filename on the command line.

The parameters are as follows:

<FILE>

This represents the file where you want to store commands that are executed during an emulation session.

noappend

If the named file is an existing file, this option causes the new commands to overwrite any information present in the file. If this option is not specified, new commands are appended to the existing contents of the file.

off

This option turns off the capability to log commands.

to

This allows you to specify a file for the logging of commands.

---

### Examples

**log\_commands to logfile**

**log\_commands off**

---

### See Also

The *wait* command.

---

## modify

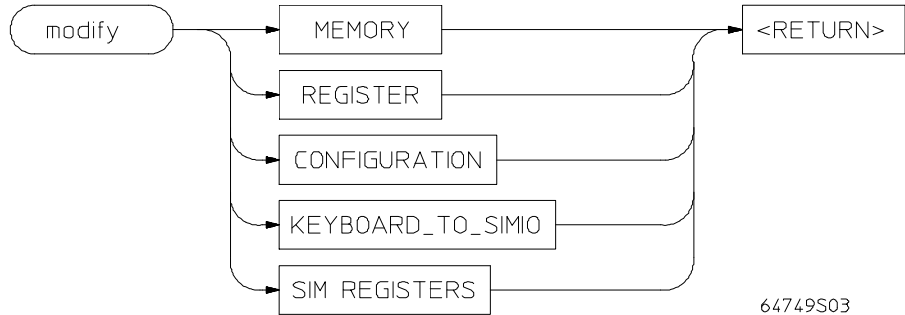

This command allows you to observe or change information specific to the emulator.

The **modify** command is used to:

- Modify contents of memory (as integers, strings, or real numbers).
- Modify the contents of the processor registers.
- View or edit the current emulation configuration.
- Modify the simulated I/O keyboard settings.
- Modify the SIM registers.

The following pages contain detailed information about the various modify syntax diagrams.

---

## modify configuration

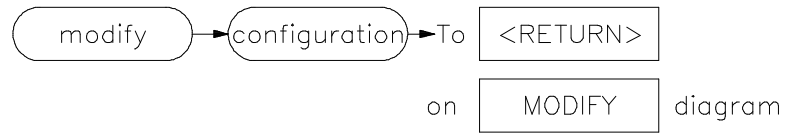

This command allows you to view and edit the current emulation configuration items.

The configuration questions are presented in sequence with either the default response, or the previously entered response. You can select the currently displayed response by pressing <RETURN>. Otherwise, you can modify the response as you desire, then press <RETURN>.

The default responses defined on powerup are displayed.

---

### Examples

*modify configuration*

### See Also

The *load configuration* command.



---

## modify keyboard\_to\_simio

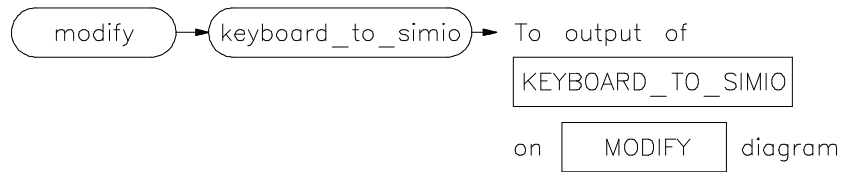

This command allows the keyboard to interact with your program through the simulated I/O software.

When the keyboard is activated for simulated I/O, its normal interaction with emulation is disabled. The emulation softkeys are blank and the **suspend** softkey is displayed on your screen. Pressing **suspend** <RETURN> will deactivate keyboard simulated I/O and return the keyboard to normal emulation mode. For details about setting up simulated I/O, refer to the *Simulated I/O User's Guide*.

### See Also

The **display simulated\_io** command.



**modify memory**

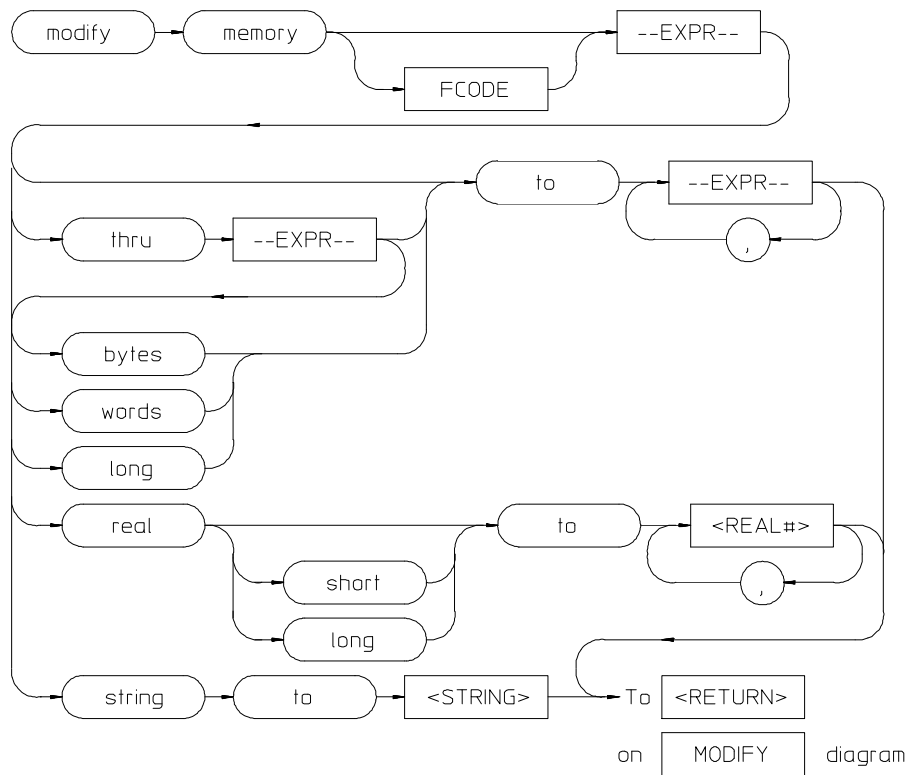

This command lets you modify the contents of selected memory locations. You can modify the contents of individual memory locations to individual values. Or, you can modify a range of memory to a single value or a sequence of values.

Modify a series of memory locations by specifying the address of the first location in the series to be modified, and the values to which the contents of that location and successive locations are to be changed. The first value listed will replace the contents of the first memory location. The second value replaces the contents of the next memory location in the series, and so on, until the list is exhausted. When more than one value is listed, the value representations must be separated by commas. (See the examples for more information.)

**modify memory**

A range of memory can be modified such that the content of each location in the range is changed to the single specified value, or to a single or repeated sequence. This type of memory modification is done by entering the limits of the memory range to be modified (--EXPR-- thru --EXPR--) and the value or list of values (--EXPR--, ... , --EXPR--) to which the contents of all locations in the range are to be changed.

Note that if the specified address range is not large enough to contain the new data, only the specified addresses are modified.

If the address range contains an odd number of bytes and a word operation is being executed, the last word of the address range will be modified. Thus the memory modification will stop one byte after the end of the specified address range.

If an error occurs in writing to memory (to guarded memory or target memory with no monitor) the modification is aborted at the address where the error occurred.

For integer memory modifications, the default is to the current display memory mode, if one is in effect. Otherwise the default is to "byte."

For real memory modifications, the default is to the current display memory mode, if one is in effect. Otherwise the default is "word."

The parameters are as follows:

bytes	Modify memory in byte values.
--EXPR--	An expression is a combination of numeric values, symbols, operators, and parentheses, specifying a memory address. See the EXPR syntax diagram.
FCODE	The function code used to define the address space being referenced. See the syntax diagram for FCODE to see a list of the function codes available and for an explanation of those codes.
long	Modify memory values as 32-bit long word values or 64-bit real values when preceded by real.
real	Modify memory as real number values.
<REAL#>	This prompts you to enter a real number as the value.
short	Modify memory values as 32-bit real numbers.
words	Modify memory values as 16-bit values.
string	Modify memory values to the ASCII character string given by <STRING>.
<STRING>	Quoted ASCII string including special characters as follows:

null	\0
newline	\n
horizontal tab	\t

backspace	\b
carriage return	\r
form feed	\f
backslash	\\
single quote	\'
bit pattern	\ooo (where ooo is an octal number)

**thru** This option lets you specify a range of memory locations to be modified.  
**to** This lets you specify values to which the selected memory locations will be changed.  
**words** Modify memory locations as 32-bit values.  
**,** A comma is used as a delimiter between values when modifying multiple memory addresses.

---

**Examples**

*modify memory* data1 **bytes to** 0E3H , 01H , 08H

*modify memory* data1 **thru** DATA100 **to** 0FFFFH

*modify memory* 0675H **real to** -1.303

*modify memory* temp **real long to** 0.5532E-8

*modify memory* buffer **string to** "Test \n\0"

---

**See Also**

The *copy memory*, *display memory*, and *store memory* commands.

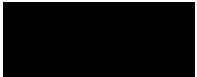

---

## modify register

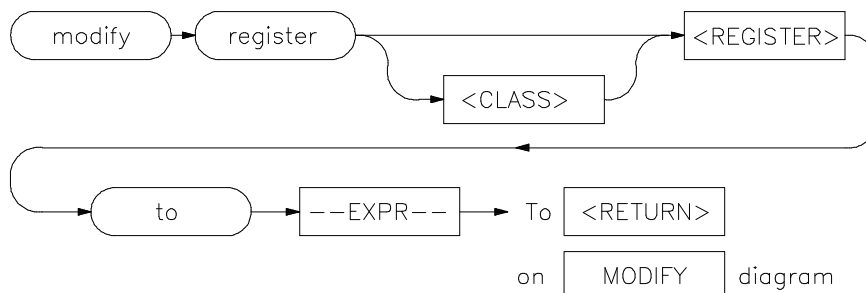

This command allows you to modify the contents of the emulation processor internal registers.

The entry you specify for <REGISTER> determines which register is modified. Individual fields of control registers may be modified.

Register modification cannot be performed during real-time operation of the emulation processor. A **break** command or condition must occur before you can modify the registers.

The parameters are as follows:

--EXPR--

An expression is a combination of numeric values, symbols, operators, and parentheses, specifying a register value. For the floating-point registers, the value is interpreted as a decimal real number. See the --EXPR-- description.

<REGISTER>

This represents the name of a register.

to

Allows you to specify the values to which the selected registers will be changed.

---

### Examples

**modify register** D2 *to* 41H

---

### See Also

The **copy registers**, **display registers**, and **modify registers** commands.

---

## modify SIM registers

The 6833x SIM is configured through the registers in the SIM register class; these registers control how the 6833x uses external signal lines to access memory.

The emulator's DE-SIM module is configured through the registers in the EMSIM register class. The DE-SIM module controls how the emulator interprets the signals from the 6833x when accessing emulation memory and passing information to the analysis trace.

Normally, the SIM and EMSIM registers should be programmed with the same values so they will be working together.

One of the primary functions of the DE-SIM is to provide A23-A19 to the memory mapper and analyzer so they will have the complete 24-bit address bus. This is easy if Port C of the 6833x is programmed as address lines; however, if any of these lines are programmed as chip selects, the corresponding address lines are not available external to the 6833x. The chip selects, however, have access to the full 24-bit address inside the 6833x. You can therefore locate memory using a chip select at an address that is not possible to decode externally. If properly programmed, the DE-SIM can use information in the programming of the chip selects to re-create the upper address lines. This provides the ability to map emulation memory at these addresses and also provides a correct address in the analysis trace so that symbolic debugging is possible.

Normally, the DE-SIM would be programmed through the EMSIM registers to match the programming of the 6833x SIM as it will exist after all of the boot-up configuration is complete. This can be done before the boot-up code is run. In fact, the programming of the EMSIM registers is part of the configuration and will be loaded along with the memory map and other configuration items when a configuration file is loaded.

The default programming of the DE-SIM matches the reset values of the 6833x SIM (refer to the Motorola *MC6833x User's Manual* for specific values).

If desired, the programming of the DE-SIM can be transferred into the 6833x SIM with the ***sync\_sim\_registers to\_6833x\_from\_config*** command. This happens automatically each time a break to the monitor from emulation reset occurs. This ensures that the 6833x is prepared to properly access memory when a program is downloaded to the emulator.

Alternatively, the emulator's DE-SIM can be programmed from the 6833x SIM with the ***sync\_sim\_registers from\_6833x\_to\_config*** command. This is useful if initialization code that configures the 6833x SIM exists, but you don't know what its values are. In this case, you can use the default configuration, run from reset to execute the initialization code, and use the ***sync\_sim\_registers from\_6833x\_to\_config*** command to configure the emulator to match the 6833x SIM.

At any time, you can verify if the SIM and DE-SIM are programmed the same with the ***sync\_sim\_registers difference*** command. Any differences between the two register sets will be listed.

It should be noted that the DE-SIM module is programmed solely from the EMSIM register set and is therefore static with respect to the application program. No attempt is made to update the programming of the DE-SIM by tracking instructions that will program the 6833x SIM.

---

Examples

***sync\_sim\_registers from\_6833x\_to\_config***

***sync\_sim\_registers to\_6833x\_from\_config***

***sync\_sim\_registers default\_emsim***

---

See Also

The ***sync\_sim\_registers*** command and the "Concepts" chapter.

---

## performance\_measurement\_end

performance\_measurement\_end → <RETURN>

This command stores data previously generated by the **performance\_measurement\_run** command, in a file named "perf.out" in the current working directory.

The file named "perf.out" is overwritten each time this command is executed. Current measurement data existing in the emulation system is not altered by this command.

---

### Examples

**performance\_measurement\_end**

---

### See Also

The **performance\_measurement\_initialize** and **performance\_measurement\_run** commands.

Refer to the "Making Software Performance Measurements" chapter for examples of performance measurement specification and use.

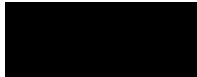

---

## performance\_measurement\_initialize

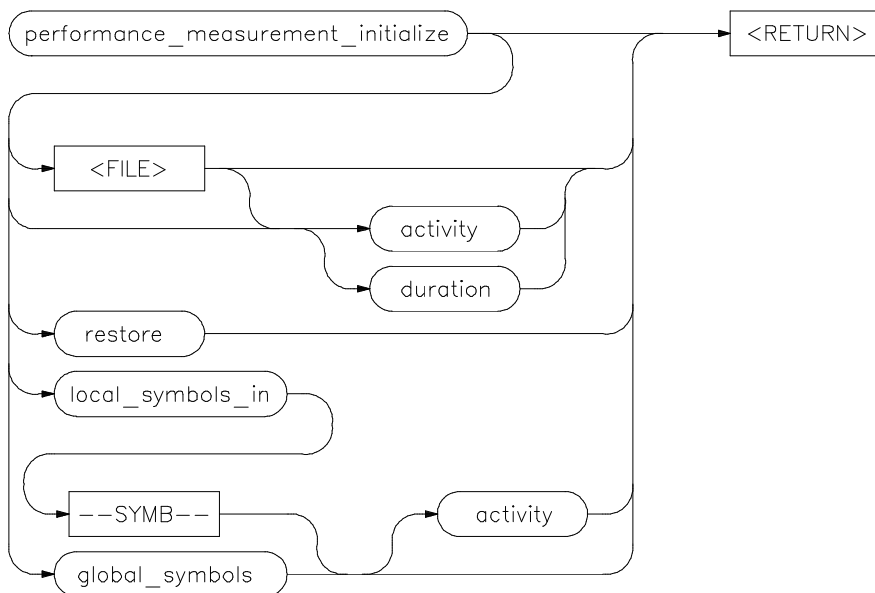

This command sets up performance measurements.

The emulation system will verify whether a symbolic database has been loaded. If a symbolic database has been loaded, the performance measurement is set up with the addresses of all global procedures and static symbols. If a valid database has not been loaded, the system will default to a predetermined set of addresses, which covers the entire emulation processor address range.

The measurement will default to "activity" mode.

Default values will vary, depending on the type of operation selected, and whether symbols have been loaded.



The parameters are as follows:

activity	This option causes the performance measurement process to operate as though an option is not specified.
duration	This option sets the measurement mode to "duration." Time ranges will default to a predetermined set (unless a user-defined file of time ranges is specified).
<FILE>	This represents a file you specify to supply user-defined address or time ranges to the emulator.
global_symbols	This option specifies that the performance measurement will be set up with the addresses of all global symbols and procedures in the source program.
local_symbols_in	This causes addresses of the local symbols to be used as the default ranges for the measurement.
restore	This option restores old measurement data so that a measurement can be continued when using the same trace command as previously used.
--SYMB--	This represents the source file that contains the local symbols to be listed. This also can be a program symbol name, in which case all symbols that are local to a function or procedure are used. See the SYMB syntax diagram.

---

**Examples**

***performance\_measurement\_initialize***

***performance\_measurement\_initialize*** duration

***performance\_measurement\_initialize***  
***local\_symbols\_in*** mod\_name

---

**See Also**

The ***performance\_measurement\_run*** and ***performance\_measurement\_end*** commands.

Refer to the "Making Software Performance Measurements" chapter for examples of performance measurement specification and use.

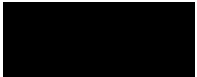

---

## performance\_measurement\_run

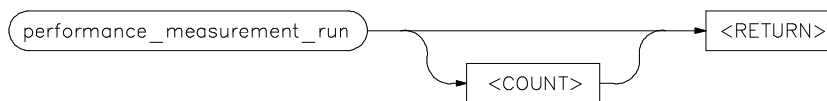

This command begins a performance measurement.

This command causes the emulation system to reduce trace data contained in the emulation analyzer, which will then be used for analysis by the performance measurement software.

The default is to process data presently contained in the analyzer.

The parameters are as follows:

<COUNT>

This represents the number of consecutive traces you specify. The emulation system will execute the trace command, process the resulting data, and combine it with existing data. This sequence will be repeated the number of times specified by the COUNT option.

Note that the trace command must be set up correctly for the requested measurement. For an activity measurement, you can use the default trace command (trace).

For a duration measurement, you must set up the trace specification to store only the points of interest. To do this, for example, you could enter:

**trace only** <symbol\_entry> **or** <symbol\_exit>

---

### Examples

***performance\_measurement\_run*** 10

***performance\_measurement\_run***

---

### See Also

The ***performance\_measurement\_end*** and ***performance\_measurement\_initialize*** commands.

Refer to the "Making Software Performance Measurements" chapter for examples of performance measurement specification and use.

## pod\_command

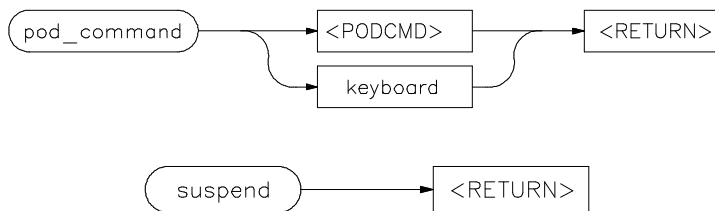

Allows you to control the emulator through the direct HP 64700 Terminal Interface.

The HP 64700 Card Cage contains a low-level Terminal Interface, which allows you to control the emulator's functions directly. You can access this interface using **pod\_command**. The options to **pod\_command** allow you to supply only one command at a time. Or, you can select a keyboard mode which gives you interactive access to the Terminal Interface.

There are certain commands that you should avoid while using the Terminal Interface through **pod\_command**.

stty, po, xp	Do not use. These commands will change the operation of the communications channel, and are likely to hang the Softkey Interface and the channel.
echo, mac	Using these may confuse the communications protocols in use on the channel.
wait	Do not use. The pod will enter a wait state, blocking access by the emulator/analyzer interface.
init, pv	These will reset the emulator pod and force an end release_system command.
t	Do not use. The trace status polling and unload will become confused.

To see the results of a particular **pod\_command** (the information returned by the emulator pod), you use **display pod\_command**.

Refer to the *6833x Emulator User's Guide for the Terminal Interface* for information on using the Terminal Interface to control the emulator.

**pod\_command**

	The parameters are as follows:
keyboard	Enters an interactive mode where you can simply type Terminal Interface commands (unquoted) on the command line. Use <code>display pod_command</code> to see the results returned from the emulator.
<POD_CMD>	Prompts you for a Terminal Interface command as a quoted string. Enter the command in quotes and press <RETURN>.
suspend	This command is displayed once you have entered keyboard mode. Select it to stop interactive access to the Terminal Interface and return to the Graphical User Interface or Softkey Interface.

---

**Examples**

This example shows a simple interactive session with the Terminal Interface.

***display pod\_command***

***pod\_command keyboard***

cf

tsq

tcq

Click ***suspend*** to return to the Graphical User Interface or Softkey Interface.

---

**See Also**

The ***display pod\_command*** command.

Also see the *6833x Emulator User's Guide for the Terminal Interface* and the Terminal Interface on-line help information.

## QUALIFIER

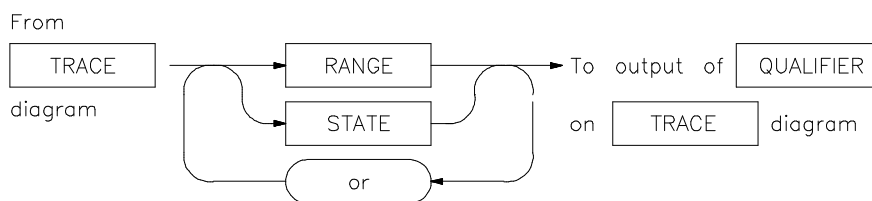

The **QUALIFIER** parameter is used with trace only, trace prestore, and **TRIGGER** to specify states captured during the trace measurement.

You may specify a range of states (**RANGE**) or specific states (**STATE**) to be captured. You can continue to "or" states until the analyzer resources are depleted. You can use only one **RANGE** statement in the entire trace command.

You can include "don't care numbers." These contain an "x" preceded and/or followed by a number. Some examples include 1fxxh, 17x7o, and 011xxx10b. "Don't care numbers" may be entered in binary, octal, or hexadecimal base.

The default is to qualify on all states.

The parameters are as follows:

or

This option allows you to specify multiple states (**STATE**) to be captured during a trace measurement. See the **STATE** syntax diagram.

**RANGE**

This allows you to specify a range of states to be captured during a trace measurement. See the **RANGE** syntax diagram.

**STATE**

This represents a unique state that can be a combination of address, data, status, and executed address values. See the **STATE** syntax diagram.



---

Examples

*trace only address* mod\_name:read\_input

*trace only address range* mod\_name:read\_input *thru*  
output

*trace only address range* mod\_name:clear *thru*  
read\_input

---

See Also

The *trace* command.

## RANGE

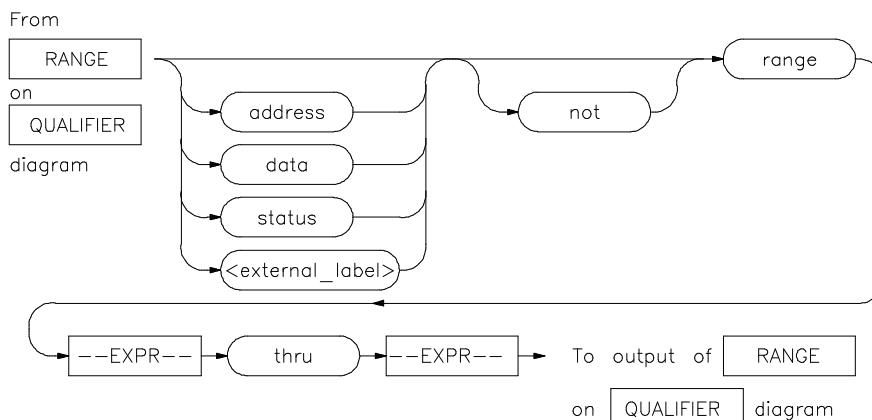

The RANGE parameter allows you to specify a condition for the trace measurement, made up of one or more values.

The range option can be used for state qualifier labels. Range can only be used once in a trace measurement.

Refer to the "Qualifying Trigger and Store Conditions" section in the "Using the Emulation Analyzer" chapter for a list of the predefined values that can be assigned to the status state qualifiers.

Expression types are "address" when none is chosen.

The parameters are as follows:

address

The value following this softkey is searched for on the lines that monitor the emulation processor's address bus.

data

The value following this softkey is searched for on the lines that monitor the emulation processor's data bus.

--EXPR--

An expression is a combination of numeric values, symbols, operators, and parentheses, specifying an address, data, status, or executed address value. See the EXPR syntax diagram for details.

<external\_label>

This represents a defined external analyzer label.

not

This specifies that the analyzer search for the logical "not" of the specified range (this includes any addresses not in the specified range).

**RANGE**

**range** This indicates a range of addresses to be specified (--EXPR-- thru --EXPR--).  
**status** The value following this softkey is searched for on the lines that monitor other emulation processor signals.

**thru** This indicates that the following address expression is the upper address in a range.

---

**Examples**

---

See the *trace* command examples.

**See Also**

The *trace* command and the QUALIFIER syntax description.



---

**reset**

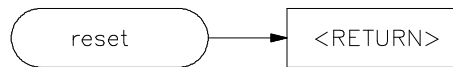

This command suspends target system operation and re-establishes initial emulator operating parameters, such as reloading control registers.

The reset signal is latched when the **reset** command is executed and released by either the run or break command.

**See Also**

The **break** and **run** commands.



## run

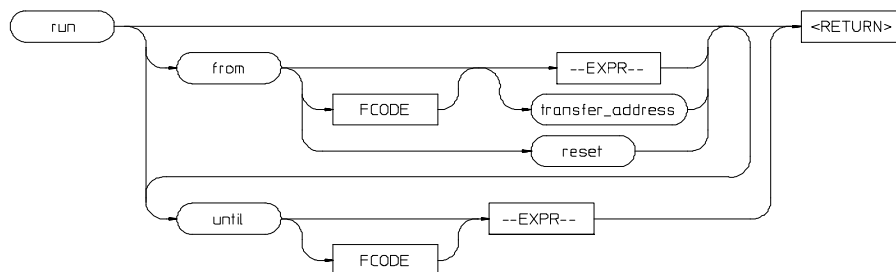

This command causes the emulator to execute a program.

If the processor is in a reset state, **run** will cause the reset to be released.

If the emulator is configured to run directly into user code out of reset, the monitor will not be entered and part of your debug environment may be temporarily disabled. A subsequent break into the monitor will restore it. See the "Enter monitor from reset?" question in the configuration menu for more information.

If the from parameter and an address are specified, the processor will start running your program at that address. Otherwise, the run will occur from the address currently stored in the processor's program counter.

A **run from reset** command will reset the processor and then allow it to run. It is equivalent to entering a **reset** command followed by a **run** command.

If the emulator is configured to participate in the READY signal on the CMB, then this emulator will release the READY signal so that it will go TRUE if all other HP 64700 emulators participating on that signal are also ready. See the **cmb\_execute** command description.

Qualifying a **run** command with an until parameter causes a software breakpoint to be set before the program is run.

If you omit the address option (--EXPR--), the emulator begins program execution at the current address specified by the emulation processor program counter. If an absolute file containing a transfer address has just been loaded, execution starts at that address.

The parameters are as follows:

address	Specifies an address for a temporary register breakpoint that will be programmed into one of the processor's two breakpoint registers. Up to two addresses may be specified.
--EXPR--	An expression is a combination of numeric values, symbols, operators, and parentheses, specifying a memory address. See the EXPR syntax diagram.
FCODE	The function code used to define the address space being referenced. See the syntax diagram for FCODE to see a list of the function codes available and for an explanation of those codes.
from	This specifies the address from which program execution is to begin.
reset	This option resets the processor prior to running.
transfer_address	This represents the starting address of the program loaded into emulation or target memory. The transfer address is defined in the linker map and is part of the symbol database associated with the absolute file.
until	Causes a software breakpoint to be set at the specified address before the program is run.

---

**Examples**

***run***

***run from*** 810H

***run from*** COLD\_START

***run from transfer\_address until*** 910H

---

**See Also**

The ***step*** command.

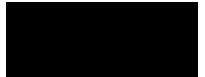

---

## SEQUENCING

From trace  
syntax diagram

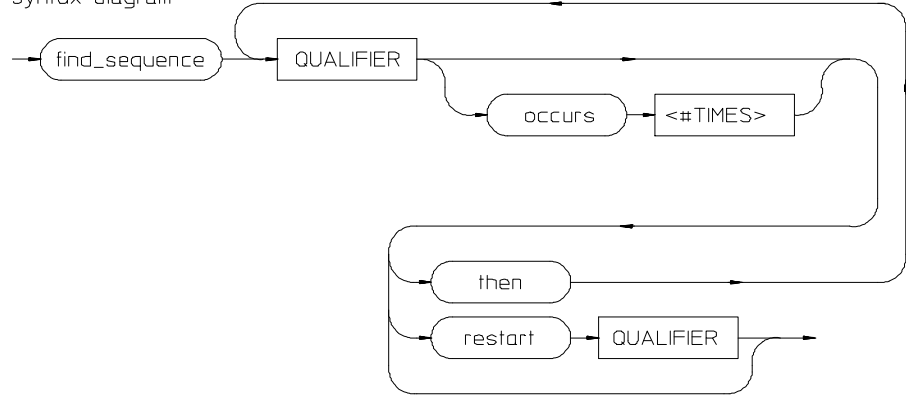

Lets you specify complex branching activity that must be satisfied to trigger the analyzer.

Sequencing provides you with parameters for the **trace** command that let you define branching conditions for the analyzer trigger.

You are limited to a total of seven sequence terms, including the trigger, if no windowing specification is given. If windowing is selected, you are limited to a total of four sequence terms.

The analyzer default is no sequencing terms. If you select the sequencer using the `find_sequence` parameter, you must specify at least one qualifying sequence term.

The parameters are as follows:

 `find_sequence`

Specifies that you want to use the analysis sequencer. You must enter at least one qualifier.

`QUALIFIER`

Specifies the address, data, status, or executed address value or value range that will satisfy this sequence term if looking for a sequence (`find_sequence`), or will restart at the beginning of the sequence (`restart`). See the `QUALIFIER` syntax pages for further information.

- occurs Selects the number of times a particular qualifier must be found before the analyzer proceeds to the next sequence term or the trigger term. This option is not available when trace windowing is in use. See the WINDOW syntax pages.
- <#TIMES> Prompts you for the number of times a qualifier must be found.
- then Allows you to add multiple sequence terms, each with its own qualifier and occurrence count.
- restart Selects global restart. If the analyzer finds the restart qualifier while searching for a sequence term, the sequencer is reset and searching begins for the first sequence term.

---

**Examples**

*trace find\_sequence* Caller\_3 *then* Write\_Num  
*restart* anly."anly.c": line 57 *trigger after*  
Results+0c4h

---

**See Also**

The *trace* command and the QUALIFIER and WINDOW syntax descriptions.

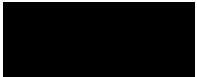

set

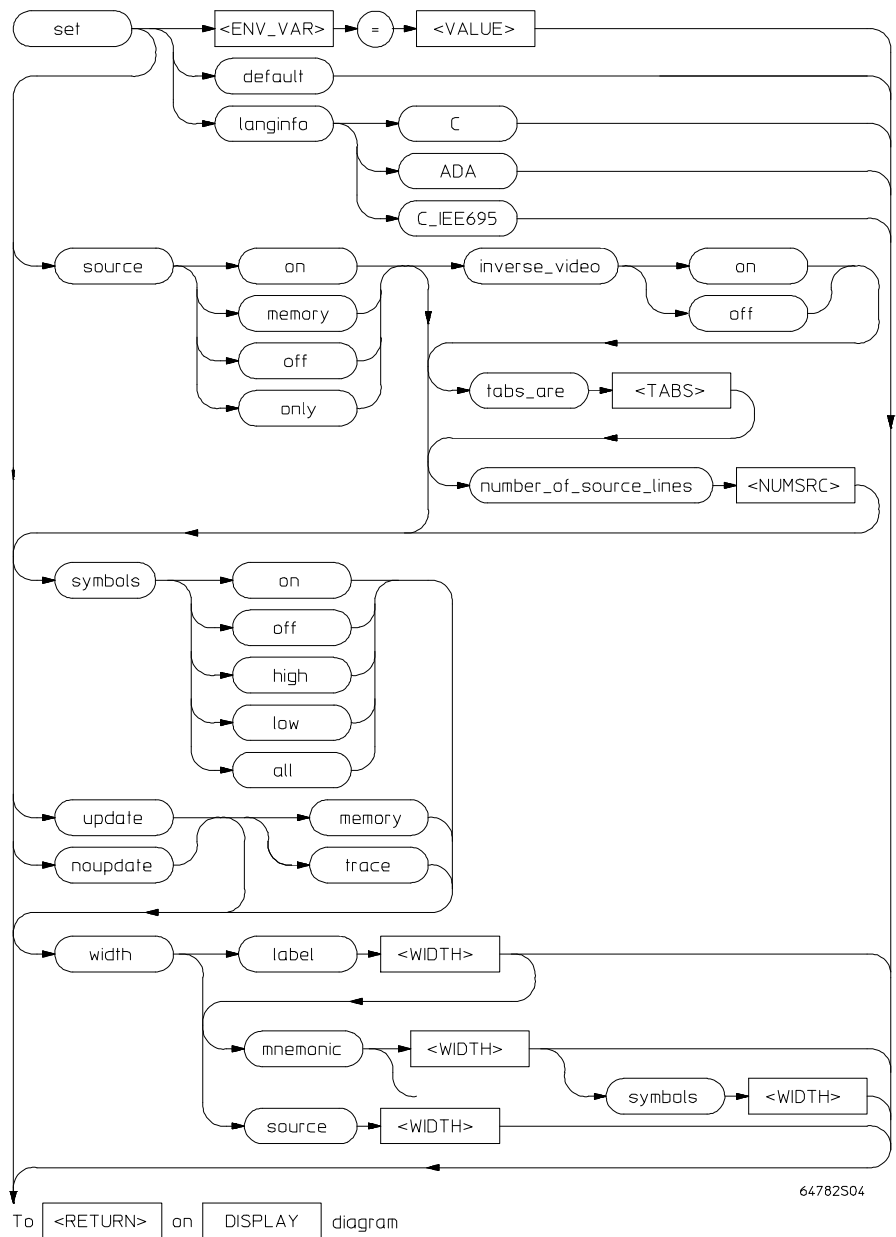

Controls the display format for the data, memory, register, software breakpoint, and trace displays. With the **set** command, you can adjust the display format results for various measurements, making them easier to read and interpret. Formatting of source lines, symbol display selection and width, and update after measurement can be defined to your needs.

The display command uses the set command specifications to format measurement results for the display window. Another option to the **set** command, **<ENV\_VAR> = <VALUE>**, allows you to set and export system variables to the UNIX environment.

The default display format parameters are the same as those set by the commands:

**set update**

**set source off symbols off**

You can return the display format to this state by entering:

**set default**

The parameters are as follows:

default

<ENV\_VAR>

=

inverse video

This option restores all the set options to their default settings.

Specifies the name of a UNIX environment variable to be set.

The equals sign is used to equate the <ENV\_VAR> parameter to a particular value represented by <VALUE>.

off This displays source lines in normal video.

on This highlights the source lines on the screen (dark characters on light background) to differentiate the source lines from other data on the screen.

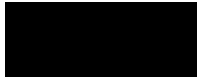

langinfo

In certain languages, you may have symbols with the same names but different types. For example, in IEEE695, you may have a file named `main.c` and a procedure named `main`. SRU would identify these as `main(module)` and `main(procedure)`. The command `display local_symbols_in main` would cause an error message to appear (Ambiguous symbol: `main(procedure, module)`). Users of C tend to think the procedure is important and users of ADA tend to think the module is important. By entering "langinfo" and "C", SRU will interpret the above command to be `main(procedure)`. With langinfo ADA, SRU will interpret the above command to be `main(module)`.

C Identifies ANSI C as the language so SRU can use the C hierarchy to disambiguate symbols.

ADA Identifies ADA as the language so SRU can use the ADA hierarchy to disambiguate symbols.

C\_IEEE695 Identifies C\_IEEE-695 as the language so SRU can use the C\_IEEE-695 hierarchy to disambiguate symbols.

An alternate method for making the langinfo specification is to use the environment variable, HP64SYMORDER. By making the following entry in your **.profile**, the langinfo setting will always be C, for example.

```
$ HP64SYMORDER=C    # I want to use the C disambiguating
                    # hierarchy
$ export HP64SYMORDER # let children processes know
                    # about it
```

memory  
nouupdate

Sets update option for memory displays only.

When using multiple windows or terminals, and specifying this option, the display buffer in that window or terminal will not update when a new measurement completes. Displays showing memory contents are not updated when a command executes that could have caused the values in memory to change (modify memory, load, etc.).

number\_of\_  
source\_lines

This allows you to specify the number of source lines displayed for the actual processor instructions with which they correlate. Only source lines up to the previous actual source line will be displayed. Using this option, you can specify how many comment lines are displayed preceding the actual source line. The default value is 5.



- <NUMSRC> This prompts you for the number of source lines to be displayed. Values in the range 1 through 50 may be entered.
- source
  - memory This displays source lines of memory.
    - off This option prevents inclusion of source lines in the trace and memory mnemonic display lists.
    - on This option displays source program lines preceding actual processor instructions with which they correlate. This enables you to correlate processor instructions with your source program code. The option works for both the trace list and memory mnemonic displays.
    - only This option displays only source lines. Processor instructions are only displayed in memory mnemonic if no source lines correspond to the instructions. Processor instructions are never displayed in the trace list.
  - symbols
    - off This prevents symbol display.
    - on This displays symbols. This option works for the trace list, memory, software breakpoints, and register step mnemonics.
    - high Displays only high level symbols, such as those available from a compiler. See the *Symbolic Retrieval Utilities User's Guide* for a detailed discussion of symbols.
    - low Displays only low level symbols, such as those generated internally by a compiler, or an assembly symbol.
    - all Displays all symbols.
  - tabs\_are This option allows you to define the number of spaces inserted for tab characters in the source listing.
  - <TABS> Prompts you for the number of spaces to use in replacing the tab character. Values in the range of 2 through 15 may be entered.
- trace
  - update Sets update option for trace displays only.
 

When using multiple windows or terminals, and specifying this option, the display buffer in that window or terminal will be updated when a new measurement completes. This is the default. Note that for displays that show memory contents, the values will be updated when a command executes that changes memory contents (such as modify memory, load, and so on).



**set**

<VALUE> Specifies the logical value to which a particular UNIX environment variable is to be set.

**width**

**source** This allows you to specify the width (in columns) of the source lines in the memory mnemonic display. To adjust the width of the source lines in the trace display, increase the widths of the label and/or mnemonic fields.

**label** This lets you specify the address width (in columns) of the address field in the trace list or label (symbols) field in any of the other displays.

**mnemonic** This lets you specify the width (in columns) of the mnemonic field in memory mnemonics, trace list and register step mnemonics displays. It also changes the width of the status field in the trace list.

<WIDTH> This prompts you for the column width of the source, label, mnemonic, or symbols field.

Note that <CTRL>f and <CTRL>g may be used to shift the display left or right to display information which is off the screen.

---

**Examples**

```
set source on inverse_video on tabs_are 2
```

```
set symbols on width label 30 mnemonic 20
```

```
set PRINTER = "lp -s"
```

```
set HP64KSYMBPATH=".file1:proc1  
.file2:proc2:code_block_1"
```



---

**See Also**

The ***display data***, ***display memory***, ***display software\_breakpoints***, and ***display trace*** commands.

## specify

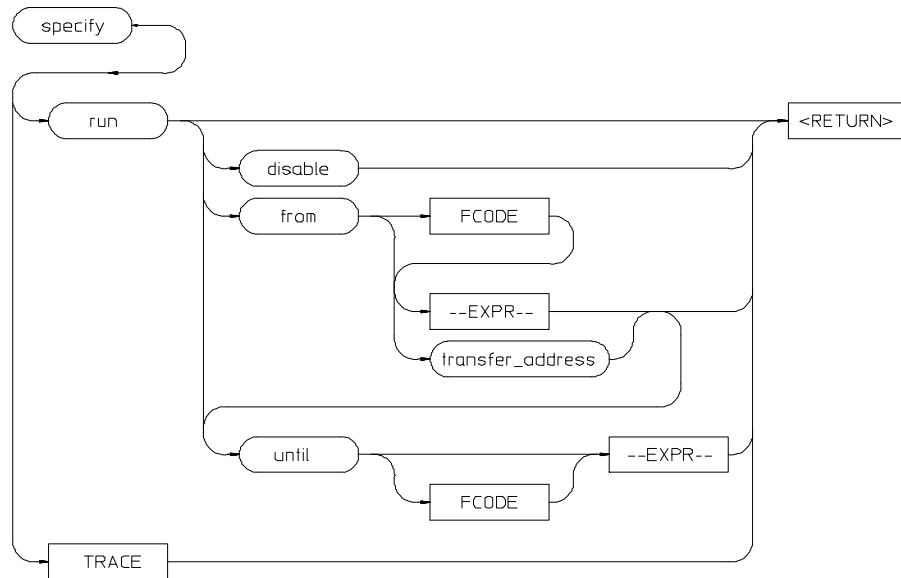

This command prepares a command for execution, and is used with the ***cmb\_execute*** command.

When you precede a ***run*** or ***trace*** command with ***specify***, the system does not execute your command immediately. Instead, it waits until until an EXECUTE signal is received from the Coordinated Measurement Bus or until you enter a ***cmb\_execute*** command.

If the processor is reset and no address is specified, a ***cmb\_execute*** command will run the processor from the "reset" condition.

Note that the run specification is active until you enter specify ***run disable***. The trace specification is active until you enter another ***trace*** command without the specify prefix.

The emulator will run from the current program counter address if no address is specified in the command.

The parameters are as follows:

disable

This option turns off the specify condition of the run process.

**specify**

from	
--EXPR--	This is used with the <code>specify run from</code> command. An expression is a combination of numeric values, symbols, operators, and parentheses, specifying a memory address. See the EXPR syntax diagram.
FCODE	The function code used to define the address space being referenced. See the syntax diagram for FCODE to see a list of the function codes available and for an explanation of those codes.
transfer_address	This is used with the <code>specify run from</code> command, and represents the address from which the program will begin running.
run	This option specifies that the emulator will run from either an expression or from the transfer address when a CMB EXECUTE signal is received.
TRACE	This option specifies that a trace measurement will be taken when a CMB EXECUTE signal is received.
until	Specifies an address where program execution is to stop. The emulator will set a software breakpoint at this address and stop execution of your program when it reaches this address and enter the monitor.

---

**Examples*****specify run from*** START***specify trace after address*** 1234H

---

**See Also**The ***cmb\_execute*** command.

---

## STATE

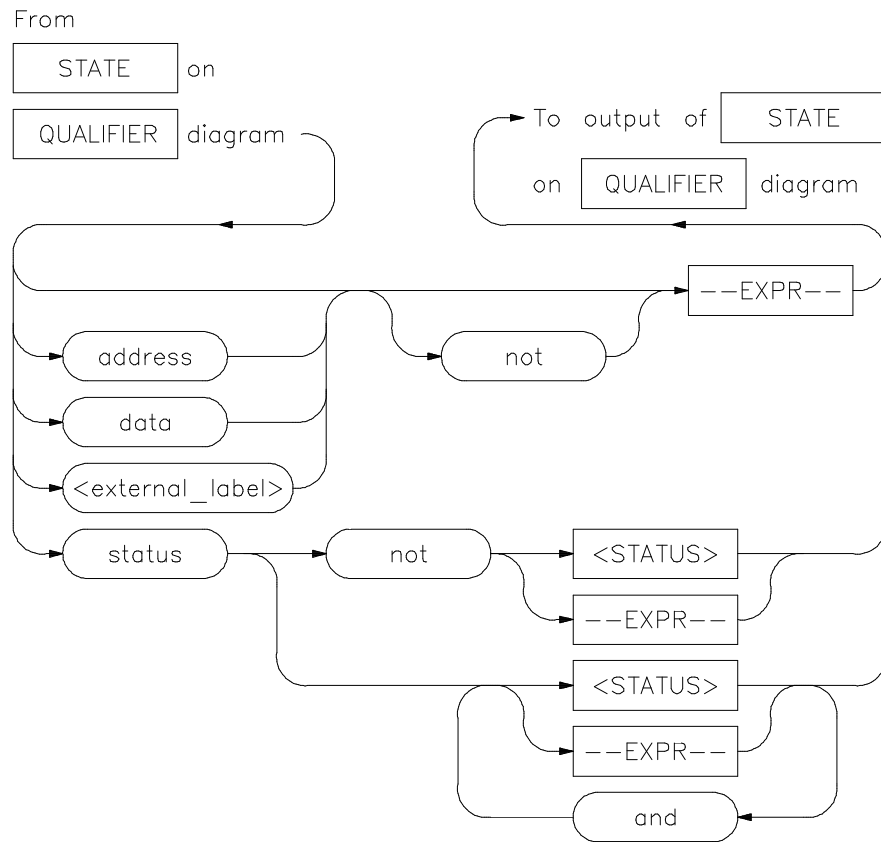

This parameter lets you specify a trigger condition as a unique combination of address, data, status, and executed address values.

The STATE option is part of the QUALIFIER parameter to the trace command, and allows you to specify a condition for the trace measurement.

Refer to the "Qualifying Trigger and Store Conditions" section in the "Using the Emulation Analyzer" chapter for a list of the predefined values that can be assigned to the status state qualifiers.

The default STATE expression type is address.

The parameters are as follows:

address	This specifies that the expression following is an address value. This is the default, and is therefore not required on the command line when specifying an address expression.
and	This lets you specify a combination of status and expression values when status is specified in the state specification.
data	The value following this softkey is searched for on the lines that monitor the emulation processor's data bus.
--EXPR--	An expression is a combination of numeric values, symbols, operators, and parentheses, specifying an address, data, status, or executed address value. See the EXPR syntax diagram.
<external_label>	This represents a defined external analyzer label.
not	This specifies that the analyzer will search for the logical "not" of a specified state (this includes any address that is not in the specified state).
status	The value following this softkey is searched for on the lines that monitor other emulation processor signals.
<STATUS>	This prompts you to enter a status value in the command line. Status values can be entered from softkeys or typed into the keyboard. Numeric values may be entered using symbols, operators, and parentheses to specify a status value. See the EXPR syntax diagram.

---

**Examples**

**trace before status write**

**trace about address 1000H status write**

---

**See Also**

The *trace* command and the QUALIFIER syntax description, and the trace command examples.

## step

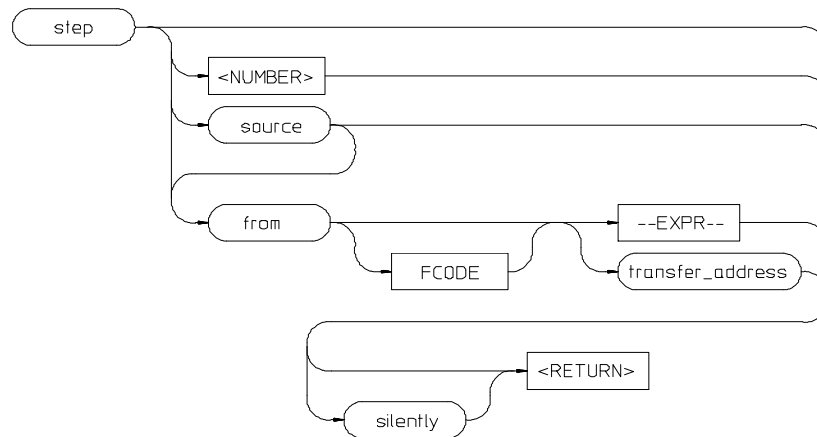

The **step** command allows sequential analysis of program instructions by causing the emulation processor to execute a specified number of assembly instructions or source lines.

You can display the contents of the processor registers, trace memory, and emulation or target memory after each **step** command.

Source line stepping is implemented by single stepping assembly instructions until the next PC is beyond the address range of the current source line.

When attempting source line stepping on assembly code (with no associated source line), stepping will complete when a source line is found. Therefore, stepping only assembly code may step forever. To abort stepping, press <CTRL>c.

When displaying memory mnemonic and stepping, the next instruction that will step is highlighted. The memory mnemonic display autopages to the new address if the next PC goes outside of the currently displayed address range. This feature works even if stepping is performed in a different emulation window than one displaying memory mnemonic.

If no value is entered for <NUMBER> times, only one step instruction is executed each time you press <RETURN>. Multiple instructions can be executed by holding down the <RETURN> key. Also, the default step is for assembly code lines, not source code lines.

**step**

If the from address option (defined by --EXPR-- or transfer\_address) is omitted, stepping begins at the next program counter address.

The parameters are as follows:

--EXPR--	An expression is a combination of numeric values, symbols, operators, and parentheses specifying a memory address. See the EXPR syntax diagram.
FCODE	The function code used to define the address space being referenced. See the syntax diagram for FCODE to see a list of the function codes available and for an explanation of those codes.
from	Use this option to specify the address from which program stepping begins.
<NUMBER>	This defines the number of instructions that will be executed by the step command. The number of instructions to be executed can be entered in binary (B), octal (O or Q), decimal (D), or hexadecimal (H) notation.
silently	When you specify a number of steps, this option updates the register step mnemonic only after stepping is complete. This will speed up stepping of many instructions. The default is to update the register step mnemonic after each assembly instruction (or source line) executes (if stepping is performed in the same window as the register display).
transfer_address	This represents the starting address of the program you loaded into emulation or target memory. The transfer_address is defined in the linker map.
source	This option performs stepping on source lines.

---

**Examples*****step******step from* 810H*****step* 5 *source******step* 20 *silently******step* 4 *from* main**

---

**See Also**

The ***display registers***, ***display memory mnemonic***, and ***set symbols*** commands.



---

## stop\_trace



This command terminates the current trace and stops execution of the current measurement.

The analyzer stops searching for trigger and trace states. If trace memory is empty (no states acquired), nothing will be displayed.

### See Also

The ***trace*** command.

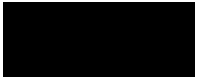

**store**

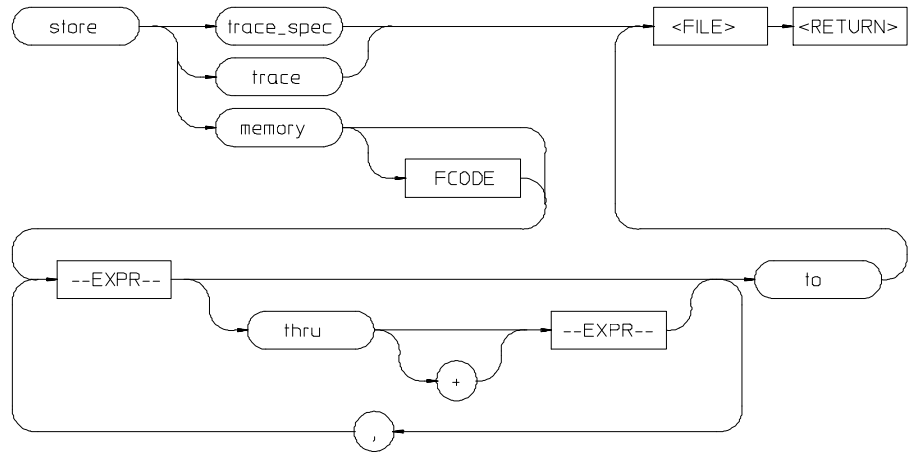

This command lets you save the contents of specific memory locations in an absolute file. You also can save trace memory contents in a trace file.

The **store** command creates a new file with the name you specify, if there is not already an absolute file with the same name. If a file represented by <FILE> already exists, you must decide whether to keep or delete the old file. If you respond with yes to the prompt, the new file replaces the old one. If you respond with no, the store command is canceled and no data is stored.

The transfer address of the absolute file is set to zero.

The parameters are as follows:

**--EXPR--** This is a combination of numeric values, symbols, operators, and parentheses, specifying a memory address. See the EXPR syntax diagram.

**FCODE** The function code used to define the address space being referenced. See the syntax diagram for FCODE to see a list of the function codes available and for an explanation of those codes.

**<FILE>** This represents a file name you specify for the absolute file identifier or trace file where data is to be stored. If you want to name a file beginning with a number, you must precede the file name with a backslash (\) so the system will recognize it as a file name.

**memory** This causes selected memory locations to be stored in the specified HP64000 format file with a .X extension.

thru	This allows you to specify that ranges of memory be stored.
to	Use this in the store memory command to separate memory locations from the file identifier.
trace	This option causes the current trace data to be stored in the specified file with a .TR extension.
trace_spec	This option stores the current trace specification in the specified file with a .TS extension.
,	A comma separates memory expressions in the command line.

---

**Examples**

```
store memory 800H thru 20FFH to TEMP2
```

```
store memory EXEC thru DONE to \12.10
```

```
store trace TRACE
```

```
store trace_spec TRACE
```

---

**See Also**

The *display memory*, *display trace*, and *load* commands.

--SYMB--

--SYMB--

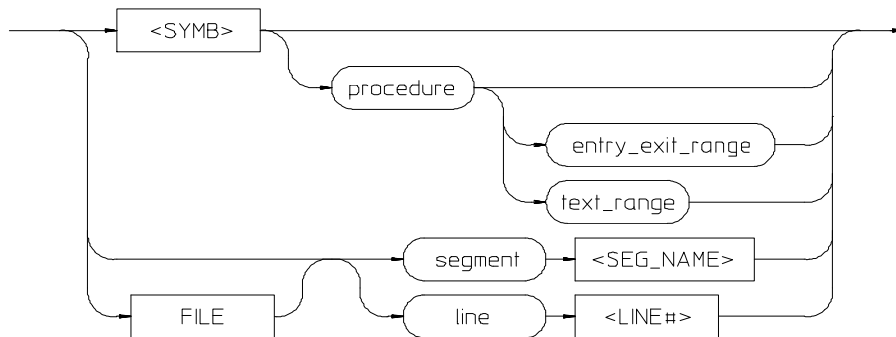

FILE

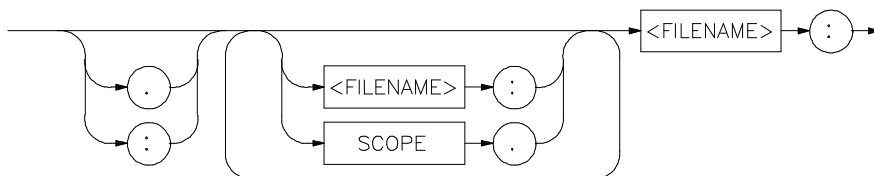

<SYMB>

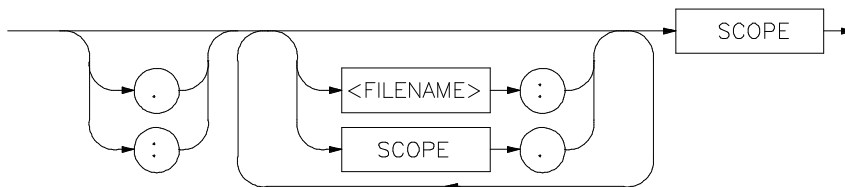

SCOPE

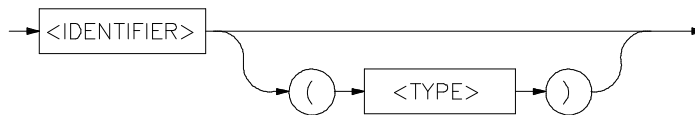

This parameter is a symbolic reference to an address, address range, file, or other value.

Note that if no default file was defined by executing the command **display local\_symbols\_in** --SYMB--, or with the cws command, a source file name (<FILE>) must be specified with each local symbol in a command line.

Symbols may be:

- Combinations of paths, filenames, and identifiers defining a scope, or referencing a particular identifier or location (including procedure entry and exit points).
- Combinations of paths, filenames, and line numbers referencing a particular source line.
- Combinations of paths, filenames, and segment identifiers identifying a particular PROG, DATA or COMN segment or a user-defined segment.

The Symbolic Retrieval Utilities (SRU) handle symbol scoping and referencing. These utilities build trees to identify unique symbol scopes.

If you use the SRU utilities to build a symbol database before entering the emulation environment, the measurements involving a particular symbol request will occur immediately. If you then change a module and re-enter the emulation environment without rebuilding the symbol database, the emulation software rebuilds the changed portions of the database in increments as necessary.

Further information regarding the SRU and symbol handling is available in the *Symbolic Retrieval Utilities User's Guide*. Also refer to that manual for information on the HP64KSYMBPATH environment variable.

The last symbol specified in a **display local\_symbols\_in** --SYMB-- command, or with the cws command, is the default symbol scope. The default is "none" if no current working symbol was set in the current emulation session.

You also can specify the current working symbol by typing the cws command on the command line and following it with a symbol name. The pws command displays the current working symbol on the status line.

Display memory mnemonic also can modify the current working symbol.

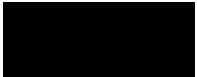

The parameters are as follows:

<FILENAME>	This is an UNIX path specifying a source file. If no file is specified, and the identifier referenced is not a global symbol in the executable file that was loaded, then the default file is assumed (the last absolute file specified by a display local_symbols_in command). A default file is only assumed when other parameters (such as line) in the --SYMB-- specification expect a file.
line	This specifies that the following numeric value references a line number in the specified source file.
<LINE#>	Prompts you for the line number of the source file.
<IDENTIFIER>	Identifier is the name of an identifier as declared in the source file.
SCOPE	Scope is the name of the portion of the program where the specified identifier is defined or active (such as a procedure block).
segment	This indicates that the following string specifies a standard segment (such as PROG, DATA, or COMN) or a user-defined segment in the source file.
<SEG_NAME>	Prompts you for entry of the segment name.
(<TYPE>)	When two identifier names are identical and have the same scope, you can distinguish between them by entering the type (in parentheses). Do not type a space between the identifier name and the type specification. The type will be one of the following:
filename	Specifies that the identifier is a source file.
module	These refer to module symbols. For Ada, they are packages. Other language systems may allow user-defined module names.
procedure	Any procedure or function symbol. For languages that allow a change of scope without explicit naming, SRU assigns an identifier and tags it with type procedure.
static	Static symbols, which includes global variables. The logical address of these symbols will not change.
task	Task symbols, which are specifically defined by the processor and language system in use.
:	A colon is used to specify the UNIX file path from the line, segment, or symbol specifier. When following the file name with a line or segment selection, there must be a space after the colon. For a symbol, there must not be a space after the colon.

---

**Examples**

The following short C code example should help illustrate how symbols are maintained by SRU and referenced in your emulation commands.

File /users/dave/control.c:

```
int *port_one;
main () {
int port_value;

    port_ptr = port_one;
    port_value = 10;

    process_port (port_ptr, port_value);
} /* end main */
```

File /system/project1/porthand.c:

```
#include "utils.c"

void process_port (int *port_num, int port_data) {
static int i;
static int i2;

    for (i = 0; i <= 64; i++) {
        i2 = i * 2;
        *port_num = port_data + i2;
        delay();
        {
            static int i;
            i = 3;
            port_data = port_data + i;
        }
    }
} /* end of process_port */
```

File /system/project1/utils.c:

```
delay() {
int i,j;
int waste_time;

    for (i = 0; i <= 256000; i++)
        for (j = 0; j <= 256000; j++)
            waste_time = 0;
} /* end delay */
```

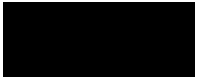

The symbol tree as built by SRU might appear as follows, depending on the object module format and compiler used:

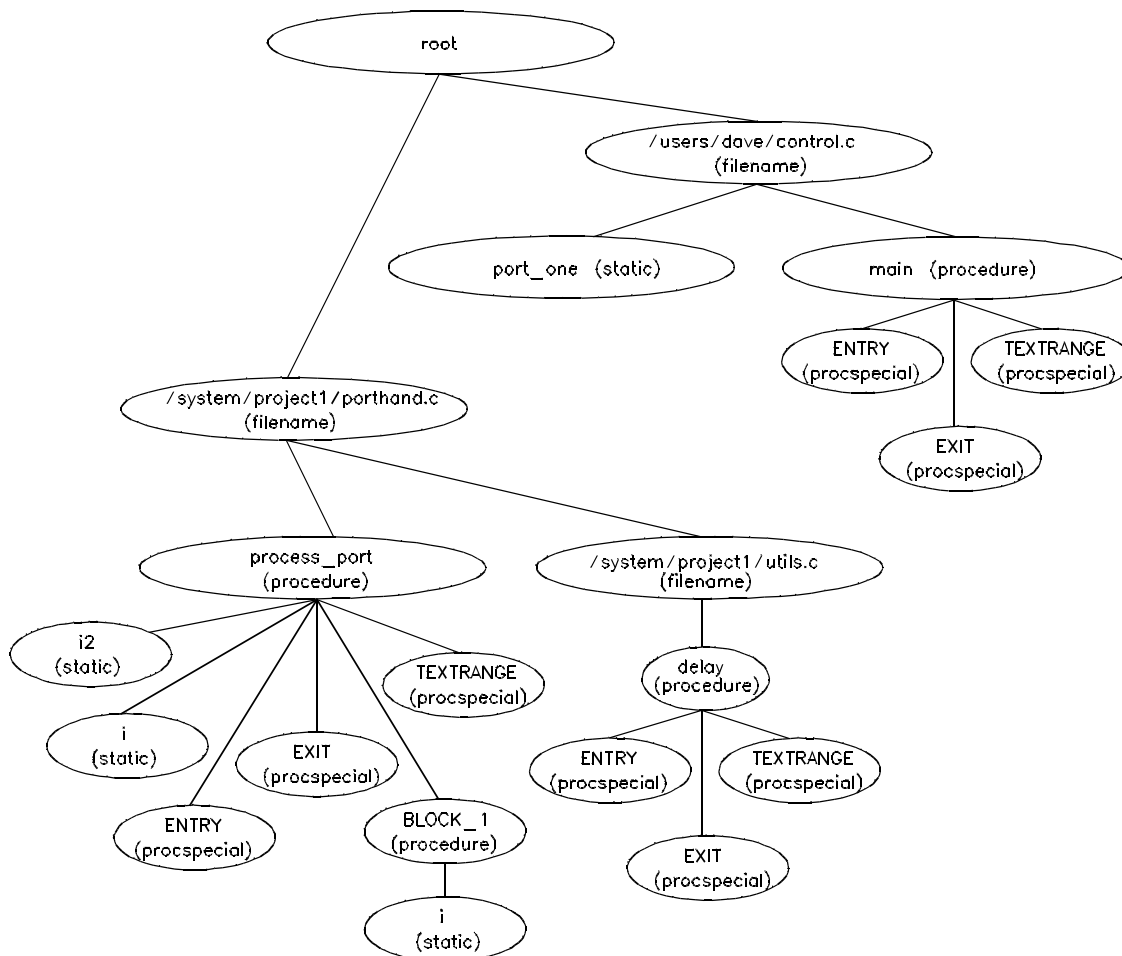

Note that SRU does not build tree nodes for variables that are dynamically allocated on the stack at run-time, such as `i` and `j` within the `delay ()` procedure. SRU has no way of knowing where these variables will be at run



time and therefore cannot build a corresponding symbol tree entry with run time address.

Here are some examples of referencing different symbols in the above programs:

```
control.c:main
```

```
control.c:port_one
```

```
porthand.c:utils.c:delay
```

The last example above only works with IEEE-695 object module format; the HP object module format does not support referencing of include files that generate program code.

```
porthand.c:process_port.i
```

```
porthand.c:process_port.BLOCK_1.i
```

Notice how you can reference different variables with matching identifiers by specifying the complete scope. You also can save typing by specifying a scope with `cws`. For example, if you are making many measurements involving symbols in the file `porthand.c`, you could specify:

```
cws porthand.c:process_port
```

Then:

```
i
```

```
BLOCK_1.i
```

are prefixed with `porthand.c: process_port` before the database lookup.

**--SYMB--**

If a symbol search with the current working symbol prefix is unsuccessful, the last scope on the current working symbol is stripped. The symbol you specified is then retested with the modified current working symbol. Note that this does not change the actual current working symbol.

For example, if you set the current working symbol as

```
cws porthand.c:process_port.BLOCK_1
```

and made a reference to symbol i2, the retrieval utilities attempt to find a symbol called

```
porthand.c:process_port.BLOCK_1.i2
```

which would not be found. The symbol utilities would then strip BLOCK\_1 from the current working symbol, yielding

```
porthand.c:process_port.i2
```

which is a valid symbol.

You also can specify the symbol type if conflicts arise. Although not shown in the tree, assume that a procedure called port\_one is also defined in control.c. This would conflict with the identifier port\_one which declares an integer pointer. SRU can resolve the difference. You must specify:

```
control.c:port_one(static)
```

to reference the variable, and

```
control.c:port_one(procedure)
```

to reference the procedure address.

**See Also**

The copy local\_symbols\_in and display local\_symbols\_in commands. Also refer to the *Symbolic Retrieval Utilities User's Guide* for further information on symbols.

---

## sync\_sim\_registers

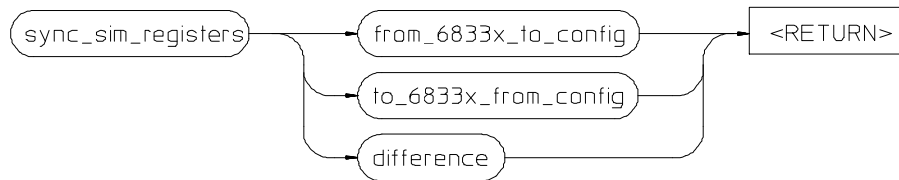

64749S05

This command synchronizes the 6833x's system integration module (SIM) registers to the emulator's EMSIM registers.

The parameters are as follows:

from\_6833x  
\_to\_config

Copies the microprocessor's SIM registers into the emulator's EMSIM registers.

to\_6833x  
\_from\_config

Copies the emulator's EMSIM registers into the microprocessor's SIM registers.

difference

Displays the differences between the microprocessor's SIM registers and the emulator's EMSIM registers.

### See Also

The *modify register* commands and the "Concepts" chapter.



---

**trace**

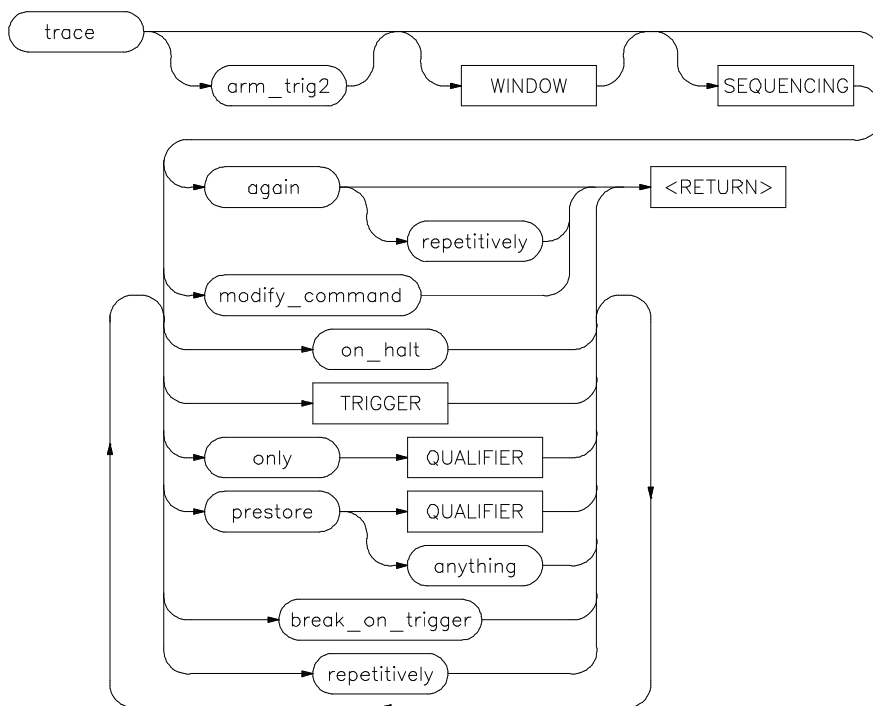

This command allows you to trace program execution using the emulation analyzer.

Note that the options shown can be executed once for each **trace** command. Refer to the TRIGGER and QUALIFIER diagrams for details on setting up a trace.

You can perform analysis tasks either by starting a program run and then specifying the trace parameters, or by specifying the trace parameters first and then initiating the program run. Once a trace begins, the analyzer monitors the system busses of the emulation processor to detect the states specified in the trace command.

When the trace specification is satisfied and trace memory is filled, a message will appear on the status line indicating the trace is complete. You can then

use **display trace** to display the contents of the trace memory. If a previous trace list is on screen, the current trace automatically updates the display. If the trace memory contents exceed the page size of the display, the <NEXT>, <PREV>, <Up arrow>, or <Down arrow> keys may be used to display all the trace memory contents. You also can press <CTRL>f and <CTRL>g to move the display left and right.

You can set up trigger and storage qualifications using the **specify trace** command. The analyzers will begin tracing when a **cmb\_execute** command executes, which causes an EXECUTE signal on the Coordinated Measurement Bus.

The analyzer will trace any state by default.

The parameters are as follows:

again	This option repeats the previous trace measurement. It also begins a trace measurement with a newly loaded trace specification. (Using trace without the again parameter will start a trace with the default specification rather than the loaded specification.)
anything	This causes the analyzer to capture any type of information.
arm_trig2	This option allows you to specify the external trigger as a trace qualifier, for coordinating measurements between multiple HP 64700s, or an HP 64700 and another instrument.  Before arm_trig2 can appear as an option, you must modify the emulation configuration interactive measurement specification. When doing this, you must specify that either BNC or CMBT drive trig2, and that the analyzer receive trig2. See the chapter on "Making Coordinated Measurements" for more information.
break_on_trigger	This stops target system program execution when the trigger is found. The emulator begins execution in the emulation monitor. When using this option, the on_halt option cannot be included in the command.
modify_command	This recalls the last trace command that was executed.
on_halt	When using this option, the analyzer will continue to capture states until the emulation processor halts or until a stop_trace command is executed. When this option is used, the break_on_trigger, repetitively, and TRIGGER options cannot be included in the command.
only	This option allows you to qualify the states that are stored, as defined by QUALIFIER.
prestore	This option instructs the analyzer to save specific states that occur prior to states that are stored (as specified with the "only" option).
QUALIFIER	This determines which of the traced states will be stored or prestored in the trace memory for display upon completion of the trace. Events can be

**trace**

	selectively saved by using trace only to enter the specific events to be saved. When this is used, only the indicated states are stored in the trace memory. See the QUALIFIER syntax.
repetitively	This initiates a new trace after the results of the previous trace are displayed. The trace will continue until a stop_trace or a new trace command is issued. When using this option, you cannot use the on_halt option.
SEQUENCING	Allows you to specify up to seven sequence terms including the trigger. The analyzer must find each of these terms in the given order before searching for the trigger. You are limited to four sequence terms if windowing is enabled. See the SEQUENCING syntax pages for more details.
TRIGGER	This represents the event on the emulation bus to be used as the starting, ending, or centering event for the trace. See the TRIGGER syntax diagram. When using this option, you cannot include the on_halt option.
WINDOW	Selectively enables and disables analyzer operation based upon independent enable and disable terms. This can be used as a simple storage qualifier. Or, you may use it to further qualify complex trigger specifications. See the WINDOW syntax pages for details.

---

**Examples*****trace after*** 1000H***trace only address range*** 1000H ***thru*** 1004H***trace after address*** 1000H ***occurs 2 only address range*** 1000H ***thru*** 1004H ***break\_on\_trigger***

---

**See Also**The ***copy trace***, ***display trace***, ***load trace***, ***load trace\_spec***, ***specify trace***, ***store trace***, and ***store trace\_spec*** commands.

## TRIGGER

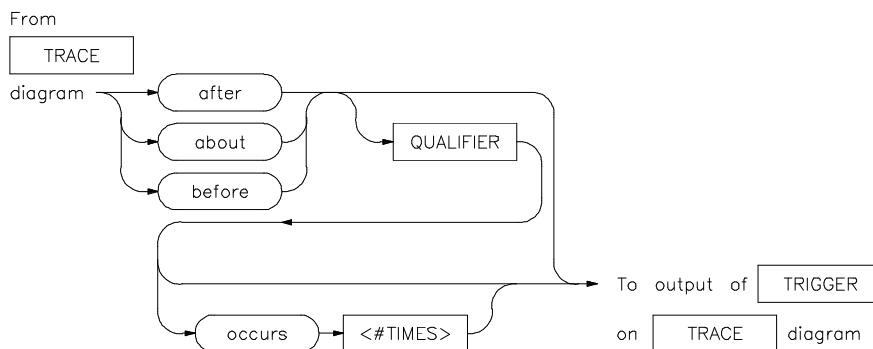

This parameter lets you define where the analyzer will begin tracing program information during a trace measurement.

A trigger is a **QUALIFIER**. When you include the occurs option, you can specify the trigger to be a specific number of occurrences of a **QUALIFIER** (see the **QUALIFIER** syntax diagram).

The default is to trace after any state occurs once.

The parameters are as follows:

about

This option captures trace data leading to and following the trigger qualifier. The trigger is centered in the trace listing.

after

Trace data is acquired after the trigger qualifier is found.

before

Trace data is acquired prior to the trigger qualifier.

occurs

This specifies a number of qualifier occurrences of a range or state on which the analyzer is to trigger.

**QUALIFIER**

This determines which of the traced states will be stored in trace memory.

<#TIMES>

This prompts you to enter a number of qualifier occurrences.

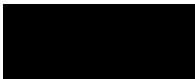

---

**Examples**

*trace after* MAIN

*trace after* 1000H *then data* 5

---

**See Also**

The *trace* command and examples.

Also, refer to the "Making Coordinated Measurements" chapter.



wait

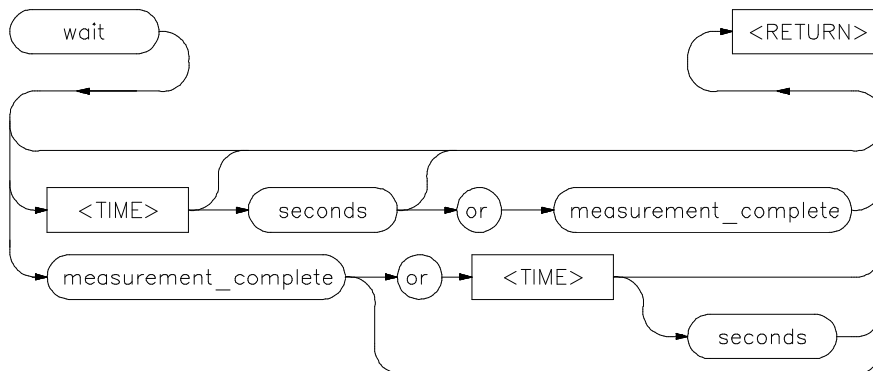

This command allows you to present delays to the system.

The wait command can be an enhancement to a command file, or to normal operation at the main emulation level. Delays allow the emulation system and target processor time to reach a certain condition or state before executing the next emulation command.

The wait command does not appear on the softkey labels. You must type the wait command into the keyboard. After you type wait, the command parameters will be accessible through the softkeys.

The system will pause until it receives a <CTRL>c signal.

Note that if set intr <CTRL>c was not executed on your system, <CTRL>c normally defaults to the backspace key. See your UNIX system administrator for more details regarding keyboard definitions.

The parameters are as follows:

measurement  
\_complete

This causes the system to pause until a pending measurement completes (a trace data upload process completes), or until a <CTRL>c signal is received. If a measurement is not in progress, the wait command will complete immediately.

or

This causes the system to wait for a <CTRL>c signal or for a pending measurement to complete. Whichever occurs first will satisfy the condition.

seconds  
<TIME>

This causes the system to pause for a specific number of seconds.

This prompts you for the number of seconds to insert for the delay.

**wait**

Note that a wait command in a command file will cause execution of the command file to pause until a <CTRL>c signal is received, if <CTRL>c is defined as the interrupt signal. Subsequent commands in the command file will not execute while the command file is paused. You can verify whether the interrupt signal is defined as <CTRL>c by typing set at the system prompt.

---

**Examples*****wait******wait 5; wait measurement\_complete***

---

## WINDOW

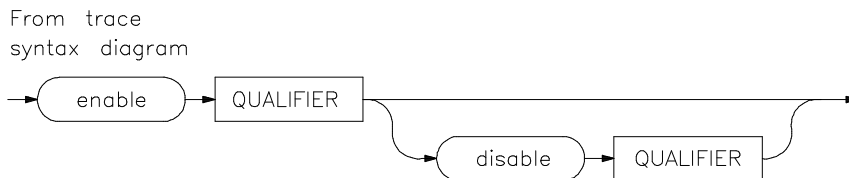

Lets you select which states are stored by the analyzer.

WINDOW allows you to selectively toggle analyzer operation. When enabled, the analyzer will recognize sequence terms, trigger terms, and will store states. When disabled, the analyzer is effectively off, and only looks for a particular enable term.

You specify windowing by selecting an enable qualifier term; the analyzer will trigger or store all states after this term is satisfied. If the disable term occurs after the analyzer is enabled, the analyzer will then stop storing states, and will not recognize trigger or sequence terms. You may specify only one enable term and one disable term.

The analyzer defaults to recognizing all states. If you specify enable, you must supply a qualifier term. If you then specify disable, you must specify a qualifier term.

The parameters are as follows:

- disable Allows you to specify the term which will stop the analyzer from recognizing states once the enable term has been found.
- enable Allows you to specify the term which will enable the analyzer to begin monitoring states.
- QUALIFIER Specifies the actual address, data, status value or range of values that cause the analyzer to enable or disable recognition of states. Note that the enable qualifier can be different from the disable qualifier. Refer to the QUALIFIER syntax pages for further details on analyzer qualifier specification.

---

### Examples

***trace enable \_rand disable 0ecch***

### See Also

The ***trace*** command and the SEQUENCING and QUALIFIER syntax descriptions.

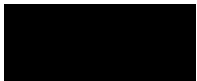



---

## Error Messages

---

## Error Messages

This chapter alphabetically lists and describes the error messages displayed on the interface status line and in the error log. The *error log* records error messages received during the emulation session. You may want to display the error log to view the error messages. Sometimes several messages will be displayed for a single error to help you locate a problem quickly. To prevent overrun, the error log purges the oldest messages to make room for the new ones.

To display the error log, enter:

***display error\_log***

Error messages are listed alphabetically by the first letter of the first word of the error messages. In the error log, some messages may be preceded by a number. Messages in this chapter that have an error message number associated with them have the number listed in parentheses following the message. These are ordered alphabetically by the first letter of the first word.

%s (622)

Cause: Monitor specific message.

<CONFIGURATION FILENAME> does not exist

Cause: The configuration file you are trying to load does not exist.

Action: Try the load configuration command again using a valid configuration file name.

<LOGICAL NAME>: End, continuing

Cause: This is a status message. The emulation session is being exited with the end command. When you restart the emulation session later, it will continue using the same settings as in the session you just ended. The emulator logical name is located in the /usr/hp64000/etc/64700tab.net (or 64700tab) file.

**<LOGICAL NAME>: End, released**

Cause: This is a status message. The emulation session is being exited with the end release\_system command. When the session has ended, the emulator is released, meaning that others can access and use it. When you restart the emulation session later, the new session will use all default settings. The emulator logical name is located in the /usr/hp64000/etc/64700tab.net (or 64700tab) file.

**64700 command aborted (10371)**

Cause: User abort occurred due to emulator being monopolized by another command.

Action: Don't issue an abort.

**Address range too small for request - request truncated**

Cause: Too small of an address range is specified in a modify memory command.

Action: Specify a larger memory range.

**Adjust PC failed during break (600)**

Cause: System failure or target condition.

Action: Run performance verification (Terminal Interface pv command), and check target system.

**Ambiguous address: %s (312)**

Cause: Certain emulators support segmentation or function code information in addressing. The emulator is unable to determine which of two or more address ranges you are referring to, based upon the information you entered.

Action: Re-enter the command and fully specify the address, including segmentation or function code information.

**Ambiguous address: (140)**

Cause: The address for the tag memory access was ambiguous.



**Analyzer Break (613)**

Cause: Status message.

**Analyzer limitation; all range resources in use**

**Analyzer limitation; all pattern resources in use**

**Analyzer limitation; all expression resources in use (10360)**

Cause: Your trace specification would use more than the maximum number of resources available to the analyzer.

Action: Simplify the trace specification.

**Analyzer trace running (1304)**

Cause: This error occurs when you attempt to change the external analyzer mode while a trace is in progress.

Action: Halt the trace before changing the external analyzer mode.

**BNC trigger break (616)**

Cause: This status message will be displayed if you have configured the emulator to break on a BNC trigger signal and the BNC trigger line is activated during a program run. The emulator is broken to the monitor.

**Break caused by CMB not ready (611)**

Cause: This status message is printed during coordinated measurements if the CMB READY line goes false. The emulator breaks to the monitor. When CMB READY is false, it indicates that one or more of the instruments participating in the measurement is running in the monitor.

Action: None, information only.

**Break condition configuration aborted (653)**

Cause: Occurs when <CTRL>c is entered during the configuration of break conditions.

**Break due to cause other than step (689)**

Cause: An activity other than a step command caused the emulator to break. This could include any of the break conditions or a <CTRL>c break.



**Break failed (602)**

Cause: The break command was unable to break the emulator to the monitor.

Action: Determine why the break failed, then correct the condition and retry the command. See message 608.

**Breakpoint code already exists: %s (667)**

Cause: You attempted to insert a breakpoint; however, there was already a software breakpoint instruction at that location which was not already in the breakpoint table.

Action: Your program code is apparently using the same instructions as used by the software breakpoints feature. Remove the breakpoint instructions from your program code and use the modify software\_breakpoints set command to insert them.

**Breakpoint disable aborted (671)**

Cause: Occurs when <CTRL>c is entered when disabling software breakpoints.

**Breakpoint enable aborted (670)**

Cause: Occurs when <CTRL>c is entered when setting software breakpoints.

**Breakpoint list full; not added: %s (664)**

Cause: The software breakpoint table is already reached the maximum of 32 breakpoints. The breakpoint you just requested, with address %s, was not inserted.

Action: Clear breakpoints that are no longer in use. Then, set the new breakpoint.

**Breakpoint not added: %s (668)**

Cause: You tried to insert a breakpoint in a memory location which was not mapped or was mapped as guarded memory.

Action: Insert breakpoints only within memory ranges mapped to emulation or target RAM or ROM.

**Breakpoint remove aborted (669)**

Cause: Occurs when <CTRL>c is entered when clearing a software breakpoint.

**Cannot access register for this processor type (168)**

Cause: You have tried to access a register that is not present in the type of processor that the emulator has determined is present.

**Cannot create module file:**

Cause: Insufficient disk space for the module file.

Action: Check disk space under /usr/hp64000.

**Cannot default emulator; already in use (10332)**

Cause: You tried to start an emulator interface, but your attempt failed because the emulator is already in use by someone else.

Action: Current user must release the emulator.

**Cannot interpret emulator output (10350)**

Cause: There may be characters dropped in the information returned from the emulator.

Action: Ignore this message unless it becomes frequent. If it becomes frequent, you may have a fatal error; call your HP 64700 representative.

**Cannot lock emulator; failure in obtaining the accessid**

**Cannot lock emulator; failure in <ERRNO MSG>**

**Cannot modify program counter to an odd value (164)**

Cause: The emulator will not allow you to modify the content of the program counter to an odd value.

**Cannot modify stack pointer to an odd value (163)**

Cause: The emulator will not allow you to modify the stack pointer to an odd value.

**Cannot run emulator pv in ACT mode with processor type = 331 (169)**

Cause: The emulator is in ACT mode, the processor type is 68331, and you have attempted to run the pv command.

Action: When running emulator performance verification with the emulator in ACT mode, the processor type must be 332.

**Cannot start. Ending previous session, try again**

Cause: The host system could not start a new emulation session, and is ending the previous session.

Action: After the previous session has ended, try starting a new emulation session. If that fails, try "emul700 -u <logical name>" to unlock the emulator and cycle power, if needed.

**Cannot start. Pod initialization failed**

Cause: The host system could not start a new emulation session because it could not initialize the emulator.

Action: Cycle power on the emulator; verify that there are no red lights on the front of the emulator. You may need to run the Terminal Interface "pv" command to verify that the emulator is functioning properly before starting a new session.

**Cannot unlock emulator; emulator in use by user: <USER NAME> (10328)**

Cause: The emulator is already in use by the named user.

Action: Current user must release the emulator.

**Cannot unlock emulator; emulator not locked (10328)**

Cause: You have issued a command to unlock an emulator that is not locked.

Action: The emulator is available now. You can start the interface.

**Cannot unlock emulator; lock file missing****Cannot unlock emulator; semaphore missing (10328)**

Cause: Lock semaphore missing.

Action: Verify existence and permissions of /usr/hp64000 directory. Cycle emulator power and use emul700 -u <logical name>.

**CMB execute; emulation trace started (1305)**

Cause: This status message informs you that an emulation trace measurement has started as a result of a CMB execute signal (as specified by the specify trace command).

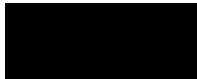

**CMB execute; run started (693)**

Cause: This status message is displayed when you are making coordinated measurements. The CMB /EXECUTE pulse has been received; the emulation processor started running at the address specified by the specify run command.

Action: None; information only.

**CMB execute break (623)**

Cause: This message occurs when coordinated measurements are enabled and an EXECUTE pulse causes the emulator to run; the emulator must break before running.

Action: This is a status message; no action is required.

**CMB trigger break (617)**

Cause: This status message will be displayed if you have configured the emulator to break on a CMB trigger signal and the CMB trigger line is activated during a program run. The emulator is broken to the monitor.

**Command not allowed in ACT mode (156)**

Cause: This command is not applicable or is not allowed in ACT mode.

**Command not applicable in ACT mode (158)**

Cause: This message will appear if you execute an emulator command that does not apply when the emulator is in ACT mode.

**Configuration aborted (624)**

Cause: Occurs when a <CTRL>c is entered while emulator configuration items are being set.

**Configuration failed; setting unknown: %s=%s (626)**

Cause: Target condition or system failure.

Action: Check target system, and run performance verification (Terminal Interface pv command).

**Configuration not valid, restoring previous configuration****Configuration not valid, restoring default configuration**

Cause: The modifications you tried to make to the emulator configuration are not valid, so the host system restored the previous configuration.

Action: See the "Configuring the Emulator" chapter for more information about the emulator configuration items and their settings.

**Configuration process QUIT**

Cause: The configuration process ended because <CTRL> "\ (SIGQUIT signal) was encountered. This is an easy way to exit configuration without saving any changes.

Action: Try starting the emulation session again. If the problem persists, you may need to cycle power on the emulator.

**Connecting to <LOGICAL NAME>**

Cause: This is a status message. The host system is making a communication connection to the emulator whose logical name is defined in /usr/hp64000/etc/64700tab.net or /usr/hp64000/etc/64700tab.

**Continue load failed**

Cause: The host system could not continue the previous emulation session because it could not load the continue file.

Action: Try again. If the failure continues, call your HP Service Representative.

**Continuing previous session, continue file loaded**

Cause: This is a status message. An emulation session which was ended earlier with the end command has been restarted. The host system reported that the session was continued (using settings from the previous session) and that the continue file loaded properly.

**Continuing previous session, user interface defaulted**

Cause: The previous emulation session was continued and the Softkey Interface was set to the default state.

**Could not create <CONFIGURATION BINARY FILENAME>**

Cause: The system could not create a binary emulation configuration file (file.EB).

Action: Check the file.EB write permission and verify that the specified directory exists and is writeable.

**Could not create default configuration**

Cause: The host system could not create a default configuration for the emulation session.

Action: Check disk space under /usr/hp64000 and verify proper software installation.

**Could not exec configuration process**

Cause: The host system could not fork the configuration process or could not execute the configuration process.

Action: Make sure that the host system is operating properly, and that all Softkey Interface files were loaded properly during the installation process. Try starting the emulation session again.

**Could not load default configuration**

Cause: The host system could not load the default configuration into the emulator.

Action: Cycle power on the emulator and run the Terminal Interface "pv" (performance verification) command on the emulator to verify that it is functioning properly. Also, verify proper software installation. If loading default configuration still fails, then call your HP 64000 representative.

**Count out of bounds: %s (318)**

Cause: You specified an occurrence count less than 1 or greater than 65535.

Action: Re-enter the command, specifying a count value from 1 to 65535.

**Coverage commands not allowed when tag mode enabled (149)**

Cause: When tag memory is enabled, coverage commands are disabled.

**CS%*s* is configured for fast termination; max clock is 8 MHz (171)**

Cause: This is a status message output by the display configuration\_info diagnostics command. Whenever chip selects are programmed for fast termination (-1 wait state) and are used to select emulation memory, the operating clock rate must be limited.

**CS%*s* is DS qualified and 0 wait states; max clock is 8 MHz (170)**

Cause: Any address range mapped to emulation memory and selected with a chip select that is DS qualified must also specify 1 or more wait states or the system clock is limited to 8 MHz.

**CS%*s* is set for block size of 1M byte but A19 is not available (167)**

Cause: This status message occurs as a result of the display configuration\_info diagnostics command. It informs you if any chip selects are programmed for a block size of 1 Mbyte when A19 is not available.

**CS%*s* is used in map spec but not defined as a chip select (172)**

Cause: This error message is a result of the display configuration\_info diagnostics command. The chip select used in the memory map specification has not been defined as a chip select in the EMCSPAR0 or EMCSPAR1 registers.

**CS%*s* is used in map spec but not enabled (byte or R/W) (173)**

Cause: This error message is a result of the display configuration\_info diagnostics command. The chip select used in the memory map specification has not been enabled by modifying the BYTE or R/W fields of the EMCSOR*x* register.

**CSBOOT width (8/16 bit) in reset config conflicts with emcspar0 (176)**

Cause: This error message is a result of the display configuration\_info diagnostics command. It occurs when there is a conflict between the EMCSPAR0 value and the reset mode configuration value specified in the emulator configuration.

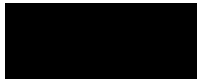

**Disable breakpoint failed: %s (604)**

Cause: System failure or target condition.

Action: Run performance verification (Terminal Interface pv command), and check target system.

**Disable breakpoint failed: %s (666)**

Cause: System failure or target condition.

Action: Check memory mapping and configuration questions.

**Display register failed: %s (634)**

Cause: The emulator was unable to display the register you requested.

Action: To resolve this, you must look at the other status messages displayed. It's likely that emulator was unable to break to the monitor to perform the register display. See message 608.

**Don't care number unexpected**

Cause: While defining an expression in your command, you included a don't care number (a binary, octal, decimal, or hexadecimal number containing "x"), which was not expected. Don't care numbers are not valid for all commands. See the EXPR command syntax for more information about expressions.

**Double bus fault -- fault address register: \_\_\_\_\_ (157)**

Cause: A double bus fault occurred because of multiple address or bus errors. When this occurs the emulator breaks into the monitor.

**Emul700dmn continuation failed**

Cause: Communication between the emulator and the host system to continue the emulation session failed.

Action: Check the data communication switch settings on the rear panel of the HP 64700 series emulator. If necessary, refer to the *HP 64700 Installation/Service Guide*.



**Emul700dnn executable not found**

Cause: The emulation session could not begin because the host system could not locate the HP 64700 emulator daemon process executable.

Action: Make sure that software installation is correct. Then try starting the emulator again.

**Emul700dnn failed to start**

Cause: The emulation session could not begin because the host system could not start the HP 64700 emulator daemon process.

Action: Make sure there is sufficient disk space under /usr/hp64000. Make sure the host system is operating properly, that all Softkey Interface software has been loaded correctly, and the data communication switch settings on the emulator rear panel match the settings in the /usr/hp64000/etc/64700tab.net (or 64700tab) file.

**Emul700dnn message too large****Emul700dnn message too small****Emul700dnn queue and/or semaphores missing****Emul700dnn queue failure****Emul700dnn error in file operation****Emul700dnn queue full**

Cause: The HP 64700 emulator daemon process command was too large for the host system to process.

Action: You must press end\_release\_system to exit this emulation session completely; then start a new session. Make sure the host system is operating properly, that all Softkey Interface software has been loaded correctly, and the data communication switch settings on the emulator rear panel match the settings in the /usr/hp64000/etc/64700tab.net (or 64700tab) file. You may have to cycle power and use emul700 -u ,logical name> to unlock the system.

**Emul700dnn sem op failed, perhaps kernel limits too low**

Cause: The host system could not start the emulation session; there may be too many processes running on the host system.

Action: Make sure the host system is operating properly, and is not overloaded with currently executing processes. Stop or remove some processes on the system. Also, verify that the semaphore capabilities have been installed in the UNIX kernel. Then try starting the emulation session again.

**Emul700dmn version incompatible with this product**

Cause: The emulation session could not begin because the version of the HP 64700 emulator daemon executable on host system is not compatible with the version of the Softkey Interface you are using.

Action: Make sure the software has been properly installed. Then try starting the emulator again.

**Emulation analyzer defaulted to delete label**

Cause: Analyzer trace labels were changed or modified while labels were in use in the trace specification.

Action: Enter the previous trace specification and try again.

**Emulation memory access failed (702)**

Cause: System failure.

Action: Run performance verification (Terminal Interface pv command).

**Emulator locked by another user (10326)**

Cause: This message occurs when you try to start an emulation interface, but your attempt failed because the emulator is being used by someone else.

Action: The current user must release the emulator.

**Emulator locked by another user interface (10330)**

Cause: You tried to start an emulator interface, but your attempt failed because the emulator is already in use by someone else.

Action: Current user must release the emulator.

**Emulator locked by user: <USER NAME> (10329)**

Cause: You tried to start an emulator interface, but your attempt failed because the emulator is already in use by someone else.

Action: Current user must release the emulator.

**Enable breakpoint failed: %s (665)**

Cause: System failure or target condition.

Action: Check memory mapping and configuration questions.

**Ending released**

Cause: This is a status message. The emulation session is being exited with the end release\_system. The emulator will be released for others to access and use it.

**Error: display size is <LINES> lines by <COLUMNS> columns. It must be at least 24 by 80.**

Cause: You tried to specify an incorrect window size.

Action: Set the window size accordingly, then start the emulation session. The size of the window must be a minimum of 24 lines (rows) by 80 columns to operate an emulation session.

**Error in configuration process****Error starting configuration process**

Cause: Unexpected configuration error.

Action: Verify proper software installation and call your HP 64000 representative.

**Exceeded maximum 64700 command line length (10351)**

Cause: Your command is longer than 240 characters.

Action: Shorten the command.

**Expanded memory map requires more than 12 map resource terms (179)**

Cause: This error message occurs as a result of the display configuration\_info diagnostics command. It shows that the memory map has been expanded to more than 12 terms, which is the maximum available. When this occurs, you must use block attributes and chip select function codes with address ranges when mapping memory to override the automatic expansion of the memory map and thereby reduce the number of actual mapper resources used.

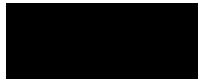

**External label in use: <label> (1301)**

Cause: This error occurs when you attempt to select the external analyzer's independent state mode while an external trace label is currently used as a qualifier in the emulation analyzer trace specification.

Action: Remove any external trace label qualifiers from emulation trace specifications before selecting the external analyzer's independent state mode.

**Failed to disable step mode (684)**

Cause: System failure.

Action: Run performance verification (Terminal Interface pv command).

**Fatal error from function <ADDRESS OF FUNCTION>**

Cause: This is an unexpected fatal system error.

Action: Cycle power on the emulator and start again. If this is a persistent problem, call your HP 64000 representative.

**FATAL SYSTEM SOFTWARE ERROR (204, 205, 208)**

Cause: The system has encountered an error from which it cannot recover.

Action: Write down the sequence of commands which caused the error. Cycle power on the emulator and re-enter the commands. If the error repeats, call your local HP Sales and Service office for assistance.

**File could not be opened**

Cause: You tried to store or load trace data to a file with incorrect permission. Or the analyzer could not find the file you specified, or else there were already too many files open when you entered your command.

Action: Check the directory and file for correct read and write permission. Specify a file that is accessible to the analyzer. Close the other files that are presently open.

**File perf.out does not exist**

Cause: You tried to execute the "restore" command to continue a previous software performance measurement, and the SPMT software found that no "performance\_measurement\_end" command was previously executed to create a file from which "restore" could be performed.

Action: Execute a new SPMT measurement.

**File perf.out not generated by measurement software**

Cause: The file named perf.out exists in the current directory, but it was not created by the "performance\_measurement\_end" command.

Action: Rename the old "perf.out" file, or move it to another directory.

**File transfer aborted (410)**

Cause: A transfer operation was aborted due to a break received, most likely a <CTRL>c from the keyboard.

Action: If you typed <CTRL>c, you probably did so because you thought the transfer was about to fail. Retry the transfer, making sure to use the correct command options. If you are unsuccessful, make sure that the data communications parameters are set correctly on the host and on the HP 64700, then retry the operation.

**Guarded memory access break (614)**

Cause: This message is displayed if the emulation processor attempts to read or write memory mapped as guarded.

Action: Troubleshoot your program; or, you may have mapped memory incorrectly.

**Guarded memory break: %s" (628)**

Cause: A memory access to a location mapped as guarded memory has occurred during execution of the user program.

Action: Investigate the cause of the guarded memory access by the user program.

**HP 64700 I/O error; communications timeout**

Cause: This is a communication failure.

Action: Check power to the emulator and check that all cables are connected properly. If you are using LAN and heavy LAN traffic is present, try setting the environment variable to HP64700TIMEOUT="30" (or larger if needed). The value is the number of seconds before timeout occurs. Then try running again.

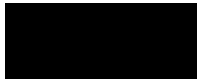

**HP 64700 I/O error; power down detected**

Cause: The emulator power was cycled.

Action: Do not do this during a user interface session; this may force the user interface to end immediately.

**HP64700 I/O channel busy; communications timed out**

Cause: The communications channel is in use for an unusually long period of time by another command.

Action: try again later.

**HP64700 I/O channel in use by emulator: <LOGICAL NAME> (10331)**

Cause: You tried to start an emulator interface, but your attempt failed because the emulator is already in use by someone else.

Action: Current user must release the emulator.

**HP64700 I/O channel semaphore failure: <string>**

Cause: Semaphore (ipc) facility not installed.

Action: Reconfigure the kernel to add ipc facility.

**HP64700 I/O error; connection timed out**

Cause: A user abort occurred while attempting to connect via LAN.

Action: Possibly connecting to an emulator many miles away, be patient.

**Illegal status combination**

Cause: You tried to specify combinations of status qualifiers in expressions incorrectly when entering commands.

Action: Refer to the "Emulator/Analyzer Interface Commands" chapter for information about syntax of commands.

**Illegal symbol name**

Cause: You tried to specify incorrect symbol names when entering commands.

Action: Specify correct symbol names. To see global symbol names, use the display global\_symbols command. To see local symbol names, use the display local\_symbols\_in <SYMB> command.

**Incompatible compatibility table entry (206)**

Cause: The emulation firmware (ROM) is not compatible with the analysis or system firmware in your HP 64700 system.

Action: The ROMs in your emulator must be compatible with each other for your emulation system to work correctly. Contact your Hewlett-Packard Representative.

**Incompatible with 64700 firmware version (10352)**

Cause: The installed interface firmware combination is incorrect or incompatible.

Action: Upgrade the interface software of product firmware.

**Initialization failed**

Cause: The emulator could not be initialized.

Action: Make sure your data communication switch settings are correct, and that all Softkey Interface software has been loaded properly. Cycle power on the emulator, then try starting up the emulation session again.

**Initialization load failed**

Cause: The emulator could not be initialized.

Action: Make sure your data communication switch settings are correct, and that all Softkey Interface software has been loaded properly. Cycle power on the emulator, then try starting up the emulation session again.

**Initializing emulator with default configuration**

Cause: This is a status message. The host system started the emulation session and initialized the emulator using the default configuration. The emulator is probably operating correctly.

**Initializing user interface with default config file**

Cause: This is a status message. The host system started the emulation session and Softkey Interface using the default configuration file. The emulator is probably operating correctly.

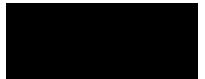

**Insufficient emulation memory, memory map may be incomplete**

Cause: You can map only the amount of emulation memory available in your emulator. Trying to map additional unavailable memory may cause information to be missing from your memory map.

Action: Modify your configuration and update the memory map to correctly reflect the amount of emulation memory available.

**Insufficient emulation memory (21)**

Cause: You have attempted to map more emulation memory than is available, or you have attempted to include tag memory with a target system memory range when there is not enough emulation memory available.

Action: Reduce the amount of emulation memory or tag memory that you are trying to map.

**Invalid address: %s (146)**

Cause: You specified an invalid address value as an argument to one of the HP 64782 specific commands. For example, you may have specified digits that don't correspond to the base specified, or you forgot to precede a hexadecimal letter digit with a number (even zero (0)).

Action: Re-enter the command and the address specification. See the <ADDRESS> and <EXPRESSION> syntax pages in the "Commands" chapter for information on address specifications.

**Invalid address range: %s (147)**

Cause: You specified an invalid address range as an argument to one of the HP 64782 specific commands. For example, you may have specified digits that don't correspond to the base specified, or you forgot to precede a hexadecimal letter digit with a number, or the upper boundary of the range you specified is less than the lower boundary.

Action: Re-enter the command and the address specification. See the <ADDRESS> and <EXPRESSION> syntax pages in the "Commands" chapter for information on address specifications. Also, make sure that the upper boundary specification is greater than the lower boundary specification (the lower boundary must always precede the upper boundary on the command line).



**Invalid analysis subsystem; product address: %s (902)**

Cause: This error occurs when the HP 64700 system controller determines that the analysis firmware (ROM) is invalid.

Action: This message is not likely to occur unless you have upgraded the ROMs in your emulator. Be sure that the correct ROMs are installed in the analyzer board.

**Invalid answer in <CONFIGURATION FILENAME> ignored**

Cause: You must provide acceptable responses to questions in the configuration file (file.EA). The emulator ignored the incorrect response. Incorrect responses may appear in configuration files when you have saved the configuration to a file, edited it later, and tried reloading it into the emulator. This may also occur if you have loaded a configuration file that you created while using another emulator, and the response differs from the response required for this emulator.

Action: Examine your configuration file to check for inappropriate responses to configuration file questions.

**Invalid auxiliary subsystem; product address: %s (904)**

Cause: For future products.

**Invalid ET subsystem; product address: %s (903)**

Cause: Detects an invalid ET. Used only internally.

**Invalid firmware for emulation subsystem (901)**

Cause: This error occurs when the HP 64700 system controller determines that the emulation firmware (ROM) is invalid.

Action: This message is not likely to occur unless you have upgraded the ROMs in your emulator. Be sure that the correct ROM is installed in the emulation controller.

**Invalid number of arguments (145)**

Cause: You have either entered too many options to a command or an insufficient number of options.

Action: Re-enter the command with correct syntax. Refer to the command syntax pages in this manual for information.

**Invalid option or operand: %s (148)**

Cause: You have specified incorrect option(s) to a command. %s, if printed, indicates the incorrect option(s).

Action: Re-enter the command with the correct syntax. Refer to the on-line help information.

**Invalid trigger duration: <duration> (2031)**

Cause: This error occurs when you attempt to specify an external timing trigger duration which is in the valid range but is not a multiple of 10 ns.

Action: Re-enter the command with the trigger duration as a multiple of 10 ns.

**Invalid word access for odd address (2)**

Cause: When the access mode is "word", you have attempted to modify a target system memory location at an odd address.

Action: Either change to an even address or modify the access mode to bytes if possible.

**Invalid word access for odd number of bytes (3)**

Cause: When the access mode is "word" and the display mode is "byte", you have attempted to modify a range of target system memory (perhaps, as small as a two byte range) with an odd number of byte values.

Action: Either specify an even number of bytes or modify the access mode to bytes if possible.

**Inverse assembly file <INVERSE ASSEMBLER FILENAME> could not be loaded**

**Inverse assembly file <INVERSE ASSEMBLER FILENAME> not found, <filename>**

**Inverse assembly not available**

Cause: The file does not exist.

Action: Reload your interface and/or real-time operating system software.

**Inverse assembly not available**

Cause: The inverse assembler for your emulator is missing.

Action: Verify proper software installation.

**Joining session already in progress, continue file loaded**

Cause: This is a status message. When operating the emulator in multiple windows, a new emulation session is "joined" to a current session. In this case, the new session was able to continue because the continue file loaded properly.

**Joining session already in progress, user interface defaulted**

Cause: When operating the emulator in multiple windows, a new emulation session is "joined" to a current session. In this case, the new session used the user interface default selections.

**Lab firmware analysis subsystem; product address: %s (912)**

Cause: This message should never occur. It shows that you have an unreleased version of analysis firmware.

**Lab firmware auxiliary subsystem; product address: %s (914)**

Cause: This message should never occur. It shows that you have an unreleased firmware version of the auxiliary subsystem.

**Lab firmware for emulation subsystem (911)**

Cause: This message should never occur. It shows that you have an unreleased version of emulation firmware.

**Lab firmware subsystem; product address: %s (913)**

Cause: This message should never occur. It shows that you have an unreleased version of system controller firmware.

**Load aborted**

Cause: While loading a file into the emulator, an event occurred that caused the host system to stop the load process.

Action: Use the `display error_log` command to view any errors. If the problem persists, make sure the host system and emulator are operating properly, and that you are trying to load an acceptable file. See the "Emulator/Analyzer Interface Commands" chapter for information about the load command.

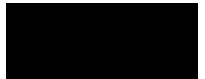

**Load completed with errors**

Cause: While loading a file into the emulator, one or more events occurred that caused errors during the load process.

Action: Use the `display error_log` command to view any errors. You may need to modify the configuration and map memory before you load the file again. If the problem persists, make sure the host system and emulator are operating properly, and that you are trying to load an acceptable file.

**Logical emulator name unknown; not found in 64700tab file (10315)**

Cause: This message may occur while trying to start up the emulator. It indicates that the emulator name specified could not be found in the `64700tab.net` or `/etc/hosts` files.

Action: Specify the name in one of these files.

**Map term n limited to 4 chip selects (165)**

Cause: This status message occurs if more than 4 chip selects are assigned to a mapped term (as defined by the EMSIM registers: `EMCSOR[0-10]`, `EMCSBR[0-10]`, `EMCSORBT`, or `EMCSBRBT`). Only the first 4 chip selects will be allowed.

**Measurement system not found**

Cause: You tried to end the current emulation session and select another measurement system module which could not be located by the host system.

Action: Either try the `end select measurement_system` command again or `end` and release the emulation session.

**Memory allocation failed, ending released**

Cause: This is a fatal system error because the emulation session was unable to allocate memory.

Action: You may need to reconfigure your UNIX kernel to increase the per process maximum memory limit and available swap space. Reboot your UNIX system and try starting a new session again.

**Memory block list unreadable**

**Memory mapping not allowed in ACT mode (154)**

Cause: When the emulator is in ACT mode the memory system is disabled. Therefore, you cannot map memory.

**Memory modify aborted; next address: %s (754)**

Cause: This message is displayed if a break occurs during processing of a modify memory command. The break could result from any of the break conditions (except a software breakpoint) or could have resulted from a <CTRL>c break.

Action: Retry the operation. If breaks are occurring continuously, you may wish to disable some of the break conditions.

**Memory range overflow**

Cause: A modify memory command is attempted that would cross physical 0.

Action: Limit the modify memory command to not overflow physical 0 or break the command into two separate modify commands.

**Memory range overflow (710)**

Cause: Accessing a word or short word, for example display memory 0ffffff blocked word will cause a rounding error that overflows physical memory.

Action: Reduce memory display request.

**Message overflow (151)**

Cause: The display configuration\_info diagnostics command may emit more messages than the HP 64700 will allow (16). This status message occurs when there are more than 16 messages.

**Need %s or chip select for map entry #%d (174)**

Cause: This error message is a result of the display configuration\_info diagnostics command. If you have mapped an address range using the p, d, s, u, sp, sd, up, or ud function codes, the EMCSPAR0 register must be programmed to set up the function code pins or one of the EMCSBRx registers must be set up to provide a chip select for that address range.

**Need DSACK1 at port E or chip select DSACK for map entry #%d (178)**

Cause: If DSACK1 line is not available at port E, any term that is mapped as emulation RAM or emulation ROM will have to be accessed with a chip select that generates an external DSACK or else the emulator will not be able to complete the bus cycle.



**Negated patterns not allowed in timing (2030)**

Cause: This error occurs when you attempt to specify a "not equals" expression when defining the external timing trigger. You can only specify labels which equal patterns (of 1's, 0's, or X's).

Action: Do not attempt to specify negated timing patterns.

**No address label defined**

Cause: The address trace label was somehow removed in the terminal interface using the tlb command.

Action: End session and start again.

**No more processes may be attached to this session**

Cause: You can operate an emulator in four windows. Each time you start the emulator in another window, a new process is attached to the current session.

Action: Do not try to use more than four windows. Once you have started the emulator in four windows, you have reached the maximum number of processes allowed for that emulator.

**No chip selects programmed for address range of map entry #*%d* (175)**

Cause: This error message is a result of the display configuration\_info diagnostics command. It can occur when you have mapped an address range using one of the chip select function codes but have not programmed any of the EMCSBR*x* registers to set up a chip select for that address range.

It's also possible that you have programmed the EMCSBR*x* registers to set up chip selects but not programmed the EMCSOR*x* registers to enable the chip selects.

**No internal registers for m6833x at address: \_\_\_\_\_ (161)**

Cause: Not all addresses in the internal register block are active (depending on the chip register content). This error occurs if a command cannot access a particular address in a valid register block.

**No symbols loaded**

Cause: You tried to step through lines in the source file before symbols are loaded.

Action: Load symbols and try again, or use step with the "source" option (i.e. step assembly language program).

**No valid trace data**

Cause: You tried to store trace data before a trace was completed.

Action: Wait until valid trace data is available before attempting to store a trace.

**No tag memory at address: (159)**

Cause: You have tried to access tag memory by issuing a modify tags command, but tag memory has not been defined at the address you specified. Tag memory is available for address ranges mapped as emulation memory. Tag memory can also be assigned to target memory ranges by using the "tag" attribute when mapping.

**Normal emulation mode not allowed with HP 64782A (155)**

Cause: The HP 64782A emulator, which supports only ACT mode, does not allow you to configure the emulator for the Normal mode.

**Not a valid trace file - load aborted**

Cause: You tried to load a file.TR that was not created by the emulation session.

Action: Only load trace data files that were created by the emulator.

**Not an absolute file**

**No absolute file: <file>**

**No absolute file, No database: <file>**

Cause: You tried to load a file into the emulator that is not an executable or absolute file, so the host system stopped the load process.

Action: Try your command again, and make sure you specify a valid absolute file name to be loaded.

**Not compatible trace file - load aborted**

Cause: You tried to load a file.TR that was created by another type of emulator.

Action: Only load trace data files that were created by the same type of emulator.

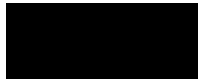

**Number of chip select function codes limited to 4 (166)**

Cause: This status message occurs when you specify more than 4 chip select function codes when mapping an address range. Only the first 4 chip selects will be allowed.

**Number of lines not in range: 1 <= valid lines <= 50**

Cause: You tried to enter a number of lines that was outside the range from 1 to 50.

Action: Try entering the command again using a valid number of lines.

**Number of spaces not in range: 2 <= valid spaces <= 15**

Cause: You tried to enter a number of spaces outside the range from 2 to 15.

Action: Try entering the command again using a valid number of spaces.

**opcode extends beyond specified address range**

Cause: Memory disassembly is attempted on an address range that is too small.

Action: Display memory mnemonic using a large address range, or no address range at all.

**perf.out file could not be opened - created**

Cause: The performance analyzer failed to open or create a file named "perf.out" in response to your "performance\_measurement\_end" command.

Action: Free up some file space or correct the write permissions in your current working directory.

**Perfinit - Absolute file (database) must be loaded line <LINE NUMBER>**

Cause: No symbolic data base has been opened (or exists) for the target file when you executed the "performance\_measurement\_initialize" command.

Action: Make sure a data base has been loaded for the target file.

**Perfinit - error in input file line <LINE NUMBER> invalid symbol**

You included a "label" file name with your "performance\_measurement\_initialize" command, and that file contains an invalid symbol.

Action: Edit the file and correct the invalid symbol.



**Perfinit - error in input file line <NUMBER>**

Cause: You included an input file name with your "performance\_measurement\_initialize" command, and that file contains a syntax error.

Action: Edit the file and correct the syntax error.

**Perfinit - File could not be opened**

Cause: You specified a file as an option to "performance\_measurement\_initialize", and the file you specified could not be found or opened by SPMT software.

Action: Make sure you entered the correct file name.

**Perfinit - No events in file**

Cause: You specified a file along with your "performance\_measurement\_initialize" command that contained no events. Any measurement displayed from this file will have NULL results.

Action: Either edit the file to add events, or use the default setup to start a new measurement.

**Perfinit <—EXPR— ERROR> line <LINE NUMBER>****Performance tool must be initialized**

Cause: You tried to make a performance measurement when the Software Performance Measurement Tool (SPMT) was not initialized.

Action: The Software Performance Measurement Tool (SPMT) must be initialized before making performance measurements on your software. Use the performance\_measurement\_initialize command to initialize the SPMT.

**Performance tool not initialized**

Cause: The Software Performance Measurement Tool (SPMT) has not been initialized.

Action: To make accurate activity or duration measurements on current data, use the performance\_measurement\_initialize command to initialize the SPMT before running a performance measurement.

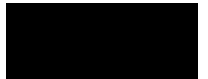

**Period not in 1/2/5 sequence: <period> (2021)**

Cause: This error message occurs when the external timing sample period is not in a 1/2/5 sequence; for example, 10ns, 20ns, 50ns, 100ns, 200ns, 500ns, 1us, 2us, 5us, etc. Some examples of invalid sample period specifications are: 12ns, 18ns, 25ns, 60ns, 80ns, etc.

Action: Use a number in the 1/2/5 sequence when specifying the external timing sample period.

**Pin is %s at reset config, emsim definition is %s (177)**

Cause: This error message is a result of the display configuration\_info diagnostics command which checks for inconsistencies between the reset mode configuration value (as specified in the emulator configuration) and how the EMSIM registers are programmed.

**Program counter is odd (84)**

Cause: You attempted to modify the program counter to an odd value using the modify registers command on a processor which expects even alignment of opcodes.

Action: Modify the program counter only to even numbered values.

The following error messages are unique to the 6833x emulator.

**Question file missing or invalid**

Cause: Some of the Softkey User Interface files are missing or are corrupted.

Action: Reinstall the host software and try starting the emulation session again.

**Range crosses segment boundary**

Cause: On a segment offset processor, an address range is specified that would cross different segments.

Action: Break the memory command into multiple commands so that the address ranges start and end in the same segment.

**Read memory failed at <PHYSICAL ADDRESS> - store aborted**

Cause: While storing memory from the emulator to a file, a read memory error occurred.

Action: Use the display error\_log command to view any errors. You may need to modify the configuration and map memory before storing the file again.

**Read PC failed during break (603)**

Cause: System failure or target condition.

Action: Try again.

**Record checksum failure (400)**

Cause: During a transfer operation, the checksum specified in a file did not agree with that calculated by the HP 64700.

Action: Retry the transfer operation. If the failure is repeated, make sure that both your host and the HP 64700 data communications parameters are configured correctly.

**Records expected: %s; records received: %s (401)**

Cause: The HP 64700 received a different number of records than it expected to receive during a transfer operation.

Action: Retry the transfer. If the failure is repeated, make sure that the data communications parameters are set correctly on the host and on the HP 64700.

**Register access aborted (630)**

Cause: Occurs when a <CTRL>c is entered during register display.

**Register class cannot be modified: %s (637)**

Cause: You tried to modify a register class instead of an individual register.

Action: You can only modify individual registers. Refer to the display registers command description for a list of register names.

**Register not writable: %s (636)**

Cause: This error occurs when you attempt to modify a read only register.

Action: If this error occurs, you cannot modify the contents of the register with the modify register command.

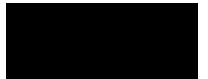

**Request access to guarded memory: %s (707)**

Cause: The address or address range specified in the command included addresses within a range mapped as guarded memory. When the emulator attempts to access these during command processing, the above message is printed, along with the specific address or addresses accessed.

Action: Re-enter the command and specify only addresses or address ranges within emulation or target RAM or ROM. Or, you can remap memory so that the desired addresses are no longer mapped as guarded.

**Request access to guarded memory: (142)**

Cause: The command tried to access guarded memory.

**Restore original processor state failed (152)**

Cause: The emulator could not restore the SFC or DFC registers after modifying them for a monitor memory access. This usually means that the emulator has lost control of the background monitor. Loss of the clock would be one reason this might occur.

**Restricted to real time runs (40)**

Cause: While the emulator is restricted to real-time execution, you have attempted to use a command that requires a temporary break in execution to the monitor. The emulator does not permit the command and issues this error message.

Action: You must break the emulator's execution into the monitor before you can enter the command.

**Retry limit exceeded, transfer failed (412)**

Cause: The limit for repeated attempts to send a record during a transfer operation was exceeded, therefore the transfer was aborted.

Action: Retry the transfer. Make sure you are using the correct command options for both the host and the HP 64700. The data communications parameters need to be set correctly for both devices. Also, if you are in a remote location from the host, it is possible that line noise may cause the failure.

**Run failed during CMB execute (694)**

Cause: System failure or target condition.

Action: Run performance verification (Terminal Interface pv command), and check target system.

**Sample period out of bounds: <bounds> (2022)**

Cause: The external timing sample period must be between 10 ns and 50 ms (in a 1/2/5 sequence).

Action: Re-enter the command with the sample period between the bounds shown.

**Session aborted**

Cause: This will only happen when running multiple emulation windows and a fatal system error occurs.

Action: Find the window that caused the error and see the error message that it displayed. All the additional windows will simply state "session aborted".

Cycle power on the emulator and enter `emul700 -u <logical name>` to make sure the emulator is unlocked.

**Session cannot be continued, ending released**

Cause: The emulation session is ending automatically because it could not be continued from the previous session. When the session has ended the emulator will be released, meaning that others can access and use it.

Action: When you restart the emulation session later, the new session will use all default settings.

**Severe error detected, file transfer failed (411)**

Cause: An unrecoverable error occurred during a transfer operation.

Action: Retry the transfer. If it fails again, make sure that the data communications parameters are set correctly on the host and on the HP 64700. Also make sure that you are using the correct command options, both on the HP 64700 and on the host.

**Slave clock requires at least one edge**

Cause: The analyzer has an invalid clock specification.

Action: Modify your configuration and try your command again.

**Software breakpoint: %s (615)**

Cause: This status message will be displayed if a software breakpoint is encountered during a program run. The emulator is broken to the monitor. The string %s indicates the address where the breakpoint was encountered.

**Software breakpoint break condition is disabled (661)**

Cause: You have attempted to set or clear a software breakpoint when software breakpoints are disabled.

Action: You must enable software breakpoints before you can set them.

**Specified breakpoint not in list: %s (663)**

Cause: You tried to clear a software breakpoint that was not previously set. The string %s prints the address of the breakpoint you attempted to clear.

Action: You must first set a software breakpoint before it can be cleared.

**Starting address greater than ending address**

Cause: You specified a starting address that is greater than the ending address.

Action: Specify a starting address that is less than or equal to the ending address.

**Starting new session, continue file loaded**

Cause: This is a status message. The emulator was started using a new emulation session, and the continue file loaded properly.

**Starting new session, user interface defaulted**

Cause: The emulator was started using a new emulation session, and the user interface was set to default selections.

Action: Call your HP Service Representative.

**Status unknown, run "emul700 -l <LOGICAL NAME>"**

Cause: The host system cannot determine the status of the emulator.

Action: To verify communication between the emulator and the host system, and display the emulator status, enter the `emul700 -l <logical name>` command. The emulator logical name is located in the `/usr/hp64000/etc/64700tab.net` (or `64700tab`) file.

**Step count must be 1 through 999**

Cause: You tried to use a step count greater than 999.

Action: Use a step count less than 1000.

**Step display failed (688)**

Cause: System failure or target condition.

Action: Check memory mapping and configuration questions.

**Stepping aborted; number steps completed: %d (686)**

Cause: This message is displayed if a break was received during a step command with a step count greater than zero. The break could have been due to any of the break conditions or a <CTRL>c break. The number of steps completed is displayed.

**Stepping aborted; number steps completed: <STEPS TAKEN>**

Cause: Stepping aborted because <CTRL>c or software breakpoint was hit, guarded memory was accessed, or some other kind of error occurred.

Action: See the error log display for any abnormal errors. Correct those errors and then step again.

**Stepping complete**

Cause: Stepping was completed successfully.

**Stepping failed (680)**

Cause: Stepping has failed for some reason.

Action: Usually, this error message will occur with other error messages. Refer to the descriptions of the accompanying error messages to find out more about why stepping failed.

**Symbols not accessible, symbol database not loaded**

Cause: You specified a trace list with values expressed using symbols defined in the source code modules, such as source on, and the database file has not been loaded into emulation. Example: display trace symbols on.

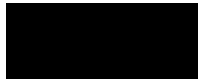

**Tag commands not allowed when tag mode disabled (150)**

Cause: When tag memory is disabled, the extra bits of emulation memory are being used for the coverage function. Therefore, the tag commands are disabled.

**Tag memory access failed (141)**

Cause: The access to the tag memory failed. This could occur because the processor is not performing external bus accesses, or a hardware failure occurred in the memory system.

**Tag memory modify aborted; next address: (144)**

Cause: The tag memory command was aborted with a <CTRL>c.

**Tag memory range overflow (143)**

Cause: The command requests an operation to tag memory which is greater than the allocated memory range.

**Target memory access failed (700)**

Cause: This message is displayed if the emulator was unable to perform the requested operation on memory mapped to the target system.

Action: In most cases, the problem results from the emulator's inability to break to the monitor to perform the operation. See message 608.

**Timeout, receiver failed to respond (415)**

Cause: Communication link or transfer protocol incorrect.

Action: Check link and transfer options.

**Timeout in emul700dmm communication**

Cause: The host system could not start the emulation session because the HP 64700 emulator process ran out of time before the emulator could start.

Action: You must press `end_release_system` to exit this emulation session completely; then start a new session. Make sure the host system is operating properly, that all Softkey Interface software has been loaded correctly, and the data communication switch settings on the emulator rear panel match the settings in the `/usr/hp64000/etc/64700tab.net` (or `64700tab`) file.



**Trace error during CMB execute (692)**

Cause: System failure.

Action: Run performance verification (Terminal Interface pv command).

**Trace file not found**

Cause: You tried to load trace data file that does not exist.

Action: Find the correct name and path of the trace data file and try again.

**Transfer failed to start (413)**

Cause: Communication link or transfer protocol incorrect.

Action: Check link and transfer options.

**trig1 break (618)**

Cause: This status message will be displayed if you use the break\_on\_trigger syntax of the trace command and the analyzer has found the trigger condition while tracing a program run. The emulator is broken to the monitor.

**trig2 break (619)**

Cause: This status message will be displayed if you have used the internal trig2 line to connect the analyzer or external analyzer trigger output to the emulator break input and the analyzer has found the trigger condition. The emulator is broken to the monitor.

**Trigger delay out of bounds: <bounds> (2042)**

Cause: This error occurs when you attempt to specify an external timing trigger delay outside the valid range. The external timing trigger delay must be between 0 and 10 ms (in 10 ns increments).

Action: Re-enter the command with the trigger delay within the bounds shown.

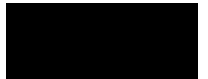

**Trigger duration out of bounds: <bounds> (2032)**

Cause: This error occurs when you attempt to specify an external timing trigger duration outside the valid range. A "greater than" duration must fall within the range of 30 ns to 10 ms (and must be a multiple of 10 ns). A "less than" duration must fall within the range 40 ns to 10ms (and must be a multiple of 10 ns).

Action: Re-enter the command with the trigger duration within the bounds shown.

**Unable to break (608)**

Cause: This message is displayed if the emulator is unable to break to the monitor because the emulation processor is reset, halted, or is otherwise disabled.

Action: First, look at the emulation prompt and other status messages displayed to determine why the processor is stopped. If reset by the emulation controller, use the break command to break to the monitor. If reset by the emulation system, release that reset. If halted, try reset and break to get to the monitor. If there is a bus grant, wait for the requesting device to release the bus before retrying the command. If there is no clock input, perhaps your target system is faulty. It's also possible that you have configured the emulator to restrict to real time runs, which will prohibit temporary breaks to the monitor.

**Unable to configure break on software breakpoints (651)**

Cause: The emulator controller cannot enable breakpoints, possibly because the emulator is in an unknown state or because of a hardware failure.

Action: Initialize the emulator or cycle power, then re-enter the command. If the same failure occurs, call your HP sales and service office.

**Unable to configure break on write to ROM (650)**

Cause: The emulator controller is unable to configure for breaks on writes to ROM, possibly because the emulator was left in an unknown state or because of a hardware failure.

Action: Initialize the emulator or cycle power. Then re-enter the command. If the same failure occurs, call your HP sales and service office.

**Unable to delete label; used by emulation analyzer: <label> (1105)**

Cause: This error occurs when you attempt to delete an emulation trace label which is currently being used as a qualifier in the emulation trace specification or is currently specified in the emulation trace format.

Action: You stop the trace or must change the trace command before you can delete the label.

**Unable to delete label; used by external state analyzer: <label> (1106)**

Cause: This error occurs when you attempt to delete an external trace label which is currently being used as a qualifier in the external state trace specification or is currently specified in the external trace format.

Action: You stop the trace or must change the trace command before you can delete the label.

**Unable to delete label; used by external timing analyzer: <label> (1107)**

Cause: This error occurs when you attempt to delete an external trace label which is currently being used as a qualifier in the external timing trace specification.

Action: Remove the label from the external timing analyzer specifications, and then delete the label.

**Unable to load new memory map; old map reloaded (725)**

Cause: There is not enough emulation memory left for this request.

Action: Reduce the amount of emulation memory requested.

**Unable to modify register: %s=%s (632)**

Cause: The emulator was unable to modify the register you requested.

Action: To resolve this, you must look at the other status messages displayed. It's likely that emulator was unable to break to the monitor to perform the register modification. See message 608.

**Unable to read registers in class: %s (631)**

Cause: The emulator was unable to read the registers you requested.

Action: To resolve this, you must look at the other status messages displayed. Most likely, the emulator was unable to break to the monitor to perform the register read. See message 608.



**Unable to redefine label; used by emulation analyzer: <label> (1108)**

Cause: This error occurs when you attempt to redefine an emulation trace label which is currently used as a qualifier in the emulation trace specification.

Action: You stop the trace or must change the trace command before you can redefine the label.

**Unable to redefine label; used by external state analyzer: <label> (1109)**

Cause: This error occurs when you attempt to redefine an external trace label which is currently used as a qualifier in the external state trace specification.

Action: You stop the trace or must change the trace command before you can redefine the label.

**Unable to redefine label; used by external timing analyzer: <label> (1110)**

Cause: This error occurs when you attempt to redefine an emulation or external trace label which is currently being used as a qualifier in the external timing trace specification.

Action: Remove the label from the external timing analyzer specifications, and then redefine the label.

**Unable to reload old memory map; hardware state unknown (726)**

Cause: System failure.

Action: Run performance verification (Terminal Interface pv command).

**Unable to reset (640)**

Cause: Target condition or system failure.

Action: Check target system, and run performance verification (Terminal Interface pv command).

**Unable to run (610)**

Cause: System failure or target condition.

Action: Run performance verification (Terminal Interface pv command), and check target system.

**Unable to run after CMB break (606)**

Cause: System failure or target condition.

Action: Run performance verification (Terminal Interface pv command), and check target system.

**Undefined software breakpoint: %s (605)**

Cause: The emulator has encountered a software breakpoint in your program that was not inserted with the modify software\_breakpoints set command.

Action: Remove the breakpoint instructions in your code before assembly and link.

**Unexpected message from emul700dmn**

Cause: The host system could not start the emulation session because of an unexpected message from the HP 64700 emulator process command.

Action: You must press end\_release\_system to exit this emulation session completely; then start a new session. Make sure the host system is operating properly, that all Softkey Interface software has been loaded correctly, and the data communication switch settings on the emulator rear panel match the settings in the /usr/hp64000/etc/64700tab.net (or 64700tab) file.

**Unexpected software breakpoint (620)**

Cause: If you have enabled software breakpoints, this message is displayed if a software breakpoint instruction is encountered in your program that was not inserted by a modify software\_breakpoints set command and is therefore not in the breakpoint table.

Action: Remove the breakpoint instructions in your code before assembly and link, and use the modify software\_breakpoints set command to reinsert them after the program is loaded into memory.

**Unexpected step break (621)**

Cause: System failure.

Action: Run performance verification (Terminal Interface pv command).

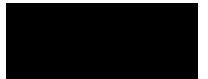

**Unknown expression type**

Cause: While entering your command, you included an unknown expression type.

Action: See the EXPR command syntax for more information about expressions. Then try entering your command again with a known expression type.

**Unload trace data failed**

Cause: An unexpected error occurred while waiting for a trace to be completed.

Action: End and release the session, and then try again.

**Wait time failure, could not determine system time**

Cause: The system call failed.

Action: Verify that 'date' executes correctly from the UNIX prompt.

**Warning: at least one integer truncated to 32 bits**

**Warning: at least one integer truncated to 16 bits**

**Warning: at least one integer truncated to 8 bits**

Cause: The number entered was too large for the currently specified display or access size.

Action: Try entering the command again using the correct size of number.

**Width not in range: 1 <= valid width <= 80**

Cause: You tried to specify the width of the field outside the range from 1 to 80.

Action: Try entering the command again using a valid number for the width.

**Write to ROM break: %s" (628)**

Cause: When the emulator is configured to break on writes to ROM, a memory write access to a location mapped as ROM has occurred during execution of the user program.

Action: Investigate the cause of the write to ROM by the user program. You can configure the emulator so that it does not break on writes to ROM.

**Write to ROM break (612)**

Cause: This status message will be printed if you have enabled breaks on writes to ROM and the emulation processor attempted a write to a memory location mapped as ROM.

Action: None (except troubleshooting your program).

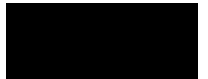





---

Concept Guide

---



## Part 4

Topics that explain concepts and apply them to advanced tasks.

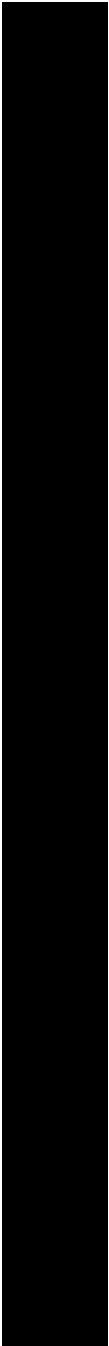

---

Concepts

---

---

## Concepts

This chapter provides conceptual information on the following topics:

- X resources and the Graphical User Interface.
- Concepts of the EMSIM and EMRAM

---

# X Resources and the Graphical User Interface

This section contains more detailed information about X resources and scheme files that control the appearance and operation of the Graphical User Interface. This section:

- Describes the X Window concepts surrounding resource specification.
- Describes the Graphical User Interface's implementation of scheme files.

## **X Resource Specifications**

An X resource specification is a resource name and a value. The resource name identifies the element whose appearance or behavior is to be defined, and the value specifies how the element should look or behave. For example, consider the following resource specification:

```
Application.form.row.done.background: red
```

The resource name is "Application.form.row.done.background:" and the value is "red".

### **Resource Names Follow Widget Hierarchy**

A *widget* is an OSF/Motif graphic device from which X applications are built. For example, pushbuttons and menu bars are Motif widgets. Applications are built using a hierarchy of widgets, and the application's X resource names follow this hierarchy. For example:

```
Application.form.row.done.background: red
```

In the resource name above, the top-level widget is named after the application. One of the top-level widget's children is a form widget, one of the form widget's children is a row-column manager widget, and one of the row-column manager widget's children is a pushbutton widget. Resource names show a path in the widget hierarchy.

Each widget in the hierarchy is a member of a widget class, and the particular instance of the widget is named by the application programmer.



### **Class Names or Instance Names Can Be Used**

When specifying resource names, you can use either instance names or class names. For example, a "Done" pushbutton may have an instance name of "done" and a class name of "XmPushButton". To set the background color for a hypothetical "Done" pushbutton, you can use:

```
Application.form.row.done.background: red
```

Or, you can use:

```
Application.form.row.XmPushButton.background: red
```

Applications also have class and instance names. For example, an application may have an instance name of "applic1" and a class name of "Application". To set the background color for a hypothetical "Done" pushbutton only in the "applic1" application, you can use:

```
applic1.form.row.done.background: red
```

Note that instance names are more specific than class names. That is, class names may apply to many instances of the widget.

The class and instance names for the widgets in the Graphical User Interface can be displayed by choosing **Help**→**X Resource Names** and clicking on the "All names" button.

### **Wildcards Can Be Used**

A wildcard may be used to match a resource specification to many different widgets at once. For example, to set the background color of all pushbuttons, you can use:

```
Application*XmPushButton.background: red
```

Note that resource names with wildcards are more general than those without wildcards.

### Specific Names Override General Names

A more specific resource specification will override a more general one when both apply to a particular widget or application.

The names for the application and the main window widget in HP64\_Softkey applications have been chosen so that you may specify custom resource values that apply in particular situations:

Apply to ALL HP64\_Softkey applications:

**HP64\_Softkey\***<resource>: <value>

Apply to specific types of HP64\_Softkey applications:

**emul\***<resource>: <value> (for the emulator)

**perf\***<resource>: <value> (for the performance analyzer)

Apply to all HP64\_Softkey applications, but only when they are connected to a particular type of microprocessor:

**\*m6833x\***<resource>: <value> (for the 6833x)

**\*m68020\***<resource>: <value> (for the 68020)

Apply to a specific HP64\_Softkey application connected to a specific processor:

**perf.m6833x\***<resource>: <value> (for the 6833x perf. analyzer)

**emul.m68020\***<resource>: <value> (for the 68020 emulator)

If all four examples above are used for a particular resource, #3 will override #2 for all applications connected to a 6833x emulator, and #4 will override #2, but only for the specifically mentioned type of microprocessor.

When modifying resources, your resource paths must either match, or be more specific than, those found in the application defaults file.

### How X Resource Specifications are Loaded

When the Graphical User Interface starts up, it loads resource specifications from a set of configuration files located in system directories as well as user-specific locations.



### **Application Default Resource Specifications**

Default resource specifications for an application are placed in a system directory:

HP-UX  
SunOS

/usr/lib/X11/app-defaults

/usr/openwin/lib/X11/app-defaults

The name of the Graphical User Interface application defaults file is HP64\_Softkey (same as the application class name). This file is well-commented and contains information about each of the X resources you can modify. You can easily view this file by choosing **Help**→**Topic** and selecting the "X Resources: App Default File" topic. Do not modify the application defaults file; any changes to this file will affect the appearance and behavior of the application for all users.

### **User-Defined Resource Specifications**

User-defined resources (for any X application) are located in the X server's RESOURCE\_MANAGER property or in the user's \$HOME/.Xdefaults file.

### **Load Order**

Resource specifications are loaded from the following places in the following order:

The application defaults file. For example, /usr/lib/X11/app-defaults/HP64\_Softkey when the operating system is HP-UX or /usr/openwin/lib/X11/app-defaults/HP64\_Softkey when the operating system is SunOS.

The \$XAPPLRESDIR/HP64\_Softkey file. (The XAPPLRESDIR environment variable defines a directory containing system-wide custom application defaults.)

The server's RESOURCE\_MANAGER property. (The xrdb command loads user-defined resource specifications into the RESOURCE\_MANAGER property.)

If no RESOURCE\_MANAGER property exists, user defined resource settings are read from the \$HOME/.Xdefaults file.



The file named by the XENVIRONMENT environment variable.

If the XENVIRONMENT variable is not set, the \$HOME/Xdefaults-*host* file is read (typically contains resource specifications for a specific remote host).

Resource specifications included in the command line with the -xrm option.

When specifications with identical resource names appear in different places, the latter specification overrides the former.

## Scheme Files

Several of the Graphical User Interface's X resources identify *scheme files* that contain additional X resource specifications. Scheme files group resource specifications for different displays, computing environments, and languages.

### Resources for Graphical User Interface Schemes

There are five X resources that identify scheme files:

HP64\_Softkey.labelScheme:

Names the scheme file to use for labels and button text. Values can be: Label, \$LANG, or a custom scheme file name. The default uses the \$LANG environment variable if it is set and if a scheme file named Softkey.\$LANG exists in one of the directories searched for scheme files; otherwise, the default is Label.

HP64\_Softkey.platformScheme:

Names the subdirectory for the platform specific color, size, and input scheme files. This resource should be set to the platform on which the X server is running (and displaying the Graphical User Interface) if it is different than the platform where the application is running. Values can be: HP-UX, SunOS, pc-xview, or a custom platform scheme directory name.

HP64\_Softkey.colorScheme:

Names the color scheme file. Values can be: Color, BW, or a custom scheme file name.



HP64\_Softkey.sizeScheme:

Names the size scheme file which defines the fonts and the spacing used. Values can be: Large, Small, or a custom scheme file name.

HP64\_Softkey.inputScheme:

Names the input scheme file which specifies mouse and keyboard operation. Values can be: Input, or a custom scheme file name.

The actual scheme file names take the form: "Softkey.<value>".

### **Scheme File Names**

There are six scheme files provided with the Graphical User Interface. Their names and brief descriptions of the resources they contain follow.

Softkey.Label	Defines the labels for the fixed text in the interface. Such things as menu item labels and similar text are in this file. If the \$LANG environment variable is set, the scheme file "Softkey.\$LANG" is loaded if it exists; otherwise, the file "Softkey.Label" is loaded.
Softkey.BW	Defines the <i>color scheme</i> for black and white displays. This file is chosen if the display cannot produce at least 16 colors.
Softkey.Color	Defines the <i>color scheme</i> for color displays. This file is chosen if the display can produce 16 or more colors.
Softkey.Large	Defines the <i>size scheme</i> (that is, the window dimensions and fonts) for high resolution displays (1000 pixels or more vertically).
Softkey.Small	Defines the <i>size scheme</i> (that is, the window dimensions and fonts) for low resolution displays (less than 1000 pixels vertically).
Softkey.Input	Defines the <i>input scheme</i> (that is, the button and key bindings for the mouse and keyboard).

**Load Order for Scheme Files**

Scheme files are searched for in the following directories and in the following order:

- System scheme files in directory `/usr/hp64000/lib/X11/HP64_schemes`.
- System-wide custom scheme files located in directory `$XAPPLRESDIR/HP64_schemes`.
- User-defined scheme files located in directory `$HOME/.HP64_schemes` (note the dot in the directory name).

**Custom Scheme Files**

You can modify scheme files by copying them to the directory for user-defined schemes and changing the resource specifications in the file. For example, if you wish to modify the color scheme, and your platform is HP-UX, you can copy the `/usr/hp64000/lib/X11/HP64_schemes/HP-UX/Softkey.Color` file to `$HOME/.HP64_schemes/HP-UX/Softkey.Color` and modify its resource specifications.

You can create custom scheme files by modifying the X resource for the particular scheme and by placing the custom scheme file in the directory for user-defined schemes. For example, if the following resource specifications are made:

```
HP64_Softkey.platformScheme:  HP-UX
HP64_Softkey.colorScheme:    MyColor
```

The custom scheme file would be:

```
$HOME/.HP64_schemes/HP-UX/Softkey.MyColor
```



---

## Concepts of the EMSIM and EMRAM

The 6833x processors provide an array of on-chip peripherals which are configured and used via memory mapped registers. These registers directly control many aspects of the external operation of the processor. The most notable of these on-chip peripherals is the SIM (System Integration Module). For example, address bits A19 through A23 can be configured as either address bits, chip select control signals, or discrete output port signals. Selection of these alternative uses drastically changes the external behavior of the processor. Internal to the processor, the full 24-bit address and bus control signals are always maintained. What is seen external to the processor is determined by the current contents of the SIM register set.

Most of the 6833x processors also have internal, on-board, static RAM which can be configured to be addressable anywhere within the address range. The processor RAM register set is used to enable this on-board RAM and to define where it is currently positioned in the 24-bit address space.

The emulator needs access to the full 24-bit address, function codes, and other control signals for proper operation of the emulation bus analyzer and the emulation memory system. To provide this access when these signals are not available external to the processor, an external bus decoder is designed into the emulator; it recreates these signals.

The following is a view of the emulator implementation:

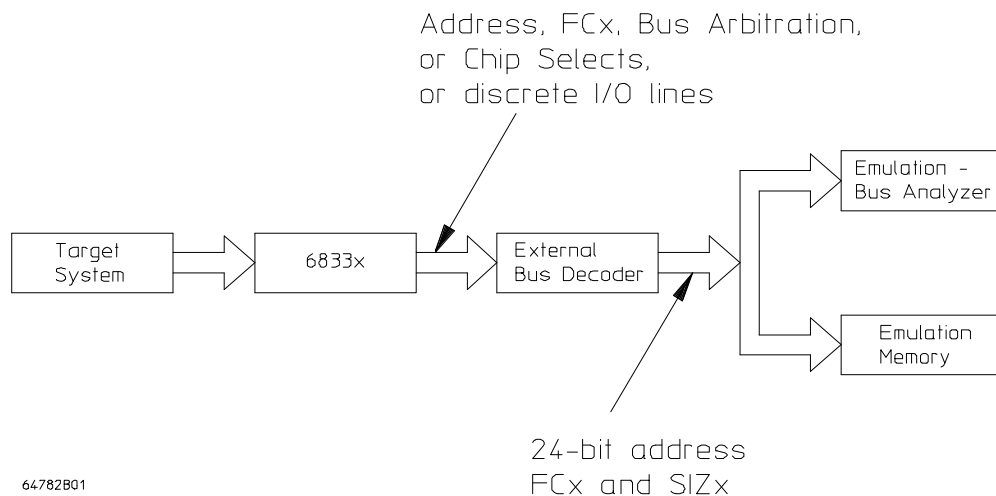

64782B01

The emulator has been designed to ensure that the emulation-bus analyzer and the emulation memory system will have access to the equivalent of the internal processor 24-bit address bus, function codes, and size information. The external bus decoder circuitry can recreate these signals for all possible combinations of processor pin usage that make sense to the target system. The external bus decoder must be given knowledge of how the processor pins will be used; this knowledge is defined by the EMSIM and EMRAM register sets.

Because the emulation-bus analyzer always receives the full 24-bit address, the user can trace activity based upon the way the code was written, not on the chip selects that are used to access the code. The analyzer can display address symbols in the trace list and accept symbolic address information entered in trace commands.

Because the emulation memory system also receives the full 24-bit address, memory can be allocated (mapped) between the target system and emulation (overlay) memory based upon the full address, not upon chip selects and a subset of the full address bus. When a program download is performed, the program information can be properly directed to emulation or target memory based upon the full 24-bit address contained in the executable file.

The concept of register copies has been implemented in order to accomplish external bus decoding. As part of the emulator configuration, the user can indicate the desired SIM and RAM values by loading the EMSIM and EMRAM copy registers. Once these register copies have been loaded, memory resources (either emulation or target memory) can be accessed in the same manner that the processor will access them when running target code. Note that the default programming of the EMSIM and EMRAM registers is exactly the same as the reset values of the SIM and RAM registers, as defined by the *Motorola 6833x User Manuals*.

In addition to providing the programming knowledge for the external bus decoder, the EMSIM and EMRAM registers provide a very helpful feature. Suppose the emulator user wants to load target memory RAM which has been implemented to be accessible via processor chip selects. In order to access this memory, the processor SIM registers must typically be changed from the reset default values. This can be done by individually modifying each SIM register or by running some processor initialization code. If the EMSIM registers hold the desired values, it can also be done by simply transferring the EMSIM registers into the SIM registers. As a convenience to the user, this transfer is performed automatically each time the monitor is entered from emulation reset. This is the only time that this transfer is performed



automatically; the user can manually transfer the EMSIM to the SIM or the SIM to the EMSIM or display their differences at any time.

### **Concepts of the EMRAM**

Most members of the 6833x family of processors have one or more internal RAM modules. For example, the 68335 has three internal RAM modules. These internal RAM modules can be used like any other system RAM; that is, their memory hardware can be assigned to support any desired address range within the 6833x address space.

The address range that a particular internal RAM module will support, and the qualifiers that might additionally be assigned to that address range are defined by the values contained within registers in the 4K Module Control Block of the processor. The values of these registers are supplied to the emulator as part of the EMRAM copy. The emulator uses this information to determine where memory accesses should be routed, based on the current emulator memory map.

The emulator cannot emulate internal RAM modules when the internal RAM is enabled. Internal RAM accesses will typically not be seen outside the processor, and therefore emulation memory will be ignored. The only way to get the processor to access emulation memory which has been mapped to the same address range as internal RAM is to disable the internal RAM, by resetting the processor. Note that internal RAM accesses may be seen externally by the analyzer using the show cycles feature, discussed below.

By default, the internal RAM module(s) in 6833x processors are turned off. The internal RAM(s) are enabled and positioned by loading the EMRAM registers. The contents of the EMRAM registers are automatically copied to the RAM registers each time the emulator enters the monitor from emulation reset.

## Concepts of Show Cycles

Typically when the processor accesses internal resources (either the Module Control Block, or internal RAM) the bus cycles are not available external to the processor. These bus cycles can be made available by enabling a feature of the 6833x processor called show cycles. In order to capture a trace of activity involving these internal resources, the 6833x processor's show cycles feature is used to make activity available to the analyzer. Two control bits in the SIM\_MCR register must be set to enable the show cycles feature. Specifically, these control bits are bits 8 and 9 of the Module Control Register. These two bits control external bus arbitration in addition to show cycles. Refer to the *Motorola 6833x User Manual* for detailed information of how to program these bits.

The external-bus decoder within the emulator will automatically decode these "show" bus cycles if the following two conditions are met.

- Condition 1: Show cycles are enabled as described above.
- Condition 2: The /DS signal is available external to the processor.

If the pin that carries the /DS signal is programmed as a portE I/O pin, the processor is not able to indicate a show cycle and the analyzer will not be able to display show cycles in a trace.

The external-bus decoder within the emulator will automatically decode these "show" bus cycles so the emulation-bus analyzer can correctly capture them. Note that the external-bus decoder can only correctly decode one internal RAM space at a time. For processors with multiple internal RAM spaces, the emulator user must select which RAM space will be decoded by answering a configuration question.

If an emulated processor has two internal RAM spaces enabled at the same time, one at address 0, and one at address 0x200000, a configuration question will ask you which internal RAM space to decode. If you answer the one at address 0, then when execution is within the range controlled by the internal RAM at address 0, decoding will be correct. When execution is within the range controlled by the RAM at address 0x200000, captured address information will not be correct; address information will indicate that the accessed addresses were within the range beginning at 0, not 0x200000. Note that even though the upper address information will be incorrect, all other information in the trace will be correct.



## **EMSIM/EMRAM Utility Command**

### **Modify→SIM Registers**

This capability lets the user compare and transfer register values between the SIM and EMSIM register sets. Note even though the word "sim" is used in the command, all operations also include the RAM and EMRAM register sets.

### **Modify→SIM Registers→Copy Emulator SIM to Processor SIM**

This transfers the current values of the EMSIM registers into the SIM registers. This happens automatically each time a break to the monitor from emulation reset occurs. This ensures that the processor is prepared to properly access memory when a program is downloaded to the emulator.

### **Modify→SIM Registers→Copy Processor SIM to Emulator SIM**

This transfers the current values of the SIM registers into the EMSIM registers. This is useful if initialization code that configures the processor SIM exists, but you don't know its values. In this case, you can use the default configuration, run from reset to execute the initialization code, and then configure the emulator to match the processor SIM.

### **Display→SIM Register Differences**

This shows current differences between the SIM registers and the EMSIM registers. This presents a list of all registers whose values are different between the SIM and the EMSIM. Use this to compare the programming between the SIM and EMSIM.

### **Display→Configuration Info**

This displays information about the emulator configuration and processor SIM programming

### **Display→Configuration Info→Diagnostics**

This checks the emulator configuration. Any inconsistencies and potential problems found during the check are listed. Resolve any items in the list to ensure correct operation of the emulator.

### **Display→Configuration Info→Chip Selects (SIM)**

This displays chip selects in the SIM (processor) register set in a table. Use this to see how the SIM registers have configured the chip select pins of the processor.



**Display→Configuration Info→Chip Selects (Emulator SIM)**

This displays chip selects in the EMSIM (emulator) register set in a table. Use this to see how the EMSIM registers have configured the chip select pins of the emulation copy.

**Display→Configuration Info→Bus Interface Ports (SIM)**

This displays bus interface ports in the SIM (processor) register set in a table. Use this to see how the SIM registers have configured the external bus interface pins of Port C, Port E, and Port F.

**Display→Configuration Info→Bus Interface Ports (Emulator SIM)**

This displays bus interface ports in the EMSIM (emulator) register set in a table. Use this to see the SIM register values that will be loaded into the processor SIM when the monitor is entered from emulation reset.

**Display→Configuration Info→Memory Map**

This displays detailed information about the memory map in a table. Use this to check the way the memory map has been configured.

**Display→Configuration Info→Reset Mode Value**

This displays the reset mode configuration value and operation in a table. This is the value that will be driven onto the data bus to configure the processor when it comes out of reset. The meaning of each data bit in the value is shown.

**Display→Configuration Info→Initialization Source Code**

This displays the assembly language program to initialize the processor SIM and RAM based on the current contents of the EMSIM and EMRAM register sets.

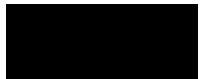



---

Installation Guide

---



Instructions for installing and configuring the product.





---

## Installation

---

# Installation

This chapter shows you how to install interface software. It also shows you how to verify installation by starting the emulator analyzer interface for the first time. These installation tasks are described in the following sections:

- Where to find information on connecting the HP 64700 to a computer or LAN.
- Installing HP 9000 software.
- Installing Sun SPARCsystem software.
- Verifying the installation.

For information about installing hardware, refer to the *MC6833x Emulator/Analyzer Installation/Service/Terminal Interface User's Guide*.

## **Minimum HP 9000 Hardware and System Requirements**

The following is a set of minimum hardware and system recommendations for operation of the Graphical User Interface on HP 9000 Series 300/400 and Series 700 workstations.

**HP-UX** For Series 9000/300 and Series 9000/400 workstations, the minimum supported version of the operating system is 7.03 or later. For Series 9000/700 workstations, the minimum supported version of the operating system is version 8.01.

**Motif/OSF** For Series 9000/700 workstations, you must also have the Motif 1.1 dynamic link libraries installed. They are installed by default, so you do not have to install them specifically for this product, but you should consult your HP-UX documentation for confirmation and more information.

**Hardware and Memory** Any workstation used with the Graphical User Interface should have a minimum of 16 megabytes of memory. Series 300 workstations should have a minimum performance equivalent to that of a HP 9000/350. A color display is also highly recommended.

From here, you should proceed to the section titled "Installation for HP 9000 Hosted Systems" for instructions on how to install, verify, and start the Graphical User Interface on HP 9000 systems.

**Minimum Sun SPARCsystem Hardware and System Requirements**

The following is a set of minimum hardware and system recommendations for operation of the Graphical User Interface on Sun SPARCsystem (SunOS or Solaris) workstations.

**SunOS** The Graphical User Interface software is designed to run on a Sun SPARCsystem with SunOS version 4.1 or 4.1.1 or greater, and Solaris version 2.3. Each tape uses the QIC-24 data format.

**64700 Operating Environment** The Graphical User Interface requires version A.04.10 or greater of the 64700 Operating Environment. (The Graphical User Interface version is A.04.00.)

**Hardware and Memory** Any workstation used with the Graphical User Interface should have a minimum of 16 megabytes of memory. A color display is also highly recommended.

From here, you should proceed to the section titled "Installation for Sun SPARCsystems" for instructions on how to install, verify, and start the Graphical User Interface on SPARCsystem workstations.

Refer to the *HP 64700 Series Installation/Service Guide* for instructions on connecting the HP 64700 to a host computer (via RS-422 or RS-232) or LAN and setting the HP 64700's configuration switches. (RS-422 and RS-232 are only supported on HP 9000 Series 300/400 machines.)





This section shows you how to install the Graphical User Interface on HP 9000 workstations. These instructions also tell you how not to install the Graphical User Interface if you want to use just the conventional Softkey Interface.

This section shows you how to:

- Install the software from the media.
- Verify the software installation.
- Start the X server and the Motif Window Manager (mwm), or start HP VUE.
- Set the necessary environment variables.

---

## Step 1. Install the software from the media

The tape that contains the Graphical User Interface software may contain several products. Usually, you will want to install all of the products on the tape. However, to save disk space, or for other reasons, you can choose to install selected filesets.

If you plan on using the Softkey Interface instead of the Graphical User Interface, you can save about 3.5 megabytes of disk space by not installing the XUI suffixed filesets in the "64700 Operating Environment" and "<processor-type> Emulation Tools" partitions. (Also, if you choose not to install the Graphical User Interface, you will not have to use a special command line option to start the Softkey Interface.)

Refer to the information on updating HP-UX in your HP-UX documentation for instructions on viewing partitions and filesets and marking filesets that should not be loaded.

The following sub-steps assume that you want to install all products on the tape.

- 1** Become the root user on the system you want to update.
- 2** Make sure the tape's write-protect screw points to **SAFE**.
- 3** Put the product media into the tape drive that will be the *source device* for the update process.

- 4 Confirm that the tape drive BUSY and PROTECT lights are on. If the PROTECT light is not on, remove the tape and confirm the position of the write-protect screw. If the BUSY light is not on, check that the tape is installed correctly in the drive and that the drive is operating correctly.
- 5 When the BUSY light goes off and stays off, start the update program by entering

**/etc/update**

at the HP-UX prompt.

- 6 When the HP-UX update utility main screen appears, confirm that the source and destination devices are correct for your system. Refer to the information on updating HP-UX in your HP-UX documentation if you need to modify these values.
- 7 Select "Load Everything from Source Media" when your source and destination directories are correct.
- 8 To begin the update, press the softkey <Select Item>. At the next menu, press the softkey <Select Item> again. Answer the last prompt with

**y**

It takes about 20 minutes to read the tape.

- 9 When the installation is complete, read /tmp/update.log to see the results of the update.

---

## Step 2. Set the necessary environment variables

The DISPLAY environment variable must be set before the Graphical User Interface will start. Also, you should modify the PATH environment variable to include the "/usr/hp64000/bin" directory, and, if you have installed software in a directory other than "/", you need to set the HP64000 environment variable.

The following instructions show you how to set these variables at the UNIX prompt. Modify your ".profile" or ".login" file if you wish these environment variables to be set when you log in. The following instructions also assume that you're using "sh" or "ksh"; if you're using "csh", environment variables are set using the "setenv <VARIABLE> <value>" command.

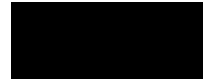

**1** Set the DISPLAY environment variable by entering

**DISPLAY=<hostname>:<server\_number>.<screen\_number>  
export DISPLAY**

For example:

```
DISPLAY=myhost:0.0; export DISPLAY
```

Consult the X Window documentation supplied with the UNIX system documentation for an explanation of the DISPLAY environment variable.

**2** Set the HP64000 environment variable.

If you installed the software relative to a directory other than the root directory, it is strongly recommended that you use a symbolic link to make the software appear to be under /usr/hp64000. For example, if you installed the software relative to directory /users/team, you would enter

```
ln -s /users/team/usr/hp64000 /usr/hp64000
```

If you installed the HP 64000 software relative to the root directory, "/", or established a symbolic link to /usr/hp64000, then you would enter

```
HP64000=/usr/hp64000; export HP64000
```

If you did not install relative to the root directory, or do not wish to establish a symbolic link, you can set the HP64000 variable to the full path that contains the HP 64000 software. Again, if you installed relative to /users/team, you would enter

```
HP64000=/users/team/usr/hp64000; export HP64000
```

**3** Set the PATH environment variable to include the **usr/hp64000/bin** directory by entering

**PATH=\$PATH:\$HP64000/bin; export PATH**

Including usr/hp64000/bin in your PATH relieves you from prefixing HP 64700 executables with the directory path.

**4** Set the MANPATH environment variable to include the **\$HP64000/man** and **\$HP64000/contrib/man** directories by entering

**MANPATH=\$MANPATH:\$HP64000/man:\$HP64000/contrib/man  
export MANPATH**

Including these directories in your MANPATH variable lets you access the on-line "man" page information included with the software.

---

## Step 3. Verify the software installation

A number of new filesets were installed on your system during the software installation process. This and following steps assume that you chose to load the Graphical User Interface filesets.

You can use this step to further verify that the filesets necessary to successfully start the Graphical User Interface have been loaded and that customize scripts have run correctly. Of course, the update process gives you mechanisms for verifying installation, but these checks can help to double-check the install process.

- 1** Verify the existence of the **HP64\_Softkey** file in the **/\$hp64000/X11/app-defaults** subdirectory by entering **ls /\$hp64000/X11/app-defaults/HP64\_Softkey** at the HP-UX prompt.

Finding this file verifies that you loaded the correct fileset and also verifies that the customize scripts executed because this file is created from other files during the customize process.

- 2** Examine **/\$hp64000/X11/app-defaults/HP64\_Softkey** near the end of the file to confirm that there are resources specific to your emulator.

Near the end of the file, there will be resource strings that contain references to specific emulators. For example, if you installed the Graphical User Interface for the 6833x emulator, resource name strings will have m6833x embedded in them.

After you have verified the software installation, you must start the X server and an X window manager (if you are not currently running an X server). If you plan to run the Motif Window Manager (mwm), or similar window manager, continue with Step 4a of these instructions. If you plan to run HP VUE, skip to Step 4b of these instructions.



---

## Step 4a. Start the X server and the Motif Window Manager (mwm)

If you are not already running the X server and a window manager, do so now. The X server is required to use the Graphical User Interface because it is an X Windows application. A window manager is not required to execute the interface, but, as a practical matter, you must use some sort of window manager with the X server.

- **Start the X server by entering `x11start` at the HP-UX prompt.**

Consult the X Window documentation supplied with the HP-UX operating system documentation if you do not know about using X Windows and the X server.

After starting the X server and Motif Window Manager, continue with step 2 of these instructions.

---

## Step 4b. Start HP VUE

If you are running the X server under HP VUE and have not started HP VUE, do so now.

HP VUE is a window manager for the X Window system. The X server is executing underneath HP VUE. Unlike the Motif Window Manager, HP VUE provides a login shell and is your default interface to the HP 9000 workstation.

This section shows you how to install the Graphical User Interface on Sun SPARCsystem workstations. These instructions also tell you how not to install the Graphical User Interface if you want to use just the conventional Softkey Interface.

This section shows you how to:

- 1 Install the software from the media.
- 2 Start the X server and OpenWindows.
- 3 Set the necessary environment variables.
- 4 Verify the software installation.
- 5 Map your function keys.

---

## Step 1. Install the software from the media

The tape that contains the Graphical User Interface software may contain several products. Usually, you will want to install all of the products on the tape. However, to save disk space, or for other reasons, you can choose to install selected filesets.

If you plan on using the conventional Softkey Interface instead of the Graphical User Interface, you can save about 3.5 megabytes of disk space by not installing the XUI suffixed filesets. (Also, if you choose not to install the Graphical User Interface, you will not have to use a special command line option to start the Softkey Interface.)

Refer to the *Software Installation Notice* for software installation instructions. After you are done installing the software, return here.



---

## Step 2. Start the X server and OpenWindows

If you are not already running the X server, do so now. The X server is required to run the Graphical User Interface because it is an X application.

- **Start the X server by entering `/usr/openwin/bin/openwin` at the UNIX prompt.**  
Consult the OpenWindows documentation if you do not know about using OpenWindows and the X server.

---

## Step 3. Set the necessary environment variables

The DISPLAY environment variable must be set before the Graphical User Interface will start. Also, you should modify the PATH environment variable to include the "usr/hp64000/bin" directory, and, if you have installed software in a directory other than "/", you need to set the HP64000 environment variable.

The following instructions show you how to set these variables at the UNIX prompt. Modify your ".profile" or ".login" file if you wish these environment variables to be set when you log in. The following instructions also assume that you're using "csh"; if you're using "sh", environment variables are set in the "<VARIABLE>=<value>; export <VARIABLE>" form.

- 1 The DISPLAY environment variable is usually set by the **openwin** startup script. Check to see that DISPLAY is set by entering

**echo \$DISPLAY**

If DISPLAY is not set, you can set it by entering

**setenv  
DISPLAY=<hostname>:<server\_number>.<screen\_number>**

For example:

```
setenv DISPLAY=myhost:0.0
```

Consult the OpenWindows documentation for an explanation of the DISPLAY environment variable.

**2 Set the HP64000 environment variable.**

For example, if you installed the HP 64000 software relative to the root directory, "/", you would enter

```
setenv HP64000 /usr/hp64000
```

If you installed the software relative to a directory other than the root directory, it is strongly recommended that you use a symbolic link to make the software appear to be under /usr/hp64000. For example, if you installed the software relative to directory /users/team, you would enter

```
ln -s /users/team/usr/hp64000 /usr/hp64000
```

If you do not wish to establish a symbolic link, you can set the HP64000 variable to the full path that contains the HP 64000 software; also set the LD\_LIBRARY\_PATH variable to the directory containing run-time libraries used by the HP 64000 products. Again, if you installed relative to /users/team, you would enter

```
setenv HP64000 /users/team/usr/hp64000  
setenv LD_LIBRARY_PATH ${LD_LIBRARY_PATH}:${HP64000}/lib
```

**3 Set the PATH environment variable to include the `usr/hp64000/bin` directory by entering**

```
setenv PATH ${PATH}:${HP64000}/bin
```

Including `usr/hp64000/bin` in your PATH relieves you from prefixing HP 64700 executables with the directory path.

**4 Set the MANPATH environment variable to include the `usr/hp64000/man` and `usr/hp64000/contrib/man` directories by entering**

```
setenv MANPATH ${MANPATH}:${HP64000}/man  
setenv MANPATH ${MANPATH}:${HP64000}/contrib/man
```

Including these directories in your MANPATH variable lets you access the on-line "man" page information included with the software.

**5 If the Graphical User Interface is to run on a SPARCsystem computer that is not running OpenWindows, include the `/usr/openwin/lib` directory in LD\_LIBRARY\_PATH.**

```
setenv LD_LIBRARY_PATH  
${LD_LIBRARY_PATH}:/usr/openwin/lib
```





---

## Step 4. Verify the software installation

A number of product filesets were installed on your system during the software installation process. Due to the complexity of installing on NFS mounted file systems, a script that verifies and customizes these products was also installed. This stand alone script may be run at any time to verify that all files required by the products are in place in the file system. If required files are not found, this script will attempt to symbolically link them from the \$HP64000 install directory to their proper locations.

- Run the script **\$HP64000/bin/envinstall**.

---

## Step 5. Map your function keys

If you are using the conventional Softkey Interface, map your function keys by following the steps below.

- 1 Copy the function key definitions by typing:**

```
cp $HP64000/etc/ttyswrc ~/.ttyswrc
```

This creates key mappings in the .ttyswrc file in your \$HOME directory.

- 2 Remove or comment out the following line from your .xinitrc file:**

```
xmodmap -e 'keysym F1 = Help'
```

If any of the other keys F1-F8 are remapped using xmodmap, comment out those lines also.

**3** Add the following to your `.profile` or `.login` file:

```
stty erase ^H
setenv KEYMAP sun
```

The erase character needs to be set to backspace so that the Delete key can be used for "delete character."

If you want to continue using the F1 key for HELP, you can use use F2-F9 for the Softkey Interface. All you have to do is set the KEYMAP variable. If you use OpenWindows, type:

```
setenv KEYMAP sun.2-9
```

If you use xterm windows (the xterm window program is located in the directory `/usr/openwin/demo`), type:

```
setenv KEYMAP xterm.2-9
```

Reminder: If you are using OpenWindows, add `/usr/openwin/bin` to the end of the `$PATH` definition, and add the following line to your `.profile`:

```
setenv OPENWINHOME /usr/openwin
```

After you have mapped your function keys, you must start the X server and an X window manager (if you are not currently running an X server).

---

# Verifying the Installation

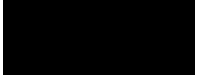

This section shows you how to:

- Determine the logical name of your emulator.
- Start the emulator/analyzer interface for the first time.
- Exit the emulator/analyzer interface.

---

## Step 1. Determine the logical name of your emulator

The *logical name* of an emulator is a label associated with a set of communications parameters in the \$HP64000/etc/64700tab.net file. The 64700tab.net file is placed in the directory as part of the installation process.

- 1 Display the 64700tab.net file by entering **more /usr/hp64700/etc/64700tab.net** at the HP-UX prompt.
- 2 Page through the file until you find the emulator you are going to use.

This step will require some matching of information to an emulator, but it should not be difficult to determine which emulator you want to address.

---

### Examples

A typical entry for a 6833x emulator connected to the LAN would appear as follows:

```
#-----  
# Channel | Logical   | Processor | Remainder of Information for the Channel  
# Type   | Name     | Type     | (IP address for LAN connections)  
#-----  
lan:    em6833x   m6833x   21.17.9.143
```

A typical entry for a 6833x emulator connected to an RS-422 port would appear as follows:

```
#-----  
# Channel | Logical   | Processor | Host | Physical | Xpar | Parity | Flow | Stop | Char  
# Type   | Name     | Type     | Name | Device   | Mode |        |      | Bits | Size  
#        |          |          |      |          | OFF  | NONE   | RTS  | 2    | 8  
#-----  
serial:  em6833x   m6833x   myhost /dev/emcom23 OFF  NONE   RTS   2    8
```

---

## Step 2. Start the interface with the **emul700** command

- 1** Apply power to the emulator you wish to access after making sure the emulator is connected to the LAN or to your host system.

On the HP 64700 Series Emulator, the power switch is located on the front panel near the bottom edge. Push the switch in to turn power on to the emulator.

- 2** Wait a few seconds to allow the emulator to complete its startup initialization.
- 3** Choose a terminal window from which to start the Graphical User Interface.
- 4** Start the Graphical User Interface by entering **emul700** command and giving the logical name of the emulator as an argument to the command, as in

```
$HP64000/bin/emul700 <logical_name> &
```

or

```
emul700 <logical name> &
```

if **\$HP64000/bin** is in your path.

If you are running the X server, if the Graphical User Interface is installed, and if your DISPLAY environment variable is set, the emul700 command will start the Graphical User Interface. Otherwise, emul700 starts the conventional Softkey Interface.

You should include an ampersand ("&") with the command to start the Graphical User Interface as a background process. Doing so frees the terminal window where you started the interface so that the window may still be used.

- 5** Optionally start additional Graphical User Interface windows into the same emulation session by repeating the previous step.

You can also choose to use the conventional Softkey Interface under X Windows, but you must include a command line argument to emul700 to override the default Graphical User Interface. Start the conventional interface by entering

```
emul700 -u skemul <logical name>
```



---

**Example**

Suppose you have discovered that the logical name for a 6833x emulator connected to the LAN is "em6833x". To start the Graphical User Interface and begin communicating with that emulator, enter (assuming your \$PATH includes \$HP64000/bin)

```
emul700 em6833x
```

After a few seconds, the Graphical User Interface Emulator/Analyzer window should appear on your screen. The window will be similar to the following:

---

---

### Step 3. Exit the Graphical User Interface

- 1** Position the mouse pointer over the pulldown menu named "File" on the menu bar at the top of the interface screen.
- 2** Press and hold the command select mouse button until the File menu appears.
- 3** While continuing to hold the mouse button down, move the mouse pointer down the menu to the "Exit" menu item.
- 4** Display the Exit cascade menu by moving the mouse pointer to the right edge of the Exit menu choice. There is an arrow on the right edge of the menu item.
- 5** Choose "Released" from the cascade menu.

The interface will terminate and release the emulator for use by others.





---

## Installing/Updating Emulator Firmware

---

## Installing/Updating Emulator Firmware

The 6833x emulator firmware is included with the emulator/analyzer interface software, and the program that downloads emulator firmware is included with the HP B1471 64700 Operating Environment product.

(The firmware, and the program that downloads it into the control card, are also included with the 6833x emulator probe on an MS-DOS format floppies. The floppies are for users that do not have hosted interface software.)

Before you can update emulator firmware, you must have already installed the emulator into the HP 64700, connected the HP 64700 to a host computer or LAN, and installed the emulator/analyzer interface and HP B1471 software as described in the "Installation" chapter.

This chapter describes how to:

- Update firmware with the "progflash" command.
- Display current firmware version information.



---

## To update emulator firmware with "progflash"

- Enter the **progflash -v <emul\_name> <products ...>** command.  
The progflash command downloads code from files on the host computer into Flash EPROM memory in the HP 64700.  
The -v option means "verbose". It causes progress status messages to be displayed during operation.  
The <emul\_name> option is the logical emulator name as specified in the /usr/hp64000/etc/64700tab.net file.  
The <products> option names the products whose firmware is to be updated.  
If you enter the progflash command without options, it becomes interactive. If you don't include the <emul\_name> option, it displays the logical names in the /usr/hp64000/etc/64700tab.net file and asks you to choose one. If you don't include the <products> option, it displays the products which have firmware update files on the system and asks you to choose one. (In the interactive mode, only one product at a time can be updated.) You can abort the interactive progflash command by pressing <CTRL>c.  
Progflash will print "Flash programming SUCCEEDED" and return 0 if it is successful; otherwise, it will print "Flash programming FAILED" and return a nonzero (error).  
You can verify the update by displaying the firmware version information.

Installing/Updating Emulator Firmware  
To update emulator firmware with "progflash"

Examples

To install or update the HP 64782 emulator firmware:

\$ **progflash** <RETURN>

HPB1471-19309 A.05.00 03Jan94  
64700 SERIES EMULATION COMMON FILES

A Hewlett-Packard Software Product  
Copyright Hewlett-Packard Co. 1988

All Rights Reserved. Reproduction, adaptation, or translation without prior written permission is prohibited, except as allowed under copyright laws.

RESTRICTED RIGHTS LEGEND

Use, duplication, or disclosure by the Government is subject to restrictions as set forth in subparagraph (c) (1) (II) of the Rights in Technical Data and Computer Software clause at DFARS 52.227-7013. HEWLETT-PACKARD Company, 3000 Hanover St., Palo Alto, CA 94304-1181

Logical Name	Processor
1 em68k	m68000
2 em80960	i80960
3 em6833x	m6833x

Number of Emulator to Update? (intr (usually cntl C or DEL) to abort)

To update firmware in the HP 64700 that contains the 6833x emulator, enter "3".

Product

1 64700
2 64703/64704/64706/64740
3 64744
4 64782
5 64760

Number of Product to Update? (intr (usually cntl C or DEL) to abort)

To update the HP 64782 6833x emulator firmware, enter "4".

Enable progress messages? [y/n] (y)

To enable status messages, enter "y".

Checking System firmware revision...  
Mainframe is a 64700B

Reading configuration from '/usr/hp64000/inst/update/64782.cfg'  
ROM identifier address = 2FFFF0H  
Required hardware identifier = 1FFFH, 12FFH, 1201H, 1202H, 1203H, 1204H, 1205H,  
1206H  
Control ROM start address = 280000H  
Control ROM size = 40000H  
Control ROM width = 16  
Programming voltage control address = 2FFFFEH  
Programming voltage control value = FFFFH  
Programming voltage control mask = 0H

Rebooting HP64700...  
Checking Hardware id code...  
Erasing Flash ROM  
Downloading ROM code: /usr/hp64000/inst/update/64782.X  
Code start 280000H (should equal control ROM start)  
Code size 2348CH (must be less than control ROM size)  
Finishing up...

Rebooting HP64700...  
Flash programming SUCCEEDED  
\$

You could perform the same update as in the previous example with the following command:

\$ **progflash -v** em6833x 64782 <RETURN>

---

## To display current firmware version information

- Use the Terminal Interface **ver** command to view the version information for firmware currently in the HP 64700.

When using the Graphical User Interface or Softkey Interface, you can enter Terminal Interface commands with the `pod_command` command. For example:

```
display pod_command <RETURN>  
pod_command "ver" <RETURN>
```

---

### Examples

The Terminal Interface `ver` command displays information similar to:

```
Copyright (c) Hewlett-Packard Co. 1987  
All Rights Reserved.  Reproduction, adaptation, or translation without prior  
written permission is prohibited, except as allowed under copyright laws.
```

```
HP64700B Series Emulation System  
Version:   B.01.00 20Dec93  
Location:  Flash  
System RAM:1 Mbyte
```

```
HP64782C Motorola 68332 Emulator  
Version:   A.03.00  
Control:   HP 64748C Emulation Control Board  
Speed:     20.1 MHz  
Memory:    1024 Kbytes  
BANK 0:    HP 64171B (35 ns) or HP 64172B (20 ns) 1 MByte Memory Module
```

```
HP64740 Emulation Analyzer  
Version:   A.02.02 13Mar91
```

---

---

## If there is a power failure during a firmware update

If there is a power glitch during a firmware update, some bits may be lost during the download process, possibly resulting in an HP 64700 that will not boot up.

- Repeat the firmware update process.
- If the HP 64700 is connected to the LAN in this situation and you are unable to connect to the HP 64700 after the power glitch, try repeating the firmware update with the HP 64700 connected to an RS-232 or RS-422 interface.



---

# Glossary

access mode	Specifies the types of cycles used to access target system memory locations. For example a "byte" access mode tells the monitor program to use load/store byte instructions to access target memory.
analyzer	An instrument that captures data on signals of interest at discreet periods.
background	The emulator mode in which foreground operation is suspended so the emulation processor can be used for communication with the emulation controller. The background monitor does not occupy any processor address space.
background emulation monitor	An emulation monitor program that does not execute as part of the user program, and therefore, operates in the emulator's background mode.
background memory	Memory space reserved for the emulation processor when it is operating in the background mode. Background memory does not take up any of the microprocessor's address space.
display mode	When displaying memory, this mode tells the emulator the size of the memory locations to display. When modifying memory, the display mode tells the emulator the size of the values to be written to memory.
embedded microprocessor system	The microprocessor system which the emulator plugs into.
emulation bus analyzer	The internal analyzer that captures emulator bus cycle information synchronously with the processor's clock signal.
emulation monitor program	A program that is executed by the emulation processor which allows the emulation controller to access target system resources. For example, when you display target system memory locations, the monitor program executes microprocessor instructions that read the target memory locations and send their contents to the emulation controller.

emulator	An instrument that performs just like the microprocessor it replaces, but at the same time, it gives you information about the operation of the processor. An emulator gives you control over target system execution and allows you to view or modify the contents of processor registers, target system memory, and I/O resources.
foreground	The mode in which the emulator is executing the user program. In other words, the mode in which the emulator operates as the target microprocessor would.
global restart	When the same secondary branch condition is used for all terms in the analyzer's sequencer, and secondary branches are always back to the first term.
prestore	The analyzer feature that allows up to two states to be stored before normally stored states. This feature is useful when you want to find the cause of a particular state. For example, if a variable is accessed from many different places in the program, you can qualify the trace so that only accesses of that variable are stored and turn on prestore to find out where accesses of that variable originate from.
primary sequencer branch	Occurs when the analyzer finds the primary branch state specified at a certain level and begins searching for the states specified at the primary branch's destination level.
real-time	Refers to continuous execution of the user program without interference from the emulator. (Such interference occurs when the emulator temporarily breaks into the monitor so that it can access register contents or target system memory or I/O.)
secondary sequencer branch	Occurs when the analyzer finds the secondary branch state specified at a certain level before it found the primary branch state and begins searching for the states specified at the secondary branch's destination level.
sequence terms	Individual levels of the sequencer. The HP 64705A analyzer provides 8 sequence terms.
sequencer	The part of the analyzer that allows it to search for a certain sequence of states before triggering.



sequencer branch	Occurs when the analyzer finds the primary or secondary branch state specified at a certain level and begins searching for the states specified at another level.
target system	The microprocessor system which the emulator plugs into.
trace	A collection of states captured on the emulation bus (in terms of the emulation bus analyzer) or on the analyzer trace signals (in terms of the external analyzer) and stored in trace memory.
trigger	The captured analyzer state about which other captured states are stored. The trigger state specifies when the trace measurement is taken.





## A

about, trigger position specification, 209-210  
absolute files, 387  
  loading, 140  
  loading without symbols, 141  
  storing memory contents into, 142  
access size (target memory), 535  
action keys, 25  
  custom, 330  
  operation, 72  
  with command files, 330  
  with entry buffer, 71-72  
activity measurements (SPMT), 257  
  additional symbols for address, 266  
  confidence level, 267  
  error tolerance, 267  
  interpreting reports, 265-274  
  mean, 265  
  relative and absolute counts, 266  
  standard deviation, 266  
  symbols within range, 266  
  trace command setup, 260  
address  
  not range command, 212  
  values, 211  
address (analyzer state qualifier softkey), 208, 407, 422  
address overlays, memory mapping, 117  
address qualifiers, 208  
address range command  
  range command, 212  
address range file format (SPMT measurements), 262  
after, trigger position specification, 209-210  
ambiguous address error message, 117  
analyzer, 535  
  arming other HP 64700 Series analyzers, 5  
  breaking emulator execution into the monitor, 4  
  breaking execution of other HP 64700 Series emulators, 5  
  definition, 4  
  general description, 4  
  occurrence count, 213  
  state qualifiers, 208  
  trace at EXECUTE, 311

  trigger condition, 209-210  
  using the, 194  
analyzer probe  
  assembling, 291  
  connecting to the target system, 293  
analyzer status  
  occurrence left information, 200  
  sequence term information, 200  
app-defaults directory  
  HP 9000 computers, 496  
  Sun SPARCsystem computers, 496  
application resource  
  *See* X resource  
arm information, 199  
arm\_trig2, in trace command, 437

## B

background, 535  
  emulation monitor, 535  
  memory, 535  
  tracing, 121  
background execution, tracing, 121  
bases (number), 204  
bbaunload command, syntax, 347  
before, trigger position specification, 209-210  
binary numbers, 204  
BKPT (breakpoint vector)  
  generally, 160-161  
blocks (emulation memory), size of, 109  
BNC  
  connector, 5, 304  
  trigger signal, 306  
break command, 157, 166-167  
  syntax, 348  
breakpoints, 34  
  copying to a file, 188  
  disabling execution breakpoints, 163  
  displaying and seeing their status, 168-169  
  enabling, 162  
  generally, 160-161  
  setting temporary breakpoints, 165  
breaks on write to ROM, 120

## C

capture continuous stream of execution, 219-222  
cascade menu, 65

## cautions

BNC accepts only TTL voltage levels, 309  
CMB 9-pin port is NOT for RS-232C, 307  
protect emulator against static discharge, 52

real-time dependent target system circuitry, 105

## changing

column width, 244  
directory context in configuration window, 101  
directory context in emulator/analyzer window, 152  
symbol context, 153

characterization of memory, 111

class name, X applications, 494

client, X, 322

clock source selection, emulator

configuration, 105

clocks

*See also* slave clocks

CMB (coordinated measurement bus), 304

EXECUTE line, 306, 349

HP 64700 connection, 307-308

READY line, 305

signals, 305

TRIGGER line, 305

cmb\_execute command, 312, 349

color scheme, 324, 328, 498

columns in main display area, 325

command buttons, 26

command files, 389

  other things to know about, 87

  passing parameters, 86

command line, 25

  Command Recall dialog box, 26

  Command Recall dialog box, operation, 80

  copy-and-paste to from entry buffer, 72

  editing entry area with popup menu, 79

  editing entry area with pushbuttons, 79

  entering commands, 78

  entry area, 25

  executing commands, 78

  help, 81

  keyboard use of, 82

  on-line help, 84-87

- recalling commands with dialog box, 80
  - turning on or off, 77, 325
  - command paste mouse button, 27
  - Command Recall dialog box operation, 73
  - command select mouse button, 27
  - commands, 82
    - combining on a single command line, 82
    - completion, 82
    - editing in command line entry area, 79
    - entering in command line, 78
    - executing in command line, 78
    - keyboard entry, 82
    - line erase, 83
    - map, 118
    - recall, 83
    - recalling with dialog box, 80
    - summary, 346
    - word selection, 83
  - configuration context
    - displaying from configuration window, 101
  - configuration info
    - copy command, 351
    - copying to a file, 188
    - display command, 360-362
  - configuration, emulator
    - background states, tracing, 121
    - breaks on writes to ROM, 120
    - exiting the interface, 103
    - loading from file, 103
    - modifying a section, 98
    - starting the interface, 96-97
    - storing, 100
  - context
    - changing directory in configuration window, 101
    - changing directory in emulator/analyzer window, 152
    - changing symbol, 153
    - displaying directory from configuration window, 101
    - displaying directory from emulator/analyzer window, 152
    - displaying symbol, 152
  - coordinated measurements, 313
    - break\_on\_trigger syntax of the trace command, 313
    - definition, 304
  - copy command, 350-352
    - configuration info, 351
    - data, 351
    - display, 351
    - error\_log, 351
    - event\_log, 351
    - global symbols, 351
    - help, 351
    - local\_symbols\_in, 353
    - memory, 354-355
    - pod\_command, 351
    - registers, 356
    - software breakpoints, 352
    - status, 352
    - trace, 357
  - copy-and-paste
    - addresses, 69
    - from entry buffer, 72
    - multi-window, 69, 72
    - symbol width, 69
    - to entry buffer, 68-70
  - copying
    - breakpoints to a file, 188
    - configuration info to a file, 188
    - data values to a file, 188
    - display area to file, 188
    - emulator status to a file, 189
    - error log to file, 189
    - event log to file, 189
    - global symbols to file, 189
    - local symbols to file, 189
    - memory to file, 188
    - pod commands to a file, 189
    - registers to file, 188
    - trace listing to file, 188
  - count states, 214-215
  - count time, 214-215
  - count, occurrence, 213
  - cursor buttons, 26
- D**
- data
    - copy command, 351
    - display command, 363-365
  - data (analyzer state qualifier softkey), 208, 407, 422
  - data range command, 212
  - data values, 178, 211
    - adding items to the existing display, 179
    - clearing the display and adding a new item, 179
      - copying to a file, 188
      - displaying, 178
    - data values, displaying, 38
    - decimal numbers, 204
    - demos, setting up, 332-334
    - demultiplexing, using slave clocks for, 298-300
    - demux, slave clock mode, 299
    - dequeuer
      - how it works, 238
    - device table file, 32, 55-56
    - dialog box, 73-75
      - Command Recall, operation, 73, 80
      - Directory Selection, 152
      - Directory Selection, operation, 73, 75
      - Entry Buffer Recall, operation, 71, 73
      - File Selection, operation, 73-74
      - Trace Specification Selection, operation, 202
    - dialog box, trace options, 232
    - directory context
      - changing in configuration window, 101
      - changing in emulator/analyzer window, 152
      - displaying from configuration window, 101
      - displaying from emulator/analyzer window, 152
    - Directory Selection dialog box operation, 73, 75
    - display area, 25
      - columns, 325
      - copying to a file, 188
      - lines, 325-326
    - display command, 358-359
      - configuration info, 360-362
      - data, 363-365
      - error\_log, 358
      - event\_log, 358
      - global\_symbols, 366
      - local\_symbols\_in, 367
      - memory, 368-371
      - memory mnemonic, 33, 173
      - pod\_command, 359

- 
- registers, 170, 372
  - simulated\_io, 190, 192, 373
  - software\_breakpoints, 374
  - status, 359
  - symbols, 143
  - trace, 197-200, 375-378
  - display mode, 535
  - display software\_breakpoints command, 168-169
  - display trace, 231
    - positioning, 203
  - display trace absolute command, 240-241
  - display trace absolute status binary command, 240-241
  - display trace absolute status hex command, 240-241
  - display trace absolute status mnemonic command, 240-241
  - display trace command, 234, 253-254
  - display trace count absolute command, 245-246
  - display trace count command, 245-246
  - display trace count relative command, 245-246
  - display trace depth command, 248
  - display trace dequeue off command, 238-239
  - display trace dequeue on command, 238-239
  - display trace
    - disassemble\_from\_line\_number command, 235-236
      - align\_data\_from\_line option, 238-239
      - options, 237
    - display trace mnemonic command, 235-236
    - display trace offset\_by command, 247
  - displays, copying, 351
  - don't care digits, 205
  - downloading absolute files, 5, 140
  - dual-port emulation memory, 106
  - duration measurements (SPMT), 275
    - average time, 280
    - confidence level, 281
    - error tolerance, 281
    - interpreting reports, 280-284
    - maximum time, 280
    - minimum time, 280
  - number of intervals, 280
  - recursion considerations, 275
  - selecting, 278-279
  - standard deviation, 281
  - trace command setup, 276-277
- E**
- editing
    - command line entry area with popup menu, 79
    - command line entry area with pushbuttons, 79
    - file, 185-187, 325
    - file at address, 185, 325
    - file at program counter, 185
    - file at symbol from symbols screen, 185
    - file from memory display screen, 185
  - 8-bit memory, substituting emulation memory for, 110
  - embedded microprocessor system, 535
  - emul700, command to start the emulator/analyzer interface, 55
  - emulation bus analyzer, 535
  - emulation memory
    - 8-bit, substituting for, 110
    - block size, 109
    - dual-port, 106
    - loading absolute files, 140
  - emulation monitor, 535
  - emulation session, exiting, 62
  - emulation, external analyzer mode, 297
  - emulator, 536
    - configuring the, 94
    - device table file, 32, 55-56
    - general description, 4
    - limitations, DMA support, 109
    - multiple start/stop, 5, 311
    - plugging into a target system, 51
    - running from target reset, 155
    - status lines, predefined values for, 208
    - using the, 134
  - emulator configuration
    - break processor on write to ROM, 120
    - clock selection, 105
    - exiting the configuration interface, 103
    - load command, 387
    - loading from file, 103
    - modify command, 391
    - modifying a configuration section, 98
    - restrict to real-time runs, 105-106
    - starting the configuration interface, 96-97
    - storing, 100
    - trace background/foreground operation, 121
    - emulator status, displaying, 189
  - emulator/analyzer interface
    - exiting, 48, 61
    - running in multiple windows, 55
    - starting, 55-56
  - end command, 48, 62, 379
  - entry
    - pod commands, 90-91
    - simulated io, 191
  - entry buffer, 25
    - address copy-and-paste to, 69
    - clearing, 68
    - copy-and-paste from, 72
    - copy-and-paste to, 68-70
    - Entry Buffer Recall dialog box, 25
    - Entry Buffer Recall dialog box, operation, 71
      - multi-window copy-and-paste from, 72
      - operation, 71
      - recall button, 25
      - recalling entries, 71
      - symbol width and copy-and-paste to, 69
      - text entry, 68
      - with action keys, 71-72
      - with pulldown menus, 71
  - Entry Buffer Recall dialog box operation, 73
  - environment variables (UNIX)
    - HP64KPATH, 88
    - HP64KSYMBPATH, 429
    - PATH, 55
    - Softkey Interface, setting while in, 183
  - eram, memory characterization, 111
  - erom, memory characterization, 111
  - error log
    - copy command, 351
    - display command, 358
    - to file, 189
  - event log, 59
    - copy command, 351
    - display command, 358
-

- 
- to file, 189
  - event\_log, 59
  - EXECUTE
    - CMB signal, 306
    - tracing at, 311
  - execution breakpoints
    - disabling, 163
    - displaying and seeing their status, 168-169
    - enabling, 162
    - setting (temporary breakpoints), 165
  - exit, emulator/analyzer interface, 48, 61
  - exiting
    - emulation session, 62
    - emulator/analyzer windows, 61
  - expressions, 204
    - EXPR-- syntax, 380-382
  - external analyzer
    - configuration, 294
    - general description, 4
    - labels, 296, 301
    - mode, 297
    - should emulation control?, 296
    - using, 290
- F**
- file
    - breakpoints, copying to, 188
    - configuration info, copying to, 188
    - data values, copying to, 188
    - display area to, 188
    - editing, 185-187
    - editing at address, 185
    - editing at program counter, 185
    - editing at symbol from symbols screen, 185
    - editing from memory display screen, 185
    - emulator configuration, 100
    - emulator configuration load, 103
    - emulator status, copying to, 189
    - error log to, 189
    - event log to, 189
    - global symbols to, 189
    - local symbols to, 189
    - memory to, 188
    - pod commands, copying to, 189
    - registers to, 188
  - trace listing to, 188
  - file extensions
    - .EA configuration files, 100
  - file formats
    - address ranges for SPMT measurements, 262
    - time ranges for SPMT measurements, 278
  - File Selection dialog box operation, 73-74
  - firmware updates, 5
  - firmware version, 532
  - foreground, 536
  - foreground operation, tracing, 121
  - formal parameters (command files), 86
  - forward command, syntax, 384
  - function codes
    - mapping memory, 117-119
    - memory mapping, 117
    - need for separately linked modules, 117
  - functions, step over, 173
- G**
- global restart qualifier, 536
  - global symbols, 33, 205, 366
    - copy command, 351
    - display command, 144, 366
    - initializing the SPMT measurement with, 262
    - to file, 189
  - grabbers, connecting to analyzer probe, 292
  - guarded memory accesses, 111, 118
- H**
- halfbright, 78-79
  - hand pointer, 25, 68
  - hardware
    - HP 9000 memory needs, 510
    - HP 9000 minimum performance, 510
    - HP 9000 minimums overview, 510
    - SPARCsystem memory needs, 511
    - SPARCsystem minimum performance, 511
    - SPARCsystem minimums overview, 511
  - help
    - command line, 81
    - copy command, 351
    - help index, 76
    - on-line, 84-87
    - softkey driven information, 84-87
    - help command, 385-386
    - help index, displaying, 76
    - hexadecimal numbers, 204
    - high level interface
      - using pod commands within, 219-222
    - HP 64700 Operating Environment, minimum version, 511
    - HP 9000
      - 700 series Motif libraries, 510
      - HP-UX minimum version, 510
      - installing software, 513
      - minimum system requirements overview, 510
    - HP 98659 RS-422 Interface Card, 5
    - HP-UX, minimum version, 510
    - HP64KPATH, UNIX environment variable, 88
    - HP64KSYMBPATH environment variable, 429
- I**
- IEEE-695 absolute file format, 140
  - input
    - pod commands, 90-91
    - simulated io, 191
  - input scheme, 324, 498
  - installation, 510
    - HP 9000 software, 513
    - SPARCsystem software, 518
  - instance name, X applications, 493-494
  - interactive measurements, 313
  - interface, emulator configuration
    - exiting, 103
    - modifying a section, 98
    - starting, 96-97
  - interface, exiting, 62
  - inverse video
    - graphical interface demo/tutorial files, 333
- K**
- keyboard
    - accelerators, 67
-

- 
- choosing menu items, 66-67
  - focus policy, 67
  - pod commands, 90-91
  - simulated io, 191
  - keyboard\_to\_simio, modify command, 392
- L**
- label scheme, 324, 328, 498
  - labels
    - configuration file, 301
  - LANG environment variable, 498
  - LD\_LIBRARY\_PATH environment variable, 520
  - libraries, Motif for HP 9000/700, 510
  - line numbers (source file), symbol display, 145
  - lines in main display area, 325-326
  - list, trace, 197-200
  - load command, 387-388
    - absolute files, 140
    - configuration, 387
    - trace, 388
    - trace\_spec, 388
  - load trace command, 253-254
  - load trace\_spec command, 250, 252
  - local symbols, 205, 367
    - copy command, 353
    - display command, 145-148, 367
    - initializing the performance measurement with, 263
    - to file, 189
  - locked, end command option, 62
  - log\_commands command, 389
- M**
- map command, 118
  - mapping memory, 109
  - maximum trace depth, 214-215
  - memory, 354-355
    - activity measurements (SPMT), 257, 265
    - characterization of, 111
    - contents listed as asterisk (\*), 354
    - copy command, 354-355
    - display command, 368-371
    - displaying, 172
    - displaying at an address, 176
    - displaying repetitively, 177
    - dual-port emulation, 106
    - loading programs into, 140
    - mapping, 109
    - mnemonic format display, 173
    - modify command, 393-395
    - modifying, 177
    - re-assignment of emulation memory blocks in mapper, 116
    - store command, 426
    - to file, 188
  - memory mapper, resolution, 109
  - memory mapping
    - block size, 109
    - function code specification, 117-119
    - overlaid addresses, 117
    - using emulation memory in place of target, 118
  - memory recommendations
    - HP 9000, 510
    - SPARCsystem, 511
  - menu, popup menu in trace list, 233
  - menus
    - editing command line with popup, 79
    - hand pointer means popup, 25, 68
    - pull-down operation with keyboard, 66-67
    - pull-down operation with mouse, 65-66
  - mixed, slave clock mode, 298
  - mixing pod commands with high level commands, 219-222
  - mnemonic memory display, 33, 173
    - setting the source/symbol modes, 180
  - modes, source/symbol, 180
  - modify command, 390
    - configuration, 391
    - keyboard\_to\_simio, 392
    - memory, 393-395
    - register, 171, 396
    - SIM registers, 397-398
  - modify software\_breakpoints clear command, 166-167
  - modify software\_breakpoints disable command, 163
  - modify software\_breakpoints enable command, 162
  - modify software\_breakpoints set command, 162-163, 165
  - modify\_command, trace command option, 202
  - module duration measurements (SPMT), 275
  - module usage measurements (SPMT), 275
  - Motif, HP 9000/700 requirements, 510
  - mouse
    - buttons, 27
    - choosing menu items, 65-66
  - multi-window
    - copy-and-paste from entry buffer, 72
  - multiple commands, 82
  - multiple emulator start/stop, 5
- N**
- name\_of\_module command, 183
  - nesting command files, 85
  - NORMAL key, 345, 380
  - nosymbols, 143
  - notes
    - "perf.out" file is in binary format, 286
    - CMB EXECUTE and TRIGGER signals, 306
    - external timing analyzer does not use configuration labels, 301
    - measurement errors on recursive/multiple entry routines, 276
    - only one range resource available, 407
    - re-assignment of emulation memory blocks by mapper, 116
    - some compilers emit more than one symbol for an address, 266
    - step command doesn't work when CMB enabled, 311
    - trigger found but trace memory not filled, 199
  - number bases, 204
  - numerical values, 204
- O**
- occurrence counts, 213, 224
  - octal numbers, 204
  - offset addresses in trace list, 247
  - online help, 84-87
  - operating system
    - HP 64700 Series minimum version, 511
    - HP-UX minimum version, 510
-

- 
- SunOS minimum version, 511
  - operators, 205
  - overlaid addresses, memory mapping, 117
- P**
- parameter passing in command files, 86
  - parent symbol, displaying from symbols screen, 149
  - paste mouse button, 27
  - PATH, UNIX environment variable, 55
  - perf.out, SPMT output file, 263, 279, 285-287, 399
  - perf32, SPMT report generator utility, 256, 285-286
    - interpreting reports, 265-274, 280-284
    - options, 287
    - using the, 287-288
  - performance measurements
    - See software performance
  - measurements
  - performance\_measurement\_end command, 399
  - performance\_measurement\_initialize command, 400-401
  - performance\_measurement\_run command, 402
  - permanent software breakpoints
    - how to set, 164
  - platform
    - HP 9000 memory needs, 510
    - HP 9000 minimum performance, 510
    - SPARCsystem memory needs, 511
    - SPARCsystem minimum performance, 511
  - platform scheme, 324, 497
  - plug-in, 51
  - pod commands, 403-404
    - copy command, 351
    - copying to a file, 189
    - display command, 359
    - display screen, 90
    - keyboard input, 90-91
  - pod commands used in high level interface, 219-222
  - popup menu in trace list, 233
  - popup menus
    - command line editing with, 79
    - hand pointer indicates presence, 25, 68
  - positioning the trace display, 203
  - power failure during firmware update, 533
  - prestore qualifier, 217-218
  - prestore qualifiers, 536
  - primary branches (analyzer sequencer), 536
  - processor type, 56
  - proglash example, 530
  - program activity measurements (SPMT), 257, 265
  - program counter
    - mnemonic memory display, 34
    - running from, 154
  - pulldown menus
    - choosing with keyboard, 66-67
    - choosing with mouse, 65-66
  - pushbutton select mouse button, 27
- Q**
- QUALIFIER, in trace command, 405-406
  - qualifiers, 208
    - simple trigger, 209-210
    - slave clock, 298-300
- R**
- RAM, mapping emulation or target, 111
  - range resource, note on, 407
  - RANGE, in trace command, 407-408
  - READY, CMB signal, 305
  - real-time runs, 536
    - commands not allowed during, 106
    - restricting the emulator to, 105-106
  - recall buffer, 25
  - columns, 331
  - initial content, 331
  - lines, 331
  - recalling entries, 71
  - recall, command, 83
    - dialog box, 80
  - recall, trace specifications dialog box, 202
  - recursion in SPMT measurements, 275
  - registers
    - copy command, 356
    - display command, 372
    - display/modify, 170
    - displaying, 39, 170
    - modify, 171
    - modify command, 396
  - SIM, 397
    - to file, 188
  - release\_system, end command option, 48, 62, 100
  - repeat the previous trace command, 202
  - repetitive display of memory, 177
  - reset (emulator), commands which cause exit from, 159
  - reset command, 409
  - reset trace display defaults, 248
  - reset, run from target, 155
  - resolution, memory mapper, 109
  - resource
    - See X resource
  - RESOURCE\_MANAGER property, 496
  - restart term, 224-227
  - restrict to real-time runs
    - emulator configuration, 105-106
    - permissible commands, 105
    - target system dependency, 105
- ROM**
- mapping emulation or target, 111
  - writes to, 111
- RS-422, host computer interface card, 5
- run command, 154, 410-411
- run from reset, 155
- S**
- scheme files (for X resources), 323, 497
    - color scheme, 324, 328, 498
    - custom, 328-329, 499
    - input scheme, 324, 498
    - label scheme, 324, 328, 498
    - platform scheme, 324, 497
    - size scheme, 324, 498
  - scroll bar, 25
  - secondary branch expression, 536
  - select mouse button, 27
  - sequencer (analyzer), 536
    - branch, 537
    - terms, 224, 536
    - using the, 223
  - sequencing and windowing specification, 230, 232-233
  - SEQUENCING, in trace command, 412-413
  - server, X, 322, 496
-



- 
- set command, 414-418
  - set default command, 248
  - set source off command, 243
  - set source on command, 243
  - set source only command, 243
  - set symbols all command, 242
  - set symbols high command, 242
  - set symbols low command, 242
  - set symbols off command, 242
  - set symbols on command, 242
  - set width label command, 244
  - set width mnemonic command, 244
  - set width source command, 244
  - shell variables, 87
  - sig INT, 285
  - signals, CMB, 305
  - SIM registers, 397
  - simulated I/O, 94, 392
    - display command, 373
    - displaying screen, 190, 192
    - keyboard input, 191
  - size scheme, 324, 498
  - slave clocks, 298-300
  - softkey driven help information, 84-87
  - softkey pushbuttons, 26
  - softkeys, 82
  - software
    - installation for HP 9000, 513
    - installation for SPARCsystems, 518
  - software breakpoints
    - clearing all breakpoints, 168
  - software breakpoints
    - clearing, 166-167
    - copy command, 352
    - display command, 374
  - software performance measurements, 255, 258-274, 276-284, 286-288
    - absolute information, 265
    - activity measurements, 257
    - adding traces, 263, 279
    - duration, 275
    - end, 399
    - ending, 286
    - how they are made, 256
    - initialize, 400-401
    - initializing, 261-264, 278-279
    - initializing, default, 261
      - initializing, duration measurements, 278-279
      - initializing, user defined ranges, 261, 278
        - initializing, with global symbols, 262
        - initializing, with local symbols, 263
        - memory activity, 257, 265
        - module duration, 275
        - module usage, 275
        - program activity, 257, 265
        - recursion, 275
        - relative information, 265
        - restoring the current measurement, 263, 279
        - run, 402
        - running, 285
        - trace command setup, 260
        - trace display depth, 260
  - source lines
    - display in trace list, 243
    - set command, 417
    - symbol display, 145
  - source/symbol modes, setting, 180
  - SPARCsystems
    - installing software, 518
    - minimum system requirements overview, 511
    - SunOS minimum version, 511
  - specify command, 419-420
  - specify trace disassembly options, 237
  - SPMT (Software Performance Measurement Tool)
    - See software performance
  - measurements
    - sq adv, captured sequence state, 225
  - SRU (Symbolic Retrieval Utilities), 429-430
  - state, external analyzer mode, 297
  - STATE, in trace command, 421-422
  - states
    - change the number available for display, 248
  - static discharge, protecting the emulator probe against, 52
  - status
    - copy command, 352
    - display command, 359
    - status (analyzer state qualifier softkey), 208, 408, 422
      - predefined values for, 208
    - status line, 25, 59
    - status range command, 212
    - status values, 211
    - status, emulator
      - copying to a file, 189
    - step command, 35, 157-158, 423-424
    - step over, 173
    - stop\_trace command, 197, 425
    - storage qualifier, 216
    - store command, 426-427
      - absolute files, 140, 142
    - store trace command, 251
    - store trace\_spec command, 250, 252
    - summary of commands, 346
    - SunOS, minimum version, 511
    - switching
      - directory context in configuration
    - window, 101
      - directory context in emulator/analyzer
    - window, 152
      - symbol context, 153
    - SYMB-- syntax, 428-434
      - symbol context
        - changing, 153
        - displaying, 152
      - symbol file, loading, 143
    - symbols, 143, 205
      - displaying, 143
      - displaying in trace list, 242
      - displaying parent from symbols screen, 149
        - global to file, 189
        - local to file, 189
        - set command, 417
        - SYMB-- syntax, 428-434
    - sync\_sim\_registers command, 435
    - synchronous measurements, 311
    - syntax conventions, 345
    - system requirements
      - HP 64700 minimum version, 511
      - HP 9000 overview, 510
      - HP-UX minimum version, 510
      - OSF/Motif HP 9000/700 requirements, 510
-

SPARCsystem overview, 511  
SunOS minimum version, 511

**T**

- target memory
  - loading absolute files, 140
  - ROM, symbols for, 143
- target reset, running from, 155
- target system, 537
  - dependency on executing code, 105
  - plugging the emulator into, 51
  - RAM and ROM, 111
- temporary software breakpoints
  - setting, 165
- terminal emulation window, opening, 189
- terminal interface
  - commands used in high level interface, 219-222
- threshold voltages, 296
- time range file format (SPMT measurements), 278
- timing
  - external analyzer mode, 297
- trace, 537
  - at EXECUTE, 311
  - continuous stream of execution, 219-222
  - copy command, 357
  - count states, 214-215
  - count time, 214-215
  - display command, 375-378
  - displaying count information, 245-246
  - displaying the, 197-200
  - displaying without disassembly, 240-241
  - listing the, 197-200
  - listing to file, 188
  - load command, 388
  - loading data, 253-254
  - loading specifications, 252
  - on program halt, 219
  - recalling trace specifications, 202
  - repeat the previous command, 202
  - reset display defaults, 248
  - restoring data, 250
  - restoring specifications, 250
  - saving data, 250
  - saving specifications, 250
  - starting, 196
  - stopping, 197
  - store command, 427
  - storing data, 251
  - Trace Specification Selection dialog box, 202
  - trigger position, 209-210
  - trace again command, 202, 252
  - trace command, 196, 436-438
    - setting up for SPMT measurements, 260
  - trace counting anystate command, 214-215
  - trace counting command, 214-215
  - trace counting off command, 214-215, 245-246
  - trace counting time command, 214-215
  - trace depth
    - how to change, 201
  - trace disassembly
    - specifying options, 237
  - trace display, 231
    - depth, SPMT measurements, 260
    - positioning, 203
    - source/symbol modes, 180
  - trace expression
    - range, 212
  - trace expressions
    - address values, 211
    - data values, 211
    - status values, 211
  - trace list
    - disassembly, 235-236
    - display around specific line number, 234
    - display source lines, 243
    - move through, 235
    - offset addresses, 247
    - popup menu, 233
  - trace on\_halt command, 219
  - trace only command, 216
  - trace options dialog box, 232
  - trace prestore anything command, 217-218
  - trace prestore command, 217-218
  - trace signals (emulation analyzer), 206
  - trace\_spec
    - load command, 388
  - store command, 427
  - tracing background operation, 121
  - tram, memory characterization, 111
  - transfer address, 155
  - trigger, 537
    - condition, 209-210
    - position, 209-210
    - position, accuracy of, 209
    - specifying a simple, 209-210
    - stop driving on break, 317
  - TRIGGER, CMB signal, 305
  - TRIGGER, in trace command, 439-440
  - trom, memory characterization, 111
  - TTL (softkey for specifying threshold voltages), 297
  - tutorials, setting up, 332-334
- U**
  - uploading memory, 5
  - user (target) memory, loading absolute files, 140
  - user program, 536
- V**
  - values, 204
    - predefined for analyzer state qualifiers, 208
  - version, firmware, 532
  - voltages, threshold, 296
- W**
  - wait command, 441-442
    - command files, using in, 85
  - widget resource
    - See X resource
  - WINDOW, in trace command, 443-444
  - windowing and sequencing specification, 230, 232-233
  - windows
    - exiting emulator/analyzer, 61
    - opening additional emulator/analyzer, 59
    - running the emulator/analyzer interface in multiple, 55
    - terminal emulation, opening, 189

---

workstation  
  HP 9000 memory needs, 510  
  HP 9000 minimum performance, 510  
  SPARCsystem memory needs, 511  
  SPARCsystem minimum performance,  
511  
write to ROM break, 120

**X**

X client, 322  
X resource, 322  
  \$XAPPLRESDIR directory, 496  
  \$XENVIRONMENT variable, 497  
  .Xdefaults file, 496  
  /usr/hp64000/lib/X11/HP64\_schemes,  
499  
  app-defaults file, 496  
  class name for applications, 494  
  class name for widgets, 494  
  command line options, 497  
  commonly modified graphical interface  
resources, 324  
  defined, 493  
  general form, 493  
  instance name for applications, 494  
  instance name for widgets, 493  
  loading order, 496  
  modifying resources, generally, 324-327  
  RESOURCE\_MANAGER property, 496  
  scheme file system directory, 499  
  scheme files, Graphical User Interface,  
497  
  scheme files, named, 498  
  schemes, forcing interface to use certain,  
497  
  Softkey.BW, 498  
  Softkey.Color, 498  
  Softkey.Input, 498  
  Softkey.Label, 498  
  Softkey.Large, 498  
  Softkey.Small, 498  
  wildcard character, 494  
  xrd, 496  
  xrm command line option, 497  
X server, 322, 496  
X Window System, 55  
xbits, external analyzer label, 301



---

# Safety

---

## Summary of Safe Procedures

The following general safety precautions must be observed during all phases of operation, service, and repair of this instrument. Failure to comply with these precautions or with specific warnings elsewhere in this manual violates safety standards of design, manufacture, and intended use of the instrument.

Hewlett-Packard Company assumes no liability for the customer's failure to comply with these requirements.

### Ground The Instrument

To minimize shock hazard, the instrument chassis and cabinet must be connected to an electrical ground. The instrument is equipped with a three-conductor ac power cable. The power cable must either be plugged into an approved three-contact electrical outlet or used with a three-contact to two-contact adapter with the grounding wire (green) firmly connected to an electrical ground (safety ground) at the power outlet. The power jack and mating plug of the power cable meet International Electrotechnical Commission (IEC) safety standards.

### Do Not Operate In An Explosive Atmosphere

Do not operate the instrument in the presence of flammable gases or fumes. Operation of any electrical instrument in such an environment constitutes a definite safety hazard.

### Keep Away From Live Circuits

Operating personnel must not remove instrument covers. Component replacement and internal adjustments must be made by qualified maintenance personnel. Do not replace components with the power cable connected. Under certain conditions, dangerous voltages may exist even with the power cable removed. To avoid injuries, always disconnect power and discharge circuits before touching them.

## **Do Not Service Or Adjust Alone**

Do not attempt internal service or adjustment unless another person, capable of rendering first aid and resuscitation, is present.

## **Do Not Substitute Parts Or Modify Instrument**

Because of the danger of introducing additional hazards, do not install substitute parts or perform any unauthorized modification of the instrument. Return the instrument to a Hewlett-Packard Sales and Service Office for service and repair to ensure that safety features are maintained.

## **Dangerous Procedure Warnings**

Warnings, such as the example below, precede potentially dangerous procedures throughout this manual. Instructions contained in the warnings must be followed.

---

**WARNING**

---

Dangerous voltages, capable of causing death, are present in this instrument. Use extreme caution when handling, testing, and adjusting.

## Safety Symbols Used In Manuals

The following is a list of general definitions of safety symbols used on equipment or in manuals:



Instruction manual symbol: the product is marked with this symbol when it is necessary for the user to refer to the instruction manual in order to protect against damage to the instrument.



Indicates dangerous voltage (terminals fed from the interior by voltage exceeding 1000 volts must be marked with this symbol).

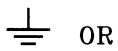

OR



Protective conductor terminal. For protection against electrical shock in case of a fault. Used with field wiring terminals to indicate the terminal which must be connected to ground before operating the equipment.



Low-noise or noiseless, clean ground (earth) terminal. Used for a signal common, as well as providing protection against electrical shock in case of a fault. A terminal marked with this symbol must be connected to ground in the manner described in the installation (operating) manual before operating the equipment.

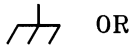

OR



Frame or chassis terminal. A connection to the frame (chassis) of the equipment which normally includes all exposed metal structures.



Alternating current (power line).



Direct current (power line).



Alternating or direct current (power line).

---

**Caution**

---

The Caution sign denotes a hazard. It calls your attention to an operating procedure, practice, condition, or similar situation, which, if not correctly performed or adhered to, could result in damage to or destruction of part or all of the product.

---

**Warning**

---

The Warning sign denotes a hazard. It calls your attention to a procedure, practice, condition or the like, which, if not correctly performed, could result in injury or death to personnel.



## **Certification and Warranty**

### **Certification**

Hewlett-Packard Company certifies that this product met its published specifications at the time of shipment from the factory. Hewlett-Packard further certifies that its calibration measurements are traceable to the United States National Bureau of Standards, to the extent allowed by the Bureau's calibration facility, and to the calibration facilities of other International Standards Organization members.

### **Warranty**

This Hewlett-Packard system product is warranted against defects in materials and workmanship for a period of 90 days from date of installation. During the warranty period, HP will, at its option, either repair or replace products which prove to be defective.

Warranty service of this product will be performed at Buyer's facility at no charge within HP service travel areas. Outside HP service travel areas, warranty service will be performed at Buyer's facility only upon HP's prior agreement and Buyer shall pay HP's round trip travel expenses. In all other cases, products must be returned to a service facility designated by HP.

For products returned to HP for warranty service, Buyer shall prepay shipping charges to HP and HP shall pay shipping charges to return the product to Buyer. However, Buyer shall pay all shipping charges, duties, and taxes for products returned to HP from another country. HP warrants that its software and firmware designated by HP for use with an instrument will execute its programming instructions when properly installed on that instrument. HP does not

warrant that the operation of the instrument, or software, or firmware will be uninterrupted or error free.

### **Limitation of Warranty**

The foregoing warranty shall not apply to defects resulting from improper or inadequate maintenance by Buyer, Buyer-supplied software or interfacing, unauthorized modification or misuse, operation outside of the environment specifications for the product, or improper site preparation or maintenance.

No other warranty is expressed or implied. HP specifically disclaims the implied warranties of merchantability and fitness for a particular purpose.

### **Exclusive Remedies**

The remedies provided herein are buyer's sole and exclusive remedies. HP shall not be liable for any direct, indirect, special, incidental, or consequential damages, whether based on contract, tort, or any other legal theory.

Product maintenance agreements and other customer assistance agreements are available for Hewlett-Packard products.

For any assistance, contact your nearest Hewlett-Packard Sales and Service Office.