

---

**User's Guide for the Graphical User Interface**

---

**MC68020/030/EC020/EC030  
Emulators/Analyzer,  
(HP 64748 and HP 64747)**

---

## Notice

**Hewlett-Packard makes no warranty of any kind with regard to this material, including, but not limited to, the implied warranties of merchantability and fitness for a particular purpose.** Hewlett-Packard shall not be liable for errors contained herein or for incidental or consequential damages in connection with the furnishing, performance, or use of this material.

Hewlett-Packard assumes no responsibility for the use or reliability of its software on equipment that is not furnished by Hewlett-Packard.

© Copyright 1991, 1992, 1993, 1994, Hewlett-Packard Company.

This document contains proprietary information, which is protected by copyright. All rights are reserved. No part of this document may be photocopied, reproduced or translated to another language without the prior written consent of Hewlett-Packard Company. The information contained in this document is subject to change without notice.

HP is a trademark of Hewlett-Packard Company.

OSF/Motif and Motif are trademarks of the Open Software Foundation in the U.S. and other countries

UNIX (R) is a registered trademark of UNIX System Laboratories Inc. in the U.S.A. and other countries.

**Hewlett-Packard Company**  
**P.O. Box 2197**  
**1900 Garden of the Gods Road**  
**Colorado Springs, CO 80901-2197, U.S.A.**

**RESTRICTED RIGHTS LEGEND.** Use, duplication, or disclosure by the U.S. Government is subject to restrictions set forth in subparagraph (c) (1) (ii) of the Rights in Technical Data and Computer Software Clause at DFARS 252.227-7013. Hewlett-Packard Company, 3000 Hanover Street, Palo Alto, CA 94304 U.S.A. Rights for non-DOD U.S. Government Departments and Agencies are as set forth in FAR 52.227-19(c)(1,2).

---

## Printing History

New editions are complete revisions of the manual. The date on the title page changes only when a new edition is published.

A software code may be printed before the date; this indicates the version level of the software product at the time the manual was issued. Many product updates and fixes do not require manual changes, and manual corrections may be done without accompanying product changes. Therefore, do not expect a one-to-one correspondence between product updates and manual revisions.

|                  |                                |
|------------------|--------------------------------|
| Edition 1        | 64748-97001, April 1991        |
| Edition 2        | 64748-97005, July 1991         |
| Edition 3        | 64748-97007, March 1992        |
| Edition 4        | 64748-97010, August 1992       |
| Edition 5        | 64748-97013, December 1993     |
| <b>Edition 6</b> | <b>64748-97016, March 1994</b> |

---

## Safety, and Certification and Warranty

Safety and certification and warranty information can be found at the end of this manual on the pages before the back cover.

# The HP 64747 and HP 64748 Emulators

HP 64700  
Card Cage

HP 64748/7  
68020/030/EC020/EC030 Emulator

```

Trace List      Offset=0
Label:  Address  Data      Opcode or Status      time count
Base:   symbols  hex
-----
start:  Pridemo+0000000 050019FE  BTST  B0,D0
+001   Pridemo,Loop  103919FE  MOVE,B  Dldemo,Cmd_Input,D0  160  n5
+002   Dldemo,Cmd_Input 00000000  #00--  supr data byte wr  120  n5
+003   Pridemo+00000010 00000000  #0000  supr prgm long rd  120  n5
+004   Pridemo+00000012 05000000  #0500  supr prgm word rd  240  n5
+005   Pridemo+00000014 66000000  BNE,W  Pridemo,Call_Int  120  n5
+006   Pridemo+00000016 00060000  #0006  supr prgm word rd  120  n5
+007   Dldemo,Cmd_Input 00060000  #00--  supr data byte rd  120  n5
+008   Pridemo+00000018 60000000  BRA,W  Pridemo,EndLoop  120  n5
+009   Pridemo+0000001A 000E0000  #000E  supr prgm word rd  200  n5
+010   Pridemo,Call_Int 61000000  BSR,W  ProgInt_Cmd  120  n5
+011   Pridemo+0000001E 000C0000  #000C  supr prgm word rd  160  n5
+012   Pridemo,EndLoop 60E40000  BRA,B  Pridemo,Loop  120  n5
+013   ProgInt_Cmd 0C000000  CMPI,B  #41,D0  160  n5
+014   handle_r+00000002 00410000  #0041  supr prgm long rd  120  n5

STATUS: M68020--Running user program Emulation trace complete.....R....
set symbols on

pod_cmd _set _perfinit perfrun_ _perferd_ _---ETC--
    
```

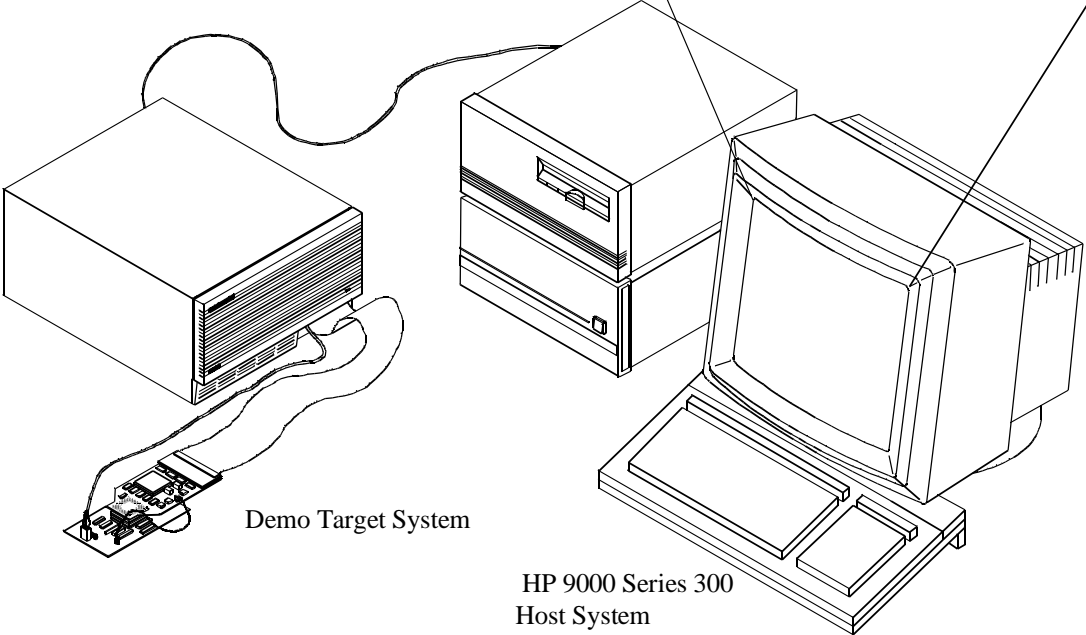

Demo Target System

HP 9000 Series 300  
Host System

## Description

The HP 64747A emulator supports the Motorola 68EC030 up to 40 MHz. The HP 64747B emulator, when used with the HP 64748C Emulation Control Card, supports the Motorola 68030. The HP 64748A/64748D emulator supports the Motorola 68020 and 68EC020 microprocessors up to 33 MHz. The only difference between the HP 64748A and HP 64748D is that the HP 64748D can accept installation of 4-Mbyte SIMMs in its probe sockets and the HP 64748A cannot.

| <b>Emulator</b>      | <b>Control Card 64748B</b> | <b>Control Card 64748C</b> |
|----------------------|----------------------------|----------------------------|
| 64748 (68020/EC020)  | Complete support.          | Complete support.          |
| 64747A (68EC030)     | Complete support.          | Complete support.          |
| 64747B (68030/EC030) | Only 68EC030 support.      | Complete support.          |

The emulators plug in to the HP 64700 instrumentation card cage and offer 80 channels of processor bus analysis with the HP 64794 or 64704A emulation-bus analyzer. Flexible memory configurations are offered from zero through two megabytes of emulation memory. High performance download is achieved through the LAN or RS-422 interface. An RS-232 port and a firmware-resident interface allows debugging of a target system at a remote location.

For software development, the HP AxCASE environment is available on SUN SPARC systems and HP workstations. This environment includes an ANSI standard C compiler, assembler/linker, a debugger that uses either a software simulator or the emulator for instruction execution, the HP Software Performance Analyzer that allows you to optimize your product software, and the HP Branch Validator for test suite verification.

If your software development platform is a personal computer, support is available from several third party vendors. This is provided through the HP 64700's ability to consume several industry standard output file formats.

Ada language support is provided on HP 9000 workstations by third party vendors such as Alsys and Verdix. An Ada application developer can use the HP emulator and any compiler that generates HP/MRI IEEE-695 to do exhaustive real-time debugging in-circuit or out-of-circuit.

## Features

### HP 64748A/64748D

- 33 MHz active probe emulator
- Support for MC68020 and MC68EC020 (probe adapter required for MC68EC020)

### HP 64747A

- 40 MHz active probe emulator
- Supports MC68EC030
- Supports burst and synchronous bus modes

### HP 64747B

- 40 MHz active probe emulator
- Supports MC68EC030 and MC68030
- Supports burst and synchronous bus modes

### Both Emulators

- Symbolic support
- Execution breakpoints
- 36 inch cable and 219 mm (8.8") x 102 mm (4") probe, terminating in PGA package
- Optional adapter for PQFP
- Background and foreground monitors
- Simulated I/O with workstation interfaces
- Consumes IEEE-695, HP-OMF, Motorola S-Records, and Extended Tek Hex File formats directly. (Symbols are available with IEEE-695 and HP-OMF formats.)
- Multiprocessor emulation - synchronous start of 32 emulation sessions - cross triggerable from another emulator, logic analyzer, or oscilloscope
- Coprocessor support - allows display and modification of FPU registers.
- Demo board and self test module included

### **Emulation-bus analyzer**

- 80-channel emulation-bus analyzer
- Post-processed dequeued trace with symbols and source lines (the PC interface trace listing contains source line numbers)
- Eight events each consisting of address, status and data comparators
- Events may be sequenced eight levels deep and can be used for complex trigger qualification and selective store

### **Emulation memory**

- Several memory configurations can be obtained (from 256 Kbyte to 8 Mbyte) by installing optional memory modules on the emulation probe
- 4 Kbytes of dual-port memory available if you use the background monitor (this 4Kbytes allows emulator accesses at full speed without wait states, except during synchronous and burst modes in the MC68030/EC030)
- Mapping resolution is 256 bytes
- HP 64748 (MC68020):
  - No wait states out of dual-ported memory up to 33 MHz
  - No wait states out of target memory
  - No wait states out of emulation memory up to 25 MHz
  - 1 wait state out of emulation memory above 25 MHz
- HP 64747A (MC68EC030), and HP 64747B (MC68030/EC030):
  - No wait states for target system accesses up to 25 MHz
  - Three-cycle asynchronous or synchronous target accesses and two-cycle burst accesses above 25 MHz
  - Dual-port/monitor memory matches target system access speeds
  - Three-cycle asynchronous or synchronous emulation memory accesses and two-cycle burst accesses at all speeds.

---

# In This Book

This manual covers the HP 64748 and HP 64747 emulators. All information in the manual applies to both emulators unless it is marked with the processor name (MC68020, MC68EC020, MC68030, or MC68EC030).

Part 1, "Quick Start Guide," tells you how to start using the emulator.

1. Getting Started
2. Solving Quick Start Problems

Part 2, "User's Guide," describes how to use the Softkey Interface to perform a variety of tasks.

3. Using the Emulator/Analyzer Interface
4. Using the Emulator
5. Using the Emulation-Bus Analyzer
6. Making Coordinated Measurements
7. Making Software Performance Measurements
8. Configuring the Emulator (to be performed before you run a program in emulation)
9. Solving Problems

Part 3, "Reference Guide," provides detailed information on emulator functions, commands and environments.

10. Using MC68030 Memory Management
11. Emulator Commands
12. Emulator Messages
13. Setting X Resources
14. The SPARCsystem Interface
15. Microtec Language Tools used with the Emulator
16. Specifications and Characteristics

Part 4, "Concepts Guide," discusses X Resources and the Graphical User Interface.

Part 5, "Installation and Service Guide," shows you how to install and maintain the emulator.

18. Installation and Service
19. Installing/Updating Emulator Firmware



---

# Contents

---

## Part 1 Quick Start Guide

### 1 Getting Started

The Emulator/Analyzer Interface — At a Glance 4

The Softkey Interface 4

Softkey Interface Conventions 5

The Graphical User Interface 6

Graphical User Interface Conventions 8

The Getting Started Tutorial 11

Step 1: Start the demo 12

Step 2: Display the program in memory 14

Step 3: Run from the transfer address 15

Step 4: Step high-level source lines 16

Step 5: Display the previous mnemonic display 17

Step 6: Run until an address 18

Step 7: Display data values 19

Step 8: Display registers 20

Step 9: Step assembly-level instructions 21

Step 10: Trace the program 22

Step 11: Display memory at an address in a register 24

Step 12: Patch assembly language code 25

Step 13: Exit the emulator/analyzer interface 28

### 2 Solving Quick Start Problems

If the desired emulator interface won't start 30

If the text-based Softkey Interface won't start under X-Windows 30

If you can't load the demo program 30

If you can't display the program 32

---

## Part 2 User's Guide

### 3 Using the emulator/analyzer interface

Maximum Number of Windows 37

Activities that Occur in the Windows 37

Using Multiple Terminals 38

Starting the Emulator/Analyzer Interface 39

To start the emulator/analyzer interface 39

To start the interface using the default configuration 40

To execute a command file at interface startup 41

To see emulator/analyzer status before interface startup 41

To see emulator/analyzer status after the interface has started 42

To unlock an interface that was left locked by another user 43

Opening Other HP 64700 Interface Windows 44

To open additional emulator/analyzer windows 44

To open the high-level debugger interface window 45

To open the software performance analyzer (SPA) interface window 45

Entering Commands 46

To turn the command line on or off in the Graphical User Interface 46

To enter commands on the command line 47

To edit the command line using the command line pushbuttons on the Graphical User Interface 48

To edit the command line using the command line popup menu 49

To edit the command line using the keyboard 50

To recall commands 50

To execute a completed command 51

To get online help on commands 52

To display the error log 53

To display the event log 53

Using Special Features of the Graphical User Interface 54

To choose a pulldown menu item using the mouse (method 1) 54

To choose a pulldown menu item using the mouse (method 2) 55

To choose a pulldown menu item using the keyboard 56

To choose popup menu items 57

To place values into the entry buffer using the keyboard 58

|  |    |
|--|----|
| To copy-and-paste to the entry buffer  | 58 |
| To recall entry buffer values  | 61 |
| To use the entry buffer  | 61 |
| To copy-and-paste from the entry buffer to the command line entry area         | 62 |
| To use the action keys   | 63 |
| To use dialog boxes  | 63 |
| <br>   |    |
| Using display-control features of the Softkey Interface                        | 67 |
| <br>   |    |
| Copying information to a file or printer                                       | 68 |
| <br>   |    |
| Exiting the Emulator/Analyzer Interface  | 70 |
| To end a single window in the interface  | 70 |
| To end the emulation session in all windows                                    | 71 |
| <br>   |    |
| Creating and Executing Command Files   | 72 |
| Passing Parameters to Command Files  | 72 |
| Using &ArG_IeFt in Command Files   | 73 |
| Using UNIX Commands and Scripts with Command Files                             | 73 |
| Using Shell Variables with Command Files                                       | 73 |
| Restrictions on Commands   | 74 |
| Status Line Updates  | 74 |
| Nesting Command Files  | 74 |
| Pausing Command Files  | 74 |
| Placing Comments in Command Files  | 75 |
| Continuing Command File Lines  | 75 |
| Specifying a Search of Several Command File Directories                        | 75 |
| To create a command file by logging commands                                   | 76 |
| To create a command file by using a text editor                                | 77 |
| To execute (or playback) a command file  | 78 |
| To nest command files  | 79 |
| To pause command file execution  | 80 |
| To add a comment to a command file   | 81 |
| To pass parameters to a command file   | 82 |
| To increase flexibility of command files by using &ArG_IeFt                    | 84 |
| To specify the order of searching several command file directories (HP64KPATH) | 85 |

## Contents

|   |     |
|---|-----|
| Forwarding Commands to Other HP 64700 Interfaces            | 87  |
| To forward commands to the high-level debugger              | 87  |
| To forward commands to the software performance analyzer    | 88  |
| Accessing the Terminal Interface                            | 89  |
| To display the Terminal Interface screen                    | 90  |
| To copy the Terminal Interface screen contents to a file    | 90  |
| To enter Terminal Interface commands                        | 91  |
| To get help on Terminal Interface commands                  | 93  |
| Accessing the Operating System                              | 94  |
| To set environment variables                                | 94  |
| To enter UNIX commands                                      | 94  |
| To display the name of the emulation module                 | 96  |
| <b>4 Using the Emulator</b>                                 |     |
| The Emulator And Its Applications                           | 98  |
| The demo Application  | 99  |
| To build programs   | 99  |
| To configure the emulator                                   | 101 |
| Loading and Storing Programs                                | 102 |
| To load a program   | 102 |
| To load the demo program                                    | 104 |
| To store a program  | 105 |
| To edit files   | 106 |
| Using Symbols   | 109 |
| To load a symbol database                                   | 110 |
| To display global symbols                                   | 111 |
| To display local symbols                                    | 112 |
| To display the parent symbol of a symbol                    | 114 |
| To copy and paste a full symbol name to the entry buffer    | 115 |
| To enter a symbol   | 116 |
| To display the current directory and current working symbol | 117 |
| To change the directory context                             | 118 |
| To change the current working symbol context                | 118 |

|  |            |
|--|------------|
| <b>Accessing Processor Memory Resources</b>        | <b>120</b> |
| To display program data structures                 | 120        |
| To display only source lines                       | 122        |
| To display intermixed source lines                 | 123        |
| To display symbols without source lines            | 124        |
| To display absolute addresses                      | 125        |
| To display memory in byte format                   | 126        |
| To display memory in word format                   | 127        |
| To display memory in long word format              | 128        |
| To display memory in mnemonic format               | 129        |
| To return to the previous mnemonic display         | 130        |
| To display memory in real number form              | 131        |
| To redisplay memory locations                      | 132        |
| To display memory repetitively                     | 132        |
| To modify memory                                   | 133        |
| <br>   |            |
| <b>Using Processor Run Controls</b>                | <b>135</b> |
| To run a program                                   | 135        |
| To run programs from the transfer address          | 137        |
| To run programs from reset                         | 137        |
| To run programs until a selected address occurs    | 138        |
| To break to the monitor                            | 139        |
| To step the processor                              | 140        |
| To reset the processor                             | 143        |
| <br>   |            |
| <b>Viewing and Modifying Registers</b>             | <b>144</b> |
| To display registers                               | 144        |
| To modify registers                                | 146        |
| <br>   |            |
| <b>Using Execution Breakpoints</b>                 | <b>148</b> |
| Setting execution breakpoints in RAM               | 148        |
| Using temporary and permanent breakpoints          | 149        |
| To enable execution breakpoints                    | 150        |
| To disable an execution breakpoint                 | 150        |
| To set a permanent breakpoint                      | 151        |
| To set a temporary breakpoint                      | 152        |
| To clear an execution breakpoint                   | 154        |
| To clear all execution breakpoints                 | 156        |
| To display the status of all execution breakpoints | 156        |

## Contents

|  |     |
|--|-----|
| Changing the Interface Settings  | 158 |
| To set the source/symbol modes   | 158 |
| To set the display modes   | 159 |
| Source/Symbols View  | 160 |
| Field Widths   | 160 |
| Auto Update  | 160 |
| Using the Emulator In-Circuit  | 161 |
| To install the emulation probe   | 161 |
| To power-on the emulator and your target system                              | 163 |
| To probe other types of target system sockets                                | 163 |
| Using The MC68030 Emulator With MMU Enabled                                  | 164 |
| To enable the processor memory management unit (MC68030 only)                | 164 |
| To view the present logical-to-physical mappings                             | 165 |
| To see translation details for a single logical address                      | 167 |
| To see details of a translation table used to map a selected logical address | 169 |
| <b>5 Using the Emulation-Bus Analyzer</b>                                    |     |
| Power of the Emulation-Bus Analyzer  | 172 |
| Making Simple Trace Measurements   | 173 |
| To start a trace measurement   | 174 |
| To stop a trace measurement  | 175 |
| To display the trace list  | 175 |
| To display the trace status  | 177 |
| To change the trace depth  | 178 |
| To modify the last trace command entered                                     | 179 |
| To define a simple trigger qualifier   | 180 |
| To specify a trigger and set the trigger position                            | 181 |
| To define a simple storage qualifier   | 182 |
| Displaying the Trace List  | 183 |
| To disassemble the trace list  | 186 |
| To specify trace disassembly options   | 187 |
| To specify trace dequeuing options   | 189 |
| To display the trace without disassembly                                     | 191 |
| To display symbols in the trace list   | 193 |

|   |     |
|---|-----|
| To display source lines in the trace list                                     | 194 |
| To change the column width  | 195 |
| To select the type of count information in the trace list                     | 196 |
| To offset addresses in the trace list   | 198 |
| To reset the trace display defaults   | 199 |
| To move through the trace list  | 199 |
| To display the trace list around a specific line number                       | 200 |
| To change the number of states available for display                          | 201 |
| To display program memory associated with a trace list line                   | 202 |
| To open an edit window into the source file associated with a trace list line | 202 |

### Analyzing Program Execution When the MC68030 MMU is Enabled 203

|  |     |
|--|-----|
| To program the deMMUer in a static memory system     | 203 |
| To store a deMMUer setup file                        | 205 |
| To load the deMMUer from a deMMUer setup file        | 205 |
| To trace program execution in physical address space | 206 |

### Making Complex Trace Measurements 207

|  |     |
|--|-----|
| To use address, data, and status values in trace expressions                         | 212 |
| To enter a range in a trace expression   | 213 |
| To use the sequencer   | 214 |
| To specify a restart term  | 215 |
| To specify trace windowing   | 216 |
| To specify both sequencing and windowing   | 217 |
| To count states or time  | 218 |
| To define a storage qualifier  | 219 |
| To define a prestore qualifier   | 220 |
| To trace activity leading up to a program halt                                       | 221 |
| To modify the trace specification  | 222 |
| To repeat the previous trace command   | 223 |
| To capture a continuous stream of program execution no matter how large your program | 224 |

### Saving and Restoring Trace Data and Specifications 228

|                                |     |
|--------------------------------|-----|
| To store a trace specification | 228 |
| To store trace data            | 229 |
| To load a trace specification  | 230 |
| To load trace data             | 231 |

## Contents

|   |     |
|---|-----|
| Saving and Restoring DeMMUer Setup Files                                | 232 |
| To store a DeMMUer setup file   | 232 |
| To load a DeMMUer setup file  | 232 |
| Using Basis Branch Analysis   | 233 |
| To store BBA data to a file   | 233 |
| <b>6 Making Coordinated Measurements</b>                                |     |
| The Elements of Coordinated Measurements                                | 236 |
| Comparison Between CMB and BNC Triggers                                 | 238 |
| Setting Up for Coordinated Measurements                                 | 239 |
| To connect the Coordinated Measurement Bus (CMB)                        | 239 |
| To connect to the rear panel BNC  | 241 |
| Starting/Stopping Multiple Emulators                                    | 243 |
| To enable synchronous measurements                                      | 243 |
| To start synchronous measurements                                       | 244 |
| To disable synchronous measurements                                     | 244 |
| Using Trigger Signals   | 245 |
| To drive the emulation-bus analyzer trigger signal to the CMB           | 247 |
| To drive the emulation-bus analyzer trigger signal to the BNC connector | 248 |
| To break emulator execution on signal from CMB                          | 249 |
| To break emulator execution on signal from BNC                          | 250 |
| To arm the emulation-bus analyzer on signal from CMB                    | 251 |
| To arm the emulation-bus analyzer on signal from BNC                    | 251 |
| Making Example Measurements   | 252 |
| To start a simultaneous program run on two emulators                    | 252 |
| To trigger one emulation-bus analyzer with another                      | 253 |
| To break to the monitor on an analyzer trigger signal                   | 254 |



## **7 Making Software Performance Measurements**

- Using the Software Performance Measurement Tool 256
- Use the Software Performance Analyzer (SPA) for more capability 256
- Understanding activity measurements 257
- Understanding duration measurements 260
- To use the Software Performance Measurement Tool 261
  - Step 1. Set up the trace command 262
  - Step 2. Initialize the performance measurement 263
  - Step 3. Run the performance measurement 267
  - Step 4. End the performance measurement 268
  - Step 5. Generate the performance measurement report 269

## **8 Configuring the Emulator**

- Configuring the Emulator 276
- Using the Configuration Interface 277
  - To start the configuration interface 278
  - To modify a configuration section 280
  - To apply configuration changes to the emulator 282
  - To store configuration changes to a file 283
  - To change the configuration directory context 284
  - To display the configuration context 284
  - To access help topics 285
  - To access help for a configuration item in a dialog box 285
  - To exit the configuration interface 286
  - To load an existing configuration file 286
- Emulation Configuration Displays 287
- Mapping Memory 293

Providing MMU Address Translation for the MC68030 Foreground Monitor 296

Locating the Foreground Monitor using the MMU Address Translation Tables 298

**9 Solving Problems**

- If the emulator appears to be malfunctioning 301
- If the analyzer triggers on a program address when it should not 301
- If there are unexplained states in the trace list 302
- If you see negative time or negative states in the trace list 302
- If the analyzer won't trigger 303
- If trace disassembly appears to be partially incorrect 304
- If the emulator won't work in a target system 304
- If you suspect that the emulator is broken 305
- If you have trouble mapping memory 306
- If you see multiple guarded memory accesses 307
- If the demo program won't work 307
- If you're having problems with DMA 308
- If you're having problems with emulation reset 308
- If the deMMUer runs out of resources during the loading process 309
- If verbose mode shows less than eight mappings but the deMMUer is "out of resources" 310
- If you only see physical memory addresses in the analyzer measurement results 310
- If the deMMUer is loaded but you still get physical addresses for some of your address space 311
- If you can't break into the monitor after you enable the MC68030 MMU 312

---

**Part 3 Reference****10 Using MC68030 Memory Management**

Understanding Emulation and Analysis Of The MC68030 Memory Management Unit 316

Terms And Conditions You Need To Understand 316

Logical vs Physical 316

What are logical addresses? 317

What are physical addresses? 317

Static and dynamic system architectures 317

Static system example 317

Non-paged dynamic system example 317

Paged dynamic system example 318

Where Is The MMU? 319

Using Function Codes 320

How the MMU is enabled 320

Hardware enable 320

Software enable 321

Restrictions when using the MC68030 emulator with the MMU turned on 321

How the MMU affects the way you compose your emulation commands 322

Seeing details of the MMU Translations 323

How the emulator helps you see the details of the MMU mappings 323

Supervisor/user address mappings 325

Translation details for a single logical address 326

Address mapping details 326

Status information 327

Table details for a selected logical address 328

Using the DeMMUer 330

What part of the emulator needs a deMMUer? 330

What would happen if the analyzer didn't get help from the deMMUer? 330

How does the deMMUer serve the analyzer? 330

Reverse translations are made in real time 331

DeMMUer options 331

Restrictions when using the deMMUer 333

Keep the deMMUer up to date 333

The target program is interrupted while the deMMUer is being loaded 333

## Contents

|  |            |
|--|------------|
| The analyzer must be off   | 333        |
| Expect strange addresses if you analyze physical memory with multiple logical mappings | 333        |
| Resource limitations   | 335        |
| Small-page/large-page modes  | 336        |
| Example to show resource limitations   | 336        |
| How to avoid the "out of resources" message  | 337        |
| Other ways to conserve space in the deMMUer table                                      | 337        |
| Minimize address ranges in the memory map  | 337        |
| Careful use of the emulator memory map   | 338        |
| What the emulator does when it loads the deMMUer                                       | 339        |
| Dividing the deMMUer table between user and supervisor memory space                    | 340        |
| Using two root pointers  | 340        |
| Using function codes   | 341        |
| <b>Solving Problems</b>  | <b>342</b> |
| Using the "display mmu_translations" command to overcome plug-in problems              | 342        |
| Use the analyzer with the deMMUer to find MMU mapping problems                         | 343        |
| Failure caused by access to guarded memory   | 343        |
| Failure due to system halt   | 344        |
| A "can't break into monitor" example   | 345        |
| <b>11 Emulator Commands</b>  |            |
| How Pulldown Menus Map to the Command Line   | 351        |
| Emulator Configuration: Memory Map   | 355        |
| How Popup Menus Map to the Command Line  | 356        |
| <b>Syntax Conventions</b>  | <b>358</b> |
| Oval-shaped Symbols  | 358        |
| Rectangular-shaped Symbols   | 358        |
| Circles  | 359        |
| The —NORMAL— Key   | 359        |

|                                    |     |
|------------------------------------|-----|
| Summary of Commands                | 360 |
| break                              | 361 |
| cmb_execute                        | 362 |
| copy                               | 363 |
| COUNT                              | 369 |
| display                            | 371 |
| DISPLAY MEMORY                     | 377 |
| DISPLAY MMU                        | 381 |
| DISPLAY TRACE                      | 385 |
| end                                | 390 |
| —EXPR—                             | 392 |
| FCODE                              | 395 |
| HELP                               | 397 |
| load                               | 398 |
| log_commands                       | 401 |
| modify                             | 402 |
| performance_measurement_end        | 409 |
| performance_measurement_initialize | 410 |
| performance_measurement_run        | 412 |
| pod_command                        | 413 |
| QUALIFIER                          | 415 |
| reset                              | 418 |
| run                                | 419 |
| SEQUENCING                         | 421 |
| set                                | 423 |
| specify                            | 429 |
| step                               | 431 |
| stop_trace                         | 434 |
| store                              | 435 |
| —SYMB—                             | 437 |
| trace                              | 445 |
| TRIGGER                            | 449 |
| <UNIX_COMMAND>                     | 451 |
| wait                               | 452 |
| WINDOW                             | 454 |

## **12 Emulator Messages**

|                                |     |
|--------------------------------|-----|
| Messages In This Chapter       | 458 |
| Organization of the Messages   | 458 |
| Messages Recorded in Error Log | 458 |

|  |     |
|--|-----|
| Unalphabetized Error and Status Messages | 459 |
|--|-----|

|  |     |
|--|-----|
| Alphabetized Error And Status Messages | 462 |
|--|-----|

## **13 Setting X Resources**

|  |     |
|--|-----|
| Setting X Resources                              | 518 |
| To modify the Graphical User Interface resources | 520 |
| To use customized scheme files                   | 524 |
| To set up custom action keys                     | 526 |
| To set initial recall buffer values              | 527 |
| To set up demos or tutorials                     | 529 |

## **14 The SPARCsystem Graphical User Interface and Softkey Interface**

|                                 |     |
|---------------------------------|-----|
| Using your SPARCsystem keyboard | 534 |
|---------------------------------|-----|

|                   |     |
|-------------------|-----|
| Keyboard template | 537 |
|-------------------|-----|

## **15 Microtec Language Tools Used With MC68020 and MC68030/EC030 Emulators**

|                               |     |
|-------------------------------|-----|
| Using Microtec Language Tools | 541 |
| To use the Microtec commands  | 542 |
| Assembler defaults            | 543 |
| Linker defaults               | 543 |
| Librarian defaults            | 544 |
| The Microtec MCC68K compiler  | 544 |

**16 Specifications and Characteristics**

|   |     |
|---|-----|
| Processor Compatibility                             | 546 |
| Electrical  | 546 |
| HP 64747 Electrical Specifications                  | 547 |
| HP 64748 Electrical Specifications                  | 554 |
| Physical (HP 64747 and HP 64748)                    | 560 |
| Environmental (HP 64747 and HP 64748)               | 561 |
| BNC, labeled TRIGGER IN/OUT (HP 64747 and HP 64748) | 561 |
| Communications (HP 64747 and HP 64748)              | 562 |

---

**Part 4 Concept Guide**

**17 X Resources and the Graphical User Interface**

X Resources and the Graphical User Interface 566

X Resource Specifications 567

Resource Names Follow Widget Hierarchy 567

Class Names or Instance Names Can Be Used 568

Wildcards Can Be Used 568

Specific Names Override General Names 569

How X Resource Specifications are Loaded 570

Application Default Resource Specifications 570

User-Defined Resource Specifications 570

Load Order 571

Scheme Files 572

Resources for Graphical User Interface Schemes 572

Scheme File Names 573

Load Order for Scheme Files 573

Custom Scheme Files 574



---

## Part 5 Installation and Service Guide

### 18 Installation and Service

Installation 578

Installing Hardware 580

Step 1. Install optional memory modules on Deep Analyzer card, if desired 582

Step 2. Connect the Emulator Probe Cables 584

Step 3. Install Boards into the HP 64700 Card Cage 587

Step 4. Install emulation memory modules on emulator probe 599

Step 5. Connect the emulator probe to the demo target system 603

Step 6. Apply power to the HP 64700 605

Connecting the HP 64700 to a Computer or LAN 607

Installing HP 9000 Software 608

Step 1. Install the software from the media 608

Step 2. Verify the software installation 611

Step 3a. Start the X server and the Motif Window Manager (mwm) 612

Step 3b. Start HP VUE 612

Step 4. Set the necessary environment variables 613

Installing Sun SPARCsystem Software 615

Step 1. Install the software from the media 615

Step 2. Start the X server and OpenWindows 616

Step 3. Set the necessary environment variables 616

Step 4. Verify the software installation 618

Step 5. Map your function keys 619

Step 6. Restart the window system 620

Step 7. Run the interface in a window 620

Verifying the Installation 621

Step 1. Determine the logical name of your emulator 621

Step 2. Start the interface with the **emul700** command 622

Step 3. Step through the demo with the Action Keys 625

Step 4. Exit the Graphical User Interface 625

Step 5. Verify the performance of the emulator 626

What is pv doing to the Emulator? 628

## Contents

Troubleshooting 628

Parts List 629

What is an Exchange Part? 631

### **19 Installing/Updating Emulator Firmware**

Installing/Updating Emulator Firmware 634

To update emulator firmware with "progflash" 635

To display current firmware version information 638

If there is a power failure during a firmware update 639

### **Glossary**

### **Index**

---

# Part 1

---

## Quick Start Guide

---

## **Quick Start Guide**

### **In This Part**

This part describes how to quickly become productive with the emulation system.

---

**1**



---

**Getting Started**

## The Emulator/Analyzer Interface — At a Glance

When an X Window System that supports OSF/Motif interfaces is running on the host computer, the emulator/analyzer interface is the Graphical User Interface which provides pull-down and pop-up menus, point and click setting of breakpoints, cut and paste, on-line help, customizable action keys, and pop-up recall buffers.

The emulator/analyzer interface can also be the Softkey Interface which is provided for several types of terminals, terminal emulators, and bitmapped displays. When using the Softkey Interface, commands are entered from the keyboard.

### The Softkey Interface

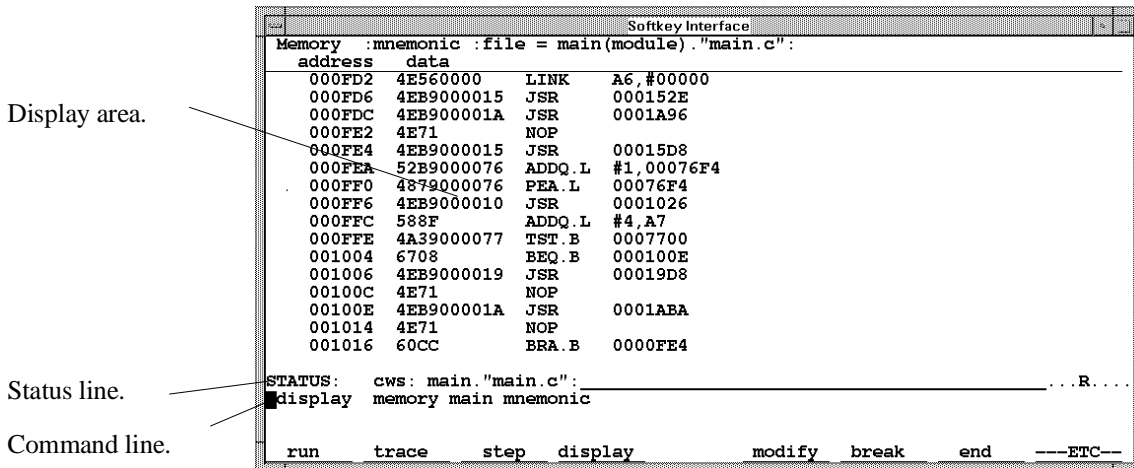

**Display area.** Can show memory, data values, analyzer traces, registers, breakpoints, status, simulated I/O, global symbols, local symbols, pod commands (the emulator's underlying Terminal Interface), error log, or display log. You can use the UP ARROW, DOWN ARROW, PAGE UP, and PAGE DOWN cursor keys to scroll or page up or down the information in the active window.

**Status line.** Displays the emulator and analyzer status. Also, when error and status messages occur, they are displayed on the status line in addition to being saved in the error log.

**Command line.** Commands are entered on the command line by pressing softkeys (or by typing them in) and executed by pressing the Return key. The Tab and Shift-Tab keys allow you to move the cursor on the command line forward or backward. The Clear line key (or CTRL-e) clears from the cursor position to the end of the line. The CTRL-u key clears the whole command line.

### Softkey Interface Conventions

Example Softkey Interface commands throughout the manual use the following conventions:

|                           |  |
|---------------------------|--|
| <b>bold</b>               | Commands, options, and parts of command syntax.  |
| <b><i>bold italic</i></b> | Commands, options, and parts of command syntax which may be entered by pressing softkeys.  |
| normal                    | User specified parts of a command.   |
| \$                        | Represents the UNIX prompt. Commands which follow the "\$" are entered at the UNIX prompt. |
| <RETURN>                  | The carriage return key.   |

## The Graphical User Interface

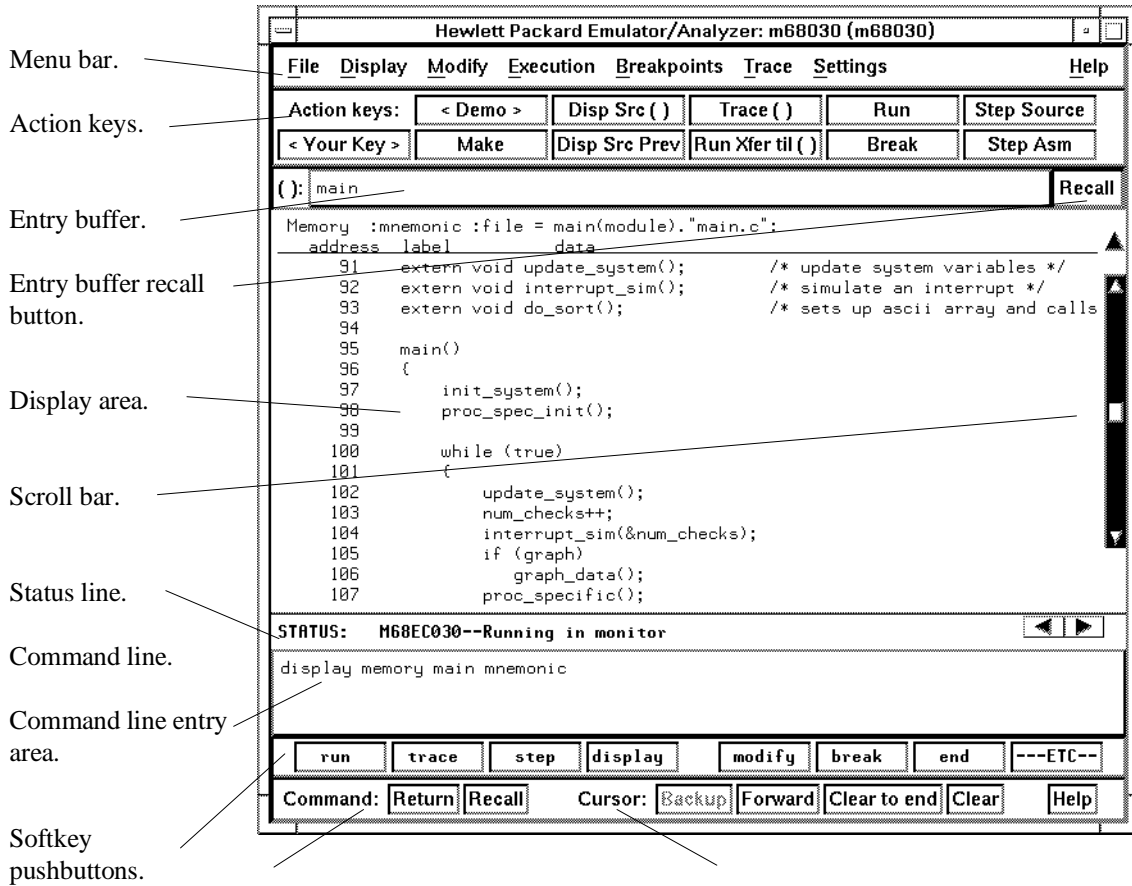

Command buttons. Includes command recall button.      Cursor buttons for command line area control.

**Menu Bar.** Provides pulldown menus from which you select commands. When menu items are not applicable, they appear half-bright and do not respond to mouse clicks.

**Action Keys.** User-defined pushbuttons. You can label these pushbuttons and define the action to be performed.



**Entry Buffer.** Wherever you see "()" in a pulldown menu, the contents of the entry buffer are used in that command. You can type values into the entry buffer, or you can cut and paste values into the entry buffer from the display area or from the command line entry area. You can also set up action keys to use the contents of the entry buffer.



**Entry Buffer Recall Button.** Allows you to recall entry buffer values that have been predefined or used in previous commands. When you click on the entry buffer **Recall** button, a dialog box appears that allows you to select values.

**Display Area.** Can show memory, data values, analyzer traces, registers, breakpoints, status, simulated I/O, global symbols, local symbols, pod commands (the emulator's underlying Terminal Interface), error log, or display log.

Whenever the mouse pointer changes from an arrow to a hand, you can press and hold the *select* mouse button to access popup menus.

**Scroll Bar.** A "sticky slider" that allows navigation in the display area. Click on the upper and lower arrows to scroll to the top (home) and bottom (end) of the window. Click on the inner arrows to scroll one line. Drag the slider handle up or down to cause continuous scrolling. Click between the inner arrows and the slider handle to page up or page down.

**Status Line.** Displays the emulator and analyzer status. Also, when error and status messages occur, they are displayed on the status line in addition to being saved in the error log. You can press and hold the *select* mouse button to access the Status Line popup menu.

**Command Line.** The command line area is similar to the command line in the Softkey Interface; however, the graphical interface lets you use the mouse to enter and edit commands.

- **Command line entry area.** Allows you to enter commands from the command line.
- **Softkey pushbuttons.** Clicking on these pushbuttons, or pressing softkeys, places the command in the command line entry area. You can press and hold the *select* mouse button to access the Command Line popup menu.
- **Command buttons** (includes command recall button). The command **Return** button is the same as pressing the carriage return key — it sends the command in the command line entry area to the emulator/analyzer.



The command **Recall** button allows you to recall previous or predefined commands. When you click on the command **Recall** button, a dialog box appears that allows you to select a command.

- **Cursor buttons for command line area control.** Allow you to move the cursor in the command line entry area forward or backward, clear to the end of the command line, or clear the whole command line entry area.

You can choose not to display the command line area by turning it off. For the most common emulator/analyzer operations, the pulldown menus, popup menus, and action keys provide all the control you need. Choosing menu items that require use of the command line will automatically turn the command line back on.

## Graphical User Interface Conventions

### Choosing Menu Commands

This chapter uses a shorthand notation for indicating that you should choose a particular menu item. For example, the following instruction

Choose **File**→**Load**→**Configuration**

means to first display the **File** pulldown menu, then display the **Load** cascade menu, then select the **Configuration** item from the Load cascade menu.

Based on this explanation, the general rule for interpreting this notation can be stated as follows:

- The leftmost item in bold is the pulldown menu label.
- If there are more than two items, then cascade menus are involved and all items between the first and last item have cascade menus attached.
- The last item on the right is the actual menu choice to be made.

## Mouse Button and Keyboard Bindings

Because the Graphical User Interface runs on different kinds of computers, which may have different conventions for mouse buttons and key names, the Graphical User Interface supports different bindings and the customization of bindings.

This manual refers to the mouse buttons using general (or "generic") terms. The following table describes the generic mouse button names and shows the default mouse button bindings.

---

### Mouse Button Bindings and Description

---

| Generic Button Name      | Bindings:           |                     | Description   |
|--------------------------|---------------------|---------------------|---|
|                          | HP 9000             | Sun SPARCsystem     |   |
| <i>paste</i>             | left                | left                | Paste from the display area to the entry buffer.                        |
| <i>command paste</i>     | middle <sup>1</sup> | middle <sup>1</sup> | Paste from the entry buffer to the command line text entry area.        |
| <i>select</i>            | right               | right               | Click selects first item in popup menus. Press and hold displays menus. |
| <i>command select</i>    | left                | right               | Displays pulldown menus.  |
| <i>pushbutton select</i> | left                | left                | Actuates pushbuttons outside of the display area.                       |

---

<sup>1</sup> Middle button on three-button mouse. Both buttons on two-button mouse.

The following table shows the default keyboard bindings.

---

**Keyboard Key Bindings**

---

| <b>Generic Key Name</b> | <b>HP 9000</b> | <b>Sun SPARCsystem</b> |
|-------------------------|----------------|------------------------|
| menu select             | extend char    | extend char            |
| insert                  | insert char    | insert char            |
| delete                  | delete char    | delete char            |
| left-arrow              | left arrow     | left arrow             |
| right-arrow             | right arrow    | right arrow            |
| up-arrow                | up arrow       | up arrow               |
| down-arrow              | down arrow     | down arrow             |
| escape                  | escape         | escape                 |
| TAB                     | TAB            | TAB                    |

---

---

## The Getting Started Tutorial

This tutorial gives you step-by-step instructions on how to perform a few basic tasks using the emulator/analyzer interface. The screen displays shown in this chapter were obtained by running the MC68030/EC030 emulator/analyzer. Some displays may differ slightly when running the MC68020 emulator/analyzer.

The tutorial examples presented in this chapter make the following assumptions:

- The HP 64747 or HP 64748 emulator and HP 64704 analyzer are installed into the HP 64700 Card Cage.
- The HP 64700 is connected to the host computer.
- The emulator/analyzer interface software has been installed as outlined in Chapter 18, "Installation and Service," and/or updated as outlined in Chapter 19, "Installing/Updating Emulator Firmware."
- The emulator is operating out-of-circuit; that is, connected to the demo board, not your target system, and switches on the demo board are set to OCE (OP).
- The emulator contains at least 60 Kbytes of emulation memory.

### The Demonstration Program

The demonstration program used in this chapter is a simple environmental control system. The program controls the temperature and humidity of a room requiring accurate environmental control.

## Step 1: Start the demo

A demo program and its associated files are provided with the Graphical User Interface.

**1** Change to the demo directory.

- If using the MC68020 emulator, type:

```
$ cd /usr/hp64000/demo/debug_env/hp64748 <RETURN>
```

- If using the MC68030/EC030 emulator, type:

```
$ cd /usr/hp64000/demo/debug_env/hp64747 <RETURN>
```

Refer to the README file for more information on the demo program.

```
$ more README <RETURN>
```

**2** Check that "/usr/hp64000/bin" and "." are in your PATH environment variable. To see the value of PATH:

```
$ echo $PATH <RETURN>
```

**3** If the Graphical User Interface software is installed on the same computer or same type of computer that you are using to run this "Getting Started" procedure, skip this step and go directly to step 4 of this "Start the demo" procedure. If the Graphical User Interface software is installed on a different type of computer than the computer you are using, edit the "platformScheme" resource setting in the "Xdefaults.emul" file.

For example, if the Graphical User Interface will be run on an HP 9000 computer and be displayed on a Sun SPARCsystem computer, change the platform scheme to "SunOS". This can't be done in the demo directory specified above because the Xdefaults.emul file is write protected. You will need to move it to a new directory and then change its permissions. The best way to do this is to enter the command:

```
$ startemul <logical_emul_name> <RETURN>
```

Where <logical\_emul\_name> is the logical name of your emulator, given in the HP 64700 emulator device table file (/usr/hp64000/etc/64700tab.net).

After you give the "Startemul" command, you will be asked if you would like to have the demo files copied to a different directory. Answer yes, and then specify your own demo directory. The files will be copied to your own directory where you can change the permissions on the Xdefaults.emul file so that you can edit it.

```
$ chmod 664 Xdefaults.emul
```

Now edit the Xdefaults.emul file. For this example, you would edit as follows:

```
$ vi Xdefaults.emul
```

```
!*platformScheme: pc-xview  
!*platformScheme: HP-UX  
*.platformScheme: SunOS  
!*platformScheme: HPxterm
```

Finally, save the Xdefaults.emul file with its modifications, and then start the emulation session again from the demo directory where you have your custom Xdefaults.emul file.

#### 4 Start the emulator/analyzer demo.

```
$ Startemul <logical_emul_name> <RETURN>
```

The <logical\_emul\_name> in the command above is the logical emulator name given in the HP 64700 emulator device table file (/usr/hp64000/etc/64700tab.net). For the MC68020 emulator, it is usually m68020; for the MC68030 emulator, m68030.

If you did not perform Step 3 of this "Start the demo" procedure, you will be asked if you would like to have the demo files copied to a directory of your own choosing. It is a good idea to have these files copied to your own demo directory if you have space available in your system because it protects the original demo files from changes you might make during this demo procedure.

This script starts the emulator/analyzer interface (with a customized set of action keys), loads a configuration file for the demo program, and then loads the demo program.



## Step 2: Display the program in memory

- 1 If the symbol "main" is not already in the entry buffer, move the mouse pointer to the entry buffer (notice the flashing I-beam cursor) and type in "main".
- 2 Choose **Display**→**Memory**→**Mnemonic ()**.

Or, using the command line, enter:

```
display memory main mnemonic <RETURN>
```

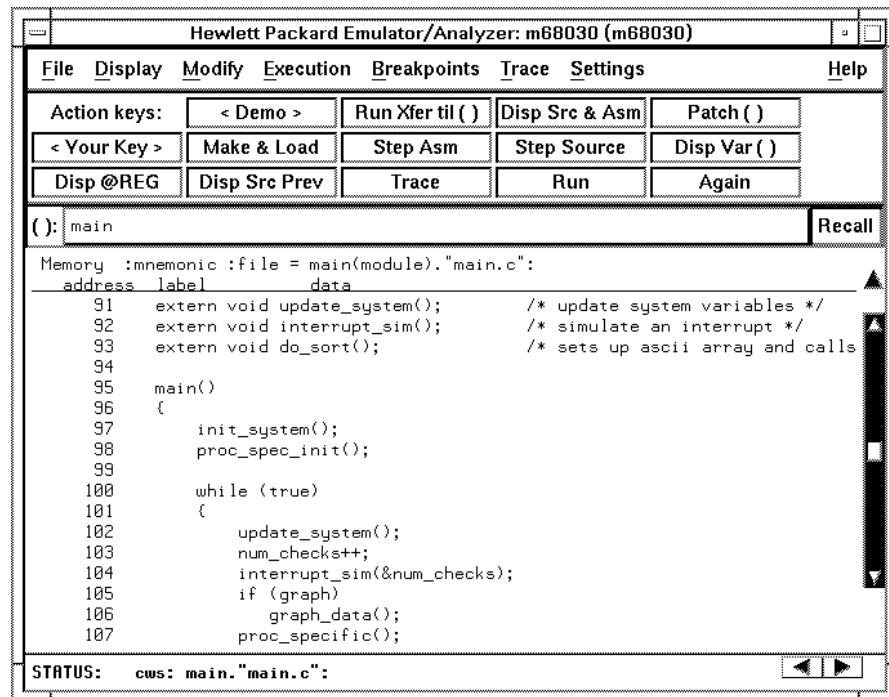

The screenshot shows the Hewlett Packard Emulator/Analyzer interface for the m68030 processor. The window title is "Hewlett Packard Emulator/Analyzer: m68030 (m68030)". The menu bar includes File, Display, Modify, Execution, Breakpoints, Trace, Settings, and Help. Below the menu bar is a grid of action keys: < Demo >, Run Xfer til ( ), Disp Src & Asm, Patch ( ), < Your Key >, Make & Load, Step Asm, Step Source, Disp Var ( ), Disp @REG, Disp Src Prev, Trace, Run, and Again. The entry buffer shows "( ): main" with a Recall button. The main display area shows the memory contents for the file "main(module).\"main.c\"":

```
Memory :mnemonic :file = main(module).\"main.c\":
address label      data
  91  extern void update_system();      /* update system variables */
  92  extern void interrupt_sim();      /* simulate an interrupt */
  93  extern void do_sort();            /* sets up ascii array and calls
  94
  95  main()
  96  {
  97      init_system();
  98      proc_spec_init();
  99
 100      while (true)
 101      {
 102          update_system();
 103          num_checks++;
 104          interrupt_sim(&num_checks);
 105          if (graph)
 106              graph_data();
 107          proc_specific();
```

The STATUS bar at the bottom indicates "cws: main.\"main.c\":".

The command line can be brought on screen by placing the cursor in the display area of the Graphical User Interface and typing the command.

The default display mode settings cause source lines and symbols to appear in displays where appropriate. Notice you can use symbols when specifying expressions. The global symbol "main" is used in the command above to specify the starting address of the memory to be displayed.



## Step 3: Run from the transfer address

The transfer address is the entry address defined by the software development tools and included with the program's symbol information.

- Click on the **Run Xfer til ()** action key.

Or, using the command line, enter:

```
run from transfer_address until main <RETURN>
```

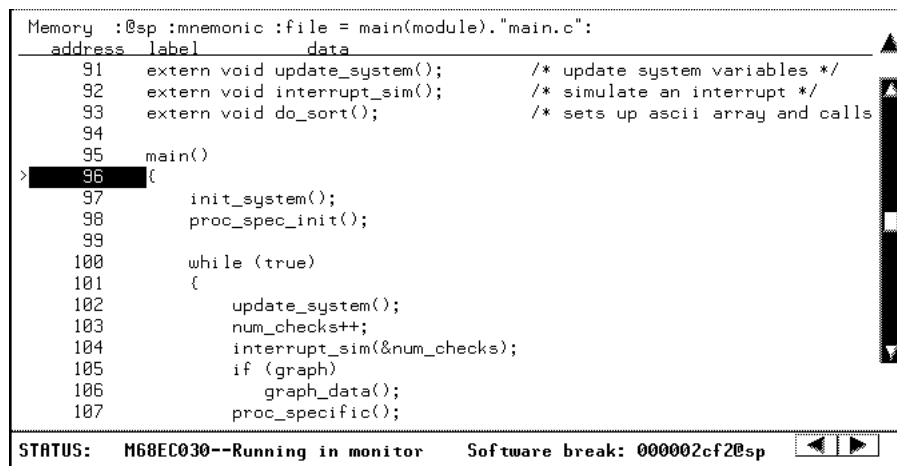

```
Memory :@sp :mnemonic :file = main(module)."main.c":
address label      data
 91  extern void update_system();      /* update system variables */
 92  extern void interrupt_sim();      /* simulate an interrupt */
 93  extern void do_sort();            /* sets up ascii array and calls
 94
 95  main()
> 96  {
 97      init_system();
 98      proc_spec_init();
 99
100      while (true)
101      {
102          update_system();
103          num_checks++;
104          interrupt_sim(&num_checks);
105          if (graph)
106              graph_data();
107          proc_specific();
STATUS:  M68EC030--Running in monitor   Software break: 000002cf20sp
```

Notice the message "Software break: <address>" is displayed on the status line and that the emulator is "Running in monitor". When you run until an address, a breakpoint is set at the address before the program is run.

Notice the highlighted bar on the screen; it shows the content of the current program counter.

## Step 4: Step high-level source lines

You can step through the program by high-level source lines. The emulator executes as many instructions as are associated with the high-level program source lines.

- 1 To step a source line from the current program counter, click on the **Step Source** action key.

Or, using the command line, enter:

```
step source <RETURN>
```

Notice that the highlighted bar (the current program counter) moves to the next high-level source line.

- 2 Step into the "init\_system" function by continuing to step source lines, either by clicking on the **Step Source** action key, by clicking on the **Again** action key which repeats the previous command, by choosing **Execution**→**Step Source**→**fromPC**, or by entering the **step source** command on the command line.

```
Memory :@sp :mnemonic :file = init_system(module).\"init_system.c\":  
-----  
address label      data  
26  
27 void init_val_arr();  
28  
29 void  
30 init_system()  
> 31 { /* FUNCTION init_system() */  
32 /* Initialize the target values for temperature and humidity */  
33 target_temp = 73;  
34 target_humid = 45;  
35  
36 /* Intialize the variables indicating the current environment */  
37 /* conditions */  
38 current_temp = 68;  
39 current_humid = 41;  
40  
41 /* Set starting directions for temp and humid */  
42 temp_dir = up;
```

## Step 5: Display the previous mnemonic display

- Click on the **Disp Src Prev** action key, or choose **Display→Memory→Mnemonic Previous**.

Or, using the command line, enter:

```
display memory mnemonic previous_display <RETURN>
```

This command is useful, for example, when you have stepped into a function that you do not wish to look at—you can return the previous mnemonic display to the screen and run your program until the source line that follows the function call is reached. The next step will run through the function "init\_system;" and stop when "proc\_spec\_init;" is reached.

## Step 6: Run until an address

When displaying memory in mnemonic format, a selection in the popup menu lets you run from the current program counter address until a specific source line.

- Position the mouse pointer over the line "proc\_spec\_init();", press and hold the *select* mouse button, and choose **Run Until** from the popup menu.

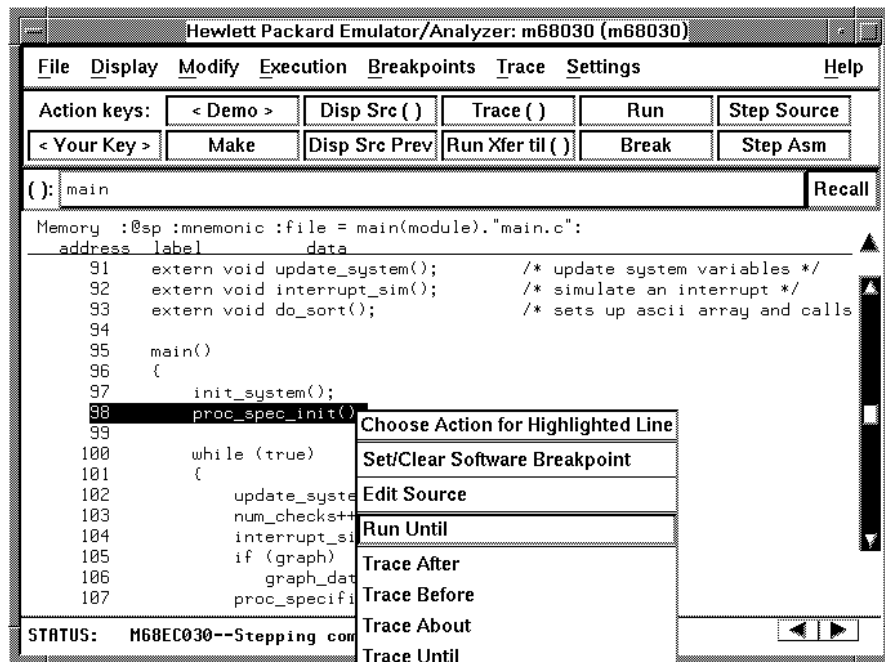

Or, using the command line, enter:

```
run until main.\"main.c\": line 97 <RETURN>
```

After the command has executed, notice the highlighted bar indicates the program counter has moved to the specified source line.

---

## Step 7: Display data values

- 1 Position the mouse pointer over "num\_checks" in the source line that reads "num\_checks++;" and click the *paste* mouse button (notice "num\_checks" is cut and pasted into the entry buffer).
- 2 Click on the **Disp Var ()** action key, or choose **Display→Data Values→Add()→int32**.

Or, using the command line, enter:

***display data , num\_checks int32*** <RETURN>

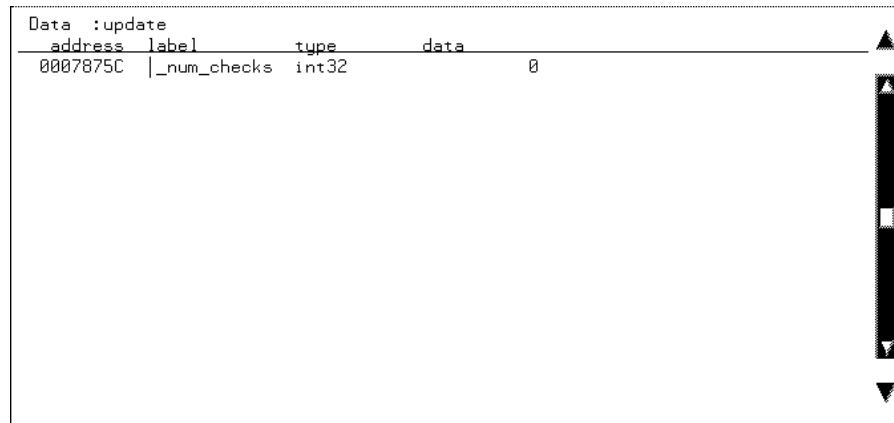

| Data :update |             |       |      |
|--------------|-------------|-------|------|
| address      | label       | type  | data |
| 0007875C     | _num_checks | int32 | 0    |

The "num\_checks" variable is added to the data values display and its value is displayed as a 32-bit integer.

## Step 8: Display registers

You can display the contents of the processor registers.

- Choose **Display**→**Registers**→**BASIC**.

Or, using the command line, enter:

*display registers* <RETURN>

```
Registers
-----
Next PC 00002D08@sp
PC 00002D08 STATUS 2704 < s z > USP 00000000 MSP 00000001 ISP 00007F90
D0-D7 00000020 00000020 000790C8 00002322 00000000 00000000 00000000 00000000
A0-A7 000781C0 FFFFFFFF 000781A8 000790C0 00078888 000001A8 00007F94 00007F90
CAAR 00000000 CACR 00000000 VBR 00000000 SFC 0 DFC 0
```

## Step 9: Step assembly-level instructions

You can step through the program one instruction at a time.

- To step one instruction from the current program counter, click on the **Step Asm** action key, or choose **Execution**→**Step Instruction**→**from PC**.

Or, using the command line, enter:

**step** <RETURN>

```
Registers
-----
Next PC 00002CFC@sp
PC 00002CFC STATUS 2704 < s z > USP 00000000 MSP 00000001 ISP 00087F94
D0-D7 00000020 00000020 00079078 00002322 00000000 00000000 00000000 00000000
A0-A7 000781A8 FFFFFFFF 00078778 00079070 00078838 000801A8 00087F94 00087F94
CAAR 00000000 CACR 00000000 VBR 00000000 SFC 0 DFC 0

Step_PC 00002CFC@sp JSR      p.proc_spec_init
Next PC 00003772@sp
PC 00003772 STATUS 2704 < s z > USP 00000000 MSP 00000001 ISP 00087F90
D0-D7 00000020 00000020 00079078 00002322 00000000 00000000 00000000 00000000
A0-A7 000781A8 FFFFFFFF 00078778 00079070 00078838 000801A8 00087F94 00087F90
CAAR 00000000 CACR 00000000 VBR 00000000 SFC 0 DFC 0
```

Notice, when registers are displayed, stepping causes the assembly language instruction just executed to be displayed.

## Step 10: Trace the program

When the analyzer traces program execution, it looks at the data on the emulation processor's bus and control signals at each clock cycle. The information seen at a particular clock cycle is called a state.

When one of these states matches the "trigger state" you specify, the analyzer stores states in trace memory. When trace memory is filled, the trace is said to be "complete."

- 1 Click on the **Recall** button to the right of the entry buffer.

A selection dialog box appears. You can select from entry buffer values that have been entered previously or that have been predefined.

- 2 Click on "main" in the selection dialog box, and click the "OK" pushbutton.

Notice that the value "main" has been returned to the entry buffer.

- 3 To trigger on the address "main" and store states that occur after the trigger, choose **Trace**→**After** ().

Or, using the command line, enter:

```
trace after main <RETURN>
```

Notice the message "Emulation trace started" appears on the status line. This shows that the analyzer has begun to look for the trigger state which is the address "main" on the processor's address bus.

- 4 Run the emulator demo program from its transfer address by choosing **Execution**→**Run**→**from Transfer Address**.

Or, using the command line, enter:

```
run from transfer_address <RETURN>
```



Notice that now the message on the status line is "Emulation trace complete". This shows the trigger state has been found and the analyzer trace memory has been filled.

5 To view the captured states, choose **Display→Trace**.

Or, using the command line, enter:

**display trace** <RETURN>

```

Trace List      Offset=0      More data off screen
Label:         Address      Opcode or Status w/ Source Lines
Base:         symbols      mnemonic w/symbols
after pr|main+00000004  NOP
#####main.c - line 1 thru 96 #####
extern void interrupt_sim(); /* simulate an interrupt */
extern void do_sort(); /* sets up ascii array and calls combs
main()
{
= prog|main.main LINK,W A6,##$0000
+001 sysstac+00007F98 $00002316 supr data long wr (ds32)
#####main.c - line 97 #####
init_system();
+002 =pr|main+00000004 JSR init.init_system
+003 pr|main+00000006 $0000321E supr prgm long rd (ds32)
+004 sysstac+00007F94 $00007FF0 supr data long wr (ds32)
+005 init_sy+00000004 NOP
#####init_system.c - line 1 thru 31 #####

```

The default display mode settings cause source lines and symbols to appear in the trace list.

Captured states are numbered in the left-hand column of the trace list. Line 0 always contains the state that caused the analyzer to trigger.

Other columns contain address information, data values, opcode or status information, and time count information.

## Step 11: Display memory at an address in a register

- 1 Click on the **Disp @REG** action key.

Or, using the command line, enter the name of the command file:

```
mematreg <RETURN>
```

A command file dialog box appears (or a prompt appears in the command line).

- 2 Move the mouse pointer to the dialog box text entry area, type "A7", and click on the "OK" button.

Or, if the prompt is in the command line:

```
A7 <RETURN>
```

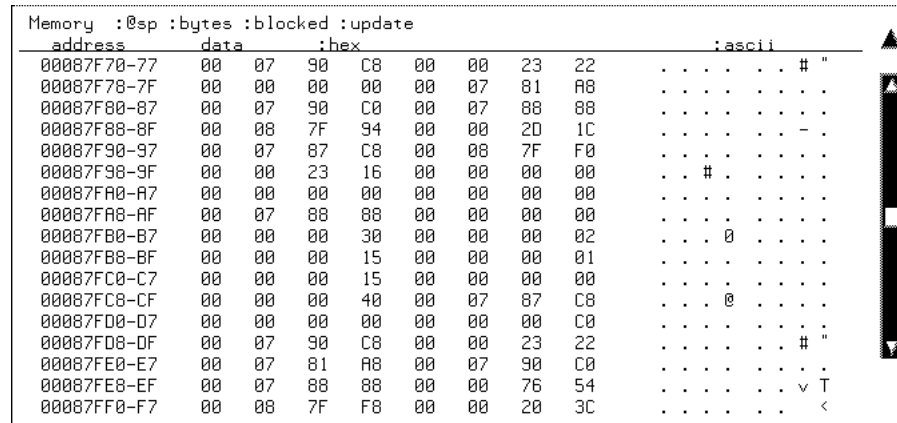

The screenshot shows a memory dump window with a table of memory addresses, data, and ASCII values. The table has columns for address, data, hex, and ascii. The data is displayed in hexadecimal and ASCII format. The ASCII column shows characters corresponding to the hex values.

| Memory :@sp :bytes :blocked :update | address     | data                    | hex                     | ascii             |
|-------------------------------------|-------------|-------------------------|-------------------------|-------------------|
|                                     | 00087F70-77 | 00 07 90 C8 00 00 23 22 | 00 07 90 C8 00 00 23 22 | . . . . . # "     |
|                                     | 00087F78-7F | 00 00 00 00 00 07 81 A8 | 00 00 00 00 00 07 81 A8 | . . . . .         |
|                                     | 00087F80-87 | 00 07 90 C0 00 07 88 88 | 00 07 90 C0 00 07 88 88 | . . . . .         |
|                                     | 00087F88-8F | 00 08 7F 94 00 00 20 1C | 00 08 7F 94 00 00 20 1C | . . . . .         |
|                                     | 00087F90-97 | 00 07 87 C8 00 08 7F F0 | 00 07 87 C8 00 08 7F F0 | . . . . .         |
|                                     | 00087F98-9F | 00 00 23 16 00 00 00 00 | 00 00 23 16 00 00 00 00 | . . # . . . . .   |
|                                     | 00087FA0-A7 | 00 00 00 00 00 00 00 00 | 00 00 00 00 00 00 00 00 | . . . . .         |
|                                     | 00087FA8-AF | 00 07 88 88 00 00 00 00 | 00 07 88 88 00 00 00 00 | . . . . .         |
|                                     | 00087FB0-B7 | 00 00 00 30 00 00 00 02 | 00 00 00 30 00 00 00 02 | . . . 0 . . . . . |
|                                     | 00087FB8-BF | 00 00 00 15 00 00 00 01 | 00 00 00 15 00 00 00 01 | . . . . .         |
|                                     | 00087FC0-C7 | 00 00 00 15 00 00 00 00 | 00 00 00 15 00 00 00 00 | . . . . .         |
|                                     | 00087FC8-CF | 00 00 00 40 00 07 87 C8 | 00 00 00 40 00 07 87 C8 | . . . 0 . . . . . |
|                                     | 00087FD0-D7 | 00 00 00 00 00 00 00 C0 | 00 00 00 00 00 00 00 C0 | . . . . .         |
|                                     | 00087FD8-DF | 00 07 90 C8 00 00 23 22 | 00 07 90 C8 00 00 23 22 | . . . . . # "     |
|                                     | 00087FE0-E7 | 00 07 81 A8 00 07 90 C0 | 00 07 81 A8 00 07 90 C0 | . . . . .         |
|                                     | 00087FE8-EF | 00 07 88 88 00 00 76 54 | 00 07 88 88 00 00 76 54 | . . . . . v T     |
|                                     | 00087FF0-F7 | 00 08 7F F8 00 00 20 3C | 00 08 7F F8 00 00 20 3C | . . . . . <       |

## Step 12: Patch assembly language code

The **Patch ()** action key lets you patch code in your program.

- 1 With "main" still in the entry buffer, click on the **Run Xfer til ()** action key.
- 2 To display memory with assembly-level instructions intermixed with the high-level source lines, click on the **Disp Src & Asm** action key.

```
Memory :@sp :mnemonic :file = main(module)."main.c":
address  label      data
-----  -
92      extern void interrupt_sim();      /* simulate an interrupt */
93      extern void do_sort();        /* sets up ascii array and calls
94
95      main()
96      {
> 00002CF2  pr|main.main 4E560000  LINK.W  A6, #0000
00002CF6      2F0A      MOVE.L  A2, -(A7)
00002CF8      247C000781 MOVEA.L #000781A8, A2
97          init_system();
00002CFE      14BC0001  MOVE.B  #01, (A2)
00002D02      4EB9000032 JSR     init.init_system
98          proc_spec_init();
00002D08      4EB9000039 JSR     p.proc_spec_init
99
100         while (true)
00002D0E      4E71      NOP
101         {
```

- 3 Click on the **Patch ()** action key.

A window appears and the **vi** editor is started. Under "ORG main", add the line:

```
LINK A6, #1234h
```

Exit out of the editor, saving your changes (using 'wq').

The file you just edited is assembled, and the patch main menu appears. Type "a" <RETURN> to apply the patch.

## Chapter 1: Getting Started

### Step 12: Patch assembly language code

```
Memory :@sp :mnemonic :file = main(module).main.c":
address label data
92 extern void interrupt_sim(); /* simulate an interrupt */
93 extern void do_sort(); /* sets up ascii array and calls
94
95 main()
96 {
> 00002CF2 pr|main.main 4E561234 LINK.W A6, $$1234
00002CF6 2F0A MOVE.L A2, -(A7)
00002CF8 247C000781 MOVEA.L #0000781A8, A2
97 init_system();
00002CFE 14BC0001 MOVE.B #01, (A2)
00002D02 4EB9000032 JSR init.init_system
98 proc_spec_init();
00002D08 4EB9000039 JSR p.proc_spec_init
99
100 while (true)
00002D0E 4E71 NOP
101 {
```

Notice in the emulator/analyzer interface that the instruction at address "main" has changed.

#### 4 Click on the **Patch ()** action key again.

A window running the **vi** editor again appears, allowing you to modify the patch code that was just created. Modify the line you added previously to:

```
LINK A6, #0
```

Exit out of the editor, saving your changes.

The file you just edited is assembled, and the patch main menu appears. Type "a" <RETURN> to apply the patch.

Notice in the emulator/analyzer interface that the instruction at address "main" has been changed back to what it was originally.

When patching a single address, make sure the new instruction takes up the same number of bytes as the old instruction; otherwise, you may inadvertently modify code that follows.

5 Type "main+4 thru main+15" in the entry buffer.

By entering an address range in the entry buffer (that is, <address> thru <address>) before clicking on the **Patch ()** action key, you can modify a patch template file which allows you to insert as much or as little code as you wish.

6 Click on the **Patch ()** action key again.

A window running the **vi** editor again appears. Suppose you want to patch the demo program so that the `proc_spec_init()` function is called before the `init_system()` function. Suppose also that there is memory available at address 7FE0H. Edit the patch template file as shown below.

```
; PCHS700 Assembly Patch File: PCHmain+4.s
;
; Date : Tue Jul 31 14:06:06 MDT 1992
; Dir  : /users/guest/demo/debug_env/hp64747
; Owner: guest
;
      INCLUDE PCHSINC.s
      ORG main+4
      BRA patch1      ;You may want to change this name!
      ORG 7FE0h       ;You MUST set this address!
patch1 NOP
; !!!!!!!!!!! You may need to modify labels and operands of the      !!!!!!!!!!!
; !!!!!!!!!!! following code to match your assembler syntax         !!!!!!!!!!!
; !!!!!!!!!!! Patching Range: main+4 thru main+15
; !!!!!!!!!!! Insert new code here !!!!!!!!!!!
      JSR _proc_spec_init
      JSR _init_system
      BRA main+16      ;You MUST set this address also!
```

Notice that symbols can be used in the patch file. Exit out of the editor, saving your changes ('wq').

The file you just edited is assembled, and the patch main menu appears. Type "a" <RETURN> to apply the patch.

You can step through the program (**Step Source**) to view execution of the patch.





## **Step 13: Exit the emulator/analyzer interface**

- To exit the emulator/analyzer interface and release the emulator, choose **File→Exit→Released**.

Or, using the command line, enter:

*end release\_system* <RETURN>

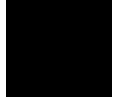

---

## **Solving Quick Start Problems**

Solutions to problems you might face during the Getting Started procedures.

## Solving Quick Start Problems

This chapter helps you identify and resolve problems that may arise while using the Getting Started chapter.

For more information, refer to Chapter 9, "Solving Problems."

---

### If the desired emulator interface won't start

- Check for correct installation of the interface software. Refer to Chapter 18, "Installation and service," and to the *HP 64700 Series Emulators Installation/Service Guide*.
  - Verify that the \$PATH environment variable includes the directory containing the interface software (/usr/hp64000/bin). The interface files are loaded in the "/usr/hp64000/bin" directory by the installation procedure.
- 

### If the text-based Softkey Interface won't start under X-Windows

- If the Graphical User Interface is starting when you are trying to start the Softkey Interface, include the **-u skemul** option to the **emul700** command to override the Graphical User Interface and force the start of the Softkey Interface.
- 

### If you can't load the demo program

- Check to ensure that the emulator probe is plugged into the demo board, with power connected to the demo board from the emulator. (The demo program may not work with target systems other than the demo board.)
-



Chapter 2: Solving Quick Start Problems  
**If you can't load the demo program**

- Check to ensure the switches on the demo board are set to the OCE (Out-of-Circuit Emulation) position, away from TEST.
  
- Check to ensure that you changed to the demo directory:
  - /usr/hp64000/demo/debug\_env/hp64748 for the MC68020.
  - /usr/hp64000/demo/debug\_env/hp64747 for the MC68030/EC030.



## If you can't display the program

- Verify that the program loaded correctly.
- Check to see that the status of the emulator is reset or is running in monitor. See the STATUS line on the display. If the emulator is halted, it can't use the monitor to display program memory. In this case, reset the emulator and try to display the program memory again.
- Check the event log by choosing **Display**→**Event Log**, or by using the **display event\_log** command on the command line. If the event log shows that the program loaded, try reloading the program again.
- If you are displaying memory with **symbols on**, ensure that the symbol data base has been loaded with the program. If this is the cause of the problem, you will be able to obtain the memory display by referring to the address using its hexadecimal value instead of its symbolic value. For example, to obtain a display of the program in memory at symbolic address demo:main:

Move the mouse pointer to the entry buffer and type in "2CF2H"; and then select **Display**→**Memory**→**Mnemonic ()**.

or use the command line to enter:

```
display memory 2CF2H mnemonic
```

---

## Part 2

---

### User's Guide

---

## **User's Guide**

### **In This Part**

This part describes how to use the emulator, analyzer, and other tools provided with the HP 64747 and HP 64748 products.

---

# 3



---

## Using the emulator/analyzer interface

How to enter commands in the Graphical User Interface and the Softkey Interface

## Using the interface

The strength of the emulator/analyzer interface is that it lets you perform the real-time analysis measurements that are helpful when integrating hardware and software.

The C debugger interface (which is a separate product) lets you view the stack backtrace and high-level data structures, and it lets you use C language expressions and macros. These features are most useful when debugging software.

The Software Performance Analyzer (SPA) interface (which is also a separate product) lets you make measurements that can help you improve the performance of your software.

These interfaces can operate at the same time with the same emulator. When you perform an action in one of the interfaces, it is reflected in the other interfaces.

This chapter shows you how to perform the basic tasks associated with each type of emulator/analyzer interface. The information is grouped into the following sections:

- Starting the emulator/analyzer interface.
- Opening other HP 64700 interface windows.
- Entering commands
- Using special features of the Graphical User Interface.
- Using display-control features of the Softkey Interface.
- Copying information to a file or printer.
- Exiting the emulator/analyzer interface.
- Creating and executing command files.
- Forwarding commands to other HP 64700 interfaces.
- Accessing the terminal interface.
- Accessing the operating system.

When an X Window System that supports OSF/Motif interfaces is running on the host computer, the emulator/analyzer interface is the Graphical User Interface

which provides pulldown and popup menus, point and click setting of breakpoints, cut and paste, on-line help, customizable action keys, and popup recall buffers.

The emulator/analyzer interface also provides the Softkey Interface for several types of terminals, terminal emulators, and bitmapped displays. When using the Softkey Interface, commands are entered from the keyboard.

When using the Graphical User Interface, the *command line* portion of the interface gives you the option of entering commands in the same manner as they are entered in the Softkey Interface. If you are using the Softkey Interface, you can only enter commands from the keyboard using the command line.

The menu commands in the Graphical User Interface are a subset of the commands available when using the command line. While you have a great deal of capability in the menu commands, there are some commands that must be entered in the command line.

### **Maximum Number of Windows**

Ten is the maximum number of windows you can use to view HP 64700 emulator/analyzer operation. Only one C debugger interface window and one SPA window are allowed, but you can start multiple emulator/analyzer interface windows.

### **Activities that Occur in the Windows**

When using an HP 64700-Series emulator in a window environment (or with multiple terminals), the following activities occur in the windows where the emulator is currently operating.

#### **Commands Complete in Sequence**

When you execute commands that access the emulator (in multiple windows) the first command you specify will complete before the second command begins executing.

#### **Status Line is Updated**

When you perform an emulation task in one window that updates the status line, status lines are updated in all other windows where the emulator is operating. The event log is also updated in each window.



### Ending the Emulation Session

When you are using the emulator in multiple windows, you can choose to either end the emulation session in a single window, or in all the windows. The **end** command by itself just ends the window where the command is executed.

### Using Multiple Terminals

If you do not have a window environment installed on your host computer, you can still obtain the benefits of multiple windows by logging onto the same UNIX system from several terminals, and starting the emulator on each terminal, just as described here for several windows.

The rest of this section describes how to start and stop interface instances and sessions in multiple windows.



## Starting the Emulator/Analyzer Interface

Before starting the emulator/analyzer interface, the emulator and interface software must have already been installed as described in Chapter 18, "Installation and Service."

This section describes how to:

- Start the interface.
- Start the interface using the default configuration.
- Execute a command file on interface startup.
- Display the status of emulators defined in the 64700tab.net file.
- Unlock an interface that was left locked by another user.

---

## To start the emulator/analyzer interface

- Use the **emul700** `<emul_name>` command.

If `/usr/hp64000/bin` is specified in your PATH environment variable, you can start the interface with the **emul700** `<emul_name>` command. The "emul\_name" is the logical emulator name given in the HP 64700 emulator device table (`/usr/hp64000/etc/64700tab.net`).

If you are running a window system on your host computer (for example, the X Window System), you can run the interface in up to 10 windows. This capability provides you with several views into the emulation system. For example, you can display memory in one window, registers in another, an analyzer trace in a third, data in fourth, results of software performance measurements in the fifth (if a software performance analyzer is installed as part of your system), etc.

## Chapter 3: Using the emulator/analyzer interface

### Starting the Emulator/Analyzer Interface

#### Examples

To start the emulator/analyzer interface for the 68020 emulator:

```
$ emul700 em68020 <RETURN>
```

The "em68020" in the command above is the logical emulator name given in the HP 64700 emulator device table file (/usr/hp64000/etc/64700tab.net).

```
# Blank lines and the rest of each line after a '#' character are ignored.
# The information in each line must be in the specified order, with one line
# for each HP series 64700 emulator. Use blanks or tabs to separate fields.
#
#-----+-----+-----+-----+
# Channel | Logical | Processor | Remainder of Information for the Channel
# Type   | Name   | Type     | (IP address for LAN connections)
#-----+-----+-----+-----+
# lan:   | em68020 | m68020   | 21.17.9.143
# serial: | em68020 | m68020   | myhost /dev/emcom23 OFF 9600 NONE XON 2 8
```

If you're currently running the X Window System, the Graphical User Interface starts; otherwise, the Softkey Interface starts.

The status message shows that the default configuration file has been loaded. If the command is not successful, you will be given an error message and returned to the UNIX prompt. Error messages are described in Chapter 12, "Emulator Messages."

---

### To start the interface using the default configuration

- Use the **emul700 -d <emul\_name>** command.

In the **emul700 -d <emul\_name>** command, the **-d** option says to use the default configuration. The **-d** option is ignored if the interface is already running in another window or on another terminal.

## To execute a command file at interface startup

- Use the **emul700 -c <cmd\_file> <emul\_name>** command.

Starting a command file (**-c <cmd\_file>**) at emulator startup allows you to automate some of the setup and configuration of the emulator. For example, you may have a command file that loads a particular configuration file, a program file, and then sets up trace display formats and specifications.

If the HP64KPATH variable is set, the interface will use the search paths specified in this variable to locate a command file passed to it with the **emul700** command.

Refer to the "Creating and Using Command Files" section later in this chapter for information on creating command files.

---

### Examples

To start the emulator/analyzer interface and run the "startup" command file:

```
$ emul700 -c startup em68020 <RETURN>
```

where "m68020" is the **logical name** for the HP64748 MC68020 emulator.

---

## To see emulator/analyzer status before interface startup

- Use the **emul700 -l** or **emul700 -lv** command.

The **-l** option of the **emul700** command lists the status of all emulators defined in the 64700tab and 64700tab.net files. If a logical emulator name is included in the command, just the status of that emulator is listed.

You can also use the **-v** option with the **-l** option for a verbose listing of the status information.

## Chapter 3: Using the emulator/analyzer interface

### Starting the Emulator/Analyzer Interface

---

#### Examples

To list, verbosely, the status of the emulator whose logical name is "em68020":

```
$ emul700 -lv em68020 <RETURN>
```

The information may be similar to:

```
em68020 - m68020 running; user = guest
description:      M68020 emulation, w/internal analysis, 260Kb emul mem
user interfaces:  xemul, skemul
device channel:   /dev/emcom23
```

Or, the information may be similar to:

```
em68020 - m68020 running; user = guest@myhost
description:      M68020 emulation w/internal analysis, 260Kb emul mem
user interfaces:  xemul, skemul
internet address: 21.17.9.143
```

---

### To see emulator/analyzer status after the interface has started

- Choose **Display**→**Status**.

or

- Use the command:

```
display status
```

The present status of the emulator is displayed on the screen, as well as detailed trace status.

## To unlock an interface that was left locked by another user

- Use the `emul700 -U <emul_name>` command.

The `-U` option to the `emul700` command may be used to unlock the emulators whose logical names are specified. You can only use this command if there is no current session in progress.



---

### Examples

To unlock the emulator whose logical name is "em68020":

```
$ emul700 -U em68020 <RETURN>
```

## Opening Other HP 64700 Interface Windows

The **File→Emul700** menu lets you open additional emulator/analyzer interface windows or other HP 64700 interface windows, if products for those windows have been installed (for example, the software performance analyzer, SPA, interface and the high-level debugger interface).

This section shows you how to:

- Open additional emulator/analyzer interface windows.
- Open the high-level debugger interface window.
- Open the software performance analyzer (SPA) interface window.

---

### To open additional emulator/analyzer windows

- To open additional Graphical User Interface windows, choose **File→Emul700→Emulator/Analyzer** under *Graphic Windows*
- To open additional Softkey Interface windows, choose **File→Emul700→Emulator/Analyzer** under *Terminal Windows*.
- Enter the **emul700 <emul\_name>** command in another terminal emulation window.

You have a choice of opening up to nine additional windows, whether they be Graphical User Interface windows, or terminal emulation windows containing the Softkey Interface.

When you open an additional window, the status line will show that this session is joining a session already in progress, and the event log is displayed.

You can enter commands in any window in which the interface is running. When you enter commands in different windows, the command entered in the first window must complete before the command entered in the second window can start. The status lines and the event log displays are updated in all windows.

The **File**→**Emul700** menu may display other choices if the interface finds other HP 64700 products on the computer.

---

### **To open the high-level debugger interface window**

- Choose **File**→**Emul700**→**High-Level Debugger ...** *under Graphic Windows.*

For information on how to use the high-level debugger interface, refer to the debugger/emulator *User's Guide*.

---

### **To open the software performance analyzer (SPA) interface window**

- Choose **File**→**Emul700**→**Performance Analyzer ...** *under Graphic Windows.*

For information on how to use the software performance analyzer, refer to the *Software Performance Analyzer User's Guide*.

## Entering Commands

The Graphical User Interface and Softkey Interface provide simple, effective mechanisms for entering commands to be processed by the emulator and analyzer. Basic descriptions of both interfaces are given in Chapter 1, "Getting Started".

This section shows you how to:

- Turn the command line on and off.
- Enter commands on the command line.
- Edit commands.
- Recall commands that were used before.
- Execute a completed command.
- Get online help on commands.
- Display the error log and the event log.

---

### To turn the command line on or off in the Graphical User Interface

- To turn the command line on or off using the pulldown menu, choose **Settings**→**Command Line**.
- To turn the command line on or off using the status line popup menu: position the mouse pointer within the status line area, press and hold the *select* mouse button, and choose **Command Line On/Off** from the menu.
- To turn the command line off using the command line entry area popup menu: position the mouse pointer within the entry area, press and hold the *select* mouse button, and choose **Command Line Off** from the menu.



- To turn the command line on, position the mouse pointer in the main display area and start typing.

The above selections turn display of the command line area on or off. When it is on, the command line is displayed; you can use the softkey pushbuttons, the command return and recall pushbuttons, and the cursor pushbuttons for command-line editing. When it is off, the command line is not displayed; you use only the pulldown menus and the action keys to control the interface.

The command line area begins just below the status line and continues to the bottom of the emulator/analyzer window. The status line is not part of the command line; it will be displayed whether the command line is on or off.

Choosing certain pulldown menu items while the command line is off causes the command line to be turned on. That is because the menu item chosen requires some command-line input that cannot be supplied any other way.

---

## To enter commands on the command line

- In the Graphical User Interface, successively position the mouse pointer on pushbuttons and click the *pushbutton select* mouse button until a complete command is formed.
- Successively press keyboard function keys corresponding to softkey buttons until a complete command is formed.
- Type in the command you want to use. You must type in the full command name as shown in Chapter 11, "Emulator Commands." This may be different from the label on the corresponding softkey.
- Type in the first few characters of a command name, and press <Tab>. The interface will complete the command name automatically. Repeat this process until a complete command is formed.

## To edit the command line using the command line pushbuttons on the Graphical User Interface

- To position the cursor at a specific character, place the mouse pointer on the character and click the *select* mouse button.
- To clear the command line, click the **Clear** pushbutton.
- To clear the command line from the cursor position to the end of the line, click the **Clear to end** pushbutton
- To move to the right one command word or token, click the **Forward** pushbutton.
- To move to the left one command word or token, click the **Backup** pushbutton.
- To insert characters at the cursor position, press the **insert key** on your keyboard to change to insertion mode, and then type the characters to be inserted.
- To replace characters at the cursor position, press the **insert key** on your keyboard to change to replacement mode, and then type the replacement characters.
- To delete characters to the left of the cursor position, press the <BACKSPACE> key on your keyboard.

When the cursor arrives at the beginning of a command word or token, the softkey labels change to display the possible choices at that point in the command.

When moving by words to the left or right, the **Forward** pushbutton becomes gray and provides no function when the cursor reaches the end of the command string. The **Backup** pushbutton becomes gray and provides no function when the cursor reaches the beginning of the command.

## To edit the command line using the command line popup menu

- To position the cursor at a specific character, place the mouse pointer on the character and click the *select* mouse button.
- To clear the command line, position the mouse pointer within the Command Line entry area, press and hold the *select* mouse button until the Command Line popup menu appears, and then choose **Clear Entire Line** from the menu.
- To clear the command line from the cursor position to the end of the line, place the mouse pointer where you want the clear-to-end function to start. Press and hold the *select* mouse button until the Command Line popup menu appears, and then choose **Clear to End of Line** from the menu.
- To insert characters, position the mouse pointer where you wish to locate the text cursor (or over a non-text area to use the current text cursor location). Press and hold the *select* mouse button to display the Command Line popup menu, and then choose **Position Cursor, Insert Mode** from the menu. Type the characters to be inserted.
- To replace characters, position the mouse pointer where you wish to locate the text cursor (or over a non-text area to use the current text cursor location). Press and hold the *select* mouse button to display the Command Line popup menu, and then choose **Position Cursor, Replace Mode** from the menu. Type the characters to be inserted.

When the cursor arrives at the beginning of a command word or token, the softkey labels change to display the possible choices at that point in the command.



## To edit the command line using the keyboard

- In the Graphical User Interface, place the mouse pointer either in the display area, on the status line, or in the command line area. Then you can use the <Left arrow>, <Right arrow>, <Tab>, <Shift><Tab>, <Insert char>, <Back space>, <Delete char>, <Clear line>, and <CTRL>u keys to select points in the command line.
- Move to the next word on the command line by pressing the <Tab> key. Move to the previous word on the command line by pressing the <Shift><Tab> key combination.
- Enter more than one command on a command line by separating the commands with semicolons (;).
- Recall previous commands by pressing <Ctrl>r to cycle backward, or <Ctrl>b to cycle forward through the command line buffer.
- Delete the current command line by pressing <Ctrl>u.
- Clear the command line from the cursor position to the end of the line by pressing <Ctrl>e.

---

## To recall commands

- 1 In the Graphical User Interface, click the pushbutton labeled **Recall** in the Command Line area to display the dialog box.
- 2 Choose a command from the dialog box. (You can also enter a command directly into the Selection area of the dialog box.)

Because all command entry methods in the interface (pulldown menus, action keys, and command line entries) are echoed to the command line entry area, the contents

of the Command Recall dialog box is not restricted to just commands entered directly into the command line entry area.

The Command Recall dialog box contains a list of interface commands executed during the session as well as any predefined commands present at interface startup.

If you exit the emulation/analysis session with the interface "locked", commands in the recall buffer are saved and will be present when you restart the interface.

You can predefine entries for the Command Recall dialog box and define the maximum number of entries by setting X resources (refer to Chapter 13, "Setting X Resources."

See "To use dialog boxes" in this chapter for information about using dialog boxes.



---

## To execute a completed command

- In the Graphical User Interface, click the pushbutton labeled **Return** (near the bottom of the command line area).
- In the Graphical User Interface, position the mouse pointer in the command line entry area; press and hold the *select* mouse button until the Command Line popup menu appears; and then choose the **Execute Command** menu item.
- Press the <RETURN> key on the keyboard.

## To get online help on commands

- To get a dialog box that lists an index of helpful information in the Graphical User Interface, select **Help**→**General Topic...** or **Help**→**Command Line...**. Then choose a topic of interest from the Help Index.
- To get specific help about the operation of the command line on the Graphical User Interface, click the **Help** pushbutton located near the bottom, right-hand corner of the Command Line area.
- Get specific help about a command to be entered on the command line, type:

*help* <command\_name>

The <command\_name> parameter can be entered from the softkeys after you type **help**.

You can type a question mark (?) in place of the keyword **help**. When you use the **help** command, information about the command you selected (including syntax and sample usage) scrolls onto the screen.

The Help Index lists topics covering operation of the interface as well other information about the interface. When you choose a topic from the Help Index, the interface displays a window containing the help information. You may leave the window on the screen while you continue using the interface.

## To display the error log

- Choose **Display**→**Error Log**.
- Position the mouse pointer on the status line, press and hold the *select* mouse button, and then choose **Display Error Log** from the popup menu.
- Using the command line, enter **display error\_log**.

The last 100 error messages that have occurred during the emulation session are displayed.

---

## To display the event log

- Choose **Display**→**Event Log**.
- Position the mouse pointer on the status line, press and hold the *select* mouse button, and then choose **Display Event Log** from the popup menu.
- Using the command line, enter **display event\_log**.

The last 100 events that have occurred during the emulation session are displayed.

The status of the emulator and analyzer are recorded in the event log, as well as the conditions that cause the status to change (for example, breakpoints and trace commands).

## Using Special Features of the Graphical User Interface

The following paragraphs show you how to use pulldown and popup menus, the entry buffer, action keys, and dialog boxes to compose commands and control emulator and analyzer operation. These features are only available in the Graphical User Interface.

This section shows you how to:

- Choose a pulldown menu item.
- Choose a popup menu item.
- Place values into the entry buffer.
- Copy and paste from the entry buffer to the command line.
- Use action keys.
- Use dialog boxes.

---

### To choose a pulldown menu item using the mouse (method 1)

- 1 Position the mouse pointer over the name of the menu on the menu bar.
- 2 Press and hold the *command select* mouse button to display the menu.

While continuing to hold down the mouse button, move the mouse pointer to the desired menu item. If the menu item has a cascade menu (identified by an arrow on the right edge of the menu button), then continue to hold the mouse button down and move the mouse pointer toward the arrow on the right edge of the menu. The cascade menu will display. Repeat this step for the cascade menu until you find the desired menu item.

- 3 Release the mouse button to select the menu choice.



## Chapter 3: Using the emulator/analyzer interface Using Special Features of the Graphical User Interface

If you decide not to select a menu item, simply continue to hold the mouse button down, move the mouse pointer off of the menu, and release the mouse button.

Some menu items have an ellipsis ("...") as part of the menu label. An ellipsis indicates that the menu item will display a dialog or message box when the menu item is chosen.

---

### To choose a pulldown menu item using the mouse (method 2)

- 1 Position the mouse pointer over the menu name on the menu bar.
- 2 Click the *command select* mouse button to display the menu.
- 3 Move the mouse pointer to the desired menu item. If the menu item has a cascade menu (identified by an arrow on the right edge of the menu button), then repeat the previous step and then this step until you find the desired item.
- 4 Click the mouse button to select the item.

If you decide not to select a menu item, simply move the mouse pointer off of the menu and click the mouse button.

Some menu items have an ellipsis ("...") as part of the menu label. An ellipsis indicates that the menu item will display a dialog or other box when the menu item is chosen.

## To choose a pulldown menu item using the keyboard

- To initially display a pulldown menu, press and hold the menu select key (for example, the "Extend char" key on an HP 9000 keyboard), and then type the underlined character in the menu label on the menu bar. (For example, "f" for "File". Type the character in lower case only.)
- To move right to another pulldown menu after having initially displayed a menu, press the **right-arrow** key.
- To move left to another pulldown menu after having initially displayed a menu, press the **left-arrow** key.
- To move down one menu item within a menu, press the **down-arrow** key.
- To move up one menu item within a menu, press the **up-arrow** key.
- To choose a menu item, type the character in the menu item label that is underlined. Or, move to the menu item using the arrow keys and then press the **<RETURN>** key on the keyboard.
- To cancel a displayed menu, press the **Escape** key.

The interface supports keyboard mnemonics and the use of the arrow keys to move within or between menus. For each menu or menu item, the underlined character in the menu or menu item label is the keyboard mnemonic character. Notice the keyboard mnemonic is not always the first character of the label. If a menu item has a cascade menu attached to it, then typing the keyboard mnemonic displays the cascade menu.

Some menu items have an ellipsis ("...") as part of the menu label. An ellipsis indicates that the menu item will display a dialog or other box when the menu item is chosen.

Dialog boxes support the use of the keyboard as well. To direct keyboard input to a dialog box, you must position the mouse pointer somewhere inside the boundaries of the dialog box. That is because the interface *keyboard focus policy* is set to

*pointer*. That just means that the window containing the mouse pointer receives the keyboard input.

In addition to keyboard mnemonics, you can also specify keyboard accelerators which are keyboard shortcuts for selected menu items. Refer to Chapter 13, "Setting X Resources" and the "Softkey.Input" scheme file for more information about setting the X resources that control defining keyboard accelerators.



---

## To choose popup menu items

- 1 Move the mouse pointer to the area whose popup menu you wish to access. (If a popup menu is available, the mouse pointer changes from an arrow to a hand.)
- 2 Press and hold the *select* mouse button.
- 3 After the popup menu appears (while continuing to hold down the mouse button), move the mouse pointer to the desired menu item.
- 4 Release the mouse button to select the menu choice.

If you decide not to select a menu item, simply continue to hold the mouse button down, move the mouse pointer off of the menu, and release the mouse button.

The following popup menus are available in the Graphical User Interface:

- Mnemonic Memory Display.
- Breakpoints Display.
- Global Symbols Display.
- Local Symbols Display.
- Status Line.
- Command Line.

## To place values into the entry buffer using the keyboard

- 1 Position the mouse pointer within the text entry area. (An "I-beam" cursor will appear.)
- 2 Enter the text using the keyboard.

To clear the entry buffer text area from beginning until end, press the <CTRL>u key combination.

---

## To copy-and-paste to the entry buffer

- To copy and paste a discrete text string as determined by the interface, position the mouse pointer over the text to copy and click the *paste* mouse button.
- To specify the exact text to copy to the entry buffer: press and hold the *paste* mouse button; drag the mouse pointer to highlight the text to copy-and-paste; release the *paste* mouse button.

You can copy-and-paste from the display area, the status line, and from the command line entry area.

When you position the pointer and click the mouse button, the interface expands the highlight to include the most complete text string it considers to be discrete. Discrete here means that the interface will stop expanding the highlight in a given direction when it discovers a delimiting character not determined to be part of the string. A common delimiter would, of course, be a space.

When you press and hold the mouse button and drag the pointer to highlight text, the interface copies all highlighted text to the entry buffer when you release the mouse button.

Because the interface displays absolute addresses as hex values, any copied and pasted string that can be interpreted as a hexadecimal value (that is, the string

## Chapter 3: Using the emulator/analyzer interface Using Special Features of the Graphical User Interface

contains only numbers 0 through 9 and characters "a" through "f") automatically has an "h" appended.

---

**Note**

If you have multiple Graphical User Interface windows open, a copy-and-paste action in any window causes the text to appear in all entry buffers in all windows. That is because although there are several displays of the entry buffer, there is only one entry buffer; it is common to all windows. That means you can copy and paste a symbol or an address seen in one window and then use it in another window.

On a memory display or trace display, a symbol may not be completely displayed because there are too many characters to fit into the width limit for a particular column of the display. To make a symbol usable for copy-and-paste, you can scroll the screen left or right to display all, or at least more, of the characters from the symbol. The interface displays absolute addresses as hex values.

Text pasted into the entry buffer replaces that which is currently there. You cannot use paste to append text to existing text already in the entry buffer.

See "To copy-and-paste from the entry buffer to the command line entry area" for information about pasting the contents of the entry buffer into the command line entry area.



Chapter 3: Using the emulator/analyzer interface  
**Using Special Features of the Graphical User Interface**

**Example**

To paste the symbol (plus offset) "mmutest+0000000C" into the entry buffer from the interface display area, position the mouse pointer over the symbol and then click the paste mouse button.

A mouse click causes the interface to expand the highlight to include the symbol mmutest+0000000C and paste the symbol into the entry buffer.

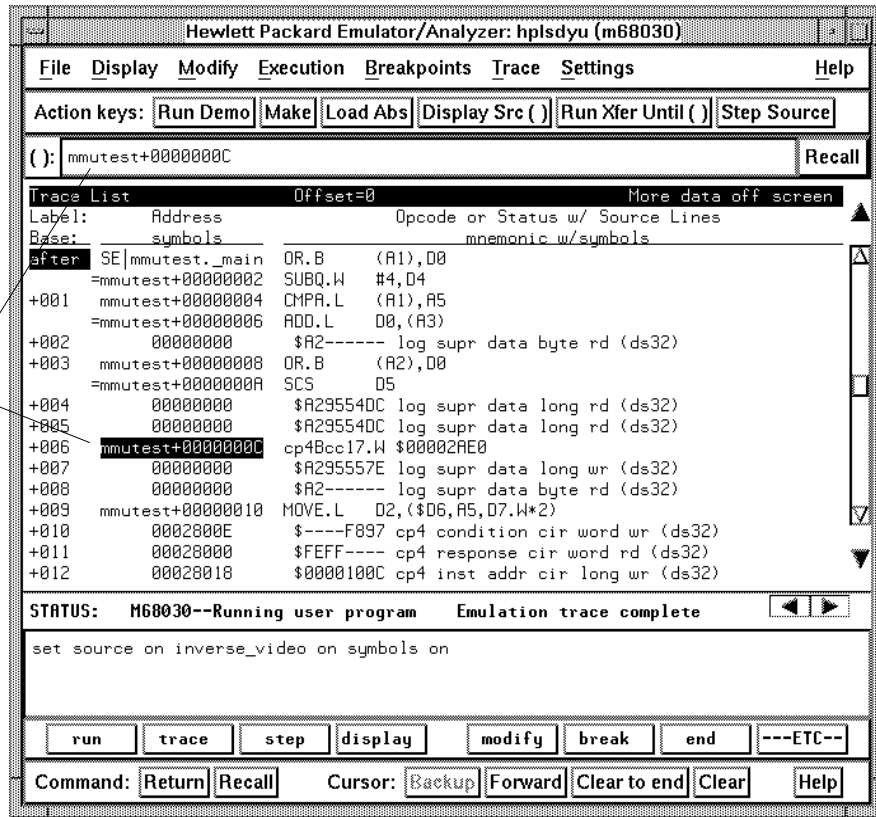

## To recall entry buffer values

- Position the mouse pointer over the **Recall** button just to the right of the entry buffer text area, click the mouse button to bring up the Entry Buffer Recall dialog box, and then choose a string from that dialog box.

The Entry Buffer Recall dialog box contains a list of entries gained during the emulation session as well as any predefined entries present at interface startup.

If you exit the emulation/analysis session with the interface 'locked', recall buffer values are saved and will be present when you restart the interface.

You can predefine entries for the Entry Buffer Recall dialog box and define the maximum number of entries by setting X resources (refer to Chapter 13, "Setting X Resources."

See the following "To use dialog boxes" section for information about using dialog boxes.

---

## To use the entry buffer

- 1 Place information into the entry buffer (see the previous "To place values into the entry buffer using the keyboard", "To copy-and-paste to the entry buffer", or "To recall entry buffer values" task descriptions).
- 2 Choose the menu item, or click the action key, that uses the contents of the entry buffer (that is, the menu item or action key that contains "()").

## To copy-and-paste from the entry buffer to the command line entry area

- 1 Place text to be pasted into the command line in the entry buffer text area.

You may do that by:

- Copying the text from the display area using the copy-and-paste feature.
- Enter the text directly by typing it into the entry buffer text area.
- Choose the text from the entry buffer recall dialog box.

- 2 Position the mouse pointer within the command line text entry area.

- 3 If necessary, reposition the cursor to the location where you want to paste the text.

- 4 If necessary, choose the insert or replace mode for the command entry area (by pressing the <insert> key on the keyboard).

- 5 Click the *command paste* mouse button to paste the text in the command line entry area at the current cursor position.

The entire contents of the entry buffer are pasted into the command line at the current cursor position.

Although a paste from the display area to the entry buffer affects all displayed entry buffers in all open windows, a paste from the entry buffer to the command line only affects the command line of the window in which you are currently working.

See "To copy-and-paste to the entry buffer" for information about pasting information from the display into the entry buffer.



## To use the action keys

- 1 If the action key uses the contents of the entry buffer, place the required information in the entry buffer.
- 2 Position the mouse pointer over the action key and click the action key.

Action keys are user-definable pushbuttons that perform interface or system functions. Action keys can use information from the entry buffer — this makes it possible to create action keys that are more general and flexible.

Several action keys are predefined when you first start the Graphical User Interface. Some of these perform tasks and others show you how to define and use action keys. You'll really appreciate action keys when you define and use your own.

Action keys are defined by setting an X resource. Refer to Chapter 13, "Setting X Resources" for more information about creating action keys.

---

## To use dialog boxes

- 1 Click on an item in the dialog box list to copy the item to the text entry area of the dialog box.
- 2 Edit the item in the text entry area (if desired).
- 3 Finally:
  - Click on the "OK" pushbutton to make the selection and close the dialog box.
  - Click on the "Apply" pushbutton to make the selection and leave the dialog box open.
  - Click on the "Cancel" pushbutton to cancel the selection and close the dialog box.

## Chapter 3: Using the emulator/analyzer interface

### Using Special Features of the Graphical User Interface

The Graphical User Interface uses a number of dialog boxes for selection and recall:

|                        |  |
|------------------------|--|
| Directory Selection    | Selects the working directory. You can change to a previously accessed directory, a predefined directory, or specify a new directory.                                    |
| File Selection         | From the working directory, you can select an existing file name or specify a new file name.   |
| Entry Buffer Recall    | You can recall a previously used entry buffer text string, a predefined entry buffer text string, or a newly entered entry buffer string, to the entry buffer text area. |
| Command Recall         | You can recall a previously executed command, a predefined command, or a newly entered command, to the command line.   |
| Settings Display Modes | You can set the display mode and customize the display presentation for memory and trace list displays.  |
| Modify Register        | You can view and modify values of any selected register, as well as recalling previous values of the registers.  |
| Symbol Selection       | Selects the current working symbol (cws). You can change to a previously accessed cws, a predefined cws, or specify a new cws.   |

The dialog boxes share some common properties:

- Most dialog boxes can be left on the screen between uses.
- Dialog boxes can be moved around the screen and do not have to be positioned over the Graphical User Interface window.
- If you iconify the interface window, all dialog boxes are iconified along with the main window.

Except for the File Selection dialog box, predefined entries for each dialog box (and the maximum number of entries) are set via X resources (refer to Chapter 13, "Setting X Resources.")

**Examples**

To use the File Selection dialog box:

The file filter selects specific files.

A list of filter-matching files from the current directory.

A list of files previously accessed during the emulation session.

A single click on a file name from either list highlights the file name and copies it to the text area. A double click chooses the file and closes the dialog box.

Label informs you what kind of file selection you are performing.

Text entry area. Text is either copied here from the recall list, or entered directly.

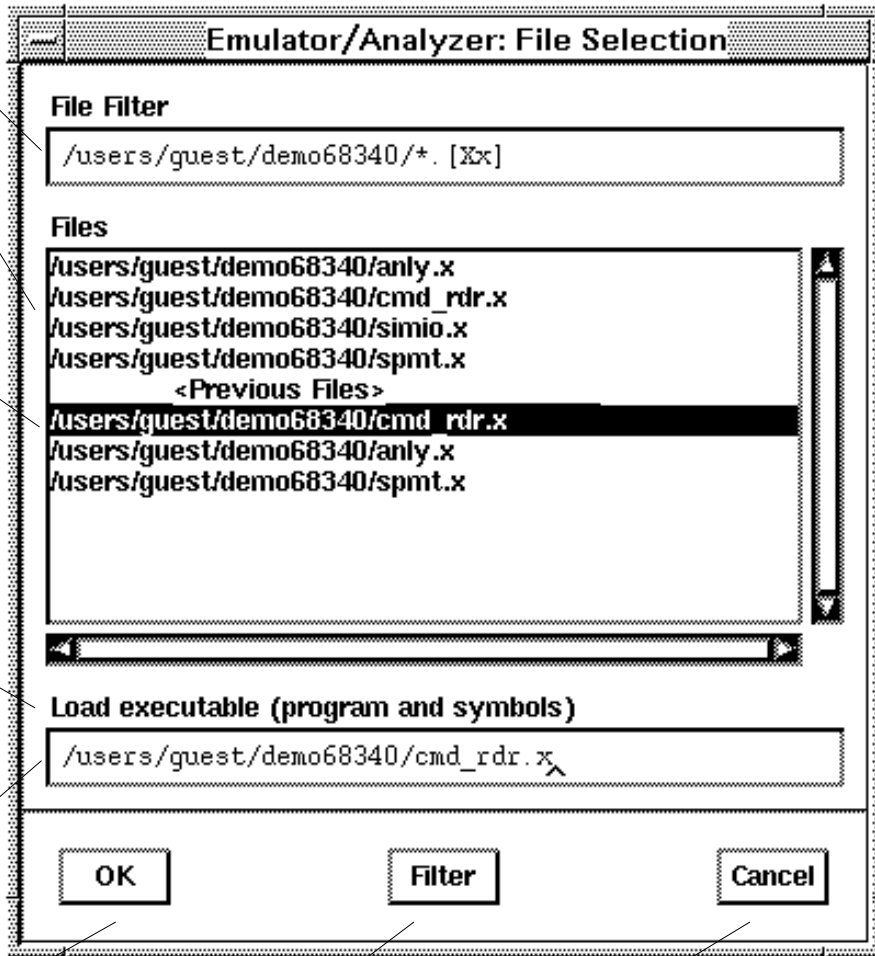

Clicking this button chooses the file name displayed in the text entry area and closes the dialog box.

Entering a new file filter and clicking this button causes a list of files matching the new filter to be read from the directory.

Clicking this button cancels the file selection operation and closes the dialog box.

Chapter 3: Using the emulator/analyzer interface  
Using Special Features of the Graphical User Interface

To use the Directory Selection dialog box:

Label informs you of the type of list displayed.

A list of predefined or previously accessed directories.

A single click on a directory name from the list highlights the name and copies it to the text entry area. A double click chooses the directory and closes the dialog box.

Text entry area. Directory name is either copied here from the recall list, or entered directly.

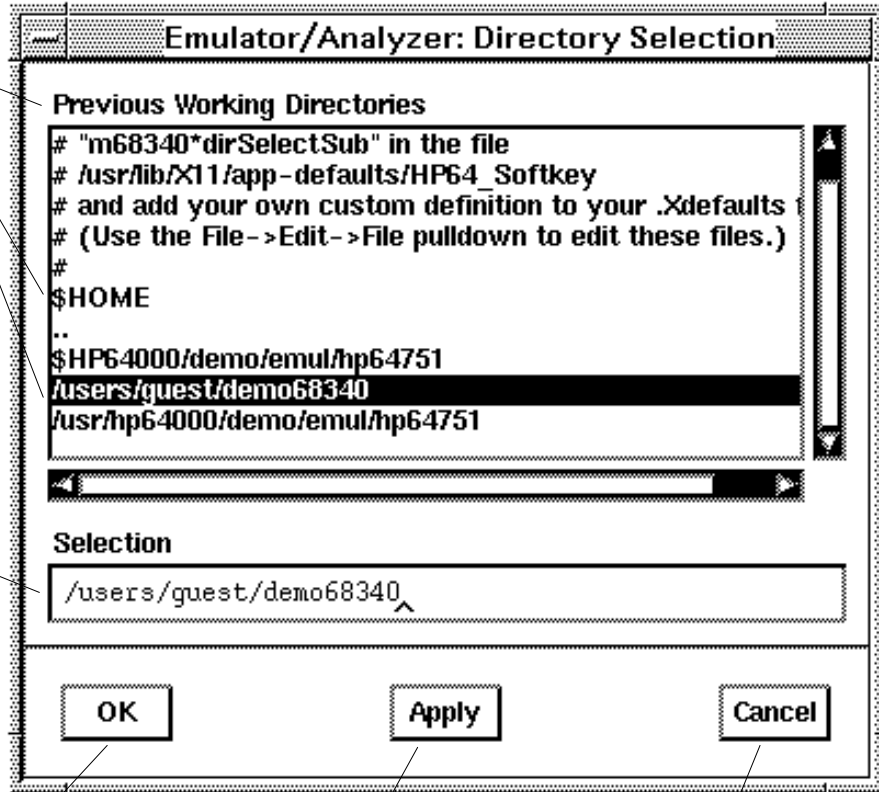

Clicking this button chooses the directory displayed in the text entry area and closes the dialog box.

Clicking this button chooses the directory displayed in the text entry area, but keeps the dialog box on the screen instead of closing it.

Clicking this button cancels the directory selection operation and closes the dialog box.

## Using display-control features of the Softkey Interface

- Use the following control-key combinations to redraw, reposition, and update the display of the Softkey Interface:

| Input   | Result                        |
|---------|-------------------------------|
| <Ctrl>l | To redraw the current display |
| <Ctrl>f | To roll the display left      |
| <Ctrl>g | To roll the display right     |
| <Ctrl>s | To stop screen updates        |
| <Ctrl>q | To resume screen updates      |

You can roll the display left and right only if there is more information than will fit into 80 columns.



## Copying information to a file or printer

- Choose **File**→**Copy**. Select the type of information from the cascade menu (see copy options below), and use the dialog box to select the file or printer.
- Using the command line, enter a command such as:

```
copy <copy option> to <destination>
```

Where <copy option> has a name similar to those listed below (available through softkey selection), and <destination> is a printer or the name of a file.

ASCII characters are copied to the file or printer. If you copy information to an existing file, it will be appended to the file. Details of the copy options are discussed in the following paragraphs.

**Display ...** Copies information currently in the display area. This option is useful for restricting the number of lines that are copied. Also, this option is useful for copying the contents of register classes other than BASIC.

**Memory ...** Copies the contents of a range of memory. The format is the same as specified in the last display memory command. For example, if you copy memory after displaying a range of memory in mnemonic format, the file would contain the mnemonic memory information. If there is no previous display memory command, the format used is a blocked hex byte format beginning at address zero.

**Data Values ...** Copies the contents of the defined data values last displayed. An error occurs if you try to copy data values to a file if you have not yet displayed data values.

**Trace ...** The most recently captured trace is copied to the file. The copied trace listing is formatted according to the current display mode.

You can set the display mode with the **Settings**→**Source/Symbols Modes** or **Settings**→**Display Modes** pulldown menu items. See the "Changing the Interface Settings" section.

**Registers ...** Copies the current values of the BASIC register class to a file. To copy the contents of the other register classes, first display the registers in that class, and then use the **File**→**Copy**→**Display ...** command.

Chapter 3: Using the emulator/analyzer interface  
**Copying information to a file or printer**

**Breakpoints ...** Copies the breakpoints list. If no breakpoints are present in the list, only the enable/disable status is copied.

**Status ...** Copies the emulator/analyzer status display.

**Global Symbols ...** Copies the global symbols. If symbols have not been loaded, this menu item is grayed-out and unresponsive.

**Local Symbols () ...** Copies the local symbols from the symbol scope named (by an enclosing symbol) in the entry buffer. If symbols have not been loaded, this menu item is grayed-out and unresponsive.

**Pod Commands ...** Copies the last 100 lines from the pod commands display.

**Error Log ...** Copies the last 100 lines from the error log display.

**Event Log ...** Copies the last 100 lines from the event log display.

See the **copy** command syntax in Chapter 11, "Emulator Commands" for more information.



## **Exiting the Emulator/Analyzer Interface**

The following paragraphs show you how to end single instances of the interface in selected windows, and how to exit from the interface and end your session.

This section shows you how to:

- End a single window in the interface.
- End the emulation session in all windows.

---

### **To end a single window in the interface**

- In the interface window you wish to close, select **File**→**Exit**→**Window**.
- If using the command line, in the interface window you wish to close, enter:

*end*

This ends the interface instance in the window where the command is executed. None of the other windows are affected.

If the window is the only window into the emulation session, the above command ends the emulation session and leaves the emulator in a locked state. Emulators restarted from a locked state will reload the last valid configuration and absolute file.



## To end the emulation session in all windows

- To exit all windows, save your configuration to a temporary file, and lock the emulator so it cannot be accessed by others, select **File→Exit→Locked**.

If using the command line, enter:

*end locked*

- To exit all windows and release the emulator for use by others, select **File→Exit→Released**.

If using the command line, enter:

**end release\_system**

If you exit locked, the interface saves the current configuration to a temporary file and locks the emulator to prevent other users from accessing it. When you again start the interface with the **emul700** command, the temporary file is reloaded, and you return to the configuration you were using when you quit.

Also, when you end locked, the contents of the entry buffer and command recall buffer are saved. These recall buffer values will be present when you restart the interface.

In contrast, if you end released, all changes you made to your configuration are lost. You may want to save your current configuration to a configuration file before you end released.



## Creating and Executing Command Files

A command file is an ASCII file containing command-line commands. The interface can read a command file and execute the commands found there as if the commands were entered one-by-one on the command line. Command files can, in turn, call other command files. The interface will execute the called file like a subroutine of the calling file.

You can create command files from within the interface by logging commands to a command file as you execute commands. You can also create a command file outside the interface with an ASCII text editor. Logging commands from the command line has the advantage of making sure the commands are syntactically correct when they reach the command file. Syntactically incorrect commands found by the interface will cause it to halt execution of a command file.

With a single command file, you can automate a complete test procedure. For example, you could start the interface and then execute a command file that would perform the following steps:

- 1 Load a configuration file.
- 2 Load an absolute file.
- 3 Modify registers or memory locations.
- 4 Set up a trace specification.
- 5 Start the program running.
- 6 Capture a trace.
- 7 Save the trace listing to a file.

Command files are also useful for saving very complex trace specifications so that they can be used again during another emulation session, or by other people.

## Passing Parameters to Command Files

Command files can accept parameters. Parameters are like variables in the command file and are usually used in place of explicit arguments to interface commands. A command file that accepts parameters can be made more general than a command file containing explicit argument values and can apply to a wider range of uses.

Parameters can be passed in either of two ways. You can pass the parameters on the command line when you execute the command file, or you can execute the command file without the parameters and let the interface prompt you for the parameters.

Parameters must be declared at the beginning of a command file using the **PARMS** keyword. Parameters are preceded by an ampersand (&) and consist of a combination of one or more letters or underscores. Letters may be upper-case or lower-case.

### **Using &ArG\_IeFt in Command Files**

A command file may contain a special argument named **&ArG\_IeFt**. This special argument does not have to be declared using the **PARMS** keyword. It can be used in command files containing other parameters, or in command files that do not contain any parameters. This special argument can accept the union of zero or more command line arguments as a single argument. See “To increase flexibility of command files by using &ArG\_IeFt” for more information.



### **Using UNIX Commands and Scripts with Command Files**

Command files may include UNIX commands and may call shell scripts. Some commands are recognized directly by the interface (**pwd**, for example) while others require a preceding exclamation point (!) to identify them as shell commands.

### **Using Shell Variables with Command Files**

Command files may contain shell variables. Command files only support shell variables beginning with “\$”, followed by an identifier. An identifier is composed of an underscore or a letter followed by zero or more letters, digits, or underscores. Identifiers may follow the “\$” symbol directly, or follow the “\$” enclosed in braces “{ }”. An identifier *must* be enclosed in braces if any letter, digit, or underscore that is not part of the identifier immediately follows the identifier. Otherwise, the following text will be interpreted as part of the identifier. You can examine any shell variables defined for your environment by using the UNIX **env** command. Positional shell variables, such as \$1, \$2, and so on, are not supported. Neither are special shell variables, such as \$@, \$\*, and so on.

To illustrate how shell variables work, consider the shell variable “S”, defined to be the string “soft”. Suppose you wanted to use the shell variable to reference the directory “/users/softkey”. The reference “/users/\${S}key” would produce the desired directory name. However, the reference “/users/\$Skey” would cause the shell variable “Skey” to be searched for.

## Restrictions on Commands

There are certain commands that you cannot execute from a command file. These are commands that require a response from you. For example, you cannot place modify configuration commands in a command file because the command file cannot “respond” to configuration questions.

Another restriction has to do with calling a command file from an executing command file when the called command file requires parameters. You must supply the parameters with the call to the command file, or the calling command file will abort. That is because the calling command file cannot respond to the called file’s parameter prompts.

## Status Line Updates

The emulator status line is not always immediately updated with new status information when the interface executes commands from a command file. You may have to explicitly display the emulator status after a command file has executed by issuing a **display status** command.

## Nesting Command Files

You can call other command files from an executing command file. Called files can, in turn, call other command files. This nesting of calls can continue to a maximum of eight levels. Command files called from an executing command file are executed like subroutines of the calling file. Control returns to the calling file after the called file has executed.

## Pausing Command Files

You can use the **wait** command in command files. This allows you to pause execution of the command file between commands.

A variation of the wait command, the **wait measurement\_complete** command, should be used after starting a trace. Use this command so that a copy or display command following a trace command will not execute until states from the new trace are available for copy or display.

If you press <CTRL>c to stop execution of a command file while the "wait" command is being executed from the command file, the <CTRL>c will terminate the "wait" command, but will not terminate command file execution. To do this, press <CTRL>c again.

## **Placing Comments in Command Files**

As with any source file, comments in command files can help to explain the operation of the command file, and record creation and modification information. You can place comments in a command file either by using a text editor or by entering the comment as a “command” in the interface command line while logging commands. A special character, the pound sign (#), causes the interface to ignore comments in command files, and also allows you to log comments to a command file from the command line. A comment may appear on a line by itself, or it may *follow* a command on a line. Commands cannot appear on a line after the comment character because they will be interpreted as part of the comment.



## **Continuing Command File Lines**

You can continue command file lines across several physical text file lines. This is done by using a continuation character.

The continuation character is the backslash (\) character. Placing a backslash at the end of the line just before the line feed causes the following line to be concatenated with the current line. Multiple lines can be concatenated by ending all but the last line with a backslash. The concatenated lines will be treated as a single command line. Note that if you end the last line of a command file with a backslash, the command will appear in the interface command line, but will not be executed.

## **Specifying a Search of Several Command File Directories**

**HP64KPATH** is a special shell variable you can set to specify alternative search paths for command files. HP64KPATH works much like the UNIX PATH in that you can specify several directories, separated by colons (:), to be searched.

The remainder of this section lists the tasks associated with creating and using command files.

## To create a command file by logging commands

- 1 Select **File**→**Log**→**Record...** and use the dialog box to select a command file name. If using the command line, enter the command:

```
log_commands to <filename>
```

- 2 Enter and execute commands to complete the desired task.
- 3 Stop logging commands by selecting **File**→**Log**→**Stop**. If using the command line, enter the command:

```
log_commands off
```

The above commands provide a mechanism that logs commands, entered and executed at the command line, to a file. Later, the command file can be executed by the interface. The **log\_commands** command does not appear on the softkeys. Type it on the command line, or type the first few letters of the command and then press <TAB>.

All commands entered on the command line after you type **log\_commands to <filename>** are logged to the <filename> until either the **log\_commands off** command is used or the interface is exited.

<filename> is any valid UNIX file name. File names may include path information. If <filename> already exists, commands are appended to the current contents of the file, unless the **noappend** option is used. If <filename> does not exist, a new file is created.

File creation errors can sometimes be caused by write permission violations of either files or directories. If you are having trouble creating a command file, make sure you have the correct permissions.

---

**Example**

To save a set of commands in the file STARTEMUL by logging commands while executing them during an emulation session, enter the following commands in the command line:

```
log_commands to STARTEMUL
# You can add a comment to a file while logging if you
# precede the comment with a pound sign.
# The Softkey Interface will
# ignore the rest of the line up to the line feed.
load configuration bigproject/config
load bigproject/program
trace after START
run from 2000h # Comments can follow on the same line
wait measurement_complete
# The preceding wait command variation ensures that
# new trace states will be available in the trace buffer
# before the "display trace" command is executed.
display trace
log_commands off
```

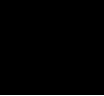

---

---

## To create a command file by using a text editor

- Use a text editor to create the command file.

A command file is a text file containing commands in the form that appear on the command line. You can create command files with an ASCII text editor, such as **vi**.

Make sure that the commands you create in your command file are syntactically correct. Syntactically incorrect command lines will halt command file execution.

## To execute (or playback) a command file

- To execute a command file at interface startup, use the **-c <command file name>** option with your **emul700** command.
- To execute a command file from within the Graphical User Interface, select **File→Log→Playback** and use the dialog box to select the name of the command file you wish to execute.
- To execute a command file using the command line, enter the name of the command file and press <RETURN>.

Any name entered on the command line that is not recognized as a member of the emulator/analyzer command set will be treated as the name of a command file. Command file names may be preceded by directory paths.

If the command file name does not have a directory path prefixed to it, the interface will search for it as follows:

- If the environment variable **HP64KPATH** is set, the interface will first search in all directories listed in the **HP64KPATH** variable. If the interface does not find the command file in those directories, it then searches the current working directory for the command file.
- If the environment variable **HP64KPATH** is *not* set, the interface searches only in the current working directory for the command file.

If the command file name has a path name prefixed to it, the interface will only look in the specified path for the command file.

See “To specify the order of searching several command file directories (HP64KPATH)” for more information about the **HP64KPATH** variable.

To interrupt execution of a command file, press the <CTRL>c key combination. (The mouse pointer must be within the interface window.)

If you press <CTRL>c to stop execution of a command file while the "wait" command is being executed from the command file, <CTRL>c will terminate the "wait" command, but will not terminate command file execution; in this case, you must press <CTRL>c again.



---

**Examples**

Suppose you have a command file named STARTEMUL, it is located in your current working directory, and it contains the following commands:

```
log_commands to STARTEMUL
load configuration bigproject/config
load bigproject/program
trace after START
run from 2000h
wait measurement_complete
# The preceding wait command variation ensures that
# new trace states will be available in the trace buffer
# before the "display trace" command is executed.
display trace
log_commands off
```

If you start the emulation session and enter STARTEMUL (the command file name) in the command line, all commands from **load configuration...** to **display trace** will be sequentially executed on the command line.

---

---

## To nest command files

- Call a command file from an executing command file by including the command file name in the executing command file.

The emulation/analyzer interface executes commands found in a command file just as if they were entered into the command line. That means if the interface encounters a command that is not part of its own command set, it will attempt to execute it as a command file. (See “To execute a command file” in this section for an explanation of command file execution.)

Command files called from other command files may be nested to a maximum of eight levels. Control returns to the calling command file after the called command file is executed. A called command file is like a subroutine of the calling command file.

## Chapter 3: Using the emulator/analyzer interface

### Creating and Executing Command Files

Command files requiring parameters must have those parameters supplied by the calling command file as part of the call. Failure to supply the parameters causes an error and a halt of the calling command file.

---

#### Example

The first command file (named “cmdfile1”) calls the second (named “cmdfile2”) and then executes a single instruction after control returns.

```
cmdfile1:

cmdfile2
display memory

cmdfile2:

load configuration democfg
load demo
```

---

### To pause command file execution

- To pause execution of a command file until the SIGINT (<CTRL>c) signal is received, use the **wait** command.
- To pause execution of a command file for a specific amount of time, use the **wait <time>** command, where <time> is in seconds.
- To pause execution of a command file until a trace trigger has been found and the trace buffer is filled, use the **wait measurement\_complete** command.

You may want to add a delay to a command file under certain conditions. For example, you may want to execute a command file up to a certain point, have it display a screen, and then pause while you examine the output on the screen.

Place **wait measurement\_complete** in your command file following a trace command to ensure that the trace completes before command file execution continues. This ensures that subsequent trace display or trace copy commands use the new trace states, not states from a previous trace.

A **wait** command without parameters will cause execution to pause until the <CTRL>c key combination is entered. If you have a command file that is hanging on a **wait** command, check to make sure that the wait has a <time> or a **measurement\_complete** argument.

---

**Examples**

Pause a command file for 5 seconds by placing the following command in the command file:

```
wait 5
```

Pause a command file until a trace trigger has been satisfied and the trace buffer has filled by placing the following command after a trace command in a command file:

```
wait measurement_complete
```

---

---

## To add a comment to a command file

- Use a pound sign (#) to precede the comment string.

You can use this technique either while logging commands to a file during an emulation session, or when you are creating a command file with a text editor. Any text that follows the comment character, up to the next new line, is ignored by the interface. Comments may appear on lines by themselves, or comments may *follow* commands on the same line.

---

**Example**

Two variations of comments are shown in the following command file fragment:

```
# The next command is the default trace command  
trace  
wait measurement_complete # make sure the trace buffer  
# has new states  
display trace
```

---

## To pass parameters to a command file

- 1 Define formal parameters on the first line of the command file following the **PARMS** keyword.
- 2 Pass actual parameters to the command file when it is executed.

A *formal parameter* is composed of an ampersand (&) followed by one or more letters or underscores. Formal parameters are like variables in the command file. Formal parameters are replaced by actual parameters when the command file is executed.

An *actual parameter* is an ASCII string that represents a symbol or value. Actual parameters containing blanks must be enclosed in single or double quotes.

Actual parameters are supplied to the command file in two ways.

- As arguments to the command file entered on the command line along with the command file name. Values are *positional*. Enter a value for the first parameter that follows the PARMS keyword in the command file immediately following the command file name on the command line. Enter a value for the second parameter second after the command file name. And so on.
- In response to prompts from the interface. If a formal parameter exists in the command file and no actual parameter was passed to it on the command line, the interface will prompt you for a value for the formal parameter. If you enter a command file name without supplying *any* actual parameters, the interface will prompt you for values for *all* the formal parameters.

You may use either method to supply parameters, or a combination of the two. Being prompted for the parameters relieves you from having to remember the parameters.

If, from another command file, you call a command file that requires parameters, you must supply all the parameters with the call. The calling command file cannot respond to parameter prompts; an error will occur and the calling command file will halt.

---

**Examples**

The following command file, called “loadany,” is a general command file for loading a configuration file and then an executable file.

```
PARMS &cfgname &binfile  
load configuration &cfgname  
load &binfile
```

The following command, entered on the command line, calls the command file “loadany” and passes the actual parameters needed by the command file:

```
loadany democfg demo
```

You could start the command file “loadany” without parameters and allow the interface to prompt you for the actual parameters. Issue the command:

```
loadany
```

and then respond to the parameter prompts. A prompt for the “cfgname” parameter for this command file will look like the following:

```
STATUS: M68020--Running in monitor-----....  
Define command file parameter [&cfgname]
```

You might also start the command file, supply just the first parameter, and have the interface prompt you for the second parameter. Issue the command:

```
loadany democfg
```

to cause the interface to prompt you for the second parameter (&binfile).

---



## To increase flexibility of command files by using **&ArG\_IeFt**

- 1 Use the special parameter **&ArG\_IeFt** anywhere in the command file.
- 2 Pass zero or more arguments to the command file on the command line.

You can create highly flexible command files using the special parameter **&ArG\_IeFt**. It must be entered with the preceding ampersand (&) and exactly in the combination of upper and lower case letters shown here. It is not a parameter in the sense of command file formal and actual parameters. (See “To pass parameters to a command file” for more information.) Instead, it is a special parameter that may be included in either a command file with formal parameters or in a command file without formal parameters.

When the interface finds **&ArG\_IeFt** in a command file, it replaces it with the union of all arguments remaining in the string of arguments passed to the command file. Arguments for this special parameter must be passed on the command line and can be zero or more in number. The interface *will not* prompt for a value for **&ArG\_IeFt**. If you do not pass any values, the interface removes the special parameter and executes the command associated with the special parameter without any arguments.

---

### Example

The following three commands are all variations of the **display memory** command:

```
display memory
display memory 1000h
display memory 1000h, 2000h thru +20h, 3000h
```

The first command displays memory in the format specified by the last memory display command. The second command displays memory at address 1000h in blocked word format. The third command displays memory at two specific memory locations and also from a range of locations all in a single blocked word display.

The following command file (consisting of one line), called “dm,” can be used to implement all three commands:

```
display memory &ArG_lEfT
```

The following three command-file invocations replicate the three separate commands:

```
dm  
dm 1000h  
dm 1000h, 2000h thru +20h, 3000h
```

---

## To specify the order of searching several command file directories (HP64KPATH)

- Set the environment variable **HP64KPATH** to one or more alternative directory paths. Separate each path from the others with a colon (:).

You can set the environment variable HP64KPATH to specify alternative directories for command files. If this variable is set, the interface searches each path listed in the variable successively until the command file it is searching for is found or no more paths exist. If the command file has not been found after this search, then the interface looks in the current working directory for the command file. If this variable is not set, the interface only searches the current working directory.

This variable is typically set to point to a common directory of command files that might be used by several people. You could also use this variable so that you would not have to store command files in the same working directory as, say, source files for a project.

The directories listed in the HP64KPATH variable are *not* searched if the command file has an explicit path name prefixed to it.

Use **set** to specify or change this variable if you are using the command line. Use **export** to set this variable from your HP-UX *.profile* file.

## Chapter 3: Using the emulator/analyzer interface

### Creating and Executing Command Files

---

#### Examples

Set this variable, from within the interface, to cause the interface to search first the “/users/common/cmdfiles” directory, then the “/users/myid/cmdfiles” directory, and then the current working directory, by issuing either of the two following **set** commands:

```
set HP64KPATH=/users/cmdfiles:/users/myid/cmdfiles
```

or

```
set HP64KPATH=/users/cmdfiles:/users/myid/cmdfiles:.
```

Force the current working directory to be the first directory searched instead of the last directory searched by including the dot symbol as the first directory in the HP64KPATH, as in

```
set HP64KPATH=./:/users/cmdfiles:/users/myid/cmdfiles
```

By making the current directory the first in the path, you speed up command file access for command files in the current working directory because the interface would otherwise search the current working directory only after searching all of the other directories listed in HP64KPATH.

---



## **Forwarding Commands to Other HP 64700 Interfaces**

To allow the emulator/analyzer interface to run concurrently with other HP 64700 interfaces like the high-level debugger and software performance analyzer, a background "daemon" process is necessary to coordinate actions in the interfaces.

This background process also allows commands to be forwarded from one interface to another. All interfaces having software versions above 5.00 may forward commands; only Graphical User Interfaces can receive forwarded commands. Commands are forwarded using the **forward** command available in the command line. The general syntax is:

```
forward <interface_name> "<command_string>" <RETURN>
```

This section shows you how to:

- Forward commands to the high-level debugger.
- Forward commands to the software performance analyzer.

---

### **To forward commands to the high-level debugger**

- Enter the **forward debug "<command\_string>"** command using the command line.

---

#### **Examples**

To send the Program Run" command to the debugger:

```
forward debug "Program Run" <RETURN>
```

Or, since only the capitalized key is required:

```
forward debug "P R" <RETURN>
```

---

## To forward commands to the software performance analyzer

Enter the **forward perf "<command\_string>"** command using the command line.

---

### Examples

To send the "profile" command to the software performance analyzer:

```
forward perf "profile" <RETURN>
```

---

---

## Accessing the Terminal Interface

The Terminal Interface is the name given to a primitive command set that resides in the emulator firmware. The Terminal Interface is described in the *MC68020/MC68EC020 and MC68030/MC68EC030 Emulators Terminal Interface User's Guide*. You may sometimes need to use Terminal Interface commands during an emulation session. For example, you must use a Terminal Interface command to run the emulator's internal performance verification (**pv**) test.

You can access the Terminal Interface of the emulator directly through *pod commands* in your high-level interface (Graphical User Interface or Softkey Interface). The high-level interface provides a screen to display Terminal Interface output and two ways to use the keyboard to input Terminal Interface commands.

Terminal Interface commands bypass the high-level interface and are executed directly by the emulator firmware. For that reason, the high-level interface can become out-of-sync with the emulator if you use certain Terminal Interface commands. Changing configuration items, for example, will cause the actual state of the emulator to be different from the internal record of the state of the emulator that is kept by the high-level interface. Changing communications parameters can prevent the high-level interface from communicating further with the emulator, and cause abnormal termination of the interface. Be careful when using Terminal Interface commands to avoid creating problems for the high-level interface. The following table lists some Terminal Interface commands to avoid, and why:

| Commands     | Reasons to Avoid   |
|--------------|--|
| stty, po, xp | Do not use. Will change the channel operation and hang emulator. |
| echo, mac    | Usage may confuse the channel protocol.                          |
| wait         | Do not use, will block access to emulator.                       |
| init, pv *   | Will reset emulator and force <b>end release_system</b> .        |
| t            | Do not use. Will confuse trace status polling and unload.        |

\**Performance verification (pv)* is an internal self-test of the emulator hardware. If you suspect any problems with your emulation system hardware, use the Terminal Interface command "pv" to run the internal self-test. pv is on this list of pod commands to avoid because running it will reset the emulator and end the emulation session. That does not mean you should not run pv if you suspect

## Chapter 3: Using the emulator/analyzer interface

### Accessing the Terminal Interface

hardware trouble. Just be aware that it will terminate the emulation session if you do run it.

See the *MC68020/MC68EC020 and MC68030/MC68EC030 Emulators Terminal Interface User's Guide* for more information about the Terminal Interface.

The remainder of this section explains how to display the Terminal Interface screen, copy the Terminal Interface screen to a file, and enter Terminal Interface commands.

---

### To display the Terminal Interface screen

- Select **Display**→**Pod Commands**. If you are using the command line, enter:

```
display pod_command
```

The interface will accept Terminal Interface commands, but will not show the results (output) of those commands unless the Terminal Interface (pod command) screen is displayed. Generally, you display this screen before entering one or more pod commands.

---

### To copy the Terminal Interface screen contents to a file

- To append the contents of the Terminal Interface screen to the contents of a file, select **File**→**Copy**→**Pod Commands ...**, or if using the command line, enter:

```
copy pod_cmd to <filename>
```

- To replace the contents of a file with the contents of the Terminal Interface screen, on the command line enter **copy pod\_cmd to <filename> noappend**.

You can save the current contents of the Terminal Interface screen to a file by using the copy command. Additionally, you can copy the Terminal Interface screen to a printer or to a UNIX command by using other copy command options. Refer to Chapter 11 “Emulator Commands” for more information about copy command options.

**<filename>** is any valid UNIX file name. The file name may include path information. If the file does not exist, the interface creates it. File creation errors can sometimes be caused by UNIX permission violations on files or subdirectories. Make sure you have write permission on the file and on the directory where you intend to create the file.



---

## To enter Terminal Interface commands

- 1 To execute just one or two Terminal Interface commands, enter the Terminal Interface command, enclosed in double quotes, as an argument to **pod\_command** on the command line.

or

- 2 If you expect to enter several Terminal Interface commands, enable Terminal Interface command pass-through and disable high-level interface command processing by selecting **Settings**→**Pod Command**→**Keyboard**, or on the command line, enter **pod\_command keyboard**.
- 3 Enter the desired Terminal Interface commands.
- 4 End Terminal Interface command pass-through and re-enable high-level interface command processing by pressing the **suspend** softkey.

Before you enter a Terminal Interface command, you should use the **display pod\_command** command to display the Terminal Interface screen. If you do not display the Terminal Interface screen, you cannot see the output from the Terminal Interface commands you enter.

If you are entering a single Terminal Interface command, the **pod\_command** “**<command>**” variation is useful. However, entering a series of pod commands is

## Chapter 3: Using the emulator/analyzer interface

### Accessing the Terminal Interface

easier if done from the **keyboard**. While **keyboard** entry is in effect, the interface passes all keyboard input through to the Terminal Interface. The Terminal Interface validates and executes all commands directly and displays the results on the Terminal Interface screen.

---

#### Examples

Access the Terminal Interface and display memory locations 0 through 20 in long word format:

```
display pod_command  
pod_command "m -d1 0..20"
```

Access the Terminal Interface from the command line, check the emulator status, then the trace configuration, and finally return keyboard control to the command line:

```
display pod_command  
pod_command keyboard  
es  
tcf  
suspend
```

---

## To get help on Terminal Interface commands

- 1 Select **Display**→**Pod Commands**. If you are using the command line, enter:

```
display pod_command
```

- 2 On the command line, enter **pod\_command** “**help** <cmd\_name>”.

<cmd\_name> is the Terminal Interface command on which you want to receive help.

You can access the emulator’s low-level Terminal Interface using the **pod\_command** keyword. If you need help on any Terminal Interface command, you can use its **help** command.

See the *MC68020/EC020 and MC68030/EC030 Emulator Terminal Interface User’s Guide* for more information regarding the Terminal Interface.

---

### Examples

Get help on the Terminal Interface **cf** command:

```
display pod_command
```

```
pod_command "help cf"
```

Get help on all Terminal Interface command groups:

```
display pod_command
```

```
pod_command "help *"
```

---

## Accessing the Operating System

Through the command line, you can access the operating system to use services available there. You can set environment variables and enter UNIX commands.

This section shows you how to:

- Set environment variables.
- Enter UNIX commands.
- Display the name of the emulation module.

---

### To set environment variables

- Type `set <ENVIRONMENT VARIABLE>=<VALUE>`.

You can set UNIX environment variables with the `set` command. The `<ENVIRONMENT VARIABLE>` can be any UNIX environment identifier name. The `<VALUE>` can be any string value. If the value has embedded spaces, use double quotes around the string.

---

#### Example

To set the `PRINTER` environment variable to `lp -s`, enter:

```
set PRINTER = "lp -s"
```

---

---

### To enter UNIX commands

- Type `!<UNIX_COMMAND>`
- Type `!<UNIX_COMMAND>! <options>`



You can execute any UNIX command by preceding it on the command line with an exclamation mark (!). The system creates a shell process and executes the command line string following the exclamation mark.

If you enter only the exclamation mark (!), a command process is created and the command shell is started. Exiting the command shell by typing **exit** returns you to the emulator/analyzer interface.

You can precede and follow your UNIX command with exclamation marks. This allows you to include options with your command, such as:

|                                    |   |
|------------------------------------|---|
| <code>in_browser</code>            | executes your UNIX command and provides results in a scrollable window instead of a terminal window (default display).  |
| <code>wait_for_exit</code>         | waits for your UNIX command to finish its execution before allowing the next command to begin. This is useful for commands that require extra time to complete, such as "make".   |
| <code>no_prompt_before_exit</code> | used to speed operation when you don't need the results display. For example, this will complete a command without prompting for the press of the RETURN key in commands that would normally prompt for the RETURN key. |

---

### Examples

Show the values of the current environment variables:

```
!set | more <RETURN>
```

Edit a command file previously created with the command:

```
log_commands to <FILENAME>
```

```
!vi <FILENAME> <RETURN>
```

See a directory listing in a browser window:

```
!ls! in_browser
```

Make files in a directory and hold off loading the executable file until the "make" has finished:

```
!make! wait_for_exit; load <file>
```

## To display the name of the emulation module

- Using the command line, enter the **name\_of\_module** command.

While operating your emulator, you can verify the name of the emulation module. This is also the logical name of the emulator in the emulator device file.

---

### Examples

To display the name of your emulation module:

```
name_of_module <RETURN>
```

The name of the emulation module is displayed on the status line.

---

---

# 4

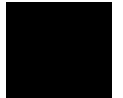

---

## Using the Emulator

How to control the processor and examine system resources

## The Emulator And Its Applications

The HP 64748/HP 64747 emulator helps you to test and debug applications in real time. The emulator is a functional replacement for MC68020 or MC68030/EC030 microprocessors. It provides access to processor registers and memory, as well as complete execution run control.

The emulator provides debugging capability for:

- embedded system hardware startup and test
- hardware/software integration

The emulator may also be used out-of-circuit as a code execution environment. However, software development and testing will probably be handled best in a host execution environment.

The emulation system is connected to a host computer by a LAN connection, or by a serial (RS-232C) data communication link.

The emulation interface can display data and symbolic assembly code in windows, or can additionally show the C-language source code intermixed with the assembly code. You can start and stop execution of application code using the **run** and **step** commands. Breakpoints can be placed at strategic locations to stop application execution when a specific address is reached.

An application can communicate directly with the emulation interface by using the simulated I/O library. This provides standard input and output, messaging and access to the UNIX file system. During initial stages of development, an application can print status and debugging messages to the emulation display using simulated I/O. Files can be created, opened, read from, and written to on the host system. These routines can be converted as target system hardware becomes available.

## The demo Application

A demo program, and an associated configuration file, are provided with the emulator. The demo application allows you to learn about the emulator without the bother of writing and loading your own program.

The demo program was written in MC68000 assembly language. When the emulator loads the program, it also defines a symbol table containing symbols from the program. You can use these symbols when you're making measurements using the program.

The demo program emulates a hypothetical environmental control system for a computer room. The name of the demo program is `ecs.x`.

For detailed information about the files used in the demo program, and methods and requirements for starting the demo program, read the `READMEDEMO` and `README` files in the directory named `/usr/hp64000/demo/debug_env/hp64747`.

To load and run the complete demo program, your emulation system must have at least 256K of emulation memory (obtained by installing at least one SRAM on the emulation probe. Refer to Chapter 18 "Installation and Service" for instructions on how to install SRAM memory modules.

---

## To build programs

- 1 Create source files in "C" or MC68020/MC68030/EC030 assembly language using a text editor.
- 2 Translate the "C" source files to relocatable object code using a compatible C cross compiler.
- 3 Translate the assembly source files to relocatable object files using a compatible MC68020 or MC68030/EC030 cross assembler.

Chapter 4: Using the Emulator  
**The Emulator And Its Applications**

- 4 Link all relocatable object files with the linker/loader to produce an absolute object file in the IEEE-695 format. (The loaders for the HP language tools produce a file with the extension .x for IEEE-695 format.) If you want to produce an absolute file in the HP64000 format, specify the appropriate loader options. (The IEEE-695 format is better for emulation tasks.)
- 5 (Optional) Build an SRU symbol database before entering emulation by entering the **srbuild** <absfilename> command.

If you're planning to load programs into emulation or target system memory, you need to have your files in a format acceptable to the MC68020 or MC68030/EC030 emulator. Usually, this means that you'll want your files in IEEE-695 absolute format. The HP language tools for the HP 9000 produce this format.

---

| <b>Processor</b> | <b>C Compiler</b> | <b>Assembler</b> |
|------------------|-------------------|------------------|
| MC68020/EC020    | HP 64903          | HP 64870         |
| MC68030/EC030    | HP 64907          | HP 64874         |

You may use other language tools if they produce either IEEE-695 or HP64000 absolute file formats.

Other file formats, such as Motorola S-records and Tektronix hex format can be converted to HP64000 format by using the HP 64888 utility software.

## To configure the emulator

- Configure the emulator to meet the resource needs of your target system and application program by following the instructions in Chapter 8, "Configuring the Emulator."
- To configure the emulator, choose **Modify**→**Emulator Config ...**. Then answer the questions that appear in the Emulator Configuration dialog box.
- Using the command line, enter **modify configuration**. This starts a series of questions whose answers define the emulator configuration.

You must configure the emulator to allocate system resources such as memory, and to set handling of interrupts, etc. You must do this before you load and execute programs and make emulator measurements. Refer to Chapter 8, "Configuring the Emulator."

If you want to use the examples in this manual, you must load a special configuration file and load the demo program. See "To load the demo program" in this chapter for more information.

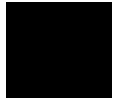

## Loading and Storing Programs

The emulator provides commands that allow you to move files into emulation or target memory from a host computer through the LAN or serial ports of the HP 64700 Card Cage. You can also save a range of memory in an absolute file for later reuse. (You might do this if you patch a section of code and need to do further testing.)

Many different absolute file formats are supported. The primary ones used with the emulator interface are the IEEE-695 and HP64000 absolute formats.

The **load** command has other options that allow you to control the load process. Refer to the **load** command syntax in Chapter 11, "Emulator Commands."

---

### To load a program

- Choose **File**→**Load**→**Executable...** In the dialog box, click on the name of the executable file to load, and then click OK.
- Using the command line, load a program absolute file into emulation or target memory by entering **load [<memory\_type>] <filename> [ fcode <fcode> ]**.

**<memory\_type>** is optional. **emul\_mem** is emulation memory and **user\_mem** is target system memory. The default is to load all memory.

**<filename>** is the name (including paths if needed) of an HP64000 or IEEE-695 format absolute file. You do not need to specify the extension if it is **.x** or **.X**.

**<fcode>** is an optional function code from the following list.



---

| <b>&lt;fcode&gt;</b> | <b>Meaning</b>                      |
|----------------------|-------------------------------------|
| none                 | emulator ignores function-code bits |
| s                    | supervisor space (program and data) |
| u                    | user space (program and data)       |
| p                    | program space (supervisor and user) |
| d                    | data space (supervisor and user)    |
| sp                   | supervisor program space            |
| sd                   | supervisor data space               |
| up                   | user program space                  |
| ud                   | user data space                     |
| cpu                  | CPU space                           |

---

The emulator can load HP64000 or IEEE-695 format absolute files into emulation or target system memory. So, you can develop programs on your UNIX workstation; then build the programs and load them into the emulator for debugging.

Use the memory type parameter if you want to load only the parts of the program that have addresses corresponding to those types of memory in the map.

The function code is an optional parameter that allows you to direct an absolute module to memory that has the proper function code type.

---

**Example**

To load the executable part of your absolute file into memory and any symbolic information found in the absolute file, choose **File→Load→Executable...**

To load the executable part of your absolute file into memory but not load symbolic information found in the absolute file, choose **File→Load→Program Only...**

To load only the symbolic information found in the absolute file (without loading the executable part of your absolute file), choose **File→Load→Symbols Only...**

Suppose you have two map terms, one of which is user program space from 1000 thru 1fff hex. The other is supervisor program space from 1000 thru 1fff hex. You have absolute files called userprog.x and supprog.x. To load these programs using the command line, enter:

```
load userprog fcode up  
load supprog fcode sp
```

The programs are loaded into the correct function code spaces.

---

## To load the demo program

- 1 With your emulator interface *not* on screen, enter the following commands in a terminal window:

```
cd /usr/hp64000/demo/debug_env/hp64748 for the MC68020  
cd /usr/hp64000/demo/debug_env/hp64747 for the MC68030/EC030  
Startemul <logical name>
```

Where <logical name> is the name assigned to your emulator. The default logical name for the MC68020 emulator is **m68020**, and for the MC68030/EC030 emulator is **m68030**. For a detailed discussion of how to find a logical name, refer to Chapter 1, "Getting Started."

- 2 The terminal window will ask you if you wish to copy the demo files to a different directory. It is best to answer "y" to this question, and then supply the full path name of your own demo directory.

The demo files will be copied and modified, as required, into the directory you specify, and then the emulator interface will appear on screen. It will be ready for you to run the demo procedure.

- 3 Press the Action keys from left to right and top to bottom to see the demo.

The demo program supplied with the MC68020 and MC68030/EC030 acts as a hypothetical environmental control system for a computer room. You can use this program to learn more about the emulator. Refer to the information on the demo program in the reference part of this manual.

The examples in this manual use the demo program. To make the examples work correctly, you must load the demo emulator configuration file and demo program as described above.

---

## To store a program

- Using the command line, transfer a range of memory locations from the emulator to an HP 9000 file by entering the **store memory** [**fcode** <fcode>] <expression> [**thru** <expression>] **to** <filename> command.

<fcode> is an optional function code as follows:

| <fcode> | Meaning                             |
|---------|-------------------------------------|
| none    | emulator ignores function-code bits |
| s       | supervisor space (program and data) |
| u       | user space (program and data)       |
| p       | program space (supervisor and user) |
| d       | data space (supervisor and user)    |
| sp      | supervisor program space            |
| sd      | supervisor data space               |
| up      | user program space                  |
| ud      | user data space                     |
| cpu     | CPU space                           |

<expression> specifies the starting (and ending, in **thru** <expression>) addresses of the memory range to be stored.

<filename> is the name (including paths if needed) of a file to store the data.

If you patched a program or data structure by modifying memory, you may want to save the memory image for comparison with other changes or for future testing. The **store** command allows you to do this.

The **store** command creates absolute files in HP64000 format. The **.X** extension is added automatically.

---

### Example

To save the memory locations of the `init_system` routine in an absolute file named `new`, use the command line to enter:

```
store memory init_system thru init_system end to new
```

## To edit files

- Choose **File**→**Edit**→**File** and use the dialog box to specify the file name.
- To edit a file based on an address in the entry buffer, place the address reference (either absolute or symbolic) in the entry buffer; and then choose **File**→**Edit**→**At () Location**.
- To edit a file based on the current program counter, choose **File**→**Edit**→**At PC Location**.
- To edit a file associated with a symbol when you are displaying symbols, position the mouse pointer over the symbol, press and hold the *select* mouse button, and choose **Edit File At Symbol** from the popup menu.
- To edit a file when displaying memory in mnemonic format, position the mouse pointer over the line of source where you want to begin the edit, press and hold the *select* mouse button, and choose **Edit Source** from the popup menu.

When editing files at addresses, the interface determines which source file contains the code generated for the address and opens an edit session on the file. The interface will issue an error message if it cannot find a source file for the address.

The interface will choose the "vi" editor as its default editor, unless you specify another editor by setting an X resource. Refer to Chapter 13, "Setting X Resources" for more information about setting this resource.

You must load symbols before most edit commands are available because symbol information is needed to be able to locate the files.

**Examples**

To edit a file that defines a symbol:

Choosing this menu item brings up a terminal window with an edit session open on the file where the highlighted symbol is defined.

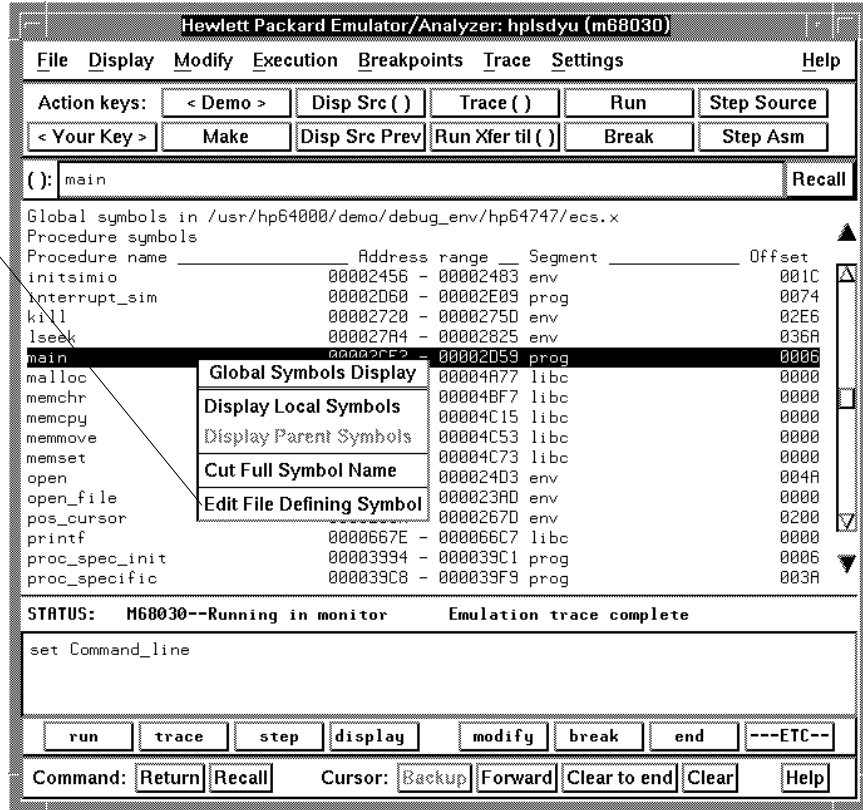

## Chapter 4: Using the Emulator Loading and Storing Programs

To edit a file at the location of a source line:

Choosing this menu item brings up a terminal window with an edit session open on the file where the highlighted source line exists.

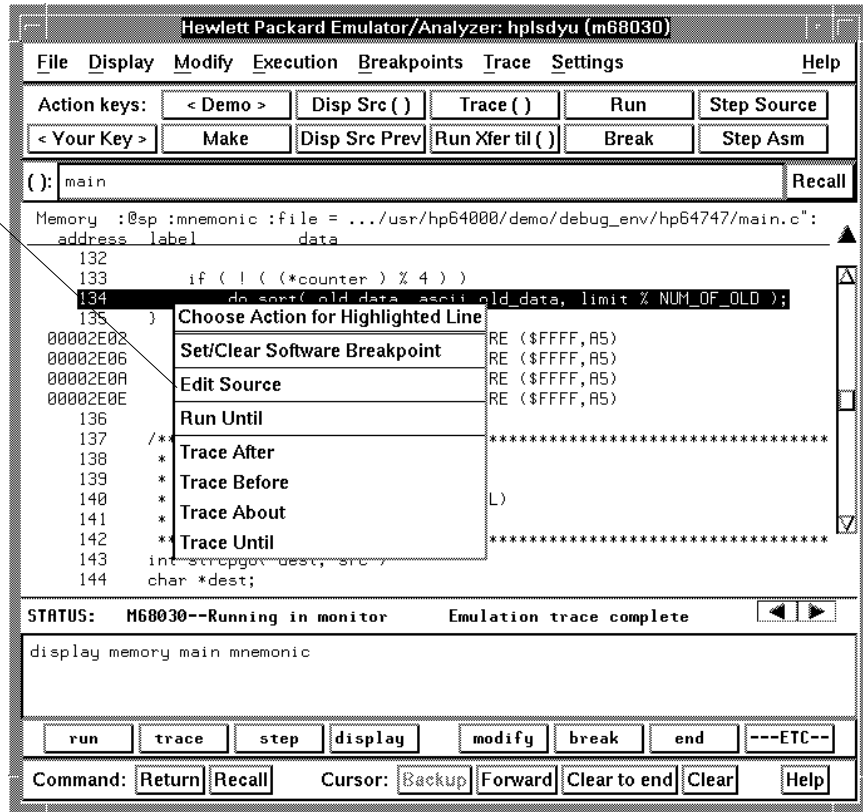

## Using Symbols

When you load a program for the first time, the emulator uses the Symbolic Retrieval Utilities (SRU) to build a symbol database for each module. This database associates symbol names and symbol type information (not data types) with logical addresses. You will see a message on screen showing the module for which the database is being built.

Once a symbol database is created for a particular module, it does not need to be rebuilt unless the module is changed. You can rebuild modules using the **srbuild** utility (refer to the *Symbol Retrieval Utilities, SRU, User's Guide*). If you reenter emulation without building symbols, the emulator software automatically rebuilds portions of the symbol database as you reference symbols in modified modules. Usually, you should use **srbuild** after you rebuild your absolute files to save time during emulation.

Global symbol information is immediately available for the file that you loaded. To obtain local symbol information, you need to reference the module that contains the symbols.

You can use the symbol names instead of addresses when entering expressions as part of an emulation command. Therefore, you don't have to remember address information to make a measurement. Also, the emulator can display symbols within the results of a measurement, using the **set symbols on** command. This helps you relate the measurement to your original program.

Long symbol names can be truncated in the symbols display; however, you can increase the width of the symbols display by starting the interface with more columns (refer to Chapter 13, "Setting X Resources").

The MC68020 and MC68030 emulator interface can read absolute files in HP-OMF or IEEE-695 format. For more information on SRU, refer to the *Symbol Retrieval Utilities, SRU, User's Guide*. Also refer to the information on symbol entry syntax in the —**SYMB**— section of Chapter 11, "Emulator Commands."

When you load an absolute file into memory (unless you specify a load without symbols), symbol information is also loaded. Both global symbols and symbols that are local to a source file can be displayed.

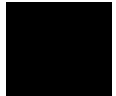

## To load a symbol database

- Choose **File**→**Load**→**Symbols Only...** In the dialog box, click on the name of the desired symbols file, and then click OK.
- Using the command line, load a new symbol database by entering the **load symbols <filename>** command.

**<filename>** is the name of the absolute file in HP64000 or IEEE-695 format for which you want to load symbols.

The **load symbols** command is useful when your system uses several different absolute files or when the target program resides in target ROM and is not loaded through the emulator. The symbol database for the most recently loaded absolute file is the current symbol database. If you want to use a symbol database from a different absolute file without reloading the file, use the **load symbols** command to load only the symbol database for that file.

---

### Example

Suppose you have a system that uses two absolute files, one called `system.x` and another called `task.x`. You load these as follows:

```
load system.x  
load task.x
```

The symbol database for `task.x` will be available because it was loaded last. To reference symbols from `system.x`, use the command:

```
load symbols system.x
```

Now the symbol database for `task.x` will not be available.

---



## To display global symbols

- Choose **Display**→**Global Symbols**.
- Using the command line, display global symbols by entering the **display global\_symbols** command.

The **display global\_symbols** command displays a list of global (externally defined) symbols in the program modules you have loaded into emulation or target memory. The symbols list includes the address range associated with a symbol, the name of the associated segment, and the offset of the symbol within the segment.

You can use the **UP** and **DOWN** cursor keys and the **NEXT** and **PREV** keys to scroll or page through the global symbols listing.

---

### Example

Display the global symbols for the demo program:

*display global\_symbols*

---

## To display local symbols

- If you are using the Graphical User Interface:
  - First place the name of the symbol whose local symbols should be displayed into the entry buffer, and then in the menu bar, choose **Display→Local Symbols()**.
  - When displaying symbols, position the mouse pointer over a symbol on the symbol display screen and click the *select* mouse button.
  - When displaying symbols, position the mouse pointer over the symbol, press and hold the *select* mouse button, and choose **Display Local Symbols** from the popup menu.
- Using the command line, display the symbols defined within a given symbol by entering the **display local\_symbols\_in <symbol\_name>** command.

This command displays address information associated with each symbol. The symbols defined within a given symbol are local to that symbol. That is, they are defined as children of that symbol. See “To enter a symbol” for more information on the **<symbol\_name>**. If no local symbols are associated with your selection, the interface displays the parent symbol.

To display the address ranges associated with the high-level program’s source file line numbers, you must display the local symbols in the file.

---

### Example

Display the local symbols for the `update_sys` module in the demo program:

```
display local_symbols_in update_sys(module)
```

Suppose that you had an IEEE-695 absolute file with a module named `system` and a procedure within that module also named `system`. You could display the local symbols for the procedure named `system` by entering:

```
display local_symbols_in system.system
```

To display the source reference address ranges:

```
display local_symbols_in system.c:
```

To display local symbols using the symbols display popup menu:

View the local symbols associated with the highlighted symbol by choosing this menu item.

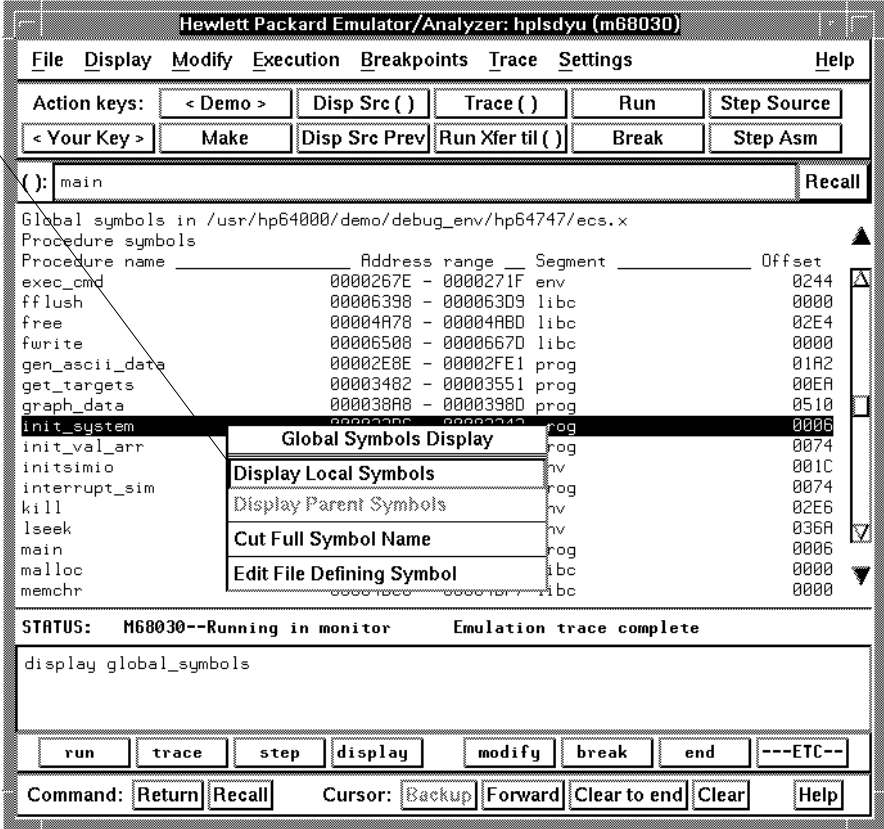

If local symbols exist within the scope of the symbol you chose, then the display changes to show those symbols. Otherwise, the interface issues an error.

## To display the parent symbol of a symbol

- When displaying symbols, position the mouse pointer over the symbol, press and hold the *select* mouse button, and choose **Display Parent Symbols** from the popup menu.

If a parent symbol does not exist for the highlighted symbol, this menu item will be grayed-out and unresponsive to mouse clicks.

### Examples

View the parent symbol associated with the highlighted symbol by choosing this menu item.

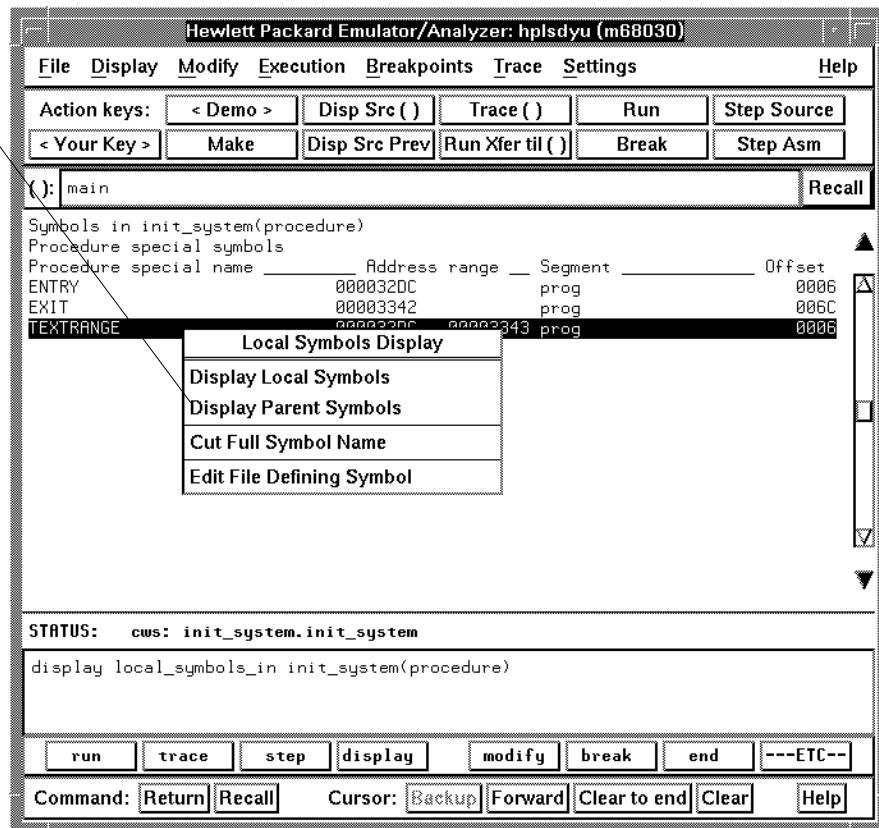

## To copy and paste a full symbol name to the entry buffer

- When displaying symbols, position the mouse pointer over the symbol, press and hold the *select* mouse button, and choose **Cut Full Symbol Name** from the popup menu.

Once the full symbol name is in the entry buffer, you can use it with pulldown menu items or paste it to the command line area.

By cutting the full symbol name, you can be sure that you specified the complete scope of the symbol, including all names of symbols that were truncated.

### Examples

Copy the full name of the highlighted symbol to the entry buffer by choosing this menu item.

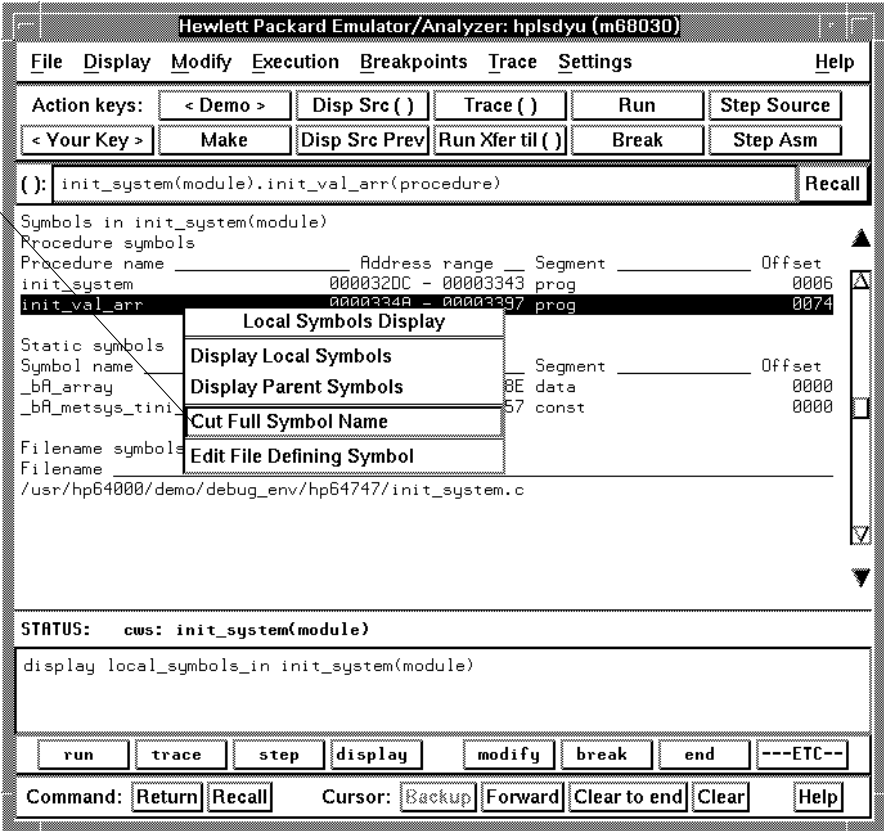

## To enter a symbol

- Enter symbols according to the syntax shown in the —SYMB— syntax pages in Chapter 11, “Emulator Commands.”

---

### Examples

These are examples of some valid symbol entries:

```
Int_Cmd  
demo.Main(procedure)  
demo.EndLoop  
handle_msg.Fill_Dest  
handle_msg.Cmd_A  
system.c:line10
```

---

## To display the current directory and current working symbol

- Choose **Display→Context...** A dialog box will open and show the name of the current directory and current working symbol.
- Using the command line, display the name of the current directory by typing **pwd**, and the name of the current working symbol by typing **pws**.

If you're entering symbol names from several different modules, you may be unsure which symbol is the current working symbol. The **Display→Context...** or **pws** commands allow you to check this.

The **pws** and **pwd** commands aren't available on the softkeys. You must type them at the keyboard.

The directory context, included in the dialog box seen in the Graphical User Interface is the directory accessed by all system references for files (primary load, store, and copy commands) if no explicit directory is mentioned. Unless you have changed directories since beginning the emulation session, the current directory context is that of the directory from which you started the interface.

The current working symbol context is supported by the emulator/analyzer and the Symbol Retrieval Utilities (SRU) working together. The current working symbol represents an enclosing scope for local symbols. If symbols have not been loaded into the interface, you cannot display or change the symbol context.

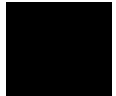

## To change the directory context

- Choose **File**→**Context**→**Directory** and use the dialog box to select a new directory.
- Using the command line, enter the **cd <directory>** command.

The Directory Selection dialog box contains a list of directories accessed during the emulation session as well as any predefined directories present at interface startup.

You can predefine directories and set the maximum number of entries for the Directory Selection dialog box by setting X resources (Refer to Chapter 13, "Setting X Resources").

---

## To change the current working symbol context

- Choose **File**→**Context**→**Symbols** and use the dialog box to select a new working symbol context.
- Using the command line, enter the **cws <symbol\_context>** command. (Because **cws** is a hidden command and doesn't appear on a softkey label, you have to type it in.)

You can predefine symbol contexts and set the maximum number of entries for the Symbol Scope Selection dialog box by setting X resources (Refer to Chapter 13, "Setting X Resources").

Displaying local symbols or displaying memory in mnemonic format causes the working symbol context to change as well. The new context will be that of the local symbols or memory locations displayed.



---

**Example**

The `update_sys` module of the demo program defines several symbols, including `get_targets`, `graph_data`, and `write_hdwr`. You refer to these in a group of memory display commands as follows:

```
display memory update_sys.get_targets blocked bytes  
display memory update_sys.graph_data blocked bytes  
display memory update_sys.write_hdwr blocked bytes
```

To save repeated typing of `update_sys`, enter:

```
cws update_sys
```

Then enter the memory display commands as:

```
display memory get_targets blocked bytes  
display memory graph_data blocked bytes  
display memory write_hdwr blocked bytes
```

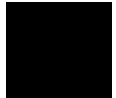

## Accessing Processor Memory Resources

While you are debugging your system, you may want to examine memory resources. For example, you may need to verify that the correct data is loaded, or check the results of a data write. Also, you may need to modify memory locations to test different data sets for a program. The emulator has flexible memory commands that allow you to view and modify memory as needed.

---

### To display program data structures

- Place an absolute or symbolic address or file name containing the desired data structures in the entry buffer. Then choose **Display**→**Data Values**→**New ()** and select the data type from the cascade menu. This clears the data values display and adds a new item.
- Place the absolute or symbolic address of the desired data in the entry buffer. Then choose **Display**→**Data Values**→**Add ()** and select the data type from the cascade menu. This adds data items to the data values display.
- Choose **Display**→**Data Values** if you have a display of data values on screen and you want to update that display.
- Using the command line, display a program data structure by entering **display data <lower> [thru <upper>] <type> {,<lower> [thru <upper>] <type>}**.

<lower> and <upper> are address expressions representing the lower and upper boundaries of the memory range to be displayed.

<type> is a data type for display formatting as follows:

---

| Type Designator | Description  |
|-----------------|--|
| byte            | Hex display of one 8-bit location                                  |
| word            | Hex display of one 16-bit location                                 |
| long            | Hex display of one 32-bit location                                 |
| int8            | Display one 8-bit location as a signed integer (two's complement)  |
| int16           | Display one 16-bit location as a signed integer (two's complement) |
| int32           | Display one 32-bit location as a signed integer (two's complement) |
| u_int8          | Display one 8-bit location as an unsigned positive integer         |
| u_int16         | Display one 16-bit location as an unsigned positive integer        |
| u_int32         | Display one 32-bit location as an unsigned positive integer        |
| char            | ASCII characters   |

---

You can use the **display data** command to display simple data types in your program. This can make the display of simple variables easier to read because you don't have to visually sort a display (such as a memory display) to find the locations of interest.

You can use symbols in the address expression.

---

**Example**

To clear the data values display and add the target\_temp static symbol from the demo program:

```
display data target_temp byte
```

To add display of the aver\_temp array from the demo program:

```
display data aver_temp thru aver_temp end word
```

---

## To display only source lines

- Choose **Settings**→**Source/Symbol Modes**→**Source Only**.
- Using the command line, enter the **set source only symbols on** command.

Only high-level source lines are displayed in mnemonic memory and trace displays.

### Examples

To turn ON source lines in displays, and display memory in mnemonic format:

```
set source only symbols on <RETURN>  
display memory main mnemonic <RETURN>
```

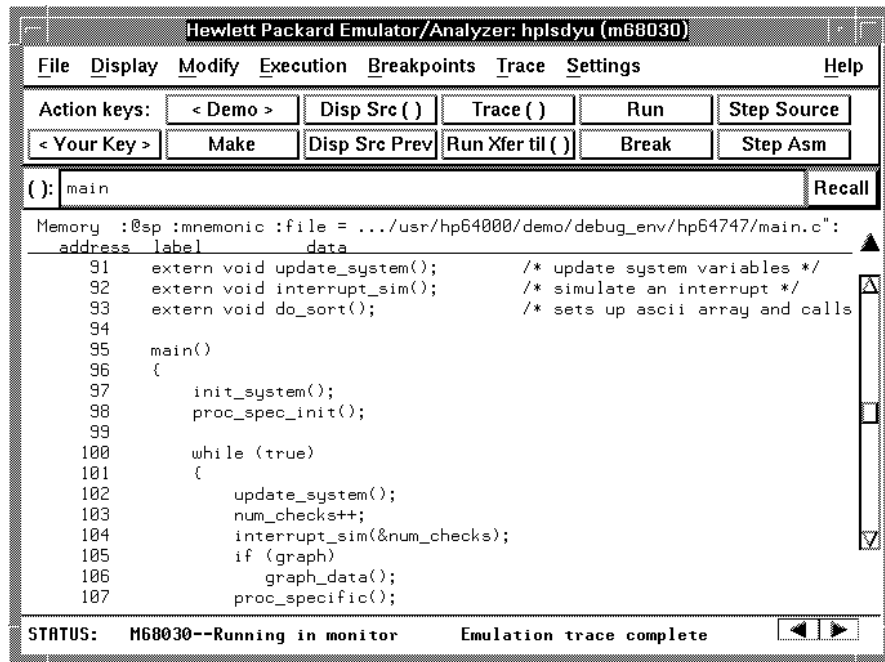

The screenshot shows the Hewlett Packard Emulator/Analyzer window titled "Hewlett Packard Emulator/Analyzer: hplsdyyu (m68030)". The menu bar includes File, Display, Modify, Execution, Breakpoints, Trace, Settings, and Help. Below the menu bar are several control buttons: Action keys, < Demo >, Disp Src ( ), Trace ( ), Run, Step Source, < Your Key >, Make, Disp Src Prev, Run Xfer til ( ), Break, and Step Asm. A status bar at the top shows "( ): main" and a "Recall" button. The main display area shows the source code for "main.c" with columns for address, label, and data. The code includes function declarations and a main function with a while loop. The status bar at the bottom indicates "STATUS: M68030--Running in monitor" and "Emulation trace complete" with navigation arrows.

```
Hewlett Packard Emulator/Analyzer: hplsdyyu (m68030)
File  Display  Modify  Execution  Breakpoints  Trace  Settings  Help
Action keys:  < Demo >  Disp Src ( )  Trace ( )  Run  Step Source
< Your Key >  Make  Disp Src Prev  Run Xfer til ( )  Break  Step Asm
( ): main  Recall
Memory :@sp :mnemonic :file = .../usr/hp64000/demo/debug_env/hp64747/main.c":
address  label  data
91  extern void update_system();  /* update system variables */
92  extern void interrupt_sim();  /* simulate an interrupt */
93  extern void do_sort();  /* sets up ascii array and calls
94
95  main()
96  {
97      init_system();
98      proc_spec_init();
99
100     while (true)
101     {
102         update_system();
103         num_checks++;
104         interrupt_sim(&num_checks);
105         if (graph)
106             graph_data();
107         proc_specific();
```

## To display intermixed source lines

- Choose **Settings**→**Source/Symbol Modes**→**Source Mixed**.
- Using the command line, enter the **set source on symbols on** command.

High-level source lines are intermixed with assembly language instructions in mnemonic memory and trace displays.

### Examples

To turn ON source lines in displays, and display memory in mnemonic format:

```
set source on symbols on <RETURN>  
display memory main mnemonic <RETURN>
```

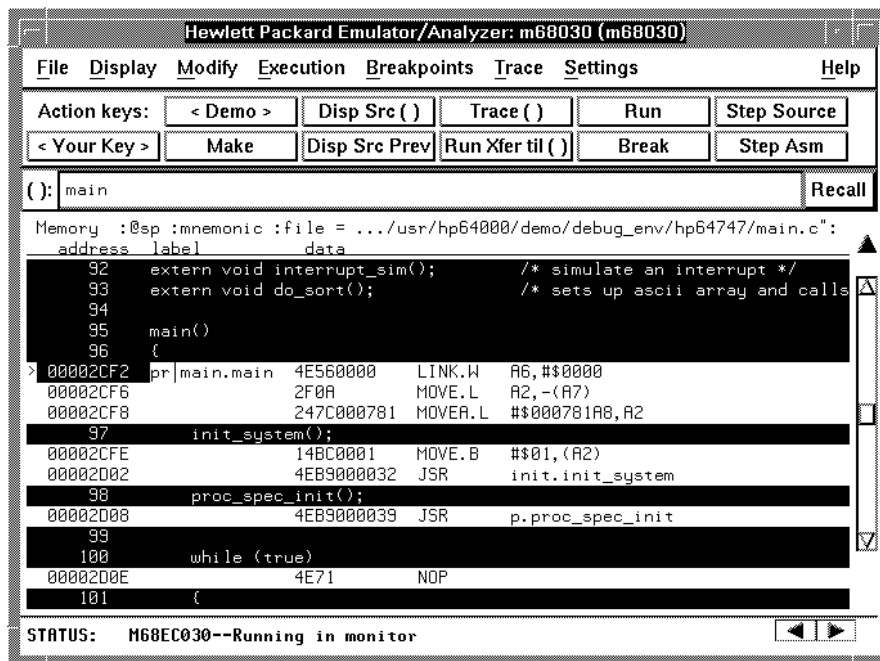

## To display symbols without source lines

- Choose **Settings**→**Source/Symbol Modes**→**Symbols**.
- Using the command line, enter the **set source off symbols on** command.

Symbols are included in memory mnemonic, trace, breakpoints, and register step displays.

### Examples

To turn ON symbols in displays, and display memory in mnemonic format:

```
set source off symbols on <RETURN>  
display memory main mnemonic <RETURN>
```

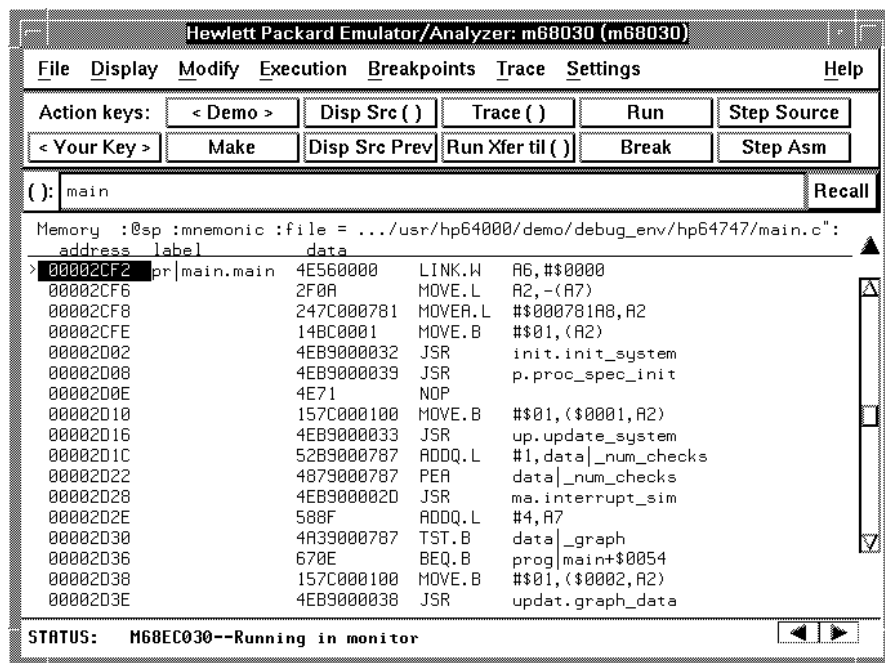

## To display absolute addresses

- Choose **Settings**→**Source/Symbol Modes**→**Absolute**.
- Using the command line, enter the **set source off symbols off** command.

No symbols or source lines are included in mnemonic memory or trace displays.

### Examples

To turn OFF symbols and source lines in displays, and display memory in mnemonic format:

```
set source off symbols off <RETURN>  
display memory main mnemonic <RETURN>
```

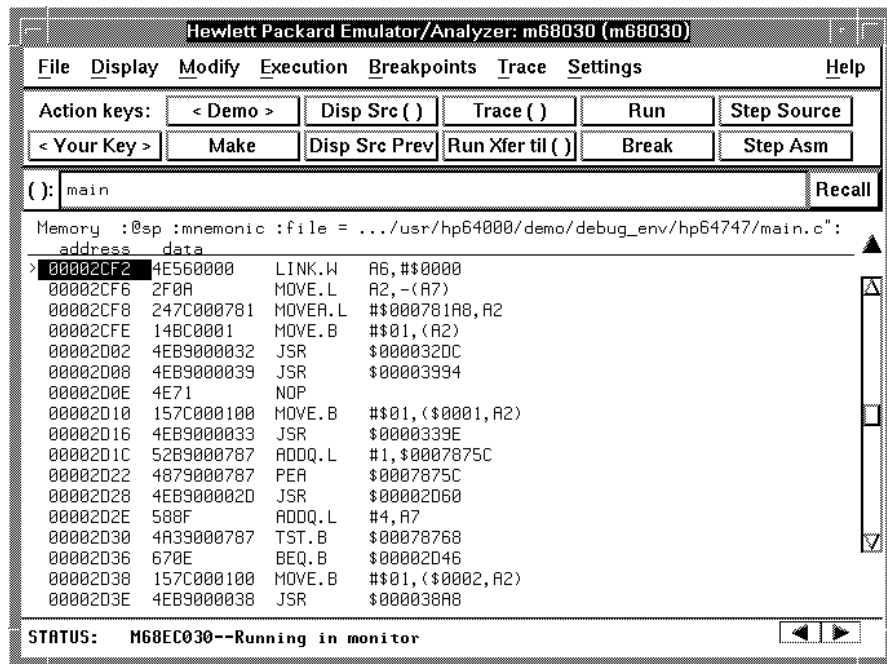

## To display memory in byte format

- Choose **Display**→**Memory**→**Hex()**→**bytes**. If you want to include a line range or starting point for your memory display in your command, enter it into the entry buffer before you execute this command.
- Using the command line, display a range of memory in byte format by entering **display memory <lower> [thru <upper>] bytes**.

To format the memory listing as a single column, add the keyword **absolute** before the data type in the **display memory** command. To format the memory listing as multiple columns, add the keyword **blocked** before the data type in the **display memory** command.

---

### Example

Display the demo program's average temperature array:

```
display memory aver_temp thru aver_temp end bytes
```



## To display memory in word format

- Choose **Display**→**Memory**→**Hex()**→**words**. If you want to include a line range or starting point for your memory display in your command, enter it into the entry buffer before you execute this command.
- Using the command line, display a range of memory in word format by entering **display memory <lower> [thru <upper>] words**.

To format the memory listing as a single column, add the keyword **absolute** before the data type in the **display memory** command. To format the memory listing as multiple columns, add the keyword **blocked** before the data type in the **display memory** command.

---

### Example

Display the demo program's average temperature array:

```
display memory aver_temp thru aver_temp end blocked words
```

## To display memory in long word format

- Choose **Display**→**Memory**→**Hex()**→**long**. If you want to include a line range or starting point for your memory display in your command, enter it into the entry buffer before you execute this command.
- Using the command line, display a range of memory in long word format by entering **display memory <lower> [thru <upper>] long**.

To format the memory listing as a single column, add the keyword **absolute** before the data type in the **display memory** command. To format the memory listing as multiple columns, add the keyword **blocked** before the data type in the **display memory** command.

---

### Example

Display the processor's interrupt vector table:

```
display memory 0 thru 3ffh absolute long
```

---

## To display memory in mnemonic format

- Choose **Display**→**Memory**→**Mnemonic()** or **Mnemonic at PC**. If you want to include a line range or starting point in your command, enter it into the entry buffer before you choose the **Mnemonic()** command.
- Using the command line, display memory in mnemonic format by entering **display memory <lower> [thru <upper>] mnemonic**.

A highlighted bar shows the location of the current program counter address. This allows you to view the program counter while stepping through user program execution.

When you **display memory mnemonic**, the emulator disassembles the memory locations beginning with the first address you specify. If this address is not the starting address of an instruction, the display will be incorrect.

To offset the addresses in the memory mnemonic display, add the parameter **offset\_by <expression>** to the end of the display memory command line. **<expression>** is an address expression that is subtracted from each address in the memory display. If code gets relocated, and therefore makes symbolic information obsolete, you can use the **offset\_by** option to change the address information so that it again agrees with the symbolic information. You can also use **offset\_by** to change listed addresses so that they match addresses in compiler or assembler listings.

Whether source lines, assembly language instructions, or symbols are included in the display depends on what you choose with the **Settings**→**Source/Symbols Modes** or **Settings**→**Display Modes** pulldown menu items.

Use the **set symbols on** command to display symbol information for addresses in the memory mnemonic display.

If symbols are loaded into the interface, the default is to display source only.

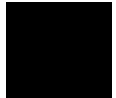

## Chapter 4: Using the Emulator

### Accessing Processor Memory Resources

---

#### Examples

To display program memory for the main part of the demo program, enter main in the entry buffer and choose **Display**→**Memory**→**Mnemonic()**, or enter on the command line:

```
display memory main mnemonic
```

Display the write\_hdwr routine for the update\_sys program in mnemonic format, with symbols in the address column:

```
set symbols on  
display memory update_sys.write_hdwr thru write_hdwr end  
mnemonic
```

---

### To return to the previous mnemonic display

- Choose **Display**→**Memory**→**Mnemonic previous**.

This command is useful for quickly returning to the previous mnemonic memory display.

For example, suppose you are stepping source lines and you step into a function that you would like to step over. You can return to the previous mnemonic memory display, set a breakpoint the line following the function call, and run the program from the current program counter.

## To display memory in real number form

- Choose **Display**→**Memory**→**Real()**→<real type>. If you want to include a line range or starting point in your command, enter it into the entry buffer before you execute this command. <real type> may be short, long, extended, or packed.
- Using the command line, enter commands as follows:
  - 1 Display memory values as 32-bit (IEEE-754 single precision) real numbers by selecting **display memory <lower> [thru <upper>] real short**.
  - 2 Display memory values as 64-bit (IEEE-754 double precision) real numbers by selecting **display memory <lower> [thru <upper>] real long**.
  - 3 Display memory values as 96-bit (IEEE-754 double extended precision) real numbers by selecting **display memory <lower> [thru <upper>] real extended**.
  - 4 Display memory values as 96-bit Motorola Packed real numbers by selecting **display memory <lower> [thru <upper>] real packed**.

Real numbers use the formats defined by the *IEEE Standard for Binary Floating-Point Arithmetic*. They can be short (32 bits), long (64 bits), or extended (96 bits).

---

### Example

To display a set of data values in real numbers, beginning with the floating humidity in the demo program, place the global symbol `float_humid` in the entry buffer and choose **Display**→**Memory**→**Real()**→**long**. If using the command line, enter:

```
display memory float_humid real long
```

## To redisplay memory locations

- Choose **Display**→**Memory**.
- Using the command line, redisplay memory with the same address range and format as the previous memory display by selecting:

*display memory*

The last range and format options are maintained in the interface. When you display memory without specifying the location or format for the display, the previous options are used.

---

## To display memory repetitively

- Choose **Display**→**Memory**→**Repetitively**.
- Using the command line, continuously display memory with:

*display memory repetitively*

This command continuously updates the memory display. Use this only to monitor memory while running your target code; it requires a lot of CPU time. To allow the current memory display to be updated whenever the emulator detects a modification to memory content (such as loading a file, setting a breakpoint, etc.) use the **set update** command, or **Settings**→**Display Modes...**

## To modify memory

- Choose **Modify→Memory**, or enter the desired memory location and new value in the entry buffer and click on **Modify→Memory at ()**. The equivalent command will be shown on the command line. Complete the command by entering appropriate information on the command line.
- Using the command line, enter commands as follows:
  - To modify a single memory location to a single value, select **modify memory <address> to <value>**.
  - To modify a range of memory locations to a single value, select **modify memory <lower> thru <upper> to <value>**.
  - To modify a range of memory locations with a list of values, select **modify memory <lower> thru <upper> to <value1>,<value2>, ...**
  - To change whether memory is modified by bytes, words, or long words, add the **<mode>** parameter before the **to** keyword.
  - To modify memory as real numbers, select **modify memory <lower> [thru <upper>] real [short|long] to <real1>[,<real2>, ...]**.
  - To modify a sequence of bytes to an ASCII string literal, select **modify memory <lower> thru <upper> string to “<string>”**.

**<string>** is a character string.

The **<address>** parameter is an expression representing a single address location. The **<lower>** and **<upper>** values are address expressions representing the lower and upper boundaries of the memory area to be modified. **<value>** represents the data value to which the contents of memory are to be modified.

The **<mode>** parameter can be either **bytes**, **words**, or **long**. Otherwise, the mode specified by the last **display memory** command determines how data is displayed. If you selected "Any" when you selected "Memory Access Size" as part of the emulation configuration, the size you specify here will be used to access memory for the modification you specify.

## Chapter 4: Using the Emulator

### Accessing Processor Memory Resources

---

#### Examples

Modify the byte at e1f hex to 43 hex:

Choose **Modify**→**Memory**, and on the command line, type 0e1fh to 43h

```
modify memory 0e1fh to 43h
```

The above example assumes that byte mode was in effect. If not, add the mode parameter:

```
modify memory 0e1fh bytes to 43h
```

Modify the command input buffer of the demo program to 43 hex:

```
modify memory demo.Cmd_Input bytes to 43h
```

Modify the range of locations from e00 through e38 to zero:

```
modify memory 0e00h thru 0e38h to 0
```

Modify the range of locations from 0e00 through 0e38 to “ABC”:

```
modify memory 0e00h thru 0e38h bytes to 41h,42h,43h
```

Modify the memory at e00 hex to the string “This is a string”:

```
modify memory 0e00h string to "This is a string\n\0"
```

Remember that the memory modification is affected by the display mode. Suppose that locations f00 and f01 each contain 01. If you enter the command:

```
modify memory 0f01h bytes to 3h
```

Then location f00 contains 01 and location f01 contains 03. But, if you entered:

```
modify memory 0f00h words to 3h
```

Then location f00 will contain 00, and location f01 will contain 03. Notice that you refer to a word by an even address, which is the address of its most significant byte (this is defined by the MC68020 and MC68030/EC030 processor architecture).

---



## Using Processor Run Controls

When you don't use an emulator, run control can be difficult. Usually, you're limited to starting the processor from reset, and then entering data values that vector program execution to the routines you want to test. Reaching those routines may be difficult or impossible if the data values are boundary conditions or if the program logic is faulty.

By using the emulator, you can run the processor from the current program counter or any desired address. If you want to examine the system after each program instruction, you can use the **step** command to step through the program. You can break to the monitor program to examine on-chip resources such as RAM and registers, and you can reset the processor from the emulator.

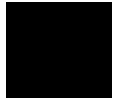

---

### To run a program

- Choose **Execution**→**Run** and select the desired starting point from the submenu, or select **until()** to specify the ending point. Enter the starting or ending address in the entry buffer before you choose a command that contains **from()** or **until()**.
- Using the command line, enter commands as follows:
  - To run a program from the current program counter (PC) value, enter **run**.
  - To run a program from a specific address, enter **run from <—EXPR—>** (where <—EXPR—> is a valid address expression that may include symbols).
  - To run a program from the reset vector, enter **run from reset**.
  - To run a program from its transfer address, enter **run from transfer\_address**.

When you're ready to start a program run, either to test target system operation or make an analyzer measurement, you use the **run** command.

<—EXPR—> is a 32-bit address expression. You can include function codes to specify the memory space to which the address applies.

## Chapter 4: Using the Emulator

### Using Processor Run Controls

The **run from reset** command pulses the processor reset line. The processor fetches the values at offsets 0 and 4 from the vector table, loads these values into the interrupt stack pointer and program counter registers, and then begins running from the program counter address value.

A **run** command causes the emulator processor to begin running from the current program counter, provided that the emulator is not in the reset state. If the emulator is in the reset state, the **run** command (with no parameters) is equivalent to a **run from reset** command, unless the **run** command is preceded by a **break** command.

If you reset the emulator, break to the monitor, and then run the emulator, the stack pointer and program counter values are taken from the values supplied to configuration items instead of from the reset vector locations. Refer to Chapter 8, “Configuring the Emulator” for more information about setting the initial stack pointer and program counter values.

---

#### Examples

To run from the demo program’s starting location:

Enter **main** in the entry buffer, and choose **Execution**→**Run**→**from()**.

Or, on the command line, enter:

```
run from main
```

To run programs from the current program counter value:

Choose **Execution**→**Run**→**from PC**, or on the command line, enter:

```
run
```

---

## To run programs from the transfer address

- Choose **Execution**→**Run**→**from Transfer Address**.
- Using the command line, enter **run from transfer\_address**.

Most software development tools allow you to specify a starting or entry address for program execution. That address is included with the absolute file's symbolic information and is known by the interface as the "transfer address".

Before you can run from the transfer address, it must exist in the absolute file, and you must load symbols along with the program code from the absolute file. If the interface does not detect a transfer address, this menu item is grayed-out and unresponsive to mouse clicks.

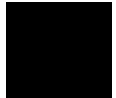

---

## To run programs from reset

- Choose **Execution**→**Run**→**from Reset**.
- Using the command line, enter **run from reset**.

This command resets the emulation processor and begins executing your target program at either the start address for the processor, or at the address fetched from the reset vector for the processor. It may be necessary to supply a reset signal from your target system as well. See your processor-specific documentation for information about the exact mechanism involved.

## To run programs until a selected address occurs

- When displaying memory in mnemonic format, position the mouse pointer over the line that you want to run until; then press and hold the *select* mouse button and choose **Run Until** from the popup menu.
- Place the address you want to run until in the entry buffer; then choose **Execution**→**Run**→**until()**.
- Using the command line, enter **run until <address>**.

When you run until an address, a breakpoint is set at the address and the program is run from the current program counter until the breakpoint is hit.

This command is useful for bypassing large areas of code. For example, you may want to run your program through the program startup code until the "main" function begins so that you can begin testing your code at "main".

When using the command line, you can combine the various types of run-from commands with the run-until command; for example, you can run from the transfer address until the start of a routine you wish to test.

You may need to enable breakpoints before "run until" will work. See "To enable or disable the breakpoint feature" later in this chapter.

## To break to the monitor

- Choose **Execution**→**Break**.
- Using the command line, cause the emulation processor to break from execution of your target program and start execution in the monitor by entering:

### *break*

The emulation monitor is a program that provides various emulation functions, including register access and target system memory manipulation. During a run that is restricted to real-time execution, you must break execution to the monitor before executing any emulation commands that access registers, emulation memory that is not dual-port, or target system memory. You also can use the **break** command to pause user program execution.

Inserting breakpoints in software and using **run until <address>** commands can be used to break to the monitor at selected points in your target program.

The status line changes to “Running in monitor.”

If you enter a **break** command while the processor is in a wait state (hung bus cycle), the emulator may terminate hung target bus cycles in an attempt to transition into the monitor. A bus cycle is considered hung when the target system has not provided the required termination within 300 ms. The emulator never attempts to terminate hung bus cycles in program space. The emulator will generate a status message for each address where it forcefully terminates a bus cycle. You can determine emulator status (**Display**→**Status**) to get information about a hung bus cycle before initiating a break (and accept the termination side effect) or use the **reset** command.

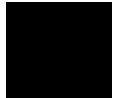

## To step the processor

- Choose **Execution**→**Step Source** or **Execution**→**Step Instruction**. Select the starting point for processor stepping from the associated submenu. If you will enter a command that requires a starting address, enter that address in the entry buffer before entering the command.
- Using the command line, enter commands as follows:
  - To step the processor one instruction from the current program counter value, enter **step**.
  - To step one line of high level source, enter **step source**.
  - To step the processor **<count>** number of times from the current program counter value, enter **step <count>**.
  - To step the processor one instruction from an address given by **<address>**, type **step from <address>**.
  - To step the processor **<count>** number of times from an address given by **<address>**, type **step <count> from <address>**.
  - To suppress display of registers for intermediate steps of a multi-step execution, add the **silently** parameter after the **step <count>** command. (**<count>** must be greater than one.) This is only effective when stepping is done in the same interface displaying registers.

The **step** command lets you single-step the processor through program code. **Step Source** executes one line in your high-level source program; **Step Instruction** executes one line of your assembly language program.

When displaying memory mnemonic, a highlighted bar shows the current program counter address. After each step, the highlighted bar moves to the new PC address. When displaying registers, the registers are updated after every step.

You can open multiple windows to show memory mnemonic and registers at the same time. Both are updated with each step.

If you omit the **<address>**, the current program counter value is used. You can use **transfer\_address** to step from the entry point of the program.

## Chapter 4: Using the Emulator Using Processor Run Controls

When stepping through instructions associated with source lines, execution may take a long time and the message "Stepping source line 1; Next PC: <address>" is displayed on the status line. In this situation, you can abort the step command by pressing <CTRL>c.

The emulator uses the built-in tracing capability of the MC68020/MC68030 processor to single step assembly instructions. The emulator needs the trace exception vector (located at offset 0x24 in the vector table) to be set properly in order to single step instructions. When a step command is given to the emulator, the emulator reads the trace exception vector and attempts to change one or more vector table entries if the trace exception vector is not set correctly. As long as the vector table is located in emulation memory or target RAM, stepping should always succeed. Upon completion of single stepping, the emulator restores modified vector table entries and issues a status message the first time the vector table is modified.

If the trace exception vector does not contain the correct value and the vector table is located in target ROM, the emulator will issue an error message and not perform the single step. There are two ways to deal with this situation. Either alter the ROM-based code so the trace vector contains the correct value, or copy/relocate the vector table into emulation memory or target RAM.

The correct value of the trace exception vector differs, depending on whether you are using a background or foreground monitor. The foreground monitor requires that the trace exception vector point to the TRACE\_ENTRY address in the monitor (located at offset 0x680 from the start of the monitor). If the trace exception vector already contains the correct value, the emulator performs the single step without modifying the vector table. Otherwise, the emulator attempts to change the trace a-line and f-line exception vectors to the TRACE\_ENTRY address in the foreground monitor.

The background monitor only requires that the trace exception vector be an even value and point to readable memory. This allows the processor to complete trace exception processing, including initial prefetches from the trace exception handler, during transition into the background monitor. After reading the trace exception vector, the emulator attempts to read from the address it points to. If the read succeeds, the emulator single steps without modifying the vector table. Otherwise, the emulator attempts to write the current value of VBR into the trace exception vector (because the vector table is readable).

There are some limitations when single stepping. A step may fail when single stepping an instruction that changes the address of the vector table (modifies the VBR register). With the background monitor, instructions that can be interrupted

## Chapter 4: Using the Emulator

### Using Processor Run Controls

(ie: floating-point operations) may not complete because the emulator generates an interrupt after a finite amount of time after the single step is initiated.

---

#### Examples

To step the processor one instruction from its present location, choose **Execution**→**Step Instruction**→**from PC**, or on the command line, enter:

*step*

To step the processor three instructions from the current program counter:

*step 3*

To step the processor five source-level instructions from the `init_system` symbol in the demo program:

*step 5 source from init\_system*

To step once from the program entry point, choose

**Execution**→**Step Instruction**→**from Transfer Address**, or on the command line, enter:

*step from transfer\_address*

---



## To reset the processor

- Choose **Execution**→**Reset**.
- Using the command line, enter commands as follows:
  - To reset the emulation processor from the emulator, enter:  

```
reset
```
  - To reset the emulator from the target system, assert the RESET signal in your target system.

When you apply power to the emulator, the initialization process leaves the emulator in the reset state. Changing some configuration items also resets the processor. (Refer to Chapter 8, "Configuring the Emulator" for more information.)

Sometimes you may want to reset the emulation processor prior to a program run. The **reset** command allows you to do this. Or, you can reset the emulation processor from the target system.

Both the MC68020 and MC68030/EC030 emulators will respond to a target system reset. A target system reset does not reset the entire emulator. It resets only the emulation processor.

If the emulators are running a user program when the target system reset occurs, they behave as if a **run from reset** command were issued.

If the MC68020 emulator is in the background monitor when the target reset occurs, it will reenter the monitor when the reset is released. The MC68030/EC030 emulator behaves this way for both the foreground and background monitors.

The reset command holds the processor in the reset state until a break, run, or step command. A CMB command can cause the emulator to run from reset. Also, a request to access memory or registers may cause a break into the monitor.

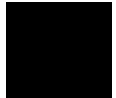

## Viewing and Modifying Registers

The emulator allows you to display registers to determine the results of program execution. You can display a single register, or you can display groups of related registers.

Sometimes you may want to modify a register, and then run a segment of program code to test the results.

---

### To display registers

- Choose **Display**→**Registers**→**BASIC**, or **FPU**, or **ACU** (if using the MC68030/EC030) to display the desired register class.
- Using the command line, enter commands as follows:
  - To display an individual register, enter: **display registers <register\_name>** where **<register\_name>** is one of the names shown in the table on the next page.
  - To display the basic processor register set, enter: **display registers** or **display registers BASIC**.
  - To display the registers in a floating-point coprocessor, enter: **display registers FPU**

If your target system does not have a floating-point coprocessor, the above command will cause an Error message to appear.

The available registers and register classes are in the table on the following page.

| Register Class                                      | Register Names  |
|---|---|
| <b>BASIC</b>  | <b>PC, ST, USP, ISP, MSP, CACR, CAAR, D0..D7, A0..A7, VBR, DFC, SFC</b> |
| <b>FPU</b>  | <b>FPCR, FPSR, FPIAR, FP0..FP7</b>                                      |
| <b>MMU (MC68030)<br/>or<br/>ACU (MC68030/EC030)</b> | <b>TT0, TT1, MMUSR, TC, CRP, SRP<br/><br/>AC0, AC1, ACUSR</b>           |

The processor must be running to allow register displays. If it's running in the monitor, the emulator does the display directly. If the emulator is reset, it will try to break to the monitor. If it's running the target system program, the emulator forces a break to the monitor, gets the register data, and then returns to the user program. (If you restrict the emulator to real-time runs, the display registers command isn't allowed while you're running your target program. Refer to Chapter 8, "Configuring the Emulator.")

---

**Examples**

Display the processor's A0 register:

*display registers A0*

---

There was an error in the first software release for the MC68030 Graphical User Interface. When you composed the **Display**→**Registers** command, the associated submenu would offer **BASIC**, **FPU**, and **ACU** as register sets, even when the MMU was enabled. If you clicked on **ACU**, you would see "syntax error". The next release of software for the Graphical User Interface (Revision 5.01) corrected this error. It offers **MMU** instead of **ACU** when the MMU is enabled. If you have the software release that has this error, click on the **MMU** softkey below the command line to correct your command.

## To modify registers

- Choose **Modify**→**Register...**, and in the dialog box, type in the register name and new value.
- Using the command line, modify a register to a new value by typing:  
**modify register <regname> to <value>**

Where **<regname>** is the name of a processor register, and **<value>** is an expression matching the data type of the register (byte or word).

To modify an MMU register in the MC68030 emulation processor, the MMU must be enabled. To modify an ACU register in the MC68030 emulation processor, the MMU must be disabled. (Refer to the emulation configuration questions discussed in Chapter 8, "Configuring the Emulator").

To modify registers in the FPU class, your target system must have a floating-point coprocessor. You can enter values into the three FPU control registers using numbers in the following bases: hexadecimal, decimal, octal, and binary. (You can't use symbols for the floating-point registers.)

You can enter values into the eight floating-point registers using either floating-point or hexadecimal notation. Special values, such as denormals, infinity, and NaN (Not a Number) can be entered by using hexadecimal notation. The following are examples of acceptable entries for the floating-point registers:

```
+12.34e+56  
-1.E23  
.1e-23  
1.2  
.7  
7654321  
0000.000001  
7fff0000ffffffffffffH
```

Modifying a register's contents can help you test the effects of different program values without the trouble of rebuilding your program code. For example, you might stop the processor at a certain point (set a breakpoint), and then modify a register and run from that point to test the result.

The register is displayed after modification to confirm the change.

The processor must be running to allow modifying registers. See "To display registers" above for more information.

---

**Examples**

To modify a register, choose **Modify**→**Register...**, and fill in the dialog box.

Place the mouse pointer in the text entry area and type in the name of the register and the new value.

Click this pushbutton to read the present value of the selected register.

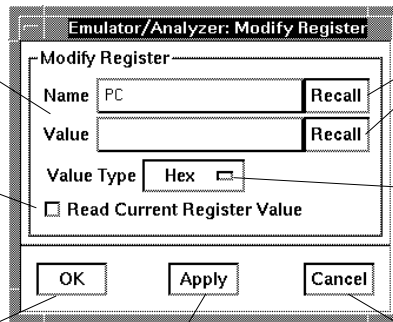

Click Recall to select register names and values from predefined or previously specified entries.

Click this pushbutton and select the desired type from the submenu.

Click OK to modify the register to the new value and close the dialog box.

Click Apply to modify the register to the value specified and leave the dialog box open.

Click this pushbutton to cancel the modification and close the dialog box.

To use the command line to modify the PC register to an address:

```
modify register PC to init_system
```

To use the command line to modify the D3 register to 0:

```
modify register D3 to 0
```

## Using Execution Breakpoints

Breakpoints allow you to stop target program execution at a particular address and transfer control to the emulation monitor. Suppose your system crashes when it executes in a certain area of your program. You can set a breakpoint in your program at a location just before the crash occurs. When the processor executes the breakpoint, the emulator will force a break to the monitor. You can display registers or memory to understand the state of the system before the crash occurs. Then you can step through the program instructions and examine changes in the system registers that lead up to the system crash.

Execution breakpoints are implemented using the BKPT instruction of the MC68020/MC68030. You can enable, disable, set, or clear execution breakpoints.

Set execution breakpoints at the first word of program instructions. Otherwise, your BKPT may be interpreted as data and no breakpoint cycle will occur. When the BKPT instruction is executed, target program execution stops immediately (unlike using the analyzer to cause a break into the monitor, which may allow several additional bus cycles to execute before the break finally occurs).

---

## Setting execution breakpoints in RAM

When you set an execution breakpoint in RAM, the emulator will place a breakpoint instruction (BKPT) at the address you specified, and then read that address to ensure that the BKPT instruction is there. The program instruction that was replaced by BKPT is saved by the emulator.

When the breakpoint instruction is executed, the BKPT acknowledge cycle is detected by the emulator, and the emulator causes a break to the monitor. At this point, the emulator replaces the BKPT instruction with the original instruction it saved. It also replaces the BKPT instruction with the original instruction whenever you disable or remove the breakpoint.

The emulator allows an unlimited number of breakpoints to be set in RAM.

## Using temporary and permanent breakpoints

When you set a temporary execution breakpoint, the emulator creates the breakpoint as described in the preceding paragraphs. When the breakpoint instruction is executed, the emulator breaks to the monitor and removes the breakpoint. Now you can execute that portion of program code as often as you like and the breakpoint will not occur again, unless you enable it again.

When you set a permanent breakpoint, the emulator will process it the same as a temporary breakpoint, but when the breakpoint instruction is executed, the original instruction will only replace the breakpoint instruction during its next execution. This allows you to step through the original instruction one time. After your first step, the BKPT instruction will replace the original instruction again so that the breakpoint will occur the next time the breakpoint address is hit.

Permanent breakpoints remain in effect until you explicitly disable or remove them.

Permanent breakpoints are available when using version A.04.00 or greater of the emulation system firmware.

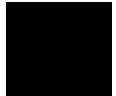

## To enable execution breakpoints

- Choose **Breakpoints**→**Enable**.
- Inside the breakpoints list display, press and hold the *select* mouse button and then choose **Enable/Disable Software Breakpoints** from the popup menu.
- Using the command line, enable breakpoints with:

```
modify software_breakpoints enable
```

You must enable breakpoints before you can set, inactivate, or clear any breakpoints.

Once you have enabled breakpoints, you can enter new ones into the breakpoint table. Note that if you enable breakpoints, add several, and then disable them, they all become inactive. If you reenable the breakpoints feature, you must choose **Breakpoints**→**Set All**, or on the command-line, enter **modify software\_breakpoints set** if you want to set all the existing breakpoint entries.

---

## To disable an execution breakpoint

- Choose **Breakpoints**→**Enable** again. The **Breakpoints**→**Enable** selection is a switch.
- Inside the breakpoints list display, press and hold the *select* mouse button and then choose **Enable/Disable Software Breakpoints** from the popup menu.
- Using the command line, disable breakpoints with:

```
modify software_breakpoints disable
```



Sometimes you will want to temporarily disable the execution breakpoints feature without removing the existing breakpoints. Use one of the above commands to do this.

When you disable breakpoints, the emulator replaces the BKPT instructions at all breakpoint locations with the original instructions. It marks the breakpoint table entries as “inactive.” The processor won’t break to monitor when the instructions at inactive locations are executed.

If you later enable breakpoints, the ones in the table are still inactive. To use them, you must set them by choosing **Breakpoints→Set All**, or on the command-line, entering the **modify software\_breakpoints set** command.

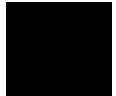

---

## To set a permanent breakpoint

When displaying memory in mnemonic format, position the mouse pointer over the program line where you wish to set the breakpoint and click the *select* mouse button. Or, press and hold the *select* mouse button and choose **Set/Clear Software Breakpoint** from the popup menu.

Place an absolute or symbolic address in the entry buffer; then, choose **Breakpoints→Permanent()**

Using the command line, enter the command:

```
modify software_breakpoints set <address> permanent
```

The breakpoints feature must be enabled before individual breakpoints can be set.

When displaying memory in mnemonic format, asterisks (\*) appear next to breakpoint addresses. An asterisk shows the breakpoint is active. Also, if assembly level code is being displayed, the disassembled instruction mnemonic at the breakpoint address will show the breakpoint instruction.

## To set a temporary breakpoint

- Type in the absolute or symbolic address of the breakpoint you want to set in the entry buffer. Then choose **Breakpoints**→**Temporary()**, ( or choose **Breakpoints**→**Set()** if your version of HP 64700 system firmware is less than A.04.00).
- Choose **Breakpoints**→**Set All** to set all existing breakpoints in the breakpoint table.
- Inside the breakpoints list display, press and hold the *select* mouse button and then choose **Set All Breakpoints** from the popup menu.
- Using the command line, enter comands as follows:
  - To set a breakpoint at a location given by <address>, enter:  
*modify software\_breakpoints set <address>*
  - To set all existing breakpoints in the breakpoint table, enter:  
*modify software\_breakpoints set*

To add a new breakpoint, you can choose **Breakpoints**→**Temporary()** with the name of the new breakpoint in the entry buffer, or use the **modify software\_breakpoints set** command and specify the address for the breakpoint. You can also use this method to reenable an existing breakpoint at that address.

If you choose **Breakpoints**→**Set All**, or use the **modify software\_breakpoints set** command without an address parameter, all existing breakpoints in the breakpoints table will be enabled. The breakpoints feature must be enabled before individual breakpoints can be set.

When displaying memory in mnemonic format, asterisks (\*) appear next to breakpoint addresses. An asterisk shows the breakpoint is active. Also, if assembly level code is being displayed, the disassembled instruction mnemonic at the breakpoint address will show the breakpoint instruction.

---

**Examples**

Set a new breakpoint at `get_targets`:

```
modify software_breakpoints set update_sys.get_targets
```

Reenable all existing breakpoints:

```
modify software_breakpoints set
```

---

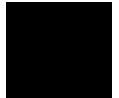

## To clear an execution breakpoint

- Type in the name of the breakpoint you want to clear in the entry buffer. Then choose **Breakpoints**→**Clear()**.
- Choose **Breakpoints**→**Clear All** to clear all existing breakpoints in the breakpoint table.
- Inside the breakpoints list display, press and hold the *select* mouse button and then choose **Clear (delete) Breakpoint** from the popup menu to clear the selected breakpoint.
- Using the command line, enter commands as follows:
  - To remove an existing breakpoint at a location given by <address>, enter:  
*modify software\_breakpoints clear <address>*
  - To remove all existing breakpoints, enter:  
*modify software\_breakpoints clear*

When you're finished using a particular breakpoint, you should clear the breakpoint table entry. The original instruction is restored to memory, and the breakpoint table entry is removed.

**Examples**

To clear a breakpoint using the breakpoints display popup menu:

Bring up the menu and choose this item to clear the highlighted breakpoint.

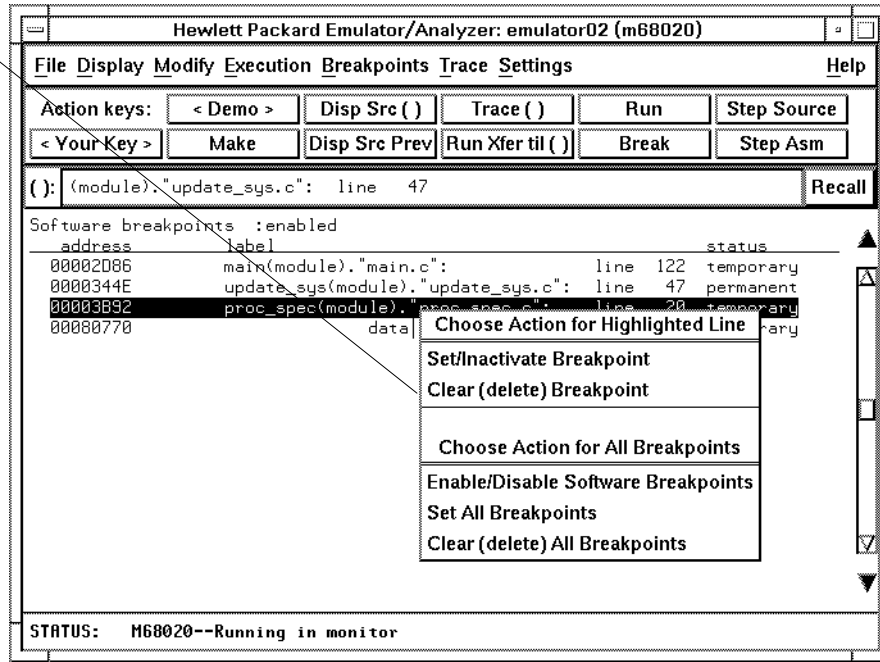

To clear an existing breakpoint at get\_targets:

*modify software\_breakpoints clear* update\_sys.get\_targets

To clear all existing breakpoints:

*modify software\_breakpoints clear*

## To clear all execution breakpoints

- When displaying breakpoints, position the mouse pointer within the breakpoints display screen, press and hold the *select* mouse button, and choose **Clear (delete) All Breakpoints** from the popup menu.
- Choose **Breakpoints**→**Clear All**.
- Using the command line, enter:

```
modify software_breakpoints clear
```

---

## To display the status of all execution breakpoints

- Choose **Breakpoints**→**Display** or **Display**→**Breakpoints**.
- Using the command line, display the status of all breakpoints by selecting:

```
display software_breakpoints
```

The breakpoints table shows you whether the breakpoints feature is currently enabled or disabled. Also, the status is shown for each breakpoint in memory. If “Pending,” the BKPT instruction is in memory at that location and the breakpoint is set. If “Inactive,” the memory location contains the original instruction, and the breakpoint will not be executed.

Active breakpoints are indicated in the memory mnemonic display by asterisks beside the lines with breakpoints set.

The status of a breakpoint can be:

|           |   |
|-----------|---|
| temporary | Which means the temporary breakpoint has been set but not encountered during program execution. These breakpoints are removed when the breakpoint is encountered. |
|-----------|---|

|             |   |
|-------------|---|
| permanent   | Which means the permanent breakpoint is active. Permanent breakpoints remain active after they are encountered during execution.  |
| inactivated | Which means the breakpoint has been inactivated. Pending breakpoints are inactivated when they are encountered during program execution. Both temporary and permanent breakpoints can be inactivated (and restored) using the breakpoints display popup menu.   |
| pending     | Which means the temporary breakpoint has been set but not encountered during program execution. When encountered, these breakpoints are inactivated, but retained in the breakpoints list. Pending breakpoints can only be set using the softkey command line with commands like <b>modify software_breakpoints set 1000</b> and not selecting the additional options <b>&lt;temporary&gt;</b> or <b>&lt;permanent&gt;</b> . The "pending" breakpoints status is retained for compatibility with older product software versions. |

In the breakpoints display, a popup menu is available, obtained by pressing the *select* mouse button. You can inactivate or restore the status of any breakpoint in the breakpoints list, as well as enable or disable the breakpoints feature, using the popup menu.

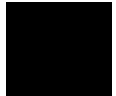

## Changing the Interface Settings

This section shows you how to:

- Set the source/symbol modes.
- Set the display modes.

---

### To set the source/symbol modes

- To display assembly language mnemonics with absolute addresses, choose **Settings**→**Source/Symbol Modes**→**Absolute**.
- To display assembly language mnemonics with absolute addresses replaced by global and local symbols where possible, choose **Settings**→**Source/Symbol Modes**→**Symbols**.
- To display assembly language mnemonics intermixed with high-level source lines, choose **Settings**→**Source/Symbol Modes**→**Source Mixed**.
- To display only high-level source lines, choose **Settings**→**Source/Symbol Modes**→**Source Only**.

Using the command line, enter commands as follows:

- To display mixed source and assembly language, enter the **set source on** command.
- To display only source language statements, enter the **set source only** command.
- To display only assembly language, enter the **set source off** command.

The source/symbol modes affect mnemonic memory displays and trace displays.



Each display mode cascade menu choice is a toggle. Choosing one of these items causes it to be the only one active and toggles all others off. Provided that symbols were loaded, the interface defaults to:

- Source only for mnemonic memory displays.
- Source mixed for trace listing displays.

---

## To set the display modes

- Choose **Settings**→**Display Modes...** to open the display modes dialog box.

Press and hold the *select* mouse button and drag the mouse to select "Source Only", "Source Mixed", or "Off".

Clicking toggles whether symbolic information is displayed.

Move the mouse pointer to the text entry area and type in the desired field widths.

Label Field sets the width of the Label:/Address field.

Mnemonic Field sets the width of the Opcode or Status field.

Symbols in Mnemonic Field sets the widths of symbols shown in the Opcode or Status field.

Source Lines field sets the width of lines that show source-file lines.

Clicking toggles auto update settings.

Clicking this checkbox changes all display mode settings to their defaults.

Clicking:

OK saves changes and closes dialog box.

Apply saves changes and leaves dialog box open.

Cancel closes dialog box and ignores changes.

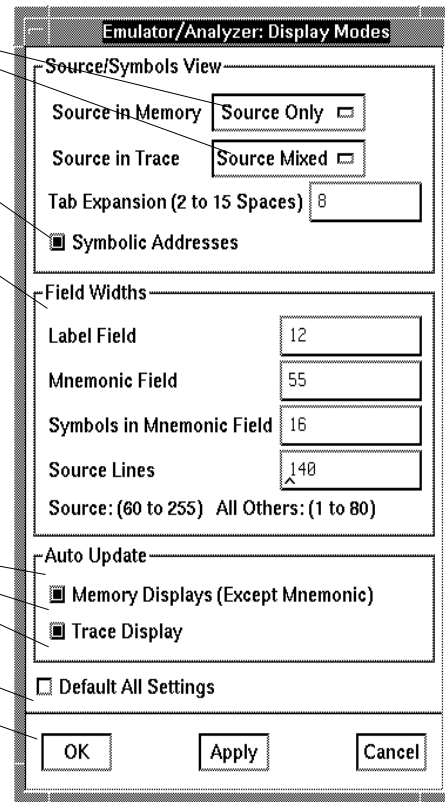

## Source/Symbols View

**Source in Memory** specifies whether source lines are included, mixed with assembly code, or excluded from mnemonic memory displays.

**Source in Trace** specifies whether source lines are included, mixed with stored states, or excluded from trace displays.

**Symbolic Addresses** specifies whether symbols are included in displays.

**Tab Expansion** sets the number of spaces displayed for tabs in source lines.

## Field Widths

**Label Field** sets the width (in characters) of the address field in the trace list or label (symbols) field in any of the other displays.

**Mnemonic Field** sets the width (in characters) of the mnemonic field in memory mnemonic, trace list, and register step mnemonic displays. It also changes the width of the status field in the trace list.

**Symbols in Mnemonic Field** sets the maximum width of symbols in the mnemonic field of the trace list, memory mnemonic, and register step mnemonic displays.

**Source Lines** sets the width (in characters) of the source lines in the memory mnemonic display.

## Auto Update

**Memory Displays (Except Mnemonic)** toggles whether memory displays are automatically updated after commands that change memory contents or whether you must enter memory display commands to update the display. You may wish to turn off memory display updates, for example, when displaying memory mapped I/O.

**Memory Mnemonic Auto PC** toggles whether the mnemonic memory display is automatically updated to follow the PC or remain unchanged.

**Trace Displays** toggles whether trace displays are automatically updated when trace measurements complete or whether you must enter trace display commands to update the display. You may wish to turn off trace display updates in one emulator/analyzer window in order to compare the display with a new trace display in another emulator/analyzer window.

## Using the Emulator In-Circuit

As your target system design progresses, you'll want to test features of your program that will interact with your target system hardware instead of emulation memory hardware.

You must connect the emulator probe to your target system to do in-circuit emulation. Then you can make analyzer measurements and have the memory display and other capabilities of the emulator to debug target system problems.

---

**Caution**

When you use the emulator in-circuit, you need to carefully consider the configuration of the emulator and its relationship to your target system design. Refer to Chapter 8, "Configuring the Emulator," for details of the emulation configuration.

---

---

## To install the emulation probe

---

**CAUTION**

Possible damage to the emulator probe. The emulation probe contains devices that are susceptible to damage by static discharge. Take precautions before handling the probe to avoid damaging the internal components of the probe with static electricity.

---

---

**CAUTION**

Possible damage to the emulator. Make sure both your target system and emulator power are OFF before installing the emulator probe into the target system. The emulator may be damaged if the power is on when installing the probe.

---

---

**CAUTION**

The emulator probe will be damaged if incorrectly installed. Make sure to align pin A1 of the probe connector with pin A1 of the socket.

---

## Chapter 4: Using the Emulator Using the Emulator In-Circuit

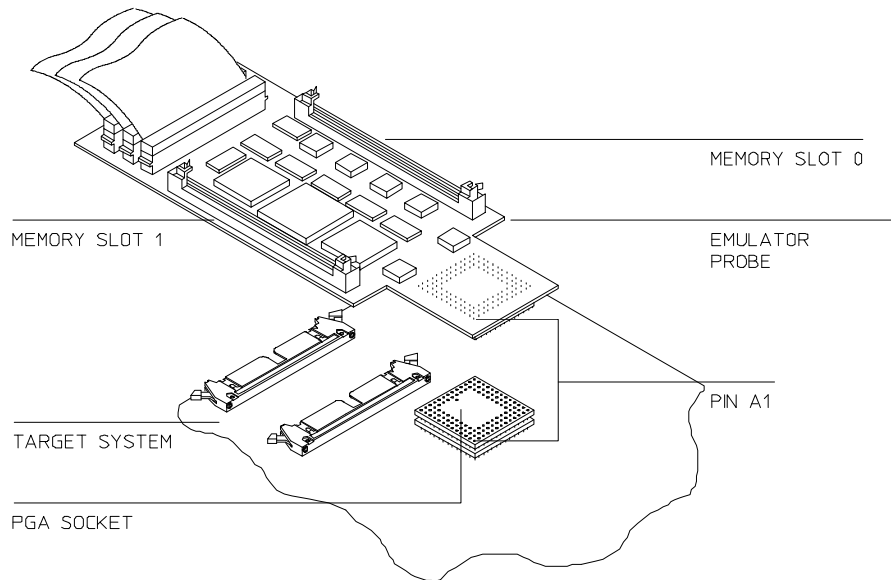

- 1 Remove the processor from your target system socket. Note the location of pin A1 on the processor and on the target system socket. Store the processor in a protected environment (such as antistatic foam).
- 2 Insert the emulator probe into your target system socket. Make sure to align pin A1 of the emulator probe and the target system socket.

---

## To power-on the emulator and your target system

---

### CAUTION

You must turn on power to the emulator before you turn on power to your target system. Otherwise, the emulator may be damaged. Turn off power to the target system before turning off power to the emulator.

- 1 Turn on power to the emulator.
- 2 Turn on power to your target system.

Before you turn off power to the emulator, be sure to turn off power to your target system.

---

## To probe other types of target system sockets

Adapters for special target system probing needs are available, as shown in the following table.

---

| Probe type  | HP part number |
|---|----------------|
| 68020 PGA to PGA extender                                   | 64748-61604    |
| 68020 PGA to PQFP extender                                  | E2426-61601    |
| 68020 PGA to 68EC020 PGA adapter                            | 64748-87602    |
| 68030/EC030 PGA to PGA extender                             | 64747-61601    |
| 68030/EC030 PGA to PQFP surface mount adapter (low profile) | E2406-61602    |
| 68030/EC030 PGA 90° CCW rotator                             | 64700-87620    |
| 68030/EC030 PGA 90° CW rotator                              | 64700-87619    |

---

## Using The MC68030 Emulator With MMU Enabled

When you enable memory management in the MC68030 emulator, many capabilities and features become available that are not otherwise offered. Also, some of the features of the emulator behave differently. The remaining pages in this chapter will help you when you are using the MC68030 emulator with the MMU enabled. Chapter 10, "Using MC68030 Memory Management", provides detailed information to help you use the MC68030 MMU most efficiently.

Disable the MMU unless you are using it for address translation. You will still be able to use the transparent translation registers for such tasks as defining cache modes.

---

### To enable the processor memory management unit (MC68030 only)

In order to use the MC68030 MMU to provide logical-to-physical address translation, the MMU must be enabled within the emulator configuration and the target system must deassert the MMUDIS signal (MMU Disable). If the MMU is not enabled within the emulator configuration, the emulator asserts the MMUDIS signal and ignores the MMUDIS signal from the target system, thus preventing the target system from using the MMU. If you are using the background monitor, you will need to select a foreground monitor before the MMU can be enabled within the emulator configuration. Refer to Chapter 8, "Configuring the Emulator," for details of setting up the emulator configuration.

Once the MMUDIS signal is driven properly, the target system software is responsible for setting up address translation tables in memory and initializing the processor's MMU registers at run time. This task is typically managed by the target system's boot code or operating system. Refer to your *Motorola 68030 User's Manual* for information on how to use the MMU.

If the emulator is being used in an MC68EC030 target system, or if the MMU is not needed for translating page addresses from address translation tables in memory, then you should disable the MMU within the emulator configuration. This causes the emulator to assert the MMUDIS signal. However, the assertion of

this signal does not affect the operation of the transparent translation or access control registers.

---

## To view the present logical-to-physical mappings

- Choose **Display→MMU Translations**. If you want to specify a logical address range for your mappings display, choose **Display→MMU Translations...** Then in the dialog box, click on **MMU Mappings**, and enter the desired logical address range.
- Using the command line, enter the command:

```
display mmu_translations
```

The display will show the logical-to-physical address translations defined by the current MMU registers and translation tables.

---

### Examples

To see the logical-to-physical mappings using the default range of logical addresses (initially 0 through 0ffffffh), choose **Display→MMU Translations**, or on the command line, enter:

```
display mmu_translations
```

To see all of the logical-to-physical mappings for logical addresses from 0 through 0ffffh (when function codes are not enabled and only the CRP root pointer is enabled), choose **Display→MMU Translations....** Then in the dialog box, click on **MMU Mappings**, and enter Start Address 0 and End Address 0ffffh, and click ok.

Chapter 4: Using the Emulator  
Using The MC68030 Emulator With MMU Enabled

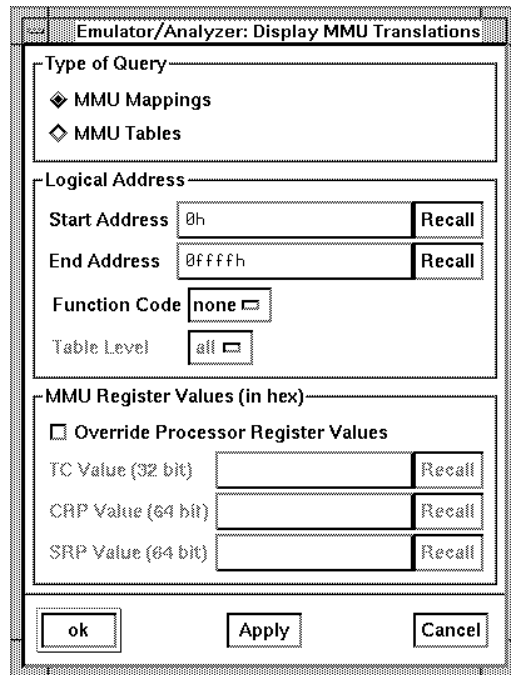

Using the command line, enter:

```
display mmu_translations 0 thru 0ffffh
```

To see the logical-to-physical mappings for the pages that contain logical address 40f0h, enter the command:

```
display mmu_translations 40f0h
```

To see only the mappings in supervisor space in the address range from 0 through 0ffffh, enter the command:

```
display mmu_translations fcode s 0 thru 0ffffh
```

To see only the mappings in user space in the address range from 0 through 0ffffh, enter the command:

```
display mmu_translations fcode up 0 thru 0ffffh
```



To show all of the valid mappings in the mapping tables for selected values of the TC, CRP, and SRP registers, ignoring the present values of those registers, enter a command, such as:

```
display mmu_translations use_TC_value 81ff2000h  
use_CRP_value 20800604bf9fffe7 use_SRP_value  
8000000200001020
```

Note that the numerical base must be specified for the TC register, but hexadecimal values are assumed for the CRP and SRP registers.

---

## To see translation details for a single logical address

- Choose **Display→MMU Translations...** Then in the dialog box, click on **MMU Tables**, and enter the Logical Address whose table details you want to see in the Address box, and click ok.
- Using the command line, enter the command:

```
display mmu_translations tables <address>
```

---

### Examples

To see how logical address 40f0h is mapped through the translation tables to its corresponding physical address, choose **Display→MMU Translations...** Then in the dialog box, click on **MMU Tables**, enter 40f0h in the Address box, and click ok.

Chapter 4: Using the Emulator  
Using The MC68030 Emulator With MMU Enabled

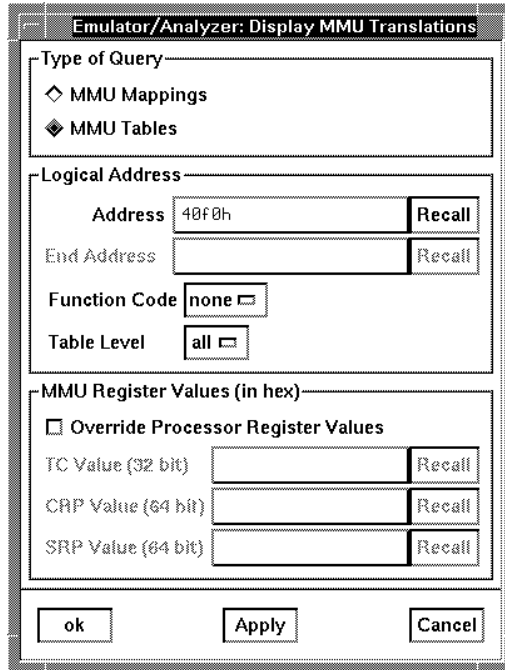

Using the command line, enter:

```
display mmu_translations tables 40f0h
```

To see how logical address 1000h in user space is mapped through the translation tables to its corresponding physical address, choose **Display→MMU Translations...** Then in the dialog box, click on **MMU Tables**, enter 1000h in the Address box, click on the pushbutton beside Function Code and select **up** from the submenu, and click ok.

Using the command line, enter:

```
display mmu_translations tables fcode up 1000h
```

## To see details of a translation table used to map a selected logical address

- Choose **Display→MMU Translations...** Then in the dialog box, click on **MMU Tables**, and enter the Logical Address whose translation table you want to see in the Address box. Finally, beside **Table Level**, click on the pushbutton to identify the table you want to see, and then click ok.
- Using the command line, enter the command:

```
display mmu_translations tables <address> level  
<table_level>
```

Where <table\_level> is the table level you want to see (either **A**, **B**, **C**, **D**, or **FC** if function codes are used), and <address> is the logical address that uses the table at the point to be shown.

Note that table level **all** is also offered. If you select **all**, you will see the translation details for your logical address through the tables. This is the same as if you had not selected the **level** <table\_level> option.

Table A may be accessed at several different base addresses, depending on which logical address is to be translated. This command ensures you see Table A where you want to see it.

---

### Examples

To see the details of Table A used to map logical address 1250h, choose **Display→MMU Translations...** Then in the dialog box, click on **MMU Tables**, and enter 1250h in the Address box. Finally, beside **Table Level**, click on the pushbutton to select A, and then click ok.

Chapter 4: Using the Emulator  
Using The MC68030 Emulator With MMU Enabled

Emulator/Analyzer: Display MMU Translations

Type of Query

- MMU Mappings
- MMU Tables

Logical Address

Address: 1250h Recall

End Address: Recall

Function Code: none

Table Level: A

MMU Register Values (in hex)

Override Processor Register Values

TC Value (32 bit): Recall

CRP Value (64 bit): Recall

SRP Value (64 bit): Recall

ok Apply Cancel

Using the command line, enter:

`display mmu_translations tables 1250h level A`

---

# 5

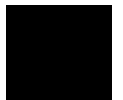

---

## Using the Emulation-Bus Analyzer

How to record program execution in real-time

## **Power of the Emulation-Bus Analyzer**

The *emulation-bus analyzer* is a powerful tool that allows you to view the execution of your program in real-time. Extensive triggering and sequencing capability ensures that the analyzer captures only the information you need so you don't spend time searching through long trace lists to find the information that is of interest.

The Graphical User Interface has menus that let you specify some simple analyzer measurements like tracing after, about, or before an address. You can also specify qualifications for which states get stored and which states can be prestored; the analyzer can prestore up to two states before each qualified store state.

The analyzer has much more capability than is available in the menus. You can access this capability by using the command line to make your trace specifications. Use of the command line is also covered in this chapter.

Once a trace specification command is entered, either with the menus or the command line, it can be recalled, edited if desired, and executed again. Also, trace specifications and trace data can be stored to files and loaded from files.

## Making Simple Trace Measurements

You can make simple records of the processor's bus activity using just a few analyzer commands. When you set up the analyzer to record processor bus activity, you are preparing to make a *trace measurement*. During the trace measurement, the analyzer saves a record of the bus activity in trace memory. The display of the trace memory content is called the *trace list*.

The information captured at the occurrence of each clock is called a state. When a captured state matches your specification for the trigger state, the analyzer identifies it as the trigger state and stores it in trace memory.

The default specification for the trigger state is "any state." When you start a trace measurement using the default trace specification, the analyzer will identify the first state it captures as the trigger state and fill the remaining space in the trace memory with the states that follow it. A trace is said to be complete when the trace memory is filled with captured states, and the trigger state resides at its specified point in the trace memory (the first state captured in memory, by default).

When a trace measurement is started, you can view the progress of the measurement by displaying the trace status.

In some situations, for example, when the trigger state is never found or when the analyzer hasn't filled its trace memory, the trace measurement does not complete. In these situations, you can halt the trace measurement.

Once a trace is displayed, you can use the cursor keys and other keyboard keys to position the trace list on screen. To speed up the display of traces, you can reduce the depth of the trace list. Also, when entering trace commands, you can recall and modify preceding trace commands to speed command entry.

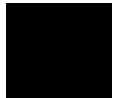

## To start a trace measurement

- Choose **Trace→Everything**.
- Using the command line, enter:

*trace*

When you use the **trace** command without any options, the analyzer begins recording processor bus cycles immediately, and continues until the trace buffer is filled. In the default trace configuration, the analyzer stores all bus cycles.

If you are using the deep analyzer, the depth of the trace list buffer depends on whether or not you installed memory modules on the analyzer card, and the capacity of the memory modules installed. Refer to Chapter 18, "Installation and Service", for details. If you are using the 1K analyzer, the trace list buffer is 512 or 1024 states deep (depending on whether or not you turn on the state/time count). See "To count states or time" in this chapter.)

---

### Example

Start the demo program and trace from the program start:

```
Startemul  
reset  
trace  
run from transfer_address
```

---



## To stop a trace measurement

- Choose **Trace→Stop**.
- Using the command line, enter:

*stop\_trace*

You must use this command to stop a trace started with a **Trace→Until Stop** command (refer to "To trace activity leading up to a program halt" later in this chapter). Several other conditions may occur that will make you want to stop a trace. The analyzer may not record any trace states because your trigger specification isn't correct, or because you have a target system problem. At other times, a valid trace may be capturing data slowly. You can use the **stop\_trace** command to prevent the analyzer from storing additional data.

You do not have to stop a trace in order to begin viewing a partial trace because the interface supports incremental trace uploading. After the trigger condition occurs, the interface begins uploading and displaying trace states as they are captured.

---

## To display the trace list

- Choose **Trace→Display**.
- Choose **Display→Trace**.
- Using the command line, enter:

*display trace*

When you complete a trace measurement, you will want to see the results. The **display trace** command shows you the current trace list. The trace display is updated each time you enter a new **trace** command, until you display some other



---

## To display the trace status

- Choose **Display**→**Status**.
- Using the command line, display the trace status with the **display status** command.

When you complete a trace measurement, you'll want to see the results.

The commands above show the current emulator and analyzer status. The analyzer status shows:

- whether the trace has completed (trace memory is full)
- analyzer arm condition
- whether the trigger has been found
- number of states captured
- current sequencer state and occurrence count

---

### Example

In the following example trace status display, the screen shows that the emulation trace has halted, an analyzer arm (activating condition) was not received or defined, the analyzer trigger was not found, no trace states were captured (because the trigger was not recognized), and no analyzer sequence terms or occurrences of states were needed to satisfy the analyzer trigger.

```
Status
Emulator Status
M68EC030--Running in monitor
Trace Status
Emulation trace halted
Arm not received
Trigger not in memory
Arm to trigger ?
States 0 (0) ?..?
Sequence term ?
Occurrence left ?

STATUS: M68EC030--Running in monitor.....R....
display status

run trace step display modify break end ---ETC---
```

## To change the trace depth

- Choose **Trace→Display Options...** and in the dialog box, enter the desired trace unload depth in the field beside Unload Depth. Then click the OK or Apply pushbutton.
- Using the command line, enter:

```
display trace depth <depth>
```

Using one of the above command forms, you specify the number of states that will be unloaded for display, copy, or file storage. By reducing the trace unload depth, you shorten the time it takes for the interface to unload the trace information. You can increase the trace unload depth to view more states of the current trace.

Regardless of how much or how little unload depth you specify, the entire trace memory will be filled with captured states during a trace.

In the deep analyzer, the maximum number of trace states depends on whether or not you installed memory modules in the analyzer card, and the capacity of the memory modules. Refer to Chapter 18, "Installation and Service", for details. In the 1K analyzer, the maximum number of trace states is 1024 when counting is turned off, and 512 otherwise. In either analyzer, the minimum trace depth is 9.

Trace data must be unloaded before it can be displayed, copied, or stored in a file. If you wish to reduce the number of states that are unloaded for display, you must enter the unload depth specification (in one of the two ways shown above) before you enter the trace command. The above commands cannot be used to reduce the number of states displayed in the current trace. You can enter a new unload depth specification after a trace is complete to increase the amount of trace memory that is unloaded, if desired.

## To modify the last trace command entered

- Choose **Trace**→**Trace Spec** and use the dialog box to select and edit a trace command.
- Using the command line, enter the **trace modify\_command** command.

The Trace Specification Selection dialog box contains a list of trace specifications executed during the emulation session as well as any predefined trace specifications present at interface startup.

You can predefine trace specifications and set the maximum number of entries for the dialog box by setting X resources (refer to Chapter 13, "Setting X Resources").

The **trace modify\_command** command recalls the last trace command. The advantage of this command over command recall is that you do not have to move forward and backward over other commands to find the last trace command; also, the last trace command is always available, no matter how many commands have since been entered.

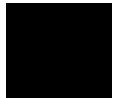

## To define a simple trigger qualifier

- Enter your trigger qualifier (such as, **address 1000h**) in the entry buffer. Then in the menu bar, click on: **Trace→After()**, **Trace→Before()**, or **Trace→About()**.
- When displaying memory in mnemonic format, position the mouse pointer over the program line that you wish to use as a trigger, press and hold the *select* mouse button, and choose **Trace After**, **Trace Before**, or **Trace About** from the popup menu.
- Using the command line, use the **trace** command to specify a trigger.

The default option for the analyzer is to begin to fill trace memory immediately after the start of the trace. The trace completes when trace memory is full and the trigger has been captured.

The trigger is a reference event in a trace list. You select trigger position to see activity leading up to the trigger event, or following the trigger event, or both.

---

### Example

To trigger a trace measurement after the demo program executes the `Init_system` procedure, place `init_system` in the entry buffer and choose **Trace→After()**, or on the command line, enter:

```
trace after long_aligned init_system
```

The “`long_aligned`” option ensures that if the address of the trigger event is not on a long word boundary, the analyzer will still be able to recognize it.

To capture a trace leading up to the address of `gen_ascii_data`, and then break to the monitor when that trigger event occurs, place `gen_ascii_data` in the entry buffer and choose **Trace→Until()**, or on the command line, enter:

```
trace before long_aligned gen_ascii_data  
break_on_trigger
```

To capture a trace of activity both preceding and following the `write_hdwr` symbol in the `update_sys` module, place `update_sys.write_hdwr` in the entry buffer and choose **Trace→About()**, or on the command line, enter:

```
trace about long_aligned update_sys.write_hdwr
```

---

---

## To specify a trigger and set the trigger position

- Place the trigger specification desired (such as **address 1000h**) in the entry buffer, and then choose **Trace→After()**, **Trace→Before()**, or **Trace→About()**.
- When displaying memory in mnemonic format, position the mouse pointer over the program line that you wish to use as the trigger, press and hold the *select* mouse button, and choose **Trace After**, **Trace Before**, or **Trace About** from the popup menu.
- Using the command line, select **trace after**, **trace before**, or **trace about** to set the trigger position.

Normally the analyzer begins to save processor activity whenever the trace is started. By selecting trigger position, you can specify which portion of processor activity you will view in the trace list.

The **trace after** command causes the analyzer to fill its trace memory with processor activity that occurred after the trigger event.

The **trace before** command causes the analyzer to fill its trace memory with processor activity that occurred before the trigger event.

The **trace about** command causes the analyzer to fill its trace memory with processor activity that occurred before and after the trigger event. With this command, the trigger event is positioned at the center of the trace.

The actual trigger position in the trace list is within +/-3 states of the position specified.

## Chapter 5: Using the Emulation-Bus Analyzer

### Making Simple Trace Measurements

When you enter a **trace about** command, the trigger state (line 0) is normally labeled “about”. However, if there are three or fewer states before the trigger, the trigger state is labeled “after”, and if there are three or fewer states after the trigger, the trigger state is labeled “before”.

---

#### Example

To trace on states before the demo program accesses the current humidity, enter:

```
trace before address current_humid status write  
set symbols on  
display trace
```

---

### To define a simple storage qualifier

- Place your storage qualifier in the entry buffer (such as **status read**), and then choose **Trace→Only()**.
- Using the command line, use the **only** option in the **trace** command.

All captured states are stored by default. However, you can qualify which states get stored with the **only** option to the **trace** command.

---

#### Example

When you are running the demo program, to store only accesses to the address "target\_temp", place target\_temp in the entry buffer, and then choose **Trace→Only()**, or on the command line, enter:

```
trace only target_temp
```

---



## Displaying the Trace List

The *trace list* is your view of the analyzer's record of processor bus activity. You can specify what is shown in the trace list to make it easier to find the information of interest. For example, you can display symbol information where available, or source lines from the high-level languages used to write the target system program. You can also change the column widths and set options for disassembly of the trace list.

This section covers many of the options available for controlling the trace display. Display control is available through the **Trace→Display Options...** dialog box, the trace list popup menu, and the command line. You can combine most options within a single command on the command line to obtain a desired trace display. See the **display trace** and **set** command descriptions in Chapter 11, "Emulator Commands," for more information.

If you are using the MC68030 emulator with the MMU enabled, you will need to enable and load the deMMUer before you can use source file symbols in your commands, display source file symbols in your trace lists, or see blocks of source code preceding related trace data. Refer to "Analyzing Program Execution when the MC68030 MMU is Enabled" later in this chapter to see how to load and use the deMMUer.

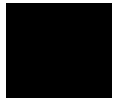

Chapter 5: Using the Emulation-Bus Analyzer  
**Displaying the Trace List**

**Examples** To use the Trace Options dialog box:

Click to select the desired format of trace disassembly.

Click to select the way that absolute status information is shown in the trace list.

Click to select count reference: Relative (to preceding state), or Absolute (to trigger).

Click to select trace list dequeuing, if available for your emulator.

Enter the desired depth of the trace memory to be unloaded for display or storage in a file.

Enter a value to be subtracted from addresses and symbol/source-line references shown in the trace list.

Enter the desired trace list line number to be placed on screen.

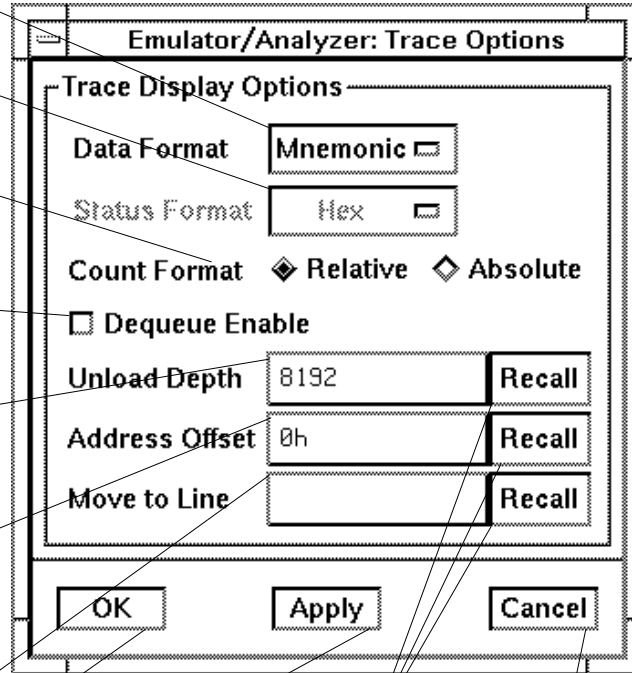

Click OK to specify the trace options and close the dialog box.

Click Apply to specify the trace options and leave the dialog box open.

Click these pushbuttons to select predefined or previously specified entries.

Click this pushbutton to cancel the entries and close the dialog box.

**Examples**

To use the trace list popup menu:

Click to begin trace disassembly from the selected line, moving that line to the top of the display.

Click to open an edit window into the source file that contains the address of the selected line.

Click to open a display window into memory containing the address of the selected line.

Note that the format of the memory display will be mnemonic for addresses in the code segment and absolute otherwise.

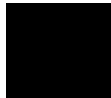
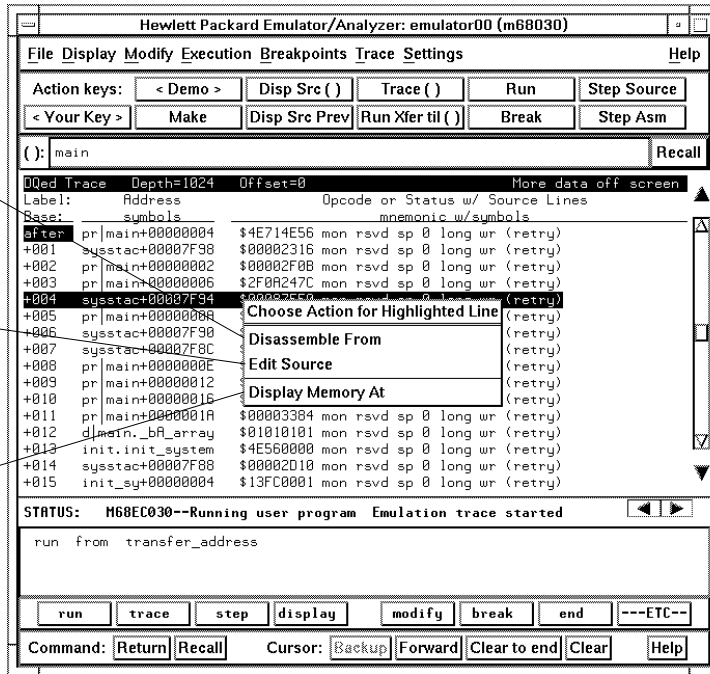

## To disassemble the trace list

- Choose **Trace→Display Options...** and in the dialog box, select Data Format Mnemonic. Then click the OK or Apply pushbutton.
- Use the mouse to place the cursor on a line in the trace list where you want disassembly to begin. Then press the *select* mouse button, and click on **Disassemble From** in the trace list popup menu.
- Using the command line, enter commands as follows:
  - To disassemble instruction data in the trace list, enter the **display trace mnemonic** command.
  - To control where trace list disassembly starts, enter the **display trace disassemble\_from\_line\_number <LINE #>** command.

<LINE #> is a line number corresponding to a state in the trace list.

Disassembly of instruction data means that you will see instructions as they would appear in an assembly language program listing. That is, instruction mnemonics and operands are shown instead of hexadecimal instruction data.

The analyzer interface normally disassembles instruction data in the trace list. However, if you specify **absolute** data display, that mode remains in effect until you select the **mnemonic** option.

When you identify a particular trace list line where disassembly is to begin, be sure to specify a line number that corresponds to an analyzer state with an opcode fetch. the analyzer interface disassembles and displays the trace starting with the state you specify.

---

**Examples**

To disassemble instruction data in the trace list starting at line 40:

Place the cursor on line 40, press the *select* mouse button, and click on **Disassemble From** in the popup menu.

Or, using the command line, enter:

```
display trace disassemble_from_line_number 40
```

---

---

## To specify trace disassembly options



- Selection of disassembly options is not supported in pulldowns of the Graphical User Interface. By default, the Graphical User Interface selects **high\_word** and **all\_cycles**. Use the command-line if you need to specify trace disassembly using other options.
- Using the command line, enter commands as follows:
  - To show only instruction cycles in the trace list, enter the **display trace disassemble\_from\_line\_number <LINE#> instructions\_only** command.
  - To show all bus cycles in the trace list, enter the **display trace disassemble\_from\_line\_number <LINE#> all\_cycles** command.
  - To start instruction disassembly from the upper word of the bus, enter the **display trace disassemble\_from\_line\_number <LINE#> high\_word** command.
  - To start instruction disassembly from the lower word of the bus, enter the **display trace disassemble\_from\_line\_number <LINE#> low\_word** command.

Normally, the MC68020 and MC68030/EC030 presents the trace list data as it was stored by the analyzer. That is, all bus cycles are shown, and disassembly starts with the most significant word of the data.

If you don't want to see operand cycles in the trace list, specify the **instructions\_only** option.

## Chapter 5: Using the Emulation-Bus Analyzer

### Displaying the Trace List

Each analyzer bus state may have two data words. An opcode can appear in either word. You can force disassembly to begin with the lower word of the first trace state by using the **low\_word** option. If the disassembled trace list isn't what you expected, try using this option.

The disassembly options remain in effect until you specify a new disassembly option.

---

#### Examples

Show only instruction cycles in the trace list starting at line 40:

```
display trace disassemble_from_line_number 40  
instructions_only
```

Show all bus cycles in the trace list:

```
display trace disassemble_from_line_number 40 all_cycles
```

Start instruction disassembly from the upper word of the bus:

```
display trace disassemble_from_line_number 100 high_word
```

Start instruction disassembly from the lower word of the bus

```
display trace disassemble_from_line_number 100 low_word
```

---

## To specify trace dequeuing options

- Choose **Trace→Display Options...** and in the dialog box, select Dequeue Enable. Then click the OK or Apply pushbutton.
- Using the command line, enter commands as follows:
  - To dequeue the trace list, enter the **display trace dequeue on** command.
  - To display the trace list without dequeuing, enter **display trace dequeue off**.
  - To tell the analyzer which data operand is aligned with the first opcode, enter the **display trace disassemble\_from\_line\_number <LINE#> align\_data\_from\_line <STATE#>** command.

<LINE #> is a line number corresponding to a state in the trace list. <STATE#> is the line number of the data operand that is associated with the instruction at <LINE#>.

A dequeued trace list is available through the disassembly options. In the dequeued trace list, unused instruction prefetch cycles are discarded, and operand cycles are placed immediately following the corresponding instruction fetch. If you choose a non-dequeued trace list, instruction and operand fetches are shown exactly as captured by the analyzer.

Once the dequeuer has been started on the correct opcode, it will continue to disassemble correctly unless an unusual condition causes it to misinterpret the data. By specifying the first instruction state for disassembly and the number of the first operand cycle for that instruction, you can resynchronize the disassembly. (You may also need to use the **low\_word** option.)

You may see TAKEN, NOT TAKEN, or ?TAKEN? beside a branch in your dequeued trace list. TAKEN is shown beside the branch if the dequeuer determines that the branch was taken. NOT TAKEN is shown if the dequeuer determines that the branch was not taken. ?TAKEN? means the dequeuer was not able to determine whether or not the branch was taken. If you read down the trace list and see that the branch was taken, use the **disassemble\_from\_line\_number** command to restart disassembly at the trace list line number of the branch destination. You will need to include the **low word** option if the destination opcode is in the low word at the destination address. You may need to resynchronize alignment of

## Chapter 5: Using the Emulation-Bus Analyzer

### Displaying the Trace List

operand cycles with the instruction at the branch address, using the **align\_data\_from\_line** option.

---

#### Examples

Dequeue the trace list:

Choose **Trace→Display Options...** and in the dialog box, select Dequeue Enable. Then click the OK or Apply pushbutton.

Or, using the command line, enter:

```
display trace dequeue on
```

Display the trace list without dequeuing:

```
display trace dequeue off
```

Tell the analyzer which data operand should be aligned with the first opcode:

```
display trace disassemble_from_line_number 40  
align_data_from_line 42
```

---



## To display the trace without disassembly

- Choose **Trace→Display Options...** and in the dialog box, select Data Format Absolute. You can select Hex, Binary, or Mnemonic format for display of status information. Then click the OK or Apply pushbutton.
- Using the command line, enter commands as follows:
  - To display the trace list without instruction disassembly and with status information in binary format, enter the **display trace absolute status binary** command.
  - To display the trace list without instruction disassembly and with status information in hexadecimal format, enter the **display trace absolute status hex** command.
  - To display the trace list without instruction disassembly and with status information in mnemonic format, enter the **display trace absolute status mnemonic** command.

For some measurements, it may be more convenient for you to view the trace data without instruction disassembly. The Data format Absolute selection in the **Trace→Display Options...** dialog box, or the **display trace absolute** command allows you to do this. Notice that once you enter this format selection, subsequent trace lists will be displayed in this format until you select the mnemonic format with the dialog box or **display trace mnemonic** command again.

You can select the display format for the status information when you choose Data Format Absolute in the dialog box, or when you use the **display trace absolute** command. The status information can be displayed in binary, hex, or as mnemonics that indicate the nature of the current bus cycle (such as a read or write).

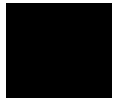

## Chapter 5: Using the Emulation-Bus Analyzer

### Displaying the Trace List

---

#### Examples

Display the trace list without instruction disassembly and with status information in binary format:

Choose **Trace→Display Options...** and in the dialog box, select Data Format Absolute. Select Status Format Binary. Then click the OK or Apply pushbutton.

Or, using the command line, enter:

```
display trace absolute status binary
```

Display the trace list without instruction disassembly and with status information in hexadecimal format; make appropriate entries in the **Trace→Display Options...** dialog box, or enter the following command:

```
display trace absolute status hex
```

Display the trace list without instruction disassembly and with status information in mnemonic format; make appropriate entries in the **Trace→Display Options...** dialog box, or enter the following command:

```
display trace absolute status mnemonic
```

---

## To display symbols in the trace list

- Choose **Settings**→**Source/Symbol Modes**→**Symbols**, or choose **Settings**→**Display Modes ...**, and in the dialog box, click on **Symbolic Addresses**. In the Field Widths area of the dialog box, you can select the widths of the Label Field and Symbols in Mnemonic Field to control the display space allocated to the symbols. To select symbol types, use the command line, described below.
- Using the command line, enter commands as follows:
  - To display symbols in the trace list, enter the **set symbols on** command.
  - To display only high level symbols, enter the **set symbols high** command.
  - To display only low level symbols, enter the **set symbols low** command.
  - To display all symbols (both high and low level), enter the **set symbols all** command.

If you are using the MC68030 emulator with the MMU enabled, you will need to enable and load the deMMUer before you can display source file symbols in your trace lists. Refer to "Analyzing Program Execution when the MC68030 MMU is Enabled" later in this chapter to see how to load and use the deMMUer.

When you enable symbol display, addresses and operands are replaced by the symbols that correspond to those values. The symbol information is derived from the SRU symbol database for that command file. See Chapter 4, "Using the Emulator" for more information on SRU and symbol handling.

High-level symbols are those that are available only from high-level languages such as a compiler. Low-level symbols are those that are available from assembly language modules (which may include symbols generated internally by a compiler).

The **Settings**→**Source/Symbol Modes...**, **Settings**→**Display Modes...**, or **set symbols** command remains in effect until you enter a new **Settings**→**Source/Symbol Modes...**, **Settings**→**Display Modes...**, or **set symbols** command with different options.

Refer to Chapter 4, "Using the Emulator," for details of how to set up and use the Display Modes dialog box.

## To display source lines in the trace list

- Choose **Settings**→**Source/Symbol Modes**→**Source Mixed** or **Settings**→**Source/Symbol Modes**→**Source Only** .
- Choose **Settings**→**Display Modes...**, and in the dialog box, click on **Source in Trace** and select either **Source Mixed** or **Source Only** from the submenu.
- Using the command line, enter commands as follows:
  - To display mixed source and assembly language in the trace list, enter the **set source on** command.
  - To display only source language statements in the trace list, enter the **set source only** command.
  - To display only assembly language in the trace list, enter the **set source off** command.

If you are using the MC68030 emulator with the MMU enabled, you will need to enable and load the deMMUer before you can display source code preceding related trace data in your trace lists. Refer to "Analyzing Program Execution when the MC68030 MMU is Enabled" later in this chapter to see how to load and use the deMMUer.

If you developed your target programs in a high-level language such as "C," you can display the source code in the trace list with the corresponding assembly language statements. Or, you can choose to display only the source listing without the assembly language information.

The analyzer uses the line-number information in the SRU symbol database for the absolute file to reference between source lines and assembly language information. Refer to Chapter 4, "Using the Emulator," for more information on SRU and symbol handling.

## To change the column width

- Choose **Settings**→**Display Modes...**, and select desired widths for information in the trace list by using the dialog box. Refer to the "Examples" page under "To display symbols in the trace list", earlier in this chapter for details of how to use the dialog box.
- To set the column width for the address column in the trace list, enter the **set width label <WIDTH>** command.
- To set the column width for the mnemonic column in the trace list, enter the **set width mnemonic <WIDTH>** command.
- To set the column width for source lines in the trace list, enter the **set width source <WIDTH>** command.
- To set the column width for the symbols column in the trace list, enter the **set width symbols <WIDTH>** command.

<WIDTH> is an integer specifying the width of the column in characters. (<WIDTH> is restricted to certain values which are shown if you press the <WIDTH> softkey.)

You can display more information by widening a column or ignore the information by narrowing the column. For example, you might want to widen the label column so that you can see the complete names of the symbols in that column.

You can combine multiple options on the command line to set the width for several columns at once.

---

### Example

Set the width of the address label column to 30 characters and the width of the mnemonic column to 50 characters:

```
set width label 30 mnemonic 50
```

---

## To select the type of count information in the trace list

- Choose **Trace→Display Options...** and in the dialog box, select Count Format Relative or Absolute, as desired. Then click the OK or Apply pushbutton.
- To display count information in the trace list relative to the trigger state, enter the **display trace count absolute** command.
- To display count information in the trace list relative to the previous trace list state, enter the **display trace count relative** command.

The count information in the trace list is always displayed if it is turned on. To turn on the trace counting function, enter a command beginning with **trace counting** on the command line. Refer to "To count states or time" later in this manual for details.

When using the 1K analyzer, the trace memory is 512 states deep if counting states or time is turned on; 1024 states deep if counting is turned off. To disable counting, in the 1K analyzer, use the command **trace counting off**. When using the deep analyzer, full memory depth is always available; the depth of the deep analyzer is not affected by the counting selected. See "To count states or time."

---

**Examples**

Count time and store only each iteration of the `update_sys` symbol in the demo program (if using the 1K analyzer, make sure the clock speed is set to "slow" in the configuration):

Specify the trace for the MC68020 emulator:

```
trace only update_sys counting time
```

Specify the trace for the MC68030/EC030 emulator:

```
trace only long_aligned update_sys counting time
```

(The **long\_aligned** parameter is needed because the MC68030/EC030 fetches opcodes as 32-bit values and `update_sys` may not be the first part of that value.)

Now, start the program run, then display the trace:

```
run from transfer_address
```

```
display trace count relative
```

Count absolute entries into the `get_targets` routine of the demo program:

```
trace only address range update_sys thru update_sys end  
counting state get_targets
```

```
run from transfer_address
```

```
display trace count absolute
```

---

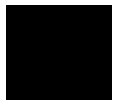

## To offset addresses in the trace list

- Choose **Trace→Display Options...** and in the dialog box, enter the desired offset value in the field beside Address Offset. Then click the OK or Apply pushbutton.
- Use the **offset\_by** option to the **display trace** command.

The Address Offset or **offset\_by** trace display options allow you to cause the address information in the trace display to be offset by the amount specified. The offset value is subtracted from the instruction's physical address to yield the address that is displayed.

If code gets relocated and therefore makes symbolic information obsolete, you can use the Address Offset or **offset\_by** option to change the address information so that it again agrees with the symbolic information.

You can also specify an offset to cause the listed addresses to match the addresses in compiler or assembler listings.

---

### Example

Trace execution from entry of the demo program (the main label) then offset by the value of main so that the addresses appear the same as the location counter in the assembler listing:

```
reset  
trace  
run from transfer_address  
display trace offset_by main
```

---



## To reset the trace display defaults

- Choose **Settings**→**Display Modes...** Then in the dialog box, click on Default All Settings, and click the OK button. This leaves the trace display in the "source intermixed and symbols on" mode.
- Using the command line, enter the **set default** command.

This turns off all symbolics and source references in the interface.

---

## To move through the trace list

- Use the scroll bar at the right of the display to scroll up and down. Use the arrows at the bottom of the display (if any) to scroll left and right.
- Using the command line, enter commands as follows:
  - To roll the trace display to the left, press **<Ctrl>f** simultaneously.
  - To roll the trace display to the right, press **<Ctrl>g** simultaneously.
  - To roll the display down one line, press the down arrow key.
  - To roll the display up one line, press the up arrow key.
  - To move to the previous page in the trace list, press the **Pg Up** or **Prev** key.
  - To move to the next page in the trace list, press the **Pg Dn** or **Next** key.

Though the trace display is set to 256 or more states, only 15 lines may be displayed in the interface window, depending on your terminal type. You can move through the trace list display using various key combinations.

You can roll the display left and right only if the trace list is wider than 80 columns. This may occur if you increased the width of the columns.

## To display the trace list around a specific line number

- Choose **Trace→Display Options...** and in the dialog box, enter the desired trace list line number in the field beside Move to Line. Then click the OK or Apply pushbutton.
- Center the trace display about a particular state given by <LINE #> by entering the **display trace <LINE #>** command.

If you need to move to a particular state quickly, you can use this command. The command places the specified state in the center of the current trace display.

---

### Examples

Display the trace about line number 20:

Choose **Trace→Display Options...** and in the dialog box, enter 20 in the field beside Move to Line. Then click the OK or Apply pushbutton.

Enter the following command on the command line to display the trace about line number 256:

```
display trace 256
```

---

## To change the number of states available for display

- Choose **Trace→Display Options...** and in the dialog box, enter the desired number of states to be made available for display in the field beside Unload Depth. Then click the OK or Apply pushbutton.
- Using the command line, set the depth of the trace list with:

*display trace depth* <DEPTH#>

<DEPTH#> is the number of states to be available in the trace list for displaying, copying, or storing to a file. If you are using the deep analyzer, the depth of the trace list buffer depends on whether or not you installed memory modules on the analyzer card, and the capacity of the memory modules installed. Refer to Chapter 18, "Installation and Service", for details. If you are using the 1K analyzer, the trace list buffer is 512 or 1024 states deep (depending on whether or not you turn on the state/time count). See "To count states or time" in this chapter.)

When you display the trace list, the interface requests the number of states specified by the trace depth from the emulator. If you want faster trace display, you can decrease the trace depth. To display more states, you can increase the trace depth. Notice that the trace depth setting only regulates the number of states sent from the emulation-bus analyzer to the interface. You still need to use the **Pg Up** and **Pg Dn** keys to page through the trace list.

---

### Examples

Set the depth of the trace memory to 256 states:

Choose **Trace→Display Options...** and in the dialog box, enter 256 in the field beside Unload Depth. Then click the OK or Apply pushbutton.

Set the depth of the trace to 1024 states:

*display trace depth* 1024

### To display program memory associated with a trace list line

- Using the mouse, place the cursor on the line in the trace list where you want to see the associated content of program memory. Then press the *select* mouse button, and click on **Display Memory At** in the trace list popup menu.

You will see a display of memory at the location of the program that emitted the selected trace list line. This is the same as placing the program address of the selected trace list line in the entry buffer and choosing **Display→Memory→At()** in the pulldown menus.

---

### To open an edit window into the source file associated with a trace list line

- Using the mouse, place the cursor on the line in the trace list whose source file you wish to edit. Then press the *select* mouse button, and click on **Edit Source** in the trace list popup menu.

A new window will open. It will show the source file that emitted the line you selected in the trace list. An edit session will be in progress on the source file in the new window. When you complete the desired edit, save the file and close the window.

## Analyzing Program Execution When the MC68030 MMU is Enabled

Most emulation and analysis commands that require an address as part of the command use logical addresses. When the MC68030 MMU is enabled, physical addresses are placed on the emulation bus. The physical addresses may not be the same as the logical addresses. The deMMUer reverse translates the physical addresses back to logical addresses and supplies these to the analyzer so that the analyzer can:

- accept commands expressed in source file symbols.
- display trace lists with addresses expressed in source file symbols.
- display appropriate portions of source code preceding lists of trace data.

Refer to Chapter 10, "Using MC68030 Memory Management," for detailed information to help you use the deMMUer more efficiently.

---

## To program the deMMUer in a static memory system

- 1 Run your program to the point where you are sure the MMU is set up.
- 2 Break to the monitor program by choosing **Execution**→**Break**.

Using the command line, enter:

**break**

- 3 Choose **Settings**→**DeMMUer**→**Load from Memory**.

If you want the emulator to override one or more of the MMU register values with values you specify during the load process, choose **Settings**→**DeMMUer**→**Load from Memory...**, and specify the desired values in the dialog box.

## Chapter 5: Using the Emulation-Bus Analyzer

### Analyzing Program Execution When the MC68030 MMU is Enabled

To see a listing of the addresses that will be reverse translated by the DeMMUer during the loading process, choose **Settings**→**DeMMUer**→**Verbose** before you enter your **DeMMUer Load** command.

Note that **DeMMUer Load** commands automatically enable the deMMUer.

- 4 Using the command line, enter the following command:

```
load demmuer [verbose]
```

Note that the **load** command automatically enables the deMMUer.

- 5 Continue execution of your target program by choosing **Execution**→**Run**→**from PC** or **Execution**→**Run**→**from Reset**, or using the command line to enter **run**, or restart the program with the command: **run from reset**.

To pick the place to load the deMMUer, you might set an execution breakpoint in your code at a point where you are sure your MMU will be set up to translate the address space you want to analyze. When the breakpoint has executed (emulator running in foreground monitor), you can load the deMMUer.

Whether you continue your program or restart it, the deMMUer will have the ability to reverse translate the physical addresses according to the MMU setup at the time you issued the **load demmuer** command. The deMMUer will remain loaded even if you reset the emulation processor.

If you restart your program, you can use the analyzer to see how the MMU tables are created and how the program operates.

Address ranges will be reverse translated correctly if they are translated by the setup of the MMU that existed when you issued the **load demmuer** command. If context switches cause the MMU to access logical memory that was not represented in the MMU tables when you loaded the deMMUer, incorrect logical addresses will be provided by the deMMUer.

## To store a deMMUer setup file

- Choose **File**→**Store**→**DeMMUer (From MMU Tables)** and enter the name to be used for the deMMUer file in the File Selection dialog box.
- Using the command line, enter:

```
store demmuer <file>
```

The deMMUer setup file is created by the emulator as it reads the present content of the MMU tables and creates a file of reverse translations appropriate for the deMMUer.

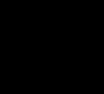

---

## To load the deMMUer from a deMMUer setup file

- Choose **Settings**→**DeMMUer**→**Load from File**, and enter the name of the deMMUer file in the File Selection dialog box.
- Choose **File**→**Load**→**DeMMUer**, and enter the name of the deMMUer file in the File Selection dialog box.
- Using the command line, enter:

```
load demmuer <file>
```

Files that store setup information for the deMMUer have filenames that end in ".ED".

## To trace program execution in physical address space

- Choose **Settings**→**Demmuer**→**Enable** to disable the deMMUer.
- Using the command line, disable the deMMUer with the command:

*set demmuer off*

The **Settings**→**Demmuer**→**Enable** command in the Graphical User Interface is a switch that enables and disables the deMMUer.

Now the analyzer will get its address information directly from the emulation address bus. This information is useful when you want to see behavior of your operating system.



## Making Complex Trace Measurements

You can have the analyzer record bus activity by simply using the trace command without any options. But this doesn't use the analyzer effectively for two reasons:

- the trace memory may fill before the program reaches the states of interest.
- you may have to search through a long trace list to find a few states pertinent to your measurement problem.

The HP 64700 analyzer has trigger and sequence capabilities that help solve these problems. These tools act as a filter for processor bus activity that allows the analyzer to capture only the states you want to see in the measurement.

A *trigger* tells the analyzer to identify a certain bus state as a point of reference in the trace of states. A *sequence* is a more complex specification that specifies a series of bus states that must be found to satisfy the trigger.

This section tells you how to get the most out of the HP 64700 analyzer by using trigger and sequence specifications. It also describes additional measurement tools to help you get more information from the trace.

Many of the options in this section can be combined one or more times. See the trace syntax in Chapter 11, "Emulator Commands," for more information.

Expressions are an important part of trace specifications because they specify the numeric or logical values that the analyzer matches for trigger and storage. Expressions are represented by the <expression> symbol in this chapter. Refer to Chapter 11, "Emulator Commands," for specifics on expression syntax.

### Expressions in Trace Commands

When modifying the analysis specification, you can enter expressions that consist of values, symbols, and operators.

**Values** Values are numbers in hexadecimal, decimal, octal, or binary. These number bases are specified by the following characters:

|                      |                                   |
|----------------------|-----------------------------------|
| <b>B b</b>           | Binary (example: 10010110b).      |
| <b>Q q O o</b>       | Octal (example: 377o or 377q).    |
| <b>D d</b> (default) | Decimal (example: 2048d or 2048). |

## Chapter 5: Using the Emulation-Bus Analyzer

### Making Complex Trace Measurements

**H h** Hexadecimal (example: 0a7fh).  
You must precede any hexadecimal number that begins with an A, B, C, D, E, or F with a zero.

Don't care digits may be included in binary, octal, or hexadecimal numbers and they are represented by the letters **X** or **x**. A zero must precede any numerical value that begins with an "X".

**Symbols** A symbol database is built when the absolute file is loaded into the emulator. Both global and local symbols can be used when entering expressions. Global symbols are entered as they appear in the global symbols display. When specifying a local symbol, you must include the name of the module ("anly.c") as shown below.

```
anly.c:cmp_function
```

**Operators** Analysis specification expressions may contain operators. All operations are carried out on 32-bit, two's complement integers. (Values which are not 32 bits will be sign extended when expression evaluation occurs.)

The available operators are listed below in the order of evaluation precedence. Parentheses are also allowed in expressions to change the order of evaluation.

|         |   |
|---------|---|
| -, ~    | Unary two's complement, unary one's complement. The unary two's complement operator is not allowed on constants containing don't care bits. |
| *, /, % | Integer multiply, divide, and modulo. These operators are not allowed on constants containing don't care bits.                              |
| +, -    | Addition, subtraction. These operators are not allowed on constants containing don't care bits.   |
| &       | Bitwise AND.  |
|         | Bitwise inclusive OR.   |

## Chapter 5: Using the Emulation-Bus Analyzer Making Complex Trace Measurements

Values, symbols, and operators may be used together in analysis specification expressions. For example, if the local symbol exists, the following is a valid expression:

```
module.c:symb+0b67dh&0fff00h
```

However, you cannot add two symbols unless one of them is an EQU type symbol.

### Emulation-Bus Analyzer Trace Signals

The emulation-bus analyzer has 80 channels available for capturing information: 64 of those channels are used for the instruction bus and data bus, and the remaining 16 channels monitor other processor signals or synthesized signals, and are collectively called the status lines. You can use status values as trigger or storage qualifiers. For example, you may want to capture processor reads to a certain address, but not processor writes. You can use a status value to qualify only processor read cycles to the memory location.

A number of status values have already been defined for you. They are collectively known as the status equates and cover most common processor operations. Status equates appear on softkeys at the appropriate time so you can include the status you want in your command line.

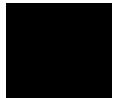

## Chapter 5: Using the Emulation-Bus Analyzer

### Making Complex Trace Measurements

The following two tables list the predefined status equates. The descriptions identify the emulator status represented by the equates

#### 68020 Equates

| Name     | Description                            |
|----------|--|
| 3byte    | three byte memory request              |
| buserror | bus error cycle                        |
| byte     | byte memory request                    |
| cpu      | function code cpu space                |
| data     | function code data space               |
| fgd      | foreground memory cycle                |
| long     | longword memory request                |
| memread  | memory read cycle                      |
| memwrite | memory write cycle                     |
| mon      | emulation monitor cycle                |
| prog     | function code program space            |
| rerun    | retrying a previous bus cycle          |
| super    | function code supervisor space         |
| supdata  | function code supervisor data space    |
| supprog  | function code supervisor program space |
| tbyte    | byte memory return                     |
| tlong    | long memory return                     |
| tword    | word memory return                     |
| user     | function code user space               |
| userdata | function code user data space          |
| userprog | function code user program space       |
| word     | word memory request                    |

68030/EC030 Equates

---

| Name     | Description                             |
|----------|---|
| 3_byte   | three byte transfer request (SIZ0/SIZ1) |
| async16  | asynchronous word transfer              |
| async32  | asynchronous long word transfer         |
| async8   | asynchronous byte transfer              |
| buserror | bus error cycle                         |
| byte     | byte transfer request (SIZ0/SIZ1)       |
| cpu      | function code cpu space                 |
| data     | function code data space                |
| logical  | logical memory address                  |
| long     | longword transfer request (SIZ0/SIZ1)   |
| physical | physical memory address                 |
| prog     | function code program space             |
| read     | read cycle                              |
| retry    | retrying a previous bus cycle           |
| super    | function code supervisor space          |
| supdata  | function code supervisor data space     |
| supprog  | function code supervisor program space  |
| sync     | synchronous long-word transfer          |
| tblwalk  | searching through translation tables    |
| user     | function code user space                |
| userdata | function code user data space           |
| userprog | function code user program space        |
| word     | word transfer request (SIZ0/SIZ1)       |
| write    | write cycle                             |

---

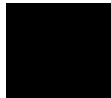

## To use address, data, and status values in trace expressions

- Enter the value(s) desired in the entry buffer (such as **address 1000h**). Then Choose **Trace→After()**, **Trace→Before()**, or **Trace→About()**, as desired.
- Using the command line, enter commands as follows:
  - To specify an address expression, enter **<expression>** or **address <expression>**.
  - To specify a data expression, enter **data <expression>**.
  - To specify a status expression, enter **status <expression>**.

Many trace commands require that you enter address, data and status expressions to specify the bus state. You can combine multiple expressions on the same command line to build a complete bus state qualifier. You can also use logical operators to build more complex states. Refer to Chapter 11, “Emulator Commands,” for details.

The default expression type is address, therefore you don’t need to specify the **address** keyword when you enter an address expression.

---

### Example

Start a trace and store only writes of 0 hex to the graph address in the demo program:

```
trace only graph data 0 status write
```

## To enter a range in a trace expression

- Use the command-line rules (described below) to create your expression in the entry buffer. Then Choose **Trace→After()**, **Trace→Before()**, or **Trace→About()**, as desired.
- Using the command line, enter commands as follows:
  - To specify an address range enter **address range <expression> thru <expression>**.
  - To specify a data range enter **data range <expression> thru <expression>**
  - To specify a status range enter **status range <expression> thru <expression>**
  - To take the logical not of a range, use the **not** keyword before the **range** keyword.

Ranges allow you to qualify analyzer actions on a contiguous set of values. Mostly, you'll use address ranges to trigger or store on access to a data block such as a lookup table. But, you can also use data ranges to qualify a trigger or storage on a range of data values.

There is only one range term available in the trace specification. Once it has been used, it cannot be reused. That is, if you specify a range in a trigger specification, you can't duplicate it in the storage specification. (The Terminal Interface does allow this type of measurement, though there is still only one range term. See the *MC68020 and MC68030/EC030 Terminal Interface User's Guide*.)

Since address is the default range type, you can omit the **address** keyword. You can't omit the **data** or **status** keywords if those are the bus parts you want to qualify.

You can use the logical **or** operator to combine the range term with several state qualifiers. See the examples.

---

**Examples**

Store only the accesses to the demo program's current\_humid location:

```
trace only range current_humid thru +1h
```

Store only bus cycles where data is in the range 6h..26h or is 29h:

```
trace only data range 6h thru 26h or data 29h
```

---

---

## To use the sequencer

- Create your first specification form on the command line. That will enter the proper format in the Trace Specification Selection dialog box. Obtain the dialog box by choosing **Trace**→**Trace Spec...** You can click on your specification in the dialog box, edit it if desired, and click OK.
- Using the command line, specify a trace sequence by entering the **trace find\_sequence <bus\_state> occurs <#times> [then <bus\_state> occurs <#times>] trigger <bus\_state>** command.

<bus\_state> represents a combination of address, data and status expressions that must be matched to satisfy the trigger or sequence qualifier. <#times> is the number of times that bus state must occur to satisfy the qualifier.

The trace sequencer allows you to specify up to seven sequence terms (including the trigger) that must be satisfied to trigger the analyzer. If you use the windowing specification, the sequence specification is limited to four sequence terms.

---

**Example**

Use the analyzer sequencer to trigger after finding a series of events:

```
trace find_sequence main then update_sys.get_targets  
trigger after proc_spec
```

---



## To specify a restart term

- Create your first specification form on the command line. That will enter the proper format in the Trace Specification Selection dialog box. Obtain the dialog box by choosing **Trace→Trace Spec...** You can click on your specification in the dialog box, edit it if desired, and click OK.
- Using the command line, restart the search for the trace sequence terms by including the restart parameter in the **trace find\_sequence <bus\_state> occurs <#times> [then <bus\_state> occurs <#times>] restart <bus\_state> trigger <bus\_state>** trace command.

<bus\_state> represents a combination of address, data and status expressions that must be matched to satisfy the trigger or sequence qualifier. <#times> is the number of times the selected bus state must occur to satisfy the qualifier.

The restart qualifier allows you to restart the trace sequence whenever a certain instruction or data access occurs. For example, you might have a complicated trace sequence that searches for an intermittent failure condition. You could set the restart term to restart the sequence whenever a bus cycle occurred that ensures that the code segment would perform correctly. Thus, the trace will be satisfied only when that restart term never occurs and the code segment fails.

---

### Example

Use the analyzer sequencer to trace a series of events and then restart the sequencer if the restart term is found while searching for the events:

```
trace find_sequence update_sys.get_targets then  
update_sys.write_hwdr restart update_sys.set_outputs  
trigger after current_humid
```

## To specify trace windowing

- Create your first specification form on the command line. That will enter the proper format in the Trace Specification Selection dialog box. Obtain the dialog box by choosing **Trace**→**Trace Spec...** You can click on your specification in the dialog box, edit it if desired, and click OK.
- Using the command line, enter commands as follows:
  - To trace only the states occurring after a particular bus cycle, enter **trace enable <bus\_state>**.
  - To trace only the states occurring between two particular bus cycles, enter **trace enable <bus\_state> disable <bus\_state>**.

**<bus\_state>** represents a combination of address, data and status expressions that must be matched to satisfy the windowing qualifier.

The trace window specification makes it easy to trace only the occurrences of a particular routine. This is especially useful in high-level languages, where storing only the accesses to a particular address range may miss several function calls within the routine.

---

### Examples

Trace states occurring after the start of the example program:

```
trace enable main
```

Trace states occurring between the start of the example program and the call to the message interpreter:

```
trace enable main disable proc_spec
```

---

## To specify both sequencing and windowing

- Create your first specification form on the command line. That will enter the proper format in the Trace Specification Selection dialog box. Obtain that dialog box by choosing **Trace**→**Trace Spec...** You can click on your specification in the dialog box, edit it if desired, and click OK.
- Using the command line, enter commands as follows:
- Specify a trace sequence that starts with a window and ends with a trigger by entering:

```
trace enable <bus_state> disable <bus_state>  
find_sequence <bus_state> occurs <#times> [then  
<bus_state> occurs <#times>] trigger <bus_state>
```

<bus\_state> represents a combination of address, data and status expressions that must be matched to satisfy the trigger or sequence qualifier. <#times> is the number of times that bus state must occur to satisfy the qualifier.

You can use the sequencing and windowing specifications together to make specification of complex qualifiers easier. If you use the windowing specification, the sequence specification is limited to four sequence terms. Also, note that when you use a windowing specification, you cannot use a restart term with your sequence specification.

---

### Example

Use the analyzer sequencer to trace states occurring between the start of the example program and the call to the message interpreter, then trigger after access to the variable that stores the value of current humidity, but only if it is accessed after a specific series of events:

```
trace enable main disable proc_spec find_sequence  
update_sys.get_targets then long_aligned  
update_sys.write_hdwr trigger after current_humid
```

## To count states or time

- Create your first specification form on the command line. That will enter the proper format in the Trace Specification Selection dialog box. Obtain that dialog box by choosing **Trace**→**Trace Spec...** You can click on your specification in the dialog box, edit it if desired, and click OK.
- Using the command line, enter commands as follows:
  - To count occurrences of a particular bus state in the trace, enter the **trace counting <bus\_state>** command.  
**<bus\_state>** represents a combination of address, data and status expressions that must be matched to satisfy the trigger qualifier.
  - To count all states in the trace, enter the **trace counting anystate** command.
  - To count time in the trace, enter the **trace counting time** command.
  - To disable counting in the trace, enter the **trace counting off** command.

You can use the analyzer's state/time counter to count time or bus states. If using the deep analyzer, counting imposes no restrictions on memory depth. If using the 1K analyzer, use of the counter restricts the trace memory to a maximum depth of 512 states. If you disable the counter in the 1K analyzer, using the **trace counting off** command, the maximum trace depth is 1024 states.

When using the 1K analyzer, the MC68020 emulator defaults to **counting time**, and the MC68030/EC030 emulator, because of its higher bus cycle rates, defaults to **counting off**. To count states or time in the MC68030/EC030 emulator, you must configure the analyzer clocks correctly. See the help screen for the Analyzer Speed item in the Trace Options configuration display for more information (refer to Chapter 8, "Configuring the emulator").

Use the **display trace count** command to determine how the count is displayed in the trace list. See "To display count information in the trace" for more information.

---

**Examples**

To count occurrences of a particular bus state in the trace (this requires the 1K analyzer speed to be set to "Slow" in configuration):

*trace counting address 10h*

Count all states in the trace:

*trace counting anystate*

Count time in the trace:

*trace counting time*

Disable counting in the trace:

*trace counting off*

---

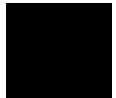

---

## To define a storage qualifier

- Enter the storage qualifier (such as **status read**) in the entry buffer. Then choose **Trace→Only()**.
- Using the command line, store only certain states in the trace list by entering the **trace only <bus\_state>** command.

<bus\_state> represents a combination of address, data and status expressions that must be matched to satisfy the storage qualifier.

Storage qualifiers can help filter unwanted information from program execution and improve your trace measurement. The analyzer stores only the information specified in the storage qualifier. Note that if you have a sequencer or trigger specification, any states given there are shown in the trace list even if they don't meet the storage qualifier.

---

**Examples**

Trace only address 10h:

```
trace only address 10h
```

Trace only data value 0ffh:

```
trace only data 0ffh
```

Trace only write operations

```
trace only status write
```

---

## To define a prestore qualifier

- Place your prestore qualification into the entry buffer. Then choose **Trace→Only() Prestore**.
- Using the command line, enter commands as follows:
  - Specify a prestore qualifier by entering the **trace prestore <bus\_state>** command.  
<bus\_state> represents a combination of address, data and status expressions that must be matched to satisfy the prestore qualifier.
  - Disable prestore qualification by entering the **trace prestore anything** command.

You use the prestore qualifier to save states that are related to other routines that you're tracing. For example, you might be tracing a subprogram, and want to see which program called it. You can specify calls be prestored and that entries to the subprogram be stored. The easiest way to do this is to prestore program reads that are outside the address range of the subprogram being called.

You may have several program modules that write to a variable, and sometime during execution of your program, that variable gets bad data written to it. Using a prestore measurement, you can find out which module is writing the bad data.

Store-qualify writes to the variable, and use prestore to capture the instructions that caused those writes to occur (perhaps by prestoreing program reads).

---

**Examples**

Specify a prestore qualifier:

```
trace prestore address not range gen_ascii_data thru  
gen_ascii_data end status prog and read only  
long_aligned gen_ascii_data
```

Disable prestore qualification:

```
trace prestore anything
```

---

---

## To trace activity leading up to a program halt

- Choose **Trace→Until Stop**.
- Using the command line, trace on a program halt by entering **trace on\_halt**.

The above commands cause the analyzer to continuously fill the trace buffer until you issue a **Trace→Stop** or **stop\_trace** command.

Sometimes you may have a program failure that can't be attributed to a specific trigger condition. For example, the emulator may access guarded memory and break to the monitor. You want to trace the events leading up to the guarded memory access but you don't know what to specify for a trigger. Use the above command. The analyzer will capture and record states until the break occurs. The trace list will display the last processor states leading up to the break condition.

Note that the "trace until stop" command may not capture the desired information when you are using a foreground monitor (unless the code that causes the break also causes the processor to halt) because the analyzer will continue to capture foreground monitor states after the break. When using a foreground monitor, you can use the command line to enter a trace command that stores only states outside the range of the foreground monitor program (for example, **trace on\_halt only not range <mon\_start\_addr> thru <mon\_end\_addr> on\_halt**).

## To modify the trace specification

- Choose **Trace→Trace Spec...** You can recall, modify, and enter your trace specification in the dialog box.
- Using the command line, enter the **trace modify\_command**. Then use the command line editing features to change the trace command specifications.

If you made an error in a trace command or want to change the measurement results slightly, it's often easier to recall the previous trace command and edit it than it is to enter a new trace command. The Trace Specification Selection dialog box lets you recall, edit, and enter trace commands that have been executed during the emulation session or trace commands that have been predefined.

Predefine entries for the Trace Specification Selection dialog box and define the maximum number of entries by setting X resources (refer to Chapter 13, "Setting X Resources").

See the "To use dialog boxes" description in Chapter 3, "Using the emulator/analyzer interface," for information about using selection dialog boxes.

---

### Example

Recall the last trace command with **Trace→Trace Spec...**, or by entering:

*trace modify\_command*

Then edit the trace command as you desire.

---



## To repeat the previous trace command

- Choose **Trace→Again**.
- To continually repeat the last trace, choose **Trace→Repetitively**.
- Using the command line, repeat the previous trace command (including its complete trace specification) by entering **trace again**.

The **trace again** command is most useful when you want to repeat a measurement with the same trace specification. It saves you the trouble of reentering the complete trace command specification.

The "repetitively" choice continually repeats the last trace command. Successive traces begin as soon as the results from the just-completed trace are displayed.

Also, this command is useful when you load a trace specification from a file. (See "To load a trace specification" in this chapter.)

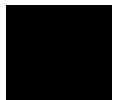

## To capture a continuous stream of program execution no matter how large your program

The following example can be performed in emulation systems using the deep analyzer (it cannot be done with the 1K analyzer). It shows you how to capture all of the execution of your target program. You may wish to capture target program execution for storage, for future reference, and/or for comparison with execution after making program modifications. The execution of a typical target program will require more memory space than is available in the trace memory of an analyzer. This example shows you how to capture all of your target program execution while excluding unwanted execution of the emulation monitor.

- 1 Choose **Trace→Display Options ...**, and in the dialog box, enter 0 or the total depth of your deep analyzer trace memory in the entry field beside Unload Depth. Then click OK or Apply. This sets unload depth to maximum.
- 2 For this measurement, the analyzer will drive trig1 and the emulator will receive trig1 from the trigger bus inside the card cage. The trig1 signal is used to cause the emulator to break to its monitor program shortly before the trace memory is filled. This use of trig1 is not supported in workstation interface commands. Therefore, terminal interface commands (accessible through the pod command feature) must be used. Enter the following commands:

### Settings→Pod Command Keyboard

**tgout trig1 -c <states before end of memory>** (trigger output trig1 before trace complete)

**bc -e trig1** (break conditions enabled on trig1)

Click the **suspend** softkey

Note that "tgout trig1 -c <states...>" means generate trig1 as an output when the state that is <states...> before the end of the trace memory is captured in the trace memory; "bc -e trig1" means enable the emulator to break to its monitor program when it receives trig1.

Select a value for **<states before end of memory>** that allows enough time and/or memory space for the emulator to break to its monitor program before the trace memory is filled. Otherwise, some of your program execution will not be captured in the trace. Many states may be executed before the emulation break occurs, depending on the state of the processor when the trig1 signal arrives. Also, if your program executes critical routines in which interrupts are masked, the occurrence of

trig1 may be ignored until the critical routine is completed (when using a foreground monitor).

- 3 If you are using a foreground monitor, enter the following additional pod commands to prevent the trace memory from capturing monitor execution. The following example commands will obtain this result in some emulators:

**Settings→Pod Command Keyboard**

**trng addr=<address range occupied by your monitor>** (trigger on range address = <address range>)

where <address range> is expressed as <first addr>..<last addr>

**tsto !r** (trace store not range)

Click the **suspend** softkey

Note that "trng addr=<addr>..<addr>" means define an address range for the analyzer; "tsto !r" means store all trace activity except activity occurring in the defined address range.

- 4 Start the analyzer trace with the command, **Trace→Again**
- 5 Start your program running using **Execution→Run→from()**, **from Transfer Address**, or **from Reset**, as appropriate.

The **Trace→Again** (or **trace again**) command starts the analyzer trace with the most recent trace specifications (including the pod\_command specifications you entered). The **trace** command cannot be used by itself because it defaults the "bc -e trig1", "trng addr=...", and "tsto !r" specifications, returning them to their default values before the trace begins.

You can see the progress of your trace with the command, **Display→Status**. A line in the Trace Status listing will show how many states have been captured.

- 6 The notation "trig1 break" usually followed by "Emulation trace complete" will appear on the status line. If "trig1 break" remains on the status line without "Emulation trace complete", manually stop the trace with the command:

**Trace→Stop**

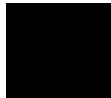

## Chapter 5: Using the Emulation-Bus Analyzer

### Making Complex Trace Measurements

You must wait for the notation "trig1 break" and/or "Emulation trace complete" to appear on the status line; this ensures the trace memory is filled during the trace (except for the unfilled space you specified in Step 2 above).

Note that when you set a delay specification using **tgout -c** or **tgout -t** (trigger output delay before trace complete/after trigger), the trace will indicate complete as soon as the analyzer has captured the state specified, even though the entire trace memory has not been filled.

If the notation "trig1 break" remains on the status line without being replaced by "Emulation trace complete", it indicates the trace memory is not completely filled, and no more states are being captured.

- 7 Store the entire trace memory content in a file with a command like:

```
wait measurement_complete ; copy trace to <directory/filename>
```

The "wait" command is inserted ahead of the "copy" command to ensure that the unload of trace data is complete before you try to store it. Without "wait", you will get an ERROR message warning that the unload is still in process. The **<filename>** is an ASCII filename for a binary file that can be viewed using the **load trace** command.

- 8 Start a new trace with the command: **trace again**
- 9 Resume the program run from the point where it was interrupted when the emulator broke to the monitor with the command: **run**
- 10 Wait until the notation "trig1 break" and/or "Emulation trace complete" appears on the status line. Then store the new trace memory content in a new file with commands like:

```
stop_trace
```

```
wait measurement_complete ; copy trace to <directory/filename+1>
```

Note that "filename+1" in the above command suggests use of consecutive filenames to store your execution files, such as FILENAME1, FILENAME2, etc.

Repeat steps 8 through 10 above until all program execution has been captured. Your destination directory will have a set of files that, taken together, contain all of your program execution. Note that if you did not prevent capture of foreground

Chapter 5: Using the Emulation-Bus Analyzer  
**Making Complex Trace Measurements**

monitor cycles in step 3 above, the last few trace lines in each file may contain monitor cycles.



## Saving and Restoring Trace Data and Specifications

The emulator/analyzer can save your trace data and trace specifications in a file for later use. This can help you record measurement results that you can use for comparison with other tests, and it is useful to automate measurements.

Suppose you're using the emulator in a manufacturing test application. The target system is your product board. You might build a command file that recalls a trace specification, makes the trace on the target board, and then recalls a previous measurement result (from a working product) and compares it to the new measurement (using the UNIX **diff** command).

---

### To store a trace specification

- Choose **File**→**Store**→**Trace Spec...** In the dialog box, select an existing filename or specify a new filename to contain the present trace specification. Then click OK.
- Using the command line, store the current trace specification by entering the **store trace\_spec <filename>** command.

**<filename>** is any UNIX file name including paths. The extension **.TS** is automatically added to the file name.

The trace specification file is a binary file.

The **store trace\_spec** command allows you to save a trace specification (effectively the current trace command with all trigger, storage and sequence options) in a file for later use. For example, you might have several **trace** commands that you want to make every time your target system program is modified. You can store each trace command in a separate file and recall it later using the **load trace\_spec** command.

---

**Example**

Store a trace specification to a file:

```
store trace_spec tspec.TS
```

---

---

## To store trace data

- Choose **File→Store→Trace Data...** In the dialog box, select an existing filename or specify a new filename to contain the present trace memory content. Then click OK.
- Using the command line, store the current trace data by entering the **store trace <filename>** command.

**<filename>** is any UNIX file name including paths. The trace data file is a binary file. The extension **.TR** is automatically added to the file name. A trace data file can be reloaded into the interface and displayed like any other trace listing.

You can store the trace data resulting from a measurement. This can be useful if you want to compare the results of later measurements with a reference result obtained in an earlier measurement.

---

**Example**

Store a trace to a file:

```
store trace tracel.TR
```

---

## To load a trace specification

- Choose **File**→**Load**→**Trace Spec...** In the dialog box, click on the name of the trace specification you want to load (placing it in the Load Trace Specification box). Then click OK.
- Using the command line, load an existing trace specification from a file by entering the **load trace\_spec <filename>** command.

**<filename>** is any UNIX file name including paths. The extension **.TS** is assumed.

Once you save a trace specification in a file using the **File**→**Store**→**Trace Spec...** or **store trace\_spec** command, you can load it using the appropriate command above. To start a trace with the trace specification that you loaded, use the **Trace**→**Again** or **trace again** command.

---

### Example

Load a trace specification from a file and start the trace:

```
load trace_spec tspec
```

```
trace again
```

---



## To load trace data

- Choose **File→Load→Trace Data...** In the dialog box, click on the name of the trace data file (file of trace memory content) you want to load (placing it in the Load Trace Data box). Then click OK.
- Using the command line, load trace data from a file by entering the **load trace <filename>** command.

<filename> is any UNIX file name including paths. The extension **.TR** is assumed.

Loads a previously saved trace from a binary trace data file (with a ".TR" suffix).

Once you save trace data in a file using the **File→Store→Trace Data...** or **store trace** command, you can reload it. To view the data you loaded, use the **Display→Trace, Trace→Display**, or **display trace** command. Remember that a new trace measurement will overwrite this trace data (but not the file from which it was loaded).

The interface will try to display the trace listing in the display format active when the trace data was stored. If the interface needs symbols to replace absolute addresses or to find high-level source lines, and symbols are not loaded, an error occurs.

For example, suppose "source-mixed" was the display mode when the trace was captured and the executable file "test1" was the file being executed in the emulator/target system. To reload and display a trace listing saved from that emulation session requires reloading the symbols for "test1".

---

### Example

Load a trace from a file:

```
load trace tracel
```

---

## Saving and Restoring DeMMUer Setup Files

---

### To store a DeMMUer setup file

- Choose **File**→**Store**→**DeMMUer (From MMU Tables)...** In the dialog box, click on the name of the file you want to store your deMMUer setup (placing it in the Store Demmuer File box). Then click OK.
- Using the command line, store a deMMUer setup file by entering:

```
store demmuer <filename>
```

<filename> is any UNIX file name including paths. The extension **.ED** is assumed.

Stores a deMMUer setup file (with a ".ED" suffix) by reading the present content of the MMU registers and the MMU tables.

---

### To load a DeMMUer setup file

Choose **File**→**Load**→**DeMMUer...** In the dialog box, click the name of the file you want to load (placing it in the Load Demmuer File box). Then click OK.

- Using the command line, load a deMMUer setup file by entering:

```
load demmuer <filename>
```

<filename> is any UNIX file name including paths that was created by an appropriate store demmuer command. The extension **.ED** is assumed.

The deMMUer setup file is loaded into the deMMUer. The present content of the MMU registers and the MMU tables are ignored.

## Using Basis Branch Analysis

Basis branch analysis (BBA) is provided by the HP Branch Validator product. This product is used to analyze the testing of your programs, create more complete test suites, and quantify your level of testing.

The HP Branch Validator records branches executed in a program and generates reports that provide information about program execution during testing. It uses a special C preprocessor to add statements that write to a data array when program branches are taken. After running the program in the emulator (using test input), you can store the BBA information to a file. Then, you can generate reports based on the stored information.

This section shows you how to:

- Store BBA data to a file.

Refer to the *HP Branch Validator (BBA) User's Guide* for complete details on the BBA product and how it works.

---

### To store BBA data to a file

- Choose **File**→**Store**→**BBA Data** and use the selection dialog box to specify the file name.

The default file name "bbadump.data" can be selected from the dialog box.



---

# 6

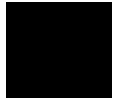

---

## Making Coordinated Measurements

Using the Coordinated Measurement Bus to start and stop multiple emulators and analyzers

## The Elements of Coordinated Measurements

The Coordinated Measurement Bus (CMB) connects multiple emulators and allows you to make synchronous measurements between those emulators.

For example, you might have a target system that contains a 68020 or 68030/EC030 processor and another processor. You use HP 64700 Series emulators to replace both target system processors, and connect the emulators using the CMB. You can run a program simultaneously on both emulators. Or, you can start a trace on one emulation-bus analyzer when the other emulator reaches a certain program address. These measurements are possible with the CMB.

When HP 64700 Card Cages are connected together via the Coordinated Measurement Bus (CMB), you can start and stop up to 32 emulators at the same time.

You can use the analyzer in one HP 64700 to arm (that is, activate) the analyzers in other HP 64700 Card Cages or to cause emulator execution in other HP 64700 Card Cages to break into the monitor.

You can use the HP 64700's BNC connector (labeled TRIGGER IN/OUT on the lower left corner of the HP 64700 rear panel) to trigger an external instrument (for example, a logic analyzer or oscilloscope) when the analyzer finds its trigger condition. Also, you can allow an external instrument to arm the analyzer or break emulator execution into the monitor.

Tasks that you perform to make coordinated measurements include:

- Setting up for coordinated measurements.
- Starting and stopping multiple emulators.
- Driving trigger signals to the CMB or BNC.
- Stopping program execution on trigger signals.
- Arming analyzers on trigger signals.

## Chapter 6: Making Coordinated Measurements The Elements of Coordinated Measurements

The location of the CMB and BNC connectors on the HP 64700 rear panel is shown in the following figure.

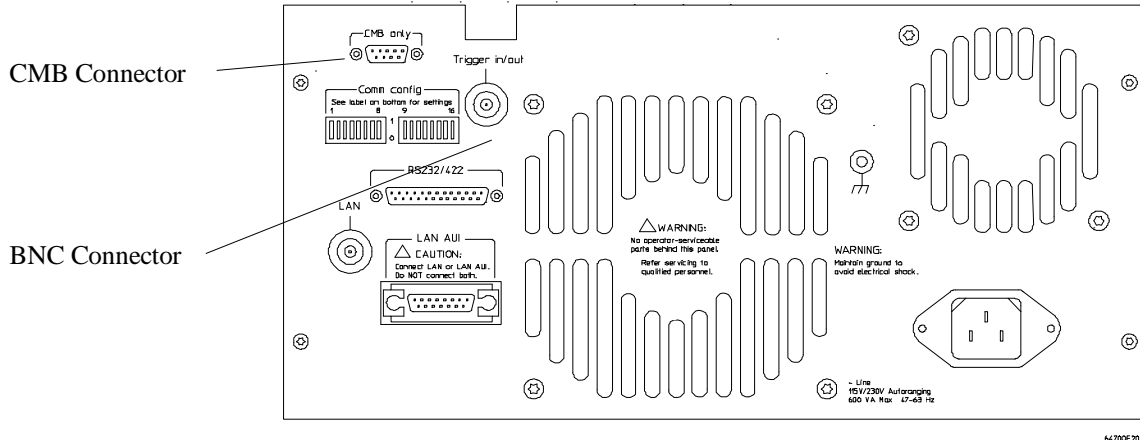

There are three bidirectional signal lines on the CMB connector on the rear panel of the emulator. These CMB signals are:

**TRIGGER** The CMB TRIGGER line is low true. This signal can be driven or received by any HP 64700 connected to the CMB. This signal can be used to trigger an analyzer. It can be used as a break source for the emulator.

**READY** The CMB READY line is high true. It is an open collector circuit and performs an ANDing of the ready state of enabled emulators on the CMB. Each emulator on the CMB releases this line when it is ready to run. This line goes true when all enabled emulators are ready to run, providing for a synchronized start.

When CMB is enabled, each emulator is required to break to background when CMB READY goes false, and will wait for CMB READY to go true before returning to the run state. When an enabled emulator breaks, it will drive the CMB READY false and will hold it false until it is ready to resume running. When an emulator is reset, it also drives CMB READY false.

## Chapter 6: Making Coordinated Measurements

### The Elements of Coordinated Measurements

**EXECUTE**            The CMB EXECUTE line is low true. Any HP 64700 on the CMB can drive this line. It serves as a global interrupt and is processed by both the emulator and the analyzer. This signal causes an emulator to run from a specified address when CMB READY returns true.

### Comparison Between CMB and BNC Triggers

The BNC trigger signal is a positive rising edge TTL level signal. The BNC trigger line can be used to either drive or receive an analyzer trigger, or receive a break request for the emulator.

The CMB trigger and BNC trigger lines have the same logical purpose: to provide a means for connecting the internal trigger signals (trig1 and trig2) to external instruments. The CMB and BNC trigger lines are bidirectional. Either signal may be used directly as a break condition.

The CMB trigger is level-sensitive, while the BNC trigger is edge-sensitive. The CMB trigger line puts out a true pulse following receipt of EXECUTE, despite the commands used to configure it. This pulse is ignored internally.

Note that if you use the EXECUTE function, the CMB TRIGGER should not be used to trigger external instruments, because a false trigger will be generated when EXECUTE is activated.



## Setting Up for Coordinated Measurements

This section describes how:

- To connect the Coordinated Measurement Bus.
- To connect the rear panel BNC.

For more information, refer to the *HP 64700 Series Installation/Service Guide*.

---

### To connect the Coordinated Measurement Bus (CMB)

---

**CAUTION**

Be careful not to confuse the 9-pin connector used for the CMB with those used by some computer systems for RS-232C communications. Applying RS-232C signals to the CMB connector is likely to result in damage to the HP 64700 Card Cage.

To use the CMB, you will need one CMB cable for the first two emulators and one additional cable for every emulator after the first two. The CMB cable is orderable from HP under product number HP 64023A. The cable is four meters long.

You can build your own compatible CMB cables using standard 9-pin D type subminiature connectors and 26 AWG wire.

Note that Hewlett-Packard does not guarantee proper CMB operation if you are using a self-built cable!

Chapter 6: Making Coordinated Measurements  
Setting Up for Coordinated Measurements

1 Connect the cables to the HP 64700 CMB ports.

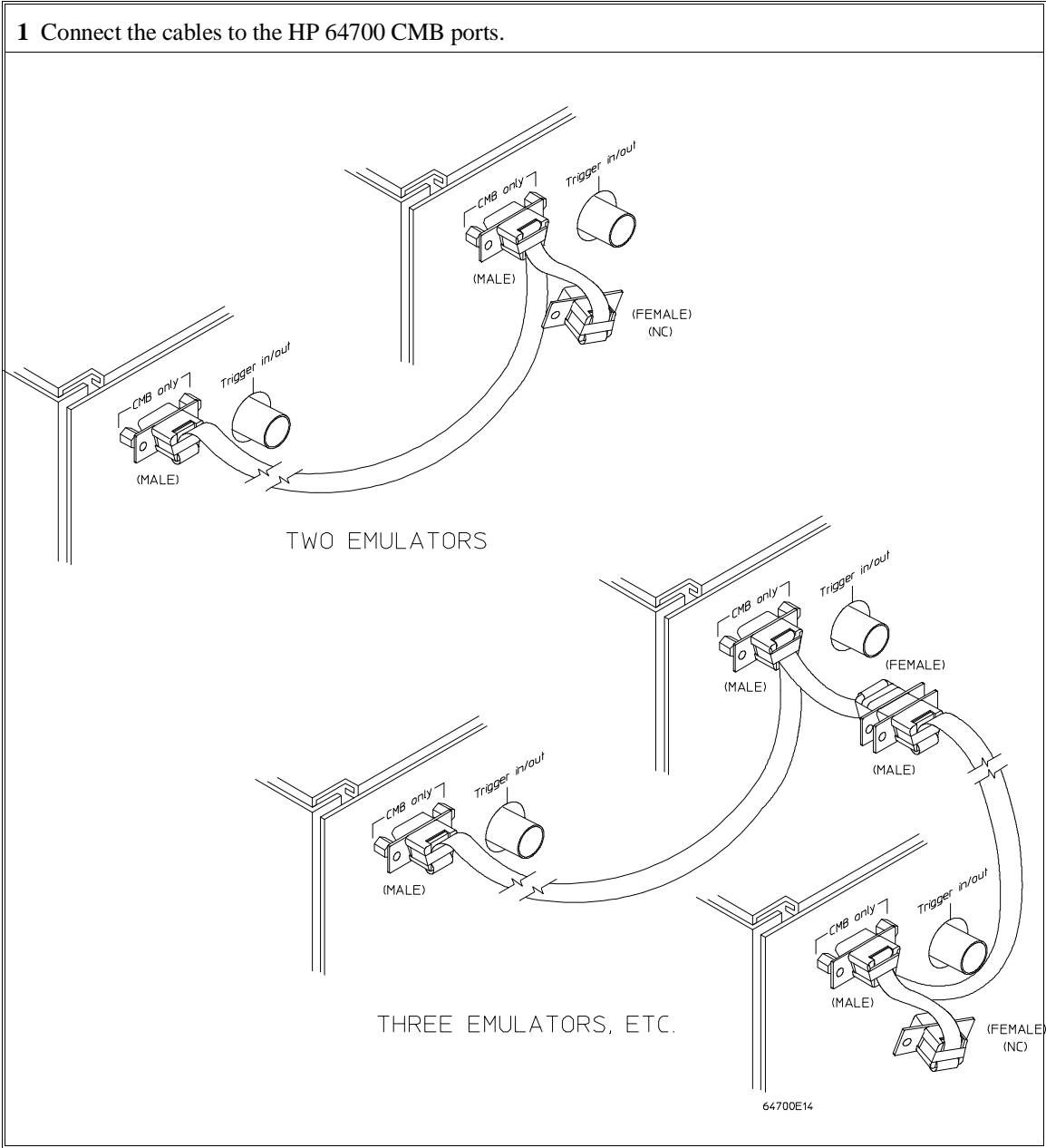

| Number of HP 64700 Series Emulators   | Maximum Total Length of Cable | Restrictions on the CMB Connection                         |
|---|-------------------------------|--|
| 2 to 8  | 100 meters                    | None.  |
| 9 to 16   | 50 meters                     | None.  |
| 9 to 16   | 100 meters                    | Only 8 emulators may have rear panel pullups connected. *  |
| 17 to 32  | 50 meters                     | Only 16 emulators may have rear panel pullups connected. * |
| <p>* A modification must be performed by your HP Customer Engineer.</p> <p>Emulators using the CMB must use background emulation monitors.</p> <p>At least 3/4 of the HP 64700-Series emulators connected to the CMB must be powered up before proper operation of the entire CMB configuration can be assured.</p> |                               |  |

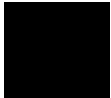

---

## To connect to the rear panel BNC

---

### **CAUTION**

The BNC line on the HP 64700 accepts input and output of TTL levels only. (TTL levels should not be less than 0 volts or greater than 5 volts.) Failure to observe these specifications may result in damage to the HP 64700 Card Cage.

---

Chapter 6: Making Coordinated Measurements  
**Setting Up for Coordinated Measurements**

- 1 Connect one end of a 50-ohm coaxial cable with male BNC connectors to the HP 64700 BNC receptacle and the other end to the appropriate BNC receptacle on the other measuring instrument.

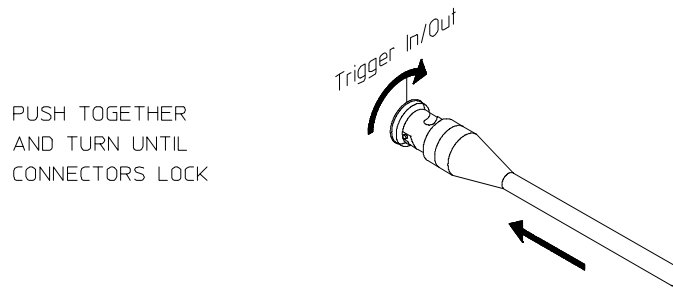
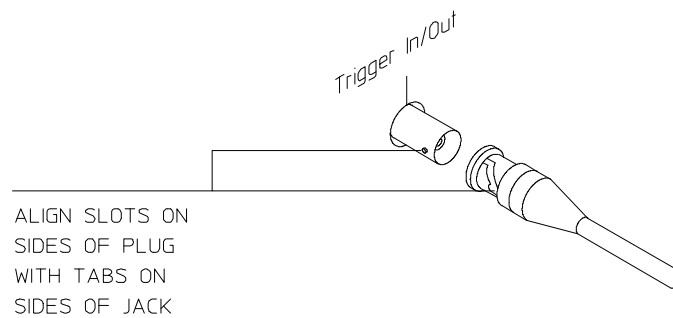

64700E15

The BNC connector is capable of driving TTL level signals into a 50 ohm load. (A positive rising edge is the trigger signal.) It requires a driver that can supply at least 4 mA at 2 volts when used as a receiver. The BNC connector is configured as an open-emitter structure which allows for multiple drivers to be connected. It can be used for cross-triggering between multiple HP 64700Bs when no other cross-measurements are needed. The output of the BNC connector is short-circuit protected and is protected from TTL level signals when the emulator is powered down.

## Starting/Stopping Multiple Emulators

When HP 64700 Card Cages are connected together via the Coordinated Measurement Bus (CMB), you can start and stop up to 32 emulators at the same time. These are called synchronous measurements.

This section describes how to:

- Enable synchronous measurements.
- Start synchronous measurements.
- Disable synchronous measurements.

---

### To enable synchronous measurements

- Enter the **specify run** command on the command line.

You can enable the emulator's interaction with the CMB by using the **specify run** command. When the EXECUTE signal is received, the emulator will run at the current program counter address or the address specified in the **specify run** command.

Note that when the CMB is being actively controlled by another emulator, the **step** command does not work correctly. The emulator may end up running in user code (NOT stepping). Disable CMB interaction while stepping the processor. (See "To disable synchronous measurements" following.)

Note that enabling CMB interaction does not affect the operation of analyzer cross-triggering.

You can use the **specify trace** command to specify that an analyzer measurement begin upon reception of the CMB EXECUTE signal.

The trace measurement defined by the **specify trace** command will be started when the EXECUTE signal becomes active. When the trace measurement begins, you will see the message "CMB execute; emulation trace started".

## Chapter 6: Making Coordinated Measurements

### Starting/Stopping Multiple Emulators

When you enter a normal **trace** command, trace at execute is disabled, and the analyzer ignores the CMB EXECUTE signal.

---

#### Examples

To enable synchronous measurements from the transfer address:

*specify run from transfer\_address*

To trace from an address when synchronous execution begins:

*specify trace after address 10h*

---

---

### To start synchronous measurements

- Enter the **cmb\_execute** command on the command line.

The **cmb\_execute** command will cause the emulator to emit a pulse on the EXECUTE line, thereby initiating a synchronous measurement. You do not have to enable CMB interaction to use the **cmb\_execute** command because by enabling CMB interaction, you are only specifying how the emulator will react to the CMB EXECUTE signal.

All emulators whose CMB interaction is enabled will break into the monitor when any one of the emulators participating in the synchronous measurement breaks to its monitor.

---

### To disable synchronous measurements

- Enter the **specify run disable** command on the command line.

You can disable the emulator's interaction with the CMB by using the **specify run disable** command. When interaction is disabled, the emulator ignores the CMB EXECUTE and READY lines.

## Using Trigger Signals

The HP 64700 contains two internal lines, **trig1** and **trig2**, that can carry trigger signals from the emulator or analyzer to other HP 64700s on the Coordinated Measurement Bus (CMB) or other instruments connected to the BNC connector.

You can configure the internal lines to make connections between the emulator, analyzer, CMB connector, or BNC connector. Measurements that depend on these connections are called *interactive measurements* or *coordinated measurements*.

To configure the internal **trig1** and **trig2** lines, you must access the emulation configuration, either by choosing **Modify**→**Emulator Config...** in the graphical user interface and then selecting Interactive Measurement Specification, or by entering the **modify configuration** command in the softkey interface, and then answer “yes” to the “Modify interactive measurement specification?” question. In the softkey interface, the following display appears.

```

Interactive Measurement Specification

      BNC <<--??-->> ---\
      CMBT <<--??-->> ---|
      Emulator <<----->> ---| Trig1
      Analyzer ----->> ---/

      BNC <<--??-->> ---\
      CMBT <<--??-->> ---|
      Emulator <<--??-->> ---| Trig2
      Analyzer <<--??-->> ---/

NOTES:
  1. The connections marked "??" are set up here in configuration.
  2. drive = ----->>  receive = <<----- (The display won't change, however.)

STATUS:  Interactive Measurement Specification.....
Should BNC drive or receive Trig1? neither

_drive_ receive_ neither_ __both__          _RECALL_

```

This display illustrates the possible connections between the internal lines (**trig1** and **trig2**) and the emulator, analyzer, and external devices.

## Chapter 6: Making Coordinated Measurements

### Using Trigger Signals

Notice that the analyzer always drives trig1, and the emulator always receives trig1. This provides for the **break\_on\_trigger** syntax of the **trace** command.

You can disable connections made by the internal trig1 and trig2 lines by answering “neither” or “no” to the appropriate interactive measurement configuration question.

These are some ways that you can use the internal trigger signals:

- You can use the trig1 or trig2 line to make a connection between the analyzer and the CMB connector or BNC connector so that, when the analyzer finds its trigger condition, a trigger signal is driven on the HP 64700’s Coordinated Measurement Bus (CMB) or BNC connector.
- You can use the trig1 or trig2 line to make a connection between the emulator break input and the CMB connector, BNC connector, or analyzer so that program execution can break when a trigger signal is received from the CMB, BNC, or analyzer.
- You can use the trig2 line to make a connection between the analyzer and the CMB connector or BNC connector so that the analyzer can be armed (that is, enabled) when a trigger signal is received from the CMB or BNC connector.
- You can use the trig1 and trig2 lines to make several types of connections at the same time. For example, when the analyzer finds its trigger condition, a signal is driven on the trig1 line. This signal may be used to stop user program execution, but the trigger signal may also be driven on the CMB and BNC connectors.
- It is possible for signals to be driven and received on the CMB or BNC connectors. So, for example, while the analyzer’s trigger signal can be driven on the CMB and BNC connectors, signals can also be received from the CMB and BNC connectors and used to stop user program execution. In this case, the emulator will break into the monitor on either the analyzer trigger or on the reception of a trigger signal from the CMB or BNC.

The following tasks show you how to set up the emulator and analyzer to:

- Drive the emulation trigger to the CMB and BNC.
- Break emulator execution on CMB and BNC signals.
- Arm the emulation-bus analyzer on CMB, BNC, and analyzer signals.



## To drive the emulation-bus analyzer trigger signal to the CMB

- Choose **Modify→Emulator Config ...**
  - 1 In the top-level emulator configuration dialog box, click on Interactive Measurement Specification under Analyzer Configuration Sections.
  - 2 Choose “receive” beside the "CMBT on Trig1" item.
- Using the command line, enter **modify configuration**.
  - 1 Answer “yes” to the “Modify interactive measurement specification?” question.
  - 2 Answer “receive” to the “Should CMBT drive or receive Trig1?” question.

You could also drive the emulation-bus analyzer trigger to the CMB over the trig2 internal line by specifying that the CMBT should receive trig2 and that the emulation-bus analyzer should drive trig2.

## To drive the emulation-bus analyzer trigger signal to the BNC connector

- Choose **Modify→Emulator Config ...**
  - 1 In the top-level emulator configuration dialog box, click on Interactive Measurement Specification under Analyzer Configuration Sections.
  - 2 Answer “receive” beside the "BNC on Trig1" item.
- Using the command line, enter **modify configuration**.
  - 1 Answer “yes” to the “Modify interactive measurement specification?” question.
  - 2 Answer “receive” to the “Should BNC drive or receive Trig1?” question.

You could also drive the emulation-bus analyzer trigger to the BNC over the trig2 internal line by specifying that the BNC should receive trig2 and that the emulation-bus analyzer should drive trig2.

## To break emulator execution on signal from CMB

- Choose **Modify→Emulator Config ...**
  - 1 In the top-level emulator configuration dialog box, click on Interactive Measurement Specification under Analyzer Configuration Sections.
  - 2 Select “drive” for the “CMBT on Trig1” item.
- Using the command line, enter **modify configuration**.
  - 1 Answer “yes” to the “Modify interactive measurement specification?” question.
  - 2 Answer “drive” to the “Should CMBT drive or receive Trig1?” question.

The trig1 signal is always supplied to the emulator. By entering the command, **trace break\_on\_trigger**, emulation will break to the monitor when the CMB signal occurs.

You could also break emulator execution on a trigger signal from the CMB over the trig2 internal line by specifying that the CMB should drive trig2 and that the emulator break should receive trig2.

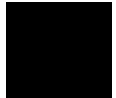

## To break emulator execution on signal from BNC

- Choose **Modify**→**Emulator Config ...**
  - 1 In the top-level emulator configuration dialog box, click on Interactive Measurement Specification under Analyzer Configuration Sections.
  - 2 Select “drive” for the “BNC on Trig1” item.
- Using the command line, enter **modify configuration**.
  - 1 Answer “yes” to the “Modify interactive measurement specification?” question.
  - 2 Answer “drive” to the “Should BNC drive or receive Trig1?” question.

The trig1 signal is always supplied to the emulator. By entering the command, **trace break\_on\_trigger**, emulation will break to the monitor when the BNC signal occurs.

You could also break emulator execution on a trigger signal from the BNC over the trig2 internal line by specifying that the BNC should drive trig2 and that the emulator break should receive trig2.

## To arm the emulation-bus analyzer on signal from CMB

- Using the command line, enter **modify configuration**.
  - 1 Answer “yes” to the “Modify interactive measurement specification?” question.
  - 2 Answer “drive” to the “Should CMBT drive or receive Trig2?” question.
  - 3 Answer “receive” to the “Should Analyzer drive or receive Trig2?” question.
  - 4 Use the **arm\_trig2** option to the **trace** command.

---

## To arm the emulation-bus analyzer on signal from BNC

- Using the command line, enter **modify configuration**.
  - 1 Answer “yes” to the “Modify interactive measurement specification?” question.
  - 2 Answer “drive” to the “Should BNC drive or receive Trig2?” question.
  - 3 Answer “receive” to the “Should Analyzer drive or receive Trig2?” question.
  - 4 Use the **arm\_trig2** option to the **trace** command.

## **Making Example Measurements**

The following tasks show you how to:

- Start a simultaneous program run on two emulators.
- Trigger one emulation-bus analyzer with another.
- Break to the monitor on an analyzer trigger signal.

---

### **To start a simultaneous program run on two emulators**

Before performing these steps, both emulators must be connected to the CMB. To connect the CMB, see “To connect the coordinated measurement bus (CMB)” at the beginning of this chapter.

- 1** Enable the CMB on each emulator.
- 2** Reset each emulator.
- 3** Set the run address for the first emulator.
- 4** Set the run address for the second emulator.
- 5** Start program execution on both emulators.

The procedure for starting a simultaneous trace on two emulators is similar. For each emulator, you should set up the trigger specification before enabling the CMB. Then start the analysis trace to enable trace on execute for each emulator. When the EXECUTE signal is received, both emulators will begin running and will start a trace according to the given trigger specification.

## To trigger one emulation-bus analyzer with another

Before performing these steps, both emulators must be connected to the CMB. To connect the CMB, see “To connect the coordinated measurement bus (CMB)” at the beginning of this chapter.

- 1 Enable the CMB on each emulator.
- 2 Reset each emulator.
- 3 Set up the first emulator to drive the CMB trigger.
- 4 Set up the second emulator to receive the CMB trigger.
- 5 Start a trace on each emulator.
- 6 Start a run on each emulator.

In the above steps, you set one emulation-bus analyzer to drive the CMB trigger, and set another to trigger on receipt of a CMB trigger. You can use the same concepts to trigger external instruments using the BNC connector on the rear panel of the HP 64700 Series Card Cage.

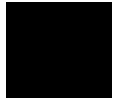

## To break to the monitor on an analyzer trigger signal

- 1 Enter the emulation configuration.
- 2 Set the emulator to receive trig1.
- 3 Set the emulation-bus analyzer to drive trig1.
- 4 Specify the trigger conditions for the trace.
- 5 Start the trace.
- 6 Start the program run.

The trigger signals and the analyzer trigger capabilities allow you to specify breakpoints. You can use the trigger specification to specify complex sequences of address, data and status, then break the program to the monitor when the sequence is found. This is useful when you want to examine memory locations and registers after the trigger condition but before further program execution.

You can use a similar process to break to monitor when a BNC trigger or CMB trigger is received.



---

# 7



---

## **Making Software Performance Measurements**

How to make software performance measurements on your programs

## Using the Software Performance Measurement Tool

The Software Performance Measurement Tool (SPMT) is a feature included in the emulator/analyzer that allows you to make software performance measurements on your programs. Two types of software performance measurements can be made with the SPMT: activity measurements, and duration measurements.

The SPMT post-processes information from the analyzer trace list. When you end a performance measurement, the SPMT dumps the post-processed information to a binary file, which is then read using the **perf32** report generator utility.

---

## Use the Software Performance Analyzer (SPA) for more capability

For more capability in making measurements of the performance of your software, you can order the Software Performance Analyzer (SPA). SPA helps designers understand the execution of software modules in an absolute file.

SPA provides answers to questions such as:

- Why does it take so long to execute a program?
- Which modules are taking extra long time to execute?

While SPA performs a measurement, it shows the current measurement results. There is no need for you to transfer files; all you do is indicate the type of display desired (histogram or table listing). If you are interested in purchasing SPA, contact your HP Sales Representative.

## Understanding activity measurements

Activity measurements are measurements of the number of accesses (reads or writes) within an address range. The SPMT shows you the percentage of analyzer trace states that are in the specified address range, as well as the percentage of time taken by those states. Two types of activity are measured: memory activity, and program activity.

Memory activity is all activity that occurs within the address range.

Program activity is the activity caused by instruction execution in the address range. Program activity includes opcode fetches and the cycles that result from the execution of those instructions (like reads and writes to memory, and stack pushes).

For example, suppose an address range being measured for activity contains an opcode that causes a stack push, which results in multiple write operations to the stack area (outside the range). The memory activity measurement will count only the stack push opcode cycle. However, the program activity measurement will count the stack push opcode cycle and the write operations to the stack.

By comparing the program activity and the memory activity in an address range, you can get an idea of how much activity in other areas is caused by the code being measured. An activity measurement report of the code (prog), data, and stack sections of a program is shown in the next figure.

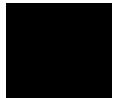

## Chapter 7: Making Software Performance Measurements

### Understanding activity measurements

```

Label
prog
  Address Range      ADEH thru      1261H

  Memory Activity
    State Percent   Rel =  57.77  Abs =  57.77
                   Mean = 295.80  Sdv =  26.77
    Time  Percent   Rel =  60.97  Abs =  60.97

  Program Activity
    State Percent   Rel =  99.82  Abs =  99.82
                   Mean = 511.10  Sdv =   0.88
    Time  Percent   Rel =  99.84  Abs =  99.84

data
  Address Range      6007AH thru      603A5H

  Memory Activity
    State Percent   Rel =  30.51  Abs =  30.51
                   Mean = 156.20  Sdv =  31.87
    Time  Percent   Rel =  28.09  Abs =  28.09

  Program Activity
    State Percent   Rel =   0.18  Abs =   0.18
                   Mean =   0.90  Sdv =   0.88
    Time  Percent   Rel =   0.16  Abs =   0.16

stack
  Address Range      40000H thru      43FFFH

  Memory Activity
    State Percent   Rel =  11.72  Abs =  11.72
                   Mean =  60.00  Sdv =  29.24
    Time  Percent   Rel =  10.94  Abs =  10.94

  Program Activity
    State Percent   Rel =   0.00  Abs =   0.00
                   Mean =   0.00  Sdv =   0.00
    Time  Percent   Rel =   0.00  Abs =   0.00

  Graph of Memory Activity relative state percents >= 1
prog      57.77% *****
data     30.51% *****
stack    11.72% *****

```

### Memory and Program Activity

## Chapter 7: Making Software Performance Measurements Understanding activity measurements

```
Graph of Memory Activity relative time percents >= 1
prog      60.97% *****
data     28.09% *****
stack    10.94% *****

Graph of Program Activity relative state percents >= 1
prog      99.82% *****

Graph of Program Activity relative time percents >= 1
prog      99.84% *****

Summary Information for      10 traces

Memory Activity
State count
  Relative count      5120
  Mean sample        170.67
  Mean Standard Dv   29.30
  95% Confidence 12.28% Error tolerance
Time count
  Relative Time - Us 2221.20

Program Activity
State count
  Relative count      5120
  Mean sample        170.67
  Mean Standard Dv   0.58
  95% Confidence 0.24% Error tolerance
Time count
  Relative Time - Us 2221.20
Absolute Totals
  Absolute count - state      5120
  Absolute count - time - Us 2221.20
```

### Memory and Program Activity (Cont'd)

## Understanding duration measurements

Duration measurements provide a best-case/worst-case characterization of code execution time. These measurements record execution times that fall within a set of specified time ranges. The **trace** command is set up to store only the entry and exit states of the module to be measured (for example, a C function or Pascal procedure). The SPMT provides two types of duration measurements: module duration and module usage.

Module duration measurements record how much time it takes to execute a particular code segment (for example, a function in the source file).

Module usage shows how much of the execution time is spent outside of the module (from exit to entry). This measurement gives an indication of how often the module is being used.

Before you perform duration measurements, you should be aware of the prefetch and recursion considerations associated with these measurements.

When using the SPMT to perform duration measurements, there should be only two addresses stored in the trace memory: the entry address, and the exit address. Prefetches or recursion can place several entry addresses before the first exit address, and/or several exit addresses before the first entry address. Duration measurements are made between the last entry address in a series of entry addresses, and the last exit address in a series of exit addresses as shown in the prefetch correction listing. All of the entry and exit addresses which precede these last addresses are assumed to be unused prefetches, and are ignored during time measurements.

```
START - unused prefetch
START - unused prefetch
START - unused prefetch
START - START actually taken -
END - unused prefetch
END - unused prefetch
END - unused prefetch
END - END actually taken -
START - unused prefetch
START - unused prefetch
START - unused prefetch
START - START actually taken -
END - unused prefetch
END - unused prefetch
```

Measure duration

Measure duration

## Chapter 7: Making Software Performance Measurements To use the Software Performance Measurement Tool

The SPMT makes its duration measurements from the last start address in the series of start addresses, to the last end address in the series of end addresses. The other start and end addresses are unused prefetches and are ignored by the software of the SPMT. Recursive procedures will still affect the accuracy of your measurements.

The prefetch correction has the following consequences:

- Prefetches are ignored. They do not affect the accuracy of the measurement in process.
- When measuring a recursive function, module duration will be measured between the last recursive call and the true end of the recursive execution. This will affect the accuracy of the measurement.
- If a module is entered at the normal point, and then exited by a point other than the defined exit point, the entry point will be ignored. It will be judged the same as any other unused prefetch, and no time-duration measurement will be made. Its time will be included in the measure of time spent outside the procedure or function.
- If a module is exited from the normal point, and then reentered from some other point, the exit will also be assumed to be an unused prefetch of the exit state.

If you are making duration measurements on a function that is recursive, or one that has multiple entry and/or exit points, the result may be invalid information.

---

## To use the Software Performance Measurement Tool

Activity and duration measurements are made with the SPMT in a five-step process, summarized as follows:

- 1 Set up the trace command.
- 2 Initialize the performance measurement.
- 3 Run the performance measurement.

- 4 End the performance measurement.
- 5 Generate the performance measurement report.

---

## Step 1. Set up the trace command

Before you initialize and run performance measurements, the current trace command (the last trace command entered) must be properly set up.

- 1 Increase the trace depth to the maximum number by entering:

```
display trace depth 512
```

In general, you want to give the SPMT as many trace states as possible to post-process to increase statistical accuracy. Also it is important that "time" be counted by the analyzer; otherwise, the SPMT measurements will not be correct.

- 2 Choose to make either activity measurements or duration measurements.
  - To make activity measurements (which measures activity as a percentage of all activity, the current trace command should be the default), enter:

```
trace counting time
```

The default trace command triggers on any state, and all captured states are stored. Also, since states are stored "after" the trigger state, the maximum number of captured states appears in each trace list.

You can use trace commands other than the default. You can qualify trace commands any way you like to obtain specific information. However, when you qualify the states that get stored in the trace memory, your SPMT results will be biased by your qualifications; the percentages shown will be of only those states stored in the trace list.



- To make duration measurements, set up the trace command to store only the entry and exit points of the module of interest. For example:

```
trace after <symbol_entry> or <symbol_exit> only  
symbol_entry or symbol_exit counting time
```

or

```
trace after <module_name> start or module_name end only  
module_name start or module_name end counting time
```

Since the trigger state is always stored, you should trigger on the entry or exit points.

<symbol\_entry> and <symbol\_exit> are symbols from the user program.

<module\_name> is the name of a C function or Pascal procedure (and is listed as a procedure symbol in the global symbol display).

---

## Step 2. Initialize the performance measurement

After you set up the trace command, you must tell the SPMT the address ranges on which you wish to make activity measurements or the time ranges to be used in the duration measurement. This is done by initializing the performance measurement, which can be accomplished in various ways.

- To use the default configuration, enter the following command with no options:

```
performance_measurement_initialize
```

This specifies an activity measurement. If a valid symbolic database has been loaded, the addresses of all global procedures and static symbols will be used. Otherwise, a default set of ranges that cover the entire processor address range will be used.

## Chapter 7: Making Software Performance Measurements

### To use the Software Performance Measurement Tool

- To initialize with user-defined files (activity or duration measurement), specify the SPMT address or time ranges to use by placing the information in a file and entering the file name in the **performance\_measurement\_initialize** command.

The formats for the address range file (activity measurements) and time range file (duration measurements) are described in this chapter.

- To include program symbols (procedure name or static), user defined address ranges, and comments in address range files, refer to this example file:

```
# Any line which starts with a # is a comment.
# All user's labels must be preceded by a "|".

|users_label 10H 1000H
program_symbol

# A program symbol can be a procedure name or a static. In the case of a pro-
# cedure name the range of that procedure will be used.

|users_label2 program_symbol1 -> program_symbol2

# "->" means thru. The above will define a range which starts with symbol1
# and goes thru symbol2. If both symbols are procedures then the range will
# be defined as the start of symbol1 thru the end of symbol2.

dirl/dir2/source_file.s:local_symbol

# The above defines a range based on the address of local_symbol.
```

- To include comments and units for time ranges in time range files, refer to this example file:

```
# Any line which starts with a # is a comment.

1 us 20 us
10.1 ms 100.6 ms
3.55 s 6.77 s

# us microseconds
# ms milliseconds
# s seconds
#
# The above are the only abbreviations allowed. The space between the number
# and the units abbreviation is required.
```

Time units can be in microseconds (us), milliseconds (ms), or seconds (s).

## Chapter 7: Making Software Performance Measurements To use the Software Performance Measurement Tool

- To select duration measurements, enter:

```
performance_measurement_initialize duration
```

or

```
performance_measurement_initialize <FILE> duration
```

When no user defined time range file is specified, the following set of default time ranges are used.

```
1 us 10 us
10.1 us 100 us
100.1 us 500 us
500.1 us 1 ms
1.001 ms 5 ms
5.001 ms 10 ms
10.1 ms 20 ms
20.1 ms 40 ms
40.1 ms 80 ms
80.1 ms 160 ms
160.1 ms 320 ms
320.1 ms 640 ms
640.1 ms 1.2 s
```

- To initialize with global symbols, enter:

```
performance_measurement_initialize
```

or

```
performance_measurement_initialize global_symbols
```

Global symbols in the symbols database becomes the address ranges for which activity is measured. If the symbols database is not loaded, a default set of ranges that cover the entire processor address range will be used. The global symbols database contains procedure symbols, which are associated with the address range from the beginning of the procedure to the end, and static symbols, which are associated with the address of the static variable.

## Chapter 7: Making Software Performance Measurements

### To use the Software Performance Measurement Tool

- To initialize with local symbols, enter:

```
performance_measurement_initialize local_symbols_in  
<source file name>
```

The symbols associated with the source file become the address ranges for which activity is measured. If the symbols database is not loaded, an error message will occur telling you that the source filename symbol was not found.

You can also use the "local\_symbols\_in" option with procedure symbols. This allows you to measure activity related to the symbols defined in a single function or procedure.

These are example commands showing performance measurement initialization with local symbols.

```
performance_measurement_initialize local_symbols_in  
spmt_demo.C:
```

```
performance_measurement_initialize local_symbols_in  
spmt_demo.C:math_library
```

```
performance_measurement_initialize local_symbols_in  
math_library
```

- To restore the current measurement, enter:

```
performance_measurement_initialize restore
```

This allows you to restore old performance measurement data from the **perf.out** file in the current directory.

If you have not exited and reentered emulation, you can add traces to a measurement simply by entering another **performance\_measurement\_run** command. However, if you exit and reenter the emulation system, you must enter the **performance\_measurement\_initialize restore** command before you can add traces to a measurement. When you restore a performance measurement, make sure your current trace command is identical to the command used with the restored measurement.

## Chapter 7: Making Software Performance Measurements To use the Software Performance Measurement Tool

When restoring old performance measurement data, the "restore" option determines if the current emulator software version matches the version used when the performance measurement data was stored (in the **perf.out** files). If the versions match, the restore will be performed. If you ran tests using a former software version and saved **perf.out** files, then updated your software to a new version number, you will not be able to restore old **perf.out** measurement files.

---

### Step 3. Run the performance measurement

The **performance\_measurement\_run** command processes analyzer trace data. When you end the performance measurement, this processed data is dumped to the binary "perf.out" file in the current directory. The **perf32** report generator utility is used to read the binary information in the "perf.out" file.

- To process the current trace data, enter:

```
performance_measurement_run
```

- To execute the current trace command consecutively, a certain number of times, enter:

```
performance_measurement_run <COUNT>
```

The data that results from each trace command is processed and combined with the existing processed data. The STATUS line will say "Processing trace <NO.>" during the run so you will know how your measurement is progressing. The only way to stop this series of traces is by using **CTRL c** (sig INT).

The more traces you include in your sample, the more accurate your results will be. At least four consecutive traces are required to obtain statistical interpretation of activity measurement results.

## Step 4. End the performance measurement

- To end the performance measurement, enter:

*performance\_measurement\_end*

The **performance\_measurement\_end** command takes the data generated by the **performance\_measurement\_run** command and places it in a file named **perf.out** in the current directory. If a file named "perf.out" already exists in the current directory, it will be overwritten. Therefore, if you wish to save a performance measurement, you must rename the **perf.out** file before performing another measurement.

The **performance\_measurement\_end** command does not affect the current performance measurement data which exists within the emulation system. In other words, you can add more traces later to the existing performance measurement by entering another **performance\_measurement\_run** command.

Once you have entered the **performance\_measurement\_end** command, you can use the **perf32** report generator to look at the data saved in the **perf.out** file.

The "perf.out" file is a binary file. Do not try to read it with the UNIX **more** or **cat** commands. The **perf32** report generator utility (described in the following section) must be used to read the contents of the "perf.out" file.

## Step 5. Generate the performance measurement report

The **perf32** report generator utility must be used to read the information in the "perf.out" file and other files dumped by the SPMT (in other words, renamed "perf.out" files). The **perf32** utility is run from the UNIX shell. You can fork a shell while in the Softkey Interface and run **perf32**, or you can exit the Softkey Interface and run **perf32**.

- To save the current performance measurement information in a file called "perf1.out", and produce a histogram showing only the program activity occupied by the functions and variables.

```
mv perf.out perf1.out
perf32 -hpf perf1.out
```

A default report, containing all performance measurement information, is generated when the **perf32** command is used without any options. The options available with **perf32** allow you to limit the information in the generated report. These options are:

|                       |   |
|-----------------------|---|
| <b>-h</b>             | Produce outputs limited to histograms.  |
| <b>-s</b>             | Produce a summary limited to the statistical data.  |
| <b>-p</b>             | Produce a summary limited to the program activity.  |
| <b>-m</b>             | Produce a summary limited to the memory activity.   |
| <b>-f&lt;file&gt;</b> | Produce a report based on the information contained in <file> instead of the information contained in perf.out. |
| <b>-c</b>             | Print only program and memory activity information consuming time.  |

Options **-h**, **-s**, **-p**, and **-m** affect the contents of reports generated for activity measurements. These options have no effect on the contents of reports generated for duration (time interval) measurements.

## Chapter 7: Making Software Performance Measurements

### To use the Software Performance Measurement Tool

The reports generated for activity measurements show you the percentage of analyzer trace states that are in the specified address range, as well as the percentage of time taken by those states. The performance measurement must include four traces before statistics (mean and standard deviation) appear in the activity report.

- To interpret reports of activity measurements, understand the information described here. You will see this information in activity measurement reports.

|                  |   |
|------------------|---|
| Memory activity  | All activity found within the address range.  |
| Program activity | All activity caused by instruction execution in the address range. Program activity includes opcode fetches and the cycles that result from the execution of those instructions (like reads and writes to memory and stack pushes). |
| Relative         | A count or time value associated with activity in address ranges in the performance measurement.  |
| Absolute         | A count or time value associated with all trace state activity, not just activity in the address ranges defined for the performance measurement.  |
| Mean             | Average number of analyzer trace states in the range specified. The following equation is used to calculate the mean:   |

$$mean = \frac{\text{states in range}}{\text{total states}}$$

Standard deviation      Deviation from the mean of state count. The following equation is used to calculate standard deviation:

$$std\ dev = \sqrt{\frac{1}{N-1} \times \sum_{i=1}^N S_{sumq} - N (mean)^2}$$



## Chapter 7: Making Software Performance Measurements To use the Software Performance Measurement Tool

Where:

|                                |   |
|--------------------------------|---|
| N                              | Number of traces in the measurement.  |
| mean                           | Average number of states in the range per trace.  |
| S <sub>sumq</sub>              | Sum of squares of states in the range per trace.  |
| Symbols within range           | Names of other symbols that identify addresses or ranges of addresses within the range of this symbol.  |
| Additional symbols for address | Names of other symbols that also identify this address. Some compilers emit more than one symbol for certain addresses. For example, a compiler may emit "math_library" and "_math_library" for the first address in a routine named math_library. The analyzer will show the first symbol it finds to represent a range of addresses, or a single address point, and it will show the other symbols under either "Symbols within range" or "Additional symbols for address", as applicable. In the "math_library" example, it may show either "math_library" or "_math_library" to represent the range, depending on which symbol it finds first. The other symbol will be shown below "Symbols within range" in the report. These conditions appear particularly in default measurements that include all global and local symbols. |
| Relative and absolute counts   | Relative count is the total number of states associated with the address ranges in the performance measurement. Relative time is the total amount of time associated with the address ranges in the performance measurement. The absolute counts are the number of states or amount of time associated with all the states in all the traces.   |

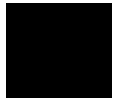

Chapter 7: Making Software Performance Measurements  
**To use the Software Performance Measurement Tool**

Error tolerance and confidence level

An approximate error may exist in displayed information. Error tolerance for a level of confidence is calculated using the mean of the standard deviations and the mean of the means. Error tolerance gives an indication of the stability of the information. For example, if the error is 5% for a confidence level of 95%, then you can be 95% confident that the information has an error of 5% or less.

The Student's "T" distribution is used in these calculations because it improves the accuracy for small samples. As the size of the sample increases, the Student's "T" distribution approaches the normal distribution.

The following equation is used to calculate error tolerance:

$$error\ pct. = \frac{O_m \times t}{N \times P_m} \times 100$$

Where:

- |       |  |
|-------|--|
| $O_m$ | Mean of the standard deviations.                                 |
| $t$   | Table entry in Student's "T" table for a given confidence level. |
| $N$   | Number of traces in the measurement.                             |
| $P_m$ | Mean of the means (the mean sample).                             |

## Chapter 7: Making Software Performance Measurements To use the Software Performance Measurement Tool

Duration measurements provide a best-case/worst-case characterization of code execution time. These measurements record execution times that fall within a set of specified time ranges.

- To interpret reports of duration measurements, understand the information described here. You will see this information in duration measurement reports.

|                     |   |
|---------------------|---|
| Number of intervals | Number of "from address" and "to address" pairs (after prefetch correction).  |
| Maximum time        | The greatest amount of time between the "from address" to the "to address".   |
| Minimum time        | The shortest amount of time between the "from address" to the "to address".   |
| Average time        | Average time between the "from address" and the "to address". The following equation is used to calculate the average time: |

$$mean = \frac{\text{amount of time for all intervals}}{\text{number of intervals}}$$

|                    |  |
|--------------------|--|
| Standard deviation | Deviation from the mean of time. The following equation is used to calculate standard deviation: |
|--------------------|--|

$$std\ dev = \sqrt{\frac{1}{N-1} \times \sum_{i=1}^N S_{sumq} - N (mean)^2}$$

Where:

|                   |  |
|-------------------|--|
| N                 | Number of intervals.                     |
| mean              | Average time.                            |
| S <sub>sumq</sub> | Sum of squares of time in the intervals. |

Chapter 7: Making Software Performance Measurements  
**To use the Software Performance Measurement Tool**

Error tolerance and confidence level

An approximate error may exist in displayed information. Error tolerance for a level of confidence is calculated using the mean of the standard deviations and the mean of the means. Error tolerance gives an indication of the stability of the information. For example, if the error is 5% for a confidence level of 95%, then you can be 95% confident that the information has an error of 5% or less.

The Student's "T" distribution is used in these calculations because it improves the accuracy for small samples. As the size of the sample increases, the Student's "T" distribution approaches the normal distribution.

The following equation is used to calculate error tolerance:

$$error\ pct. = \frac{O_m \times t}{N \times P_m} \times 100$$

Where:

|       |  |
|-------|--|
| $O_m$ | Mean of the standard deviations in each time range.                            |
| $t$   | Table entry in Student's "T" table for a given confidence level.               |
| $N$   | Number of intervals.   |
| $P_m$ | Mean of the means (for example, mean of the average times in each time range). |

---

**8**



---

**Configuring the Emulator**

## Configuring the Emulator

This chapter describes how to configure the emulator. By default, the emulator assumes all memory addresses are in RAM space in your target system. If you wish to load some of your target program in emulation memory hardware, or identify some of your memory addresses as ROM hardware or Guarded address space, enter those specifications in the emulation memory map. When you plug the emulator into a target system, you must configure the emulator so that it operates correctly in the target system. The configuration tasks are grouped into the following sections:

- Using the configuration interface.
- Emulation configuration displays.
- Mapping memory.
- Providing MMU address translation for the MC68030 Foreground Monitor.

The simulated I/O feature and configuration questions are further described in the *Simulated I/O User's Guide*.

The interactive measurement configuration options are further described in Chapter 6, "Making Coordinated Measurements".

## Using the Configuration Interface

This section shows you how to modify, store, and load configurations using the emulator configuration interface.

This section shows you how to:

- Start the configuration interface.
- Modify a configuration section.
- Apply configuration changes to the emulator.
- Store configuration changes to a file.
- Change the configuration directory context.
- Display the configuration context.
- Access help topics.
- Access help for a configuration item in a dialog box.
- Exit the configuration interface.
- Load an existing configuration file.



## To start the configuration interface

- Choose **Modify**→**Emulator Config...** from the emulator/analyzer interface pulldown menu.
- Using the command line, enter the **modify configuration** command.

The configuration interface top-level dialog box (see the following example) is displayed.

The configuration interface may be left running while you are using the emulator/analyzer interface.

If you are using the Softkey Interface from a terminal or terminal emulation window, you don't get a dialog box from which to choose configuration sections; however, you have access to the same configuration options through a series of configuration questions.





**Examples**

The emulator configuration interface top-level dialog box is shown below.

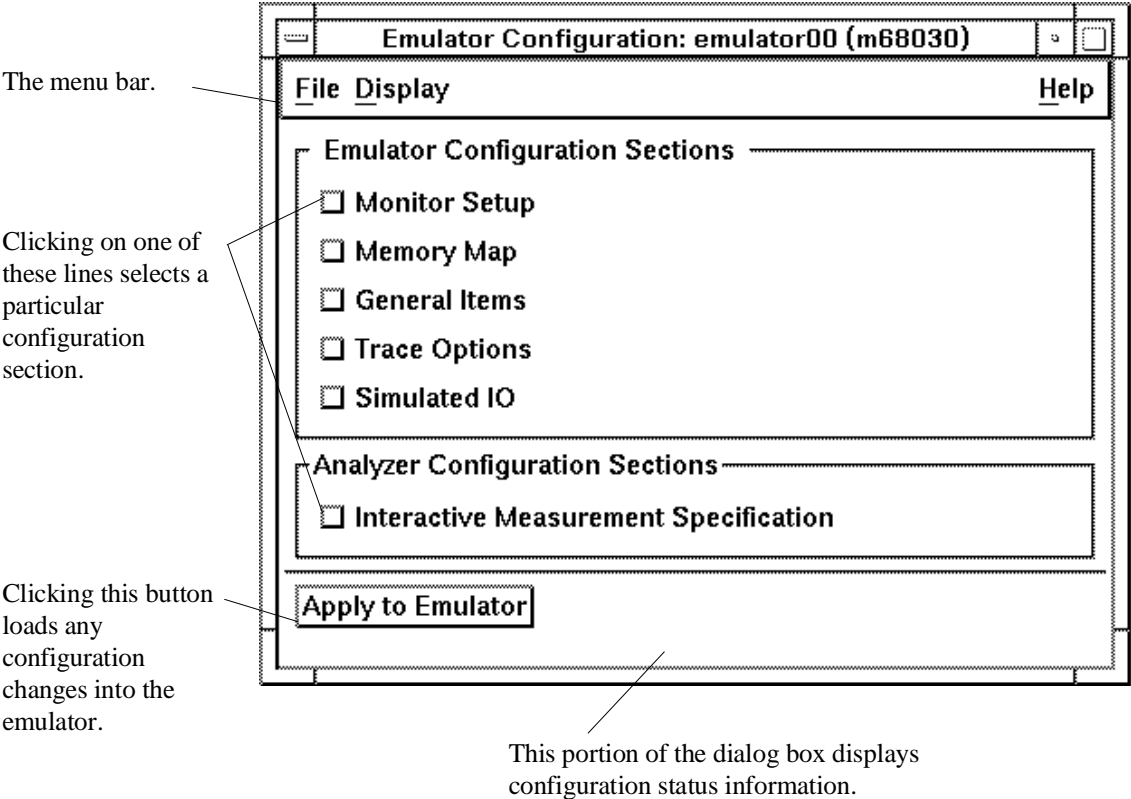

## To modify a configuration section

- If you are using the Graphical User Interface:
  - 1 Start the emulator configuration interface.
  - 2 Click on a section name in the configuration interface top-level dialog box.
  - 3 Use the section dialog box to make changes to the configuration.

- If you are using the Softkey Interface:

The configuration questions in the "Monitor Setup" section are the first to be asked.

To access the memory map and define, modify, or delete map entries in the "Memory Map" section, answer "yes" to the "Modify memory configuration?" question.

To access the questions in the "General Items" section, answer "yes" to the "Modify emulator pod configuration?" question.

To access the questions in the "Trace Options" section, answer "yes" to the "Modify debug/trace options?" question.

To access the questions in the "Simulated IO" section, answer "yes" to the "Modify simulated I/O configuration?" question.

To access the questions in the "Interactive Measurement Specification" under "Analyzer Configuration Sections", answer "yes" to the "Modify interactive measurement specification?" question.

**Examples**

Most configuration sections provide dialog boxes similar to the following.

The dialog for this section has been opened

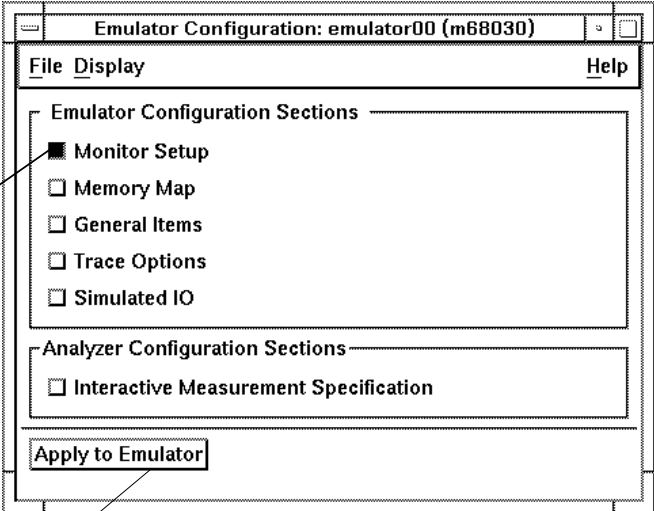

Applies configuration changes to the emulator

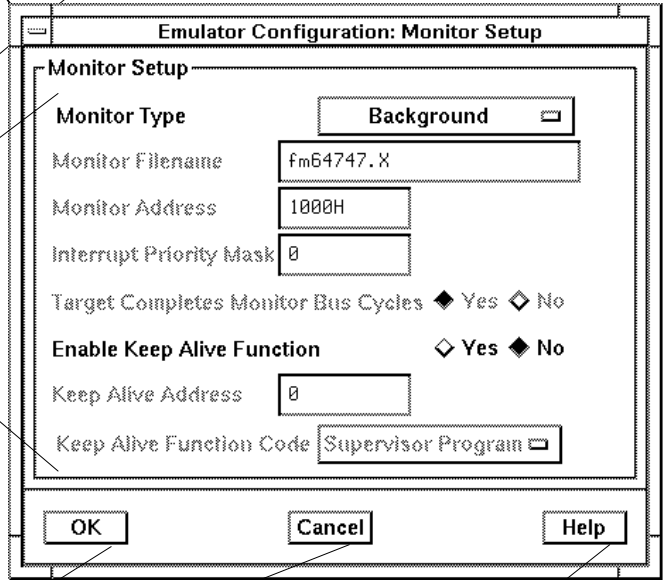

Configuration options in this section

Closes the dialog box

Cancels all changes since last "OK", "Apply to Emulator", or store to file.

Presents emulator configuration help topic browser.

## Chapter 8: Configuring the Emulator

### Using the Configuration Interface

As soon as you change a configuration option, the change is recorded, but not loaded (as seen by the "Changes Not Loaded" message in the top level dialog).

---

## To apply configuration changes to the emulator

- Click the "Apply to Emulator" button in the top-level dialog box.

This loads the configuration changes into the emulator. Status text to the right shows whether the load was successful.

You can apply configuration changes to the emulator at any time (even while section dialog boxes are open). This lets you verify changes without closing section dialog boxes.

The "Apply to Emulator" button does not store configuration changes to a file.

When you exit the configuration interface and there are configuration changes that have not been stored to a file, you are asked whether you want to store the changes, exit without storing, or cancel the exit.

## To store configuration changes to a file

- Choose **File**→**Store...** from the pulldown menu in the top-level configuration interface window, and use the file selection dialog box to name the configuration file.
- If you are using the Softkey Interface, the last configuration question, "Configuration file name?", lets you name the file to which configuration information is stored. If you don't enter a name, configuration information is saved to a temporary file (which is deleted when you exit the interface and release the emulation system).

When modifying a configuration using the Graphical User Interface, you can store your answers at any time.

Configuration information is saved in a file with the extension ".EA". This file is the "source", ASCII format copy of the file. (The interface will create a temporary file with the extension ".EB" which is the "binary" or loadable copy of the file.)

---

### CAUTION

Do not modify configurations by editing the ".EA" files. Use the configuration interface to modify and save configurations.

For more information on how to use dialog boxes, refer to the "Entering Commands", and "Using Special Features of the Graphical User Interface" sections Chapter 3, "Using the emulator/analyzer interface".

## To change the configuration directory context

- Choose **File**→**Directory...** from the pulldown menu in the top-level configuration interface window, and use the directory selection dialog box to specify the new directory.

The directory context specifies the directory to which configuration files are stored and from which they are loaded.

For more information on how to use dialog boxes, refer to the "Entering Commands", and "Using Special Features of the Graphical User Interface" sections in Chapter 3, "Using the emulator/analyzer interface".

---

## To display the configuration context

- Choose **Display**→**Context...** from the pulldown menu in the top-level configuration interface window.

The current directory context and the current configuration files are displayed in a window. Click the "Done" pushbutton when you wish to close the window.

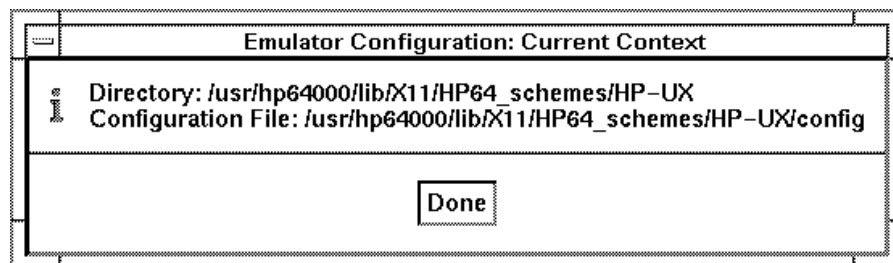

## To access help topics

- Choose **Help**→**General Topic...** from the pulldown menu in the top-level configuration interface window, click on a topic in the selection dialog box, and click the "OK" button.

---

## To access help for a configuration item in a dialog box

- Place the mouse pointer on the line of interest and press the f1 key.
- Choose **Help**→**On Item...** in the top-level configuration interface window or the memory map window. The mouse pointer changes from an arrow to a question mark. Place the question mark over a selection button or in the entry field on the line of interest, and click the *pushbutton select* mouse button.

Depending on the platform you are using, you may find that the f1 key is the best way to obtain help on a field, or that the **Help**→**On Item...** selection is a better way to obtain help on a field.

If you are using the **Help**→**On Item...** pulldown and its associated question mark, you may find that in some dialog boxes, the question mark may not obtain a help screen when you place it on a command name, but the help screen may be obtained when you place the question mark over an input field or button associated with the command name.

The configuration interface provides individual help for each item in the top level dialog box and throughout the configuration section dialog boxes.

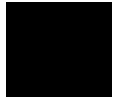

## To exit the configuration interface

- Choose **File**→**Exit...** from the pulldown menu in the top-level configuration interface window (or type <CTRL>x).

If configuration changes have not been stored to a file, a confirmation dialog box appears, giving you the options of: storing, exiting without storing, or canceling the exit.

---

## To load an existing configuration file

- In the emulator/analyzer interface, choose **File**→**Load**→**Emulator Config...** from the pulldown menu, and use the file selection dialog box to specify the configuration file to be loaded.
- Using the command line, enter the **load configuration <FILE>** command.

This command loads previously created and stored configuration files. You cannot load a configuration while the configuration interface is running.



## **Emulation Configuration Displays**

The displays of the emulation configuration are shown in this section. They give you access to all of the options that must be defined to configure the emulator. Help for making selections in these displays can be obtained as discussed earlier in this chapter. The emulation configuration displays are as follows:

Monitor Setup.

Memory Map.

General Items.

Trace Options.

Simulated IO.

Interactive Measurement Specification.

The displays in this section were obtained from an MC68030 emulator. The displays of an MC68020 emulator are the same, except as noted below each illustration. Use the online help screens (as discussed earlier in this chapter) to obtain information for making selections in the configuration displays. Additional information not available in the help screens is given below some of the emulator configuration displays in this chapter.

The memory mapping displays are discussed separately in the next section of this chapter.

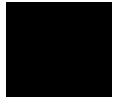

## Chapter 8: Configuring the Emulator Emulation Configuration Displays

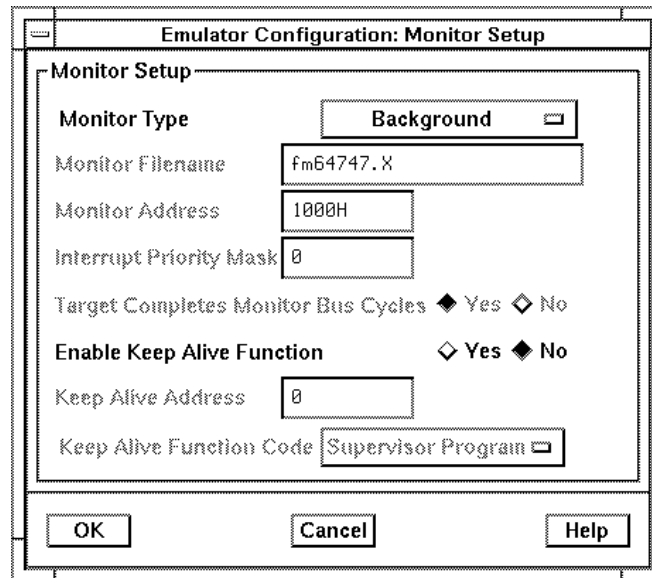

In the Monitor Setup for the MC68020, you will not see support for a Keep Alive Function because the background monitor bus cycles are visible to the MC68020 target system, making the Keep Alive function unnecessary.

When using the background monitor, interrupts are disabled (including level 7 interrupts). Some target systems will not to operate properly under this condition. With these target systems, you will need to use a foreground monitor.

When using the MC68030 memory manager, make sure the foreground monitor of the MC68030 is mapped to memory address space that has a 1:1 translation. You can define a 1:1 translation for the monitor address space by modifying the content of the translation tables in the emulation processor MMU. Refer to "Providing MMU Address Translation for the MC68030 Foreground Monitor" at the end of this chapter for instructions on how to modify the transparent translation registers or the translation tables in the MC68030 MMU.

## Chapter 8: Configuring the Emulator Emulation Configuration Displays

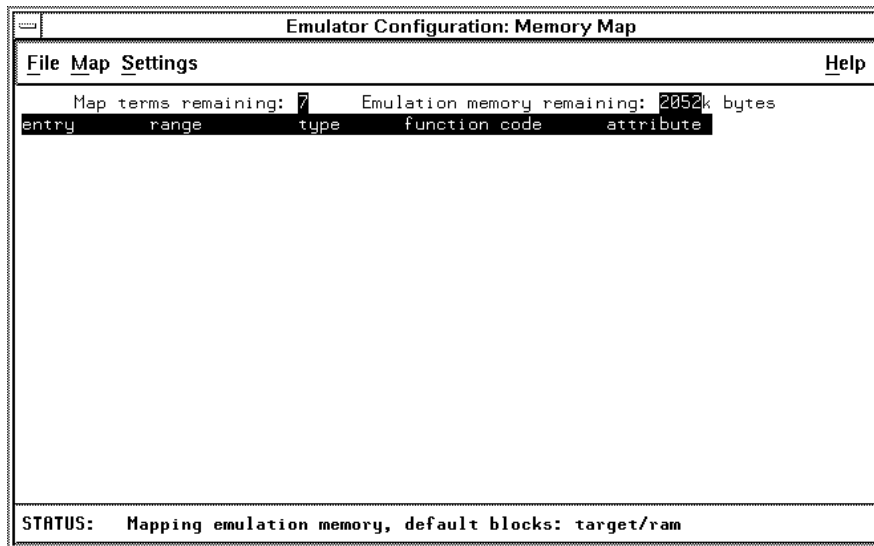

Refer to Mapping Memory later in this chapter for details of how to use the Memory Map configuration screen.



## Chapter 8: Configuring the Emulator

### Emulation Configuration Displays

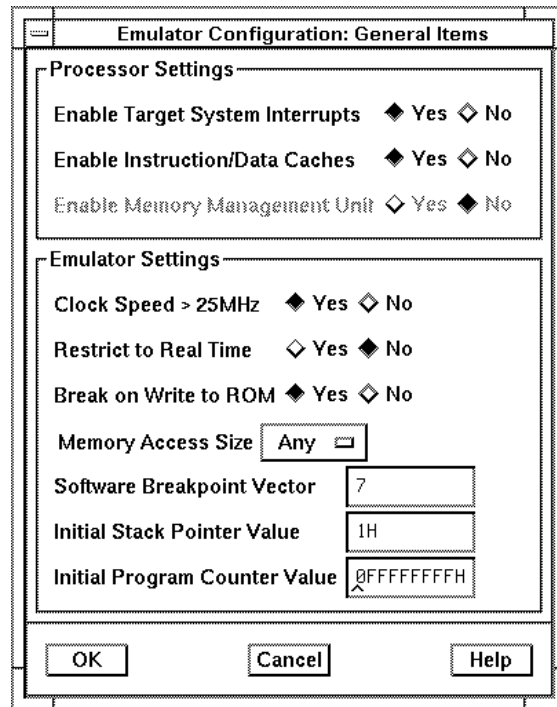

The MC68020 General Items configuration screen does not offer control over a Data Cache. It also does not offer the ability to enable a Memory Management Unit because memory management is not supported in the MC68020 emulator.

If your target system may be damaged by not running target system code continuously, answer Yes to the Restrict to Real Time question. The operation of the emulator breakpoints function is not affected by your choice to restrict the emulator to real time operation.

Even if you answer Yes to Break on Write to ROM, RAM memory that has been mapped as ROM in the emulation or target system will be changed by processor write transactions.

Enter 32-bit hexadecimal addresses for the Initial Stack Pointer Value and Initial Program Counter Value. These values usually correspond to the values loaded at offsets 0 and 4 of your vector table. The default values in the General Items configuration screen are invalid, requiring you to enter valid values.

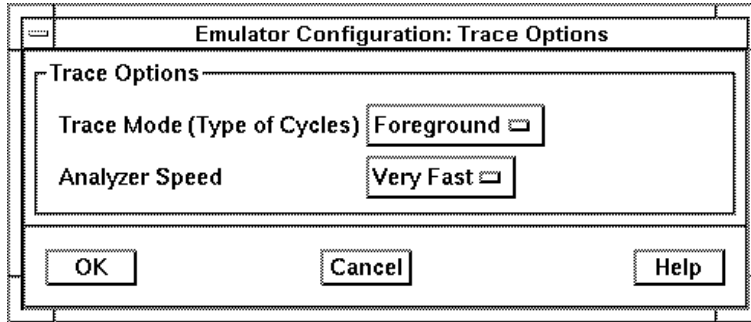

If you are using the deep analyzer with the MC68030 emulator, the Analyzer Speed question does not appear. The deep analyzer can do state and time counting regardless of Analyzer Speed. The Analyzer Speed question is also not asked in the MC68020 Trace Options window because emulation-bus analyzers can make measurements without tradeoffs in the MC68020 emulator.

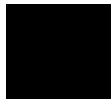
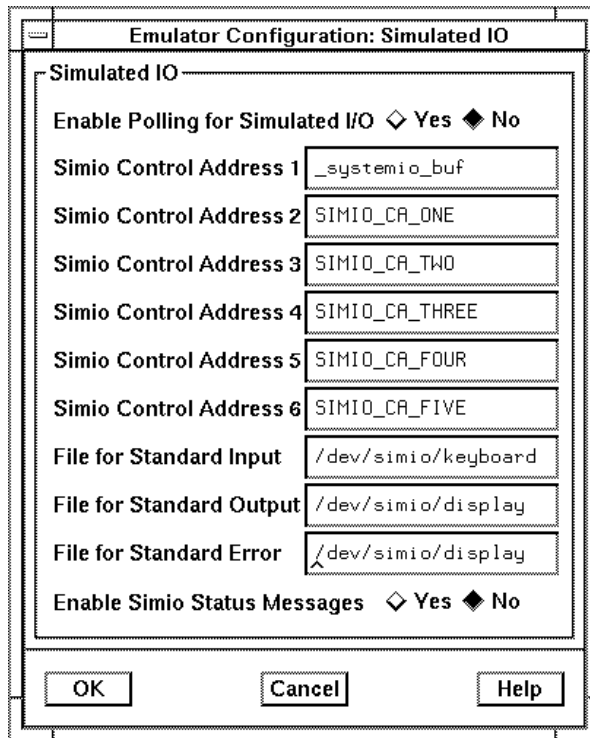

Chapter 8: Configuring the Emulator  
**Emulation Configuration Displays**

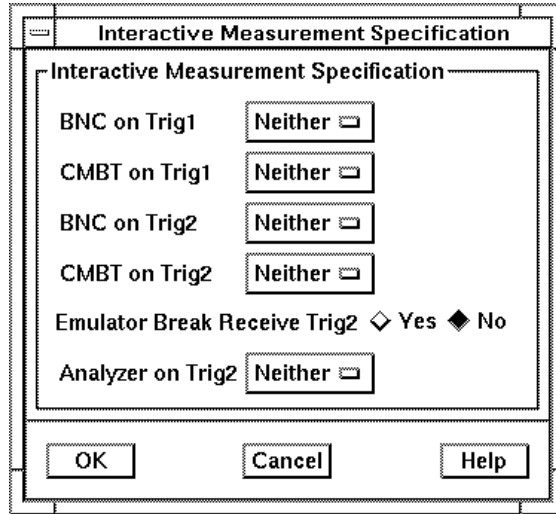

Refer to the Simulated I/O User's Guide for details on configuring and using simulated I/O.

To give proper answers to these questions, refer to Chapter 6, "Making coordinated measurements."

## Mapping Memory

This section of the chapter discusses the details of how to map memory for the emulator, its emulation monitor, and the target system. The Memory Map shown on this page is for an emulator using the background monitor. If you decide to use a foreground monitor, the first entry you will see in the Memory Map will be the 4-Kbyte address range reserved for the monitor.

By default, the emulator assumes all memory addresses are in RAM space in your target system. If you wish to load some of your target program in emulation memory, or identify some of your memory addresses as ROM or Guarded, enter those specifications in the memory map. The resolution of mapped ranges is 256 bytes; memory ranges begin at addresses ending in 00h; memory ranges end on addresses ending in FFh.

The Memory Map display on this page chooses **Map→Default Memory Type→Target RAM→Cache Inhibit OFF**. The emulator will treat all address space that is not specified within the Memory Map as memory hardware of the Default Memory Type you specify here. If memory characterized as Guarded is accessed, the emulator will break to its monitor.

To create a new map entry or modify an existing entry, choose **Map→Add New Entry**, or **Map→Modify Entry→<NO.>**. The appropriate Memory Map dialog box will open.

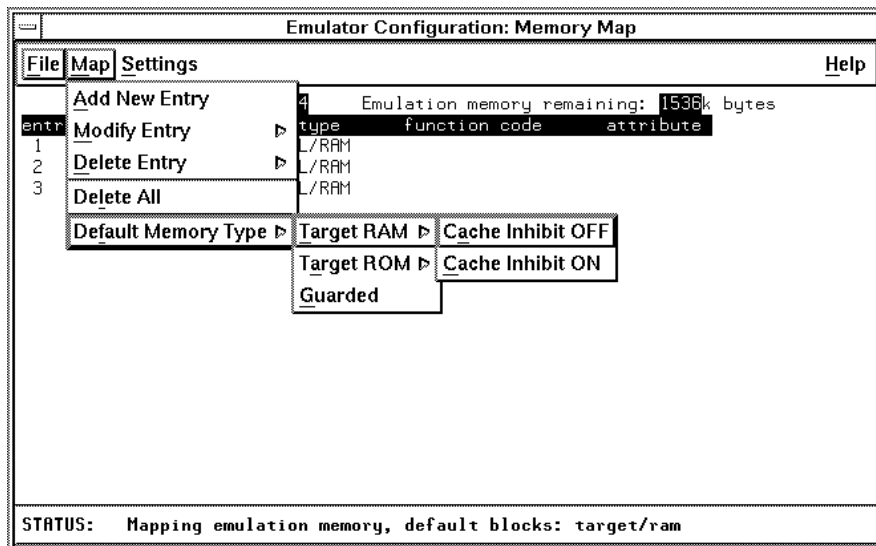

## Chapter 8: Configuring the Emulator

### Mapping Memory

To create a new map entry or modify an existing entry from the Memory Map popup menu, press and hold the *select* mouse button and choose **Add New Entry**, or **Modify Entry**. The appropriate Memory Map dialog box will open.

The memory map of the MC68020 emulator does not support cache inhibit within selected address ranges.

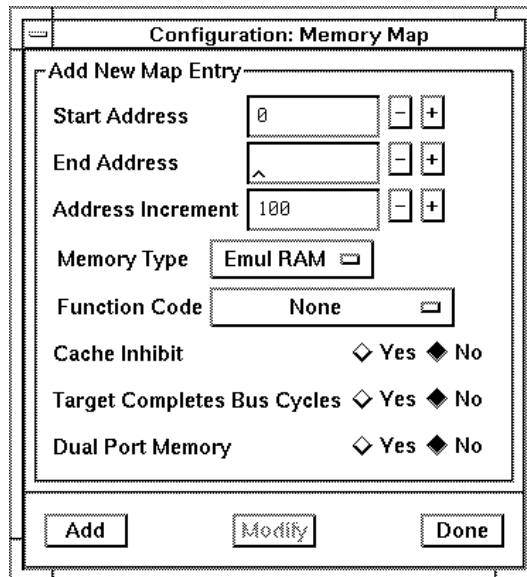
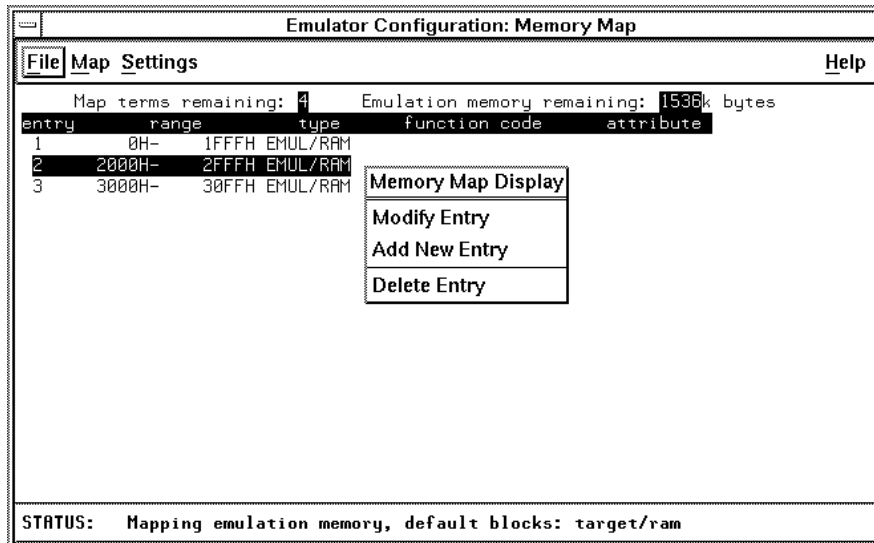



---

**Examples**

Mapping Example 1: Suppose you are using the emulator in-circuit, and there is a 12-byte I/O port at 1c000 hex in your target system. You have ROM in your target system from 0 through ffff hex. Also, you want to use the dual-port emulation memory at 20000 hex. You could use the Memory Map dialog box to create the following three map entries:

Start Address **1c000h**, End Address **1c0ffh**, Memory Type **Target RAM**  
Start Address **0h**, End Address **0ffffh**, Memory Type **Target ROM**  
Start Address **20000h**, End Address **20fffh**, Memory Type **Emul RAM**, Dual Port  
Memory = **Yes**

The background monitor is used; that is the only way to make the dual-port emulation memory available for your target program. When a foreground monitor is in use, it occupies the dual-port emulation memory, by default.

Mapping Example 2: This example shows the relationship between memory ranges and memory block sizes. Suppose you have installed 256-Kbyte SRAM memory modules in Memory slots 0 and 1 (called BANK 0 and BANK 1) on the emulation probe. This makes four 64-Kbyte blocks and two 128-Kbyte blocks available to the memory mapper. Then you enter the following map commands:

Start Address **0h**, End Address **7fffh**, Memory Type **Emul RAM**  
Start Address **20000h**, End Address **3f000h**, Memory Type **Emul RAM**  
Start Address **40000h**, End Address **4ffffh**, Memory Type **Emul RAM**  
Start Address **50000h**, End Address **500ffh**, Memory Type **Emul RAM**  
**Map→Default Memory Type→Target RAM→Cache Inhibit ON**

If you have not used the dual-port emulation RAM, the first map term that is small enough to fit is assigned to that memory. In this example, that is the last term you defined (the range from 50000..500ff). The entire 4-Kbyte block is reserved though you specified only a 256-byte range. Two 64-Kbyte blocks and one 128-Kbyte block are used from the SRAM emulation memory on the probe, leaving two 64-Kbyte blocks and one 128-Kbyte block. One of the 64-Kbyte blocks is used for the first map term, but 32 Kbytes of that block are unused and unavailable. The third term uses the other 64-Kbyte block. The second term uses part of the 128-Kbyte block, leaving the rest unavailable.

Mapper resolution is independent of block allocation. In the above example, if you had **default guarded** and your program accessed 8000h, the emulator would do a guarded memory break.

## Providing MMU Address Translation for the MC68030 Foreground Monitor

When using the memory management unit (MMU) of the MC68030, the target system must provide the proper address translation for the foreground monitor. To be able to do this, you will need to understand your target system's physical memory map and MMU address translation structure. You may need to modify your mapping scheme or some of its mapping protections.

In order for the monitor to operate after the MMU is turned on, the target system must provide 1:1 address translation (logical address = physical address) for the block of memory occupied by the monitor. The foreground monitor will reside in a 4-Kbyte block of emulation memory corresponding to a single page or series of consecutive pages in the MMU. This memory can be mapped to begin on any 4-Kbyte address boundary. Simply specify an address ending in 000h when you answer the monitor address question when you set up the emulation configuration.

For example, if the monitor is located at logical address 0fff1000h, then the MMU must translate that address to physical address 0fff1000h, logical address 0fff1004h to physical address 0fff1004h, etc.

Do not write-protect the address range occupied by the foreground monitor.

There are two ways to provide proper address translation for the memory space occupied by the foreground monitor:

- Locate the foreground monitor in a block of memory that is transparently translated via TT0 or TT1, the transparent translation registers (TTRs). When the MMU processes translations, it first compares the logical address with the parameters of the TTRs. If it finds a match, the MMU uses the logical address as the physical address for the access (obtaining the needed 1:1 translation).

The minimum block size that can be transparently translated by a TTR is 16 Mbytes. If your target system already sets one or both TTRs for supervisor, or both supervisor and user, access and no write-protection, you may be able to find an unused 4-Kbyte block within this 16-Mbyte range where the monitor can reside.

If your target system does not use the TTRs, you may want to modify your MMU boot code to configure a TTR specifically for the monitor.

**Providing MMU Address Translation for the MC68030 Foreground Monitor**

---

**Example**

This example shows how to modify boot code to use a TTR. Assume your target system does not access any physical addresses in the 16-Mbyte range 02000000..02ffffffh, and TT0 is unused. By locating the monitor at address 02000000 and adding the following code fragment to your boot code, you should be able to break into the monitor while the MMU is turned on:

```
* configure TT0 for emulation monitor
MOVE.L  #$0200C000,D0
MOVEC   D0,TT0
```

Without these transparent translations for the monitor, the MMU will probably generate an access fault when you attempt to break into the monitor. The access fault would occur because addresses in the 02000000 range would have no valid translations (they would be on a non-resident page).

---

If you cannot modify your boot code, you may be able to use an execution breakpoint to break into the monitor before the MMU is enabled and use the monitor to configure the TTR. Do this only as a last resort because the MC68030 processor automatically disables both TTRs whenever an emulation or target reset occurs (and the TTRs must be reinitialized each time).

- The second way to provide proper address translation for the foreground monitor is to locate the monitor within a page that is controlled by the MMU address translation tables; one that is always resident, writeable, supervisor accessible, and translated 1:1. The monitor occupies one 4-Kbyte page (or series of consecutive smaller pages totaling 4 Kbytes) of emulation memory. It will be stored in the 4-Kbyte range of the dual-port memory.



## Locating the Foreground Monitor using the MMU Address Translation Tables

Locate the foreground monitor at a specific page address (or series of consecutive pages totaling 4 Kbytes and beginning on a 4-Kbyte address boundary) and add the proper address translation for this page in your supervisor address translation tables. The page (or pages) that contains the foreground monitor must always be resident, translated 1:1 (logical address = physical address), and never write-protected.

The most direct way to do this is to modify the address translation tables in your source code, rebuild your executable file, and download the executable into RAM, or reprogram the executable into ROM. For systems that use an operating system to manage dynamic translation tables in RAM, the page (or series of pages) allocated to the monitor must not be allowed to be swapped out by the operating system. This may require that the page (or pages) selected for the monitor reside in unused space within the operating system (assuming the operating system is translated 1:1). The easiest way to create unused space is to globally define an 8-Kbyte array of data that is never referenced by your software. After rebuilding your operating system software, refer to the linker symbol map file to determine the address range of this array. Use the lowest address that resides on a 4-Kbyte boundary within this range as the starting address for the monitor.

As a last resort, if your target system software cannot be rebuilt, you can use the emulator to modify your translation tables directly.

The emulator provides a command to display individual address translations in detail, including address, value, and mnemonic information about each descriptor from the translation tables. You may be able to provide the proper address translation for the monitor by simply modifying a single descriptor (long word) to convert an invalid page into a resident page.

If the translation tables are located in ROM, you will need to copy them into emulation memory before you attempt to modify them. This is done by storing all or part of your ROM to a file, and then mapping emulation memory over the ROM address range and reloading the file.

---

# 9



---

## Solving Problems

What to do when the emulator doesn't behave as expected

## Chapter 9: Solving Problems

Sometime during your use of the emulator, you'll encounter a problem that isn't adequately explained by an error message or obvious target system symptoms. This chapter explains how to solve some of these more complex problems.

Consider the following sources of information in addition to the specific problems discussed in this chapter:

- Look at the error log. Sometimes a problem will cause several error messages to be generated. Only the last error message will be shown on the status line. You can see the last 100 error messages by viewing the error log. Refer to Chapter 3, "Using the emulator/analyzer interface," for details of how to display the error log.
- Look at the event log. Changes in status of the emulator/analyzer may cause unexpected results. To see a list of the last 100 events that affected the status of the emulator/analyzer, view the event log. Refer to Chapter 3, "Using the emulator/analyzer interface," for details of how to display the event log.
- Look at the present status of the emulator/analyzer to see if it will suggest the cause of your problems. Refer to Chapter 3, "Using the emulator/analyzer interface," for details of how to display emulator/analyzer status.



### If the emulator appears to be malfunctioning

- Check to make sure that the cables connecting the Emulation Control Board to the Emulation Probe are connected correctly. Refer to Chapter 18, "Installation and Service," for details.
- Run the performance verification procedure as described in Chapter 18, "Installation and Service." If the emulator fails this test, contact your Hewlett-Packard representative.
- If the emulator passes the performance verification procedure, look for other reasons for the problem. Performance Verification is a thorough test, but it cannot find every hardware failure in the emulator. It is a good indication that the emulator is functioning correctly, but if you are still convinced that the emulator is malfunctioning, contact your local Hewlett-Packard representative.

---

### If the analyzer triggers on a program address when it should not

- Check to see if the analyzer is triggering on an instruction prefetch. The analyzer cannot distinguish between prefetch and execution because the processor does not provide that information. Usually your actual trigger address is within 16 words of the address where trigger is occurring.
- Try to pad the program code with NOP instructions to move the trigger address away from the other code so that it won't be prefetched until it is time to trigger.
- You may be able to insert a write instruction to a meaningless variable in your code immediately before the trigger address. Then you can trigger on a write to the address of the meaningless variable. Write transactions never appear in instruction prefetches.

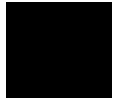

### If there are unexplained states in the trace list

- Check that the sequence, storage and trigger specifications are set up to exclude the states you don't need.
- Try using the **disassemble\_from\_line\_number** <LINE#> **align\_data\_from\_line** <STATE#> option to the **display trace** command to inform the dequeuer which operand state belongs with the first instruction state.
- Try using **display trace dequeuing on**.
- Try using the **disassemble\_from\_line\_number** <LINE#> **low\_word** option to the **display trace** command to begin disassembly from the low word of the starting state, instead of the high word.
- Check to see if instruction or operand accesses in the range covered by the trace could be filled from cache memory. If so, these cycles won't appear in the trace list, which will confuse the disassembler. Either disable the cache memory entirely or disable caching for those address ranges by adding the **ci** (cache inhibit) attribute to those ranges in the memory map. (Refer to Chapter 8, "Configuring the Emulator.")



---

### If you see negative time or negative states in the trace list

- If counter overflow occurs during a deep analyzer trace measurement, you may see a count of negative time or negative states in the trace list. This is a normal condition. It indicates that the counter value stored with the reference state was greater than the counter value stored with the present state. In absolute time counts, negative times will continue to be seen until a state is captured whose counter value is greater than the trigger state counter value. In relative time counts, negative time should only be seen beside the first state captured after the counter overflows.



## **If the analyzer won't trigger**

- Instruction fetches from cache memory aren't visible to the analyzer. You can disable the cache while using the analyzer by answering **no** to the configuration question "Enable the 68020 instruction cache?" (MC68020) or "Enable the 68030 instruction and data cache?" (MC68030/EC030). (Use the **modify configuration** command to access this configuration question.) Reenable the cache to improve performance when you're finished using the analyzer.
  
- The analyzer can be configured to trace background monitor execution, foreground monitor and target program execution, or both background and foreground operations. If you trace only background monitor execution, the analyzer will not see any foreground cycles and will not trigger the trace. (Use the **modify configuration** command to access this configuration question.)
  
- The MC68030/EC030 emulator only fetches instructions on long word boundaries (least significant hex digit of address is 0, 4, 8, or C). However, program labels can be aligned on word boundaries between long word boundaries. If you try to trace on a label located on a non-long-word boundary, the bus analyzer will never trigger because the address never appears on the address bus. To mask an address so that it is on a long word boundary, use the **long\_aligned** keyword with trace specifications.

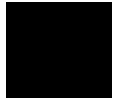

### If trace disassembly appears to be partially incorrect

- Check to see if the analyzer began disassembly of the trace on a long-word boundary but the instruction started on the low word within the long word. This will make disassembly incorrect. You can start disassembly on the low word within the long word by use of **display trace disassemble\_from\_line\_number <trace list line number> low\_word**.
- If the trace list seems correct for a few states after disassembly starts, and then it seems incorrect, restart disassembly of the trace at the low word where disassembly first becomes incorrect **display trace disassemble\_from\_line\_number <trace list line number> low\_word**.
- If an instruction seems to have incorrect data associated with it, you can read down the trace list to see if you can find correct data for the instruction on another line. You can cause the disassembler to realign the instruction with the correct data by entering a command like **display trace disassemble\_from\_line\_number <trace list line number> align\_data\_from\_line <trace list line containing data>**.



---

### If the emulator won't work in a target system

- Ensure that the probe is inserted into the target system in the correct manner—the pins should be lined up correctly.
- If you are using spacers to connect the emulator probe to the target system, make sure that the spacers are correctly connected.
- The emulator uses the clock from the target system. Unsupported or improperly configured clock speeds will affect emulator performance. (Use the **modify configuration** command to access this configuration question.)
- The emulator must recognize the target system's clock signal to function correctly. Power up the emulator and then apply power to the target system.

- Check to see that the signal timing specifications of your target system match the specifications in Chapter 16, "Specifications and Characteristics."

---

## If you suspect that the emulator is broken

- 1 Shut off power to the target system, then the Card Cage.
- 2 Disconnect the emulator from your target system.
- 3 Connect the emulator to the demo board. Also connect the power cable from the emulator to the demo board. (Refer to Chapter 18, "Installation and Service.")
- 4 Set all the demo board configuration switches to the TEST position (all switches closed—refer to Chapter 18, "Installation and Service").
- 5 Apply power to the Card Cage.
- 6 Run performance verification by entering the commands:

```
display pod_command  
pod_command "pv 1"
```

Note that the emulator/analyzer interface will report an I/O error since the **pv** command initializes the emulator. You will need to enter the **end release\_system** command to exit the emulator/analyzer interface.

If either the emulator or analyzer fail the performance verification, check the installation of those modules. Refer to Chapter 18, "Installation and Service," for information on installation and an explanation of the performance verification software. If the installation is correct, contact your local HP Sales and Service office for assistance.

## If you have trouble mapping memory

- The emulator uses a best fit algorithm to assign memory blocks to map requests. Because the memory block sizes available depend on the emulation memory module installations and the use of the dual-port memory, it's possible that a 256-byte map request may use 512 Kbytes. (The map term will be only 256 bytes.) Most systems won't have such differences between memory block size requirements and available memory. However, certain emulation memory module installations will aggravate the problem.
  
- Also, use of the dual-port memory is controlled first by monitor selection and next by explicit selection of a dual-port term in the map. If you choose a foreground monitor, the dual-port memory block is reserved for that purpose. If you choose a background monitor, and don't explicitly map a term with the **dp** attribute, the dual-port memory may be used to satisfy any map request. For example, if you request a 256-byte map term and this memory block is available, it will be used to satisfy the request since it is closest to the needed size. Or, if you request a term that is slightly larger than another available block, the dual-port memory will be used with another map term to satisfy the request. (For example, a 260 Kbyte request may use one 256-Kbyte block and the 4-Kbyte dual-port memory.)
  
- If dual-port memory is used with the emulation memory module to satisfy a map request, you may see unusual behavior in the trace list. The processor executes correctly, but you will notice a status change from 32 bit accesses (ds32) to 16 bit accesses (ds16) as the execution crosses the boundary from the emulation memory module to the dual-port memory. (You won't have this problem with the MC68030/EC030 emulator because the dual-port memory is 32 bits wide, but you may see a speed difference when accessing the dual-port memory.) To fix this, map the dual-port memory explicitly to another unused range (use the dp attribute). Then the request for a 260-Kbyte block will use memory from the emulation memory modules only.

See the section "Memory Mapping" in Chapter 8, "Configuring the Emulator," for more information on memory allocation.

## If you see multiple guarded memory accesses

- Check the stack pointer value. If it points to guarded memory, you will see multiple guarded memory accesses each time that you press the <Enter> key (to get a new prompt). Reset the emulator and set the stack pointer to a correct value.

---

## If the demo program won't work

- Do you have the emulator plugged into the demo board, with power connected to the demo board from the emulator? (The demo program will not work with other target systems.)
- Are the switches on the demo board set to the OCE position (Out-of-Circuit Emulation, away from TEST)?
- Did you change to the demo directory?

(/usr/hp64000/demo/debug\_env/hp64748 for the MC68020;  
/usr/hp64000/demo/debug\_env/hp64747 for the MC68030/EC030)

- Did you start the demo program with the proper command?

**Startemul** <logical name>  
**Startall** <logical name>

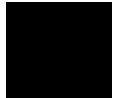

### If you're having problems with DMA

- Check to make sure that your DMA process doesn't access memory ranges mapped to **emulation ram** or **emulation rom**. DMA to emulation memory is not supported.

---

### If you're having problems with emulation reset

- Check to make sure that your system uses an open-collector driver to drive the processor **RESET** line (this also applies to **HALT** on the MC68020 processor). This line is bidirectional; the processor must be able to pull the line low.
- Check to make sure that all critical components in your system are reset by the **RESET** signal to the processor. System startup problems can arise when this rule is violated. Suppose that your target system reset circuit drives several critical system components directly, but drives the processor through an open-collector buffer. Suppose also that the critical components are memory-mapping circuits that locate ROM containing the vector table at address zero for startup, then move it to a high address range after system initialization. An emulator reset system can't drive this separate target reset line. Therefore, a run after emulation reset will fail, because the vector table is not located in the correct place. Use the target reset to reinitialize memory or use a **run** command instead of a **run from reset** command.

## If the deMMUer runs out of resources during the loading process

- Check the physical address ranges that will be reverse translated by the present setup of the deMMUer. Enter **load demmuer verbose** to see a list of those physical address ranges. If all of the physical spaces where you have code under development are listed, ignore the "out of resources" message.
- Check to ensure that you have placed sufficient restrictions in the MMU mapping paths to prevent reverse translating physical address space where you have no memory.
- Check your emulation memory map to make sure you have entries to support each of the address spaces where you have code under development. Make sure those spaces are no larger than they need to be to accommodate your program code.
- Check if you are using both root pointers in your memory mapping scheme. The deMMUer may have run out of resources for only one of the root pointers.
- Check if you are using function-code mapping. The deMMUer may have run out of resources for only one of the function-code memory spaces.
- Read "Using the deMMUer" in Chapter 10, "Using 68030 Memory Management," for ways to make more efficient use of deMMUer resources.

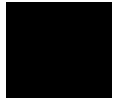

### If verbose mode shows less than eight mappings but the deMMUer is "out of resources"

- Check if you are using both root pointers in your memory mapping scheme? The deMMUer may have run out of resources for only one of the root pointers.
- Check if you are using function-code mapping. The deMMUer may have run out of resources for only one of the function-code memory spaces.
- Read "Using the deMMUer" in Chapter 10, "Using 68030 Memory Management" to understand how deMMUer resources are allocated when using different root pointers or when using function-code mappings.

---

### If you only see physical memory addresses in the analyzer measurement results

- Check to see if you enabled the deMMUer with the command: **set demmuer on**.
- Check to see if you loaded the deMMUer with the information needed to reverse translations made by the MMU with the command: **load demmuer verbose**.
- Read "Using the deMMUer" in Chapter 10, "Using 68030 Memory Management" to understand how the deMMUer selects physical address ranges to reverse translate for the analyzer.



## If the deMMUer is loaded but you still get physical addresses for some of your address space

- Some physical accesses are normal, especially accesses to the MMU tables and cpu space.
- Check to see which physical memory spaces are being reverse translated by the deMMUer. Enter the **load demmuer verbose** command to see a list of the physical address spaces that will be deMMUed.
- Check the setup of the MMU mapping tables. Make sure that unused address spaces are marked with invalid descriptors in the mapping tables.
- Check the emulation memory map. Make sure you have allocated only the memory spaces needed to accommodate code you are developing in your map. Make sure you have mapped the smallest spaces that you can for the code you are developing.
- Check that the MMU had the setup you wanted to analyze when you loaded the deMMUer. If it was managing memory for some other MMU setup, break to the monitor and issue the **load demmuer** command again.
- Check to see if there was a context change in the MMU during execution of your program. If there was, the content of the root pointer may have changed for execution of the new context. The deMMUer tables were set up to reverse translate the MMU tables under the root pointer values that existed when you entered the **load demmuer** command. If those root pointer values change (pointing to other translation tables), there is no way to automatically update the deMMUer. It will continue to provide reverse translations for the setup that existed at the time you issued the **load demmuer** command. Issue the **load demmuer** command again.

Read "Using the deMMUer" in Chapter 10, "Using 68030 Memory Management" to understand how the deMMUer selects the physical addresses it will translate.

### If you can't break into the monitor after you enable the MC68030 MMU

- Enter the commands: **reset**, and then **break**. If your MC68030 is now running in the monitor, look at your MMU Tables or the transparent translation register that maintains 1:1 mapping for your foreground monitor. The mapping has failed. Modify your MMU tables or the transparent translation register to obtain the 1:1 mapping for the address space occupied by the foreground monitor.
- If you are mapping a page size that is smaller than 4 Kbytes, make sure that you have provided 1:1 address mappings for all of the pages that contain monitor code.
- Refer to the end of Chapter 10, "Using 68030 Memory Management" for a detailed example that discusses how to solve a "can't break into monitor" problem.



---

## Part 3

---

Reference

---

## Reference

### In This Part

This part provides detailed information on aspects of using the Graphical User Interface and the Softkey Interface for the HP 64747 and 64748 products.

---

# 10



---

## Using MC68030 Memory Management

Understanding logical and physical emulation and analysis

## **Understanding Emulation and Analysis Of The MC68030 Memory Management Unit**

You only need to read this chapter if you are using the on-chip MMU (Memory Management Unit) of the MC68030 microprocessor. If you are using an MC68020 or MC68EC030, or if you are using an MC68030 with its MMU disabled, you won't need the information in this chapter.

This chapter begins with a discussion of terms and conditions you need to understand when you are using the MC68030 emulator/analyzer with the MMU enabled. Under these conditions, many capabilities and features become available that are not otherwise offered. Also, some of the features you have been using behave differently. These are discussed in this chapter.

---

### **Terms And Conditions You Need To Understand**

The following paragraphs explain the differences between logical and physical memory, and between static and dynamic virtual memory systems.

#### **Logical vs Physical**

When you develop a program, compile it or assemble it, and link it, addresses are assigned to contain each of the bytes of the program. These addresses are logical addresses. When the program is loaded into hardware memory so that it can be executed by the microprocessor, it is loaded into physical address space. When you are not using an MMU, the program is loaded into physical memory hardware at the logical addresses assigned in the linker load map. Under these conditions, there is no need to differentiate between logical addresses and physical addresses because they are the same (simply addresses). When you use the MMU, it becomes necessary to understand the difference between logical addresses and physical addresses.

Most emulation and analysis commands that require an address as part of the command use logical addresses. Some emulation and analysis commands will accept either logical or physical addresses.

### **What are logical addresses?**

Logical addresses are the addresses that are assigned to your program code when you develop your program. They are the addresses represented by symbols in your symbols data base (the symbol "Main" represents a logical address).

### **What are physical addresses?**

Physical addresses are the addresses assigned by the MMU to contain your program. Physical addresses identify locations where you actually have memory hardware in your target system. Physical addresses appear on the processor address bus instead of logical addresses.

---

## **Static and dynamic system architectures**

There are several design strategies where memory management can help in developing a system or product. Three of these are described in the following paragraphs. One shows memory management used in a static memory system. The other two show memory management used in different dynamic memory systems. The MC68030 emulator is designed to work in any of these system types; however, the deMMUer which provides reverse translations to the analyzer is primarily intended for use in static systems.

### **Static system example**

A static system design may use the MMU simply to protect supervisor code and I/O space against accesses from a user program. Once a static system is initialized, it never changes. Your HP emulator and analyzer can give you complete support for a static memory management system. After the MMU has been set up to manage memory in a static system, the deMMUer can be loaded with information to reverse the MMU translations over the entire range managed by the MMU.

### **Non-paged dynamic system example**

Assume three programmers are developing separate programs to run in a real-time operating system environment. The programmers each write their programs to begin at address 0h. The operating system accepts the responsibility to know where

## Understanding Emulation and Analysis Of The MC68030 Memory Management Unit

in physical memory space each of these programs will be located. The programmers don't have to worry that some additional code they write in their programs might overwrite some of the code that was written by another programmer. The operating system will place all of the code in available memory space and place appropriate translation mappings in the MMU to ensure that when the logical address for one of the programs (tasks) is present in the program counter, the appropriate physical address will appear on the bus to access the desired physical memory location.

Your HP emulator/analyzer can give you partial support for a non-paged, dynamic system. When the MMU has been set up to manage memory during execution of one of the above tasks, you can update the deMMUer to translate addresses for that task. When that task is executing, the analyzer will be able to make trace measurements and provide correct results. When any of the other tasks are executing, trace measurement results will be invalid because the other tasks will depend on different translation tables in the MMU and there is no way to automatically update the deMMUer when execution switches from one task to another.

### Paged dynamic system example

Assume you have developed a program that occupies 10 megabytes of logical address space. Perhaps you have only 2 megabytes of physical address space in your system. Still, you want to be able to run the entire program. You set up a specification in the MMU translation control register to divide the address space into pages (the 68030 lets you divide the memory space into one of several page sizes. You can choose to divide the memory into pages as small as 256 bytes or as large as 32 Kbytes). Assume you set up the MMU to divide the memory into 1-Kbyte pages. Your program will occupy 10,000 pages of code, and 2,000 of these pages can be contained within your physical memory space at any given time.

As your program executes, the operating system moves pages of your program code into address space in physical memory. When execution goes beyond the addresses contained on the presently active page, the MMU checks to see if the next logical address is on a page that has already been placed in physical memory. If it is, the MMU performs the appropriate translation for the next logical address, placing the appropriate physical address on the bus, and execution continues. If it is not, the operating system moves the page that has the next address to be executed up from an external storage device to physical memory space, overwriting one of the pages that had occupied physical space before. The operating system updates the translation tables to identify the new logical address space that now occupies that 1 Kbyte of physical memory, and program execution continues.



Chapter 10: Using MC68030 Memory Management  
**Understanding Emulation and Analysis Of The MC68030 Memory Management Unit**

As pages are swapped back and forth between an external storage device and the physical memory, the relationship between any one logical address and its corresponding physical address may change many times.

Your HP emulator will let you run a paged, dynamic system, but the analyzer will not be able to provide support for such features as symbolic addresses, or display of corresponding source files. The deMMUer cannot detect changes in the MMU mappings. The longer the system runs, the further out of date the deMMUer will become. Of course, the analyzer will still be able to show activity captured at physical addresses. By experimenting with several starting points for the inverse assembler, you can obtain a trace list with activity inverse assembled into an equivalent assembly language listing (**display trace disassemble\_from\_line\_number <NO.> [low\_word]**).

---

## Where Is The MMU?

The MMU is located between the CPU core and the external address bus. The program counter always contains logical address values. When the MMU is turned off, the program counter value is placed directly on the address bus to access an address in physical memory. When the MMU is turned on, the MMU accepts the logical address value and translates it (by using its translation tables) to a physical address. The physical address from the MMU is placed on the processor address bus.



## Using Function Codes

The MMU lets you use function codes as the first level within the translation tables that map memory. It also allows separate tables to be set up for supervisor and user access. For example, you can create one set of tables to translate addresses in supervisor space and another set of mapping tables to translate addresses in user space. The supervisor space can use the SRP (supervisor root pointer) or the CRP (CPU root pointer), as you choose. The user space must use the CRP. The supervisor memory can begin at supervisor address 0 and the user memory can begin at user address 0. The MMU must ensure that these addresses are placed in different physical spaces.

You can use the MMU to protect your program space from unauthorized accesses. If you map a portion of your program through the MMU and identify it as supervisor space, the MMU will not allow any access to that program space unless the function code is supervisor at the time the access is attempted. Take care to ensure that function codes are specified with addresses if the MMU will be making the distinction (example: <address> **supervisor emulation rom**).

---

## How the MMU is enabled

The MMU depends on a hardware enable and a software enable. Both of these enables must agree to enable the MMU before it can translate logical addresses to physical addresses. If either one (or both) of these enables fail to enable the MMU, it will remain disabled.

### Hardware enable

The hardware enable is performed by the  $\overline{\text{MMUDIS}}$  signal. When  $\overline{\text{MMUDIS}}$  is asserted, the MMU is disabled. When  $\overline{\text{MMUDIS}}$  is negated, the MMU is enabled to translate addresses. The emulator controls the  $\overline{\text{MMUDIS}}$  line according to the way you set the "Enable Memory Management Unit" configuration item.

If you enter **no**, the  $\overline{\text{MMUDIS}}$  line is held asserted. If you enter **yes**, the  $\overline{\text{MMUDIS}}$  line is directly controlled by the target system. In this condition, your target system can hold the line high or low to enable or disable the MMU.

### Software enable

The software enable is performed when the operating system loads a value into the translation control register (TC). If the enable bit of the TC register value is "e=1" and the value in the TC register is valid, the MMU will be enabled. If the enable bit in the TC register is "e=0", or if the value loaded into the TC register is invalid, the MMU will be disabled.

---

### Restrictions when using the MC68030 emulator with the MMU turned on

There are only three restrictions: you must use a foreground monitor, it must not be write protected, and you must map it to address space that the MMU translates 1:1 (logical=physical).

You must use a foreground monitor. The background monitor does not have the capabilities to support the MMU functions. The foreground monitor can operate with the MMU turned on.

You must map the monitor code to address space that the MMU translates 1:1. The emulator executes monitor code to implement many of its emulation features. The emulator must be able to find the monitor code whether the MMU is turned on or off. By mapping the monitor into address space that has a 1:1 translation, the monitor stays within known address space at all times, and the emulator can always find it when it needs to use it. This mapping is described at the end of Chapter 8, "Configuring the Emulator."

Be sure that no write protection exists in the MMU mapping for the monitor.

---

#### Caution

Make sure your translation tables are valid. Turning on the MMU can cause your program or emulator to fail if the MMU tables are not set up correctly. The address space where the program is executing can change when the MMU is turned on or turned off. Stack space or other data spaces can move. Breakpoints that have been set can be lost.

---

## How the MMU affects the way you compose your emulation commands

When you display registers, the address registers, stack pointers, and program counter always contain logical addresses, even when the MMU is turned on.

If you place an address in the entry buffer and choose **Execution**→**Run**→**from()**, or enter a **run from <address>** command, the address you enter must be a logical address. The program counter will accept it and supply it to the MMU for translation before it places the address on the processor bus.

Breakpoint addresses are always logical addresses. When you set a breakpoint at an address, that address is translated by the MMU and the BKPT #7 replaces the instruction at the appropriate physical address. When the breakpoint is executed, the emulator restores the original instruction to the physical address, by first translating the logical address through the MMU.

Consider what happens if you set a breakpoint at a particular address, and before the breakpoint is hit, you update the translation tables in the MMU, changing the mapping to the location where the breakpoint is set? This is discussed in detail under "Solving Problems" at the end of this chapter.

If you enter a command to display memory or modify memory, your command is directed to logical address space. If you want to display memory at a physical address, you have to change your command. For example, the command to display memory at address 100H (**Display**→**Memory**→**Hex()**, or **display memory 100h**) will show you the memory content at logical address 100H (which might be some other physical address). If you want to see the content at physical memory address 100H, you will have to enter the command **display memory physical 100h**.

Addresses expressed using symbols are always logical addresses. In the case of symbols, the emulator looks in the symbol data base and finds the logical address that corresponds to the symbol you used in your command, and it loads that logical address into the program counter.

If you attempt to modify a memory location that is write protected by the MMU, the access will fail. To avoid this, modify the MMU tables to remove write protection from the memory you want to modify.

## Seeing details of the MMU Translations

The following paragraphs discuss emulator displays that help you understand translations made by your MMU. There are three displays, each giving a different level of detail of the MMU translations.

- The present address mappings in your MMU tables.
- The translation table entries for a single logical address.
- The contents of a single level of the translation tables pointed to by a selected logical address.

---

## How the emulator helps you see the details of the MMU mappings

To see all of the logical-to-physical translations presently mapped, choose **Display→MMU Translations** from the pulldown menu, or enter the command **display mmu\_translations**. The emulator will read the present state of the translation tables and show all of the valid mappings in those tables. The display will be similar to the following:

MMU Mappings

| FUNCTION<br>CODE | LOGICAL ADDRESS |          | PHYSICAL ADDRESS |          |
|------------------|-----------------|----------|------------------|----------|
|                  | Lower           | Upper    | Lower            | Upper    |
| user data        | 0               | 7FFF     | 00000000         | 00007FFF |
|                  | 8000            | 1FFFF    | 00028000         | 0003FFFF |
|                  | 7FFF8000        | 7FFFFFFF | 00008000         | 0000FFFF |
|                  | FFFE8000        | FFFFFFF  | 00010000         | 00027FFF |
| user prog        | 0               | 7FFF     | 00000000         | 00007FFF |
|                  | 8000            | 1FFFF    | 00028000         | 0003FFFF |
|                  | 7FFF8000        | 7FFFFFFF | 00008000         | 0000FFFF |
|                  | FFFE8000        | FFFFFFF  | 00010000         | 00027FFF |
| supr data        | 0               | 7FFF     | 00000000         | 00007FFF |
|                  | 8000            | 1FFFF    | 00028000         | 0003FFFF |
|                  | 7FFF8000        | 7FFFFFFF | 00008000         | 0000FFFF |
|                  | FFFE8000        | FFFFFFF  | 00010000         | 00027FFF |
| supr prog        | 0               | 7FFF     | 00000000         | 00007FFF |
|                  | 8000            | 1FFFF    | 00028000         | 0003FFFF |
|                  | 7FFF8000        | 7FFFFFFF | 00008000         | 0000FFFF |
|                  | FFFE8000        | FFFFFFF  | 00010000         | 00027FFF |

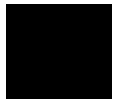

## Chapter 10: Using MC68030 Memory Management

### Seeing details of the MMU Translations

The above listing shows function codes were included in the mapping scheme. If function codes had not been included, the function code headings would not be present, and only a single list of logical-to-physical address mappings would be shown.

Note that the emulator enters the monitor to obtain the information it shows in the MMU displays. Execution of your target program is suspended while the emulator gathers information for an MMU display. If there are portions of your target program that should not be interrupted during execution, insert an execution breakpoint in some safe area of your program code and run until the breakpoint is executed. Then you can safely view the MMU mappings.

The display you get with the **Display→MMU Translations** or **display mmu\_translations** command can show as little as one line per page (or group of adjacent pages) of mapped logical address space. Contiguous entries are shown on one line to make the display more readable. Early terminations (which result in contiguous translation of multiple pages) will also be shown on a single display line.

The display of MMU mappings will only show pages for which the system has valid mappings. No information is given in the default **mmu\_translations** display for paths designated invalid, or for paths containing illegal entries.

If your system uses a small page size and has a large physical memory, the **Display→MMU Translations** command may cause your display to scroll through a long list of mappings. To avoid a list of mappings that scrolls for a long time, include an address or address range in your command. By choosing **Display→MMU Translations...** and entering a limited address range in the dialog box, or using the command **display mmu\_translations 0 thru 0ffffh**, for example, the emulator will show the valid mappings for only the logical addresses in the range you specify, instead of all possible mappings.

Another way to limit the number of address ranges shown in an MMU mappings display is to include a function code in your command (if function-code mapping is in use). By choosing **Display→MMU Translations...**, entering Start Address 0 and End Address 0ffffh, and clicking on the desired function code in the dialog box, or using the command **display mmu\_translations fcode u 0 thru 0ffffh**, the display will show all only the mappings for addresses 0 through 0ffff in user address space.

Note: For convenience, **display mmu\_translations** will use the logical address range from the most recent **display mmu\_translations <ADDRESS> thru <ADDRESS>** command, if possible. To change the default logical address range back to the full address space, use the command: **display mmu\_translations 0**

thru 0ffffffh, or obtain the **Display→MMU Translations...** dialog box and enter the desired address.

The display does not take into account overrides caused by the transparent translation registers. A status message will indicate that a transparent translation overlapped a mapping. Choose **Display→Registers** or use the **display registers** command to determine the transparent translation.

---

## Supervisor/user address mappings

If you are using separate supervisor and user mappings, the emulator will support this choice and show appropriate information. The MMU has two ways of doing this:

- (1). Using SRP and CRP root pointers. When using the SRP and CPU root pointers to provide separate user and supervisor translation mappings, no distinction is made between program and data space.
  - To see only the mappings under the SRP, choose **Display→MMU Translations...** and in the dialog box obtain function code s and enter the desired address range, or use the command: **display mmu\_translations fcode s [<address>[thru <address>]]**. This tells the emulator to show the supervisor mapping for the associated logical address or address range.
  - To see only the mappings under the CRP, choose **Display→MMU Translations...** and in the dialog box obtain function code u and enter the desired address range, or use the command: **display mmu\_translations fcode u [<address>[thru <address>]]**.
  - If you specify no function code, then mappings will be shown for both root pointers.
- (2). Use function code lookup table level. The emulator supports four separate sets of translation tables, each under a different function code value, as follows: user data, user program, supervisor data, and supervisor program).
  - To see only the mappings under a selected function code, choose **Display→MMU Translations...** and in the dialog box click on the Function Code button to obtain the desired function code, or use a command like: **display mmu\_translations fcode ud [<address> [thru <address>]]**

Chapter 10: Using MC68030 Memory Management  
**Seeing details of the MMU Translations**

where: **ud** displays mappings under user data.  
**up** displays mappings under user program.  
**sd** displays mappings under supervisor data.  
**sp** displays mappings under supervisor program.

- The default suffix is **sp** (supervisor program) when an address is specified in **Display→MMU Translations...** or your **display mmu\_translations** command.

### Translation details for a single logical address

To see translation details for a logical address, choose **Display→MMU Translations...** and click on MMU Tables in the dialog box, or enter a command such as: **display mmu\_translations tables <address>**. The **tables** option tells the emulator to show the translation details for the specified address. The display will show the way the logical address is mapped through the tables to reach its corresponding physical address.

MMU Tables

```

Logical Address (hex)   supr prog   0   0   0   0   4   0   F   8
Logical Address (bin)         110   0000 0000 0000 0000 0100 0000 1111 1000
Table Level             FCODE   IIII IIII IIII IABB CDDD PPPP PPPP PPPP
LEVEL INDEX LOCATION   CONTENTS   TBL/PAGE L/U LIMIT S CI M U WP DT
SRP                    80000003 00001050 00001050
FC 0006 00001080 8000000b 000010a0 000010a0 L 0000 0 1 0 LONG
A 0000 000010a0 8000000a 000010b0 000010b0 L 0000 0 1 0 SHORT
B 0000 000010b0 000010da 000010d0 000010d0 1 0 SHORT
C 0000 000010d0 0000114a 00001140 00001140 1 0 SHORT
D 0004 00001150 0000c001 0000c000 0000c000 0 1 0 0 PAGE
Physical Address (hex) = 0000c0f8

```

### Address mapping details

The example display shows:

- The translation mapping for logical address 40f8H in supervisor program space. Both the hexadecimal and binary values of the logical address are shown.
- The Table Level line shows how each address bit is mapped by the translation control register. In the example display, the 13 high-order bits are ignored by



## Chapter 10: Using MC68030 Memory Management Seeing details of the MMU Translations

the initial-shift. The next bit is used as an offset into Table A. The next two bits offset into Table B, etc. The lowest-order 12 bits contain the offset into the physical page indicated by Table D.

- The SRP (supervisor root pointer) is used by this address mapping. Its contents point to the function code table whose base address is 1050.
- The index used in the function code table is 6 (supervisor program space) which points to physical address 1080. The content of this address is 10a0, indicating a long A level table located at base address 10a0. The status also indicates that this table has been used "U".
- The function code table points to Table A whose base address is 10a0. The index into Table A is 0. The content of Table A at the indexed location is 10b0. This indicates the base address of Table B. There are also a number of status flags indicated.
- The physical address of the page indicated by Table D is finally calculated by adding the physical page offset (f8) to the base address of the physical page ( $c000 + f8 = c0f8$ ).

### Status information

Status can be assigned to an address at any point in its mapping. To interpret status, you must OR the status information at each level of the mapping. For example: the "M" bit shows that the content of the page indicated by Table D has been modified (by a write or read-modify-write). This applies only to addresses in this page. A "1" might have been shown under the "S" status bit in the FC line. It would indicate that only supervisor accesses are allowed for this function code. This restriction would apply to all addresses of this function code, even though  $S=1$  only appeared at the upper level of the table.

The L/U and LIMIT status entries work together. For example, if Table A had eight bits assigned to it (shown in the Table Level line), then there could be as many as 256 entries in Table A, pointing to as many as 256 separate Table B's. You might have specified a limit of ten Table A entries even though many more could have been specified. This limit would be shown under LIMIT in the display. In the L/U column, L would be shown to indicate that ten is the lower limit of valid spaces in Table A. A message saying "Limit violation accessing Table A" would appear if you tried to offset into Table A at some location other than the ten locations that were allowed by the limit.

## Chapter 10: Using MC68030 Memory Management

### Seeing details of the MMU Translations

The DT (descriptor type) column may show:

- SHORT indicates this is a short format table descriptor.
- LONG indicates this is a long format table descriptor.
- PAGE indicates this is the base address of a page in physical memory.
- INVALID indicates an invalid path through the tables.
- EARLY indicates this is the base address of a page in physical memory before the table levels in use have been exhausted.

Note that the address shown in the example display was mapped to supervisor program space by the function code table. This is the default mapping when function codes are used in the mapping scheme. If you wanted to see the mapping through the tables under the user function code for address 30f8h, you would choose **Display→MMU Translations...** and in the dialog box, click on MMU Tables, and Function Code u, and enter Address 30f8h, or enter the command **display mmu\_translations tables fcode u 30f8h**. You can add the desired function code table index to your command to see how any address is mapped through the tables under the selected function code.

---

### Table details for a selected logical address

The lowest level of detail you might like to see is the content of one of the tables used to map a particular logical address. You might choose **Display→MMU Translations...** and in the dialog box, click on MMU Tables, enter Address 40f8h, and click on Table Level to obtain B; or enter a command like: **display mmu\_translations tables 40F8h level B**. The emulator would show the details of Table B where it is used to map logical address 40F8. There might be a great many Table B's, but this command will only show the Table B that is used to map the logical address you specified in your command.

In the example display of table details:

- Table B has only four entries; only two bits in the logical address are used to index into Table B.
- The LOCATION column shows the physical address of each indexed location in Table B.

## Chapter 10: Using MC68030 Memory Management Seeing details of the MMU Translations

- The TBL/PAGE column shows the base addresses of Table C's indicated by each location in Table B. In other mapping schemes, the contents might have pointed to four base addresses of pages in physical memory.
- The first indexed location in Table B shows its associated Table C has been accessed ("U" bit equals "1").

### MMU Tables

|                       |       |          |          |          |      |       |      |      |      |   |    |       |
|-----------------------|-------|----------|----------|----------|------|-------|------|------|------|---|----|-------|
| Logical Address (hex) | supr  | prog     | 0        | 0        | 0    | 0     | 4    | 0    | F    | 8 |    |       |
| Logical Address (bin) | 110   | 0000     | 0000     | 0000     | 0000 | 0100  | 0000 | 1111 | 1000 |   |    |       |
| Table Level           | FCODE | IIII     | IIII     | IIII     | IABB | CDDD  | PPPP | PPPP | PPPP |   |    |       |
| LEVEL                 | INDEX | LOCATION | CONTENTS | TBL/PAGE | L/U  | LIMIT | S    | CI   | M    | U | WP | DT    |
| B                     | 0000  | 000010b0 | 000010da | 000010d0 |      |       |      |      |      | 1 | 0  | SHORT |
| B                     | 0001  | 000010b4 | 000010e3 | 000010e0 |      |       |      |      |      | 0 | 0  | LONG  |
| B                     | 0002  | 000010b8 | 000010f2 | 000010f0 |      |       |      |      |      | 0 | 0  | SHORT |
| B                     | 0003  | 000010bc | 00001102 | 00001100 |      |       |      |      |      | 0 | 0  | SHORT |

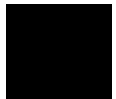

## Using the DeMMUer

The deMMUer circuitry reverses the translations made by the MMU (translates the physical addresses it finds on the processor buses back to their corresponding logical addresses) before sending the addresses to the analyzer.

---

### What part of the emulator needs a deMMUer?

Actually, the emulator doesn't need the deMMUer; the analyzer does. It can't provide its full symbolic features unless it has help from the deMMUer. The analyzer normally receives its address information directly from the processor address bus. It uses the symbols data base created for the program loaded in memory to cross reference the addresses it receives to the symbols and corresponding code in your source files. When the MMU is used, logical addresses are translated to physical addresses before they are placed on the processor address bus. Therefore, they no longer match the symbols data base.

### What would happen if the analyzer didn't get help from the deMMUer?

The analyzer would get its address information directly from the address bus of the emulation processor. It would have no way to know what translation had occurred in the MMU. Therefore, it could not trigger or qualify its trace on any symbol defined in the symbols data base. Further, its trace list could only show you the physical address value it found on the address bus; it would not be able to show any symbols associated with that physical address, or any corresponding source file lines. You would have to figure out for yourself what portion of your program address space was executing when that physical address appeared on the bus.

### How does the deMMUer serve the analyzer?

The analyzer does not get its information directly from the processor address bus when the deMMUer is turned on. Instead, the deMMUer accepts the physical address from the processor address bus, reverse-translates it to its logical address value, and supplies it to the analyzer. By having the logical address corresponding to the transactions on the processor address bus, the analyzer can accept trace

specifications expressed in source file symbols, show symbols in its trace lists, and show the regions of the source files that were executing when the bus activity occurred.

---

## Reverse translations are made in real time

The deMMUer performs its reverse translations without slowing down the measurement. For this reason, the analyzer that obtains its information from the deMMUer is able to provide its full feature set.

---

## DeMMUer options

- **Settings→DeMMUer→Enable** or **set demmuer off**. Your analyzer receives physical addresses if the MMU is enabled. The analyzer can only show hexadecimal values for those physical addresses. They may not correspond to the logical addresses of your program code. Note that until the MMU is enabled in hardware and software, addresses will be logical. Only after the MMU is enabled is there a distinction between physical and logical.
- **Settings→DeMMUer→Enable** or **set demmuer on**. Your analyzer receives logical addresses translated by the deMMUer according to the tables in place when you last loaded the deMMUer.
- **Settings→DeMMUer→Load From Memory** or **load demmuer**. The emulator reads the MMU registers and interprets the translation tables to load the deMMUer. The deMMUer is also enabled after it is loaded.
- **Settings→DeMMUer→Load from Memory...** This opens a dialog box in which you can specify values to override the present values in MMU registers when loading the DeMMUer.

## Chapter 10: Using MC68030 Memory Management Using the DeMMUer

- **Settings→DeMMUer→Load from File...** This opens a dialog box in which you can specify the name of a file of reverse translations. This file will be loaded directly into the DeMMUer instead of reading the present translation tables and MMU register values to create the reverse translations. Note that this file must have been previously created using the **File→Store→DeMMUer (From MMU Tables)** command from the pulldown menu. This file will have a ".ED" filename extension.
- **Settings→DeMMUer→Verbose.** This sets verbose mode for the deMMUer load function. In the pulldown menus, this is simply a switch. When "Verbose" is selected for loading the DeMMUer, a list is displayed of the physical address ranges that will be reverse-translated by the deMMUer. Addresses will be shown as <address>..<address>@s. This means <address> through <address> at supervisor address space.



## Restrictions when using the deMMUer

### Keep the deMMUer up to date

When you load the deMMUer, the emulator reads the present value of the TC, SRP, and CRP registers in the MMU, and the present translation tables, and calculates the address translations that can be performed (all possible physical-to-logical translations are determined during this process). Then the emulator loads the deMMUer to reverse those translations. After the deMMUer is loaded, any change to the MMU, its registers, or its translation tables will make the deMMUer out of date. The only way to update for changes in the translation setup is to load the deMMUer again.

### The target program is interrupted while the deMMUer is being loaded

The emulator uses the foreground monitor to load reverse translations into the deMMUer. Depending on the complexity of your tables, this process can take a long time. If there are portions of your target program that must not be interrupted for long periods of time, make sure your code is executing in safe regions before you load the deMMUer. You might set a breakpoint in a region of your target program that is outside the time-critical regions and perform the load of the deMMUer after the breakpoint is executed.

### The analyzer must be off

Your analyzer must not be making a trace when you load the deMMUer. Otherwise, part of the trace will be based on physical addresses and the other part will be based on logical addresses.

### Expect strange addresses if you analyze physical memory with multiple logical mappings

The deMMUer can only translate a physical address into one logical address. If two programs both use the same physical space (such as when two programs use a single data location), they might refer to that space by two different logical address values (and two different logical address symbols). The deMMUer translation RAM will be loaded with the highest logical address. This means that you might

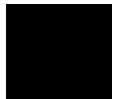

## Chapter 10: Using MC68030 Memory Management Using the DeMMUer

be analyzing execution of your program and find it accesses a data space at an address you don't recognize, even though the data may be what you expect to see. The unexpected address will be the logical address known to the other program that also uses this location.

The way the deMMUer selects a logical address for a physical address when two or more logical addresses are available is as follows:

- The deMMUer selects the logical address with the lowest address value.
- If one of the addresses is controlled by the MMU tables and one by a transparent translation register, the deMMUer sends the address defined in the MMU tables.
- If one of the logical addresses is within a range defined in the emulation configuration memory map and another is not, the logical address defined in the memory map is sent.





## Resource limitations

If you load the DeMMUer by using one of the **Settings→DeMMUer→Load From Memory/Memory...** or **load demmuer** commands and your emulator performs its task and returns a prompt to the command line, you won't need to know about the deMMUer resource limitations. When the deMMUer is loaded without any problems, the prompt simply shows on screen and you can proceed with your measurement. The following information will help you deal with problems when you try to load the deMMUer and receive a message such as "deMMUer out of resources". Note that when you see one error message, there may have been other messages generated at the same time. Display the error log to see all of the error messages that were generated. This will give you additional information about the error that caused the message to appear.

The deMMUer has a table where it records ranges of physical addresses that it can reverse translate to logical addresses. This table has eight entries, and each entry contains a single physical address range. Normally, entries in this table are allocated automatically, without intervention.

|                         |
|-------------------------|
| <b>address..address</b> |
| <b>address..address</b> |
| <b>address..address</b> |
| <b>address..address</b> |
| <b>address..address</b> |
| <b>address..address</b> |
| <b>address..address</b> |
| <b>address..address</b> |



### Small-page/large-page modes

The size of each address range in the table depends on the page size you selected in the TC register of the MMU. If you are using the small-page mode (smaller than 4 Kbytes per page), each address range in the deMMUer table will be 2 Mbytes; up to 16 Mbytes of physical addresses can be reverse translated. If you are using the large-page mode (4 Kbytes or more per page), each address range in the deMMUer table will be 32 Mbytes; up to 256 Mbytes of physical addresses can be reverse translated.

### Example to show resource limitations

Consider the following program arrangement:

|               |               |                       |               |               |               |
|---------------|---------------|-----------------------|---------------|---------------|---------------|
| <b>4M RAM</b> | <b>Unused</b> | <b>2M Peripherals</b> | <b>Unused</b> | <b>4M ROM</b> | <b>Unused</b> |
| 0             | 4M            | 12M                   | 14M           | 100M          | 104M          |

Assume a system contains memory and peripherals at three different ranges: one from 0 to 4 Mbytes, one from 12 to 14 Mbytes, and one from 100 to 104 Mbytes. The rest of the physical address space is unused.

If your MMU mapping tables are set up to only access memory in these ranges, your deMMUer will load properly and you can proceed with your measurements. If you have failed to restrict your mappings to these physical ranges, the deMMUer may not load completely.

When the emulator tries to load the deMMUer and finds there is more physical memory identified in the MMU mapping tables than it can translate in its deMMUer table, it will try to get help by reading the emulation memory map. If the emulation memory map is arranged as follows, the deMMUer will load in a way that ensures the physical ranges of interest will be in the deMMUer.

```
0 to 3FFFH EMUL/RAM
12000 to 13FFFH TARGET/RAM
100000 to 103FFFH TARGET/ROM
default guarded
```

When the emulator reads the memory map for help in loading the deMMUer, it sorts the entries by size first and address range second. If using the small-page mode, the smallest address range (12M to 14M) will occupy term 1 in the deMMUer translation table. Address range (0 to 4M) will occupy terms 2 and 3,

and address range (100M to 104M) will occupy terms 4 and 5. Terms 6, 7, and 8 will be assigned to any other physical ranges encountered in the tables. You may see an "out of resources" message because the deMMUer table might run out of space, but the program spaces you care about will all be reverse translated. You can use the **verbose** option of the deMMUer load command to make sure the program spaces you care about will be reverse translated.

If you had been using the large page mode, your entire program would have fit within two table entries.

---

## How to avoid the "out of resources" message

With the above example, you could have avoided the "out of resources" message. If you had placed invalid descriptors in your MMU tables in the paths that lead to unused physical address ranges, or if you had used limit fields in your table descriptors, the deMMUer would have had more than enough spaces in its eight-entry table to reverse translate the valid address ranges.

---

## Other ways to conserve space in the deMMUer table

### Minimize address ranges in the memory map

You can compose a memory map that allocates blocks of physical memory only large enough to accommodate the address space occupied by code you are trying to develop. The deMMUer algorithm will allocate spaces in its eight-entry table to reverse translate those physical address ranges.



## Careful use of the emulator memory map

What if you try to accommodate the example program (repeated here for your convenience) with the following memory map?

|               |               |                       |               |               |               |
|---------------|---------------|-----------------------|---------------|---------------|---------------|
| <b>4M RAM</b> | <b>Unused</b> | <b>2M Peripherals</b> | <b>Unused</b> | <b>4M ROM</b> | <b>Unused</b> |
| 0             | 4M            | 12M                   | 14M           | 100M          | 104M          |

0 to 3FFFH EMUL/RAM  
100000 to 103FFFH TARGET/ROM  
default target ram

Your memory map will work fine for the emulator. The 2M of peripheral address space will be in the space mapped to target ram and the emulator will handle it correctly. The map will not give much help to the deMMUer. The emulator will read the memory map and assign deMMUer terms to reverse translate, as follows:

- Terms 1 and 2 to reverse translate address range 0 to 4M.
- Terms 3 and 4 to reverse translate address range 100M to 104M.
- Terms 5, 6, 7, and 8 may be used to reverse translate address ranges 4M to 6M, 6M to 8M, 8M to 10M, and 10M to 12M.
- The "out of resources" message will be displayed and the peripherals address space will not be reverse translated.

You can get the reverse translations you need in the above example by adding one term to your emulation memory map: 12M to 14M TARGET/ROM. This small map entry will cause the emulator to reserve a term in the deMMUer table to reverse translate your peripherals address space. Without this entry, the deMMUer will run out of room for table entries before it gets to your peripherals address space.

Use the **verbose** option to the deMMUer load command to make sure all of the memory space you need to reverse translate is loaded into the deMMUer table.

## What the emulator does when it loads the deMMUer

When the emulator loads the deMMUer from memory, it does the following:

- Reads the MMU tables and provides spaces in the deMMUer table to reverse translate all of the valid addresses in the MMU tables.
- If there are more valid physical memory addresses than can be accommodated in the deMMUer table, the emulator reads the emulation memory map for help in selecting appropriate address ranges to reverse translate.
- Provides deMMUer table entries to reverse translate small address spaces defined in the emulation memory map before providing table entries to reverse translate larger address spaces.
- Allocates remaining resources to reverse translate addresses beginning with the lowest remaining address.
- If there are valid physical memory addresses remaining after all available spaces have been used in the deMMUer table, the emulator displays the "out of resources" message.



## Dividing the deMMUer table between user and supervisor memory space

### Using two root pointers

If you enable use of the supervisor root pointer (SRP), you will have two sets of MMU translation tables, one under each root pointer. The emulator divides the deMMUer table into two equal address spaces. The first four spaces provide reverse translations for user physical address ranges, and the last four spaces provide reverse translations for supervisor physical address ranges.

|                           |
|---------------------------|
| <b>address..address@u</b> |
| <b>address..address@u</b> |
| <b>address..address@u</b> |
| <b>address..address@u</b> |
| <b>address..address@s</b> |
| <b>address..address@s</b> |
| <b>address..address@s</b> |
| <b>address..address@s</b> |

If you have more physical supervisor address space than can be reverse translated by four table entries, you will receive the "out of range" message.

## Using function codes

If you enable use of function code addressing (FCL=1 in the TC register), the emulator assumes you have four sets of MMU translation tables, one under each of the following: user data, user program, supervisor data, and supervisor program. In this case, the emulator divides the deMMUer table into four blocks, with two entries for each of the supported function codes.

|                            |
|----------------------------|
| <b>address..address@ud</b> |
| <b>address..address@ud</b> |
| <b>address..address@up</b> |
| <b>address..address@up</b> |
| <b>address..address@sd</b> |
| <b>address..address@sd</b> |
| <b>address..address@sp</b> |
| <b>address..address@sp</b> |

If you have more physical address space than can be reverse translated by two entries under any one of the four function codes (for example three deMMUer table entries needed for user program space), you will see the "out of resources" message.

The deMMUer will not provide any reverse translations for MMU tables under any of the undefined function codes.

The emulator does not rigidly enforce the splitting of the resources into equal sizes for each function code. If the emulation memory map contains entries referring to specific function codes, they will take precedence, and may cause the deMMUer to contain only entries of that type.

## Solving Problems

Your program and emulator may be running fine until you turn on the MMU. Then program execution may fail. You may not be able to use features of your emulator. How can this happen? It can happen if the MMU mapping tables are incorrect. When the MMU turns on and starts managing memory by performing tablewalks in tables that are invalid, pages of logical memory may overwrite your stack space, your emulation monitor, or any other address space, making your entire system unusable. If this happens, note where the program is executing. The stack may be inaccessible. The monitor (with its emulation feature set) may be inaccessible. The vector table may be placed in guarded memory. Program data space may become inaccessible.

---

## Using the "display mmu\_translations" command to overcome plug-in problems

Plug-in problems involving the MMU are often caused by incorrect mappings in your translation tables. If your logical address is translated to an incorrect physical address, the **Display→MMU Translations** or **display mmu\_translations** command can show the details of how your logical addresses are mapped to the wrong physical addresses.

You can also enter the **Display→MMU Translations** or **display mmu\_translations** command to test your mappings before you enable the MMU. This command by itself reads all present translations in your MMU tables. No invalid or illegal paths are shown in the listing. You can read through the display on screen to see if all of your address ranges are represented, and if they are mapped to appropriate space in physical memory.

When you enter the **Display→MMU Translations** or **display mmu\_translations** command, the emulator reads the MMU registers (TC, CRP, and SRP) and MMU tables, even if the enable bit in the TC register is in the "disable" state. If you do not have correct values in the TC, CRP, and SRP registers, the emulator will let you specify correct values to be used when composing the display of translations. You can use the dialog box that is called by the **Display→MMU Translations...** selection and click on Override Processor Register Values and enter the desired



values for the TC, CRP, and/or SRP registers (or RECALL desired values from earlier usages). If you are using the command line, you can use the **use\_TC\_value**, **use\_CRP\_value**, and/or **use\_SRP\_value** options to the **display mmu\_translations** command to specify desired values for the registers in order to obtain the display of MMU translations.

---

## Use the analyzer with the deMMUer to find MMU mapping problems

If your system operates properly until you turn on the MMU, and then it fails, the problem is most likely in the mappings used by the MMU to translate logical addresses to physical addresses. You could go down the list of logical-to-physical translations to see the mapping scheme used to translate each logical address to its corresponding physical address, but normally that would take too much time. The analyzer can help you identify the one, or few, logical addresses that are being mapped incorrectly by the MMU. Then you can choose **Display→MMU Translations...**, click on MMU Tables in the dialog box, and enter the suspect addresses to see the mapping tables used to translate those addresses. On the command line, you can use the **display mmu\_translations tables <address>** command to look at the mapping tables used to translate the suspected addresses.

## Failure caused by access to guarded memory

If the problem is an access to guarded memory, remember that guarded memory is guarded physical memory. You need to find the logical address that the MMU improperly translated to guarded physical memory and then investigate the mappings the MMU used to perform the translation.

Begin by looking at the registers display (**Display→Registers→BASIC** or **display registers**) to see the value of the logical address in the program counter. Then choose **Display→MMU Translations...**, and use the dialog box, or use the **display mmu\_translations tables <address>** command to see the path through the tables that the MMU took when it translated that logical address to a guarded address in physical memory. Note that the value of the program counter may have changed after the guarded access occurred. In this case, the present address in the program counter may map to proper physical memory.

## Chapter 10: Using MC68030 Memory Management Solving Problems

If the present program counter address does not translate to an address in guarded physical memory, the access to guarded memory may have been caused when your program read or wrote to data memory before the present program counter address appeared. Set up the analyzer to make a trace (with the deMMUer turned on) and trigger at the logical program counter address (by placing the PC address in the entry buffer and choosing **Trace**→**About** ()), or using the command **trace about address <pc address>**). Selecting a center trigger lets you see activity preceding and following the trigger point. In order to capture every transaction on the emulation bus, qualify all states for capture (don't use the **trace only** option).

If the access occurs again just before the program counter address you used as your trigger specification, you should be able to read back in the trace list and find one or more addresses that could be causing the problem. Then you can try those suspected addresses in commands (choose **Display**→**MMU Translations...**, click on MMU Tables in the dialog box, and enter the suspect addresses, or on the command line, **display mmu\_translations tables <suspect\_address>**) to see how each of them is mapped through the MMU tables. This should identify the error in the MMU mapping tables.

If you find a particular address that is mapped to guarded memory, and if the problem seems to be in Table B (for example), you can look at the details of Table B for that address by clicking on Table Level B in the **Display MMU Translation...** dialog box, or using a command, such as **display mmu\_translations tables <address> level B**.

### Failure due to system halt

If the emulator and/or target system simply stops operating, set up the analyzer to trace with a trigger-never specification (**Trace**→**Until Stop** or **trace on\_halt**) so that the trace will run continuously until the system stops again. After the system halt occurs again, read the trace list to find the addresses preceding the system halt. Check suspected addresses by choosing **Display**→**MMU Translations...**, clicking on MMU Tables in the dialog box, and entering the suspect addresses, or on the command line, entering **display mmu\_translations tables <address>** commands to see how the MMU maps each one to physical memory.

## A "can't break into monitor" example

The following example assumes you mapped your foreground monitor beginning at address 4000H. You connected your emulator into your target system and ran your target program (which set up the MC68030 MMU). You tried to break into the emulation monitor and got the message, "Can't break into monitor."

The emulator can't break into the monitor because it can't find the monitor. The MMU mapped the foreground monitor to physical address space that is not a 1:1 translation from logical address space.

A variety of failure modes can happen at this point. Your emulation system may execute unknown code, or it may simply halt.

To analyze this problem, reset into the monitor by choosing **Execution**→**Reset** and then **Execution**→**Break**, or using command-line commands: **reset**, and then **break**.

The **reset** does not change the content of the MMU mapping tables or registers. It only disables the "enable bit" in the TC register of the MMU. Now you can look at the translations that are performed by the MMU to find the translation that was applied to your foreground monitor. Choose **Display**→**MMU Translations**, or enter the command: **display mmu\_translations**.

The display will show a list of the logical-to-physical address translations that will be performed when the MMU is enabled. Find the logical address range that contains your foreground monitor and see the physical address where it is mapped. The physical address range needs to be the same as the logical address range for the emulator to be able to find the monitor.

The display you get by choosing **Display**→**MMU Translations**, or entering the command: **display mmu\_translations**, might show the logical address range of your foreground monitor mapped to physical addresses beginning at C000H, as follows:

| LOGICAL ADDRESS |       | PHYSICAL ADDRESS |          |
|-----------------|-------|------------------|----------|
| Lower           | Upper | Lower            | Upper    |
| 4000            | 4FFF  | 0000C000         | 0000CFFF |

## Chapter 10: Using MC68030 Memory Management Solving Problems

The next step in this analysis is to display the MMU mapping table for the logical base address of the foreground monitor. You might choose **Display→MMU Translations...**, and in the dialog box, click on MMU Tables and type in Address 4000H, or you could enter the command: **display mmu\_translations tables 4000h**. In this example, you would see the following display of mappings:

```
Mmmu -t 4000
Logical Address (hex)      0 0 0 0 4 0 0 0
Logical Address (bin)    0000 0000 0000 0000 0100 0000 0000 0000
Table Level              AAAA AAAA BBBB BBBB CCCC PPPP PPPP PPPP

LEVEL INDEX LOCATION      CONTENTS          TBL/PAGE L/U LIMIT S CI M U WP DT
CRP
A    0000 00001020 00000003 00001020 00001020 U 0000          1 0 LONG
B    0000 00001030 0000000b 00001030 00001030 U 0000 0        1 0 LONG
C    0004 00001050 0007000a 00001040 00001040 U 0007 0        1 0 SHORT
                                0000c009          0000c000          0 0 1 0 PAGE

Physical Address (hex) = 0000c000
```

In the example display, the foreground monitor whose logical address is 4000h was placed in physical address C000h. Table C points to the page containing the foreground monitor. The base address of Table C is 00001040h, and the content used by logical address 4000h is at index 0004 whose physical address is 00001050h. The content of this address is 0000C000h (the address of the page containing the monitor).

To solve the problem in this example, you can obtain the needed 1:1 mapping by modifying the content of the MMU table directly with the following command-line command: **modify memory physical 00001050h to 00004009h**.

## Chapter 10: Using MC68030 Memory Management Solving Problems

After this modification, you can get a new display of the mapping tables for logical address 4000h to see if your modified MMU tables now map your foreground monitor correctly. Choose **Display→MMU Translations...**, and in the dialog box, click on MMU Tables and type in Address 4000H, or enter the command:  
**display mmu\_translations tables 4000h**

```

Logical Address (hex)      0 0 0 0 4 0 0 0
Logical Address (bin)    0000 0000 0000 0000 0100 0000 0000 0000
Table Level              AAAA AAAA BBBB BBBB CCCC PPPP PPPP PPPP

LEVEL INDEX LOCATION      CONTENTS          TBL/PAGE L/U LIMIT S CI M U WP DT
CRP
A   0000 00001020 00000003 00001020 00001020 U 0000
B   0000 00001030 0007000a 00001030 00001030 U 0000 0 1 0 LONG
C   0004 00001050 00004009 00001040 00001040 U 0007 0 1 0 SHORT
                                00004000                                0 0 1 0 PAGE

Physical Address (hex) = 00004000

```

Note that in the example shown here, the MMU page size was 4 Kbytes. Therefore, the monitor was contained on one page. If the page size had been smaller, the 4 Kbytes of the foreground monitor would have occupied two or more pages. You would have to modify the logical base address of each page that contained monitor code.

The above modifications will provide the proper mapping for your system until you rerun the portion of your target program that sets up the MMU. Then the same problem will occur again. To fix the problem permanently, you need to modify your target program so it provides a 1:1 mapping for the address space where the foreground monitor is located.

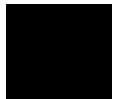



---

## **Emulator Commands**

The command syntax reference for the emulator softkey interface

## **Emulator/Analyzer Interface Commands**

This chapter describes the emulator/analyzer interface commands in alphabetical order. First, the syntax conventions are described and the commands are summarized.

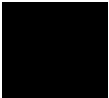



---

## How Pulldown Menus Map to the Command Line

---

| Pulldown                                    | Command Line                                |
|---|---|
| <b>File→Context→Directory</b>               | cd  |
| <b>File→Context→Symbols</b>                 | cws   |
| <b>File→Load→Emulator Config</b>            | load configuration                          |
| <b>File→Load→Executable</b>                 | load <abs_file>                             |
| <b>File→Load→Program Only</b>               | load <abs_file> nosymbols                   |
| <b>File→Load→Symbols Only</b>               | load symbols                                |
| <b>File→Load→Trace Data</b>                 | load trace                                  |
| <b>File→Load→Trace Spec</b>                 | load trace_spec                             |
| <b>File→Load→DeMMUer</b>                    | load demmuer <file>                         |
| <b>File→Store→Trace Data</b>                | store trace                                 |
| <b>File→Store→Trace Spec</b>                | store trace_spec                            |
| <b>File→Store→BBA Data</b>                  | bbaunload                                   |
| <b>File→Store→DeMMUer (From MMU Tables)</b> | store demmuer <file>                        |
| <b>File→Copy→Display</b>                    | copy display to                             |
| <b>File→Copy→Memory</b>                     | copy memory to                              |
| <b>File→Copy→Data Values</b>                | copy data to                                |
| <b>File→Copy→MMU Translations</b>           | copy mmu_translations to                    |
| <b>File→Copy→Trace</b>                      | copy trace to                               |
| <b>File→Copy→Registers</b>                  | copy registers to                           |
| <b>File→Copy→Breakpoints</b>                | copy software_breakpoints to                |
| <b>File→Copy→Status</b>                     | copy status to                              |
| <b>File→Copy→Global Symbols</b>             | copy global_symbols to                      |
| <b>File→Copy→Local Symbols ()</b>           | copy local_symbols_in --SYMB-- to           |
| <b>File→Copy→Pod Commands</b>               | copy pod_command to                         |
| <b>File→Copy→Error Log</b>                  | copy error_log to                           |
| <b>File→Copy→Event Log</b>                  | copy event_log to                           |
| <b>File→Log→Playback</b>                    | <command file>                              |
| <b>File→Log→Record</b>                      | log_commands to                             |
| <b>File→Log→Stop</b>                        | log_commands off                            |
| <b>File→Emul700→Emulator/Analyzer</b>       | N/A   |
| <b>File→Emul700→&lt;other products&gt;</b>  | N/A   |
| <b>File→Edit→File</b>                       | ! vi <file> ! no_prompt_before_exit         |
| <b>File→Edit→At () Location</b>             | ! vi +<line> <file> ! no_prompt_before_exit |
| <b>File→Edit→At PC Location</b>             | ! vi +<line> <file> ! no_prompt_before_exit |
| <b>File→Term</b>                            | !   |

| Pulldown  | Command Line                             |
|---|--|
| <b>File→Exit→Window (save session)</b>                    | end                                      |
| <b>File→Exit→Locked (all windows, save session)</b>       | end locked                               |
| <b>File→Exit→Released (all windows, release emulator)</b> | end release_system                       |
| <b>Display→Context</b>                                    | pwd, pws                                 |
| <b>Display→Memory</b>                                     | display memory                           |
| <b>Display→Memory→Mnemonic ()</b>                         | display memory --EXPR-- mnemonic         |
| <b>Display→Memory→Mnemonic at PC</b>                      | display memory mnemonic at_pc            |
| <b>Display→Memory→Mnemonic Previous</b>                   | display memory mnemonic previous_display |
| <b>Display→Memory→Hex ()→bytes</b>                        | display memory --EXPR-- blocked bytes    |
| <b>Display→Memory→Hex ()→words</b>                        | display memory --EXPR-- blocked words    |
| <b>Display→Memory→Hex ()→long</b>                         | display memory --EXPR-- blocked long     |
| <b>Display→Memory→Real ()→short</b>                       | display memory --EXPR-- real short       |
| <b>Display→Memory→Real ()→long</b>                        | display memory --EXPR-- real long        |
| <b>Display→Memory→Real ()→extended</b>                    | display memory --EXPR-- real extended    |
| <b>Display→Memory→Real ()→packed</b>                      | display memory --EXPR-- real packed      |
| <b>Display→Memory→At ()</b>                               | display memory --EXPR--                  |
| <b>Display→Memory→Repetitively</b>                        | display memory repetitively              |
| <b>Display→Data Values</b>                                | display data                             |
| <b>Display→Data Values→New ()→&lt;type&gt;</b>            | display data --EXPR-- <type>             |
| <b>Display→Data Values→Add ()→&lt;type&gt;</b>            | display data, --EXPR-- <type>            |
| <b>Display→MMU Translations</b>                           | display mmu_translations                 |
| <b>Display→Trace</b>                                      | display trace                            |
| <b>Display→Registers→&lt;type&gt;</b>                     | display registers <type>                 |
| <b>Display→Breakpoints</b>                                | display software_breakpoints             |
| <b>Display→Status</b>                                     | display status                           |
| <b>Display→Simulated IO</b>                               | display simulated_io                     |
| <b>Display→Global Symbols</b>                             | display global_symbols                   |
| <b>Display→Local Symbols ()</b>                           | display local_symbols_in --SYMB--        |
| <b>Display→Pod Commands</b>                               | display pod_command                      |
| <b>Display→Error Log</b>                                  | display error_log                        |
| <b>Display→Event Log</b>                                  | display event_log                        |
| <b>Modify→Emulator Config</b>                             | modify configuration                     |
| <b>Modify→Memory</b>                                      | modify memory                            |
| <b>Modify→Memory at ()</b>                                | modify memory --EXPR--                   |
| <b>Modify→Register</b>                                    | modify register                          |

| Pulldown  | Command Line  |
|---|---|
| <b>Execution</b> → <b>Run</b> → <b>from PC</b>                            | run   |
| <b>Execution</b> → <b>Run</b> → <b>from ()</b>                            | run from --EXPR--                                     |
| <b>Execution</b> → <b>Run</b> → <b>from Transfer Address</b>              | run from transfer_address                             |
| <b>Execution</b> → <b>Run</b> → <b>from Reset</b>                         | run from reset  |
| <b>Execution</b> → <b>Run</b> → <b>until ()</b>                           | run until --EXPR--                                    |
| <b>Execution</b> → <b>Step Source</b> → <b>from PC</b>                    | step source   |
| <b>Execution</b> → <b>Step Source</b> → <b>from ()</b>                    | step source from --EXPR--                             |
| <b>Execution</b> → <b>Step Source</b> → <b>from Transfer Address</b>      | step source from transfer_address                     |
| <b>Execution</b> → <b>Step Instruction</b> → <b>from PC</b>               | step  |
| <b>Execution</b> → <b>Step Instruction</b> → <b>from ()</b>               | step from --EXPR--                                    |
| <b>Execution</b> → <b>Step Instruction</b> → <b>from Transfer Address</b> | step from transfer_address                            |
| <b>Execution</b> → <b>Break</b>   | break   |
| <b>Execution</b> → <b>Reset</b>   | reset   |
| <b>Breakpoints</b> → <b>Display</b>                                       | display software_breakpoints                          |
| <b>Breakpoints</b> → <b>Enable</b>  | modify software_breakpoints enable/disable            |
| <b>Breakpoints</b> → <b>Temporary()</b>                                   | modify software_breakpoints set --EXPR--<br>temporary |
| <b>Breakpoints</b> → <b>Permanent()</b>                                   | modify software_breakpoints set --EXPR--<br>permanent |
| <b>Breakpoints</b> → <b>Set ()</b>  | modify software_breakpoints set --EXPR--              |
| <b>Breakpoints</b> → <b>Set All</b>                                       | modify software_breakpoints set                       |
| <b>Breakpoints</b> → <b>Clear ()</b>                                      | modify software_breakpoints clear --EXPR--            |
| <b>Breakpoints</b> → <b>Clear All</b>                                     | modify software_breakpoints clear                     |

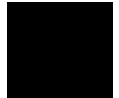

| <b>Pulldown</b>                                  | <b>Command Line</b>   |
|--|---|
| <b>Trace→Display</b>                             | display trace   |
| <b>Trace→Display Options</b>                     | display trace ...   |
| <b>Trace→Trace Spec</b>                          | N/A (browses recall buffer for trace commands)              |
| <b>Trace→After ()</b>                            | trace after STATE   |
| <b>Trace→Before ()</b>                           | trace before STATE  |
| <b>Trace→About ()</b>                            | trace about STATE   |
| <b>Trace→Only ()</b>                             | trace only STATE  |
| <b>Trace→Only () Prestore</b>                    | trace only STATE prestore anything                          |
| <b>Trace→Again</b>                               | trace again   |
| <b>Trace→Repetitively</b>                        | <previous trace spec> repetitively                          |
| <b>Trace→Everything</b>                          | trace   |
| <b>Trace→Until ()</b>                            | trace before STATE break_on_trigger                         |
| <b>Trace→Until Stop</b>                          | trace on_halt   |
| <b>Trace→Stop</b>                                | stop_trace  |
| <b>Settings→Source/Symbol Modes→Absolute</b>     | set source off symbols off                                  |
| <b>Settings→Source/Symbol Modes→Symbols</b>      | set source off symbols on                                   |
| <b>Settings→Source/Symbol Modes→Source Mixed</b> | set source on inverse_video on symbols on                   |
| <b>Settings→Source/Symbol Modes→Source Only</b>  | set source only inverse_video off symbols on                |
| <b>Settings→Display Modes</b>                    | set ...   |
| <b>Settings→DeMMUer→Load from Memory</b>         | load demmuer  |
| <b>Settings→DeMMUer→Load from File</b>           | load demmuer <file>   |
| <b>Settings→DeMMUer→Load Verbose</b>             | N/A (toggles the verbose mode of the DeMMUer load function) |
| <b>Settings→DeMMUer→Enable</b>                   | set demmuer on/off  |
| <b>Settings→Pod Command Keyboard</b>             | display pod_command; pod_command keyboard                   |
| <b>Settings→Simulated IO Keyboard</b>            | display simulated_io; modify keyboard_to_simio              |
| <b>Settings→Command Line</b>                     | N/A (toggles the command line)                              |

---

## Emulator Configuration: Memory Map

---

| Pulldown   | Command Line                          |
|--|---------------------------------------|
| <b>File→Print Map</b>  | print                                 |
| <b>File→Exit</b>   | end                                   |
| <b>Map→Add New Entry</b>   | N/A (calls the associated dialog box) |
| <b>Map→Modify Entry→&lt;entry#&gt;</b>                           | N/A (calls the associated dialog box) |
| <b>Map→Delete Entry→&lt;entry#&gt;</b>                           | delete <entry#>                       |
| <b>Map→Delete All</b>  | delete all                            |
| <b>Map→Default Memory Type→Target RAM→<br/>Cache Inhibit OFF</b> | default target ram                    |
| <b>Map→Default Memory Type→Target RAM→<br/>Cache Inhibit ON</b>  | default target ram ci                 |
| <b>Map→Default Memory Type→Target ROM→<br/>Cache Inhibit OFF</b> | default target rom                    |
| <b>Map→Default Memory Type→Target ROM→<br/>Cache Inhibit ON</b>  | default target rom ci                 |
| <b>Map→Default Memory Type→Guarded</b>                           | default guarded                       |
| <b>Settings→Command Line</b>                                     | N/A (toggles the command line)        |

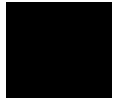

---

## How Popup Menus Map to the Command Line

---

### Mnemonic Memory Display Popup

### Command Line

---

|                                      |   |
|--------------------------------------|---|
| <b>Set/Clear Software Breakpoint</b> | modify software_breakpoints set/clear --EXPR--<br>permanent |
| <b>Edit Source</b>                   | ! vi +<line> <file> ! no_prompt_before_exit                 |
| <b>Run Until</b>                     | run until fcode sp --EXPR--                                 |
| <b>Trace After</b>                   | trace after STATE   |
| <b>Trace Before</b>                  | trace before STATE  |
| <b>Trace About</b>                   | trace about STATE   |
| <b>Trace Until</b>                   | trace before STATE break_on_trigger                         |

---

### Breakpoints Display Popup

### Command Line

---

|  |   |
|--|---|
| <b>Set/Inactivate Breakpoint</b>           | modify software_breakpoints set/deactivate --EXPR-- |
| <b>Clear (delete) Breakpoint</b>           | modify software_breakpoints clear --EXPR--          |
| <b>Enable/Disable Software Breakpoints</b> | modify software_breakpoints enable/disable          |
| <b>Set All Breakpoints</b>                 | modify software_breakpoints set                     |
| <b>Clear (delete) All Breakpoints</b>      | modify software_breakpoints clear                   |

---

### Symbols Display Popup

### Command Line

---

|                                  |  |
|----------------------------------|--|
| <b>Display Local Symbols</b>     | display local_symbols_in --SYMB--                            |
| <b>Display Parent Symbols</b>    | display local_symbols_in --SYMB--, display<br>global_symbols |
| <b>Cut Full Symbol Name</b>      | N/A  |
| <b>Edit File Defining Symbol</b> | ! vi +<line> <file> ! no_prompt_before_exit                  |

---

| <b>Trace Display Popup</b> | <b>Command Line</b>                                |
|----------------------------|--|
| <b>Disassemble From</b>    | display trace disassemble_from_line_number <line#> |
| <b>Edit Source</b>         | ! vi +<line> <file> ! no_prompt_before_exit        |
| <b>Display Memory At</b>   | display memory <address> mnemonic                  |

| <b>Status Line Popup</b>        | <b>Command Line</b>    |
|---------------------------------|------------------------|
| <b>Remove Temporary Message</b> | N/A                    |
| <b>Command Line On/Off</b>      | (toggles command line) |
| <b>Display Error Log</b>        | display error_log      |
| <b>Display Event Log</b>        | display event_log      |

| <b>Command Line Popup</b>            | <b>Command Line</b>                     |
|--------------------------------------|---|
| <b>Position Cursor, Replace Mode</b> | <INSERT CHAR> key (when in insert mode) |
| <b>Position Cursor, Insert Mode</b>  | <INSERT CHAR> key                       |
| <b>Execute Command</b>               | <RETURN> key                            |
| <b>Clear to End of Line</b>          | <CTRL>e                                 |
| <b>Clear Entire Line</b>             | <CTRL>u                                 |
| <b>Command Line Off</b>              | (toggles command line)                  |

| <b>Emulation Configuration:<br/>Memory Map Display Popup</b> | <b>Command Line</b>             |
|--|---------------------------------|
| <b>Modify Entry</b>  | delete <entry#>, <add <entry#>> |
| <b>Add New Entry</b>   | <add <entry#>>                  |
| <b>Delete Entry</b>  | delete <entry#>                 |

## Syntax Conventions

Conventions used in the command syntax diagrams are defined below.

### Oval-shaped Symbols

Oval-shaped symbols contain command tokens. Command tokens, together with symbols and numeric values, make up complete Softkey Interface commands. Most command tokens appear on softkey labels. Those that do not appear as softkeys must be typed into the command line (for example, **log\_commands** and **wait**). An example of an oval-shaped symbol is as follows:

global\_symbols

### Rectangular-shaped Symbols

Rectangular-shaped symbols contain prompt softkeys, softkey-changers, and references to other syntax diagrams. Prompt softkeys are enclosed in angle brackets (< and >). Softkey-changers are enclosed in dashes (--). References to other diagrams are shown in all capital letters without any enclosing symbols.

Examples of all three kinds of rectangular symbols follow:

<REGISTERS>

Prompt Softkey. Press to get a hint about the kind of information needed.

--EXPR--

Softkey Changer. Press to get another set of softkeys. Some softkey changers have their own syntax diagrams in this chapter.

QUALIFIER

Reference to a diagram showing details in this chapter.



## Circles

Circles contain operators and delimiters used in expressions and on the command line. An example of a circle symbol is as follows:



## The —NORMAL— Key

The softkey labeled —NORMAL— is a special softkey-changer; use it to return to the former set of softkeys. For example, you can press the —EXPR— softkey to call up a set of prompt softkeys to help you complete an expression. After you complete the expression, you can return to the set of softkeys containing the —EXPR— softkey by pressing the —NORMAL— softkey.

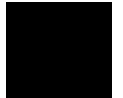

---

## Summary of Commands

Softkey Interface commands are summarized in the following table:

---

### Emulator Commands

|   |                                       |  |
|---|---------------------------------------|--|
| UNIX_COMMAND                            | display event_log                     | modify configuration                       |
| break                                   | display global_symbols                | modify keyboard_to_simio <sup>2</sup>      |
| cd (change directory) <sup>3</sup>      | display local_symbols_in              | modify memory <sup>4</sup>                 |
| cmb_execute                             | display memory <sup>5</sup>           | modify register <sup>1</sup>               |
| <command file> <sup>3</sup>             | display pod_command                   | modify software_breakpoints <sup>1</sup>   |
| copy data <sup>4</sup>                  | display local_symbols_in              | name_of_module <sup>3</sup>                |
| copy display                            | display memory <sup>4</sup>           | performance_measurement_end                |
| copy error_log                          | display mmu_translations <sup>5</sup> | performance_measurement_init               |
| copy event_log                          | display registers <sup>1</sup>        | performance_measurement_run                |
| copy global_symbols                     | display simulated_io <sup>2</sup>     | pod_command                                |
| copy help                               | display software_breakpoints          | pwd (print working directory) <sup>3</sup> |
| copy local_symbols_in                   | display status                        | pws (print working symbol) <sup>3</sup>    |
| copy memory <sup>4</sup>                | display trace                         | reset                                      |
| copy mmu_translations <sup>5</sup>      | end                                   | run  |
| copy pod_command                        | help <sup>3</sup>                     | set  |
| copy registers <sup>1</sup>             | load <absolute_file>                  | specify                                    |
| copy software_breakpoints               | load configuration                    | step                                       |
| copy status                             | load demmuer <sup>5</sup>             | stop_trace                                 |
| copy trace                              | load emul_mem                         | store_demmuer                              |
| cws(change working symbol) <sup>3</sup> | load trace                            | store memory                               |
| display data <sup>4</sup>               | load trace_spec                       | store trace                                |
| display error_log                       | load user_memory                      | store trace_spec                           |
|   | log_commands <sup>3</sup>             | trace                                      |
|   |                                       | wait <sup>3</sup>                          |

<sup>1</sup> This option is not available in real-time mode.

<sup>2</sup> This is only available when simulated I/O is defined.

<sup>3</sup> These commands are not displayed on softkeys.

<sup>4</sup> This option is not available in real-time mode if addresses are in target memory or in emulation memory that is *not* dual-port.

<sup>5</sup> These commands are available only to the MC68030 emulator, and only when its MMU is enabled.

## **break**



This command causes the emulator to leave user program execution and begin executing in the monitor.

The behavior of **break** depends on the state of the emulator:

|                    |   |
|--------------------|---|
| running            | Break diverts the processor from execution of your program to the emulation monitor.                    |
| reset              | Break releases the processor from reset, and diverts execution to the monitor.                          |
| running in monitor | The <b>break</b> command does not perform any operation while the emulator is executing in the monitor. |

---

### **Example**

```
break <RETURN>
```

---

### **See Also**

```
help break  
run  
step
```

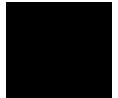

## **cmb\_execute**



The **cmb\_execute** command causes the emulator to emit an EXECUTE pulse on its rear panel CMB connector. All emulators connected to the CMB (including the one sending the CMB EXECUTE pulse) and configured to respond to this signal will take part in the measurement.

---

### **Example**

```
cmb_execute <RETURN>
```

---

### **See Also**

```
help cmb  
help cmb_execute  
help specify  
specify run  
specify trace
```

### copy

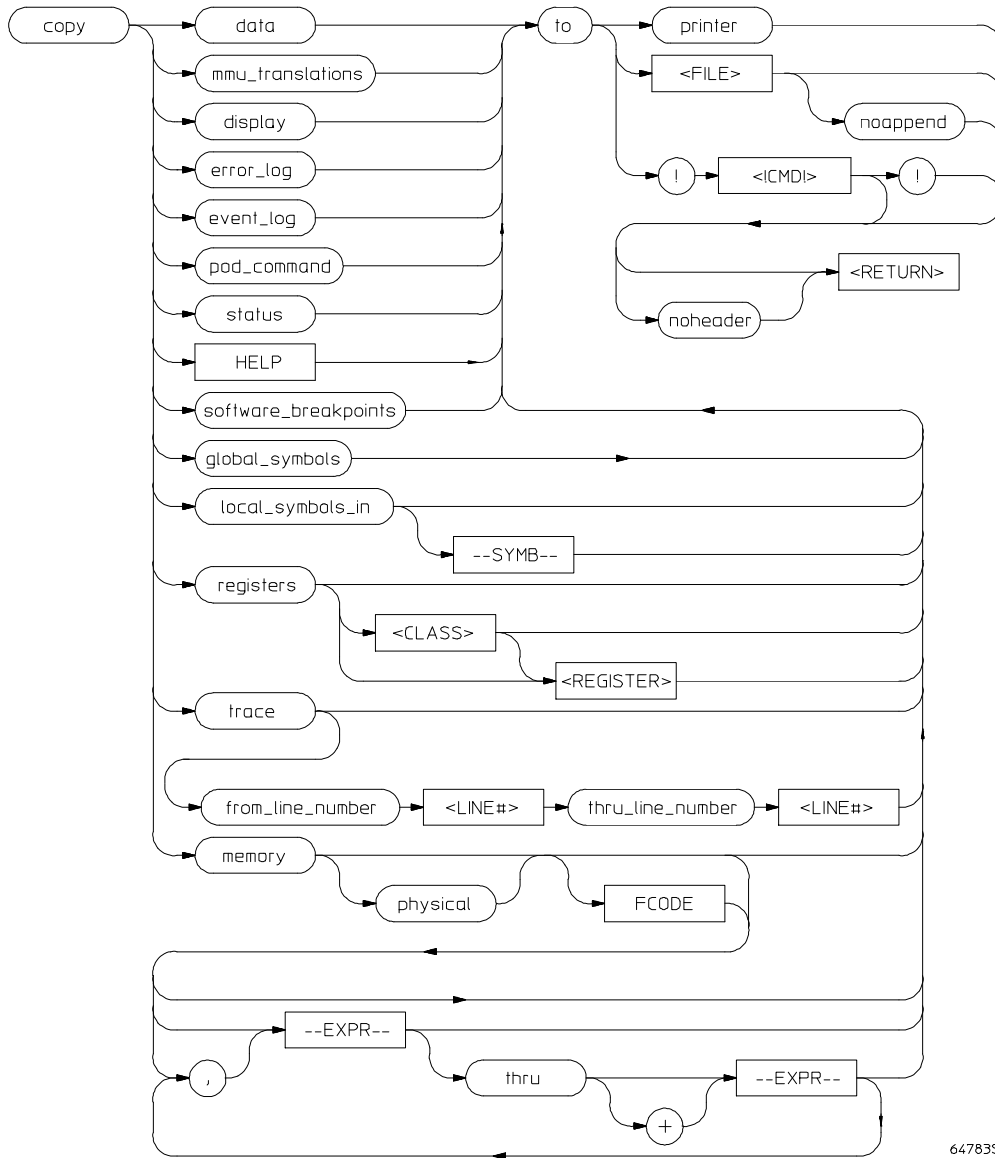

64783511



## Chapter 11: Emulator Commands

### copy

The **copy** command copies selected information to your system printer or listing file, or directs it to an UNIX process.

Depending on the information you choose to copy, default values may be options selected for the previous execution of the **display** command. For example, if you display memory locations 10h through 20h, then issue a **copy memory to myfile** command, myfile will list only memory locations 10h through 20h.

|           |   |
|-----------|---|
| ,         | A comma used immediately after <b>memory</b> in the command line appends the current <b>copy memory</b> command to the preceding <b>display memory</b> command. The data specified in both commands is copied to the destination specified in the current command. Data is formatted as specified in the current command. The comma is also used as a delimiter between values when specifying multiple memory addresses. |
| <CLASS>   | Specifies a particular class of the emulator registers. See the "registers" parameter in this section for more information about processor registers.   |
| < !CMD!>  | This represents an UNIX filter or pipe where you want to route the output of the <b>copy</b> command. UNIX commands must be preceded by an exclamation point (!). An exclamation point following the UNIX command continues Softkey Interface command line execution after the UNIX command executes. Emulation is not affected when using an UNIX command that is a shell intrinsic.                                     |
| data      | This allows you to copy a list of memory contents formatted in various data types (see display data).   |
| display   | This allows you to copy the display to a selected destination.  |
| error_log | This allows you to copy the most recent errors that occurred.   |
| event_log | This allows you to copy the most recent events that occurred.   |
| !         | An exclamation point specifies the delimiter for UNIX commands. An exclamation point must precede all UNIX commands. A trailing exclamation point should be used if you want to return to the command line and specify noheader. Otherwise, the trailing exclamation point is optional. If an exclamation point is part of the UNIX command, a backslash (\) must precede the exclamation point.                          |
| —EXPR—    | An expression is a combination of numeric values, symbols, operators, and parentheses, specifying a memory address or offset value. See the EXPR syntax diagram.  |

|                  |  |
|------------------|--|
| FCODE            | The function code used to define the address space being referenced. See the syntax diagram for FCODE to see a list of the function codes available and for an explanation of those codes.   |
| <FILE>           | This prompts you for the name of a file where you want the specified information to be copied. If you want to specify a file name that begins with a number, you must precede the file name with a backslash. For example: <b>copy display to \12.10 &lt;RETURN&gt;</b>  |
| from_line_number | This specifies the trace list line number from which copying will begin.   |
| global_symbols   | This lets you copy a list of global symbols to the selected destination.   |
| help             | The help command is not shown on the softkeys. It allows you to obtain a copy of a help file on your printer. For details of the help command, refer to the help syntax diagram in this chapter.   |
| <LINE#>          | Use this with <b>from_line_number</b> and <b>thru_line_number</b> to specify the starting and ending trace list lines to be copied.  |
| local_symbols_in | <p>This lets you copy all the children of a given symbol to the selected destination. See the <b>—SYMB—</b> syntax page and the <i>SRU User's Guide</i> for information on symbol hierarchy.</p> <p>Local symbols are symbols that are children of the particular file or symbol defined by <b>—SYMB—</b>, that is, they are defined in that file or scope.</p>  |
| memory           | <p>This allows you to copy a list of the contents of memory to the selected destination. The memory contents are copied in the same format as specified in the last display memory command.</p> <p>Contents of memory can be displayed if program runs are not restricted to real-time. Memory contents are listed as an asterisk (*) under the following conditions:</p> <ol style="list-style-type: none"><li>1 The address refers to guarded memory.</li><li>2 Runs are restricted to real-time, the emulator is running a user program, and the address is located in target memory or in emulation memory that is not dual-port.</li></ol> <p>Values in emulation memory can always be displayed.</p> <p>Initial values are the same as those specified by the command <b>display memory 0 blocked bytes offset_by 0</b>.</p> |

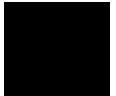

## Chapter 11: Emulator Commands

### copy

Defaults are to values specified in the previous **display memory** command.

- mmu\_translations** This allows you to copy a list of all present translations of all logical addresses to the selected destination.
- noappend** This causes any copied information to overwrite an existing file with the same name specified by <FILE>. If this option is not selected, the default operation is to append the copied information to the end of an existing file with the same name that you specify.
- noheader** This copies the information into a file without headings.
- physical** This allows you to specify that the addresses to be copied are addresses in physical memory.
- pod\_command** This allows you to copy the most recent commands sent to the HP 64700-Series emulator/analyzer. For details, refer to the syntax page for the **pod\_command** in this chapter.
- printer** This option specifies your system printer as the destination device for the **copy** command. Before you can specify the printer as the destination device, you must define **PRINTER** as a shell variable. For example, enter the text shown below after the “\$” symbol:

```
$ PRINTER=lp
export PRINTER
```

If you don't want the print message to overwrite the command line, execute:

```
$ set PRINTER = "lp -s"
```

### registers

This allows you to copy a list of the contents of the emulation processor registers to the selected destination. The **copy register** command is not available if the emulator is configured for real-time-only operation.

With no options specified, the basic register class is copied. Basic registers include: PC, STATUS, USP, ISP, MSP, CACR, CAAR, D0 through D7, A0 through A7, VBR, DFC, and SFC.

Other registers you can copy include:

The FPU registers (if your target system is equipped with a floating point coprocessor): FPCR, FPSR, FPIAR, and FP0 through FP7.



The ACU registers (if you are using a 68030/EC030 with the MMU disabled): AC0, AC1, and ACUSR.

The MMU registers (if you are using a 68030 with the MMU enabled): TT0, TT1, MMUSR, TC, SRP, and CRP.

|                          |  |
|--------------------------|--|
| <REGISTER>               | Specifies the name of an individual register.  |
| software_<br>breakpoints | This option lets you copy a list of the current execution breakpoints to a selected destination.   |
| status                   | This allows you to copy emulation and analysis status information.   |
| —SYMB—                   | This option represents the symbol whose children are to be listed. See the — <b>SYMB</b> — syntax diagram and the <i>SRU User's Guide</i> for information on symbol hierarchy. |
| thru_line_number         | Specifies the last line number of the trace list to include in the copied range.   |
| to                       | This allows you to specify a destination for the copied information.   |
| trace                    | This lets you copy the current trace listing to the selected destination. Initial values are the same as specified by the last <b>display trace</b> command.                   |

---

### Examples

```
copy local_symbols_in prog68k.S: to printer <RETURN>
copy local_symbols_in cmd_rdr.s: to myfile <RETURN>
copy memory START to printer <RETURN>
copy memory 0 thru 100H , START thru +5 , 500H ,
TARGET2 to memlist <RETURN>
copy memory 2000h thru 204fh to memlist <RETURN>
copy registers BASIC to printer <RETURN>
copy registers to reglist <RETURN>
copy trace to tlist <RETURN>
```

## Chapter 11: Emulator Commands

### **copy**

```
copy trace from_line_number 0 thru_line_number 5  
to longtrac <RETURN>
```

```
copy trace to !mail myfriend@col.hp!
```

---

### **See Also**

```
display local_symbols_in <SYMB>  
display memory  
display registers  
display trace  
modify memory  
modify registers  
store memory  
store trace  
help copy  
help registers  
help trace
```

## COUNT

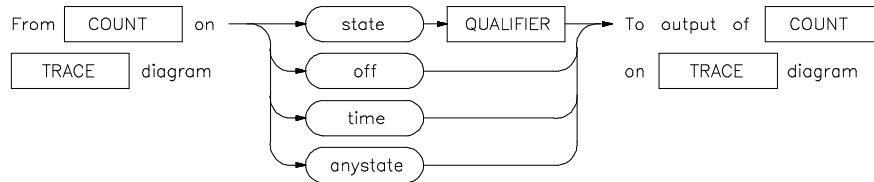

The analyzer trace depth is 1024 states. A state is a unique combination of address, data, and status values occurring on the emulation bus simultaneously. When counting is off, the analyzer can store 1024 states in the trace buffer. When counting is on, the analyzer can only store 512 states in the trace buffer. That is because the analyzer must now use two states in the trace buffer for each state captured on the analyzer bus. One of the two states stores the state information itself. The other state stores the count information associated with the state information.

By default, the interface displays a maximum of 256 of states. This is true whether counting is off or on. You can increase the depth of the trace display buffer to display up to the maximum amount of states that are available for display (512 when counting is on, or 1024 when counting is off). The following command increases the trace display depth to 512 states:

```
display trace depth 512 <RETURN>
```

By default, the analyzer counting function is turned off.

|                  |   |
|------------------|---|
| <b>anystate</b>  | This option allows you to set up the <b>counting</b> parameter for the analyzer to count on any state.                        |
| <b>off</b>       | This option turns off trace counting capability. As previously explained, turning off counting provides a larger trace depth. |
| <b>QUALIFIER</b> | This is defined by you and used with the <b>state</b> option to define the states to be captured by the analyzer.             |
| <b>state</b>     | This causes the emulation-bus analyzer to count occurrences of the specified state during a trace measurement.                |

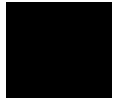

## Chapter 11: Emulator Commands

### COUNT

**time** This option causes the emulation-bus analyzer to count the time between states captured during the trace measurement.

---

### Examples

```
trace after START counting state LOOP2 <RETURN>
```

```
trace counting time <RETURN>
```

---

### See Also

```
help trace  
trace
```

## display

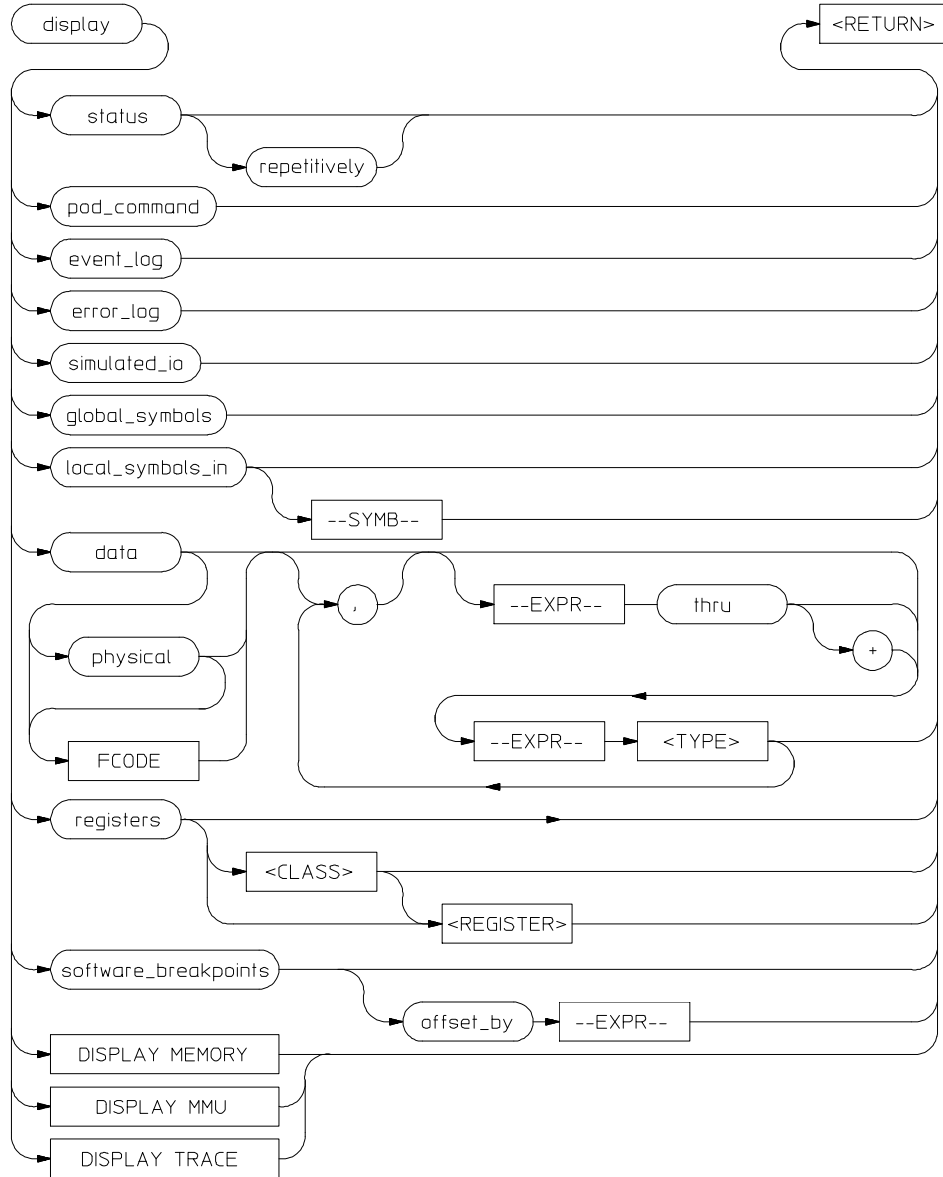

64783S12

**display**

You can use the **up arrow**, **down arrow**, **PREV PAGE**, and **NEXT PAGE** keys to view the displayed information. For software\_breakpoints, data, memory, and trace displays you can use the **CTRL g** and **CTRL f** keys to scroll left and right if the information goes past the edge of the screen.

Depending on the information you select, defaults may be the options selected for the previous execution of the **display** command.

, A leading comma allows you to append additional expressions to the previous **display data** command.

Commas between expression/data type specifications allow you to specify multiple variables and types for display with the current command.

data You can display the values of simple data types in your program. This command saves you time; without it you would need to search through memory displays for the location and value of a particular variable.

The address, identifier, and data value of each symbol may be displayed. You must issue the command **set symbols on** to see the symbol names displayed.

For the first **display data** command after you begin an emulation session, you must supply at least one expression specifying the data item(s) to display.

Thereafter, the **display data** command defaults to the expressions specified in the last **display data** command, unless new expressions are supplied or appended (with a leading comma).

Symbols are normally set off until you give the command **set symbols on**. Otherwise, only the address, data type, and value of the data item will be displayed.

error\_log This option displays the recorded list of error messages that occurred during the emulation session.

event\_log This option displays the recorded list of events.

—EXPR— An expression is a combination of numeric values, symbols, operators, and parentheses, specifying an offset value for the breakpoint address. See the —**EXPR**— syntax diagram.

|                  |  |
|------------------|--|
| FCODE            | The function code used to define the address space being referenced. See the syntax diagram for FCODE to see a list of the function codes available and for an explanation of those codes.   |
| global_symbols   | This option lets you display a list of all global symbols in memory.<br><br>Global symbols are symbols declared as global in the source file. They include procedure names, variables, constants, and file names. When the <b>display global_symbols</b> command is used, the listing will include the symbol name and its logical address.  |
| local_symbols_in | This option lets you display all the children of a given symbol. Local symbols of <b>—SYMB—</b> are the ones that are children of the file and/or scope specified by <b>—SYMB—</b> . That is, they are defined in that file or scope. Displaying the local symbols sets the current working symbol to the one specified.   |
| <b>—SYMB—</b>    | This option represents the symbol whose children are to be listed. See the <b>—SYMB—</b> syntax diagram and the <i>SRU User's Guide</i> for more information on symbol hierarchy and representation.   |
| memory           | This option allows you to display the contents of memory.  |
| offset_by        | This option allows you to offset the listed breakpoint address value from the actual address of the breakpoint. By subtracting the offset value from the breakpoint address, the system can cause the listed address to match that given in the assembler or compiler listing.   |
| physical         | This allows you to specify that the addresses to be displayed are addresses in physical memory.  |
| pod_command      | This option lets you display the Terminal Interface screen. You must display the Terminal Interface screen to view the output of any Terminal Interface (pod commands) you have used or are going to use. For details, refer to the syntax page for the pod_command in this chapter.   |
| repetitively     | This optional part of the <b>display status</b> command causes the emulator status screen to be updated continuously.  |
| registers        | This allows you to display the contents of emulation processor registers.<br><br>If a <b>step</b> command was just executed, the mnemonic representation of the last instruction is also displayed (if the current display is the register display). This process does not occur in real-time. The emulation system must be configured for nonreal-time operation to display registers while the processor is running. Symbols |

## Chapter 11: Emulator Commands

### display

also may be displayed in the register step mnemonic string (refer to **set symbols** in this chapter).

With no options specified, the basic register class is displayed. Basic registers include: PC, STATUS, USP, ISP, MSP, CACR, CAAR, D0 through D7, A0 through A7, VBR, DFC, and SFC.

Other registers you can display include:

The FPU registers (if your target system is equipped with a floating point coprocessor): FPCR, FPSR, FPIAR, and FP0 through FP7.

The ACU registers (if you are using an MC68030/EC030 with the MMU disabled): AC0, AC1, and ACUSR.

The MMU registers (if you are using an MC68030 with the MMU enabled): TT0, TT1, MMUSR, TC, SRP, and CRP.

|                          |   |
|--------------------------|---|
| <CLASS>                  | This allows you to display a particular class of processor registers.   |
| <REGISTER>               | This displays an individual register.   |
| simulated_io             | <p>This lets you display data written to the simulated I/O display buffer after you have enabled polling for simulated I/O in the emulation configuration.</p> <p>After you have enabled polling for simulated I/O during the emulation configuration process, six simulated I/O addresses can be defined. You then define files used for standard input, standard output, and standard error. For details on setting up simulated I/O, refer to the question “Modify simulated I/O configuration?” in Chapter 8, “Configuring the Emulator.”</p>   |
| software_<br>breakpoints | <p>This option lets you display the current list of execution breakpoints.</p> <p>If the emulation session is continued from a previous session, the listing will include any previously defined breakpoints. The column marked “status” shows whether the breakpoint is pending, inactivated, or unknown.</p> <p>An “unknown” breakpoint status will occur if you set the breakpoint, then remap the breakpoint address as guarded. A pending breakpoint causes the processor to enter the emulation monitor or background memory upon execution of that breakpoint. Executed breakpoints are listed as inactivated.</p> |



Entries that show an inactive status can be reactivated by executing the following command:

**modify software\_breakpoints set** <RETURN>

A label column also may be displayed for addresses that correspond to a symbol. See the **set** command for details.

**status** This displays the emulator and trace status screen.

**thru —EXPR—** Allows you to specify a range of addresses for which you want data display. Typically, you use this to display the contents of an array. You can display both single-dimensional and multi-dimensional arrays. Arrays are displayed in the order specified by the language definition, typically row major order for most Algol-like languages. Including the + operator allows you to specify an address range as an offset from the 'base' address specified in —EXPR—.

**trace** This displays the current trace list.

| <TYPE>  | Meaning   |
|---------|---|
| byte    | Hex display of one 8-bit location.  |
| word    | Hex display of one 16-bit location.   |
| long    | Hex display of one 32-bit location.   |
| int8    | Display of one 8-bit location as a signed integer using two's complement notation.  |
| int16   | Display of two bytes as a signed integer using two's complement notation.   |
| int32   | Display of four bytes as a signed integer using two's complement notation.  |
| u_int8  | Display of one byte as an unsigned positive integer.  |
| u_int16 | Display of two bytes as an unsigned positive integer.   |
| u_int32 | Display of four bytes as an unsigned positive integer.  |
| char    | Displays one byte as an ASCII character in the range 0..127. Control characters and values in the range 128..255 are displayed as a period (.). |



## Chapter 11: Emulator Commands

### display

<TYPE> Specifies the format in which to display the information, as shown in the following table. (Data type information is not available from the symbol database, so you must specify it.)

---

#### Examples

```
display event_log <RETURN>
display local_symbols_in cmd_rdr.s: <RETURN>
display global_symbols <RETURN>
display local_symbols_in templ.S: <RETURN>
display local_symbols_in prog68k.S:main <RETURN>
display simulated_io <RETURN>
display software_breakpoints <RETURN>
display software_breakpoints offset_by 1000H
<RETURN> display registers <RETURN>
display registers BASIC <RETURN>

display data Msg_A thru +17 char, Stack long
set symbols on
set width label 30
display data , Msg_B thru +17 char, Msg_Dest thru +17
char
```

---

#### See Also

```
copy
help copy
help display
help registers
help software_breakpoints
modify registers
modify software_breakpoints
set
step
cws
pws
```

The following pages describe various **display memory**, **display MMU**, and **display trace** syntax diagrams.

**DISPLAY MEMORY**

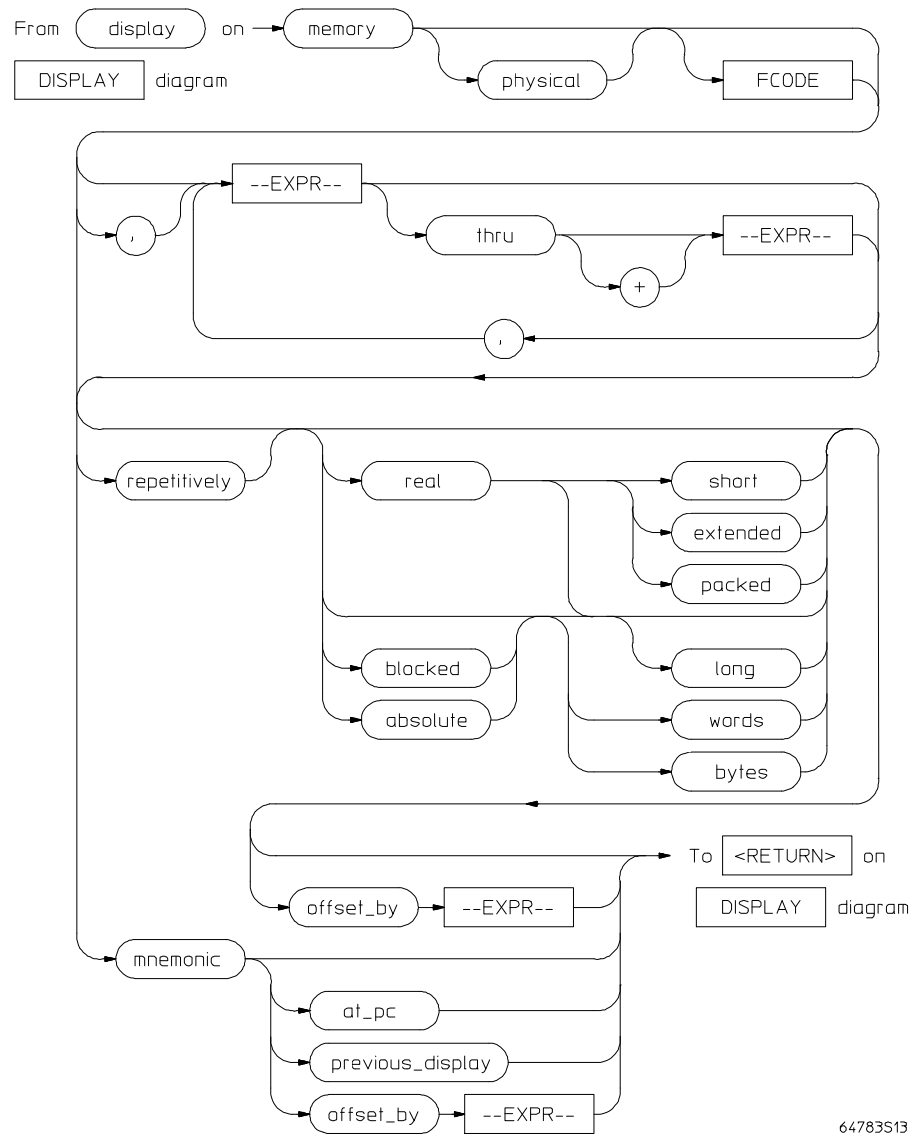

64783513

## Chapter 11: Emulator Commands

### DISPLAY MEMORY

The memory contents can be displayed in mnemonic, hexadecimal, or real number format. In addition, the memory addresses can be listed offset by a value, which allows the information to be easily compared to the program listing.

When displaying memory mnemonic and stepping, the next instruction that will step is highlighted. The memory mnemonic display autopages to the new address if the next PC goes outside the currently displayed address range. This feature works even if stepping is performed in a different emulation window from the one displaying memory mnemonic (see the discussion on windowing capabilities in Chapter 3, "Using the Emulator/Analyzer Interface").

Pending breakpoints are shown in the memory mnemonic display by an asterisk (\*) in the leftmost column of the assembly instruction or source line that has a pending breakpoint.

A label column (symbols) may be displayed for all memory displays except blocked mode. Memory mnemonic may be displayed with source and assembly code intermixed, or with source code only. Symbols also can be displayed in the memory mnemonic string. (See the **set** command.)

Initial values are the same as specified by the command:

```
display memory 0 blocked bytes offset_by 0
```

Defaults are values specified in a previous **display memory** command.

The symbols and source defaults are:

```
set source off symbols off
```

|          |  |
|----------|--|
| absolute | Formats the memory listing in a single column.   |
| at_pc    | Displays the memory at the address pointed to by the current program counter value. If you are running a program when you enter this command, the memory will be displayed at the address pointed to by the program counter at the moment you enter the command. |
| blocked  | Formats the memory listing in multiple columns.  |
| bytes    | Displays the absolute or blocked memory listing as byte values.  |
| —EXPR—   | An expression is a combination of numeric values, symbols, operators, and parentheses, specifying a memory address or memory offset value. See the EXPR syntax diagram.  |

|                  |  |
|------------------|--|
| extended         | Displays memory as 96-bit IEEE-754 real numbers.   |
| FCODE            | The function code used to define the address space being referenced. See the syntax diagram for FCODE to see a list of the function codes available and for an explanation of those codes.   |
| long             | Displays the memory listing as long word values. When used with the <b>real</b> parameter, <b>long</b> displays memory in a 64-bit real number format.   |
| mnemonic         | This causes the memory listing to be formatted in assembly language instruction mnemonics with associated operands. When specifying mnemonic format, you should include a starting address that corresponds to the first byte of an operand to ensure that the listed mnemonics are correct. If <b>set source only</b> is on, you will see only the high level language statements and corresponding line numbers.   |
| offset_by        | <p>This option lets you specify an offset that is subtracted from each of the absolute addresses before the addresses and corresponding memory contents are listed. You might select the offset value so that each module appears to start at address 0000H. The memory contents listing will then appear similar to the assembler or compiler listing.</p> <p>This option is also useful for displaying symbols and source lines in dynamically relocated programs.</p> |
| packed           | Displays memory as 96-bit Motorola-format packed real numbers.   |
| physical         | This allows you to specify that the addresses to be displayed are addresses in physical memory.  |
| previous_display | Places the previous display window on screen. This token lets you switch the display back and forth between the previous window and the new window. This is useful when you are stepping a program in memory and it suddenly jumps to a different location in memory, changing your display window.  |
| real             | Formats memory values in the listing as real numbers. (NaN in the display list means "Not a Number.")  |
| repetitively     | Updates the memory listing display continuously. You should only use this to monitor memory while running user code, since it is very CPU intensive. To allow updates to the current memory display whenever memory is modified, a file is loaded, a breakpoint is set, etc., use the <b>set update</b> command.   |
| short            | Formats the memory list as 32-bit real numbers.  |

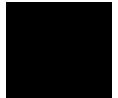

## Chapter 11: Emulator Commands

### DISPLAY MEMORY

|       |  |
|-------|--|
| thru  | This option lets you specify a range of memory locations to be displayed. Use the <b>up arrow</b> , <b>down arrow</b> , <b>NEXT PAGE</b> , and <b>PREV PAGE</b> keys to view additional memory locations.  |
| words | Displays the memory listing as word values.  |
| ,     | A comma after <b>memory</b> in the command line appends the current <b>display memory</b> command to the preceding <b>display memory</b> command. The data specified in both commands is displayed. The data will be formatted as specified in the current command. The comma is also a delimiter between values when specifying multiple addresses. |

---

#### Examples

```
display memory 2000h thru 204fh blocked words
```

```
display memory 2000h thru 202fh , 2100h real long
```

```
display memory 400h mnemonic  
set symbols on  
set source on  
display memory main mnemonic
```

---

#### See Also

```
copy memory  
cws  
help display  
modify memory  
pws  
set  
store memory
```

## DISPLAY MMU

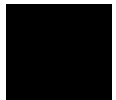
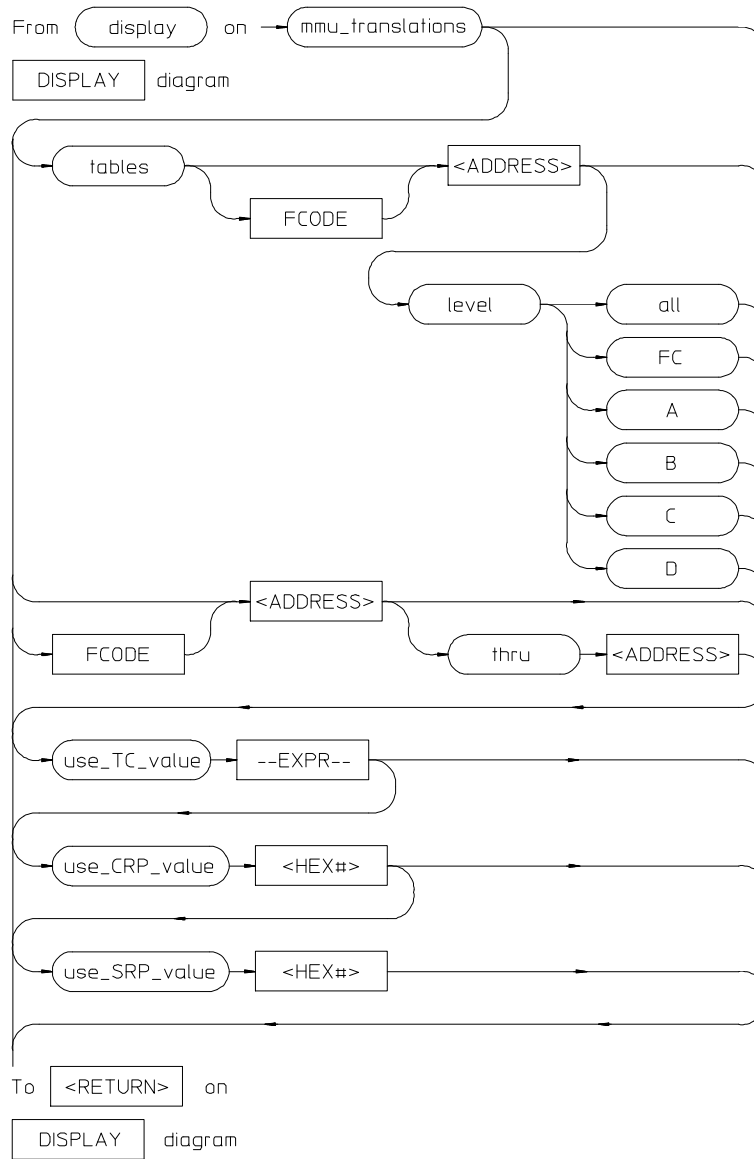

## Chapter 11: Emulator Commands

### DISPLAY MMU

This command is only available to the MC68030 emulator, and only when its MMU is enabled.

The **display mmu\_translations** command is used to display all of the present translations for all logical addresses, or for only a limited range of logical addresses. Further, you can display the details of how a single logical address is mapped through the tables to its corresponding physical address. Finally, you can display the details of a single translation table used by a selected logical address.

You can use the **display mmu\_translations** command to view the present set of valid translations, even when the TC register and the root pointer registers are invalid. Parameters in the **display mmu\_translations** command let you specify values to use when none exist in these MMU registers.

<ADDRESS>

The address or address range specifies a logical address reference for the MMU information to be displayed. This takes the form of --EXPR-- (see the --EXPR-- syntax diagram).

—EXPR—

An expression is a combination of numeric values, symbols, operators, and parentheses, specifying a value, such as an address. See the EXPR syntax diagram.

FCODE

The function code used to define the address space being referenced. See the syntax diagram for FCODE to see a list of the function codes available and for an explanation of those codes.

<HEX#>

A hexadecimal number is required for this entry. This number will be used in place of the present value within the referenced MMU register (CRP or SRP). This number does not overwrite the present content of the register.

level

|     |  |
|-----|--|
| all | Shows the details of each table for the single address you specify with this comand. This is the same as ignoring the <b>level</b> option. |
| FC  | Shows the content of the function-code table for the logical address you included in your command.   |
| A   | Shows the content of Table A for the logical address you included in your command.   |
| B   | Shows the content of Table B for the logical address you included in your command.   |



|                  |   |  |
|------------------|---|--|
|                  | C | Shows the content of Table C for the logical address you included in your command.   |
|                  | D | Shows the content of Table D for the logical address you included in your command.   |
| mmu_translations |   | Shows a list of the valid MMU mappings. One entry in the list is allocated for each page or group of adjacent pages in the system.                                     |
| tables           |   | Shows the details of the translation through the tables for the logical address you included in your command.  |
| thru             |   | Allows you to enter the upper address in a range of addresses.   |
| use_CRP_value    |   | Lets you specify a value to be used in place of the present content of the CRP (CPU root pointer) when reading the tables and showing the address mappings.            |
| use_SRP_value    |   | Lets you specify a value to be used in place of the present content of the SRP (supervisor root pointer) when reading the tables and showing the address mappings.     |
| use_TC_value     |   | Lets you specify a value to be used in place of the present content of the TC (translation control) register when reading the tables and showing the address mappings. |

---

**Examples**

Show all of the valid logical-to-physical mappings in the MMU:

*display mmu\_translations*

Show all of the logical-to-physical mappings for logical addresses in the range of 7FF0 through 800F:

*display mmu\_translations 7ff0H thru 800fH*

Show the table details used to translate logical address 400:

*display mmu\_translations tables 400H*

Show the details of Table A used to translate logical address 40FC.

*display mmu\_translations tables 40fcH level A*

**DISPLAY MMU**

Show the present MMU mappings based on a TC register value of 81FF2000 instead of the present TC register value:

```
display mmu_translations use_TC_value 81ff2000h
```

---

**See Also**

**load demmuer** (Preparing the deMMUer to reverse MMU translations.)

**set demmuer on/off** (Obtaining logical or physical addresses in the trace list.)

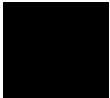

## DISPLAY TRACE

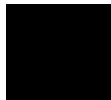
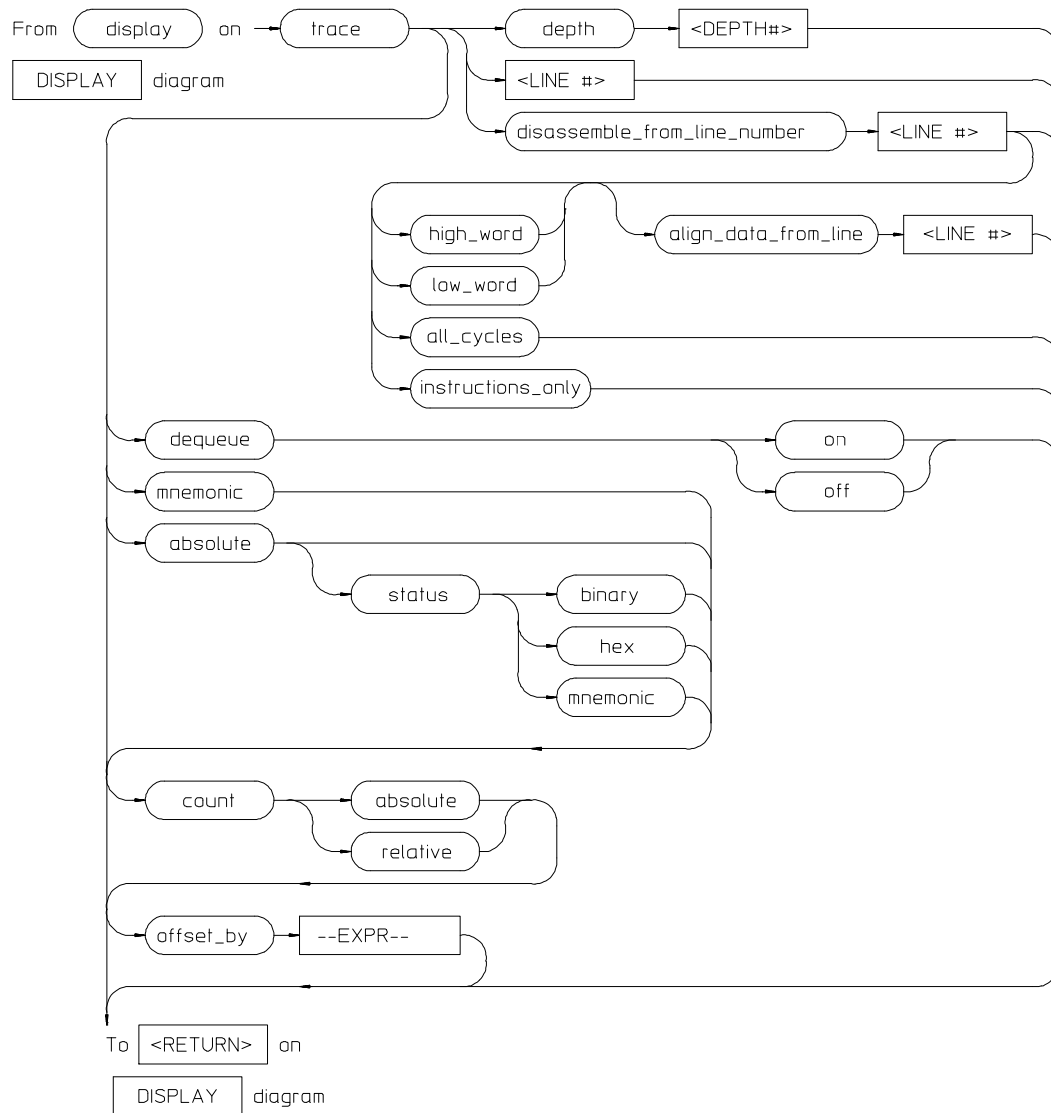

## Chapter 11: Emulator Commands

### DISPLAY TRACE

Captured information can be presented as absolute hexadecimal values or in mnemonic form. The processor status values captured by the analyzer can be listed mnemonically or in hexadecimal or binary form.

Addresses captured by the analyzer are physical addresses.

The **offset\_by** option subtracts the specified offset from the addresses of the executed instructions before listing the trace. With an appropriate entry for **offset\_by**, code that has been relocated (making symbolic information invalid) will have its addresses set so that symbolic information is again valid. If desired, **offset\_by** can be used to instructions in the listed trace at the same addresses where they appear in the assembled or compiled program listing.

The **count** parameter lists the current trace of time or state either relative to the previous event in the trace list or as an absolute count measured from the trigger event. If time counts are currently selected, the **count** parameter causes an absolute or relative time count to be listed. If the current trace contains state counts, a relative or absolute state count results.

The **source** parameter allows display of source program lines in the trace listing, enabling you to quickly correlate the trace list with your source program.

Initial values are the same as specified by the command:

```
display trace mnemonic count relative offset_by 0  
<RETURN>
```

absolute

Lists trace information in hexadecimal format, rather than mnemonic opcodes.

align\_data\_  
from\_line

Use this to correct data-alignment problems if you see any in a dequeued trace list. If you see that the dequeuer has aligned data with the wrong instructions, use this token to select the correct data alignment by specifying the line that should begin a data realignment (**align\_data\_from\_line 36**).

all\_cycles

Used to specify that all cycles should be included in the inverse assembled information shown in the trace list.

|                              |          |  |
|------------------------------|----------|--|
| count                        |          |  |
|                              | absolute | This lists the state or time count for each event of the trace as the total count measured from the trigger event.   |
|                              | relative | This lists the state or time count for each event of the trace as the count measured relative to the previous event.   |
| depth                        |          |  |
|                              | <DEPTH#> | This defines the number of states to be uploaded by the Softkey Interface.<br><br>After you have changed the trace depth, execute the command <b>wait measurement_complete</b> before displaying the trace. Otherwise the new trace states will not be available.  |
| dequeue                      |          | This obtains a trace list showing the activity of the emulation processor during the trace. Unused prefetches are eliminated from this display, and data transactions are aligned with the instructions that caused them to occur.   |
| disassemble_from_line_number |          | This causes the inverse assembly software to begin disassembling the trace code from the specified line number. This feature is required for processors where the inverse assembler cannot uniquely identify the first state of an instruction on the processor bus. The command is not available on emulators where the corresponding inverse assembler can identify instructions on the processor bus.   |
| —EXPR—                       |          | An expression is a combination of numeric values, symbols, operators, and parentheses, specifying an offset value to be subtracted from the addresses traced by the emulation analyzer. See the EXPR syntax diagram.   |
| high_word                    |          | Causes inverse assembly to begin with the opcode in the high word of the long word located in the specified trace-memory line number.  |
| instructions_only            |          | Causes the trace list to contain only those lines that show an instruction opcode.   |
| <LINE#>                      |          | When used alone, this is the trace list line number to be centered in the display. When used with <b>disassemble_from_line_number</b> , this is the line number from which the inverse assembler attempts to disassemble data in the trace list. When used with <b>align_data_from_line</b> , this is the line number from which to begin aligning data. The line number specified for data alignment must be the same as, or higher than, the line number specified for the beginning of the trace disassembly. |



## Chapter 11: Emulator Commands

### DISPLAY TRACE

**low\_word** Causes inverse assembly to begin with the opcode stored in the low word of the long word at the specified trace memory line number.

**mnemonic** Lists trace information with opcodes in mnemonic format.

**offset\_by** This option allows you to offset the listed address value from the address of the instruction. By subtracting the offset value from the physical address of the instruction, the system makes the listed address match that given in the assembler or compiler listing.

This option is also useful for displaying symbols and source lines in dynamically relocated programs.

Note that when using the **set source only** command, the analyzer may operate more slowly than when using the **set source on** command. This is an operating characteristic of the analyzer:

When you use the command **set source on**, and are executing only assembly language code (not high-level language code), no source lines are displayed. The trace list will fill immediately with the captured assembly language instructions.

When using **set source only**, no inverse assembled code is displayed. Therefore, the emulation software will try to fill the display with high-level source code. This requires the emulation software to search for any captured analysis data generated by a high-level language statement.

In conclusion, you should not set the trace list to **set source only** when tracing assembly code. This will result in optimum analyzer performance.

### status

**binary** Lists absolute status information in binary form.

**hex** Lists absolute status information in hexadecimal form.

**mnemonic** Lists absolute status information in mnemonic form.

---

**Examples**

*display trace count absolute*

*display trace absolute status binary*

*set source on*

*display trace mnemonic set source only*

---

**See Also**

*copy trace*  
*help display*  
*help trace*  
*store trace*  
*set*

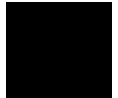

## end

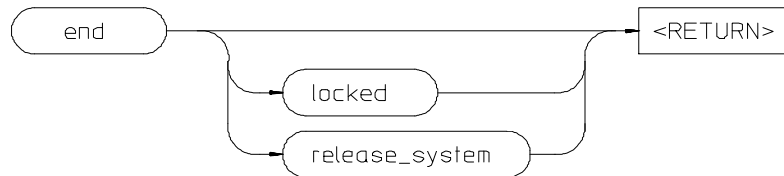

You can end the emulation session and leave the emulator in one of three states.

- You can exit the interface and leave the emulator in a continue state which allows you to re-enter the emulation session.
- You can exit the interface and leave the emulator in a locked state so that it cannot be accessed by other users.
- You can exit the interface and release the emulator for use by others.

Pressing **CNTL d** performs the same operation as pressing **end <RETURN>**.

Pressing **CNTL \** or **CNTL |** performs the same as **end release\_system <RETURN>**.

### end

If the command is specified without any options, two different things can occur. What occurs depends on whether the interface instance being ended is the only one currently executing. If it is, then this command ends the interface, but leaves the emulator in a continue state. The interface, if restarted, will reload the last configuration used.

If the interface instance is one of several into the same emulation session, then the end command ends the interface instance where the end is issued. Other interface instances into the same emulation session are not affected.

### locked

This option allows you to stop all active instances of an emulator Softkey Interface session in one or more windows and/or terminals. When the emulation session ends, control returns to the UNIX shell, but the emulator is still locked to your user id and is not available to others.

### release\_system

This option stops all instances of the Softkey Interface in one or more windows or terminals. The emulation system is released for other users. If you do not release the emulation system, others cannot access it.



---

**Examples**

```
end <RETURN>  
  
end locked <RETURN>  
  
end release_system <RETURN>
```

---

**See Also**

```
emul700 <emulator_name>  
help end
```

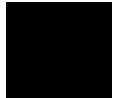

**—EXPR—**

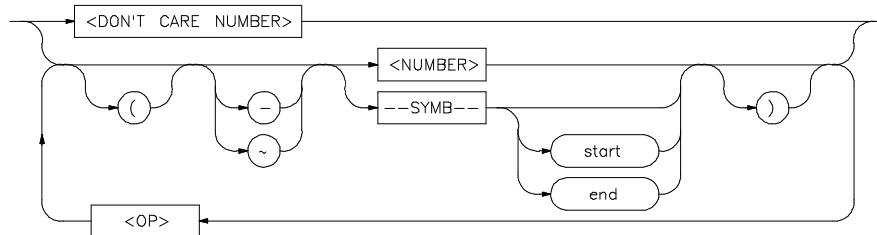

The function of an expression (**—EXPR—**) is to let you define the address, data, or status expression that fits your needs. You can combine multiple values to define the expression.

Some emulation commands will allow the option of **<+EXPR>** after pressing a thru softkey. This allows you to enter a range without retyping the original base address or symbol. For example, you could specify the address range

```
disp_buf thru disp_buf + 25
```

as

```
disp_buf thru +25
```

DON'T CARE NUMBER

You can include “don’t care numbers” in expressions. These are indicated by a number containing an “x.” These numbers may be defined as binary, octal, decimal, or hexadecimal. For example: 1fxxh, 17x7o, and 011xxx10b are valid.

“Don’t care numbers” are not valid for all commands.

**—NORMAL—**

This appears as a softkey label to enable you to return to the **—EXPR—** key. The **—NORMAL—** label can be accessed whenever defining an expression, but is only valid when “C” appears on the status line, which indicates a valid expression has been defined.

<NUMBER>

This can be an integer in any base (binary, octal, decimal, or hexadecimal), or can be a string of characters enclosed with quotation marks.

<OP> This represents an algebraic or logical operand and may be any of the following (in order of precedence):

| Operator | Description    |
|----------|----------------|
| mod      | modulo         |
| *        | multiplication |
| /        | division       |
| &        | logical AND    |
| +        | addition       |
| -        | subtraction    |
|          | logical OR     |

**—SYMB—** This allows you to define symbolic information for an address, range of addresses, or a file. See the **—SYMB—** syntax pages and the *SRU User's Guide* for more information on symbols.

**end** This displays the last location where the symbol information may be located. For example, if a particular symbol is associated with a range of addresses, **end** will represent the last address in that range.

**start** This displays the first memory location where the symbol you specify may be located. For example, if a particular symbol is associated with a range of addresses, **start** will represent the first address in that range.

<UNARY> This defines either the algebraic negation (minus) sign (-) or the logical negation (NOT) sign (~).

( ) Parentheses may be used in expressions to enclose numbers. For every opening parenthesis, a closing parenthesis must exist.

When "C" appears on the right side of the status line, a valid expression exists. The **—NORMAL—** key can be accessed at any time, but is only valid when "C" is on the command line.



**Examples**

```
05fxh
DISP_BUF + 5
SYMB_TBL + (OFFSET / 2)
START
cprog.C: line 15 end
```

---

**See Also**

```
help expressions
SYMB
```

---

## FCODE

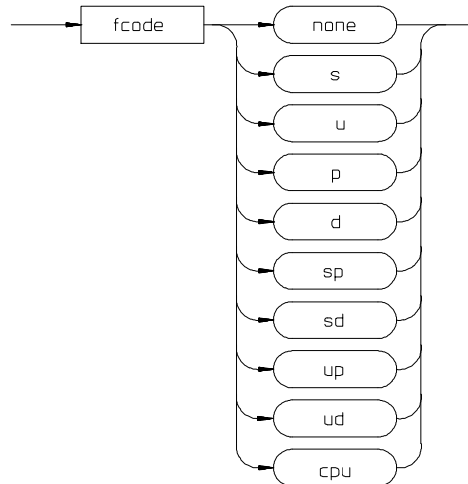

The function code is used to define the address space being referenced. Select the appropriate function code from those listed below.

- |      |   |
|------|---|
| cpu  | CPU space.  |
| d    | Data space.   |
| none | Causes the emulator to ignore the function code bits. |
| p    | Program space.  |
| s    | Supervisor space.                                     |
| sd   | Supervisor data space.                                |
| sp   | Supervisor program space.                             |
| u    | User space.   |
| ud   | User data space.                                      |
| up   | User program space.                                   |

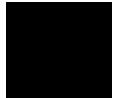

**FCODE**

---

**Examples**

To copy a portion of user data memory to a file:

*copy memory fcode ud 1000H thru 1fffH to mymem <RETURN>*

To modify a location in program memory:

*modify memory fcode p 5000h long to 12345678h <RETURN>*

---

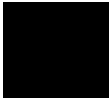

## HELP



Typing **help** or **?** displays softkey labels that list the options on which you may receive help. When you select an option, the system will list the information to the screen.

The **help** command is not displayed on the softkeys. You must enter it at the keyboard. You may use a question mark in place of **help** to access the help information.

<HELP\_FILE>

This represents the name of one of the available help files on the softkey labels. You can either press the softkey that represents the desired help file, or type in the help file name. If you are typing in the help file name, make sure you use the complete syntax. Not all of the softkey labels reflect the complete file name.

---

### Examples

```
help system_commands <RETURN>  
? run <RETURN>
```

To display information about the command named **pod\_command**, enter:

```
help pod_command <RETURN>
```

---

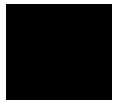

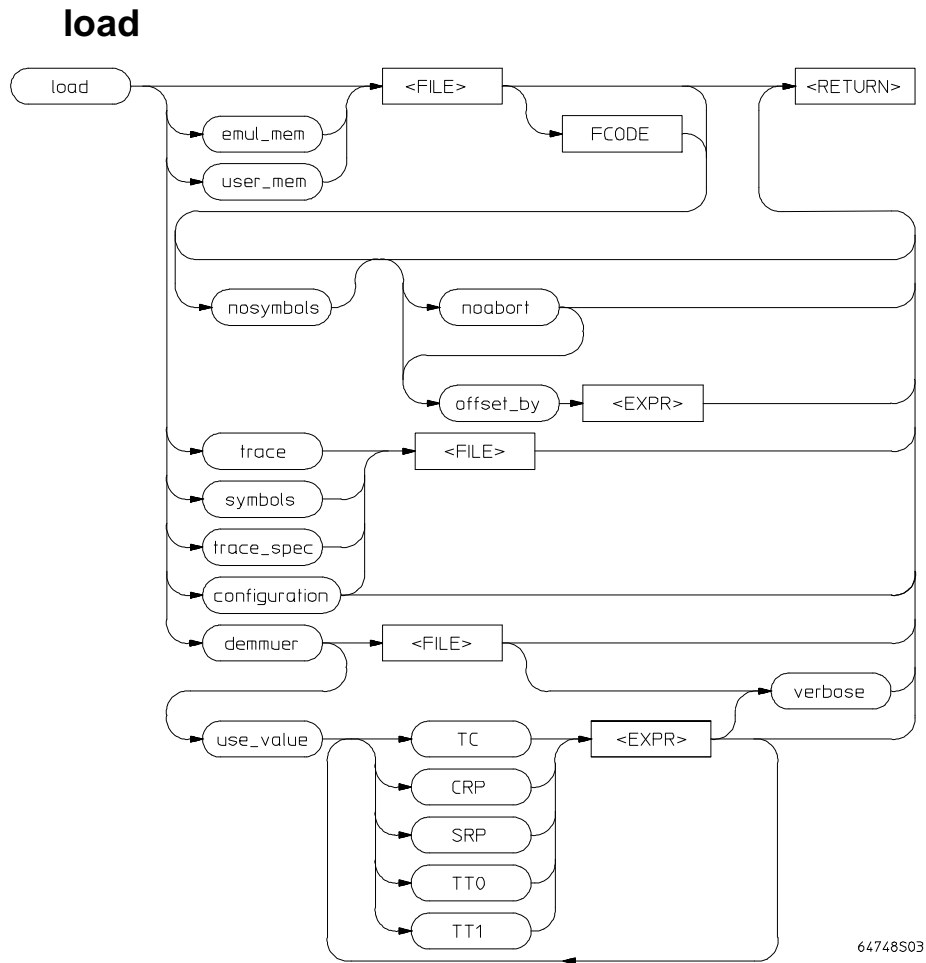

The absolute file contains information about where the file is stored. The memory map specifies that the locations of the file are in user (target system) memory or emulation memory. This command also allows you to access and display previously stored trace data, load a previously created configuration file, and load absolute files with symbols.

Any file specified by <FILE> cannot be named “configuration”, “emul\_mem”, “user\_mem”, “symbols”, “trace”, or “trace\_spec” because these are reserved words, and are not recognized by the emulation system as ordinary file names.



|               |   |
|---------------|---|
|               | The absolute file is loaded into emulation memory by default.   |
| configuration | This option specifies that a previously created emulation configuration file will be loaded into the emulator. You can follow this option with a file name. Otherwise the previously loaded configuration will be reloaded.   |
| demmuer       | This option causes the emulator to read the MMU registers and MMU tables and load the deMMUer with appropriate information to reverse-translate the physical addresses it receives from the emulation bus so it can deliver corresponding logical addresses to the analyzer.  |
| emul_mem      | Load the file into emulation memory hardware. In some emulators, you can also load a background monitor file.   |
| FCODE         | The function code used to define the address space being referenced. See the syntax diagram for FCODE to see a list of the function codes available and for an explanation of those codes.  |
| <FILE>        | This represents the absolute file to be loaded into either target system memory, emulation memory (.X files are assumed), or the trace memory (.TR files are assumed).  |
| noabort       | This option allows you to load a file even if part of the file is located at memory mapped as “guarded” or “target ROM” (trom).   |
| nosymbols     | This option causes the file specified to be loaded without symbols.   |
| offset_by     | This option allows you to offset the listed address values from the actual addresses. The offset value you specify will be subtracted from the actual addresses.  |
| symbols       | This option causes the file specified to be loaded with symbols.  |
| trace         | This option allows you to load a previously generated trace file.   |
| trace_spec    | This option allows you to load a previously generated trace specification.<br><br>The current trace specification will be modified, but a new trace will not be started. To start a trace with the newly loaded trace specification, enter <b>trace again</b> or <b>specify trace again</b> (not <b>trace</b> ). If you specify <b>trace</b> , a new trace will begin with the default trace specification, not the one you loaded. |
| use_value     | Lets you specify a value to be used in place of the present content of the TC, CRP, SRP, TT0, and TT1 registers when reading the tables to determine the reverse translations.  |



## Chapter 11: Emulator Commands

### load

|          |  |
|----------|--|
| user_mem | Load the file into user (target system) memory hardware. In some emulators, you can also load a background monitor file.   |
| verbose  | This options sets the verbose mode for the deMMUer load function. The verbose mode shows a list of the physical address that can be translated by the deMMUer after loading the deMMUer. If these address translations include function codes, the function codes are shown beside the addresses (example: 000000000..003ffffff@sp). |

---

### Examples

```
load sort1 <RETURN>

load configuration config3 <RETURN>

load trace trace3 <RETURN>

load demmuer verbose <RETURN>
```

---

### See Also

```
display trace
display mmu_translations
help load
```

## log\_commands

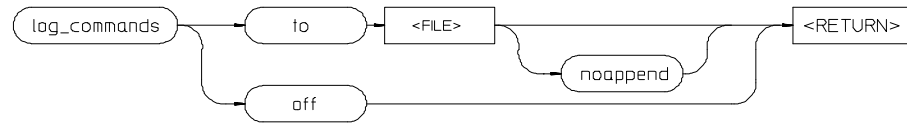

A command file is an ASCII file containing Softkey Interface commands. The interface can read a command file and execute its commands as if they were typed into the command line. Simply type the filename on the command line.

This interface command lets you create command files by logging. When the interface is in logging mode, all commands entered and executed on the command line are also copied to the named file. Once started, logging continues until either logging is turned off or the emulation session is ended.

The **log\_commands** command is not on the softkeys. You must type it into the command line to access the remainder of the log\_commands softkeys. See the User's Guide for information about entering Softkey Interface commands.

- |                     |   |
|---------------------|---|
| <b>&lt;FILE&gt;</b> | This represents the file where you want to store interface commands. If the file does not exist, a new file is created. If the file already exists, the new commands are appended to the present content in the file, unless the <b>noappend</b> option is specified. |
| <b>off</b>          | This option stops command logging.  |
| <b>noappend</b>     | If the named file is an existing file, this option causes the new commands to overwrite any information present in the file. If this option is not specified, new commands are appended to the existing contents of the file.   |

---

### Examples

```
log_commands to logfile
```

```
log_commands off
```

---

### See Also

```
help system_commands
```

## modify

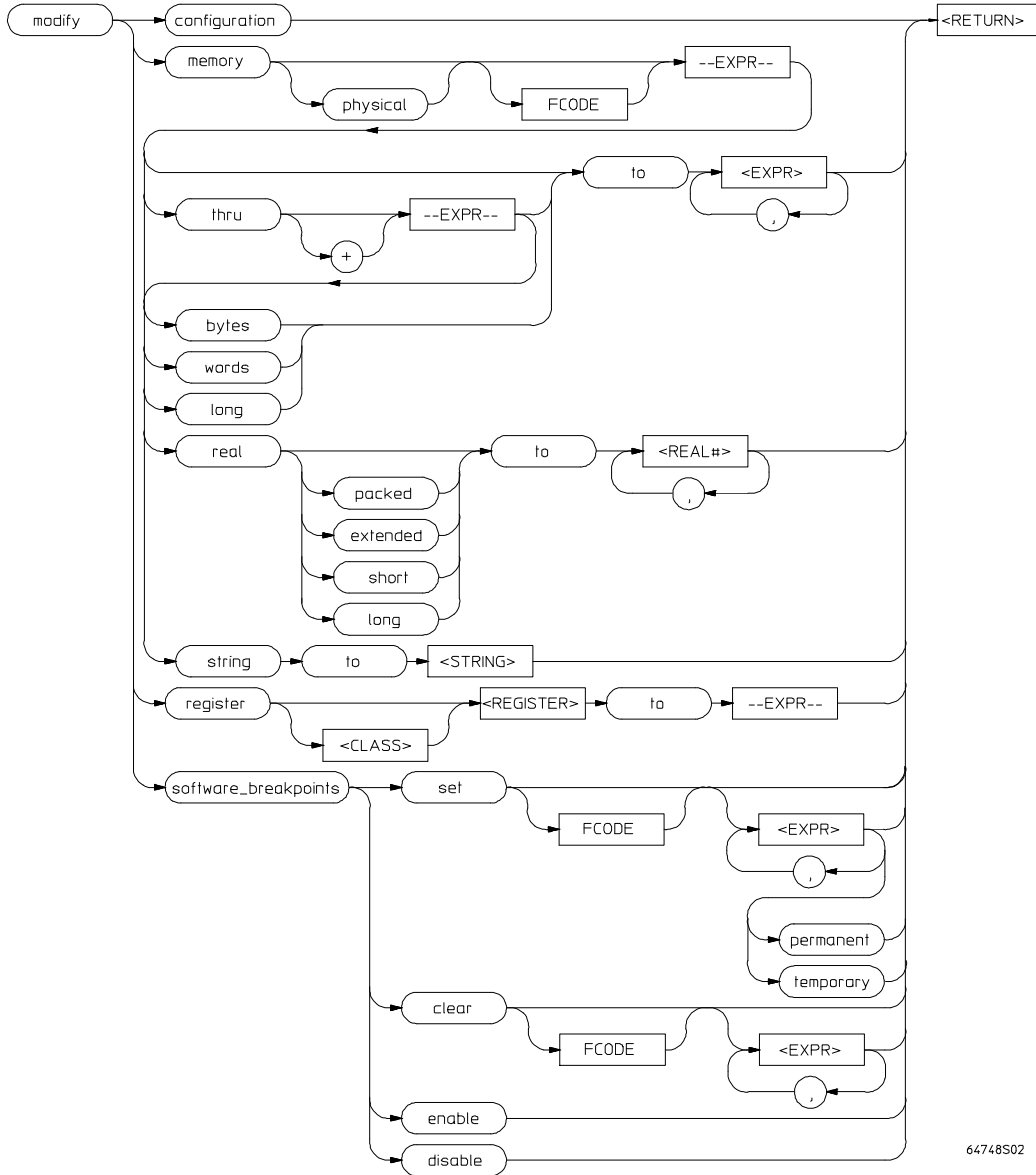

64748502

The **modify** command is used to:

- View or edit the current emulation configuration.
- Modify the contents of memory (as integers, strings, or real numbers).
- Modify the contents of the processor registers.
- Write specified values to I/O port addresses.
- Modify the breakpoints table.

|               |   |
|---------------|---|
| bytes         | Modify using byte values.   |
| <CLASS>       | This represents the name of a processor register class. Register classes are displayed on the softkey labels. See the "register" option for more information.   |
| clear         | This option erases the specified breakpoint address and restores the original content of the memory location. (The location must not have changed (by loading a file or modifying memory) after the breakpoint was set.) If no breakpoints are specified in the command, all currently specified breakpoints are cleared and the memory locations are restored to their original values.  |
| ,             | A comma is used as a delimiter between values when modifying multiple values.   |
| configuration | <p>The configuration questions are presented in sequence with either the default response, or the previously entered response. You can select the currently displayed response by pressing &lt;RETURN&gt;. Otherwise, you can modify the response as you desire, then press &lt;RETURN&gt;.</p> <p>For each emulator, default responses defined on powerup are displayed. For more information, refer to Chapter 8, "Configuring the Emulator."</p> |
| —EXPR—        | An expression is a combination of numeric values, symbols, operators, and parentheses, specifying a value. See the —EXPR— syntax diagram.   |
| extended      | This option allows you to modify memory as 96-bit IEEE real numbers.  |
| FCODE         | The function code used to define the address space being referenced. See the syntax diagram for FCODE to see a list of the function codes available and for an explanation of those codes.  |
| long          | Modify memory as long word values. When used with the <b>real</b> parameter, <b>long</b> specifies that memory be modified as a 64-bit IEEE-754 real number value.  |



## Chapter 11: Emulator Commands

### modify

#### memory

You can modify the contents of individual memory locations to individual values, or you can modify a range of memory to a single value or a sequence of values.

Modify a series of memory locations by specifying the address of the first location in the series to be modified, and the values to which the contents of that location and successive locations are to be changed. The first value listed will replace the contents of the first memory location. The second value replaces the contents of the next memory location in the series, and so on, until the list is exhausted. When more than one value is listed, the value representations must be separated by commas. (See the examples for more information.)

A range of memory can be modified such that the content of each location in the range is changed to the single specified value, or to a single or repeated sequence. This type of memory modification is done by entering the limits of the memory range to be modified (`—EXPR—` thru `—EXPR—`) and the value or list of values (`—EXPR—, ... , —EXPR—`) to which the contents of all locations in the range are to be changed.

If the specified address range is not large enough to contain the new data, only the specified addresses are modified.

If the address range contains an odd number of bytes and a word operation is being executed, the last word of the address range will be modified. Thus the memory modification will stop one byte after the end of the specified address range.

If an error occurs in writing to memory (to guarded memory or target memory with no monitor) the modification is aborted at the address where the error occurred.

Memory modifications of integer values use the currently set display memory mode. Byte is the default.

Memory modifications of "real" values use the currently set display memory mode. Short is the default.

#### packed

This option allows you to modify memory as 96-bit Motorola-format packed real numbers.

#### permanent

This option allows you to set a breakpoint that remains at the breakpoint address and causes a break each time it is hit during execution. It is not automatically replaced by the target-program instruction when it is hit. Permanent breakpoints can only be set if your version of HP 64700 system firmware is A.04.00 or greater.

#### physical

This allows you to specify that the addresses to be modified are addresses in physical memory.

|                          |  |
|--------------------------|--|
| real                     | Modify memory as real number values.   |
| <REAL#>                  | This prompts you to enter a real number as the value.  |
| register                 | <p>The entry you specify for &lt;REGISTER&gt; determines which register is modified.</p> <p>Register modification cannot be performed during real-time operation of the emulation processor. A <b>break</b> command, or a condition that causes the emulator to break to the monitor, must occur before you can modify registers. Basic registers include: PC, STATUS, USP, ISP, MSP, CACR, CAAR, D0 through D7, A0 through A7, VBR, DFC, and SFC.</p> <p>Other registers you can modify include:</p> <p>The FPU registers (if your target system is equipped with a floating point coprocessor): FPCR, FPSR, FPIAR, and FP0 through FP7.</p> <p>The ACU registers (if you are using an MC68030/EC030 with the MMU disabled): AC0, AC1, and ACUSR.</p> <p>The MMU registers (if you are using an MC68030 with the MMU enabled): TT0, TT1, MMUSR, TC, SRP, and CRP.</p> |
| <REGISTER>               | This represents the name of a register that you specify.   |
| set                      | This option allows you to activate breakpoints in your program. If no breakpoint addresses are specified in the command, all breakpoints that have been inactivated (executed) are reactivated.  |
| short                    | Modify memory values as 32-bit IEEE-754 real numbers.  |
| software<br>_breakpoints | <p>Breakpoints allow you to break program execution when the breakpoint address is encountered. Any valid address (number, label, or expression) may be specified as a breakpoint. Valid addresses identify the first byte of valid instructions. Operation of the program can be resumed after the breakpoint is encountered, by specifying either a <b>run</b> or <b>step</b> command.</p> <p>If you modify breakpoints while the memory mnemonic display is active, the new breakpoints are indicated by a “*” in the leftmost column of the instruction containing the breakpoint.</p> <p>Do not modify breakpoints while your target program is running. If you do, program execution may be unpredictable.</p> <p>You must enable breakpoints before you can perform an action on them.</p>  |



## Chapter 11: Emulator Commands

### modify

When you set breakpoints, the emulator will search through the existing breakpoint list and reactivate all entries that are inactivated.

When you clear breakpoints, the entire breakpoint list is deleted and memory is restored to its original values.

disable            This option turns off the breakpoint capability.

enable            This option allows you to modify the breakpoint specification.

string

Modify memory values to the ASCII character string given by <STRING>.

<STRING>

A quoted ASCII string, which may include the following special characters:

|                 |  |
|-----------------|--|
| null            | \0                                     |
| newline         | \n                                     |
| horizontal tab  | \t                                     |
| backspace       | \b                                     |
| carriage return | \r                                     |
| form feed       | \f                                     |
| backslash       | \\                                     |
| single quote    | \'                                     |
| bit pattern     | \OOO (where OOO is<br>an octal number) |

temporary

This option allows you to set a breakpoint that is in effect only the first time it is hit during execution. It is automatically replaced by the target-program instruction when it is hit. Temporary breakpoints (the default breakpoints) differ from permanent breakpoints which can only be set if your version of HP 64700 system firmware is A.04.00 or greater.

thru

This option lets you specify a range of memory locations to be modified.

to

This lets you specify values to which the selected memory locations or register will be changed.

words

This lets you modify memory in word format.



---

**Examples**

```
modify configuration <RETURN>

modify keyboard_to_simio <RETURN>

modify memory 00A0H words to 1234H <RETURN>

modify memory DATA1 bytes to 0E3H , 01H , 08H <RETURN>

modify memory DATA1 thru DATA100 to 0FFFFFFH <RETURN>

modify memory 0675H real to -1.303 <RETURN>

modify memory TEMP real long to 0.5532E-8 <RETURN>

modify memory buffer string to "This is a test \n\0"

display memory blocked bytes

modify memory Msg_Dest thru +50 to 41h, 42h, 43h

modify memory Msg_Dest string to "HP 64000 Softkey
Interface"

modify memory Msg_Dest thru +50 to 0

modify register D0 to 9H <RETURN>

modify register BASIC PC to 2000H <RETURN>

modify software_breakpoints enable <RETURN>

modify software_breakpoints clear 99H , 1234H <RETURN>
```

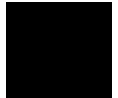

## Chapter 11: Emulator Commands

### **modify**

```
modify software_breakpoints set LOOP1 END ,  
LOOP2END , 0EH <RETURN>
```

```
modify software_breakpoints set <RETURN>
```

---

### **See Also**

```
copy memory  
copy registers  
copy software_breakpoints  
display memory  
display registers  
display software_breakpoints  
help modify  
help registers  
help software_breakpoints  
modify registers  
store memory
```

## **performance\_measurement\_end**



This command stores data previously generated by the **performance\_measurement\_run** command, in a file named “perf.out” in the current working directory.

The file named “perf.out” is overwritten each time this command is executed. This command does not alter current measurement data in the emulation system.

---

### **Example**

```
performance_measurement_end <RETURN>
```

---

### **See Also**

```
help performance_measurement_initialize  
help performance_measurement_run  
performance_measurement_initialize  
performance_measurement_run
```

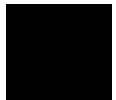

## performance\_measurement\_initialize

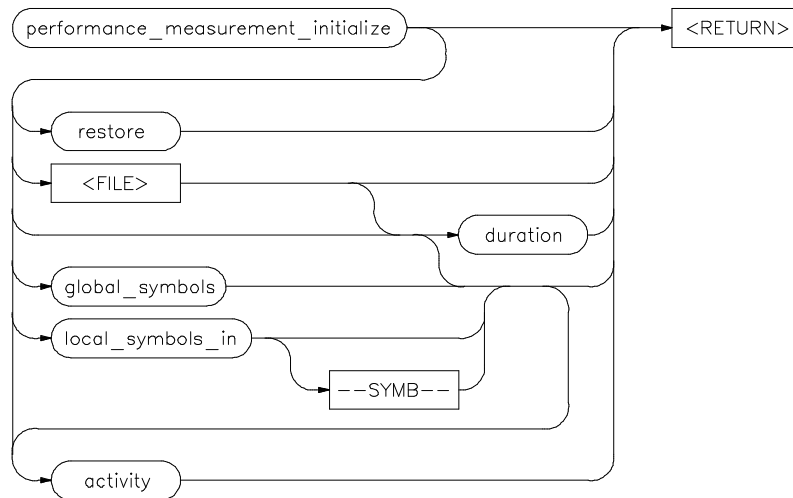

This command sets up performance measurements. The emulation system will verify whether a symbolic database has been loaded. If a symbolic database has been loaded, the performance measurement is set up with the addresses of all global procedures and static symbols. If a valid database has not been loaded, the system will default to a predetermined set of addresses, which covers the entire emulation processor address range.

The measurement will default to “activity” mode.

Default values will vary, depending on the type of operation selected, and whether symbols have been loaded.

- |  |  |
|--|--|
| <div style="background-color: black; width: 20px; height: 20px; display: inline-block; margin-bottom: 5px;"></div> <b>activity</b> | This option causes the performance measurement process to operate as though an option is not specified.  |
| <b>duration</b>  | This option sets the measurement mode to “duration.” Time ranges will default to a predetermined set (unless a user-defined file of time ranges is specified). |
| <b>&lt;FILE&gt;</b>  | This represents a file you specify to supply user-defined address or time ranges to the emulator.  |
| <b>global_symbols</b>  | This option specifies that the performance measurement will be set up with the addresses of all global symbols and procedures in the source program.           |

|                  |  |
|------------------|--|
| local_symbols_in | This uses local symbols as the default ranges for the measurement.   |
| restore          | This restores old measurement data so that the current measurement can be continued when using the <b>trace</b> command used previously.   |
| —SYMB—           | This represents the source file that contains the local symbols to be listed. This also can be a program symbol name, in which case all symbols that are local to a function or procedure are used. See the SYMB syntax diagram. |

---

**Examples**

```
performance_measurement_initialize <RETURN>

performance_measurement_initialize duration <RETURN>

performance_measurement_initialize local_symbols_in
prog68k.S: <RETURN>
```

---

**See Also**

```
help performance_measurement_initialize
help performance_measurement_run
performance_measurement_run
performance_measurement_end
```

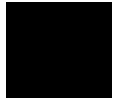

## performance\_measurement\_run

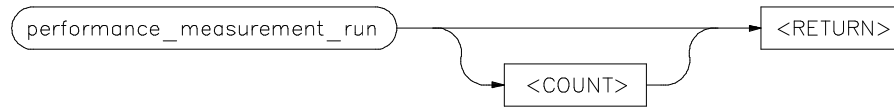

This command begins a performance measurement. It causes the emulation system to reduce trace data contained in the emulation-bus analyzer. The resulting data is used for analysis by the performance measurement software.

The default is to process data presently contained in the analyzer.

`<COUNT>`

This represents the number of consecutive traces you specify. The emulation system will execute the `trace` command, process the resulting data, and combine it with existing data. This sequence will be repeated the number of times specified by the **COUNT** option.

The **trace** command must be set up correctly for the requested measurement. For an activity measurement, you can use the default **trace** command (**trace counting time <RETURN>**).

For a duration measurement, you must set up the trace specification to store only the points of interest. To do this, for example, you could enter:

***trace only*** `<symbol_entry>` **or** `<symbol_exit>`

---

### Examples

```
performance_measurement_run 10 <RETURN>
```

```
performance_measurement_run <RETURN>
```

### See Also

```
help performance_measurement_initialize  
help performance_measurement_run  
performance_measurement_end  
performance_measurement_initialize
```

## pod\_command

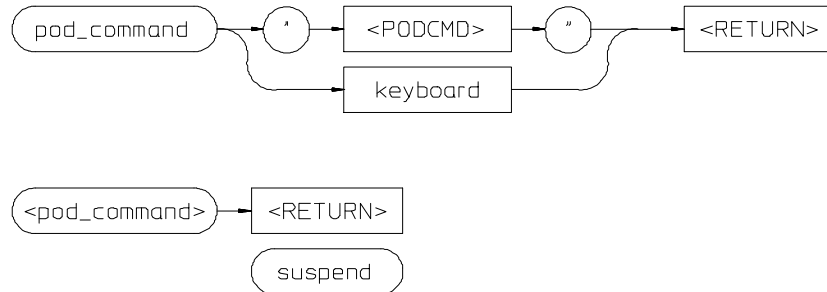

The HP 64700 Series emulators contain a low-level Terminal Interface, which allows you to control the emulator's functions directly. You can issue Terminal Interface commands through the Softkey Interface by using **pod\_command**. With **pod\_command**, you can issue a single command, or enter the keyboard mode which allows you to enter a series of commands.

The *MC68020 and MC68030/EC030 Emulator Terminal Interface User's Guide* is an excellent source of information about using the Terminal Interface to control the emulator. There are certain commands you should avoid while using the Terminal Interface through **pod\_command**, however, because these commands can affect the operation of the Softkey Interface. See the User's Guide and the Terminal Interface screen for more information about Terminal Interface commands that should not be used.

Although you can issue Terminal Interface commands via this command, you cannot see the results of those commands unless you display the Terminal Interface screen with **display pod\_command**.

|           |  |
|-----------|--|
| keyboard  | Enters an interactive mode where you can simply type Terminal Interface commands (unquoted) on the command line. Use <b>display pod_command</b> to see the results returned from the emulator. |
| <POD_CMD> | Prompts you for a Terminal Interface command as a quoted string. Enter the command in quotes and press <RETURN>.   |
| suspend   | This command is displayed once you have entered keyboard mode. Select it to stop interactive access to the Terminal Interface and return to the Softkey Interface.                             |

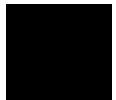

**pod\_command**

---

**Examples**

This example shows a simple interactive session with the Terminal Interface.

```
display pod_command  
pod_command keyboard
```

```
cf
```

```
tsq
```

```
tcq
```

Enter **suspend** to return to the Softkey Interface.

---

**See Also**

```
display pod_command  
help pod_command
```

Also see the *MC68020 and MC68030/EC030 Emulator Terminal Interface User's Guide*.





## QUALIFIER

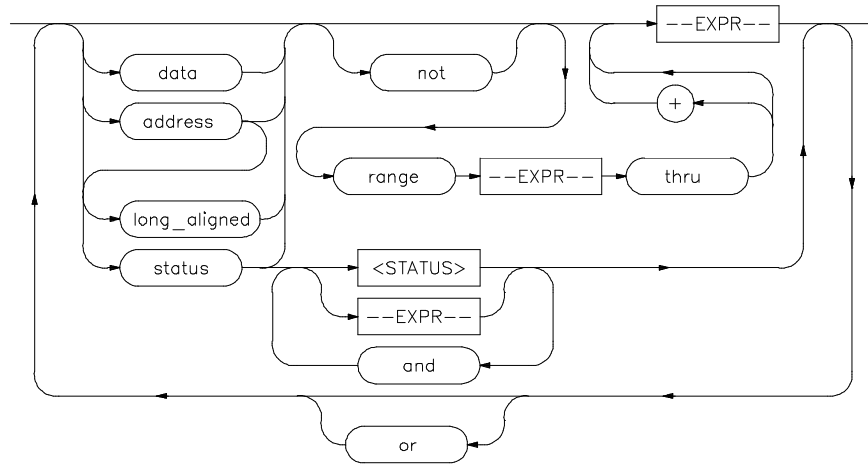

The **QUALIFIER** parameter is used with **trace only**, **trace prestore**, **TRIGGER**, and **trace counting** to specify states captured during the trace measurement.

You may specify a range of states or specific states to be captured. You can specify a unique combination of address/data/status values as conditions for the trace measurement. You can continue to “or” states until the analyzer resources are depleted. You can use only one ‘range’ statement in the entire **trace** command.

You can include “don’t care numbers.” These contain an “x” preceded and/or followed by a number. Some examples include 1fxxh, 17x7o, and 011xxx10b. “Don’t care numbers” may be entered in binary, octal, or hexadecimal base.

Expression types are “address” when none is chosen. The default is to qualify on all states.

- address** This specifies that the expression following is an address value. This is the default, and is therefore not required on the command line when specifying an address expression.
- and** This lets you specify a combination of status and expression values when **status** is specified in the state specification.

## Chapter 11: Emulator Commands

### QUALIFIER

|              |   |
|--------------|---|
| data         | This specifies that the expression that follows is a data value on the emulation processor data bus.  |
| —EXPR—       | An expression is a combination of numeric values, symbols, operators, and parentheses, specifying an address, data, or status value. See the EXPR syntax diagram.   |
| long_aligned | Causes a mask to be applied to the address to force it to a long word boundary (least significant hex digit is 0, 4, 8, or C). This is necessary because the emulation-bus analyzer may not otherwise see the address on the address bus due to the way the processor fetches instructions.   |
| not          | This specifies that the analyzer search for the logical “not” of the specified range or state, that is addresses not in the specified range or an address not in the specified state.   |
| or           | This option allows you to specify multiple states to be captured during a trace measurement.  |
| range        | This indicates a range of addresses to be specified (—EXPR— thru —EXPR—).   |
| status       | This specifies that the expression following, or status word, is a status value for the processor.  |
| <STATUS>     | This prompts you to enter a status value in the command line. Status values can be entered from softkeys or typed into the keyboard. Numeric values may include symbols, operators, and parentheses. See the EXPR syntax diagram. Refer to Chapter 5, "Using the Emulation-Bus Analyzer," for a list of predefined status equates that cover common processor operations. |
| thru         | This indicates that the following address expression is the upper address in a range.   |

---

**Examples**

```
trace only address prog68k.S:READ_INPUT <RETURN>
```

```
trace only address range prog68k.S:READ_INPUT thru  
OUTPUT <RETURN>
```

```
trace only address range prog68k.S:CLEAR thru  
READ_INPUT <RETURN>
```

---

Also see the **trace** command examples.

**See Also**

```
help trace  
trace
```

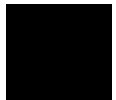

**reset**

---

**reset**

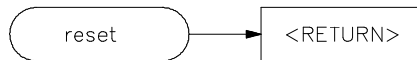

This command suspends target system operation and asserts the reset signal on the emulation processor. The reset signal is latched when the **reset** command is executed, and is released by either the **run** or **break** command.

---

**Example**

```
reset <RETURN>
```

---

**See Also**

```
help reset
```

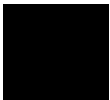

run

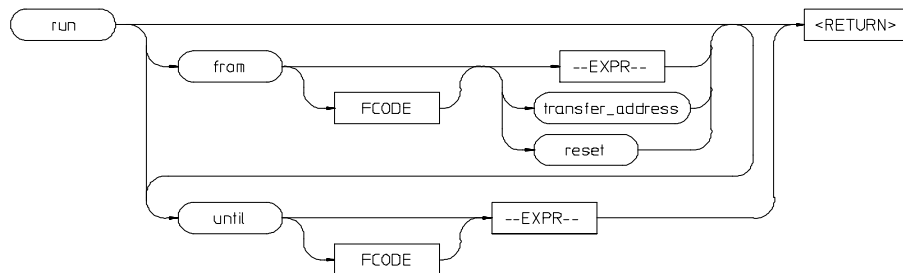

This command causes the emulator to execute a program. If the processor is in the reset state, **run** releases the reset condition. If you specify **run from —EXPR—** or **run from transfer\_address**, the processor is directed to the particular address. If the processor is running in the emulation monitor or background memory, a **run** command causes the processor to exit into your program. The program can either run from a specified address (**—EXPR—**), from the address stored in the emulation processor program counter, or from a label specified in the program.

For an explanation of how the emulator runs from a reset condition (using the **run from reset** command), refer to the paragraph titled "To run a program" in Chapter 4, "Using the Emulator".

If you omit the address option (**—EXPR—**), the emulator begins program execution at the current address specified by the emulation processor program counter. If an absolute file containing a transfer address has just been loaded, execution starts at that address.

**—EXPR—**

An expression is a combination of numeric values, symbols, operators, and parentheses, specifying a memory address. See the EXPR syntax diagram.

**FCODE**

The function code used to define the address space being referenced. See the syntax diagram for FCODE to see a list of the function codes available and for an explanation of those codes.

**from**

This specifies the address where program execution is to begin.

**reset**

This option starts the processor executing from the reset vector address.



## Chapter 11: Emulator Commands

### **run**

**transfer\_address** This represents the starting address of the program loaded into emulation or target memory. The transfer address is defined in the linker map.

**until** Specifies an address where execution is to stop. The emulator will execute your target program up to the point where the **until** address is found. Execution will stop at the **until** address, and the emulator will begin executing the emulation monitor.

---

### **Examples**

```
run <RETURN>
```

```
run from 810H <RETURN>
```

```
run from COLD_START <RETURN>
```

```
run from TEST_START until TEST_POINT_1 <RETURN>
```

---

### **See Also**

```
help run  
help step  
step
```

## SEQUENCING

From trace  
syntax diagram

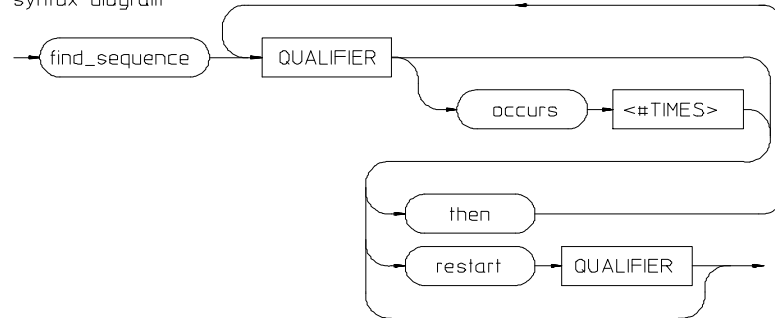

Sequencing provides you with parameters for the **trace** command that let you define branching conditions for the analyzer trigger.

You are limited to a total of seven sequence terms, including the trigger, if no windowing specification is given. If windowing is selected, you are limited to a total of four sequence terms.

The analyzer default is no sequencing terms. If you select the sequencer using the `find_sequence` parameter, you must specify at least one qualifying sequence term.

|                            |   |
|----------------------------|---|
| <code>find_sequence</code> | Specifies that you want to use the analysis sequencer. You must enter at least one qualifier.   |
| QUALIFIER                  | Specifies the address, data, or status value or value range that will satisfy this sequence term if looking for a sequence ( <code>find_sequence</code> ), or will restart at the beginning of the sequence ( <code>restart</code> ). See the QUALIFIER syntax pages for further information. |
| occurs                     | Selects the number of times a particular qualifier must be found before the analyzer proceeds to the next sequence term or the trigger term. This option is not available when trace windowing is in use. See the <b>WINDOW</b> syntax pages.   |
| <#TIMES>                   | Prompts you for the number of times a qualifier must be found.  |
| then                       | Allows you to add multiple sequence terms, each with its own qualifier and occurrence count.  |

## SEQUENCING

**restart** Selects global restart. If the analyzer finds the restart qualifier while searching for a sequence term, the sequencer is reset and searching begins for the first sequence term.

---

### Examples

The following example uses symbols from an imaginary program that performs a series of tests in sequence. Occasionally test2 completes but does not start test3 (instead, it jumps directly to test 9). The following trace command would be used to capture a trace only when the program fails to step from test2 to test 3 so you could look at activity associated with this program failure:

*display trace*

```
trace find_sequence test1 then test2 restart test3  
trigger about not range test3 thru test3 end
```

---

### See Also

*trace*  
QUALIFIER  
WINDOW  
help *trace*



**set**

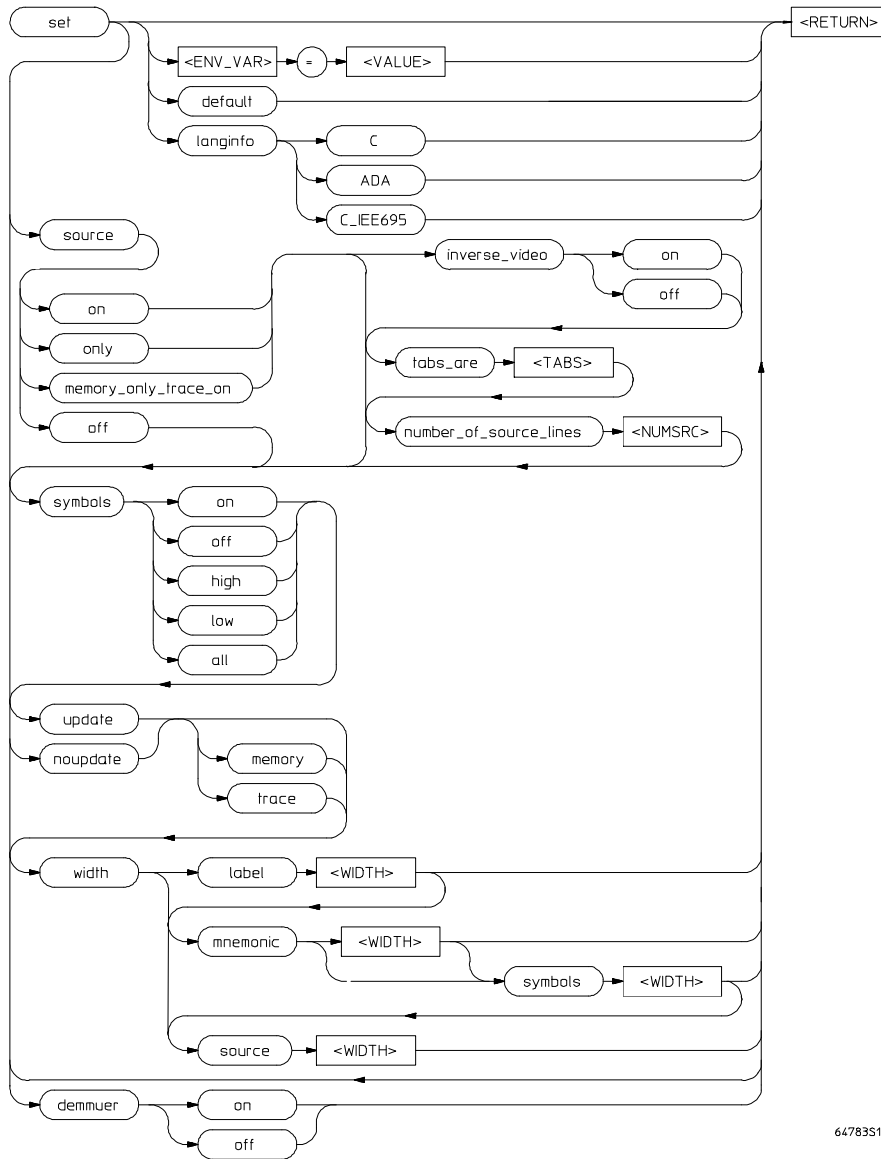

64783518

## Chapter 11: Emulator Commands

### set

With the **set** command, you can adjust the display format results for various measurements, making them easier to read and interpret.

Formatting of source lines, symbol display selection and width, and update after measurement can be modified to your needs.

The display command uses the **set** command specifications to format measurement results for the display window.

Another option to the **set** command, **<ENV\_VAR> = <VALUE>**, allows you to set and export system variables.

The default display format parameters are the same as those set by the commands:

```
set update  
set source off symbols off
```

You can return the display format to this state by simply using the command:

```
set default
```

default

This option restores all the set options to their default settings.

demmuer

on                    This option turns on the deMMUer. Addresses on the emulation bus will be reverse-translated (physical to logical) before being supplied to the analyzer. Reverse translations will be made according to the setup that was present in the MMU at the time you entered your last **load demmuer** command.

off                   This option turns off the deMMUer. Addresses on the emulation bus will be supplied directly to the analyzer without translation.

 <ENV\_VAR>

Specifies the name of an environment variable to be set within the HP 64000-UX environment or the system environment.

=

The equals sign is used to equate the <ENV\_VAR> parameter to a particular value represented by <VALUE>.

inverse video

- off                    This displays source lines in normal video.
- on                    This highlights the source lines on the screen (dark characters on light background) to differentiate the source lines from other data on the screen.

langinfo

In certain languages, you may have symbols with the same names but different types. For example, in IEEE695, you may have a file named main.c and a procedure named main. SRU would identify these as main(module) and main(procedure). The command **display local\_symbols\_in main** would cause an error message to appear (Ambiguous symbol: main(procedure, module)). Users of C tend to think the procedure is important and users of ADA tend to think the module is important. By entering "langinfo" and "C", SRU will interpret the above command to be **main(procedure)**. With langinfo ADA, SRU will interpret the above command to be **main(module)**.

- C                    Identifies ANSI C as the language so SRU can use the C hierarchy to disambiguate symbols.
- ADA                Identifies ADA as the language so SRU can use the ADA hierarchy to disambiguate symbols.
- C\_IEEE695        Identifies C\_IEEE-695 as the language so SRU can use the C\_IEEE-695 hierarchy to disambiguate symbols.

---

**Note**

An alternate method for making the langinfo specification is to use the environment variable, HP64SYMORDER. By making the following entry in your **.profile**, the langinfo setting will always be C, for example.

```
HP64SYMORDER=C        #I want to use the C disambiguating hierarchy
export HP64SYMORDER    #let children processes know about it
```

memory

Specifies the type of display to be updated or not updated.

noupdate

This option stops the display buffer in a window or terminal from updating when a new measurement completes. Without this option, displays that show memory contents are updated when a command executes that changes the values in memory (modify memory, load, etc.).

## Chapter 11: Emulator Commands

### set

number\_of\_  
source\_lines

This allows you to specify the number of source lines to be displayed above the program instructions or trace data to which they correlate. Displays may contain several blocks of source lines, with each block followed by program code or emulation-bus activity. Each block of source lines can begin with the next source line following the preceding block. If a particular block contains a lot of comment lines, the block can become very big. This option lets you specify a number to limit the size of the blocks of source lines. The default value is 5.

<NUMSRC>

This prompts you for the number of source lines to be displayed. Enter a value from 1 through 50.

source

memory\_only\_  
trace\_on

This provides a way to default the memory and trace displays to a setting that HP believes is the nicest possible formats for memory and trace displays. Parameters such as "source on/only", number of source lines to show, display width, and turning symbols on are all governed by this one selection. With this selection, memory displays will show the maximum available source lines preceding each block of code, and trace lists will show five source lines preceding trace data.

off

This option prevents inclusion of source lines in the trace and memory mnemonic display lists.

on

This option displays source program lines preceding the processor instructions to which they correlate. This enables you to correlate processor instructions with source program code. The option is available in both the trace list and memory mnemonic displays.

only

This option displays only source lines. Processor instructions are only displayed in memory mnemonic if no source lines correspond to the instructions. Processor instructions are never displayed in the trace list.

symbols

- off Prevents symbol display.
- on Displays symbols. This option works for the trace list, memory, breakpoints, and register step mnemonics.
- high Displays only high level symbols, such as those available from a compiler. See the *Symbolic Retrieval Utilities User's Guide* for a detailed discussion of symbols.
- low Displays only low level symbols, such as those generated internally by a compiler or an assembler.
- all Displays all symbols.

tabs\_are

This option allows you to define the number of spaces inserted for tab characters in the source listing.

<TABS> Prompts you for the number of spaces to use in replacing the tab character. Enter values in the range of 2 through 15.

trace

Specifies the type of display to be updated or not updated.

update

When using multiple windows or terminals, and specifying this option, the display buffer in that window or terminal will be updated when a new measurement completes. This is the default. Note that for displays that show memory contents, the values will be updated when a command executes that changes memory contents (such as modify memory, load, and so on).

<VALUE>

Specifies the logical value to which a particular UNIX or HP 64000-UX system environment variable is to be set.

width

source This allows you to specify the width (in columns) of the source lines in the memory mnemonic display. To adjust the width of the source lines in the trace display, increase the widths of the label and/or mnemonic fields.

label This lets you specify the address width (in columns) of the address field in the trace list or label (symbols) field in any of the other displays.



## Chapter 11: Emulator Commands

### set

|          |   |
|----------|---|
| mnemonic | This lets you specify the width (in columns) of the mnemonic field in memory mnemonics, trace list and register step mnemonics displays. It also changes the width of the status field in the trace list. |
| symbols  | This lets you specify the maximum width of symbols in the mnemonic field of the trace list, memory mnemonic, and register step mnemonic displays.   |
| <WIDTH>  | This prompts you for the column width of the source, label, mnemonic, or symbols field.   |
|          | <CTRL>f and <CTRL>g may be used to shift the display left or right to display information which is off the screen.  |

---

### Examples

```
set noupdate

set source on inverse_video on tabs_are 2

set symbols on width label 30 mnemonic 20

set PRINTER = "lp -s"

set HP64KSYMBPATH=".file1:proc1
.file2:proc2:code_block_1"
```

---

### See Also

```
display data
display memory
display software_breakpoints
display trace
```

## specify

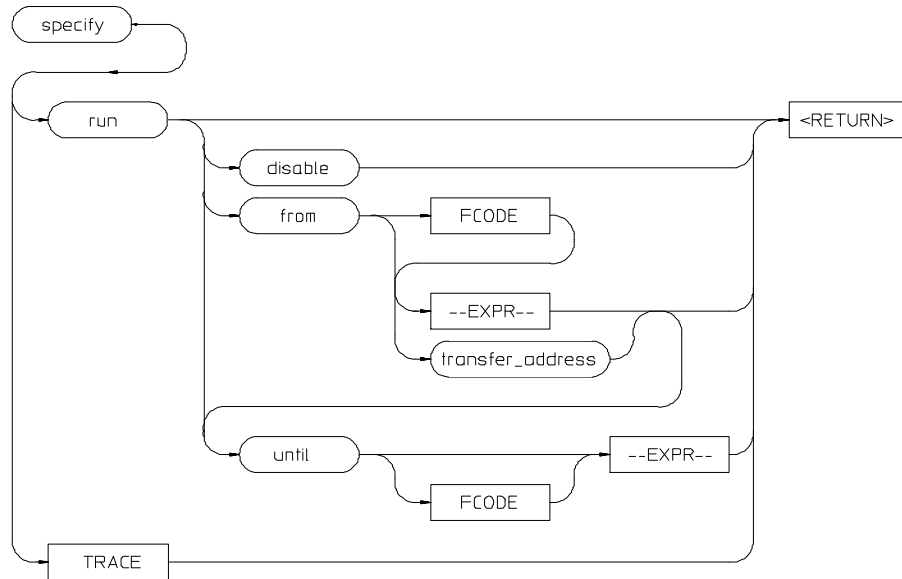

This command prepares a **run** or **trace** command for execution, and is used with the **cmb\_execute** command. When you precede a **run** or **trace** command with **specify**, the system does not execute your command immediately. Instead, it waits until you enter a **cmb\_execute** command.

If the processor is reset and no address is specified, a **cmb\_execute** command will run the processor from the “reset” condition.

The **run** specification is active until you enter **specify run disable**. The trace specification is active until you enter another **trace** command without the **specify** prefix.

The emulator will run from the current program counter address, unless otherwise directed.

**disable**

This option turns off the specify condition of the **run** process.

**specify**

from

—EXPR— This is used with the **specify run from** command. An expression is a combination of numeric values, symbols, operators, and parentheses specifying a memory address. See the EXPR syntax diagram.

FCODE The function code used to define the address space being referenced. See the syntax diagram for FCODE to see a list of the function codes available and for an explanation of those codes.

transfer  
\_address This is used with the **specify run from** command, and represents the address from which the program will begin running.

run This option specifies that the emulator will run from either an expression or from the transfer address when a CMB EXECUTE signal is received.

TRACE This option specifies that a trace measurement will be taken when a CMB EXECUTE signal is received.

until Specifies an address where program execution is to stop. The emulator will stop execution of your program when it reaches this address and enter the monitor.

---

**Examples**

```
specify run from START <RETURN>
```

```
specify trace after address 1234H <RETURN>
```

---

**See Also**

*cmb\_execute*  
help *specify*



**step**

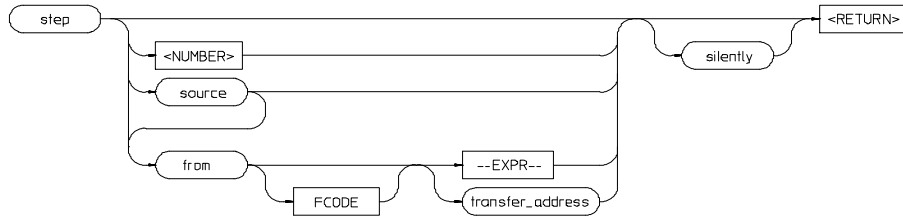

The **step** command allows sequential analysis of program instructions by causing the emulation processor to execute a specified number of assembly instructions or source lines.

You can display the contents of the processor registers, trace memory, and emulation or target memory after each **step** command.

Source line stepping is implemented by single stepping through assembly instructions until the next PC is beyond the address range of the current source line. When attempting source line stepping on assembly code (with no associated source line), stepping will complete when a source line is found. Therefore, stepping only assembly code may step indefinitely. To abort stepping, type <CTRL>c.

When displaying memory mnemonic and stepping, the next instruction that will step is highlighted. The memory mnemonic display autopages to the new address if the next PC goes outside of the currently displayed address range. This feature works even if stepping is performed in a different emulation window than one displaying memory mnemonic (see the discussion on opening and using other interface windows in Chapter 3, "Using the Emulator/Analyzer Interface").

If no value is entered for <NUMBER> times, only one **step** instruction is executed each time you press <RETURN>. Multiple instructions can be executed by holding down the <RETURN> key. Also, the default step is for assembly code lines, not source code lines.

If the **from** address option (defined by —EXPR— or transfer\_address) is omitted, stepping begins at the next program counter address.

—EXPR—

An expression is a combination of numeric values, symbols, operators, and parentheses specifying a memory address. See the EXPR syntax diagram.

## Chapter 11: Emulator Commands

### **step**

|                  |   |
|------------------|---|
| FCODE            | The function code used to define the address space being referenced. See the syntax diagram for FCODE to see a list of the function codes available and for an explanation of those codes.  |
| from             | Use this option to specify the address from which program stepping begins.  |
| <NUMBER>         | This defines the number of instructions that will be executed by the <b>step</b> command. The number of instructions to be executed can be entered in binary (B), octal (O or Q), decimal (D), or hexadecimal (H) notation.   |
| silently         | This option updates the register step mnemonic only after stepping is complete. This will speed up instruction stepping. The default is to update the register step mnemonic after each assembly instruction (or source line) executes (if stepping is performed in the same window as the register display). |
| transfer_address | This represents the starting address of the program you loaded into emulation or target memory. The <b>transfer_address</b> is defined in the linker map.   |
| source           | This option performs stepping on source lines.  |

---

### **Examples**

```
step <RETURN>

step from 810H <RETURN>

step 20 from 0A0H <RETURN>

step 5 source <RETURN>

step 20 silently <RETURN>

step 4 from main
```

---

**See Also**

*help step*  
*display registers*  
*display memory mnemonic*  
*set symbols*

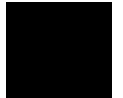

## **stop\_trace**



This command terminates the current trace and stops execution of the current measurement. The analyzer stops searching for trigger and trace states. If trace memory is empty (no states acquired), nothing will be displayed.

---

### **Example**

```
stop_trace <RETURN>
```

---

### **See Also**

```
help stop_trace  
trace
```

**store**

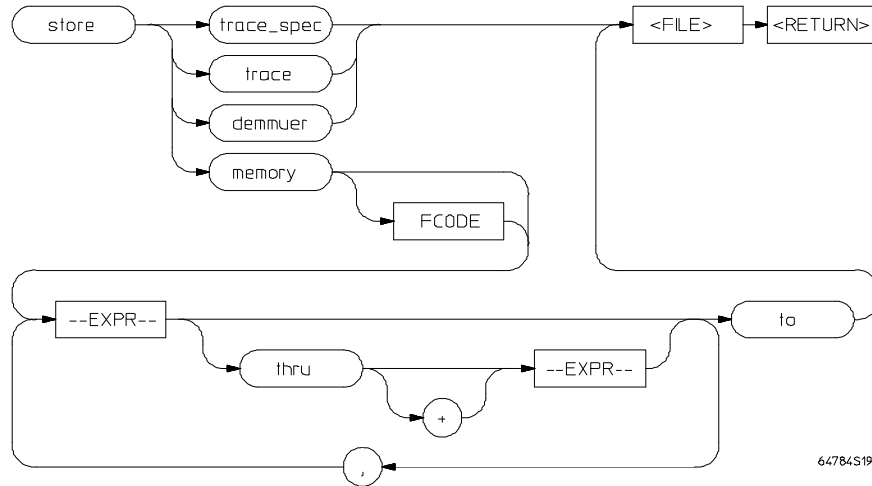

64784519

This command lets you save the contents of specific memory locations in an absolute file. You also can save trace memory contents in a trace file. A new file is created with the name you specify, if there is not already an absolute file with the same name. If a file represented by <FILE> already exists, you must decide whether to keep or delete the old file. If you respond with **yes** to the prompt, the new file replaces the old one. If you respond with **no**, the **store** command is canceled and no data is stored.

The transfer address of the absolute file is set to zero.

demmuer

This causes the emulator to read the content of the MMU tables and store the appropriate demmuer setup in a file you name, with a **.ED** extension.

—EXPR—

This is a combination of numeric values, symbols, operators, and parentheses, specifying a memory address. See the EXPR syntax diagram.

FCODE

The function code used to define the address space being referenced. See the syntax diagram for FCODE to see a list of the function codes available and for an explanation of those codes.

## Chapter 11: Emulator Commands

### store

|            |  |
|------------|--|
| <FILE>     | This represents a file name you specify for the absolute file identifier or trace file where data is to be stored. If you want to name a file beginning with a number, you must precede the file name with a backslash (\) so the system will recognize it as a file name. |
| memory     | This causes selected memory locations to be stored in the specified file with a <b>.X</b> extension.   |
| thru       | This allows you to specify that ranges of memory be stored.  |
| to         | Use this in the <b>store memory</b> command to separate memory locations from the file identifier.   |
| trace      | This option causes the current trace data to be stored in the specified file with a <b>.TR</b> extension.  |
| trace_spec | This option stores the current trace specification in the specified file with a <b>.TS</b> extension.  |
| ,          | A comma separates memory expressions in the command line.  |

---

### Examples

```
store memory 800H thru 20FFH to TEMP2 <RETURN>
```

```
store memory EXEC thru DONE to \12.10 <RETURN>
```

```
store trace TRACE <RETURN>
```

```
store trace_spec TRACE <RETURN>
```



### See Also

```
display memory  
display trace  
help store  
load
```

**—SYMB—**

--SYMB--

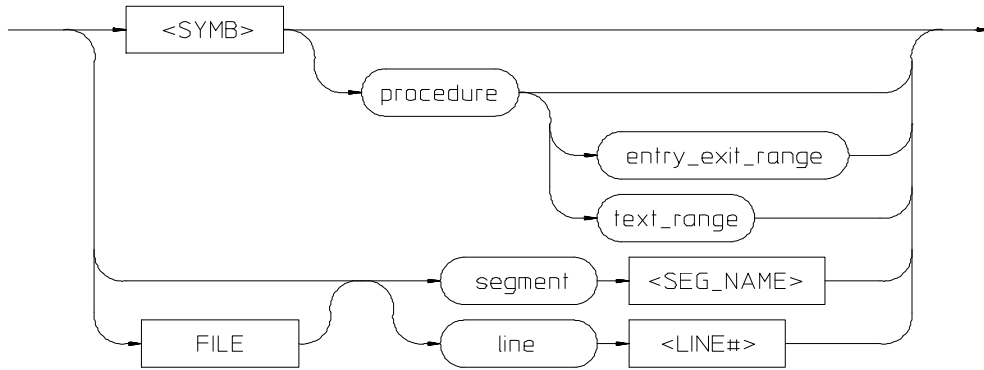

FILE

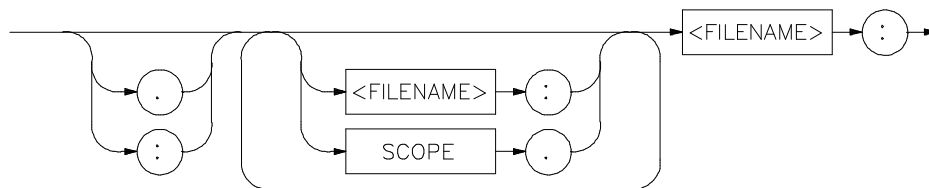

<SYMB>

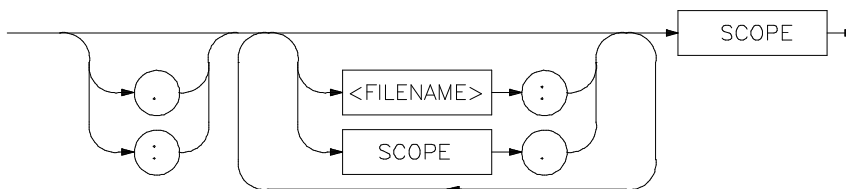

SCOPE

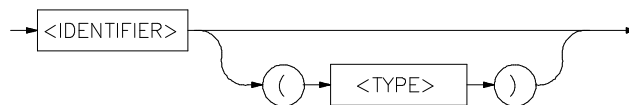

**—SYMB—**

This parameter is a symbolic reference to an address, address range, file, or other value. Symbols may be:

- Combinations of paths, filenames, and identifiers defining a scope, or referencing a particular identifier or location (including procedure entry and exit points).
- Combinations of paths, filenames, and line numbers referencing a particular source line.
- Combinations of paths, filenames, and segment identifiers identifying a particular PROG, DATA or COMN segment or a user-defined segment.

The Symbolic Retrieval Utilities (SRU) handle symbol scoping and referencing. These utilities build trees to identify unique symbol scopes.

If you use the SRU utilities to build a symbol database before entering the emulation environment, the measurements involving a particular symbol request will occur immediately. If you then change a module and re-enter the emulation environment without rebuilding the symbol database, the emulation software rebuilds the changed portions of the database in increments as necessary.

Further information regarding the SRU and symbol handling is available in the *SRU User's Guide*. Also refer to that manual for information on the **HP64KSYMBPATH** environment variable.

The last symbol specified in a **display local\_symbols\_in —SYMB—** command, or with the **cws** command, is the default symbol scope. The default is “none” if no current working symbol was set in the current emulation session.

You also can specify the current working symbol by typing the **cws** command on the command line and following it with a symbol name. The **pws** command displays the current working symbol on the status line.

The **display memory mnemonic** command also can modify the current working symbol.

If no default file was defined by executing the command **display local\_symbols\_in —SYMB—**, or with the **cws** command, a source file name (<FILE>) must be specified with each local symbol in a command line.

entry\_exit\_range

The range of addresses beginning with the entry point and ending with the return instruction. The entry point is the address used by other files when they call this procedure.



|              |  |
|--------------|--|
| <FILENAME>   | This is an UNIX path specifying a source file. If no file is specified, and the identifier referenced is not a global symbol in the executable file that was loaded, then the default file is assumed (the last absolute file specified by a <b>display local_symbols_in</b> command). A default file is only assumed when other parameters (such as <b>line</b> ) in the <b>—SYMB—</b> specification expect a file.                           |
| line         | This specifies that the following numeric value references a line number in the specified source file.   |
|              | <LINE#>            Prompts you for the line number of the source file.   |
| <IDENTIFIER> | This is the name of an identifier as declared in the source file.  |
| SCOPE        | Scope is the name of the portion of the program where the specified identifier is defined or active (such as a procedure block).   |
| segment      | This indicates that the following string specifies a standard segment (such as PROG, DATA, or COMN) or a user-defined segment in the source file.  |
| <SEG_NAME>   | Prompts you for entry of the segment name.   |
| text_range   | The range of addresses beginning with the lowest address occupied by any code in the procedure and ending with the highest address occupied by any code in the procedure. Normally, the text_range will be the same as the entry_exit_range; some compilers may rearrange code so that the return instruction (for example) is not at the highest address in the range occupied by code of the procedure.                                      |
| (<TYPE>)     | When two identifier names are identical and have the same scope, you can distinguish between them by entering the type (in parentheses). Do not type a space between the identifier name and the type specification. The type will be one of the following:  |
| filename     | Specifies that the identifier is a source file.  |
| fsegment     | This provides an alternate way to reference a file segment in a command (example: <b>myfile.c:PROG(fsegment)</b> ). It is better to use the keyword <b>segment</b> (example: <b>myfile.c: segment PROG</b> ). The "segment" keyword is preferred because it will do scanning for PROG, Prog, prog, and other expressions of the program segment in the example line. The <b>fsegment</b> keyword will only scan for the one expression (PROG). |
| module       | These refer to module symbols. For most C compilers, these names derive from the source file name. For Ada, they are   |

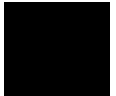

packages. Other language systems may allow user-defined module names.

procedure Any procedure or function symbol. For languages that allow a change of scope without explicit naming, SRU assigns an identifier and tags it with type procedure.

prospecial Prospecial symbols are symbols that were created by the HP SRU (such as entry, exit, and return). They are derived symbols, not intended for the product user. Typical prospecial symbols would be entry1, entry2, and entry3 in a procedure that has three possible entry points.

static Static symbols, which include global variables. The logical address of these symbols will not change.

task Task symbols, which are specifically defined by the processor and language system in use.

: A colon is used to delimit the UNIX file path from the line, segment, or symbol specifier. When following the file name with a line or segment selection, there must be a space after the colon. For a symbol, there must not be a space after the colon.

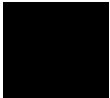

---

**Examples**

The following C code example is provided to help illustrate how symbols are maintained by SRU and referenced in your emulation commands.

File /users/dave/control.c contains:

```
int *port_one;

main()
{
    int port_value;

    port_one = 255;
    port_value = 10;
    process_port (port_one, port_value);
} /* end main */
```

File /users/project1/porthand.c contains:

```
#include "utils.c"

process_port (int *port_num, int port_data)
{
    static int i;
    static int i2;

    for (i = 0; i <= 64; i++) {
        i2 = i * 2;
        *port_num = port_data + i2;
        delay ();
        {
            static int i;
            i = 3;
            port_data = port_data + i;
        }
    }
} /* end of process_port */
```

File /users/project1/utils.c contains:

```
delay()
{
    int i,j;
    int waste_time;

    for (i = 0; i <= 256000; i++)
        for (j = 0; j <= 256000; j++)
            waste_time = 0;
} /* end delay */
```

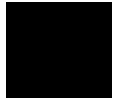

The symbol tree as built by SRU might appear as shown in the following diagram, depending on the object module format (OMF) and compiler used.

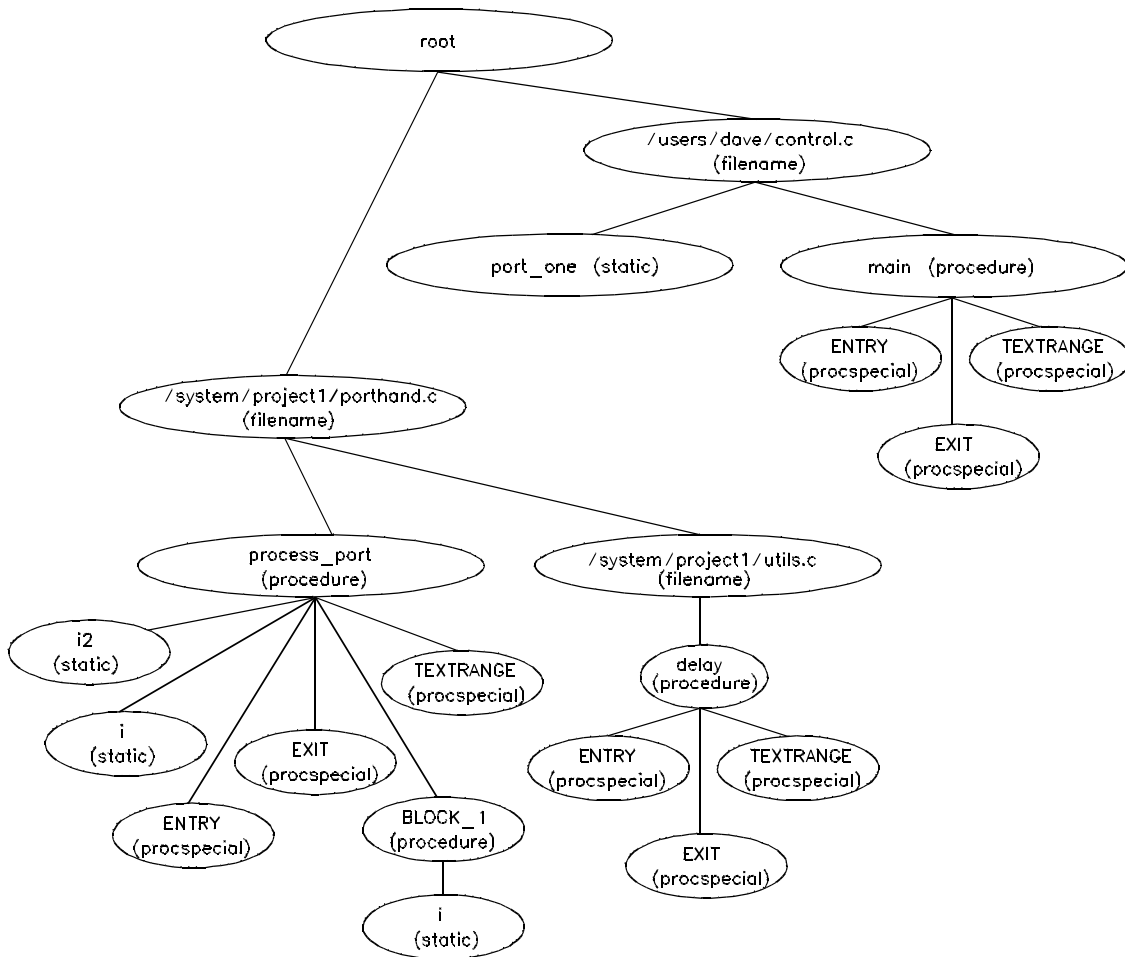

Note that SRU does not build tree nodes for variables that are dynamically allocated on the stack at run-time, such as *i* and *j* within the `delay ()` procedure. SRU has no way of knowing where these variables will be at run time and therefore cannot build a corresponding symbol tree entry with run time address.

These are examples of referencing different symbols in the programs listed:

```
control.c:main  
control.c:port_one  
porthand.c:utils.c:delay
```

The last example above only works with IEEE-695 object module format; the HP object module format does not support referencing of include files that generate program code.

```
porthand.c:process_port.i  
porthand.c:process_port.BLOCK_1.i
```

Notice how you can reference different variables with matching identifiers by specifying the complete scope. You also can save typing by specifying a scope with **cws**. For example, if you are making many measurements involving symbols in the file porthand.c, you could specify:

```
cws porthand.c:process_port
```

Then:

```
i  
BLOCK_1.i
```

are prefixed with porthand.c: process\_port before the database lookup.

If a symbol search with the current working symbol prefix is unsuccessful, the last scope on the current working symbol is stripped. The symbol you specified is then retested with the modified current working symbol. Note that this does not change the actual current working symbol.

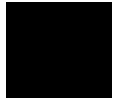

For example, if you set the current working symbol as

```
cws porthand.c:process_port.BLOCK_1
```

and made a reference to symbol `i2`, the retrieval utilities attempt to find a symbol called

```
porthand.c:process_port.BLOCK_1.i2
```

which would not be found. The symbol utilities would then strip `BLOCK_1` from the current working symbol, yielding

```
porthand.c:process_port.i2
```

which is a valid symbol.

You also can specify the symbol type if conflicts arise. Although not shown in the tree, assume that a procedure called `port_one` is also defined in `control.c`. This would conflict with the identifier `port_one` which declares an integer pointer. SRU can resolve the difference. You must specify:

```
control.c:port_one(static)
```

to reference the variable, and

```
control.c:port_one(procedure)
```

to reference the procedure address.

---

### See Also

```
copy local_symbols_in  
cws  
display local_symbols_in  
help symbols  
pws
```

Also refer to the *Symbolic Retrieval Utilities User's Guide* for additional information on symbols and information on building a symbol data base.

**trace**

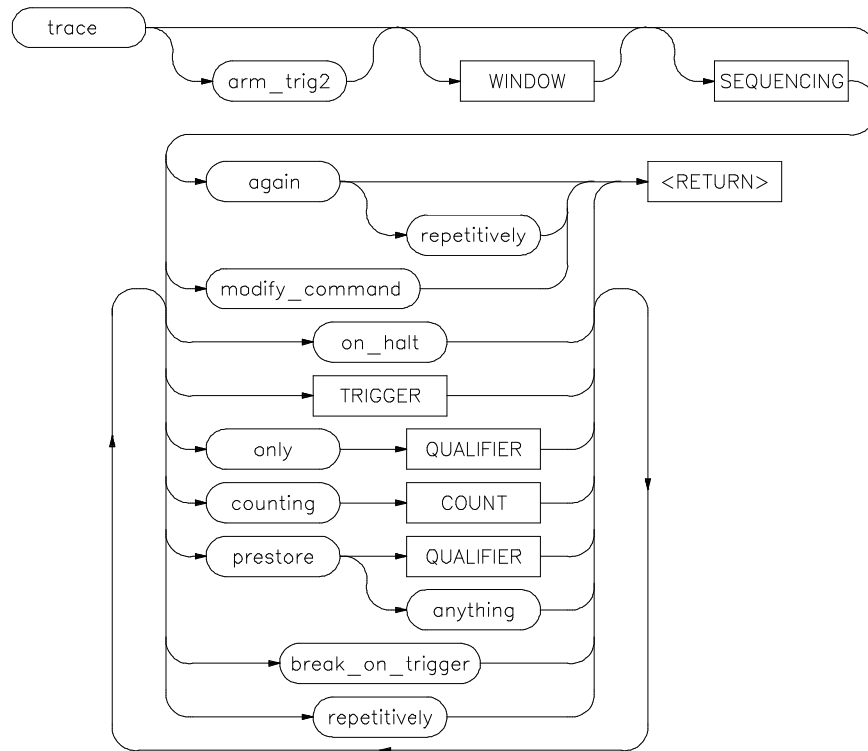

The options shown can be executed once for each **trace** command. Refer to the COUNT, QUALIFIER, SEQUENCING, TRIGGER, and WINDOW diagrams for details on setting up a trace.

You can perform analysis tasks either by starting a program run and then specifying the trace parameters, or by specifying the trace parameters first and then initiating the program run. Once a **trace** begins, the analyzer monitors the system busses of the emulation processor to detect the states specified in the **trace** command. The analyzer will trace any state, counting time by default.

When the trace specification is satisfied and trace memory is filled, a message will appear on the status line indicating the trace is complete. You can then use display trace to display the contents of the trace memory. If a previous trace list is on

## Chapter 11: Emulator Commands

### trace

screen, the current trace automatically updates the display. If the trace memory contents exceed the page size of the display, the **NEXT PAGE**, **PREV PAGE**, **up arrow**, or **down arrow** keys may be used to display all the trace memory contents. You also can press **CTRL f** and **CTRL g** to move the display left and right.

You can set up trigger and storage qualifications using the **specify trace** command. When a **cmb\_execute** command is given, which puts an EXECUTE signal on the Coordinated Measurement Bus, analyzers will begin tracing.

|                  |  |
|------------------|--|
| again            | This option repeats the previous trace measurement. It also begins a trace measurement with a newly loaded trace specification. (Using <b>trace</b> without the <b>again</b> parameter will start a trace with the default specification rather than the loaded specification.)  |
| anything         | This causes the analyzer to capture any type of information.   |
| arm_trig2        | This option allows you to specify the external trigger as a trace qualifier, for coordinating measurements between multiple HP 64700 Series emulators, or an HP 64700 Series emulator and another instrument.<br><br>Before <b>arm_trig2</b> can appear as an option, you must modify the emulation configuration interactive measurement specification. When doing this, you must specify that either <b>BNC</b> or <b>CMBT</b> drive <b>trig2</b> , and that the analyzer receive <b>trig2</b> . Refer to Chapter 6, “Coordinated Measurements,” for more information. |
| break_on_trigger | This stops target system program execution when the trigger is found. The emulator begins execution in the emulation monitor. When using this option, the <b>on_halt</b> option cannot be included in the command.   |
| COUNT            | This specifies whether time or state occurrences, or nothing, will be counted during the trace. See the <b>COUNT</b> syntax diagram for details.   |
| counting         | This option specifies whether the analyzer will count time or occurrences of states during a trace, or whether the option is to be turned off.   |
| modify_command   | This recalls the last trace command that was executed.   |
| on_halt          | When using this option, the analyzer will continue to capture states until the emulation processor halts or until a <b>stop_trace</b> command is executed. When this option is used, the <b>break_on_trigger</b> , <b>repetitively</b> , and <b>TRIGGER</b> options cannot be included in the command.   |
| only             | This option allows you to qualify the states that are stored, as defined by <b>QUALIFIER</b> .   |



|              |  |
|--------------|--|
| prestore     | This option instructs the analyzer to save specific states that occur prior to states that are stored (as specified with the “only” option).   |
| QUALIFIER    | This determines which of the traced states will be stored or prestored in the trace memory for display upon completion of the trace. Events can be selectively saved by using <b>trace only</b> to enter the specific events to be saved. When this is used, only the indicated states are stored in the trace memory. See the QUALIFIER syntax. |
| repetitively | This initiates a new trace after the results of the previous trace are displayed. The trace will continue until a <b>stop_trace</b> or a new <b>trace</b> command is issued. When using this option, you cannot use the <b>on_halt</b> option.   |
| SEQUENCING   | Allows you to specify up to seven sequence terms including the trigger. The analyzer must find each of these terms in the given order before searching for the trigger. You are limited to four sequence terms if windowing is enabled. See the <b>SEQUENCING</b> syntax pages for more details.   |
| TRIGGER      | This represents the event on the emulation bus to be used as the starting, ending, or centering event for the trace. See the <b>TRIGGER</b> syntax diagram. When using this option, you cannot include the <b>on_halt</b> option.  |
| WINDOW       | Selectively enables and disables analyzer operation based upon independent enable and disable terms. This can be used as a simple storage qualifier. You may also use it to further qualify complex trigger specifications. See the <b>WINDOW</b> syntax pages for details.  |

---

**Examples**

```
trace after 1000H <RETURN>
```

```
trace only address range 1000H thru 1004H  
<RETURN>
```

```
trace counting state address 1004H <RETURN>
```

```
trace after address 1000H occurs 2 only address  
range 1000H thru 1004H counting time  
break_on_trigger <RETURN>
```

**trace**

**See Also**

*copy trace*  
*display trace*  
*help trace*  
*load trace*  
*load trace\_spec*  
*specify trace*  
*store trace*  
*store trace\_spec*

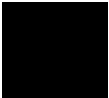

## TRIGGER

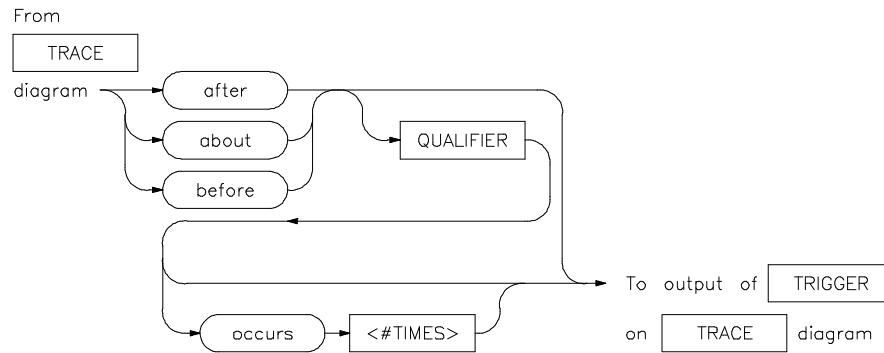

This parameter lets you define where the analyzer will begin tracing program information during a trace measurement.

A trigger is a QUALIFIER. When you include the **occurs** option, you can specify the trigger to be a specific number of occurrences of a QUALIFIER (see the QUALIFIER syntax diagram).

The default is to trace after any state occurs once.

|           |   |
|-----------|---|
| about     | This option captures trace data leading to and following the trigger qualifier. The trigger is centered in the trace listing. |
| after     | Trace data is acquired after the trigger qualifier is found.  |
| before    | Trace data is acquired prior to the trigger qualifier.  |
| occurs    | This specifies a number of qualifier occurrences of a range or state on which the analyzer is to trigger.                     |
| QUALIFIER | This determines which of the traced states will be stored in trace memory.  |
| <#TIMES>  | This prompts you to enter a number of qualifier occurrences.  |



## TRIGGER

---

### Examples

```
trace after MAIN <RETURN>
```

```
trace after 1000H then data 5 <RETURN>
```

Also see the **trace** command examples.

---

### See Also

```
help trace  
trace
```

Also refer to Chapter 6, “Making coordinated measurements.”

---

## <UNIX\_COMMAND>

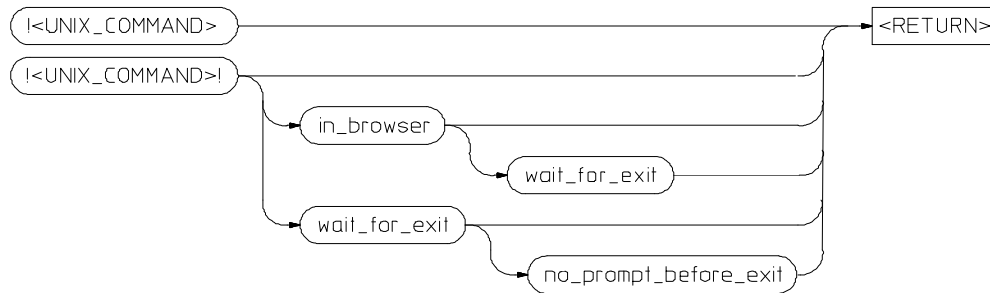

This structure allows you to execute UNIX commands on the emulator/analyzer command line. The UNIX commands and command-line options are interpreted as no-ops in the emulator/analyzer interface.

- in\_browser** Places the resulting display in a scrollable box instead of an XTERM window.
- wait\_for\_exit** Use this command to ensure completion of the associated UNIX command before starting the next command.
- no\_prompt\_before\_exit** When the associated UNIX command completes, the results display is shown and then removed without need to press the RETURN key. Use this option to speed execution of your command when the results display is not important to you.

---

### Examples

To see your present working directory:

```
!pwd
```

To see a directory listing in a browser instead of terminal window:

```
!ls! in_browser
```

To make and load an executable:

```
!make <file>! wait_for_exit; load <executable_file>
```

## **wait**

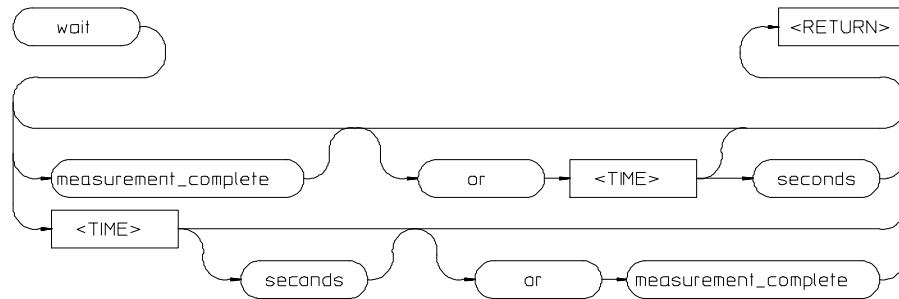

This command allows you to pause the system. The **wait** command can be included in a command file, or used during normal operation at the main emulation level. Delays allow the emulation system and target processor to reach a certain condition or state before executing the next emulation command.

The **wait** command does not appear on the softkey labels. You must type the **wait** command into the keyboard. After you type **wait**, the command parameters will be accessible through the softkeys.

If you issue a **wait <RETURN>** command without any other options, the system will pause until it receives a **<CTRL>c** signal.

If **set intr <CTRL>c** was not executed on your system, **<CTRL>c** normally defaults to the backspace key. See your UNIX system administrator for more details regarding keyboard definitions.

A **wait** command in a command file will cause execution of the command file to pause until a **<CTRL>c** signal is received, if **<CTRL>c** is defined as the interrupt signal. Subsequent commands in the command file will not execute while the command file is paused.

You can verify whether the interrupt signal is defined as **<CTRL>c** by typing **set** at the system prompt.

|                       |   |
|-----------------------|---|
| measurement_ complete | This causes the system to pause until a pending measurement completes (for example, when a trace data upload process completes), or until a <CTRL>c signal is received. If a measurement is not in progress, the <b>wait</b> command will complete immediately. |
| or                    | This causes the system to wait for a <CTRL>c signal or for a pending measurement to complete. The wait will end when the first one of these two conditions occurs.  |
| seconds               | This causes the system to pause for a specific number of seconds.   |
| <TIME>                | This prompts you for the number of seconds to insert for the delay.   |

---

**Examples**

```
wait <RETURN>
```

```
wait 5; wait measurement_complete <RETURN>
```

---

**See Also**

```
help system_commands  
help wait
```

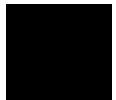

## WINDOW

From trace  
syntax diagram

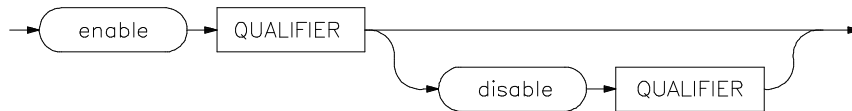

**WINDOW** allows you to selectively toggle analyzer operation. When enabled, the analyzer will recognize sequence terms and trigger terms, and will store states. When disabled, the analyzer is effectively off, and only looks for a particular enable term.

You specify windowing by selecting an enable qualifier term; the analyzer will trigger or store all states after this term is satisfied. If the disable term occurs after the analyzer is enabled, the analyzer will then stop storing states, and will not recognize trigger or sequence terms. You may specify only one enable term and one disable term.

The analyzer defaults to recognizing all states. If you specify enable, you must supply a qualifier term. If you then specify disable, you must specify a qualifier term.

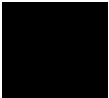
|   |  |
|---|--|
| disable   | Allows you to specify the term which will stop the analyzer from recognizing states once the enable term has been found.   |
| enable  | Allows you to specify the term which will enable the analyzer to begin monitoring states.  |
|  QUALIFIER | Specifies the actual address, data, status value or range of values that cause the analyzer to enable or disable recognition of states. Note that the enable qualifier can be different from the disable qualifier. Refer to the QUALIFIER syntax pages for further details on analyzer qualifier specification. |



---

**Examples**

The following example uses an imaginary program that writes messages. The window specification ensures that the trace memory will only store message writes (store write transactions only during the time when the Write\_Msg routine is active), and not store other program activity.

*display trace*

*trace enable* Write\_Msg *start disable* Write\_Msg *end only*  
*status write*

---

**See Also**

help *trace*  
SEQUENCING  
*trace*  
QUALIFIER

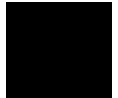



---

# 12

---

## Emulator Messages

The information displayed on the Status line to let you know something is wrong, or advise you when the emulator is performing a task.

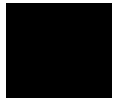

## Messages In This Chapter

The emulator/analyzer interface provides feedback to the user through messages that are displayed on the STATUS line.

### Organization of the Messages

The messages in this chapter are organized as follows:

- Messages are listed in alphabetical order, except for the first few messages.
- The first few messages shown in this chapter are not in alphabetical order because the first word of the messages will begin with the name you assigned to a configuration file, your emulator/analyzer, or your stack.
- Some messages have error numbers assigned to them. These error numbers are shown in parenthesis within the message text in this chapter.

### Messages Recorded in Error Log

The *error log* records error messages received during the emulation session. You may want to display the error log to view the error messages. In those instances where several messages are generated for a single error condition, you will have to view the error log to see the complete list of messages. Only the last error message in the sequence will remain in the status line display area.

The error log can hold up to 100 messages. To prevent overrun, the error log purges the oldest messages to make room for the new ones.

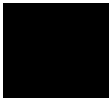

## Unalphabetized Error and Status Messages

These error and status messages begin with names you assigned to configuration files, your emulator/analyzer, and stack space.

### <CONFIGURATION FILENAME> does not exist

Cause: The configuration file you are trying to load does not exist.

Action: Try the **load configuration** command again using a valid configuration file name.

### <LOGICAL NAME>: End, continuing

Cause: This is a status message. The emulation session is being exited with the **end** command. When you restart the emulation session later, it will continue using the same settings as in the session you just ended. The emulator logical name is located in the /usr/hp64000/etc/64700tab.net (or 64700tab) file.

### <LOGICAL NAME>: End, released

Cause: This is a status message. The emulation session is being exited with the **end release\_system** command. When the session has ended, the emulator is released, meaning that others can access and use it. When you restart the emulation session later, the new session will use all default settings. The emulator logical name is located in the /usr/hp64000/etc/64700tab.net (or 64700tab) file.

### <STACK> stack is located in emulation ROM (Error 151)

Cause: You tried to run from some address or perform a monitor operation that required the stack named <STACK>. But, the stack pointer points to emulation ROM, which is invalid.

Action: Use the **modify register** command to set the stack pointer to an even value that points at a memory region that can be used for stack operations. For the ISP (interrupt stack pointer), you can use a configuration item to preset the initial value when the emulator enters the monitor from reset. (The ISP must point to a memory region that may be used as an interrupt stack.) Or, check your program to make sure that it doesn't modify the ISP to an odd value. If the M bit in the status register is set, the processor uses the master stack instead of the interrupt stack. The master stack must also be an even value.

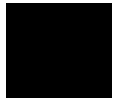

Chapter 12: Emulator Messages  
**Unalphabetized Error and Status Messages**

**<STACK> stack is located in guarded memory (Error 151)**

Cause: You tried to run from some address or perform a monitor operation that required the stack named <STACK>. But, the stack pointer points to guarded memory, which is invalid.

Action: Use the **modify register** command to set the stack pointer to an even value that points at a memory region that can be used for stack operations. For the ISP (interrupt stack pointer), you use configuration item to preset the initial value when the emulator enters the monitor from reset. (The ISP must point to a memory region that may be used as an interrupt stack.) Or, check your program to make sure that it doesn't modify the ISP to an odd value. If the M bit in the status register is set, the processor uses the master stack instead of the interrupt stack. The master stack must also be an even value.

**<STACK> stack is located in target ROM (Error 151)**

Cause: You tried to run from some address or perform a monitor operation that required the stack named <STACK>. But, the stack pointer points to target ROM, which is invalid.

Action: Use the **modify register** command to set the stack pointer to an even value that points at a memory region that can be used for stack operations. For the ISP (interrupt stack pointer), you use a configuration item to preset the initial value when the emulator enters the monitor from reset. (The ISP must point to a memory region that may be used as an interrupt stack.) Or, check your program to make sure that it doesn't modify the ISP to an odd value. If the M bit in the status register is set, the processor uses the master stack instead of the interrupt stack. The master stack must also be an even value.



**<STACK> stack pointer is odd or uninitialized (Error 151)**

Cause: You tried to run from some address or perform a monitor operation that required the stack named <STACK>. But, the stack was set to an odd value, which is invalid.

Action: Use the **modify register** command to set the stack pointer to an even value that points at a memory region that can be used for stack operations. For the ISP (interrupt stack pointer), use a configuration item to preset the initial value when the emulator enters the monitor from reset. (The ISP must point to a memory region that may be used as an interrupt stack.) Or, check your program to make sure that it doesn't modify the ISP to an odd value. If the M bit in the status register is set, the processor uses the master stack instead of the interrupt stack. The master stack must also be an even value.

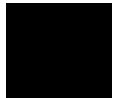

## **Alphabetized Error And Status Messages**

The remaining error and status messages are in alphabetical order. Messages that have associated error numbers show those error numbers in parenthesis at the end of the message text.

### **Address range too small for request - request truncated**

Cause: Too small of an address range is specified in a modify memory command.

Action: Specify a larger memory range.

### **Address(es) transparently translated via TT0/TT1 (Error 161)**

Cause: You used the **display mmu\_translations** command to display MMU address translations and one or more addresses are transparently translated by the processor TT0 and/or TT1 registers. Other than this status message, the **display mmu\_translations** command completely ignores transparent translations when looking up logical-to-physical address translations. This status is only used to warn you that the MMU is currently set up to transparently translate one or more addresses 1:1, instead of using the displayed address translations.

### **Ambiguous address: <address> (Error 312)**

Cause: You mapped memory using function codes, but didn't enter a function code in an address specification for a run or trace measurement. The emulator is unable to determine which of two or more address ranges you are referring to, based on the information you entered.

Action: Reenter the command and fully specify the address, including function code information.

### **Analyzer Break (613)**

Status message. No action necessary.



**Analyzer limitation; all expression resources in use (Error 10360)**

**Analyzer limitation; all pattern resources in use (Error 10360)**

**Analyzer limitation; all range resources in use (Error 10360)**

Cause: Your trace specification would use more than the maximum number of resources available to the analyzer.

Action: Simplify the trace specification.

**Analyzer SIMMs are not all the same size; using smallest size (Status 1002)**

Cause: Plug-in SIMMs are used to expand the trace depth to 64k or 256k states in the deep analyzer. Four SIMMs, all of the same size must be used. If they are not all the same size, the smallest SIMM size in the set of four will be used for trace depth.

Action: No action necessary.

**Arm term used more than once (Error 1250)**

Cause: This error occurs when you attempt to use the “arm” qualifier more than once in a sequencer branch expression.

Action: Reenter the trace command and specify the “arm” qualifier only once.

**Ascii symbol download failed (Error 881)**

Cause: This error occurs because the system is out of memory.

Action: You must either reduce the number of symbols to be loaded, or free up additional system space and try the download again.

**Attempt to change foreground monitor map term (Error 20)**

Cause: When configuring the emulator to use a foreground monitor, a memory range is automatically mapped for the monitor’s use. You attempted to alter that term when mapping memory.

Action: Try using another memory range for the new map term. If you need to have the range used by the foreground monitor, then switch to a background monitor, delete the old foreground monitor map term, and add the new term. Now you can return to using a foreground monitor; remember you will need to reload the monitor code.

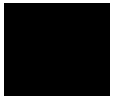

## Chapter 12: Emulator Messages

### Alphabetized Error And Status Messages

#### **Background monitor unavailable while MMU is enabled (Error 156)**

Cause: You attempted to switch to the background monitor while the MMU was enabled.

Action: Use only a foreground monitor when the MMU is enabled.

#### **BNC trigger break (Error 616)**

Cause: This status message will be displayed if you have configured the emulator to break on a BNC trigger signal and the BNC trigger line is activated during a program run. The emulator is broken to the monitor.

#### **Break caused by CMB not ready (Error 611)**

Cause: This status message is printed during coordinated measurements if the CMB READY line goes false. The emulator breaks to the monitor. When CMB READY is false, it indicates that one or more of the instruments participating in the measurement is running in the monitor.

Action: No action is necessary (status only).

#### **Break condition configuration aborted (Error 653)**

Cause: Occurs when <CTRL> c is entered during the configuration of break conditions.

#### **Break due to cause other than step (Error 689)**

Cause: An activity other than a **step** command caused the emulator to break. This could include any of the break conditions or a <CTRL> c break.

#### **Breakpoint code already exists: <address> (Error 667)**

Cause: You attempted to insert a breakpoint; however, there was already a breakpoint instruction at that location which was not already in the breakpoint table.

Action: Your program code is apparently using the same breakpoint instruction as used by the breakpoints feature. Remove the breakpoint instructions from your program code and use the **modify software\_breakpoints set** command to insert them.

**Breakpoint disable aborted (Error 671)**

Cause: Occurs when <CTRL> c is entered when disabling breakpoints.

**Breakpoint enable aborted (Error 670)**

Cause: Occurs when <CTRL> c is entered when setting breakpoints.

**Breakpoint list full; not added: <address> (Error 664)**

Cause: The breakpoint table is full. The breakpoint you just requested, with address <address>, was not inserted.

Action: Remove breakpoints that are no longer in use. Then insert the new breakpoint.

**Breakpoint not added: <address> (Error 668)**

Cause: You tried to insert a breakpoint in a memory location which was not mapped or was mapped as guarded memory.

Action: Insert breakpoints only within memory ranges mapped to emulation or target RAM or ROM.

**Breakpoint remove aborted (Error 669)**

Cause: Occurs when <CTRL> c is entered when clearing a breakpoint.

**Cannot create module file:**

Cause: Insufficient disk space for the module file.

Action: Check disk space under /usr/hp64000.

**Cannot default emulator; already in use (Error 10332)**

Cause: You tried to start an emulator interface, but your attempt failed because the emulator is already in use by someone else.

Action: Current user must release the emulator.

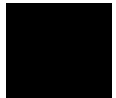

Chapter 12: Emulator Messages  
**Alphabetized Error And Status Messages**

**Cannot interpret emulator output (Error 10350)**

Cause: There may be characters dropped in the information returned from the emulator.

Action: Ignore this message unless it becomes frequent. If it becomes frequent, you may have a fatal error; call your HP 64700 representative.

**Cannot lock emulator; failure in obtaining the accessid (Error 10327)**  
**Cannot lock emulator; failure in <ERRNO MSG> (Error 10327)**

Cause: The lockfile is missing in /usr/hp64000/lock or the semaphore is missing.

Action: Exit the emulator and start a new session using the command **emul700 -U <logical\_address>**.

**Cannot start. Ending previous session, try again**

Cause: The host system could not start a new emulation session, and is ending the previous session.

Action: After the previous session has ended, try starting a new emulation session. If that fails, try "emul700 -u <logical name>" to unlock the emulator and cycle power, if needed.

**Cannot start. Pod initialization failed**

Cause: The host system could not start a new emulation session because it could not initialize the emulator.

Action: Cycle power on the emulator; verify that there are no red lights on the front of the emulator. You may need to run "pv" to verify that the emulator is functioning properly before starting a new session (refer to Chapter 18, "Installation and service," for information on how to run "pv", performance verification).

**Cannot unlock emulator; emulator in use by user: <USER NAME> (Error 10328)**

Cause: The emulator is already in use by the named user.

Action: Current user must release the emulator.

**Cannot unlock emulator; emulator not locked (Error 10328)**

Cause: You have issued a command to unlock an emulator that is not locked.

Action: The emulator is available now. You can start the interface.

**Cannot unlock emulator; lock file missing (Error 10328)**

**Cannot unlock emulator; semaphore missing (Error 10328)**

Cause: Lock semaphore missing.

Action: Verify existence and permissions of /usr/hp64000 directory. Cycle emulator power and use **emul700 -u <logical name>**.

**Clock speed not available with current count qualifier (Error 1239)**

Cause: This error occurs when you attempt to specify a fast (F) or very fast (VF) maximum qualified clock speed when counting time. This error also occurs when you attempt to specify a very fast (VF) maximum qualified clock speed when counting states.

Action: Change the count qualifier; then reenter the command. Refer to Chapter 5, "Using the emulation-bus analyzer," for more information.

**CMB execute break (Error 623)**

Cause: This message occurs when coordinated measurements are enabled and an EXECUTE pulse causes the emulator to run. The emulator must break before running.

Action: This is a status message; no action is required.

**CMB execute; emulation trace started (Error 1305)**

Cause: This is a status message that informs you that an emulation trace measurement has started as a result of a CMB execute signal (as specified by the "**specify trace**" command).

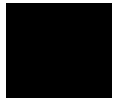

Chapter 12: Emulator Messages  
**Alphabetized Error And Status Messages**

**CMB execute; run started (Error 693)**

Cause: This status message is displayed when you are making coordinated measurements. The CMB /EXECUTE pulse has been received; the emulation processor started running at the address specified by the **specify run** command.

Action: None required. This is information only.

**CMB trigger break (Error 617)**

Cause: This status message will be displayed if you have configured the emulator to break on a CMB trigger and the CMB trigger line is activated during a program run. The emulator is broken to the monitor.

**Command line too complex (Error 816)**

Cause: Too many expression operators are used.

Action: Split up the command line, or use fewer expressions.

**Command line too complex (Error 818)**

Cause: A maximum nesting level has been exceeded for nested command execution.

Action: Reduce the number of nesting levels.

**Configuration aborted (Error 624)**

Cause: Occurs when a <CTRL> c is entered while emulator configuration items are being set.

**Configuration failed; setting unknown: <item>=<value> (Error 626)**

Cause: Target condition or system failure while trying to change configuration item.

Action: Try to reset. Then reenter your command. Check target system, and run performance verification (**pv** command).

**Configuration not valid, restoring previous configuration**

**Configuration not valid, restoring default configuration**

Cause: The modifications you tried to make to the emulator configuration are not valid, so the host system restored the previous configuration.

Action: Refer to Chapter 8, "Configuring the Emulator" for more information about the emulator configuration items and their settings.

**Configuration process QUIT**

Cause: The configuration process ended because <ctrl> "\ " (SIGQUIT signal) was encountered. This is an easy way to exit configuration without saving any changes.

Action: Try starting the emulation session again. If the problem persists, you may need to cycle power on the emulator.

**Conflict between expected and received symbol information (Error 880)**

Cause: The information you supplied in a symbol definition is not what the HP 64700 expected to receive.

Action: Make sure that all symbols in the symbol file are defined correctly. Verify that there are no spaces in the address definitions for the symbols in the symbol file being downloaded.

**Connecting to <LOGICAL NAME>**

Cause: This is a status message. The host system is making a communication connection to the emulator whose logical name is defined in /usr/hp64000/etc/64700tab.net or /usr/hp64000/etc/64700tab.

**Continue load failed**

Cause: The host system could not continue the previous emulation session because it could not load the continue file.

Action: Try again. If the failure continues, call your HP Service Representative.

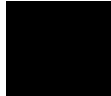

## Chapter 12: Emulator Messages

### Alphabetized Error And Status Messages

#### **Continuing previous session, continue file loaded**

Cause: This is a status message. An emulation session which was ended earlier with the **end** command has been restarted. The host system reported that the session was continued (using settings from the previous session) and that the continue file loaded properly.

#### **Continuing previous session, user interface defaulted**

Cause: The previous emulation session was continued and the emulator/analyzer interface was set to the default state.

#### **Continuing with default foreground monitor (Error 144)**

Cause: You tried to load a custom foreground monitor, but the load failed because the addresses in the absolute file didn't match the address range reserved for the monitor. The emulator aborts the load and reverts to the built-in foreground monitor. The **<range>** parameter shows the range of addresses covered by the custom monitor definition.

Action: To use a custom foreground monitor, you must:

- Select the foreground monitor.
- Set the foreground monitor base address.
- Load an absolute file that fits in the 4-Kbyte range that starts with **<ADDRESS>**.

#### **Copy memory aborted; next destination: <address> (Error 752)**

Cause: One of these messages is displayed if a break occurs during processing of the **copy memory** or **modify memory** commands. The break could result from any of the break conditions or could have resulted from a **<CTRL> c** break.

Action: Retry the operation. If breaks are occurring continuously, you may wish to disable some of the break conditions.



**Copy target image not supported (Error 161)**

Cause: The **cim** (copy image memory) command doesn't exist in the MC68020 and MC68030/EC030 emulators. In other emulators, this command is used to copy a target system memory range to emulation memory so you can set breakpoints or patch code.

Action: To do this without the **cim** command, copy the target system memory range to an absolute file using the **copy** command. Then remap the target memory range to emulation memory, and load the absolute file into emulation memory using the **load** command. Refer to Chapter 4, "Using the Emulator," for information on saving and loading absolute files.

**Could not create default configuration**

Cause: The host system could not create a default configuration for the emulation session.

Action: Check disk space under /usr/hp64000 and verify proper software installation.

**Could not create <CONFIGURATION BINARY FILENAME>**

Cause: The system could not create a binary emulation configuration file (file.EB).

Action: Check the file.EB write permission and verify that the specified directory exists and is writeable.

**Could not exec configuration process**

Cause: The host system could not fork the configuration process or could not execute the configuration process.

Action: Make sure that the host system is operating properly, and that all emulator/analyzer interface files were loaded properly during the installation process. Try starting the emulation session again.

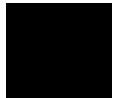

## Chapter 12: Emulator Messages

### Alphabetized Error And Status Messages

#### **Could not load default configuration**

Cause: The host system could not load the default configuration into the emulator.

Action: Cycle power on the emulator and run "pv" (performance verification) on the emulator to verify that it is functioning properly (refer to Chapter 18, "Installation and Service," for information on running "pv"). Also, verify proper software installation. If loading default configuration still fails, then call your HP 64000 representative.

#### **Count out of bounds: <number> (Error 318)**

Cause: You specified an occurrence count less than 1 or greater than 65535 for a **trace trigger** or **trace find\_sequence** command.

Action: Reenter the command, specifying an occurrence count from 1 to 65535.

#### **Count qualifier not available with current clock speed (Error 1240)**

Cause: This error occurs when you attempt to specify the "time" count qualifier when the current maximum qualified clock speed is fast (F) or very fast (VF). This error also occurs when you attempt to specify a "state" count qualifier when the maximum qualified clock speed is fast (F).

Action: Change the clock speed; then change the count qualifier. Refer to Chapter 5, "Using the Emulation-Bus Analyzer," for more information.

#### **Coverage not supported (Error 160)**

Cause: The memory coverage command doesn't exist in the MC68020 and MC68030/EC030 emulators because there is no supporting hardware.

#### **DeMMUer has not been loaded (Error 164)**

Cause: You used the **set demmuer on** command to enable the deMMUer before it had been loaded.

Action: Use the **load demmuer [verbose]** command to load the deMMUer before you try to enable the deMMUer with the **set demmuer on** command.

**Disable breakpoint failed: <address> (Error 604)**

Cause: System failure or target condition.

Action: The emulator was unable to write previously saved opcode to target memory. Check the target memory system.

**Disable breakpoint failed: <address> (Error 666)**

Cause: System failure or target condition.

Action: Check memory mapping and configuration questions.

**Display register failed: <register> (Error 634)**

Cause: The emulator was unable to display the register you requested.

Action: To resolve this, you must look at the other messages displayed in the error log. It's likely that the emulator was unable to break to the monitor to perform the register display. See message "Unable to break (Error 608)".

**Don't care number unexpected**

Cause: While defining an expression in your command, you included a don't care number (a binary, octal, decimal, or hexadecimal number containing "x"), which was not expected. Don't care numbers are not valid for all commands. See the EXPR command syntax for more information about expressions.

**Downloaded monitor spans multiple 4K byte block boundaries (Error 145)**

Cause: You tried to load a custom foreground monitor, but the absolute file has address records that are outside the range of a single 4-Kbyte block.

Action: Modify your custom monitor so that its code and data fit into a single 4-Kbyte block. Then assemble, link, and repeat the load operation.

**Dual ported memory already in use (Error 142)**

Cause: There is only one 4-Kbyte block of dual-port emulation memory available for mapping. You mapped this term and tried to map another using the **dp** attribute.

Action: Decide which block of memory you want to have in the dual-port emulation memory, and define only that block using the **dp** attribute.

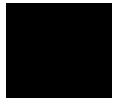

## Chapter 12: Emulator Messages

### Alphabetized Error And Status Messages

#### Dual ported memory in use by foreground monitor (Error 143)

Cause: There is only one 4-Kbyte block of dual-port emulation memory available for your use. If you select the foreground monitor, this block is used by the monitor and isn't available for mapping.

Action: Reenter the map term without the **dp** attribute, or select a background monitor and reenter the map term with the **dp** attribute.

#### Dual ported memory limited to 4K bytes (Error 141)

Cause: There are only 4 Kbytes of dual-port emulation memory on the emulator probe. You tried to map an emulation memory term whose address range spanned more than 4 Kbytes by using the **dp** attribute.

Action: You can:

- Reenter the map term using the **dp** attribute, but restrict the address range to 4 Kbytes (0..fff).
- Reenter the map term, but use regular emulation memory instead of dual-port memory. That is, omit the **dp** attribute.

#### Dual ported memory not mapped to <range> for downloaded monitor (Error 144)

Cause: You tried to load a custom foreground monitor, but the load failed because the addresses in the absolute file didn't match the address range reserved for the monitor. The emulator aborts the load and reverts to the built-in foreground monitor. The **<range>** parameter shows the range of addresses covered by the custom monitor definition.

Action: To use a custom foreground monitor, you must:

- Select the foreground monitor.
- Set the foreground monitor base address.
- Load an absolute file that fits in the 4-Kbyte range that starts with **<ADDRESS>**.

**Emulation analyzer defaulted to delete label**

Cause: Analyzer trace labels were changed or modified while labels were in use in the trace specification.

Action: Enter the previous trace specification and try again.

**Emulation memory access failed (Error 702)**

Cause: This message is displayed if the emulator was unable to perform the requested operation on memory mapped to the target system.

Action: In most cases, the problem results from the emulator's inability to break to the monitor to perform the operation. Usually there are other error messages. Refer to the error log to read them to fully understand the cause of the error. See message "Unable to break (Error 608)".

**Emulator is in the reset state (Error 61)**

Cause: You have entered a command that requires the emulator to be running in the monitor (for example, displaying registers).

Action: Enter the **break** command to cause the emulator to run in the monitor, and then enter the command that caused the error again.

**Emulator locked by another user (Error 10326)**

Cause: This message occurs when you try to start an emulation interface, but your attempt failed because the emulator is being used by someone else.

Action: The current user must release the emulator.

**Emulator locked by another user interface (Error 10330)**

Cause: You tried to start an emulator interface, but your attempt failed because the emulator is already in use by someone else.

Action: Current user must release the emulator.

**Emulator locked by user: <USER NAME> (Error 10329)**

Cause: You tried to start an emulator interface, but your attempt failed because the emulator is already in use by someone else.

Action: Current user must release the emulator.

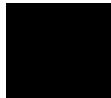

## Chapter 12: Emulator Messages

### Alphabetized Error And Status Messages

#### **Emul700dmn continuation failed**

Cause: Communication between the emulator and the host system to continue the emulation session failed.

Action: Check the data communication switch settings on the rear panel of the HP 64700 series emulator. If necessary, refer to the *HP 64700 Installation/Service Guide*.

#### **Emul700dmn executable not found**

Cause: The emulation session could not begin because the host system could not locate the HP 64700 emulator daemon process executable.

Action: Make sure that software installation is correct. Then try starting the emulator again.

#### **Emul700dmn failed to start**

Cause: The emulation session could not begin because the host system could not start the HP 64700 emulator daemon process.

Action: Make sure there is sufficient disk space under /usr/hp64000. Make sure the host system is operating properly, that all emulator/analyzer interface software has been loaded correctly, and the data communication switch settings on the emulator rear panel match the settings in the /usr/hp64000/etc/64700tab.net (or 64700tab) file.

#### **Emul700dmn message too large**

#### **Emul700dmn message too small**

#### **Emul700dmn queue and/or semaphores missing**

#### **Emul700dmn queue failure**

#### **Emul700dmn error in file operation**

#### **Emul700dmn queue full**

Cause: The HP 64700 emulator daemon process command was too large for the host system to process.

Action: You must press **end\_release\_system** to exit this emulation session completely; then start a new session. Make sure the host system is operating properly, that all emulator/analyzer interface software has been loaded correctly, and the data communication switch settings on the emulator rear panel match the settings in the /usr/hp64000/etc/64700tab.net (or 64700tab) file. You may have to cycle power and use **emul700 -U <logical name>** to unlock the system.

**Emul700dmn sem op failed, perhaps kernel limits too low**

Cause: The host system could not start the emulation session; there may be too many processes running on the host system.

Action: Make sure the host system is operating properly, and is not overloaded with currently executing processes. Stop or remove some processes on the system. Also, verify that the semaphore capabilities have been installed in the UNIX kernel. Then try starting the emulation session again.

**Emul700dmn version incompatible with this product**

Cause: The emulation session could not begin because the version of the HP 64700 emulator daemon executable on host system is not compatible with the version of the emulator/analyzer interface you are using.

Action: Make sure the software has been properly installed. Then try starting the emulator again.

**Enable breakpoint failed: <address> (Error 665)**

Cause: System failure or target condition.

Action: Check memory mapping and configuration questions.

**Ending released**

Cause: This is a status message. The emulation session is being exited with the **end release\_system**. The emulator will be released for others to access and use it.

**Error: display size is <LINES> lines by <COLUMNS> columns. It must be at least 24 by 80.**

Cause: You tried to specify an incorrect window size.

Action: Set the window size accordingly; then start the emulation session. The size of the window must be a minimum of 24 lines (rows) by 80 columns to operate an emulation session.

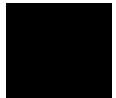

Chapter 12: Emulator Messages  
**Alphabetized Error And Status Messages**

**Error in configuration process**  
**Error starting configuration process**

Cause: Unexpected configuration error.

Action: Verify proper software installation and call your HP 64000 representative.

**Exceeded maximum 64700 command line length (Error 10351)**

Cause: Your command is longer than 240 characters.

Action: Shorten the command.

**Failed to disable step mode (Error 684)**

Cause: System failure.

Action: Run performance verification (**pv** command).

**Fatal error from function <ADDRESS OF FUNCTION>**

Cause: This is an unexpected fatal system error.

Action: Cycle power on the emulator and start again. If this is a persistent problem, call your HP 64000 representative.

**FATAL SYSTEM SOFTWARE ERROR (Error 204)**

**FATAL SYSTEM SOFTWARE ERROR (Error 205)**

**FATAL SYSTEM SOFTWARE ERROR (Error 208)**

Cause: The system has encountered an error from which it cannot recover.

Action: Write down the sequence of commands that caused the error. Cycle power on the emulator and reenter the commands. If the error repeats, call your local HP Sales and Service office for assistance.



**File could not be opened**

Cause: You tried to store or load trace data to a file with incorrect permission. Or the analyzer could not find the file you specified, or else there were already too many files open when you entered your command.

Action: Check the directory and file for correct read and write permission. Specify a file that is accessible to the analyzer. Close the other files that are presently open.

**File perf.out does not exist**

Cause: You tried to execute the "restore" command to continue a previous software performance measurement, and the SPMT software found that no "performance\_measurement\_end" command was previously executed to create a file from which "restore" could be performed.

Action: Execute a new SPMT measurement.

**File perf.out not generated by measurement software**

Cause: The file named perf.out exists in the current directory, but it was not created by the "performance\_measurement\_end" command.

Action: Rename the old "perf.out" file, or move it to another directory.

**File transfer aborted (Error 410)**

Cause: A **transfer** operation was aborted due to a break received, most likely a <CTRL> c from the keyboard. If you typed <CTRL> c, you probably did so because you thought the transfer was about to fail.

Action: Retry the transfer, making sure to use the correct command options. If you are unsuccessful, make sure that the data communications parameters are set correctly on the host and on the HP 64700, then retry the operation.

**Guarded mem break: <address> (Error 628)**

Cause: Your program attempted to read or write a memory location mapped as guarded. The <address> parameter indicates the address and function code at which the bus cycle occurred. The emulator breaks into the monitor.

Action: Investigate the cause of the guarded memory access by your target program.

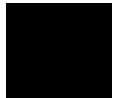

Chapter 12: Emulator Messages  
**Alphabetized Error And Status Messages**

**HP64700 I/O channel in use by emulator: <LOGICAL NAME> (Error 10331)**

Cause: You tried to start an emulator interface, but your attempt failed because the emulator is already in use by someone else.

Action: Current user must release the emulator.

**HP64700 I/O channel semaphore failure: <string>**

Cause: Semaphore (ipc) facility not installed.

Action: Reconfigure the kernel to add ipc facility.

**HP 64700 I/O error; communications timeout**

Cause: This is a communication failure.

Action: Check power to the emulator and check that all cables are connected properly. If you are using LAN and heavy LAN traffic is present, try setting the environment variable to HP64700TIMEOUT="30" (or larger if needed). The value is the number of seconds before timeout occurs. Then try running again.

**HP64700 I/O error; connection timed out**

Cause: A user abort occurred while attempting to connect via LAN.

Action: Possibly connecting to an emulator many miles away, be patient.

**HP 64700 I/O error; power down detected**

Cause: The emulator power was cycled.

Action: Do not do this during a user interface session; this may force the user interface to end immediately.

**HP64700 I/O channel busy; communications timed out**

Cause: The communications channel is in use for an unusually long period of time by another command.

Action: try again later.

**Illegal base for count display (Error 1130)**

Cause: When specifying the trace format, counts may only be displayed relative or absolute. When counting states, the count is always a decimal number.

Action: Respecify the trace format without using a base for the count column.

**Illegal base for mnemonic disassembly display (Error 1131)**

Cause: When specifying the trace format, you tried to specify a number base for the column containing mnemonic information.

Action: Respecify the trace format without using a base for the mnemonic column.

**Illegal base for sequencer display (Error 1132)**

Cause: When specifying the trace format, you tried to specify a number base for the column containing sequencer information.

Action: Respecify the trace format without using a base for the sequencer column.

**Illegal status combination**

Cause: You tried to specify combinations of status qualifiers in expressions incorrectly when entering commands.

Action: Refer to Chapter 11, "Emulator Commands," for information about syntax of commands.

**Illegal symbol name**

Cause: You tried to specify incorrect symbol names when entering commands.

Action: Specify correct symbol names. To see global symbol names, use the **display global\_symbols** command. To see local symbol names, use the **display local\_symbols\_in <SYMB>** command.

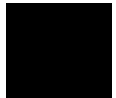

Chapter 12: Emulator Messages  
**Alphabetized Error And Status Messages**

**Incompatible with 64700 firmware version (Error 10352)**

Cause: The installed interface firmware combination is incorrect or incompatible.

Action: Upgrade the interface software of product firmware.

**Initialization failed**

Cause: The emulator could not be initialized.

Action: Make sure your data communication switch settings are correct, and that all emulator/analyzer interface software has been loaded properly. Cycle power on the emulator, then try starting up the emulation session again.

**Initialization load failed**

Cause: The emulator could not be initialized.

Action: Make sure your data communication switch settings are correct, and that all emulator/analyzer interface software has been loaded properly. Cycle power on the emulator, then try starting up the emulation session again.

**Initializing emulator with default configuration**

Cause: This is a status message. The host system started the emulation session and initialized the emulator using the default configuration. The emulator is probably operating correctly.

**Initializing user interface with default config file**

Cause: This is a status message. The host system started the emulation session and emulator/analyzer interface using the default configuration file. The emulator is probably operating correctly.

**Insufficient emulation memory (Error 21)**

Cause: You tried to map more emulation memory than is available.

Action: Check your map specification. Do not try to map more emulation memory than is available in your system.

**Insufficient emulation memory, memory map may be incomplete**

Cause: You can map only the amount of emulation memory available in your emulator. Trying to map additional unavailable memory may cause information to be missing from your memory map.

Action: Modify your configuration and update the memory map to correctly reflect the amount of emulation memory available.

**Invalid address: <address> (Error 310)**

Cause: You specified an invalid address value as an argument to a command (other than an analyzer command). For example, you may have specified digits that don't correspond to the base specified, or you forgot to precede a hexadecimal letter digit with a number (even zero (0)).

Action: Reenter the command and the address specification. Use online help by typing **help --EXPR--** and **help --SYMB--**. See the <ADDRESS> and the <EXPRESSION> syntax pages in this manual for information on address specifications.

**Invalid address range: <address\_range> (Error 311)**

Cause: You specified an invalid address range as an argument to a command (other than an analyzer command). For example, you may have specified digits that don't correspond to the base specified, or you forgot to precede a hexadecimal letter digit with a number, or the upper boundary of the range you specified is less than the lower boundary.

Action: Reenter the command and the address specification. Use online help by entering **help --EXPR--** or **help --SYMB--**. See the <ADDRESS> syntax pages and <EXPRESSION> syntax pages in this manual for information on address specifications. Also, make sure that the upper boundary specification is greater than the lower boundary specification (the lower boundary must always precede the upper boundary on the command line).

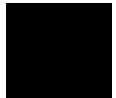

## Chapter 12: Emulator Messages

### Alphabetized Error And Status Messages

#### **Invalid answer in <CONFIGURATION FILENAME> ignored**

Cause: You must provide acceptable responses to questions in the configuration file (file.EA). The emulator ignored the incorrect response. Incorrect responses may appear in configuration files when you have saved the configuration to a file, edited it later, and tried reloading it into the emulator. This may also occur if you have loaded a configuration file that you created while using another emulator, and the response differs from the response required for this emulator.

Action: Examine your configuration file to check for inappropriate responses to configuration file questions.

#### **Invalid attribute for memory type : <attribute> (Error 104)**

Cause: The memory type attributes **dp** and **dsi** are valid only for emulation ROM and emulation RAM memory types. You tried to assign one of these attributes to target memory.

Action: Refer to Chapter 8, "Configuring the Emulator," for information on the memory type attributes.

#### **Invalid count: <option> (Error 315)**

Cause: This error occurs when the emulation system expects a certain number (of arguments, for example), but you specify a different number.

Action: Enter the number the system expects to receive.

#### **Invalid expression: <expression> (Error 307)**

Cause: You have entered an expression with incorrect syntax; therefore, it cannot be evaluated. <expression> is the bad expression.

Action: Use online help by typing **help --EXPR--**. Reenter the expression, following the syntax rules for that type of expression. Refer to Chapter 11, "Emulator Commands," to determine the correct syntax for the expression type.

**Invalid memory map attribute: <attribute> (Error 731)**

Cause: You tried to type in an invalid memory map attribute.

Action: Use memory map attributes offered on the softkeys. The only valid memory map attributes for the MC68020 emulator are **dp** (dual-port memory) and **dsi** (interlock DSACKs). The MC68030/EC030 emulator supports these attributes and the **ci** (cache inhibit) attribute. For example, the following command will cause an error: **0h thru 100h emulation RAM ds2**.

**Invalid number of arguments (Error 308)**

Cause: You either entered too many options to a command or an insufficient number of options.

Action: Reenter the command with correct syntax. Refer to Chapter 11, "Emulator Commands," for information.

**Invalid number of bytes for longword access (Error 152)**

Cause: The access mode was set to long word, but the number of bytes you supplied for a memory modify was not a multiple of four.

Action: Either change the access mode to byte or word, or supply a number of bytes that is a multiple of four. (Note: this message will not appear for memory mapped with the **dp** attribute.)

**Invalid number of bytes for word access (Error 152)**

Cause: The access mode was set to word, but you supplied an odd number of bytes for a memory modify.

Action: Either change the access mode to byte, or supply an even number of bytes. (Note: this message will not appear for memory mapped with the **dp** attribute.)

**Invalid number of words for longword access (Error 152)**

Cause: The access mode was set to long word, but the number of bytes you supplied for a memory modify was not a multiple of four.

Action: Either change the access mode to byte or word, or supply a number of bytes that is a multiple of four. (Note: this message will not appear for memory mapped with the **dp** attribute.)

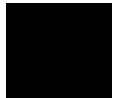

Chapter 12: Emulator Messages  
**Alphabetized Error And Status Messages**

**Invalid option or operand (Error 300)**

**Invalid option or operand: <option> (Error 305)**

Cause: You have specified an incorrect option to a command. <option>, if printed, indicates the incorrect option.

Action: Use online help by typing **help <command>** or **? <command>**. Reenter the command with the correct syntax. Refer to Chapter 11, "Emulator Commands," for more information.

**Invalid pod number: <pod#> (Error 1253)**

Cause: This error message occurs when you attempt to specify a slave clock for a non-existent analyzer pod.

Action: Use the trace activity command to display the valid pod numbers, and use only these numbers when entering commands.

**Inverse assembly file <INVERSE ASSEMBLER FILENAME> could not be loaded**

**Inverse assembly file <INVERSE ASSEMBLER FILENAME> not found, <filename>**

**Inverse assembly not available**

Cause: The file does not exist.

Action: Reload your interface and/or real-time operating system software.

**Inverse assembly not available**

Cause: The inverse assembler for your emulator is missing.

Action: Verify proper software installation.

**Joining session already in progress, continue file loaded**

Cause: This is a status message. When operating the emulator in multiple windows, a new emulation session is "joined" to a current session. In this case, the new session was able to continue because the continue file loaded properly.



**Joining session already in progress, user interface defaulted**

Cause: When operating the emulator in multiple windows, a new emulation session is “joined” to a current session. In this case, the new session used the user interface default selections.

**Load aborted**

Cause: While loading a file into the emulator, an event occurred that caused the host system to stop the load process.

Action: Use the **display error\_log** command to view any errors. If the problem persists, make sure the host system and emulator are operating properly, and that you are trying to load an acceptable file. Refer to Chapter 11, “Emulator Commands,” for information about the **load** command.

**Load completed with errors**

Cause: While loading a file into the emulator, one or more events occurred that caused errors during the load process.

Action: Use the **display error\_log** command to view any errors. You may need to modify the configuration and map memory before you load the file again. If the problem persists, make sure the host system and emulator are operating properly, and that you are trying to load an acceptable file.

**Logical emulator name unknown; not found in 64700tab file (Error 10315)**

Cause: This message may occur while trying to start up the emulator. It indicates that the emulator name specified could not be found in the 64700tab.net or /etc/hosts files.

Action: Specify the name in one of these files.

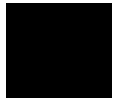

## Chapter 12: Emulator Messages

### Alphabetized Error And Status Messages

#### **Measurement system not found**

Cause: You tried to end the current emulation session and select another measurement system module which could not be located by the host system.

Action: Either try the **end select measurement\_system** command again or end and release the emulation session.

#### **Memory allocation failed, ending released**

Cause: This is a fatal system error because the emulation session was unable to allocate memory.

Action: You may need to reconfigure your UNIX kernel to increase the per process maximum memory limit and available swap space. Reboot your UNIX system and try starting a new session again.

#### **Memory modify aborted; next address: <address> (Error 754)**

Cause: One of these messages is displayed if a break occurs during processing of the **copy memory** or **modify memory** commands. The break could result from any of the break conditions or could have resulted from a <CTRL> c break.

Action: Retry the operation. If breaks are occurring continuously, you may wish to disable some of the break conditions.

#### **Memory range overflow**

Cause: A modify memory command is attempted that would cross physical 0.

Action: Limit the modify memory command to not overflow physical 0 or break the command into two separate modify commands.

**Missing option or operand (Error 313)**

Cause: You have omitted a required option to the command.

Action: Reenter the command with the correct syntax. Use online help by entering **help <command>**. Refer to Chapter 11, "Emulator Commands," for further information on required syntax.

**MMU configuration error - invalid <register> value (Error 162)**

Cause: You tried to use the **display mmu\_translations** or **load demmuver verbose** command to display MMU translations or to load the deMMUer, but one of MMU registers (TC, CRP or SRP) was invalid. You will also see this message if you specify an invalid alternate register value on the command line in a **display mmu\_translations** command.

Action: To solve this problem, use the **modify register MMU <register> to <value>** command to initialize the MMU registers to valid values, or use the **display mmu\_translations use\_TC\_value <value> use\_CRP\_value <value> use\_SRP\_value <value>** command to display MMU translations using alternate register values.

**MMU not enabled via configuration (Error 160)**

Cause: You tried to use the **display mmu\_translations** or **load demmuver verbose** command to display MMU translations or to load the deMMUer, but the MMU was not enabled in the emulation configuration.

Action: Enable the MMU before trying to use these commands. Refer to Chapter 8, "Configuring the Emulator," for more information.

**MMU not enabled via TC register (Error 160)**

Cause: You used the **display mmu\_translations** or **load demmuver verbose** command to display MMU translations or to load the deMMUer, but the MMU was not enabled in software (by setting the enable bit in the translation control register). The MMU does not have to be enabled in software in order to use these commands and this status message is only used to advise you that the MMU is not actually enabled.

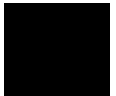

Chapter 12: Emulator Messages  
**Alphabetized Error And Status Messages**

**Monitor failure; bus error (Error 107)**

Cause: The monitor is unable to run because the processor has encountered a bus fault (such as the /BERR line).

Action: Release the /BERR line and determine why it was activated.

**Monitor failure; bus grant (Error 104)**

Cause: The monitor is unable to run. The emulation processor is not running because it has granted the bus to another device.

Action: Wait until the processor has regained bus control. Then retry the operation.

**Monitor failure; bus grant (Error 170)**

Cause: During a monitor command, an external target system device monopolized the bus; the monitor is no longer responding.

Action: Wait until the processor has regained bus control, and then retry the operation or don't let external devices monopolize the bus for extended periods of time.

**Monitor failure; CPU in wait state (Error 170)**

Cause: Request to access memory failed because the target system did not provide cycle termination for this address and the processor is stuck in a continuous wait state. A continuous wait state may indicate target system problems.

Action: If this occurred during an access to emulation memory, then the **dsi** memory attribute must have been used. If the target is not supposed to provide cycle terminations for this range, delete and reenter the map term without **dsi**.

**Monitor failure; halted (Error 105)**

Cause: The monitor is unable to run because the processor is halted (due to an external halt line or a halt instruction).

Action: Release the external halt and retry the operation. If the processor halted due to a halt instruction, try the **reset** command. Then retry the operation.

**Monitor failure; halted (Error 170)**

**Monitor failure; no bus cycles (Error 170)**

Cause: During a monitor command, one or more target exceptions caused the processor to stop running bus cycles.

Action: Use the emulation-bus analyzer to determine what exceptions caused the problem and try to work around them.

**Monitor failure; no clock input (Error 102)**

Cause: The monitor is unable to run because no emulation processor clock is available.

Action: If you are not using a target system, plug the emulator probe into the demo board, and connect the power cable of the demo board to the HP 64700 Card Cage. If you are using a target system, make sure the target system has power and the clock in the target is functioning correctly.

**Monitor failure; no processor cycles (Error 103)**

Cause: The monitor is unable to run because the processor is not running. The monitor is unable to determine the cause of the failure.

Action: If running in-circuit, troubleshoot the target system. If running out-of-circuit, reinitialize the emulator and try the procedure again.

**Monitor failure; no target power (Error 170)**

Cause: You do not have proper power applied to your target system or demo board.

Action: Check the connection from your emulation probe to the target system or demo board. If using the demo board, be sure you have connected the external power cable.

**Monitor failure; slow clock (Error 170)**

Cause: The target system is providing target power but no clock signal.

Action: Make sure the clock oscillator is installed correctly.

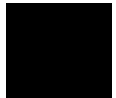

Chapter 12: Emulator Messages  
**Alphabetized Error And Status Messages**

**Monitor failure; target reset (Error 170)**

Cause: During a monitor command, the target system ascertained (and continues to ascertain) the reset signal; the monitor is no longer responding.

Action: Prevent your target system from ascertaining the reset signal when you are using monitor commands.

**Monitor failure; wait state (Error 106)**

Cause: The monitor is unable to run because the processor is in a continuous wait state.

Action: A continuous wait state may indicate target system problems. Check the  $\overline{DSACK}$  lines. If you were running out-of-circuit, you may have to reload the emulation configuration file to re-initialize the emulator. You will also have to reload your program code. If that does not help, try cycling power on the emulator.

**Monitor handled target exception; <exception> (Error 170)**

Cause: The vector base register points to the exception vector table in the foreground monitor and the target program generated an exception that was detected by the monitor.

**Monitor must be mapped on a 4K byte boundary (Error 146)**

Cause: You tried to change the base address of the monitor to one that doesn't start on a 4-Kbyte boundary (one that ends in 000).

Action: Reenter the command and specify an address that ends in 000.

**Monitor type changed to foreground monitor (Error 157)**

Cause: You enabled the MMU via a terminal interface configuration command while the background monitor was selected. The emulator automatically changed to use the default foreground monitor when you enabled the MMU. Only a foreground monitor can be used when the MMU is enabled.

**M68020 probe not connected or configured incorrectly (Error 179)**

**M68030/EC030 probe not connected or configured incorrectly (Error 179)**

Cause: The emulator is reading an invalid identifier for the emulation probe.

Action: Make sure the probe cables are connected correctly. Also make sure that the probe is the MC68020/MC68EC020, or the MC68030/EC030 probe, as applicable. Make sure correct firmware is flashed on the control card (020 firmware for the 020 probe or 030 firmware for the 030 probe).

**No address label defined**

Cause: The address trace label was somehow removed in the terminal interface using the **tlb** command.

Action: End session and start again.

**No map terms available; maximum number already defined (Error 721)**

Cause: You tried to add more mapper terms than are available for this emulator. For example, with the MC68020 and MC68030/EC030 emulator, there are only seven terms. If you had already defined memory types for these terms, then tried to map another term, you would see the above error message.

Action: Either combine map ranges to conserve the number of terms or delete mapper terms that aren't needed.

**No module specified for local symbol (Error 882)**

Cause: This error occurs because you tried to specify a local symbol name without specifying the module name where the symbol is located.

Action: Enter the module name where the local symbol is located, followed by a colon, then the local symbol name.

**No more processes may be attached to this session**

Cause: You can operate an emulator in four windows. Each time you start the emulator in another window, a new process is attached to the current session.

Action: Do not try to use more than four windows. Once you have started the emulator in four windows, you have reached the maximum number of processes allowed for that emulator.

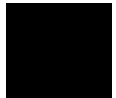

## Chapter 12: Emulator Messages

### Alphabetized Error And Status Messages

#### **Not an absolute file**

**No absolute file:** <file>

**No absolute file, No database:** <file>

Cause: You tried to load a file into the emulator that is not an executable or absolute file, so the host system stopped the load process.

Action: Try your command again, and make sure you specify a valid absolute file name to be loaded.

#### **No symbols loaded**

Cause: You tried to step through lines in the source file before symbols are loaded.

Action: Load symbols and try again, or use step with the "source" option (i.e. step assembly language program).

#### **No translation for CPU space addresses (Error 162)**

Cause: You tried to use the **display mmu\_translations fcode cpu <address>** command to display MMU translations. By definition, there are no translations performed by the MMU on CPU space addresses; a CPU logical address is the physical address.

Action: Try any other function code space.

#### **No valid trace data**

Cause: You tried to store trace data before a trace was completed.

Action: Wait until valid trace data is available before attempting to store a trace.

#### **Not a valid trace file - load aborted**

Cause: You tried to load a file.TR that was not created by the emulation session.

Action: Only load trace data files that were created by the emulator.

#### **Not compatible trace file - load aborted**

Cause: You tried to load a file.TR that was created by another type of emulator.

Action: Only load trace data files that were created by the same type of emulator.



**Number of lines not in range: 1 <= valid lines <= 50**

Cause: You tried to enter a number of lines that was outside the range from 1 to 50.

Action: Try entering the command again using a valid number of lines.

**Number of spaces not in range: 2 <= valid spaces <= 15**

Cause: You tried to enter a number of spaces outside the range from 2 to 15.

Action: Try entering the command again using a valid number of spaces.

**opcode extends beyond specified address range**

Cause: Memory disassembly is attempted on an address range that is too small.

Action: Display memory mnemonic using a large address range, or no address range at all.

**Out of DeMMUer resources (Error 163)**

Cause: You used the **load demmuer** command to load the deMMUer but there was not enough resources to reverse translate all address translations defined by your translation tables. Depending upon the MMU page size selected, the deMMUer can reverse translate 16M or 256M physical addresses into logical addresses.

Action: Refer to Chapter 10, "Using MC68030 Memory Management," for more information on how to make the most efficient use of the deMMUer resources.

**Out of system memory (Error 201)**

Cause: Macros and equates that you have defined have used all of the available system memory.

**Perfinit - Absolute file (database) must be loaded line <LINE NUMBER>**

Cause: No symbolic data base has been opened (or exists) for the target file when you executed the "performance\_measurement\_initialize" command.

Action: Make sure a data base has been loaded for the target file.



Chapter 12: Emulator Messages  
**Alphabetized Error And Status Messages**

**Perfinit - error in input file line <LINE NUMBER> invalid symbol**

You included a "label" file name with your "performance\_measurement\_initialize" command, and that file contains an invalid symbol.

Action: Edit the file and correct the invalid symbol.

**Perfinit - error in input file line <NUMBER>**

Cause: You included an input file name with your "performance\_measurement\_initialize" command, and that file contains a syntax error.

Action: Edit the file and correct the syntax error.

**Perfinit <---EXPR--- ERROR> line <LINE NUMBER>**

Cause: An error exists in your file of ranges to be measured.

Action: See **Help**→**Command Line**→**performance\_measurement\_initialize** or refer to Chapter 7, "Making Software Performance Measurements," for information about formatting address-range files and time-range files.

**Perfinit - File could not be opened**

Cause: You specified a file as an option to "performance\_measurement\_initialize", and the file you specified could not be found or opened by SPMT software.

Action: Make sure you entered the correct file name.

**Perfinit - No events in file**

Cause: You specified a file along with your "performance\_measurement\_initialize" command that contained no events. Any measurement displayed from this file will have NULL results.

Action: Either edit the file to add events, or use the default setup to start a new measurement.

**perf.out file could not be opened - created**

Cause: The performance analyzer failed to open or create a file named "perf.out" in response to your "performance\_measurement\_end" command.

Action: Free up some file space or correct the write permissions in your current working directory.

**Performance tool must be initialized**

Cause: You tried to make a performance measurement when the Software Performance Measurement Tool (SPMT) was not initialized.

Action: The Software Performance Measurement Tool (SPMT) must be initialized before making performance measurements on your software. Use the **performance\_measurement\_initialize** command to initialize the SPMT.

**Performance tool not initialized**

Cause: The Software Performance Measurement Tool (SPMT) has not been initialized.

Action: To make accurate activity or duration measurements on current data, use the **performance\_measurement\_initialize** command to initialize the SPMT before running a performance measurement.

**Program counter is located in guarded memory (Error 150)**

Cause: You tried to run the processor from the current PC, but the PC pointed to guarded memory.

Action: Modify the PC to an even value that points to a valid program memory area.

**Program counter is odd (Error 84)**

Cause: You tried to modify the program counter to an odd value using the **modify register PC** command. The processor expects even alignment of opcodes.

Action: Modify the program counter only to even numbered values.

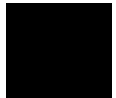

Chapter 12: Emulator Messages  
**Alphabetized Error And Status Messages**

**Program counter is odd or uninitialized (Error 84)**

Cause: You tried to run the processor from the current PC, but the PC was odd or pointed to an unmapped memory area.

Action: Modify the PC to an even value.

**Question file missing or invalid**

Cause: Some of the emulator/analyzer interface files are missing or are corrupted.

Action: Reinstall the host software and try starting the emulation session again.

**Range crosses segment boundary**

Cause: On a segment offset processor, an address range is specified that would cross different segments.

Action: Break the memory command into multiple commands so that the address ranges start and end in the same segment.

**Range resource in use (Error 1221)**

Cause: This error occurs when you attempt to redefine the “complex” configuration range resource while it is currently being used as a qualifier in the trace specification.

Action: In the “complex” configuration, display the sequencer specification to see where the range resource is being used and remove it; then, you can redefine the range resource.

**Range term used more than once (Error 1248)**

Cause: This error occurs when you attempt to use the range resource more than once in a sequencer branch expression.

Action: Do not use the range resource more than once in a sequencer branch expression.

**Read memory failed at <PHYSICAL ADDRESS> - store aborted**

Cause: While storing memory from the emulator to a file, a read memory error occurred.

Action: Use the **display error\_log** command to view any errors. You may need to modify the configuration and map memory before storing the file again.

**Read PC failed during break (Error 603)**

Cause: The monitor is not responding.

Action: Check your target system configuration, the emulator configuration and memory map, or reinitialize the emulator. Then try the command sequence again.

**Record checksum failure (Error 400)**

Cause: During a **transfer** operation, the checksum specified in a file did not agree with that calculated by the HP 64700.

Action: Retry the **transfer** operation. If the failure is repeated, make sure that both your host and the HP 64700 data communications parameters are configured correctly.

**Records expected: <number>; records received: <number> (Error 401)**

Cause: The HP 64700 received a different number of records than it expected to receive during a **transfer** operation.

Action: Retry the **transfer**. If the failure is repeated, make sure that the data communications parameters are set correctly on the host and on the HP 64700. See the *HP 64700-Series Card Cage Installation/Service Guide* for details.

**Register access aborted (Error 630)**

Cause: Occurs when a <CTRL> c is entered during register display.

**Register class cannot be modified: <register\_class> (Error 637)**

Cause: You tried to modify a register class instead of an individual register.

Action: You can only modify individual registers. See the **display registers** syntax pages in Chapter 11, "Emulator Commands," for a list of register names.

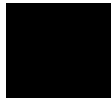

## Chapter 12: Emulator Messages

### Alphabetized Error And Status Messages

#### **Register not writable: <register> (Error 636)**

Cause: This error occurs when you attempt to modify a read only register.

Action: If this error occurs, you cannot modify the contents of the register with the **modify register** command.

#### **Request access to guarded memory: <address> (Error 707)**

Cause: The address or address range specified in the command included addresses within a range mapped as guarded memory. When the emulator attempts to access these during command processing, the above message is printed, along with the specific address or addresses accessed.

Action: Reenter the command and specify only addresses or address ranges within emulation or target RAM or ROM. Or, you can remap memory so that the desired addresses are no longer mapped as guarded.

#### **Request failed; bus error (Error 170)**

Cause: The monitor detected a bus error exception while attempting to display or modify memory. This can occur if the target system terminates a memory access with a bus error.

Action: See if this bus error occurred in emulation memory; if it did, the **dsi** memory attribute must have been used. If the target is not supposed to provide cycle terminations for this emulation memory range, delete and reenter this map term without the **dsi** attribute.

The MC68030 MMU can also terminate an access with a bus error if there is no valid address translation. Use the **display mmu\_translations** command to verify that the address translation tables are set up correctly.

#### **Request failed; level 7 interrupt (Error 170)**

Cause: The monitor detected a non-maskable, level 7 interrupt (autovector) generated by the target system while executing a monitor command. During monitor commands, the monitor uses its own exception vector table and attempts to block all interrupts. However, a non-maskable, level 7 interrupt causes the monitor to abort the command, and restore the original vector table and interrupt priority mask. THE TARGET SYSTEM LEVEL 7 INTERRUPT HANDLER IS NOT EXECUTED.

**Request failed; no MC68881/882 floating point coprocessor (Error 170)**

Cause: You entered a command to display or modify an FPU register, but you don't have one in your system.

**Request failed; unexpected exception <vector> (Error 170)**

Cause: The monitor detected an exception that was generated during execution of a monitor command.

**Restricted to real time runs (Error 40)**

Cause: While the emulator is restricted to real-time execution, you have attempted to use a command that requires a temporary break in execution to the monitor. The emulator does not permit the command and issues this error message.

Action: You must break the emulator's execution into the monitor before you can enter the command.

**Retry limit exceeded, transfer failed (Error 412)**

Cause: The limit for repeated attempts to send a record during a **transfer** operation was exceeded, therefore the transfer was aborted.

Action: Retry the transfer. Make sure you are using the correct command options for both the host and the HP 64700. The data communications parameters need to be set correctly for both devices. Also, if you are in a remote location from the host, line noise may cause the failure.

**Run failed during CMB execute (Error 694)**

Cause: System failure or target condition.

Action: Run performance verification (**pv** command), and check target system.

**Sequence term not contiguous: <term> (Error 1225)**

Cause: This error occurs when you attempt to insert a sequence term which is not between existing terms or after the last term.

Action: Be sure that the sequence term you enter is either between existing sequence terms or after the last sequence term.

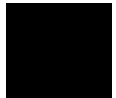

## Chapter 12: Emulator Messages

### Alphabetized Error And Status Messages

#### **Sequence term not defined: <term> (Error 1227)**

Cause: This error occurs when you attempt to delete or specify a primary branch expression for a sequence term number that is possible, but is not currently defined.

Action: Insert the sequence term, and respecify the primary branch expression for that term.

#### **Sequence term number out of range: <term> (Error 1224)**

Cause: This error occurs when a sequencer qualification command specifies a non-existent sequence term. The easy configuration sequencer may have a maximum of four sequence terms. Eight sequence terms exist in the complex configuration sequencer.

Action: Reenter the command using an existing sequence term.

#### **Session aborted**

Cause: This will only happen when running multiple emulation windows and a fatal system error occurs.

Action: Find the window that caused the error and see the error message that it displayed. All the additional windows will simply state "session aborted". Cycle power on the emulator and enter **emul700 -U <logical name>** to make sure the emulator is unlocked.

#### **Session cannot be continued, ending released**

Cause: The emulation session is ending automatically because it could not be continued from the previous session. When the session has ended the emulator will be released, meaning that others can access and use it.

Action: When you restart the emulation session later, the new session will use all default settings.

#### **Severe error detected, file transfer failed (Error 411)**

Cause: An unrecoverable error occurred during a **transfer** operation.

Action: Retry the transfer. If it fails again, make sure the data communications parameters are set correctly on the host and on the HP 64700. Also make sure you are using the correct command options, both on the HP 64700 and on the host.



**Slave clock requires at least one edge**

Cause: The analyzer has an invalid clock specification.

Action: Modify your configuration and try your command again.

**Software breakpoint: <address> (Error 615)**

Cause: This status message is displayed when a breakpoint is encountered during a program run. The emulator breaks to the monitor. The string <address> shows the address where the breakpoint was encountered.

**Software breakpoint break condition is disabled (Error 661)**

Cause: You have attempted to set or clear a breakpoint when breakpoints are disabled.

Action: You must enable breakpoints before you can set them.

**Specified breakpoint not in list: <address> (Error 663)**

Cause: You tried to clear a breakpoint that was not previously set. The string <address> prints the address of the breakpoint you attempted to enable.

Action: You must first set a breakpoint before it can be cleared.

**Stack pointer is odd (Error 80)**

Cause: You tried to modify the stack pointer to an odd value for a processor that expects the stack to be aligned on a word boundary.

Action: Modify the stack pointer to an even value.

**Starting address greater than ending address**

Cause: You specified a starting address that is greater than the ending address.

Action: Specify a starting address that is less than or equal to the ending address.

**Starting new session, continue file loaded**

Cause: This is a status message. The emulator was started using a new emulation session, and the continue file loaded properly.

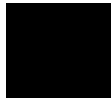

## Chapter 12: Emulator Messages

### Alphabetized Error And Status Messages

#### **Starting new session, user interface defaulted**

Cause: The emulator was started using a new emulation session, and the user interface was set to default selections.

Action: Call your HP Service Representative.

#### **Status unknown, run “emul700 -l <LOGICAL NAME>”**

Cause: The host system cannot determine the status of the emulator.

Action: To verify communication between the emulator and the host system, and display the emulator status, enter the **emul700 -l <logical name>** command. The emulator logical name is located in the /usr/hp64000/etc/64700tab.net (or 64700tab) file.

#### **Step count must be 1 through 999**

Cause: You tried to use a step count greater than 999.

Action: Use a step count less than 1000.

#### **Step display failed (Error 688)**

Cause: System failure or target condition.

Action: Check memory mapping and configuration questions.

#### **Stepping aborted (Error 685)**

This message is displayed if a break was received during a **step** command with a stepcount of zero (0). The break could have been due to any of the break conditions, such as a <CTRL> c break.

#### **Stepping aborted; number steps completed: <STEPS TAKEN>**

Cause: Stepping aborted because <ctrl>c or a breakpoint was hit, guarded memory was accessed, or some other kind of error occurred.

Action: See the error log display for any abnormal errors. Correct those errors and then step again.

**Stepping aborted; number steps completed: <steps completed> (Error 686)**

Cause: This message is displayed if a break was received during a **step** command with a stepcount greater than zero. The break could have been due to any of the break conditions or a <CTRL> c break. The number of steps completed is displayed.

**Stepping failed (Error 680)**

Cause: Stepping has failed for some reason. For example, this message will appear if the emulator can't modify the trace vector, which is used to implement the step function.

Action: Usually, this error message will occur with other error messages. Refer to the descriptions of the accompanying error messages to find out more about why stepping failed. (See descriptions of the <STACK> error messages at the beginning of this chapter.)

**Stepping complete**

Cause: Stepping was completed successfully.

**Symbol cannot contain text after the wildcard (Error 879)**

Cause: You tried to include text after the wildcard specified in the symbol name (for example, sym\*text).

Action: Enter the symbol again, but don't include text after the wildcard (\*).

**Symbol cannot contain wildcard in this context (Error 878)**

Cause: You tried to enter a global, local, or user symbol name using the wildcard (\*) incorrectly.

Action: When you enter the symbol name again, include the wildcard (\*) at the end of the symbol.

**Symbol not found: <symbol> (Error 877)**

Cause: This occurs when you try to enter a symbol name that doesn't exist.

Action: Enter a valid symbol name.

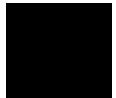

## Chapter 12: Emulator Messages

### Alphabetized Error And Status Messages

#### **Symbols not accessible, symbol database not loaded**

Cause: You specified a trace list with values expressed using symbols defined in the source code modules, such as source on, and the database file has not been loaded into emulation. Example: display trace symbols on.

#### **Target memory access failed (Error 700)**

Cause: This message is displayed if the emulator was unable to perform the requested operation on memory mapped to the target system.

Action: In most cases, the problem results from the emulator's inability to break to the monitor to perform the operation. Usually there are other error messages. Refer to the error log to read them to fully understand the cause of the error. See message "Unable to break (Error 608)".

#### **Timeout in emul700dmn communication**

Cause: The host system could not start the emulation session because the HP 64700 emulator process ran out of time before the emulator could start.

Action: You must press **end\_release\_system** to exit this emulation session completely; then start a new session. Make sure the host system is operating properly, that all emulator/analyzer interface software has been loaded correctly, and the data communication switch settings on the emulator rear panel match the settings in the /usr/hp64000/etc/64700tab.net (or 64700tab) file.

#### **Too many sequence terms (Error 1226)**

Cause: This error occurs when you attempt to insert more than four sequence terms.

Action: Do not attempt to insert more than four sequence terms.

#### **Trace error during CMB execute (Error 692)**

Cause: System failure.

Action: Run performance verification (**pv** command).

#### **Trace file not found**

Cause: You tried to load trace data file that does not exist.

Action: Find the correct name and path of the trace data file and try again.

**Trace format command failed; using old format (Error 1133)**

Cause: This error occurs when the trace format command fails for some reason.

Action: This error message always occurs with another error message. Refer to the description for the other error message displayed.

**Trace vector modified to <address> for single stepping (Error 155)**

Cause: You used the **step** command. The emulator modified the trace vector to <address> so that the single step function would operate correctly.

Action: See “To step the processor” in Chapter 4, "Using the Emulator," for more information.

**Trace vector points to unreadable memory (Error 156)**

Cause: You used the **step** command. The emulator found that the trace vector was even and in a mapped memory range; however, the processor entered an indefinite wait state when trying to read the location pointed to by the vector. This may be caused by a memory system failure, either in the target system or the emulator.

Action: Make sure the VBR register table is where you expect it to be. See “To step the processor” in Chapter 4, "Using the Emulator," for more information.

**Transparent addresses denoted as physical in analysis trace (Error 164)**

Cause: You used the **load demmu** command to load the deMMUer and one or more address ranges to be reverse translated are transparently translated via TT0/TT1 registers. The deMMUer will reverse translate your transparently translated addresses 1:1; however, these addresses will be tagged as physical instead of logical. Unfortunately symbolic lookup is not performed on addresses tagged as physical so you will not be able to obtain symbolic support for these addresses (either in your commands or in your trace displays).

If you have specified a read or write qualification for TT0 or TT1, the deMMUer will not provide the correct translation for addresses that do not meet the read/write qualification. Because the deMMUer cannot distinguish between read and write cycles, the deMMUer always interprets the TT0/TT1 registers as if the read/write mask bit has been set to ignore the read/write line (RWM=1).

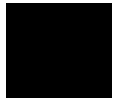

## Chapter 12: Emulator Messages

### Alphabetized Error And Status Messages

#### **trig1 break (Error 618)**

Cause: This status message is displayed if you used the **break\_on\_trigger** syntax of the **trace** command and the analyzer has found the trigger condition while tracing a program run. The emulator is broken to the monitor.

#### **Trig1 signal cannot be driven and received (Error 1302)**

Cause: This error occurs when you attempt to specify the internal trig1 signal as the trace arm condition while the same analyzer's trigger output is currently driving the trig1 signal. This error also occurs if you attempt to specify that the trigger output drive the internal trig1 signal while that signal is currently specified as the arm condition for the same analyzer.

Action: You can either change the arm or the trigger output specification; in either case, make sure that they do not use the same internal signal.

#### **trig2 break (Error 619)**

Cause: This status message is displayed if you have used the internal **trig2** line to connect the analyzer trigger output to the emulator break input and the analyzer has found the trigger condition. The emulator is broken to the monitor.

#### **Trig2 signal cannot be driven and received (Error 1303)**

Cause: This error occurs when you attempt to specify the internal trig2 signal as the trace arm condition while the same analyzer's trigger output is currently driving the trig2 signal. This error also occurs if you attempt to specify that the trigger output drive the internal trig2 signal while that signal is currently specified as the arm condition for the same analyzer.

Action: You can either change the arm or the trigger output specification; in either case, make sure that they do not use the same internal signal.

#### **Unable to access the deMMUer while analysis trace is in process (Error 164)**

Cause: You used the **load demmuer [verbose]** command while an analysis trace is currently running. Because the **load demmuer [verbose]** command will adversely affect the analysis data path, it can only be used when an analysis trace is not in process.

Action: Let the current analysis trace complete or use the **stop\_trace** command to halt the analysis trace. Then retry the operation.

**Unable to break (Error 608)**

Cause: This message is displayed if the emulator is unable to break to the monitor because the emulation processor is reset, halted, or is otherwise disabled.

Action: First, look at the emulation prompt and other status messages displayed to determine why the processor is stopped. If reset by the emulation controller, use the **break** command to break to the monitor. If reset by the emulation system, release that reset. If halted, try **reset** and the **break** to get to the monitor. If there is a bus grant, wait for the requesting device to release the bus before retrying the command. If there is no clock input, perhaps your target system is faulty. It's also possible that you have configured the emulator to restrict to real time runs, which will prohibit temporary breaks to the monitor. If this message has occurred immediately after you enabled the MMU in the MC68030 emulation processor, refer to the "Solving Problems" section at the end of Chapter 10, "Using MC68030 Memory Management."

**Unable to delete label; used by emulation analyzer: <label> (Error 1105)**

Cause: This error occurs when you attempt to delete an emulation trace label which is currently being used as a qualifier in the emulation trace specification or is currently specified in the emulation trace format.

Action: Display the emulation trace sequencer specification in the configuration, display the emulation trace patterns in the complex configuration, or display the trace format to see where the label is used. Also, you should check **tcq** and **tpq** for uses of that label. You must change the pattern or format specification to remove the label before you can delete it.

**Unable to load new memory map; old map reloaded (Error 725)**

Cause: There is not enough emulation memory left for this request.

Action: Reduce the amount of emulation memory requested.

**Unable to modify register: <register>=<value> (Error 632)**

Cause: The emulator was unable to modify the register you requested.

Action: To resolve this, you must look at the other status messages displayed. It's likely that the emulator was unable to break to the monitor to perform the register modification. See message "Unable to break (Error 608)".

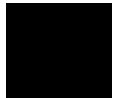

## Chapter 12: Emulator Messages

### Alphabetized Error And Status Messages

#### **Unable to read registers in class: <name> (Error 631)**

Cause: The emulator was unable to read the registers you requested.

Action: To resolve this, you must look at the other status messages displayed. Most likely, the emulator was unable to break to the monitor to perform the register read. See message "Unable to break (Error 608)".

#### **Unable to redefine label; used by emulation analyzer: <label> (Error 1108)**

Cause: This error occurs when you attempt to redefine an emulation trace label which is currently used as a qualifier in the emulation trace specification.

Action: You must stop the trace or change the trace command before you can redefine the label.

#### **Unable to reload old memory map; hardware state unknown (Error 726)**

Cause: Error occurred while trying to modify the emulation memory map.

Action: Usually there are other error messages present. Refer to the error log and read the other messages to more fully understand the cause and action to take for this error.

#### **Unable to reset (Error 640)**

Cause: Target condition or system failure.

Action: Check target system, and run performance verification (**pv** command).

#### **Unable to run (Error 610)**

Cause: The run has failed for some reason. For example, this message will appear if the emulator cannot write to the stack, which is required to run. Usually, this error message will occur with other error messages.

Action: Read the error log to see the other error messages that were generated. Refer to the descriptions of the accompanying error messages to find out more information about why the run failed. Look at the emulator status line to see if the emulator is halted, etc. Take a trace with the analyzer to see where the emulator is executing.



**Unable to run after CMB break (Error 606)**

Cause: System failure or target condition.

Action: Run performance verification (**pv** command), and check target system.

**Unable to run HP64747 tests without target power (Error 178)**

**Unable to run HP64748 tests without target power (Error 178)**

Cause: The demo board does not have proper power connected to it.

Action: Check the connection of the emulation probe and the external power cable to the demo board.

**Unable to run performance verification tests (Error 178)**

Cause: You entered the **pv** command, but the emulator was unable to start performance verification.

Action: Make sure the correct emulator probe is connected and all cables are secured. Make sure the demo board is connected to the emulator probe and the switches on the demo board are set to the test position. Also verify that the demo board power cable is connected to the HP 64700 Card Cage.

**Unable to set trace vector to <address>; vector table in TROM (Error 156)**

Cause: You used the **step** command. The emulator can't modify the trace vector to the correct value for stepping because the vector table region is mapped to target ROM.

Action: Make sure you initialized the vector correctly in your vector table. You need to remap memory so that the vector table will be located in a valid memory area. See "To step the processor" in Chapter 4, "Using the Emulator," for more information.

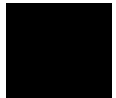

## Chapter 12: Emulator Messages

### Alphabetized Error And Status Messages

#### **Unable to set trace vector to <address>; vector table write failed (Error 156)**

Cause: You used the **step** command. The emulator tried to set the trace vector to the correct value for stepping, but failed. The most likely cause is that the vector table is mapped to target RAM but the physical memory is target ROM or there is no memory at that address.

Action: Make sure you initialized the vector correctly in your vector table. You need to remap memory so that the vector table will be located in a valid memory area. See “To step the processor” in Chapter 4, "Using the Emulator," for more information.

#### **Unable to verify trace vector; vector table in guarded memory (Error 156)**

Cause: You used the **step** command. The emulator tried to set the trace vector to the correct value for stepping and failed due to a guarded memory access.

Action: Check the VBR register to make sure the vector table is where you expect it to be. You need to remap memory so that the vector table will be located in a valid memory area. See “To step the processor” in Chapter 4, "Using the Emulator," for more information.

#### **Unable to verify trace vector; vector table read failed (Error 156)**

Cause: You used the **step** command. The emulator tried to set the trace vector to the correct value for stepping. It failed because the vector table region was mapped to target RAM or ROM, and (most likely) no physical memory was located at that address.

Action: Make sure you initialized the vector correctly in your vector table. You need to remap memory so the vector table will be located in a valid memory area. See “To step the processor” in Chapter 4, "Using the Emulator," for more information.

**Undefined software breakpoint:<address> (Error 605)**

Cause: The emulator has encountered a BKPT instruction in your program that was not inserted with the **modify breakpoints** command.

Action: You can choose one of BKPT 1 through BKPT 7 for the breakpoint instruction, using the supplied configuration item. Otherwise, remove the breakpoints inserted in your code before assembly and link. Then reinsert them using the **modify software\_breakpoints set** command. If this message occurred immediately after you enabled the MMU in the MC68030 emulation processor, refer to the "Solving Problems" section at the end of Chapter 10, "Using MC68030 Memory Management."

**Unexpected message from emul700dmn**

Cause: The host system could not start the emulation session because of an unexpected message from the HP 64700 emulator process command.

Action: You must press **end\_release\_system** to exit this emulation session completely; then start a new session. Make sure the host system is operating properly, that all emulator/analyzer interface software has been loaded correctly, and the data communication switch settings on the emulator rear panel match the settings in the /usr/hp64000/etc/64700tab.net (or 64700tab) file.

**Unexpected software breakpoint (Error 620)**

**Unexpected step break (Error 621)**

Cause: System failure.

Action: Run performance verification (**pv** command).

**Unknown expression type**

Cause: While entering your command, you included an unknown expression type.

Action: See the EXPR command syntax for more information about expressions. Then try entering your command again with a known expression type.

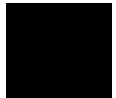

## Chapter 12: Emulator Messages

### Alphabetized Error And Status Messages

#### **Unload trace data failed**

Cause: An unexpected error occurred while waiting for a trace to be completed.

Action: End and release the session, and then try again.

#### **Unmatched quote encountered (Error 820)**

Cause: In entering a string, such as with the **echo** command, you didn't properly match the string delimiters (either “ or ”). For example, you might have entered

**echo “set S1 to off**

Action: Reenter the command and string, making sure to properly match opening and closing delimiters. Note that both delimiters must be the same character. For example: **echo “set S1 to off”**.

#### **Update HP64700 firmware to version A.03.01 or newer (Error 176)**

Cause: The emulator has found that at least one module of your system firmware is too old to be compatible with the emulation firmware.

Action: Update your system firmware to the latest release.

#### **Update HP64740 firmware to version A.02.02 or newer (Error 176)**

Cause: The emulator has found that your analysis firmware is too old to be compatible with the emulation firmware.

Action: Update the analysis firmware to the latest release.

#### **Wait time failure, could not determine system time**

Cause: The system call failed.

Action: Verify that 'date' executes correctly from the UNIX prompt.

**Warning: at least one integer truncated to 32 bits**

**Warning: at least one integer truncated to 16 bits**

**Warning: at least one integer truncated to 8 bits**

Cause: The number entered was too large for the currently specified display or access size.

Action: Try entering the command again using the correct size of number.

**Width not in range: 1 <= valid width <= 80**

Cause: You tried to specify the width of the field outside the range from 1 to 80.

Action: Try entering the command again using a valid number for the width.

**Write to ROM break: <address> (Error 628)**

Cause: A memory access to a location mapped as guarded memory has occurred during execution of the target program.

Action: Investigate the cause of the write to ROM by your target program. The <address> parameter indicates the address and function code where the write occurred. The emulator breaks into the monitor.

**64700 command aborted (Error 10371)**

Cause: User abort occurred due to emulator being monopolized by another command.

Action Don't issue an abort.

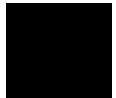



---

**13**

---

**Setting X Resources**

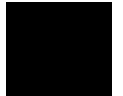

## Setting X Resources

The Graphical User Interface is an X Window System application which means it is a *client* in the X Window System client-server model.

The X server is a program that controls all access to input devices (typically a mouse and a keyboard) and all output devices (typically a display screen). It is an interface between application programs you run on your system and the system input and output devices.

An X *resource* controls an element of appearance or behavior in an X application. For example, in the graphical interface, one resource controls the text in action key pushbuttons as well as the action performed when the pushbutton is clicked.

By modifying resource settings, you can change the appearance or behavior of certain elements in the graphical interface.

When the graphical interface starts up, it reads resource specifications from a set of configuration files. Resources specifications in later files override those in earlier files. Files are read in the following order:

- 1 The application defaults file. For example, `/usr/lib/X11/app-defaults/HP64_Softkey` when the operating system is HP-UX or `/usr/openwin/lib/X11/app-defaults/HP64_Softkey` when the operating system is SunOS.
- 2 The `$XAPPLRESDIR/HP64_Softkey` file. (The `XAPPLRESDIR` environment variable defines a directory containing system-wide custom application defaults.)
- 3 The server's `RESOURCE_MANAGER` property. (The `xrdb` command loads user-defined resource specifications into the `RESOURCE_MANAGER` property.)

If no `RESOURCE_MANAGER` property exists, user defined resource settings are read from the `$HOME/.Xdefaults` file.



- 4 The file named by the XENVIRONMENT environment variable.  
If the XENVIRONMENT variable is not set, the \$HOME/.Xdefaults-*host* file is read (typically contains resource specifications for a specific remote host).
- 5 Resource specifications included in the command line with the **-xrm** option.
- 6 System scheme files in directory /usr/hp64000/lib/X11/HP64\_schemes.
- 7 System-wide custom scheme files located in directory \$XAPPLRESDIR/HP64\_schemes.
- 8 User-defined scheme files located in directory \$HOME/.HP64\_schemes (note the dot in the directory name).

*Scheme files* group resource specifications for different displays, computing environments, and languages.

This chapter shows you how to:

- Modify the Graphical User Interface resources.
- Use customized scheme files.
- Set up custom action keys.
- Set initial recall buffer values.
- Set up demos or tutorials.

Refer to Chapter 17, "X Resources and the Graphical Interface," for more detailed information.

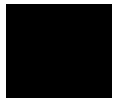

## To modify the Graphical User Interface resources

You can customize the appearance of an X Windows application by modifying its X resources. The following tables describe some of the commonly modified application resources.

| Application Resources for Schemes |                             |   |
|-----------------------------------|-----------------------------|---|
| Resource                          | Values                      | Description   |
| HP64_Softkey.platformScheme       | HP-UX<br>SunOS<br>(custom)  | Names the subdirectory for platform specific schemes. This resource should be set to the platform on which the X server is running (and displaying the Graphical User Interface) if it is different from the platform where the application is running. |
| HP64_Softkey.colorScheme          | BW<br>Color<br>(custom)     | Names the color scheme file.  |
| HP64_Softkey.sizeScheme           | Small<br>Large<br>(custom)  | Names the size scheme file which defines the fonts and the spacing used.  |
| HP64_Softkey.labelScheme          | Label<br>\$LANG<br>(custom) | Names to use for labels and button text. The default uses the \$LANG environment variable if it is set and if a scheme file named Softkey.\$LANG exists in one of the directories searched for scheme files; otherwise, the default is Label.           |
| HP64_Softkey.inputScheme          | Input<br>(custom)           | Specifies mouse and keyboard operation.   |

| <b>Commonly Modified Application Resources</b> |                          |   |
|--|--------------------------|---|
| <b>Resource</b>                                | <b>Values</b>            | <b>Description</b>  |
| HP64_Softkey.lines                             | 24<br>(min. 18)          | Specifies the number of lines in the main display area.   |
| HP64_Softkey.columns                           | 100<br>(min. 80)         | Specifies the number of columns, in characters, in the main display area.   |
| HP64_Softkey.enableCmdline                     | True<br>False            | Specifies whether the command line area is displayed when you initially enter the Graphical User Interface.   |
| *editFile                                      | (example) vi<br>%s       | Specifies the command used to edit files.   |
| *editFileLine                                  | (example) vi<br>+%d %s   | Specifies the command used to edit a file at a certain line number.   |
| *<proc>*actionKeysSub.keyDefs                  | (paired list of strings) | Specifies the text that should appear on the action key push buttons and the commands that should be executed in the command line area when the action key is pushed. Refer to the "To set up custom action keys" section for more information. |
| *<proc>*dirSelectSub.entries                   | (list of strings)        | Specifies the initial values that are placed in the <b>File</b> → <b>Context</b> → <b>Directory</b> popup recall buffer. Refer to the "To set initial recall buffer values" section for more information.                                       |
| *<proc>*recallSub.entries                      | (list of strings)        | Specifies the initial values that are placed in the entry buffer (labeled "(:)"). Refer to the "To set initial recall buffer values" section for more information.  |

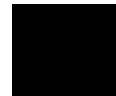

## Chapter 13: Setting X Resources

### To modify the Graphical User Interface resources

The following steps show you how to modify the Graphical User Interface's X resources.

- 1 Copy part or all of the HP64\_Softkey application defaults file to a temporary file.

The HP64\_Softkey file contains the default definitions for the graphical interface application's X resources.

For example, on an HP 9000 computer you can use the following command to copy the complete HP64\_Softkey file to HP64\_Softkey.tmp (note that the HP64\_Softkey file is several hundred lines long):

```
cp /usr/lib/X11/app-defaults/HP64_Softkey HP64_Softkey.tmp
```

NOTE: The HP64\_Softkey application defaults file is re-created each time Graphical User Interface software is installed or updated. You can use the UNIX **diff** command to check for differences between the new HP64\_Softkey application defaults file and the old application defaults file that is saved as /usr/hp64000/lib/X11/HP64\_schemes/old/HP64\_Softkey.

- 2 Modify the temporary file.

Modify the resource that defines the behavior or appearance that you wish to change.

For example, to change the number of lines in the main display area to 36:

```
vi HP64_Softkey.tmp
```

Search for the string "HP64\_Softkey.lines". You should see lines similar to the following.

```
!-----  
! The lines and columns set the vertical and horizontal dimensions of the  
! main display area in characters, respectively. Minimum values are 18 lines  
! and 80 columns. These minimums are silently enforced.  
!  
! Note: The application cannot be resized by using the window manager.  
  
!HP64_Softkey.lines:    24  
!HP64_Softkey.columns: 85
```

## Chapter 13: Setting X Resources To modify the Graphical User Interface resources

Edit the line containing "HP64\_Softkey.lines" so that it is uncommented and is set to the new value:

```
!-----  
! The lines and columns set the vertical and horizontal dimensions of the  
! main display area in characters, respectively. Minimum values are 18 lines  
! and 80 columns. These minimums are silently enforced.  
!  
! Note: The application cannot be resized by using the window manager.  
  
HP64_Softkey.lines:      36  
!HP64_Softkey.columns:  85
```

Save your changes and exit the editor.

- 3 If the RESOURCE\_MANAGER property exists (as is the case with HP VUE — if you're not sure, you can check by entering the **xrdb -query** command), use the **xrdb** command to add the resources to the RESOURCE\_MANAGER property. For example:

```
xrdb -merge -nocpp HP64_Softkey.tmp
```

Otherwise, if the RESOURCE\_MANAGER property does not exist, append the temporary file to your \$HOME/.Xdefaults file. For example:

```
cat HP64_Softkey.tmp >> $HOME/.Xdefaults
```

- 4 Remove the temporary file.
- 5 Start or restart the Graphical User Interface.

After you have completed the above steps, you must either start, or restart by exiting and starting again, the Graphical User Interface. Starting and exiting the Graphical User Interface is described in Chapter 3, "Using the Emulator/Analyzer Interface."

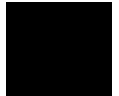

## To use customized scheme files

Scheme files are used to set platform specific resources that deal with color, fonts and sizes, mouse and keyboard operation, and labels and titles. You can create and use customized scheme files by following these steps.

- 1 Create the `$HOME/.HP64_schemes/<platform>` directory.

For example:

```
mkdir $HOME/.HP64_schemes  
mkdir $HOME/.HP64_schemes/HP-UX
```

- 2 Copy the scheme file to be modified to the `$HOME/.HP64_schemes/<platform>` directory.

Label scheme files are not platform specific; therefore, they should be placed in the `$HOME/.HP64_schemes` directory. All other scheme files should be placed in the `$HOME/.HP64_schemes/<platform>` directory.

For example:

```
cp /usr/hp64000/lib/X11/HP64_schemes/HP-UX/Softkey.Color  
$HOME/.HP64_schemes/HP-UX/Softkey.MyColor
```

Note that if your custom scheme file has the same name as the default scheme file, the load order requires resources in the custom file to explicitly override resources in the default file.

- 3 Modify the `$HOME/.HP64_schemes/<platform>/Softkey.<scheme>` file.

For example, you could modify the `"$HOME/.HP64_schemes/HP-UX/Softkey.MyColor"` file to change the defined foreground and background colors. Also, since the scheme file name is different from the default, you could comment out various resource settings to cause general foreground and background color definitions to apply to the Graphical User Interface. At least one resource must be defined in your color scheme file for it to be recognized.

- 4 If the name of your custom scheme file is different from the name of the default scheme file, you must modify the scheme resource definitions.

The Graphical User Interface application defaults file contains resources that specify which scheme files are used. If your custom scheme files have different names than the default scheme files, you must modify these resource settings so that your customized scheme files are used instead of the default scheme files.

For example, to use the "\$HOME/.HP64\_schemes/HP-UX/Softkey.MyColor" color scheme file you would set the "HP64\_Softkey.colorScheme" resource to "MyColor":

```
HP64_Softkey.colorScheme: MyColor
```

Refer to the previous "To customize Graphical User Interface resources" section for more detailed information on modifying resources.

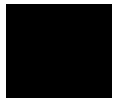

## To set up custom action keys

- Modify the "actionKeysSub.keyDefs" resource.

The "actionKeysSub.keyDefs" resource defines a list of paired strings. The first string defines the text that should appear on the action key pushbutton. The second string defines the command that should be sent to the command line area and executed when the action key is pushed.

A pair of parentheses (with no spaces, that is "()") can be used in the command definition to indicate that text from the entry buffer should replace the parentheses when the command is executed.

Action keys that use the entry buffer should always include the entry buffer symbol, "()", in the action key label as a visual cue to remind you to place information in the entry buffer before clicking the action key.

Shell commands can be executed by using an exclamation point prefix. A second exclamation point ends the command string and allows additional options on the command line.

Also, command files can be executed by placing the name of the file in the command definition.

Finally, an empty action ("") means to repeat the previous operation, whether it came from a pulldown, a dialog, a popup, or another action key.

---

### Examples

To set up custom action keys when the graphical interface is used with the 68020 emulator, modify the "\*m68020\*actionKeysSub.keyDefs" resource:

```
*m68020*actionKeysSub.keyDefs: \  
"Make"           "cd /users/project2/68020; !make! in_browser" \  
"Load Pgm"      "load configuration config.EA; load program2" \  
"Run Pgm"       "run from reset" \  
"Trace after ( )" "trace after (); display trace" \  
"Step Source"   "set source on; display memory mnemonic; step source" \  
"Again"        ""
```

Refer to the previous "To modify Graphical User Interface resources" section for more detailed information on modifying resources.



## To set initial recall buffer values

- Modify the "entries" resource for the particular recall buffer.

There are six popup recall buffers present in the Graphical User Interface. The resources for these popup recall buffers are listed in the following table.

The window manager resource `*transientDecoration` controls the borders around dialog box windows. The most natural setting for this resource is "title."

| Popup Recall Buffer Resources |  |   |
|-------------------------------|--|---|
| Recall Popup                  | Resources  | Description   |
| File→Context→Directory ...    | *dirSelect.textColumns<br>*dirSelect.listVisibleItemCount<br>*dirSelectSub.entries | The default number of text columns in the popup is 50.  |
| File→Context→Symbols ...      | *symSelect.textColumns<br>*symSelect.listVisibleItemCount<br>*symSelectSub.entries | The default number of visible lines in the popup is 12.   |
| Trace→Trace Spec ...          | *modtrace.textColumns<br>*modtrace.listVisibleItemCount<br>*modtraceSub.entries    | The "entries" resource is defined as a list of strings (see the following example).                   |
| Entry Buffer ():              | *recall.textColumns<br>*recall.listVisibleItemCount<br>*recallSub.entries          | Up to 40 unique values are saved in each of the recall buffers (as specified by the resource settings |
| Command Line command recall   | *recallCmd.textColumns<br>*recallCmd.listVisibleItemCount<br>*recallCmdSub.entries | "*XcRecall.maxDepth: 40" and "*XcRecall.onlyUnique: True").   |
| Command Line pod/simio recall | *recallKbd.textColumns<br>*recallKbd.listVisibleItemCount<br>*recallKbdSub.entries |   |

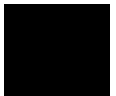

## Chapter 13: Setting X Resources

### To set initial recall buffer values

---

#### Examples

To set the initial values for the directory selection dialog box when the Graphical User Interface is used with 68020 emulators, modify the

"\*m68020\*dirSelectSub.entries" resource:

```
*m68020*dirSelectSub.entries: \  
    "$HOME" \  
    "." \  
    "/users/project1" \  
    "/users/project2/68020"
```

Refer to the previous "To modify the Graphical User Interface resources" section for more detailed information on modifying resources.

---

## To set up demos or tutorials

You can add demos or tutorials to the Graphical User Interface by modifying the resources described in the following tables.

| Demo Related Component Resources |                      |   |
|----------------------------------|----------------------|---|
| Resource                         | Value                | Description   |
| *enableDemo                      | False<br>True        | Specifies whether <b>Help→Demo</b> appears in the pulldown menu.  |
| *demoPopupSub.indexFile          | ./Xdemo/Index-topics | Specifies the file containing the list of topic and file pairs.   |
| *demoPopup.textColumns           | 30                   | Specifies the width, in characters, of the demo topic list popup. |
| *demoPopup.listVisibleItemCount  | 10                   | Specifies the length, in lines, of the demo topic list popup.     |
| *demoTopic                       | About demos          | Specifies the default topic in the demo popup selection buffer.   |

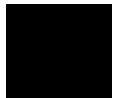

Chapter 13: Setting X Resources  
To set up demos or tutorials

| Tutorial Related Component Resources |                          |   |
|--------------------------------------|--------------------------|---|
| Resource                             | Value                    | Description   |
| *enableTutorial                      | False<br>True            | Specifies whether <b>Help</b> → <b>Tutorial</b> appears in the pulldown menu. |
| *tutorialPopupSub.indexFile          | ./Xtutorial/Index-topics | Specifies the file containing the list of topic and file pairs.               |
| *tutorialPopup.textColumns           | 30                       | Specifies the width, in characters, of the tutorial topic list popup.         |
| *tutorialPopup.listViewItemCount     | 10                       | Specifies the length, in lines, of the tutorial topic list popup.             |
| *tutorialTopic                       | About tutorials          | Specifies the default topic in the tutorial popup selection buffer.           |

The mechanism for providing demos and tutorials in the graphical interface is identical. The following steps show you how to set up demos or tutorials in the Graphical User Interface.

- 1 Create the demo or tutorial topic files and the associated command files.

Topic files are simply ASCII text files. You can use "\I" to produce inverse video in the text, "\U" to produce underlining in the text, and "\N" to restore normal text.

Command files are executed when the "Press to perform demo (or tutorial)" button (in the topic popup dialog) is pushed. A command file must have the same name as the topic file with ".cmd" appended. Also, a command file must be in the same directory as the associated topic file.

2 Create the demo or tutorial index file.

Each line in the index file contains first a quoted string that is the name of the topic which appears in the index popup and second the name of the file that is raised when the topic is selected. For example:

```
"About demos"      /users/guest/gui_demos/general  
"Loading programs" /users/guest/gui_demos/loadprog  
"Running programs" /users/guest/gui_demos/runprog
```

You can use absolute paths (for example, /users/guest/topic1), paths relative to the directory in which the interface was started (for example, mydir/topic2), or paths relative to the product directory (for example, ./Xdemo/general where the product directory is something like /usr/hp64000/inst/emul/64751A).

3 Set the "\*enableDemo" or "\*enableTutorial" resource to "True".

4 Define the demo index file by setting the "\*demoPopupSub.indexFile" or "\*tutorialPopupSub.indexFile" resource.

For example:

```
*demoPopupSub.indexFile: /users/guest/gui_demos/index
```

You can use absolute paths (for example, /users/guest/Index), paths relative to the directory in which the interface was started (for example, mydir/indexfile), or paths relative to the product directory (for example, ./Xdemo/Index-topics where the product directory is something like /usr/hp64000/inst/emul/64748B).

5 If you wish to define a default topic to be selected, set the "\*demoTopic" or "\*tutorialTopic" resource to the topic string.

For example:

```
*demoTopic: "About demos"
```

Refer to the previous "To customize Graphical User Interface resources" section for more detailed information on modifying resources.

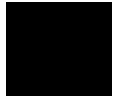

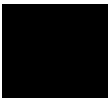

---

# 14

---

## **The SPARCsystem Graphical User Interface and Softkey Interface**

Using the emulator/analyzer interface on the SPARCsystem

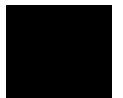

## The SPARCsystem Emulator/Analyzer Interface

This chapter contains a description of how the emulator/analyzer uses the keys on your SPARCsystem keyboard.

---

## Using your SPARCsystem keyboard

The following table describes the use of the keys on your SPARCstation keyboard. The “roll” functions are for an hp64term window in OpenWindows only.

---

| To get function | Press this key |  |
|-----------------|----------------|--|
| delete char     | Del            |  |
| insert char     | Ins            | (For SunView and xterm windows only.<br>Does not work in OpenWindows windows.) |
| next page       | PgDn           |  |
| prev page       | PgUp           |  |
| roll up         | Shift ↑        | (for xterm only)   |
| roll down       | Shift ↓        | (for xterm only)   |
| roll left       | Shift ←        | (for xterm only)   |
| roll right      | Shift →        | (for xterm only)   |
| up arrow        | ↑              |  |
| down arrow      | ↓              |  |
| left arrow      | ←              |  |

---



Chapter 14: The SPARCsystem Graphical User Interface and Softkey Interface  
**Using your SPARCsystem keyboard**

---

| <b>To get function</b> | <b>Press this key</b> |             |
|------------------------|-----------------------|-------------|
| right arrow            | →                     |             |
| home                   | Home                  |             |
| anti-home              | End                   |             |
| carriage return        | Enter                 |             |
| tab                    | Tab                   |             |
| backtab                | Undo                  |             |
| cleartoel              | Control               | E           |
| roll left              | Control               | F           |
| roll right             | Control               | G           |
| clearline              | Control               | U           |
| FW_recall              | Control               | B           |
| BK_recall              | Control               | R           |
| eof                    | Control               | D           |
| refresh                | Control               | L           |
| other                  | Control               | X           |
| sigint                 | Control               | C           |
| sigquit                | Control               | end release |

---

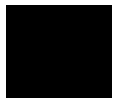

Chapter 14: The SPARCsystem Graphical User Interface and Softkey Interface  
**Using your SPARCsystem keyboard**

---

| To get function | Press this key   |
|-----------------|--|
| kill !!!        | Control Z <b>(Do not use!</b><br>Disabled in xterm window created by<br>hp64term.) |
| softkey 1       | F1   |
| softkey 2       | F2   |
| softkey 3       | F3   |
| softkey 4       | F4   |
| softkey 5       | F5   |
| softkey 6       | F6   |
| softkey 7       | F7   |
| softkey 8       | F8   |

---

## Keyboard template

Cut out the template on this page and place it on your keyboard for quick reference.

Place the Sk1 label over the F1 key.

If you exported KEYMAP=sun.2-9 or KEYMAP=xterm.2-9, then place the Sk1 label over the F2 key.

The roll keys only work in xterm windows.

^R means to hold down the control key while pressing R.

|  |                  |                            |                   |            |                              |
|--|------------------|----------------------------|-------------------|------------|------------------------------|
|  |                  | <b>HEWLETT<br/>PACKARD</b> |                   | xterm      | HP64000-UX Softkey Interface |
| ^R/^B  | = BK/FW recall   | Ins/Del                    | = insert/del char |            |                              |
| Home/End   | = home/home down | PgUp/Dn                    | = prev/next page  |            |                              |
| ◀▶▲▼   | = arrow keys     | <shift>◀▶▲▼                | = roll keys       |            |                              |
| Undo   | = back tab       | Tab                        | = cmd completion  |            |                              |
| ^U   | = clearline      | ^L                         | = refresh         |            |                              |
| <b>Sk1</b>   | <b>Sk2</b>       | <b>Sk3</b>                 | <b>Sk4</b>        | <b>Sk5</b> | <b>Sk6</b>                   |
| <b>Sk7</b>   | <b>Sk8</b>       |                            |                   |            |                              |

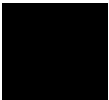



---

## **Microtec Language Tools Used With MC68020 and MC68030/EC030 Emulators**

Using the emulator/analyzer with Microtec language tools



## **Microtec Language Tools used with the Emulator/Analyzer**

This chapter contains the following important information about use of Microtec language tools with the 68020 and 68030/EC030 emulator/analyzer:

- A comparison of the names of Microtec and HP executables.
- Microtec commands.
- Assembler defaults.
- Linker defaults.
- Librarian defaults.

---

## Using Microtec Language Tools

You can use the Microtec Research, Inc. language tools with emul700 and **db68k**. The language tools available from Microtec<sup>®</sup> are the **mcc68k** C compiler and the **asm68k** assembler.

The following table compares the names of the Microtec and HP executables:

---

| <b>Program</b>                              | <b>Microtec name</b> | <b>HP AxLS name</b> | <b>HP product number</b> |
|---|----------------------|---------------------|--------------------------|
| <b>Executables for the MC68020:</b>         |                      |                     |                          |
| assembler                                   | asm68k               | as68k               | B1464                    |
| linker                                      | lnk68k               | ld68k               | B1464                    |
| librarian                                   | lib68k               | ar68k               | B1464                    |
| compiler                                    | mcc68k               | cc68020             | B1461                    |
| <b>Executables for the MC68030/EC68030:</b> |                      |                     |                          |
| assembler                                   | asm68k               | as68030             | B1465                    |
| linker                                      | lnk68k               | ld68030             | B1465                    |
| librarian                                   | lib68k               | ar68030             | B1465                    |
| compiler                                    | mcc68k               | cc68030             | B1478                    |

---

The emulator and Softkey Interface are designed to work with the HP Advanced Cross Language System. Microtec's language tools are quite similar to the HP language tools. The input syntax and code generated by the HP and Microtec assemblers, linkers, and librarians are identical with few exceptions.

Microtec uses a license manager to enable execution of their products. Be sure to read about this in the Microtec manuals.

## To use the Microtec commands

- To assemble a file to generate an HP-OMF (.X) absolute file, use the following commands:

```
asm68k -h -o filename.o -f d,case filename.s
lnk68k -H filename.L -o filename.X -c filename.k filename.o
```

- To compile a C program to generate an HP-OMF object file, use the following commands:

```
mcc68k -hgc -Wa,-f"d" -o filename.o filename.c
lnk68k -m -fd -H filename.L -c filename.k filename.o > filename.MAP
```

- To assemble a file to generate an HP-MRI IEEE-695 (.x) absolute file, use the following commands:

```
asm68k -o filename.o -f d,case filename.s
lnk68k -fi -o filename.x -c filename.k filename.o
```

- To compile a C program to generate an HP-MRI IEEE-695 (.x) absolute file, use the following commands:

```
mcc68k -Wl,-m,-fd -g -I/usr/hp64000/include/68xxx -efilename.k -o
filename.X \
filename.c
```



## Assembler defaults

You should be aware of these differences between **asm68k** and **as68k**:

### Command-line syntax

The differences are minor. See the on-line man pages for a description of the command-line options.

### Case sensitivity

**as68k** is case sensitive by default, **asm68k** is not. Use the command line flag “-fcase” to make **asm68k** case sensitive.

### Symbols in HP-MRI IEEE-695 files

The HP assembler places local symbols in the output object file by default, **asm68k** does not. Use the command line flag “-fd” with **asm68k** to generate local symbols.

The HP assembler places global symbols put in the debug part by default. There is no way to do this with Microtec’s **asm68k**. This information is needed by emul700/SRU to correctly scope symbols. Thus you will find that some symbols may be incorrectly scoped when using the emulator with the Microtec assembler.

---

## Linker defaults

You should be aware of these differences between **lnk68k** and **ld68k**:

### Output file format

**ld68k** produces HP-MRI IEEE-695 by default. **lnk68k** produces Motorola S-Records by default. To generate an HP-MRI IEEE-695 (.x) format absolute file, use the **-H** command line option or **-fi** flag.

### Local symbols

**ld68k** provides local symbols in absolute file by default, but **lnk68k** does not. The command line flag **-fi** and option **-H** also set the **d** flag, which will cause **lnk68k** to generate local symbols.

### Support files

**ld68k** and **lnk68k** have different default locations and environment variables used to locate linker command files and libraries.

---

## Librarian defaults

**ar68k** uses **.a** as the default library suffix. **lib68k** uses **.lib** as the default library suffix.

## The Microtec MCC68K compiler

**mcc68k** is very different from **cc68k**. Study the Microtec documentation if you need specific information about **mcc68k**.

To get **db68k** to work with **mcc68k** output, you need to add the following to your .profile:

```
HP64_DEBUG_PATH=<path to source files>  
export HP64_DEBUG_PATH
```

If this is not done, the debugger cannot find the high-level “C” source files.



---

## **Specifications and Characteristics**

Electrical specifications and characteristics for the MC68020 and MC68030/EC030 emulators

## **Processor Compatibility**

HP 64747: Compatible with the Motorola MC68030 (HP64747A requires MMU be disabled/HP 64747B supports MMU enabled) and MC68EC030 processors, and with any processors that meet all specifications of the MC68030 or MC68EC030 processors.

HP 64748: Compatible with the Motorola MC68020 and MC68EC020 processors, and with any processors that meet all specifications of the MC68020 or MC68EC020 processors.

---

## **Electrical**

### **Maximum clock speed**

HP 64747: the maximum external clock speed is 40 MHz. No wait states are required for any memory accesses in asynchronous bus mode. In synchronous and burst modes, emulation memory requires one wait state for all clock speeds. Target system memory requires one wait state in synchronous and burst modes for clock frequencies above 25 MHz.

HP 64748: the maximum external clock speed is 33 MHz. No wait states are required for target system memory. Emulation memory requires one wait state at speeds greater than 25 MHz. (Dual-port emulation memory will run at full rated clock speed without wait states.)

## HP 64747 Electrical Specifications

| <b>HP 64747 - DC ELECTRICAL SPECIFICATIONS</b><br>(V <sub>CC</sub> =5.0 Vdc ±5%; GND=0 Vdc; T <sub>A</sub> =0 to 70°C)  |  |                 |      |  |      |
|---|--|-----------------|------|--|------|
| Characteristic  |  | Symbol          | Min  | Max                                    | Unit |
| Input High Voltage  |  | V <sub>IH</sub> | 2.0  | V <sub>CC</sub>                        | V    |
| Input Low Voltage   |  | V <sub>IL</sub> | -0.5 | 0.8                                    | V    |
| Input Leakage Current<br>GND ≤ V <sub>in</sub> ≤ V <sub>CC</sub>  | <u>BR</u> , <u>BGACK</u> , <u>IPLx</u> , <u>CDIS</u>   | I <sub>IN</sub> | -2.5 | 2.5                                    | μA   |
| Input High Current  | <u>CBACK</u> , <u>CIIN</u> , <u>STERM</u> , <u>BERR</u> , <u>AVEC</u> ,<br><u>DSACKx</u> , <u>HALT</u> , <u>MMUDIS</u><br><u>CLK</u> , <u>RESET</u>  | I <sub>IH</sub> | -    | 0<br>25<br>50                          | μA   |
| Input Low Current   | <u>RESET</u> , <u>CBACK</u> , <u>CIIN</u> , <u>STERM</u><br><u>CLK</u> , <u>BERR</u> , <u>AVEC</u> , <u>DSACKx</u> , <u>HALT</u> , <u>MMUDIS</u>   | I <sub>IL</sub> | -    | -1.4<br>-0.25                          | mA   |
| Output High Voltage<br>I <sub>OH</sub> =-400μA  | <u>A0-A31</u> , <u>AS</u> , <u>BG</u> , <u>D0-D31</u> , <u>DBEN</u> , <u>DS</u> ,<br><u>ECS</u> , <u>R/W</u> , <u>STATUS</u> , <u>REFILL</u> , <u>IPEND</u> ,<br><u>OCS</u> , <u>RMC</u> , <u>SIZ0-SIZ1</u> , <u>FC0-FC2</u> ,<br><u>CBREQ</u> , <u>C1OUT</u>            | V <sub>OH</sub> | 2.4  | -                                      | V    |
| Output Low Voltage<br>I <sub>OL</sub> = 2.5 mA<br>I <sub>OL</sub> =3.2 mA<br>I <sub>OL</sub> =4.5 mA<br>I <sub>OL</sub> =5.3 mA<br>I <sub>OL</sub> =2.0 mA<br>I <sub>OL</sub> =9.3 mA | <u>A0-A31</u> , <u>FC0-FC2</u> , <u>SIZ0-SIZ1</u><br><u>BG</u> , <u>D0-D31</u><br><u>R/W</u> , <u>RMC</u><br><u>AS</u> , <u>DS</u> , <u>DBEN</u> , <u>IPEND</u><br><u>STATUS</u> , <u>REFILL</u> , <u>CBREQ</u> , <u>C1OUT</u> , <u>ECS</u> , <u>OCS</u><br><u>RESET</u> | V <sub>OL</sub> | -    | 0.5<br>0.5<br>0.5<br>0.5<br>0.5<br>0.5 | V    |
| Power Dissipation <sup>1</sup>  | T <sub>A</sub> =0°C  | P <sub>D</sub>  | -    | 3.4                                    | W    |
| Capacitance<br>V <sub>in</sub> =0V, T <sub>A</sub> =25°C, f=1 MHz   |  | C <sub>in</sub> | -    | 20                                     | pF   |
| Load Capacitance  | <u>A0-A31</u> , <u>FC0-FC2</u> , <u>SIZ0-SIZ1</u> , <u>R/W</u> , <u>CBREQ</u> ,<br><u>C1OUT</u><br>All Other   | C <sub>L</sub>  | -    | 100<br>50                              | pF   |

Chapter 16: Specifications and Characteristics  
**HP 64747 Electrical Specifications**

Notes:

- 1 The power dissipation is an indication of how much power is drawn from the target system by the emulator probe, not the true power dissipation of the emulator probe.

| HP 64747 - AC ELECTRICAL SPECIFICATIONS - CLOCK INPUT |                        |                   |     |                   |     |      |
|---|------------------------|-------------------|-----|-------------------|-----|------|
| Num   | Characteristic         | HP 64747<br>25MHz |     | HP 64747<br>40MHz |     | Unit |
|   |                        | Min               | Max | Min               | Max |      |
|   | Frequency of Operation | 12.5              | 25  | 25                | 40  | MHz  |
| 1   | Cycle Time             | 40                | 80  | 25                | 40  | ns   |
| 2,3   | Clock Pulse Width      | 19                | 61  | 11.5              | 29  | ns   |
| 4,5   | Rise and Fall Times    | -                 | 4   | -                 | 2   | ns   |

| HP64747 -AC ELECTRICAL SPECIFICATIONS — READ AND WRITE CYCLES<br>(V <sub>CC</sub> =5.0 Vdc ± 5%; GND=0 Vdc; T <sub>A</sub> =0 to 70°C) |  |                   |     |                   |     |      |
|--|--|-------------------|-----|-------------------|-----|------|
| Num  | Characteristic   | HP 64747<br>25MHz |     | HP 64747<br>40MHz |     | Unit |
|  |  | Min               | Max | Min               | Max |      |
| 6  | Clock High to $\overline{FC}$ , $\overline{Size}$ , $\overline{RMC}$ , $\overline{C1OUT}$ , Address Valid<br>Clock High to IPEND Valid                               | 0                 | 20  | 0                 | 14  | ns   |
|  |  | 0                 | 24* | 0                 | 24* | ns   |
| 6A   | Clock High to $\overline{ECS}$ , $\overline{OCS}$ Asserted   | 0                 | 15  | 0                 | 10  | ns   |
| 6B   | $\overline{FC}$ , $\overline{Size}$ , $\overline{RMC}$ , $\overline{C1OUT}$ , Address Valid to Negating $\overline{ECS}$<br>IPEND Valid to Negating $\overline{ECS}$ | 3                 | -   | 3                 | -   | ns   |
|  |  | 1*                | -   | -7*               | -   | ns   |
| 7  | Clock High to $\overline{FC}$ , $\overline{Size}$ , $\overline{RMC}$ , $\overline{C1OUT}$ , Address,<br>Data High Impedance  | 0                 | 40  | 0                 | 25  | ns   |
| 8  | Clock High to $\overline{FC}$ , $\overline{Size}$ , $\overline{RMC}$ , IPEND, $\overline{C1OUT}$ ,<br>Address Invalid  | 0                 | —   | 0                 | —   | ns   |

Chapter 16: Specifications and Characteristics  
**HP 64747 Electrical Specifications**

| <b>HP64747 -AC ELECTRICAL SPECIFICATIONS — READ AND WRITE CYCLES</b><br>(V <sub>CC</sub> =5.0 Vdc ± 5%; GND=0 Vdc; T <sub>A</sub> =0 to 70°C) |  |                   |     |                   |     |      |
|---|--|-------------------|-----|-------------------|-----|------|
| Num   | Characteristic   | HP 64747<br>25MHz |     | HP 64747<br>40MHz |     | Unit |
|   |  | Min               | Max | Min               | Max |      |
| 9   | Clock Low to $\overline{\text{AS}}, \overline{\text{DS}}, \overline{\text{CBREQ}}$ Asserted  | 3                 | 18  | 2                 | 15* | ns   |
| 9A <sup>1</sup>   | $\overline{\text{AS}}$ to $\overline{\text{DS}}$ Assertion Skew (Read)   | -10               | 10  | -8*               | 8*  | ns   |
| 9B <sup>14</sup>  | $\overline{\text{AS}}$ Asserted to $\overline{\text{DS}}$ Asserted (Write)   | 27                | —   | 14*               | —   | ns   |
| 10  | $\overline{\text{ECS}}$ Width Asserted   | 10                | —   | 5                 | —   | ns   |
| 10A   | $\overline{\text{OCS}}$ Width Asserted   | 10                | —   | 5                 | —   | ns   |
| 10B <sup>7</sup>  | $\overline{\text{ECS}}, \overline{\text{OCS}}$ Width Negated   | 10                | —   | 5                 | —   | ns   |
| 11  | FC, Size, $\overline{\text{RMC}}, \overline{\text{C1OUT}}$ , Address Valid to $\overline{\text{AS}}$ Asserted<br>(and $\overline{\text{DS}}$ Asserted, Read) | 7                 | —   | 5                 | —   | ns   |
| 12  | Clock Low to $\overline{\text{AS}}, \overline{\text{DS}}, \overline{\text{CBREQ}}$ Negated   | 0                 | 18  | 0                 | 15* | ns   |
| 12A   | Clock Low to $\overline{\text{ECS}}, \overline{\text{OCS}}$ Negated  | 0                 | 18  | 0                 | 12  | ns   |
| 13  | $\overline{\text{AS}}, \overline{\text{DS}}$ Negated to FC, Size, $\overline{\text{RMC}}, \overline{\text{C1OUT}}$ , Address Invalid                         | 6*                | —   | -2*               | —   | ns   |
| 14  | $\overline{\text{AS}}$ (and $\overline{\text{DS}}$ , Read) Width Asserted (Asynchronous Cycle)   | 70                | —   | 30                | —   | ns   |
| 14A <sup>11</sup>   | $\overline{\text{DS}}$ Width Asserted, Write   | 30                | —   | 18                | —   | ns   |
| 14B   | $\overline{\text{AS}}$ (and $\overline{\text{DS}}$ Read) Width Asserted (Synchronous Cycle)  | 30                | —   | 18                | —   | ns   |
| 15  | $\overline{\text{AS}}, \overline{\text{DS}}$ Width Negated   | 30                | —   | 18                | —   | ns   |
| 15A <sup>8</sup>  | $\overline{\text{DS}}$ Negated to $\overline{\text{AS}}$ Asserted  | 25                | —   | 16                | —   | ns   |
| 16  | Clock High to $\overline{\text{AS}}, \overline{\text{DS}}, \overline{\text{R/W}}, \overline{\text{DBEN}}, \overline{\text{CBREQ}}$ High Impedance            | —                 | 40  | —                 | 25  | ns   |
| 17  | $\overline{\text{AS}}, \overline{\text{DS}}$ Negated to $\overline{\text{R/W}}$ Invalid  | 6*                | —   | -2*               | —   | ns   |
| 18  | Clock High to $\overline{\text{R/W}}$ High   | 0                 | 20  | 0                 | 14  | ns   |
| 20  | Clock High to $\overline{\text{R/W}}$ Low  | 0                 | 20  | 0                 | 15  | ns   |

Chapter 16: Specifications and Characteristics  
**HP 64747 Electrical Specifications**

| HP64747 -AC ELECTRICAL SPECIFICATIONS — READ AND WRITE CYCLES<br>(V <sub>CC</sub> =5.0 Vdc ± 5%; GND=0 Vdc; T <sub>A</sub> =0 to 70°C) |  |                   |     |                   |     |      |
|--|--|-------------------|-----|-------------------|-----|------|
| Num  | Characteristic   | HP 64747<br>25MHz |     | HP 64747<br>40MHz |     | Unit |
|  |  | Min               | Max | Min               | Max |      |
| 21 <sup>6</sup>  | R/W High to $\overline{AS}$ Asserted   | 7                 | —   | 5                 | —   | ns   |
| 22 <sup>6</sup>  | R/W Low to $\overline{DS}$ Asserted (Write)  | 47                | —   | 24                | —   | ns   |
| 23   | Clock High to Data Out Valid   | —                 | 20  | —                 | 19* | ns   |
| 24   | Data Out Valid to Negating Edge of $\overline{AS}$   | 5                 | —   | 1*                | —   | ns   |
| 25 <sup>6,11</sup>   | $\overline{AS}$ , $\overline{DS}$ Negated to Data Out Invalid  | 7                 | —   | 0*                | —   | ns   |
| 25A <sup>9,11</sup>  | $\overline{DS}$ Negated to $\overline{DBEN}$ Negated (Write)   | 7                 | —   | 1*                | —   | ns   |
| 26 <sup>6,11</sup>   | Data Out Valid to $\overline{DS}$ Asserted (Write)   | 7                 | —   | 1*                | —   | ns   |
| 27   | Data-In Valid to Clock Low (Synchronous Setup)   | 6*                | —   | 6*                | —   | ns   |
| 27A  | Late $\overline{BERR}$ , $\overline{HALT}$ Asserted to Clock Low (Setup)   | 8*                | —   | 8*                | —   | ns   |
| 28 <sup>12</sup>   | $\overline{AS}$ , $\overline{DS}$ Negated to $\overline{DSACKx}$ , $\overline{BERR}$ , $\overline{HALT}$ , $\overline{AVEC}$ Negated (Asynchronous Hold) | 0                 | 40  | 0                 | 20  | ns   |
| 28A <sup>12</sup>  | Clock Low to $\overline{DSACKx}$ , $\overline{BERR}$ , $\overline{HALT}$ , $\overline{AVEC}$ Negated (Synchronous Hold)                                  | 8                 | 70  | 6                 | 40  | ns   |
| 29 <sup>12</sup>   | $\overline{DS}$ Negated to Data-In Invalid (Asynchronous Hold)   | 0                 | —   | 0                 | —   | ns   |
| 29A <sup>12</sup>  | $\overline{DS}$ Negated to Data-In High-Impedance  | —                 | 40  | —                 | 25  | ns   |
| 30 <sup>12</sup>   | Clock Low to Data-In Invalid (Synchronous Hold)  | 8                 | —   | 6                 | —   | ns   |
| 30A <sup>12</sup>  | Clock Low to Data-In High-Impedance (Read followed by Write)   | —                 | 60  | —                 | 30  | ns   |
| 31 <sup>2</sup>  | $\overline{DSACKx}$ Asserted to Data-In Valid (Asynchronous Data Setup)  | —                 | 26  | —                 | 12* | ns   |
| 31A <sup>3</sup>   | $\overline{DSACKx}$ Asserted to $\overline{DSACKx}$ Valid (Skew)   | —                 | 7   | —                 | 1*  | ns   |
| 32   | $\overline{RESET}$ Input Transition Time   | —                 | 1.5 | —                 | 1.5 | Clks |



Chapter 16: Specifications and Characteristics  
**HP 64747 Electrical Specifications**

| <b>HP64747 -AC ELECTRICAL SPECIFICATIONS — READ AND WRITE CYCLES</b><br>(V <sub>CC</sub> =5.0 Vdc ± 5%; GND=0 Vdc; T <sub>A</sub> =0 to 70°C) |  |                   |     |                   |     |      |
|---|--|-------------------|-----|-------------------|-----|------|
| Num   | Characteristic   | HP 64747<br>25MHz |     | HP 64747<br>40MHz |     | Unit |
|   |  | Min               | Max | Min               | Max |      |
| 33  | Clock Low to $\overline{\text{BG}}$ Asserted   | 0                 | 20  | 0                 | 14  | ns   |
| 34  | Clock Low to $\overline{\text{BG}}$ Negated  | 0                 | 20  | 0                 | 14  | ns   |
| 35  | $\overline{\text{BR}}$ Asserted to $\overline{\text{BG}}$ Asserted ( $\overline{\text{RMC}}$ Not Asserted)   | 1.5               | 3.5 | 1.5               | 3.5 | Clks |
| 37  | $\overline{\text{BGACK}}$ Asserted to $\overline{\text{BG}}$ Negated   | 1.5               | 3.5 | 1.5               | 3.5 | Clks |
| 37A   | $\overline{\text{BGACK}}$ Asserted to $\overline{\text{BR}}$ Negated   | 0                 | 1.5 | 0                 | 1.5 | Clks |
| 39 <sup>6</sup>   | $\overline{\text{BG}}$ Width Negated   | 60                | —   | 30                | —   | ns   |
| 39A   | $\overline{\text{BG}}$ Width Asserted  | 60                | —   | 30                | —   | ns   |
| 40  | Clock Low to $\overline{\text{DBEN}}$ Negated (Read)   | 0                 | 20  | 0                 | 21* | ns   |
| 41  | Clock Low to $\overline{\text{DBEN}}$ Negated (Read)   | 0                 | 20  | 0                 | 21* | ns   |
| 42  | Clock Low to $\overline{\text{DBEN}}$ Asserted (Write)   | 0                 | 20  | 0                 | 21* | ns   |
| 43  | Clock High to $\overline{\text{DBEN}}$ Negated (Write)   | 0                 | 20  | 0                 | 21* | ns   |
| 44  | R/W Low to $\overline{\text{DBEN}}$ Asserted (Write)   | 7                 | —   | 5                 | —   | ns   |
| 45 <sup>5</sup>   | $\overline{\text{DBEN}}$ Width Asserted (Asynchronous Read)  | 40                | —   | 22                | —   | ns   |
|   | $\overline{\text{DBEN}}$ Width Asserted (Asynchronous Write)   | 80                | —   | 45                | —   |      |
| 45A <sup>9</sup>  | $\overline{\text{DBEN}}$ Width Asserted (Synchronous Read)   | 5                 | —   | 5                 | —   | ns   |
|   | $\overline{\text{DBEN}}$ Width Asserted (Synchronous Write)  | 40                | —   | 22                | —   |      |
| 46  | $\overline{\text{R/W}}$ Width Asserted (Asynchronous Write or Read)  | 100               | —   | 50                | —   | ns   |
| 46A   | $\overline{\text{R/W}}$ Width Asserted (Synchronous Write or Read)   | 60                | —   | 30                | —   | ns   |
| 47A   | Asynchronous Input Setup Time ( $\overline{\text{HALT}}, \overline{\text{BERR}}, \overline{\text{DSACKx}}$ ) | 7*                | —   | 7*                | —   | ns   |
|   | Asynchronous Input Setup Time ( $\overline{\text{IPLx}}$ )   | 12*               | —   | 12*               | —   |      |

Chapter 16: Specifications and Characteristics  
**HP 64747 Electrical Specifications**

| HP64747 -AC ELECTRICAL SPECIFICATIONS — READ AND WRITE CYCLES<br>(V <sub>CC</sub> =5.0 Vdc ± 5%; GND=0 Vdc; T <sub>A</sub> =0 to 70°C) |   |                   |     |                   |     |      |
|--|---|-------------------|-----|-------------------|-----|------|
| Num  | Characteristic  | HP 64747<br>25MHz |     | HP 64747<br>40MHz |     | Unit |
|  |   | Min               | Max | Min               | Max |      |
| 47B  | Asynchronous Input Hold Time from Clock Low   | 8                 | —   | 6                 | —   | ns   |
| 48 <sup>4</sup>  | $\overline{\text{DSACKx}}$ Asserted to $\overline{\text{BERR}}$ , $\overline{\text{HALT}}$ Asserted |                   | 25  |                   | 14  | ns   |
| 53   | Data Out Hold from Clock High   | 3                 | —   | 2                 | —   | ns   |
| 55   | $\overline{\text{R/W}}$ Asserted to Data Bus Impedance Change                                       | 20                | —   | 11                | —   | ns   |
| 56   | $\overline{\text{RESET}}$ Pulse Width (Reset Instruction)   | 512               | —   | 512               | —   | Clks |
| 57   | $\overline{\text{BERR}}$ Negated to $\overline{\text{HALT}}$ Negated (Rerun)                        | 0                 | —   | 0                 | —   | ns   |
| 58 <sup>10</sup>   | $\overline{\text{BGACK}}$ Negated to Bus Driven   | 1                 | —   | 1                 | —   | Clks |
| 59 <sup>10</sup>   | $\overline{\text{BG}}$ Negated to Bus Driven  | 1                 | —   | 1                 | —   | Clks |
| 60 <sup>13</sup>   | Synchronous Input Valid to Clock High (Setup Time)  | 4*                | —   | 4*                | —   | ns   |
| 61 <sup>13</sup>   | Clock High to Synchronous Input Invalid (Hold Time)   | 8                 | —   | 6                 | —   | ns   |
| 62   | Clock Low to $\overline{\text{STATUS}}$ , $\overline{\text{REFILL}}$ Asserted                       | 0                 | 20  | 0                 | 15  | ns   |
| 63   | Clock Low to $\overline{\text{STATUS}}$ , $\overline{\text{REFILL}}$ Negated                        | 0                 | 20  | 0                 | 15  | ns   |

Notes:

- 1 This number can be reduced to 5 nanoseconds if strobes have equal loads.
- 2 If the asynchronous setup time (#47) requirements are satisfied, the  $\overline{\text{DSACKx}}$  low to data setup time (#31) and  $\overline{\text{DSACKx}}$  low to  $\overline{\text{BERR}}$  low setup time (#48) can be ignored. The data must only satisfy the data-in to clock low setup time (#27) for the following clock cycle,  $\overline{\text{BERR}}$  must only satisfy the late  $\overline{\text{BERR}}$  low to clock low setup time (#27A) for the following clock cycle.
- 3 This parameter specifies the maximum allowable skew between  $\overline{\text{DSACK0}}$  to  $\overline{\text{DSACK1}}$  asserted or  $\overline{\text{DSACK1}}$  to  $\overline{\text{DSACK0}}$  asserted, specification #47 must be met by  $\overline{\text{DSACK0}}$  or  $\overline{\text{DSACK1}}$ .

Chapter 16: Specifications and Characteristics  
HP 64747 Electrical Specifications

- 4 This specification applies to the first  $\overline{\text{DSACKx}}$  signal asserted. In the absence of  $\text{DSACKx}$ ,  $\text{BERR}$  is an asynchronous input using the asynchronous input setup time (#47).
- 5  $\text{DBEN}$  may stay asserted on consecutive write cycles.
- 6 The minimum values must be met to guarantee proper operation. If this maximum value is exceeded,  $\text{BG}$  may be reasserted.
- 7 This specification indicates the minimum high time for  $\overline{\text{ESC}}$  and  $\overline{\text{OCS}}$  in the event of an internal cache hit followed immediately by a cache miss or operand cycle.
- 8 This specification guarantees operation with the  $\text{MC68881}$  or  $\text{MC68882}$ , which specifies a minimum time for  $\text{DS}$  negated to  $\text{AS}$  asserted (specification #13A in the  $\text{MC68881}/\text{MC68882}$  User's Manual). Without this specification, incorrect interpretation of specifications #9A and #15 would indicate that the  $\text{MC68030}$  does not meet the  $\text{MC68881}$  requirements.
- 9 This specification allows a system designed to guarantee data hold times on the output side of data buffers that have output enable signals generated with  $\text{DBEN}$ . The timing on  $\text{DBEN}$  precludes its use for synchronous read cycles with no wait states.
- 10 These specifications allow system designers to guarantee that an alternate bus master has stopped driving the bus when the  $\text{MC68030}/\text{EC030}$  regains control of the bus after an arbitration sequence.
- 11  $\text{DS}$  will not be asserted for synchronous write cycles with no wait states.
- 12 These hold times are specified with respect to strobes (asynchronous) and with respect to the clock (synchronous). The designer is free to use either hold time.
- 13 Synchronous inputs must meet specifications #60 and #61 with stable logic levels for all rising edges of the clock. These values are specified relative to the high level of the rising clock edge.
- 14 This specification allows system designers to qualify the  $\text{CS}$  of an  $\text{MC68881}/\text{MC68882}$  with  $\text{AS}$  (allowing 7 ns for a gate delay) and still meet the  $\text{CS}$  to  $\text{DS}$  setup time requirement (spec 8B) of the  $\text{MC68881}/\text{MC68882}$ .
- 15 The asterisk "\*" means there is some difference between the specification for the emulator and the specification for the  $\text{MC68030}/\text{EC030}$  for this entry.

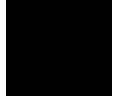

## HP 64748 Electrical Specifications

| <b>HP 64748 - DC ELECTRICAL SPECIFICATIONS</b><br>( $V_{CC}=5.0\text{ Vdc} \pm 5\%$ ; $GND=0\text{ Vdc}$ ; $T_A=0\text{ to }70^\circ\text{C}$ )  |   |          |                            |  |               |
|--|---|----------|----------------------------|--|---------------|
| Characteristic   | Symbol  | Min      | Max                        | Unit                                   |               |
| Input High Voltage   | $V_{IH}$  | 2.0      | $V_{CC}$                   | V                                      |               |
| Input Low Voltage  | $V_{IL}$  | -0.5     | 0.8                        | V                                      |               |
| Input Leakage Current<br>$GND \leq V_{in} \leq V_{CC}$   | $\overline{BR}, \overline{BGACK}, \overline{IPLx}$  | $I_{IN}$ | -2.5                       | 2.5                                    | $\mu\text{A}$ |
| Input High Current   | $\overline{BERR}, \overline{AVEC}, \overline{DSACKx}$<br>$\overline{CLK}, \overline{RESET}, \overline{HALT}$  | $I_{IH}$ | —<br>—                     | 25<br>50                               | $\mu\text{A}$ |
| Input Low Current  | $\overline{RESET}, \overline{HALT}$<br>$\overline{CLK}, \overline{BERR}, \overline{AVEC}, \overline{DSACKx}$  | $I_{IL}$ | —<br>—                     | -1.4<br>-0.25                          | mA            |
| Output High Voltage<br>$I_{OH}=-400\mu\text{A}$  | $\overline{A0-A31}, \overline{AS}, \overline{BG}, \overline{D0-D31}, \overline{DBEN}, \overline{DS},$<br>$\overline{ECS}, \overline{R/W}, \overline{IPEND}, \overline{OCS}, \overline{RMC},$<br>$\overline{SIZ0-SIZ1}, \overline{FC0-FC2}$  | $V_{OH}$ | 2.4                        | —                                      | V             |
| Output Low Voltage<br>$I_{OL} = 2.5\text{ mA}$<br>$I_{OL} = 3.2\text{ mA}$<br>$I_{OL} = 4.5\text{ mA}$<br>$I_{OL} = 5.3\text{ mA}$<br>$I_{OL} = 2.0\text{ mA}$<br>$I_{OL} = 9.3\text{ mA}$ | $\overline{A0-A31}, \overline{FC0-FC2}, \overline{SIZ0-SIZ1}$<br>$\overline{BG}, \overline{D0-D31}$<br>$\overline{R/W}, \overline{RMC}$<br>$\overline{AS}, \overline{DS}, \overline{DBEN}, \overline{IPEND}$<br>$\overline{ECS}, \overline{OCS}$<br>$\overline{RESET}, \overline{HALT}$ | $V_{OL}$ | —<br>—<br>—<br>—<br>—<br>— | 0.5<br>0.5<br>0.5<br>0.5<br>0.5<br>0.5 | V             |
| Power Dissipation  | $T_A = 0^\circ\text{C}$<br>$T_A = 70^\circ\text{C}$   | $P_D$    | —<br>—                     | 200<br>200                             | mW            |
| Capacitance<br>$V_{in}=0\text{V}$ , $T_A = 25^\circ\text{C}$ ,<br>$f=1\text{MHz}$  |   | $C_{in}$ | —                          | 20                                     | pF            |
| Load Capacitance   | $\overline{A0-A31}, \overline{FC0-FC2}, \overline{SIZ0-SIZ1}, \overline{R/W}$<br>All Other  | $C_L$    |                            | 100<br>50                              | pF            |

Notes:

- 1 The power dissipation is an indication of how much power is drawn from the target system by the emulator probe, not the true power dissipation of the emulator probe.

| HP 64748 - AC ELECTRICAL SPECIFICATIONS - CLOCK INPUT |                        |                   |     |          |     |      |
|---|------------------------|-------------------|-----|----------|-----|------|
| Num   | Characteristic         | MC68020<br>33 MHz |     | HP 64748 |     | Unit |
|   |                        | Min               | Max | Min      | Max |      |
|   | Frequency of Operation | 12.5              | 33  | 12.5     | 33  | MHz  |
| 1   | Cycle Time             | 30                | 80  | 30       | 80  | ns   |
| 2,3   | Clock Pulse Width      | 14                | 66  | 14       | 66  | ns   |
| 4,5   | Rise and Fall Times    | —                 | 3   | —        | 3   | ns   |

| HP 64748 - AC ELECTRICAL SPECIFICATIONS — READ AND WRITE CYCLES<br>(V <sub>CC</sub> =5.0 Vdc ± 5%; GND=0 Vdc; T <sub>A</sub> =0 to 70°C) |  |                  |     |          |     |      |
|--|--|------------------|-----|----------|-----|------|
| Num  | Characteristic   | MC68020<br>33MHz |     | HP 64748 |     | Unit |
|  |  | Min              | Max | Min      | Max |      |
| 6  | Clock High to FC,Size,RMC,Address Valid                      | 0                | 21  | 0        | 21  | ns   |
| 6A   | Clock High to ECS,OCS Asserted                               | 0                | 10  | 0        | 10  | ns   |
| 7  | Clock FC,Size,RMC,Address,Data High Impedance                | 0                | 30  | 0        | 30  | ns   |
| 8  | Clock High to FC,Size,RMC,Address Invalid                    | 0                | —   | 0        | —   | ns   |
| 9  | Clock Low to AS,DS Asserted                                  | 3                | 15  | 3        | 20* | ns   |
| 9A <sup>1</sup>  | $\overline{AS}$ to $\overline{DS}$ Assertion Skew (Read)     | -10              | 10  | -12      | 12  | ns   |
| 9B <sup>11</sup>   | $\overline{AS}$ Asserted to $\overline{DS}$ Asserted (Write) | 22               | —   | 20       | —   | ns   |

Chapter 16: Specifications and Characteristics  
**HP 64748 Electrical Specifications**

| HP 64748 - AC ELECTRICAL SPECIFICATIONS — READ AND WRITE CYCLES<br>(V <sub>CC</sub> =5.0 Vdc ± 5%; GND=0 Vdc; T <sub>A</sub> =0 to 70°C) |   |                  |     |          |     |      |
|--|---|------------------|-----|----------|-----|------|
| Num  | Characteristic  | MC68020<br>33MHz |     | HP 64748 |     | Unit |
|  |   | Min              | Max | Min      | Max |      |
| 10   | $\overline{\text{ECS}}$ Width Asserted  | 10               | —   | 10       | —   | ns   |
| 10A  | $\overline{\text{OCS}}$ Width Asserted  | 10               | —   | 10       | —   | ns   |
| 10B <sup>7</sup>   | $\overline{\text{ECS}}, \overline{\text{OCS}}$ Width Negated  | 5                | —   | 5        | —   | ns   |
| 11   | FC, Size, $\overline{\text{RMC}}$ , Address Valid to $\overline{\text{AS}}$ Asserted (and $\overline{\text{DS}}$ Asserted, Read)            | 5                | —   | 5        | —   | ns   |
| 12   | Clock Low to $\overline{\text{AS}}, \overline{\text{DS}}$ Negated   | 0                | 15  | 0        | 20* | ns   |
| 12A  | Clock Low to $\overline{\text{ECS}}, \overline{\text{OCS}}$ Negated   | 0                | 15  | 0        | 15  | ns   |
| 13   | $\overline{\text{AS}}, \overline{\text{DS}}$ Negated to FC, Size, $\overline{\text{RMC}}$ , Address Invalid                                 | 5                | —   | 0*       | —   | ns   |
| 14   | $\overline{\text{AS}}$ (and $\overline{\text{DS}}$ , Read) Width Asserted (Asynchronous Cycle)  | 50               | —   | 48       | —   | ns   |
| 14A  | $\overline{\text{DS}}$ Width Asserted, Write  | 25               | —   | 23       | —   | ns   |
| 15   | $\overline{\text{AS}}, \overline{\text{DS}}$ Width Negated  | 25               | —   | 23       | —   | ns   |
| 15A <sup>8</sup>   | $\overline{\text{DS}}$ Negated to $\overline{\text{AS}}$ Asserted   | 18               | —   | 16       | —   | ns   |
| 16   | Clock High to $\overline{\text{AS}}, \overline{\text{DS}}, \overline{\text{R}}, \overline{\text{W}}, \overline{\text{DBEN}}$ High Impedance | —                | 30  | —        | 30  | ns   |
| 17   | $\overline{\text{AS}}, \overline{\text{DS}}$ Negated to $\overline{\text{R}}, \overline{\text{W}}$ Invalid                                  | 5                | —   | 0*       | —   | ns   |
| 18   | Clock High to $\overline{\text{R}}, \overline{\text{W}}$ High   | 0                | 15  | 0        | 15  | ns   |
| 20   | Clock High to $\overline{\text{R}}, \overline{\text{W}}$ Low  | 0                | 15  | 0        | 15  | ns   |
| 21   | $\overline{\text{R}}, \overline{\text{W}}$ High to $\overline{\text{AS}}$ Asserted  | 5                | —   | 5        | —   | ns   |
| 22   | $\overline{\text{R}}, \overline{\text{W}}$ Low to $\overline{\text{DS}}$ Asserted (Write)   | 35               | —   | 35       | —   | ns   |
| 23   | Clock High to Data Out Valid  | —                | 18  | —        | 23* | ns   |
| 25   | $\overline{\text{AS}}, \overline{\text{DS}}$ Negated to Data Out Invalid  | 5                | —   | 2        | —   | ns   |

| <b>HP 64748 - AC ELECTRICAL SPECIFICATIONS — READ AND WRITE CYCLES</b><br>(V <sub>CC</sub> =5.0 Vdc ± 5%; GND=0 Vdc; T <sub>A</sub> =0 to 70°C) |  |                  |     |          |     |      |
|---|--|------------------|-----|----------|-----|------|
| Num   | Characteristic   | MC68020<br>33MHz |     | HP 64748 |     | Unit |
|   |  | Min              | Max | Min      | Max |      |
| 25A <sup>9</sup>  | $\overline{DS}$ Negated to $\overline{DBEN}$ Negated (Write)   | 5                | —   | 0        | —   | ns   |
| 26  | Data Out Valid to $\overline{DS}$ Asserted (Write)   | 5                | —   | 5        | —   | ns   |
| 27  | Data-In Valid to Clock Low (Synchronous Setup)   | 5                | —   | 10*      | —   | ns   |
| 27A   | Late $\overline{BERR}$ , $\overline{HALT}$ Asserted to Clock Low (Setup)   | 5                | —   | 10*      | —   | ns   |
| 28  | $\overline{AS}$ , $\overline{DS}$ Negated to $\overline{DSACKx}$ , $\overline{BERR}$ , $\overline{HALT}$ , $\overline{AVEC}$ Negated (Asynchronous Hold) | 0                | 40  | 0        | 30* | ns   |
| 29  | $\overline{DS}$ Negated to Data-In Invalid (Asynchronous Hold)   | 0                | —   | 0        | —   | ns   |
| 29A   | $\overline{DS}$ Negated to Data-In High-Impedance  | —                | 30  | —        | 30  | ns   |
| 30  | Clock Low to Data-In Invalid (Synchronous Hold)  | 6                | —   | 6        | —   | ns   |
| 31 <sup>2</sup>   | $\overline{DSACKx}$ Asserted to Data-In Valid (Asynchronous Data Setup)  | —                | 17  | —        | 13* | ns   |
| 31A <sup>3</sup>  | $\overline{DSACKx}$ Asserted to $\overline{DSACKx}$ Valid (Skew)   | —                | 10  | —        | 7   | ns   |
| 32  | $\overline{RESET}$ Input Transition Time   | —                | 1.5 | —        | 1.5 | Clks |
| 33  | Clock Low to $\overline{BG}$ Asserted  | 0                | 20  | 0        | 30  | ns   |
| 34  | Clock Low to $\overline{BG}$ Negated   | 0                | 20  | 0        | 30  | ns   |
| 35  | $\overline{BR}$ Asserted to $\overline{BG}$ Asserted ( $\overline{RMC}$ Not Asserted)  | 1.5              | 3.5 | 1.5      | 3.5 | Clks |
| 37  | $\overline{BGACK}$ Asserted to $\overline{BG}$ Negated   | 1.5              | 3.5 | 1.5      | 3.5 | Clks |
| 37A <sup>6</sup>  | $\overline{BGACK}$ Asserted to $\overline{BR}$ Negated   | 0                | 1.5 | 0        | 1.5 | Clks |
| 39  | $\overline{BG}$ Width Negated  | 50               | —   | 50       | —   | ns   |
| 39A   | $\overline{BG}$ Width Asserted   | 50               | —   | 50       | —   | ns   |
| 40  | Clock Low to $\overline{DBEN}$ Negated (Read)  | 0                | 15  | 0        | 15  | ns   |

Chapter 16: Specifications and Characteristics  
**HP 64748 Electrical Specifications**

| <b>HP 64748 - AC ELECTRICAL SPECIFICATIONS — READ AND WRITE CYCLES</b><br>(V <sub>CC</sub> =5.0 Vdc ± 5%; GND=0 Vdc; T <sub>A</sub> =0 to 70°C) |  |                  |     |          |     |      |
|---|--|------------------|-----|----------|-----|------|
| Num   | Characteristic   | MC68020<br>33MHz |     | HP 64748 |     | Unit |
|   |  | Min              | Max | Min      | Max |      |
| 41  | Clock Low to $\overline{\text{DBEN}}$ Negated (Read)   | 0                | 15  | 0        | 15  | ns   |
| 42  | Clock Low to $\overline{\text{DBEN}}$ Asserted (Write)   | 0                | 15  | 0        | 15  | ns   |
| 43  | Clock High to $\overline{\text{DBEN}}$ Negated (Write)   | 0                | 15  | 0        | 15  | ns   |
| 44  | R/ $\overline{\text{W}}$ Low to $\overline{\text{DBEN}}$ Asserted (Write)  | 5                | —   | 5        | —   | ns   |
| 45 <sup>5</sup>   | $\overline{\text{DBEN}}$ Width Asserted (Asynchronous Read)  | 30               | —   | 30       | —   | ns   |
|   | $\overline{\text{DBEN}}$ Width Asserted (Asynchronous Write)   | 60               | —   | 60       | —   |      |
| 46  | R/ $\overline{\text{W}}$ Width Asserted (Asynchronous Write or Read)   | 75               | —   | 75       | —   | ns   |
| 47A   | Asynchronous Input Setup Time ( $\overline{\text{HALT}}$ , $\overline{\text{BERR}}$ , $\overline{\text{DSACKx}}$ )<br>Asynchronous Input Setup Time (IPLx) | 5                | —   | 10*      | —   | ns   |
|   |  | 5                | —   | 10*      | —   |      |
| 47B   | Asynchronous Input Hold Time from Clock Low  | 10               | —   | 10       | —   | ns   |
| 48 <sup>4</sup>   | $\overline{\text{DSACKx}}$ Asserted to $\overline{\text{BERR}}$ , $\overline{\text{HALT}}$ Asserted  |                  | 15  |          | 11  | ns   |
| 53  | Data Out Hold from Clock High  | 0                | —   | 0        | —   | ns   |
| 55  | R/ $\overline{\text{W}}$ Asserted to Data Bus Impedance Change   | 20               | —   | 10       | —   | ns   |
| 56  | $\overline{\text{RESET}}$ Pulse Width (Reset Instruction)  | 512              | —   | 512      | —   | Clks |
| 57  | $\overline{\text{BERR}}$ Negated to $\overline{\text{HALT}}$ Negated (Rerun)   | 0                | —   | 2        | —   | ns   |
| 58 <sup>10</sup>  | $\overline{\text{BGACK}}$ Negated to Bus Driven  | 1                | —   | 1        | —   | Clks |
| 59 <sup>10</sup>  | $\overline{\text{BG}}$ Negated to Bus Driven   | 1                | —   | 1        | —   | Clks |



Notes:

- 1 This number can be reduced to 5 nanoseconds if strobes have equal loads.
- 2 If the asynchronous setup time (#47) requirements are satisfied, the  $\overline{DSACKx}$  low to data setup time (#31) and  $\overline{DSACKx}$  low to  $\overline{BERR}$  low setup time (#48) can be ignored. The data must only satisfy the data-in to clock low setup time (#27) for the following clock cycle,  $\overline{BERR}$  must only satisfy the late  $\overline{BERR}$  low to clock low setup time (#27) for the following clock cycle.
- 3 This parameter specifies the maximum allowable skew from  $\overline{DSACK0}$  to  $\overline{DSACK1}$  asserted or  $\overline{DSACK1}$  to  $\overline{DSACK0}$  asserted, specification #47 must be met by  $\overline{DSACK0}$  or  $\overline{DSACK1}$ .
- 4 This specification applies to the first  $\overline{DSACKx}$  signal asserted. In the absence of  $\overline{DSACKx}$ ,  $\overline{BERR}$  is an asynchronous input using the asynchronous input setup time (#47).
- 5  $\overline{DBEN}$  may stay asserted on consecutive write cycles.
- 6 The minimum values must be met to guarantee proper operation. If this maximum value is exceeded,  $\overline{BG}$  may be reasserted.
- 7 This specification indicates the minimum high time for  $\overline{ECS}$  and  $\overline{OCS}$  in the event of an internal cache hit followed immediately by a cache miss or operand cycle.
- 8 This specification guarantees operation with the MC68881, which specifies a minimum time for  $\overline{DS}$  negated to  $\overline{AS}$  asserted (specification #13A in the MC68881 User's Manual). Without this specification, incorrect interpretation of specifications #9A and #15 would indicate that the MC68020 does not meet the MC68881 requirements.
- 9 This specification allows a system designed to guarantee data hold times on the output side of data buffers that have output enable signals generated with  $\overline{DBEN}$ . The timing on  $\overline{DBEN}$  precludes its use for synchronous read cycles with no wait states.
- 10 These specifications allow system designers to guarantee that an alternate bus master has stopped driving the bus when the MC68020 regains control of the bus after an arbitration sequence.
- 11 This specification allows system designers to qualify the  $\overline{CS}$  of an MC68881/MC68882 with  $\overline{AS}$  (allowing 7 ns for a gate delay) and still meet the  $\overline{CS}$  to  $\overline{DS}$  setup time requirement (spec 8B) of the MC68881/MC68882.
- 12 The asterisk "\*" means there is some difference between the specification for the emulator and the specification for the MC68020 for that entry.



## Physical (HP 64747 and HP 64748)

### Emulator Dimensions

173 mm height x 325 mm width x 389 mm depth (6.8 in. x 12.8 in. x 15.3 in.)

### Cable Length

Emulator to target system, approximately 914 mm (36 inches).

### Probe dimensions

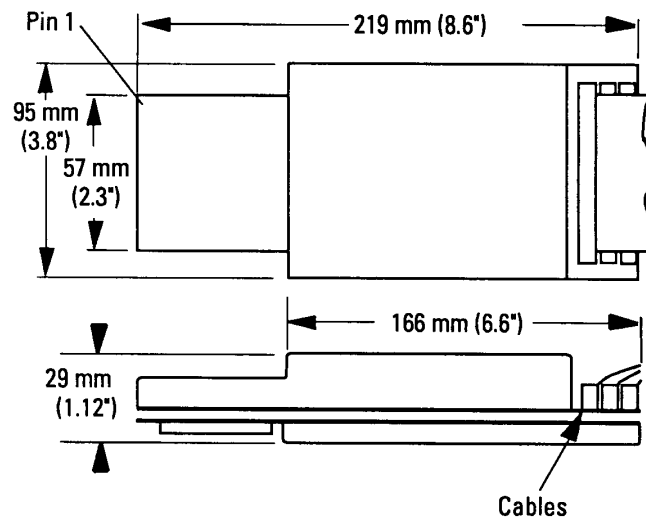

## Environmental (HP 64747 and HP 64748)

### Temperature

Operating, 0° to +40° C (+32° to +104° F);  
Nonoperating, -40° C to +60° C (-40° F to +140° F).

For the HP 64747 (MC68030/EC030), 100 lfm of airflow over the probe is recommended to ensure optimum performance.

### Altitude

Operating, 4600 m (15 000 ft), nonoperating, 15 300 m (50 000 ft).

### Relative Humidity

15% to 95%.

---

## BNC, labeled TRIGGER IN/OUT (HP 64747 and HP 64748)

### Output Drive

Logic high level with 50-ohm load  $\geq 2.0$  V. Logic low level with 50-ohm load  $\leq 0.4$  V.

### Input

74HCT132 with 135 ohms to ground in parallel. Maximum input: 5 V above Vcc; 5 V below ground.

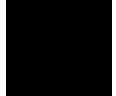

## Communications (HP 64747 and HP 64748)

### Host Port

25-pin female type "D" subminiature connector.

RS-232-C DCE or DTE to 38.4 kbaud.

RS-422 DCE only to 460.8 kbaud.

### CMB Port

9-pin female type "D" subminiature connector.

---

# Part 4

---

## Concept Guide

---

## Concepts Guide

### In this part

Part 4 of this book provides conceptual information on the X resources and the Graphical User Interface.



---

**X Resources and the Graphical User Interface**

## **X Resources and the Graphical User Interface**

This chapter contains more detailed information about X resources and scheme files that control the appearance and operation of the Graphical User Interface. This chapter:

- Describes the X Window concepts surrounding resource specification.
- Describes the Graphical User Interface's implementation of scheme files.



## **X Resource Specifications**

An X resource specification is a resource name and a value. The resource name identifies the element whose appearance or behavior is to be defined, and the value specifies how the element should look or behave. For example, consider the following resource specification:

```
Application.form.row.done.background: red
```

The resource name is "Application.form.row.done.background:" and the value is "red".

### **Resource Names Follow Widget Hierarchy**

A *widget* is an OSF/Motif graphic device from which X applications are built. For example, pushbuttons and menu bars are Motif widgets. Applications are built using a hierarchy of widgets, and the application's X resource names follow this hierarchy. For example:

```
Application.form.row.done.background: red
```

In the resource name above, the top-level widget is named after the application. One of the top-level widget's children is a form widget, one of the form widget's children is a row-column manager widget, and one of the row-column manager widget's children is a pushbutton widget. Resource names show a path in the widget hierarchy.

Each widget in the hierarchy is a member of a widget class, and the particular instance of the widget is named by the application programmer.

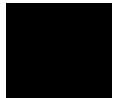

### **Class Names or Instance Names Can Be Used**

When specifying resource names, you can use either instance names or class names. For example, a "Done" pushbutton may have an instance name of "done" and a class name of "XmPushButton". To set the background color for a hypothetical "Done" pushbutton, you can use:

```
Application.form.row.done.background: red
```

Or, you can use:

```
Application.form.row.XmPushButton.background: red
```

Applications also have class and instance names. For example, an application may have an instance name of "applic1" and a class name of "Application". To set the background color for a hypothetical "Done" pushbutton only in the "applic1" application, you can use:

```
applic1.form.row.done.background: red
```

Note that instance names are more specific than class names. That is, class names may apply to many instances of the widget.

The class and instance names for the widgets in the Graphical User Interface can be displayed by choosing **Help**→**X Resource Names** and clicking on the "All names" button.

### **Wildcards Can Be Used**

A wildcard may be used to match a resource specification to many different widgets at once. For example, to set the background color of all pushbuttons, you can use:

```
Application*XmPushButton.background: red
```

Note that resource names with wildcards are more general than those without wildcards.

## Specific Names Override General Names

A more specific resource specification will override a more general one when both apply to a particular widget or application.

The names for the application and the main window widget in HP64\_Softkey applications have been chosen so that you may specify custom resource values that apply in particular situations:

- 1 Apply to ALL HP64\_Softkey applications:

HP64\_Softkey\*<resource>: <value>

- 2 Apply to specific types of HP64\_Softkey applications:

emul\*<resource>: <value> (for the emulator)

perf\*<resource>: <value> (for the performance analyzer)

- 3 Apply to all HP64\_Softkey applications, but only when they are connected to a particular type of microprocessor:

\*m68030\*<resource>: <value> (for the 68030)

\*m68020\*<resource>: <value> (for the 68020)

- 4 Apply to a specific HP64\_Softkey application connected to a specific processor:

perf.m68030\*<resource>: <value> (for the 68030 perf. analyzer)

emul.m68020\*<resource>: <value> (for the 68020 emulator)

If all four examples above are used for a particular resource, #3 will override #2 for all applications connected to a 68030 emulator, and #4 will override #2, but only for the specifically mentioned type of microprocessor.

When modifying resources, your resource paths must either match, or be more specific than, those found in the application defaults file.

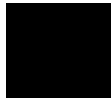

## How X Resource Specifications are Loaded

When the Graphical User Interface starts up, it loads resource specifications from a set of configuration files located in system directories as well as user-specific locations.

### Application Default Resource Specifications

Default resource specifications for an application are placed in a system directory:

HP-UX            /usr/lib/X11/app-defaults

SunOS            /usr/openwin/lib/X11/app-defaults

The name of the Graphical User Interface application defaults file is `HP64_Softkey` (same as the application class name). This file is well-commented and contains information about each of the X resources you can modify. You can easily view this file by choosing **Help**→**Topic** and selecting the "X Resources: App Default File" topic. Do not modify the application defaults file; any changes to this file will affect the appearance and behavior of the application for all users.

### User-Defined Resource Specifications

User-defined resources (for any X application) are located in the X server's `RESOURCE_MANAGER` property or in the user's `$HOME/.Xdefaults` file.

## Load Order

Resource specifications are loaded from the following places in the following order:

- 1 The application defaults file. For example, `/usr/lib/X11/app-defaults/HP64_Softkey` when the operating system is HP-UX or `/usr/openwin/lib/X11/app-defaults/HP64_Softkey` when the operating system is SunOS.
- 2 The `$XAPPLRESDIR/HP64_Softkey` file. (The `XAPPLRESDIR` environment variable defines a directory containing system-wide custom application defaults.)
- 3 The server's `RESOURCE_MANAGER` property. (The `xrdb` command loads user-defined resource specifications into the `RESOURCE_MANAGER` property.)

If no `RESOURCE_MANAGER` property exists, user defined resource settings are read from the `$HOME/.Xdefaults` file.

- 4 The file named by the `XENVIRONMENT` environment variable.  
If the `XENVIRONMENT` variable is not set, the `$HOME/.Xdefaults-host` file is read (typically contains resource specifications for a specific remote host).
- 5 Resource specifications included in the command line with the `-xrm` option.

When specifications with identical resource names appear in different places, the latter specification overrides the former.



## Scheme Files

Several of the Graphical User Interface's X resources identify *scheme files* that contain additional X resource specifications. Scheme files group resource specifications for different displays, computing environments, and languages.

### Resources for Graphical User Interface Schemes

There are five X resources that identify scheme files:

#### HP64\_Softkey.labelScheme:

Names the scheme file to use for labels and button text. Values can be: Label, \$LANG, or a custom scheme file name. The default uses the \$LANG environment variable if it is set and if a scheme file named Softkey.\$LANG exists in one of the directories searched for scheme files; otherwise, the default is Label.

#### HP64\_Softkey.platformScheme:

Names the subdirectory for the platform specific color, size, and input scheme files. This resource should be set to the platform on which the X server is running (and displaying the Graphical User Interface) if it is different from the platform where the application is running. Values can be: HP-UX, SunOS, pc-xview, or a custom platform scheme directory name.

#### HP64\_Softkey.colorScheme:

Names the color scheme file. Values can be: Color, BW, or a custom scheme file name.

#### HP64\_Softkey.sizeScheme:

Names the size scheme file which defines the fonts and the spacing used. Values can be: Large, Small, or a custom scheme file name.

#### HP64\_Softkey.inputScheme:

Names the input scheme file which specifies mouse and keyboard operation. Values can be: Input, or a custom scheme file name.

The actual scheme file names take the form: "Softkey.<value>".

## Scheme File Names

There are six scheme files provided with the Graphical User Interface. Their names and brief descriptions of the resources they contain follow.

|               |   |
|---------------|---|
| Softkey.Label | Defines the labels for the fixed text in the interface. Such things as menu item labels and similar text are in this file. If the \$LANG environment variable is set, the scheme file "Softkey.\$LANG" is loaded if it exists; otherwise, the file "Softkey.Label" is loaded. |
| Softkey.BW    | Defines the <i>color scheme</i> for black and white displays. This file is chosen if the display cannot produce at least 16 colors.   |
| Softkey.Color | Defines the <i>color scheme</i> for color displays. This file is chosen if the display can produce 16 or more colors.   |
| Softkey.Large | Defines the <i>size scheme</i> (that is, the window dimensions and fonts) for high resolution displays (1000 pixels or more vertically).  |
| Softkey.Small | Defines the <i>size scheme</i> (that is, the window dimensions and fonts) for low resolution displays (less than 1000 pixels vertically).   |
| Softkey.Input | Defines the <i>input scheme</i> (that is, the button and key bindings for the mouse and keyboard).  |

## Load Order for Scheme Files

Scheme files are searched for in the following directories and in the following order:

- 1 System scheme files in directory /usr/hp64000/lib/X11/HP64\_schemes.
- 2 System-wide custom scheme files located in directory \$XAPPLRESDIR/HP64\_schemes.
- 3 User-defined scheme files located in directory \$HOME/.HP64\_schemes (note the dot in the directory name).

## Custom Scheme Files

You can modify scheme files by copying them to the directory for user-defined schemes and changing the resource specifications in the file. For example, if you wish to modify the color scheme, and your platform is HP-UX, you can copy the `/usr/hp64000/lib/X11/HP64_schemes/HP-UX/Softkey.Color` file to `$HOME/.HP64_schemes/HP-UX/Softkey.Color` and modify its resource specifications.

You can create custom scheme files by modifying the X resource for the particular scheme and by placing the custom scheme file in the directory for user-defined schemes. For example, if the following resource specifications are made:

```
HP64_Softkey.platformScheme:  HP-UX
HP64_Softkey.colorScheme:     MyColor
```

The custom scheme file would be:

```
$HOME/.HP64_schemes/HP-UX/Softkey.MyColor
```



---

# Part 5

---

## Installation and Service Guide

---

## Installation and Service Guide

### In this part

Part 5 of this book describes how to install the emulator in the card cage, how to install the demo board power cable, SRAM modules, rivets and covers, and the emulator probe cable. It also shows you how to connect the probe to the demo board, verify performance of the hardware, and use the progflash program to ensure software compatibility.

---

**18**



---

**Installation and Service**

## Installation

This chapter shows you how to install emulation and analysis hardware and interface software. It also shows you how to verify installation by starting the emulator/analyzer interface for the first time. These installation tasks are described in the following sections:

- Installing hardware.
- Connecting the HP 64700 to a computer or LAN.
- Installing HP 9000 software.
- Installing Sun SPARCsystem software.
- Verifying the installation.

### Minimum HP 9000 Hardware and System Requirements

The following is a set of minimum hardware and system recommendations for operation of the Graphical User Interface on HP 9000 Series 300/400 and Series 700 workstations.

**HP-UX** For Series 9000/300 and Series 9000/400 workstations, the minimum supported version of the operating system is 7.03 or later. For Series 9000/700 workstations, the minimum supported version of the operating system is version 8.01.

**64700 Operating Environment** The Graphical User Interface requires version A.04.10 of the 64700 Operating Environment. (The Graphical User Interface version is A.04.00.)

**Motif/OSF** For Series 9000/700 workstations, you must also have the Motif 1.1 dynamic link libraries installed. They are installed by default, so you do not have to install them specifically for this product, but you should consult your HP-UX documentation for confirmation and more information.

**Hardware and Memory** Any workstation used with the Graphical User Interface should have a minimum of 16 megabytes of memory (32 megabytes or more is recommended). Series 300 workstations should have a minimum performance equivalent to that of a HP 9000/350. A color display is also highly recommended.

From here, you should proceed to the section titled "Installation for HP 9000 Hosted Systems" for instructions on how to install, verify, and start the Graphical User Interface on HP 9000 systems.

### **Minimum Sun SPARCsystem Hardware and System Requirements**

The following is a set of minimum hardware and system recommendations for operation of the Graphical User Interface on Sun SPARCsystem workstations.

**SunOS** The Graphical User Interface software is designed to run on a Sun SPARCsystem with SunOS version 4.1 or 4.1.1 or greater (Solaris 1.X). At the time this manual was printed, the Graphical User Interface software would not run on Solaris 2.X; ask your Hewlett-Packard Sales Office if the present version of Graphical User Interface software will run on Solaris 2.X. The tape uses the QIC-24 data format.

**64700 Operating Environment** The Graphical User Interface requires version A.04.10 or greater of the 64700 Operating Environment. (The minimum Graphical User Interface version required is A.04.00.)

**Hardware and Memory** Any workstation used with the Graphical User Interface should have a minimum of 16 megabytes of memory (32 megabytes or more is recommended). A color display is also highly recommended.

From here, you should proceed to the section titled "Installation for Sun SPARCsystems" for instructions on how to install, verify, and start the Graphical User Interface on SPARCsystem workstations.

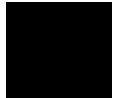

## **Installing Hardware**

This section describes how to install emulation and analysis hardware and how to connect the emulator probe to the demo target system.

### **Equipment supplied**

The minimum system contains:

- HP 64748 68020 or HP 64747A/B 68030/EC030 PGA Emulator Probe (which includes the demo target system).
- HP 64748C Emulation Control card.
- HP 64794 Emulation-Bus Analyzer (deep analyzer) card, or HP 64704A Emulation-Bus Analyzer (1K analyzer) card.
- Ribbon cable.
- HP 64700 Card Cage.

Optional parts are:

- HP 64171A/64172A 256-Kbyte Memory Modules for additional memory depth.
- HP 64171B/64172B 1-Mbyte Memory Modules for additional memory depth.
- HP 64173A 4-Mbyte Memory Modules for additional memory depth.
- HP 64708A Software Performance Analyzer.

### **Equipment and tools needed**

In order to install and use the MC68020 or MC68030/EC030 emulation system, you need:

- Flat-blade screwdriver with shaft at least 5 inches long (13 mm aprox).

### **Installation overview**

The steps in the installation process are:

- 1 Install optional memory modules on the deep analyzer card, if desired.
- 2 Connect the HP 64747 or HP 64748 emulator probe to the HP 64748C emulator control card.
- 3 Install cards into the HP 64700 card cage.
- 4 Install emulation memory modules on the emulator probe.
- 5 Connect the emulator probe to the demo target system.
- 6 Apply power to the HP 64700 Card Cage.

### **Antistatic precautions**

Integrated-circuit boards contain electrical components that are easily damaged by small amounts of static electricity. To avoid damage to the emulator cards, follow these guidelines:

- If possible, work at a static-free workstation.
- Handle the boards only by the edges; do not touch components or traces.
- Use a grounding wrist strap that is connected to the HP 64700's chassis. See Step 3 in this chapter for the location of the ground strap plug.

---

#### **Caution**

If you already have a modular HP 64700 Series Card Cage and want to remove the existing emulator and insert an HP 64747 or HP 64748 emulator in its place, the HP 64700 Series generic firmware and analyzer firmware may NOT be compatible, and the software will indicate incompatibility. In this event, you must purchase a Flash EPROM board to update the firmware. Instructions for installing this board and programming it from a PC or HP 9000 are provided in the HP 64700 Card Cage Installation/Service manual. Instructions for installing and updating emulator firmware using the Flash EPROM board are covered in Chapter 19, "Installing/Updating Emulator Firmware."

---

#### **Note**

If you already have a modular HP 64700 Series Card Cage and want to remove the 1K analyzer and install the deep analyzer in its place, the analyzer firmware will be updated by your installation. The analyzer firmware is on the analyzer card.

### **Checking Hardware Installation**

After hardware installation, run a performance test to verify that the emulator is working properly. The performance verification procedure is described under "Verifying the Installation" later in this chapter.

### **Service Information**

Use this chapter when removing and installing hardware, running performance verification, and ordering parts. See the HP 64700 Series Installation/Service Guide for information on system configurations, installing product software, software updates, and ordering parts for the card cage. Turn off power to the card cage before removing or installing hardware.

## Step 1. Install optional memory modules on Deep Analyzer card, if desired

### Observe antistatic precautions listed on the fifth page of this chapter

With no optional memory modules installed on the deep analyzer card, the trace memory depth is 8K. If you are going to use the deep analyzer with this default trace memory depth, skip this step and proceed to Step 2 of this installation procedure.

**1** Determine placement of the optional memory modules. Two types of modules may be installed: 256-Kbyte (HP 64172A), and 1-Mbyte (HP 64172B). Either module type may be installed in the banks on the analyzer card. Do not use HP 64171A/B or HP 64173A memory modules; they are too slow.

If you install no memory modules, the deep analyzer will have 8K maximum memory depth.

If you install four 256-Kbyte memory modules, the analyzer will have 64K maximum memory depth.

If you install four 1-Mbyte memory modules, the analyzer will have 256K maximum memory depth.

If you install a combination of 256-Kbyte memory modules and 1-Mbyte memory modules, the analyzer will have 64K maximum memory depth. All four connectors must have memory modules installed before the analyzer depth will be increased.

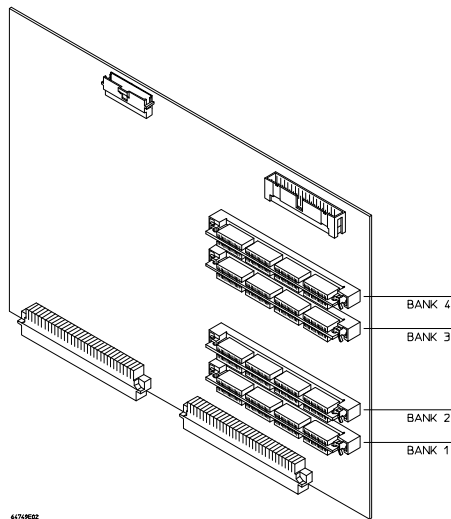



**2** To ensure correct installation of optional memory modules on the deep analyzer card, there is a cutout at one end of the memory modules so they can only be installed the correct way.

To install a memory module:

Align the groove in the memory module with the alignment rib in the connector.

Align the cutout in the memory module with the projection in the connector.

Place the memory module into the connector groove at an angle.

Firmly press the memory module into the connector and make sure it is completely seated.

Rotate the memory module forward so that the pegs on the connector fit into the holes on the memory module.

Make sure the release tabs at each end of the connector snap around the memory module to hold it in place.

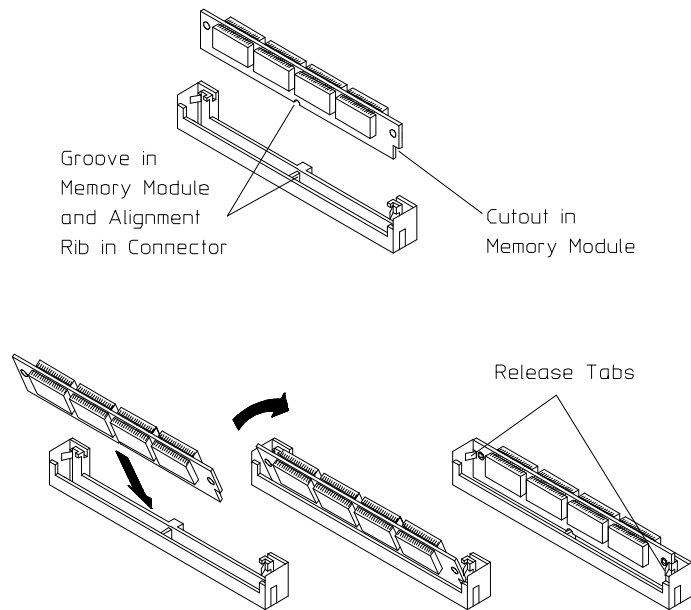

64794E03

## Step 2. Connect the Emulator Probe Cables

Three ribbon cables connect the HP 64748C emulation control card to the HP 64747 or HP 64748 (MC68030 or MC68020) emulator probe.

The shortest cable connects from J1 of the emulation control card to J3 of the emulator probe. The medium length cable connects from J2 of the emulation control card to J2 of the emulator probe. The longest cable connects from J3 of the emulation control card to J1 of the emulator probe.

Make sure the cable connectors are seated. There are stainless steel clips on the cable connectors; these must be properly latched inside the sockets. Otherwise, the cables will work loose and you will see erratic operation. See illustration next page (step 2).

### 1 Connect the emulator probe cables to the emulation control card.

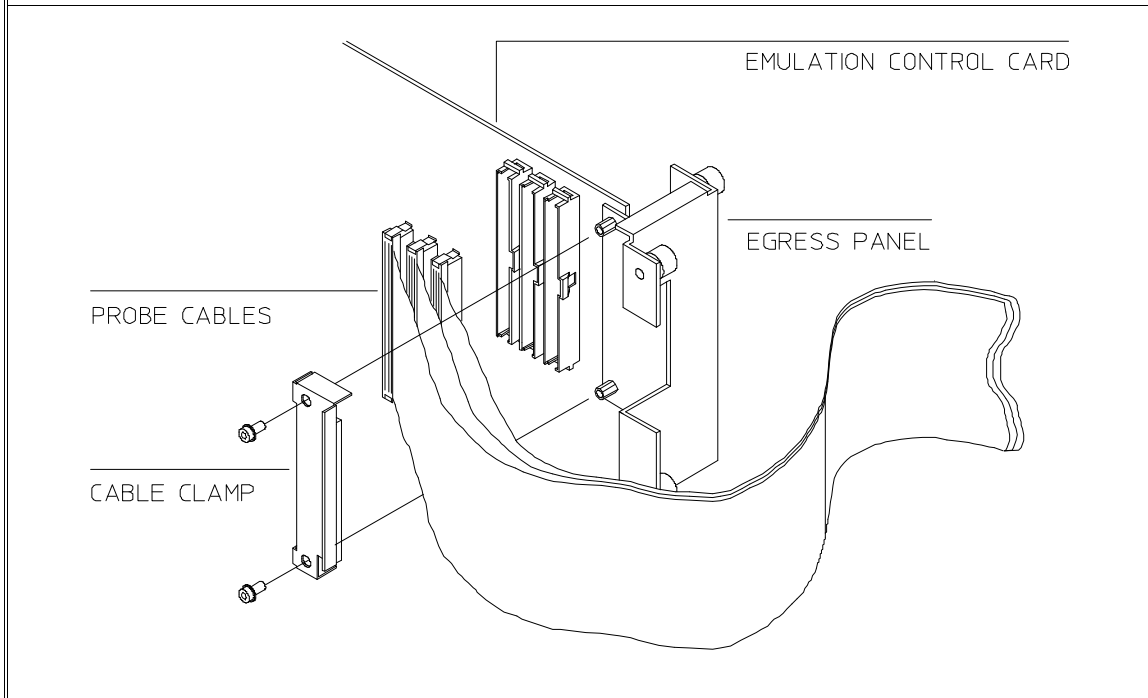

**2** When inserting cable connectors into the sockets, press inward on the connector clips so that they hook into the sockets as shown. The order of connecting cables was given in step 1.

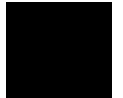
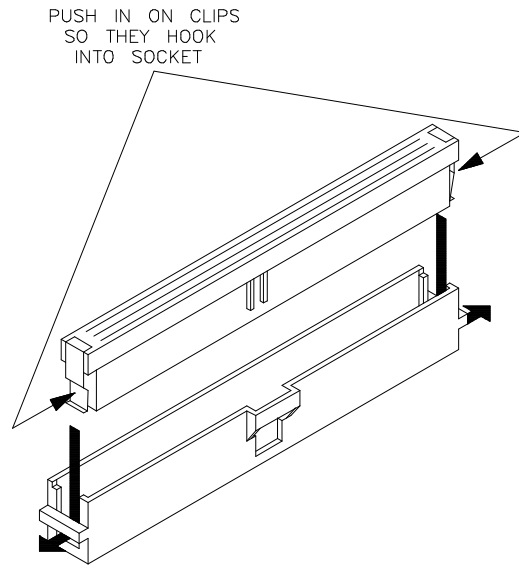

Chapter 18: Installation and Service  
**Installing Hardware**

**3** Connect the other ends of the cables to the emulator probe. Again, make sure the stainless steel clips on the cable connectors are properly latched within the sockets, as shown in step 2.

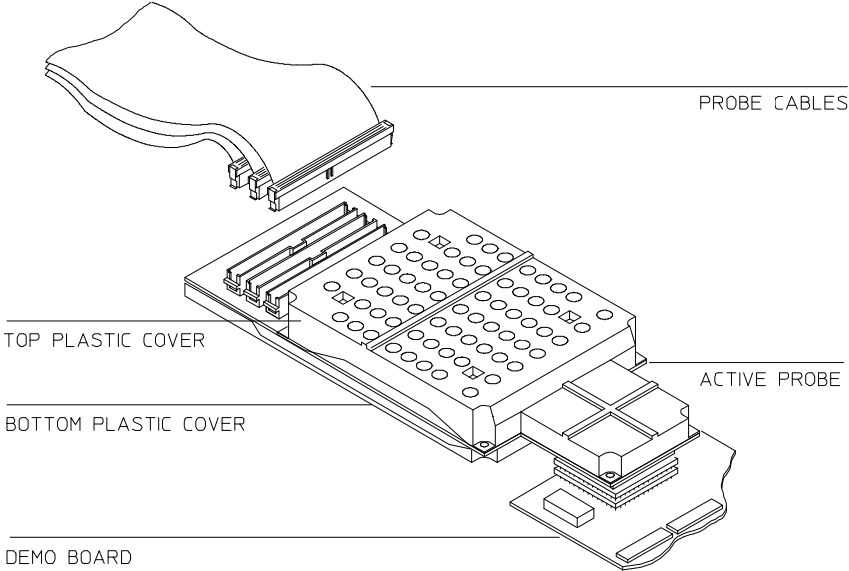

---

### Step 3. Install Boards into the HP 64700 Card Cage

---

**WARNING**

Before removing or installing parts in the HP 64700 Card Cage, make sure that the card cage power is off and that the power cord is disconnected.

---

**CAUTION**

Do NOT stand the HP 64700 Card Cage on the rear panel. You could damage the rear panel ports and connectors.

- 
- 1 Use a ground strap when removing or installing boards or memory modules into the HP 64700 Card Cage to reduce the risk of damage from static discharge. A jack on the rear panel of the HP 64700 Card Cage is provided for this purpose.

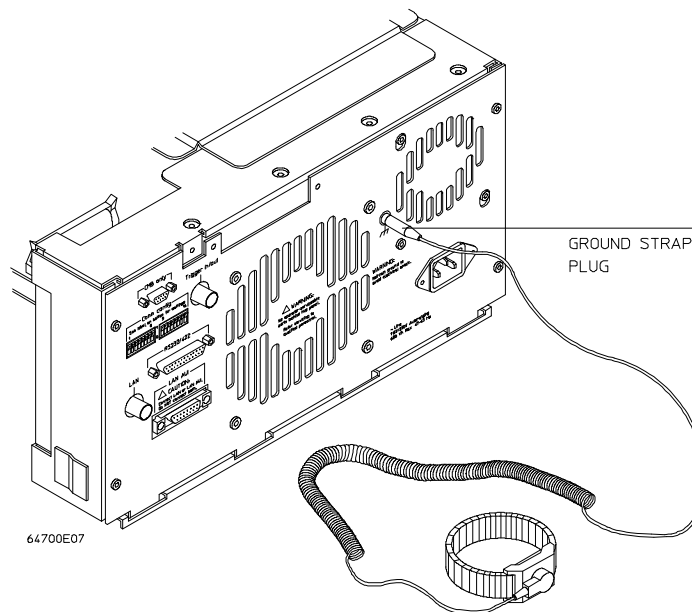

Chapter 18: Installation and Service  
**Installing Hardware**

**2** Turn the thumb screw and remove the top cover by sliding the cover toward the rear and up.

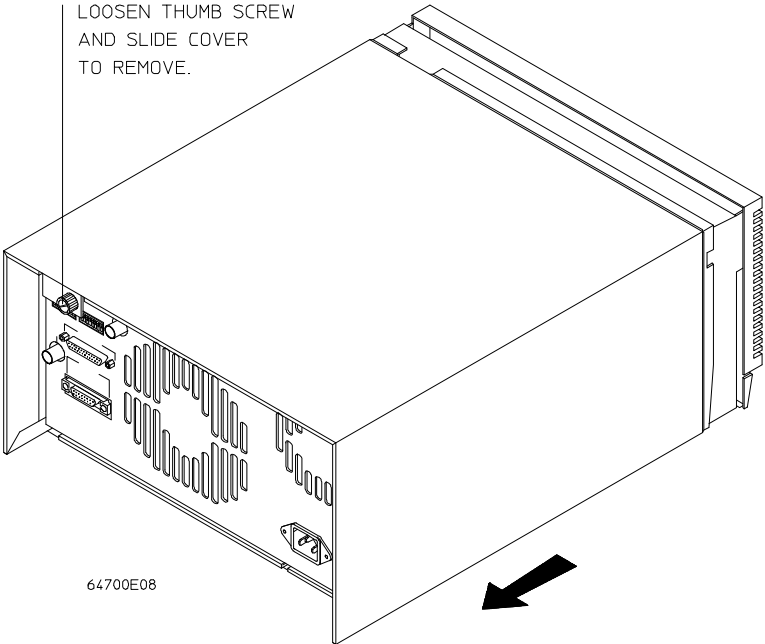

**3** Remove the side cover by unsnapping the two latches and lifting off.

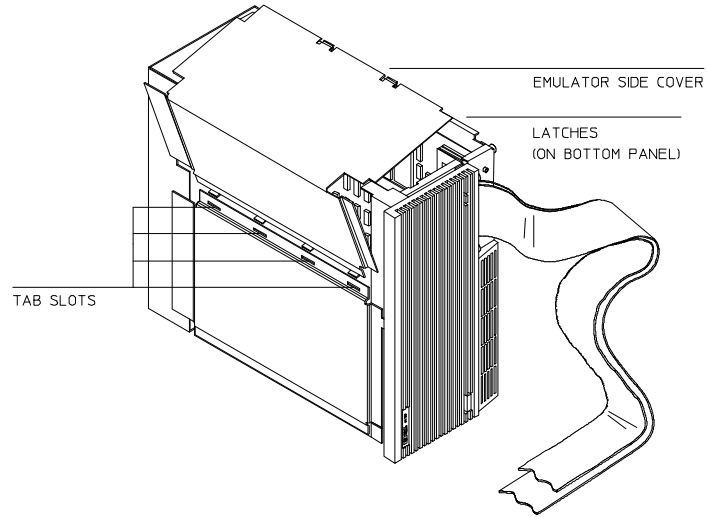

**4** Remove the card supports.

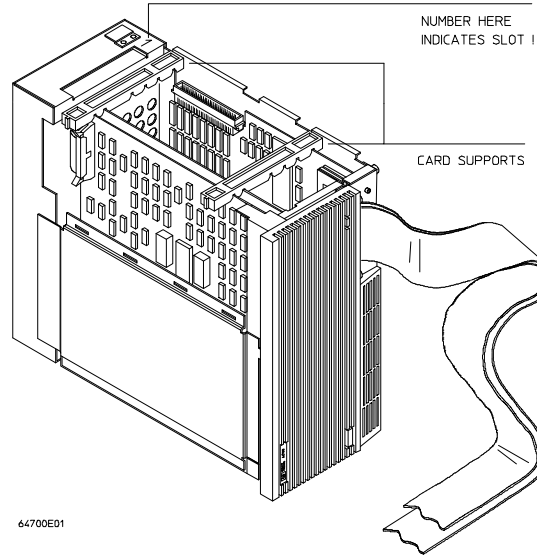

64700E01

Chapter 18: Installation and Service  
**Installing Hardware**

**5** First, completely loosen the four egress thumb screws.

To remove emulator cards, insert a flat blade screwdriver in the access hole and eject the emulator cards by rotating the screwdriver.

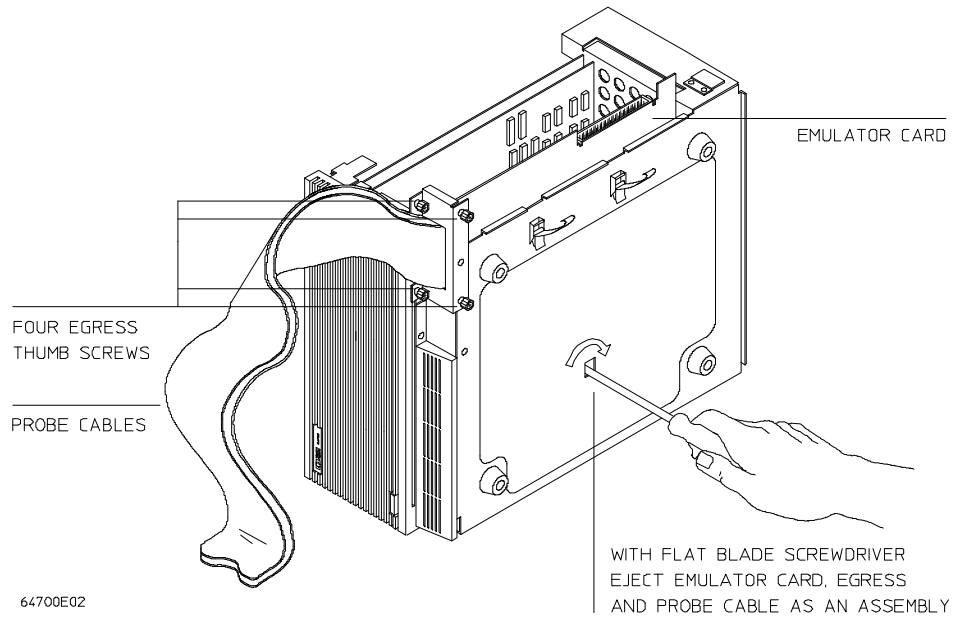



**6** Insert a screw driver into the third slot of the right side of the front bezel, push to release catch, and pull the right side of the bezel about one-half inch away from the front of the HP 64700. Then, do the same thing on the left side of the bezel. When both sides are released, pull the bezel toward you approximately 2 inches.

Be careful because the plastic ears are easily broken on the front bezel.

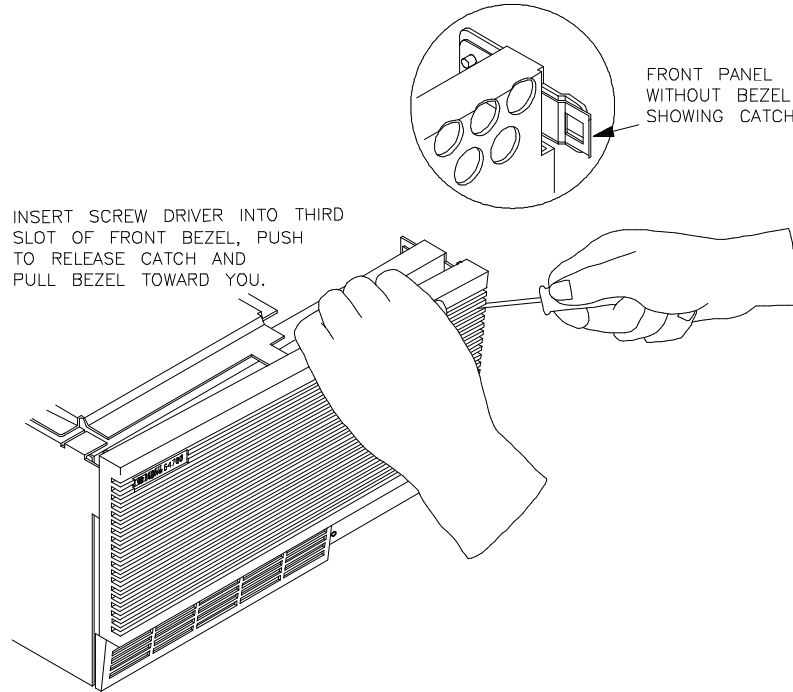

Chapter 18: Installation and Service  
**Installing Hardware**

**7** Lift the bezel panel to remove. Be careful not to put stress on the power switch extender.

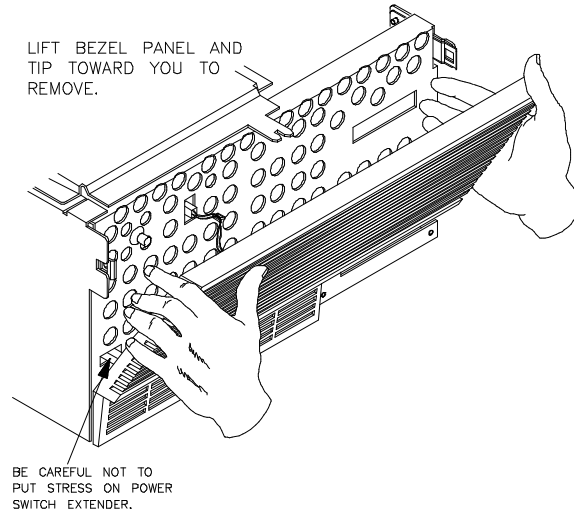

**8** If you're removing an existing analyzer card that provides external analysis, remove the right-angle adapter board by turning the thumb screws counterclockwise.

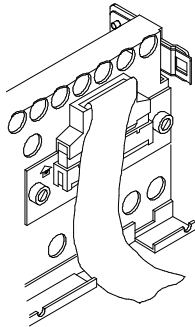

**9** To remove the analyzer card, insert a flat blade screwdriver in the access hole and eject the analyzer card by rotating the screwdriver.

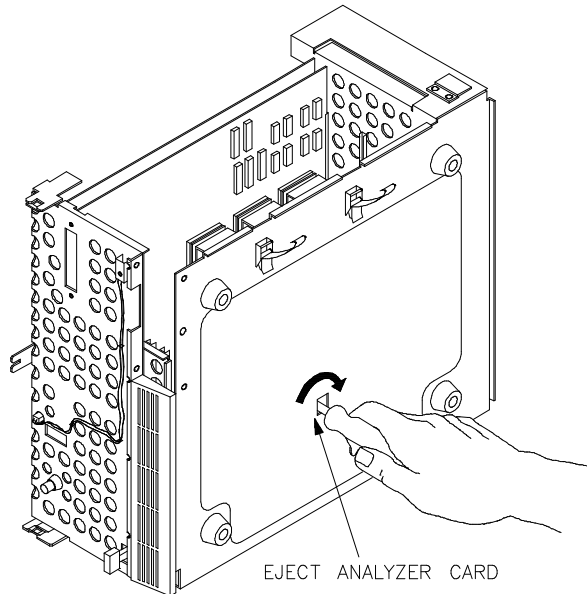

Do not remove the system control board. This board is used in all HP 64700 emulation and analysis systems.

Chapter 18: Installation and Service  
**Installing Hardware**

**10** Install the analyzer and emulation control cards. The analyzer is installed in the slot next to the system control card. The emulation control card is installed in the second slot from the bottom of the card cage. The software performance analyzer card may occupy any slot between the emulation-bus analyzer and the emulation control card. These cards are identified with labels that show their model numbers and serial numbers. Note that components on the analyzer card face the opposite direction to the other cards.

To install a card, insert it into the plastic guides. Make sure the connectors are properly aligned; then, press the card into the mother board socket. Ensure that each card is seated all the way into its socket. If the cards can be removed with your fingers, the cards are NOT seated all the way into the mother board sockets.

Attach the ribbon cable from the emulation control card to the analyzer card, and to the software performance analyzer, if installed. Tighten the thumbscrews that hold the emulation control card to the cardcage frame.

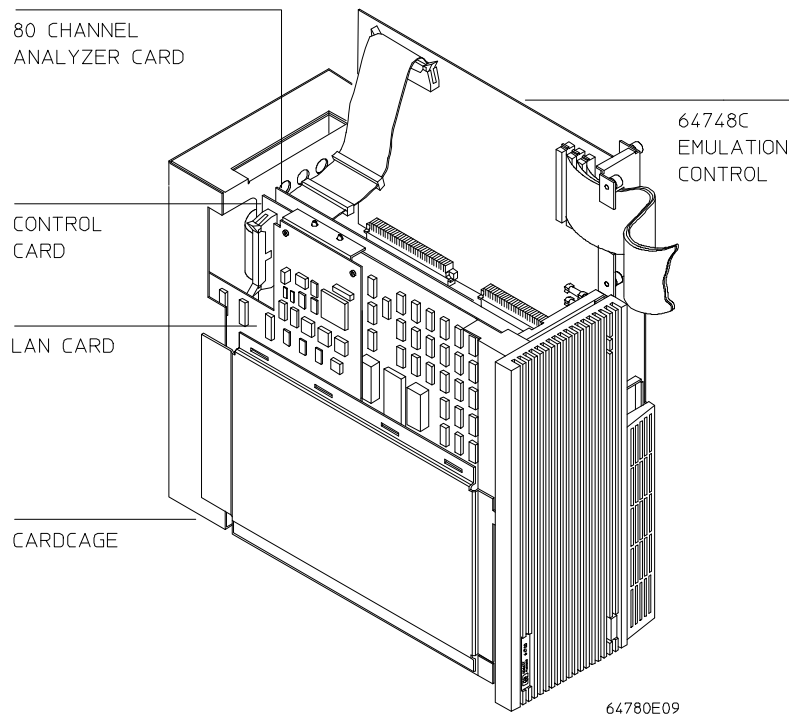

**11** Connect the +5 V power cable to the connector in the HP 64700 front panel.

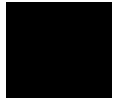
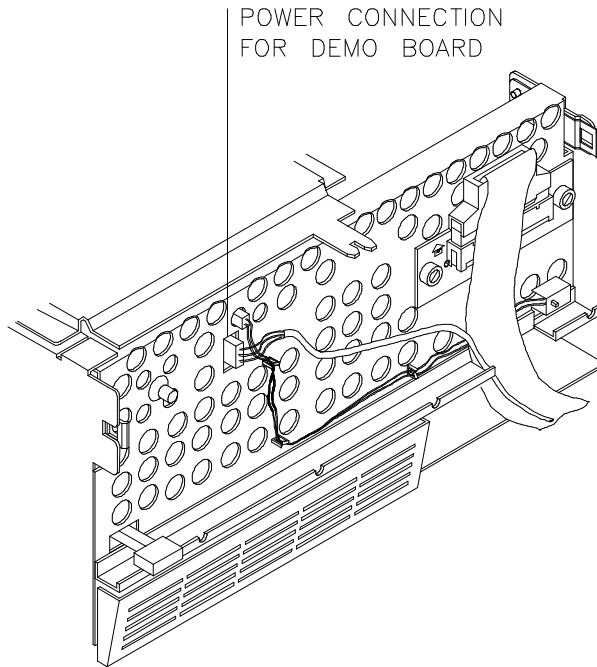

Chapter 18: Installation and Service  
**Installing Hardware**

**12** To reinstall the front bezel, be sure that the bottom rear groove of the front bezel is aligned with the lip as shown below.

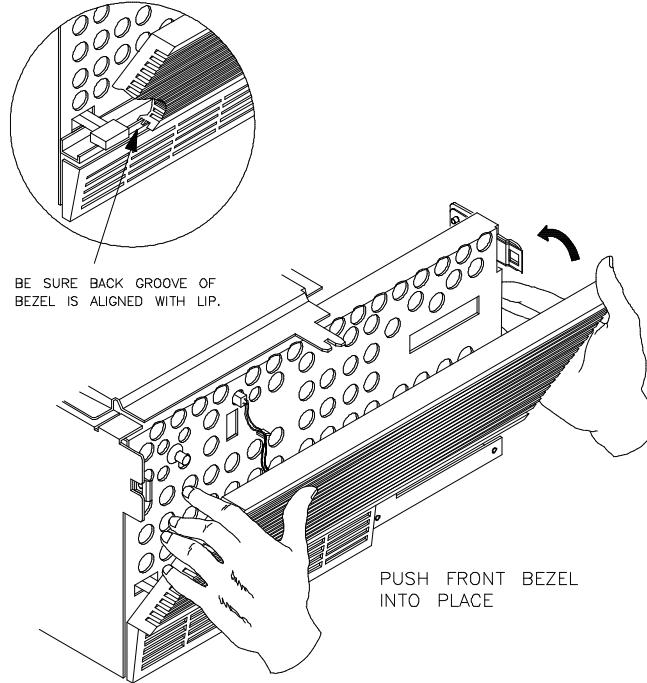

**13** This step applies only if your emulator is installed in an HP 64700A card cage. If you wish to install the flash card (used for updating firmware as described in Chapter 19), refer to the diagram two pages earlier in this chapter for locations of cards in the card cage. Install the flash card in any available slot between the 80-channel analyzer card and the HP 64748C control card in the card cage. Insert the flash card in the plastic guides. Make sure the connectors are properly aligned. Then press the card into the mother board sockets. Make sure the card is seated all the way into the sockets.

**14** Install the card supports.

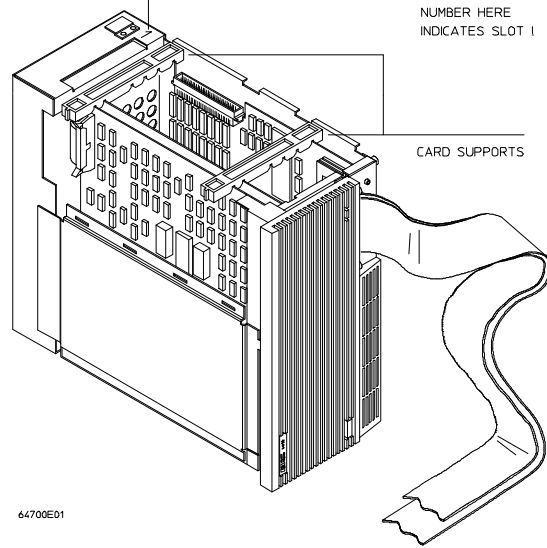

**15** To install the side cover, insert the side cover into the tab slots and fasten the two latches.

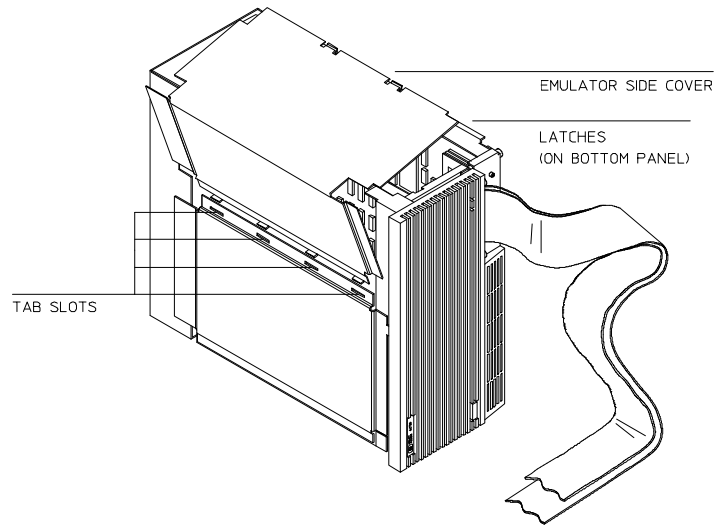

Chapter 18: Installation and Service  
**Installing Hardware**

**16** Install the top cover in reverse order of its removal, but make sure that the side panels of the top cover are attached to the side clips on the frame.

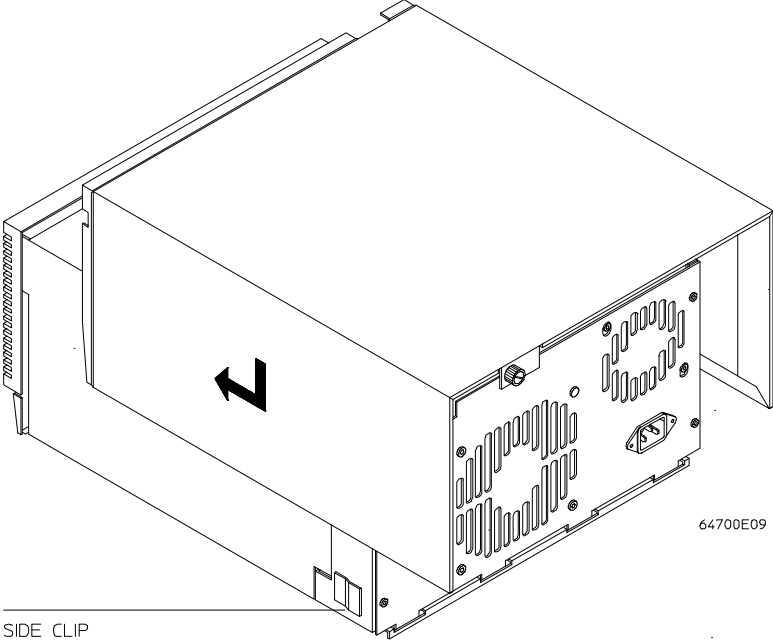



### Step 4. Install emulation memory modules on emulator probe (Observe antistatic precautions listed on the fifth page of this chapter)

1 Remove plastic rivets that secure the plastic cover on the top of the emulator probe, and remove the cover. The bottom cover is only removed when you need to replace a defective active probe on the exchange program.

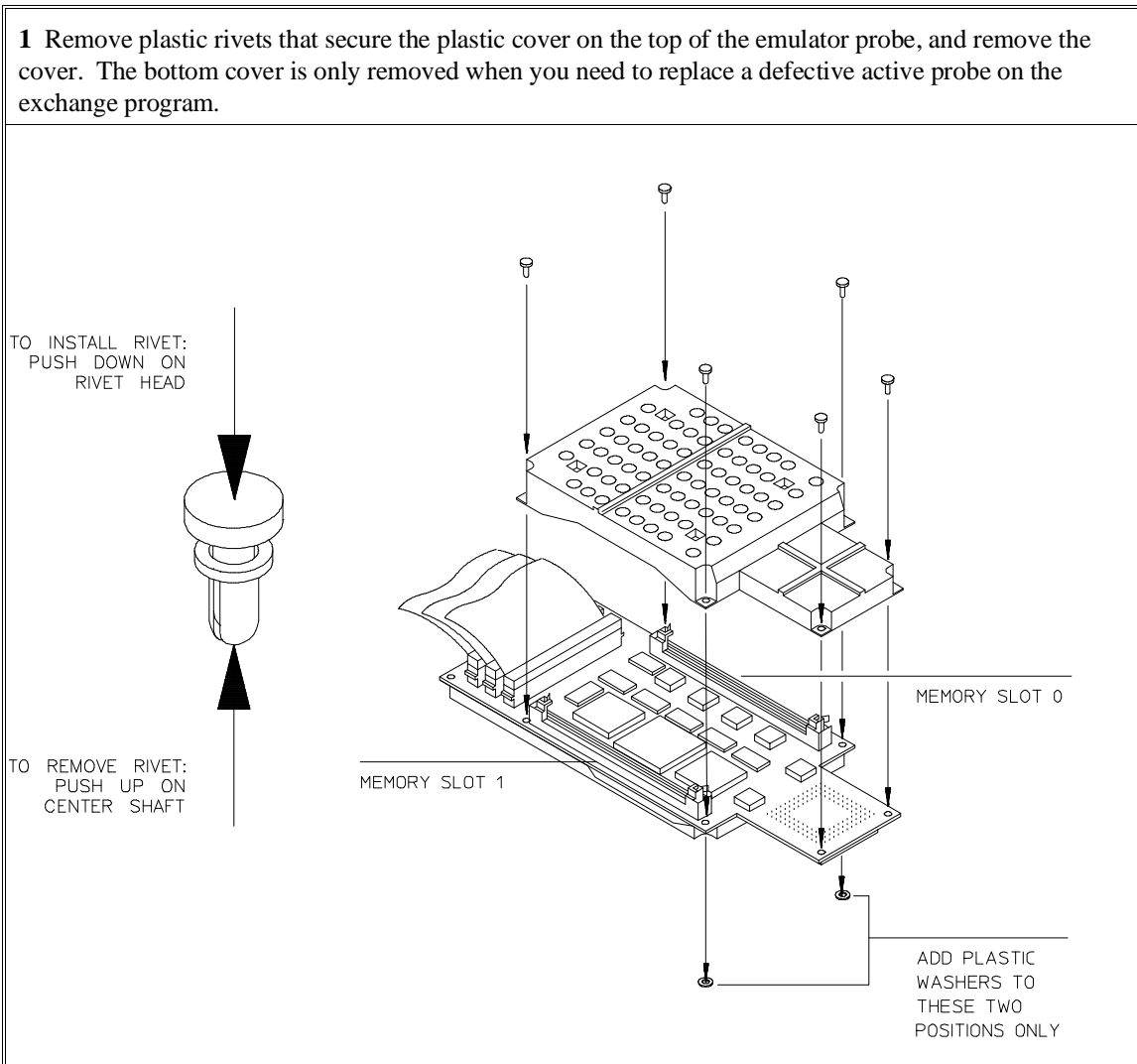

Chapter 18: Installation and Service  
**Installing Hardware**

**2** Determine the placement of the emulation memory modules. Three types of modules may be installed: 256 Kbyte (HP 64171A/64172A), 1 Mbyte (HP 64171B/64172B), and 4 Mbyte (HP 64173A). Any of these types of modules may be installed in either memory slot on the probe (except 64748A which cannot accept HP 64173A).

Memory in memory slot 0 is divided into four equal blocks that can be allocated by the memory mapper. Memory in memory slot 1 is divided into two equal blocks.

If you have only one emulation memory module, place it in memory slot 0.

If you have two memory modules of different sizes, place the memory module with the greatest capacity in memory slot 0 to take advantage of the way memory slot 0 and memory slot 1 are divided by the emulator. For example, if you install a 1-Mbyte module in memory slot 0 and a 256-Kbyte module in memory slot 1, then the emulator will provide four 256-Kbyte blocks of memory in memory slot 0 and two 128-Kbyte blocks of memory in memory slot 1.

**Observe antistatic precautions listed on the fifth page of this chapter**

**3** Install emulation memory modules on the emulator probe. There is a cutout at one end of the memory modules so they can only be installed the correct way.

To install a memory module:

- 1** Align the groove in the memory module with the alignment rib in the connector.
- 2** Align the cutout in the memory module with the projection in the connector.
- 3** Place the memory module into the connector groove at an angle.
- 4** Firmly press the memory module into the connector and make sure it is completely seated.
- 5** Rotate the memory module forward so that the pegs on the connector fit into the holes on the memory module.
- 6** Make sure the release tabs at each end of the connector snap around the memory module to hold it in place.

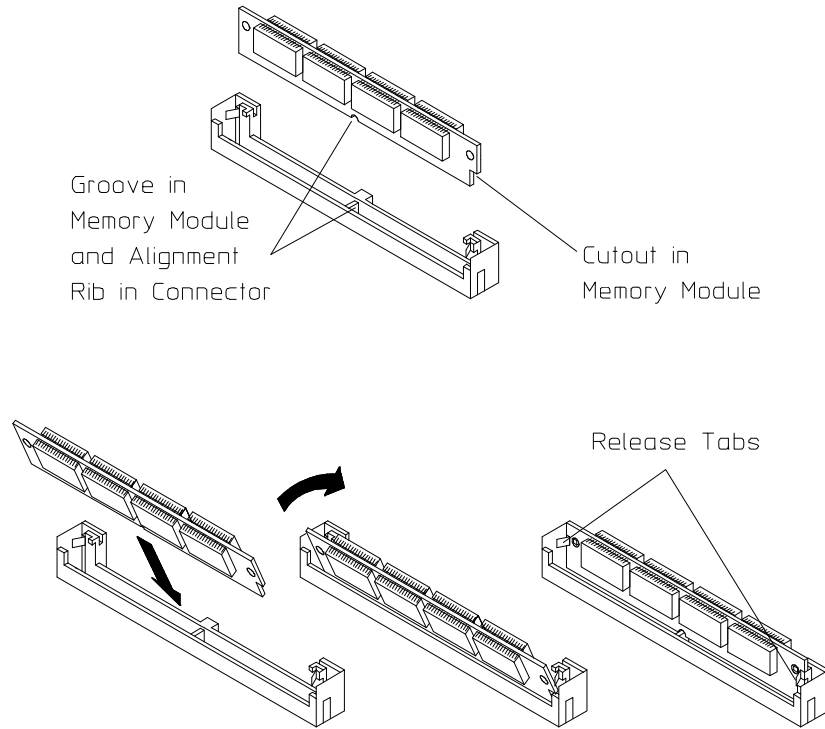

64794E03

Chapter 18: Installation and Service  
**Installing Hardware**

**4** Replace the plastic cover, and insert new plastic rivets (supplied with the emulator) to secure the cover.

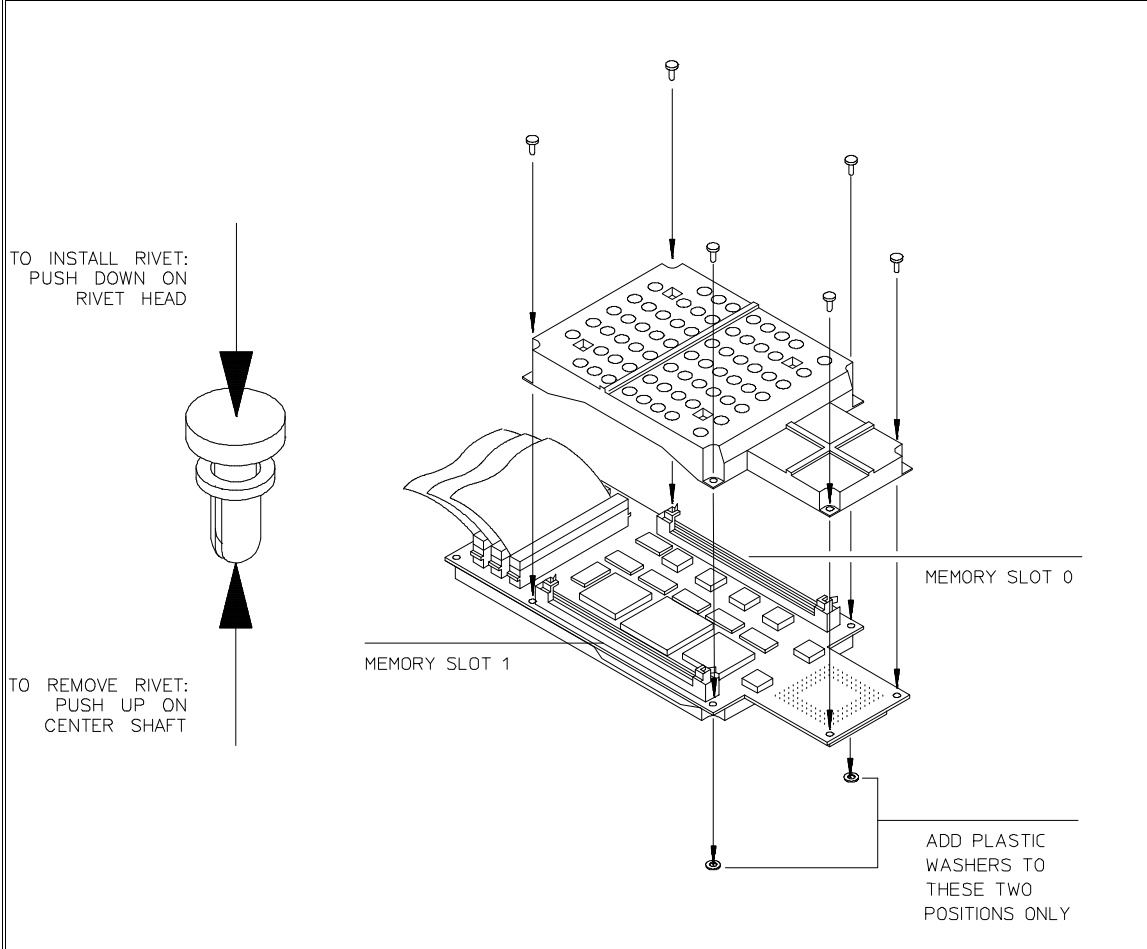

## Step 5. Connect the emulator probe to the demo target system

**1** With HP 64700 power OFF, connect the emulator probe to the demo target system. When you install the probe into the demo board, be careful not to bend any of the pins. The socket of the M68020 is keyed to prevent inserting the probe into the demo board socket incorrectly. There is no keying on the MC68030/EC030 so be very careful.

After connecting the probe to the demo board, set the TEST/OCE switches. Press each switch rocker down in the desired direction. Use the closed (CL) position for all switches when running performance verification tests (TEST), and use the open (OP) position for out-of-circuit emulation (OCE).

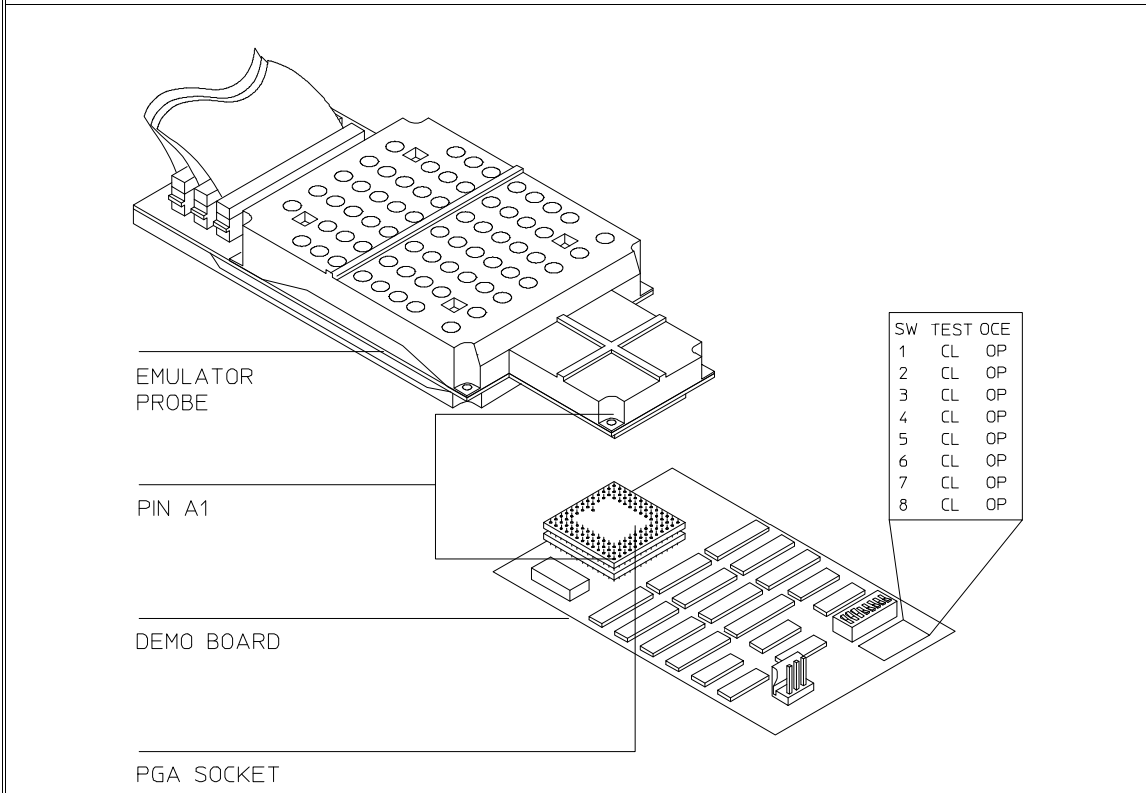

Chapter 18: Installation and Service  
**Installing Hardware**

**2** Connect the power supply wires from the emulator to the demo target system. The 3-wire cable has one power wire and two ground wires. **When attaching the 3-wire cable to the demo target system, make sure the connector is aligned properly so that all three pins are connected.**

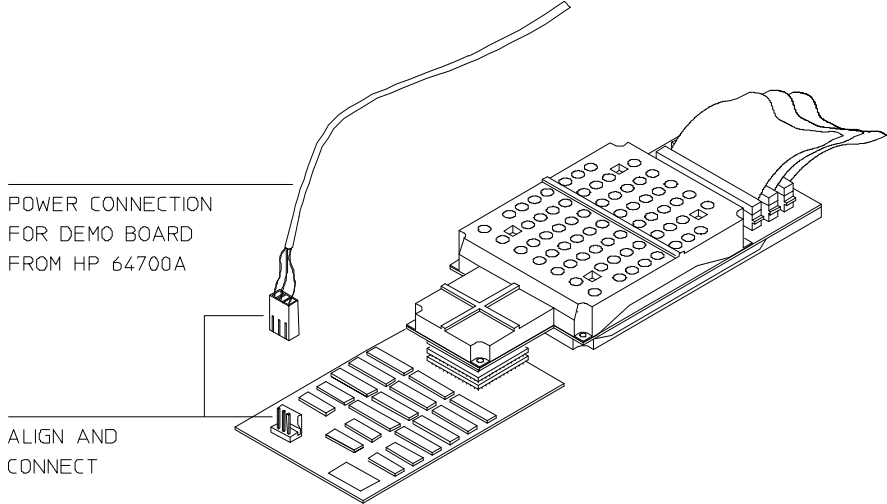

## Step 6. Apply power to the HP 64700

The HP 64700B automatically selects the 115 Vac or 220 Vac range. In the 115 Vac range, the HP 64700B will draw a maximum of 345 W and 520 VA. In the 220 Vac range, the HP 64700B will draw a maximum of 335 W and 600 VA.

If you have the emulator installed in an HP 64700A card cage, select the line voltage using a thumb-wheel switch inside the power control module on the rear panel of the card cage. The input frequency must be in the range of 48 to 66 Hz. At 115 VAC, the emulator will draw a maximum of 3.0 A. At 220 VAC, it will draw a maximum of 1.5 A.

The HP 64700 is shipped from the factory with a power cord appropriate for your country. You should verify that you have the correct power cable for installation.

If the cable you received is not appropriate for your electrical power outlet type, contact your Hewlett-Packard sales and service office.

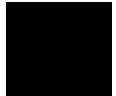

Chapter 18: Installation and Service  
**Installing Hardware**

**1** Connect the power cord and turn on the HP 64700.

The line switch is a pushbutton located at the lower, left-hand corner of the front panel. To turn ON power to the HP 64700, push the line switch button in to the ON (1) position. The power light at the lower, right-hand corner of the front panel will be illuminated.

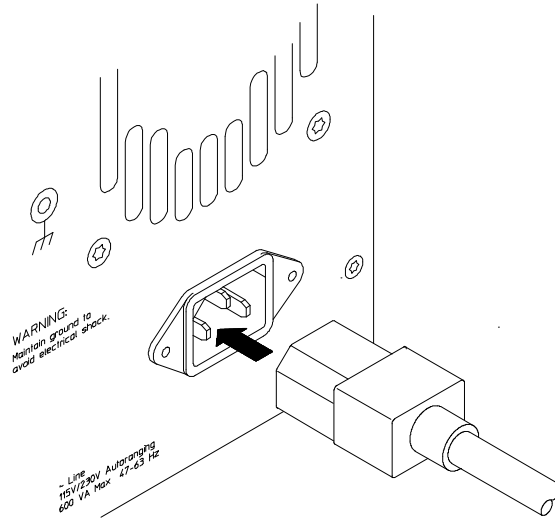



## **Connecting the HP 64700 to a Computer or LAN**

Refer to the *HP 64700 Series Installation/Service Guide* for instructions on connecting the HP 64700 to a host computer (via RS-422 or RS-232) or LAN and setting the HP 64700's configuration switches. (RS-422 and RS-232 are only supported on HP 9000 Series 300/400 machines.)

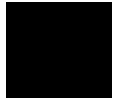

## Installing HP 9000 Software

This section shows you how to install the Graphical User Interface on HP 9000 workstations. Installation involves installing the interface and the 64700 Operating Environment. These instructions also tell you how to prevent installation of the Graphical User Interface if you want to use only the Softkey Interface.

This section shows you how to:

- 1 Install the software from the media.
- 2 Verify the software installation.
- 3 Start the X server and the Motif Window Manager (mwm), or start HP VUE.
- 4 Set the necessary environment variables.

---

### Step 1. Install the software from the media

During the installation process, you may make some choices about how much of the product software to load from the product media. As a general rule, you should load everything from the media because that ensures that you will not miss filesets and therefore have problems with the operation of the software. However, you may not need or want to install certain partitions or filesets from the product media when installing the Graphical User Interface. There are at least two reasons why that is so.

- If you were shipped the HP 64801 64000-UX Operating Environment instead of the HP B1471 64700 Operating Environment, you were shipped files that are not necessary to the operation of HP 64700 Series interface products. As of this writing, excluding these files will save you about 4.5 megabytes of disk space.
- You may not have the system performance necessary, or you may choose, for some other reason, not to use the Graphical User Interface and instead use the Softkey Interface. If that is the case, you should exclude the filesets that contain the Graphical User Interface because:
  - As of this writing, you will save about 3.5 megabytes of disk space.

- If you are using X Windows, the Graphical User Interface is the default interface. If you load the Graphical Interface, but do not use it, you will have to manually override it each time you begin an emulation session.

The following sub-steps assume that you may want to exclude partitions or filesets. Perform the following sub-steps to load the software on your system:

- 1 Become the root user on the system you want to update.
- 2 Make sure the tape's write-protect screw points to SAFE.
- 3 Put the product media into the tape drive that will be the *source device* for the update process.
- 4 Confirm that the tape drive BUSY and PROTECT lights are on. If the PROTECT light is not on, remove the tape and confirm the position of the write-protect screw. If the BUSY light is not on, check that the tape is installed correctly in the drive and that the drive is operating correctly.
- 5 When the BUSY light goes off and stays off, start the update program by entering  
**/etc/update**  
at the HP-UX prompt.
- 6 When the HP-UX update utility main screen appears, confirm that the source and destination devices are correct for your system. Refer to your HP-UX System Administrator documentation if you need to modify these values.
- 7 Select the choice on the update menu that allows you to view the product partitions.
- 8 If you see the partition named 64801 and described as "64000-UX Operating Environment", then you have the HP 64801 product. In this case, mark the 64801 partition with "n" to prevent loading this partition. Do this only if you have 64700 Series emulators and do not use "meas-sys".

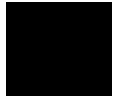

Chapter 18: Installation and Service  
**Installing HP 9000 Software**

- 9 Except for the emulator-specific partition and the 64700 Operating Environment partition, mark all other partitions with "y" to confirm that you want these partitions loaded. (Do not mark 64801 with "y" if you marked it with "n" in the last step.)

The emulator-specific partition will be named something like "<processor> Emulation Tools" where "<processor>" is the processor supported by the emulator.

- 10 If you plan to install and use the Graphical User Interface, do the following:

- Mark the emulator-specific partition and the 64700 Operating Environment partition with "y" to confirm the installation of these partitions.
- Skip to sub-step 12 of these instructions.

- 11 If you do not want to install the Graphical User Interface, do the following:

- View the filesets for the 64700 Operating Environment.
- Mark the fileset **64700XUI** with "n" to exclude it from installation.
- Mark all other filesets in the partition with "y" to confirm installation.
- Return to the partition screen.
- View the filesets in the emulator-specific partition (named something like <processor-type> Emulation Tools).
- Mark the fileset **647xxXUI** with "n" to exclude it from installation.
- Mark all other filesets in the partition with "y" to confirm installation.
- Return to the partition screen.

- 12 From the partition screen, choose the update utility softkey that starts the installation process.

## Step 2. Verify the software installation

A number of new filesets were installed on your system during the software installation process. This and following steps assume that you chose to load the Graphical User Interface filesets.

You can use this step to further verify that the filesets necessary to successfully start the Graphical User Interface have been loaded and that customize scripts have run correctly. Of course, the update process gives you mechanisms for verifying installation, but these checks can help to double-check the installation process.

- 1 Verify the existence of the **HP64\_Softkey** file in the **/usr/lib/X11/app-defaults** subdirectory by entering  
**ls /usr/lib/X11/app-defaults/HP64\_Softkey** at the HP-UX prompt.

Finding this file verifies that you loaded the correct fileset and also verifies that the customize scripts executed because this file is created from other files during the customize process.

- 2 Examine **/usr/lib/X11/app-defaults/HP64\_Softkey** near the end of the file to confirm that there are resources specific to your emulator.

Near the end of the file, there will be resource strings that contain references to specific emulators. For example, if you installed the Graphical User Interface for the 68020 emulator, resource name strings will have **m68020** embedded in them.

After you have verified the software installation, you must start the X server and an X window manager (if you are not currently running an X server). If you plan to run the Motif Window Manager (mwm), or similar window manager, continue with Step 3a of these instructions. If you plan to run HP VUE, skip to Step 3b of these instructions.

### Step 3a. Start the X server and the Motif Window Manager (mwm)

If you are not already running the X server and a window manager, do so now. The X server is required to use the Graphical User Interface because it is an X Windows application. A window manager is not required to execute the interface, but, as a practical matter, you must use some sort of window manager with the X server.

- Start the X server by entering **x11start** at the HP-UX prompt.

Consult the X Window documentation supplied with the HP-UX operating system documentation if you do not know about using X Windows and the X server. Chapter 13, "Using X Resources," also discusses X Windows and the X server.

After starting the X server and Motif Window Manager, continue with step 4 of these instructions.

---

### Step 3b. Start HP VUE

If you are running the X server under HP VUE and have not started HP VUE, do so now.

HP VUE is a window manager for the X Window system. The X server is executing underneath HP VUE. Unlike the Motif Window Manager, HP VUE provides a login shell and is your default interface to the HP 9000 workstation.

HP VUE differs slightly from other window managers in that it does not read your *.Xdefaults* file to find resources you may want to customize. Instead, it uses resources from the X resource database. In order to customize resources for the Graphical User Interface under HP VUE therefore, you must either merge a file of customized resources with the X resource database, or set an environment variable that causes the X resource manager to read a file of customized resources. For ease of use, choose the *.Xdefaults* file as your merge file.

- To merge the file *.Xdefaults* with the X resource database, enter

**xrdb -merge .Xdefaults**

at the HP-UX prompt.

Customized resources will be merged with the X resource database and will be available for retrieval by the Graphical User Interface.

- To enable the Graphical User Interface to find the *.Xdefaults* file directly, enter the following commands:

**XENVIRONMENT=\$HOME/.Xdefaults**

**export XENVIRONMENT**

The Graphical User Interface will be able to find and read the file in order to retrieve customized resources.

---

## **Step 4. Set the necessary environment variables**

The DISPLAY environment variable must be set before the Graphical User Interface will start. Also, you should modify the PATH environment variable to include the "/usr/hp64000/bin" directory, and, if you have installed software in a directory other than "/", you need to set the HP64000 environment variable.

The following instructions show you how to set these variables at the UNIX prompt. Modify your ".profile" or ".login" file if you wish these environment variables to be set when you log in. The following instructions also assume that you're using "sh" or "ksh"; if you're using "csh", environment variables are set using the "setenv <VARIABLE> <value>" command.

- 1 Set the DISPLAY environment variable by entering

**DISPLAY=<hostname>:<server\_number>.<screen\_number>**  
**export DISPLAY**

For example:

**DISPLAY=myhost:0.0; export DISPLAY**

## Chapter 18: Installation and Service

### Installing HP 9000 Software

Consult the X Window documentation supplied with the UNIX system documentation for an explanation of the DISPLAY environment variable.

- 2 Set the HP64000 environment variable.

For example, if you installed the HP 64000 software relative to the root directory, "/", you would enter

```
HP64000=/usr/hp64000; export HP64000
```

If you installed the software relative to a directory other than the root directory, it is strongly recommended that you use a symbolic link to make the software appear to be under /usr/hp64000. For example, if you installed the software relative to directory /users/team, you would enter

```
ln -s /users/team/usr/hp64000 /usr/hp64000
```

If you do not wish to establish a symbolic link, you can set the HP64000 variable to the full path that contains the HP 64000 software. Again, if you installed relative to /users/team, you would enter

```
HP64000=/users/team/usr/hp64000; export HP64000
```

- 3 Set the PATH environment variable to include the **usr/hp64000/bin** directory by entering

```
PATH=$PATH:$HP64000/bin; export PATH
```

Including **usr/hp64000/bin** in your PATH relieves you from prefixing HP 64700 executables with the directory path.

- 4 Set the MANPATH environment variable to include the **usr/hp64000/man** and **usr/hp64000/contrib/man** directories by entering

```
MANPATH=$MANPATH:$HP64000/man:$HP64000/contrib/man  
export MANPATH
```

Including these directories in your MANPATH variable lets you access the on-line "man" page information included with the software.



## Installing Sun SPARCsystem Software

This section shows you how to install the Graphical User Interface on Sun SPARCsystem workstations. Installation involves installing the interface and the 64700 Operating Environment. These instructions also tell you how to prevent installation of the Graphical User Interface if you want to use only the Softkey Interface.

This section shows you how to:

- 1 Install the software from the media.
- 2 Start the X server and OpenWindows.
- 3 Set the necessary environment variables.
- 4 Verify the software installation.
- 5 Map your function keys.

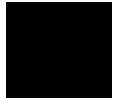

---

### Step 1. Install the software from the media

The tape that contains the Graphical User Interface software may contain several products. Usually, you will want to install all of the products on the tape. However, to save disk space, or for other reasons, you can choose to install selected filesets.

If you plan to use the Softkey Interface instead of the Graphical User Interface, you can save about 3.5 megabytes of disk space by not installing the filesets suffixed "XUI". (Also, if you choose not to install the Graphical User Interface, you will not have to use a special command line option to start the Softkey Interface.)

Refer to the *Software Installation Notice* for software installation instructions. After you are done installing the software, return here.

## Step 2. Start the X server and OpenWindows

If you are not already running the X server, do so now. The X server is required to run the Graphical User Interface because it is an X application.

- Start the X server by entering `/usr/openwin/bin/openwin` at the UNIX prompt.

Consult the OpenWindows documentation if you do not know about using OpenWindows and the X server.

---

## Step 3. Set the necessary environment variables

The DISPLAY environment variable must be set before the Graphical User Interface will start. Also, you should modify the PATH environment variable to include the `usr/hp64000/bin` directory, and, if you have installed software in a directory other than `/`, you need to set the HP64000 environment variable.

The following instructions show you how to set these variables at the UNIX prompt. Modify your `.profile` or `.login` file if you wish these environment variables to be set when you log in. The following instructions also assume that you're using `csh`; if you're using `sh`, environment variables are set in the `"<VARIABLE>=<value>; export <VARIABLE>"` form.

- 1 The DISPLAY environment variable is usually set by the `openwin` startup script. Check to see that DISPLAY is set by entering

```
echo $DISPLAY
```

If DISPLAY is not set, you can set it by entering

```
setenv DISPLAY=<hostname>:<server_number>.<screen_number>
```

For example:

```
setenv DISPLAY=myhost:0.0
```

Consult the OpenWindows documentation for an explanation of the DISPLAY environment variable.

**2** Set the HP64000 environment variable.

For example, if you installed the HP 64000 software relative to the root directory, "/", you would enter

```
setenv HP64000 /usr/hp64000
```

If you installed the software relative to a directory other than the root directory, it is strongly recommended that you use a symbolic link to make the software appear to be under /usr/hp64000. For example, if you installed the software relative to directory /users/team, you would enter

```
ln -s /users/team/usr/hp64000 /usr/hp64000
```

If you do not wish to establish a symbolic link, you can set the HP64000 variable to the full path that contains the HP 64000 software; also set the LD\_LIBRARY\_PATH variable to the directory containing run-time libraries used by the HP 64000 products. Again, if you installed relative to /users/team, you would enter

```
setenv HP64000 /users/team/usr/hp64000  
setenv LD_LIBRARY_PATH ${LD_LIBRARY_PATH}:${HP64000}/lib
```

**3** Set the PATH environment variable to include the **usr/hp64000/bin** directory by entering

```
setenv PATH ${PATH}:${HP64000}/bin
```

Including **usr/hp64000/bin** in your PATH relieves you from prefixing HP 64700 executables with the directory path.

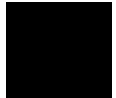

- 4 Set the MANPATH environment variable to include the **usr/hp64000/man** and **usr/hp64000/contrib/man** directories by entering

```
setenv MANPATH ${MANPATH}:${HP64000}/man
setenv MANPATH ${MANPATH}:${HP64000}/contrib/man
```

Including these directories in your MANPATH variable lets you access the on-line "man" page information included with the software.

- 5 If the Graphical User Interface is to run on a SPARCsystem computer that is not running OpenWindows, include the **/usr/openwin/lib** directory in **LD\_LIBRARY\_PATH**.

```
setenv LD_LIBRARY_PATH ${LD_LIBRARY_PATH}:/usr/openwin/lib
```

---

## Step 4. Verify the software installation

A number of product filesets were installed on your system during the software installation process. Due to the complexity of installing on NFS mounted file systems, a script that verifies and customizes these products was also installed. This stand-alone script may be run at any time to verify that all files required by the products are in place in the file system. If required files are not found, this script will attempt to symbolically link them from the \$HP64000 install directory to their proper locations.

- Run the script **\$HP64000/bin/envinstall**.

## Step 5. Map your function keys

If you are using the Softkey Interface, map your function keys by following the steps below.

- 1 Copy the function key definitions by typing:

```
cp $HP64000/etc/ttyswrc ~/.ttyswrc
```

This creates key mappings in the .ttyswrc file in your \$HOME directory.

- 2 Remove or comment out the following line from your .xinitrc file:

```
xmodmap -e 'keysym F1 = Help'
```

If any of the other keys F1-F8 are remapped using xmodmap, comment out those lines also.

- 3 Add the following to your .profile or .login file:

```
stty erase ^H
setenv KEYMAP sun
TERMINFO=/usr/hp64000/lib/terminfo
export TERMINFO
```

The erase character needs to be set to backspace so that the Delete key can be used for "delete character."

If you want to continue using the F1 key for HELP, you can use F2-F9 for the Softkey Interface. All you have to do is set the KEYMAP variable. If you use OpenWindows, type:

```
setenv KEYMAP sun.2-9
```

If you use xterm windows (the xterm window program is located in the directory /usr/openwin/demo), type:

```
setenv KEYMAP xterm.2-9
```

Reminder: If you are using OpenWindows, add /usr/openwin/bin to the end of the \$PATH definition, and add the following line to your .profile:

```
setenv OPENWINHOME /usr/openwin
```

After you have mapped your function keys, you must start the X server and an X window manager (if you are not currently running an X server).

---

## Step 6. Restart the window system

- 1 Exit the window system you are using.
  - If you are using SunView windows, use the Exit SunView menu item.
  - If you are using Open Windows, use the Exit item in the Workspace menu.
- 2 Start your window system again.
  - To restart SunView windows, type: sunview
  - To restart Open Windows windows, type: openwin

The new function key settings are now active

---

## Step 7. Run the interface in a window

Here are two ways to start the interface:

- In an OpenWindows or SunView shelltool window, type:  
emul700 <logical\_name>
- If you are running OpenWindows, you can use the installed script to open an xterm window:

```
$ /usr/hp64000/bin/hp64term
```

Then in the new window, type:

```
$ emul700 <logical_name>
```

## Verifying the Installation

This section shows you how to:

- Determine the logical name of your emulator.
- Start the emulator/analyzer interface for the first time.
- Step through the demo by using the action keys.
- Exit the emulator/analyzer interface.
- Run performance verification.

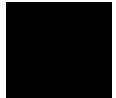

---

### Step 1. Determine the logical name of your emulator

The *logical name* of an emulator is a label associated with a set of communications parameters in the **\$HP64000/etc/64700tab.net** file. The 64700tab.net file is placed in the directory as part of the installation process.

- 1 Display the 64700tab.net file by entering **more /usr/hp64700/etc/64700tab.net** at the HP-UX prompt.
- 2 Page through the file until you find the emulator you are going to use.

This step will require some matching of information to an emulator, but it should not be difficult to determine which emulator you want to address.

---

#### Examples

A typical entry for a 68020 emulator connected to the LAN would appear as follows:

```
#-----  
# Channel | Logical   | Processor | Remainder of Information for the Channel  
# Type   | Name     | Type     | (IP address for LAN connections)  
#-----  
lan:    em68020  m68020    21.17.9.143
```

## Chapter 18: Installation and Service

### Verifying the Installation

A typical entry for a 68030 emulator connected to an RS-422 port would appear as follows:

```
#-----#
# Channel | Logical | Processor | Host | Physical | Xpar | Parity | Flow | Stop | Char |
# Type   | Name   | Type     | Name | Device   | Mode |        |      | Bits | Size |
#       |       |         |     |         |     |        |     |     |     |
#-----#
serial:  em68030   m68030   myhost /dev/emcom23 OFF  NONE  RTS   2    8
```

### Step 2. Start the interface with the **emul700** command

The **emul700** software is part of the HP 64700 Operating Environment software you installed during the update process.

- 1 Apply power to the emulator you wish to access after making sure the emulator is connected to the LAN or to your host system.

On the HP 64700 Series Emulator, the power switch is located on the front panel near the bottom edge. Push the switch in to turn power on to the emulator.

- 2 Wait a few seconds to allow the emulator to complete its startup initialization.
- 3 Choose a terminal window from which to start the Graphical User Interface.



- 4 Start the Graphical User Interface by entering the **emul700** command and giving the logical name of the emulator as an argument to the command, as in

```
$HP64000/bin/emul700 <logical_name> &
```

or

```
emul700 <logical name> &
```

if **\$HP64000/bin** is in your path.

If you are running the X server, if the Graphical User Interface is installed, and if your DISPLAY environment variable is set, the **emul700** command will start the Graphical User Interface. Otherwise, **emul700** starts the Softkey Interface.

You should include an ampersand ("&") with the command to start the Graphical User Interface as a background process. Doing this frees the terminal window where you started the interface so that the window may still be used.

- 5 Optionally start additional Graphical User Interface windows into the same emulation session by repeating the previous step.

You can also choose to use the Softkey Interface under X Windows, but you must include a command line argument to **emul700** to override the default Graphical User Interface. Start the Softkey Interface by entering

```
emul700 -u skemul <logical name>.
```

---

### Example

Suppose you have discovered that the logical name for a 68030 emulator connected to the LAN is "m68030". To start the Graphical User Interface and begin communicating with that emulator, enter (assuming your \$PATH includes **\$HP64000/bin**)

```
emul700 m68030
```

After a few seconds, the Graphical User Interface Emulator/Analyzer window should appear on your screen. The window will be similar to the following:

Chapter 18: Installation and Service  
**Verifying the Installation**

|   |         |               |                  |             |          |             |           |              |       |      |       |      |         |        |       |     |           |
|---|---------|---------------|------------------|-------------|----------|-------------|-----------|--------------|-------|------|-------|------|---------|--------|-------|-----|-----------|
| Hewlett Packard Emulator/Analyzer: m68030 (m68030)  |         |               |                  |             |          |             |           |              |       |      |       |      |         |        |       |     |           |
| File  | Display | Modify        | Execution        | Breakpoints | Trace    | Settings    | Help      |              |       |      |       |      |         |        |       |     |           |
| Action keys:  |         | < Demo >      | Disp Src ( )     | Trace ( )   | Run      | Step Source |           |              |       |      |       |      |         |        |       |     |           |
| < Your Key >  | Make    | Disp Src Prev | Run Xfer til ( ) | Break       | Step Asm |             |           |              |       |      |       |      |         |        |       |     |           |
| ( ):  | main    |               |                  |             |          |             | Recall    |              |       |      |       |      |         |        |       |     |           |
| <p>HPB1479-19312 C.05.01 23Jul92 Unreleased<br/>         68030/68EC030 GRAPHICAL USER INTERFACE</p> <p>A Hewlett-Packard Software Product<br/>         Copyright Hewlett-Packard Co. 1991</p> <p>All Rights Reserved. Reproduction, adaptation, or translation without prior<br/>         written permission is prohibited, except as allowed under copyright laws.</p> <p>RESTRICTED RIGHTS LEGEND</p> <p>Use, duplication, or disclosure by the Government is subject to<br/>         restrictions as set forth in subparagraph (c) (1) (II) of the Rights<br/>         in Technical Data and Computer Software clause at DFARS 52.227-7013.<br/>         HEWLETT-PACKARD Company, 3000 Hanover St., Palo Alto, CA 94304-1181</p> |         |               |                  |             |          |             |           |              |       |      |       |      |         |        |       |     |           |
| STATUS: M68EC030--Running in monitor  |         |               |                  |             |          |             |           |              |       |      |       |      |         |        |       |     |           |
| <table border="1"> <tr> <td>run</td> <td>trace</td> <td>step</td> <td>display</td> <td>modify</td> <td>break</td> <td>end</td> <td>---ETC---</td> </tr> </table>  |         |               |                  |             |          |             |           |              |       | run  | trace | step | display | modify | break | end | ---ETC--- |
| run   | trace   | step          | display          | modify      | break    | end         | ---ETC--- |              |       |      |       |      |         |        |       |     |           |
| Command:  |         | Return        | Recall           | Cursor:     |          | Backup      | Forward   | Clear to end | Clear | Help |       |      |         |        |       |     |           |

### Step 3. Step through the demo with the Action Keys

Action keys are unique to the Graphical User Interface. When you first install and start the interface, a set of default Action Keys will be present. These Action Keys will let you load and start the emulator and run the demo program supplied with the interface. Doing so will help you familiarize yourself with the Graphical User Interface.

- Click on the <Demo> Action Key. A window of instructions will appear, telling you how to set up and run the demo program. Step through the demo program by clicking the Action Keys from left to right and top to bottom.

After you have seen some of the capabilities by stepping through the demo, try the various menus, work with the command line, and read some on-line help topics. What you do is not important; it is important to begin getting comfortable with the interface.

---

### Step 4. Exit the Graphical User Interface

After you have experimented with the interface, you can exit the session, or continue on to other chapters and try some of the commands given. Chapters following the Getting Started chapter give you instructions for performing various tasks with the interface; you do not have to work through them from front to back. Skip around to topics that interest you.

If, instead, you want to exit the interface now, do the following:

- 1 Position the mouse pointer over the pulldown menu named "File" on the menu bar at the top of the interface screen.
- 2 Press and hold the *command select* mouse button until the File menu appears.
- 3 While continuing to hold the mouse button down, move the mouse pointer down the menu to the "Exit" menu item.

- 4 Display the Exit cascade menu by moving the mouse pointer to the right edge of the Exit menu choice. There is an arrow on the right edge of the menu item.
- 5 Choose "Released" from the cascade menu.

The interface will terminate and release the emulator for use by others.

---

## **Step 5. Verify the performance of the emulator**

- 1 If you have a special configuration or session in progress, save it now. This procedure will cause your session to be lost.
- 2 Turn off power to the HP 64700 Card Cage.
- 3 Plug the emulator probe into the Demo Board if it is not already there.
- 4 Connect Demo Board power cable from the Demo Board to the HP 64700 Card Cage front panel. (See the section on installing hardware in this chapter.)
- 5 Set all switches on the Demo Board to the TEST (CL - closed) position.
- 6 Turn on power to the HP 64700 Card Cage.
- 7 Establish communication with the emulator from your host, and use the Softkey User Interface or Graphical User Interface.
- 8 On the command line, enter: **display pod\_command** <return>.
- 9 On the command line, enter: **pod\_command "pv 1"** <return>.

Don't be alarmed if you notice an error message, such as: "I/O error; power down detected." If using the Graphical User Interface, the message, "Fatal System Error End Release System?" will also appear. These are normal conditions. The performance verification tests will be complete, and you can read the results of the tests on screen.

Here's what caused the fatal error. To check the emulator status, your interface constantly polls the emulator in the card cage. The last step in the performance verification procedure reinitializes the card cage with the power down option. During initialization, the card cage is unable to communicate with your interface. When the polling signals of the interface are unanswered, the interface assumes communication has been lost between it and the card cage. Then the interface reports the fatal error, but no harm has been done. You must "end\_release\_system" in the Softkey User Interface, or click on OK in the Fatal System Error box in the Graphical User Interface.

If you are using a LAN, there is another way to run performance verification without the loss of communication between the interface and the emulator hardware. It uses the telnet capability and the Terminal Interface:

- 1 From your host computer, enter the command: **telnet <emulator\_name>**.
- 2 Now enter the command: **pv 1**
- 3 When your performance verification test is complete, use the keyboard **<CTRL>d** keys to end the emulation session.

---

### Examples

Start the performance verification test routines from the Softkey User Interface with the commands:

*display pod\_command*

*pod\_command "pv <N>"*

where <N> is an integer that specifies the number of times to run the set of performance verification tests. It is sometimes necessary to enter the pod command **tcf -e** before running performance verification.

A message similar to the following should appear:

```
Testing: HP 64748 Motorola 68020 Emulator
PASSED:
Number of tests: 1          Number of failures: 0
Testing: HP 64740 Emulation Analyzer
PASSED:
Number of tests: 1          Number of failures: 0
```

```
Copyright (c) Hewlett-Packard Co. 1987
All Rights Reserved.  Reproduction, adaptation, or translation
without prior
written permission is prohibited, except as allowed under copyright
laws.
```

```
HP64700B Series Emulation System
```

## Chapter 18: Installation and Service

### Verifying the Installation

```
Version:    B.01.00 20Dec93
Location:   Flash
System RAM:1 Mbyte
HP64748 Motorola 68020 Emulator
HP64740 Emulator Analyzer
```

If you have an emulation failure, you can replace the assembly that failed through your local Hewlett-Packard representative, and through the Support Materials Organization (SMO). Refer to the list of replaceable parts at the end of this chapter.

### What is pv doing to the Emulator?

The performance verification procedures provide a thorough check of the functionality of all of the products installed in the HP 64700 Card Cage. The Test Suite for the HP 64747/48 Emulator consists of the following modules.

| Test # | Function Test Name          |
|--------|-----------------------------|
| 0      | Host Tests                  |
| 1      | Reset Release Tests         |
| 2      | Transition Tests            |
| 3      | Dual Port Access Tests      |
| 4      | Emulation Memory Banks Test |
| 5      | Analysis Interface          |
| 6      | Demo Board                  |

### Troubleshooting

The test results for all of these modules are indicated by a simple PASS/FAIL message. The PASS message gives a high level of confidence that all major functions and signals are operating because it includes a loopback test that includes read and write tests to the demo board. The demo board also stimulates inputs to the emulator, including interrupt lines BR, BERR, etc.

A FAIL message on the other hand indicates that one or more of the tested functions is NOT working. In this event, an HP field representative can either swap assemblies to isolate the failure to an individual board, or replace all the major assemblies shown in the replaceable parts list. The emulation memory modules and plastic cover are not part of the probe assembly. The emulation memory modules must be ordered separately and the plastic covers should be removed from the probe assembly before replacing the probe assembly.

**Parts List**

| <b>Main Assembly</b>                    | <b>New</b>  | <b>Exchange</b> |
|---|-------------|-----------------|
| <b>Component Part</b>                   |             |                 |
| HP 64747A Probe and Demo Board          |             |                 |
| FG Monitor Floppy                       | 64747-18003 |                 |
| MC68030 Probe assembly                  | 64747-62107 | 64747-69507     |
| HP 64747A/B Demo Board                  | 64747-66506 |                 |
| HP 64747B Probe and Demo Board          |             |                 |
| FG Monitor Floppy                       | 64747-18004 |                 |
| MC68030 Probe assembly                  | 64747-66509 | 64747-69509     |
| HP 64747A/B Demo Board                  | 64747-66506 |                 |
| Top Plastic Cover                       | 64747-04101 |                 |
| Bottom Plastic Cover                    | 64747-04102 |                 |
| HP 64748A/D Probe and Demo Board        |             |                 |
| FG Monitor Floppy                       | 64748-18002 |                 |
| MC68020 Probe assembly                  | 64748-62101 | 64748-69101     |
| HP 64748 Demo Board                     | 64748-66510 |                 |
| Top Plastic Cover                       | 64748-04101 |                 |
| Bottom Plastic Cover                    | 64748-04102 |                 |
| Probe and Demo Board Generic Parts      |             |                 |
| Washer                                  | 3050-0300   |                 |
| Plastic Rivet                           | 0361-1215   |                 |
| External Power Cable                    | 5181-0201   |                 |
| Plastic Rivets Kit (rivets and washers) | 64748-68700 |                 |

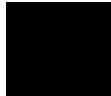

Chapter 18: Installation and Service  
**Parts List**

| <b>Main Assembly</b>   |             |                 |
|--|-------------|-----------------|
| <b>Component Part</b>  | <b>New</b>  | <b>Exchange</b> |
| HP 64748B Emulation Control Card Subassembly                             |             |                 |
| Plastic Rivet  | 0361-1215   |                 |
| Egress Panel   | 64748-00201 |                 |
| Bracket (used with Egress Panel)   | 64748-01201 |                 |
| Strain Relief Strap  | 64748-01204 |                 |
| Cable-100 36"  | 64748-61601 |                 |
| Cable-100 37"  | 64748-61602 |                 |
| Cable-100 38"  | 64748-61603 |                 |
| Emulation Control Card<br>(without external cable or egress panel)       | 64748-66507 | 64748-69507     |
| Wrist strap  | 9300-1405   |                 |
| HP 64748C Emulation Control Card Subassembly                             |             |                 |
| Egress Panel   | 64748-00205 |                 |
| Bracket (used with Egress Panel)   | 64748-01201 |                 |
| Spacer, Hex M3X6   | 0515-1146   |                 |
| Screw, Machine M3X8  | 0515-0372   |                 |
| Cable-100 36"  | 64748-61601 |                 |
| Cable-100 37"  | 64748-61602 |                 |
| Cable-100 38"  | 64748-61603 |                 |
| Cable Clamp  | 64744-01201 |                 |
| Rubber Strip   | 64744-81001 |                 |
| Emulation Control Card<br>(without external cable or egress panel)       | 64748-66515 | 64748-69515     |
| Wrist strap  | 9300-1405   |                 |
| HP 64171A 256 Kbyte SRAM Module  | 64171-66503 | 64171-69503     |
| HP 64172A 256 Kbyte SRAM Module  | 64172A      | 64172-69501     |
| HP 64171B 1 Mbyte SRAM Module  | 64171-66502 | 64171-69502     |
| HP 64172B 1 Mbyte SRAM Module  | 64172B      | 64172-69502     |
| HP 64173A 4 Mbyte SRAM Module (do not use on 64748A<br>or deep analyzer) | 64173A      | 64173-69501     |



| <b>Main Assembly</b>                                   |             |                 |
|--|-------------|-----------------|
| <b>Component Part</b>                                  | <b>New</b>  | <b>Exchange</b> |
| HP 64794A Emulation-Bus Analyzer Card with deep memory | 64794-66502 | 64740-69502     |
| 34-pin ribbon cable                                    | 64708-61601 |                 |
| HP 64740 Emulation-Bus Analyzer Card with 1K memory    | 64740-66526 | 64740-69526     |
| 34-pin ribbon cable                                    | 64708-61601 |                 |

### **What is an Exchange Part?**

Exchange parts are shown on the parts list. A defective part can be returned to HP for repair in exchange for a rebuilt part.

#### **Probe (exchange)**

To replace the Probe on the exchange program, you must remove certain parts, and return only that part considered an exchange part. When returning the Probe, you must remove the:

- cable assembly.
- top and bottom plastic covers.
- SRAM modules.
- demo board.

#### **Emulation Control Card (exchange)**

To replace the Emulation Control Card on the exchange program, you must remove certain parts, and return only that part considered an exchange part. When returning the Emulation Control Card, you must remove the:

- ribbon cable that connects the Emulation Control Card to the analyzer card.
- cable assembly.
- egress panel.





---

**Installing/Updating Emulator  
Firmware**

## Installing/Updating Emulator Firmware

If you ordered the HP 64747 MC68030 or HP 64748 MC68020 emulator probe and the HP 64748C emulation control card together, the control card contains the correct firmware for the emulator.

However, if you ordered the emulator probe and the HP 64748C separately, or if you are using an HP 64748C that has been used previously with a different emulator probe, you must download the correct firmware into the emulation control card.

The 68020 and 68030/EC030 emulator firmware is included with the emulator/analyzer interface software, and the program that downloads emulator firmware is included with the HP B1471 64700 Operating Environment product.

(The firmware, and the program that downloads it into the control card, are also included with the 68020 or 68030/EC030 emulator probe on MS-DOS format floppies. The floppies are for users that do not have hosted interface software.)

Before you can update emulator firmware, you must have already installed the emulator into the HP 64700, connected the HP 64700 to a host computer or LAN, and installed the emulator/analyzer interface and HP B1471 software as described in Chapter 18, "Installation and Service."

This chapter shows you how to:

- Update firmware with the "progflash" command.
- Display current firmware version information.

## To update emulator firmware with "progflash"

- Enter the **progflash -v <emul\_name> <products ...>** command.

The **progflash** command downloads code from files on the host computer into Flash EPROM memory in the HP 64700.

The **-v** option (verbose) causes progress status messages to be displayed during operation.

The **<emul\_name>** option is the logical emulator name as specified in the `/usr/hp64000/etc/64700tab.net` file, such as `m68030`.

The **<products>** option names the products whose firmware is to be updated, such as `64747`.

If you enter the **progflash** command without options, the downloading process becomes interactive. If you don't include the **<emul\_name>** option, your computer displays the logical names in the `/usr/hp64000/etc/64700tab.net` file and asks you to choose one. If you don't include the **<products>** option, your computer displays the products that have firmware update files on the system and asks you to choose one. (In the interactive mode, only one product at a time can be updated.) You can abort the interactive **progflash** command by pressing **<CTRL>c**.

**progflash** will print "Flash programming SUCCEEDED" and return 0 if it is successful; otherwise, it will print "Flash programming FAILED" and return a nonzero (error).

You can verify the update by displaying the firmware version information.

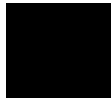

## Chapter 19: Installing/Updating Emulator Firmware

### To update emulator firmware with "progflash"

#### Examples

To update emulator firmware in the HP 64700 that contains the "em68030" emulator:

```
$ progflash <RETURN>
```

```
HPB1471-19309 A.05.00 03Jan94
64700 SERIES EMULATION COMMON FILES
```

```
A Hewlett-Packard Software Product
Copyright Hewlett-Packard Co. 1988
```

All Rights Reserved. Reproduction, adaptation, or translation without prior written permission is prohibited, except as allowed under copyright laws.

#### RESTRICTED RIGHTS LEGEND

Use, duplication, or disclosure by the Government is subject to restrictions as set forth in subparagraph (c) (1) (II) of the Rights in Technical Data and Computer Software clause at DFARS 52.227-7013. HEWLETT-PACKARD Company, 3000 Hanover St., Palo Alto, CA 94304-1181

| Logical Name | Processor |
|--------------|-----------|
| 1 em68k      | m68000    |
| 2 em80960    | i80960    |
| 3 m68030     | m68030    |

Number of Emulator to Update? (intr (usually cntl C or DEL) to abort)

To update firmware in the HP 64700 that contains the 68030 emulator, enter "3".

```
Product
1 64700
2 64703/64704/64706/64740
3 64744
4 64760
5 64747
```

Number of Product to Update? (intr (usually cntl C or DEL) to abort)

To update the HP 64747 68030 emulator firmware, enter "5".

Enable progress messages? [y/n] (y)

To enable status messages, enter "y".

## Chapter 19: Installing/Updating Emulator Firmware To update emulator firmware with "progflash"

```
Checking System firmware revision...
Mainframe is a 64700B

Reading configuration from '/usr/hp64000/inst/update/64747.cfg'
ROM identifier address = 2FFFF0H
Required hardware identifier = 1FFFH 1FFBH, 1FFDH, FFFH, FFBH, FFDH
Control ROM start address = 280000H
Control ROM size = 40000H
Control ROM width = 16
Programming voltage control address = 2FFFFEH
Programming voltage control value = FFFFH
Programming voltage control mask = 0H

Rebooting HP64700...
Checking Hardware id code...
Erasing Flash ROM
Downloading ROM code: /usr/hp64000/inst/update/64747.X
  Code start 280000H (should equal control ROM start)
  Code size 24D44H (must be less than control ROM size)
Finishing up...

Rebooting HP64700...
Flash programming SUCCEEDED
$
```

You could perform the same update as in the previous example with the following command:

```
$ progflash -v m68030 64747 <RETURN>
```

## To display current firmware version information

- Use the Terminal Interface **ver** command to view the version information for firmware currently in the HP 64700.

When using the Graphical User Interface or Softkey Interface, you can enter Terminal Interface commands with the **pod\_command** command. For example:

```
display pod_command <RETURN>  
pod_command "ver" <RETURN>
```

---

### Examples

The Terminal Interface **ver** command displays information similar to:

```
Copyright (c) Hewlett-Packard Co. 1987  
All Rights Reserved.  Reproduction, adaptation, or translation without prior  
written permission is prohibited, except as allowed under copyright laws.
```

```
HP64700B Series Emulation System  
Version:   B.01.00 20Dec93  
Location:  Flash  
System RAM:1 Mbyte  
  
HP64747B Motorola 68030/EC030 Emulator  
Version:   A.01.00 28Apr92  
Control:   HP64748C Emulation Control Board  
Speed:     40 MHz  
Memory:    1028 Kbytes  
Bank 0:    HP64171B 1 Mbyte 35ns Memory Module  
  
HP64740 Emulation Analyzer  
Version:   A.02.02 13Mar91
```

---



## **If there is a power failure during a firmware update**

If there is a power glitch during a firmware update, some bits may be lost during the download process, possibly resulting in an HP 64700 that will not boot up.

- Repeat the firmware update process.
  
- If the HP 64700 is connected to the LAN in this situation and you are unable to connect to the HP 64700 after the power glitch, try repeating the firmware update with the HP 64700 connected to an RS-232 or RS-422 interface.





---

# Glossary

## **Absolute Count**

in the trace list count column, an absolute count indicates the total count accumulated between the displayed state and the trigger state. For example, an absolute time count shown beside trace memory line number 100 indicates the elapsed time between capture of the trigger state and capture of state 100.

## **Absolute File**

a file consisting of machine-readable instructions in which absolute addresses are used to store instructions, data, or both. These are the files that are generated by the compiler/assembler/linker and are loaded into HP 64700 Series emulators.

## **Access Breakpoint**

a break from execution of your target program to execution of the emulation monitor when the emulator detects an access violation, such as an attempt to write to ROM or guarded memory space. The same effect can be obtained for an emulation break due to trigger recognition within the emulation-bus analyzer, or due to a signal from an external device supplied over the CMBT or the rear-panel BNC. Access breakpoints do not obtain immediate transfer to the monitor program. Several instruction cycles may be executed after the access violation occurs before execution begins in the monitor. Refer to Chapter 4, "Using the Emulator", for details of how to use breakpoints, and effects of their use on execution of your target program. Also, refer to Execution Breakpoints in this glossary.

### **Analyzer**

an instrument that captures activity of signals synchronously with a clock signal. An emulation-bus analyzer captures emulator bus cycle information. An external analyzer captures activity on signals external to the emulator. No external analyzer is supported by the MC68020 or MC68030 emulators because all analysis bits are used by the emulation-bus analyzer.

### **Analyzer Clock Speed**

the bus cycle rate of the emulation processor. If the emulation processor is running at 21 MHz and the fastest bus cycle requires 3 clocks, then the analyzer clock speed (bus cycle rate) is  $21/3 = 7$  MHz.

### **Applications**

are composed of a hierarchy of widgets.

### **Arm Condition**

a condition that reflects the state of a signal external to the analyzer. The arm condition can be used in branch or storage qualifiers. External signals can be from another analyzer or an instrument connected to the CMB or BNC.

### **Assembler**

a program that translates symbolic instructions into object code.

### **Background**

a memory that parallels (and overlaps) the emulation processor's normal address range. Entry to background can only take place under emulator control, and cannot be reached via your target program.

**Background Monitor**

a monitor program that operates entirely in the background address space. The background monitor can execute when target program execution is temporarily suspended. The background monitor does not occupy any of the address space that is available to your target program.

**BNC Connector**

a connector that provides a means for the emulator to drive/receive a trigger signal to/from an external device (such as a logic analyzer, oscilloscope, or HP 64000-UX system).

**Breakpoint**

a point at which emulator execution breaks from the target program and begins executing in the monitor. (See also Execution Breakpoint and Access Breakpoint.)

**Class names**

names that may apply to many instances of a widget.

**Command File**

a file containing a sequence of commands to be executed.

**Compatible Mode**

configures the deep analyzer to provide the same memory depth as the 1K analyzer: 1024 states deep when the analyzer is not configured to make a count of states or time during a measurement, and 512 states deep when the analyzer is configured to make a count of states or time during a measurement. If the emulator interface you are using along with the deep analyzer requires that you use the compatible mode, the deep analyzer will still be able to provide one of its benefits for your measurement; you will be able to make your counts of states or time at full emulator clock speed.



### **Compiler**

a program that translates high-level language source code into object code, or produces an assembly language program with subsequent translation into object code by an assembler. Compilers typically generate a program listing which may list errors displayed during the translation process.

### **Configuration File**

a file in which configuration information is stored. Typically, configuration files can be modified and re-loaded to configure instruments (such as an emulator) or programs (such as the PC Interface).

### **Coordinated Measurement**

a synchronized measurement made between the emulator and analyzer, between emulation-bus analyzer and external analyzer, or between multiple emulators or analyzers. For example, a coordinated measurement is made when two or more HP 64700 emulators/analyzers start executing together, or break into background monitors at the same time.

### **Coordinated Measurement Bus (CMB)**

the bus that is used for communication between multiple HP 64700 Series emulators/analyzers or between HP 64700 emulators/analyzers and an HP 64306 IMB/CMB Interface to allow coordinated measurements.

### **Counter Overflow**

when the trace tag counter of the deep analyzer reaches maximum count and begins a new count from zero. The counter in the deep analyzer simply counts continuously once a trace begins; it increments its count every 20 ns, and reaches maximum count in about 22.9 minutes (22 minutes and 54 seconds). The deep analyzer sets a flag in memory and stores it along with the first state that is captured after the counter overflow occurs (first state captured after the counter begins again at zero).

**Cross-Trigger**

the situation in which the trigger condition of one analyzer is used to trigger another analyzer. Two signals internal to the HP 64700 can be connected through the BNC on the instrumentation card cage to allow cross-triggering between the emulation-bus analyzer and other analyzers.

**DCE (Data Communications Equipment)**

a specific RS-232C hardware interface configuration. Typically, DCE is a modem.

**Deep Analyzer**

in this manual, "deep analyzer" refers to the HP 64794 Emulation-Bus Analyzer with deep trace memory.

**Downloading**

the process of transferring absolute files from a host computer into the emulator.

**DTE (Data Terminal Equipment)**

a specific RS-232C hardware interface configuration. Typically, DTE is a terminal or printer.

**Emulation-bus Analyzer**

a system component built into the HP 64700 that captures the emulation processor's address, data, and status information.

**Emulation Memory**

high-speed memory (RAM) in the emulator that can be used in place of target system memory.



**Emulator**

a tool that replaces the processor in your target system. The goal of the emulator is to operate just like the processor it replaces. The emulator gives information about the bus cycle operation of the processor and control over target system execution. Using the emulator, you may view contents of processor registers, target system memory, and I/O resources.

**Emulator Probe**

the assembly that connects the emulator to the target system microprocessor socket.

**Execution Breakpoint**

a BKPT instruction placed in your software in RAM, replacing the normal instruction at the RAM address. Breakpoints for code in ROM are stored in emulation hardware and jammed on the emulation bus during the fetch cycle. When the BKPT is executed, emulation immediately transfers from execution of your target program to execution of the emulation monitor. Refer to Chapter 4, "Using the Emulator", for details of how to use execution breakpoints, and effects of their use on execution of your target program. Also, refer to Access Breakpoints in this glossary.

**Foreground**

the directly addressable memory range of the emulation processor.



**Foreground Monitor**

a monitor program that executes in the foreground address space. When the monitor exists in foreground, it is directly accessible by, and can interact with, your target program.

**Guarded Memory**

an address range that is to be inaccessible to the emulation processor. The emulator will generate a break and display an error message if an access to guarded memory occurs.

**Handshaking**

a process that involves receiving and sending control characters which indicate a device is ready to receive data, that data has been sent, and that data has been accepted.

**Host Computer**

a computer to which an HP 64700 Series emulator can be connected. A host computer may run interface programs which control the emulator. Host computers may also be used to develop programs to be downloaded into the emulator.

**Instance Name**

the name of a single, unique widget.

**Inverse Assembler**

a program that translates absolute code into assembly language mnemonics.

**Linker**

a program that combines relocatable object modules into an absolute file which can be loaded into the emulator and executed.



**Logical Address Space**

the addresses assigned to code during the process of compiling, assembling and linking to generate absolute files. Refer to Chapter 10, "Using MC68030 Memory Management", for a detailed explanation.

**Macros**

custom made commands that represent a sequence of other commands. Entire sequences of commands defined in macros will be automatically executed when you enter the macro name. Macro nesting is permitted; this allows a macro definition to contain other macros.

**Memory Mapper Term**

a number assigned to a specific address range in the memory map. Term numbers are consecutive.

**Memory Mapping**

defining ranges of the processor address space as emulation RAM or ROM, target RAM or ROM, or guarded memory.

**Monitor Program**

a program executed by the emulation processor that allows the emulation system controller to access system resources. For example, when you enter a command that requires access to your system resources, the system controller writes a command code to a storage area and breaks the execution of the emulation processor from your target program into the monitor. The monitor program then reads the command from the storage area and executes the processor instructions that access the target system. After the system resources have been accessed, execution returns to your target program.

**Operating System**

software which controls the execution of computer programs and the flow of data to and from peripheral devices.

**Overflow**

see counter overflow.

**Parity Setting**

the configuration of the parity switches. Depending on the configuration of the parity output switch and the parity switch, a parity check bit is added to the end of data to make the sum of the total bits either even or odd. A parity check is performed after data has been transferred, and is accomplished by testing a unit of the data for either odd or even parity to determine whether an error has occurred in reading, writing, or transmitting the data.

**Path**

also referred to as a directory (for example \users\projects).

**PC Interface**

a program that runs on the HP Vectra and IMB PC/AT compatible computers. This is a friendly interface used to operate an HP 64700 Series emulator.

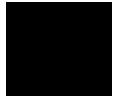

**Performance Verification**

a program that tests the emulator to determine whether the emulation and analysis hardware is functioning properly.

**Physical Address Space**

the address space in hardware memory and hardware I/O that is accessed by the microprocessor during normal program execution. Refer to Chapter 9, "Solving Problems", for a detailed explanation.

**Prefetch**

the ability of a microprocessor to fetch additional opcodes and operands before the current instruction is finished executing.

**Prestore**

the storage of states captured by the analyzer that precede states which are normally stored. If the normal storage qualifier specifies the entry address of a function or routine, prestore can be used to identify the callers of that function or routine.

### **Prestore Qualifier**

a specification that must be met by a state before it can be saved in the analyzer prestore memory.

### **Qualifier**

a specification that must be met before an action can be taken by the analyzer. For example, a store qualifier is a specification that must be met by an incoming state before it can be stored in the trace memory. The "arm" condition can be used as an additional qualifier. For example, an external analyzer may be set up to supply a true signal to the rear panel BNC connector on the card cage when it detects a true condition in the target system. Then the analyzer can be set up to store qualify a certain kind of state, but only when the arm signal from the BNC is true.

### **Real-Time Execution**

refers to the emulator configuration in which commands that temporarily interrupt target program execution (for example, display/modify target memory or processor registers) are not allowed.

### **Relative Count**

in the trace list count column, a relative count shows the count between the present displayed state and the state displayed immediately before it. Relative time count, for example, shows the elapsed time between the previous displayed state and the present state. Note that the count is between displayed states. If your trace list is inverse assembled and/or dequeued, several states may have been captured in memory between the present displayed state and the displayed state immediately before it.

**Remote Configuration**

the configuration in which an HP 64700 Series emulator is directly connected to a host computer via a single port. Commands are entered (typically from an interface program running on the host computer) and absolute code is downloaded into the emulator through that single port.

**RS-232C**

a standard serial interface used to connect computers and peripherals.

**Sequencer**

a state machine in the analyzer that searches for execution of states in a particular order.

**Single-step**

the execution of one microprocessor instruction. Single-stepping the emulator allows you to view program execution one instruction at a time.

**Softkey Interface**

the host computer interface program used in the UNIX environment. The Softkey Interface is a friendly interface used to control HP 64700 emulators.

**Software Breakpoint**

refer to execution breakpoint and access breakpoint in this glossary.

**Software Performance Analyzer**

an analyzer that measures execution of software modules, interaction between software modules, and usage of data points and I/O ports.

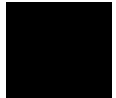

**Standalone Configuration**

the configuration in which a data terminal is used to control the HP 64700 Series emulator, and the emulator is not connected to a host computer.

**stderr**

an abbreviation for “standard error output.” Standard error can be directed to various output devices connected to the HP 64700 ports.

**stdin**

an abbreviation for “standard input.” Standard input is typically defined as your computer keyboard.

**stdout**

an abbreviation for “standard output.” Standard output can be directed to various output devices connected to the HP 64700 ports.

**Step**

see Single-step.

**Store Qualifier**

a specification that must be met by a state before it can be saved in the analyzer trace memory.

**Synchronous Execution**

the execution of multiple HP 64700 Series emulators/analyzers at the same time (i.e., multiple emulator start/stop).

**Syntax**

the order in which expressions are structured in command languages. Syntax rules determine which forms of command language syntax are grammatically acceptable.

**Target Program**

The program you are developing for your product. It is also called user program.

**Target System**

the circuitry where the emulator probe is connected (typically a microprocessor-based system under development).

**Target System Memory**

storage that is present in the target system.

**Terminal Interface**

the command interface present inside the HP 64700 Series emulators that is used when the emulator is connected to a simple data terminal. This interface provides on-line help, command recall, macros, and other features which provide for easy command entry from a terminal.

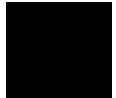

**Trace**

a collection of states captured synchronously by the analyzer.

### **Trigger**

the condition that identifies a reference state within an analyzer trace measurement.

Trigger also refers to the analyzer signal that becomes active when the trigger condition is found. The trigger signals are called trig1 and trig2. They are bidirectional signal lines that can be used to coordinate measurement activity between emulators and analyzers installed in the instrumentation card cage, and between instruments connected to the BNC on the rear panel of the card cage. For details of how to configure and use trig1 and trig2, refer to Chapter 6, "Making coordinated measurements."

Note that there is delay when you use trig1 and/or trig2 for measurement coordination. For example, you may specify that the emulator break to its monitor program when it receives trig1 from the analyzer. Several states may be executed in the emulator between the time the analyzer recognizes its trigger condition, generates trig1, delivers trig1 to the emulator, and the emulator responds to trig1 by breaking to its monitor program.

### **Uploading**

the transfer of emulation or target system memory contents to a host computer.

### **Unlocked Exit**

one of two methods used to leave the high level (graphical or softkey) interface and return to the host computer operating system. An unlocked exit command allows you to exit the high level interface and re-enter later with the default configuration. (See also Locked Exit.) This is not available in the Terminal Interface.

### **User Program**

Another name for your target program (the program you are developing for your product).



**Viewport**

see Window.

**Wait States**

extra microprocessor clock cycles that increase the total time of a bus cycle. Wait states are typically used when slower memory is implemented.

**Widget**

an OSF/Motif graphic device from which X applications are built. For example, pushbuttons and menu bars are Motif widgets.

**Window**

a specified rectangular area of virtual space shown on the display in which data can be observed.

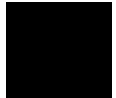

**X Resource Specification**

a resource name and value. The resource name identifies the element whose appearance or behavior is to be defined, and the value specifies how the element should look or behave.

**1K Analyzer**

in this manual, "1K analyzer" refers to the HP 64703, HP 64704, and HP 64706 Emulation-Bus analyzers with 1K trace memories.



---

# Index

- A**
  - absolute file, **398**
  - absolute, glossary definition of, **641**
  - action keys, **6**
    - custom, **526**
    - operation and use, **63**
    - with command files, **526**
    - with entry buffer, **61, 63**
  - activities occurring in windows, **37-38**
  - activity measurements (SPMT), **257-259**
    - additional symbols for address, **271**
    - confidence level, **272**
    - error tolerance, **272**
    - interpreting reports, **270**
    - mean, **270**
    - relative and absolute counts, **271**
    - standard deviation, **270**
    - symbols within range, **271**
    - trace command setup, **262**
  - ACU error in display registers command, **145**
  - addresses
    - overlapping, effect on deMMUer, **333**
    - physical in trace list, check list, **310**
    - how affected when the MMU is on, **322**
    - logical vs physical explained, **316**
  - address mapping
    - details of a single address, **326**
    - in the MMU, supervisor/user, **325**
    - when MMU uses function codes, **325**
  - address not range command, **213**
  - address range command, **213**
  - address range file format (SPMT measurements), **264**
  - address translation details of single address, **167**
  - address values, **212**
  - alternative paths to command files, **85**
  - altitude specifications, **561**

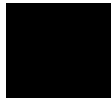

- analyzer
    - arm emulation on signal from BNC, **251**
    - arm emulation on signal from CMB, **251**
    - drive emulation trigger signal to BNC, **248**
    - drive emulation trigger signal to CMB, **247**
    - glossary definition of analyzer clock speed, **642**
    - introduction, **172**
    - trace at EXECUTE, **243**
    - trigger one with another, **253**
  - app-defaults directory
    - HP 9000 computers, **570**
    - Sun SPARCsystem computers, **570**
  - application resource
    - See X resource*
  - architectures of virtual memory, **317**
  - ArG\_iEft with command files, **73**
  - &ArG\_iEft, **73**
  - available adapters table, **163**
  - 1K analyzer, glossary definition of, **655**
- B**
- bases (number), **207**
  - BBA (basis branch analysis), storing BBA data to a file, **233**
  - binary numbers, **207**
  - bindings, mouse button and keyboard, **9**
  - BKPT (breakpoint vector), **148**
  - BNC
    - comparison to CMB trigger, **238**
    - connect to the rear panel, **241**
    - connector, **236**
    - trigger signal, **238**
  - break on analyzer trigger signal, **254**
  - break command, **139, 154, 361**
  - breakpoints, **15**
    - disabling execution breakpoints, **150**
    - enabling, **150**
    - generally, **148**
    - setting temporary breakpoints, **152**
  - bus cycle, hung bus cycle defined, **139**
  - byte format, **126**

- C** cables
  - connecting to the emulator probe, **584**
  - power, **605**
- can't break into monitor example, **345**
- capture continuous stream of execution, **224**
- card cage
  - applying power, **605**
  - connecting to computer or LAN, **607**
- cautions
  - antistatic precautions, **581**
  - apply power to emulator before target system, **163**
  - BNC accepts only TTL voltage levels, **241**
  - CMB 9-pin port is NOT for RS-232C, **239**
  - make sure translation tables are valid, **321**
  - protect against static discharge, **161**
  - rear panel, do not stand HP 64700 on, **587**
  - turn OFF power before installing emulator probe, **161**
  - verify pin 1 when installing emulator probe, **161**
- changing
  - column width, **195**
  - directory context in configuration window, **284**
- characteristics of the emulators, **545**
- class name, X applications, **568**
- client, X, **518**
- clocks specifications, **546**
- CMB (coordinated measurement bus), **236**
  - cables needed, **239**
  - comparison to BNC trigger, **238**
  - EXECUTE line, **238**
  - EXECUTE signal, **362**
  - HP 64700 connection, **239**
  - READY line, **237**
  - signals, **237**
  - specifications, **562**
  - TRIGGER line, **237**
- cmb\_execute command, **244, 362**
- code patching example in getting started chapter, **25-27**
- color scheme, **520, 524, 573**
- columns in main display area, **521**

- command
  - buttons, **7**
  - summary, **360**
- command conventions
  - graphical user interface, **8**
  - softkey interface, **5**
- command files
  - alternative directories, **75, 85**
  - ArG\_IeFt passing, **73**
  - &ArG\_IeFt, **84**
  - command line continuation, **75**
  - comments in, **75, 81**
  - creating by logging commands, **75**
  - creating by using a text editor, **77**
  - directory path, **85**
  - executing, **78**
  - general information, **72-86**
  - HP64KPATH, **75, 85**
  - nesting, **74, 79**
  - parameter passing, **72, 82, 84**
  - PARMS keyword, **82**
  - path variable, **85**
  - pausing, **74, 80**
  - restricted Softkey commands, **74**
  - scripts, **73**
  - shell scripts, **73**
  - shell variables, **73**
  - specifying search of directories, **75**
  - status line update, **74**
  - UNIX commands, **73**
  - wait command, **74, 80**
- command line, **7**
  - Command Recall dialog box, **8**
  - copy-and-paste from entry buffer, **62**
  - editing commands using the keyboard, **50**
  - editing through the popup menu, **49**
  - editing with graphical user interface buttons, **48**
  - entering commands, **47**
  - entry area, **7**
  - turning it on or off, **46**
  - turning on or off, **521**

command line  
*command paste* mouse button, **9**  
Command Recall dialog box operation, **64**  
*command select* mouse button, **9**  
commands  
    forwarding to other interfaces, **87**  
    forwarding to software performance analyzer, **88**  
    getting online help for, **52**  
    methods to recall for edit and reuse, **50**  
    of the emulator/analyzer interface, **350**  
    syntax conventions in manual, **358**  
    terminal interface commands to avoid, **89**  
    to execute when command is complete, **51**  
comments in command files, **75, 81**  
compatible mode, glossary definition of, **643**  
complex trace measurements, **207-227**  
configuration, emulator  
    displaying context from configuration window, **284**  
    exiting the interface, **286**  
    help for configuration items in dialog boxes, **285**  
    loading from file, **286**  
    modifying a section, **280**  
    starting the interface, **278**  
    storing, **283**  
configure, emulator, **101**  
connecting card cage to computer or LAN, **607**  
connecting probe to demo target system, **603**  
context  
    changing directory in configuration window, **284**  
    displaying directory from configuration window, **284**  
continuing command file lines, **75**  
control-c, **267**  
coordinated measurements, **245**  
    break\_on\_trigger syntax of the trace command, **246**  
    definition, **236**  
    set up, **23**

- copy
  - local\_symbols\_in, **365**
  - memory, **365**
  - noheader, **366**
  - registers, **366**
  - terminal interface screen to file, **90**
  - trace, **367**
- copy command, **363-368**
- copy-and-paste
  - addresses, **59**
  - from entry buffer to command line, **62**
  - full symbol to entry buffer, **115**
  - multi-window, **59, 62**
  - symbol width, **59**
  - to entry buffer, **58**
- copying to a file or printer, **68-69**
- COUNT option to trace command, **369-370**
- count states, **218**
- count time, **218**
- counter overflow, glossary definition of, **644**
- current working directory
  - displaying, **117**
  - to change the context, **118**
- current working symbol
  - displaying, **117**
  - to change the context, **118**
- cursor buttons, **8**
  
- D**
  - data communications specifications, **562**
  - data range command, **213**
  - data values, **212**
    - displaying, **19**
  - debugger
    - forwarding commands to, **87**
    - opening an interface window, **45**
  - decimal numbers, **207**
  - deep analyzer, glossary definition of, **645**
  - definitions of terms, **641-655**



deMMUer

- command options, **331**
- detailed discussion, **330-341**
- how it is loaded by the emulator, **339**
- how to enable, **331**
- how to load reverse translations, **331**
- its reverse translation table, **335**
- keeping it up to date, **333**
- out of resources, things to check, **309**
- places strange addresses in trace list, **333**
- programming in static memory system, **203**
- resource limitations, **335**
- resources used for function codes, **341**
- resources used for two root pointers, **340**
- restrictions when using, **333**
- seeing present reverse translations, **331**
- table, how to conserve space, **337**
- terms allocated from memory map, **338**

demo program

- introduction, **99**
- loading, **104**
- starting, **12-13**

demo target system, connecting the emulator probe, **603**

demos, setting up, **529-531**

depth of memory, how to obtain different depths, **582**

dequeuer, how it works, **189**

device table file, **13, 39-40**

dialog box, **63**

- Command Recall, operation, **64**
- Directory Selection, operation, **64**
- Entry Buffer Recall, operation, **61, 64**
- File Selection, operation, **64**
- Modify Register, operation, **64**
- Settings Display Modes, operation, **64**
- Symbol Selection, operation, **64**

directory, alternatives for command files, **75**

directory context

- changing in configuration window, **284**
- displaying from configuration window, **284**

Directory Selection dialog box operation, **64**

- disable synchronous measurements, **244**
- display
  - global\_symbols, **373**
  - local\_symbols\_in, **373**
  - MMU options to display diagram, **381-384**
  - present MMU mappings, **323**
  - registers, **144, 373**
  - simulated\_io, **374**
  - single address mapped by MMU, **326**
  - software\_breakpoints, **374**
  - table details at a logical address, **328**
  - terminal interface screen, **90**
  - to return to the previous mnemonic display, **130**
  - trace option to display diagram, **385-389**
- display area, **7**
  - columns, **521**
  - lines, **521-522**
- display command
  - memory mnemonic, **14**
  - options, **371-376**
- display data command, **120**
- display global\_symbols command, **111**
- display local\_symbols\_in command, **112**
- display memory command, **126-129, 132**
- display memory options to display command, **377-380**
- display memory repetitively command, **132**
- display modes
  - details of dialog box, **159**
  - setting, **158**
- display pod\_command command, **90, 93**
- display software\_breakpoints command, **156**
- display status command, **42, 177**
- display trace absolute command, **191**
- display trace absolute status binary command, **191**
- display trace absolute status hex command, **191**
- display trace absolute status mnemonic command, **191**
- display trace command, **175, 183-202, 231**
- display trace count absolute command, **196**
- display trace count command, **196**
- display trace count relative command, **196**
- display trace depth command, **201**

- display trace dequeue off command, **189**
  - display trace dequeue on command, **189**
  - display trace disassemble\_from\_line\_number command, **186**
    - align\_data\_from\_line option, **189**
    - options, **187**
  - display trace mnemonic command, **186**
  - display trace offset\_by command, **198**
  - don't care digits, **208**
  - duration measurements (SPMT), **260**
    - average time, **273**
    - confidence level, **274**
    - error tolerance, **274**
    - interpreting reports, **273**
    - maximum time, **273**
    - minimum time, **273**
    - number of intervals, **273**
    - prefetch and recursion considerations, **260**
    - selecting, **265**
    - standard deviation, **273**
    - trace command setup, **263**
  - dynamic virtual memory systems, **317**
- E**
- EARLY defined in address mapping display, **328**
  - editing
    - file, **521**
    - file at address, **521**
    - files in the interfaces, **106**
  - emul700, command to start the emulator/analyzer interface, **39**
  - emulation configuration, **403**
  - emulation-bus analyzer
    - trace signals, **209**
  - emulation configuration
    - help for items in dialog boxes, **285**
  - emulation memory map used by deMMUer, **336**
  - emulation memory modules, installing, **599**
  - emulator
    - break execution on signal from BNC, **250**
    - break execution on signal from CMB, **249**
    - configuration, **101**
    - configuring the, **276**
    - device table file, **13, 39-40**
    - how it loads the deMMUer, **339**

- emulator (continued)
  - in-circuit use, **161-163**
  - installing/updating firmware, **634**
  - introduction, **98-101**
  - messages, **458**
  - multiple start/stop, **243-244**
  - performance verification, **626**
- emulator configuration
  - exiting the configuration interface, **286**
  - loading from file, **286**
  - modifying a configuration section, **280**
  - starting the configuration interface, **278**
  - storing, **283**
- emulator probe
  - connecting the cables, **584**
  - connecting to demo target system, **603**
  - precautions, **161**
- emulator specifications and characteristics, **545**
- emulator/analyzer
  - displaying the status, **42**
- emulator/analyzer interface
  - executing command file at startup, **41**
  - exiting, **28**
  - exiting a single window, **70**
  - exiting all windows, ending the session, **71**
  - opening additional windows, **44**
  - running in multiple windows, **39**
  - seeing status before startup, **41**
  - starting, **39-43**
  - starting with default option, **40**
  - unlocking interface that was left locked, **43**
- enabling
  - synchronous measurements, **243**
  - the MMU, **164-170, 320**
- end command, **28**
  - options, **390-391**
- entering graphical/softkey interface commands, **47**
- entry buffer, **7**
  - address copy-and-paste to, **59**
  - clearing, **58**
  - copy and paste a full symbol name into, **115**

entry buffer (continued)  
copy-and-paste to, **58**  
copy-and-paste value to the command line, **62**  
Entry Buffer Recall dialog box, **7, 61**  
multi-window copy-and-paste from, **62**  
multi-window copy-and-paste to, **59**  
operation and use of, **61**  
recall button, **7**  
recalling entries, **61**  
symbol width and copy-and-paste to, **59**  
text entry, **58**  
to recall values, **61**  
with action keys, **61, 63**  
with pulldown menus, **61**  
Entry Buffer Recall dialog box operation, **64**  
environment variables  
setting, **94**  
environment variables (UNIX)  
PATH, **39**  
equates, **210**  
for MC68020, **210**  
for MC68030, **211**  
error log, how to display it, **53**  
error messages, **458**  
event\_log, **44**  
how to display it, **53**  
example, can't break into monitor, **345**  
exchange part, defined, **631**  
EXECUTE  
CMB signal, **238**  
tracing at, **243**  
executing command files, **78**  
execution breakpoints, **148-149, 151-157**  
disabling, **150**  
enabling, **150**  
setting (temporary breakpoints), **152**  
exit, emulator/analyzer interface, **28**  
exiting a single window in the interface, **70**  
exiting the emulator/analyzer interface, **70**  
expressions, **207**  
options, **392-394**

- F** FCODE command options, **395-396**
  - file
    - copying or printing, **68-69**
    - .EA configuration files, **283**
    - emulator configuration, **283**
    - emulator configuration load, **286**
  - file formats
    - address ranges for SPMT measurements, **264**
    - time ranges for SPMT measurements, **264**
  - File Selection dialog box operation, **64**
  - firmware
    - installing/updating on the emulator, **634**
    - version, **638**
  - floating-point number form, **131**
  - foreground monitor, mapping it for use with MC68040 MMU, **296-298**
  - forwarding commands to other interfaces, **87**
  - function codes
    - code list, **102**
    - mapped in deMMUer resources, **341**
    - used in translation tables, **320**
- G** global symbols, **14, 208, 373**
  - displaying, **111**
  - initializing the SPMT measurement with, **265**
- glossary, **641-655**
- graphical user interface, **6**
  - command conventions, **8**
  - command descriptions, **350**
  - entering commands, **47**
  - how to use it, **35**
  - to use its special command features, **54**
- guarded memory access when using MMU, **343**
- H** halt of system when using MMU, **344**
- hand pointer, **7, 57**
- hardware
  - HP 9000 memory needs, **578**
  - HP 9000 minimum performance, **578**
  - HP 9000 minimums overview, **578**
  - SPARCsystem memory needs, **579**
  - SPARCsystem minimum performance, **579**
  - SPARCsystem minimums overview, **579**

- hardware breakpoints
    - see execution breakpoints, **148-149, 151-157**
  - hardware enable for the MMU, **320**
  - help
    - for configuration items, **285**
    - terminal interface commands, **93**
  - help command, **52, 93**
    - options, **397**
  - hexadecimal numbers, **208**
  - high level interface, using pod commands within, **224**
  - HP 64700
    - internal lines, **245-251**
    - Operating Environment, minimum version, **578-579**
  - HP 9000
    - 700 series Motif libraries, **578**
    - HP-UX minimum version, **578**
    - installing software, **608-614**
    - minimum system requirements overview, **578**
  - HP-UX CMD, **364**
  - HP-UX, minimum version, **578**
  - HP64KPATH, **75**
  - HP64KPATH and command files, **85**
  - humidity specifications, **561**
  - hung bus cycle, **139**
- I**
- in-circuit emulator use, **161-163**
  - input scheme, **520, 573**
  - installation, **578-579**
    - emulator firmware, **634**
    - hardware, **580-606**
    - how to verify it is correct, **621-628**
    - HP 9000 software, **608-614**
    - of optional memory modules, **582**
    - placing boards in the card cage, **587**
    - SPARCsystem software, **615-620**
  - instance name, X applications, **567-568**
  - interactive measurements, **245**
  - interface
    - forwarding commands to other interfaces, **87**
    - graphical user, **6**
    - how to use the graphical or softkey interface, **35**
    - if it won't start, **30**

interface (continued)  
  softkey, **4**  
  the SPARCsystem softkey interface, **533**  
interface, emulator configuration  
  exiting, **286**  
  modifying a section, **280**  
  starting, **278**  
INVALID in address mapping display, **328**  
inverse video, graphical user interface demo/tutorial files, **530**

- K** keyboard  
  accelerators, **57**  
  bindings, **9**  
  focus policy, **56**
- L** label scheme, **520, 524, 573**  
LAN, connecting the card cage, **607**  
LANG environment variable, **573**  
large page mode of deMMUer defined, **336**  
LD\_LIBRARY\_PATH environment variable, **618**  
libraries, Motif for HP 9000/700, **578**  
lines in main display area, **521-522**  
list of replaceable parts, **629-631**  
listing the present MMU mappings, **323**  
load command, **102**  
  options, **398-400**  
load configuration democfg command, **104**  
load demo command, **104**  
load symbols command, **110**  
load trace command, **231**  
load trace\_spec command, **228, 230**  
loading and storing, **102-108**  
local symbols, **208, 365, 373**  
  displaying, **112**  
  initializing the performance measurement with, **266**  
locked interface, to unlock the interface, **43**  
log\_commands command  
  options, **401**  
logging commands to a command file, **75, 77**



- logical address
  - defined, **317**
  - table details, **328**
  - translation details, to view, **167**
- logical-to-physical mappings, to view, **165**
- LONG defined in address mapping display, **328**
- long word format, **128**
- L/U and LIMIT in address mapping display, **327**
- M**
  - mappings, logical-to-physical, to view, **165**
  - maximum trace depth, **218**
  - memory, **365, 404**
    - display in byte format, **126**
    - display in long word format, **128**
    - display repetitively, **132**
    - displaying in floating-point number format, **131**
    - displaying in mnemonic format, **129**
    - displaying in real number format, **131**
    - displaying in word format, **127**
    - displaying options, **377**
    - modifying, **133**
    - redisplay locations, **132**
  - memory activity measurements (SPMT), **257, 270**
  - Memory contents listed as asterisk (\*), **365**
  - memory displays
    - selecting source/symbol displays in, **158**
  - memory management systems supported, **317**
  - memory map, how it is used by deMMUer, **336**
  - memory modules
    - installing on the deep analyzer, **582**
    - installing on the emulation probe, **599**
  - memory recommendations
    - HP 9000, **578**
    - SPARCsystem, **579**
  - menus, hand pointer means popup, **7, 57**
  - mixing pod commands with high level commands, **224**

- MMU
  - discussion of special problems, **342-347**
  - displaying options, **381-384**
  - enabling in MC68040, **164**
  - how is it enabled, **320**
  - how it affects command composition, **322**
  - mapping 1:1 for use with MC68040, **296-298**
  - restrictions when using, **321**
  - where is it located, **319**
- MMU enabled
  - how it affects the analyzer, **203-206**
  - using the emulator with, **164-170**
- MMU mappings
  - details of a single address, **326**
  - how the emulator obtains them, **324**
  - listing the present mappings, **323**
  - modifying for monitor, **345**
  - obtaining a shorter list of, **324**
- mnemonic format, **129**
- mnemonic memory display, **14**
  - how to return to the previous display, **130**
- modify
  - configuration, **403**
  - memory, **404**
  - register, **405**
  - software\_breakpoints, **405**
- modify command
  - options, **402-408**
- modify configuration command, **101, 245, 247-251**
- modify interactive measurement specification?, **247-251**
- modify memory command, **133**
- Modify Register dialog box operation, **64**
- modify registers, **146**
- modify software\_breakpoints clear command, **154**
- modify software\_breakpoints disable command, **150**
- modify software\_breakpoints enable command, **150**
- modify software\_breakpoints set command, **150, 152**
- module duration measurements (SPMT), **260**
- module usage measurements (SPMT), **260**

- monitor
  - break on analyzer trigger signal, **254**
  - break to, **139**
  - to map 1:1 for use with MC68040 MMU, **296-298**
- Motif, HP 9000/700 requirements, **578**
- mouse button bindings, **9**
- multi-window
  - copy-and-paste from entry buffer, **62**
  - copy-and-paste to entry buffer, **59**
- N**
  - nesting command files, **74, 79**
  - NORMAL key, **359, 392**
  - NOT TAKEN in trace list, **190**
  - notes
    - CMB EXECUTE and TRIGGER signals, **238**
    - CMB interaction does not affect cross-triggering, **243**
    - step command doesn't work when CMB enabled, **243**
  - number bases, **207**
  - numerical values, **207**
- O**
  - octal numbers, **207**
  - offset addresses in trace list, **198**
  - offset\_by used in mnemonic displays, **129**
  - operating system
    - accessing, **94-96**
    - HP 64700 Series minimum version, **578-579**
    - HP-UX minimum version, **578**
    - SunOS minimum version, **579**
  - operators, **208**
    - bitwise AND, **208**
    - bitwise OR, **208**
    - integer, **208**
    - unary one's complement, **208**
    - unary two's complement, **208**
  - out of resources
    - deMMUer, things to check, **309**
    - how to avoid this message, **337**
  - overflow, glossary definition of, **648**
  - overlapping ranges, how they affect deMMUer, **333**

- P** **PAGE** defined in address mapping display, **328**
- page mode of deMMUer defined, **336**
- parameters to command files, **72, 82, 84**
- parent symbols, how to display, **114**
- parts list, **629-631**
- paste* mouse button, **9**
- patching code example in getting started chapter, **25-27**
- PATH**, UNIX environment variable, **39**
- perf.out file, **409**
- perf.out, SPMT output file, **266-269**
- perf32, SPMT report generator utility, **256, 267-268**
  - interpreting reports, **270, 273**
  - options, **269**
  - using the, **269**
- performance measurements, **255-274**
  - absolute information, **270**
  - activity measurements, **257-259**
  - adding traces, **266**
  - duration, **260**
  - ending, **268, 409**
  - how they are made, **256**
  - initialize options, **410-411**
  - initializing, **263**
  - initializing, default, **263**
  - initializing, duration measurements, **265**
  - initializing, user defined ranges, **264**
  - initializing, with global symbols, **265**
  - initializing, with local symbols, **266**
  - memory activity, **257, 270**
  - module duration, **260**
  - module usage, **260**
  - prefetch and recursion considerations, **260**
  - program activity, **257, 270**
  - relative information, **270**
  - restoring the current measurement, **266**
  - run options, **412**
  - running, **267**
  - SPA for more capability, **256**
  - trace command setup, **262**
  - trace counting time, **262**
  - trace display depth, **262**

performance verification procedure, **626**

permanent software breakpoints, how to set, **151**

physical addresses

- defined, **317**
- in trace list, check, **310**
- tracing execution in, **206**

physical-logical mappings, how to view, **165**

platform

- HP 9000 memory needs, **578**
- HP 9000 minimum performance, **578**
- SPARCsystem memory needs, **579**
- SPARCsystem minimum performance, **579**

platform scheme, **520, 572**

pod commands used in high level interface, **224**

pod\_command command, **91, 93, 397**

- options, **413-414**

pod\_command keyboard command, **91**

popup menus

- hand pointer indicates presence, **7, 57**
- how they map to the command line, **356**
- how to choose an item, **57**

power applied to the card cage, **605**

power cables, connecting, **605**

power failure during firmware update, **639**

power-on

- emulator, **163**
- target system, **163**

prefetch correction in SPMT, **260**

prestore qualifier, **220**

prestore qualifier, glossary definition of, **650**

printing, copying files to a printer, **68-69**

probe

- connecting the cables, **584**
- connecting to demo target system, **603**
- dimensions, **560**
- other target system sockets, **163**



- problems
  - analyzer won't trigger, **303**
  - can't break to monitor after MMU enabled, **312**
  - deMMUer out of resources, **309-310**
  - demo program won't work, **307**
  - desired interface won't start, **30**
  - discussion for the MMU, **342-347**
  - DMA problem, **308**
  - emulation reset problem, **308**
  - emulator won't work in target system, **304**
  - multiple guarded memory accesses, **307**
  - physical memory addresses in trace list, **310-311**
  - problem types and their solutions, **299**
  - solving quick start problems, **29-32**
  - trouble mapping memory, **306**
  - unexplained states in the trace list, **302**
  - you suspect the emulator is broken, **305**
- processor
  - accessing memory resources, **120-134**
  - reset, **143**
  - run controls, **135-143**
  - stepping, **140**
  - type, **40**
- progflash, **635-637**
  - example, **636**
- program activity measurements (SPMT), **257, 270**
- program counter, mnemonic memory display, **15**
- programs
  - building, **99**
  - displaying data structures, **120**
  - loading, **102**
  - running, **135**
  - storing, **102, 105**
- pulldown menu item
  - using the keyboard, **56**
  - using the mouse, **54-55**
- pulldown menus, how they map to the command line, **351**
- pushbutton select* mouse button, **9**
- pws command, **117**

- Q** QUALIFIER parameter, **415-417**  
qualifier, glossary definition of, **650**  
quick start, solving problems, **29-32**
- R** READY CMB signal, **237**  
real number form, **131**  
recall buffer, **7**  
    columns, **527**  
    initial content, **527-528**  
    lines, **527**  
    recalling entries, **61**  
recursion in SPMT measurements, **260**  
redisplay memory locations, **132**  
registers, **366, 373, 405**  
    displaying, **20**  
    modify, **146**  
    to view and modify, **144-147**  
relative, glossary definition of, **650**  
release\_system, end command option, **28, 283**  
repeat the previous trace command, **223**  
reset command, **143**  
    options, **418**  
reset trace display defaults, **199**  
resource  
    *See X resource*  
RESOURCE\_MANAGER property, **570-571**  
restart terms, **215**  
root pointers both used in deMMUer resources, **340**  
run command, **135**  
    options, **419-420**  
run from reset command, **135**  
run from transfer\_address command, **135**
- S** scheme files (for X resources), **519, 572-574**  
    color scheme, **520, 524, 573**  
    custom, **524-525, 574**  
    input scheme, **520, 573**  
    label scheme, **520, 524, 573**  
    platform scheme, **520, 572**  
    size scheme, **520, 573**  
scripts with command files, **73**  
scroll bar, **7**

**@sd** defined, **325**  
*select* mouse button, **9**  
sequence definition, **207**  
sequencing and windowing specification, **217**  
SEQUENCING parameter, **421-422**  
server, X, **518, 570**  
set command, **94, 183-202**  
    options, **423-428**  
set default command, **199**  
set source off command, **194**  
set source on command, **194**  
set source only command, **194**  
set symbols all command, **193**  
set symbols high command, **193**  
set symbols low command, **193**  
set symbols off command, **193**  
set symbols on, **129**  
set symbols on command, **109-119, 193**  
set update command, **132**  
set width label command, **195**  
set width mnemonic command, **195**  
set width source command, **195**  
Settings Display Modes dialog box operation, **64**  
shell scripts with command files, **73**  
shell variables with command files, **73**  
SHORT defined in address mapping display, **328**  
should analyzer drive or receive trig2?, **251**  
should BNC drive or receive Trig1?, **248, 250**  
should BNC drive or receive trig2?, **251**  
should CMBT drive or receive trig1?, **247-249**  
should CMBT drive or receive trig2?, **251**  
sig INT, **267**  
signals, CMB, **237**  
simulated I/O, **276, 374**  
simultaneous program run, to start, **252**  
single-step, **140**  
size scheme, **520, 573**  
small page mode of deMMUer defined, **336**



- softkey interface, **4**
  - command conventions, **5**
  - command descriptions, **350**
  - entering commands, **47**
  - getting online help on commands, **52**
  - how to use it, **35**
  - introduction to using, **36**
  - manipulating the display with control keys, **67**
  - SPARCsystem, **534**
- softkey pushbuttons, **7**
- software
  - breakpoints, **374, 405**
  - installation for HP 9000, **608-614**
  - installation for SPARCsystems, **615-620**
- software breakpoints
  - clearing, **154**
  - clearing all breakpoints, **156**
  - displaying and seeing their status, **156**
  - see execution breakpoints, **148-149, 151-157**
- software enable for the MMU, **321**
- software performance analyzer
  - comparison to SPMT, **256**
  - forwarding commands to, **88**
  - opening a measurement window, **45**
- software performance measurements
  - See* performance measurements
- source lines
  - display in trace list, **194**
  - memory display, **122-123**
  - trace display, **122-123**
- source/symbols in displays, **158**
- @sp defined, **325**
- SPARCsystem
  - assembler defaults, **543**
  - keyboard template, **537**
  - librarian defaults, **544**
  - linker defaults, **543**
  - softkey interface introduction, **534, 540**
  - using Microtec commands, **542**
  - using Microtec Language Tools, **541-544**
  - using the keyboard, **534-536**

- SPARCsystem softkey interface, **533**
- SPARCsystems
  - installing software, **615-620**
  - minimum system requirements overview, **579**
  - SunOS minimum version, **579**
- specifications
  - altitude, **561**
  - clock, **546**
  - CMB, **562**
  - data communications, **562**
  - humidity, **561**
  - probe dimensions, **560**
  - temperature, **561**
  - trigger in/out, **561**
- specifications of the emulators, **545**
- specify command
  - options, **429-430**
- specify run command, **243**
- specify run disable command, **244**
- specify trace command, **243**
- specify trace dequeueing options, **189**
- specify trace disassembly options, **187**
- SPMT (Software Performance Measurement Tool)
  - See* performance measurements
- SPMT measurements
  - using recursion, **260**
  - with prefetch correction, **260**
- SRU (Symbolic Retrieval Utilities), **109**
- srbuid, **109**
- srbuid command, **99**
- start simultaneous program run, **252**
- states, change the number available for display, **201**
- static discharge, protecting the emulator probe against, **161**
- static memory system, loadig deMMUer, **203**
- static virtual memory system, **317**
- status
  - seeing status before interface startup, **41**
- status line, **7**
  - display, **44**
  - update with command files, **74**

- status range command, **213**
- status values, **212**
- step command, **16, 135-143**
  - options, **431-433**
- step from command, **140**
- step silently command, **140**
- stop\_trace command, **175**
  - options, **434**
- storage qualifier, **219**
  - defining, **182**
- store command, **105**
  - options, **435-436**
- store qualifier, glossary definition of, **652**
- store trace command, **229**
- store trace\_spec command, **228, 230**
- storing and loading, **102-108**
- strange addresses in trace from deMMUer, **333**
- summary of commands, **360**
- SunOS, minimum version, **579**
- switching directory context in configuration window, **284**
- Symbol Selection dialog box operation, **64**
- symbols, **208**
  - database loading, **110**
  - displaying in memory and traces, **124**
  - displaying in trace list, **193**
  - displaying the parent symbol, **114**
  - entering, **116**
  - handling, **109**
  - introduction, **109-119**
- symbols (SYMB), **437-444**
- symbols that don't agree with code, correct by offsetting addresses, **129**
- synchronous measurements, **243**
  - disabling, **244**
  - starting, **244**
- syntax
  - command conventions in manual, **358**
  - conventions, **358**
- syntax error in display registers MMU command, **145**

- system requirements
  - HP 64700 minimum version, **578-579**
  - HP 9000 overview, **578**
  - HP-UX minimum version, **578**
  - OSF/Motif HP 9000/700 requirements, **578**
  - SPARCsystem overview, **579**
  - SunOS minimum version, **579**
- systems, virtual memory explained, **317**
- T**
  - table details for a single logical address, **169, 328**
  - TAKEN, NOT TAKEN, and ?TAKEN? in trace list, **190**
  - target system probe
    - probe installation, **161**
    - probing sockets, **163**
  - temperature specifications, **561**
  - temporary software breakpoints, setting, **152**
  - terminal interface
    - commands to avoid, **89**
    - commands used in high level interface, **224**
    - copying screen to a file, **90**
    - defined, **89-93**
    - displaying screen, **90**
    - entering commands, **91**
    - getting help, **93**
  - terms and their definitions, **641-655**
  - time range file format (SPMT measurements), **264**
  - trace, **367**
    - at EXECUTE, **243**
    - continuous stream of execution, **224**
    - count states, **218**
    - count time, **218**
    - display options, **385-389**
    - display status, **177**
    - displaying count information, **196**
    - displaying without disassembly, **191**
    - introduction, **173-182**
    - loading data, **231**
    - loading specifications, **230**
    - modify specifications, **222**
    - on program halt, **221**
    - repeat the previous command, **223**
    - reset display defaults, **199**

trace (continued)

- restoring data, **228-231**
- restoring specifications, **228-231**
- saving data, **228-231**
- saving specifications, **228-231**
- specify sequence, **214**
- starting, **174**
- stopping, **175**
- storing data, **229**

trace about command, **181**

trace after command, **181**

trace again command, **223, 230**

trace arm\_trig2 command, **251**

trace before command, **181**

trace break\_on\_trigger command, **246**

trace command, **174, 180, 182, 243**

- options, **445-448**
- setting up for SPMT measurements, **262**
- to edit and execute the last trace command, **179**

trace counting anystate command, **218**

trace counting command, **218**

trace counting off command, **196, 218**

trace counting time command, **218**

trace depth, how to change, **178**

trace dequeuing, specifying options, **189**

trace disassembly, specifying options, **187**

trace display depth, SPMT measurements, **262**

trace enable command, **216**

trace expressions

- address values, **212**
- data values, **212**
- range, **213**
- status values, **212**

trace find\_sequence command, **214-215**

trace list

- disassembly, **186**
- display around specific line number, **200**
- display source lines, **194**
- displaying, **175, 183-202**
- move through, **199**
- offset addresses, **198**

- trace modify\_command command, **222**
- trace on\_halt command, **221**
- trace only command, **219**
- trace prestore anything command, **220**
- trace prestore command, **220**
- trace signals of the emulation-bus analyzer, **209**
- trace windowing, **216**
- translation
  - details of single logical address, **167**
  - of single address through MMU, **326**
  - table details for a logical address, **169**
- trigger
  - BNC signal, **238**
  - CMB signal, **237**
  - definition of, **207**
  - how to specify for a trace, **181**
  - in/out specifications, **561**
  - one analyzer with another, **253**
  - parameter, **449-450**
  - qualifier, how to define, **180**
  - setting position, **181**
- troubleshooting, **628**
- tutorials, setting up, **529-531**
  
- U** U in LU field of address mapping display, **327**
  - @**ud** defined, **325**
  - AND, **451**
  - UNIX commands
    - entering, **94**
    - with command files, **73**
  - @**up** defined, **325**
  - using the softkey interface, **36**
  
- V** values, **207**
  - verifying emulator performance, **626**
  - version, firmware, **638**
  
- W** wait command
  - options, **452-453**
  - with command files, **74, 80**
- warnings, power must be OFF during installation, **587**

- widget resource
  - See* X resource
- WINDOW parameter, **454-455**
- windowing and sequencing specification, **217**
- windows
  - maximum number of, **37**
  - opening additional emulator/analyzer, **44**
  - running the emulator/analyzer interface in multiple, **39**
- word format, **127**
- workstation
  - HP 9000 memory needs, **578**
  - HP 9000 minimum performance, **578**
  - SPARCsystem memory needs, **579**
  - SPARCsystem minimum performance, **579**
- X**
  - X client, **518**
  - X resource, **518**
    - \$XAPPLRESDIR directory, **571**
    - \$XENVIRONMENT variable, **571**
    - .Xdefaults file, **570**
    - /usr/hp64000/lib/X11/HP64\_schemes, **573**
    - app-defaults file, **570**
    - class name for applications, **568**
    - class name for widgets, **568**
    - command line options, **571**
    - commonly modified graphical interface resources, **520**
    - defined, **567-569**
    - general form, **567**
    - instance name for applications, **568**
    - instance name for widgets, **567**
    - loading order, **571**
    - modifying resources, generally, **520-523**
    - RESOURCE\_MANAGER property, **571**
    - scheme file system directory, **573**
    - scheme files, Graphical User Interface, **572-574**
    - scheme files, named, **573**
    - schemes, forcing interface to use certain, **572**
    - Softkey.BW, **573**
    - Softkey.Color, **573**
    - Softkey.Input, **573**
    - Softkey.Label, **573**

## Index

- X resource (continued)
  - Softkey.Large, **573**
  - Softkey.Small, **573**
  - wildcard character, **568**
  - xrdb, **571**
  - xrm command line option, **571**
- X server, **518, 570**
- X Window System, **39**





---

## **Certification and Warranty**

---

### **Certification**

Hewlett-Packard Company certifies that this product met its published specifications at the time of shipment from the factory. Hewlett-Packard further certifies that its calibration measurements are traceable to the United States National Bureau of Standards, to the extent allowed by the Bureau's calibration facility, and to the calibration facilities of other International Standards Organization members.

---

### **Warranty**

This Hewlett-Packard system product is warranted against defects in materials and workmanship for a period of 90 days from date of installation. During the warranty period, HP will, at its option, either repair or replace products which prove to be defective.

Warranty service of this product will be performed at Buyer's facility at no charge within HP service travel areas. Outside HP service travel areas, warranty service will be performed at Buyer's facility only upon HP's prior agreement and Buyer shall pay HP's round trip travel expenses. In all other cases, products must be returned to a service facility designated by HP.

For products returned to HP for warranty service, Buyer shall prepay shipping charges to HP and HP shall pay shipping charges to return the product to Buyer. However, Buyer shall pay all shipping charges, duties, and taxes for products returned to HP from another country. HP warrants that its software and firmware designated by HP for use with an instrument will execute its programming instructions when properly installed on that instrument. HP does not warrant that the operation of the instrument, or software, or firmware will be uninterrupted or error free.

### **Limitation of Warranty**

The foregoing warranty shall not apply to defects resulting from improper or inadequate maintenance by Buyer, Buyer-supplied software or interfacing, unauthorized modification or misuse, operation outside of the environment specifications for the product, or improper site preparation or maintenance.

**No other warranty is expressed or implied. HP specifically disclaims the implied warranties of merchantability and fitness for a particular purpose.**

### **Exclusive Remedies**

**The remedies provided herein are buyer's sole and exclusive remedies. HP shall not be liable for any direct, indirect, special, incidental, or consequential damages, whether based on contract, tort, or any other legal theory.**

Product maintenance agreements and other customer assistance agreements are available for Hewlett-Packard products.

For any assistance, contact your nearest Hewlett-Packard Sales and Service Office.

---

# Safety

---

## Summary of Safe Procedures

The following general safety precautions must be observed during all phases of operation, service, and repair of this instrument. Failure to comply with these precautions or with specific warnings elsewhere in this manual violates safety standards of design, manufacture, and intended use of the instrument. Hewlett-Packard Company assumes no liability for the customer's failure to comply with these requirements.

### Ground The Instrument

To minimize shock hazard, the instrument chassis and cabinet must be connected to an electrical ground. The instrument is equipped with a three-conductor ac power cable. The power cable must either be plugged into an approved three-contact electrical outlet. The power jack and mating plug of the power cable meet International Electrotechnical Commission (IEC) safety standards.

### Do Not Operate In An Explosive Atmosphere

Do not operate the instrument in the presence of flammable gases or fumes. Operation of any electrical instrument in such an environment constitutes a definite safety hazard.

## **Keep Away From Live Circuits**

Operating personnel must not remove instrument covers. Component replacement and internal adjustments must be made by qualified maintenance personnel. Do not replace components with the power cable connected. Under certain conditions, dangerous voltages may exist even with the power cable removed. To avoid injuries, always disconnect power and discharge circuits before touching them.

## **Designed to Meet Requirements of IEC Publication 348**

This apparatus has been designed and tested in accordance with IEC Publication 348, safety requirements for electronic measuring apparatus, and has been supplied in a safe condition. The present instruction manual contains some information and warnings which have to be followed by the user to ensure safe operation and to retain the apparatus in safe condition.

## **Do Not Service Or Adjust Alone**

Do not attempt internal service or adjustment unless another person, capable of rendering first aid and resuscitation, is present.

## **Do Not Substitute Parts Or Modify Instrument**

Because of the danger of introducing additional hazards, do not install substitute parts or perform any unauthorized modification of the instrument. Return the instrument to a Hewlett-Packard Sales and Service Office for service and repair to ensure that safety features are maintained.

## **Dangerous Procedure Warnings**

Warnings, such as the example below, precede potentially dangerous procedures throughout this manual. Instructions contained in the warnings must be followed.

---

**Warning**

---

Dangerous voltages, capable of causing death, are present in this instrument. Use extreme caution when handling, testing, and adjusting.

## Safety Symbols Used In Manuals

The following is a list of general definitions of safety symbols used on equipment or in manuals:



Instruction manual symbol: the product is marked with this symbol when it is necessary for the user to refer to the instruction manual in order to protect against damage to the instrument.



Hot Surface. This symbol means the part or surface is hot and should not be touched.



Indicates dangerous voltage (terminals fed from the interior by voltage exceeding 1000 volts must be marked with this symbol).

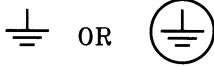

Protective conductor terminal. For protection against electrical shock in case of a fault. Used with field wiring terminals to indicate the terminal which must be connected to ground before operating the equipment.



Low-noise or noiseless, clean ground (earth) terminal. Used for a signal common, as well as providing protection against electrical shock in case of a fault. A terminal marked with this symbol must be connected to ground in the manner described in the installation (operating) manual before operating the equipment.

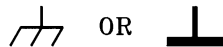

Frame or chassis terminal. A connection to the frame (chassis) of the equipment which normally includes all exposed metal structures.



Alternating current (power line).



Direct current (power line).



Alternating or direct current (power line).

---

**Caution**

---

The Caution sign denotes a hazard. It calls your attention to an operating procedure, practice, condition, or similar situation, which, if not correctly performed or adhered to, could result in damage to or destruction of part or all of the product.

---

**Warning**

---

The Warning sign denotes a hazard. It calls your attention to a procedure, practice, condition or the like, which, if not correctly performed, could result in injury or death to personnel.