

Honeywell

ALM ASSEMBLER
PROGRAM LOGIC MANUAL

SERIES 60 (LEVEL 68)

MULTICS

SOFTWARE

RESTRICTED DISTRIBUTION

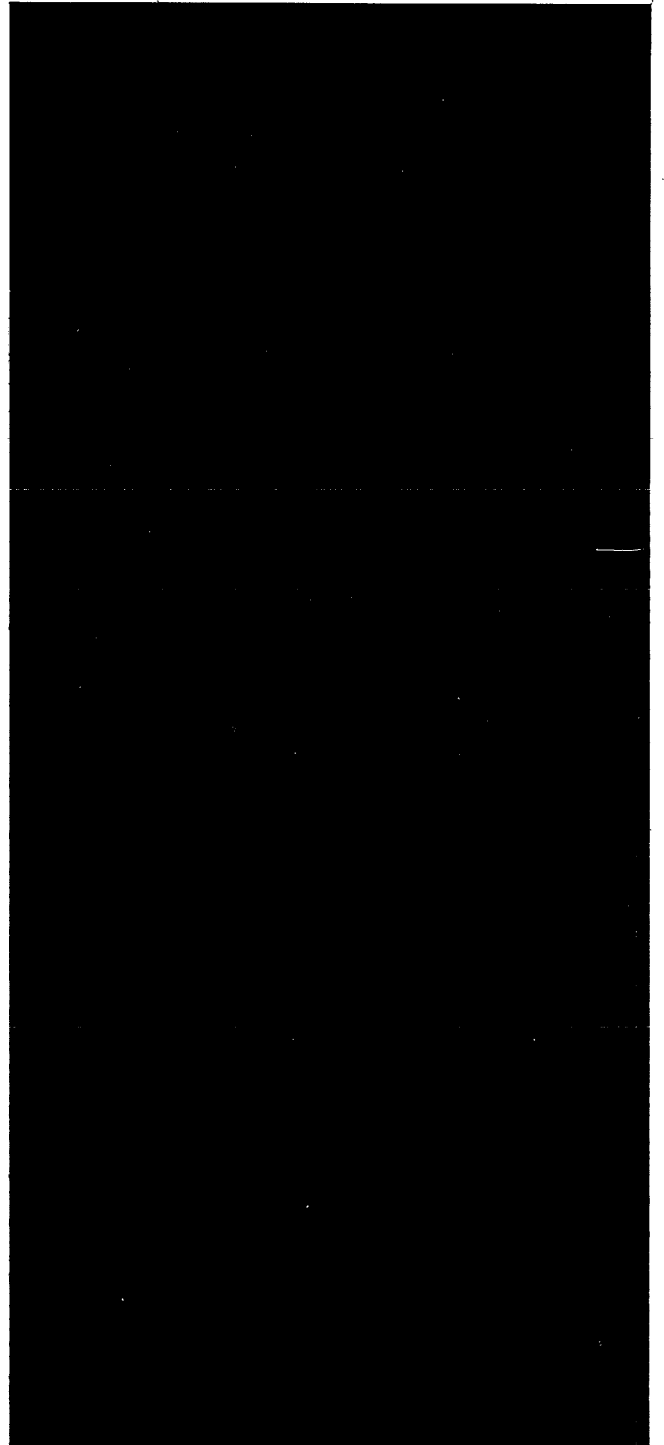

SERIES 60 (LEVEL 68)

MULTICS

RESTRICTED DISTRIBUTION

SUBJECT:

This Document is a Description of the ALM Assembler.

SPECIAL INSTRUCTIONS:

This Program Logic Manual (PLM) describes certain internal modules constituting the Multics System. It is intended as a reference for only those who are thoroughly familiar with the implementation details of the Multics operating system; interfaces described herein should not be used by application programmers or subsystem writers; such programmers and writers are concerned with the external interfaces only. The external interfaces are described in the Multics Programmers' Manual, Commands and Active Functions (Order No. AG92), Subroutines (Order No. AG93), and Subsystem Writers' Guide (Order No. AK92).

As Multics evolves, Honeywell will add, delete, and modify module descriptions in subsequent PLM updates. Honeywell does not ensure that the internal functions and internal module interfaces will remain compatible with previous versions.

This PLM is one of a set which, when complete, will supersede the System Programmers' Supplement to the Multics Programmers' Manual (Order No. AK96).

THE INFORMATION CONTAINED IN THIS COPYRIGHTED DOCUMENT IS THE EXCLUSIVE PROPERTY OF HONEYWELL INFORMATION SYSTEMS. DISTRIBUTION IS LIMITED TO HONEYWELL EMPLOYEES AND CERTAIN USERS AUTHORIZED TO RECEIVE COPIES. THIS DOCUMENT SHALL NOT BE REPRODUCED OR ITS CONTENTS DISCLOSED TO OTHERS IN WHOLE OR IN PART.

DATE:

February 1975

ORDER NUMBER:

AN63, Rev. 0

PREFACE

Multics Program Logic Manuals (PLMs) are intended for use by Multics system maintenance personnel, development personnel, and others who are thoroughly familiar with Multics internal system operation. They are not intended for application programmers or subsystem writers.

The PLMs contain descriptions of modules that serve as internal interfaces and perform special system functions. These documents do not describe external interfaces, which are used by application and system programmers.

Since internal interfaces are added, deleted, and modified as design improvements are introduced, Honeywell does not ensure that the internal functions and internal module interfaces will remain compatible with previous versions. To help maintain accurate PLM documentation, Honeywell publishes a special status bulletin containing a list of the PLMs currently available and identifying updates to existing PLMs. This status bulletin is distributed automatically to all holders of the System Programmers' Supplement to the Multics Programmers' Manual (Order No. AK96) and to others on request. To get on the mailing list for this status bulletin, write to:

Large Systems Sales Support
Multics Project Office
Honeywell Information Systems Inc.
Post Office Box 6000 (MS A-85)
Phoenix, Arizona 85005

This PLM assumes that the reader is familiar with the description of the ALM language in the Multics Programmers' Manual, Subsystem Writers' Guide (Order No. AK92).

Throughout this manual, references are frequently made to two of the four manuals that are collectively referred to as the Multics Programmers' Manual (MPM). For convenience, these references will be as follows:

<u>Document</u>	<u>Referred To In Text As</u>
<u>Subroutines</u> (Order No. AG93)	MPM Subroutines
<u>Subsystem Writers' Guide</u> (Order No. AK92)	MPM Subsystem Writers' Guide

CONTENTS

	Page
Section I	Overview..... 1-1
	Features Available..... 1-1
	Features Not Available..... 1-2
Section II	Overall Operation..... 2-1
	The First Pass: pass1_..... 2-1
	The Second Pass: pass2_ 2-3
	The Post Assembly Processor: postp2_ ... 2-4
Section III	Details of Internal Operation..... 3-1
	Access to the Assembler..... 3-1
	Structure of the Data Base, g1p1_ 3-1
	Assignment Table Structure, table_ 3-1
	Evaluation of Variable (Operand/Address) Field..... 3-4
	Linkage and List Maintenance..... 3-7
	Evaluating Data Fields (Constants)..... 3-13
	Input..... 3-14
	Output..... 3-14
	Output of the Listing..... 3-15
	Utility Programs..... 3-15
Section IV	Subroutine Summary..... 4-1

CONTENTS (cont)

	Page
ILLUSTRATIONS	
Figure 2-1	Assembler List Maintenance Block..... 2-3
Figure 3-1	Internal Symbol Block..... 3-2
Figure 3-2	Multiple Location Symbol Block..... 3-2
Figure 3-3	Literal List Block Structure..... 3-7
Figure 3-4	Structure of a namlst Block..... 3-8
Figure 3-5	Structure of a Type-Pair Block..... 3-9
Figure 3-6	Structure of a Trap-Pointer List Entry..... 3-9
Figure 3-7	Structure of a Normal explst Block..... 3-10
Figure 3-8	Structure of an Entry Point Interlude Block..... 3-11
Figure 3-9	Structure of a segdef Block..... 3-11
Figure 3-10	Schematic Object Code for "lda" Instruction..... 3-12

SECTION I

OVERVIEW

The ALM (assembly language for Multics) assembler translates a stream of ASCII characters, which represents the source code for a Multics program written in the ALM language, into a Multics standard binary object segment. It optionally produces a listing of the text of the program followed by linkage data, symbol definitions, and a cross-reference table. The assembler is accessed by invoking the alm command with appropriate arguments. (See MPM Subsystem Writers' Guide.)

FEATURES AVAILABLE

The following is a partial list of the features that are available to the ALM programmer.

1. The entire machine instruction repertoire can be used.
2. Pointer register names are known to the assembler so that "epp4" and "eppl" can be used interchangeably.
3. Data generation and storage allocation pseudo-operations can be used.
4. Variable field literals can be used.
5. Literals with du and dl modification can be used.
6. Complete address field modification can be used.
7. User-defined location counter controls are available.

FEATURES NOT AVAILABLE

The following is a list of features that are not available to the ALM programmer.

1. Macro and macro-related operations
2. Most listing control pseudo-operations.

NOTE: Throughout the rest of this manual, pseudo-operations will be identified as pseudo-ops.

SECTION II

OVERALL OPERATION

The ALM assembler is a two-pass translator. It also includes a post assembly processor that produces Multics intersegment linkage data and symbol table data for the object program. (The linkage format and symbol table data are described in the MPM Subsystem Writers' Guide.) The first and second passes and the post assembly processing are handled by the `pass1_`, `pass2_`, and `postp2_`, procedures. These procedures are essentially administrative procedures that call common subroutines to perform the required functions. A list of these subroutines can be found in Section IV of this manual.

THE FIRST PASS: `pass1_`

The primary function of the first pass is to define all symbols internal to the program being assembled. An internal table of symbols and their values are generated. The values are used by `pass2_` to generate the variable address fields of the instructions. The predefined system location counters used by `pass1_` are initialized as though they were internal symbols within the object program.

Symbols are defined by `pass1_` as follows. A program counter is updated as each source instruction is processed. In the case of certain pseudo-ops, the counter is incremented by 1 for a group of instructions. Each value of the program counter represents one binary word in the object segment. The values are used by `pass2_` to assign locations to the binary words. Each time `pass1_` encounters a new symbol in the label field of a statement, it defines the symbol with the current value of the program counter; the symbol is assigned to the internal symbol table by the subroutine `table_`.

Symbols that have been defined by pseudo-ops are handled differently depending on the pseudo-op being processed.

1. Internal symbols are defined as described above.
2. External symbols, possibly including a trap pointer, are assembled as a result of the basref and segref pseudo-ops.
3. External symbols defined relative to the stack pointer base (pr6) result from the temp, tempd, and temp8 pseudo-ops.
4. Symbols resulting from the use pseudo-op are defined as internal location counter references and are collected at their corresponding join pseudo-ops.
5. The bool, equ, and link pseudo-ops cause symbols to be defined in terms of expressions given in the arguments of the pseudo-ops.

For more details on pseudo-ops, see the alm command description in the MPM Subsystem Writers' Guide. If a symbol cannot be defined in pass1_, pass2_ will attempt to define it.

Literals are also processed by pass1_. They are evaluated and assigned to the pool of literals (literal table). They are not assigned a specific location until pass2_ because the length of the object program up to its end statement is not known during pass1_. No literal appears twice. The pool is maintained in order by pointers associated with each literal. (See Section III of this manual for more detail.)

The first pass does not produce an intermediate or collation segment; the second pass rereads the input stream from the beginning. A list, ordered by the value of the program counter after each source statement has been processed, is generated by pass1_. This list is checked for correspondence by pass2_. If it does not correspond, a phase error is signalled. The format of each block in the list is given in Figure 2-1 below.

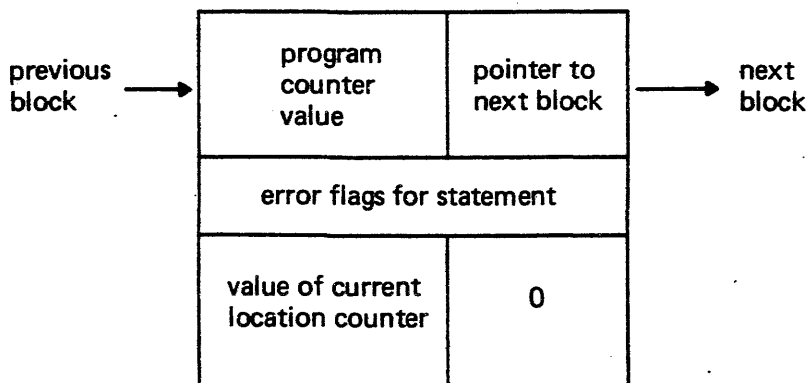

Figure 2-1. Assembler List Maintenance Block

THE SECOND PASS: pass2_

The second pass of the ALM assembler generates the binary output associated with each input statement. It also generates the assembly listing and completes information (literals, segdef names, etc.) to be generated by the post assembly processor postp2_.

The binary code for a normal instruction is generated as follows. The oplook_ subroutine is called to find the binary equivalent of the symbolic operation code in a table (alphabetically ordered) that is associated with the oplook_ procedure. The binary value of the variable address field is determined by the varevl_ subroutine. The operation code and address field are assembled in a binary word equivalent to the symbolic instruction. When a newline character (ASCII code 012) is encountered, prwr_ is called to generate the listing.

The binary code for pseudo-ops is generated as follows. First the symbols are evaluated to make sure their values are the same as those determined by pass1_. System pseudo-ops (call, push, return, entry, etc.) are expanded to generate the special code they imply. Single word pseudo-ops (zero, setlp, vfd, etc.) are evaluated individually and their binary values generated.

Since many pseudo-ops generate more than one word of equivalent printed output, the listing for a given source line is maintained in a buffer by the prwd_ subroutine until a newline character indicating the end of a source statement is encountered.

The pass2_ procedure checks the input stream for syntax errors and monitors the assembler itself for possible malfunctions. The errors that were detected by pass1_ are transmitted to pass2_, which may add to or duplicate the errors signalled for a given statement. If a phase error occurs (pass1_ and pass2_ program and/or current location counters do not match), the assembly is aborted.

THE POST ASSEMBLY PROCESSOR: postp2_

The post assembly processor for the ALM assembler serves two major functions:

1. It processes and generates all the definition information (i.e., the contents of the definition section of the object segment).
2. It generates the linkage block and the symbol table header for the object segment.

For the text portion, postp2_ generates binary output for:

1. literals
2. entry points

For the definition section, postp2_ generates binary output for:

1. segdef definitions
2. external names
3. trap-pointer words
4. type-pair words
5. internal expression words

The order of output of this information is important because the previous items are referenced by the later ones and thus the binary locations must be known.

For the linkage block, the post assembly processor writes out the linkage header and the linkage pairs.

The post assembly processor has the overall task of defining the locations for all the information it puts out. Relative pointers are the only connection within the assembler among the linkage pairs, expression words, type-pair words, trap-pointer words, external names, and segment names.

SECTION III

DETAILS OF INTERNAL OPERATION

ACCESS TO THE ASSEMBLER

The assembler is entered from the `alm` command by a call to the `alm_6180_` procedure. This central procedure calls the main programs of the assembler and reports assembly on the `user_output` switch.

STRUCTURE OF THE DATA BASE, `gpl_`

Every item of information maintained by the assembler is kept in a list structure. The total list structure is accessed via entry points of `gpl_` (general list processing language).

ASSIGNMENT TABLE STRUCTURE, `table_`

The table of symbols (assignment table) is maintained as a list of all symbols that have been defined within the program. The list and structure is managed by the `table_` procedure.

The assigned symbols fall into a number of classes (eight at present), which include internal, external, and stack. The class is indicated in the flag field of the table entry (see Figure 3-1 below). A given symbol can be assigned to more than one class with no conflict since the class of symbol is recognized by its contextual use.

The symbols are constructed from a character string (up to 31 ASCII characters) and the count of the string.

The assignment table is not one long list of symbols, but 211 (a convenient prime) lists. The symbols are distributed randomly among these lists according to the following procedure.

The first word of the symbol is taken; a constant is added to it; the resultant value mod 211 is extracted. This value specifies which of the 211 lists is to be searched for the symbol. The list entries for internal symbols and multiple location counter symbols are, respectively, the three-word or five-word blocks pictured in Figures 3-1 and 3-2 below.

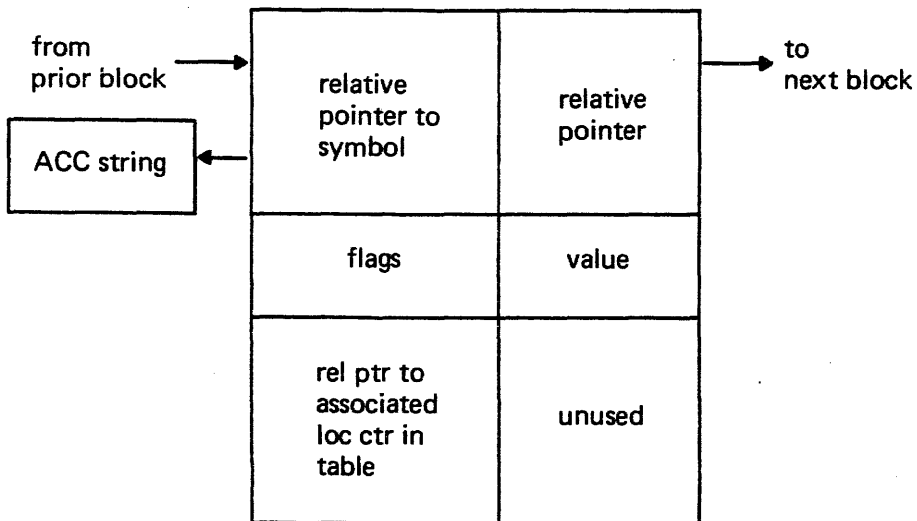

Figure 3-1. Internal Symbol Block

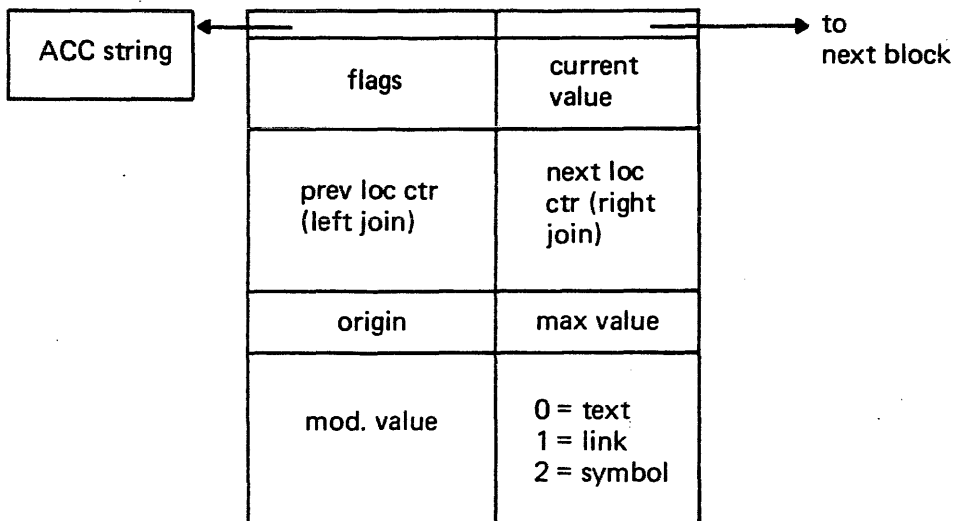

Figure 3-2. Multiple Location Symbol Block

The following list explains the terms used in Figures 3-1 and 3-2.

value is an 18-bit number that is the value of the program counter when the symbol was encountered.

flags is a 3-bit class number and a 15-bit indicator field.

Class number:

clunk	0	undefined
clint	1	internal
clept	2	external
clbas	3	pointer register (unused)
clstk	4	stack
clndx	5	index register (unused)
clmlc	6	multiple location counter
	7	unused

Note: If a symbol belongs to more than one class, a different block for each class will appear in the list.

Indicator bits:

fdef	00001	symbol defined
fmal	00002	multiple definition
fpks	00004	in phase error
fset	00010	symbol resettable
frel	00020	relocatable
fabs	00040	absolute
fbol	00100	Boolean

fcom 00200 in common
 find 00400 value is indirect reference

Note: Only nine of the 15 are used; they may be ORed together.

EVALUATION OF THE VARIABLE (OPERAND/ADDRESS) FIELD

The variable field is evaluated by two subroutines, varevl_ and expevl_. Instructions and pseudo-ops are treated differently. The variable field of instructions may contain an external reference followed by an internal expression or simply an internal expression, either of which may be followed by a comma and modifier. Some pseudo-ops are constructed like normal instructions while others have specific requirements, e.g., the evaluation of internal or Boolean expressions. The varevl_ subroutine handles the evaluation and formatting of external references. Arithmetic or Boolean expressions are evaluated by expevl_, which may be called either by varevl_ or the main passes.

The values of symbols and expressions may be either absolute or relative to some location counter (lc). The operands of the arithmetic operators are restricted to the combinations in the following list:

<u>operand 1</u>	<u>operator</u>	<u>operand 2</u>	= <u>result</u>
absolute	+	absolute	= absolute
relative to lc	+	absolute	= relative to lc
absolute	+	relative to lc	= relative to lc
absolute	-	absolute	= absolute
relative to lc	-	absolute	= relative to lc
relative to lc	-	relative to lc	= absolute
absolute	*	absolute	= absolute
absolute	/	absolute	= absolute
-none-	(unary)-	absolute	= absolute

Expressions evaluated by `pass1_`, such as those appearing in `equ` and `org` pseudo-ops, must be absolute.

Procedure `varevl_` may be called in three cases:

1. to evaluate a full address field (possibly external, possibly literal).
2. to evaluate a complete internal expression with no modifier.
3. to evaluate a pure Boolean expression with no modifier.

If the address field is an external reference, `varevl_` checks for an address in one of the following formats:

EXTERNAL

1. `<seg>|[xname]_+inexp,mod`
2. `<seg>|inexp,mod`
3. `pr|[xname]_+inexp,mod`
4. `pr|inexp,mod`
5. `segref_name+_inexp,mod` (segref_name or basref_name)
6. `stackname+_inexp,mod`
7. `inexp,mod`
8. `=literal,mod`

The first six examples above are references external to the segment being assembled and cause `varevl_` to turn on bit 29 of the instruction. Examples 1, 2, 3, and 5 cause entries to be made in the link, type block, and external name lists and force the instructions to be referenced through the linkage segment (e.g., use `pr4 = lp` with bit 29 set on). Conversely, examples 4 and 6 cause reference to be made directly to the segment without making entries in any of the assembler's tables or lists. The internal expressions, the literals, and the modifiers are evaluated by `expevl_`, `litevl_`, and `modevl_`, respectively.

Subroutine `expevl_` is responsible for evaluating arithmetic and Boolean expressions consisting entirely of symbols, numbers, operators (+, -, *, and /), parentheses, and expression terminators (e.g., blank, comma, semicolon, etc.). Parentheses bracket subexpressions and they may be nested to any level up to 100 pairs. Expressions are evaluated by a stack technique in

which the operators and delimiters are examined in order of precedence as follows:

<u>Name</u>	<u>Order</u>	<u>Meaning</u>
lndt	1	left end terminator
rndt	2	right end terminator (all others)
(3	left parenthesis
)	4	right parenthesis
+	5	binary plus or Boolean OR
-	5	binary minus or exclusive OR
*	6	binary multiply or AND
/	6	binary divide or AND NOT
neg	7	Unary minus
not	7	Unary NOT

Any unknown operator is given a precedence of 2, which is synonymous with the right end terminator. An excessive right parenthesis is treated as a terminator and if the field ends with an unbalanced left parenthesis, an error is reported and the field is set to zero.

A literal is recognized by varevl_ by the presence of the equal sign (=) in the first position of the variable field and causes varevl_ to invoke subroutine litevl_. Subroutine litevl_ determines the specific type of literal (e.g., its, itp, vfd, etc.) and invokes a particular data field evaluator to process the field. The literals thus evaluated are then placed in a list of literals (the literal pool) in such a way that no literal appears twice.

The structure of a block in the literal list is shown in Figure 3-3 below.

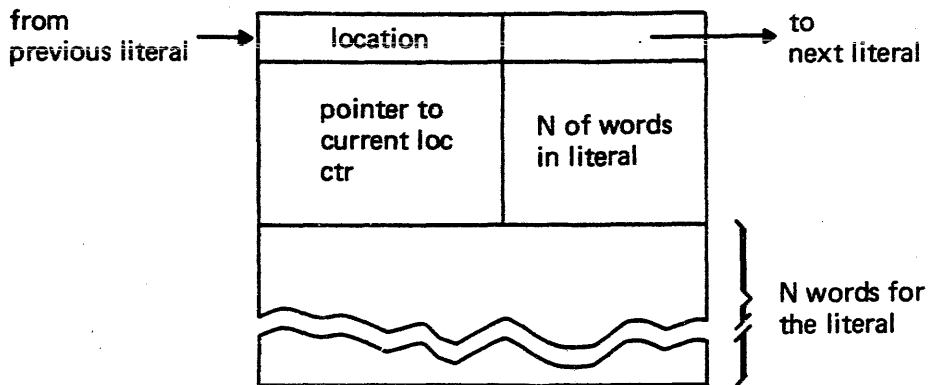

Figure 3-3. Literal List Block Structure

The location of the literal is not assigned until pass2_ when the literal is actually used in the object code. All multiword literals are located at an even location. Single word literals may be located at an odd or even location and are placed in the table so as to fill in any "holes" between multiword entries first. Subroutine litevl_ also checks for the du and dl modifiers and returns the proper address and modifier in such uses. No entry is made in the literal list if du or dl is specified.

The modifier field is evaluated by subroutine modevl_. All types of symbolic (named) modifiers are allowed including the numeric modifiers.

LINKAGE GENERATION AND LIST MAINTENANCE

The information required for intersegment communication is generated and maintained by the following eight entries.

- lstman_\$blkasn
- lstman_\$calser (obsolete)
- lstman_\$eptasn
- lstman_\$lnkasn
- lstman_\$namasn

lstman_\$outasn (obsolete)

lstman_\$sdfasn

lstman_\$trpasn

The namasn entry of lstman_ is responsible for assigning external (segment and location) names to the namlst list and making sure that those names are entered only once. The structure of a namlst block is as shown in Figure 3-4 below.

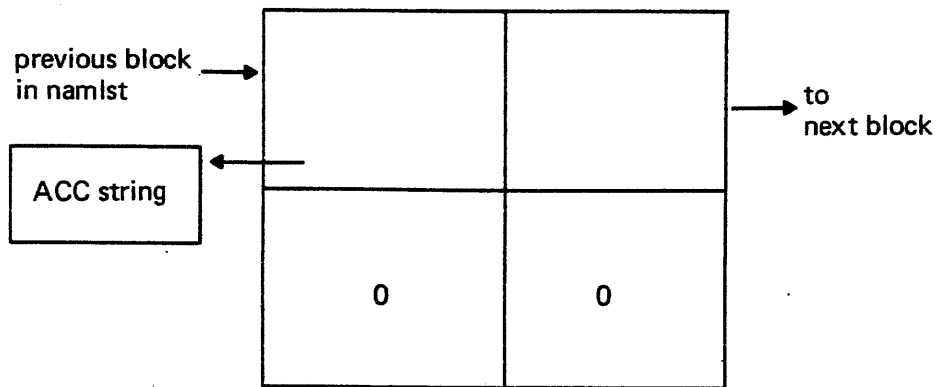

Figure 3-4. Structure of a namlst Block

The blkasn entry of lstman_ is responsible for maintaining the list of type-pair blocks, blklst. A given unique type-pair block is entered only once in the list. The format of a type-pair block is as shown in Figure 3-5 below.

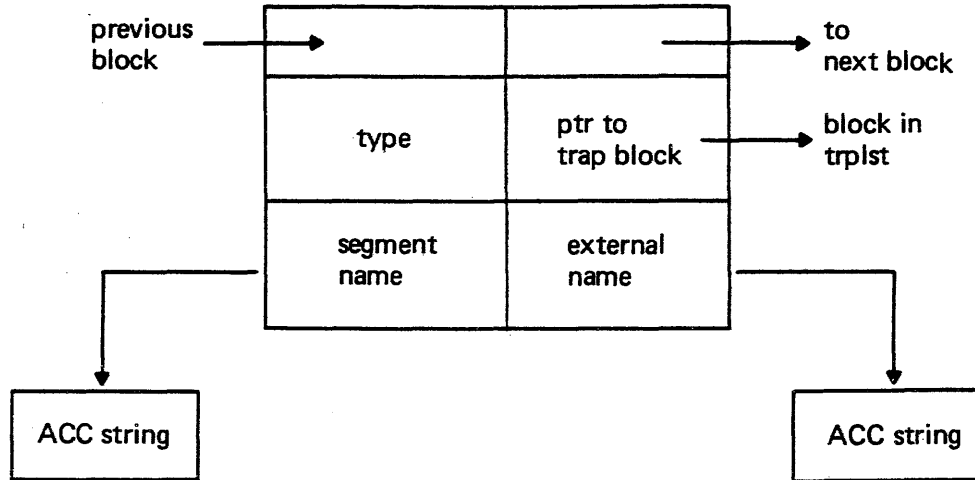

Figure 3-5. Structure of a Type-Pair Block

The trpasn entry of lstman_ is responsible for maintaining the list of trap-pointer words, trplst. No trap-pointer word is entered more than once in the list. A block in this list is constructed as shown in Figure 3-6 below.

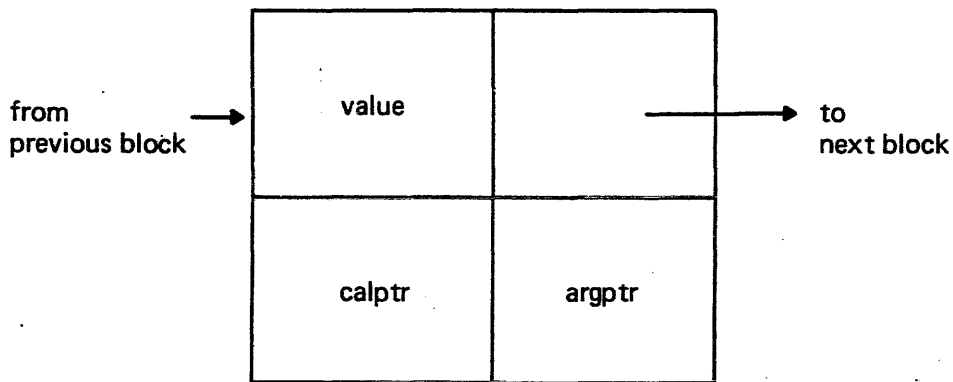

Figure 3-6. Structure of a Trap-Pointer List Entry

The following list explains the terms used in Figure 3-6.

- calptr is the link number of the call to the trap routine
- argptr is the link number of the associated argument list
- value is assigned by postp2_ as the relative location of the trap-pointer word when generated

The lnkasn entry to lstman_ generates and maintains lists of linkage data. The explst is a list of internal expressions. An entry in the explst is a block of the format shown in Figure 3-7 below.

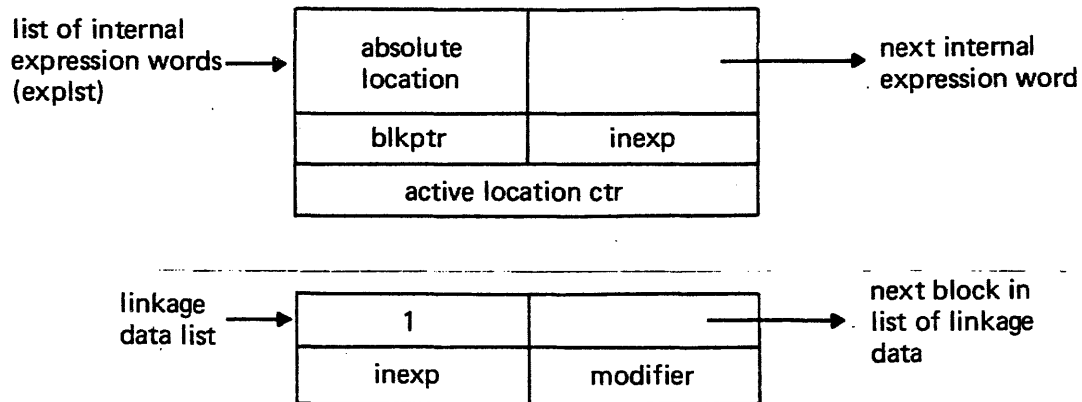

Figure 3-7. Structure of a Normal explst Block

The following list explains the terms used in Figure 3-7.

- blkptr points to the associated type-pair data in the blklist entry
- modifier is the address modifier in the original instruction

The eptasn entry to lstman_ assigns entry points to the link structure list. A block in the list has the format shown in Figure 3-8 below.

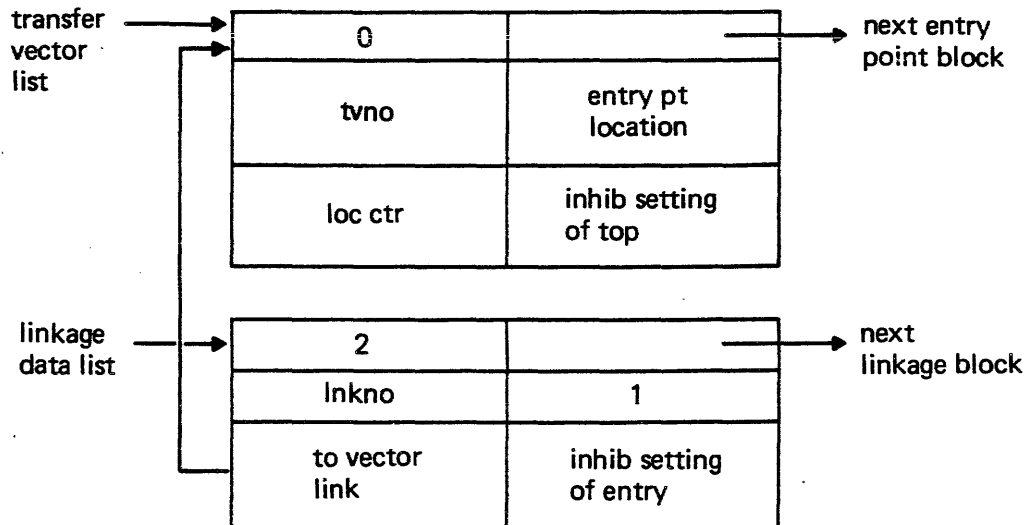

Figure 3-8. Structure of an Entry Point Interlude Block

Information about external names (segdefs) is entered by the sdfasn entry to lstman_ into the definition list, sdf1st. An entry in sdf1st is formatted as shown in Figure 3-9 below.

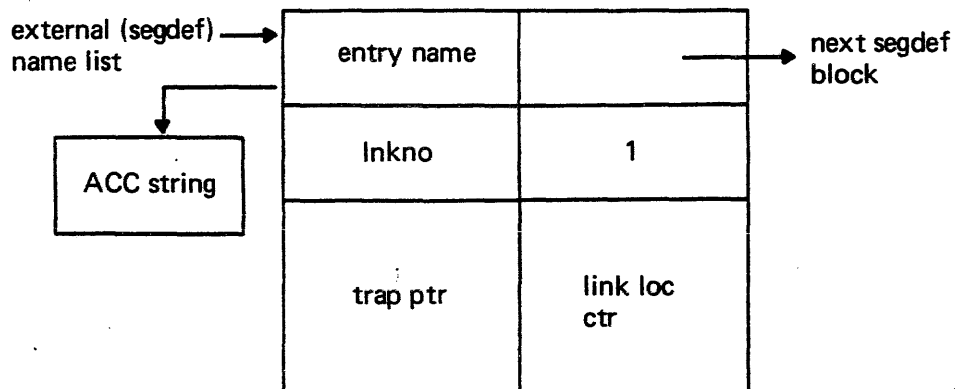

Figure 3-9. Structure of a segdef Block

The overall structure of the linkage information in the above lists implies that the order of definition of final values in the linkage section of the object segment must be 1) names, 2) trap-pointer words, 3) type-pair words, and 4) the internal expression words.

The lists just mentioned (namlst, blkst, trplst, explst, lnkfst, sdfst, outlst) are interconnected with pointers much like words are linked in the text and linkage portions of the object segment. For example, if the instruction:

```
lda <sega>|[namea ]+inexp,mod
```

were assembled, the resulting object code in terms of relative pointers would be as shown in Figure 3-10 below.

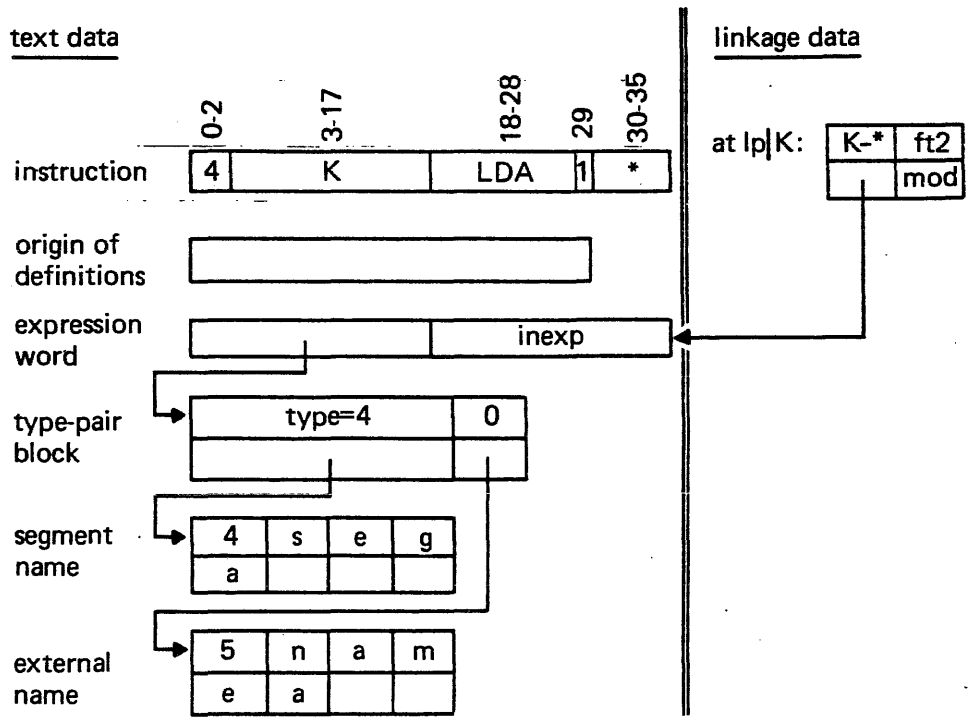

Figure 3-10. Schematic Object Code for "lda" Instruction

EVALUATING DATA FIELDS (CONSTANTS)

Literals and pseudo-ops that produce constants are evaluated by calls to subroutines especially designed for that purpose. Five basic types of constants are allowed: ASCII, BCD, decimal, octal, and vfd. The first two types of fields are evaluated by the subroutine `ascevl_`. The last three are evaluated by `decevl_`, `octevl_`, and `vfdevl_`, respectively.

Subroutine `ascevl_` is used to evaluate the variable field of the `acc`, `aci`, and `bci` pseudo-ops. The variable (character) field is bounded by a nonblank character. No more than 40 words (159 characters for the `acc` pseudo-op, 160 characters for the `aci` pseudo-op, and 240 words for the `bci` pseudo-op) may be generated. Literal fields containing ASCII characters are evaluated by either `litevl_` or `decevl_` depending on their format.

Subroutine `decevl_` is used to evaluate the operand field of a `dec` pseudo-op and to evaluate a decimal field. The field may be integer, fixed, floating, or double precision with the usual conventions for the (decimal) point, and the letters B, D, and E. ASCII literals of the form `"=naxxx"` (e.g., `"=3aSYM"`) are also evaluated by `decevl_`. Decimal words are manipulated by the various entry points in `decsub_`, which handles the decimal values in "triple" precision, one word for the exponent and two words for the mantissa.

Subroutine `octevl_` evaluates the subfields in the operand field of the `oct` pseudo-op and evaluates octal literals of the form `"=oxxx"` (e.g., `"=o675432"`). No signs are allowed, and a check is made for more than 12 characters or a nonoctal digit in the data field.

Subroutine `vfdevl_` evaluates the entire field of a `vfd` pseudo-op and also evaluates `vfd` literals of the form `"=vxxx"`. Three types of `vfd` subfields are allowed: arithmetic, Boolean (octal), and ASCII. The arithmetic and Boolean subfields are processed by `expevl_`, while the ASCII subfields are evaluated by `vfdevl_`.

INPUT

All input to the assembler is processed by `inputs_$next` and `inputs_$nextnb`. These entry points read the next character from the input segment and store the ASCII character with its corresponding code type for the user. The `inputs_$next` entry handles any legitimate Multics character. The `inputs_$nextnb` entry reads any character except a space or horizontal tab. If the previous character was a statement terminator (newline, ASCII code 012; semicolon, 073; or carriage return, 015), `inputs_$nextnb` simply returns to the calling program.

The entry `getid` collects the next complete symbol identifier (up to 31 alphanumeric characters, the first of which must be a letter, period, or underline) and associated break character (tab, blank, comma, etc.). The entry `getnam` collects the next symbol, which may contain any legitimate character. The subroutine `setid_`, like `getid_`, collects the identifier but also assigns it to free storage for subsequent use by the assembler. The procedure `getid_` is a transfer vector to access these three entries (`getid_`, `getnam`, and `setid_`).

OUTPUT

Output operations consist of the generation of an object segment and an optional listing segment. Output for the object segment and the processing of the relocation bits are done as follows:

1. The text is written directly into the final object segment, as it is being assembled.
2. The relocation bits for the text, linkage, and symbol as well as the object linkage and symbol words are temporarily stacked in the assembler's scratch segment. All the entries in the subroutine `object_` manipulate this scratch segment.
3. After `postp2_` has completed its processing, subroutine `pakbit_` is called to process all the relocation bits.
4. Subroutine `merge_` then appends all the object linkage and symbol words, including the packed words of relocation bits from `pakbit_`, to complete the object segment being assembled.

OUTPUT OF THE LISTING

The major part of processing the optional listing segment is done by the `prwr_` subroutine. During `pass2_`, each input character that is read is placed in a one character per word buffer. When a newline character (ASCII code 012) is encountered, `prwr_$source_only` is called to combine the input statement from the source segment with the printed equivalent of the binary word. Whenever a word of binary output is generated, a call is made to `prwr_` to convert that word and its associated location and error flags to printable characters and place the result into the output segment. Subroutines `prlst_` and `prnam_` are also used to generate printable output for the listing segment. The `prlst_` program is used to insert a line of noninput characters (e.g., headings, etc.) into the listing segment. The `prnam_` program generates the characters for ASCII names (e.g., segment names, entry points, etc.) that are inserted in the object segment.

Error comments are transmitted to the user's `error_output` I/O switch (e.g., terminal) and placed in the (optional) listing segment by subroutine `prnter_`. This program calls `ioa_` and `prlst_` to write out the actual line of text. (For a description of `ioa_`, see the MPM Subroutines.)

UTILITY PROGRAMS

The assembler uses a number of smaller subroutines to perform frequently executed tasks. These programs are the following:

1. `gpl_` is a set of routines for performing fast list processing.
2. `utils_` is a set of routines for performing miscellaneous tasks that were required to support the FORTRAN in which the assembler was originally written.

All programs of the assembler use a common data segment named `eb_data_`. This data segment contains pure information in its text portion and impure information in its linkage portion. For details, consult the segment and/or the calling procedures.

SECTION IV
SUBROUTINE SUMMARY

The following is a list of the various subroutines of the assembler, ordered by function:

1. Main control programs

alm	command interface
alm_6180_	drives the major programs of the assembler
pass1_	first pass of ALM
postp1_	post processor for joining multiple location counter
pass2_	second pass of ALM
postp2_	post processor for linkage and symbol data
pakbit_	packs relocation bits
merge_	appends linkage and symbol data to the object segment
alm_eis_parse_	handles EIS multiword instruction pseudo-ops

2. Assignment table maintenance

table_	assigns or searches the internal symbol table
--------	---

3. Variable field evaluation

varevl_	evaluates an operand
expevl_	evaluates a complete expression
modevl_	determines the address modifier
litevl_	evaluates literals

4. Processing list of linkage data

lstman_\$namasn	assigns a symbol to the external name list
lstman_\$blkasn	assigns a type-pair block
lstman_\$lnkasn	assigns a linkage-pair block
lstman_\$trpasn	assigns a trap-pointer block
lstman_\$outasn	assigns a mastermode/executeonly call-out node (obsolete)
lstman_\$calser	searches for a mastermode/executeonly call-out node (obsolete)
lstman_\$eptasn	assigns an entry point node
lstman_\$sdfasn	assigns a segdef node
alm_definitions_	puts out the symbolic definition region

5. Data Generating Subroutines

ascevl_	evaluates acc, aci, and bci variable fields
decevl_	evaluates decimal fields
octevl_	evaluates octal fields
vfdevl_	evaluates vfd fields

6. General Utility Programs

getid_	collects the characters of an identifier
setid_	same as getid_
oplook_	searches for an op-code or pseudo-op symbol
utils_	performs high-speed logical operations
glpl_	manages the "free storage" segment
inputs_	reads the source segment

7. Printing-associated routines

prwr_	converts a binary word to printable characters
prlst_	inserts a line of noninput into the listing
prnter_	reports an error message on the error_output I/O switch and in the listing
prnam_	converts and deposits printable characters into the listing segment from a binary word containing ASCII

8. Manage binary words for the output segment

putout_	determines the portion of the object segment and calls the appropriate subroutine to write out a list or single word into the object segment handler
putxt_	writes a binary word and the associated relocation bits for the text portion of the object segment
pulnk_	writes a binary word and the associated relocation bits for the linkage portion of the object segment

pusmb_ writes a binary word and the associated relocation bits for the symbol portion of the object segment

object_ manages a rigidly formatted scratch segment of binary data

alm_source_map_ creates the source map for the object segment

alm_cross_reference_ formats and prints the cross-reference table

alm_include_file_ manages include files

9. Relocation bit processor

getbit_ determines the relocation bits from the components of an assembled binary word

pakbit_ collects and packs the relocation bits for the object segment

10. Symbol table management

sthdr_ (obsolete) template for symbol table header

new_sthdr_ new version of sthdr

HONEYWELL INFORMATION SYSTEMS

Technical Publications Remarks Form

CUT ALONG LINE

TITLE

SERIES 60 (LEVEL 68) MULTICS ALM
ASSEMBLER PROGRAM LOGIC MANUAL

ORDER NO.

AN63, REV. 0

DATED

FEBRUARY 1975

ERRORS IN PUBLICATION

[Empty box for reporting errors in publication]

SUGGESTIONS FOR IMPROVEMENT TO PUBLICATION

[Empty box for providing suggestions for improvement to publication]



Your comments will be promptly investigated by appropriate technical personnel and action will be taken as required. If you require a written reply, check here and furnish complete mailing address below.

FROM: NAME _____

DATE _____

TITLE _____

COMPANY _____

ADDRESS _____

PLEASE FOLD AND TAPE –

NOTE: U. S. Postal Service will not deliver stapled forms

FIRST CLASS
PERMIT NO. 39531
WALTHAM, MA
02154

Business Reply Mail
Postage Stamp Not Necessary if Mailed in the United States

Postage Will Be Paid By:

HONEYWELL INFORMATION SYSTEMS
200 SMITH STREET
WALTHAM, MA 02154

ATTENTION: PUBLICATIONS, MS 486

Honeywell

CUT ALONG LINE

FOLD ALONG LINE

FOLD ALONG LINE