

KMS11-BD/BE

VAX-11 Installation Manual

1st Edition, April 1983

© Digital Equipment Corporation 1983
All Rights Reserved

The information in this document is subject to change without notice and should not be construed as a commitment by Digital Equipment Corporation. Digital Equipment Corporation assumes no responsibility for any errors that may appear in this document.

Printed in U.S.A.

The following are trademarks of Digital Equipment Corporation:

digital™

DEC
DECmate
DECset
DECsystem-10
DECSYSTEM-20
DECUS

DECwriter
DIBOL
MASSBUS
PDP
P/OS
Professional
Rainbow
RSTS

RSX
TS05
TSV05
UNIBUS
VAX
VMS
VT
Work Processor

PREFACE

This manual provides information for installing and testing the KMS11-BD/BE Communications Processor in the VAX-11 family of processors.

Chapter 1 contains general electrical, mechanical, and operational specifications. This chapter also includes general system configuration, UNIBUS addressing, and related documentation information.

Chapter 2 describes specific installation procedures for current and noncurrent revisions of the KMS. System startup and diagnostic programs are also included.

1.1 GENERAL DESCRIPTION

The KMS11-BD/BE is an intelligent communications interface for use on PDP-11 and VAX-11 systems. This eight-line version of the KMS11, Figure 1-1, consists of a KMC11-B microprocessor, a DMS11-DA line unit, a DM11-BA modem control, and an H317-P distribution panel. The KMS11-BD version is also shipped with a DD11-DK, nine-slot system unit.

A system block diagram is provided in Figure 1-2.

Specifications*

Mechanical

Mounting Requirements	Space for nine-slot system unit, DD11 type
H317-P Distribution Panel	13.125 cm by 47.5 cm (5.25 in by 19.0 in) of rack space

Operational Environment

Class B

Temperature	10°C to 40°C (50°F to 104°F)
Relative Humidity	10% to 90%
Maximum Wet Bulb	28°C (82°F)
Minimum Dew Point	2°C (36°F)

Electrical

Logic	TTL
Interface Levels	RS-232-C, RS-423, MIL-188-114 unbalanced
Power (maximum)	+5 Vdc at 12.5 A +15 Vdc at 1.5 A -15 Vdc at 0.5 A

*Specifications are subject to change without notice.

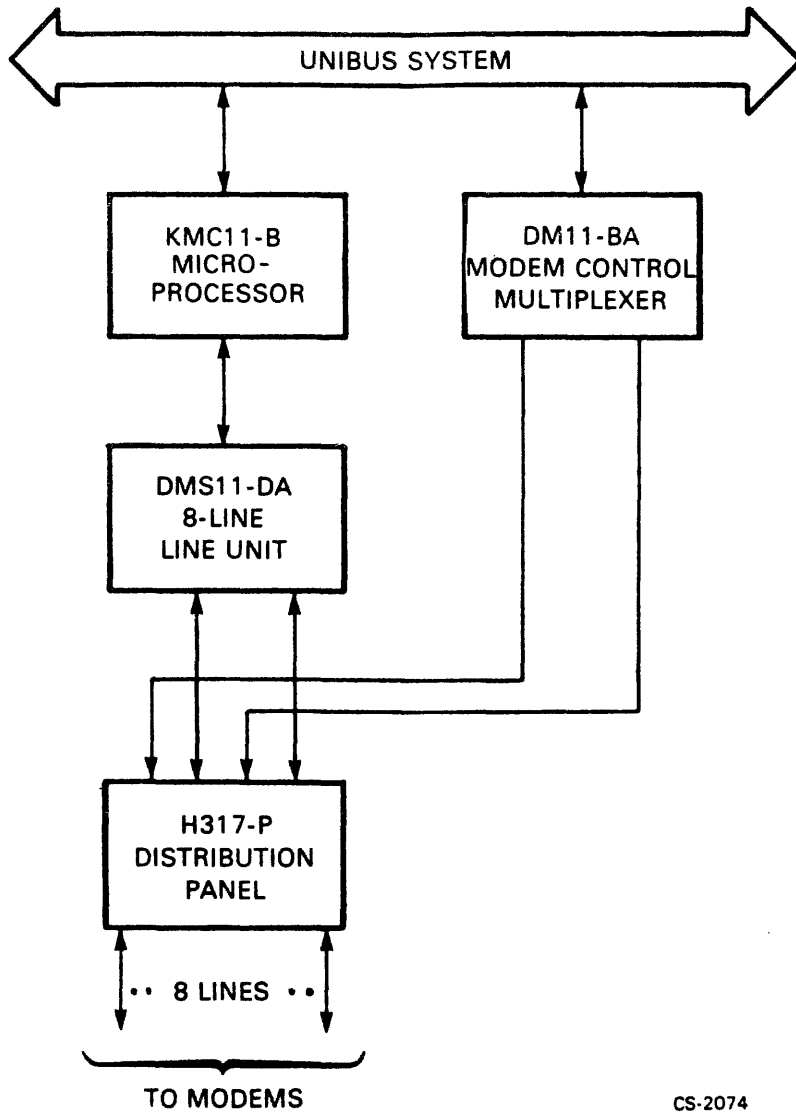

CS-2074

Figure 1-1 Eight-Line KMS11-BD/BE

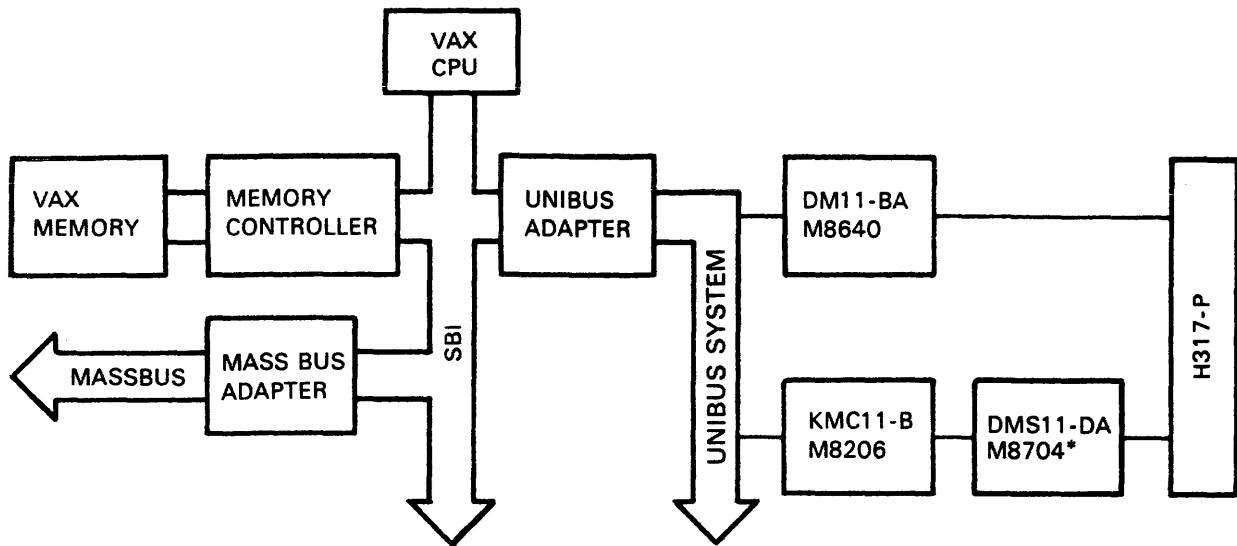

*OLD VERSIONS USE M8711-YA

CS-2190

Figure 1-2 KMS11-BD/BE System Block Diagram

UNIBUS Information

UNIBUS Loads	Seven ac unit loads Two dc unit loads
Addresses	KMC11-B: 764100-764106 (typical) DM11-BA: 764110-764116 (typical)
Vectors	KMC11-B: 310,314 (typical) DM11-BA: 300 (typical)
Interrupt Levels	KMC11-B: BR5, NPR DM11-BA: BR4

NOTE

Addresses and vectors are switch selectable within the USER address and vector space.

Detailed specification for each module may be found by referencing the appropriate option description.

1.2 RELATED DOCUMENTATION

The following documents are useful references.

Title	Document No.
<u>KMS11-BD/BE Communications Processor User's Guide</u>	EK-KMSBE-UG
<u>DMS11-D/DA Synchronous Line Unit Option Description</u>	YM-C186C-00
<u>DM11-BA Modem Control Multiplexer Option Description</u>	YM-C138C-00
<u>KMC11-B Programmers Manual</u>	YM-P093C-00
<u>KMC11-B UNIBUS Microprocessor User's Guide</u>	EK-KMC1B-UG
<u>VAX-11/780 System Installation Manual</u>	EK-S1789-IN
<u>VAX-11/780 Diagnostic User Guide</u>	EK-DS780-UG
<u>KMS11 Synchronous Communications Processor Pocket Service Guide</u>	EK-KMS11-PS

Diagnostic listings are as follows:

ZZ-EVDHA	ZZ-EVDIA
ZZ-EVDHB	ZZ-EVDIB
ZZ-EVDKA	ZZ-EVDJA

2.1 UNPACKING AND INSPECTION

Unpack and inspect all parts. Report damages and shortages immediately. Note that the following documentation MUST be included.

- One KMS11-BD/BE Option Installation Addendum
- One User's Guide (KMS11-BD/BE) (EK-KMSBE-UG)
- One KMS11-BD/BE Engineering Drawing Set (MP-01111)

2.2 SITE PREPARATION

The KMS11-BD option requires space for mounting a nine-slot system unit in a Ball-K expander box.

The H317-P distribution panel requires a 13.125 cm (5.25 inch) by 47.5 cm (19.0 inch) rack mounting space, and should be mounted within a 3 meter (10 foot) cable length of the modules in the expander box.

The KMS11-BD/BE is designed for operation in a Class B environment. Refer to Chapter 1 for particulars.

2.2.1 Ground References

Since the KMS11-BD/BE is a communications option in which signals are transmitted over cables, careful site preparation is important to avoid ground loop problems and poor noise rejection. DEC-STD-186, Paragraph 5.4 should be adhered to as follows.

Optimally, the KMS11 and equipment to which it connects (modems, modem eliminators, and so on) should share a common ac power source. In addition, this power source should not be shared by electrically "noisy" machinery of any type.

If these two conditions are met, then it can be assured that circuit reference of the KMS11 is identical to circuit reference of the modem or modem eliminator. In turn, with signal references identical, no dc current loops flow through interconnecting cables, and circuit noise rejection is maximized.

Minimally, earth grounds of the KMS11 and the modem should be common. If this condition is not satisfied, large, potentially damaging currents may flow through interconnecting cables.

CAUTION

RS-232-C mode operation is particularly sensitive to proper equipment grounding. Even small signal reference variations can be expected to adversely affect the KMS11 operation, and could possibly damage the system.

2.2.2 H317-P Signal Path Options

There are several grounding options available on the H317-P distribution panel, Figure 2-1, for each of the eight 25-pin EIA connectors. The various configurations follow, with the normal configuration first.

NOTE

If these jumpers are removed and W1, W3, W5, and W7 are inserted, pin 1 of each EIA connector is electrically connected to chassis (frame) ground.

1. Pin 1 (EIA protective ground) and pin 7 (EIA signal ground) connected directly to circuit/frame ground.
2. Pin 1 and pin 7 connected to circuit/frame ground through a 100 ohm resistor.
3. Pin 1 connected to circuit/frame ground and pin 7 isolated from circuit/frame ground.

Unless instructed otherwise, the installer should assume the normal configuration. Other configurations are used only when requested by the customer and the DIGITAL Applications Engineer.

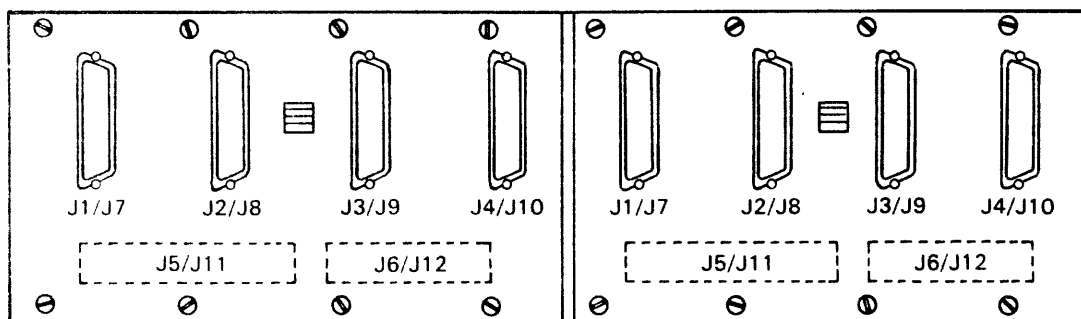

H317-P DISTRIBUTION PANEL

MK-4515

Figure 2-1 H317-P Distribution Panel

2.2.3 Address and Vector Assignment

The KMS11-BD/BE should be assigned addresses and vectors in the USER address area. The USER address area consists of addresses 764100 through 767776. The M8206 (KMC11-B) requires four address locations, and the M8640 (DM11-BA) requires two locations. The two devices should be assigned contiguous locations on 10 octal boundaries.

The KMS11 uses floating CSR and vector addresses. Floating vector addresses begin at 300 (octal) and proceed up to 774 (octal). The CSR and vector addresses are chosen by the autoconfiguration program. Note that the KMC11-B requires two vector locations: XX0 and XX4. The vector location XX0 is manually set in the vector switches and XX4 is then assigned automatically.

2.3 GENERAL INSTALLATION

When address and vector assignments are set in the appropriate switch registers of the M8206 (KMC11-B) and M8640 (DM11-BA), and when the M8704 (if used) is properly configured, the three modules that make up the KMS11-BD/BE are installed in a nine-slot system unit (DD11-DK). Two cables each from the DM11-BA (M8640) and the DMS11-DA (M8711-YA or M8704) are connected to the H317-P distribution panel.

2.3.1 H317-P Distribution Panel Installation

Install the H317-P distribution panel in the cabinet. Ensure that switches S1-S4 on each panel are ON for the checkout procedure, as these switches supply needed clocks to lines being tested. Maintenance clocks originating in the KMS11-BD/BE are supplied to pin 24 of the EIA connector. Normally, pin 24 is not used by external devices; however, in some cases, after checkout and before connecting an external device to the distribution panel, it may be necessary to open the clock switches (S1-S8) associated with the line being installed.

NOTE

Switches S1-S8 must be ON to run the KMS11-BD/BE diagnostics externally looped back through the H317-P panel.

2.3.2 System Unit Installation (KMS11-BD Only)

Mount the system unit, connecting the power harness to the most convenient power distribution connectors. If it is desired that the KMS11-BE expansion be added to a previously installed KMS11-BD, or that the KMS11-BD and KMS11-BE is installed in the same nine-slot system unit, contact Computer Special Systems (CSS), Nashua, N.H., for configuration and power requirements.

2.3.3 KMC11-B Microprocessor

1. Ensure that the priority plug (level 5 supplied) is properly seated in its socket.
2. Verify that jumper W1 (M8206) is installed, Figures 2-2 through 2-4. This jumper should not be removed in the field; it is removed only during automated module testing at the factory to inhibit the oscillator in the microprocessor clock logic.

E31 VECTOR SELECT (7-POSITION SWITCH)
E129 ADDRESS SELECT (10-POSITION SWITCH)
E82-8 PROGRAM TIMER SELECT (8-POSITION SWITCH)
W1 ALWAYS IN
W3 NORMALLY IN (OFF TO DISABLE KMC11-B CONTROL OF AC LO)

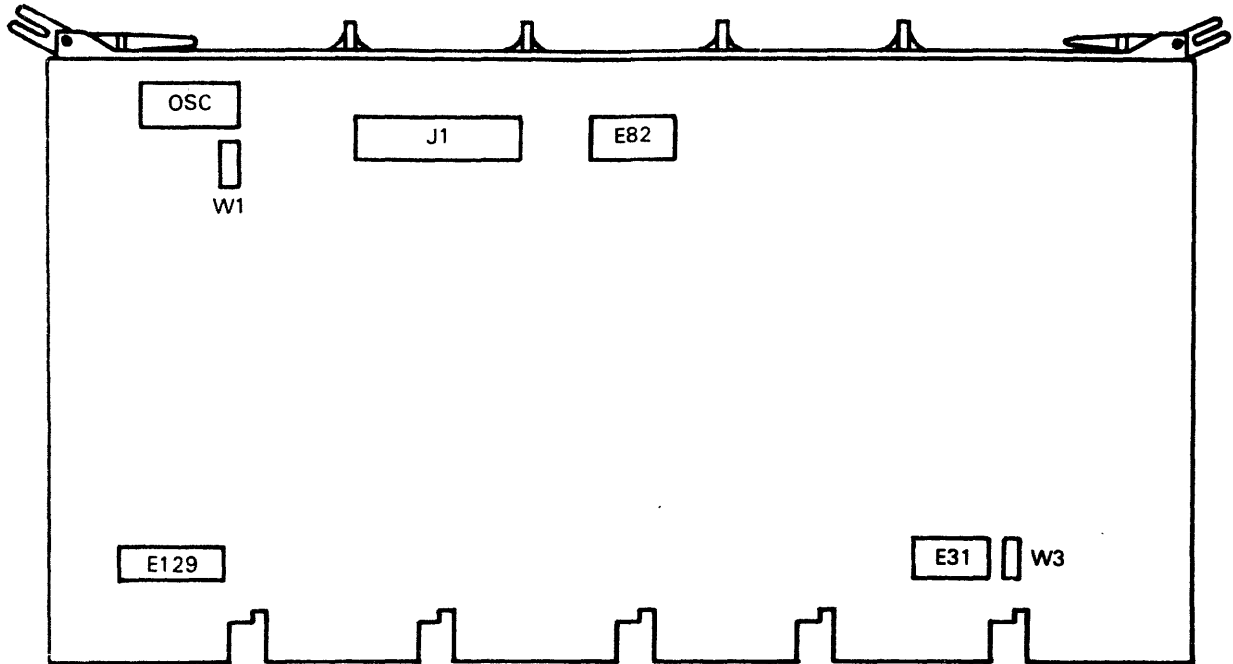

CS-2134

Figure 2-2 KMC11-B M8206-E Switch and Jumper Locations

- E129 = ADDRESS SELECT (10-POSITION SWITCH)
- E31 = VECTOR SELECT (7-POSITION SWITCH)
- W2 = ALWAYS IN
- W3 = NORMALLY IN (ALLOWS KMC CONTROL OF AC LO)
- W1 = ALWAYS IN
- W4 = ALWAYS IN (ECO NU006)

NOTE: E31 MAY BE 10 POSITIONS. IF SO E31-9 REPLACES W2 AND E31-10 REPLACES W3.

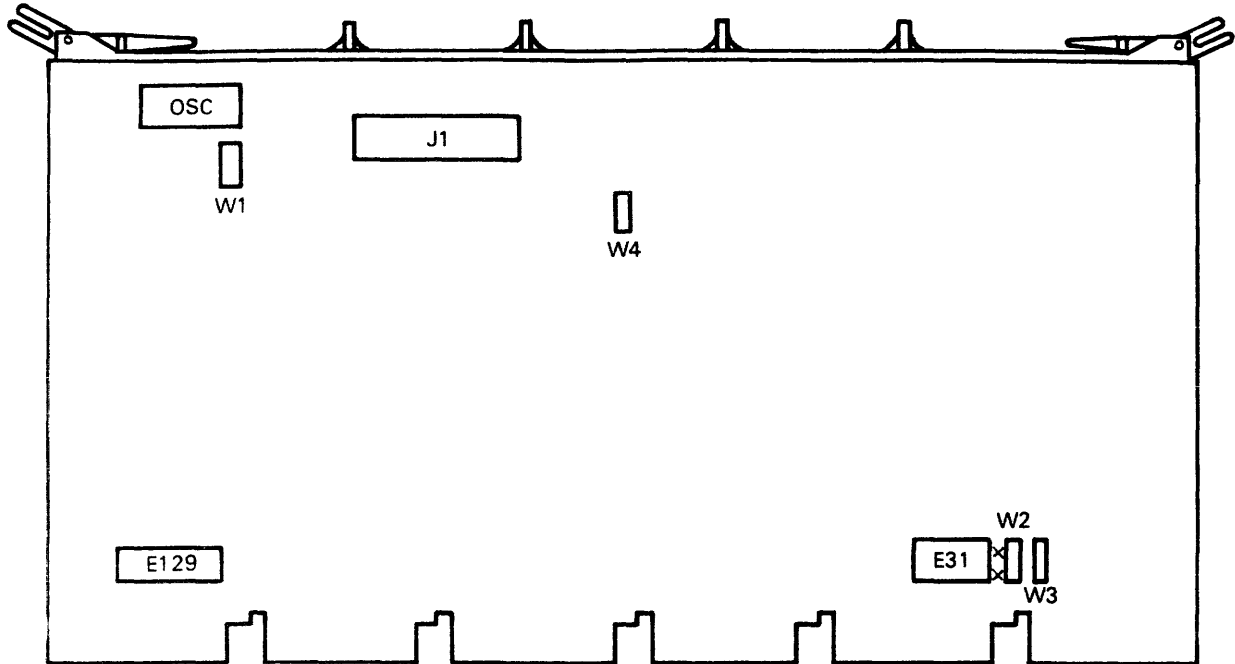

CS-2135

Figure 2-3 KMC11-B M8206-D Switch and Jumper Locations

E125 = ADDRESS SELECT (10-POSITION SWITCH)
 E27 = VECTOR SELECT (7-POSITION SWITCH)
 W2 = ALWAYS IN
 W3 = NORMALLY IN (ALLOWS KMC CONTROL OF AC LO)
 W1 = ALWAYS IN
 W4 = ALWAYS IN (ECO NU006)

NOTE: E27 MAY BE 10 POSITIONS. IF SO, E27-9 REPLACES W2 AND E27-10 REPLACES W3.

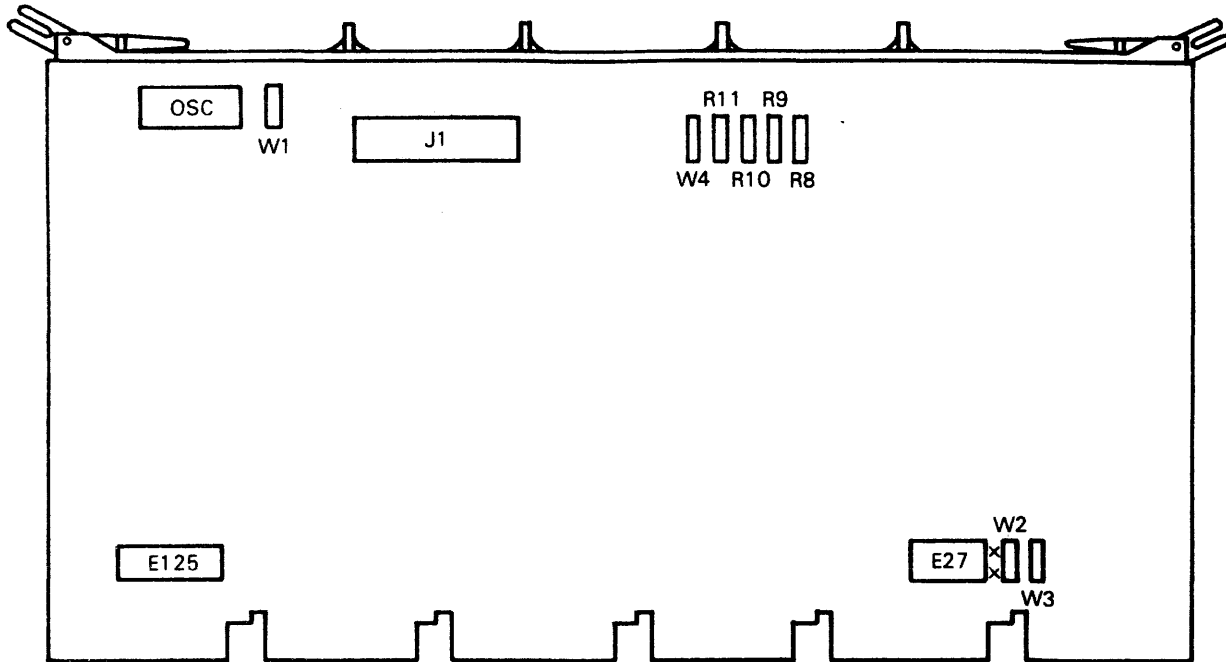

CS-2136

Figure 2-4 KMC11-B M8206-C Switch and Jumper Locations

3. Set the switches located at position E129 (E125 for Etch Revision C) so that the module responds to its assigned address. When a switch is OFF (open), a binary 1 is decoded; when ON (closed), a binary 0 is decoded. Note that the switch labeled "1" (Figure 2-5) corresponds to address bit 3, "2" to address bit 4, "3" to address bit 5, and so on.
4. In early releases of Etch Revisions C and D of the KMC11-B, a 10-position switch pack (locations E27 or E31) provided for vector selection, an automated testing function, and AC LO disable. Subsequent ECOs replaced that switch with a seven-position vector selection switch and two jumpers, W2 and W3, respectively. Since field modification is not necessary, many KMC11-Bs still contain the 10-position switch. For the following explanation, refer to Figure 2-2, 2-3, or 2-4 (KMC11-B, M8206-E, -D, or -B) for switch and jumper locations. Note that Etch Revision E is always shipped with a seven-position switch and one jumper (W3); S2 was eliminated.

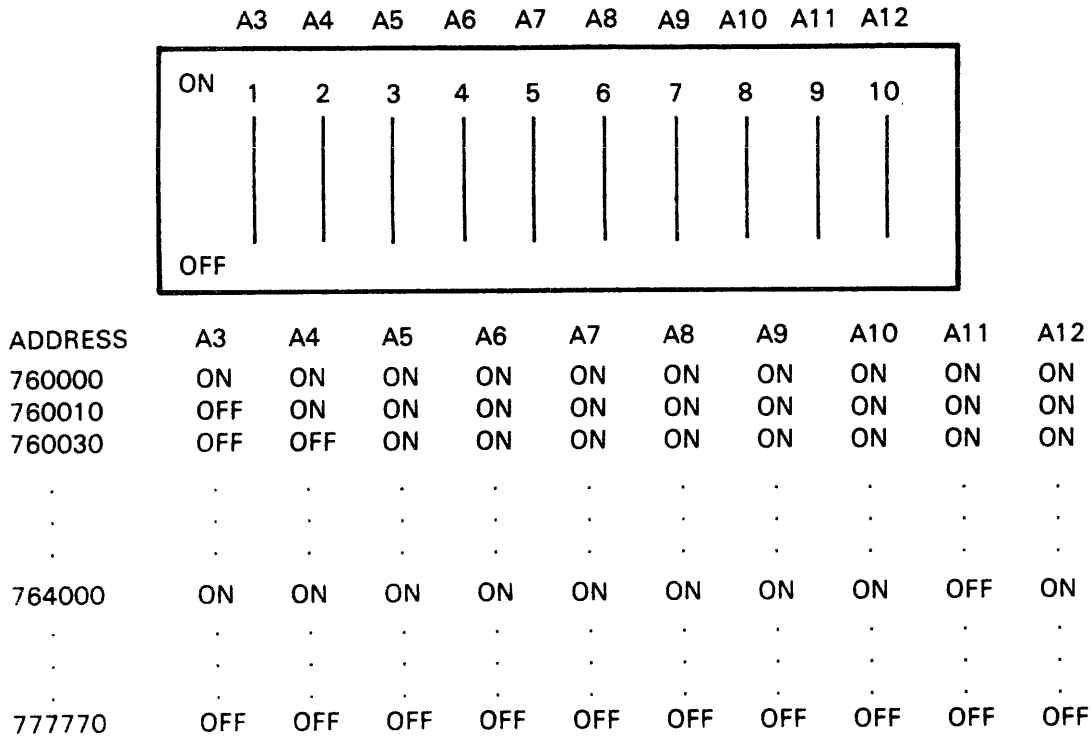

CS-2076

Figure 2-5 KMC11-B Address Selection

Vector selection for Etch Revisions C, D, and E is accomplished using switches 1 through 6, at locations E27 or E31 (Figures 2-6 and 2-7). When a switch is OFF (open), a binary 0 is decoded; when ON (closed), a binary 1 is decoded. Note that switch "1" corresponds to vector bit 3, "2" to bit 4, and so on.

Jumper W2 (Etch Revisions D and C only) should be IN at all times. As with W1, jumper W2 is removed only for automated testing.

Jumper W3 (all three revisions) is normally IN, and should only be removed if the KMC11-B is not to control AC LO.

If a 10-position switch is present at location E31 (E27, Revision C), E31-9 (E27-9, Revision C) serves the same function as jumper W2, and should always be ON. E31-10 (E27-10, Revision C) serves the same function as jumper W3, and should normally be ON.

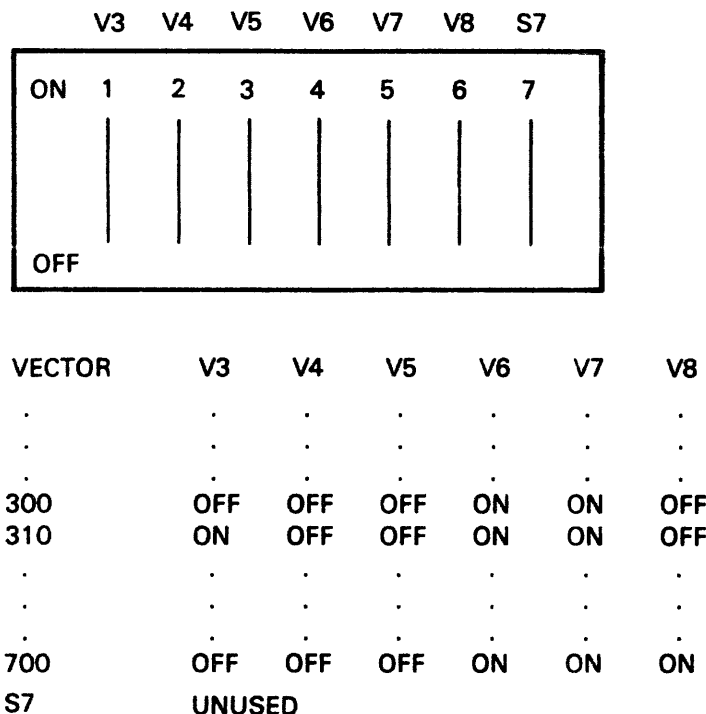

CS-2137

Figure 2-6 KMC11-B Vector Selection - Seven-Position Switch

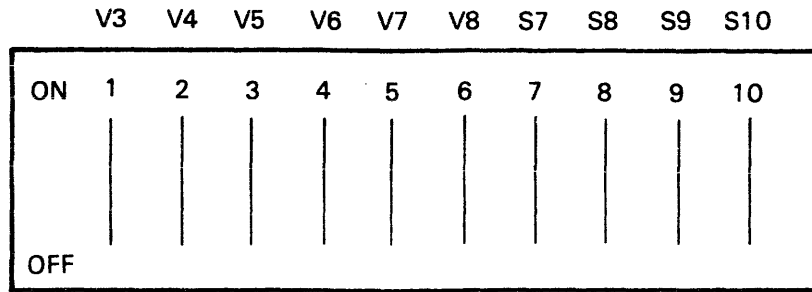

VECTOR	V3	V4	V5	V6	V7	V8
300	OFF	OFF	OFF	ON	ON	OFF
310	ON	OFF	OFF	ON	ON	OFF
.
.
700	OFF	OFF	OFF	ON	ON	ON
S7, S8	UNUSED					
S9	ALWAYS ON					
S10	NORMALLY ON; ALLOWS KMC11-B TO CONTROL AC LO					

CS-2077

Figure 2-7 KMC11-B Vector Selection - 10-Position Switch

- The KMC11-B contains a timer to run certain protocol firmware. It is important that timer values be set accurately prior to installation.

Newer versions of the M8206 UNIBUS microprocessor contain a switch pack, at location E82, which is used to select the value of the program timer. E82-8 ON provides a timeout value of 115 milliseconds; OFF yields 75 microseconds. (E82 1-7 are not used.) On earlier versions, the timeout value is selected by installing the proper value of capacitor C40, as shown in Table 2-1.

Table 2-1 Program Timer Values

Part Number	Capacitor Value	Timeout Value
10-04813-00*	10 μ F, 20 V	115 ms
10-03183-00	4700 pF, 100 V	75 μ s

*Must be installed with "+" side toward E55.

6. Install the KMC11-B in the nine-slot system unit (Figure 2-8). Ensure that the NPR grant continuity wire between pins CA1 and CB1 is removed for the slot in which KMC11-B is installed.

2.3.4 DMS11-D/DA Installation

The DMS11 line unit is a KMC11-B controlled device; there are no UNIBUS addresses or vectors to be set. The DMS11-DA has two different modules associated with it; early versions of the DMS11-DA use an M8711-YA, while later versions use an M8704.

2.3.4.1 M8711 and M8711-YA Configurations - Configuration of the M8711-YA module is preset prior to the module leaving CSS. While several configurations are possible, these configurations are not field selectable. CSS should be contacted prior to making any changes. Note that in the standard configuration (RS-232-C), jumpers W1 through W8 are installed, and details A through E of drawing UA-M8711-0-0 are complied with.

2.3.4.2 M8704 Switch Settings - The newer DMS11-DA module (M8704, Figure 2-9) provides several switch-selectable configurations.

1. Set the switches at locations E1, E4, and E10 to select either RS-232-C or RS-423-A compatibility, as shown in Table 2-2.
2. Select between EIA (RS-232-C and RS-423-A) or MIL-188-C polarities, with switches located at position E25 per Table 2-3.

2.3.4.3 DMS11-D/DA General Installation

1. Connect two BC11W-10 cables from J1 and J2 of module M8704 (Figure 2-10) or M8711-YA (Figure 2-11) to J5 and J11 of the H317-P distribution panel, respectively.

NOTE

Cables are seated with the arrow on the cable connector aligned with the arrow on the module connector (Figures 2-10 and 2-11).

2. Connect the BC08R-01 cable (40-pin BergTM connector) to J3 of the DMS11-DA.
3. Install the module in the appropriate slot of the nine-slot system unit (Figure 2-8). Care should be taken to avoid snagging the cables on the back of the KMC11-B module while installing.
4. Connect the BC08R-01 cable to the 40-pin Berg on the KMC11-B. The cable should be installed ribbed side up on the DMS11-DA and flat side up on the KMC11-B.

BergTM is a trademark of Berg Electronics.

										1	
											2
											3
											4
											5
											6
											7
											8
											9

MK-3332

Figure 2-8 KMS11-BD Nine-Slot System Unit

E1 TRANSMIT CLOCK
 E4 RECEIVE CLOCK
 E10 RECEIVE DATA

ON = EIA RS-232-C
 OFF = EIA RS-423-A

E25 ON = EIA RS-232-C OR RS-423-A
 OFF = MIL-188-C

ALL SWITCHES ARE 8 POSITIONS

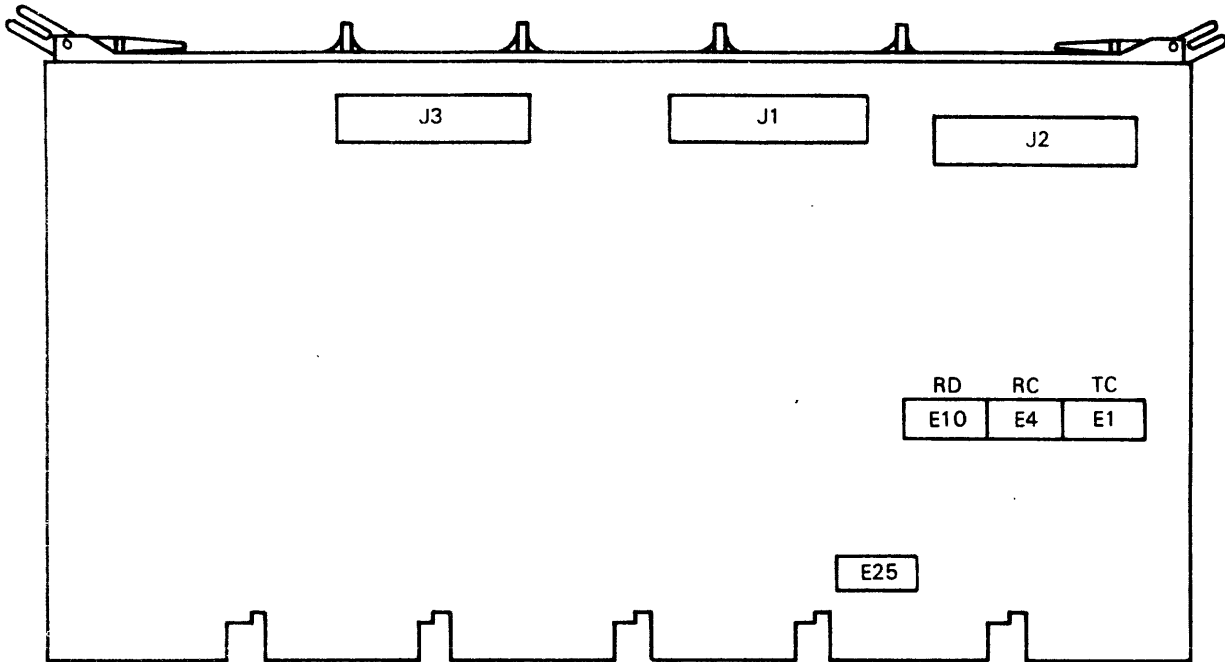

CS-2139

Figure 2-9 DMS11-DA (M8704) Switch Locations

Table 2-2 RS-232-C Versus RS-423-A Switch Settings

Line Number	Switch Numbers	RS-232-C	RS-423-A
0	E1-1, E4-1, E10-1	ON	OFF
1	E1-2, E4-2, E10-2	ON	OFF
2	E1-3, E4-3, E10-3	ON	OFF
3	E1-4, E4-4, E10-4	ON	OFF
4	E1-5, E4-5, E10-5	ON	OFF
5	E1-6, E4-6, E10-6	ON	OFF
6	E1-7, E4-7, E10-7	ON	OFF
7	E1-8, E4-8, E10-8	ON	OFF

Table 2-3 EIA Versus MIL-188-C

Line Number	Switch Numbers	RS-232-C/ RS-423-A	MIL-188-C
0	E25-1	ON	OFF
1	E25-2	ON	OFF
2	E25-3	ON	OFF
3	E25-4	ON	OFF
4	E25-5	ON	OFF
5	E25-6	ON	OFF
6	E25-7	ON	OFF
7	E25-8	ON	OFF

2.3.5 DM11-BA Installation

Starting with Revision C of the M8640, jumpers W1 through W17 are replaced with dip switches. To avoid confusion, a separate installation section is included to support each of the older and later revisions.

2.3.5.1 M8640 (Pre-Etch Revision C)

1. Ensure that the priority insert (level 4 supplied) is properly inserted in its socket.
2. Set the switches at location E108, and the jumper W1, so that the module responds to its assigned address (Figure 2-12). When a switch is ON (closed), a binary 1 is decoded; when OFF (open), a binary 0 is decoded. Note that the switch labeled "1" corresponds to address bit 3, "2" to address bit 4, and so on. Jumper W1 (decoded in the same manner as the switch) corresponds to address bit 2. See Figure 2-13 for address selection.

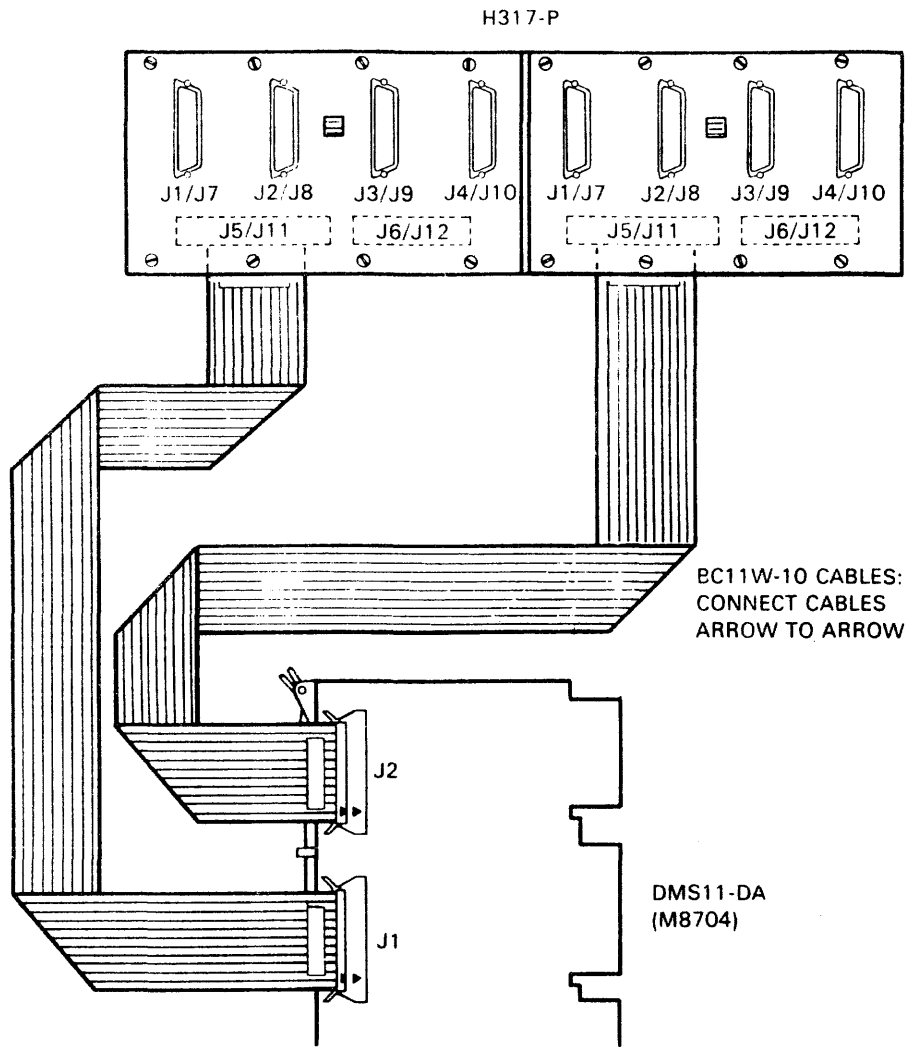

MK-4513

Figure 2-10 DMS11-DA (M8704) to H317-P Cabling

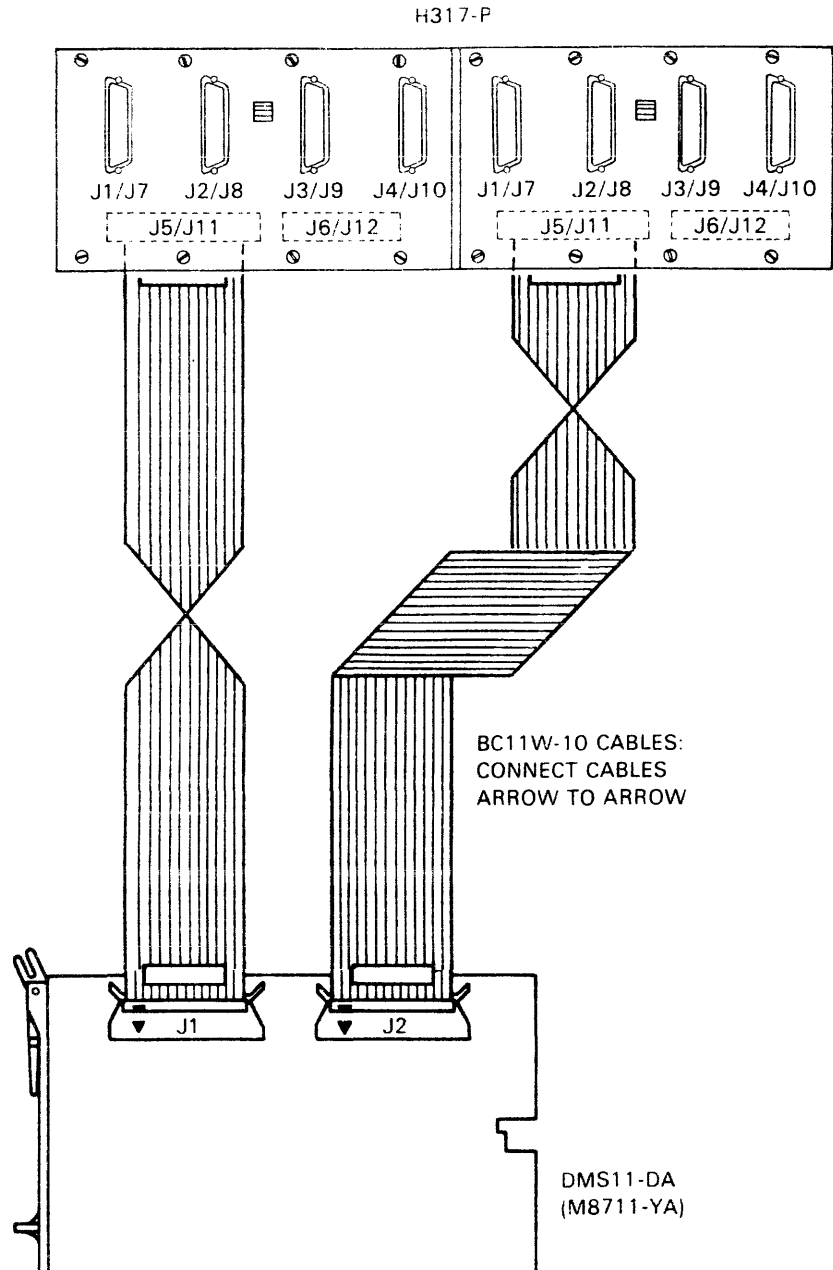

MK-4512

Figure 2-11 DMS11-DA (M8711-YA) to H317-P Cabling

E108 = ADDRESS LOCATION (10-POSITION SWITCH)
 E84 = VECTOR LOCATION (8-POSITION SWITCH)
 W1 ADDRESS BIT A2
 W5, W6, W7, W9 NORMALLY OUT | TRANSITION DETECT ENABLES
 W2, W3, W4, W8 NORMALLY IN

W10, W11, W12, W13, W14, W15, W16, W17 = NORMALLY IN

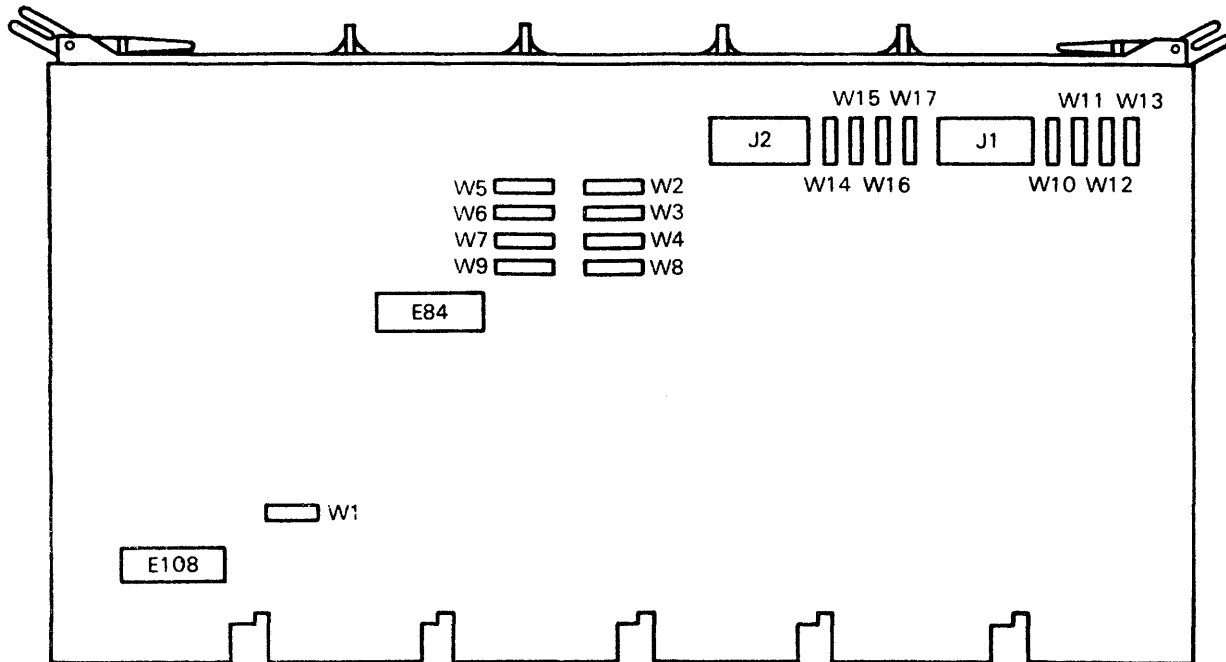

CS-2140

Figure 2-12 DM11-BA (M8640 Etch Revision B) Jumper and Switch Locations

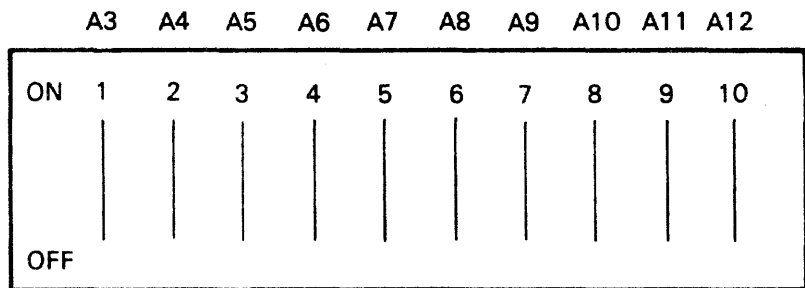

ADDRESS	W1	A3	A4	A5	A6	A7	A8	A9	A10	A11	A12
760000	OUT	OFF	OFF	OFF	OFF	OFF	OFF	OFF	OFF	OFF	OFF
760004	IN	OFF	OFF	OFF	OFF	OFF	OFF	OFF	OFF	OFF	OFF
760010	OUT	ON	OFF	OFF	OFF	OFF	OFF	OFF	OFF	OFF	OFF
760500	OUT	OFF	OFF	OFF	ON	OFF	ON	OFF	OFF	OFF	OFF

CS-2141

Figure 2-13 DM11-BA (M8640 Etch Revisions A/B) Address Selection

3. Vector selection is accomplished by using an eight-position switch located at position E84 on the M8640 module (Figure 2-12). When the switch is ON (closed), a binary 0 is decoded; when OFF (open), a binary 1 is decoded. Note that the switch position labeled "8" (Figure 2-14) is not used, and that switch "1" corresponds to vector bit 2, "2" to bit 3, and so on.
4. Install the eight jumpers W10-W17 located near connectors J1 and J2 to allow for either RS-423-A or RS-232-C operation (Figure 2-12). All are OUT for RS-423-A compatibility and all are IN for RS-232-C compatibility (Table 2-4).
5. To individually or totally disable DSR, CS, CO, or RING from causing interrupts, insert jumpers W5, W6, W7, or W9, respectively, and remove jumpers W2, W3, W4, and W8, respectively (Table 2-5).

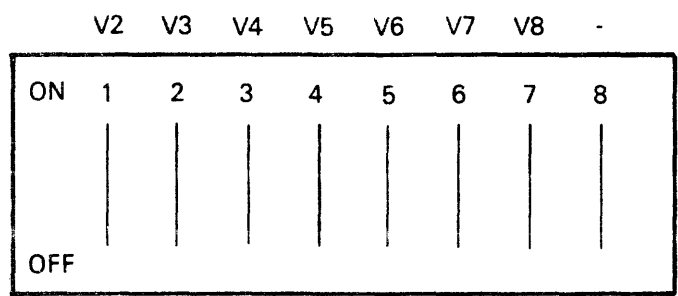

VECTOR	V2	V3	V4	V5	V6	V7	V8
300	ON	ON	ON	ON	OFF	OFF	ON
304	OFF	ON	ON	ON	OFF	OFF	ON
310	ON	OFF	ON	ON	OFF	OFF	ON
.
.
700	ON	ON	ON	ON	OFF	OFF	OFF

NOTE: SWITCH 8 IS NOT USED.

CS-2142

Figure 2-14 DM11-BA (M8640 Etch Revisions A/B) Vector Selection

Table 2-4 RS-232-C Versus RS-423-A Jumper Locations

Line Number	Jumper Number	RS-232-C	RS-423-A
0	W10	IN	OUT
1	W11	IN	OUT
2	W12	IN	OUT
3	W13	IN	OUT
4	W14	IN	OUT
5	W15	IN	OUT
6	W16	IN	OUT
7	W17	IN	OUT

Table 2-5 Jumper Functions

Jumper	W1	CSR Address 7xxxx0 = OUT	CSR Address 7xxxx4 = IN	Interrupt Enabled	Interrupt Disabled
		Modem Input			
W2		DSR		IN	OUT
W5		DSR		OUT	IN
W3		CS		IN	OUT
W6		CS		OUT	IN
W4		CO		IN	OUT
W7		CO		OUT	IN
W8		RING		IN	OUT
W9		RING		OUT	IN

2.3.5.2 M8640 (CS Revision C)

1. Ensure that the priority insert (level 4 supplied) is properly inserted in its socket.
2. Set the switches at locations E65 and E49-8 so that the module responds to its assigned address (Figure 2-15). When a switch is ON (closed), a binary 1 is decoded; when OFF (open), a binary 0 is decoded. Note that the switch labeled "1" corresponds to address bit 3, "2" to address bit 4, and so on. E49-8 corresponds to address bit 2. See Figure 2-16 for address selection.
3. Vector selection is accomplished by using an eight-position switch (Figure 2-17) located at position E49. When a switch is ON (closed), a binary 0 is decoded; when OFF (open), a binary 1 is decoded. Note that the switch position labeled "A2" (Figure 2-17) is address bit A2, and that switch "1" corresponds to vector 2, switch "2" to bit 3, and so on.

E45 RS-232-C = ON RS-423-A = OFF (8-POSITION SWITCH)
E49 VECTOR SELECT (E49-8 = ADDRESS BIT A2; 8-POSITION SWITCH)
E66 TRANSITION DETECT ENABLE (8-POSITION SWITCH)
E65 ADDRESS SELECT (10-POSITION SWITCH)

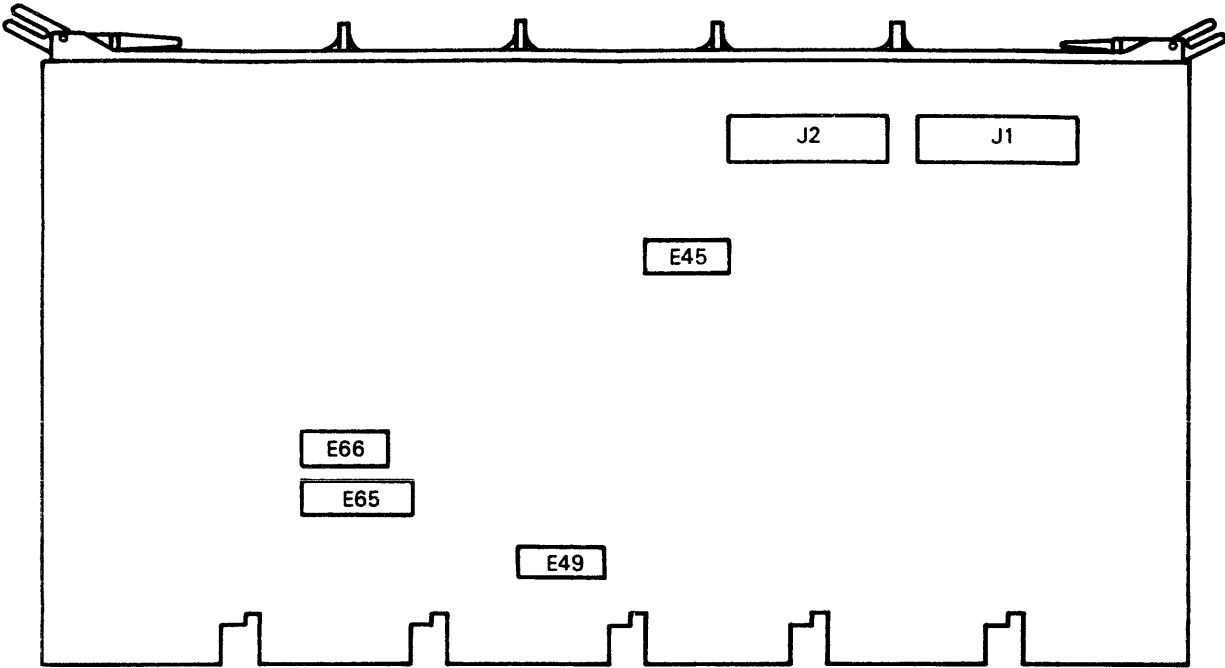

CS-2143

Figure 2-15 DM11-BA (M8640 Etch Revision C) Switch Locations

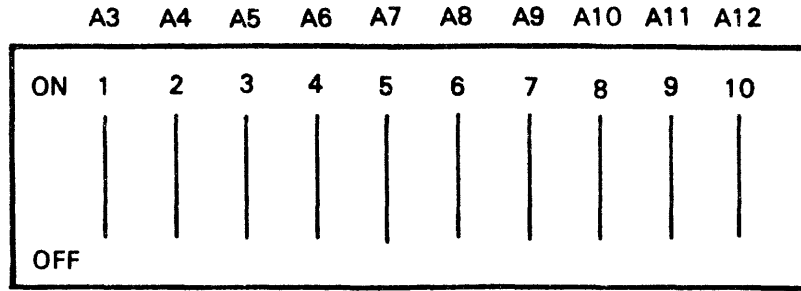

ADDRESS	E49-8(A2)	A3	A4	A5	A6	A7	A8	A9	A10	A11	A12
760000	OFF	OFF	OFF	OFF	OFF	OFF	OFF	OFF	OFF	OFF	OFF
760004	ON	OFF	OFF	OFF	OFF	OFF	OFF	OFF	OFF	OFF	OFF
760010	OFF	ON	OFF	OFF	OFF	OFF	OFF	OFF	OFF	OFF	OFF
760500	OFF	OFF	OFF	OFF	ON	OFF	ON	OFF	OFF	OFF	OFF

CS-2080

Figure 2-16 DM11-BA (M8640 Etch Revision C) Address Selection

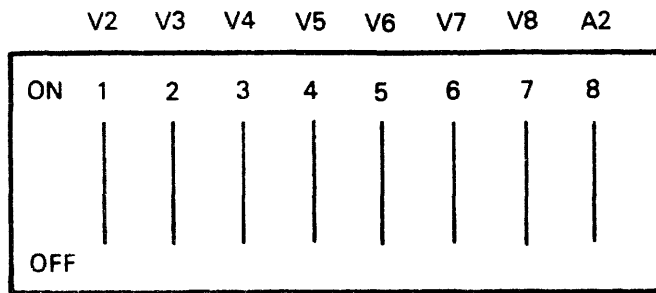

VECTOR	V2	V3	V4	V5	V6	V7	V8	A2
300	ON	ON	ON	ON	OFF	OFF	ON	*
304	OFF	ON	ON	ON	OFF	OFF	ON	*
310	ON	OFF	ON	ON	OFF	OFF	ON	*
.
.
700	ON	ON	ON	ON	OFF	OFF	OFF	*

*REFER TO FIGURE 2-16

CS-2081

Figure 2-17 DM11-BA (M8640 Etch Revision C) Vector Selection

4. Set the switches at location E45 to select between RS-232-C and RS-423-A compatibility per Table 2-6.
5. Set the switches at location E65 to enable or disable CSR, CS, CO, or RING from causing an interrupt (Table 2-7).

Table 2-6 RS-232-C Versus RS-423-A Switch Settings

Line Number	Switch Number	RS-232-C	RS-423-A
0	S7	ON	OFF
1	S6	ON	OFF
2	S8	ON	OFF
3	S5	ON	OFF
4	S1	ON	OFF
5	S4	ON	OFF
6	S2	ON	OFF
7	S3	ON	OFF

Table 2-7 Interrupt Setting

Switch Number	Modem Input	Interrupt Enabled	Interrupt Disabled
S8	DSR	ON	OFF
S7	DSR	OFF	ON
S6	CS	ON	OFF
S5	CS	OFF	ON
S4	CO	ON	OFF
S3	CO	OFF	ON
S2	RING	ON	OFF
S1	RING	OFF	ON

2.3.5.3 M8640 General

1. Connect the two BC08R-10 cables to the M8640 module and the H317-P distribution panel (Figure 2-18). Note that J1 on the M8640 is connected to J6 on the H317-P, and that J2 is connected to J12. The cables require a one-half twist and should be installed with the smooth side up at the H317-P and the ribbed side up at the M8640.
2. Mount the M8640 module in the appropriate slot of the nine-slot system unit (Figure 2-8).

H317-P

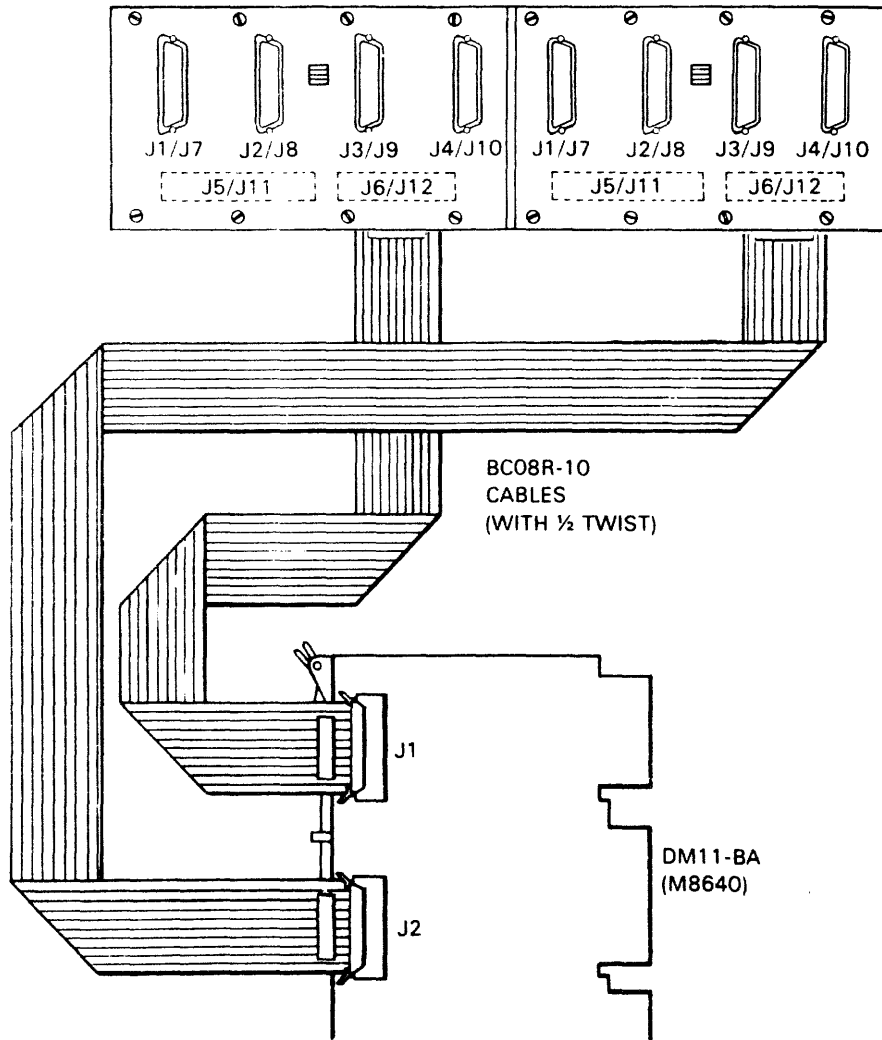

MK-4514

Figure 2-18 DM11-BA (M8640) to H317-P Cabling

2.4 POWER ON SEQUENCE

1. Ensure that modules are securely seated with cables installed properly.
2. Ensure that the NPG continuity wire from CA1 to CB1 is removed from the backplane in the slot in which the KMC11-1B (M8206) is installed.
3. Perform resistance checks to verify that no power circuits are shorted to ground. The following pins are power pins.

All A2 pins	+5 V
CU1	+15 V
CB2	-15 V

4. Turn system power ON. Verify that all voltages are within specified tolerances.

2.5 DIAGNOSTICS AND TESTING

VAX-11 family diagnostics available for testing the KMS11-BD/BE are summarized in Table 2-8. Note that looparound test connectors are required when running diagnostics that exercise the DM11-BA, or when running the DMS11-DA dynamic tests in external mode (Section 2.5.1).

Table 2-8 VAX-11 Diagnostics

Name	Options Tested	Level
ZZ-EVDHA KMC11-B Repair Level	KMC11-B Only	3
ZZ-EVDHB KMC11-B Functional	KMC11-B Only	2
ZZ-EVDKA DMS11-DA Repair Level	KMC11-B/DMS11-DA (Static)	3
ZZ-EVDIA KMS11-BD Repair Level	KMC11-B/DMS11-DA (Dynamic)	3
ZZ-EVDIB KMS11-BD Functional	KMC11-B/DMS11-DA (Dynamic)	2
ZZ-EVDJA DM11-BA Repair Level	DM11-BA Only	3

2.5.1 Diagnostic Test Connectors

Data loopback can be accomplished in several ways. The KMS11-BD/BE is shipped with module level turnaround connectors to be used with the DM11-BA (M8640) and DMS11-DA (M8711-YA or M8704). Older versions of these modules are shipped with wired test connectors, part numbers 2M-E122A (for the DM11-BA) and 2M-E044A (for the DMS11-DA). Newer versions of the DM11-BA (M8640 Revision C) and the DM11-BA (M8704) are shipped with printed circuit test connectors part numbers 54-14700 (for the M8640-C) and 54-14698 (for the M8704). Printed circuit test connectors allow an additional level of diagnostic flexibility over the wired versions because the newer connectors can be plugged directly into the far end of the flat cable associated with the respective module. This feature allows loopback testing at both the module and the far end of the interconnecting cable (Figures 2-19 and 2-20).

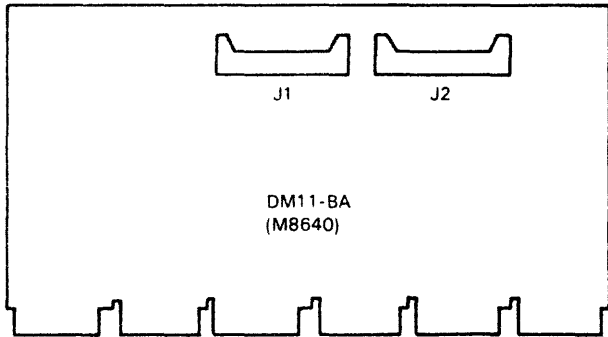
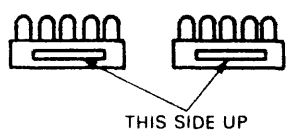
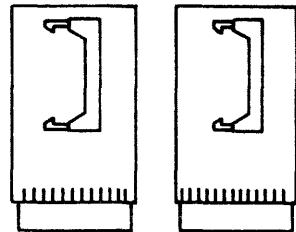
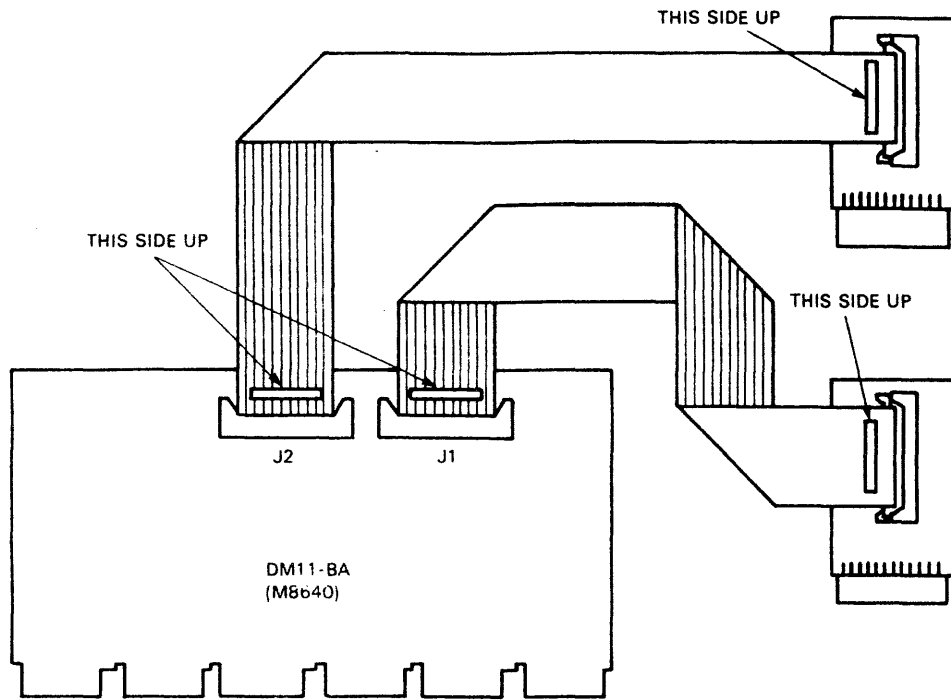

CS-2085

Figure 2-19 DM11-BA (M8640) Test Connector Use

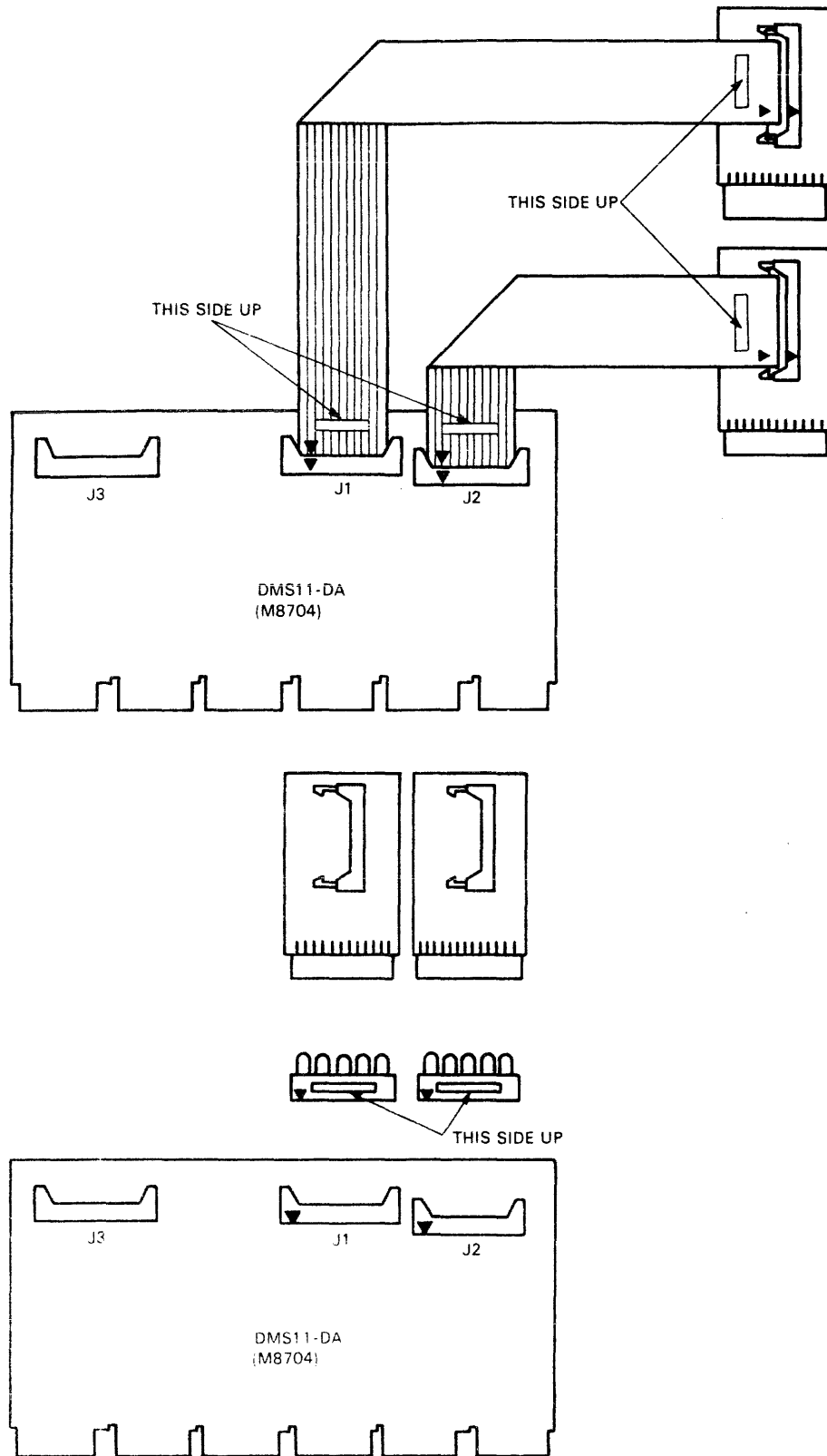

CS-2144

Figure 2-20 DMS11-DA (M8704) Test Connector Use

Loopback can also be accomplished at the H317-P distribution panel. Once the KMS11-BD/BE is fully installed and cabled, H3256 test connectors are installed into the EIA connectors that are part of the H317-P. These connectors loop back required clock, data, and modem signals, and so allow diagnostic testing.

2.5.2 ZZ-EVDHA KMC11-B Repair Level (Level 3)

ZZ-EVDHA tests the logic of the KMC11-B (M8206) in standalone mode. No test connectors are required, nor does the DMS11-DA line unit need to be cabled to the KMC11-B. Operation is straightforward and there are no event flags to set beyond those that are standard under the VAX-11 diagnostic supervisor. Note, however, that this test takes several minutes to complete.

2.5.3 ZZ-EVDHB KMC11-B Functional (Level 2)

This diagnostic verifies KMC11-B operation in the VMS environment. Diagnostic firmware is loaded and run during this test, and therefore ZZ-EVDHB is a higher level test than ZZ-EVDHA.

2.5.4 ZZ-EVDKA DMS11-DA Repair Level (Level 3)

This test verifies that the various registers associated with the DMS11-DA can be written and read, and that the DMS11-DA responds properly when commands are received. Before running this test, verify operation of the KMC11-B (M8206). This test runs at level 3 (repair level). There are no special event flags to set when running this diagnostic, however, diagnostic test connectors should be installed.

2.5.5 ZZ-EVDIA KMC11-BD Repair Level (Level 3)

ZZ-EVDIA runs dynamic tests (firmware running) on a DMS11-DA/KMC11-B pair at level 3 (repair level). Data can be looped back either internally within USYNR/T chips or externally using turnaround connectors. See Section 2.5.1 for a discussion of loopback connectors.

Either BOP or CCP mode firmware can be run during testing. For a thorough test, both modes should be run. Table 2-9 notes run-time options that are selectable when running ZZ-EVDIA.

2.5.6 ZZ-EVDIB VAX-11 Family Dynamic Functional Level

ZZ-EVDIB runs dynamic tests (firmware running) on a DMS11-DA/KMC11-B pair at level 2 (functional level). As in ZZ-EVDIA, both internal and external loopback capabilities exist, and either BOP or CCP mode firmware can be selected. See Section 2.5.1 for a discussion of loopback connectors, and Table 2-9 for run-time options available.

Table 2-9 ZZ-EVDIA/ZZ-EVDIB Run-Time Options

Option	Event	Flag
INTERNAL Loopback	Event Flag 5	Clear
EXTERNAL Loopback	Event Flag 5	Set
BOP Mode	Event Flag 3	Clear
CCP Mode	Event Flag 3	Set
Deselect Line 0	Event Flag 10	Set
Deselect Line 1	Event Flag 11	Set
Deselect Line 2	Event Flag 12	Set
Deselect Line 3	Event Flag 13	Set
Deselect Line 4	Event Flag 14	Set
Deselect Line 5	Event Flag 15	Set
Deselect Line 6	Event Flag 16	Set
Deselect Line 7	Event Flag 17	Set

2.5.7 ZZ-EVDJA DM11-BA Repair Level (Level 3)

ZZ-EVDJA tests the DM11-BA independently of other devices present. Loopback connectors must be installed (Section 2.5.1).

ZZ-EVDJA consists of two sections: a default section that runs all eight lines and tests all line scanner and line multiplexer functions, and a single line test section. To run the default section, start the diagnostic in the normal manner, first configuring under the diagnostic supervisor, and then beginning, the test with the command ST/<options>. To execute the single line tests, begin by using the command ST/SEC:H3256/<OPTIONS>. The diagnostic will respond by typing originate line = [(0), 0-7 (D)]. Enter the desired line and a carriage return to start the test.

2.6 CUSTOMER ACCEPTANCE

Successful completion of the following should ensure customer acceptance.

1. Run all level 3 diagnostics for 10 passes. The KMS11-BD/BE should be fully cabled and H3256 test connectors should be installed on the H317-P distribution panel. Note that ZZ-EVDIA should be run in the external mode (Event Flag 5 set), and run 10 passes each of BOP and CCP modes.
2. Run all level 2 diagnostics for 10 passes. Again, the KMS11-BD/BE should be fully cabled and H3256 test connectors should be installed on the H317-P. ZZ-EVDIB should be run in the external mode (Event Flag 5 set), and 10 passes each of BOP and CCP modes should be run.
3. Remove the H3256 test connectors.
4. Turn over to customer.

Your comments and suggestions will help us in our continuous effort to improve the quality and usefulness of our publications.

What is your general reaction to this manual? In your judgement is it complete, accurate, well organized, well written, etc? Is it easy to use? _____

What features are most useful? _____

What faults or errors have you found in the manual? _____

Does this manual satisfy the need you think it was intended to satisfy? _____

Does it satisfy *your* needs? _____ Why? _____

Please send me the current copy of the *Technical Documentation Catalog*, which contains information on the remainder of DIGITAL's technical documentation.

Name _____ Street _____
Title _____ City _____
Company _____ State/Country _____
Department _____ Zip _____

Additional copies of this document are available from:

Digital Equipment Corporation
444 Whitney Street
Northboro, MA 01532

Attention: Printing and Circulation Services (NR2/M15)
Customer Services Section

Order No. EK-KBEVX-IN-001

Fold Here

Do not Tear - Fold Here and Staple

digital



No Postage
Necessary
if Mailed in the
United States

BUSINESS REPLY MAIL

FIRST CLASS PERMIT NO. 33 MAYNARD, MA

POSTAGE WILL BE PAID BY ADDRESSEE

**Digital Equipment Corporation
Computer Special Systems
Technical Documentation Department
5 Flagstone Drive
Hudson, NH 03051**

