

SELF

digital™

MAINTENANCE

SERVICES

U.S. Edition

Effective Dates:
January 2, 1989 to June 30, 1989

Reference Code: LA

Digital Hardware Maintenance Training

Solutions At Hand

In Step With Hardware Technology

Your job as a technical specialist demands knowledge and skills that you have to keep razor sharp and up-to-date! Hardware technology changes quickly with new applications and diagnostics—and so do the exciting hardware maintenance training courses from Digital Educational Services.

Learn From the Experts

Because our hardware maintenance instructors are experts on maintaining Digital's equipment, they're able to teach you the most contemporary skills necessary to keep your system up and running. Our instructors have seen the evolution of hardware maintenance, and can tell you where it's going—and how you can keep up with it.

Variety of Learning Formats

Keeping up with Hardware Maintenance Training from Digital is easy with the variety of learning formats available from Educational Services.

Whether you prefer to learn at your site or ours—Digital offers training that is appropriate. Learn at your location with self-paced products, attend a Digital

Training Center for hands-on classroom instruction, or, learn with the entire staff at your own facility or ours with On-Site or Exclusive training.

With Digital, you'll get the expert instruction needed to maximize your product knowledge. Our variety of learning formats and choice of training centers are the key to your success. Refer to the Educational Services pages in Section Two of this catalog for a complete listing of hardware maintenance courses. Refer to page seven to learn more about new hardware maintenance training courses and the Training Centers that offer them.

For Solutions at Hand

Return the business reply card in this catalog. Request a copy of the new 1989 Customer Educational Catalog, and its companion piece, Digest, for a complete list of scheduled courses.

Register for Courses Today!

Hardware Maintenance Training is available at these Digital Training Centers . . .

| | |
|-------------|--------------|
| Boston | 617-276-4380 |
| Atlanta | 404-392-4771 |
| Santa Clara | 408-748-4048 |

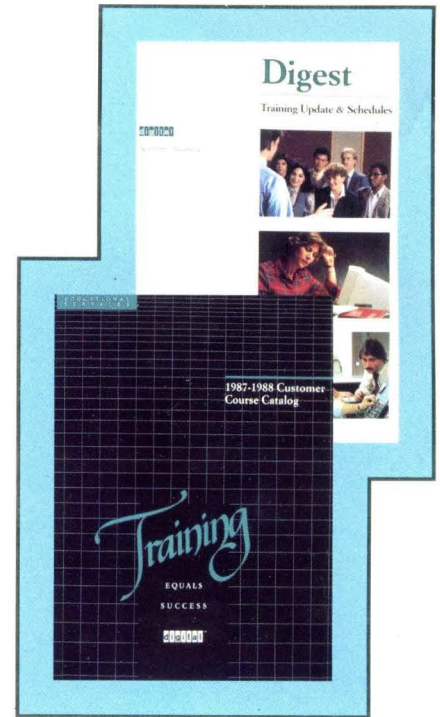

Today's Total Solution—Refer to page 7 for more information on Hardware Maintenance Training

See curriculum maps and a full list of courses from Hardware Maintenance Training in Section Two of this Catalog.

The Solution is Always at Hand with Digital Training

digital™

Section One

Welcome to Digital's Self-Maintenance Services 2

What To Consider When Setting Up Your Operation 3

 Important Planning Tools 3

Helpful Services

 Maintenance Products Recommendation Service 4

 Self-Maintenance Program Information Line 4

 Spares Part Number Assistance 4

 Unlisted Parts Service 5

 Emergency Order Service 5

 Maintenance Documentation Service 6

Educational Services 7

Feature Products

 VAX 6000 Series Systems 8

 MicroVAX 3300/3400 Systems 9

 RA70 Disk Drive 10

 SA600 Storage Array 11

 RA8X Head Disk Assembly 12

DECmailer Mail-in Service 13

Factory Repair Mail-in Service 14

Digital's Hardware Product Foundation Warranty 14

Computer Site Environmental Surveillance Products 15

Ordering Information 16

**Section Two—Self
Maintenance Products**

System Spares Matrices (Recommended Service Products) 19

 PDP-11 Products 20

 VAX Products 21

 MicroVAX Products 34

 VAXstation Product 37

Diagnostics Information 39

 Diagnostics for VAX-11 Family Systems, VAX 8600/8650 Systems,
 and MicroVAX II Systems 39

 VAXBI System Diagnostics 41

 PDP-11 Family Diagnostics 44

Educational Services—Hardware Maintenance Training 49

 VAX Curriculum 49

 PDP-11 Curriculum 50

 Data Communications Curriculum 51

 Terminals Curriculum 52

 Disk Maintenance Curriculum 53

 Magtape Curriculum 54

Peripheral Products Spares Kits 55

 Communication Products 55

 Storage Products 55

 Terminals/Printers 56

What Is in the Kits

 Hardware Spares Kits 57

 Documentation Kits 81

**Section Three—
Price Lists**

How to Use the Price List 91

Parts Classification Index 92

Part A—Hardware Spares A-1

Part B—Documentation/Diagnostics B-1

Part C—DECmailer Repair Services C-1

Part D—Factory Repair Services D-1

Purchase Policies E-1

Welcome to Digital's Self-Maintenance Services

Digital's Self-Maintenance Services (SMS) Group, a part of Digital Field Service, is dedicated to providing assistance to our customers who need to manage their own maintenance for their Digital computers.

Digital's Self-Maintenance Program offers a complete menu of products and services to assist customers performing their own maintenance. We believe it is the best self-maintenance program in the industry. Components of the program include:

- Economically priced spare parts and kits for all major CPUs and options.
- Comprehensive, high-quality training programs from Digital's Educational Services organization.
- Extensive maintenance documentation in hard copy or microfiche formats.
- Diagnostics of the same quality and scope as those used by our Field Service engineers.
- A variety of part-repair services.
- A maintenance product recommendation program.
- A variety of helpful ordering services as well as convenient ordering channels and product discounts.
- Backup support from Digital's outstanding Field Service organization.

The Self-Maintenance Services Price Book

One of the most valuable tools in implementing and running a successful self-maintenance program for your Digital computer systems, is this *Self-Maintenance Services Price Book*. Published twice each year, the price book provides up-to-date part number and pricing information for all of our self-maintenance products and services.

The book is organized into three major sections. Section One is this color section at the front of the book. In it, you will find summaries of our major products and services. Each edition of the

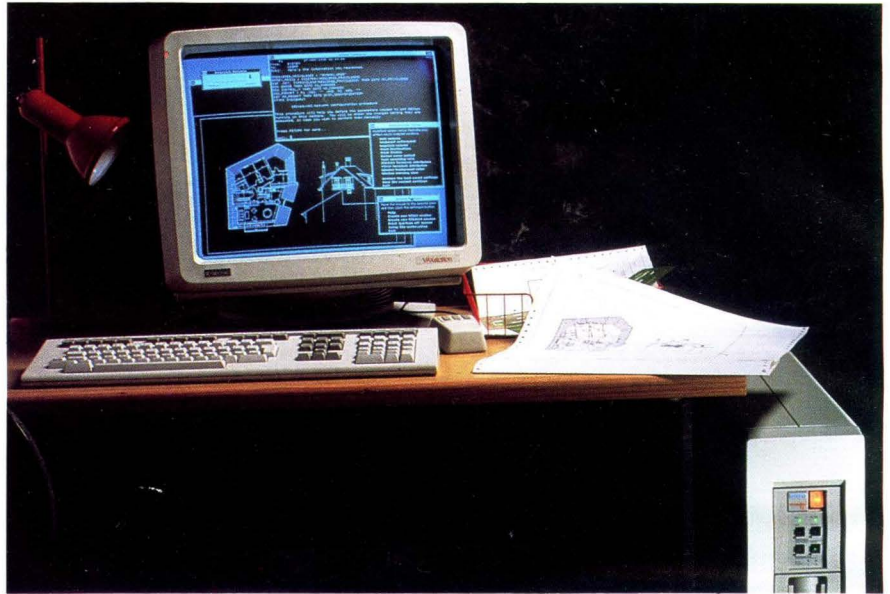

price book will feature some of our new products in Section One. This section also tells you how to order the parts and services you need, and describes the several channels (phone and mail) of ordering available to you.

What Products Do You Need?

Section Two of the book tells you what maintenance products you should order, given *your* system configuration. It has five subsections:

- **Matrices** — where you can quickly determine what service products we recommend for a given *system configuration*.
- **Diagnostics** — where you can determine which diagnostics are appropriate for your system and what sort of licensing is required for the diagnostics.
- **Educational Services** — Where you will find the training programs we recommend for your maintenance personnel.
- **Peripheral Products and Associated Spares** — where the appropriate spares kits for our terminals, printers, communication products, and storage products are detailed.
- **Kits** — Where the contents of our hardware spares kits and documentation kits are detailed.

The Price Lists

Section Three contains the maintenance product price lists. Once you have determined what products you need and their part numbers in Section Two, you can refer to Section Three to find the price of the products as well as some additional ordering information. Section Three is organized *alphanumerically by part number*.

Section Three is organized into four parts. Part A, Hardware Spares, and Part B, Diagnostics and Documentation, provide pricing, ordering, and discount information for these products. Part C, DECmailer, and Part D, Factory Repair, provide the prices for repairing qualified products under these programs.

Page 91 provides a detailed guide to using the pricing information in Section Three, while page 92 provides an index to the various sections of the pricing information.

Purchase Policies

Finally, at the back of the book, you will find Digital's Policies containing the terms and conditions of sale for our maintenance products and services.

What To Consider When Setting Up Your Operation . . .

Planning and Manpower Management

- Determine needs and resources
- Inventory and repair control
- Training
- Service call management
- Measuring performance

Installation and Site Management

- Configuration control
- Growth planning
- Power and environmental factors

Preventive and Unplanned Maintenance

- Field Change Orders (FCOs)
- Routine maintenance
- Emergency service
- Problem escalation (Back-up)

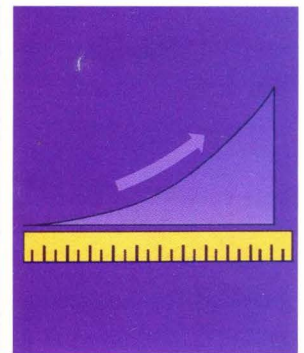
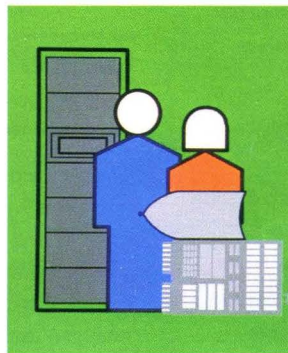
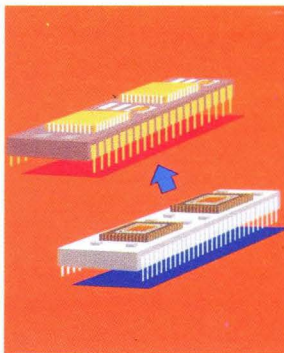
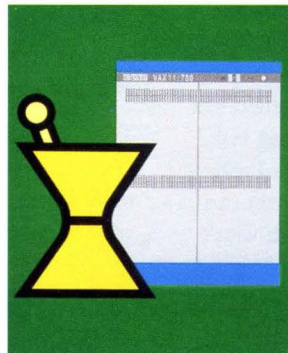
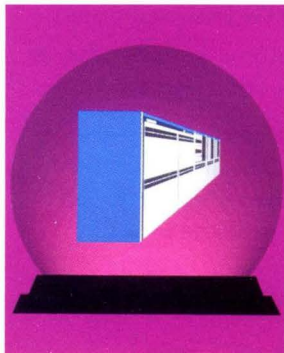
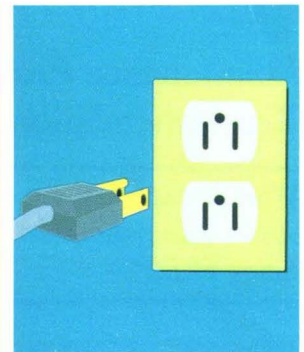
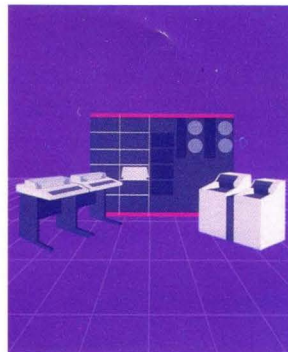
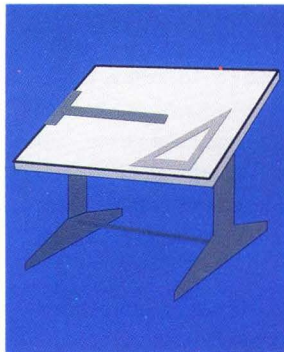

Important Planning Tools

Self-Maintenance Handbook

The first complete handbook that deals with the complex subject of computer maintenance and logistics management. Included is a chapter devoted to Electrostatic Discharge (ESD) with suggestions made to eliminate or minimize product exposure. Part number is EB-29448-94. Price is \$19.99.

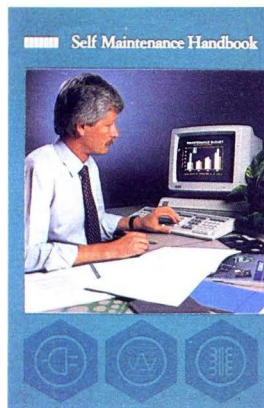

At Your Service Newsletter

Offered free of charge to our self-maintenance customers, this quarterly newsletter communicates important product information. Return the subscription card in this book to obtain this valuable publication.



The help you'll need to maintain your system is only a Phone Call away!

Maintenance Products Recommendation Service

What products will you need to service your system? Get a complete listing. FREE!

Maintenance requirements vary significantly from one customer to another, and even within one organization from site to site. Making decisions about the particular products that are needed can become a complex and confusing task. But with Digital's Maintenance Products Recommendation Service you can get the answers you need, and it won't cost you a thing!

Simply call your local Digital Sales Representative, and within seven days you'll get a complete list of the products you need to effectively service your equipment.

Your customized response includes a list of:

- **Spare parts** — the modules, sub-assemblies and associated kits needed for on-site repair.
- **Tools and Test Equipment** — the most commonly used maintenance aids for both off-line and on-line diagnosis and exercising at the option level.
- **Preventive Maintenance Parts** — parts that require routine replacement on a scheduled basis. For example, air filters.
- **Hardware Documentation** — associated hardcopy drawings, manuals and guides for individual options.

Please provide us with a system configuration. Our response listing can be sorted either by option or system configuration. A system sort will optimize sparing by combining redundant spares into a single requirement.

You will also need to determine the appropriate level of service required to meet your maintenance objectives. This is expressed as a percentage of expectancy that a replacement part will be in stock when a failure occurs. Choose between:

- 98% (A complete list of recommended spares will be provided)
- 95% (Excludes the least used spares)
- 90% (Minimum level recommended for effective on-site self-maintenance)

Take advantage of this *free* service and make sure you have all the necessary tools for effective maintenance. Call your sales representative today!

Self-Maintenance Program Information Line

Questions about Self-Maintenance? Call the experts!

Chances are you'll be faced with some questions you just can't answer on your own. When that happens, call on us. The Self-Maintenance Information Line is staffed with knowledgeable personnel who can assist you in many aspects of planning and implementing your maintenance program.

Call (603) 884-5000 and get the answers you need:

- Suggestions for planning your maintenance strategy
- Literature References
- Information about any of Digital's self-maintenance programs and customer support services

There is no cost to you for this service. Call us! The Maintenance Information Line is open Monday through Friday from 8:30 AM to 5 PM (ET).

Spares Part Number Assistance

You know the part you need, but don't know the part number? We'll find it for you!

Tracking down a part number can slow down your maintenance efforts. Instead of losing valuable time, call for Spare Part Number Assistance at (603) 884-5000. Our specialists can quickly find the right number for you. You can also call on them to:

- Identify the spares kit which contains the item
- Interpret and distinguish mechanical specifications
- Identify critical spare part numbers for high volume products
- Do spares technical research
- Cross reference to identify replacement
- Cross reference vendor part numbers for Digital products
- Identify associated next higher assembly
- Assist in making the appropriate spare part buying decision
- Determine whether a field replaceable unit is available
- Refer to the appropriate illustrated parts breakdown

Part Number Assistance lines are open Monday through Friday from 8:30 AM to 5 PM. For this *free* service call (603) 884-5000.

Unlisted Parts Service

It's an unlisted maintenance part, but it may still be available. Call us! We will provide you with a quote to help you place your order.

Some lower level assemblies and non-critical parts are not included in this directory. To request such a quotation, call the Unlisted Parts Service (UPS) at (603) 884-5001. Within ten working days you will receive a quotation with a price and delivery.

The following information must be provided with all requests:

- Your name, company name, address and phone number
- Part number, description and quantity requested item
- Digital option on which item is used

Responses to requests will be based on the current availability of requested material.

This service is **not an expedited parts delivery service**. For fastest response time and delivery, we recommend you order parts listed in the price book.

Unlisted Parts Terms and Conditions

- Orders for Unlisted Parts must be placed as a separate order referencing a UPS quotation number
- Discounts do not apply
- \$50 minimum per line item
- Quotations are valid as stated on the quote
- Unlisted part requests can be made for the following part classes only: 12, 17, 18, 23, 29, 30, 36, 54, 57, 70, 74, 90, and some alpha series (i.e. BCXXX-XX, MXXXX-XX).

- Purchaser must accept partial delivery and partial payments
- All orders received will be processed under both Unlisted Parts' and Digital's Standard Terms and Conditions.
- Orders will be filled providing material is available on receipt of order.
- Unlisted Parts Service is open Monday through Friday from 8:30 AM to 5 PM (ET).

Emergency Order Service

Keep a crisis under control. Our lines are open 24 hours a day!

A system has gone down that's critical to your organization. Get the parts you urgently need. Call the Emergency Order Service anytime, 24-hours a day.

Call at Any Hour

Customers in the U.S. call (603) 884-7063 Monday through Friday, 8:30 AM to 5 PM (ET). At any other time, call (508) 369-5900. Customers outside the U.S. should contact their local Digital subsidiary.

Shipping Commitments

Shipping commitments will be given only between 8:30 AM and 5 PM (ET), Monday through Friday! For orders received on any other day, shipping commitments will be given on the following work day.

For orders received during the normal work week, you'll get the status of your order within three hours. In the rare event that the part is out of stock, we will recommend alternative action. For example, we may suggest calling on Digital Field Service, or ordering the next highest assembly.

Here's what we need to process your order:

- Digital device type that is inoperable
- Machine serial number
- Billing, shipping information and stocking location
- Purchase order number
- Tax status
- Insurance by customer or Digital
- Part number (limit 2)
- Quantity (limit 2; more at Digital's discretion)
- Customer's name and phone number

Delivery and Service Fees

For all U.S. emergency orders, charges include current list price for part(s), shipping charges, and a \$100 service charge per order. In subsidiaries, charges include local price for part(s), air freight, custom charges, and a service charge determined by the subsidiary.

Restrictions

- Only domestic U.S. orders can be serviced
- Limit of two orders per month per customer stocking location
- Parts limited to those designated as spares by Digital
- Limit of two part types per order, maximum quantity of two each
- Service provided for a machine down situation only
- Non-U.S. customers contact their local Digital subsidiary
- No discounts apply
- Parts are not returnable

This service is available to U.S. customers who are providing hardware maintenance service on Digital products that are owned, leased or resold by the purchaser.

Maintenance Documentation Service

A compact tool to keep your maintenance documentation current!

Having the proper documentation and knowing where to find it is essential. With that in mind, Digital developed Maintenance Documentation Service (MDS).

All the information you need in one compact file box. The MDS library is on easy-to-use microfiche. So you no longer have to sift through cumbersome volumes of information.

Documentation on the devices you service. Your MDS library gives you complete, current information on entire "families" of Digital products, whether you service VAX or PDP-11 systems, terminals, or other systems.

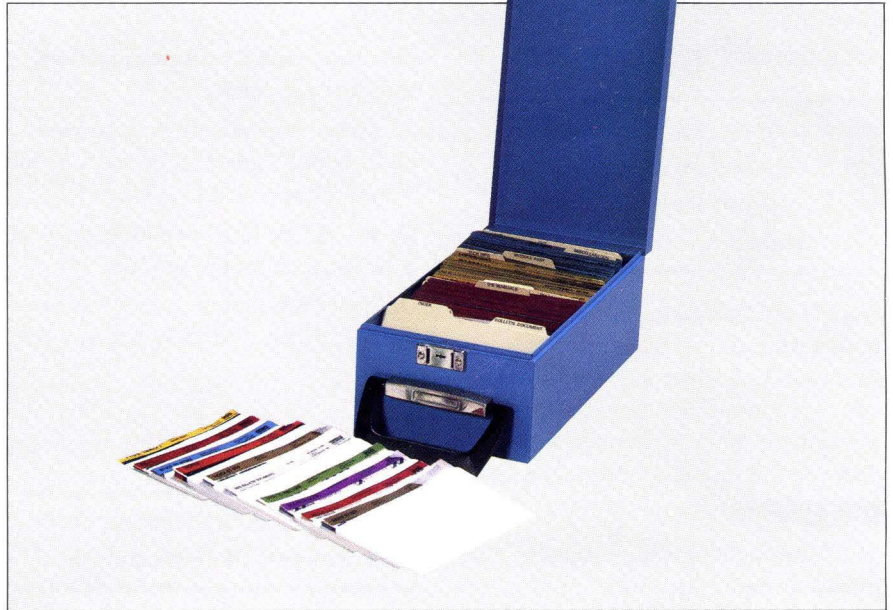

- Each MDS library includes:
- Hardware Manuals
 - Illustrated Parts Breakdowns
 - Revision Matrix
 - Preventive Maintenance Manuals
 - Diagnostic Listings
 - DEC-O-LOG (FCO Synopsis)
 - FCOs (Field Change Orders)

Something New! A small change with extra savings built in

We have made it easier for you to order the MDS Libraries and Update Subscription Service. When you decide which MDS product you want to purchase, one order number will automatically combine a library with the correct update subscription service.

You need not worry which Update Subscription Service should be ordered with your library. Just consider whether you want to receive one year of Update service or two.

For example:

MD-VAX-01 Orders the library plus one year of updates.

MD-VAX-02 Orders the library plus two years of updates.

The MDS part numbers have changed and so have some of the prices. Refer to the Documentation Price List in Section Three of this book for a complete list

of new order numbers and prices, or contact Part Number Assistance at 603-884-5000.



Hardware Maintenance Training News



Learn from Experts

Expert Instruction

Selected hardware maintenance training courses are available in training centers coast to coast. Professionals like you learn about hardware maintenance by attending exciting lecture/lab courses with expert instructors. Learn from experts in classrooms where you'll interact with peers and acquire the skills necessary to be your professional best!

Training Locations

Call the training center of your choice today to register for classes.

Boston

12 Crosby Drive BUO/E28
Bedford, Massachusetts 01730
(617) 276-4380

Atlanta

1455 Lincoln Parkway, 8th Floor
Atlanta, Georgia 30346
(404) 392-4771

Santa Clara

2525 Augustine Drive
Santa Clara, California 95054
(408) 748-4048

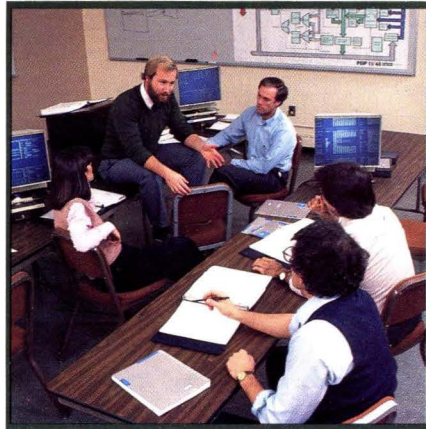

Interact with Peers

Recently Announced . . .

To Meet Your Training Needs

Exceed your potential with these impressive hardware technology courses:

- LN03 Laser Printer Maintenance. Install, maintain, and troubleshoot LN03 laser printers.
- RA60 Differences. Service, maintain and repair the RA60 disk drive.
- UNIBUS Data Communications Hardware Maintenance. Install, diagnose, and repair standard data communication devices available for the UNIBUS.
- Q-Bus Data Communications Hardware Maintenance. Install, diagnose, and repair data communication products used on Digital's Q-bus-based CPUs.
- VAX/VMS for Hardware Maintenance Level I. Troubleshoot a VAX/VMS computer system.
- VAXcluster Maintenance. Install, configure and maintain a VAXcluster system.



Be Your Professional Best

New Courses

Just released . . . from Digital's hardware experts

- RA82 Disk Maintenance Differences Troubleshooting and Repair. Remove and replace FRUs with diagnostic and troubleshooting strategy.
- MicroVAX 3500/3600 Diagnostics and Module Level Repair. Identify problems and learn how to use tools for quick, effective repair.
- VAX 6200 Diagnostic and Module Level Repair. Learn self-maintenance skills and how to use tools critical to your job.

Grow With Digital Expertise!

Call 1-800-332-5656, extension 169, for more information about Digital's hardware maintenance training, or refer to the Educational Services section in this book for a complete schedule of hardware courses in a training center near you.

Self-Maintenance Support for the New MicroVAX 3300/3400 Systems Features “Kernel Kits”

The MicroVAX 3300/3400 system is a higher performance, replacement product for the highly successful MicroVAX II computer. The MicroVAX 3300/3400 system offers more than two times the CPU performance, increased memory capacity, and new DSSI storage devices in BA213 and BA215 packaging.

The MicroVAX 3300/3400 system enhances the growth of the very successful MicroVAX family of products.

Digital's Self-Maintenance Services organization is pleased to support this new system family with the products highlighted in the accompanying spares matrix.

Once again our support for this new computer family features kits that consider the commonality of spares across a large number of systems. Our “Kernel Kits” will provide base-level spares for these systems. Additional spares are available in an *a-la-carte* fashion depending on your specific configuration.

This support concept is intended to eliminate sparing redundancies across systems and to help reduce the number of decisions in your service planning and ordering process.

Kernel Kits

Four “Kernel Kits” have been configured to support all 72 of the new MicroVAX 3300/3400 series packaged systems. Their content and commonality are detailed in the following matrix. The hardware spares included in each are indicated by an “X” in the column directly below the kit part number.

MicroVAX 3300/3400 VAXservers 3300/3400 Series System Spares Matrix

| Systems | System Options | | | | MDS | | Diagnostics | | | |
|-------------------|----------------|------------|------------|------|------|------|----------------|----------------|------------|---------|
| | KERNEL KIT | KERNEL KIT | KERNEL KIT | TK70 | TK70 | TK70 | 1.E.MX LIB 2/R | 1.E.MX LIB 1/R | UPDATE KIT | DOC KIT |
| DU/DV-330S1-AA/A2 | | | | X | X | X | X | X | X | X |
| DU/DV-330S1-A3/AE | | | | | X | X | X | X | X | X |
| DU/DV-330S2-AA/A2 | | | X | | | | X | X | X | X |
| DU/DV-330S2-A3/AE | | | | X | | | X | X | X | X |
| DU/DV-330T1-AA/A2 | X | | | | X | X | X | X | X | X |
| DU/DV-330T1-A3/AE | | X | | | X | X | X | X | X | X |
| DU/DV-330T2-AA/A2 | X | | | | | | X | X | X | X |
| DU/DV-330T2-A3/AE | | X | | | | | X | X | X | X |
| DU/DV-340S1-AA/A2 | | | X | | | | X | X | X | X |
| DU/DV-340S1-A3/AE | | | | X | | | X | X | X | X |
| DU/DV-340S2-AA/A2 | | | X | | | | X | X | X | X |
| DU/DV-340S2-A3/AE | | | | X | | | X | X | X | X |
| DU/DV-340T1-AA/A2 | X | | | | X | X | X | X | X | X |
| DU/DV-340T1-A3/AE | | X | | | X | X | X | X | X | X |
| DU/DV-340T2-AA/A2 | X | | | | | | X | X | X | X |
| DU/DV-340T2-A3/AE | | X | | | | | X | X | X | X |
| DV-340S3-AA/A2 | | | X | | X | X | X | X | X | X |
| DV-340S3-A3/AE | | | | X | X | X | X | X | X | X |
| DV-340T3-AA/A2 | X | | | | X | X | X | X | X | X |
| DV-340T3-A3/AE | | X | | | X | X | X | X | X | X |

| Recommended Spares | System Options | | | | MDS | | Diagnostics | | | |
|--------------------|----------------|-------------|-------------|-------------|--------|---------|--------------|----------|---------|---------|
| | 4A-640QX-AA | 4A-640QX-A3 | 4A-640QX-BA | 4A-640QX-B3 | TK70-X | TK70-00 | 1ND-E.VAX.01 | 1MEX-LI2 | 1MEX-H5 | 1MEX-HW |
| | X | X | X | X | X | X | X | X | X | X |
| | | X | X | X | X | X | X | X | X | X |
| | | | X | X | X | X | X | X | X | X |
| | | | | X | X | X | X | X | X | X |

| Part Number | Description | 4A-640QX-AA | 4A-640QX-A3 | 4A-640QX-BA | 4A-640QX-B3 |
|--------------------|--|-------------|-------------|-------------|-------------|
| H7868-A | Power Supply 120V | X | | | X |
| H7868-B | Power Supply 240V | | | X | X |
| M7621-AA | MS650-AA- 8MB Memory | X | X | | |
| M7624-AA | MicroVAX CPU Module | X | X | | |
| M7624-BA | VAXserver CPU Module | | | X | X |
| 45A-RF30-A | RF 30 Spare Drive | X | X | X | X |
| 4A-640QX-AA | Kernel Kit for MicroVAX 3300/3400 60Hz | | | | |
| 4A-640QX-A3 | Kernel Kit for MicroVAX 3300/3400 50Hz | | | | |
| 4A-640QX-BA | Kernel Kit for VAXserver 3300/3400 60Hz | | | | |
| 4A-640QX-B3 | Kernel Kit for VAXserver 3300/3400 50Hz | | | | |

Announcing Service Products for Digital's New, State-of-the-Art, Thin Film Disk Drives

RA70 Disk Drive

The RA70 disk drive launches a new generation of Digital's high-technology disk products. The RA70 is a 5.25-inch form factor, random access, moving head Winchester disk drive that utilizes thin film media technology. It has a formatted capacity of 280 MB and is designed for I/O intensive applications. It features full DSA/SDI functionality, dual ports, high reliability, high performance, and high capacity in a 5.25-inch format.

The RA70 disk drive is made up of two major replaceable spares: the HDA assembly, and the Electronics Control Module Set (ECM). The ECM is a combination of two modules which must not be separated. This is partly because of ESD sensitivity, but mainly because the drive's internal error log is only on one of the modules. In order to interpret and analyze the error log information the two modules must remain together as a set.

The table on this page shows the maintenance products that Self-Maintenance Services currently offers to support the RA70 disk drive.

Hardware Spares Kit

| Part Number | Description | Quantity | Unit Price |
|-------------|-------------------------------|----------|------------|
| 4A-RA70-A | RA70-A Spares Kit | | \$8,117.00 |
| 70-21946-01 | HDA Assembly | 1 | 5,394.40 |
| 70-22474-01 | Shoe Plate | 1 | 21.00 |
| 70-22494-01 | Electronic Control Module Set | 1 | 3,995.00 |

Documentation Kit

| Part Number | Description | Quantity | Unit Price |
|-------------|-----------------------------|----------|------------|
| FB-RA70-00 | RA70 Documentation Kit | 1 | \$ 318.00 |
| EK-ORA70-PS | Pocket Service Guide | 1 | 20.00 |
| EK-RA70A-IP | Illustrated Parts Breakdown | 1 | 20.00 |
| MP-01428-01 | Printset | 1 | 358.00 |

Repair Services

| Part Number | Description | DECmailer Price | Factory Repair Price |
|-------------|---------------------------|-----------------|----------------------|
| 70-21946-01 | Head Disk Assembly | \$4,315.00 | \$4,099.00 |
| 70-22494-01 | Electronic Control Module | 1,125.00 | 1,069.00 |

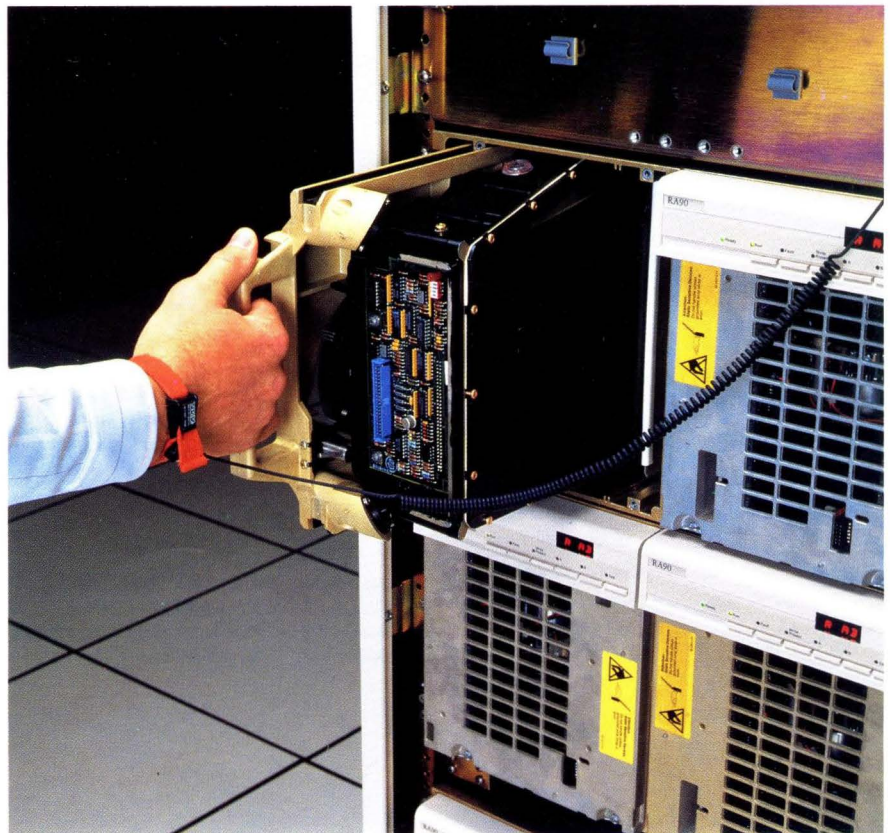

SA600 Storage Array

The SA600 Storage Array is based on the 1.2GB random access, moving head RA90 component disk drive. The RA90 uses state-of-the-art thin-film heads and media. It also occupies half the physical space of an RA81 disk drive.

Each SA600 storage array can have up to eight fully independent DSA/SDI compatible RA90 component drives mounted in it. The 60-inch high SA600 storage array cabinet has the same physical dimensions and is electronically similar to the SA482.

Each RA90 is made up of six major replaceable spares: Power Supply, Operator Control Panel, Preamp Control Module, Blower/Bezel Assembly, Head Disk Assembly, and the Electronics Control Module (ECM). Like the RA70, the RA90 ECM set must not be separated.

The table on this page shows the maintenance products that Self-Maintenance Services currently offers to support the SA600 Storage Array.

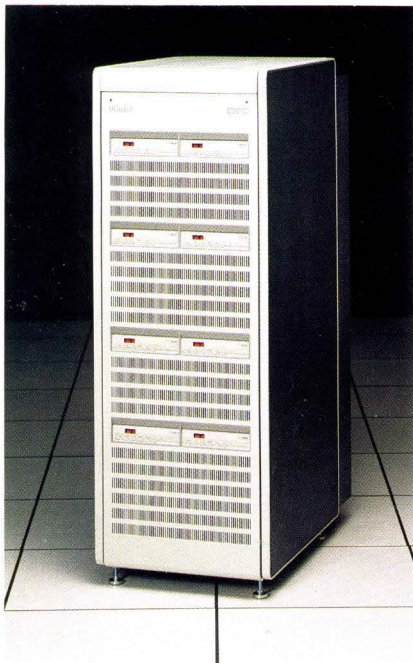

Hardware Spares Kit

| Part Number | Description | Quantity | Unit Price |
|-------------|---------------------------|----------|-------------|
| 4A-RA90-00 | RA90 Spares Kit | | \$23,701.00 |
| 30-23506-01 | Power Supply | 1 | 600.00 |
| 30-24453-01 | Operator Control Panel | 1 | 324.00 |
| 70-22939-01 | Blower/Bezel Assembly | 1 | 1,000.00 |
| 70-22942-01 | Electronic Control Module | 1 | 7,067.58 |
| 70-22951-01 | Head Disk Assembly | 1 | 15,535.00 |

Documentation Kit

| Part Number | Description | Quantity | Unit Price |
|-------------|----------------------------------|----------|------------|
| FB-RA90-00 | RA90 Documentation Kit | | \$ 318.00 |
| EK-0RA90-PS | RA90 Pocket Service Guide | 1 | 20.00 |
| EK-0RA90-IP | RA90 Illustrated Parts Breakdown | 1 | 20.00 |
| MP-01424-00 | SA600-X Printset | 1 | 358.00 |

Repair Services

| Part Number | Description | DECmailer Price | Factory Repair Price |
|-------------|---------------------------|-----------------|----------------------|
| 30-23506-01 | Power Supply | \$ 289.00 | \$ 275.00 |
| 70-22492-01 | Electronic Control Module | 2,299.00 | 2,184.00 |
| 70-22951-01 | Head Disk Assembly | 12,429.00 | 11,807.00 |

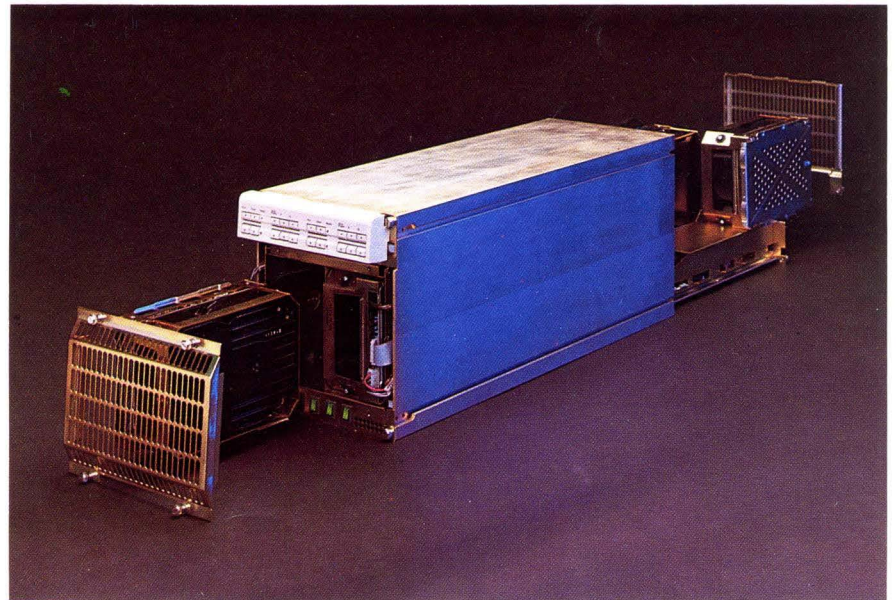

RA8X Head Disk Assembly (HDA)

Long Term Investments Can Pay Big Dividends

Digital is committed to using only the highest quality replacement parts in providing service to our customers. As part of our ongoing research on improving the quality of our products and spare parts, we discovered that we could achieve a substantial improvement in reliability by ceasing to repair our HDAs and employing only brand new, or “new build” HDAs. While this did increase the cost of the replacement

HDAs, the cost was far more than offset by the reliability improvements.

In the past, our research revealed that each repair cycle on an HDA decreased the reliability of the HDA. The mean time between failures of repaired HDAs was increasing creating costly downtime.

This graph charts the reliability improvements over the last three revisions of HDAs. The reliability has doubled over just the last two revisions.

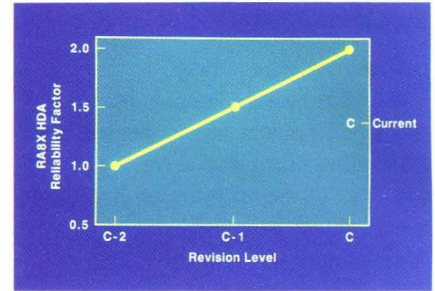

New Build HDAs Offer the Best Deal

Another point to consider is HDA life. These are electro-mechanical devices and eventually they “wear out.” A new HDA delivers all new parts. When you buy an HDA that is repaired, you really don’t know how old the HDA and each of its components are, or how long it will be until the next part wears out.

All Digital replacement HDAs are subjected to the same extensive test processes as our new disk drives.

This analysis clearly demonstrates that “new build” results in a superior replacement HDA in terms of Quality, Reliability, and Life.

Don’t be misled by vendors offering lower prices for repaired HDAs. In light of the facts, the choice is clear: new build HDAs are a better deal, the best deal.

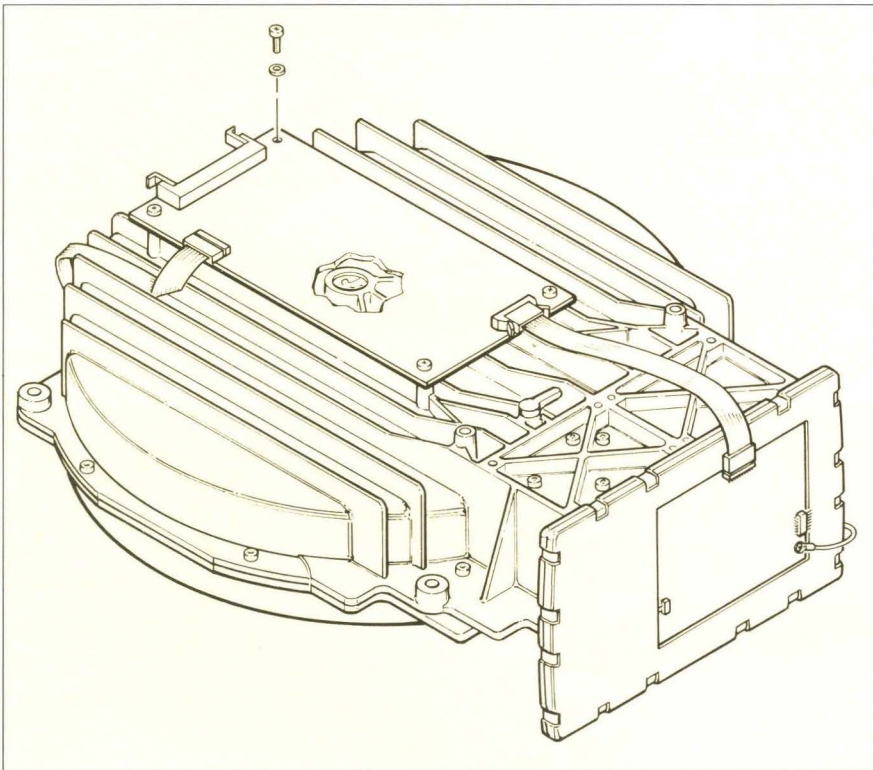

DECmailer — Convenience and Cost Savings!

DECmailer

DECmailer is Digital's fast, reliable and economical mail-in parts replacement service. We designed DECmailer to help you stretch your maintenance budget by providing the repair resources you need — spare parts and skilled technicians — so you can allocate your maintenance resources for the most critical repairs.

Take a look at some of the features:

- **Fast Turnaround.** Within five days of receiving your faulty part we will send you a replacement.
- **Larger Repair Menu.** Over 2,000 replacement parts are eligible.
- **Emergency Dispatch.** In an emergency, available parts will be shipped to you within 24 hours of your call. (There is an additional fee for this service.)
- **90-Day Warranty.** We will replace free of charge any repaired part that malfunctions within three months of shipment.
- **Transaction or Monthly Billing.** Choose either an open account with a monthly invoice or an invoice for each line item to help you manage your repair budget.
- **Reference Number for Tracking Orders.** (optional) We help you track replacement part orders by using your designated reference number when we receive your part. This number is printed on both our shipping document and invoice.
- **Pre-addressed Shipping Labels.** A more convenient way to mail the defective parts back to us.
- **Technical Improvements.** Your replacement part will be updated with the current technical improvements.
- **Fast Return Freight Paid by Digital.** We will send a replacement part via a two-day package delivery service — and we pay the cost of return shipping.

- **Quarterly Activity Report.** This report summarizes all DECmailer activity for a 3-month period, including the amount of time it takes to turn around your order. This report is a valuable tool for reconciling your account and planning your inventory needs.

DECmailer is available for all qualified customers who maintain their equipment to the module and subassembly level. Call us at 1-800-225-5385 for a complete application kit!

Another feature for DECmailer customers!

DECmailer Emergency Dispatch Service

Follow these instructions for your emergency repair needs:

1. Check the price listing, to be sure the part is available under DECmailer.
2. Call our facility in Woburn, Massachusetts, between 8:30 AM and 8 PM (EST) at 1-800-225-5385.
3. Specify that you want to use the Emergency Dispatch feature of your DECmailer account. Be prepared to provide the following:
 - DECmailer account number
 - Type of machine
 - Machine serial number
 - Ship-to information
 - Special instructions (hold at airport, etc.)
 - Part(s) required
 - Requester's name and phone number
4. Within three hours of the phone call, we will contact you about the availability of the part(s).

5. Available parts will be shipped via air freight within 24 hours of the initial phone call. For emergency orders confirmed after 4 PM, this means the first available commercial flight on the next working day.
6. Return the defective part to our facility within 10 working days, referencing the DECmailer line number and using the Emergency Dispatch label.
7. If the defective part is not returned, or if the board you returned is unrepairable or below acceptable etch level, you will be charged 100% of the manufacturer's list price.
8. If you return your defective part within 10 working days and we meet our obligations, your next invoice will include charges for the Emergency Dispatch Service (50% uplift plus \$125 handling charge).

90-day Warranty Provisions

We will replace free of charge any part shipped under DECmailer if it fails within 90 days.

If this occurs, *do not* return the part against your DECmailer reference number. Please follow these instructions to prevent duplicate charges.

1. Call the CRC at 1-800-225-5385. Be prepared to provide the following:
 - Your DECmailer number
 - Part and serial numbers of defective item
 - DECmailer line number on which part was shipped to us
2. We will provide you with a Return Authorization Number for return of the part and will ship a replacement at no charge to you after we receive the faulty part.

Factory Repair

Factory Repair (and Same Board Repair) Service is an economical and convenient way to supplement your maintenance efforts. This service provides the same quality repair service as DECmailer, but with an extended turnaround time and a lower cost. This program is available for all Digital customers who maintain their equipment to the module or sub-assembly level.

On a limited number of parts under this program, we repair your part, upgrade it to the current revision level, and return it within six to eight weeks. For the remaining items we reserve the right to ship a replacement part within the six- to eight-week time frame.

How to Use Factory Repair/ Same Board Repair Services

1. Call the CRC at 1-800-225-5385 for a Return Authorization number. Be prepared to provide your full "bill to" and "ship to" address, purchase order number, quantity, part number and serial number.
 2. Pack the defective part(s) to prevent damage during shipping.
 3. Include a packing list showing your return address and Return Authorization number.
 4. Ship the part prepaid to the CRC (by a traceable method of transportation) to the address listed below. To ensure a prompt receipt, make sure to include the RA# on the outer carton and all associated paperwork.
- Digital Equipment Corporation
 33 Cabot Road
 Woburn, MA 01801
 Attn: Stockroom 26
 RA# _____
5. If repair time exceeds a reasonable period, we reserve the option to ship a replacement part with your approval.

The Customer Returns Center and Digital's Hardware Product Foundation Warranty

FRU Repair/Replacement Service

The Hardware Product Foundation Warranty is a limited warranty consisting of one-year return of a system's or option's field replaceable units (FRUs) to the Customer Returns Center (CRC) with free repair or replacement of the FRU. Each system or option has a defined set of FRUs. The list is available on request from your local Digital sales representative.

FRUs as defined by Digital are the only parts eligible for coverage. FRUs in need of repair due to improper treatment or use are not eligible for return. If FRUs are returned and are subsequently deemed ineligible, Digital may demand return of any replacement FRUs or charge for the full List Price value of the replacement FRU(s) and will return the ineligible FRU(s) upon receipt of payment or the replacement FRU(s).

Before returning any FRU to Digital for replacement, you must call the CRC at 1-800-225-5385 to obtain a Return Authorization Number (RA#). The following information will be required:

- Your full Ship-to and Bill-to Address
- The Part Number(s) and Serial Number(s) of the FRU(s)
- The System or Option and Serial Number
- The Original DEC Order Number (DEC#)

The RA# which you are given should be placed on the shipping label, on the packing list, and on all associated paperwork and correspondence. The eligible FRUs should be protected against Electro-Static Discharge (ESD), packaged to prevent damage in shipment, and shipped pre-paid to Digital. The CRC will use best efforts to, at its option, repair or replace eligible FRUs within 15 working days of their receipt and acceptance at the CRC receiving dock. Return shipment of replacement FRU's will be F.O.B. Digital shipping point.

All repairs/replacements are warranted against defects in workmanship and material until the completion of the original, one year warranty.

Repaired and/or replacement parts will be at the current revision level. In the event newly installed Field Engineering Change Orders (FCOs) cause an incompatibility or other interference within your system the resolution for such incompatibility or interference is your responsibility.

If you have questions concerning the return of FRUs under the Hardware Product Foundation Warranty, call the CRC.

Computer Site Environmental Surveillance Products

There When You Can't Be

Emergencies can occur at any moment. You won't always be there when a serious power fluctuation disturbs your computer room, or a water leak short circuits your hardware. Digital's Environmental Products offer protection for your computer investment.

For more information about Environmental Products please complete and return the business reply card in this book.

EMS and REMS...Two New Products

The Environmental Monitoring System (EMS)

Timely Warnings Against Environmental Threats

EMS is an advanced, microprocessor-based data collection system built to handle the electronic environmental surveillance of any computer site and its supporting equipment. The unit uses from one to 112 external sensors/probes to provide real-time sampling of physical environmental changes.

It then compares these changes to user-established thresholds. When a predefined threshold is exceeded, EMS will indicate that an alarm is present, and record the alarm data chronologically until it is retrieved manually.

EMS (H7310) functions as a stand-alone unit or daisy chains together with up to seven additional EMS units to form a monitoring network. It can also be daisy-chained to Power Conditioning Systems Plus (H7318) and Power Distribution Systems Plus (H7317) to expand network monitoring capabilities. The EMS unit is an economical solution for computer room surveillance needs and is easily installed at conventionally wired computer sites.



VAX Remote Environmental Monitoring Software (REMS)

Real-Time Centralized Reporting

Building on the power of the VAX/VMS operating system, REMS layered software allows you to monitor every room in your computer network from one place. You can monitor local or remote computer sites from any VT100-compatible terminal. REMS receives collected environmental monitoring information from either the new Environmental Monitoring System, the PCS+, or the PDS+. It then communicates that information, in real-time, to a central location. REMS' centralized reporting feature allows you to have a network of environmental products at your fingertips.

REMS continuously collects information and stores it in an indexed sequential file, creating a database on power conditions, temperature, water, air conditioning, and other probes that you may specify. REMS can then generate statistical reports, send mail, or call up subroutines to prevent environmental failures and, in turn, prevent problems from recurring. For example, REMS can call up an operator-programmed, logical computer shut down in response to an abnormally high temperature in your computer room.

Digital's Solutions to Power-Related Problems

- **HA3000 Uninterruptible Power System (UPS)** — Three-phase UPS provides battery back-up and full power conditioning for mid-sized to large systems. Designed to support non-linear power loads, it features microprocessor-controlled operations, PWM inverter technology, static and maintenance bypass, and online diagnostics. A small footprint and sealed maintenance-free batteries allow the HA3000 to fit the computer room environment.
- **PCS+ /PCS** — Conditions, distributes, monitors. Protects from high energy, transients, impulses, voltage sags and surges; phase rotation; improper wiring or grounding; electrical noise.
- **PDS+** — Distributes, monitors. Protects from phase rotation; improper wiring or grounding; electrical noise.
- **CVC** — Conditions, distributes. Protects from high energy, transients, impulses; voltage sags and surges; improper wiring or grounding; electrical noise.
- **TVSS** — Suppresses. Protects from high energy, transients, spikes.
- **Standby UPS** — Protects against black-outs; high energy; transients; impulses; spikes; electrical noise.

Save time and money! Order all your spares and maintenance products directly from Digital



Order by Phone

Call 1-800-344-4825. For your convenience, lines are open from 8:30 AM to 8:00 PM (ET).

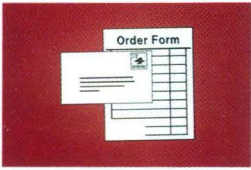

Order by Mail

Orders by mail may be placed by sending your purchase order direct to:

Digital Equipment Corporation
P.O. Box CS2008
Nashua, NH 03061



Sales Office

Purchase orders may be placed directly at any Digital Sales Office.

Minimum Order. Minimum order is \$35 unless you prepay by check, money order or credit card. (Phone and mail orders only.)

Credit Cards. MasterCard and VISA accepted. (Phone and mail orders only.)

Terms. Terms are payment with order. Or, if you have an approved account, terms are net 30 days.

Prices. Prices are listed in U.S. dollars and are subject to change without notice. The price charged will be the price in effect when Digital receives the order.

F.O.B. Shipping Point.

Shipping Information. Pay for your order in advance, and Digital will prepay and absorb all UPS or other surface freight shipping charges within the continental U.S. including Alaska, Hawaii and Puerto Rico. When Digital is required to invoice you for your order, transportation charges will be prepaid and added to your invoice.

We will make partial shipment to speed your order along, unless you specify "must ship complete."

Discounts. Your order may qualify for substantial discounts in conformance with the Digital Corporate Discount structure. All Spares, Diagnostics, Documentation, and Environmental Products are eligible for discount under the Digital Business Agreement (DBA).¹ Refer to the Spares Parts List Index (page 92) in this book for specific discount information.

To receive your discount, please be sure to reference the correct Discount Agreement Number and your Customer Account Number when placing your order.

Product Availability. To ensure that you are prepared, we recommend that you have an inventory of Spares Kits for your CPUs and options. These are shipped within 30 days. See the Diagnostics and Kits sections in this book, or contact your local sales office to obtain a suggested list of kits for your equipment.

Loose piece parts, to replace inventory as the Spares Kit contents are consumed, are shipped within 30 days. Software diagnostics products are shipped within 60 days.

Returns. To ensure prompt service for credit or exchange, call your Customer Service Representative for the required return authorization number. Report any order discrepancies promptly, within 30 days of ship date.²

Call for Service

We're available by telephone. Call us for the following services:

- **Self-Maintenance Information Line**
(603) 884-5000

For recommendations of the products you need or to answer your questions. (See the description of this service on page 4.)

- **Spares Part Number Assistance**
(603) 884-5000

When you know the part you need, but not the part number. (See the description of this service on page 4.)

- **Unlisted Parts Service**
(603) 884-5001

To determine if an unlisted part is still available. (See the description of this service on page 5.)

- **Emergency Order Service**
(603) 884-7063 8:30 to 5:00 weekdays
(508) 369-5900 other times

For service 24 hours a day in "machine-down" situations. (See the description of this service on page 5.)

- **DECmailer**
1-800-225-5385

In MA, AK, or HI call
(617) 938-2280 collect

When you need a part repaired. (See the description of this service on page 13.)

¹Discountable under the DBA End User Volume Curve "A."

²Documentation products may not be returned for credit.

Section Two
Self-Maintenance Products

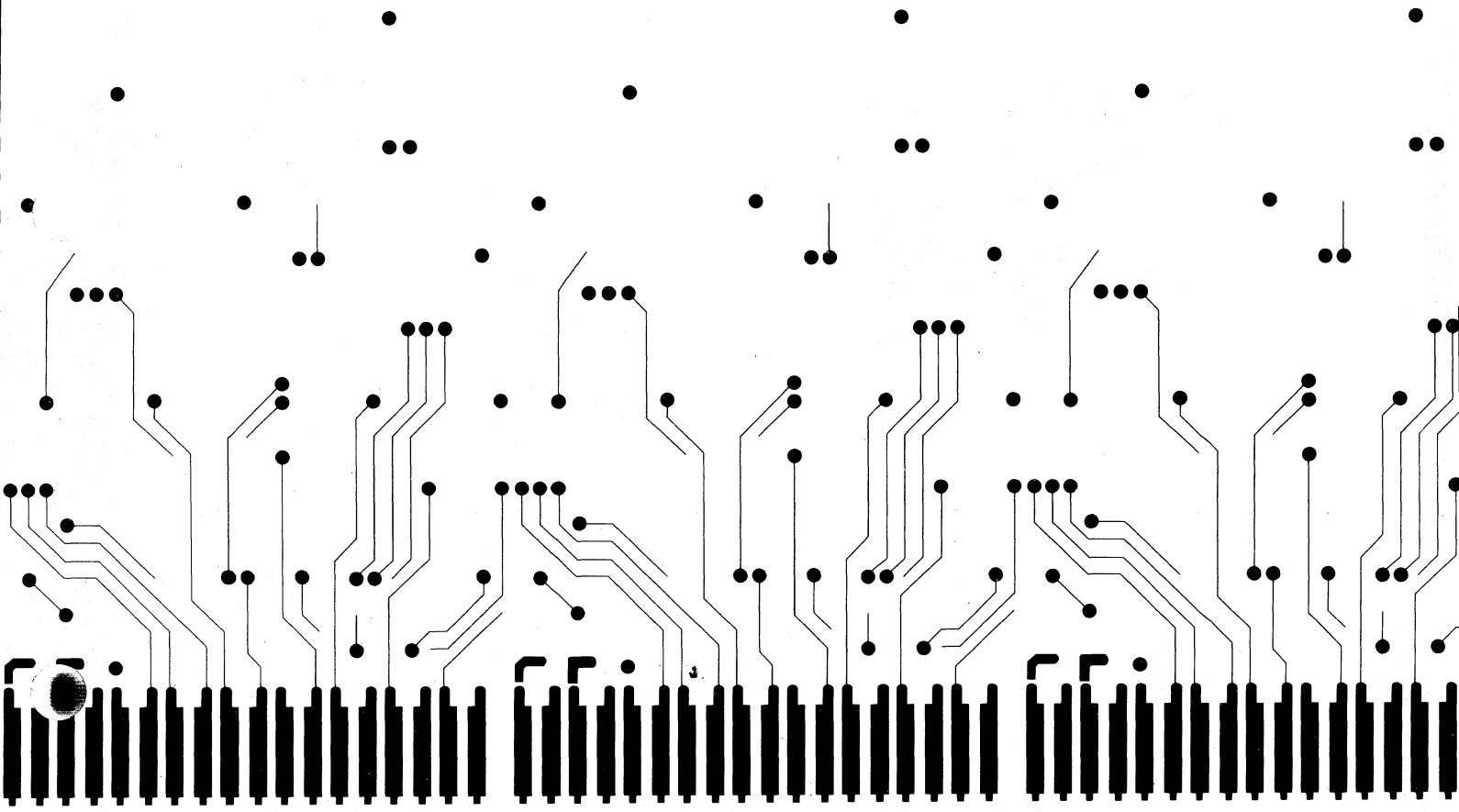

System Spares Matrices

How to Use the System Spares Matrices

The matrices on the following pages are a reference tool to help with your inventory planning. These matrices help you to see the commonality of spares across systems, and thus allow you to plan the most effective inventory of spares for your systems. The basic structure of each matrix is the same, and it is easy to interpret.

Simply scan the left column for your designated system. The spares that are recommended for that system are indi-

cated by an "X" in the adjacent boxes. The part numbers to use in ordering the recommended spares are positioned along the base of the matrix. The options that the spares support are listed at the top of the matrix.

In the case of hardware spares and documentation, the "X" signifies that these are recommended support items. An "X" in the license column under "diagnostics" indicates that diagnostics are available, and proper licensing is required.

The shaded areas in the matrices indicate one of two situations:

- A single system option requires more than one spare for support. The shading will cover all of the columns of spares recommended for that option, with the option designation repeated at the top of the matrix and the part numbers for the different spares at the bottom.
- A single spare part services more than one system option. The shading will cover all of the columns of options that the spare services, with the part number for the spare repeated at the bottom, and the different system option designations at the top.

Sample System Spares Matrix (VAX 8200 Series)

| Systems | System Options | | | | | | | | | | | | | | MDS | Diagnostics | | | | | | | |
|-------------|----------------|-----|--------|---------|---------|----------|----------|---------|---------|---------|---------|---------|---------|---------|---------|-------------|-------------|---------|-----------|---------|---------|---|---|
| | 87B | 87D | BA2-AA | CIBC1-A | DEBNT-M | DEJMA-00 | DWJUA-00 | KA20-CA | KA20-AA | KA20-CA | KA20-AA | MS20-AA | MS20-BA | RA50-AA | KDB50-A | VAX LIB 1/R | VAX LIB 2/R | LICENSE | MEDIA KIT | UPDATES | DOC KIT | | |
| 821BA-AE/BE | | X | X | | | X | X | X | X | X | X | X | X | * | X | X | X | X | X | X | X | X | X |
| 821BA-AJ/BJ | X | X | | | | X | X | X | X | X | X | X | X | * | X | X | X | X | X | X | X | X | X |
| 821BA-DE/EE | | X | X | | | X | X | X | X | X | X | X | X | * | X | X | X | X | X | X | X | X | X |
| 821BA-DJ/EJ | X | X | | | | X | X | X | X | X | X | X | X | * | X | X | X | X | X | X | X | X | X |
| 821BB-AE/DE | | X | X | X | | | | | | X | X | X | X | * | X | X | X | X | X | X | X | X | X |
| 821BB-AJ/DJ | X | X | | | X | | | | | X | X | X | X | * | X | X | X | X | X | X | X | X | X |
| 821CA-AP/DP | | X | X | X | | | | | | X | X | X | X | * | X | X | X | X | X | X | X | X | X |
| 821CA-AT/DT | X | X | X | | | | | | | X | X | X | X | * | X | X | X | X | X | X | X | X | X |
| 821CB-AP/DP | | X | X | X | X | | | | | X | X | X | X | * | X | | | X | X | X | X | X | X |
| 821CB-AT/DT | X | X | X | X | | | | | | X | X | X | X | * | X | | | X | X | X | X | X | X |
| 821BA-AE/DE | | X | X | X | | | | | | X | X | X | X | * | | X | | X | X | X | X | X | X |
| 822BA-AJ/DJ | X | X | X | X | | | | | | X | X | X | X | * | | X | | X | X | X | X | X | X |
| 82XBE-BJ/EE | | X | X | | | | | | | X | X | X | X | * | X | | | X | X | X | X | X | X |
| 82XBE-EJ | X | X | | | | | | | | X | X | X | X | * | X | | | X | X | X | X | X | X |
| 82XBF-BJ/EE | | X | X | | | | | | | X | X | X | X | * | X | | | X | X | X | X | X | X |
| 82XBF-EJ | X | X | | | | | | | | X | X | X | X | * | X | | | X | X | X | X | X | X |

| Recommended Spares | | | | | | | | | | | | | | MDS | Diagnostics | | | | | |
|--------------------|-----|------------|-------------|---------|---------|---------|---------|---------|------------|------------|---------|---------|------------|-------------|-------------|-----------|----------|----------|----------|----------|
| 87B | 87D | 4A-BA32-00 | 4A-CIBC1-AA | T102-00 | M732-00 | M733-00 | M715-00 | T101-00 | 5A-1572-01 | 5A-1572-01 | T108-BA | T109-AA | 4A-HX50-AA | 4A-KDB50-AA | MD-VAX-01 | MD-VAX-02 | Z5200-UZ | Z5200-KW | Z5200-WW | ZL300-GZ |

PDP-11 Products

PDP-11/73, -11/83, 11/84 Series System Spares Matrix

**PDP-11
MATRIX**

| Systems | System Options | | | | | | | | | | | | | | | | | | | | | | | | | | | | MDS | | Diagnostics | | | | | | | | | | | | | | | | |
|-------------|----------------|-------|-------|-------|-------|-------|----------|------|---------|--------|----------|----------|----------|----------|---------|----------|----------|----------|----------|----------|---------|---------|--------|----------|----------|----------|----------|----------|------|-----------|-------------|---------|---------|---------|-------------|-------------|---|---|---|---|---|---|---|---|---|---|---|
| | 814-A | 814-B | 814-D | 814-F | 817-B | 817-D | BA123-A2 | BA23 | DAU11-A | DH11-M | KDA50-QA | KDJ11-BB | KDJ11-BG | KDJ11-BE | MSV11-B | MSV11-JB | MSV11-JC | MSV11-JE | MSV11-PL | MSV11-QA | RA81-AA | RA81-AD | RD53-A | ROC25-BA | ROC25-BB | ROC25-BA | RUC25-BA | RUC25-BB | TK60 | TOK50-A1B | TU80-AA | TU80-AB | UDA50-A | LIBRARY | UPDATES 1YR | UPDATES 2YR | | | | | | | | | | | |
| 11/84-AA | | | | | | | X | | | | | | | X | X | X | | | | | | | | | | | | | | | | | | | | X | X | X | | | | | | | | | |
| 11/84-AB | | | | | | | X | | | | | | | | X | X | X | | | | | | | | | | | | | | | | | | | | X | X | X | | | | | | | | |
| 11/84-BA | | | | | | | X | | | | | | | | X | X | | X | | | | | | | | | | | | | | | | | | | X | X | X | | | | | | | | |
| 11/84-BB | | | | | | | X | | | | | | | | X | X | X | | | | | | | | | | | | | | | | | | | | | X | X | X | | | | | | | |
| 11H73-AA | X | | | | | | | | | X | | | | X | | | | | | X | | | | | | | X | X | | | | | | | | | | X | X | X | | | | | | | |
| 11H73-AB | | X | | | | | | | | X | | | | X | | | | | | X | | | | | | | X | X | | | | | | | | | | | X | X | X | | | | | | |
| 11X84-AA | | | | | | | | | | X | | | | | X | X | X | | | | | | | | | | | | | | | | | | | | | | X | X | X | | | | | | |
| 11X84-AB | | | | | | | X | | | | | | | | X | X | X | | | | | | | | | | | | | | | | | | | | | | | X | X | X | | | | | |
| 11X84-BA | | | | | | | X | X | | | | | | | X | X | X | | | | | | | | | | | | | | | | | | | | | | | X | X | X | | | | | |
| 11X84-BB | | | | | | | X | | | | | | | | X | X | X | | | | | | | | | | | | | | | | | | | | | | | | X | X | X | | | | |
| 173QY-C2 | | | | | | | | | | X | X | X | | | | | | | | | X | | | X | | X | | | | X | X | | | | | | | | | X | X | X | | | | | |
| 173QY-C3 | | | | | | | | | | X | X | X | | | | | | | | | X | | | X | | X | | | | X | X | | | | | | | | | | X | X | X | | | | |
| 173QZ-C2 | | | | | | | | | | X | X | X | | | | | | | | | X | | | X | | X | | | | X | X | | | | | | | | | | X | X | X | | | | |
| 173QZ-C3 | | | | | | | | | | X | X | X | | | | | | | | | X | | | X | | X | | | | X | X | | | | | | | | | | X | X | X | | | | |
| 183QE-D2 | | | | | X | | | | | X | | | | | X | | | | | X | | | | | | | | | | | | | | | | | | | | | | X | X | X | | | |
| 183QE-D3 | | | | | X | | | | | X | | | | | X | | | | | X | | | | | | | | | | | | | | | | | | | | | | X | X | X | | | |
| DH-173Q1-B2 | | | | | | | | | | X | X | X | | | | | | | | | X | | | X | | X | | | | X | X | | | | | | | | | | | X | X | X | | | |
| DH-173Q1-B3 | | | | | | | | | | X | X | X | | | | | | | | | X | | | X | | X | | | | X | X | | | | | | | | | | | | X | X | X | | |
| DH-173Q1-BA | | | | | | | | | | X | X | X | | | | | | | | | X | | | X | | X | | | | X | X | | | | | | | | | | | | X | X | X | | |
| DH-183Q2-A2 | | | | | | | X | | | X | X | | | | X | | | | | X | | | | X | | X | | | | X | X | | | | | | | | | | | | X | X | X | | |
| DH-183Q2-A3 | | | | | | | X | | | X | X | | | | X | | | | | X | | | | X | | X | | | | X | X | | | | | | | | | | | | | X | X | X | |
| DH-183Q2-AA | | | | | | | X | | | X | X | | | | X | | | | | X | | | | X | | X | | | | X | X | | | | | | | | | | | | | X | X | X | |
| DH-183Q3-A2 | | | | | X | | | | | X | X | X | | | X | | | | | X | | | | X | | X | | | | X | X | | | | | | | | | | | | | X | X | X | |
| DH-183Q3-A3 | | | | | X | | | | | X | X | X | | | X | | | | | X | | | | X | | X | | | | X | X | | | | | | | | | | | | | | X | X | X |
| DH-183Q3-AA | | | | | X | | | | | X | X | X | | | X | | | | | X | | | | X | | X | | | | X | X | | | | | | | | | | | | | | X | X | X |
| SK-JX100-EX | | | | | | | X | | | X | X | | | | X | X | X | | | | | | | | | | | | | | | | | | | | | | | | | | | X | X | X | |
| SK-JX100-EY | | | | | | | X | | | X | X | | | | X | X | X | | | | | | | | | | | | | | | | | | | | | | | | | | | | X | X | X |
| SK-JXEDA-EX | | | | | X | | | | | X | X | | | | X | X | X | | | | | | X | | | | | | | | | | | | | | | | | | | | | X | X | X | |
| SK-JXEDA-EY | | | | | X | X | | | | X | X | | | | X | X | X | | | | | | X | | | | | | | | | | | | | | | | | | | | | | X | X | X |
| SK-JXNNA-EX | | | | | | | X | | | X | X | | | | X | X | X | | | | | | | | | | | | | | | | | | | | | | | | | | | | X | X | X |
| SK-JXNNA-EY | | | | | | | X | | | X | X | | | | X | X | X | | | | | | | | | | | | | | | | | | | | | | | | | | | | X | X | X |

(1)

NOTE:

(1) See the Diagnostics Section following these matrices for PDP-11 Diagnostics information.

VAX Products

VAXBI Power and Memory Matrix

| Systems | Power Supplies | | | | | | | | | | | | | | | Memory Options | | | | | | | | | | | | | | |
|----------------|----------------|-------|-------|--------|--------|--------|--------|---------|---------|---------|---------|---------|---------|---------|---------|----------------|----------|---------|---------|---------|----------|----------|----------|-------------|----------|------------|------------|---------|---------|---------|
| | 876-A | 876-B | 880-A | HA05-A | HA05-B | HA05-E | HA05-F | HT060-A | HT061-A | HT062-A | HT066-A | HT110-A | HT117-A | HT180-A | HT186-A | HT187-A | HT188-AB | HT189-A | HT206-A | HT214-A | HT215-00 | HT250-00 | HT251-00 | 4A-HT317-LG | 10116-AA | 4A-MS88-CA | 4A-MS88-DA | T108-BA | T109-AA | T104-AA |
| 62XX 60HZ | | | | X | | | | | | | | | | | X | X | X | | | | | | | | | | | | | X |
| 62XX 50HZ | | | | | X | | | | | | | | | | X | X | X | | | | | | | | | | | | | X |
| 82XX 60HZ | | | | | | | | | | | | | | | | | | | | | | X | X | X | | | | | | |
| 82XX 50HZ | | | | | | | | | | | | | | | | | | | | | | X | X | X | | | | | | |
| 83XX 60HZ | | | | | | | | | | | | | | | | | | | | | | X | X | X | | | | | | |
| 83XX 50HZ | | | | | | | | | | | | | | | | | | | | | | X | X | X | | | | | | |
| 85XX 60HZ | | | X | | | X | X | | | X | X | | X | X | X | X | X | | | | | X | X | X | | | | | | |
| 85XX 50HZ | | | | X | | X | X | | | X | X | | X | X | X | X | X | | | | | X | X | X | | | | | | |
| 87XX 60HZ | X | | | | | X | X | X | X | X | | X | X | X | X | X | | | | | | X | X | X | | | | | | |
| 87XX 50HZ | | X | | | | X | X | X | X | X | | X | X | X | X | X | | | | | | X | X | X | | | | | | |
| 8800 60HZ | X | | | | | X | X | X | X | X | | X | X | X | X | X | | | | | | X | X | X | | | | | | |
| 8800 50HZ | | X | | | | X | X | X | X | X | | X | X | X | X | X | | | | | | X | X | X | | | | | | |
| 8810 60HZ | X | | | | | X | X | X | X | X | | X | X | X | X | X | | | | | | X | X | X | | | | | | |
| 8810 50HZ | | X | | | | X | X | X | X | X | | X | X | X | X | X | | | | | | X | X | X | | | | | | |
| 8820/30/40 60H | | | X | | | | | | X | | X | X | X | X | X | X | | | | | | | | | | | | | | |
| 8820/30/40 50H | | | | | | | | | X | | X | | X | | X | | | | | | | | | X | | | | | | |

VAX
MATRIX

VAX Products

VAX 8200 Series System Spares Matrix

| System: | System Options | | | | | | | | | | | | | | MDS | | Diagnostics | | | | |
|--------------------|----------------|------------|-------------|----------|----------|----------|----------|----------|-------------|-------------|----------|----------|------------|-------------|-------------|-------------|-------------|-----------|----------|----------|---|
| | 877-B | 877-D | BA32-AA | CIBC1-A | DEBNT-M | DEUNA-00 | DWBUA-00 | K&B2-AA | K&B10-AA | K&B10-AA | MS820-AA | MS820-BA | RS50-AA | KDB50-A | VAX LIB 1YR | VAX LIB 2YR | LICENSE | MEDIA KIT | UPDATES | DOC KIT | |
| 821BA-AE/BE | | | X | X | | | X | X | X | X | X | X | * | * | X | X | X | X | X | X | X |
| 821BA-AJ/BJ | X | | | X | | | X | X | X | X | X | X | * | * | X | X | X | X | X | X | X |
| 821BA-DE/EE | | | X | X | | | X | X | X | X | X | X | * | * | X | X | X | X | X | X | X |
| 821BA-DJ/EJ | X | | X | | | | X | X | X | X | X | X | * | * | X | X | X | X | X | X | X |
| 821BB-AE/DE | | | X | X | | X | | | | X | X | X | * | * | X | X | X | X | X | X | X |
| 821BB-AJ/DJ | X | | X | | X | | | | | X | X | X | * | * | X | X | X | X | X | X | X |
| 821CA-AP/DP | | | X | X | X | | | | | X | X | X | * | * | X | X | X | X | X | X | X |
| 821CA-AT/DT | X | | X | X | X | | | | | X | X | X | * | * | X | X | X | X | X | X | X |
| 821CB-AP/DP | | | X | X | X | X | | | | X | X | X | * | * | X | X | X | X | X | X | X |
| 821CB-AT/DT | X | | X | X | X | X | | | | X | X | X | * | * | X | X | X | X | X | X | X |
| 821BA-AE/DE | | | X | X | X | | | | | X | X | X | * | * | X | X | X | X | X | X | X |
| 822BA-AJ/DJ | X | | X | X | X | | | | | X | X | X | * | * | X | X | X | X | X | X | X |
| 82XBE-BJ/EE | | | X | X | | | | | | X | X | X | * | * | X | X | X | X | X | X | X |
| 82XBE-EJ | X | | X | | | | | | | X | X | X | * | * | X | X | X | X | X | X | X |
| 82XBF-BJ/EE | | | X | X | | | | | | X | X | X | * | * | X | X | X | X | X | X | X |
| 82XBF-EJ | X | | X | | | | | | | X | X | X | * | * | X | X | X | X | X | X | X |
| Recommended Spares | | | | | | | | | | | | | | MDS | | Diagnostics | | | | | |
| 877-B | 877-D | 4A-BA32-00 | 4A-CIBC1-AA | T1032-00 | MT792-00 | MT793-00 | MT106-00 | T1001-00 | 5A-16572-01 | 5A-16574-01 | T1008-BA | T1019-AA | 4A-RX50-AA | 4A-KDB50-00 | MD-VAX-01 | MD-VAX-02 | Z3200-LZ | Z3200-KW | Z3200-WW | ZL200-GZ | |

VAX 8300 Series System Spares Matrix

| Systems | System Options | | | | | | | | | | | | | | MDS | | Diagnostics | | | | |
|--------------------|----------------|------------|-------------|----------|----------|----------|----------|----------|-------------|-------------|----------|----------|------------|-------------|-------------|-------------|-------------|-----------|----------|----------|---|
| | 877-B | 877-D | BA32-AA | CIBC1-A | DEBNT-M | DEUNA-00 | DWBUA-00 | K&B2-AA | K&B10-AA | K&B10-AA | MS820-AA | MS820-BA | RS50-AA | KDB50-A | VAX LIB 1YR | VAX LIB 2YR | LICENSE | MEDIA KIT | UPDATES | DOC KIT | |
| 831BA-AE/DE | | | X | X | | | X | X | X | X | X | X | * | * | X | X | X | X | X | X | X |
| 831BA-AJ/DJ | X | | | X | | | X | X | X | X | X | X | * | * | X | X | X | X | X | X | X |
| 831BB-AE/DE | | | X | X | | X | | | | X | X | X | * | * | X | X | X | X | X | X | X |
| 831BB-AJ/DJ | X | | X | X | X | | | | | X | X | X | * | * | X | X | X | X | X | X | X |
| 831CA-AP/DP | | | X | X | X | | X | X | X | X | X | X | * | * | X | X | X | X | X | X | X |
| 831CA-AT/DT | X | | X | X | X | | X | X | X | X | X | X | * | * | X | X | X | X | X | X | X |
| 831CB-AP/DP | | | X | X | X | X | | | | X | X | X | * | * | X | X | X | X | X | X | X |
| 831CB-AT/DT | X | | X | X | X | X | | | | X | X | X | * | * | X | X | X | X | X | X | X |
| 832BA-AE/DE | | | X | X | X | | | | | X | X | X | * | * | X | X | X | X | X | X | X |
| 832BA-AJ/DJ | X | | X | X | X | | | | | X | X | X | * | * | X | X | X | X | X | X | X |
| 83XBA-AE/DE | | | X | X | | | | | | X | X | X | * | * | X | X | X | X | X | X | X |
| 83XBA-AJ/DJ | X | | X | | | | | | | X | X | X | * | * | X | X | X | X | X | X | X |
| Recommended Spares | | | | | | | | | | | | | | MDS | | Diagnostics | | | | | |
| 877-B | 877-D | 4A-BA32-00 | 4A-CIBC1-AA | T1032-00 | MT792-00 | MT793-00 | MT106-00 | T1001-00 | 5A-16572-01 | 5A-16574-01 | T1008-BB | T1019-AA | 4A-RX50-AA | 4A-KDB50-00 | MD-VAX-01 | MD-VAX-02 | Z1200-LZ | Z1200-PW | Z1200-WW | ZL200-GZ | |

NOTE:

*Your system may contain different memory options to achieve total memory capacity.

Please check your system to determine which memory option(s) is appropriate for you.

digital To Order, Call DECdirect at 800-344-4825. 8:30 AM to 8:00 PM (ET) in the Continental USA.

VAX MATRIX

VAX Products

VAX 8200/8300 Series System Spares Matrix Preconfigured

| Systems | System Options | | | | | | | | | | | | | | | | | | | | MDS | | Diagnostics | | | | | | | | | | | | | |
|----------------|----------------|-------|---------|---------|---------|---------|---------|----------|---------|---------|----------|----------|----------|----------|----------|---------|---------|---------|---------|--------|--------|---------|-------------|-------|-------------|-------------|---------|---------|-----------|-----------|---------|---------|---------|---|---|---|
| | 877-B | 877-D | BA32-AA | DEUNA-M | DEUNA-M | DEBNT-M | DMF32-M | DWPJA-CA | K&R20-A | K&R50-A | K&R10-AA | K&R10-AA | KLESI-BB | MS820-AA | MS820-BA | RA50-AA | RA60-AA | RA81-AA | RA81-AD | TU80-A | TU81-A | TU81E-A | 874-D | 874-F | VAX LIB 1YR | VAX LIB 2YR | LICENSE | LICENSE | MEDIA KIT | MEDIA KIT | UPDATES | UPDATES | DOC KIT | | | |
| SV-82EDA-GK | | X | X | X | X | | X | X | X | X | X | X | X | X | * | * | X | | X | X | | | | | | X | X | X | X | X | X | X | X | X | | |
| SV-82EDB-GN | X | | X | X | X | | X | X | X | X | X | X | X | X | * | * | X | | X | X | X | | | | | | X | X | X | X | X | X | X | X | X | |
| SV-82EDC-GK | | X | X | X | X | | X | X | X | X | X | X | X | X | * | * | X | | X | X | X | | | | | | X | X | X | X | X | X | X | X | X | |
| SV-82EDD-GN | X | | X | X | X | | X | X | X | X | X | X | X | X | * | * | X | | X | X | X | | | | | | X | X | X | X | X | X | X | X | X | |
| SV-82EEA-GK | | X | X | X | X | | X | X | X | X | X | X | X | X | * | * | X | | X | X | X | | | | | | X | X | X | X | X | X | X | X | X | |
| SV-82EEB-GN | X | | X | X | X | | X | X | X | X | X | X | X | X | * | * | X | | X | X | X | | | | | | X | X | X | X | X | X | X | X | X | |
| SV-82EEC-GK | | X | X | X | X | | X | X | X | X | X | X | X | X | * | * | X | | X | X | X | | | | | | X | X | X | X | X | X | X | X | X | |
| SV-82EED-GN | X | | X | X | X | | X | X | X | X | X | X | X | X | * | * | X | | X | X | X | | | | | | X | X | X | X | X | X | X | X | X | |
| SV-82EEE-GK/GL | | X | X | | | X | | | | | | | | | X | * | * | X | | X | X | | | | | X | X | X | X | X | X | X | X | X | X | |
| SV-82EEE-GM/GN | X | | X | | | X | | | | | | | | | X | * | * | X | | X | X | | | | | X | X | X | X | X | X | X | X | X | X | |
| SV-82EEN-GK/GL | | X | X | | | X | | | | | | | | | X | * | * | X | | X | X | | | | | X | X | X | X | X | X | X | X | X | X | |
| SV-82EEN-GM/GN | X | | X | | | X | | | | | | | | | X | * | * | X | | X | X | | | | | X | X | X | X | X | X | X | X | X | X | |
| SV-82EPA-GK | | X | X | X | X | | X | X | X | X | X | X | X | X | * | * | X | X | X | X | | | | | | X | X | X | X | X | X | X | X | X | X | X |
| SV-82EPB-GN | X | | X | X | X | | X | X | X | X | X | X | X | X | * | * | X | X | X | X | | | | | | X | X | X | X | X | X | X | X | X | X | X |
| SV-82EPC-GK | | X | X | X | X | | X | X | X | X | X | X | X | X | * | * | X | X | X | X | | | | | | X | X | X | X | X | X | X | X | X | X | X |
| SV-82EPD-GN | X | | X | X | X | | X | X | X | X | X | X | X | X | * | * | X | X | X | X | | | | | | X | X | X | X | X | X | X | X | X | X | X |
| SV-83EEA-GK/GL | | X | X | | | X | | | | | | | | | X | * | * | X | | X | X | | | | | X | X | X | X | X | X | X | X | X | X | X |
| SV-83EEA-GM/GN | X | | X | | | X | | | | | | | | | X | * | * | X | | X | X | | | | | X | X | X | X | X | X | X | X | X | X | X |
| SV-83EEN-GK/GL | | X | X | | | X | | | | | | | | | X | * | * | X | | X | X | | | | | X | X | X | X | X | X | X | X | X | X | X |
| SV-83EEN-GM/GN | X | | X | | | X | | | | | | | | | X | * | * | X | | X | X | | | | | X | X | X | X | X | X | X | X | X | X | X |

| Systems | Recommended Spares | | | | | | | | | | | | | | | | | | | | MDS | | Diagnostics | | | | | | | | | | | | | | |
|----------------|--------------------|-------|------------|----------|----------|----------|----------|----------|----------|-------------|-------------|-------------|---------|----------|----------|------------|------------|------------|------------|------------|------------|-------------|-------------|-------|-----------|-----------|----------|----------|----------|----------|----------|----------|--|--|--|--|--|
| | 877-B | 877-D | 4A-BA32-00 | M7192-00 | M7192-00 | T1022-00 | M8396-00 | M7196-00 | T1001-00 | 4A-KD550-00 | 5A-16572-01 | 5A-16574-01 | T1014-A | T1008-BA | T1019-BA | 4A-RX50-AA | 4A-RA60-AA | 4A-RA81-AA | 4A-RA81-AD | 4A-TU80-00 | 4A-TU81-00 | 4A-TU81E-00 | 874-D | 874-E | MD-VAX-01 | MD-VAX-02 | Z3200-UZ | Z3200-KW | Z3200-KW | Z3200-WW | Z3200-WW | ZL200-GZ | | | | | |
| SV-82EDA-GK | | | | | | | | | | | | | | | | | | | | | | | | | | | | | | | | | | | | | |
| SV-82EDB-GN | | | | | | | | | | | | | | | | | | | | | | | | | | | | | | | | | | | | | |
| SV-82EDC-GK | | | | | | | | | | | | | | | | | | | | | | | | | | | | | | | | | | | | | |
| SV-82EDD-GN | | | | | | | | | | | | | | | | | | | | | | | | | | | | | | | | | | | | | |
| SV-82EEA-GK | | | | | | | | | | | | | | | | | | | | | | | | | | | | | | | | | | | | | |
| SV-82EEB-GN | | | | | | | | | | | | | | | | | | | | | | | | | | | | | | | | | | | | | |
| SV-82EEC-GK | | | | | | | | | | | | | | | | | | | | | | | | | | | | | | | | | | | | | |
| SV-82EED-GN | | | | | | | | | | | | | | | | | | | | | | | | | | | | | | | | | | | | | |
| SV-82EEE-GK/GL | | | | | | | | | | | | | | | | | | | | | | | | | | | | | | | | | | | | | |
| SV-82EEE-GM/GN | | | | | | | | | | | | | | | | | | | | | | | | | | | | | | | | | | | | | |
| SV-82EEN-GK/GL | | | | | | | | | | | | | | | | | | | | | | | | | | | | | | | | | | | | | |
| SV-82EEN-GM/GN | | | | | | | | | | | | | | | | | | | | | | | | | | | | | | | | | | | | | |
| SV-82EPA-GK | | | | | | | | | | | | | | | | | | | | | | | | | | | | | | | | | | | | | |
| SV-82EPB-GN | | | | | | | | | | | | | | | | | | | | | | | | | | | | | | | | | | | | | |
| SV-82EPC-GK | | | | | | | | | | | | | | | | | | | | | | | | | | | | | | | | | | | | | |
| SV-82EPD-GN | | | | | | | | | | | | | | | | | | | | | | | | | | | | | | | | | | | | | |
| SV-83EEA-GK/GL | | | | | | | | | | | | | | | | | | | | | | | | | | | | | | | | | | | | | |
| SV-83EEA-GM/GN | | | | | | | | | | | | | | | | | | | | | | | | | | | | | | | | | | | | | |
| SV-83EEN-GK/GL | | | | | | | | | | | | | | | | | | | | | | | | | | | | | | | | | | | | | |
| SV-83EEN-GM/GN | | | | | | | | | | | | | | | | | | | | | | | | | | | | | | | | | | | | | |

NOTE:

*Your system may contain different memory options to achieve total memory capacity. Please check your system to determine which memory option(s) is appropriate for you.

VAX MATRIX

VAX Products

VAX 8250 Series System Spares Matrix

| Systems | System Options | | | | | | | | | | | | | | MDS | Diagnostics | | | | | |
|-------------------|----------------|-------|---------|--------|---------|---------|----------|----------|---------|----------|----------|----------|---------|---------|-----|-------------|------------|---------|-----------|---------|---------|
| | 871-B | 871-D | BA32-AA | CIBC-A | DEBIA-M | DEBNT-M | DWBUA-BA | KA825-AA | KDB30-A | KK810-AA | MS820-AA | MS820-BA | RA30-AA | CIBC-AA | | VAX-IB 1YR | VAX-IB 2YR | LICENSE | MEDIA KIT | UPDATES | DOC KIT |
| 824BB-AE/BE/DE/EE | | X | X | | | | X | | X | X | X | X | X | X | X | X | X | X | X | X | X |
| 824BB-AJ/BJ/DJ/EJ | X | | X | | | | X | | X | X | X | X | X | X | X | X | X | X | X | X | X |
| 824BC-AE/BE/DE/EE | | X | X | | X | | | | X | X | X | X | * | * | X | X | X | X | X | X | X |
| 824BC-AJ/BJ/DJ/EJ | X | | X | | X | | | | X | X | X | X | * | * | X | X | X | X | X | X | X |
| 824CA-AP/DP | | X | X | X | X | | X | | X | X | X | X | X | X | X | X | X | X | X | X | X |
| 824CA-AT/DT | X | | X | X | X | | X | | X | X | X | X | X | X | X | X | X | X | X | X | X |
| 824CC-AP/DP | | X | X | | X | | | | X | X | X | * | * | X | X | X | X | X | X | X | X |
| 824CC-AT/DT | X | | X | | X | | | | X | X | X | * | * | X | X | X | X | X | X | X | X |
| 825BA-AE/BE/DE/EE | | X | X | | | X | | X | X | X | X | X | X | X | X | X | X | X | X | X | X |
| 825BA-AJ/BJ/DJ/EJ | X | | X | | | X | | X | X | X | X | X | X | X | X | X | X | X | X | X | X |
| 825BB-AE/BE/DE/EE | | X | X | | X | | | | X | X | X | * | * | X | X | X | X | X | X | X | X |
| 825BB-AJ/BJ/DJ/EJ | X | | X | | X | | | | X | X | X | * | * | X | X | X | X | X | X | X | X |
| 825CA-AP/DP | | X | X | X | X | | X | | X | X | X | X | X | X | X | X | X | X | X | X | X |
| 825CA-AT/DT | X | | X | X | X | | X | | X | X | X | X | X | X | X | X | X | X | X | X | X |
| 825CB-AP/DP | | X | X | | | X | | X | X | X | X | X | X | X | X | X | X | X | X | X | X |
| 825CB-AT/DT | X | | X | | | X | | X | X | X | X | X | X | X | X | X | X | X | X | X | X |
| 825CD-AP/DP | | X | X | | X | | | | X | X | X | * | * | X | X | X | X | X | X | X | X |
| 825CD-AT/DT | | X | X | | X | | | | X | X | X | * | * | X | X | X | X | X | X | X | X |
| 8AXBA-AE/BE/DE/EE | | | X | | | | X | X | X | X | X | X | X | X | X | X | X | X | X | X | X |
| 8AXBA-AJ/BJ/DJ/EJ | | | X | | | | X | X | X | X | X | X | X | X | X | X | X | X | X | X | X |
| 8AXBB-AE/BE/DE/EE | | | X | | | | X | X | X | X | X | X | X | X | X | X | X | X | X | X | X |
| 8AXBB-AJ/BJ/DJ/EJ | | | X | | | | X | X | X | X | X | X | X | X | X | X | X | X | X | X | X |
| 8AXBC-AE/BE/DE/EE | | | X | | | | X | X | X | X | X | * | * | X | X | X | X | X | X | X | X |
| 8AXBC-AJ/BJ/DJ/EJ | | | X | | | | X | X | X | X | X | * | * | X | X | X | X | X | X | X | X |
| 8AXBD-AE/BE/DE/EE | | | X | | | | X | X | X | X | X | * | * | X | X | X | X | X | X | X | X |
| 8AXBD-AJ/BJ/DJ/EJ | | | X | | | | X | X | X | X | X | * | * | X | X | X | X | X | X | X | X |

VAX MATRIX

NOTE:

*Your system may contain different memory options to achieve total memory capacity. Please check your system to determine which memory option(s) is appropriate for you.

VAX Products

VAX 8350 Series System Spares Matrix

**VAX
MATRIX**

| Systems | System Options | | | | | | | | | | | | | | MDS | | Diagnostics | | | | |
|-------------------|----------------|------|---------|--------|---------|---------|----------|---------|----------|----------|----------|----------|---------|---------|------------|------------|-------------|-----------|---------|---------|---|
| | 87-B | 87-D | BA32-AA | CIBC-A | DEBNA-M | DVBNT-M | KAB25-AA | KDB30-A | KB810-AA | KB810-AA | MS820-BA | MS820-CA | RA50-AA | CIBC-AA | VAX-1B-1YR | VAX-1B-2YR | LICENSE | MEDIA KIT | UPDATES | DOC KIT | |
| 834BA-AE/BE/DE/EE | | X | X | | | | X | X | X | X | X | X | X | X | X | X | X | X | X | X | X |
| 834BA-AJ/BJ/DJ/EJ | X | | X | | | | X | X | X | X | X | X | X | X | X | X | X | X | X | X | X |
| 834BB-AE/BE/DE/EE | | X | X | X | | | X | X | X | X | X | X | X | X | X | X | X | X | X | X | X |
| 834BB-AJ/BJ/DJ/EJ | X | | X | X | X | | X | X | X | X | X | X | X | X | X | X | X | X | X | X | X |
| 834CA-AP/DP | | X | X | X | | | X | X | X | X | X | X | X | X | X | X | X | X | X | X | X |
| 834CA-AT/DT | X | | X | X | X | | X | X | X | X | X | X | X | X | X | X | X | X | X | X | X |
| 834CC-AP/DP | | X | X | X | | | X | X | X | X | X | X | X | X | X | X | X | X | X | X | X |
| 834CC-AT/DT | X | | X | X | X | | X | X | X | X | X | X | X | X | X | X | X | X | X | X | X |
| 835BA-AE/BE/DE/EE | | X | X | | | | X | X | X | X | X | X | X | X | X | X | X | X | X | X | X |
| 835BA-AJ/BJ/DJ/EJ | X | | X | | | | X | X | X | X | X | X | X | X | X | X | X | X | X | X | X |
| 835BB-AE/BE/DE/EE | | X | X | X | | | X | X | X | X | X | X | X | X | X | X | X | X | X | X | X |
| 835BB-AJ/BJ/DJ/EJ | X | | X | X | X | | X | X | X | X | X | X | X | X | X | X | X | X | X | X | X |
| 835CA-AP/DP | | X | X | X | | | X | X | X | X | X | X | X | X | X | X | X | X | X | X | X |
| 835CA-AT/DT | X | | X | X | X | | X | X | X | X | X | X | X | X | X | X | X | X | X | X | X |
| 835CB-AP/DP | | X | X | | | | X | X | X | X | X | X | X | X | X | X | X | X | X | X | X |
| 835CB-AT/DT | X | | X | | | | X | X | X | X | X | X | X | X | X | X | X | X | X | X | X |
| 835CC-AP/DP | | X | X | X | | | X | X | X | X | X | X | X | X | X | X | X | X | X | X | X |
| 835CC-AT/DT | X | | X | X | | | X | X | X | X | X | X | X | X | X | X | X | X | X | X | X |
| 8BXBA-AE/BE/DE/EE | | | | | | | X | X | X | X | X | X | X | X | X | X | X | X | X | X | X |
| 8BXBA-AJ/BJ/DJ/EJ | | | | | | | X | X | X | X | X | X | X | X | X | X | X | X | X | X | X |
| 8BXBB-AE/BE/DE/EE | | | | | | | X | X | X | X | X | X | X | X | X | X | X | X | X | X | X |
| 8BXBB-AJ/BJ/DJ/EJ | | | | | | | X | X | X | X | X | X | X | X | X | X | X | X | X | X | X |

| Systems | Recommended Spares | | | | | | | | | | | | | | MDS | | Diagnostics | | | | |
|-------------------|--------------------|------|------------|-----------|----------|----------|----------|----------|-------------|-------------|-------------|----------|----------|------------|------------|-----------|-------------|----------|----------|----------|--|
| | 87-B | 87-D | BA-BA32-00 | AA-CIBC-A | T1024-00 | T1032-00 | M7166-00 | T1001-1A | AA-XDB50-00 | SA-16572-01 | SA-16574-01 | T1019-AA | T1040-AA | AA-RX50-AA | AA-CIBC-AA | MD-VAX-01 | MD-VAX-02 | Z7200-UZ | Z7200-NW | Z7200-GZ | |
| 834BA-AE/BE/DE/EE | | | | | | | | | | | | | | | | | | | | | |
| 834BA-AJ/BJ/DJ/EJ | | | | | | | | | | | | | | | | | | | | | |
| 834BB-AE/BE/DE/EE | | | | | | | | | | | | | | | | | | | | | |
| 834BB-AJ/BJ/DJ/EJ | | | | | | | | | | | | | | | | | | | | | |
| 834CA-AP/DP | | | | | | | | | | | | | | | | | | | | | |
| 834CA-AT/DT | | | | | | | | | | | | | | | | | | | | | |
| 834CC-AP/DP | | | | | | | | | | | | | | | | | | | | | |
| 834CC-AT/DT | | | | | | | | | | | | | | | | | | | | | |
| 835BA-AE/BE/DE/EE | | | | | | | | | | | | | | | | | | | | | |
| 835BA-AJ/BJ/DJ/EJ | | | | | | | | | | | | | | | | | | | | | |
| 835BB-AE/BE/DE/EE | | | | | | | | | | | | | | | | | | | | | |
| 835BB-AJ/BJ/DJ/EJ | | | | | | | | | | | | | | | | | | | | | |
| 835CA-AP/DP | | | | | | | | | | | | | | | | | | | | | |
| 835CA-AT/DT | | | | | | | | | | | | | | | | | | | | | |
| 835CB-AP/DP | | | | | | | | | | | | | | | | | | | | | |
| 835CB-AT/DT | | | | | | | | | | | | | | | | | | | | | |
| 835CC-AP/DP | | | | | | | | | | | | | | | | | | | | | |
| 835CC-AT/DT | | | | | | | | | | | | | | | | | | | | | |
| 8BXBA-AE/BE/DE/EE | | | | | | | | | | | | | | | | | | | | | |
| 8BXBA-AJ/BJ/DJ/EJ | | | | | | | | | | | | | | | | | | | | | |
| 8BXBB-AE/BE/DE/EE | | | | | | | | | | | | | | | | | | | | | |
| 8BXBB-AJ/BJ/DJ/EJ | | | | | | | | | | | | | | | | | | | | | |

NOTE:

*Your system may contain different memory options to achieve total memory capacity.
Please check your system to determine which memory option(s) is appropriate for you.

VAX Products

VAX 8250/8350 Series System Spares Matrix Preconfigured

| Systems | System Options | | | | | | | | | | | | | | | | | | | | MDS | | Diagnostics | | | | | | | | |
|----------------|--------------------|---------|-------|-------|------------|---------|---------|---------|----------|---------|-------------|-------------|-------------|----------|-------------|----------|----------|------------|------------|------------|-------------|-------------|-------------|-----------|-----------|-----------|-----------|-----------|----------|----------|----------|
| | 874-D | 874-F | 877-B | 877-D | BA32-AA | DEBNA-M | DEBNT-M | DMB32-M | KA825-AA | KD850-A | KK810-AA | KK810-AA | KL851-BB | LA100-AA | MS820-AA | MS820-BA | RA81-AA | RA81-AA | RX80-AA | TUB1E-A | VAX LIB 1YR | VAX LIB 2YR | LICENSE | LICENSE | MEDIA KIT | MEDIA KIT | UPDATES | UPDATES | DOC KIT | | |
| SV-8AEEB-GK/GL | | | | | X | X | X | | | X | X | X | X | X | X | X | X | X | X | X | X | X | X | X | X | X | X | X | X | | |
| SV-8AEEB-GM/GN | | | | | X | | X | X | | X | X | X | X | X | X | X | X | X | X | X | X | X | X | X | X | X | X | X | X | | |
| SV-8AEED-GK/GL | X | | | | X | X | X | X | | X | X | X | X | X | X | X | X | X | X | X | X | X | X | X | X | X | X | X | X | | |
| SV-8AEED-GM/GN | X | | | | X | X | X | X | | X | X | X | X | X | X | X | X | X | X | X | X | X | X | X | X | X | X | X | X | | |
| SV-8AEEN-GK/GL | | | | | X | X | X | X | | X | X | X | X | X | X | X | X | X | X | X | X | X | X | X | X | X | X | X | X | | |
| SV-8AEEN-GM/GN | | | | | X | X | X | X | | X | X | X | X | X | X | X | X | X | X | X | X | X | X | X | X | X | X | X | X | | |
| SV-8AEEP-GK/GL | | | | | X | X | X | X | | X | X | X | X | X | X | X | X | X | X | X | X | X | X | X | X | X | X | X | X | | |
| SV-8AEEP-GM/GN | | | | | X | X | X | X | | X | X | X | X | X | X | X | X | X | X | X | X | X | X | X | X | X | X | X | X | | |
| SV-8BEEA-GK/GL | X | | | | X | X | X | X | | X | X | X | X | X | X | X | X | X | X | X | X | X | X | X | X | X | X | X | X | | |
| SV-8BEEA-GM/GN | X | | | | X | X | X | X | | X | X | X | X | X | X | X | X | X | X | X | X | X | X | X | X | X | X | X | X | | |
| SV-8BEEB-GK/GL | | | | | X | X | X | X | | X | X | X | X | X | X | X | X | X | X | X | X | X | X | X | X | X | X | X | X | | |
| SV-8BEEB-GM/GN | | | | | X | X | X | X | | X | X | X | X | X | X | X | X | X | X | X | X | X | X | X | X | X | X | X | X | | |
| SV-8BEEN-GK/GL | X | | | | X | X | X | X | | X | X | X | X | X | X | X | X | X | X | X | X | X | X | X | X | X | X | X | X | | |
| SV-8BEEN-GM/GN | X | | | | X | X | X | X | | X | X | X | X | X | X | X | X | X | X | X | X | X | X | X | X | X | X | X | X | | |
| SV-8BEES-GK/GL | | | | | X | X | X | X | | X | X | X | X | X | X | X | X | X | X | X | X | X | X | X | X | X | X | X | X | | |
| SV-8BEES-GM/GN | | | | | X | X | X | X | | X | X | X | X | X | X | X | X | X | X | X | X | X | X | X | X | X | X | X | X | | |
| | SP874-D | SP874-F | 877-B | 877-D | 4A-BA32-00 | T103-00 | T103-00 | T102-00 | T101-00 | T101-00 | 4A-K0850-00 | 5A-16572-01 | 5A-16574-01 | T1014-A | 4A-LA100-AA | T1019-AA | T1040-AA | 4A-RA81-AA | 4A-RA81-AA | 4A-RX50-AA | 4A-RX50-AA | 4A-TUB1E-00 | MD-VAX-01 | MD-VAX-02 | Z5200-UZ | Z7200-UZ | Z5200-PHW | Z7200-PHW | Z5200-UZ | Z7200-UZ | Z1200-GZ |
| | Recommended Spares | | | | | | | | | | | | | | | | | | | | MDS | | Diagnostics | | | | | | | | |

VAX MATRIX

VAX Products

VAX 8500 Series System Spares Matrix

VAX MATRIX

| Systems | System Options | | | | | | | | | | | | | | | MDS | | Diagnostics | | | | | | | | |
|-------------------|----------------|-------|-------|-------|---------|---------|---------|---------|---------|---------|----------|----------|---------|---------|----------|---------|---------|-------------|----------|-------------|-------------|---------|---------|-----------|---------|---|
| | 874-D | 874-F | 877-B | 877-D | DB88-AA | DEBNA-M | DMB92-L | CIBC1-A | HT189-A | KA85-AA | KDB50-AA | KL5E1-BB | MS88-AA | MS88-CA | PC881-AA | RA81-AA | RA81-AD | TUB1E-AA | TUB1E-AB | VAX LIB 1YR | VAX LIB 2YR | LICENSE | UPDATES | MEDIA KIT | DOC KIT | |
| 851BA-AE/AJ/DE/DJ | | | | | | | X | X | | | X | X | X | * | * | X | | | | | X | X | X | X | X | X |
| 851BB-AE/AJ/BE/BJ | | | | | | | X | X | | | X | X | X | * | * | X | | | | | X | X | X | X | X | X |
| 851BB-DE/DJ/EE/EJ | | | | | | | X | X | | | X | X | X | * | * | X | | | | | X | X | X | X | X | X |
| 851CA-AP/DP | | | | | | X | X | X | | X | X | X | | * | * | X | | | | | X | X | X | X | X | X |
| 851CA-AT/DT | | | | X | | X | X | X | | X | X | X | | * | * | X | | | | | X | X | X | X | X | X |
| 851CB-AP/DP | | | | | X | X | X | X | | X | X | X | | * | * | X | | | | | X | X | X | X | X | X |
| 851CB-AT/DT | | | | X | | X | X | X | | X | X | X | | * | * | X | | | | | X | X | X | X | X | X |
| SV-85EEA-EK/EL | X | | | | | X | X | X | | X | X | X | X | * | * | X | X | X | X | X | X | X | X | X | X | X |
| SV-85EEA-EM/EN | X | | | | | X | X | X | | X | X | X | X | * | * | X | X | X | X | X | X | X | X | X | X | X |
| SV-85EEB-EK/EL | X | | | | | X | X | X | | X | X | X | X | * | * | X | X | X | X | X | X | X | X | X | X | X |
| SV-85EEB-EM/EN | X | | | | | X | X | X | | X | X | X | X | * | * | X | X | X | X | X | X | X | X | X | X | X |

VAX 8530 Series System Spares Matrix

| Systems | System Options | | | | | | | | | | | | | | | MDS | | Diagnostics | | | | | | | |
|----------------|----------------|---------|---------|----------|---------|---------|----------|----------|---------|---------|----------|---------|---------|----------|----------|-------------|-------------|-------------|---------|-----------|---------|---|---|---|---|
| | CIBC1-AA | DB88-AA | DEBNA-M | DMB92-LP | HT189-A | KA85-AA | KDB50-AA | KL5E1-BB | MS88-AA | MS88-CA | PC881-AA | RA81-AA | RA81-AD | TUB1E-AA | TUB1E-AB | VAX LIB 1YR | VAX LIB 2YR | LICENSE | UPDATES | MEDIA KIT | DOC KIT | | | | |
| 851BC-AE/AJ | | X | X | | X | X | X | | * | * | X | | | | | | | X | X | X | X | X | X | X | X |
| 851BC-BE/BJ | | X | X | | X | X | X | | * | * | X | | | | | | | X | X | X | X | X | X | X | X |
| 851BC-DE/DJ | | X | X | | X | X | X | | * | * | X | | | | | | | X | X | X | X | X | X | X | X |
| 851BC-EE/EJ | | X | X | | X | X | X | | * | * | X | | | | | | | X | X | X | X | X | X | X | X |
| 851CD-AP/AT | X | X | X | | X | X | X | | * | * | X | | | | | X | | X | X | X | X | X | X | X | X |
| 851CD-DP/DT | X | X | X | | X | X | X | | * | * | X | | | | | X | | X | X | X | X | X | X | X | X |
| SV-85EEC-EK/EL | X | X | X | | X | X | X | X | * | * | X | X | | | X | | X | X | X | X | X | X | X | X | X |
| SV-85EEC-EM/EN | X | X | X | | X | X | X | X | * | * | X | X | | | X | | X | X | X | X | X | X | X | X | X |

NOTE:

*Your system may contain different memory options to achieve total memory capacity. Please check your system to determine which memory option(s) is appropriate for you.

digital To Order, Call DECdirect at 800-344-4825. 8:30 AM to 8:00 PM (ET) in the Continental USA.

VAX Products

VAX 8600/8650 Series System Spares Matrix

**VAX
MATRIX**

| Systems | System Options | | | | | | | | | | | | | | | | | MDS | Diagnostics | | | | | | | | | |
|----------|----------------|-------|--------------|----------|---------|---------|---------|---------|---------|---------|---------|----------|---------|---------|---------|---------|---------|----------|-------------|---------|---------|------------|------------|-----------|---------|------------|---|---|
| | 50HZ SYSTEMS | 876-A | BA11-AL 60HZ | CI180-MA | DEJUM-M | DEJUM-N | DW180-M | HT170-A | HT180-A | HT186-A | HT187-A | HT188-AB | HT231-B | KAB6-AA | KAB6-BA | MS86-AA | MS86-CA | RL172-00 | RL172-AK | UC150-A | UDA60-A | VAX 1B 1YR | VAX 1B 2YR | C LICENSE | UPDATES | DZ LICENSE | | |
| 861CC-AE | | X | X | | | X | X | X | X | X | X | X | X | X | X | X | X | X | X | X | X | X | X | X | X | X | X | |
| 861CC-AJ | X | X | X | | | X | X | X | X | X | X | X | X | X | X | X | X | X | X | X | X | X | X | X | X | X | X | X |
| 861CC-AP | | X | X | | X | X | X | X | X | X | X | X | X | X | X | X | X | X | X | X | X | X | X | X | X | X | X | X |
| 861CC-AT | X | X | | X | X | X | X | X | X | X | X | X | X | X | X | X | X | X | X | X | X | X | X | X | X | X | X | X |
| 861XA-AE | | X | X | | | X | X | X | X | X | X | X | X | X | X | X | X | X | X | X | X | X | X | X | X | X | X | X |
| 861XA-AJ | X | X | X | | | X | X | X | X | X | X | X | X | X | X | X | X | X | X | X | X | X | X | X | X | X | X | X |
| 861XA-BE | | X | X | | | X | X | X | X | X | X | X | X | X | X | X | X | X | X | X | X | X | X | X | X | X | X | X |
| 861XA-BJ | X | X | X | | | X | X | X | X | X | X | X | X | X | X | X | X | X | X | X | X | X | X | X | X | X | X | X |
| 865CC-AE | | X | X | | X | X | X | X | X | X | X | X | X | X | X | X | X | X | X | X | X | X | X | X | X | X | X | X |
| 865CC-AJ | X | X | X | X | X | X | X | X | X | X | X | X | X | X | X | X | X | X | X | X | X | X | X | X | X | X | X | X |
| 865CC-AP | | X | X | | X | X | X | X | X | X | X | X | X | X | X | X | X | X | X | X | X | X | X | X | X | X | X | X |
| 865CC-AT | X | X | | X | X | X | X | X | X | X | X | X | X | X | X | X | X | X | X | X | X | X | X | X | X | X | X | X |
| 865CD-AP | X | X | | X | X | X | X | X | X | X | X | X | X | X | X | X | X | X | X | X | X | X | X | X | X | X | X | X |
| 865CD-AT | X | X | X | X | X | X | X | X | X | X | X | X | X | X | X | X | X | X | X | X | X | X | X | X | X | X | X | X |
| 865XA-AE | | X | X | | | X | X | X | X | X | X | X | X | X | X | X | X | X | X | X | X | X | X | X | X | X | X | X |
| 865XA-AJ | X | X | X | | | X | X | X | X | X | X | X | X | X | X | X | X | X | X | X | X | X | X | X | X | X | X | X |
| 865XA-BE | | X | X | | | X | X | X | X | X | X | X | X | X | X | X | X | X | X | X | X | X | X | X | X | X | X | X |
| 865XA-BJ | X | X | X | | | X | X | X | X | X | X | X | X | X | X | X | X | X | X | X | X | X | X | X | X | X | X | X |
| 865XB-AE | | X | X | | | X | X | X | X | X | X | X | X | X | X | X | X | X | X | X | X | X | X | X | X | X | X | X |
| 865XB-AJ | X | X | X | | | X | X | X | X | X | X | X | X | X | X | X | X | X | X | X | X | X | X | X | X | X | X | X |
| 865XB-BE | | X | X | | | X | X | X | X | X | X | X | X | X | X | X | X | X | X | X | X | X | X | X | X | X | X | X |
| 865XB-BJ | X | X | X | | | X | X | X | X | X | X | X | X | X | X | X | X | X | X | X | X | X | X | X | X | X | X | X |

| Recommended Spares | | | | | | | | | | | | | | | | | MDS | Diagnostics | | | |
|--------------------|--|--|--|--|--|--|--|--|--|--|--|--|--|--|--|--|-----|-------------|--|--|--|
|--------------------|--|--|--|--|--|--|--|--|--|--|--|--|--|--|--|--|-----|-------------|--|--|--|

digital To Order, Call DECdirect at 800-344-4825. 8:30 AM to 8:00 PM (ET) in the Continental USA.

VAX Products

VAX 8800 Series System Spares Matrix

| Systems | System Options | | | | | | | | | | | | | | | | | | | | | | | | | | | | MDS | Diagnostics | | | | | | | | | | |
|-------------|--------------------|-------------|-------------|------------|---------|-------------|-----------|-----------|-------------|----------|----------|---------|---------|---------|---------|---------|---------|----------|----------|----------|----------|-------------|------------|-------------|----------|----------|-------------|------------|------------|-------------|------------|------------|-------------|-------------|----------|-----------|----------|----------|---|---|
| | 876-A | C1BCA-AA | C1BC1-AA | DB88-AA | DEBNA-M | DELIN1-AA | DELIN4-AA | DELIN4-AA | DI-530Q3-F | DIV11-M | DWBUA-CA | HT080-A | HT081-A | HT170-A | HT180-A | HT186-A | HT187-A | HT188-A | HT188-AB | HT204-BA | HT204-BA | HSC5X-CA | KAB8-8800 | KDB50-A | MS88-AA | MS88-CA | PC38N-AA | SA482-AA | SA482-AD | TS78-BB | TU78-A | VT200-D | VAX-LIB-1TR | VAX-LIB-2TR | LICENSE | MEDIA-KIT | UPDATES | DOC-KIT | | |
| 882BC-BE/EJ | X | | | X | X | | | | | | | | X | X | | X | X | X | X | X | X | | X | X | | | | | | | | | | X | X | X | X | X | X | |
| 882BC-EE/EJ | X | | | X | X | | | | | | | | X | X | | X | X | X | X | X | X | | X | X | | | | | | | | | | | X | X | X | X | X | X |
| 882BD-BE/EJ | X | | | X | X | | | | | | | | X | X | X | X | X | X | X | X | X | | | X | X | | | | | | | | | | X | X | X | X | X | X |
| 882BD-EE/EJ | X | | | X | X | | | | | | | | X | X | X | X | X | X | X | X | X | | | X | X | | | | | | | | | | X | X | X | X | X | X |
| 882CA-AP/AT | X | X | X | | | | | X | X | | X | X | X | X | X | X | X | X | X | X | X | X | | X | X | | | | | | | | | | X | X | X | X | X | X |
| 882CA-DP/DT | X | X | X | | | | | X | X | | X | X | X | X | X | X | X | X | X | X | X | X | | X | X | | | | | | | | | | X | X | X | X | X | X |
| 882CB-AP/AT | X | | | X | X | | | | | | | | X | X | X | X | X | X | X | X | X | X | X | X | | | | | | | | | | | X | X | X | X | X | X |
| 882CB-DP/DT | X | | | X | X | | | | | | | | X | X | X | X | X | X | X | X | X | X | X | X | | | | | | | | | | | X | X | X | X | X | X |
| 882CC-AP/AT | X | X | X | X | X | | | | | | | | X | X | X | X | X | X | X | X | X | X | | X | X | | | | | | | | | | X | X | X | X | X | X |
| 882CC-DP/DT | X | X | X | X | X | | | | | | | | X | X | X | X | X | X | X | X | X | X | | X | X | | | | | | | | | | X | X | X | X | X | X |
| 894CB-AP/AT | X | X | X | X | X | | | | | X | | X | X | X | X | X | X | X | X | X | X | X | | X | X | | | | | | | | | X | X | X | X | X | X | X |
| 894CB-DP/DT | X | X | X | X | X | | | | | X | | X | X | X | X | X | X | X | X | X | X | X | | X | X | | | | | | | | | X | X | X | X | X | X | X |
| 898CB-AP/AT | X | X | X | X | X | | | | | X | X | X | X | X | X | X | X | X | X | X | X | X | | X | X | | | | | | | | | X | X | X | X | X | X | X |
| 898CB-DT | X | X | X | X | X | | | | | X | X | X | X | X | X | X | X | X | X | X | X | X | | X | X | | | | | | | | | X | X | X | X | X | X | X |
| | 876-A | 4A-C1BCA-AA | 4A-C1BC1-AA | 4A-DB88-AA | T104-00 | 5A-15A15-00 | MT782-00 | MT783-00 | 4A-530Q3-F2 | M3104-00 | T1010-00 | HT080-A | HT081-A | HT170-A | HT180-A | HT186-A | HT187-A | HT188-AB | HT189-A | HT204-BA | HT204-BA | 4A-HSC5X-CA | 4A-KAB8-AA | 4A-KDB50-00 | LD116-AA | LD115-00 | 4A-PC380-AA | 4A-RA82-AA | 4A-RA82-AD | 4A-TS78-BB | 4A-TU78-00 | 4A-VT220-D | MD-VAX-01 | MD-VAX-02 | ZM200-UZ | ZM200-HW | ZM200-WW | ZL201-GZ | | |
| | Recommended Spares | | | | | | | | | | | | | | | | | | | | | | | | | | | | MDS | Diagnostics | | | | | | | | | | |

VAX MATRIX

NOTE:

*Your system may contain different memory options to achieve total memory capacity. Please check your system to determine which memory option(s) is appropriate for you.

MicroVAX Products

MicroVAX II Series System Spares Matrix

**MicroVAX
MATRIX**

| Systems | System Options | | | | | | | | | | | | | MDS | | Diagnostics | | | | | | | |
|-------------------|--------------------|-------------|-------------|---------|-------------|-------------|----------|----------|----------|----------|----------|----------|-----------|---------------|---------------|-------------|-------------|-------------|-----------|----------|----------|----------|----------|
| | 869-D | BA123-A2 | BA23 | DEQMA-M | DQO1-M | K630-AA | MS60-AA | MS60-BB | MS60-CA | RD52-A | RD53-A | RD54-A | RD50-A | LEVAX LIB 1YR | LEVAX LIB 2YR | LIC-RX50 | LIC-TK50 | UPDT-RX50 | UPDT-TK50 | DOC KIT | | | |
| 630QB-A2/A3 | | | | X | | | | X | | | | | | | | X | X | | | | | | |
| 630QY-A2/A3 | | | | | X | | | X | | | | | | | | X | X | | | | | | |
| 630QZ-A2/A3 | | | | | X | | | X | | | | | | | | X | X | | | | | | |
| DH-630Q1-D2/D3/DA | X | | | | | X | | X | | | X | | | | X | X | X | X | X | X | X | | |
| DH-630Q2-D2/D3/DA | X | | | | | | X | X | | | | X | | | X | X | X | X | X | X | X | | |
| DH-630Q2-F2/F3/FA | X | | | | | | X | | X | | X | | | | X | X | X | X | X | X | X | | |
| DH-630Q3-E2/E3/EA | X | | | | | | | | X | | X | | | | X | X | X | X | X | X | X | | |
| DH-630Q3-F2/F3/FA | X | | | | | | X | | X | | X | | | | X | X | X | X | X | X | X | | |
| DH-630Q4-E2/E3/EA | X | | | | | | | | X | | X | | | | X | X | X | X | X | X | X | | |
| DH-630Q4-F2/F3/FA | X | | | | | | X | | | X | | X | | | X | X | X | X | X | X | X | | |
| DH-630Q4-H2/H3/HA | X | | | | | | X | | | X | | X | | | X | X | X | X | X | X | X | | |
| DH-630Q5-E2/E3/EA | | X | | | | | | | X | | X | | | | X | X | X | X | X | X | X | | |
| DH-630Q5-F2/F3/FA | | X | | | | | | | X | | X | | | | X | X | X | X | X | X | X | | |
| RF-630QZ-A2/AA | | X | X | | | | | | | X | | | | | X | X | | X | X | X | X | | |
| | 4A-630QX-AA | 4A-630QX-AB | 4A-630QX-AC | 869-D | 4A-BA123-00 | 30-21749-01 | MT304-00 | M3106-00 | MT306-AA | MT307-AA | MT308-BA | MT309-AA | 4A-RD52-A | 4A-RD53-A | 4A-RD54-A | 4A-RD50-A | MD-LEVAX-01 | MD-LEVAX-02 | ZNABX-C3 | ZNABX-C5 | ZNABX-H3 | ZNABX-H5 | ZNABX-GZ |
| | Recommended Spares | | | | | | | | | | | | | MDS | | Diagnostics | | | | | | | |

MicroVAX 2000 Series System Spares Matrix

| Systems | System Options | | | | | | | | | | MDS | | Diagnostics | | | | |
|----------------|--------------------|-----------------|-----------------|-------------|-------------|------------|-----------|-----------|----------------|-------------|---------------|---------------|-------------|-----------|---------|----------|--|
| | KAT10-A | PWR SUPPLY 120V | PWR SUPPLY 240V | MS40-AA | MS40-BA | RD32 | RX33 | RD53 | CONVERTER ASSY | DESVP-AA | LEVAX LIB 1YR | LEVAX LIB 2YR | LICENSE | MEDIA KIT | UPDATES | DOC KIT | |
| DH-625N1-AA/A2 | X | X | | X | X | X | X | X | X | X | X | X | X | X | X | X | |
| DH-625N1-A3 | X | | | X | X | X | X | X | X | X | X | X | X | X | X | X | |
| DH-625N2-AA/A2 | X | X | | | X | X | X | X | X | X | X | X | X | X | X | X | |
| DH-625N2-A3 | X | | | X | X | X | X | X | X | X | X | X | X | X | X | X | |
| DH-625N3-AA/A2 | X | X | | X | | | | X | X | X | X | X | X | X | X | X | |
| DH-625N3-A3 | X | | | X | X | | | | X | X | X | X | X | X | X | X | |
| DH-625N4-AA/A2 | X | X | | | X | | | X | X | X | X | X | X | X | X | X | |
| DH-625N4-A3 | X | | | X | | | | X | X | X | X | X | X | X | X | X | |
| SV-PXXGA-EK | X | X | | | X | | | | X | X | X | X | X | X | X | X | |
| SV-PXXGA-FN | X | | | X | | | | | X | X | X | X | X | X | X | X | |
| | 70-24268-01 | H7348-BA | H7348-BB | 5A-16002-AA | 5A-16002-BA | 4A-RD32-EA | 4A-RD33-A | 4A-RD53-A | 4A-RD53-00 | 5A-16004-01 | MD-LEVAX-01 | MD-LEVAX-02 | ZNMGX-UZ | ZNMGX-HW | NOIE | ZNABX-GZ | |
| | Recommended Spares | | | | | | | | | | MDS | | Diagnostics | | | | |

digital To Order, Call DECdirect at 800-344-4825. 8:30 AM to 8:00 PM (ET) in the Continental USA.

MicroVAX Products

MicroVAX 3300/3400 Series System Spares Matrix

| Systems | System Options | | | MDS | | Diagnostics | | | | | | | |
|-------------------|----------------|------------|------------|------|---------------|---------------|---------|-----------|---------|---------|---|---|---|
| | KERNEL KIT | KERNEL KIT | KERNEL KIT | TK70 | LEVAX LIB 1YR | LEVAX LIB 2YR | LICENSE | MEDIA KIT | UPDATES | DOC KIT | | | |
| DU/DV-330S1-AA/A2 | | | X | | X | X | X | X | X | X | X | X | X |
| DU/DV-330S1-A3/AE | | | | X | X | X | X | X | X | X | X | X | X |
| DU/DV-330S2-AA/A2 | | | X | | | | X | X | X | X | X | X | X |
| DU/DV-330S2-A3/AE | | | | X | | | X | X | X | X | X | X | X |
| DU/DV-330T1-AA/A2 | X | | | | X | X | X | X | X | X | X | X | X |
| DU/DV-330T1-A3/AE | | X | | | X | X | X | X | X | X | X | X | X |
| DU/DV-330T2-AA/A2 | X | | | | | | X | X | X | X | X | X | X |
| DU/DV-330T2-A3/AE | | X | | | | | X | X | X | X | X | X | X |
| DU/DV-340S1-AA/A2 | | | X | | | | X | X | X | X | X | X | X |
| DU/DV-340S1-A3/AE | | | | X | | | X | X | X | X | X | X | X |
| DU/DV-340S2-AA/A2 | | | X | | | | X | X | X | X | X | X | X |
| DU/DV-340S2-A3/AE | | | | X | | | X | X | X | X | X | X | X |
| DU/DV-340T1-AA/A2 | X | | | | X | X | X | X | X | X | X | X | X |
| DU/DV-340T1-A3/AE | | X | | | X | X | X | X | X | X | X | X | X |
| DU/DV-340T2-AA/A2 | X | | | | | | X | X | X | X | X | X | X |
| DU/DV-340T2-A3/AE | | X | | | | | X | X | X | X | X | X | X |
| DV-340S3-AA/A2 | | | X | | X | X | X | X | X | X | X | X | X |
| DV-340S3-A3/AE | | | | X | X | X | X | X | X | X | X | X | X |
| DV-340T3-AA/A2 | X | | | | X | X | X | X | X | X | X | X | X |
| DV-340T3-A3/AE | | X | | | X | X | X | X | X | X | X | X | X |

| Systems | Recommended Spares | | | MDS | | Diagnostics | | | | | | | |
|-------------------|--------------------|-------------|-------------|----------|---------|-------------|---------|---------|---------|---------|--|--|--|
| | 4A-6400X-AA | 4A-6400X-A3 | 4A-6400X-BA | MT553-00 | TK70-A1 | MD-LEVAX-01 | ZNEX-L2 | ZNEX-H5 | ZNEX-WW | ZNEX-GZ | | | |
| DU/DV-330S1-AA/A2 | | | | | | | | | | | | | |
| DU/DV-330S1-A3/AE | | | | | | | | | | | | | |
| DU/DV-330S2-AA/A2 | | | | | | | | | | | | | |
| DU/DV-330S2-A3/AE | | | | | | | | | | | | | |
| DU/DV-330T1-AA/A2 | | | | | | | | | | | | | |
| DU/DV-330T1-A3/AE | | | | | | | | | | | | | |
| DU/DV-330T2-AA/A2 | | | | | | | | | | | | | |
| DU/DV-330T2-A3/AE | | | | | | | | | | | | | |
| DU/DV-340S1-AA/A2 | | | | | | | | | | | | | |
| DU/DV-340S1-A3/AE | | | | | | | | | | | | | |
| DU/DV-340S2-AA/A2 | | | | | | | | | | | | | |
| DU/DV-340S2-A3/AE | | | | | | | | | | | | | |
| DU/DV-340T1-AA/A2 | | | | | | | | | | | | | |
| DU/DV-340T1-A3/AE | | | | | | | | | | | | | |
| DU/DV-340T2-AA/A2 | | | | | | | | | | | | | |
| DU/DV-340T2-A3/AE | | | | | | | | | | | | | |
| DV-340S3-AA/A2 | | | | | | | | | | | | | |
| DV-340S3-A3/AE | | | | | | | | | | | | | |
| DV-340T3-AA/A2 | | | | | | | | | | | | | |
| DV-340T3-A3/AE | | | | | | | | | | | | | |

digital To Order, Call DECdirect at 800-344-4825. 8:30 AM to 8:00 PM (ET) in the Continental USA.

MATRICES

MicroVAX Products

MicroVAX 3500/3600

VAXservers 3500/3600/3602 Series System Spares Matrix

MicroVAX
MATRIX

| Systems | System Options | | | | | | | | | | MDS | | Diagnostics | | | |
|----------------|----------------|-------------|-------------|------|---------|------|-----------|-----------|------------|------------|---------------|---------------|-------------|-----------|---------|---------|
| | KERNEL KIT | RA2-AA 60HZ | RA2-AD 50HZ | RD5A | TU81E-B | RA70 | H86A 60HZ | H86A 50HZ | BA213 60HZ | BA213 50HZ | LEVAX LIB 1YR | LEVAX LIB 2YR | LICENSE | MEDIA KIT | UPDATES | DOC KIT |
| DU-350S1-AA/A2 | X | | | | | | X | | | X | | X | X | X | X | X |
| DU-350S1-A3 | X | | | | | | X | | | X | | X | X | X | X | X |
| DU-350T1-AA/A2 | X | | | | | | X | | | X | | X | X | X | X | X |
| DU-350T1-A3 | X | | | | | | X | | | X | | X | X | X | X | X |
| DU-350T2-AA/A2 | X | | | | X | | | | | X | | X | X | X | X | X |
| DU-350T2-A3 | X | | | | X | | | | | X | | X | X | X | X | X |
| DU-360S1-AA/A2 | X | X | | | | | | X | | X | | X | X | X | X | X |
| DU-360S1-A3/C3 | X | X | X | | | | | | | X | | X | X | X | X | X |
| DU-360S1-CA/C2 | X | X | | | | | | X | | X | | X | X | X | X | X |
| DU-360S2-AA/A2 | X | X | | | | | | X | | X | | X | X | X | X | X |
| DU-360S2-A3 | X | X | X | | | | | | | X | | X | X | X | X | X |
| DU-360T1-AA/A2 | X | X | | | | | | X | | X | | X | X | X | X | X |
| DU-360T1-A3/C3 | X | X | X | | | | | | | X | | X | X | X | X | X |
| DU-360T1-CA/C2 | X | X | | | | | | X | | X | | X | X | X | X | X |
| DU-360T2-AA/A2 | X | X | | | X | | | X | | X | | X | X | X | X | X |
| DU-360T2-A3 | X | X | X | | X | | | | | X | | X | X | X | X | X |
| DV-350S1-AA/A2 | X | | | | | | X | | | X | | X | X | X | X | X |
| DV-350S1-A3/C3 | X | | | | | | X | | | X | | X | X | X | X | X |
| DV-350S1-CA/C2 | X | | | | | | X | | | X | | X | X | X | X | X |
| DV-350T1-AA/A2 | X | | | | | | X | | | X | | X | X | X | X | X |
| DV-350T1-A3 | X | | | | | | X | | | X | | X | X | X | X | X |
| DV-350T2-AA/A2 | X | | | | X | | | | | X | | X | X | X | X | X |
| DV-350T2-A3 | X | | | | X | | | | | X | | X | X | X | X | X |
| DV-360S1-AA/A2 | X | X | | | | | | X | | X | | X | X | X | X | X |
| DV-360S1-A3 | X | X | X | | | | | X | | X | | X | X | X | X | X |
| DV-360S2-AA/A2 | X | X | | | | | | X | | X | | X | X | X | X | X |
| DV-360S2-A3 | X | X | X | | | | | | | X | | X | X | X | X | X |
| DV-360T1-AA/A2 | X | X | | | | | | X | | X | | X | X | X | X | X |
| DV-360T1-A3/C3 | X | X | | | | | | X | | X | | X | X | X | X | X |
| DV-360T1-CA/C2 | X | X | | | | | | X | | X | | X | X | X | X | X |
| DV-360T2-AA/A2 | X | X | | | X | | | X | | X | | X | X | X | X | X |
| DV-360T2-A3 | X | X | X | | X | | | | | X | | X | X | X | X | X |

| Recommended Spares | | | | | | | | | | MDS | | Diagnostics | | | | |
|--------------------|-----------|-----------|-----------|---------|-------------|-----------|-------|----------|---------|---------|-------------|-------------|----------|----------|----------|----------|
| 4A-6500X-AA | 4A-RA2-AA | 4A-RA2-AD | 4A-RA2-AA | 4A-RD5A | 4A-TU81E-00 | 4A-RA70-A | 874-D | 4A-874-F | H7868-A | H7868-B | MD-LEVAX-01 | MD-LEVAX-02 | ZNAEX-UZ | ZNAEX-H5 | ZNAEX-WW | ZNAEX-G2 |

digital To Order, Call DECdirect at 800-344-4825. 8:30 AM to 8:00 PM (ET) in the Continental USA.

VAXstation Products

VAXstation II/GPX Series System Spares Matrix

| | System Options | | | MDS | Diagnostics | | | |
|----------------|----------------|---------|------|----------|---------------|---------------|--------|---------|
| | BA/2 | MS30-BA | VR50 | VS10F-EA | LEVAX-LIB 1YR | LEVAX-LIB 2YR | UPDATE | DOC KIT |
| Systems | | | | | | | | |
| SU-LV55C-EK/EN | X | X | X | X | X | X | X | X |
| SU-LV55D-EK/EN | X | X | X | X | X | X | X | X |
| SU-LV55K-EK/EN | X | X | X | X | X | X | X | X |
| SU-LV55L-EK/EN | X | X | X | X | X | X | X | X |
| SU-LV55U-EK/EN | X | X | X | X | X | X | X | X |
| SU-LV55W-EK/EN | X | X | X | X | X | X | X | X |
| SU-LV55Y-EK/EN | X | X | X | X | X | X | X | X |
| SV-LV55B-EK/EN | X | X | X | X | X | X | X | X |
| SV-LV55C-EK/EN | X | X | X | X | X | X | X | X |
| SV-LV55D-EK/EN | X | X | X | X | X | X | X | X |
| SV-LV55F-EK/EN | X | X | X | X | X | X | X | X |
| SV-LV55H-EK/EN | X | X | X | X | X | X | X | X |
| SV-LV55J-EK/EN | X | X | X | X | X | X | X | X |
| SV-LV55L-EK/EN | X | X | X | X | X | X | X | X |
| SV-LV55U-EK/EN | X | X | X | X | X | X | X | X |
| SV-LV55W-EK/EN | X | X | X | X | X | X | X | X |
| SV-LV55Y-EK/EN | X | X | X | X | X | X | X | X |

| | Recommended Spares | | | MDS | Diagnostics | | | | | | | |
|--|--------------------|-------------|----------|-------------|-------------|-------------|------------|-------------|-------------|----------|----------|----------|
| | 4A-LV55X-AA | 30-21749-01 | MT608-AA | 4A-VR200-00 | 4A-LK201-AA | 30-20088-01 | 4A-VS1X-AA | MD-LEVAX-01 | MD-LEVAX-02 | ZNABX-C3 | ZNABX-H5 | ZNABX-GZ |
| | | | | | | | | | | | | |

VAXstation MATRIX

VAXstation 2000 Series System Spares Matrix

| | System Options | | | MDS | Diagnostics | | | | |
|----------------|----------------|------------|------------|---------------|---------------|---------|-----------|--------|---------|
| | SPARES KIT | SPARES KIT | SPARES KIT | LEVAX-LIB 1YR | LEVAX-LIB 2YR | LICENSE | MEDIA KIT | UPDATE | DOC KIT |
| Systems | | | | | | | | | |
| VS450-DA | X | | | X | X | X | X | X | X |
| VS450-D3 | | X | | X | X | X | X | X | X |
| VS450-EA | | | X | X | X | X | X | X | X |
| VS450-E3 | | | X | X | X | X | X | X | X |
| VS450-FA | X | | | X | X | X | X | X | X |
| VS450-F3 | | X | | X | X | X | X | X | X |
| VS450-GA | | | X | X | X | X | X | X | X |
| VS450-G3 | | | X | X | X | X | X | X | X |

| | Recommended Spares | | | MDS | Diagnostics | | | | |
|--|--------------------|-------------|-------------|-------------|-------------|----------|----------|------|----------|
| | 4A-VS400-DA | 4A-VS400-DS | 4A-VS400-EA | MD-LEVAX-01 | MD-LEVAX-02 | ZNABX-LZ | ZNABX-HW | NONE | ZNABX-GZ |
| | | | | | | | | | |

VAXstation Products

VAXstation 3200/3500 Series System Spares Matrix

**VAXstation
MATRIX**

| Systems | System Options | | | | | | | | | | MDS | Diagnostics | | | | | | |
|----------------|---------------------|---------------------|---------------|------|--------------|-------|------|-------|-------|------|-----------------------|---------------|--------|-----------|---------|---------|--|--|
| | BA213 KERNEL KIT | BA213 KERNEL KIT | BA213 60HZ | TK70 | TK70 50HZ | KDA50 | RA10 | VR280 | VR290 | BA23 | BA23 LEVIK LIB 1YR | LEVIK LIB 2YR | LIGENR | MEDIA KIT | UPDATES | DOC KIT | | |
| VS300-AA/A3 | X | | | | | | | | | X | X | X | X | X | X | X | | |
| VS300-BA/B3 | X | | | | | | | | | X | X | X | X | X | X | X | | |
| VS305-AA/A3/A4 | X | | | | | | | | | X | X | X | X | X | X | X | | |
| VS305-BA/B3/B4 | X | | | | | | | | | X | X | X | X | X | X | X | | |
| VS310-AA/A3 | | X | | | | | | | | X | X | X | X | X | X | X | | |
| VS310-BA/B3 | | X | | | | | | | | X | X | X | X | X | X | X | | |
| VS315-AA/A3/A4 | | X | | | | | | | | X | X | X | X | X | X | X | | |
| VS315-BA/B3/B4 | | X | | | | | | | | X | X | X | X | X | X | X | | |
| VS350-AA/A3 | X | X | | X | X | X | X | X | X | | | | X | X | X | X | | |
| VS350-BA/B3 | X | X | | X | X | X | X | X | X | | | | X | X | X | X | | |
| VS355-AA/BA | X | | X | X | X | X | X | X | X | X | | | X | X | X | X | | |
| VS355-A3/A4 | X | | | X | X | X | X | X | X | X | | | X | X | X | X | | |
| VS355-B3/B4 | X | | | X | X | X | X | X | X | X | | | X | X | X | X | | |

| Systems | System Options | | | | | | | | | | Recommended Spares | | | | | | | | | | MDS | Diagnostics | | | |
|----------------|----------------|-------------|-------------|-------------|-------------|----------|----------|----------|----------|-------------|--------------------|-------------|-------------|-------------|----------|----------|----------|----------|--|--|-----|-------------|--|--|--|
| | 4A-VR280-00 | 4A-VR290-00 | 30-21749-01 | MD-LEVIK-01 | MD-LEVIK-02 | ZNAEX-UZ | ZNAEX-H5 | ZNAEX-WW | ZNABX-GZ | 4A-VR280-00 | 4A-VR290-00 | 30-21749-01 | MD-LEVIK-01 | MD-LEVIK-02 | ZNAEX-UZ | ZNAEX-H5 | ZNAEX-WW | ZNABX-GZ | | | | | | | |
| VS300-AA/A3 | | | | | | | | | | | | | | | | | | | | | | | | | |
| VS300-BA/B3 | | | | | | | | | | | | | | | | | | | | | | | | | |
| VS305-AA/A3/A4 | | | | | | | | | | | | | | | | | | | | | | | | | |
| VS305-BA/B3/B4 | | | | | | | | | | | | | | | | | | | | | | | | | |
| VS310-AA/A3 | | | | | | | | | | | | | | | | | | | | | | | | | |
| VS310-BA/B3 | | | | | | | | | | | | | | | | | | | | | | | | | |
| VS315-AA/A3/A4 | | | | | | | | | | | | | | | | | | | | | | | | | |
| VS315-BA/B3/B4 | | | | | | | | | | | | | | | | | | | | | | | | | |
| VS350-AA/A3 | | | | | | | | | | | | | | | | | | | | | | | | | |
| VS350-BA/B3 | | | | | | | | | | | | | | | | | | | | | | | | | |
| VS355-AA/BA | | | | | | | | | | | | | | | | | | | | | | | | | |
| VS355-A3/A4 | | | | | | | | | | | | | | | | | | | | | | | | | |
| VS355-B3/B4 | | | | | | | | | | | | | | | | | | | | | | | | | |

Diagnostics

Digital's Self-Maintenance Services offers diagnostics products of the same quality and scope as those used by our own Field Service engineers.

Licensed maintenance diagnostics are available for the VAX-11 family systems,

VAX 8600/8650 systems, MicroVAX systems, and VAXBI systems. Copyrighted diagnostics are available for the PDP-11 and MicroPDP-11 systems.

The following sections describe which diagnostics are appropriate for your sys-

tem. More detailed information on the restrictions governing the purchase and use of Digital's licensed diagnostics and copyrighted diagnostics is available in the Policies Section at the back of this book.

Diagnostics for VAX-11 Family Systems, VAX 8600/8650 Systems and MicroVAX II Systems

"C" and "DZ" License Codes

Diagnostics for these systems are sold by ordering a single use, end-user license. When the diagnostics are ordered, license prerequisites are verified and registration takes place. The following information will be helpful in answering any questions you have about purchaser requirements.

Who can order these products?

The customer must be the owner, lessee or end user in physical control of the computer system for which licensed diagnostics are being ordered.

What is the minimum first order?

To run diagnostics on a single CPU system, (dual processors are considered a single CPU,) you must order a license code "C" category diagnostic kit (for example, part #ZXXXX-CX). The kit includes a license to use the program on a single system, plus machine-readable diagnostic software on either tape, floppy, or disk.

What if I have additional systems?

If you want to use the diagnostics on additional systems you must also order a license code "DZ" category kit. (For example, part #ZXXXX-DZ.) With this license you can copy the diagnostic software from the original "C" kit and use it on a single additional computer system. There is no media or documentation included with the "DZ" category kit. Verification of the primary "C" license order for the same CPU type is required.

What about Diagnostic listings?

Diagnostic listings must be ordered separately from the kit. The listings can be ordered as part of the Maintenance Documentation Service (MDS) Library. For a description of all that's included in MDS see page 6. (Refer to Section B of the Price List in this book for MDS part numbers and prices.)

How do I keep my diagnostics current with hardware changes?

Because new products are released regularly, existing diagnostics may be enhanced at any time. Digital's Diagnostic Subscription Update Service helps you keep diagnostic software current with your hardware. Updates are available for each computer family. (For example, part #ZXXXX-HX.) Verification of the primary "C" license order for the same CPU type is required.

What are the specific diagnostic products I need for my system?

See the charts below.

NOTE: All "C" licenses are in binary form. No diagnostic listings or support services are included in the purchase of the license. Diagnostic Module L0006-YA is a prerequisite for the VAX-11/750. It must be ordered separately.

VAX-11 Family Diagnostics

| Product | Media | Single System License Part # | Price | Additional System License Part # | Price | Annual Update Service Part # | Price |
|------------------------------------|----------------|------------------------------|----------|----------------------------------|--------|------------------------------|---------|
| VAX-11/750 SPD #26.42.00 | TU58 | ZD201-CG | \$ 7,350 | ZD201-DZ | \$ 735 | ZD201-HG | \$3,150 |
| | Magtp/ TU58 | ZD201-CW | 7,350 | ZD201-DZ | 735 | ZD201-HW | 3,150 |
| VAX-11/780 SPD #26.41.00 | Magtp | ZE200-CM | \$ 9,450 | ZE200-DZ | \$ 945 | ZE200-HM | \$3,150 |
| | RX01/ Magtp | ZE200-CW | 9,450 | ZE200-DZ | 945 | ZE200-HW | 3,150 |
| | RX01 | ZE200-CY | 9,450 | ZE200-DZ | 945 | ZE200-HY | 3,150 |

Continued on next page

DIAGNOSTICS

VAX-11 Family Diagnostics—continued

| Product | Media | Single System License Part # | Price | Additional System License Part # | Price | Annual Update Service Part # | Price |
|---|----------------|------------------------------|----------|----------------------------------|-----------------|------------------------------|------------------|
| VAX-11/785 SPD #26.81.00 | RX01 | ZE210-CY | \$12,600 | ZE210-DZ | \$1,260 | ZE210-HY | \$3,150 |
| | Magtp/ RX01 | ZE210-CW | 12,600 | ZE210-DZ | 1,260 | ZE210-HW | 3,150 |
| VAX-11/780 to VAX-11/785 Upgrade SPD #26.81.00 | Magtp/ RX01 | ZE215-CW | \$ 3,150 | ZE200-DZ or ZE210-DZ | \$ 945 1,260 | ZE210-HW ZE210-HY | \$3,150 3,150 |

VAX 8600/8650 System Diagnostics

| | | | | | | | |
|--|------|----------|----------|----------|---------|----------|---------|
| VAX 8600/8650 SPD #26.82.01 | RL02 | ZK200-CH | \$18,000 | ZK200-DZ | \$1,890 | ZK200-HH | \$5,250 |
|--|------|----------|----------|----------|---------|----------|---------|

MicroVAX II Diagnostics (MDM)

| Product | Media | Single System License Part # | Price | Additional System License Part # | Price | Annual Update Service Part # | Price |
|---|---------|------------------------------|----------|----------------------------------|--------|------------------------------|--------|
| MicroVAX II SPD #28.09.03 KA630 CPU | RX50 | ZNABX-C3* | \$ 2,625 | ZNABX-DZ | \$ 158 | ZNABX-H3 | \$ 714 |
| | TK50 | ZNABX-C5* | 2,625 | ZNABX-DZ | 158 | ZNABX-H5 | 714 |
| MicroVAX Development SPD #28.16.00 KA630/650 CPU | Magtape | ZNA03-CM** | \$10,500 | ZNABX-DZ | \$ 158 | ZNA03-HM | \$ 420 |
| | TK50 | ZNA03-C5** | 10,500 | ZNABX-DZ | 158 | ZNA03-H5 | 420 |

The MicroVAX Development (MDM) kit can be purchased in addition to MicroVAX II diagnostics. It will help you develop customized diagnostics for

your MicroVAX system. Because these will be based on Digital diagnostics, you must purchase an additional code

“DZ” license if you wish to copy the developed diagnostics (in whole or in part) for use on an additional system.

*Purchase of license and media includes loopback connector.

**Customer must have purchased ZNABX-C3 or ZNABX-C5 in order to purchase this kit.

digital To Order, Call DECdirect at 800-344-4825. 8:30 AM to 8:00 PM (ET) in the Continental USA.

VAXBI System Diagnostics

“UZ” License Codes

Diagnostics for all VAX systems require a license to operate, which is valid only for the specific CPU. Self-Maintenance Services introduces a new policy with the introduction of the VAXBI Diagnostic Family. (The existing policy of ordering licenses “C” and “DZ” still applies for the MicroVAX II, the VAX-11 series, the VAX 8600 and VAX 8650).

With the introduction of diagnostics for the VAXBI family, a customer must order a “UZ” license code category diagnostic license for each CPU. This is an end-user license only, and it is required for each system using Digital diagnostics. An “HW” media kit contains the required media and User’s Guides supporting the specific licensed CPU. This is usually ordered in conjunction with the “UZ” product license.

In order to ensure license holders a means of keeping their diagnostic software current with their systems hardware/software, Digital provides an Annual Diagnostic Update Service which carries the “WW” category code.

This yearly subscription provides media updates upon release (several times a year). The subscription service is ordered for each licensed CPU to be updated. It is recommended that customers order the update subscription service with the “UZ” license purchase.

When you order diagnostics for your system, be aware that you actually order two separate parts: the media kit and the license to use the diagnostics contained on the media. The “UZ” license must be ordered first, then the media can be ordered by specifying the appropriate “HW” kit.

Do you have an additional CPU? You must order a “UZ” license for each additional CPU. If appropriate, the “HW” kit already ordered may be copied onto additional CPUs for which “UZ” licenses have been ordered. This authorization to copy is included in the “UZ” license ordered for each additional CPU.

Example of Minimum Order Data for Diagnostics

This example uses VAX 8200 system diagnostics as an example. The first order would be:

- Z5200-UZ License
- Z5200-HW Media Kit
- *Z5200-WW Update Subscription

For each subsequent order of the same type of CPU:

- Z5200-UZ License
- *Z5200-HW Media Kit
- *Z5200-WW Update Subscription

*The starred items are optional.

Update Service Note

Licensed users of VAX Diagnostics may order the Annual Subscription Update Service at the prevailing rate for such updates. The update is distributed in binary form on the appropriate medium and includes no installation or other services unless specifically stated. In order to keep your diagnostics current you must order the update service when you order the “UZ” license.

VAXBI Diagnostics

| Product | Part No. | Description | Price |
|---|----------|---|---------|
| VAX 8200 Diagnostics SPD # 27.81.00 KA820-A/8200 KA825-AA/82500 | Z5200-UZ | Single-use, end-user license only; no binaries, no documentation, no support services. | \$3,100 |
| | Z5200-HW | VAX 8200/8300 Diagnostic Media/Documentation kit, binaries (on 9-track 1600 BPI Magtape), and a set of RX50 diskettes. | 1,050 |
| | Z5200-WW | VAX 8200/8300 Annual Diagnostic Update Service. | 525 |
| | ZL200-GZ | VAXBI 8200/8300 Diagnostic Documentation Kit. | 126 |
| VAX 8300 Diagnostics SPD # 27.81.00 KA820-A/8300 KA825-AA/8350 | Z7200-UZ | Single-use, end-user license only; no documentation, no support services. | \$4,210 |
| | Z7200-HW | VAX 8200/8300 Diagnostic Media/Documentation kit and binaries (on 9-track 1600 BPI Magtape), and a set of RX50 diskettes. | 1,050 |
| | Z7200-WW | VAX 8200/8300 Annual Diagnostic Update Service. | 525 |
| | ZL200-GZ | VAXBI 8200/8300 Diagnostic Documentation Kit. | 126 |

Continued on next page

DIAGNOSTICS

VAXBI Diagnostics—continued

| Product | Part No. | Description | Price |
|---|----------|---|----------|
| VAX 8500 Diagnostics SPD # 27.82.00 KA85-AA/8500 KA85-AA/8530 | Z9200-UZ | Single-use, end-user license only; no documentation, no support services. | \$7,535 |
| | Z9200-HW | VAX 8500, 8700 and 8800 Diagnostic Media/Documentation kit and binaries (on 9-track 1600 BPI Magtape), and a set of RX50 diskettes. | 1,050 |
| | Z9200-WW | VAX 8500, 8700 and 8800 Annual Diagnostic Update Service. | 525 |
| | ZL200-GZ | VAXBI 8500/8800 Diagnostic Documentation Kit. | 126 |
| VAX 8550 Diagnostics SPD # 27.82.00 KA88/8550 | Z2200-UZ | Single-use, end-user license only; no documentation, no support services. | \$9,645 |
| | Z2200-HW | VAX 8500, 8700 and 8800 Diagnostic Media/Documentation kit and binaries (on 9-track 1600 BPI Magtape), and a set of RX50 diskettes. | 1,050 |
| | Z2200-WW | VAX 8500, 8700 and 8800 Annual Update Service. | 525 |
| | ZL200-GZ | VAXBI 8500/8800 Diagnostic Documentation Kit. | 126 |
| VAX 8700/8810 Diagnostics SPD # 27.82.00 KA88-AA | Z2201-UZ | Single-use, end-user license only; no documentation, no support services. | \$12,785 |
| | Z2201-HW | VAX 8500, 8700 and 8800 Diagnostic Media/Documentation kit and binaries (on 9-track 1600 BPI Magtape), and a set of RX50 diskettes. | 1,050 |
| | Z2201-WW | VAX 8500, 8700 and 8800 Annual Diagnostic Update Service. | 525 |
| | ZL201-GZ | VAXBI 8500/8800 Diagnostic Documentation Kit. | 126 |
| VAX 8800 Diagnostics SPD # 27.82.00 KA88 | ZM200-UZ | Single-use, end-user license only; no documentation, no support services. | \$16,430 |
| | ZM200-HW | VAX 8500, 8700 and 8800 Diagnostic Media/Documentation kit and binaries (on 9-track 1600 BPI Magtape), and a set of RX50 diskettes. | 1,050 |
| | ZM200-WW | VAX 8500, 8700 and 8800 Annual Diagnostic Update Service. | 525 |
| | ZL200-GZ | VAXBI 8500/8800 Diagnostic Documentation Kit. | 126 |
| VAX 6210 SPD#25.C9 | ZU200-UZ | Single-Use, end-user license only; no binaries, no documentation, no support services | \$4,200 |
| | ZU200-HW | VAX 6210-6240 Diagnostic Media/Documentation kit binaries on 9-track 1600 BPI magtape and TK50 | 1,000 |
| | ZU200-WW | VAX 6210-6240 Annual Update Service | 500 |
| VAX 6220 SPD#25.C9 | ZU202-UZ | Single-Use, end-user license only; no binaries no documentation, no support services | \$5,200 |
| | ZU202-HW | VAX 6210-6240 Diagnostic Media/Documentation kit binaries on 9-track 1600 BPI magtape and TK50 | 1,000 |
| | ZU202-WW | VAX 6210-6240 Annual Update Service | 500 |
| VAX 6230 SPD#25.C9 | ZU203-UZ | Single-Use, end-user license only; no binaries no documentation, no support services | \$7,200 |
| | ZU203-HW | VAX 6210-6240 Diagnostic Media/Documentation kit binaries on 9-track 1600 BPI magtape and TK50 | 1,000 |
| | ZU203-WW | VAX 6210-6240 Annual Update Service | 500 |

Continued on next page

digital To Order, Call DECdirect at 800-344-4825. 8:30 AM to 8:00 PM (ET) in the Continental USA.

VAXBI Diagnostics—continued

| Product | Part No. | Description | Price |
|---|----------|--|----------|
| VAX 6240 SPD#25.C9 | ZU204-UZ | Single-Use, end-user license only; no binaries no documentation, no support services | \$9,200 |
| | ZU204-HW | VAX 6210-6240 Diagnostic Media/Documentation kit binaries on 9-track 1600 BPI magtape and TK50 | 1,000 |
| | ZU204-WW | VAX 6210-6240 Annual Update Service | 500 |
| VAX 8810 | | See VAX 8700/8810 Diagnostics (Z2201 Series Part Numbers) | |
| VAX 8820 SPD#25.C7 | ZA201-UZ | Single-Use, end-user license only; no binaries no documentation, no support services | \$17,200 |
| | ZA201-HW | VAX 8820-8840 Diagnostic Media/Documentation kit binaries on 9-track 1600 BPI magtape and TK50 | 1,000 |
| | ZA201-WW | VAX 8820-8840 Annual Update Service | 500 |
| VAX 8830 SPD#25.C7 | ZA202-UZ | Single-Use, end-user license only; no binaries no documentation, no support services | \$19,200 |
| | ZA202-HW | VAX 8820-8840 Diagnostic Media/Documentation kit binaries on 9-track 1600 BPI magtape and TK50 | 1,000 |
| | ZA202-WW | VAX 8820-8840 Annual Update Service | 500 |
| VAX 8840 SPD#25.C7 | ZA203-UZ | Single-Use, end-user license only; no binaries no documentation, no support services | \$24,900 |
| | ZA203-HW | VAX 8820-8840 Diagnostic Media/Documentation kit binaries on 9-track 1600 BPI magtape and TK50 | 1,000 |
| | ZA203-WW | VAX 8820-8840 Annual Update Service | 500 |
| MicroVAX/ VAXstation 3XXX KA650 CPU | ZNAEX-UZ | Single-Use, end-user license only; no binaries no documentation, no support services | \$ 250 |
| | ZNAEX-H5 | MicroVAX/VAXstation 3XXX Diagnostic Media/Documentation kit on TK50 cartridge | 1,000 |
| | ZNAEX-WW | MicroVAX/VAXstation 3XXX Annual Update Service | 300 |
| MicroVAX/ VAXstation 2000 KA410 CPU SPD#25.C3 | ZNAGX-UZ | Single-Use, end-user license only; no binaries no documentation, no support services | \$150 |
| | ZNAGX-HW | MicroVAX/VAXstation 2000 Diagnostic Maintenance Package | 500 |
| MicroVAX Ethernet Server Kit KA630/KA650 SPD#29.89 | ZNA07-UZ | Single-Use, end-user license only; no binaries no documentation, no support services | \$ 250 |
| | ZNA07-H* | MicroVAX Diagnostic Monitor Ethernet Media Kit | 1,000 |
| | ZNA07-W* | MicroVAX Diagnostic Monitor Ethernet Updates | 300 |

*Media Chart: (H)=RL02, (5)=TK50, (M)=1600 BPI Magtape

VAXBI
DIAGNOSTICS

PDP-11 Family Diagnostics

PDP-11 Diagnostic software can be ordered in the same way as any of the other products in this book. You are not required to purchase a single-use, end-user license. However, the software is protected by U.S. copyright. The copyright laws prohibit the user from copying software programs except for archival purposes.

All PDP-11 Diagnostics contain media only. Diagnostic listings are available through the MDS library. (Refer to Part B in the Price List section of this book for MDS part numbers and prices.)

The following media contain diagnostics for the entire PDP-11 or MicroPDP-11 family, including all supporting devices.

In the following listing, there is a * in the Part Number. This star replaces a letter that indicates the current revision of the product. Refer to Part B in the Price List to get the actual current revision letter for the part number you desire.

PDP-11 and MicroPDP-11 Diagnostics

| Product | Media | Part # | Price |
|-----------------------------|----------------|--------------------------------|------------|
| PDP-11 | RK06 | AM-FJ44*-MC | \$750 |
| | RK07 | AY-T539*-MC | 750 |
| | RL02 | BC-FH95*-MC | 750 |
| | 1600 BPI MT | BB-FF99*-MC | 750 |
| | 800 BPI MT | AP-FK21*-MC and AP-FK22*-MC | 375 375 |
| | TU81, 6250 BPI | BM-FJ93*-MC | 850 |
| MicroPDP-11 Only: | RX50 | ZYA05-P3 | 714 |
| | TK50 | ZYA05-P5 | 714 |
| MicroPDP-11 Formatter Only: | RX50 | BL-FN7AC-MC | 89 |
| | RX33 | ZYA06-P3 | 89 |

PDP-11 Family Diagnostics on TU58 or RX02 Media

If you need TU58 or RX02 media you must purchase individual diagnostics for each CPU and device. Use the chart below and on the following pages to determine the appropriate part numbers.

Refer to Part B of the Price List for the prices of these products, and for the current revision letter that replaces the asterisk shown in the part number.

PDP-11 Family Diagnostics on TU58 or RX02 Media

| Device | TU58 Part # | RX02 Part # |
|-----------------|-------------|-------------|
| AAV11 | BE-F669*-MC | BA-FG90*-MC |
| ADV11 | BE-F669*-MC | BA-FG75*-MC |
| ADV11-C/AXV11-C | BE-T618*-MC | BA-FG90*-MC |
| BDV11 | BE-T618*-MC | BA-FF52*-MC |
| CD11/CM11-F | *** | BA-F159*-MC |
| CMQ11-K | *** | BA-F160*-MC |

*Refer to Price List in Section Three for the current revision letter and price.

***Not available on this media.

Continued on next page

PDP-11 Family Diagnostics on TU58 or RX02 Media—continued

| Device | TU58 Part # | RX02 Part # |
|------------------|--------------------------------|---|
| DCF11 | BE-F668*-MC | *** |
| DCF11-AA | BE-T891*-MC and BE-T892*-MC | *** |
| DEC/X11 | BE-T958*-MC | BA-T957*-MC and BA-U019*-MC |
| DH11 | *** | BA-FG76*-MC and BA-F159*-MC |
| DHU11 | *** | BA-FG76*-MC |
| DHV11-M | BE-FG12*-MC BE-FG11*-MC | BA-F160*-MC |
| DJ11/DL11-E,W | *** | BA-FG76*-MC |
| DLV11-E,F | BE-F669*-MC | BA-FF98*-MC |
| DLV11-J | BE-F668*-MC | BA-FG90*-MC |
| DMC11-DMR11 | *** | BA-F129*-MC |
| DMV-11 | *** | BA-F129*-MC, BA-F160*-MC, and BA-T965*-MC |
| DPV11 | BE-F669*-MC | BA-FG90*-MC |
| DQ11 | *** | BA-F886*-MC |
| DR11-A,B,C,K,L,M | *** | BA-F886*-MC |
| DR70 | *** | BA-F821*-MC |
| DR11-A | *** | BA-F129*-MC |
| DRU11 | *** | BA-F129*-MC |
| DRV11-B | BE-F668*-MC | BA-FG90*-MC |
| DRV11-J | BE-F668*-MC | BA-FG90*-MC |
| DT07 | *** | BA-F821*-MC |
| DT11 | *** | BA-F821*-MC |
| DUV11 | BE-F669*-MC | BA-FG76*-MC |
| DX11-B | *** | BA-F886*-MC |
| DZ11 | BE-T958*-MC | BA-FG76*-MC |
| DZV11 | BE-F669*-MC | BA-FG90*-MC |
| IBV11-A | BE-F668*-MC | BA-FG90*-MC |
| IEC11A/B | *** | BA-F821*-MC |
| IEU11/IEQ11 | BE-T618*-MC | BA-F821*-MC |
| KDF11-B | BE-T892*-MC and BE-T618*-MC | BA-FG75*-MC, and BA-FF52*-MC |
| KDJ11 | *** | BA-FJ66*-MC |
| KEF11/AA | BE-F688*-MC | BA-FG75*-MC, and BA-FF98*-MC |
| KEF11-B | BE-T892*-MC | BA-FI60*-MC |
| KMC11/KMS11 | *** | BA-F035*-MC |

*Refer to Price List in Section Three for the current revision letter and price.

***Not available on this media.

Continued on next page

DIAGNOSTICS

PDP-11 Family Diagnostics on TU58 or RX02 Media—continued

| Device | TU58 Part # | RX02 Part # |
|----------------|--|---|
| KMV11A/B | *** | BA-FI60*-MC, and BA-T965*-MC |
| KMV11C | *** | BA-F821*-MC |
| KTF11 | BE-F668*-MC | BA-FG75*-MC, and BA-FF98*-MC |
| KTF11-AA | BE-T891*-MC and BE-T892*-MC | BA-FG75*-MC, and BA-FF98*-MC |
| KUV11 | BE-F668*-MC | BA-FG75*-MC |
| KW11-C/L/P/W | *** | BA-F033*-MC |
| KXT11-CA | *** | BA-T965*-MC |
| LA36 | *** | BA-FI59*-MC |
| LA180 | *** | BA-FI59*-MC |
| LCP01 | *** | BA-FI59*-MC |
| LN01 | *** | BA-FI59*-MC |
| LPA | *** | BA-F027*-MC |
| LP05/LP07 | *** | BA-FI59*-MC |
| LP11/LP14 | *** | BA-FI59*-MC |
| LP25/LP26/LP27 | *** | BA-FI59*-MC |
| LSI-11 | BE-F668*-MC BE-FF50*-MC | BA-FG90*-MC, BA-FG75*-MC, and BA-FI60*-MC |
| LXY11/21 | *** | BA-FI59*-MC, and BA-F821*-MC |
| LXV11 | *** | BA-FI59*-MC, and BA-F821*-MC |
| MDE/T-11 | *** | BA-FI60*-MC |
| MINC-11 | *** | BA-FF98*-MC, and BA-FF52*-MC |
| ML11 | *** | BA-T171*-MC |
| MM111/MF11-UP | *** | BA-FG75*-MC |
| MS11-L/M | BE-S047*-MC and BE-T891*-MC | BA-F033*-MC, and BA-T171*-MC |
| MSV11 | BE-F668*-MC | BA-FG75*-MC |
| MXV11-A | BE-F668*-MC | BA-FG90*-MC |
| MXV11-B | *** | BA-FG90*-MC |
| M8203 | *** | BA-FI29*-MC |
| NCV-11 | *** | BA-F028*-MC |
| PCL11 | *** | BA-F821*-MC |
| 11/23 | BE-F668*-MC | BA-FG75*-MC |
| 11/23-B | BE-T892*-MC | BA-FI60*-MC |
| 11/24 | BE-T891*-MC, BE-F668*-MC and BE-S047*-MC | BA-F033*-MC, and BA-FG75*-MC |

*Refer to Price List in Section Three for the current revision letter and price.

***Not available on this media.

Continued on next page

digital To Order, Call DECdirect at 800-344-4825. 8:30 AM to 8:00 PM (ET) in the Continental USA.

PDP-11 Family Diagnostics on TU58 or RX02 Media—continued

| Device | TU58 Part # | RX02 Part # |
|---------------|---|---|
| 11/34 | BE-F668*-MC and BE-S046*-MC | BA-F033*-MC, BA-F028*-MC, BA-F159*-MC, and BA-FG76*-MC |
| 11/40 | BE-S047*-MC | BA-F033*-MC, BA-F028*-MC, BA-F033*-MC, and BA-F159*-MC |
| 11/44 | BE-S046*-MC and BE-S047*-MC | BA-F864*-MC, BA-F033*-MC, and BA-FG76*-MC |
| 11/45 | BE-S047*-MC | BA-FJ66*-MC, BA-F033*-MC, and BA-F159*-MC |
| 11/70 | BE-F668*-MC BE-S046*-MC | BA-F031*-MC, BA-FG75*-MC, and BA-F885*-MC |
| RA80 | *** | BA-T301*-MC |
| RC25 | *** | BA-F029*-MC |
| RK06/07 | BE-F692*-MC, BE-F693*-MC, and BE-S066*-MC | BA-F026*-MC |
| RL01/02 | BE-F667*-MC BE-F716*-MC | BA-FF53*-MC, BA-FG90*-MC, and BA-F557*-MC |
| RL11 RLV11 | BE-F667*-MC BE-F667*-MC | BA-F557*-MC BA-F160*-MC, BA-FG90*-MC, and BA-F557*-MC |
| RLV12 | BE-F667*-MC | BA-F557*-MC, BA-F160*-MC, and BA-FG90*-MC |
| RM02/3/5 | BE-F707*-MC and BE-F708*-MC | BA-S172*-MC |
| RM80 | *** | BA-T245*-MC |
| ROMS | *** | BA-F028*-MC |
| RP04/5/6 | BE-F675*-MC and BE-F676*-MC | BA-F020*-MC and BA-F026*-MC |
| RP11-C | *** | BA-F037*-MC |
| RQDX/RUX50 | *** | BA-F037*-MC |
| RX01,RX02 | BE-F667*-MC | BA-FF53*-MC, BA-FF52*-MC, and BA-F557*-MC |
| TK25/TSU05 | *** | BA-T966*-MC |
| TM02/TU16 | *** | BA-FF51*-MC |
| TM02/TU45 | *** | BA-FF51*-MC |

**PDP-11
DIAGNOSTICS**

*Refer to Price List in Section Three for the current revision letter and price.
***Not available on this media.

Continued on next page

DIAGNOSTICS

PDP-11 Family Diagnostics on TU58 or RX02 Media—continued

| Device | TU58 Part # | RX02 Part # |
|----------------|--------------------------------|---------------------------------|
| TM03/TE16 | *** | BA-FH96*-MC |
| TM03/TU45 | *** | BA-FF51*-MC |
| TS03/TS04/TS11 | BE-F702*-MC | BA-FH96*-MC |
| TSV05 | *** | BA-F821*-MC, and BA-T965*-MC |
| TU58 | BE-T891*-MC and BE-T892*-MC | BA-FF51*-MC |
| TU80 | *** | BA-FF51*-MC |
| DEUNA | *** | BA-T546*-MC |
| VSV01 | *** | BA-F395*-MC |
| VSV11 | *** | BA-F821*-MC |
| VT61-T/VT71-T | *** | BA-F395*-MC |
| VTV30-J/H | *** | BA-F821*-MC |
| VT30 | *** | BA-F821*-MC |
| VT36 | BE-T132*-MC and BE-T134*-MC | *** *** |
| VTV31-K | *** | BA-F395*-MC |
| VT105 | *** | BA-F395*-MC |
| XXDP | BE-F665-MC and BE-FF48*-MC | BA-F019*-MC |
| MEMORY | *** | BA-T171*-MC |

*Refer to Price List in Section Three for the current revision letter and price.

***Not available on this media.

VAX Systems Maintenance Training Program

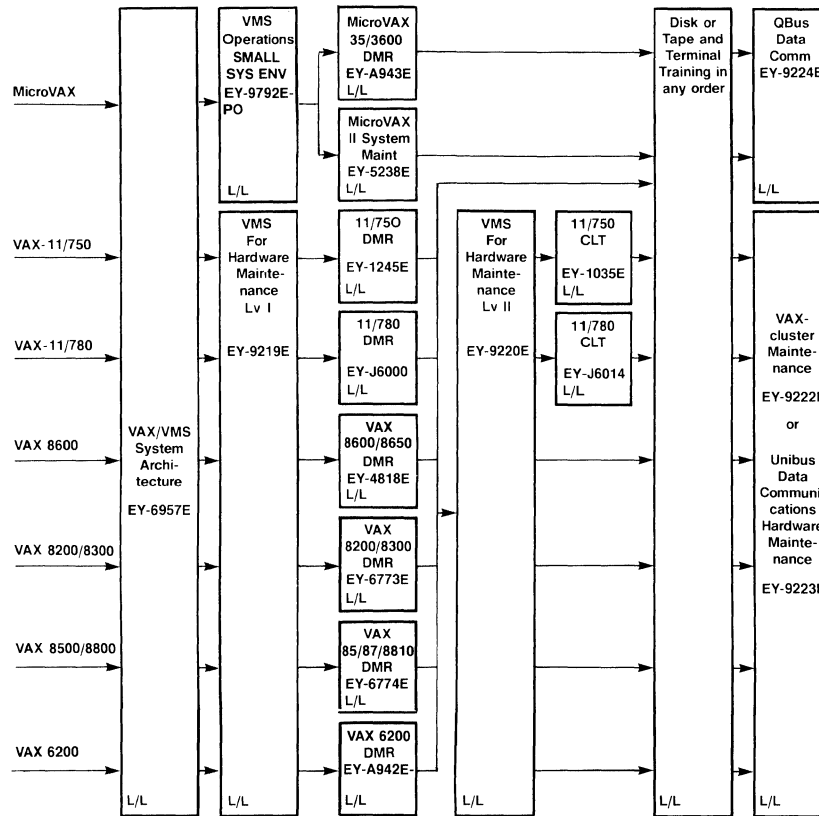

Key:
DMR=Diagnostic Module Level Repair
CLT=Component Level Troubleshooting

HARDWARE TRAINING

VAX Systems Curriculum

| Course Number | Title | Length (Days) | Tuition |
|---|--|---------------|---------|
| Generic Hardware Training | | | |
| EY-2040E-LO | Introduction to Computer Systems | 5 | \$ 995 |
| EY-J5074-LO | Introduction to Digital Computer Logic | 5 | 995 |
| VAX Systems Maintenance Training | | | |
| EY-6957E-LO | VAX/VMS System Architecture | 3 | \$ 995 |
| EY-9792E-PO | VMS Operations—Small System Environment | | |
| EY-5238E-LO | MicroVAX II System Maintenance | 5 | 1,695 |
| EY-A943E-LO | MicroVAX 3500/3600 Diagnostics & Module Level Repair | 5 | 2,050 |
| EY-9219E-LO | VMS for Hardware Maintenance Level I | 5 | 1,695 |
| EY-1245E-LO | VAX-11/750 Diagnostics & Module Level Repair | 15 | 4,695 |
| EY-1035E-LO | VAX-11/750 Component Level Troubleshooting | 20 | 6,195 |
| EY-J6000-LO | VAX-11/780 Diagnostics & Module Level Repair | 15 | 4,695 |
| EY-J6014-LO | VAX-11/780 Component Level Troubleshooting | 25 | 7,795 |
| EY-4818E-LO | VAX 8600/8650 Diagnostics & Module Level Repair | 15 | 6,195 |
| EY-6773E-LO | VAX 8200/8300 Diagnostics and Module Level Repair | 5 | 2,050 |
| EY-9245E-LO | VAX 85/87/8810 Diagnostics and Module Level Repair | 10 | 5,095 |
| EY-A942E-LO | VAX 6200 Diagnostic & Module Level Repair | 5 | 2,295 |
| EY-9220E-LO | VMS for Hardware Maintenance Level II | 5 | 1,795 |
| EY-9222E-LO | VAXcluster Maintenance | 10 | 3,450 |
| VAX Communications Training | | | |
| EY-9224E-LO | Q-Bus Data Communications Hardware Maintenance | 5 | \$1,695 |
| EY-9223E-LO | UNIBUS Data Communications Hardware Maintenance | 10 | 3,395 |

PDP-11 Systems Maintenance Training Program

HARDWARE TRAINING

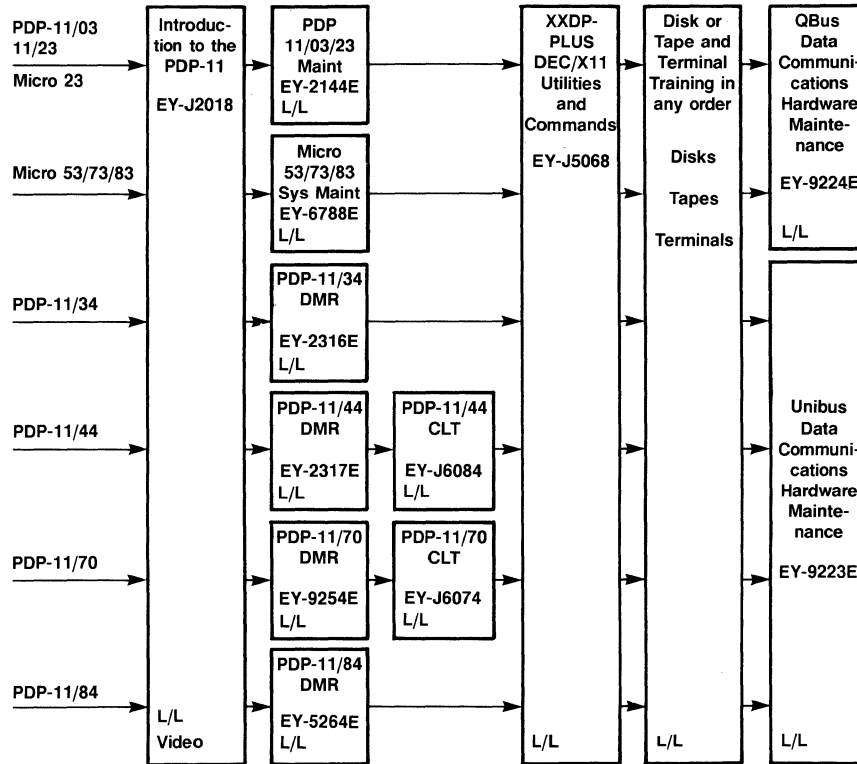

Key:
 Video=Video Based Instruction
 DMR=Diagnostic Module Level Repair
 CLT=Component Level Troubleshooting

PDP-11 Systems Curriculum

| Course Number | Title | Length (Days) | Tuition |
|---|---|---------------|---------|
| Generic Hardware Training | | | |
| EY-2040E-LO | Introduction to Computer Systems | 5 | \$ 995 |
| EY-J5074-LO | Introduction to Digital Computer Logic | 5 | 995 |
| PDP-11 Introductory Hardware Training | | | |
| EY-J2018-LO | Introduction to the PDP-11 | 5 | \$ 995 |
| PDP-11 Processors and Options Maintenance Training | | | |
| EY-2144E-LO | LSI-11, PDP-11/03, /23 Maintenance | 10 | \$3,095 |
| EY-6788E-LO | Micro 53/73/83 System Maintenance | 10 | 3,255 |
| EY-2316E-LO | PDP-11/34 Diagnostics & Module Level Repair | 5 | 1,550 |
| EY-2317E-LO | PDP-11/44 Diagnostics & Module Level Repair | 5 | 1,550 |
| EY-J6084-LO | PDP-11/44 Component Level Troubleshooting | 15 | 4,695 |
| EY-9254E-LO | PDP-11/70 Diagnostics & Module Level Repair | 10 | 3,095 |
| EY-J6074-LO | PDP-11/70 Component Level Troubleshooting | 10 | 3,255 |
| EY-5264E-LO | PDP-11/84 Diagnostics & Module Level Repair | 5 | 1,628 |
| PDP-11 Diagnostic Training | | | |
| EY-J5068-LO | XXDP-PLUS, DEC/X11 Utilities and Commands | 5 | \$1,550 |
| PDP-11 Communications Training | | | |
| EY-9224E-LO | Q-Bus Data Communications Hardware Maintenance | 5 | \$1,695 |
| EY-9223E-LO | UNIBUS Data Communications Hardware Maintenance | 10 | 3,395 |

Data Communications Hardware Maintenance Training Program

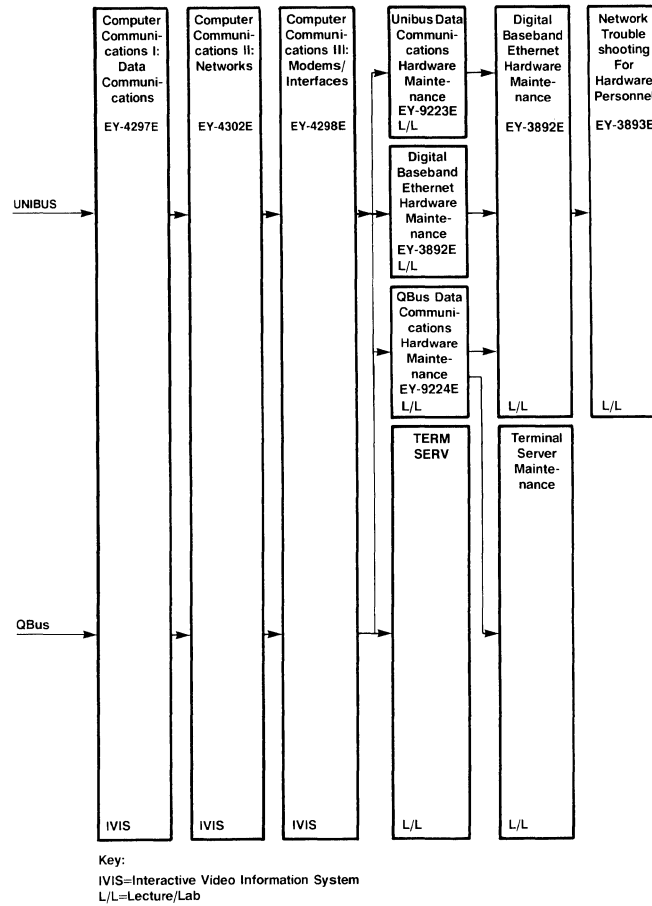

HARDWARE TRAINING

Data Communications Curriculum

| Course Number | Title | Length (Days) | Tuition |
|---|---|---------------|---------|
| Generic Hardware Training | | | |
| EY-2040E-LO | Introduction to Computer Systems | 5 | \$ 995 |
| EY-J5074-LO | Introduction to Digital Computer Logic | 5 | 995 |
| Data Communications Maintenance Training | | | |
| EY-4297E-LO | Computer Communications I: Data Communications—IVIS | 1/2 | \$ 158 |
| EY-4302E-LO | Computer Communications II: Networks—IVIS | 1/2 | 158 |
| EY-4298E-LO | Computer Communications III: Modems/Interfaces—IVIS | 1/2 | 158 |
| EY-9223E-LO | UNIBUS Data Communications Hardware Maintenance | 15 | 3,395 |
| EY-9224E-LO | Q-Bus Data Communications Hardware Maintenance | 5 | 1,695 |
| EY-3892E-LO | Digital Baseband Ethernet Hardware Maintenance | 5 | 1,795 |
| EY-3893E-LO | Network Troubleshooting for Hardware Personnel | 5 | 1,795 |

Terminals Maintenance Training Program

HARDWARE TRAINING

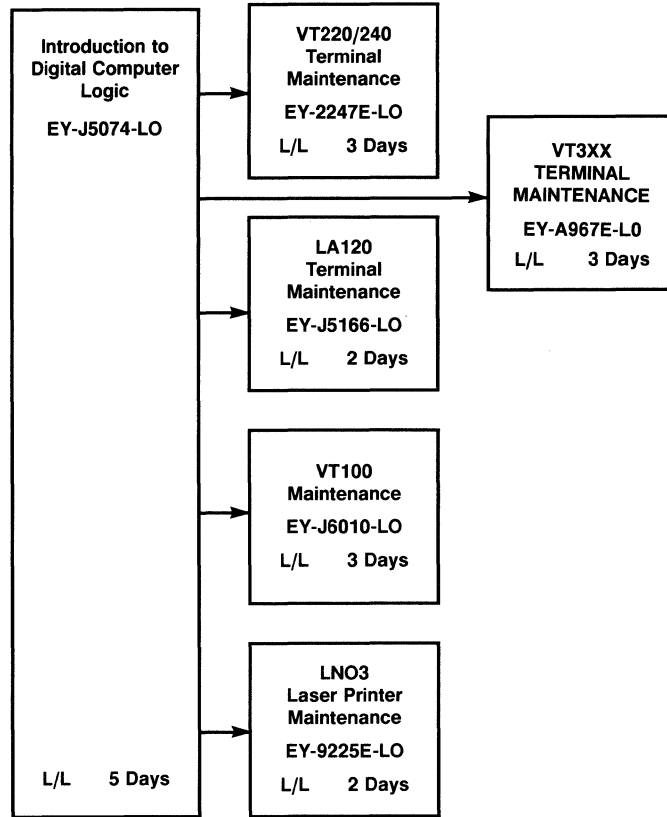

Key:
L/L = Lecture/Lab

Terminals Curriculum

| Course Number | Title | Length (Days) | Tuition |
|---------------------------------------|--|---------------|---------|
| Generic Hardware Training | | | |
| EY-2040E-LO | Introduction to Computer Systems | 5 | \$ 995 |
| EY-J5074-LO | Introduction to Digital Computer Logic | 5 | 995 |
| Terminals Maintenance Training | | | |
| EY-2247E-LO | VT220/240 Terminal Maintenance | 3 | \$1,050 |
| EY-A967E-LO | VT3xx Terminal Maintenance | 3 | |
| EY-J5166-LO | LA120 Terminal Maintenance | 2 | 895 |
| EY-J6010-LO | VT100 Terminal Maintenance | 3 | 1,050 |
| EY-9225E-LO | LNO3 Laser Printer Maintenance | 2 | 995 |

Disk Maintenance Training Program

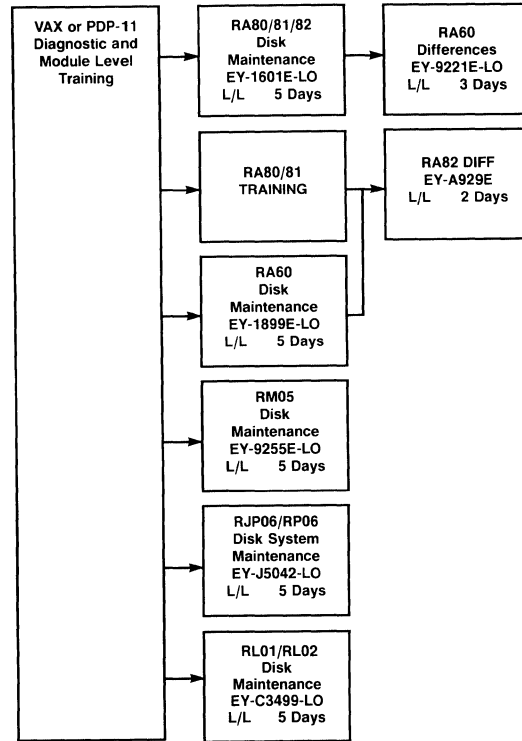

Key:
L/L = Lecture/Lab

HARDWARE TRAINING

Disk Maintenance Curriculum

| Course Number | Title | Length (Days) | Tuition |
|----------------------------------|--|---------------|---------|
| Generic Hardware Training | | | |
| EY-2040E-LO | Introduction to Computer Systems | 5 | \$ 995 |
| EY-J5074-LO | Introduction to Digital Computer Logic | 5 | 995 |
| Disk Maintenance Training | | | |
| EY-1899E-LO | RA60 Disk Maintenance | 5 | \$1,695 |
| EY-9221E-LO | RA60 Disk Differences | 2 | 995 |
| EY-1601E-LO | RA80/81/82 Disk Maintenance | 5 | 1,695 |
| EY-A929E-LO | RA82 Disk Differences | 2 | 995 |
| EY-9255E-LO | RM05 Disk Maintenance | 5 | 1,695 |
| EY-J5042-LO | RJP06/RP06 Disk System Maintenance | 5 | 1,695 |
| EY-C3499-LO | RL01/RL02 Disk System Maintenance | 5 | 1,695 |

Magtape Maintenance Training Program

HARDWARE TRAINING

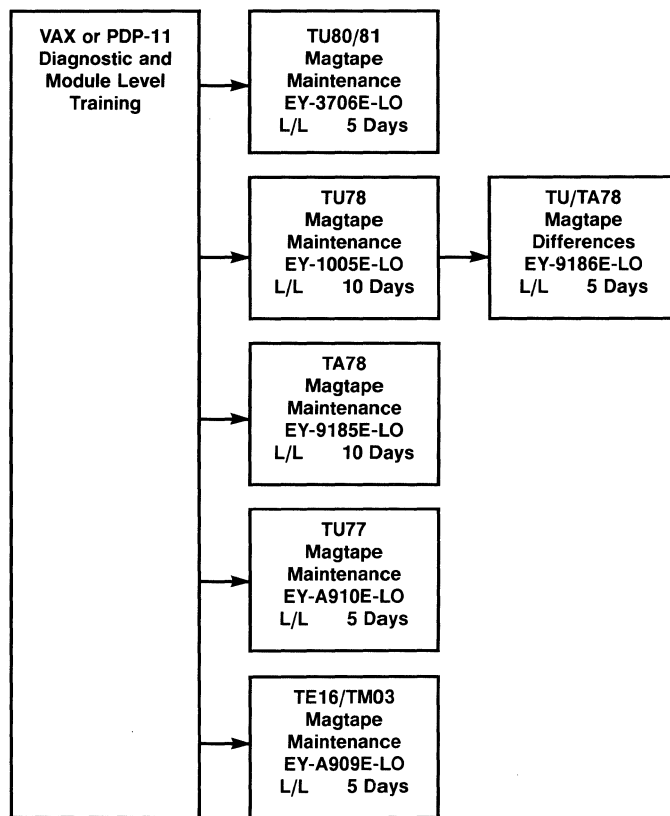

Key:
L/L = Lecture/Lab

Magtape Curriculum

| Course Number | Title | Length (Days) | Tuition |
|-------------------------------------|--|---------------|---------|
| Generic Hardware Training | | | |
| EY-2040E-LO | Introduction to Computer Systems | 5 | \$ 995 |
| EY-J5074-LO | Introduction to Digital Computer Logic | 5 | 995 |
| Magtape Maintenance Training | | | |
| EY-3706E-LO | TU80/81 Magtape Maintenance | 5 | \$1,695 |
| EY-1005E-LO | TU78 Magtape Maintenance | 10 | 3,255 |
| EY-9186E-LO | TU/TA78 Magtape Differences | 5 | 1,695 |
| EY-9185E-LO | TA78 Magtape Maintenance | 10 | 3,255 |
| EY-A910E-LO | TU77 Magtape Maintenance | 5 | 1,695 |
| EY-A909E-LO | TE16/TM03 Magtape Maintenance | 5 | 1,695 |

Communication Products

| Option | Spare Part/Kit | Option | Spare Part/Kit | Option | Spare Part/Kit |
|---------------|----------------|------------|----------------|-------------|----------------|
| CXA16-AA | M3118-YA | DEUNA | M7792-00 | DZ11 | M7814-00 |
| CXB16-AA | M3118-YB | | M7793-00 | | M7819-00 |
| CXY08-AA | M3119-YA | DHB32-M | T1044-00 | DZQ11-SA | M3106-PA |
| DCSAX-LA | 4A-DCSAX-LA | DHU11-M | M3105-00 | DZQ11-M | M3106-00 |
| DCSAX-LB | 4A-DCSAX-LB | DHQ11-M | M3107-00 | DZV11 | M7957-00 |
| DCSAX-LC | 4A-DCSAX-LC | DHV11-M | M3104-00 | H4000 | 54-14966-00 |
| DEBNA-M | T1034-00 | DMB32-LP/M | T1012-00 | IBQ01-SA | M3125-PA |
| DECSA-CA | 4A-DECSA-CA | DMF32 | M8396-00 | DEBET-AA | 4A-DEBET-AA |
| DECSA-DA | 4A-DECSA-DA | DMP11 | M8203-00 | DST32-AA | 54-17215-01 |
| DECSA-EA | 4A-DECSA-EA | | M8207-YA | | 54-17230-01 |
| DECSA-FA | 4A-DECSA-FA | DMR11 | M8203-00 | DHT32-AA | 54-17129-01 |
| DELNI-AA | 54-15475-00 | | M8207-RA | | 54-17131-01 |
| DELQA-M | M7516-00 | DMV11 | M8503-MA | DEPCA-AA | 70-24252-01 |
| DELQA-SA | M7516-PA | | M8064-MA | DSV11-M | M3108-00 |
| DEMPR-AA 120V | 4A-DEMPR-AA | DPV11-SA | M8020-PA | DSV11-SA | M3108-PA |
| DEMPR-AB 220V | 4A-DEMPR-AB | DR11-C | 4A-DR11-C | IEQ11-SF | M8634-PA |
| DEQNA-M | M7504-00 | DR11-W | M8716-00 | DESQA-SA/SF | M3127-PA |
| DEQNA-SA | M7504-PA | DRQ3B-SA | M7658-PA | H4005-00 | 4A-H4005-00 |
| DESTA-AA | 4A-DESTA-AA | DRB32-M | T1022-00 | DSRVB-AA | DSRVB-A2 |
| | | DV11 | 4A-DV11-AA | DSRVB-BA | DSRVB-B2 |

Storage Products

Disk Drives

| Option | Spare Part/Kit |
|--------------|----------------|
| RA60-XX | 4A-RA60-AA |
| RA70 | 4A-RA70-A |
| RA80 120 VAC | 4A-RA80-A |
| RA80 220 VAC | 4A-RA80-D |
| RA81 120 VAC | 4A-RA81-AA |
| RA81 220 VAC | 4A-RA81-AD |
| RA82 120 VAC | 4A-RA82-AA |
| RA82 220 VAC | 4A-RA82-AD |
| RD31 | 4A-RD31-A |
| RD32 | 4A-RD32-A |
| RD52 | 4A-RD52-A |
| RD53 | 4A-RD53-A |
| RD54 | 4A-RD54-A |
| RL02 | 4A-RL02-A |
| RUC25 | 4A-RUC25-00 |
| RX01 120 VAC | 4A-RX01-A |
| RX01 220 VAC | 4A-RX01-D |
| RX02 120 VAC | 4A-RX02-A |
| RX02 220 VAC | 4A-RX02-D |
| RX33 | 4A-RX33-A |
| RX50 | 4A-RX50-A |
| RF30-AA | 4A-RF30-A |
| RA90 | 4A-SA600-00 |
| RV20 | 4A-RV20-00 |

Disk Controllers

| Option | Spare Part/Kit |
|---------------|----------------|
| HSC50 120 VAC | 4A-HSC50-AA |
| HSC50 220 VAC | 4A-HSC50-AB |
| HSC5X-BA | 4A-HSC5X-BA |
| HSC5X-CA | 4A-HSC5X-CA |
| HSC70 120 VAC | 4A-HSC70-AA |
| H7C70 220 VAC | 4A-HSC70-AB |
| KDA50-QA | 4A-KDA50-QA |
| KDB50 | 4A-KDB50-00 |
| KLESI-BB | T1014-A |
| KLESI-QA | M7740-C |
| KLESI-UA/B | M8739-00 |
| RB730 | M8388-00 |
| RH750 | L0007-00 |
| RH780 | 4A-RH780-00 |
| RL11 | M7762-00 |
| RLV12 | M8061-00 |
| RQDX1 | M8639-YA |
| RQDX2 | M8639-YB |
| RQDX3 | M7555-00 |
| RUX50 | M7522-00 |
| RX11 | M7846-00 |
| RX211 | M8256-00 |
| RXV11 | M7946-00 |
| RXV21 | M8029-00 |
| UDA50 | 4A-UDA50-A |

Tape Drives

| Option | Spare Part/Kit |
|------------|----------------|
| TA81 | 4A-TA81-00 |
| TE16 | 4A-TE16-E |
| TK25 | 30-22969-01 |
| TK50 | TK50-AX |
| TK70 | TK70-AX |
| TM78 | 4A-TM78-00 |
| TS05 | 4A-TS05-00 |
| TU58-XA | 4A-TU58-XA |
| TU78 | 4A-TU78-00 |
| TU79-AF/AJ | 4A-TU79-00 |
| TU80 | 4A-TU80-00 |
| TU81 | 4A-TU81-00 |
| TU81E | 4A-TU81E-00 |

Tape Controllers

| Option | Spare Part/Kit |
|---------|----------------|
| RH750 | L0007-00 |
| RH780 | 4A-RH780-00 |
| TQK25 | 30-22971-01 |
| RQK50 | M7546-00 |
| TQK70 | M7559-00 |
| TS78 | 4A-TS78-BB |
| TSU05 | M7455-00 |
| TSV05 | M7196-00 |
| TU58-XB | STU58-XB |

Terminals/Printers

Video

| Option | Spare Part/Kit |
|-------------|----------------|
| VCB01-K | M7602-YA |
| VCB02-B/C | M7168-00 |
| | M7169-00 |
| | M7168-00 |
| VCB02-D/E/F | M7168-00 |
| VR260 | 4A-VR260-00 |
| VR290 | 4A-VR290-00 |
| VS450-DA/FA | 4A-VS450-DA |
| VS450-EA/GA | 4A-VS450-EA |
| VT100 | 4A-VT100-00 |
| VT1XX-AB | 54-13097-00 |
| VT220-A/D/C | 4A-VT220-A |
| VT220-D/E/F | 4A-VT220-D |
| VT240 | 4A-VT240-A |
| VT320-A2 | 4A-VT320-A2 |
| VT320-A3 | 4A-VT320-A3 |
| VT330 | 4A-VT330-00 |
| VT340 | 4A-VT340-00 |

Hard Copy

| Option | Spare Part/Kit |
|------------|----------------|
| LA100-AX | 4A-LA100-AA |
| LA100-PC | 4A-LA100-PC |
| LA100-RA | 4A-LA100-RA |
| LA12 | 4A-LA12-00 |
| LA120-AX | 4A-LA120-AA |
| LA120-RA | 4A-LA120-RA |
| LA120-UP | 4A-LA120-UP |
| LA210- | 4A-LA210-00 |
| LA50 | 4A-LA50-00 |
| LA75-A2 | 4A-LA75-A2 |
| LA75-A3/A4 | 4A-LA75-A4 |
| LA75-A5 | 4A-LA75-A5 |

Hard Copy—continued

| Option | Spare Part/Kit |
|----------|----------------|
| LAS12 | 4A-LAS12-X |
| LG01 | 4A-LG01-00 |
| LG02 | 4A-LG02-00 |
| LG31-A2 | 4A-LG31-A2 |
| LJ250-CA | 4A-LJ250-CA |
| LJ252-CA | 4A-LJ252-CA |
| LN03-A2 | 4A-LN03-A2 |
| LN03-A3 | 4A-LN03-A3 |
| LP11 | M7258-00 |
| LPS40-A | 4A-LPS40-A3 |
| LPV11 | M8027-00 |
| LQP45 | 4A-LQP45-A |

PERIPHERALS
KITS

Hardware Spares Kits

| | | | | | |
|-------------------|--------------------------------------|----------------|--------------------|--------------------------------------|-----------------|
| H9544-MG | BA11-A SLIDE KIT | \$185 | 4A-11751-C | 11751 CPU KIT W/64K MEM CONT. | \$17,764 |
| 12-16197-00 | SCREW,PIVOT | 2 | *L0002-00 | DATA PATH & MICRO SEQUENCER | 1 |
| 12-16971-00 | CHASSIS SLIDE FOR BA11-A | 1 | *L0003-00 | MEMORY INTERFACE & CACHE | 1 |
| 74-13659-00 | BRACKET,SHIPPING | 1 | *L0004-00 | UNIBUS INTERFACE | 1 |
| 74-21613-00 | SLIDE INDEX PLATES | 1 | *L0008-YA | 11750 PATCHABLE CONTROL STORE | 1 |
| 74-21613-01 | SLIDE INDEX PLATE | 1 | *L0016-00 | 64K MEMORY CONTRL,4-LAYER HEX | 1 |
| 90-06565-01 | NUT,HEX EXT TOOTH LCKWSHR 10 | 1 | 11-10324-00 | LED 1MCD@10MA #MV5054-1#HP488 | 10 |
| | | | 12-10773-00 | KNOB CONTROL Y4 SHAFT D FLAT | 10 |
| RK05-LA | RK05 LAMP ASSEMBLY KIT | \$76 | 12-11714-00 | FAN, 200+CFM,BALL BRNG,115V | 1 |
| 30-10638-03 | BULB ASSY,POTTED | 1 | 12-14314-00 | CONN 2 POS JUMPER | 10 |
| 70-12691-00 | CLAMP (RK05) | 1 | 12-15935-00 | GASKET,THERMAL:50"X.80" | 10 |
| | | | 12-15936-00 | HEAT SINK,FORCED CONVECTION | 10 |
| STU58-XA | SPARE DRIVE & CABLE ASSY. | \$457 | 12-16524-00 | CAP,PB SW WHITE | 10 |
| | | | 70-18117-00 | TWIN AIRFLOW SENSOR ASSY. | 1 |
| 4A-00861-B | 861-B SPARES KIT | \$300 | 4A-11780-00 | KA780,KC780,DW780 SPARES KIT | \$28,929 |
| 12-05303-00 | LAMP, PILOT IND DEVICES #1020 | 10 | *M7940-00 | SERIAL LINE 11V03 | 1 |
| 12-11142-00 | CKT BKR 20.0 A 277V 3P SERIES | 1 | *M7946-00 | RXV11 | 1 |
| 12-11147-01 | CONTACTOR, 30A,3P DBL BRK,600 | 1 | *M8044-EA | 24K 16BIT MOS RAM, 16K CHIPS | 1 |
| 12-11179-00 | RLY,REED, 48V COIL,SPST,.50A | 1 | *M8218-00 | SBL-LOW BIT INTERFACE | 1 |
| 12-11180-02 | SW,TOG 1 PDT ON-OFF-ON | 1 | *M8219-00 | SBH CPU HIGH BITS INTERFACE | 1 |
| *54-11522-00 | PILOT CONTROL | 1 | *M8220-00 | CAM CPU CACHE ADAPTER MATRIX | 1 |
| | | | *M8222-00 | TBM CPU TRANSLATION BUFFER MA | 1 |
| 4A-00861-C | 861-C SPARES KIT | \$290 | *M8223-00 | IRC CPU INSTRUCT DECODE&CLOCK | 1 |
| 12-05303-00 | LAMP, PILOT IND DEVICES #1020 | 10 | *M8225-00 | DEP DATA PATH E | 1 |
| 12-11147-00 | CONTACTOR, 30A,3P DBL BRK,600 | 1 | *M8226-00 | DDP DATA PATH D | 1 |
| 12-11179-00 | RLY,REED, 48V COIL,SPST,.50A | 1 | *M8227-00 | DCP DATA PATH C | 1 |
| 12-11180-02 | SW,TOG 1 PDT ON-OFF-ON | 1 | *M8228-00 | P.C. DESIGN DATA BASE | 1 |
| 12-11196-00 | CKT BKR 20,20,30A 277V 3P SER | 1 | *M8229-00 | DAP DATA PATH A | 1 |
| *54-11522-00 | PILOT CONTROL | 1 | *M8230-00 | CPU CONDITION CODE | 1 |
| | | | *M8231-00 | CPU TRAPS AND INTERRUPTS CONT | 1 |
| 4A-00861-D | PWR CONT'L 120V 24A 3PHASE | \$1,212 | *M8232-00 | CLK CPU CLOCK | 1 |
| | | | *M8234-00 | PCS CPU PROM CONTROL STORE | 1 |
| 4A-00869-D | 869-D SPARES KIT, 120V | \$427 | *M8235-00 | MICRO SEQUENCER CONTROL | 1 |
| 12-12266-01 | CONTACTOR 3P, 40A, 600V.120V | 1 | *M8236-00 | CIB CONSOLE INTERFACE | 1 |
| 12-14458-00 | CKT BKR 30.0A 250V | 1 | *M8237-00 | TERMINATOR SILO | 1 |
| 12-14842-00 | CKT BKR 20.0A 240V | 1 | *M8270-00 | YSI SBI INTERFACE | 1 |
| 16-23370-01 | XFMR, POWER 120VAC 47-63HZ | 1 | *M8271-00 | YMD UNIBUS MAP AND DATA PATH | 1 |
| *54-13016-00 | 869 PILOT CONT BRD | 1 | *M8272-00 | UNIBUS ADAPTER ADDRESS | 1 |
| 54-13184-YA | CAP, MOV BOARD 120V | 1 | 4A-KD11-F | KD11-F SPARES MODULE KIT | 1 |
| 90-08527-00 | FUSE, SLO BLO, 125A | 10 | 12-05303-00 | LAMP, PILOT IND DEVICES #1020 | 10 |
| | | | 12-13893-00 | BLOWER,CENTRIFUGAL | 1 |
| 4A-00869-E | 869-E SPARES KIT, 240V | \$475 | *54-11776-00 | H780 POWER SUPPLY | 1 |
| 12-12266-00 | CONTACTOR 3P, 40A, 600V.230V | 1 | *54-12560-00 | -5V REGULATOR | 1 |
| 12-14458-01 | CKT,BKR 15.0A,250V 4P SERIES | 1 | 54-12763-01 | TODPS AND BACKUP | 1 |
| *54-13016-00 | 869 PILOT CONT BRD | 1 | 90-07221-00 | FUSE, REG BLOW, 5.000A, 250V | 10 |
| 54-13184-YB | CAP., MOV BRD 240V | 1 | 90-08387-00 | FUSE, REG BLOW, 2.500A, 250V | 10 |
| 70-15230-01 | XFMR ASSY 240V | 1 | 90-08527-00 | FUSE, SLO BLO, 125A | 10 |
| 90-08527-00 | FUSE, SLO BLO, 125A | 10 | | | |
| 4A-00871-C | 19" PWR CONT'L 120V 16A | \$468 | | | |
| 4A-00874-F | 220/240V FILTERED POWER CONT' | \$559 | | | |
| *00874-F | 220-240 12A PWR CONTROL | 1 | | | |

*Those products which are repairable are marked with an asterisk

Continued on next page

digital To Order, Call DECdirect at 800-344-4825. 8:30 AM to 8:00 PM (ET) in the Continental USA.

HARDWARE SPARES KITS

Hardware Spares Kits—continued

HARDWARE KITS

4A-11785-00 KA785 REV 3, KC785 SPARES KIT \$51,041

| | | |
|--------------|----------------------------------|----|
| *M7459-00 | TRS, TERMINATOR & SILO, 4-LAYER | 1 |
| *M7460-00 | KA785, SBL, LOW BITS INTER. | 1 |
| *M7461-00 | KA785, SBH, HIGH BITS INTER. | 1 |
| *M7462-00 | KA785, CAM, CACHE ADD MATRIX | 1 |
| *M7463-00 | KA785, CDM, CACHE DATA MATRIX | 1 |
| *M7464-00 | KA785, TBM, CPU TRANSLATION BUF | 1 |
| *M7465-00 | KA785, IDP, CPU INSTR DATA PATH | 1 |
| *M7466-00 | KA785, IRC, CPU INSTRUCT DECODE | 1 |
| *M7467-00 | KA785, DBP, CPU DATA PATH "B" | 1 |
| *M7468-YA | DEP, DATAPATH MODULE, 16-31 BIT | 1 |
| *M7469-YA | DDP, DATAPATH MODULE, 08-15 BIT | 1 |
| *M7470-YA | DCP, DATAPATH MODULE, 00-07 BIT | 1 |
| *M7471-YA | DAP, DATAPATH CONTROL MODULE | 1 |
| *M7472-00 | KA785, CEH, COND CODES HIGH BIT | 1 |
| *M7473-00 | KA785, ICL, INTR. CONT. LOW BITS | 1 |
| *M7474-00 | KA785, CLK, CPU CLOCK | 1 |
| *M7476-00 | KA785, USC, MICRO SEQUENCER | 1 |
| *M7477-00 | KA785, CIB CPU CONSOLE INTR | 1 |
| *M7940-00 | SERIAL LINE 11V03 | 1 |
| *M7946-00 | RXV11 | 1 |
| *M8044-EA | 24K 16BIT MOS RAM, 16K CHIPS | 1 |
| 4A-KD11-F | KD11-F SPARES MODULE KIT | 1 |
| 12-05303-00 | LAMP, PILOT IND DEVICES #1020 | 10 |
| 12-13893-00 | BLOWER, CENTRIFUGAL | 1 |
| *54-11776-00 | H780 POWER SUPPLY | 1 |
| *54-12560-00 | -5V REGULATOR | 1 |
| 54-12763-01 | TODPS AND BACKUP | 1 |
| 90-07221-00 | FUSE, REG BLOW, 5.000A, 250V | 10 |
| 90-08387-00 | FUSE, REG BLOW, 2.500A, 250V | 10 |
| 90-08527-00 | FUSE, SLO BLO, 125A | 10 |

4A-11785-AA KA785, KC785 SPARES KIT \$51,041

| | | |
|--------------|----------------------------------|----|
| *M7459-00 | TRS, TERMINATOR & SILO, 4-LAYER | 1 |
| *M7460-00 | KA785, SBL, LOW BITS INTER. | 1 |
| *M7461-00 | KA785, SBH, HIGH BITS INTER. | 1 |
| *M7462-00 | KA785, CAM, CACHE ADD MATRIX | 1 |
| *M7463-00 | KA785, CDM, CACHE DATA MATRIX | 1 |
| *M7464-00 | KA785, TBM, CPU TRANSLATION BUF | 1 |
| *M7465-00 | KA785, IDP, CPU INSTR DATA PATH | 1 |
| *M7466-00 | KA785, IRC, CPU INSTRUCT DECODE | 1 |
| *M7467-00 | KA785, DBP, CPU DATA PATH "B" | 1 |
| *M7468-00 | KA785, DEP, CPU DATA PATH "E" | 1 |
| *M7469-00 | KA785, DDP, CPU DATA PATH "D" | 1 |
| *M7470-00 | KA785, DCP, CPU DATA PATH | 1 |
| *M7471-00 | KA785, DAP, CPU DATA PATH "A" | 1 |
| *M7472-00 | KA785, CEH, COND CODES HIGH BIT | 1 |
| *M7473-00 | KA785, ICL, INTR. CONT. LOW BITS | 1 |
| *M7474-00 | KA785, CLK, CPU CLOCK | 1 |
| *M7476-00 | KA785, USC, MICRO SEQUENCER | 1 |
| *M7477-00 | KA785, CIB CPU CONSOLE INTR | 1 |
| *M7940-00 | SERIAL LINE 11V03 | 1 |
| *M7946-00 | RXV11 | 1 |
| *M8044-EA | 24K 16BIT MOS RAM, 16K CHIPS | 1 |
| 4A-KD11-F | KD11-F SPARES MODULE KIT | 1 |
| 12-05303-00 | LAMP, PILOT IND DEVICES #1020 | 10 |
| 12-13893-00 | BLOWER, CENTRIFUGAL | 1 |
| *54-11776-00 | H780 POWER SUPPLY | 1 |
| *54-12560-00 | -5V REGULATOR | 1 |
| 54-12763-01 | TODPS AND BACKUP | 1 |
| 90-07221-00 | FUSE, REG BLOW, 5.000A, 250V | 10 |
| 90-08387-00 | FUSE, REG BLOW, 2.500A, 250V | 10 |
| 90-08527-00 | FUSE, SLO BLO, 125A | 10 |

4A-630Q1-D2 SYS SPARES KT FOR DH-630Q1-D2 \$13,395

| | | |
|--------------|--------------------------------|---|
| *M7504-00 | DEQNA Q-BUS TO ETHERNET ADAPT | 1 |
| *M7555-00 | RD/RX CONTROL MODULE (RQDX3) | 1 |
| *M7606-AA | MVII W/1MB, FP, CLK, B00T/DIAG | 1 |
| *M7607-AA | 1MB MEMORY FOR MS630-AA | 1 |
| *30-21749-01 | BA23 POWER SUPPLY, 5V 230W | 1 |
| 4A-RD52-A | RD52-A SPARE DRIVE, 31MB | 1 |
| 4A-RX50-AA | RX50-AA SPARE DRIVE | 1 |

4A-630Q2-D2 SYS SPARES KT FOR DH-630Q2-D2 \$15,292

| | | |
|--------------|--------------------------------|---|
| *M3106-00 | DZQ11, 4LN DBL BUF ASYNC MUX | 1 |
| *M7546-00 | Q-BUS TAPE CNTRL, DBL 8.5 | 1 |
| *M7555-00 | RD/RX CONTROL MODULE (RQDX3) | 1 |
| *M7606-AA | MVII W/1MB, FP, CLK, B00T/DIAG | 1 |
| *M7607-AA | 1MB MEMORY FOR MS630-AA | 1 |
| *TK50-AX | TK50-AA PACKAGED | 1 |
| *30-21749-01 | BA23 POWER SUPPLY, 5V 230W | 1 |
| 4A-RD53-00 | RD53 SPARES KIT | 1 |

150 days 4A-630Q2-F2 SYS SPARES KT FOR DH-630Q2-F2 \$14,880

| | | |
|--------------|--------------------------------|---|
| *M3106-00 | DZQ11, 4LN DBL BUF ASYNC MUX | 1 |
| *M7546-00 | Q-BUS TAPE CNTRL, DBL 8.5 | 1 |
| *M7555-00 | RD/RX CONTROL MODULE (RQDX3) | 1 |
| *M7606-AA | MVII W/1MB, FP, CLK, B00T/DIAG | 1 |
| *M7608-BA | 4MB MEMORY FOR MS630-BB | 1 |
| *TK50-AX | TK50-AA PACKAGED | 1 |
| *30-21749-01 | BA23 POWER SUPPLY, 5V 230W | 1 |
| 4A-RD53-00 | RD53 SPARES KIT | 1 |

4A-630Q3-E2 SYS SPARES KT FOR DH-630Q3-E2 \$20,742

| | | |
|-------------|--------------------------------|---|
| *M3104-00 | 8-LINE ASYNC MUX, DMA (DHV11) | 1 |
| *M7546-00 | Q-BUS TAPE CNTRL, DBL 8.5 | 1 |
| *M7555-00 | RD/RX CONTROL MODULE (RQDX3) | 1 |
| *M7606-AA | MVII W/1MB, FP, CLK, B00T/DIAG | 1 |
| *M7608-BA | 4MB MEMORY FOR MS630-BB | 1 |
| *TK50-AX | TK50-AA PACKAGED | 1 |
| 30-28231-01 | P.S. 120/240V 50/60HZ BA123 | 1 |
| 4A-RD53-00 | RD53 SPARES KIT | 1 |
| 4A-RX50-AA | RX50-AA SPARE DRIVE | 1 |

4A-630Q3-F2 SYS SPARES KT FOR DH-630Q3-F2 \$18,950

| | | |
|-------------|--------------------------------|---|
| *M3104-00 | 8-LINE ASYNC MUX, DMA (DHV11) | 1 |
| *M7504-00 | DEQNA Q-BUS TO ETHERNET ADAPT | 1 |
| *M7546-00 | Q-BUS TAPE CNTRL, DBL 8.5 | 1 |
| *M7555-00 | RD/RX CONTROL MODULE (RQDX3) | 1 |
| *M7606-AA | MVII W/1MB, FP, CLK, B00T/DIAG | 1 |
| *M7608-BA | 4MB MEMORY FOR MS630-BB | 1 |
| *TK50-AX | TK50-AA PACKAGED | 1 |
| 30-28231-01 | P.S. 120/240V 50/60HZ BA123 | 1 |
| 4A-RD53-00 | RD53 SPARES KIT | 1 |

*Those products which are repairable are marked with an asterisk

Continued on next page

digital To Order, Call DECdirect at 800-344-4825. 8:30 AM to 8:00 PM (ET) in the Continental USA.

Hardware Spares Kits—continued

| | | | |
|--------------------|--|---|-----------------|
| 4A-630Q4-E2 | SYS SPARES KT FOR DH-630Q4-E2 | | \$20,331 |
| *M3104-00 | 8-LINE ASYNC MUX, DMA (DHV11) | 1 | |
| *M7546-00 | Q-BUS TAPE CNTRL, DBL 8.5 | 1 | |
| *M7555-00 | RD/RX CONTROL MODULE (RQDX3) | 1 | |
| *M7606-AA | MVII W/1MB,FP,CLK,B00T/DIAG | 1 | |
| *M7608-BA | 4MB MEMORY FOR MS630-BB | 1 | |
| *TK50-AX | TK50-AA PACKAGED | 1 | |
| 30-28231-01 | P.S. 120/240V 50/60HZ BA123 | 1 | |
| 4A-RD53-00 | RD53 SPARES KIT | 1 | |

| | | | |
|--------------------|--|---|-----------------|
| 4A-630Q4-F2 | SYS SPARES KT FOR DH-630Q4-F2 | | \$21,469 |
| *M3104-00 | 8-LINE ASYNC MUX, DMA (DHV11) | 1 | |
| *M7504-00 | DEQNA Q-BUS TO ETHERNET ADAPT | 1 | |
| *M7546-00 | Q-BUS TAPE CNTRL, DBL 8.5 | 1 | |
| *M7555-00 | RD/RX CONTROL MODULE (RQDX3) | 1 | |
| *M7606-AA | MVII W/1MB,FP,CLK,B00T/DIAG | 1 | |
| *M7609-AA | 8MB MEMORY FOR MS630-CA | 1 | |
| *TK50-AX | TK50-AA PACKAGED | 1 | |
| 30-28231-01 | P.S. 120/240V 50/60HZ BA123 | 1 | |
| 4A-RD53-00 | RD53 SPARES KIT | 1 | |

| | | | |
|--------------------|--|---|-----------------|
| 4A-630Q4-H2 | SYS SPARES KT FOR DH-630Q4-H2 | | \$25,968 |
| *M3104-00 | 8-LINE ASYNC MUX, DMA (DHV11) | 1 | |
| *M7504-00 | DEQNA Q-BUS TO ETHERNET ADAPT | 1 | |
| *M7546-00 | Q-BUS TAPE CNTRL, DBL 8.5 | 1 | |
| *M7555-00 | RD/RX CONTROL MODULE (RQDX3) | 1 | |
| *M7606-AA | MVII W/1MB,FP,CLK,B00T/DIAG | 1 | |
| *M7609-AA | 8MB MEMORY FOR MS630-CA | 1 | |
| *TK50-AX | TK50-AA PACKAGED | 1 | |
| 30-28231-01 | P.S. 120/240V 50/60HZ BA123 | 1 | |
| 4A-RD54-A | RD54-A SPARE DRIVE | 1 | |

| | | | |
|--------------------|--|---|-----------------|
| 4A-630Q5-E2 | SYS SPARES KT FOR DH-630Q5-E2 | | \$21,592 |
| *M3104-00 | 8-LINE ASYNC MUX, DMA (DHV11) | 1 | |
| *M7504-00 | DEQNA Q-BUS TO ETHERNET ADAPT | 1 | |
| *M7546-00 | Q-BUS TAPE CNTRL, DBL 8.5 | 1 | |
| *M7606-AA | MVII W/1MB,FP,CLK,B00T/DIAG | 1 | |
| *M7608-BA | 4MB MEMORY FOR MS630-BB | 1 | |
| *TK50-AX | TK50-AA PACKAGED | 1 | |
| *30-21749-01 | BA23 POWER SUPPLY, 5V 230W | 1 | |
| 4A-KDA50-QA | KDA50-QA SPARES KIT | 1 | |

| | | | |
|--------------------|--|---|-----------------|
| 4A-630Q5-F2 | SYS SPARES KT FOR DH-630Q5-F2 | | \$20,843 |
| *M3104-00 | 8-LINE ASYNC MUX, DMA (DHV11) | 1 | |
| *M7504-00 | DEQNA Q-BUS TO ETHERNET ADAPT | 1 | |
| *M7546-00 | Q-BUS TAPE CNTRL, DBL 8.5 | 1 | |
| *M7606-AA | MVII W/1MB,FP,CLK,B00T/DIAG | 1 | |
| *M7609-AA | 8MB MEMORY FOR MS630-CA | 1 | |
| *TK50-AX | TK50-AA PACKAGED | 1 | |
| *30-21749-01 | BA23 POWER SUPPLY, 5V 230W | 1 | |
| 4A-KDA50-QA | KDA50-QA SPARES KIT | 1 | |

| | | | |
|--------------------|---|---|-----------------|
| 4A-630QX-AA | MVII KERNEL SPARES KIT Q1,Q2 | | \$12,010 |
| *M7546-00 | Q-BUS TAPE CNTRL, DBL 8.5 | 1 | |
| *M7555-00 | RD/RX CONTROL MODULE (RQDX3) | 1 | |
| *M7606-AA | MVII W/1MB,FP,CLK,B00T/DIAG | 1 | |
| *TK50-AX | TK50-AA PACKAGED | 1 | |
| *30-21749-01 | BA23 POWER SUPPLY, 5V 230W | 1 | |

| | | | |
|--------------------|---|---|-----------------|
| 4A-630QX-AB | MVII KERNEL SPARES KIT Q3,Q4 | | \$15,342 |
| *M3104-00 | 8-LINE ASYNC MUX, DMA (DHV11) | 1 | |
| *M7546-00 | Q-BUS TAPE CNTRL, DBL 8.5 | 1 | |
| *M7555-00 | RD/RX CONTROL MODULE (RQDX3) | 1 | |
| *M7606-AA | MVII W/1MB,FP,CLK,B00T/DIAG | 1 | |
| *TK50-AX | TK50-AA PACKAGED | 1 | |
| 30-28231-01 | P.S. 120/240V 50/60HZ BA123 | 1 | |

| | | | |
|--------------------|---|---|-----------------|
| 4A-630QX-AC | MVII KERNEL SPARES KIT Q5,QZ | | \$16,984 |
| *M3104-00 | 8-LINE ASYNC MUX, DMA (DHV11) | 1 | |
| *M7546-00 | Q-BUS TAPE CNTRL, DBL 8.5 | 1 | |
| *M7606-AA | MVII W/1MB,FP,CLK,B00T/DIAG | 1 | |
| *TK50-AX | TK50-AA PACKAGED | 1 | |
| *30-21749-01 | BA23 POWER SUPPLY, 5V 230W | 1 | |
| 4A-KDA50-QA | KDA50-QA SPARES KIT | 1 | |

| | | | |
|--------------------|--|---|-----------------|
| 4A-630QZ-A2 | SYS SPARES KT FOR RF-630QZ-A2 | | \$20,614 |
| *M3104-00 | 8-LINE ASYNC MUX, DMA (DHV11) | 1 | |
| *M7546-00 | Q-BUS TAPE CNTRL, DBL 8.5 | 1 | |
| *M7606-AA | MVII W/1MB,FP,CLK,B00T/DIAG | 1 | |
| *M7608-BA | 4MB MEMORY FOR MS630-BB | 1 | |
| *TK50-AX | TK50-AA PACKAGED | 1 | |
| *30-21749-01 | BA23 POWER SUPPLY, 5V 230W | 1 | |
| 4A-00869-D | 869-D SPARES KIT, 120V | 1 | |
| 4A-KDA50-QA | KDA50-QA SPARES KIT | 1 | |

| | | | |
|--------------------|------------------------------------|---|-----------------|
| 4A-640QX-A3 | MICROVAX 3300/3400 240V KIT | | \$20,481 |
| H7868-B | POWER SUPPLY,240V | 1 | |
| *M7621-AA | MS650-AA 8MB MEMORY | 1 | |
| M7624-AA | MAYFAIR 2CPU 4MEG ECC MEM | 1 | |
| 4A-RF30-A | RF30-A SPARE DRIVE | 1 | |

| | | | |
|--------------------|------------------------------------|---|-----------------|
| 4A-640QX-AA | MICROVAX 3300/3400 120V KIT | | \$20,481 |
| H7868-A | POWER SUPPLY,120V | 1 | |
| *M7621-AA | MS650-AA 8MB MEMORY | 1 | |
| M7624-AA | MAYFAIR 2CPU 4MEG ECC MEM | 1 | |
| 4A-RF30-A | RF30-A SPARE DRIVE | 1 | |

| | | | |
|--------------------|-------------------------------------|---|-----------------|
| 4A-640QX-B3 | VAXSERVER 3300/3400 240V KIT | | \$15,981 |
| H7868-B | POWER SUPPLY,240V | 1 | |
| M7624-BA | M7624-AA W/MOD ROM LIC ONLY | 1 | |
| 4A-RF30-A | RF30-A SPARE DRIVE | 1 | |

| | | | |
|--------------------|-------------------------------------|---|-----------------|
| 4A-640QX-BA | VAXSERVER 3300/3400 120V KIT | | \$15,081 |
| H7868-A | POWER SUPPLY,120V | 1 | |
| M7624-BA | M7624-AA W/MOD ROM LIC ONLY | 1 | |
| 4A-RF30-A | RF30-A SPARE DRIVE | 1 | |

*Those products which are repairable are marked with an asterisk

Continued on next page

DECdirect To Order, Call DECdirect at 800-344-4825. 8:30 AM to 8:00 PM (ET) in the Continental USA.

HARDWARE SPARES KITS

Hardware Spares Kits—continued

| | | | |
|--|------------------|---|-----------------|
| 4A-650QX-AA MICROVAX 3000 KERNEL KIT | \$27,300 | 4A-CI780-00 CI780 SPARES KIT | \$14,440 |
| *M7516-00 Q-BUS TO ETHERNET ADAPT,DUAL | 1 | *L0101-00 IPB(CI CNTL STORE&PACKET BUF) | 1 |
| *M7559-00 TQK70 TAPE CONTROLLER | 1 | *L0102-00 IDP (CI DATA PATH),HEX 12 | 1 |
| *M7620-AA CVAX 90NS CPU MOD,MEM SLU | 1 | *L0104-00 ISI (CI SBI INTERFACE FOR CI) | 1 |
| *M7621-AA MS650-AA 8MB MEMORY | 1 | *L0118-00 32 NODE CLUSTER LINK MODULE | 1 |
| *TK70-AX TK70-AA WITH NO CARTRIDGE | 1 | | |
| 4A-KDA50-QA KDA50-QA SPARES KIT | 1 | | |
| 4A-650QX-BA VAXSERVER 3000 KERNEL KIT | \$27,300 | 4A-CIBCA-AA CIBCA SPARES KIT | \$18,275 |
| *M7516-00 Q-BUS TO ETHERNET ADAPT,DUAL | 1 | *T1015-00 PORT CONTROL | 1 |
| *M7559-00 TQK70 TAPE CONTROLLER | 1 | *T1025-00 CI FRONT END + PACKET BUFFER | 1 |
| *M7620-BA M7620-AA W/MOD ROM | 1 | | |
| *M7621-AA MS650-AA 8MB MEMORY | 1 | 4A-CIBCI-AA CIBCI MODULE SPARES KIT | \$18,044 |
| *TK70-AX TK70-AA WITH NO CARTRIDGE | 1 | *L0101-00 IPB(CI CNTL STORE&PACKET BUF) | 1 |
| 4A-KDA50-QA KDA50-QA SPARES KIT | 1 | *L0118-00 32 NODE CLUSTER LINK MODULE | 1 |
| | | *L0400-00 CDP (CI750 DATA PATH MODULE) | 1 |
| | | *T1017-00 BI-BUS TO CI750 INTERF CONT | 1 |
| | | *T1018-00 BI ADAPTOR DATA TRANS. MODULE | 1 |
| 4A-886CA-AA CPU SPARES MODULE KIT | \$243,000 | 4A-DB88-AA DB88-AA SPARES KIT | \$17,172 |
| *F1002-00 SHIFTER LOGIC MODULE | 1 | *F1011-00 NBI(NMI TO BI INTERFACE MOD) | 1 |
| *F1003-00 ALU SLICE #1 MODULE | 1 | *T1020-00 MEM INTERCONNECT | 1 |
| *F1004-00 ALU SLICE #0 MODULE | 1 | | |
| *F1005-00 ADDRESS DTA PATH MODULE | 1 | 4A-DB88-BA DB88-BA SPARES KIT | \$13,250 |
| *F1007-00 DECODER MODULE | 1 | F1031-00 PBIA NMI TO BI MODULE | 1 |
| *F1009-00 16K WORD WRITE CONT STORE | 1 | *T1020-00 MEM INTERCONNECT | 1 |
| F1021-00 MEMORY CONTROL MODULE | 1 | | |
| F1026-00 PBIA LOAD MODULE | 1 | 4A-DCSAX-LA DCSAX-LA SPARE MOD KIT | \$475 |
| F1028-00 MICRO SEQUENCER MODULE | 1 | (M3100) | |
| F1032-00 CONSOLE INTERFACE MODULE | 1 | DCSAX-LA 1-LINE SYNC LINE CARD, EIA | 1 |
| F1033-00 CLOCK MODULE | 1 | | |
| F1034-00 NMI BUS WINDOW MODULE | 1 | 4A-DCSAX-LB DCSAX-LB SPARE MOD KIT | \$744 |
| F1036-00 CACHE CNTL SEQUENCER MODULE | 1 | (M3101) | |
| M7553-00 Q-BUS CONSOLE MODULE | 1 | DCSAX-LB 1-LINE SYNC CARD, V.35 | 1 |
| | | | |
| 4A-BA123-00 BA123 SPARES KIT | \$2,589 | 4A-DCSAX-LC DCSAX-LC SPARE MOD KIT | \$429 |
| 12-22271-01 FAN, TUBE AXIAL 4.5" | 1 | (M3102) | |
| 12-22355-09 SW, RKR DPST ON-OFF 16A/250V | 1 | DCSAX-LC 2-LINE ASYNC. LINE CARD, EIA | 1 |
| 12-23395-01 FAN, TUBE AXIAL 5.0" 100CFM | 1 | | |
| 30-28231-01 P.S. 120/240V 50/60HZ BA123 | 1 | 4A-DEBET-AA ETHERNET/BRIDGE/LOCAL/120V | \$8,800 |
| 54-16596-01 CONSOLE BD FOR BA123-A | 1 | DEBET-AA ETHERNET/BRIDGE/LOCAL/120VAC | 1 |
| 54-16665-01 SENSE OF TEMP. FOR BA123 | 1 | | |
| | | 4A-DECSA-CA DECSA-CA SPARES KIT | \$12,495 |
| 4A-BA32-00 BA32 EXPANDER BOX SPARES KIT | \$4,646 | 120/240V | |
| *H7250-00 1250W 300VDC SUPPLY,120/240 | 1 | G7273-00 BUS GRANT&NON-PROCESSOR GRANT | 1 |
| *H7251-00 POWER MOD # 1 | 1 | *M3110-00 PROTOCOL ASSIST #1 SPEC CHAR | 1 |
| *H7253-00 POWER MOD # 3 | 1 | *M3111-00 PROTOCOL ASSIST #2 SPEC CHAR | 1 |
| 12-22707-02 BLOWER,FORWD CURVED,300CFM 24 | 1 | *M3112-00 CONSOLE BOOT TERMINATOR, HEX | 1 |
| 12-23676-01 SENSOR,AIR FLOW | 1 | *M7133-YA KDF11-UA CPU,LINE CLOCK,2 SER | 1 |
| 54-16133-02 POWER DISTRIBUTION MODULE | 1 | *M7792-00 PORT MODULE | 1 |
| | | *M7793-00 LINK MODULE | 1 |
| 4A-BLVBI-CA VAX BI EXTENDER BOARD | \$3,678 | *M8743-AA 512KB (256K X 2) ECC RAM | 1 |
| | | 12-13185-03 FAN,70CFM,115V,TUBE AXIAL,LOW | 1 |
| 4A-CI750-00 CI750 SPARES KIT 120/240V | \$9,976 | 12-15336-02 CONN, TEST, SHEILDED | 1 |
| *L0009-00 CCI (CMI TO CIPA INTERFACE) | 1 | 4A-DCSAX-LC DCSAX-LC SPARE MOD KIT(M3102) | 2 |
| *L0101-00 IPB(CI CNTL STORE&PACKET BUF) | 1 | *70-18762-00 POWER SUPPLY ASSY | 1 |
| *L0118-00 32 NODE CLUSTER LINK MODULE | 1 | | |
| *L0400-00 CDP (CI750 DATA PATH MODULE) | 1 | | |

*Those products which are repairable are marked with an asterisk

Continued on next page

digital To Order, Call DECdirect at 800-344-4825. 8:30 AM to 8:00 PM (ET) in the Continental USA.

Hardware Spares Kits—continued

| | | | | |
|---|-------------------------------|-----------------|--|-----------------|
| 4A-DECSA-DA DECSA-DA SPARES KIT | | | 4A-DR11-C SPARES GENERAL PURPOSE INTERF | \$340 |
| 120/240V | | \$12,772 | *DR11-C GENERAL PURPOSE INTERFACE | 1 |
| G7273-00 | BUS GRANT&NON-PROCESSOR GRANT | 1 | | |
| *M3110-00 | PROTOCOL ASSIST #1 SPEC CHAR | 1 | | |
| *M3111-00 | PROTOCOL ASSIST #2 SPEC CHAR | 1 | | |
| *M3112-00 | CONSOLE BOOT TERMINATOR, HEX | 1 | | |
| *M7133-YA | KDF11-UA CPU,LINE CLOCK,2 SER | 1 | | |
| *M7792-00 | PORT MODULE | 1 | | |
| *M7793-00 | LINK MODULE | 1 | | |
| *M8743-AA | 512KB (256K X 2) ECC RAM | 1 | | |
| 12-13185-03 | FAN,70CFM,115V,TUBE AXIAL,LOW | 1 | | |
| 12-15336-02 | CONN, TEST, SHEILDED | 1 | | |
| 4A-DCSAX-LC | DCSAX-LC SPARE MOD KIT(M3102) | 3 | | |
| *70-18762-00 | POWER SUPPLY ASSY | 1 | | |
| 4A-DECSA-EA DECSA-EA SPARES KIT | | \$12,049 | 4A-DR780-00 DR780 MODULE SPARES KIT | \$12,361 |
| G7273-00 | BUS GRANT&NON-PROCESSOR GRANT | 1 | M8296-00 SYNC BACKPLANE INTERCON | 1 |
| *M3110-00 | PROTOCOL ASSIST #1 SPEC CHAR | 1 | M8297-00 DR780 CONTROL,4 LAYER,HEX | 1 |
| *M3111-00 | PROTOCOL ASSIST #2 SPEC CHAR | 1 | M8298-00 DR780 MICROPROCESSOR | 1 |
| *M3112-00 | CONSOLE BOOT TERMINATOR, HEX | 1 | M8299-00 DR780 SILO,HEX,12 | 1 |
| *M7133-YA | KDF11-UA CPU,LINE CLOCK,2 SER | 1 | | |
| *M7792-00 | PORT MODULE | 1 | | |
| *M7793-00 | LINK MODULE | 1 | | |
| *M8743-AA | 512KB (256K X 2) ECC RAM | 1 | | |
| 12-13185-03 | FAN,70CFM,115V,TUBE AXIAL,LOW | 1 | | |
| 12-15336-02 | CONN, TEST, SHEILDED | 1 | | |
| 4A-DCSAX-LA | DCSAX-LA SPARE MOD KIT(M3100) | 1 | | |
| *70-18762-00 | POWER SUPPLY ASSY | 1 | | |
| 4A-DECSA-FA DECSA-FA SPARES KIT | | \$12,406 | 4A-DV11-AA DV11-AA SPARES MODULE KIT | \$4,872 |
| 120/240V | | | *M7147-00 MODEM CONTROL | 1 |
| G7273-00 | BUS GRANT&NON-PROCESSOR GRANT | 1 | *M7807-00 EIA LEVEL CONVERT | 1 |
| *M3110-00 | PROTOCOL ASSIST #1 SPEC CHAR | 1 | *M7836-00 DV11 ALU & TRANSFER BUS | 1 |
| *M3111-00 | PROTOCOL ASSIST #2 SPEC CHAR | 1 | *M7837-00 DV11 UNIBUS DATA & NPR CONT | 1 |
| *M3112-00 | CONSOLE BOOT TERMINATOR, HEX | 1 | *M7838-00 DV11 ROM RAM & BRANCH | 1 |
| *M7133-YA | KDF11-UA CPU,LINE CLOCK,2 SER | 1 | | |
| *M7792-00 | PORT MODULE | 1 | | |
| *M7793-00 | LINK MODULE | 1 | | |
| *M8743-AA | 512KB (256K X 2) ECC RAM | 1 | | |
| 12-13185-03 | FAN,70CFM,115V,TUBE AXIAL,LOW | 1 | | |
| 12-15336-02 | CONN, TEST, SHEILDED | 1 | | |
| 4A-DCSAX-LA | DCSAX-LA SPARE MOD KIT(M3100) | 1 | | |
| *70-18762-00 | POWER SUPPLY ASSY | 1 | | |
| 4A-DECSA-BA DECSA-BA SPARES KIT | | \$12,406 | 4A-DW780-00 DW780 SPARES KIT 120/240V | \$6,782 |
| 120/240V | | | *M8270-00 YSI SBI INTERFACE | 1 |
| G7273-00 | BUS GRANT&NON-PROCESSOR GRANT | 1 | *M8271-00 YMD UNIBUS MAP AND DATA PATH | 1 |
| *M3110-00 | PROTOCOL ASSIST #1 SPEC CHAR | 1 | *M8272-00 UNIBUS ADAPTER ADDRESS | 1 |
| *M3111-00 | PROTOCOL ASSIST #2 SPEC CHAR | 1 | *M8273-00 UNIBUS ADAPTER CONTROL | 1 |
| *M3112-00 | CONSOLE BOOT TERMINATOR, HEX | 1 | | |
| *M7133-YA | KDF11-UA CPU,LINE CLOCK,2 SER | 1 | | |
| *M7792-00 | PORT MODULE | 1 | | |
| *M7793-00 | LINK MODULE | 1 | | |
| *M8743-BA | 1MB(512K X 22)ECC RAM | 1 | | |
| 12-13185-03 | FAN,70CFM,115V,TUBE AXIAL,LOW | 1 | | |
| 12-15336-02 | CONN, TEST, SHEILDED | 1 | | |
| 4A-DCSAX-LA | DCSAX-LA SPARE MOD KIT(M3100) | 1 | | |
| *70-18762-00 | POWER SUPPLY ASSY | 1 | | |
| 4A-DELNI-AA LOCAL NTRWK INTERCON, | | \$1,375 | 4A-DWMB-CA DWMB-CA SPARES KIT | \$9,518 |
| 120/240V | | | *T1043-00 XMI TO BI ADAPTER (XBIB) | 1 |
| DELNI-BA | LOCAL NETWORK INTERCONNECT US | 1 | *T2012-00 XMI TO BI ADAPTER MODULE | 1 |
| 4A-DEMPR-AA THNWR ENET MLTPRT RPTR | | \$3,100 | 4A-FP287-00 FLOATING POINT PROCESSOR KIT | \$520 |
| 120V | | | FP287-00 VAXMATE 80287 NUMERIC CO-PROC | 1 |
| DEMPR-AA | THINWIRE ENET MLTPRT RPTR/120 | 1 | | |
| 4A-DEMPR-AB THNWR ENET MLTPRT RPTR | | \$3,100 | 4A-FP780-00 FP780 SPARES KIT | \$6,744 |
| 240V | | | *M8285-00 FOATING POINT FRACTION NORMAL | 1 |
| DEMPR-AB | THINWIRE ENET MLTPRT RPTR/240 | 1 | *M8286-00 FLOATING POINT FRACTION MULTI | 1 |
| | | | *M8287-00 FLOATING POINT FRACTION ADDER | 1 |
| | | | *M8288-00 FLOATING POINT ACCELLERATOR C | 1 |
| | | | *M8289-00 FMH | 1 |
| 4A-DESTA-AA THINWIRE ENET STATION | | \$275 | 4A-FP785-AA FP785 CPU SPARES KIT | \$11,332 |
| DESTA-AA | THINWIRE ENET STATION ADAPTER | 1 | *M7540-00 FP785,FLOAT PT FRACT NORMALIZ | 1 |
| | | | *M7541-00 FP785,FMH,FLOAT PT FRACT MULT | 1 |
| | | | *M7542-00 FP785,FML,FLOAT PT FRACT MULT | 1 |
| | | | *M7543-00 FP785,FAD,FLOAT PT FRAC ADDER | 1 |
| | | | *M7544-00 FP785,FCT,FLOAT PT ACC CONTRL | 1 |
| | | | 4A-FP86-AA FP86-AA FLOATING POINT KIT | \$29,400 |
| | | | *L0212-00 FBA FBOX FLOATING PT | 1 |
| | | | *L0213-00 FBM FBOX FLOATING PT | 1 |
| | | | 4A-FPJ11-AA FLOATING POINT CHIP | \$525 |
| | | | 4A-H4005-00 802.3/ETHERNET TRANSCEIVER SP | \$225 |
| | | | H4005-00 802.3/ETHERNET TRNCUR | 1 |

*Those products which are repairable are marked with an asterisk

Continued on next page

digital To Order, Call DECdirect at 800-344-4825. 8:30 AM to 8:00 PM (ET) in the Continental USA.

HARDWARE KITS

HARDWARE SPARES KITS

Hardware Spares Kits—continued

HARDWARE
KITS

| | | | | | |
|--------------------|--------------------------------------|----------------|--------------------|-----------------------------|----------------|
| 4A-H7100-00 | H7100 SPARES KIT 120/240V | \$2,107 | 4A-H7227-AA | PDS SPARES KIT, 60HZ | \$3,821 |
| 12-12124-06 | CKT BKR 20.0A IP | 1 | 29-23799-00 | SWITCH, FAN/THERMO | 1 |
| *54-12550-00 | MOTHER BOARD | 1 | 29-23810-00 | LAMP 18V | 1 |
| *54-12554-00 | BIAS CONTROL | 1 | 29-23812-00 | SWITCH ASSY | 1 |
| *54-12556-00 | + 12V REGULATOR | 1 | 29-23814-00 | PCBA, ERROR MON MOD | 1 |
| *54-12560-00 | -5V REGULATOR | 1 | 29-23815-00 | PCBA, GRD CUR MON MOD. | 1 |
| 54-12562-00 | STATUS CARD | 1 | 29-23816-00 | PCBA, CUR/KVA SELECT MOD. | 1 |
| 54-13087-00 | H7100 SNUBBER CARD | 1 | 29-23817-00 | PCBA CUR/KVA MONITOR | 1 |
| *54-13414-00 | + & - 5V BATTERY REGULATOR | 1 | 29-23818-00 | PCBA INTERNAL ALARM MOD | 1 |
| 90-08527-00 | FUSE, SLO BLO, 125A | 10 | 29-23819-00 | PCBA INTERNAL ALARM DUR | 1 |
| | | | 29-23821-00 | PCBA LAMP DRIVER MOD | 1 |
| | | | 29-23822-00 | PCBA MAIN LOGIC MOD. | 1 |
| 4A-H7104-00 | H7104 P.S. SPARES KIT 120/240 | \$1,923 | 29-23823-00 | PCBA PWR SUP MOD | 1 |
| *54-12550-00 | MOTHER BOARD | 1 | 29-23824-00 | PCBA PWR BLOCK INTERFACE BD | 1 |
| *54-12556-00 | + 12V REGULATOR | 1 | 29-23826-00 | PCBA CLOCK MODULE | 1 |
| *54-13016-00 | 869 PILOT CONT BRD | 1 | 29-23827-00 | PCBA DVM MODULE | 1 |
| 54-13382-00 | BIAS CONTROL | 1 | 29-25067-00 | LED DISPLAY 60 HZ | 1 |
| *54-13396-00 | +2.5V CONTROL BOARD | 1 | | | |
| *54-13414-00 | + & - 5V BATTERY REGULATOR | 1 | 4A-H7227-LA | PDS SPARES KIT, 50HZ | \$3,833 |
| 54-13417-00 | POSITIVE-NEGATIVE 15VOLT REG. | 1 | 29-23799-00 | SWITCH, FAN/THERMO | 1 |
| 90-08527-00 | FUSE, SLO BLO, 125A | 10 | 29-23810-00 | LAMP 18V | 1 |
| | | | 29-23812-00 | SWITCH ASSY | 1 |
| 4A-H7140-00 | H7140 SPARES KIT | \$4,326 | 29-23814-00 | PCBA, ERROR MON MOD | 1 |
| 12-16563-00 | FAN,TUBE AXIAL 35V 75HZ | 1 | 29-23815-00 | PCBA, GRD CUR MON MOD. | 1 |
| *54-13599-00 | +5V INVERTER BOARD | 1 | 29-23816-00 | PCBA, CUR/KVA SELECT MOD. | 1 |
| *54-13601-00 | +5V CONTROL BOARD | 1 | 29-23817-00 | PCBA CUR/KVA MONITOR | 1 |
| *54-13603-00 | MEMORY INVERTER BOARD | 1 | 29-23818-00 | PCBA INTERNAL ALARM MOD | 1 |
| *54-13605-00 | BIAS & INTERFACE BOARD | 1 | 29-23819-00 | PCBA INTERNAL ALARM DUR | 1 |
| *54-13607-00 | MEMORY REGULATOR BOARD | 1 | 29-23821-00 | PCBA LAMP DRIVER MOD | 1 |
| | | | 29-23822-00 | PCBA MAIN LOGIC MOD. | 1 |
| 4A-H7202-B | H7202-B P.S. SPARES KIT | \$2,352 | 29-23823-00 | PCBA PWR SUP MOD | 1 |
| *H7200-00 | 5V POWER MODULE:60A,300V,200W | 1 | 29-23824-00 | PCBA PWR BLOCK INTERFACE BD | 1 |
| *H7211-00 | COMM OPT PS:+15V 2A-15V 3A | 1 | 29-23826-00 | PCBA CLOCK MODULE | 1 |
| *H7213-00 | MEMORY PWR MODULE:+5V 15A,+12 | 1 | 29-23827-00 | PCBA DVM MODULE | 1 |
| | | | 29-25430-00 | 50 HZ STATUS PANEL | 1 |
| 4A-H7224-00 | H7224 PDS SPARES KIT | \$3,608 | 4A-H7317-00 | H7317 SPARES KIT | \$5,030 |
| 29-23799-00 | SWITCH, FAN/THERMO | 1 | 29-26751-00 | 45KEYBOARD | 1 |
| 29-23810-00 | LAMP 18V | 1 | 29-26756-00 | 45MAIN PROCESSOR BD M4 | 1 |
| 29-23812-00 | SWITCH ASSY | 1 | 29-26757-00 | 45PROCESSOR BD M3 | 1 |
| 29-23814-00 | PCBA, ERROR MON MOD | 1 | 29-26758-00 | 45LOGIC PWR BRD P4 | 1 |
| 29-23815-00 | PCBA, GRD CUR MON MOD. | 1 | 29-26759-00 | 45LED DISPLAY ASSY | 1 |
| 29-23816-00 | PCBA, CUR/KVA SELECT MOD. | 1 | 29-26763-00 | 45LCD | 1 |
| 29-23817-00 | PCBA CUR/KVA MONITOR | 1 | 29-26764-00 | 45INTERFACE BD I3 | 1 |
| 29-23818-00 | PCBA INTERNAL ALARM MOD | 1 | 29-26779-00 | 45BATTERY FUSE 2A | 1 |
| 29-23819-00 | PCBA INTERNAL ALARM DUR | 1 | 29-26780-00 | 45FUSE 3.2A SLO BLO | 1 |
| 29-23821-00 | PCBA LAMP DRIVER MOD | 1 | 29-26781-00 | 45LAMP | 1 |
| 29-23822-00 | PCBA MAIN LOGIC MOD. | 1 | | | |
| 29-23823-00 | PCBA PWR SUP MOD | 1 | 4A-H7318-AA | H7318 SPARES KIT | \$1,382 |
| 29-23824-00 | PCBA PWR BLOCK INTERFACE BD | 1 | 29-16141-00 | GOGGLES, IMPACT CLEAR LENS | 1 |
| 29-23825-00 | PCBA DISPLAY PNL DTR BRD | 1 | 29-25420-00 | 16 GAUGE FUSE LINK WIRE | 1 |
| 29-23826-00 | PCBA CLOCK MODULE | 1 | 29-25421-00 | 4518 GAGE FUSE LINK | 1 |
| 29-23827-00 | PCBA DVM MODULE | 1 | 29-25422-00 | GAUGE FUSE LINK WIRE | 1 |
| | | | 29-25423-00 | GAUGE FUSE LINK WIRE | 1 |
| | | | 29-25428-00 | 451200 V SCR DRIVER MOD | 1 |
| | | | 29-25431-00 | 45 HEAT SINK PAD | 1 |
| | | | 29-25504-00 | 45 SCR CONTROL | 1 |
| | | | 29-26649-00 | CONTROL LOGIC MODULE | 1 |

*Those products which are repairable are marked with an asterisk

Continued on next page

digital To Order, Call DECdirect at 800-344-4825. 8:30 AM to 8:00 PM (ET) in the Continental USA.

Hardware Spares Kits—continued

| | | | | | |
|--------------------|----------------------------------|-----------------|--------------------|--------------------------------------|------------------|
| 4A-H765-00 | H765-A/-B SPARES KIT | \$1,884 | 4A-HSC70-AB | HSC70-AB SPARES KIT 50HZ | \$47,460 |
| *H744-00 | 25 AMPERE POWER REGLATOR +5V | 1 | *L0100-00 | ILI(CI LINK INTERFACE) HEX 12 | 1 |
| *H745-00 | POWER REGULATOR | 1 | *L0107-YA | HSC50 KPLI (PLI PORT CONTROL) | 1 |
| *H754-00 | + 20 VOLT REGULATOR | 1 | *L0109-00 | HSC50 PACKET BUFFER BOARD | 1 |
| 12-11714-00 | FAN, 200+CFM,BALL BRNG,115V | 1 | *L0111-00 | J-11 I/O CTRL PROCESSOR MOD | 1 |
| *54-11086-00 | +15V REGULATOR (BA11-K) | 1 | *L0117-AA | STD2 MEM FOR HSC70:521KB DATA | 1 |
| | | | 12-18828-00 | BLOWER,CENTRIFUGAL 120VAC60HZ | 1 |
| 4A-H8223-00 | T-CONNECTOR (12-25534-01) | \$15 | 4A-HSC5X-BA | HSC50 DISK DATA CHANNEL | 1 |
| H8223-00 | T CONNECTOR THINWIRE W/BOOT | 1 | 4A-RX33-A | RX33-A SPARE DRIVE (1.2MB) | 1 |
| | | | 4A-TU58-XA | SPARES DRIVE + CABLE ASSY FOR | 1 |
| | | | 4A-TU58-XB | SPARE SERIAL ELECTRONIC FOR T | 1 |
| | | | *70-20033-04 | STANDARD POWER SUPPLY ASSY | 1 |
| 4A-H9400-AA | BI BACKPLANE SPARE | \$2,000 | 4A-KA730-00 | KA730 SPARES KIT MINUS FAN | \$7,473 |
| H9400-AA | BI BACKPLANE,BASIC | 1 | *M8390-00 | DAP (DATA PATH) | 1 |
| | | | *M8391-YA | MEM CONTR W BATTERY BACKUP | 1 |
| | | | *M8394-00 | WRITEABLE CONTROL STORE,HEX | 1 |
| | | | *54-14340-00 | AIR FLOW SENSOR | 1 |
| 4A-HSC50-AA | HSC50-AA SPARES KIT 60HZ | \$30,791 | 4A-KA750-C | 11750 CPU KIT W/64K MEM CONT. | \$17,764 |
| *L0100-00 | ILI(CI LINK INTERFACE) HEX 12 | 1 | *L0002-00 | DATA PATH & MICRO SEQUENCER | 1 |
| *L0105-00 | HSC50 PIOC(F11 PROC &I/O CTL) | 1 | *L0003-00 | MEMORY INTERFACE & CACHE | 1 |
| *L0106-AA | 128KB DATA & CONT, 256KB PGM | 1 | *L0004-00 | UNIBUS INTERFACE | 1 |
| *L0107-YA | HSC50 KPLI (PLI PORT CONTROL) | 1 | *L0008-YA | 11750 PATCHABLE CONTROL STORE | 1 |
| *L0109-00 | HSC50 PACKET BUFFER BOARD | 1 | *L0016-00 | 64K MEMORY CONTRL,4-LAYER HEX | 1 |
| 12-18828-00 | BLOWER,CENTRIFUGAL 120VAC60HZ | 1 | 12-11068-00 | LAMP,T-1 5VDC, .115A | 1 |
| 17-01276-02 | PWR CORD,TERM SHR PLUG-MATNLO | 1 | 12-12749-00 | LIGHT,PNL INDICATOR,LED,RED | 1 |
| 4A-HSC5X-BA | HSC50 DISK DATA CHANNEL | 1 | 12-12749-01 | LIGHT,PNL INDICATOR,LED,GRN | 1 |
| 4A-TU58-XA | SPARES DRIVE + CABLE ASSY FOR | 1 | 12-15434-00 | BLOWER,CENTRIFUGAL 340CFM @.5 | 1 |
| 4A-TU58-XB | SPARE SERIAL ELECTRONIC FOR T | 1 | *70-14320-0E | AIR FLOW SENSOR ASSY | 1 |
| *70-20033-03 | STANDARD POWER SUPPLY ASSY | 1 | | | |
| 4A-HSC50-AB | HSC50-AB SPARES KIT 50HZ | \$30,791 | 4A-KA85-AA | KA85-AA CPU SPARES KIT | \$138,227 |
| *L0100-00 | ILI(CI LINK INTERFACE) HEX 12 | 1 | *F1001-00 | MEM CONT. LOGIC MODULE | 1 |
| *L0105-00 | HSC50 PIOC(F11 PROC &I/O CTL) | 1 | *F1002-00 | SHIFTER LOGIC MODULE | 1 |
| *L0106-AA | 128KB DATA & CONT, 256KB PGM | 1 | *F1003-00 | ALU SLICE #1 MODULE | 1 |
| *L0107-YA | HSC50 KPLI (PLI PORT CONTROL) | 1 | *F1004-00 | ALU SLICE #0 MODULE | 1 |
| *L0109-00 | HSC50 PACKET BUFFER BOARD | 1 | *F1005-00 | ADDRESS DTA PATH MODULE | 1 |
| 12-18828-00 | BLOWER,CENTRIFUGAL 120VAC60HZ | 1 | *F1006-00 | CACHE MODULE FOR CPU | 1 |
| 17-01276-03 | PWR CORD,TERM SHR PLUG-MATENL | 1 | *F1008-00 | MICRO SEQUENCER LOGIC MOD | 1 |
| 4A-HSC5X-BA | HSC50 DISK DATA CHANNEL | 1 | *F1009-00 | 16K WORD WRITE CONT STORE | 1 |
| 4A-TU58-XA | SPARES DRIVE + CABLE ASSY FOR | 1 | *F1010-00 | CLOCK GENERATION & CONSOLE | 1 |
| 4A-TU58-XB | SPARE SERIAL ELECTRONIC FOR T | 1 | *F1015-00 | DECODER F MODULE | 1 |
| *70-20033-04 | STANDARD POWER SUPPLY ASSY | 1 | | | |
| 4A-HSC5X-BA | HSC50 DISK DATA CHANNEL | \$10,500 | 4A-KA86-AA | KA86-AA CPU KIT | \$162,303 |
| HSC5X-BA | DISK DATA CHANNEL SUP 4 DISKS | 1 | *L0201-00 | CSL CONSOLE CONTROL | 1 |
| | | | *L0202-00 | SBS SBIA SBI INTERFACE | 1 |
| 4A-HSC5X-CA | HSC50 TAPE DATA CHANNEL | \$10,500 | *L0203-00 | SBA SBIA ABUS INTERFACE | 1 |
| HSC5X-CA | TAPE DATA CHANNEL SUP 4 FORM | 1 | *L0204-00 | MCD MBOX DATA PATH | 1 |
| | | | *L0205-00 | MAP MBOX ADDR PATH | 1 |
| 4A-HSC70-AA | HSC70-AA SPARES KIT 60HZ | \$47,460 | *L0206-00 | IDP IBOX DATA PATH | 1 |
| *L0100-00 | ILI(CI LINK INTERFACE) HEX 12 | 1 | *L0207-00 | ICA IBOX CNTRL A | 1 |
| *L0107-YA | HSC50 KPLI (PLI PORT CONTROL) | 1 | *L0208-00 | IBD IBOX INSTRUCTION BUFFER | 1 |
| *L0109-00 | HSC50 PACKET BUFFER BOARD | 1 | *L0209-00 | EDP EBOX DATA PATH | 1 |
| *L0111-00 | J-11 I/O CTRL PROCESSOR MOD | 1 | *L0210-00 | EBC EBOX BUFFER | 1 |
| *L0117-AA | STD2 MEM FOR HSC70:521KB DATA | 1 | *L0211-00 | EBD EBOX CONTROL | 1 |
| 12-18828-00 | BLOWER,CENTRIFUGAL 120VAC60HZ | 1 | *L0214-00 | ICB IBOX CNTRL B | 1 |
| 4A-HSC5X-BA | HSC50 DISK DATA CHANNEL | 1 | *L0215-00 | CSA CONTROL STORE ARRAY BD | 1 |
| 4A-RX33-A | RX33-A SPARE DRIVE (1.2MB) | 1 | *L0216-00 | CSB CONTROL STORAGE ARRAY | 1 |
| 4A-TU58-XA | SPARES DRIVE + CABLE ASSY FOR | 1 | *L0217-00 | CLK CLOCK | 1 |
| 4A-TU58-XB | SPARE SERIAL ELECTRONIC FOR T | 1 | *L0219-00 | EBC EBOX CONTROL | 1 |
| *70-20033-03 | STANDARD POWER SUPPLY ASSY | 1 | *L0220-00 | MCC CACHE CONTROL | 1 |

*Those products which are repairable are marked with an asterisk

Continued on next page

DECdirect To Order, Call DECdirect at 800-344-4825. 8:30 AM to 8:00 PM (ET) in the Continental USA.

HARDWARE SPARES KITS

Hardware Spares Kits—continued

HARDWARE
KITS

| | | | | | |
|--------------------|--------------------------------------|------------------|--------------------|---------------------------------------|----------------|
| 4A-KA865-AA | 8650 CPU SPARES KIT | \$205,097 | 4A-KDF11-AA | DUAL HEIGHT CPU SPARE MOD KIT | \$1,407 |
| *L0201-00 | CSL CONSOLE CONTROL | 1 | KDF11-AA | Q-BUS CPU | 1 |
| *L0202-00 | SBS SBIA SBI INTERFACE | 1 | | | |
| *L0203-00 | SBA SBIA ABUS INTERFACE | 1 | 4A-KDF11-BA | KDF11-BA SPARE MOD KIT (M8189) | \$1,838 |
| *L0204-00 | MCD MBOX DATA PATH | 1 | KDF11-BA | 11/23+ CPU,MMU,2KROM BASE OPT | 1 |
| *L0205-00 | MAP MBOX ADDR PATH | 1 | | | |
| *L0206-00 | IDP IBOX DATA PATH | 1 | 4A-KDF11-CB | KDF11-CB SPARE MODULE KIT | \$1,443 |
| *L0207-00 | ICA IBOX CNTRL A | 1 | | | |
| *L0208-00 | IBD IBOX INSTRUCTION BUFFER | 1 | 4A-KDJ11-CA | KDJ11-CA CPU SPARES KIT | \$3,051 |
| *L0209-00 | EDP EBOX DATA PATH | 1 | | | |
| *L0210-00 | EBC EBOX BUFFER | 1 | 4A-KE44-A | KE44-A CIS SPARES KIT | \$6,715 |
| *L0211-00 | EBD EBOX CONTROL | 1 | *M7091-00 | KE44-A CIS CONTROL STORE | 1 |
| *L0214-00 | ICB IBOX CNTRL B | 1 | *M7092-00 | KE44-A CIS DATA PATH/LOGIC | 1 |
| *L0215-00 | CSA CONTROL STORE ARRAY BD | 1 | | | |
| *L0216-00 | CSB CONTROL STORAGE ARRAY | 1 | 4A-KEF11-AA | KEF11-AA SPARES KIT | \$225 |
| *L0219-00 | EBE EBOX CONTROL | 1 | KEF11-AA | LSI-11/23 FP OPTION | 1 |
| *L0230-00 | MCC (M-BOX CACHE CONTROL) | 1 | | | |
| *L0231-00 | CLOCK FOR KA86 | 1 | 4A-KLESI-QA | SPARE KLESI-QA MODULE AND CAB | \$1,575 |
| | | | | | |
| 4A-KA88-AA | KA88-AA CPU SPARES KIT | \$181,391 | 4A-KW11-K | KE11-K SPARES DUAL RTC | \$1,150 |
| *F1001-00 | MEM CONT. LOGIC MODULE | 1 | KW11-K | DUAL PROG REAL TIME CLOCK | 1 |
| *F1002-00 | SHIFTER LOGIC MODULE | 1 | | | |
| *F1003-00 | ALU SLICE #1 MODULE | 1 | 4A-LA100-AA | KEYBD/SEND-REC SPARES KIT | \$1,582 |
| *F1004-00 | ALU SLICE #0 MODULE | 1 | *H7847-AA | POWER SUPPLY 120/240V | 1 |
| *F1005-00 | ADDRESS DTA PATH MODULE | 1 | 12-15332-00 | BAR,BAIL,LA34 | 1 |
| *F1006-00 | CACHE MODULE FOR CPU | 1 | 12-15348-00 | CABLE,RIBBON DRIVE ASSY. | 1 |
| *F1007-00 | DECODER MODULE | 1 | 12-15362-00 | BELT,TIMING .080 PITCH LGTH 3 | 1 |
| *F1008-00 | MICRO SEQUENCER LOGIC MOD | 1 | 12-15915-00 | BELT, TIMING .080 PITCH | 10 |
| *F1009-00 | 16K WORD WRITE CONT STORE | 1 | 12-16687-00 | SW,REED,MINI MAGNETIC ASSY | 1 |
| *F1010-00 | CLOCK GENERATION & CONSOLE | 1 | 12-17474-00 | MOTOR,STEPPER ASSY | 1 |
| | | | 17-00307-01 | CABLE ASSY,16 COND. W/CONN | 1 |
| 4A-KD11-EA | 1134A CPU SPARES KIT FOR KD11 | \$3,726 | *54-14256-00 | LA100 LOGIC BOARD | 1 |
| *M8265-00 | DATA PATH,HEX(KD11EA) | 1 | 70-15733-01 | FRICTION ASSY LA100 | 1 |
| *M8266-00 | CONTROL,HEX(KD11EA) | 1 | 70-15738-00 | BAIL BAR ASSY | 1 |
| | | | 70-17859-01 | CARRIAGE ASSEMBLY | 1 |
| 4A-KD11-F | KD11-F SPARES MODULE KIT | \$1,210 | *70-17863-01 | KEYBOARD/KEYCAP ASSY KSR | 1 |
| | | | *70-18960-00 | SERVO MOTOR/ENCODER ASSY. | 1 |
| 4A-KD11-Z | KD11-Z SPARES KIT | \$10,800 | *70-19655-01 | PRINT HEAD ASSEMBLY LAMINATED | 1 |
| *M7090-00 | 11/44 CONSOLE INTERFACE | 1 | 90-07217-00 | FUSE, REG BLOW, 3.000A, 250V | 10 |
| *M7094-00 | DATA PATH HEX (KD11-Z) | 1 | | | |
| *M7095-00 | CONT MODULE HEX (KD11-Z) | 1 | 4A-LA100-PC | LA100-PC SPARES KIT | \$1,340 |
| *M7096-00 | MULTIFUNCTION HEX (KD11-Z) | 1 | *H7847-AA | POWER SUPPLY 120/240V | 1 |
| *M7098-00 | KD11-Z, UNIBUS INTERFACE, HEX | 1 | 12-15332-00 | BAR,BAIL,LA34 | 1 |
| | | | 12-15348-00 | CABLE,RIBBON DRIVE ASSY. | 1 |
| 4A-KD32-AA | MICROVAX I SPARES WG FLT PT | \$6,295 | 12-15915-00 | BELT, TIMING .080 PITCH | 10 |
| *M7135-00 | MICROVAX I DATAPATH WF FLT PT | 1 | 12-16687-00 | SW,REED,MINI MAGNETIC ASSY | 1 |
| *M7136-00 | MEM CONTROL (MICROVAX) | 1 | 12-17474-00 | MOTOR,STEPPER ASSY | 1 |
| | | | 17-00307-01 | CABLE ASSY,16 COND. W/CONN | 1 |
| 4A-KD32-AB | MICROVAX I SPARES WD FLT PT | \$6,295 | *54-14256-06 | LOGIC BOARD | 1 |
| *M7135-YA | MICROVAX I DATA PATH WD FLT P | 1 | 70-15733-01 | FRICTION ASSY LA100 | 1 |
| *M7136-00 | MEM CONTROL (MICROVAX) | 1 | 70-15738-00 | BAIL BAR ASSY | 1 |
| | | | 70-17514-00 | BEZEL KEYBD INTERFACE (R.O.) | 1 |
| 4A-KDA50-QA | KDA50-QA SPARES KIT | \$6,597 | 70-17859-01 | CARRIAGE ASSEMBLY | 1 |
| *M7164-00 | QDA PROCESSOR, QUAD | 1 | *70-18960-00 | SERVO MOTOR/ENCODER ASSY. | 1 |
| *M7165-00 | QDA SDI, QUAD | 1 | *70-19655-01 | PRINT HEAD ASSEMBLY LAMINATED | 1 |
| | | | 90-07217-00 | FUSE, REG BLOW, 3.000A, 250V | 10 |
| 4A-KDB50-00 | KDB50 SPARES KIT | \$7,140 | 12-15362-00 | BELT,TIMING .080 PITCH LGTH 3 | 1 |
| *T1002-00 | BI- DISK- ADAPTER I (BDA) | 1 | | | |
| *T1003-00 | BI-DISK-ADAPTER TO SDI | 1 | | | |

*Those products which are repairable are marked with an asterisk

Continued on next page

digital To Order, Call DECdirect at 800-344-4825. 8:30 AM to 8:00 PM (ET) in the Continental USA.

Hardware Spares Kits—continued

| | | |
|--------------------|-------------------------------|----------------|
| 4A-LA100-RA | READ ONLY SPARES KIT | \$1,434 |
| *H7847-AA | POWER SUPPLY 120/240V | 1 |
| 12-15332-00 | BAR,BAIL,LA34 | 1 |
| 12-15348-00 | CABLE,RIBBON DRIVE ASSY. | 1 |
| 12-15362-00 | BELT,TIMING .080 PITCH LGTH 3 | 1 |
| 12-15915-00 | BELT, TIMING .080 PITCH | 10 |
| 12-16687-00 | SW,REED,MINI MAGNETIC ASSY | 1 |
| 12-17474-00 | MOTOR,STEPPER ASSY | 1 |
| 17-00307-01 | CABLE ASSY,16 COND. W/CONN | 1 |
| *54-14256-00 | LA100 LOGIC BOARD | 1 |
| 70-15733-01 | FRICTION ASSY LA100 | 1 |
| 70-15738-00 | BAIL BAR ASSY | 1 |
| 70-17514-00 | BEZEL KEYBD INTERFACE (R.O.) | 1 |
| 70-17859-01 | CARRIAGE ASSEMBLY | 1 |
| *70-18960-00 | SERVO MOTOR/ENCODER ASSY. | 1 |
| *70-19655-01 | PRINT HEAD ASSEMBLY LAMINATED | 1 |
| 90-07217-00 | FUSE, REG BLOW, 3.000A, 250V | 10 |

| | | |
|-------------------|-------------------------------|----------------|
| 4A-LA12-00 | LA12 SPARES KIT | \$1,339 |
| 12-15336-01 | LOOP BACK CONN ASSY | 1 |
| *54-14610-00 | LA12 POWER SUPPLY | 1 |
| *54-14630-02 | LA12 LOGIC BOARD | 1 |
| 70-17940-00 | PULLEY,IDLER ASSY | 1 |
| 70-17968-00 | FRICTION FEED ASSY. | 1 |
| 70-17973-00 | BAIL BAR ASSY | 1 |
| 70-18377-1E | PRINT HEAD CABLE ASSY | 1 |
| *70-18431-01 | KEYBOARD/KEYCAP ASSY | 1 |
| 70-18696-00 | PLATEN ASSY | 1 |
| 70-18703-01 | CARRIAGE ASSEMBLY | 1 |
| 70-18864-00 | SERVO MOTOR ENCODER ASSY. | 1 |
| *70-19655-01 | PRINT HEAD ASSEMBLY LAMINATED | 1 |
| 90-07217-00 | FUSE, REG BLOW, 3.000A, 250V | 10 |

| | | |
|--------------------|-----------------------------------|----------------|
| 4A-LA120-AA | LA120 SPARES KIT 120V/60HZ | \$1,855 |
| *M7081-00 | PRINTER LOGIC AND POWER BOARD | 1 |
| 11-10864-00 | LED 2MCD@10MA | 10 |
| 12-09070-00 | FUSE, SUB-MINI, 5.000A, 125V | 10 |
| 12-11583-00 | BELT TIMING .200PITCH LGT H.4 | 1 |
| 12-12255-01 | SW,PB P 10A @125VAC,MOM | 1 |
| 12-12581-00 | FAN, 35CFM,115VAC,3"DIA | 1 |
| 12-18685-02 | TRACTOR,R.H. + L.H. (PAIR) | 1 |
| *30-27655-01 | PRINthead, DOT MATRIX 7 WIRE | 1 |
| *54-13044-00 | PWR SUPPLY,MAIN BOARD, LA120 | 1 |
| 70-09694-00 | IDLER GEAR ASSEMBLY | 1 |
| 70-11446-00 | RIBBON DRIVE ASSEMBLY | 1 |
| 70-13859-00 | RIBBON CHASSIS ASSY | 1 |
| 70-15168-00 | POWER ENTRY BRKT ASSY (CVT) | 1 |
| *70-15388-00 | SERVO MOTOR ASSY | 1 |
| 70-15389-01 | STEPPING MOTOR ASSY | 1 |
| *70-17630-01 | KEYBOARD/CAP ASSY | 1 |
| 74-12424-00 | PAPER OUT SWITCH | 1 |
| 90-07213-00 | FUSE, SLO BLO 1.5A 250V | 10 |
| 90-07218-00 | FUSE, SLO BLOW, 3.000A, 250V | 10 |
| 90-07222-00 | FUSE, SLO BLOW, 5.000A, 250V | 10 |
| 90-07879-00 | FUSE, SLO BLOW, 2.500A, 250V | 10 |
| EK-LA120-PS | LA120 SERIES POCKET SERVICE G | 1 |

| | | |
|--------------------|-------------------------------------|----------------|
| 4A-LA120-RA | LA120-RA SPARES KIT 120/240V | \$2,018 |
| *H7150-00 | LA120 PS:120V/240V | 1 |
| *M7081-00 | PRINTER LOGIC AND POWER BOARD | 1 |
| 11-10864-00 | LED 2MCD@10MA | 10 |
| 12-09070-00 | FUSE, SUB-MINI, 5.000A, 125V | 10 |
| 12-11583-00 | BELT TIMING .200PITCH LGT H.4 | 1 |
| 12-12255-01 | SW,PB P 10A @125VAC,MOM | 1 |
| 12-12581-00 | FAN, 35CFM,115VAC,3"DIA | 1 |
| 12-18685-02 | TRACTOR,R.H. + L.H. (PAIR) | 1 |
| *30-27655-01 | PRINthead, DOT MATRIX 7 WIRE | 1 |
| 70-09694-00 | IDLER GEAR ASSEMBLY | 1 |
| 70-11446-00 | RIBBON DRIVE ASSEMBLY | 1 |
| 70-13859-00 | RIBBON CHASSIS ASSY | 1 |
| *70-15388-00 | SERVO MOTOR ASSY | 1 |
| 70-15389-01 | STEPPING MOTOR ASSY | 1 |
| 74-12424-00 | PAPER OUT SWITCH | 1 |
| 90-07879-00 | FUSE, SLO BLOW, 2.500A, 250V | 10 |
| 90-07999-00 | FUSE, REG BLOW, 6.000A 250V, | 10 |
| 90-09320-00 | FUSE, SLO BLOW, Y.000A 32V | 10 |
| EK-LA120-PS | LA120 SERIES POCKET SERVICE G | 1 |

| | | |
|--------------------|-----------------------------------|----------------|
| 4A-LA120-UP | LA120 KIT 120/240V,50/60HZ | \$2,275 |
| *H7150-00 | LA120 PS:120V/240V | 1 |
| *M7081-00 | PRINTER LOGIC AND POWER BOARD | 1 |
| 11-10864-00 | LED 2MCD@10MA | 10 |
| 12-09070-00 | FUSE, SUB-MINI, 5.000A, 125V | 10 |
| 12-11583-00 | BELT TIMING .200PITCH LGT H.4 | 1 |
| 12-12255-01 | SW,PB P 10A @125VAC,MOM | 1 |
| 12-12581-00 | FAN, 35CFM,115VAC,3"DIA | 1 |
| 12-18685-02 | TRACTOR,R.H. + L.H. (PAIR) | 1 |
| *30-27655-01 | PRINthead, DOT MATRIX 7 WIRE | 1 |
| 70-09694-00 | IDLER GEAR ASSEMBLY | 1 |
| 70-11446-00 | RIBBON DRIVE ASSEMBLY | 1 |
| 70-13859-00 | RIBBON CHASSIS ASSY | 1 |
| *70-15388-00 | SERVO MOTOR ASSY | 1 |
| 70-15389-01 | STEPPING MOTOR ASSY | 1 |
| *70-17630-01 | KEYBOARD/CAP ASSY | 1 |
| 74-12424-00 | PAPER OUT SWITCH | 1 |
| 90-07879-00 | FUSE, SLO BLOW, 2.500A, 250V | 10 |
| 90-07999-00 | FUSE, REG BLOW, 6.000A 250V, | 10 |
| 90-09320-00 | FUSE, SLO BLOW, Y.000A 32V | 10 |
| EK-LA120-PS | LA120 SERIES POCKET SERVICE G | 1 |

| | | |
|--------------------|-------------------------------------|-------------|
| 4A-LA12X-CB | LA120 DATA CHANNEL INTERFACE | \$79 |
| LA12X-CB | LA120 DATA CHANNEL INTERFACE | 1 |

| | | |
|--------------------|-------------------------------|----------------|
| 4A-LA210-00 | LA210 SPARES KIT | \$1,115 |
| *H7847-AA | POWER SUPPLY 120/240V | 1 |
| 12-15336-01 | LOOP BACK CONN ASSY | 1 |
| 12-15362-00 | BELT,TIMING .080 PITCH LGTH 3 | 1 |
| 12-17474-00 | MOTOR,STEPPER ASSY | 1 |
| 70-15733-01 | FRICTION ASSY LA100 | 1 |
| 70-15735-00 | PULLEY IDLER ASSY | 1 |
| *70-19655-01 | PRINT HEAD ASSEMBLY LAMINATED | 1 |
| 70-20681-01 | SERVO MOTOR/HOUSING ASSY | 1 |
| *70-20689-01 | MODULE ACCESS DOOR ASSEMBLY | 1 |
| 70-20811-01 | PLATEN ASSY | 1 |
| 70-21151-01 | CONTROL PANEL ARRAY ASSY | 1 |
| 90-07219-02 | FUSE, REG BLO 4A, 250V GLASS | 1 |

*Those products which are repairable are marked with an asterisk

Continued on next page

DECdirect To Order, Call DECdirect at 800-344-4825. 8:30 AM to 8:00 PM (ET) in the Continental USA.

HARDWARE KITS

HARDWARE SPARES KITS

Hardware Spares Kits—continued

| | | | | | |
|-------------------|-------------------------------------|--------------|-------------------|--------------------------------------|----------------|
| 4A-LA50-00 | LA50 SPARES KIT | \$584 | 4A-LAS12-X | LAS12 SPARES KIT (BASIC) | \$2,213 |
| 12-19283-00 | FUSE, 250V, LOW BK. CAP. | 10 | *M7081-YB | M7081 W/ROMS FOR LAS12 | 1 |
| 12-19284-05 | FUSE, 250V, HIGH BK. CAP. | 10 | 12-09070-00 | FUSE, SUB-MINI, 5.000A, 125V | 10 |
| 12-19284-07 | FUSE, 250V, HIGH BK. CAP. | 10 | 12-11583-00 | BELT TIMING .200PITCH LGT H.4 | 1 |
| 29-24230-00 | KIT, 1 SCREWS LA150 | 1 | 12-12255-01 | SW,PB P 10A @125VAC,MOM | 1 |
| 29-24231-00 | KIT, 2E-RING LA150 | 1 | 12-12446-00 | PULLEY,TIMING BELT 30TOOTH | 1 |
| 29-24232-00 | KIT, 3 SPRING LA50 | 1 | 12-12581-00 | FAN, 35CFM,115VAC,3"DIA | 1 |
| *29-24238-00 | CPU LA50 | 1 | 12-15239-00 | PULLEY, 20 TOOTH MOLD | 1 |
| 29-24245-00 | CA T LE PULLEY | 1 | *30-27655-01 | PRINthead, DOT MATRIX 7 WIRE | 1 |
| 29-24246-00 | CA WIRE AK | 1 | *54-13044-00 | PWR SUPPLY,MAIN BOARD, LA120 | 1 |
| 29-24247-00 | CA TRANSISTOR AK | 1 | 70-09694-00 | IDLER GEAR ASSEMBLY | 1 |
| 29-24253-00 | CARRIER MOTOR BK | 1 | 70-11446-00 | RIBBON DRIVE ASSEMBLY | 1 |
| 29-24254-00 | PF MOTOR AK | 1 | 70-13859-00 | RIBBON CHASSIS ASSY | 1 |
| 29-24258-00 | CONN. AK | 1 | *70-15388-00 | SERVO MOTOR ASSY | 1 |
| *29-24272-00 | HEAD BK | 1 | 70-15389-01 | STEPPING MOTOR ASSY | 1 |
| 29-24274-00 | FRAME, CARRIER BK | 1 | *70-17630-03 | KEYBOARD CAP ASSEMBLY | 1 |
| 29-24278-00 | KNOB, PLATEN | 1 | 74-12424-00 | PAPER OUT SWITCH | 1 |
| 29-24281-00 | FOOT, RUBBER | 1 | 90-07218-00 | FUSE, SLO BLOW, 3.000A, 250V | 10 |
| 90-07215-00 | FUSE,REG BLOW 2.00A 250V | 10 | 90-07222-00 | FUSE, SLO BLOW, 5.000A, 250V | 10 |
| | | | 90-07879-00 | FUSE, SLO BLOW, 2.500A, 250V | 10 |
| | | | 90-09320-00 | FUSE, SLO BLOW, Y.000A 32V | 10 |
| 4A-LA75-A2 | LA75-A2 SPARES KIT, 120V | \$654 | 4A-LAXX-KG | EIA INTO FOR LA36,9' CABLE | \$75 |
| 29-25916-00 | PRINthead | 1 | 4A-LAXX-LG | EIA W/MOD CONT F LA35,36' CAB | \$130 |
| 29-25917-00 | TRACTOR ASSY. | 1 | 4A-LAXX-NW | BUFFERED EIA INT FOR LA180 | \$605 |
| *29-25918-00 | MECH. ASSY. | 1 | 4A-LG01-00 | LG01 SPARES KIT | \$8,062 |
| 29-25919-00 | FRICtion RELEASE LEVER | 1 | 29-25552-00 | SHUTTLE MOTOR BOBBIN | 1 |
| 29-25921-00 | LINE FEED MOTOR | 1 | 29-25554-00 | PICO FUSE, 2 AMP | 1 |
| 29-25955-00 | PLATEN ASSY. | 1 | 29-25555-00 | PAPER DRIVE MOTOR | 1 |
| 29-25956-00 | CARRIAGE MOTOR | 1 | *29-25556-00 | HAMMER DRIVER PCB | 1 |
| 29-25957-00 | SENSOR ASSY. | 1 | 29-25560-00 | SEQUENCER PCB | 1 |
| 29-25958-00 | POWER SUPPLY 120V | 1 | 29-25561-00 | LG01 CONTROL PCB | 1 |
| *29-25968-00 | LOGIC BOARD | 1 | 29-25562-00 | RIBBON DRIVE MOTOR | 1 |
| 29-25969-00 | CONTROL PANEL | 1 | 29-25570-00 | PAPER DRIVE BELT | 1 |
| 29-25970-00 | BAIL RELEASE LEVER | 1 | *29-25573-00 | POWER AMP PCB | 1 |
| 29-25971-00 | PLATEN KNOB | 1 | 29-25574-00 | PAPER/STATUS PCB | 1 |
| | | | 29-25575-00 | SHUTTLE & RIBBON PCB | 1 |
| | | | 29-25577-00 | PWR SUPPLY PCB | 1 |
| | | | 29-25578-00 | FUSE-SLO BLO 5 AMP | 1 |
| | | | 29-25579-00 | FUSE - 2A | 1 |
| | | | 29-25580-00 | FUSE - 12A | 1 |
| | | | 29-25585-00 | RIBBON SHIELD ASSY. | 1 |
| | | | 29-25586-00 | PLATTEN ASSY. | 1 |
| | | | 29-25587-00 | HAMMER MODULE UPPER | 1 |
| | | | 29-25588-00 | HAMMER MOD. LOWER | 1 |
| | | | 29-26394-00 | UPPER L/UPPER R TRACTOR | 1 |
| | | | 29-26395-00 | LOWER L/LOWER R TRACTOR | 1 |
| 4A-LA75-A4 | LA75-A4 SPARES KIT, 220/240V | \$654 | | | |
| 29-25916-00 | PRINthead | 1 | | | |
| 29-25917-00 | TRACTOR ASSY. | 1 | | | |
| *29-25918-00 | MECH. ASSY. | 1 | | | |
| 29-25919-00 | FRICtion RELEASE LEVER | 1 | | | |
| 29-25921-00 | LINE FEED MOTOR | 1 | | | |
| 29-25955-00 | PLATEN ASSY. | 1 | | | |
| 29-25956-00 | CARRIAGE MOTOR | 1 | | | |
| 29-25957-00 | SENSOR ASSY. | 1 | | | |
| 29-25960-00 | POWER SUPPLY 220V/240V | 1 | | | |
| *29-25968-00 | LOGIC BOARD | 1 | | | |
| 29-25969-00 | CONTROL PANEL | 1 | | | |
| 29-25970-00 | BAIL RELEASE LEVER | 1 | | | |
| 29-25971-00 | PLATEN KNOB | 1 | | | |
| 4A-LA75-A5 | LA75-A5 SPARES KIT, 100V | \$654 | | | |
| 29-25916-00 | PRINthead | 1 | | | |
| 29-25917-00 | TRACTOR ASSY. | 1 | | | |
| *29-25918-00 | MECH. ASSY. | 1 | | | |
| 29-25919-00 | FRICtion RELEASE LEVER | 1 | | | |
| 29-25921-00 | LINE FEED MOTOR | 1 | | | |
| 29-25955-00 | PLATEN ASSY. | 1 | | | |
| 29-25956-00 | CARRIAGE MOTOR | 1 | | | |
| 29-25957-00 | SENSOR ASSY. | 1 | | | |
| 29-25959-00 | POWER SUPPLY 100V | 1 | | | |
| *29-25968-00 | LOGIC BOARD | 1 | | | |
| 29-25969-00 | CONTROL PANEL | 1 | | | |
| 29-25970-00 | BAIL RELEASE LEVER | 1 | | | |
| 29-25971-00 | PLATEN KNOB | 1 | | | |

*Those products which are repairable are marked with an asterisk

Continued on next page

digital To Order, Call DECdirect at 800-344-4825. 8:30 AM to 8:00 PM (ET) in the Continental USA.

Hardware Spares Kits—continued

| | | | |
|---|-----------------|--|----------------|
| 4A-LG02-00 LG02 SPARES KIT | \$10,032 | 4A-LJ252-CA LJ252 SPARES KIT, 120V | \$1,247 |
| 29-25552-00 SHUTTLE MOTOR BOBBIN | 1 | 29-26481-00 SPRING BALL | 1 |
| 29-25554-00 PICO FUSE, 2 AMP | 1 | 29-26508-00 BAIL | 1 |
| 29-25555-00 PAPER DRIVE MOTOR | 1 | 29-26511-00 PLATEN GEAR | 1 |
| *29-25556-00 HAMMER DRIVER PCB | 1 | 29-26512-00 CLUSTER GEAR | 1 |
| 29-25560-00 SEQUENCER PCB | 1 | 29-26520-00 PAPER SENSOR | 1 |
| 29-25562-00 RIBBON DRIVE MOTOR | 1 | 29-26523-00 PEN LATCH | 1 |
| 29-25570-00 PAPER DRIVE BELT | 1 | 29-26526-00 BELT | 1 |
| *29-25573-00 POWER AMP PCB | 1 | 29-26527-00 CARRIAGE ASSY | 1 |
| 29-25574-00 PAPER/STATUS PCB | 1 | 29-26528-00 ENCODER STRIP | 1 |
| 29-25575-00 SHUTTLE & RIBBON PCB | 1 | 29-26530-00 PCA CENTRONICS | 1 |
| 29-25577-00 PWR SUPPLY PCB | 1 | 29-26532-00 STEPPER MOTOR | 1 |
| 29-25578-00 FUSE-SLO BLO 5 AMP | 1 | 29-26533-00 CARRAIGE MOTOR | 1 |
| 29-25579-00 FUSE - 2A | 1 | 29-26536-00 KNOB-PLATEN | 1 |
| 29-25580-00 FUSE - 12A | 1 | 29-26537-00 CONTROL PANEL | 1 |
| 29-25585-00 RIBBON SHIELD ASSY. | 1 | | |
| 29-25586-00 PLATTEN ASSY. | 1 | 4A-LK10X-WA M KEYBOARD,NUMERIC PAD W/CBL | \$267 |
| 29-25587-00 HAMMER MODULE UPPER | 1 | 17-00119-02 WIRE HARN ASSY 16COND 26AWG | 1 |
| 29-25588-00 HAMMER MOD. LOWER | 1 | 70-16653-02 NUMERIC KEYPAD OPTION ASSY | 1 |
| 29-26154-00 LG02 CONTROL PCB (LG02) | 1 | *70-17863-01 KEYBOARD/KEYCAP ASSY KSR | 1 |
| 29-26394-00 UPPER L/UPPER R TRACTOR | 1 | | |
| 29-26395-00 LOWER L/LOWER R TRACTOR | 1 | 4A-LK201-AA LK201-AA SPARE KEYBOARD | \$210 |
| *29-26617-00 LG02 CONTROLLER | 1 | LK201-AA KBD/PWR CRD,USA/CAN-PC100,300 | 1 |
| | | 4A-LK201-AE LK201-AE SPARE KEYBOARD | \$210 |
| 4A-LG31-A2 LG31-A2 SPARES KIT | \$6,605 | LK201-AE KBD/PWR CRD,UK-PC100,300 | 1 |
| 29-26707-00 TIMING BELT | 1 | 4A-LK201-AG LK201-AG SPARE KEYBOARD | \$210 |
| 29-26714-00 BRUSHLESS FAN | 1 | LK201-AG KBD/PWR CRD,GERMANY-PC100,300 | 1 |
| 29-26715-00 SHUTTLE MOTOR ASM KIT | 1 | 4A-LK201-AK LK201-AK SPARE KEYBOARD | \$210 |
| 29-26716-00 TRACTOR (LOWER LEFT) | 1 | LK201-AK KBD/PWR CRD,SW(FR)-PC100,300 | 1 |
| 29-26717-00 TRACTOR (LOWER RIGHT) | 1 | 4A-LK201-AP LK201-AP SPARE KEYBOARD | \$210 |
| 29-26718-00 TRACTOR (UPPER LEFT) | 1 | LK201-AP KBD/PWR CRD,FRANCE-PC100,300 | 1 |
| 29-26719-00 TRACTOR (UPPER RIGHT) | 1 | 4A-LK201-BA LK201-BA SPARE KEYBOARD | \$210 |
| 29-26725-00 RIBBON DRIVE MOTOR | 1 | LK201-BA KYBD/PWR CRD,USA/CAN-PC200 | 1 |
| 29-26726-00 LINE FEED MOTOR ASM. | 1 | 4A-LK201-LA SPARE KEYBOARD, USA | \$200 |
| 29-26727-00 LVT COIL ASM | 1 | LK201-LA KYBD-US/AUSTRALIAN | 1 |
| 29-26729-00 PCB SH ACTR DRVR | 1 | 4A-LK201-NA SPARE KEYBOARD, USA/UK | \$200 |
| 29-26730-00 PCB SM IMG PROC | 1 | LK201-NA KYBD-US/UK (VT330,340) | 1 |
| 29-26731-00 PCB SM IMG HRDW | 1 | 4A-LK201-PE SPARE WPS/US/UK LK201-PE KEYB | \$200 |
| 29-26732-00 PCB SP SUPPLY REG | 1 | LK201-PE KYBD/WPS-US/UK (VT320) | 1 |
| 29-26733-00 PCB SM SYS PROC | 1 | 4A-LK201-RE LK201 SPARE KEYBOARD, ENGLISH | \$200 |
| 29-26734-00 PCB SP SUPPLY MSTR | 1 | LK201-RE KYBD-UK/US (VT220CR) | 1 |
| 29-26735-00 PCB SM MTR CTRL | 1 | 4A-LK250-AA ENGLISH KEYBOARD SPARES KIT | \$263 |
| 29-26736-00 PRINT MODULE | 1 | LK250-AA ENGLISH LANGUAGE KEYBOARD | 1 |
| 29-26737-00 RIBBON SHIELD | 1 | 4A-LN01-TK LN01 TOOL KIT | \$2,242 |
| | | | |
| 4A-LJ250-CA LJ250 SPARES KIT, 120V | \$1,247 | | |
| 29-26481-00 SPRING BALL | 1 | | |
| 29-26508-00 BAIL | 1 | | |
| 29-26511-00 PLATEN GEAR | 1 | | |
| 29-26512-00 CLUSTER GEAR | 1 | | |
| 29-26520-00 PAPER SENSOR | 1 | | |
| 29-26523-00 PEN LATCH | 1 | | |
| 29-26526-00 BELT | 1 | | |
| 29-26527-00 CARRIAGE ASSY | 1 | | |
| 29-26528-00 ENCODER STRIP | 1 | | |
| 29-26529-00 PCA-RS232 | 1 | | |
| 29-26532-00 STEPPER MOTOR | 1 | | |
| 29-26533-00 CARRAIGE MOTOR | 1 | | |
| 29-26536-00 KNOB-PLATEN | 1 | | |
| 29-26537-00 CONTROL PANEL | 1 | | |

*Those products which are repairable are marked with an asterisk

Continued on next page

digital To Order, Call DECdirect at 800-344-4825. 8:30 AM to 8:00 PM (ET) in the Continental USA.

HARDWARE SPARES KITS

Hardware Spares Kits—continued

HARDWARE
KITS

| | | | | | |
|-------------------|---------------------------------|----------------|--------------------|---------------------------------|-----------------|
| 4A-LN03-A2 | LN03-A2 SPARES KIT, 120V | \$3,495 | 4A-LPS40-A3 | LPS40 SPARES KIT | \$25,148 |
| *29-25070-00 | OPTICAL HOUSING | 1 | *M7504-00 | DEQNA Q-BUS TO ETHERNET ADAPT | 1 |
| *29-25071-00 | DEVELOPMENT UNIT | 1 | M7507-00 | 2.5MG FULL PAGE BITMAP MEM. | 1 |
| *29-25072-00 | FUSING UNIT, 100V | 1 | M7508-00 | 29116 IMAGE GEN. PROC. | 1 |
| 29-25074-00 | CLEANING UNIT | 1 | M7509-00 | G-BUS/PRINT ENGINE INTERFACE | 1 |
| 29-25076-00 | PAPER TRAY MTR. | 1 | M7510-AA | H. LINE PROC W/256KB FONT RAM | 1 |
| 29-25078-00 | UPPER TRANSP. ROLLER | 1 | *M7606-AA | MVII W/1MB,FP,CLK,B00T/DIAG | 1 |
| 29-25081-00 | TRANSP. MAG. CLUTCH | 1 | *M7608-AA | 2MB MEMORY FOR MS630-BA | 1 |
| 29-25082-00 | FEED MAG. CLUTCH | 1 | 29-25822-00 | DRUM | 1 |
| 29-25083-00 | MAIN MTR. ASSY | 1 | 29-25835-00 | LASER DRIVE PS | 1 |
| 29-25084-00 | MAIN MTR. DRIVE BD | 1 | 29-25847-00 | CLEANING UNIT | 1 |
| 29-25085-00 | DRIVE BELT LONG | 1 | 29-25848-00 | FUSING UNIT | 1 |
| 29-25086-00 | DRIVE BELT SHORT | 1 | 29-25849-00 | TRANSPORT UNIT | 1 |
| *29-25089-00 | POWER SUPPLY 100V | 1 | 29-25850-00 | DEVEL. UNIT | 1 |
| 29-25094-00 | TOTAL COUNTER | 1 | 29-25851-00 | DEVICE CONTROLLER | 1 |
| 29-25095-00 | FAN MTR. EXHAUST | 1 | 29-25864-00 | OPER. PANEL PCB | 1 |
| 29-25096-00 | FAN MTR. OZONE | 1 | 29-25866-00 | TONER DENS. CB | 1 |
| 29-25100-00 | ZONER DIODE ASSY | 1 | 29-25867-00 | DEV. MT. DR. BD. | 1 |
| *29-25334-00 | CONTROLLER | 1 | 29-25868-00 | POLY MT. DR. BD. | 1 |
| 29-25344-00 | LOWER TRANSPORT ROLLER | 1 | 29-25869-00 | MAIN MTR. DR. BD. | 1 |
| *29-25380-00 | ENG. DRIVE BOARD | 1 | 29-25870-00 | VID. CONTR. D. | 1 |
| 29-26056-00 | OPC COUNTER (LN03C.R.) | 1 | 29-25875-00 | ELECTRICAL KIT | 1 |
| | | | 29-25877-00 | DC P.S. | 1 |
| | | | 29-25879-00 | POWER PCK | 1 |
| 4A-LN03-A3 | LN03-A3 SPARES KIT, 240V | \$3,495 | 29-25891-00 | MAIN CONTROL BOARD | 1 |
| *29-25070-00 | OPTICAL HOUSING | 1 | 29-25898-00 | SEQ CONT BD | 1 |
| *29-25071-00 | DEVELOPMENT UNIT | 1 | 29-25899-00 | PS UNIT | 1 |
| 29-25073-00 | FUSING UNIT, 200V | 1 | | | |
| 29-25074-00 | CLEANING UNIT | 1 | 4A-LQP45-A | LQP45 SPARES KIT, 120V | \$2,383 |
| 29-25076-00 | PAPER TRAY MTR. | 1 | *29-26164-00 | PRINTER MECH ASSY | 1 |
| 29-25078-00 | UPPER TRANSP. ROLLER | 1 | *29-26171-00 | MAIN BOARD | 1 |
| 29-25081-00 | TRANSP. MAG. CLUTCH | 1 | 29-26188-00 | CONSOLE | 1 |
| 29-25082-00 | FEED MAG. CLUTCH | 1 | | | |
| 29-25083-00 | MAIN MTR. ASSY | 1 | 4A-LV55X-AA | VAXSTATION II KERNEL KIT | \$13,878 |
| 29-25084-00 | MAIN MTR. DRIVE BD | 1 | *M7504-00 | DEQNA Q-BUS TO ETHERNET ADAPT | 1 |
| 29-25085-00 | DRIVE BELT LONG | 1 | *M7546-00 | Q-BUS TAPE CNTRL, DBL 8.5 | 1 |
| 29-25086-00 | DRIVE BELT SHORT | 1 | *M7555-00 | RD/RX CONTROL MODULE (RQDX3) | 1 |
| 29-25090-00 | POWER SUPPLY 200V | 1 | *M7602-YA | QVSS BIT MAP GRAPHICS OPTION | 1 |
| 29-25094-00 | TOTAL COUNTER | 1 | *M7606-AA | MVII W/1MB,FP,CLK,B00T/DIAG | 1 |
| 29-25095-00 | FAN MTR. EXHAUST | 1 | *TK50-AX | TK50-AA PACKAGED | 1 |
| 29-25096-00 | FAN MTR. OZONE | 1 | 4A-RD53-A | RD53-A SPARE DRIVE | 1 |
| 29-25100-00 | ZONER DIODE ASSY | 1 | | | |
| *29-25334-00 | CONTROLLER | 1 | 4A-LV55X-AB | VAXSTATION II GPX | \$16,639 |
| 29-25344-00 | LOWER TRANSPORT ROLLER | 1 | | KERNEL KIT | |
| *29-25380-00 | ENG. DRIVE BOARD | 1 | *M7168-00 | 4 PLANE COLOR BITMAP | 1 |
| 29-26056-00 | OPC COUNTER (LN03C.R.) | 1 | *M7169-00 | Q22 BUS VIDEO CONTRL MODULE | 1 |
| | | | *M7504-00 | DEQNA Q-BUS TO ETHERNET ADAPT | 1 |
| | | | *M7546-00 | Q-BUS TAPE CNTRL, DBL 8.5 | 1 |
| | | | *M7555-00 | RD/RX CONTROL MODULE (RQDX3) | 1 |
| | | | *M7606-AA | MVII W/1MB,FP,CLK,B00T/DIAG | 1 |
| | | | *TK50-AX | TK50-AA PACKAGED | 1 |
| | | | 4A-RD53-A | RD53-A SPARE DRIVE | 1 |
| | | | 4A-M5011-00 | M5011 SPARE MODULE KIT | \$431 |
| | | | M5011-00 | 16 NON-ISOL DC INTERRUPT | 1 |

*Those products which are repairable are marked with an asterisk

Continued on next page

digital To Order, Call DECdirect at 800-344-4825. 8:30 AM to 8:00 PM (ET) in the Continental USA.

Hardware Spares Kits—continued

| | | | | | |
|--------------------|--------------------------------------|-----------------|--------------------|-------------------------------------|------------------|
| 4A-MA780-AS | MA780 SPARES KIT | \$6,545 | 4A-MV200-20 | QUANTITY 20 OF 4A-MV200-01 | \$407,020 |
| *M8258-00 | MULTIPOINT PORT INTER | 1 | *M7546-00 | Q-BUS TAPE CNTRL, DBL 8.5 | 20 |
| *M8259-00 | MULTIPOINT PORT CONT | 1 | *M7606-AA | MVII W/1MB,FP,CLK,B00T/DIAG | 20 |
| *M8260-00 | MULTIPOINT ARRAY | 1 | *M7609-AA | 8MB MEMORY FOR MS630-CA | 20 |
| *M8261-00 | MULTIPOINT SYNCHRONIZER | 1 | *TK50-AX | TK50-AA PACKAGED | 20 |
| M9045-00 | BDI PADDLE CARD FOR MA780 | 1 | | | |
| 4A-MM11-DP | MM11-DP SPARE MEMORY KIT | \$5,750 | 4A-PC100-00 | PC100 SPARES KIT 120/240V | \$2,210 |
| MM11-DP | 16K CORE MEMORY 11/04-34 | 1 | *H7842-D | SMALL SYS UNIT POW SUP | 1 |
| | | | 12-13185-03 | FAN,70CFM,115V,TUBE AXIAL,LOW | 1 |
| | | | 12-22355-09 | SW, RKR DPST ON-OFF 16A/250V | 1 |
| 4A-MM8-AB | MM8-AB SPARE MEMORY KIT | \$3,680 | 4A-RX50-AA | RX50-AA SPARE DRIVE | 1 |
| MM8-AB | 16K CORE MEMORY | 1 | *54-15482-00 | PC100 RX50 CONTROLLER | 1 |
| | | | *70-19974-00 | CPU ASSY, RAINBOW 100 | 1 |
| 4A-MS11-LB | MS11-LB SPARE MEM (M7891-BA) | \$1,190 | 4A-PC100-B2 | PC100-B SPARES KIT, 120V | \$2,156 |
| *MS11-LB | 128KB MOS MEMRY FOR 11/24-34A | 1 | *H7842-D | SMALL SYS UNIT POW SUP | 1 |
| | | | 12-22355-09 | SW, RKR DPST ON-OFF 16A/250V | 1 |
| 4A-MS780-C | MS780-C MEMORY SPARES KIT | \$8,866 | 4A-RX50-AA | RX50-AA SPARE DRIVE | 1 |
| *M8210-00 | 32KW (72 BIT WORD) MOS MEM | 1 | *54-15482-00 | PC100 RX50 CONTROLLER | 1 |
| *M8212-00 | MDT MEMORY DATA PATH | 1 | *70-19974-02 | CPU ASSY, RAIN 100B LANG CL1 | 1 |
| *M8213-00 | MCN MEMORY CONTROLLER | 1 | 70-20816-01 | FAN ASSEMBLY | 1 |
| *M8214-00 | MEMORY SBI BOARD | 1 | | | |
| 4A-MS780-E | 1MB MEMORY SPARES KIT | \$4,982 | 4A-PC238-AA | DMIII SYSTEM BOX SPARES 120V | \$1,589 |
| *M8373-AA | 256K X 39BIT MOS 1MB ARRAY | 1 | *H7845-BA | 120V SMALL SYS PWR SUP:85WATT | 1 |
| *M8375-00 | MEMORY CONTROL,4-LAYER HEX 12 | 1 | 4A-RX50-AA | RX50-AA SPARE DRIVE | 1 |
| *M8376-00 | SBI INTERFACE,4-LAYER HEX 12 | 1 | *54-16489-01 | DECMATE III SYSTEM BD. | 1 |
| | | | 54-16506-01 | DECMATE III ADPTER BD | 1 |
| 4A-MS780-H | 4MB MEMORY SPARES KIT | \$7,922 | 4A-PC238-AB | DMIII SYSTEM BOX SPARES 240V | \$1,589 |
| *M8374-AA | 4MB INTERLEAVED MEM EXP | 1 | H7845-BB | 240V SMALL SYS PWR SUP:85WATT | 1 |
| *M8375-00 | MEMORY CONTROL,4-LAYER HEX 12 | 1 | 4A-RX50-AA | RX50-AA SPARE DRIVE | 1 |
| *M8376-00 | SBI INTERFACE,4-LAYER HEX 12 | 1 | *54-16489-01 | DECMATE III SYSTEM BD. | 1 |
| | | | 54-16506-01 | DECMATE III ADPTER BD | 1 |
| 4A-MS86-CA | MS86-CA SPARES MEMORY KIT | \$3,875 | 4A-PC278-00 | PC278 SPARES KIT 120/240V | \$2,388 |
| *L0225-00 | MEM MOTHER BD W/NO DAUGHTER | 1 | *H7842-D | SMALL SYS UNIT POW SUP | 1 |
| *54-16500-BA | 2MB DAUGHTER BOARD | 1 | 12-13185-03 | FAN,70CFM,115V,TUBE AXIAL,LOW | 1 |
| | | | 12-22355-09 | SW, RKR DPST ON-OFF 16A/250V | 1 |
| 4A-MS86-DA | 64MB MEMORY SPARES KIT | \$16,203 | 4A-RX50-AA | RX50-AA SPARE DRIVE | 1 |
| L0235-00 | 64MB MEM MOTHER BD/NO DTR BD | 1 | *70-19973-00 | CPU ASSY, DECMATE | 1 |
| 54-17052-AA | 16MB DAUGHTER BOARD | 1 | | | |
| 4A-MS88-CA | 16MB MEMORY SPARES KIT | \$4,150 | 4A-PC350-00 | PC350 SPARES KIT 120/240V | \$4,591 |
| *L0115-00 | 16MB MOTHER BOARD | 1 | *H7862-C | H7862 EXCEPT +5V 2-20A, +12V | 1 |
| *54-16500-BA | 2MB DAUGHTER BOARD | 1 | *KDF11-CC | KDF11-CA W/ROMS FOR IVIS | 1 |
| | | | 12-09159-00 | FUSE, SUB-MINI, .500A, 125V | 10 |
| 4A-MS88-DA | 64MB MEMORY SPARES KIT | \$15,603 | 12-10929-04 | FUSE, SUB-MINI .250A, 125V | 10 |
| L0122-00 | MOTHER BOARD W/LOGIC | 1 | 12-10929-05 | FUSE, SUB-MINI 2.500A, 125V | 10 |
| 54-17052-AA | 16MB DAUGHTER BOARD | 1 | 12-13185-03 | FAN,70CFM,115V,TUBE AXIAL,LOW | 1 |
| | | | 12-14415-01 | FUSE,REG BLOW,.250A 250V | 10 |
| 4A-MSV11-DD | MSV11-DD SPARE MEM (M8044-DA) | \$1,000 | 12-22355-09 | SW, RKR DPST ON-OFF 16A/250V | 1 |
| *MSV11-DD | 32K BY 16 RAM | 1 | 4A-RX50-AA | RX50-AA SPARE DRIVE | 1 |
| | | | *54-15058-00 | RX50 CONTROLLER | 1 |
| | | | *54-15084-FA | C.T. RAM 128 KB | 1 |
| | | | *54-15138-00 | PC350 VIDEO GENERATOR | 1 |
| 4A-MV200-01 | MICROVAX II SPARES KIT | \$20,351 | | | |
| *M7546-00 | Q-BUS TAPE CNTRL, DBL 8.5 | 1 | | | |
| *M7606-AA | MVII W/1MB,FP,CLK,B00T/DIAG | 1 | | | |
| *M7609-AA | 8MB MEMORY FOR MS630-CA | 1 | | | |
| *TK50-AX | TK50-AA PACKAGED | 1 | | | |

*Those products which are repairable are marked with an asterisk

Continued on next page

digital To Order, Call DECdirect at 800-344-4825. 8:30 AM to 8:00 PM (ET) in the Continental USA.

HARDWARE SPARES KITS

Hardware Spares Kits—continued

| | | | |
|--|----------------|--|----------------|
| 4A-PC380-AA PC380-AA SPARES KIT, 120/240V | \$5,377 | 4A-PM123-00 TE10N/10W/TE16 P.M. KIT | \$360 |
| *H7862-C H7862 EXCEPT +5V 2-20A, +12V | 1 | 12-09877-00 WASHER , TAPE GUIDE | 1 |
| 12-13185-03 FAN,70CFM,115V,TUBE AXIAL,LOW | 1 | 12-09956-00 MUFFLER 3IN LGX1-13/16 M02/01 | 2 |
| 12-22355-09 SW, RKR DPST ON-OFF 16A/250V | 1 | 12-13119-00 HUB,QUICK RELEASE FOR TU10/16 | 1 |
| 4A-KDJ11-CA KDJ11-CA CPU SPARES KIT | 1 | 29-11760-00 HUB REPAIR KIT | 2 |
| 4A-RX50-AA RX50-AA SPARE DRIVE | 1 | | |
| *54-16239-01 PC380 EXT BIT MAP OPT/256KB | 1 | 4A-PM130-00 TU77 P.M. KIT | \$321 |
| | | 29-23220-00 MUFFLER | 2 |
| 4A-PC500-AA PC500 SPARES KIT, 110V | \$3,387 | 29-23259-00 FILTER, AIR | 2 |
| *H7270-A 110V PC500 PS MOD. | 1 | | |
| 17-01190-01 WIRE HARN. ASSY. | 1 | 4A-R80-AA R80-AA SPARES KIT, 120V | \$1,470 |
| 4A-RX33-A RX33-A SPARE DRIVE (1.2MB) | 1 | 12-12635-03 BELT,WOVEN,ENDLESS,1/2" WX35 | 1 |
| 54-16828-01 CRT SWEEP CIRCUIT | 1 | 12-14011-00 SW,MICRO 1P 5A | 1 |
| *54-17158-01 CPU BOARD FOR VAXMATE | 1 | 12-16817-00 SN,OPTICAL ASSY | 1 |
| *70-23297-01 I/O BOARD ASSY. | 1 | *54-13596-00 READ/WRITE | 1 |
| | | *70-16723-02 LOW VOLTAGE 60HZ | 1 |
| 4A-PC500-AB PC500 SPARES KIT, 220V | \$3,387 | *70-16976-00 SERVO BD/STIFFENER ASSY | 1 |
| *H7270-B 220V PC500 PS MOD. | 1 | 74-22440-00 SPRING BELT RELEASE | 10 |
| 17-01190-01 WIRE HARN. ASSY. | 1 | | |
| 4A-RX33-A RX33-A SPARE DRIVE (1.2MB) | 1 | 4A-RA60-AA RA60-AA SPARES KIT, 120/240V | \$8,839 |
| 54-16828-01 CRT SWEEP CIRCUIT | 1 | 12-12714-00 SW,PB CAP,YEL/BLK,"RUN STOP" | 10 ~ |
| *54-17158-01 CPU BOARD FOR VAXMATE | 1 | 12-12714-01 SW,PB CAP,YEL/BLK"WRITE PROT" | 10 ~ |
| *70-23297-01 I/O BOARD ASSY. | 1 | 12-12714-02 SW,PB CAP,RED/BLK,"FAULT" | 10 ~ |
| | | 12-12714-03 SW,PB CAP,WHT/BLK,"A" | 10 ~ |
| 4A-PC50X-AA PC50X-AA SPARES KIT | \$1,295 | 12-12714-04 SW,PB,CAP,WHT/BLK,"B" | 10 ~ |
| PC50X-AA VAXMATE 2-MBYTE MEMORY | 1 | 12-12716-00 LAMP,WEDGE,6.3V,.2A,.4MSCP,T1 | 10 ~ |
| | | 12-17556-01 FAN,TUBE AXIAL 4.5" 105CFM | 1 |
| 4A-PM113-00 RK07 P.M. KIT | \$161 | 12-18199-00 SW, ENCODER BUTTON | 10 ~ |
| 12-12640-00 CONTACT,GROUNDING,RK06 | 1 | 12-18204-02 GROUNDING ASSY | 1 |
| 12-12904-00 FILTER,AIR,HEPA, 32CF-RK06 | 1 | *54-15264-01 POST AMP/DATA SEPERATOR MODUL | 1 |
| 12-12944-00 FILTER,FOAM 30PPI, 7.38X 3.75 | 10 | *54-15266-01 DRIVE LOGIC MODULE | 1 |
| | | 54-15268-01 PREAMP MODULE | 1 |
| 4A-PM114-00 RL01 P.M. KIT | \$100 | *54-15270-01 I/O MODULE | 1 |
| 12-13097-00 FILTER, AIR, HEPA, 33CFM | 1 | *54-15272-01 FRONT PANEL | 1 |
| 74-15294-00 BRUSH GROUND | 10 | 54-15278-01 BACKPLANE MODULE | 1 |
| | | 70-18461-01 PINION DATA HEAD (A-UP) | 1 |
| 4A-PM115-00 RL02 P.M. KIT | \$77 | 70-18461-02 PINION DATA HEAD (A-DOWN) | 1 |
| 12-13097-00 FILTER, AIR, HEPA, 33CFM | 1 | 70-18461-03 PINION DATA HEAD (B-UP) | 2 ~ |
| 74-15297-00 FILTER, PAD | 1 | 70-18461-04 PINION DATA HEAD (B-DOWN) | 2 ~ |
| 74-15302-00 STRAP BRUSH HOLDER | 10 | *70-18474-01 POWER MODULE ASSEMBLY | 1 |
| | | *70-18476-01 CAPACITOR/RECTIFIER ASSEMBLY | 1 |
| 4A-PM116-00 RM02/03 P.M. KIT | \$344 | 4A-RA70-A RA70-A SPARES KIT | \$8,117 |
| 29-22925-00 FILTER AIR 15.77 X 11 | 2 | *70-21946-01 HDA ASSEMBLY (RA70) | 1 |
| 29-23368-00 FILTER, PRE, FO | 10 | 70-22474-01 SHOE PLATE ASSY (RA70) | 1 |
| | | *70-22494-01 ELEC MODULE CLUSTER (RA70) | 1 |

*Those products which are repairable are marked with an asterisk

Continued on next page

digital To Order, Call DECdirect at 800-344-4825. 8:30 AM to 8:00 PM (ET) in the Continental USA.

Hardware Spares Kits—continued

| 4A-RA80-A | RA80-AA SPARES KIT, 120V 60HZ | \$9,458 | 4A-RA80-D | RA80-AD SPARES KIT, 240V 50HZ | \$9,458 |
|------------------|--------------------------------------|----------------|------------------|--------------------------------------|----------------|
| *H7660-C | POWER SUPPLY (60HZ) | 1 | *H7660-D | POWER SUPPLY (50HZ) | 1 |
| 10-16924-00 | CAP. 297 MFD MOTOR START 115V | 1 | 10-11248-00 | 48 MFD330VAC 10% MOTOR STA | 1 |
| 11-10324-00 | LED 1MCD@10MA #MV5054-1#HP488 | 10 | 11-10324-00 | LED 1MCD@10MA #MV5054-1#HP488 | 10 |
| 11-12689-00 | LED .8MCD@16MA VF=5V | 1 | 11-12689-00 | LED .8MCD@16MA VF=5V | 1 |
| 12-10719-03 | FAN,TUBE AXIAL,115V 25-35 CFM | 1 | 12-10719-03 | FAN,TUBE AXIAL,115V 25-35 CFM | 1 |
| 12-12635-03 | BELT,WOVEN,ENDLESS,1/2" WX35 | 1 | 12-12635-05 | BELT,WOVEN,ENDLESS,.375WX36.8 | 1 |
| 12-12691-00 | SW. PB CAP "O/READY" | 1 | 12-12691-00 | SW. PB CAP "O/READY" | 1 |
| 12-12714-00 | SW,PB CAP,YEL/BLK,"RUN STOP" | 10 | 12-12714-00 | SW,PB CAP,YEL/BLK,"RUN STOP" | 10 |
| 12-12714-01 | SW,PB CAP,YEL/BLK"WRITE PROT" | 10 | 12-12714-01 | SW,PB CAP,YEL/BLK"WRITE PROT" | 10 |
| 12-12714-02 | SW,PB CAP,RED/BLK,"FAULT" | 10 | 12-12714-02 | SW,PB CAP,RED/BLK,"FAULT" | 10 |
| 12-12714-03 | SW,PB CAP,WHT/BLK,"A" | 10 | 12-12714-03 | SW,PB CAP,WHT/BLK,"A" | 10 |
| 12-12714-04 | SW,PB,CAP,WHT/BLK,"B" | 10 | 12-12714-04 | SW,PB,CAP,WHT/BLK,"B" | 10 |
| 12-12716-00 | LAMP,WEDGE,6.3V,.2A,.4MSP,T1 | 10 | 12-12716-00 | LAMP,WEDGE,6.3V,.2A,.4MSP,T1 | 10 |
| 12-12716-02 | LAMP WEDGE,28/24V,04A,30MSP | 10 | 12-12716-02 | LAMP WEDGE,28/24V,04A,30MSP | 10 |
| 12-12717-01 | SW,PB 1P 3A | 1 | 12-12717-01 | SW,PB 1P 3A | 1 |
| 12-12717-06 | SW,PB LT 1P MOM | 1 | 12-12717-06 | SW,PB LT 1P MOM | 1 |
| 12-14011-00 | SW,MICRO 1P 5A | 1 | 12-14011-00 | SW,MICRO 1P 5A | 1 |
| 12-16458-00 | SW,STRIP 1P 3A 16POS BINARYCO | 1 | 12-16458-00 | SW,STRIP 1P 3A 16POS BINARYCO | 1 |
| 12-16577-00 | BRAKE, 110 VOLT | 1 | 12-16577-00 | BRAKE, 110 VOLT | 1 |
| 12-16578-00 | MOTOR,115VAC CAP START | 1 | 12-16578-02 | MOTOR, 220VAC CAP, START | 1 |
| 12-16817-00 | SN,OPTICAL ASSY | 1 | 12-16817-00 | SN,OPTICAL ASSY | 1 |
| 12-16870-01 | THERMOSTAT,0 @ 128,C @ 105 | 1 | 12-16870-01 | THERMOSTAT,0 @ 128,C @ 105 | 1 |
| 12-17715-02 | FAN,TUBE AXIAL 4.5" 120CFM | 1 | 12-17715-02 | FAN,TUBE AXIAL 4.5" 120CFM | 1 |
| 12-18199-00 | SW, ENCODER BUTTON | 10 | 12-18199-00 | SW, ENCODER BUTTON | 10 |
| *54-13596-00 | READ/WRITE | 1 | *54-13596-00 | READ/WRITE | 1 |
| *54-15284-01 | RA80 MICRO PROCESSOR W/ROMS | 1 | *54-15284-01 | RA80 MICRO PROCESSOR W/ROMS | 1 |
| 70-16230-00 | WING PIVOT ASSY | 1 | 70-16230-00 | WING PIVOT ASSY | 1 |
| 70-16723-02 | LOW VOLTAGE 60HZ | 1 | 70-16723-03 | HIGH VOLTAGE 50HZ | 1 |
| 70-16724-00 | ACTUATOR ASSY. | 1 | 70-16724-00 | ACTUATOR ASSY. | 1 |
| *70-16976-00 | SERVO BD/STIFFENER ASSY | 1 | *70-16976-00 | SERVO BD/STIFFENER ASSY | 1 |
| 70-16980-00 | BELT TENSION SWITCH HARNESS | 1 | 70-16980-00 | BELT TENSION SWITCH HARNESS | 1 |
| 70-18324-00 | OPERATOR CONTROL PANEL ASSY. | 1 | 70-18324-00 | OPERATOR CONTROL PANEL ASSY. | 1 |
| *70-18327-00 | PERSONALITY BD/STIFFENER ASSY | 1 | *70-18327-00 | PERSONALITY BD/STIFFENER ASSY | 1 |
| 74-21455-02 | PULLEY, MOTOR(3.483 DIA,60HZ) | 1 | 74-21455-03 | PULLEY,MOTOR(4.179DIA,50HZ) | 1 |
| 74-22440-00 | SPRING BELT RELEASE | 10 | 74-22440-00 | SPRING BELT RELEASE | 10 |
| 74-22826-00 | SLIDE,TENSION ADJUST | 1 | 74-22826-00 | SLIDE,TENSION ADJUST | 1 |
| 90-07217-00 | FUSE, REG BLOW, 3.000A, 250V | 10 | 90-07217-00 | FUSE, REG BLOW, 3.000A, 250V | 10 |
| 90-07222-00 | FUSE, SLO BLOW, 5.000A, 250V | 10 | 90-07222-00 | FUSE, SLO BLOW, 5.000A, 250V | 10 |
| 90-08290-00 | FUSE, SLO BLOW, 12.000A, 32V | 10 | 90-08290-00 | FUSE, SLO BLOW, 12.000A, 32V | 10 |

HARDWARE KITS

*Those products which are repairable are marked with an asterisk

Continued on next page

digital To Order, Call DECdirect at 800-344-4825. 8:30 AM to 8:00 PM (ET) in the Continental USA.

HARDWARE SPARES KITS

Hardware Spares Kits—continued

HARDWARE
KITS

| | | | | | |
|-------------------|---------------------------------|-----------------|-------------------|---------------------------------|----------------|
| 4A-RA81-AA | RA81-AA SPARES KIT, 120V | \$11,174 | 4A-RA82-AA | RA82-AA SPARES KIT, 120V | \$8,011 |
| *H7660-C | POWER SUPPLY (60HZ) | 1 | *H7660-C | POWER SUPPLY (60HZ) | 1 |
| 10-16924-00 | CAP, 297 MFD MOTOR START 115V | 1 | 12-12635-06 | BELT,WOVEN,ENDLESS, (60HZ) | 1 |
| 12-10719-03 | FAN,TUBE AXIAL,115V 25-35 CFM | 1 | 12-12716-00 | LAMP,WEDGE,6.3V,.2A,.4MSCP,T1 | 1 |
| 12-12635-06 | BELT,WOVEN,ENDLESS, (60HZ) | 1 | 12-16817-00 | SN,OPTICAL ASSY | 1 |
| 12-12714-00 | SW,PB CAP,YEL/BLK,"RUN STOP" | 10 | 12-16870-01 | THERMOSTAT,0 @ 128,C @ 105 | 1 |
| 12-12714-01 | SW,PB CAP,YEL/BLK,"WRITE PROT" | 10 | 12-17715-04 | FAN,TUBE AXIAL 4.5" 120CFM | 1 |
| 12-12714-02 | SW,PB CAP,RED/BLK,"FAULT" | 10 | 12-18199-00 | SW, ENCODER BUTTON | 10 |
| 12-12714-03 | SW,PB CAP,WHT/BLK,"A" | 10 | 12-22845-01 | SW,SUBMINI,SPDT,LEV ACTUATOR | 1 |
| 12-12714-04 | SW,PB,CAP,WHT/BLK,"B" | 10 | *54-16188-01 | R82 SERVO CONTROL | 1 |
| 12-12716-00 | LAMP,WEDGE,6.3V,.2A,.4MSCP,T1 | 10 | *54-16190-01 | R82 HYBRID MODULE | 1 |
| 12-16817-00 | SN,OPTICAL ASSY | 1 | *54-16192-01 | R82 READ/WRITE MODULE | 1 |
| 12-16870-01 | THERMOSTAT,0 @ 128,C @ 105 | 1 | 70-18324-00 | OPERATOR CONTROL PANEL ASSY. | 1 |
| 12-17715-02 | FAN,TUBE AXIAL 4.5" 120CFM | 1 | 70-21168-01 | FAN HOLDER ASSEMBLY | 1 |
| 12-18199-00 | SW, ENCODER BUTTON | 10 | 70-21173-01 | MOTOR/BRAKE ASSEMBLY (60HZ) | 1 |
| 12-22845-01 | SW,SUBMINI,SPDT,LEV ACTUATOR | 1 | 70-23215-01 | GROUND BRUSH ASSEMBLY | 1 |
| 54-14927-01 | OPERATOR CONTROL PANEL | 1 | 74-29721-01 | FILTER, FOAM | 10 |
| *54-15247-00 | R81 MICRO PROCESSOR MODULE | 1 | 90-10477-01 | STANDOFF, 1/4 TURN NYLATCH | 10 |
| *54-15253-00 | R81 READ/WRITE MODULE | 1 | | | |
| *70-19045-01 | SERVO BD AND STIFF ASSEMBLY | 1 | 4A-RA82-AD | RA82-AD SPARES KIT, 240V | \$8,011 |
| *70-19046-01 | PERSONALITY BD AND STIFF ASSY | 1 | *H7660-D | POWER SUPPLY (50HZ) | 1 |
| 70-21173-01 | MOTOR/BRAKE ASSEMBLY (60HZ) | 1 | 12-12635-07 | BELT,WOVEN,ENDLESS, (50HZ) | 1 |
| 70-21452-01 | BELT TENSION SWITCH HARNESS | 1 | 12-12716-00 | LAMP,WEDGE,6.3V,.2A,.4MSCP,T1 | 1 |
| 70-21592-01 | CABLE SPRING ASSEMBLY | 1 | 12-16817-00 | SN,OPTICAL ASSY | 1 |
| 90-10477-01 | STANDOFF, 1/4 TURN NYLATCH | 10 | 12-16870-01 | THERMOSTAT,0 @ 128,C @ 105 | 1 |
| | | | 12-17715-04 | FAN,TUBE AXIAL 4.5" 120CFM | 1 |
| | | | 12-18199-00 | SW, ENCODER BUTTON | 10 |
| 4A-RA81-AD | RA81-AD SPARES KIT, 240V | \$11,174 | 12-22845-01 | SW,SUBMINI,SPDT,LEV ACTUATOR | 1 |
| *H7660-D | POWER SUPPLY (50HZ) | 1 | *54-16188-01 | R82 SERVO CONTROL | 1 |
| 10-11248-00 | 48 MFD330VAC 10% MOTOR STA | 1 | *54-16190-01 | R82 HYBRID MODULE | 1 |
| 12-10719-03 | FAN,TUBE AXIAL,115V 25-35 CFM | 1 | *54-16192-01 | R82 READ/WRITE MODULE | 1 |
| 12-12635-07 | BELT,WOVEN,ENDLESS, (50HZ) | 1 | 70-18324-00 | OPERATOR CONTROL PANEL ASSY. | 1 |
| 12-12714-00 | SW,PB CAP,YEL/BLK,"RUN STOP" | 10 - | 70-21168-01 | FAN HOLDER ASSEMBLY | 1 |
| 12-12714-01 | SW,PB CAP,YEL/BLK,"WRITE PROT" | 10 - | 70-21173-02 | MOTOR/BRAKE ASSEMBLY (50HZ) | 1 |
| 12-12714-02 | SW,PB CAP,RED/BLK,"FAULT" | 10 - | 70-23215-01 | GROUND BRUSH ASSEMBLY | 1 |
| 12-12714-03 | SW,PB CAP,WHT/BLK,"A" | 10 - | 74-29721-01 | FILTER, FOAM | 10 |
| 12-12714-04 | SW,PB,CAP,WHT/BLK,"B" | 10 - | 90-10477-01 | STANDOFF, 1/4 TURN NYLATCH | 10 |
| 12-12716-00 | LAMP,WEDGE,6.3V,.2A,.4MSCP,T1 | 10 - | | | |
| 12-16817-00 | SN,OPTICAL ASSY | 1 | 4A-RD31-A | RD31-A SPARES KIT | \$1,095 |
| 12-16870-01 | THERMOSTAT,0 @ 128,C @ 105 | 1 | RD31-A | 20 MB DISK DRIVE, SKIDPLATE | 1 |
| 12-17715-02 | FAN,TUBE AXIAL 4.5" 120CFM | 1 | | | |
| 12-18199-00 | SW, ENCODER BUTTON | 10 - | 4A-RD32-A | RD32-A SPARES DRIVE | \$1,621 |
| 12-22845-01 | SW,SUBMINI,SPDT,LEV ACTUATOR | 1 | RD32-A | 42 MB WINCHESTER DISK | 1 |
| 54-14927-01 | OPERATOR CONTROL PANEL | 1 | | | |
| *54-15247-00 | R81 MICRO PROCESSOR MODULE | 1 | 4A-RD51-00 | RD51 SPARES KIT | \$339 |
| *54-15253-00 | R81 READ/WRITE MODULE | 1 | 29-24113-00 | SPRING GROUND | 1 |
| *70-19045-01 | SERVO BD AND STIFF ASSEMBLY | 1 | 29-24115-00 | DIP SHUNT | 1 |
| *70-19046-01 | PERSONALITY BD AND STIFF ASSY | 1 | 29-24116-00 | INDEX SENSOR | 1 |
| 70-21173-02 | MOTOR/BRAKE ASSEMBLY (50HZ) | 1 | 29-24620-00 | PCBA W/BRAKE | 1 |
| 70-21452-01 | BELT TENSION SWITCH HARNESS | 1 | 29-24664-00 | TRACK ZERO SENSOR | 1 |
| 70-21592-01 | CABLE SPRING ASSEMBLY | 1 | 29-24666-00 | COVER, FRONT RD51 | 1 |
| 90-10477-01 | STANDOFF, 1/4 TURN NYLATCH | 10 - | *29-24926-00 | R/W BOARD | 1 |
| | | | | | |
| | | | 4A-RD51-A | RD51-A SPARE DRIVE,10MB | \$1,360 |
| | | | RD51-A | WINCHESTER (10MB) | 1 |
| | | | 4A-RD52-A | RD52-A SPARE DRIVE,31MB | \$3,465 |
| | | | RD52-A | 31/33 MB 5.25"WINCHESTER DISK | 1 |

*Those products which are repairable are marked with an asterisk

Continued on next page

digital To Order, Call DECdirect at 800-344-4825. 8:30 AM to 8:00 PM (ET) in the Continental USA.

Hardware Spares Kits—continued

| | | | | | |
|--------------------|-------------------------------|----------------|-------------------|---------------------------------|-----------------|
| 4A-RD53-00 | RD53 SPARES KIT | \$2,298 | 4A-RM05-AC | RM05-AC SPARES KIT, 60HZ | \$20,400 |
| 29-25337-00 | PRGAMP PCB | 1 | *M5922-00 | MASS BUS TRANSCIEVER, PORT A | 1 |
| 29-25338-00 | MOTOR PCB | 1 | *M7684-00 | CONTROL SEQUENCER | 1 |
| *29-25339-00 | DEVICE PCB | 1 | *M7686-YA | RM02,3,5 CONTROL INTRFACE HEX | 1 |
| 29-25340-00 | SOLOINOID | 1 | *M8685-00 | DATA SEQUENCER, 4-LAYER HEX | 1 |
| 29-25341-00 | BRAKE ARM | 1 | M8687-00 | RM05 DRIVE INTERFACE, HEX | 1 |
| | | | *29-22875-00 | PCBA HRVV RECEIVER | 1 |
| 4A-RD53-A | RD53-A SPARE DRIVE | \$3,800 | *29-22880-00 | PCBA HTVV TRANSMITTER | 1 |
| RD53-A | 67/71MB 5.25" WINCHESTER DISK | 1 | *29-22881-00 | PCBA HFRV FINE SERVO | 1 |
| | | | *29-22882-00 | PCBA EKPV FAULT REGISTER | 1 |
| 4A-RD54-A | RD54-A SPARE DRIVE | \$4,950 | *29-22885-00 | PCBA HLRV DATA LATCH | 1 |
| RD54-A | 159 MB WINCHESTER DISK | 1 | *29-22886-00 | PCBA CLSV WRITE PLOT | 1 |
| | | | *29-22887-00 | PCBA ELTV A-CONT/SECTOR | 1 |
| 4A-RF30-A | RF30-A SPARE DRIVE | \$5,500 | *29-22890-00 | PCBA FLWV DIFF GENERATOR | 1 |
| | | | *29-22891-00 | PCBA ELXV NRZ TO MFM | 1 |
| | | | *29-22892-00 | PCBA BLZV READ PLOT | 1 |
| | | | *29-22894-00 | PCBA FZQN SERVO PREAMP | 1 |
| 4A-RH780-00 | RH780 SPARES KIT | \$5,400 | 29-22904-00 | CONTROL PANEL ASSY | 1 |
| *M8274-00 | RH780 EXTENDED SILO MASSBUS | 1 | 29-22919-00 | SWITCH INTERLOCK | 1 |
| *M8275-00 | MSI MASSBUS ADAPTER SBI INTER | 1 | 29-22920-00 | SWITCH, MINI | 1 |
| *M8276-00 | MIR MASSBUS INTERNAL REGISTER | 1 | 29-22938-00 | 6 MFD 660VAC 6% | 1 |
| *M8278-00 | MCB MASSBUS ADAPTER CONTROL | 1 | 29-23538-00 | TRANSFORMER ASSY. | 1 |
| | | | 29-23539-00 | RECTIFIER, BRIDGE | 1 |
| 4A-RK07-00 | RK07 SPARES KIT | \$5,458 | *29-23540-00 | PCBA AZCN, PWR AMP | 1 |
| *M7705-00 | RK06 DRIVE CONTROL LOGIC | 1 | *29-23541-00 | PCBA 5YEN,CAP BRD | 1 |
| *M7706-00 | RK06 INTERFACE + TIMING | 1 | 29-23542-00 | POWER CONTACTOR | 1 |
| *M7906-00 | SERVO ANALOG | 1 | *29-23543-00 | PCBA AYEN, RELAY BRD. | 1 |
| *M7907-00 | SERVO CONTROL | 1 | *29-23553-00 | PCBA DMSV, AN. SERV. | 1 |
| *M7908-00 | TRACK POSITIONING OSCILL | 1 | *29-23554-00 | PCBA, READ AMP. | 1 |
| 12-10755-00 | SW,LEVER 1P 11A | 1 | *29-23555-00 | PCBA,WRITE DRIVER | 1 |
| 12-12716-00 | LAMP,WEDGE,6.3V,.2A.,4MSCP,T1 | 10 | *29-23556-00 | PCBA, R/W CONTROL | 1 |
| *54-11042-00 | POWER AMP RK06 | 1 | *29-23557-00 | PCBA, DIF/HEAD REG | 1 |
| *54-11060-YA | READ/WRITE MODULE RK07 | 1 | *29-23558-00 | PCBA, ACCESS CNTRL. | 1 |
| 54-11687-00 | SERNO PRE AMP RK06 | 1 | 29-23560-00 | SENSOR PACK ASSY | 1 |
| 54-11823-00 | OPERATING CONTROL PANEL RK06 | 1 | 29-23561-00 | TRANS/CONN. ASSY | 1 |
| 54-11893-00 | TRANSISTOR BOARD RK06 | 1 | 29-23565-00 | CAM | 1 |
| *70-11915-01 | CARRIAGE, COIL ASSY | 1 | *29-23566-00 | PCBA, REG. 5V | 1 |
| *70-11917-00 | MAGNET HOUSING ASSY | 1 | *29-23567-00 | PCBA, 4XFN MB | 1 |
| *70-14411-00 | BDN-DATA (METRIC) | 1 | *29-23568-00 | PCBA, BXGN SHS | 1 |
| *70-14411-01 | RK07 DISK HEAD | 1 | 29-23569-00 | PCBA, SZGN SER CONN | 1 |
| *70-14411-02 | BDN-SERVO (METRIC) | 1 | 29-23570-00 | SPEED SENSOR ASSY. | 1 |
| | | | 29-23571-00 | FLEX CONDUCTOR | 1 |
| 4A-RL02-A | RL02-A SPARES KIT | \$3,375 | 29-23572-00 | ACTUATOR ASSY. | 1 |
| 10-13102-00 | 10 MFD 370V 6% NON-PC | 1 | 29-23573-00 | BLOWER MOTOR | 1 |
| 12-09403-02 | FAN,117CFM, BALL BEARING,STD | 1 | 29-23575-00 | BELT, DRIVE 60HZ | 1 |
| 12-12716-01 | BULB, WEDGE LAMP | 10 | 29-23577-00 | PCBA, ACCESS CONT. | 1 |
| 12-13369-00 | BELT,WOVEN,ENDLESS.375WX27.14 | 1 | 29-23578-00 | SWITCH, TOGGLE | 1 |
| *54-11848-00 | ETCH BRD 54-11848 | 1 | *29-23656-00 | HEAD/ARM ASSY | 1 |
| *54-13534-00 | DC SERVO + POWER SUPPLY | 1 | *29-23657-00 | HEAD/ARM ASSY | 1 |
| *54-13536-00 | RL01/RL02 READ/WRITE | 1 | *29-23658-00 | HEAD/ARM ASSY | 1 |
| *54-14025-00 | DRIVE LOGIC | 1 | 29-23890-00 | PCBA, RECT CCBN | 1 |
| *70-12114-00 | DISK MOTOR ASSY | 1 | 29-23891-00 | PCBA, LOGIC FCFN | 1 |
| *70-12117-00 | POSITIONER ASSY | 1 | 29-23892-00 | PCBA, RELAY CFNN | 1 |
| 70-12127-01 | TERMINAL BLOCK ASSY | 1 | 29-23893-00 | DRIVE MOTOR/BRAKE ASSY 60HZ | 1 |
| 70-12130-00 | POWER PANEL ASSY | 1 | | | |
| 70-12137-00 | TRANSDUCER ASSY | 1 | | | |
| 70-12142-00 | CABLE | 1 | | | |
| *70-15637-00 | RL02 DATA HEAD "A" UP | 1 | | | |
| *70-15637-01 | RL02 DATA HEAD "A" DOWN | 1 | | | |
| 70-16991-00 | SWITCH COVER ASSY. | 1 | | | |

*Those products which are repairable are marked with an asterisk

Continued on next page

digital To Order, Call DECdirect at 800-344-4825. 8:30 AM to 8:00 PM (ET) in the Continental USA.

HARDWARE SPARES KITS

Hardware Spares Kits—continued

HARDWARE KITS

| | | | | | |
|-------------------|---------------------------------|-----------------|--------------------|-----------------------------------|-----------------|
| 4A-RM05-AD | RM05-AD SPARES KIT, 50HZ | \$20,400 | 4A-RUC25-00 | RUC25 SPARES KIT, 120/240V | \$11,520 |
| *M5922-00 | MASS BUS TRANSCEIVER, PORT A | 1 | *M8739-00 | UNIBUS INTERFACE, QUAD | 1 |
| *M7684-00 | CONTROL SEQUENCER | 1 | 12-18668-00 | DUAL SPEED BLOWER,120V50/60HZ | 1 |
| *M7686-YA | RM02,3,5 CONTROL INTRFACE HEX | 1 | 12-19910-01 | CKT BKR 8.0A 250V 2P MAGNETIC | 1 |
| *M8685-00 | DATA SEQUENCER, 4-LAYER HEX | 1 | *54-14636-00 | RC25 CONTROLLER MODULE | 1 |
| M8687-00 | RM05 DRIVE INTERFACE, HEX | 1 | *54-14645-00 | RC25 DRIVE CARD | 1 |
| *29-22875-00 | PCBA HRV RECEIVER | 1 | *54-15160-00 | RC25 DISK POWER SUPPLY | 1 |
| *29-22880-00 | PCBA HTVV TRANSMITTER | 1 | 70-19506-00 | SWITCH ASSY, H7863 | 1 |
| *29-22881-00 | PCBA HFRV FINE SERVO | 1 | 70-20266-00 | SWITCH, PANEL ASSY. | 1 |
| *29-22882-00 | PCBA EKPV FAULT REGISTER | 1 | *70-21127-01 | BASE PLATE CHASSIS ASSY | 1 |
| *29-22885-00 | PCBA HLRV DATA LATCH | 1 | | | |
| *29-22886-00 | PCBA CLSV WRITE PLOT | 1 | 4A-RV20-00 | RV20 SPARES KIT | \$21,052 |
| *29-22887-00 | PCBA ELTV A-CONT/SECTOR | 1 | 29-26424-00 | RV20 DRIVE BELT | 1 |
| *29-22890-00 | PCBA FLWV DIFF GENERATOR | 1 | 29-26425-00 | SPINDLE | 1 |
| *29-22891-00 | PCBA ELXV NRZ TO MFM | 1 | 29-26426-00 | RV20 CARRIAGE | 1 |
| *29-22892-00 | PCBA BLZV READ PLOT | 1 | 29-26427-00 | RV20 ISI PCA | 1 |
| *29-22894-00 | PCBA FZQN SERVO PREAMP | 1 | 29-26428-00 | R/W PCA (RV20) | 1 |
| 29-22904-00 | CONTROL PANEL ASSY | 1 | 29-26429-00 | ECC PCA (RV20) | 1 |
| 29-22919-00 | SWITCH INTERLOCK | 1 | 29-26430-00 | RV20 POW SUPPLY | 1 |
| 29-22920-00 | SWITCH, MINI | 1 | 29-26431-00 | RV20 MOTOR | 1 |
| 29-22938-00 | 6 MFD 660VAC 6% | 1 | 29-26434-00 | MAINT PANEL ASSY | 1 |
| 29-23538-00 | TRANSFORMER ASSY. | 1 | 29-26435-00 | RV20 SDC PCA | 1 |
| 29-23539-00 | RECTIFIER, BRIDGE | 1 | 29-26436-00 | RV20 ESG OCA | 1 |
| *29-23540-00 | PCBA AZCN, PWR AMP | 1 | 29-26437-00 | RV20 SS PCA | 1 |
| *29-23541-00 | PCBA 5YEN,CAP BRD | 1 | 29-26438-00 | PCA OPER PANEL | 1 |
| 29-23542-00 | POWER CONTACTOR | 1 | 29-26439-00 | MDS PCA | 1 |
| *29-23543-00 | PCBA AYEN, RELAY BRD. | 1 | 29-26440-00 | SPINDLE BEARING | 1 |
| *29-23553-00 | PCBA DMSV, AN. SERV. | 1 | 29-26457-00 | BASEPLATE TERM PCA | 1 |
| *29-23554-00 | PCBA, READ AMP. | 1 | 29-26459-00 | LESI ADAPTER PCA (RV20) | 1 |
| *29-23555-00 | PCBA,WRITE DRIVER | 1 | 29-26460-00 | RV20 BACKPLANE PCA | 1 |
| *29-23556-00 | PCBA, R/W CONTROL | 1 | 29-26461-00 | RV20 I/O PANEL | 1 |
| *29-23557-00 | PCBA, DIF/HEAD REG | 1 | | | |
| *29-23558-00 | PCBA, ACCESS CNTRL. | 1 | 4A-RX01-A | RX01 SPARES KIT, 60HZ | \$2,613 |
| 29-23560-00 | SENSOR PACK ASSY | 1 | *M7726-00 | RX01 CONTROLLER | 1 |
| 29-23561-00 | TRANS/CONN. ASSY | 1 | *M7727-00 | RX01 R/W CONTROL | 1 |
| 29-23565-00 | CAM | 1 | 12-13454-00 | BELT,DRIVE-FLAT NEOPRENE 23.2 | 1 |
| *29-23566-00 | PCBA, REG. 5V | 1 | *70-10718-00 | BOARD POWER ASSY H771 | 1 |
| *29-23567-00 | PCBA, 4XFN MB | 1 | *70-13077-00 | FLEXIBLE DRIVE ASSY (60HZ) | 1 |
| *29-23568-00 | PCBA, BXGN SHS | 1 | | | |
| 29-23569-00 | PCBA, SZGN SER CONN | 1 | 4A-RX01-D | RX01 SPARES KIT, 50HZ | \$2,613 |
| 29-23570-00 | SPEED SENSOR ASSY. | 1 | *M7726-00 | RX01 CONTROLLER | 1 |
| 29-23571-00 | FLEX CONDUCTOR | 1 | *M7727-00 | RX01 R/W CONTROL | 1 |
| 29-23572-00 | ACTUATOR ASSY. | 1 | 12-13454-01 | BELT,DRIVE-FLAT NEOPRENE 23.4 | 1 |
| 29-23573-00 | BLOWER MOTOR | 1 | *70-10718-00 | BOARD POWER ASSY H771 | 1 |
| 29-23577-00 | PCBA, ACCESS CONT. | 1 | *70-13077-01 | FLEXIBLE DRIVE ASSY (50HZ) | 1 |
| 29-23578-00 | SWITCH, TOGGLE | 1 | | | |
| 29-23584-00 | DRIVE BELT 50HZ | 1 | 4A-RX02-A | RX02 SPARES KIT, 60HZ | \$2,475 |
| *29-23656-00 | HEAD/ARM ASSY | 1 | *M7744-YC | M7744 WITH FCC COMPLIANCE,HEX | 1 |
| *29-23657-00 | HEAD/ARM ASSY | 1 | *M7745-YA | M7745 WITH FCC COMPLIANCE,HEX | 1 |
| *29-23658-00 | HEAD/ARM ASSY | 1 | 12-14005-00 | BELT,DRIVE-FLAT NEOPRENE 23"L | 1 |
| 29-23890-00 | PCBA, RECT CCBN | 1 | *70-13077-00 | FLEXIBLE DRIVE ASSY (60HZ) | 1 |
| 29-23891-00 | PCBA, LOGIC FCFN | 1 | 70-13454-00 | HANDLE ASSY. | 1 |
| 29-23892-00 | PCBA, RELAY CFNN | 1 | | | |
| 29-23894-00 | DRIVE MOTOR/BRAKE ASSY 50HZ | 1 | 4A-RX02-D | RX02 SPARES KIT, 50HZ | \$2,475 |
| | | | *M7744-YC | M7744 WITH FCC COMPLIANCE,HEX | 1 |
| | | | *M7745-YA | M7745 WITH FCC COMPLIANCE,HEX | 1 |
| | | | 12-14005-01 | BELT,DRIVE-FLAT NEOPRENE 23"L | 1 |
| | | | *70-13077-01 | FLEXIBLE DRIVE ASSY (50HZ) | 1 |
| | | | 70-13454-00 | HANDLE ASSY. | 1 |

*Those products which are repairable are marked with an asterisk

Continued on next page

digital To Order, Call DECdirect at 800-344-4825. 8:30 AM to 8:00 PM (ET) in the Continental USA.

Hardware Spares Kits—continued

| | | | | | |
|--------------------|-------------------------------------|-----------------|-------------------|-----------------------------------|----------------|
| 4A-RX33-A | RX33-A SPARE DRIVE (1.2MB) | \$350 | 4A-TKIT-AA | SYSTEMS TERM TOOL KIT 60HZ | \$510 |
| RX33-A | 1.2 MB FLEXIBLE DISK DRIVE | 1 | | | |
| 4A-SA600-00 | SA600-HA/HD/JA/JD SPARES KIT | \$23,701 | 4A-TKIT-AB | SYSTEMS TERM TOOL KIT 50HZ | \$510 |
| *30-23506-01 | RA90 UNIVERSAL P.S. | 1 | 4A-TM03-00 | TM03 SPARES KIT | \$6,351 |
| 30-24453-01 | OPERATOR CONTOL PANEL RA90 | 1 | *M5903-00 | DRIVE TRANCEIVER | 1 |
| 70-22939-01 | BLOWER/BEZEL ASSY RA90 | 1 | *M8905-YB | MAINENANCE REGISTER-TM03 | 1 |
| *70-22942-01 | ELECTRONIC CONTROL MODULERA90 | 1 | *M8908-00 | RECEIVER/TERM | 1 |
| *70-22951-01 | HDA/CARRIER ASSY(RA90) | 1 | *M8908-YA | M8908/TERM RESISTOR | 1 |
| 4A-SEKIT-AA | SYSTEMS ENGR,TOOL KIT, 120V | \$855 | *M8909-YA | MASS BUSS INTFACE (TM02+TM03) | 1 |
| 4A-SEKIT-AB | SYSTEM ENGR TOOL KIT, 240V | \$860 | *M8932-00 | TAPE CONTROL P.E. | 1 |
| 4A-SEKIT-MS | METRIC SUPPLEMENT TOOL ROLL | \$129 | *M8933-00 | MODULE TAPE CONTROL TM03 | 1 |
| | | | *M8937-00 | TM03, CONTROL AND WRITE DRIVE | 1 |
| | | | 12-09403-02 | FAN,117CFM, BALL BEARING,STD | 1 |
| | | | 12-10719-03 | FAN,TUBE AXIAL,115V 25-35 CFM | 1 |
| | | | *54-09728-00 | BOARD REGULATOR | 1 |
| 4A-TA81-00 | TA81 SPARES KIT | \$24,516 | 4A-TM78-00 | TM78 SPARES KIT, 240V | \$9,722 |
| 29-24211-00 | SENSOR, FILE, PROTECT | 1 | *M8950-00 | TM78,READ CHANNEL | 1 |
| 29-24212-00 | HUB ASSY | 1 | *M8951-00 | TM78 ERROR CORRECTION BOARD | 1 |
| *29-24213-00 | KIT, MOTOR INSTALLATION | 1 | *M8952-00 | CRC + ACRC, TM78 | 1 |
| 29-24219-00 | TRANSDUCER | 1 | *M8953-00 | READ PATH SEQUENCER, TM78 | 1 |
| *29-24223-00 | POWER AMP PWA | 1 | *M8955-00 | TM78 PORT | 1 |
| 29-24224-00 | HUB ASSY | 1 | *M8956-00 | MASS BUSS DATA PORT, TM78 | 1 |
| 29-24228-00 | BLOWER | 1 | *M8957-00 | MASS BUSS CONTROL, TM78 | 1 |
| 29-24355-00 | DOOR INTERLOCK, SWITCH | 1 | *M8958-00 | TM78 TRANSLATOR | 1 |
| 29-24356-00 | SENSOR OT/BOT | 1 | *M8959-00 | WRITE MICROCONTROLLER, TM78 | 1 |
| 29-24358-00 | TACHOMETER 1 LINE | 1 | *M8960-00 | TM78 MICROCOMPUTER (8085) | 1 |
| *29-24704-00 | 51AMP,PWA READ | 1 | 12-02556-00 | LAMP, PILOT IND DEVICES #1020 | 10 |
| *29-24705-00 | PWA SERVO CONTROL | 1 | 12-05303-00 | LAMP, PILOT IND DEVICES #1020 | 10 |
| *29-24706-00 | PWA WRITE DRIVE | 1 | 12-11079-00 | SW,PB,SPDT, 1A@115V,MOM. | 1 |
| *29-24707-00 | PWA MSCP | 1 | 12-11164-04 | SW,DIP P 1A 8POS | 1 |
| *29-24708-00 | PWA FORMATTER WRITE | 1 | 12-12124-00 | CKT BKR 30.A 240V 2P SERIES | 1 |
| *29-24709-00 | PWA FORMATTER READ | 1 | 13-11996-00 | VARIStOR 150VAC VOLT TRANS SU | 10 |
| *29-24752-00 | MAG HEAD 9 TRK | 1 | 54-13716-01 | +5V REGULATOR | 1 |
| 29-25046-00 | PNEUMATIC ASSY. 50/60HZ | 1 | 54-14174-00 | TM78 KEYPAD | 1 |
| *29-25345-00 | STI MODULE | 1 | 54-14192-00 | AC DC LOWBOARD | 1 |
| 29-25346-00 | CONTROL PANEL | 1 | *54-14240-00 | H7476 REGULATOR | 1 |
| 29-26372-00 | TU80/81 UNIV.50/60HZ P.S. | 1 | | | |
| 4A-TE16-E | 9 TRACK SPARES KIT | \$13,515 | 4A-TS05-00 | TS05 SPARES KIT, 120V | \$8,260 |
| *G066-00 | READ AMP 9-CH | 2 | 29-24078-00 | TACHOMETER ASSY | 1 |
| *H607-00 | TAPE MOTION BOARD | 2 | 29-24079-00 | COMP. ARM ASSY | 1 |
| *M8916-00 | LOGIC AND WRITE BOARD | 1 | 29-24080-00 | HEAD ASSY | 1 |
| *M8931-00 | SLAVE CLOCK AND MOTION DELAY | 1 | 29-24081-00 | GUIDE,ROLLER TAPE | 1 |
| 12-09403-02 | FAN,117CFM, BALL BEARING,STD | 1 | 29-24082-00 | SENSOR EOT/BOT | 1 |
| 12-09677-00 | MOTOR, REEL 4010-7 | 1 | 29-24083-00 | SENSOR TAPE | 1 |
| 12-09786-00 | MOTOR,LOW INERTIA | 1 | 29-24084-00 | SENSOR FILE | 1 |
| 12-10477-00 | SENSOR,LOW PRESSURE,10 H2O | 1 | 29-24085-00 | POWER SUPPLY | 1 |
| 12-10929-00 | FUSE, SUB-MINI, 15.000A, 32V | 10 | *29-24086-00 | MODULE | 1 |
| 12-11581-00 | BELT,-V-POLYFLEX | 5 | 29-24090-00 | SWITCH FRONT PANEL | 1 |
| *54-12242-00 | POWER SUPPLY TU16 | 1 | 29-24094-00 | MOTOR-TAKE UP | 1 |
| *70-13585-01 | TE 16 9 TRACK NARROW RADIUS | 1 | 29-24095-00 | MOTOR ASSY | 1 |
| *70-16687-00 | VACUUM ASSEMBLY | 1 | 29-24096-00 | PUMP AIR | 1 |
| 74-07957-00 | CAPSTAN | 1 | 29-24101-00 | GUIDE,ROLLER | 1 |
| 90-07210-00 | FUSE,REG. BLOW .75A | 10 | 29-25064-00 | FRONT PANEL ASSY. | 1 |
| 90-07218-00 | FUSE, SLO BLOW, 3.000A, 250V | 10 | | | |
| 90-07220-00 | FUSE, SLO BLOW, 4.000A, 250V | 10 | | | |
| 90-07223-00 | FUSE, SLO BLOW, 6.250A, 250V | 10 | | | |
| 90-07227-00 | FUSE, SLO BLOW, 15.000A, 32V | 10 | | | |
| 90-07999-00 | FUSE, REG BLOW, 6.000A 250V, | 10 | | | |
| 90-08835-00 | FUSE,REG BLOW, 20A 32V | 10 | | | |
| 90-09791-00 | FUSE,SLO BLOW 5A | 10 | | | |

*Those products which are repairable are marked with an asterisk.

Continued on next page

digital To Order, Call DECdirect at 800-344-4825. 8:30 AM to 8:00 PM (ET) in the Continental USA.

HARDWARE SPARES KITS

Hardware Spares Kits—continued

| | | | | | |
|-------------------|--------------------------------------|-----------------|-------------------|-------------------------------|-----------------|
| 4A-TS78-BB | TS78-BB SPARES KIT | \$14,691 | 4A-TU77-00 | TU77-AF/-AJ SPARES KIT | \$13,146 |
| *M8950-00 | TM78,READ CHANNEL | 1 | *M8940-00 | MTA (MAGTAPE ADAPTOR) | 1 |
| *M8951-00 | TM78 ERROR CORRECTION BOARD | 1 | 12-05303-00 | LAMP, PILOT IND DEVICES #1020 | 10 |
| *M8952-00 | CRC + ACRC, TM78 | 1 | 12-11142-00 | CKT BKR 20.0 A 277V 3P SERIES | 1 |
| *M8953-00 | READ PATH SEQUENCER, TM78 | 1 | 12-11147-01 | CONTACTOR, 30A,3P DBL BRK,600 | 1 |
| *M8955-00 | TM78 PORT | 1 | 12-11179-00 | RLY,REED, 48V COIL,SPST,,50A | 1 |
| *M8958-00 | TM78 TRANSLATOR | 1 | 12-11180-02 | SW,TOG 1 PDT ON-OFF-ON | 1 |
| *M8959-00 | WRITE MICROCONTROLLER, TM78 | 1 | *29-23226-00 | PCBA WRITE | 1 |
| *M8970-00 | STI INTERFACE MICRO BD (QUAD) | 1 | *29-23227-00 | PCBA DATA L | 1 |
| *M8971-00 | STI INTERFACE DRIVER BD (QUAD) | 1 | *29-23230-00 | PCBA CAPSTAN SERVO | 1 |
| *M8972-00 | TA78 MICROCOMPUTER, QUAD | 1 | *29-23231-00 | PCBA REEL SERVO | 1 |
| *M8973-00 | 8085 EXTENDED MEMORY,DBL8.5 | 1 | *29-23232-00 | PCBA 9TRK PREA. | 1 |
| 12-02556-00 | LAMP, PILOT IND DEVICES #1020 | 1 | 29-23233-00 | HEAD RD/WR | 1 |
| 12-05303-00 | LAMP, PILOT IND DEVICES #1020 | 10 | *29-23234-00 | MOTOR ASSY CAP | 1 |
| 12-11079-00 | SW,PB,SPDT, 1A@115V,MOM. | 1 | 29-23235-00 | WRITE PROTECT A | 1 |
| 12-11164-04 | SW,DIP P 1A 8POS | 1 | *29-23236-00 | MOTOR ASSY, REEL | 1 |
| 12-12124-00 | CKT BKR 30.A 240V 2P SERIES | 1 | 29-23238-00 | SWITCH PRESSURE | 1 |
| 13-11996-00 | VARISTOR 150VAC VOLT TRANS SU | 10 | 29-23239-00 | SWITCH, PRESSURE | 1 |
| 54-13716-01 | +5V REGULATOR | 1 | 29-23240-00 | SWITCH,PRESSURE | 1 |
| 54-14192-00 | AC DC LOWBOARD | 1 | 29-23241-00 | CLEANER, TAPE | 1 |
| *54-14240-00 | H7476 REGULATOR | 1 | 29-23242-00 | EOT/BOT SENSE ASSY | 1 |
| | | | 29-23248-00 | VALVE ASSY, VACUUM | 1 |
| 4A-TU58-P | TU58 PARALLEL SPARES KIT | \$855 | *29-23249-00 | VALVE ASSY, PRESSURE | 1 |
| 4A-TU58-XA | SPARES DRIVE + CABLE ASSY FOR | 1 | *29-23257-00 | COMPRESSOR | 1 |
| *54-13491-00 | TU58 ELECTRONICS, PARALLEL | 1 | *29-23774-00 | PCBA CONTROL M2 | 1 |
| | | | 29-23989-00 | BELT, BLOWER | 1 |
| 4A-TU58-S | TU58 SERIAL SPARES KIT | \$718 | 29-23991-00 | BELT, BLOWER | 1 |
| 4A-TU58-XA | SPARES DRIVE + CABLE ASSY FOR | 1 | 29-23995-00 | BELT, COMPRESSOR | 1 |
| 4A-TU58-XB | SPARE SERIAL ELECTRONIC FOR T | 1 | 29-23996-00 | BELT, COMPRESSOR | 1 |
| | | | *54-11522-00 | PILOT CONTROL | 1 |
| 4A-TU58-XA | SPARES DRIVE + CABLE ASSY FOR | \$457 | 90-07221-00 | FUSE, REG BLOW, 5.000A, 250V | 10 |
| | | | 90-08835-00 | FUSE,REG BLOW, 20A 32V | 10 |
| | | | 90-08838-00 | FUSE, REG BLOW, 10.000A, 32V | 10 |
| 4A-TU58-XB | SPARE SERIAL ELECTRONIC FOR T | \$462 | | | |
| *STU58-XB | SPARE SERIAL ELECTRONICS | 1 | | | |

*Those products which are repairable are marked with an asterisk

Continued on next page

digital To Order, Call DECdirect at 800-344-4825. 8:30 AM to 8:00 PM (ET) in the Continental USA.

Hardware Spares Kits—continued

| 4A-TU78-00 TU78-AF/-AJ SPARES, 240V 50/60 | | \$20,145 | 4A-TU79-00 TU79-AF/-AJ SPARES KIT, 240V | | \$20,856 |
|--|-------------------------------|-----------------|--|-------------------------------|-----------------|
| BC05L-08 | CABLE JUMPER | 1 | BC05L-08 | CABLE JUMPER | 1 |
| 10-11643-00 | 18,000 MFD 25V G% 36D AL EL | 2 | 10-11643-00 | 18,000 MFD 25V G% 36D AL EL | 2 |
| 12-10930-02 | FAN,TUBE AXIAL 4.5" 100CFM | 1 | 12-10930-02 | FAN,TUBE AXIAL 4.5" 100CFM | 1 |
| 12-17916-02 | FAN,TUBE AXIAL 230V 120CFM | 1 | 12-17916-02 | FAN,TUBE AXIAL 230V 120CFM | 1 |
| 29-16280-00 | SWITCH, MICRO | 3 | 29-16280-00 | SWITCH, MICRO | 3 |
| 29-23211-00 | PCBA INTERCONNECT D1 | 1 | 29-23216-00 | SENSE ASSY, REEL | 1 |
| 29-23216-00 | SENSE ASSY, REEL | 1 | 29-23217-00 | SENSE ASSY PACK | 1 |
| 29-23217-00 | SENSE ASSY PACK | 1 | *29-23231-00 | PCBA REEL SERVO | 1 |
| *29-23231-00 | PCBA REEL SERVO | 1 | 29-23235-00 | WRITE PROTECT A | 1 |
| 29-23235-00 | WRITE PROTECT A | 1 | *29-23236-00 | MOTOR ASSY, REEL | 2 |
| *29-23236-00 | MOTOR ASSY, REEL | 2 | 29-23238-00 | SWITCH PRESSURE | 5 |
| 29-23238-00 | SWITCH PRESSURE | 5 | 29-23239-00 | SWITCH, PRESSURE | 2 |
| 29-23239-00 | SWITCH, PRESSURE | 2 | 29-23240-00 | SWITCH,PRESSURE | 2 |
| 29-23240-00 | SWITCH,PRESSURE | 2 | 29-23242-00 | EOT/BOT SENSE ASSY | 1 |
| 29-23242-00 | EOT/BOT SENSE ASSY | 1 | *29-23246-00 | TRANSDUCER ASSY VAC. | 1 |
| *29-23246-00 | TRANSDUCER ASSY VAC. | 1 | 29-23247-00 | CIRCUIT BREAKER | 1 |
| 29-23247-00 | CIRCUIT BREAKER | 1 | 29-23248-00 | VALVE ASSY, VACUUM | 1 |
| 29-23248-00 | VALVE ASSY, VACUUM | 1 | *29-23249-00 | VALVE ASSY, PRESSURE | 1 |
| *29-23249-00 | VALVE ASSY, PRESSURE | 1 | *29-23257-00 | COMPRESSOR | 1 |
| *29-23257-00 | COMPRESSOR | 1 | 29-23280-00 | MOTOR, GEAR DRIVE | 1 |
| 29-23280-00 | MOTOR, GEAR DRIVE | 1 | 29-23287-00 | MOTOR, AC | 1 |
| 29-23287-00 | MOTOR, AC | 1 | 29-23297-00 | SWITCH, INTERLOCK | 1 |
| 29-23297-00 | SWITCH, INTERLOCK | 1 | 29-23298-00 | BLOWER ASSY | 1 |
| 29-23298-00 | BLOWER ASSY | 1 | 29-23308-00 | RELAY,SOLID STATE | 1 |
| 29-23308-00 | RELAY,SOLID STATE | 1 | 29-23309-00 | CAPACITOR,8447000 MFD 15WVD | 1 |
| 29-23309-00 | CAPACITOR,8447000 MFD 15WVD | 1 | 29-23310-00 | CAPACITOR,8461000 MFD 50WVD | 1 |
| 29-23310-00 | CAPACITOR,8461000 MFD 50WVD | 1 | 29-23311-00 | RECTIFIER, BRIDGE, 25A | 1 |
| 29-23311-00 | RECTIFIER, BRIDGE, 25A | 1 | 29-23312-00 | RECTIFIER,BRIDGE,10A | 1 |
| 29-23312-00 | RECTIFIER,BRIDGE,10A | 1 | 29-23320-00 | RESISTOR, 330 OHM 120W | 10 |
| 29-23320-00 | RESISTOR, 330 OHM 120W | 10 | 29-23361-00 | CAP PLUG, AIR | 10 |
| 29-23361-00 | CAP PLUG, AIR | 10 | 29-23365-00 | CAM, PRE D1 (HOSE/TUBING KIT) | 1 |
| 29-23365-00 | CAM, PRE D1 (HOSE/TUBING KIT) | 1 | 29-23475-00 | HUB ASSY 75 IPS | 1 |
| 29-23475-00 | HUB ASSY 75 IPS | 1 | *29-23762-00 | PCBA DATA READ | 1 |
| *29-23762-00 | PCBA DATA READ | 1 | *29-23763-00 | PCBA WRITE | 1 |
| *29-23763-00 | PCBA WRITE | 1 | *29-23764-00 | PCBA CONTROL M2 | 1 |
| *29-23764-00 | PCBA CONTROL M2 | 1 | *29-23765-00 | PCBA CAPSTAN | 1 |
| *29-23765-00 | PCBA CAPSTAN | 1 | *29-23766-00 | PCBA PREAMP | 1 |
| *29-23766-00 | PCBA PREAMP | 1 | 29-23767-00 | HEAD, RD/WR | 1 |
| 29-23767-00 | HEAD, RD/WR | 1 | *29-23770-00 | PCBA INTERCONNECT F1 | 1 |
| *29-23768-00 | MOTOR ASSY, CAPSTAN | 1 | 29-23771-00 | CONTROLS ASSY | 1 |
| *29-23769-00 | PCBA MIA | 1 | 29-23989-00 | BELT, BLOWER | 1 |
| *29-23770-00 | PCBA INTERCONNECT F1 | 1 | 29-23991-00 | BELT, BLOWER | 1 |
| 29-23771-00 | CONTROLS ASSY | 1 | 29-23996-00 | BELT, COMPRESSOR | 1 |
| 29-23989-00 | BELT, BLOWER | 1 | 29-24013-00 | 26 BLOWER ASSY | 1 |
| 29-23991-00 | BELT, BLOWER | 1 | *29-26254-00 | 26WRITING PCBA | 1 |
| 29-23996-00 | BELT, COMPRESSOR | 1 | *29-26255-00 | 26PREAMP PCB | 1 |
| 70-14569-00 | BLOWER ASSY. | 1 | 90-07221-00 | FUSE, REG BLOW, 5.000A, 250V | 10 |
| 90-07221-00 | FUSE, REG BLOW, 5.000A, 250V | 10 | 90-08835-00 | FUSE,REG BLOW, 20A 32V | 10 |
| 90-08835-00 | FUSE,REG BLOW, 20A 32V | 10 | 90-08838-00 | FUSE, REG BLOW, 10.000A, 32V | 10 |
| 90-08838-00 | FUSE, REG BLOW, 10.000A, 32V | 10 | | | |

HARDWARE KITS

*Those products which are repairable are marked with an asterisk

Continued on next page

digital To Order, Call DECdirect at 800-344-4825. 8:30 AM to 8:00 PM (ET) in the Continental USA.

HARDWARE SPARES KITS

Hardware Spares Kits—continued

HARDWARE
KITS

| | | | | | |
|--------------------|-------------------------------------|-----------------|--------------------|-----------------------------------|-----------------|
| 4A-TU80-00 | TU80-A SPARES KIT, 120V/240V | \$11,539 | 4A-UDA50-A | UDA50-A SPARES KIT | \$5,040 |
| *M7454-00 | TU80 UNIBUS INTERFACE | 1 | *M7485-YA | M7485 W/BLASTED ROMS,4-LAYER | 1 |
| 29-24211-00 | SENSOR, FILE, PROTECT | 1 | *M7486-00 | UDA SI | 1 |
| 29-24212-00 | HUB ASSY | 1 | | | |
| *29-24213-00 | KIT, MOTOR INSTALLATION | 1 | 4A-VID08-A2 | VID08 SPARES KIT | \$12,298 |
| *29-24215-00 | KIT, MAG HEAD INSTALLATION | 1 | *H7280-A | POWER SUPPLY 120V | 1 |
| 29-24219-00 | TRANSDUCER | 1 | *30-25560-01 | HIGH VOLT. PWR. SUPPLY | 1 |
| *29-24221-00 | FORMATTER CONTROL PWA | 1 | *54-16947-01 | HORZ & VERT DEFLECTION MOD | 1 |
| *29-24222-00 | READ/WRITE SERVO PWA | 1 | *54-16975-01 | VIDEO SUB SYSTEM, IMAGE PROC | 1 |
| *29-24223-00 | POWER AMP PWA | 1 | *54-17040-01 | LOW VOLTAGE POWER SUPPLY | 1 |
| 29-24224-00 | HUB ASSY | 1 | *54-17102-01 | VIDEO DAUGHTER MODULE | 1 |
| 29-24228-00 | BLOWER | 1 | *70-24018-01 | VIDEO ENCLOSURE ASSY. | 1 |
| 29-24355-00 | DOOR INTERLOCK, SWITCH | 1 | 70-24019-01 | CONTROL PANEL ASSY. | 1 |
| 29-24356-00 | SENSOR OT/BOT | 1 | *70-24044-01 | SYSTEM BOARD ASSY. | 1 |
| 29-24358-00 | TACHOMETER 1 LINE | 1 | | | |
| 29-25046-00 | PNEUMATIC ASSY. 50/60HZ | 1 | | | |
| 29-26372-00 | TU80/81 UNIV.50/60HZ P.S. | 1 | | | |
| 4A-TU81-00 | TU81 SPARES KIT, 120/240V | \$20,542 | 4A-VR150-AA | VR150 SPARES KIT | \$679 |
| 29-24211-00 | SENSOR, FILE, PROTECT | 1 | 29-26673-00 | VIDEO BOARD | 1 |
| 29-24212-00 | HUB ASSY | 1 | 29-26674-00 | MAIN BOARD | 1 |
| *29-24213-00 | KIT, MOTOR INSTALLATION | 1 | | | |
| 29-24219-00 | TRANSDUCER | 1 | 4A-VR160-D3 | VR160-D3/D4 SPARES KIT | \$1,467 |
| *29-24223-00 | POWER AMP PWA | 1 | 29-26667-00 | VIDEO SUB ASSY | 1 |
| 29-24224-00 | HUB ASSY | 1 | 29-26669-00 | MAIN SUB ASSY 240V | 1 |
| 29-24228-00 | BLOWER | 1 | | | |
| 29-24355-00 | DOOR INTERLOCK, SWITCH | 1 | 4A-VR160-DA | VR160-DA SPARES KIT | \$1,467 |
| 29-24356-00 | SENSOR OT/BOT | 1 | 29-26667-00 | VIDEO SUB ASSY | 1 |
| 29-24358-00 | TACHOMETER 1 LINE | 1 | 29-26668-00 | MAIN SUB ASSY | 1 |
| *29-24704-00 | 51AMP,PWA READ | 1 | | | |
| *29-24705-00 | PWA SERVO CONTROL | 1 | 4A-VR260-00 | VR260 SPARES KIT | \$1,612 |
| *29-24706-00 | PWA WRITE DRIVE | 1 | 12-19283-19 | FUSE, 0.5A 250V | 1 |
| *29-24707-00 | PWA MSCP | 1 | *54-15624-01 | VR260 DEFLECTION BOARD | 1 |
| *29-24708-00 | PWA FORMATTER WRITE | 1 | *54-15626-01 | VIDEO AMP BOARD | 1 |
| *29-24709-00 | PWA FORMATTER READ | 1 | 70-21266-01 | REAR BULKHEAD ASSY | 1 |
| *29-24752-00 | MAG HEAD 9 TRK | 1 | 70-21861-01 | FRONT BEZEL ASSY | 1 |
| 29-25046-00 | PNEUMATIC ASSY. 50/60HZ | 1 | 70-21863-01 | BRIGHTNESS/CONTRAST ASSY | 1 |
| 29-26372-00 | TU80/81 UNIV.50/60HZ P.S. | 1 | 90-07212-00 | FUSE, SLO BLOW, 1.000A, 250V | 10 |
| 4A-TU81E-00 | TU81E SPARES KIT, 50/60 HZ | \$25,841 | 4A-VR290-00 | VR290 SPARES KIT | \$2,200 |
| 29-24211-00 | SENSOR, FILE, PROTECT | 1 | *29-25536-00 | VIDEO SUB ASSY | 1 |
| 29-24212-00 | HUB ASSY | 1 | 29-25537-00 | CRT SOCKET BOARD | 1 |
| *29-24213-00 | KIT, MOTOR INSTALLATION | 1 | *29-25538-00 | DEFLECTION BOARD | 1 |
| 29-24219-00 | TRANSDUCER | 1 | *29-25539-00 | APP BOARD | 1 |
| *29-24223-00 | POWER AMP PWA | 1 | *29-25540-00 | MAINS BOARD | 1 |
| 29-24224-00 | HUB ASSY | 1 | 29-25541-00 | CONTROL UNIT | 1 |
| 29-24228-00 | BLOWER | 1 | 29-25543-00 | LED AND MISCELLANEOUS | 1 |
| 29-24355-00 | DOOR INTERLOCK, SWITCH | 1 | | | |
| 29-24356-00 | SENSOR OT/BOT | 1 | 4A-VS10X-BA | VS10X-BA SPARE MODULE KIT | \$2,100 |
| 29-24358-00 | TACHOMETER 1 LINE | 1 | VS10X-BA | 11" X 11" GRAPHICS TAB W/CRSR | 1 |
| *29-24704-00 | 51AMP,PWA READ | 1 | | | |
| *29-24705-00 | PWA SERVO CONTROL | 1 | 4A-VS300-AA | VAXSTATION 3000 KERNEL KIT | \$15,640 |
| *29-24706-00 | PWA WRITE DRIVE | 1 | *M7168-00 | 4 PLANE COLOR BITMAP | 1 |
| *29-24708-00 | PWA FORMATTER WRITE | 1 | *M7169-00 | Q22 BUS VIDEO CONTRL MODULE | 1 |
| *29-24709-00 | PWA FORMATTER READ | 1 | *M7516-00 | Q-BUS TO ETHERNET ADAPT,DUAL | 1 |
| *29-24752-00 | MAG HEAD 9 TRK | 1 | *M7620-BA | M7620-AA W/MOD ROM | 1 |
| 29-25046-00 | PNEUMATIC ASSY. 50/60HZ | 1 | *M7621-AA | MS650-AA 8MB MEMORY | 1 |
| *29-25797-00 | BUFF. TMSCP MODULE | 1 | | | |
| 29-26372-00 | TU80/81 UNIV.50/60HZ P.S. | 1 | | | |

*Those products which are repairable are marked with an asterisk

Continued on next page

DECdata To Order, Call DECdirect at 800-344-4825. 8:30 AM to 8:00 PM (ET) in the Continental USA.

Hardware Spares Kits—continued

| | | | |
|--|-----------------|---|-----------------|
| 4A-VS300-AB VAXSTATION 3000/RD54 KIT | \$21,492 | 4A-VS710-A3 VS710 SPARES KIT WT. GRAPHICS | \$70,000 |
| *M7168-00 4 PLANE COLOR BITMAP | 1 | L8000-00 STRUCTURE MEMORY | 1 |
| *M7169-00 Q22 BUS VIDEO CONTRL MODULE | 1 | L8001-00 RENDERING CONTROLLER | 1 |
| *M7516-00 Q-BUS TO ETHERNET ADAPT,DUAL | 1 | L8002-00 STRUCTURE WALKER | 1 |
| *M7555-00 RD/RX CONTROL MODULE (RQDX3) | 1 | L8003-00 FRAME BUFFER | 1 |
| *M7620-BA M7620-AA W/MOD ROM | 1 | L8004-00 VIDEO CONTROLLER | 1 |
| *M7621-AA MS650-AA 8MB MEMORY | 1 | *T1001-YA KA825-AA CPU MODULE | 1 |
| 4A-RD54-A RD54-A SPARE DRIVE | 1 | T1030-CA KA800 CPU BD. ACP | 1 |
| | | T1031-00 DISK CONTROLLER FOR KA800-AA | 1 |
| 4A-VS450-D3 VS450-D3/F3 SPARES KIT, 240V | \$4,780 | *T1034-00 NI ADPTR BD W/TK50 CNTLR | 1 |
| H7848-BB VS400 PWR SUPPLY 240V | 1 | *T1040-AA 16MB ECC MEMORY W/1MB RAMS | 1 |
| *54-15624-01 VR260 DEFLECTION BOARD | 1 | *TK50-AX TK50-AA PACKAGED | 1 |
| *54-15626-01 VIDEO AMP BOARD | 1 | 30-23925-01 BI POWER SUPPLY | 1 |
| *54-16802-AA MS400-AA 2MB MEM | 1 | 30-28308-01 SFX POWER SUPPLY | 1 |
| *54-16804-01 NETWORK INT OPT FOR VAXMATE | 1 | 4A-RD54-A RD54-A SPARE DRIVE | 1 |
| 70-21266-01 REAR BULKHEAD ASSY | 1 | 4A-VR290-00 VR290 SPARES KIT | 1 |
| 70-21863-01 BRIGHTNESS/CONTRAST ASSY | 1 | 54-16572-01 CONTROL MODULE | 1 |
| *70-24268-01 KA410 SYSTEM MODULE | 1 | 54-17688-01 CONTROL PANEL | 1 |
| | | 54-17696-01 AIO DISTRIBUTION BOARD | 1 |
| 4A-VS450-DA VS450-DA/FA SPARES KIT, 120V | \$4,780 | 4A-VSXXX-AA 3 BUTTON MOUSE SPARES KIT | \$184 |
| *H7848-BA VS400 PWR SUPPLY 120V | 1 | VSXXX-AA CORPORATE MOUSE | 1 |
| *54-15624-01 VR260 DEFLECTION BOARD | 1 | | |
| *54-15626-01 VIDEO AMP BOARD | 1 | 4A-VSXXX-AB TABLET W/CURSOR, STYLUS SP KIT | \$1,045 |
| *54-16802-AA MS400-AA 2MB MEM | 1 | VSXXX-AB GRAPHIC TABLET | 1 |
| *54-16804-01 NETWORK INT OPT FOR VAXMATE | 1 | | |
| 70-21266-01 REAR BULKHEAD ASSY | 1 | 4A-VSXXX-DA SPARE DIAL BOX | \$1,990 |
| 70-21863-01 BRIGHTNESS/CONTRAST ASSY | 1 | VSXXX-DA DIAL BOX FOR VS800Q | 1 |
| *70-24268-01 KA410 SYSTEM MODULE | 1 | | |
| 4A-VS450-E3 VS450-E3/G3 SPARES KIT 240V | \$6,680 | 4A-VT100-00 VT100 SPARES KIT | \$1,634 |
| H7848-BB VS400 PWR SUPPLY 240V | 1 | 12-14155-03 SW,SLIDE 3P 10.1A @125V,5A @ | 1 |
| *54-15624-01 VR260 DEFLECTION BOARD | 1 | 12-15232-00 SW,TOG 2P 25A ON/NONE/OFF | 1 |
| *54-15626-01 VIDEO AMP BOARD | 1 | *54-13009-03 BASIC VIDEO | 1 |
| *54-16802-BA MS400-BA 4MB MEM | 1 | *70-14979-00 POWER SUPPLY ASSY | 1 |
| *54-16804-01 NETWORK INT OPT FOR VAXMATE | 1 | *70-15765-00 KEYBOARD/KEYCAP ASSY | 1 |
| 70-21266-01 REAR BULKHEAD ASSY | 1 | *70-17362-01 MONITOR PC BD ASSY/EMITTER | 1 |
| 70-21863-01 BRIGHTNESS/CONTRAST ASSY | 1 | 70-17363-01 FLYBACK AND CHOKE ASSEMBLY | 1 |
| *70-24268-01 KA410 SYSTEM MODULE | 1 | 90-07217-00 FUSE, REG BLOW, 3.000A, 250V | 10 |
| | | 90-09313-01 STANDOFFS | 50 |
| 4A-VS450-EA VS450-EA/GA SPARES KIT, 120V | \$6,680 | EK-VT100-J1 VT100 SERIES POCKET SERVICE | 1 |
| *H7848-BA VS400 PWR SUPPLY 120V | 1 | | |
| *54-15624-01 VR260 DEFLECTION BOARD | 1 | 4A-VT101-00 VT101 SPARES KIT | \$964 |
| *54-15626-01 VIDEO AMP BOARD | 1 | 12-14740-00 PLUNGER,NYLATCH,SPECIAL FOR V | 10 |
| *54-16802-BA MS400-BA 4MB MEM | 1 | *54-14185-00 VT101 TERMINAL CONTROL | 1 |
| *54-16804-01 NETWORK INT OPT FOR VAXMATE | 1 | 54-14245-00 H7838-A POWER SUPPLY | 1 |
| 70-21266-01 REAR BULKHEAD ASSY | 1 | *70-15765-00 KEYBOARD/KEYCAP ASSY | 1 |
| 70-21863-01 BRIGHTNESS/CONTRAST ASSY | 1 | *70-17362-01 MONITOR PC BD ASSY/EMITTER | 1 |
| *70-24268-01 KA410 SYSTEM MODULE | 1 | 70-17363-01 FLYBACK AND CHOKE ASSEMBLY | 1 |
| | | 90-00020-01 FUSE,REG BLOW 1.25A 250V | 10 |
| 4A-VS710-A2 VS710 SPARES KIT W/O GRAPHICS | \$50,000 | 90-09624-00 FEET BUMPER SQ. ADHS. BACK | 50 |
| *T1001-YA KA825-AA CPU MODULE | 1 | | |
| T1030-CA KA800 CPU BD. ACP | 1 | | |
| T1031-00 DISK CONTROLLER FOR KA800-AA | 1 | | |
| *T1034-00 NI ADPTR BD W/TK50 CNTLR | 1 | | |
| *T1040-AA 16MB ECC MEMORY W/1MB RAMS | 1 | | |
| *TK50-AX TK50-AA PACKAGED | 1 | | |
| 30-23925-01 BI POWER SUPPLY | 1 | | |
| 4A-RD54-A RD54-A SPARE DRIVE | 1 | | |
| 4A-VR290-00 VR290 SPARES KIT | 1 | | |
| 54-16572-01 CONTROL MODULE | 1 | | |
| 54-17688-01 CONTROL PANEL | 1 | | |
| 54-17696-01 AIO DISTRIBUTION BOARD | 1 | | |

*Those products which are repairable are marked with an asterisk

Continued on next page

digital To Order, Call DECdirect at 800-344-4825. 8:30 AM to 8:00 PM (ET) in the Continental USA.

HARDWARE SPARES KITS

Hardware Spares Kits—continued

HARDWARE
KITS

| | | | | | |
|--------------------|---------------------------------|----------------|--------------------|------------------------------------|----------------|
| 4A-VT102-00 | VT102 SPARES KIT | \$1,211 | 4A-VT240-A | VT240-A SPARES KIT 120/240V | \$1,455 |
| 12-14740-00 | PLUNGER,NYLATCH,SPECIAL FOR V | 10 | 12-19284-00 | FUSE, 1A250V, HGH BRK CAP | 1 |
| *54-14185-01 | VT102 TERMINAL CONTROL | 1 | *54-15495-02 | VS240 MODULE | 1 |
| 54-14245-00 | H7838-A POWER SUPPLY | 1 | *70-19499-01 | CHASSIS ASSY | 1 |
| *70-15765-10 | KEYBOARD/KEYCAP ASSY | 1 | *70-19584-00 | MONITOR BOARD ASSY | 1 |
| *70-17362-01 | MONITOR PC BD ASSY/EMITTER | 1 | 90-07215-00 | FUSE,REG BLOW 2.00A 250V | 1 |
| 70-17363-01 | FLYBACK AND CHOKE ASSEMBLY | 1 | | | |
| 90-00020-01 | FUSE,REG BLOW 1.25A 250V | 10 | | | |
| 90-09624-00 | FEET BUMPER SQ. ADHS. BACK | 50 | | | |
| 4A-VT125-00 | VT125 SPARES KIT | \$2,688 | 4A-VT24X-WA | VT240 ROM REPAIR KIT | \$187 |
| *54-13009-03 | BASIC VIDEO | 1 | 23-56E6-00 | E6-01 ROM, 32KX 8 | 1 |
| *54-14275-00 | VT125 PADDLE BOARD | 1 | 23-57E6-00 | E6-01 ROM, 32KX 8 | 1 |
| *54-14277-00 | VT125 MONO BOARD | 1 | 23-58E6-00 | E6-01 ROM, 32KX 8 | 1 |
| 70-14653-00 | KEYBOARD ASSEMBLY | 1 | 23-59E6-00 | E6-01 ROM, 32KX 8 | 1 |
| *70-14979-00 | POWER SUPPLY ASSY | 1 | 23-8E6-00 | E6-01 ROM, 32KX 8 | 1 |
| *70-17362-01 | MONITOR PC BD ASSY/EMITTER | 1 | EK-VT240-AN | VT240 ADD. FEATURES NOTICE | 1 |
| 70-17363-01 | FLYBACK AND CHOKE ASSEMBLY | 1 | FA-04568-01 | VT240-R0003 FCO DOC | 1 |
| 4A-VT131-00 | VT131 SPARES KIT | \$1,433 | 4A-VT320-A2 | VT320 SPARES KIT 120V 60HZ | \$394 |
| 12-14740-00 | PLUNGER,NYLATCH,SPECIAL FOR V | 10 | 70-24244-01 | POWER SUPPLY ASSY. | 1 |
| *54-14185-02 | VT131 TERMINAL CONTROL | 1 | *70-24577-01 | MONITOR,LOGIC BOARD | 1 |
| 54-14245-00 | H7838-A POWER SUPPLY | 1 | | | |
| *70-15765-11 | KEYBOARD/KEYCAP ASSY | 1 | 4A-VT320-A3 | VT320 KIT 120/240V 50HZ | \$444 |
| *70-17362-01 | MONITOR PC BD ASSY/EMITTER | 1 | 70-24244-02 | PWR. SUP. 120/240V 50HZ | 1 |
| 70-17363-01 | FLYBACK AND CHOKE ASSEMBLY | 1 | *70-24577-02 | MONITOR,LOGIC BOARD | 1 |
| 90-00020-01 | FUSE,REG BLOW 1.25A 250V | 10 | | | |
| 90-09624-00 | FEET BUMPER SQ. ADHS. BACK | 50 | 4A-VT330-00 | VT330 SPARES KIT | \$1,400 |
| 4A-VT132-00 | VT132 SPARES KIT | \$1,640 | *54-16903-01 | GRAPHIC BITMAP MODULE | 1 |
| 12-14155-03 | SW,SLIDE 3P 10.1A @125V,5A @ | 1 | *54-16905-01 | MONO MONITOR PWR. SUP. MODULE | 1 |
| 12-15232-00 | SW,TOG 2P 25A ON/NONE/OFF | 1 | 54-16907-01 | MONO. VIDEO AMPLIFIER MODULE | 1 |
| *54-13009-04 | BASIC VIDEO | 1 | *54-16909-01 | MONOCHROME CPU MODULE | 1 |
| 54-13097-02 | VT132 ADVANCED VIDEO | 1 | 4A-VT340-00 | VT340 SPARES KIT | \$2,000 |
| *70-14979-00 | POWER SUPPLY ASSY | 1 | 54-16963-01 | COLOR VIDEO AMPLIFIER MOD. | 1 |
| *70-15765-04 | VT132 KEYBOARD MODULE | 1 | *54-16965-01 | PANDA CG VIDEO BOARD (MOD.) | 1 |
| *70-17362-01 | MONITOR PC BD ASSY/EMITTER | 1 | *70-24516-01 | PS/MONITOR & ARC PROTECT ASSY | 1 |
| 70-17363-01 | FLYBACK AND CHOKE ASSEMBLY | 1 | | | |
| 90-07217-00 | FUSE, REG BLOW, 3.000A, 250V | 10 | | | |
| 90-09313-01 | STANDOFFS | 50 | | | |
| 4A-VT220-A | VT220-A,-B,-C SPARES KIT | \$625 | | | |
| 12-19284-00 | FUSE, 1A250V, HGH BRK CAP | 1 | | | |
| *70-20624-01 | MONITOR, PWR SUPPLY BOARD | 1 | | | |
| 70-20772-01 | FLYBACK ASSY | 1 | | | |
| *70-20814-02 | TERM. CONTROL BD. BEZEL ASSY | 1 | | | |
| 90-07215-00 | FUSE,REG BLOW 2.00A 250V | 1 | | | |
| 4A-VT220-D | VT220-D,-E,-F SPARES KIT | \$554 | | | |
| *70-23361-01 | MONITOR, PWR SUPPLY BOARD | 1 | | | |
| *70-23363-01 | TERMINAL CONTROLLER BOARD | 1 | | | |
| 4A-VT22X-WA | VT220 ROM REPAIR KIT | \$63 | | | |
| 23-182E5-00 | E5-01 ROM, 16KX 8 | 1 | | | |
| 23-183E5-00 | E5-01 ROM, 16KX 8 | 1 | | | |

*Those products which are repairable are marked with an asterisk

Continued on next page

digital To Order, Call DECdirect at 800-344-4825. 8:30 AM to 8:00 PM (ET) in the Continental USA.

Documentation Kits

| | | | | | |
|--------------------|--------------------------------------|----------------|--------------------|--------------------------------|----------------|
| FB-00861-00 | 861 A,B,C,D,E DOCUMENTS | \$175 | FB-DR11-C | DR11 C DOCUMENTS | \$200 |
| EK-00861-IP | 861-A/B/C/D/E/F IPB | 1 | EK-DR11C-OP | DR11-C GENERAL DEVICE USERS M | 1 |
| EK-861AB-MM | 861-A/B/C/D/E/F MAINTENANCE M | 1 | EK-DR11C-PM | DR11-C PREVENTIVE MAINT MAN. | 1 |
| EK-861AB-OP | 861-A/B/C/D/E/F USERS MANUAL | 1 | EK-DR11C-TM | DR11-C GENERAL DEVICE INTERFA | 1 |
| MP-N0861-00 | 861 PRINTSET | 1 | MP-DR11-C | DR11-C PRINTSET | 1 |
| FB-11/44-00 | 11/44 (KD11-Z) CPU/SYSTEM DOC | \$1,845 | FB-DR11-W | DR11-W DOC | \$280 |
| EK-01144-IP | PDP-11/44 UNIT ASSEMBLY IPB | 1 | EK-DR11W-UG | DR11-W DIRECT MEMORY USERS MA | 1 |
| EK-11044-UG | PDP-11/44 SYSTEM USERS GUIDE | 1 | MP-00693-00 | DR11-W PRINTSET | 1 |
| EK-BA11A-IP | BA11-A UNIT ASSEMBLY IPB | 1 | FB-DR750-00 | DR750 DOC | \$613 |
| EK-KD11Z-TM | PDP-11/44 SYSTEM TECHNICAL MA | 1 | EK-DR750-RM | DR750 MAINTENANCE ADVISORY | 1 |
| EK-PDP44-MC | PDP-11/44 MAINTENANCE CARD | 1 | EK-DR750-UG | DR750 USERS GUIDE | 1 |
| MP-00809-00 | 11/44 SYS PRINTSET | 1 | MP-01363-00 | DR750 PRINTSET | 1 |
| FB-1134A-00 | 1134A (KD11-EA) CPU/SYSTEM | \$3,376 | FB-DR780-00 | DR780 DOCUMENTATION KIT | \$980 |
| EK-11034-MC | PDP-11/04/34 MAINTENANCE CARD | 1 | EK-DR780-TD | DR780 GENERAL PURPOSE TECHNIC | 1 |
| EK-11034-UG | PDP-11/34 SYSTEM USERS GUIDE | 1 | EK-DR780-UG | DR780 GENERAL PURPOSE USERS G | 1 |
| EK-1134A-TM | PDP-11/34A POWER SYSTEM DESCR | 1 | MP-00835-00 | DR780 PRINTSET | 1 |
| EK-KD1EA-MM | KD11-E/A MAINTENANCE MANUAL | 1 | FB-DTC03-00 | DECTALK DTC03 KIT | \$404 |
| MP-00190-00 | 11/34-A PRINTSET | 1 | EK-DTC03-OM | DECTALK DTC03 TEXT TO SPEECH | 1 |
| FB-625NT-00 | MVAX 2000 TECH DOCUMENTION | \$648 | EK-DTC03-PS | DECTALK DTC03 POCKET SERVICE | 1 |
| EK-MVDH6-IP | MICROVAX 2000 IPB | 1 | EK-DTC03-RC | DECTALK DTC03 PROG. REF. CARD | 1 |
| EK-TZK50-MC | TZK50 MAINTENANCE CARD | 1 | MP-02270-01 | DTC03-AA PRINT SET | 1 |
| EK-TZK50-TM | TZK50 TECHNICAL MANUAL | 1 | FB-DW780-00 | DW780 DOCUMENTATION | \$1,260 |
| MP-02389-01 | H7848-B PRINT SET | 1 | EK-DW780-TD | VAX-11/780 DW780 TECH DESCRP. | 1 |
| MP-02399-01 | DH625NT PRINT SET | 1 | MP-00497-00 | DW780 PRINTSET | 1 |
| FB-650QX-00 | MVAX 3500/3600/3602 TECH DOC | \$1,104 | FB-DZ11-A | DZ11-A/B/E DOC | \$190 |
| EK-KA650-UG | KA650 USERS GUIDE | 1 | EK-DZ110-TM | DZ11 ASYNCH MX TECHNICAL MANU | 1 |
| EK-OTK70-SM | TK70 SERVICE MANUAL | 1 | EK-DZ110-UG | DZ11 USERS GUIDE | 1 |
| MP-02379-01 | DELQA PRINTSET | 1 | MP-00970-01 | DZ11-M MAINTENANCE PRINT | 1 |
| MP-02511-01 | H7868 | 1 | FB-DZ11-C | DZ11-C/D/F | \$200 |
| MP-02538-01 | MVAX 3000 BA213 PRINTSET | 1 | EK-DZ110-TM | DZ11 ASYNCH MX TECHNICAL MANU | 1 |
| FB-BDV11-00 | BDV11 DOCUMENTS | \$205 | EK-DZ110-UG | DZ11 USERS GUIDE | 1 |
| EK-BDV11-TM | BDV11 TECHNICAL MANUAL | 1 | MP-00970-02 | DZ11-N MAINTENANCE PRINT | 1 |
| MP-00489-00 | BDV11-A PRINTSET | 1 | FB-DZV11-00 | DZV11 DOCUMENTS | \$580 |
| FB-CI780-00 | CI780 DOCUMENTATION KIT | \$2,520 | EK-DZV11-TM | DZV11 ASYNCH MULTI TECH MAN | 1 |
| EK-CI780-TD | CI780 TECHNICAL DESCRIPTION | 1 | EK-DZV11-UG | DZV11 USER'S GUIDE | 1 |
| EK-CI780-UG | CI780 USERS GUIDE | 1 | MP-00462-00 | DZV11 PRINTSET | 1 |
| EK-CIVAX-RM | CI750 & 780 REFERENCE MANUAL | 1 | FB-FP730-00 | FP730 DOCUMENTATION KIT | \$498 |
| MP-01267-00 | CI780 PRINT SET | 1 | EK-FP730-TD | VAX-11/730 FP730 FPA TECHNICA | 1 |
| FB-DLV11-J | DLV11-J DOC | \$145 | MP-01364-00 | FP730 PRINTSET | 1 |
| EK-DLV1J-UG | DLV11-J USERS GUIDE | 1 | FB-FP780-00 | FP780-A DOCUMENTATION | \$885 |
| MP-00989-01 | DLV11-J PRINTSET | 1 | EK-FP780-TD | VAX-11/780 FLT PT TECHNICAL D | 1 |
| FB-DMF32-00 | DMF32 DOCUMENTATION KIT | \$250 | MP-00565-00 | FP780 PRINTSET | 1 |
| EK-DMF32-RM | DMF32 MAINTENANCE ADVISORY | 1 | | | |
| EK-DMF32-TD | DMF32 MULTI FUNCTION COMMU N | 1 | | | |
| EK-DMF32-UG | DMF32 USERS GUIDE | 1 | | | |
| MP-00965-00 | DMF32 MAINTENANCE PRINT | 1 | | | |

Continued on next page

 To Order, Call DECdirect at 800-344-4825. 8:30 AM to 8:00 PM (ET) in the Continental USA.

DOCUMENTATION KITS

Documentation Kits—continued

| | | | | | |
|--------------------|--------------------------------------|----------------|--------------------|-----------------------------------|----------------|
| FB-KA730-00 | KA730 DOCUMENTATION KIT | \$2,153 | FB-LA100-00 | LA100 DOC | \$825 |
| EK-11730-UG | VAX-11/730 HARDWARE USER GUID | 1 | EK-LA100-PS | LA100 SERIES POCKET SERVICE G | 1 |
| EK-1VAXD-TM | VAX DIAGNOSTIC DESIGN GUIDE | 1 | EK-LP1PC-UG | LA100 USER PACK | 1 |
| EK-DS730-UG | VAX-11/730 DIAGNOSTIC OVERVIE | 1 | MP-01096-00 | LA100 PRINT SET | 1 |
| EK-KA730-TD | VAX-11/730 CENTRAL PROCESSING | 1 | | | |
| EK-SI730-IN | VAX-11/730 INSTALLATION GUIDE | 1 | FB-LA12-00 | LA12 DOCUMENTATION KIT | \$750 |
| EK-VX11D-UG | VAX DIAGNOSTIC SYSTEM USERS G | 1 | EK-CPL12-PS | DECWRITER CORRESPONDENT SER.G | 1 |
| MP-01270-00 | 11/730-Z PRINTSET | 1 | EK-CPL12-UG | DECWRITER CORRESPONDENT USE P | 1 |
| | | | MP-01357-00 | LA12 PRINTSET | 1 |
| FB-KA750-00 | VAX-11/750 (KA750) CPU/SYSTEM | \$1,750 | FB-LA120-00 | LA120 DOCUMENTS | \$825 |
| EK-1VAXD-TM | VAX DIAGNOSTIC DESIGN GUIDE | 1 | EK-H7150-IP | H7150 POWER SUPPLY IPB | 1 |
| EK-750YA-RM | VAX-11/750 MICRODIAGNOSTIC RE | 1 | EK-LA120-IP | LA120 DECWRITER III IPB | 1 |
| EK-750YA-UG | VAX-11/750 SELF MAINT DIAGNOS | 1 | EK-LA120-PS | LA120 SERIES POCKET SERVICE G | 1 |
| EK-KA750-TD | VAX-11/750 CENTRAL PROCESSOR | 1 | EK-LA120-RG | LA120 OPERATOR REFERENCE CARD | 1 |
| EK-SI75F-IN | VAX-11/750 INSTALLATION GUIDE | 1 | EK-LA120-TM | LA120 TECHNICAL MANUAL | 1 |
| EK-UI750-TD | VAX-11/750 UNIBUS INTERFACE T | 1 | EK-LA120-UG | LA120 USERS GUIDE | 1 |
| EK-VXD75-UG | VAX-11/750 DIAGNOSTIC SYS OVE | 1 | MP-00663-00 | LA120 PRINTSET | 1 |
| MP-00838-00 | 11/750 PRINTSET | 1 | | | |
| MP-01024-00 | KA750 PRINTSET | 1 | FB-LA120-RA | LA120-RA DOCUMENTATION KIT | \$575 |
| | | | EK-H7150-IP | H7150 POWER SUPPLY IPB | 1 |
| FB-KA780-00 | KA780 DOC. KIT | \$4,609 | EK-LA2RA-IP | LA120-RA DECWRITER III IPB | 1 |
| EK-11780-UG | VAX-11/780 HARDWARE USERS GUI | 1 | EK-LA2RA-UG | LA120-RA USER GUIDE | 1 |
| EK-DS780-TD | VAX-11/780 TECHNICAL DESCRIPT | 1 | MP-01046-00 | LA120-RA PRINTSET | 1 |
| EK-DS780-UG | VAX-11/780 USERS GUIDE | 1 | | | |
| EK-KA780-TD | VAX-11/780 KA780 CENTRAL PROC | 1 | FB-LA180-00 | LA180 DOCUMENTS | \$572 |
| EK-MM780-TD | VAX-11/780 BUFFER, CACHE, SBI | 1 | EK-LA180-IP | LA180 DECPRINTER I IPB | 1 |
| EK-PS780-TD | VAX-11/780 POWER SYS TECHNICA | 1 | EK-LA180-MM | LA180 DECPRINTER I MAINTENANC | 1 |
| EK-SI78F-IN | VAX-11/780 INSTALLATION MAN. | 1 | EK-LA180-OP | LA180 DECPRINTER I USERS MANU | 1 |
| MP-00539-00 | 11/780 PRINTSET | 1 | MP-LA180-00 | LA180 PRINTSET | 1 |
| MP-01259-00 | H9602-M PRINT SET | 1 | | | |
| FB-KA785-00 | VAX 11/785 CPU AND SYS | \$5,200 | FB-LA34-00 | LA34 DOCUMENTATION KIT | \$760 |
| EK-11785-UG | VAX-11/785 USERS GUIDE | 1 | EK-LA34S-IP | LA34 DECWRITER IV IPB | 1 |
| EK-780EH-TD | MS780E & MS780H TECH. DESC. | 1 | EK-LA34S-PS | DECWRITER IV POCKET SERVICE G | 1 |
| EK-DW780-TD | VAX-11/780 DW780 TECH DESCRP. | 1 | EK-LA34S-TM | DECWRITER IV TECHNICAL MANUAL | 1 |
| EK-FP785-TD | FP785 FLOAT. PT ACC TECH DESC | 1 | EK-OLA34-RG | LA34 DECWRITER IV REFERENCE G | 1 |
| EK-KA785-TD | VAX 11/785 TECH. DESCRIPTION | 1 | EK-OLA34-UG | DECWRITER IV KSR SERIES USER | 1 |
| EK-KC785-TD | VAX-11/785 CONSOLE INTER TECH | 1 | MP-00695-00 | LA34 PRINTSET | 1 |
| EK-MM785-TD | VAX-11/785 TRANSLATION BUFFER | 1 | | | |
| EK-PS780-TD | VAX-11/780 POWER SYS TECHNICA | 1 | FB-LA36-00 | LA36 DOCUMENTS | \$465 |
| EK-RH780-TD | VAX-11/780 RH780 TECH DESCR M | 1 | EK-1LA36-MM | LA36 (BASIC MACHINE) MAINT MA | 1 |
| MP-01747-00 | VAX-11/785 PRINT | 1 | EK-2LA36-MM | LA36 (OPTION INFO) MAINT MANU | 1 |
| MP-01749-00 | 11785 CPU MAINT PRINT SET | 1 | EK-LA356-J1 | LA35/36 DECWRITER MINI MAINT | 1 |
| | | | EK-LA365-OP | LA35/36 DECWRITER II USERS MA | 1 |
| FB-KC750-00 | KC750 DOCUMENTS | \$60 | EK-OLA36-IP | LA36 DECWRITER II IPB | 1 |
| EK-KC750-IN | KC750 OPTIONS INSTALLATION GU | 1 | MP-LA36-00 | LA36 PRINTSET | 1 |
| EK-KC750-RM | VAX-11/750 DIAGNOSTICS MINI R | 1 | | | |
| EK-KC750-TM | KC750 MICRODIAGNOSTIC/TECHNIC | 1 | FB-LK201-00 | LK201 DOC | \$135 |
| EK-KC750-UG | KC750 OPTIONS USER GUIDE | 1 | EK-LK201-IP | LK201 KEYBOARD IPB | 1 |
| | | | MP-01395-00 | LK201-A-1 PRINTSET | 1 |
| FB-KC780-00 | KC780 DOCUMENTATION | \$885 | FB-LPS40-00 | TECH DOC KIT | \$2,360 |
| EK-KC780-IN | KC780 OPTIONS HARDWARE INSTAL | 1 | EK-LPS40-IP | LPS40 PRINTSERVER IPB | 1 |
| EK-KC780-TD | VAX-11/780 CONSOLE INTERFACE | 1 | EK-LPS40-SV | LPS40 SERVICE GDE | 1 |
| EK-KC780-UG | KC780 OPTION USERS GUIDE | 1 | MP-02273-01 | LPS40 PRINTSET | 1 |
| MP-00534-00 | KC780 PRINTSET | 1 | | | |
| FB-KE44-A | KE44-A DOC | \$250 | | | |
| EK-KE44A-TM | KE44-A CISP TECHNICAL MANUAL | 1 | | | |
| EK-KE44A-UG | KE44-A CISP USERS GUIDE | 1 | | | |
| MP-00813-00 | KE44-A PRINTSET | 1 | | | |

Continued on next page

digital To Order, Call DECdirect at 800-344-4825. 8:30 AM to 8:00 PM (ET) in the Continental USA.

Documentation Kits—continued

| | | | | | |
|--------------------|--|----------------|--------------------|--------------------------------------|----------------|
| FB-LPS40-UK | USERS DOC KIT -IN -OP -RC | \$2,360 | FB-MVII-02 | 630Q3-H,Q3-J,Q4-J TECH DOC | \$2,122 |
| EK-LPS40-IN | PRINTSERVER 40 INSTALL. GUIDE | 1 | EK-DHQ11-MC | DHQ11 MAINTENANCE CARD | 1 |
| EK-LPS40-OP | LPS40 OPERATORS GDE | 1 | EK-DHQ11-TM | DHQ11 TECH MANUAL | 1 |
| EK-LPS40-RC | LPS40 REFERENCE CARD | 1 | EK-LEP05-IP | TK50-D/R TAPE DRIVE SUBSYSTEM | 1 |
| FB-M9312-00 | M9312 DOCUMENTS | \$688 | EK-OTK50-TM | TK50 TAPE DRIVE TECH. MANUAL | 1 |
| EK-M9312-TM | M9312 TECHNICAL MANUAL (PDP-1 | 1 | EK-OTK70-SM | TK70 SERVICE MANUAL | 1 |
| MP-00617-00 | M9312 PRINTSET | 1 | EK-RD53A-IP | RD53A ILLUSTRATED PARTS | 1 |
| FB-MA780-00 | MA780 DOCUMENTATION | \$2,500 | EK-RD53A-TD | RD53-A FIXED DISK DRIVE TECH. | 1 |
| EK-MA780-TD | MA780 MULTIPOINT MEMORY TECHN | 1 | EK-RD54A-IP | RD54A ILLUSTRATED PARTS | 1 |
| MP-00826-00 | MA780-A MAINT PRINT | 1 | MP-02054-01 | TK50 PRINT SET | 1 |
| FB-MICRO-11 | MICRO/PDP-11 HARDWARE DOC KIT | \$893 | MP-02259-01 | RQDX3 PRINTSET | 1 |
| EK-KDFEB-UG | KDF11-BA CPU MODULE USER GUID | 1 | MP-02379-01 | DELQA PRINTSET | 1 |
| EK-MIC11-SG | MICRO PDP-11 SYS MAINT GUIDE | 1 | MP-02380-00 | DHQ11 PRINTSET | 1 |
| EK-MSVOP-UG | MSV11-P USER GUIDE | 1 | FB-MVII-03 | 630Q5-H, 630Q6-B TECH DOC | \$1,360 |
| EK-O67AB-PG | MICROSYSTEMS SITE PREP GD | 1 | EK-00874-IP | 874 POWER CONTROLLER IPB | 1 |
| EK-OLCP5-IN | MICRO/PDP-11 UNPACKING & INST | 1 | EK-BA23A-IP | BA23-A UNIT ASSEMBLY IPB | 1 |
| EK-OLCP5-IP | MICRO/PDP-11 IPB | 1 | EK-DHQ11-MC | DHQ11 MAINTENANCE CARD | 1 |
| EK-OLCP5-OM | MICRO/PDP-11 OWNERS MANUAL | 1 | EK-DHQ11-TM | DHQ11 TECH MANUAL | 1 |
| EK-MIC11-SG | MICRO PDP-11 SYS MAINT GUIDE | 1 | EK-OTK70-SM | TK70 SERVICE MANUAL | 1 |
| EK-OLCP5-TM | MICRO/PDP-11 SYS TECHNICAL MA | 1 | MP-01016-00 | 874 PRINTSET | 1 |
| MP-01236-00 | KDF11-B PRINTSET | 1 | MP-02065-01 | MICROVAX II BA23 PEDESTAL PRI | 1 |
| MP-01239-00 | MSV11-P PRINSET | 1 | MP-02379-01 | DELQA PRINTSET | 1 |
| FB-MS730-00 | MS730 DOCUMENTATION KIT | \$375 | MP-02380-00 | DHQ11 PRINTSET | 1 |
| EK-MS730-TD | VAX-11/730 MEMORY SYS TECH DE | 1 | FB-PC100-00 | PC100 TECH & SV DOC | \$171 |
| MP-01366-00 | MS730 PRINTSET | 1 | EK-LK201-IP | LK201 KEYBOARD IPB | 1 |
| FB-MS780-00 | MS780 DOCUMENTATION | \$1,565 | EK-ORX50-IP | RX50 DUAL DISKETT DRIVE IPB | 1 |
| EK-780EH-RM | MS780-E/F & MS780-H/S MAINT. | 1 | EK-P100E-IN | RAINBOW 100 A INSTALLATION GU | 1 |
| EK-780EH-TD | MS780E & MS780H TECH. DESC. | 1 | EK-P100E-OM | RAINBOW OWNERS MANUAL | 1 |
| EK-MS780-TD | MS780 MEMORY SYSTEM TECH DESC | 1 | EK-PC100-PS | RAINBOW 100 POCKET SERVICE GU | 1 |
| MP-00498-00 | MS780 PRINTSET | 1 | EK-PCMXE-IN | RAINBOW 100 MEMORY EXTENSION | 1 |
| FB-MVII-00 | 630Q1 TECH DOCUMENTATION | \$1,960 | EK-SB100-IP | PC100 RAINBOW 100 SYSTEM UNIT | 1 |
| EK-BA23A-IP | BA23-A UNIT ASSEMBLY IPB | 1 | EK-VR201-IP | VR20/MONOCROME MONITOR IPB | 1 |
| EK-RD53A-IP | RD53A ILLUSTRATED PARTS | 1 | FB-PC100-MP | PC100 PRINTSET | \$830 |
| EK-RD53A-TD | RD53-A FIXED DISK DRIVE TECH. | 1 | MP-01395-00 | LK201-A-1 PRINTSET | 1 |
| MP-02065-01 | MICROVAX II BA23 PEDESTAL PRI | 1 | MP-01410-00 | VR201 PRINTSET | 1 |
| MP-02259-01 | RQDX3 PRINTSET | 1 | MP-01482-00 | RX50-AA PRINTSET | 1 |
| MP-02379-01 | DELQA PRINTSET | 1 | MP-01491-00 | PC100 PRINTSET | 1 |
| FB-MVII-01 | 630Q2-H, 630Q2-F TECH DOC | \$2,024 | FB-PC278-00 | PC278 TECH & SV DOC | \$194 |
| EK-BA23A-IP | BA23-A UNIT ASSEMBLY IPB | 1 | EK-DECM2-IN | DECMATE INSTALLATION GUIDE | 1 |
| EK-DZQ11-MC | DZQ11 MAINTENANCE CARD | 1 | EK-DECM2-OM | DECMATE II OWNERS MANUAL | 1 |
| EK-DZQ11-TM | DZQ11-A ASYNCH MULTI TECH MAN | 1 | EK-DECM2-PS | DECMATE II POCKET SERVICE GUI | 1 |
| EK-LEP05-IP | TK50-D/R TAPE DRIVE SUBSYSTEM | 1 | EK-DM250-IN | RX50 DISKETTE DRIVE INSTALLAT | 1 |
| EK-OTK50-TM | TK50 TAPE DRIVE TECH. MANUAL | 1 | EK-DM2CP-IN | DECMATE II CP/M BOARD INSTALL | 1 |
| EK-RD53A-IP | RD53A ILLUSTRATED PARTS | 1 | EK-DM2DM-RC | DECMATE II DOCUMENTATION MAP | 1 |
| EK-RD53A-TD | RD53-A FIXED DISK DRIVE TECH. | 1 | EK-LK201-IP | LK201 KEYBOARD IPB | 1 |
| EK-RD54A-IP | RD54A ILLUSTRATED PARTS | 1 | EK-ORX50-IP | RX50 DUAL DISKETT DRIVE IPB | 1 |
| MP-01795-01 | DZQ11-M PRINTSET | 1 | FB-PC278-MP | DECMATE II MAINT PRINTSET KIT | \$820 |
| MP-02054-01 | TK50 PRINT SET | 1 | MP-01395-00 | LK201-A-1 PRINTSET | 1 |
| MP-02065-01 | MICROVAX II BA23 PEDESTAL PRI | 1 | MP-01410-00 | VR201 PRINTSET | 1 |
| MP-02259-01 | RQDX3 PRINTSET | 1 | MP-01482-00 | RX50-AA PRINTSET | 1 |
| | | | MP-01492-00 | PC 278 PRINTSET | 1 |

Continued on next page

digital To Order, Call DECdirect at 800-344-4825. 8:30 AM to 8:00 PM (ET) in the Continental USA.

DOCUMENTATION KITS

Documentation Kits—continued

| | | | | | |
|--------------------|------------------------------------|----------------|--------------------|-----------------------------------|----------------|
| FB-PC350-00 | PC350 TECH & SV DOC | \$80 | FB-RL01-00 | RL01 DOCUMENTATION KIT | \$580 |
| EK-LK201-IP | LK201 KEYBOARD IPB | 1 | EK-ORL01-IP | RL01 DISK DRIVE IPB | 1 |
| EK-ORX50-IP | RX50 DUAL DISKETT DRIVE IPB | 1 | EK-RL012-PG | RL01/02 POCKET SERVICE GUIDE | 1 |
| EK-PC350-PS | PROFESSIONAL 300 SERIES SERVI | 1 | EK-RL012-UG | RL01/02 USERS GUIDE | 1 |
| EK-VR201-IP | VR20/MONOCROME MONITOR IPB | 1 | EK-RL121-TM | RL01/RL02 TECH MAN. VOL I. | 1 |
| | | | EK-RL122-TM | RL01/RL02 TECH MAN. VOL II. | 1 |
| | | | EK-RLTER-PS | RL01/02 POCKET SERVICE GUIDE | 1 |
| | | | MP-00347-00 | RL01 PRINTSET | 1 |
| FB-PC350-MP | PC350 PRINT SET KIT | \$1,200 | FB-RL02-00 | RL02 DOCUMENTATION KIT | \$580 |
| MP-01394-00 | PC350 PRINTSET | 1 | EK-ORL02-IP | RL02 DISK DRIVE IPB | 1 |
| MP-01395-00 | LK201-A-1 PRINTSET | 1 | EK-RL012-PG | RL01/02 POCKET SERVICE GUIDE | 1 |
| MP-01410-00 | VR201 PRINTSET | 1 | EK-RL012-UG | RL01/02 USERS GUIDE | 1 |
| MP-01482-00 | RX50-AA PRINTSET | 1 | EK-RL121-TM | RL01/RL02 TECH MAN. VOL I. | 1 |
| | | | EK-RL122-TM | RL01/RL02 TECH MAN. VOL II. | 1 |
| | | | EK-RLTER-PS | RL01/02 POCKET SERVICE GUIDE | 1 |
| | | | MP-00553-00 | RL02 PRINTSET | 1 |
| FB-R80-00 | R80 TECH DOCUMENTATION KIT | \$1,104 | FB-RL11-00 | RL11 DOC. KIT | \$430 |
| EK-OH766-IP | H766 POWER SUPPLY IPB | 1 | EK-ORL11-TD | RL11 CONTROLLER TECHNICAL DES | 1 |
| EK-OOR80-IP | R80 DISK DRIVE I P B | 1 | MP-00153-00 | RL11 PRINTSET | 1 |
| EK-OOR80-PS | R80 DISK DRIVE POCKET SERVICE | 1 | | | |
| EK-OOR80-SV | R80 DISK DRIVE SERVICE MANUAL | 1 | FB-RLV12-00 | RLV12 DOCUMENTS | \$285 |
| MP-01419-00 | R80 PRINTSET | 1 | EK-RLV12-UG | RLV12 DISK CONTROLLER USERS G | 1 |
| | | | MP-01282-00 | RLV12 PRINTSET | 1 |
| FB-RA60-00 | RA60 TECH DOCUMENTATION KIT | \$684 | FB-RM02-00 | RM02 DOC. KIT | \$578 |
| EK-ORA60-FG | RA60 SUBSYSTEM FAULT ISOLATIO | 1 | EK-ORM02-IP | RM02 ILLUSTRATED PARTS | 1 |
| EK-ORA60-IP | RA60 DISK DRIVE IPB | 1 | EK-RM023-SV | RM02/03 DISK SUBSYSTEM SERVIC | 1 |
| EK-ORA60-SV | RA60 DISK DRIVE SERVICE MANUA | 1 | EK-RM023-UG | RM02/03 USERS GUIDE MANUAL | 1 |
| MP-01421-00 | RA60 PRINT | 1 | ER-ORM02-MP | RM02 PRINTSET | 1 |
| | | | ER-ORM02-TM | RM02 TECHNICAL MANUAL | 1 |
| | | | MP-00456-00 | RM02 PRINTSET | 1 |
| FB-RA70-00 | RA70 DOCUMENTATION KIT | \$318 | FB-RM03-00 | RM03 DOCUMENTS | \$578 |
| EK-ORA70-PS | RA70 DSK DRV POCKET REF CARD | 1 | EK-ORM03-IP | RM03 DISK DRIVE IPB | 1 |
| EK-RA70A-IP | RA70 ILLUSTRATED PARTS BRKDN | 1 | EK-RM023-SV | RM02/03 DISK SUBSYSTEM SERVIC | 1 |
| MP-01428-01 | RA70 PRINTSET | 1 | EK-RM023-UG | RM02/03 USERS GUIDE MANUAL | 1 |
| | | | ER-ORM03-MP | RM03 DISK DRIVE MAINT MANUAL | 1 |
| | | | ER-ORM03-TM | RM03 DISK DRIVE TECH MANUAL | 1 |
| | | | MP-00350-00 | RM03 PRINTSET | 1 |
| FB-RA80-00 | RA80 DOCUMENTS | \$1,284 | FB-RM05-00 | RM05 DOCUMENTS | \$2,075 |
| EK-00874-IP | 874 POWER CONTROLLER IPB | 1 | EK-ORM05-IP | RM05 DISK DRIVE IPB | 1 |
| EK-OH766-IP | H766 POWER SUPPLY IPB | 1 | EK-ORM05-SV | RM05 DISK DRIVE SERVICE MANUA | 1 |
| EK-ORA80-IP | RA80/RUA80 DISK DRIVE IPB | 1 | EK-ORM05-UG | RM05 DISK SUBSYSTEM USERS GUI | 1 |
| EK-ORA80-SV | RA80 DISK DRIVE SERVICE MANUA | 1 | MP-01075-00 | RM05 PRINTSET | 1 |
| EK-ORA80-UG | RA80 DISK DRIVE USER GUIDE | 1 | | | |
| MP-01420-00 | RA80 PRINT SET | 1 | FB-RM80-00 | RM80 DOCUMENTS | \$150 |
| | | | EK-ORM80-IP | RM80 IPB | 1 |
| FB-RA90-00 | RA90 TECHNICAL DOC KIT | \$335 | EK-ORM80-PG | RM80 DISK DRIVE POCKET GUIDE | 1 |
| EK-ORA90-IP | RA90 ILLUSTRATED PARTS | 1 | EK-ORM80-SV | RM80 DISK DRIVE SERVICE MANUA | 1 |
| EK-ORA90-PS | RA90 POCKET SERVICE GUIDE | 1 | EK-ORM80-TD | RM80 DISK DRIVE TECH DESCRIPT | 1 |
| MP-01424-00 | SA600-X (RA90 PRINTSET) | 1 | EK-ORM80-UG | RM80 DISK DRIVE USERS GUIDE | 1 |
| | | | | | |
| FB-RB730-00 | RB730 DOCUMENTATION KIT | \$242 | FB-RV20-00 | RV20 TECHNICAL DOCUMNT KIT | \$1,268 |
| EK-RB730-TD | VAX-11/730 IDC TECHNICAL | 1 | EK-ORV20-SV | RV20 SERVICE MANUAL | 1 |
| MP-01278-00 | RB730 PRINTSET | 1 | EK-RV20P-IP | RV20 ILLUSTRATED PARTS | 1 |
| | | | MP-02293-01 | RV20 MAINTENANCE PRINTSET | 1 |
| FB-RH780-00 | RH780 DOCUMENTATION KIT | \$805 | | | |
| EK-RH780-TD | VAX-11/780 RH780 TECH DESCR M | 1 | | | |
| MP-00499-00 | RH780 PRINTSET | 1 | | | |
| FB-RK07-00 | RK07 DOCUMENTS | \$1,150 | | | |
| EK-ORK07-IP | RK07 IPB | 1 | | | |
| EK-RK067-SV | RK06/RK07 DISK DRIVE SERVICE | 1 | | | |
| EK-RK067-TD | RK06/07 TECHNICAL DESCRIPTION | 1 | | | |
| EK-RK067-UG | RK06/07 USERS MANUAL | 1 | | | |
| MP-00576-00 | RK07 PRINTSET | 1 | | | |

Continued on next page

digital To Order, Call DECdirect at 800-344-4825. 8:30 AM to 8:00 PM (ET) in the Continental USA.

Documentation Kits—continued

| | | | | | |
|--------------------|-------------------------------------|----------------|--------------------|------------------------------------|----------------|
| FB-RX01-00 | RX01 DOCUMENTATION KIT | \$765 | FB-TM03-00 | TM03 DOCUMENTS | \$1,200 |
| EK-13077-IP | 70-13077 FLEXIBLE DISK DRIVE | 1 | EK-H740D-IP | H740-D/DA POWER SUPPLY IPB | 1 |
| EK-ORX01-IP | RX01 FLOPPY DISK IPB | 1 | EK-OTM03-IP | TM03 FORMATTER IPB | 1 |
| EK-ORX01-MM | RX01/08/11 MAINTENANCE MANUAL | 1 | EK-OTM03-TM | TM03 MAGNETIC TAPE FORMATTER | 1 |
| EK-ORX01-OP | RX8/RX11 RX01 FLOPPY DISK SYS | 1 | EK-OTM03-UG | TM03 MAGNETIC TAPE FORMATTER | 1 |
| EK-RX012-PS | RX01/RX02 POCKET SERVICE GUID | 1 | MP-00349-00 | TM03 PRINTSET | 1 |
| EK-RX102-RC | RX01/RX02 REFERENCE CARD | 1 | | | |
| MP-00296-00 | RX01 PRINTSET | 1 | | | |
| | | | FB-TM78-00 | TM78 DOCUMENTS | \$145 |
| FB-RX02-00 | RX02 DOCUMENTATION KIT | \$695 | EK-00872-IP | 872 POWER CONTROLLER IPB | 1 |
| EK-13077-IP | 70-13077 FLEXIBLE DISK DRIVE | 1 | EK-00874-IP | 874 POWER CONTROLLER IPB | 1 |
| EK-ORX02-IP | RX02 FLOPPY DISK IPB | 1 | EK-OTM78-TM | TM78 MAGNETIC TAPE FORMATTER | 1 |
| EK-ORX02-TM | RX02 FLOPPY DISK SYS TECHNICA | 1 | EK-OTM78-UG | TM-78 TAPE USERS GUIDE | 1 |
| EK-ORX02-UG | RX02 FLOPPY DISK SYSTEM USERS | 1 | | | |
| EK-RX012-PS | RX01/RX02 POCKET SERVICE GUID | 1 | FB-TS11-00 | TS11 DOCUMENTS | \$1,550 |
| EK-RX102-RC | RX01/RX02 REFERENCE CARD | 1 | EK-OTS11-PS | TS11 POCKET SERVICE GUIDE | 1 |
| MP-00629-00 | RX02 PRINTSET | 1 | EK-OTS11-TM | TS11 SUBSYSTEM TECHNICAL MANU | 1 |
| | | | EK-OTS11-UG | TS11 SUBSYSTEM USERS GUIDE | 1 |
| FB-RX33-00 | RX33 TECH DOCUMENTATION KIT | \$117 | EK-TS11A-IP | TS11-A MAGNETIC TAPE SYSTEM I | 1 |
| EK-ORX33-IP | RX33 IPB | 1 | EK-TS11C-IP | TS11-C MAGNETIC TAPE SUBSYSTE | 1 |
| EK-RX33T-TM | RX33T/RX33 TECH DESCRIPTION | 1 | MP-00849-00 | TS11-A PRINTSET | 1 |
| MP-02279-01 | RX33 PRINT SET | 1 | | | |
| | | | FB-TSV05-00 | TSV05 DOC | \$465 |
| FB-RX50-00 | RX50 DOC KIT | \$235 | EK-TSV05-IN | TSV05 TAPE TRANSPORT SUBSYSTE | 1 |
| EK-DM250-IN | RX50 DISKETTE DRIVE INSTALLAT | 1 | EK-TSV05-PS | TSV05 TAPE TRANSPORT POCKET S | 1 |
| EK-ORX50-IP | RX50 DUAL DISKETT DRIVE IPB | 1 | EK-TSV05-TM | TSV05 TAPE TRANSPORT SUBSYS. | 1 |
| MP-01482-00 | RX50-AA PRINTSET | 1 | EK-TSV05-UG | TSV05 TAPE TRANSPORT SUBSYS U | 1 |
| | | | MP-01157-00 | TSV05 PRINTSET | 1 |
| | | | | | |
| FB-RXV11-00 | RXV11 DOCUMENTS | \$1,390 | FB-TU58-00 | TU58 DOC. KIT | \$375 |
| EK-RXV11-OP | RXV11 USER'S GUIDE | 1 | EK-OTU58-IP | TU58 CARTRIDGE TAPE DIRVE IPT | 1 |
| MP-00024-00 | RXV11 PRINTSET | 1 | EK-OTU58-PS | TU58 DECTAPE II POCKET SERVIC | 1 |
| | | | EK-OTU58-TM | TU58 DECTAPE-11 TECHNICAL MAN | 1 |
| FB-TA78-00 | TA78 TECH DOCUMENTATION KIT | \$616 | EK-OTU58-UG | TU58 DECTAPE-11 USERS GUIDE | 1 |
| EK-OTA78-SV | TA78 MAGNETIC TAPE DRIVE | 1 | MP-00747-00 | TU58-C PRINTSET | 1 |
| EK-OTA79-TM | TA79,TA78,TU78,TECH MANUAL | 1 | | | |
| MP-01614-00 | TA78 PRINT SET | 1 | FB-TU77-00 | TU77 DOCUMENTS | \$325 |
| | | | EK-00861-IP | 861-A/B/C/D/E/F IPB | 1 |
| FB-TA79-00 | TA79,TU79,TS78 TM78 DOC KIT | \$1,340 | EK-1TU77-TM | TU77 MAGNECTIC TAPE TRANSPORT | 1 |
| EK-OTA79-SV | TA79 SERVICE MANUAL | 1 | EK-2TU77-TM | TU77 MAGTAPE TECH MANUAL V2 | 1 |
| EK-OTA79-TM | TA79,TA78,TU78,TECH MANUAL | 1 | EK-H740D-IP | H740-D/DA POWER SUPPLY IPB | 1 |
| EK-TUA79-IP | TA79 ILLUSTRATED PARTS | 1 | EK-OTU77-IP | TU77 MAGNETIC TAPE TRANSPORT | 1 |
| MP-02289-01 | TA79,TU79,TS78,TM78 PRINT | 1 | EK-OTU77-UG | TU77 MAGTAPE TRANSPORT USER G | 1 |
| | | | MP-00644-00 | TU77 PRINTSET | 1 |
| | | | | | |
| FB-TE16-00 | TE16 DOCUMENTS | \$945 | FB-TU78-00 | TU78 DOCUMENTS | \$1,500 |
| EK-00861-IP | 861-A/B/C/D/E/F IPB | 1 | EK-00872-IP | 872 POWER CONTROLLER IPB | 1 |
| EK-OTE16-IP | TE16 DEC MAGTAPE IPB | 1 | EK-00874-IP | 874 POWER CONTROLLER IPB | 1 |
| EK-OTE16-TM | TE16/TE10W/TE10N MAINTENANCE | 1 | EK-OTA79-TM | TA79,TA78,TU78,TECH MANUAL | 1 |
| EK-OTEWN-OP | TE16/TE10W/TE10N USERS MANUAL | 1 | EK-OTA79-TM | TA79,TA78,TU78,TECH MANUAL | 1 |
| MP-00333-00 | TE16 PRINTSET | 1 | EK-OTU78-PS | TU78 SUBSYSTEM POCKET SERVIC | 1 |
| | | | EK-OTU78-UG | TU78 MAGNETIC TAPE TRANSPORT | 1 |
| | | | MP-01061-00 | TU78 PRINTSET | 1 |
| | | | | | |
| FB-TK50-00 | TK50 TECHNICAL DOCUMENTATION | \$280 | FB-TU80-00 | TU80 HARDWARE DOCUMENTATION | \$390 |
| EK-LEP05-IP | TK50-D/R TAPE DRIVE SUBSYSTEM | 1 | EK-OTU80-IP | TU80 IPB | 1 |
| EK-OTK50-TM | TK50 TAPE DRIVE TECH. MANUAL | 1 | EK-OTU80-PS | TU80 POCKET SERVICE GUIDE | 1 |
| MP-02054-01 | TK50 PRINT SET | 1 | EK-OTU80-SV | TU80 PATHFINDER USER GUIDE | 1 |
| | | | EK-OTU80-TM | TU80 TAPE SUBSYS TECHNICAL MA | 1 |
| | | | EK-OTU80-UG | TU80 SUBSYSTEM USERS GUIDE | 1 |
| | | | MP-01603-01 | TU80 PRINTSET | 1 |
| FB-TK70-00 | TK70 TECH DOC KIT | \$320 | | | |
| EK-OTK70-SM | TK70 SERVICE MANUAL | 1 | | | |
| EK-TK70A-IP | TK70 ILUSTRATED PARTS BRKDN | 1 | | | |
| MP-02294-01 | TK70 PRINTSET | 1 | | | |

Continued on next page

 To Order, Call DECdirect at 800-344-4825. 8:30 AM to 8:00 PM (ET) in the Continental USA.

DOCUMENTATION KITS

Documentation Kits—continued

| | | | | | |
|--------------------|-----------------------------------|----------------|--------------------|--|----------------|
| FB-TU81-00 | TU81 DOC KIT | \$1,044 | FB-VR290-00 | VR290 DCO KIT | \$262 |
| EK-OTU81-IP | TU81 IPB | 1 | EK-VR290-IP | VR290 IPB | 1 |
| EK-OTU81-PS | TU81 POCKET SERVICE GUIDE | 1 | EK-VR290-SV | VR290 ILLUSTRATED SERVICE | 1 |
| EK-TUA81-SV | TU81/TA81 SERVICE MANUAL | 1 | MP-02362-00 | VR290 PRINTSET | 1 |
| EK-TUA81-TM | TU81/TA81 TECH MANUAL | 1 | | | |
| MP-01618-00 | TU81 PRINT SET | 1 | FB-VS300-00 | VAXSTATION 3200/3500 TECH DOC | \$1,110 |
| FB-UDA50-00 | UDA50 DOCUMENTS | \$460 | EK-104AA-TM | VCB02 VIDEO SYS TECH MANUAL | 1 |
| EK-UDA50-SV | UDA50 SERVICE MANUAL | 1 | EK-KA650-UG | KA650 USERS GUIDE | 1 |
| EK-UDA50-UG | UDA50 USER GUIDE | 1 | MP-02083-01 | VCBO2 PRINTSET | 1 |
| MP-01331-00 | UDA50 PRINT SET | 1 | MP-02379-01 | DELQA PRINTSET | 1 |
| FB-VAXBI-00 | VAX BI FAMILY TECH DOC KIT | \$128 | FB-VT100-00 | VT100 DOCUMENTS | \$725 |
| EB-29228-46 | VAX BI OPTIONS HDBK 88Q2 | 1 | EK-VT100-IP | VT100 VIDEO TERMINAL IPB | 1 |
| EK-KA88D-UG | VAX 8500/8550/8700/8800 DIAG | 1 | EK-VT100-J1 | VT100 SERIES POCKET SERVICE | 1 |
| EY-6774E-MG | VAXBI MAINT GDE TRAINING VERS | 1 | EK-VT100-RC | VT100 PROGRAM REFERENCE CARD | 1 |
| | | | EK-VT100-TM | VT100 TECHNICAL MANUAL | 1 |
| | | | EK-VT100-UG | VT100 USERS GUIDE | 1 |
| | | | MP-00633-00 | VT100 PRINTSET | 1 |
| FB-VAXBI-01 | VAX 8200/8300 TECH DOC KIT | \$2,190 | FB-VT101-00 | VT101 DOCUMENTS | \$820 |
| EK-KA820-TM | KA820/KA825 PROC TECH MANUAL | 1 | EK-VT101-IP | VT101 IPB | 1 |
| EK-VXDSU-UG | VAX DIAGNOSTIC SUPERVISOR USE | 1 | EK-VT101-PS | VT101 POCKET SERVICE GUIDE | 1 |
| MP-01786-01 | VAX 8200 PRINTSET | 1 | EK-VT101-RC | VT101 PROGRAMMING REFERENCE C | 1 |
| MP-01791-01 | VAX 8300 PRINTSET | 1 | MP-01066-00 | VT101 PRINTSET | 1 |
| FB-VAXBI-03 | VAX 8700/8800 TECH DOC KIT | \$2,575 | FB-VT102-00 | VT102 DOCUMENTS | \$70 |
| EK-8800H-UG | VAX 8700/8800 SYS HDW USRS GD | 1 | EK-VT102-IP | VT102 IPB | 1 |
| EK-8800X-IP | VAX 8700/8800 SYSTEM IPB | 1 | EK-VT102-RC | VT102 PROGRAMMING REFERENCE C | 1 |
| EK-KA88G-UG | VAX 8800 BACKPLANE X-REF GD. | 1 | EK-VT102-UG | VT102 VIDEO TERMINAL USERS GU | 1 |
| EK-KA88H-UG | VAX 8800 MACHINE CHECK GUIDE | 1 | | | |
| MP-01788-01 | VAX 8700/8800 PRINTSET | 1 | FB-VT125-00 | VT125 DOCUMENTATION KIT | \$925 |
| FB-VAXBI-04 | VAX 8820/8830/8840 DOC KIT | \$4,096 | EK-VT125-GI | VT125 REGIS PRIMER | 1 |
| EK-8840A-IP | VAX 8820/8830/8840 IPB | 1 | EK-VT125-IP | VT125 VIDEO TERMINAL IPB | 1 |
| EK-8840H-UG | VAX 8820/8830/8840 USERS GDE | 1 | EK-VT125-RC | VT125 PROGRAMMING REFERENCE C | 1 |
| MP-01788-01 | VAX 8700/8800 PRINTSET | 1 | EK-VT125-UG | VT125 USERS GUIDE | 1 |
| MP-01837-01 | VAX 8820/8830/8840 PRINTSET | 1 | MP-01053-00 | VT125 PRINTSET | 1 |
| FB-VAXBI-05 | VAX 6200 TECHNICAL DOC KIT | \$848 | FB-VT180-00 | VT180 DOCUMENTATION KIT | \$42 |
| EK-620AA-HR | VAX 6200 REFERENCE MANUAL | 1 | EK-VT18X-PS | VT180 SERIES POCKET SERVICE G | 1 |
| EK-620AA-TM | VAX 6200 TECHNICAL MANUAL | 1 | EK-VT18X-TM | VT180 SERIES TECHNICAL MANUAL | 1 |
| MP-01848-01 | VAX 6200 MAINTENANCE PRINTSET | 1 | | | |
| FB-VR150-00 | VR150 DOCUMENTATION KIT | \$180 | FB-VT220-00 | VT220 HARDWARE DOCUMENTATION | \$820 |
| EK-VR150-IP | VR150 ILLUSTRATED PARTS | 1 | EK-VT220-IP | VT220 IPB | 1 |
| EK-VR150-PS | VR150 MONOCHROME POCKET SERV | 1 | EK-VT220-PS | VT220 POCKET SERVICE GUIDE | 1 |
| MP-02544-01 | VR150 MAINTENANCE PRINTSET | 1 | EK-VT220-TM | VT220 TECHNICAL MANUAL | 1 |
| | | | MP-01732-01 | VT220 MAINTENANCE PRINTS | 1 |
| FB-VR160-00 | VR160 DOCUMENTATION KIT | \$204 | FB-VT220-UK | VT220 USER DOCUMENTATION KIT | \$96 |
| EK-VR160-IP | VR160 ILLUSTRATED PARTS | 1 | EK-VT220-AN | VT220 ADDITIONAL NOTES | 1 |
| EK-VR160-PS | VR160 POCKET SERVICE GUIDE | 1 | EK-VT220-HR | VT220 PROGRAMMER POCKET GUIDE | 1 |
| MP-02595-01 | VR160 MAINTENANCE PRINT | 1 | EK-VT220-IN | VT220 INSTALLATION GUIDE | 1 |
| | | | EK-VT220-RM | VT220 PROGRAMMER REFERENCE MA | 1 |
| | | | EK-VT220-UG | VT220 OWNERS MANUAL | 1 |
| FB-VR260-00 | VR260 DOC KIT | \$222 | | | |
| EK-VR260-IP | VR260 19" MONITOR IPB | 1 | | | |
| EK-VR260-MA | VR260 MAINTENANCE ADVISORY | 1 | | | |
| MP-02004-01 | VR260 MONITOR PRINT SET | 1 | | | |

Continued on next page

digital To Order, Call DECdirect at 800-344-4825. 8:30 AM to 8:00 PM (ET) in the Continental USA.

Documentation Kits—continued

| | | | |
|--------------------|---|---|--------------|
| FB-VT240-00 | VT240 HARDWARE DOCUMENTATION | | \$880 |
| EK-VT240-IP | VT240 VIDEO TERM. IPB | 1 | |
| EK-VT240-PS | VT240 POCKET SERVICE GUIDE | 1 | |
| EK-VT240-TM | VT240 TECHNICAL MANUAL | 1 | |
| MP-01807-01 | VT240 MAINTENANCE PRINTS | 1 | |
| FB-VT240-UK | VT240 USER DOCUMENTATION KIT | | \$160 |
| EK-VT240-HR | VT240 PROGRAMMER POCKET GUIDE | 1 | |
| EK-VT240-IN | VT240 INSTALLATION GUIDE | 1 | |
| EK-VT240-RM | VT240 PROGRAMMER REFERENCE MA | 1 | |
| EK-VT240-UG | VT240 OWNER'S MANUAL | 1 | |
| FB-VT241-00 | VT241 TECH DOCUMENTATION KIT | | \$995 |
| EK-V241E-PS | VR241-A COLOR VIDEO MAINTENAN | 1 | |
| EK-VR241-IP | VR241-A 13" COLOR MON. IPB | 1 | |
| EK-VR241-PS | VR241-A POCKET SERVICE GUIDE | 1 | |
| EK-VS240-IP | VS240 SYSTEM BOX IPB | 1 | |
| EK-VT241-IP | VT241 COLOR TERMINAL IPB | 1 | |
| MP-02002-01 | VR241 PRNT W/LK201 & VS240 | 1 | |
| FB-VT320-00 | VT320 TECH DOCUMENTATION KIT | | \$525 |
| EK-VT320-IP | VT320 ILLUSTRATED PARTS | 1 | |
| EK-VT320-PS | VT320 POCKET SERVICE GUIDE | 1 | |
| MP-02509-01 | VT320 PRINTSET | 1 | |
| FB-VT330-00 | VT330 TECH DOCUMENTATION KIT | | \$453 |
| EK-VT330-IP | VT330 IPB | 1 | |
| EK-VT330-PS | VT330 POCKET SERVICE GDE | 1 | |
| MP-02411-01 | VT330 PRINTSET | 1 | |
| FB-VT340-00 | VT340 TECH DOCUMENTATION | | \$525 |
| EK-VT340-IP | VT340 IPB | 1 | |
| EK-VT340-PS | VT340 POCKET SERVICE GUIDE | 1 | |
| MP-02412-01 | VT340 PRINTSET | 1 | |

Section Three
Self-Maintenance Products Price Lists

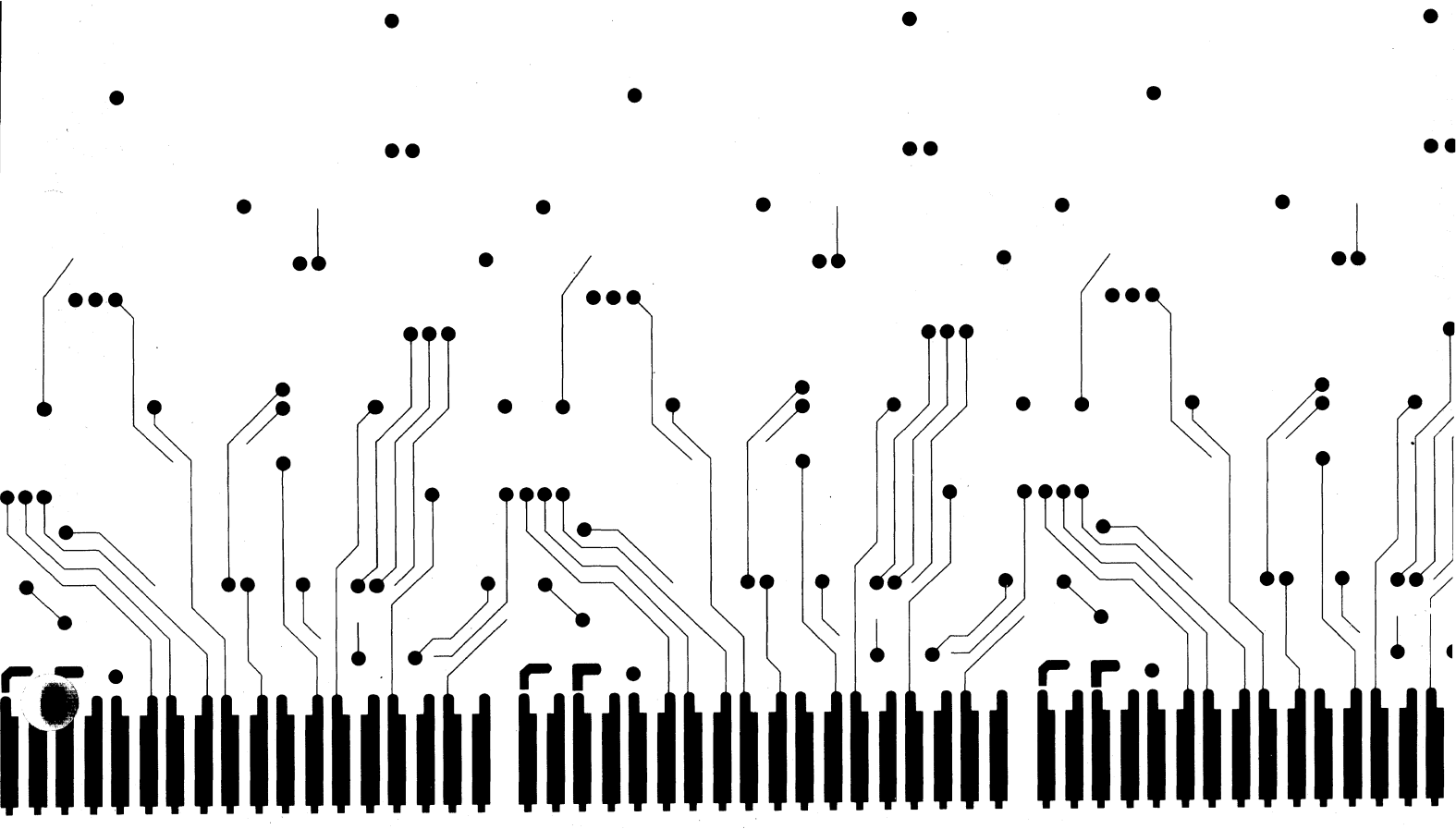

How to Read the Price List

The following pages list all the Self-Maintenance Products, both kits and individual items, in alpha/numeric order by part number. Each part number listing includes extensive information as shown in the following example:

| Part Number | Description | Unit Order | Unit Price | Rep | D | L | Replacement Part No. |
|-------------|--------------------|------------|------------|-----|---|---|----------------------|
| 70-18491-01 | Head/Disk Assembly | Each | \$5882.00 | Y | | | 3 |
| 1 | 2 | 3 | 4 | 5 | 6 | 7 | 8 |

1. Part Number—70-18491-01

The part number is formatted as follows:

Class Field: 70

Basic Field: 18491

Variation Field: 01

The 'basic field' and the 'variation field' are left-justified if alphanumeric, and right-justified with leading zeros if numeric.

2. Description—Head Disk Assembly

The description will tell you what the part number is for.

3. Unit Order

QTY: If a quantity is indicated here, the part must be ordered in multiples of that number. For example, "QTY OF 10," means you must order the part in groups of ten.

EACH: If "EACH" is indicated here, the item is ordered in individual units.

Prices are always indicated for a *single unit*, even if the order quantity is more than one. Always multiply the price given times the total quantity ordered.

4. Unit Price—\$5882

The price of a single unit of the part. Even if the unit order is more than one, the price given is for a single unit.

5. Repair

A "Y" here indicates that the part can be repaired. The cost of repairing one of these items is listed in the DECmailer or Factory Repair sections of the price list. If the part is not repairable, this column will be blank.

6. Discount

3 For end-users, a "3" in this column indicates that the part is discountable under the DBA End User, Category A (0 to 21%) Discount.

3 For OEMs, a "3" in this column indicates that the part is discountable under the DBA Reseller Volume, Category A (0 to 21%), and 0% Product Discount.

U For OEMs, a "U" in this column indicates that the part is discountable under the DBA Reseller Volume, Category B (12% to 21%), and 10% Product Discount.

If this column is blank, the part is not discountable.

7. License

This is for diagnostic products. A "B" indicates that a binary license is required. An "N" indicates that no license is required.

8. Replacement Part Numbers

If the part you are looking up is no longer available, the word "replaced" will appear in the Unit Price column. The new part number that has replaced the old will appear in this column.

Diagnostic Software Ordering

Check the information in the Diagnostics Part of Section Two to be sure that you order the software product that matches your media, service, and system requirements.

Price List Sections

A. Hardware Spare Parts and Kits

B. Documentation and Diagnostics

C. DECmailer

D. Factory Repair

E. Terms and Conditions of Sale

Parts Classification Index

Hardware Spares and Field
Change Order Information

| Class | Description | Page Number |
|-------|---|-------------|
| - | Modules, Cables, and Power Supplies | A-1 |
| 10 | Capacitors | A-16 |
| 11 | Diodes | A-17 |
| 12 | Electromechanical | A-18 |
| 13 | Resistors | A-23 |
| 15 | Transistors | A-24 |
| 16 | Transformers | A-25 |
| 17 | Cables | A-26 |
| 18 | Crystals | A-26 |
| 19 | IC's | A-27 |
| 21 | MOS's | A-29 |
| 23 | ROM's and PROM's | A-30 |
| 29 | Vendor Parts | A-35 |
| 30 | Purchased Parts | A-50 |
| 34 | ESD Module Containers | A-50 |
| 47 | Machine Tools | A-50 |
| 48 | Raw Fab Materials | A-50 |
| 4A | Kits | A-50 |
| 54 | Module Boards | A-53 |
| 55 | Overlays | A-56 |
| 57 | LSI Hybrid Assemblers | A-56 |
| 70 | DEC Manufactured Parts/Cables | A-56 |
| 74 | Prefab Parts/Cables | A-62 |
| 90 | Expendable Parts | A-64 |
| 93 | Tools, Fixtures | A-65 |
| 96 | Extractors | A-65 |
| 99 | ESD Protective Packaging | A-65 |
| EQ | Field Change Order Kits | A-65 |
| FA | Field Change Order Documentation | A-66 |

Diagnostics and Documentation

| Class | Description | Page Number |
|-------|---|-------------|
| Z | Diagnostic Software Kits | B-1 |
| AM | Diagnostics on RK06 | B-2 |
| AP | Diagnostic Magtape (800 BPI) | B-2 |
| AQ | Diagnostics on TK50 | B-2 |
| AS | Diagnostics on RX01 Floppy | B-2 |
| AY | Diagnostics on RK07 Disk | B-3 |
| AZ | Hardware Manuals | B-4 |
| BA | Diagnostics on RX02 | B-4 |
| BB | Diagnostics on Magtape (1600 BPI) | B-4 |
| BC | Diagnostics on RL02 Disk | B-5 |
| BE | Diagnostics on TU58 Cassette Tape | B-5 |
| BK | Diagnostics on RC25 Pack | B-6 |
| BL | Diagnostics on RX50 Floppy | B-6 |
| BM | Diagnostics on TU81 Media (6250 BPI) | B-7 |
| BN | Diagnostics on RX33 Floppy | B-7 |
| EK | Hardware Manuals | B-7 |
| ER | Hardware Manuals | B-17 |
| EY | Hardware Maintenance Training Manuals | B-18 |
| EZ | Networking Model Kit | B-18 |
| FB | Hardware Documentation Kits | B-18 |
| MD | Maintenance Documentation Service and DEC-O-LOG | B-19 |
| MP | Maintenance Prints | B-19 |
| QA | Software Media and Documentation | B-23 |
| QL | Software License and Warranty | B-23 |

Part A
Hardware Spares Price List

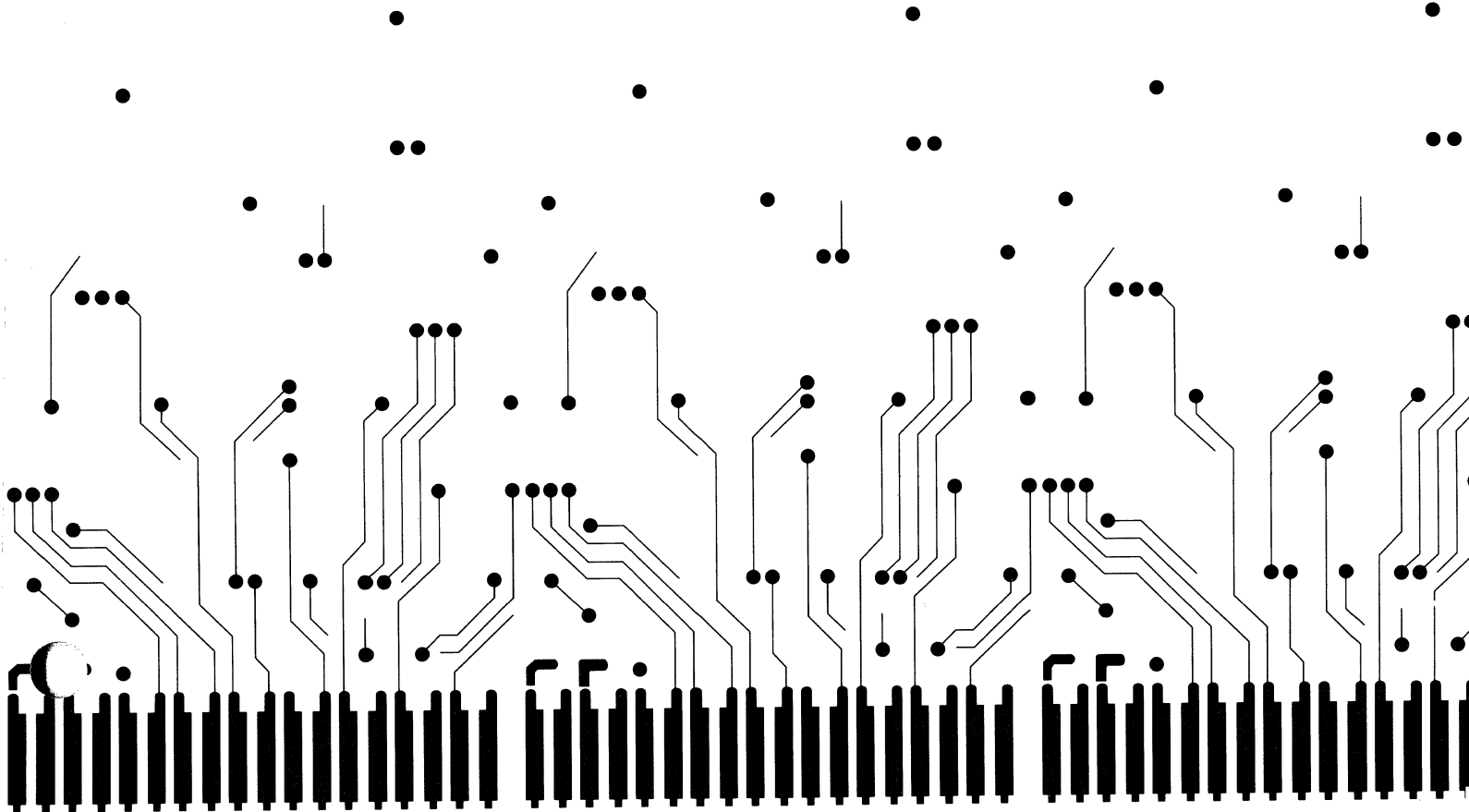

HARDWARE SPARES PRICE LIST

| PART NUMBER | DESCRIPTION | UNIT ORDER | UNIT PRICE | REP D L | REPLACEMENT PART NUMBER | PART NUMBER | DESCRIPTION | UNIT ORDER | UNIT PRICE | REP D L | REPLACEMENT PART NUMBER |
|---|-------------------------------|------------|------------|---------|-------------------------|-------------|-------------------------------|------------|------------|---------|-------------------------|
| BLANK CLASS Modules, Cables, Power Supplies and Kits | | | | | | | | | | | |
| 00861-B | PWR CONTR. 240V 16A 1 PHASE | EACH | \$694.00 | Y 3 A | | BC24K-30 | CABLE WITH 2 NEMA #5-15R,30FT | EACH | \$241.00 | U A | |
| 00861-C | POWER CONTROL. 120V 24A | EACH | REPLACED | Y 3 A | 00874-D | BC24K-40 | CABLE WITH 2 NEMA #5-15R,40FT | EACH | \$284.00 | U A | |
| 00869-D | 866-D W/PWR SEQ.120V 24A 3-PH | EACH | \$1,911.00 | Y 3 A | | BC24K-50 | CABLE WITH 2 NEMA #5-15R,50FT | EACH | \$316.00 | U A | |
| 00869-E | 866-E W/PWR SEQ.240V 12A 3-PH | EACH | \$1,911.00 | Y 3 A | | BC24K-60 | CABLE WITH 2 NEMA #5-15R,60FT | EACH | \$359.00 | U A | |
| 00871-A | 120V 12A POWER CONTROL UNFIL. | EACH | REPLACED | Y 3 A | 00874-B | BC24K-75 | CABLE WITH 2 NEMA #5-15R,75FT | EACH | \$423.00 | U A | |
| 00874-A | 120V 12A FILTERED PWR CONTROL | EACH | \$572.00 | Y 3 A | | BC24K-A0 | CABLE W 2 NEMA #5-15R,100FT | EACH | \$530.00 | U A | |
| 00874-B | 220-240V 12A FILTERED PWR CON | EACH | \$572.00 | Y 3 A | | BC24L-10 | CABLE WITH 4 NEMA #5-15R,10FT | EACH | \$241.00 | U A | |
| 00874-C | 120V 16A FILTERED PWR CONTROL | EACH | \$469.00 | Y 3 A | | BC24L-20 | CABLE WITH 4 NEMA #5-15R,20FT | EACH | \$273.00 | U A | |
| 00874-D | 120V 24A FILTERED PWR CONTROL | EACH | \$713.00 | Y 3 A | | BC24L-30 | CABLE WITH 4 NEMA #5-15R,30FT | EACH | \$305.00 | U A | |
| 00874-E | 220-240V 24A FILTERED PWR CON | EACH | \$685.00 | Y 3 A | | BC24L-40 | CABLE WITH 4 NEMA #5-15R,40FT | EACH | \$338.00 | U A | |
| 00874-K | PWR CNTL FLTRD 240V 24A | EACH | REPLACED | Y 3 A | 00874-E | BC24L-50 | CABLE WITH 4 NEMA #5-15R,50FT | EACH | \$380.00 | U A | |
| 00876-A | 120V/208V 30A 3 PHASE PC | EACH | \$3,746.00 | Y 3 A | | BC24L-60 | CABLE WITH 4 NEMA #5-15R,60FT | EACH | \$423.00 | U A | |
| 00877-B | 240V 12A FILTERED POWER CTL | EACH | \$565.00 | 3 A | | BC24L-75 | CABLE WITH 4 NEMA #5-15R,75FT | EACH | \$476.00 | U A | |
| 00877-D | 120V 24A FILTERED POWER CTL | EACH | \$565.00 | 3 A | | BC24L-A0 | CABLE W 4 NEMA #5-15R,100FT | EACH | \$573.00 | U A | |
| 00877-E | 240V 24A FILTERED POWER CTL | EACH | \$630.00 | 3 A | | BC24M-10 | CABLE WITH NEMA #5-20R,10FT | EACH | \$166.00 | U A | |
| A005-00 | RELAY 8 CH MULTIPLEXER FOR A0 | EACH | \$2,048.00 | Y 3 A | | BC24M-20 | CABLE WITH NEMA #5-20R,20FT | EACH | \$209.00 | U A | |
| A007-00 | 16 CH BIT MUX FOR A005 | EACH | \$2,462.00 | Y 3 A | | BC24M-30 | CABLE WITH NEMA #5-20R,30FT | EACH | \$241.00 | U A | |
| A6000-00 | 12 BIT D/A W REF | EACH | \$280.00 | 3 A | | BC24M-40 | CABLE WITH NEMA #5-20R,40FT | EACH | \$273.00 | U A | |
| BC05L-08 | CABLE JUMPER | EACH | \$38.00 | 3 A | | BC24M-50 | CABLE WITH NEMA #5-20R,50FT | EACH | \$316.00 | U A | |
| BC05L-15 | H855 TO H855 FLAT REVERSED 15 | EACH | \$79.00 | 3 A | | BC24M-60 | CABLE WITH NEMA #5-20R,60FT | EACH | \$359.00 | U A | |
| BC05L-50 | H855-H855 3M NOT SHLDED,50 FT | EACH | \$126.00 | 3 A | | BC24M-75 | CABLE WITH NEMA #5-20R,75FT | EACH | \$423.00 | U A | |
| BC06L-0J | MIRROR IMAGE CABLE 50 COND. | EACH | \$74.00 | 3 A | | BC24N-10 | CABLE WITH 2 NEMA #5-20R,10FT | EACH | \$166.00 | U A | |
| BC06R-06 | MASSBUS CABLE 6FT | EACH | \$53.00 | 3 A | | BC24N-20 | CABLE WITH 2 NEMA #5-20R,20FT | EACH | \$209.00 | U A | |
| BC06R-10 | MASSBUS CABLE 10FT | EACH | \$58.00 | 3 A | | BC24N-30 | CABLE WITH 2 NEMA #5-20R,30FT | EACH | \$241.00 | U A | |
| BC06R-25 | MASSBUS CABLE 25FT | EACH | \$100.00 | 3 A | | BC24N-40 | CABLE WITH 2 NEMA #5-20R,40FT | EACH | \$284.00 | U A | |
| BC06S-2H | MASSBUS CABLE | EACH | \$294.00 | 3 A | | BC24N-50 | CABLE WITH 2 NEMA #5-20R,50FT | EACH | \$316.00 | U A | |
| BC06Z-25 | MASSBUS CABLE,DBL SHLDED 25FT | EACH | \$788.00 | 3 A | | BC24N-60 | CABLE WITH 2 NEMA #5-20R,60FT | EACH | \$359.00 | U A | |
| BC08R-01 | H856-H856 3M CABLE(1') | EACH | \$57.00 | 3 A | | BC24N-75 | CABLE WITH 2 NEMA #5-20R,75FT | EACH | \$423.00 | U A | |
| BC08R-25 | H856-H856 3M CABLE(25') | EACH | \$105.00 | 3 A | | BC24P-10 | CABLE WITH 4 NEMA #5-20R,10FT | EACH | \$241.00 | U A | |
| BC08R-50 | H856-H856 3M CABLE(50') | EACH | \$194.00 | 3 A | | BC24P-20 | CABLE WITH 4 NEMA #5-20R,20FT | EACH | \$262.00 | U A | |
| BC08S-15 | H856-H856 3M STRAIT 15' | EACH | \$95.00 | 3 A | | BC24P-30 | CABLE WITH 4 NEMA #5-20R,30FT | EACH | \$316.00 | U A | |
| BC08S-25 | H856-H856 3M STRAIT 25' | EACH | \$121.00 | 3 A | | BC24P-40 | CABLE WITH 4 NEMA #5-20R,40FT | EACH | \$348.00 | U A | |
| BC11A-02 | EXTERNAL UNIBUS 2' | EACH | \$142.00 | 3 A | | BC24P-50 | CABLE WITH 4 NEMA #5-20R,50FT | EACH | \$380.00 | U A | |
| BC11A-05 | EXTERNAL UNIBUS 5' | EACH | \$163.00 | 3 A | | BC24P-60 | CABLE WITH 4 NEMA #5-20R,60FT | EACH | \$423.00 | U A | |
| BC11A-08 | EXTERNAL UNIBUS 8' | EACH | \$179.00 | 3 A | | BC24P-75 | CABLE WITH 4 NEMA #5-20R,75FT | EACH | \$488.00 | U A | |
| BC11A-10 | EXTERNAL UNIBUS 10' | EACH | \$191.00 | 3 A | | BC24R-10 | CABLE WITH 8 NEMA #5-20R,10FT | EACH | \$402.00 | U A | |
| BC11A-12 | CABLE ASSY (BA11A) | EACH | \$210.00 | 3 A | | BC24R-20 | CABLE WITH 8 NEMA #5-20R,20FT | EACH | \$423.00 | U A | |
| BC11A-15 | EXTERNAL UNIBUS 15' | EACH | \$221.00 | 3 A | | BC24R-30 | CABLE WITH 8 NEMA #5-20R,30FT | EACH | \$450.00 | U A | |
| BC11A-25 | EXTERNAL UNIBUS 25' | EACH | \$242.00 | 3 A | | BC24R-40 | CABLE WITH 8 NEMA #5-20R,40FT | EACH | \$498.00 | U A | |
| BC11A-8F | EXTERNAL UNIBUS 8.5' | EACH | \$189.00 | 3 A | | BC24R-50 | CABLE WITH 8 NEMA #5-20R,50FT | EACH | \$530.00 | U A | |
| BC24J-10 | CABLE WITH NEMA #5-15R,10FT | EACH | \$155.00 | U A | | BC24R-60 | CABLE WITH 8 NEMA #5-20R,60FT | EACH | \$573.00 | U A | |
| BC24J-20 | CABLE WITH NEMA #5-15R,20FT | EACH | \$209.00 | U A | | BC24R-75 | CABLE WITH 8 NEMA #5-20R,75FT | EACH | \$638.00 | U A | |
| BC24J-30 | CABLE WITH NEMA #5-15R,30FT | EACH | \$241.00 | U A | | BC24S-10 | CABLE WITH NEMA #L5-30R,10FT | EACH | \$176.00 | U A | |
| BC24J-40 | CABLE WITH NEMA #5-15R,40FT | EACH | \$273.00 | U A | | BC24S-20 | CABLE WITH NEMA #L5-30R,20FT | EACH | \$231.00 | U A | |
| BC24J-50 | CABLE WITH NEMA #5-15R,50FT | EACH | \$320.00 | U A | | BC24S-30 | CABLE WITH NEMA #L5-30R,30FT | EACH | \$262.00 | U A | |
| BC24J-60 | CABLE WITH NEMA #5-15R,60FT | EACH | \$359.00 | U A | | BC24S-40 | CABLE WITH NEMA #L5-30R,40FT | EACH | \$305.00 | U A | |
| BC24J-75 | CABLE WITH NEMA #5-15R,75FT | EACH | \$423.00 | U A | | BC24S-50 | CABLE WITH NEMA #L5-30R,50FT | EACH | \$348.00 | U A | |
| BC24J-A0 | CABLE WITH NEMA #5-15R,100FT | EACH | \$493.00 | U A | | BC24S-60 | CABLE WITH NEMA #L5-30R,60FT | EACH | \$391.00 | U A | |
| BC24K-10 | CABLE WITH 2 NEMA #5-15R,10FT | EACH | \$166.00 | U A | | BC24S-75 | CABLE WITH NEMA #L5-30R,75FT | EACH | \$455.00 | U A | |
| BC24K-20 | CABLE WITH 2 NEMA #5-15R,20FT | EACH | \$209.00 | U A | | BC24T-10 | CABLE WITH NEMA #L6-20R,10FT | EACH | \$188.00 | U A | |
| | | | | | | BC24T-20 | CABLE WITH NEMA #L6-20R,20FT | EACH | \$231.00 | U A | |
| | | | | | | BC24T-30 | CABLE WITH NEMA #L6-20R,30FT | EACH | \$262.00 | U A | |
| | | | | | | BC24T-40 | CABLE WITH NEMA #L6-20R,40FT | EACH | \$316.00 | U A | |
| | | | | | | BC24T-50 | CABLE WITH NEMA #L6-20R,50FT | EACH | \$338.00 | U A | |
| | | | | | | BC24T-60 | CABLE WITH NEMA #L6-20R,60FT | EACH | \$380.00 | U A | |



Prices Effective 02-January-89 to 30-June-89
 To Order—Call DECdirect™ TOLL-FREE 800-344-4825, 8:30 a.m. to 8:00 p.m. ET in Continental U.S.A.

HARDWARE SPARES PRICE LIST

| PART NUMBER | DESCRIPTION | UNIT ORDER | UNIT PRICE | REP D L | REPLACEMENT PART NUMBER | PART NUMBER | DESCRIPTION | UNIT ORDER | UNIT PRICE | REP D L | REPLACEMENT PART NUMBER |
|-------------|-------------------------------|------------|------------|---------|-------------------------|-------------|--------------------------------|------------|------------|---------|-------------------------|
| BC24T-75 | CABLE WITH NEMA #L6-20R,75FT | EACH | \$445.00 | U A | | BC28D-50 | CANADIAN W/NEMA 5-20R, 50FT | EACH | \$300.00 | U A | |
| BC24U-10 | CABLE WITH NEMA #L14-20R,10FT | EACH | \$176.00 | U A | | BC28D-60 | CANADIAN W/NEMA 5-20R, 60FT | EACH | \$339.00 | U A | |
| BC24U-20 | CABLE WITH NEMA #L14-20R,20FT | EACH | \$231.00 | U A | | BC28D-75 | CANADIAN W/NEMA 5-20R, 75FT | EACH | \$386.00 | U A | |
| BC24U-30 | CABLE WITH NEMA #L14-20R,30FT | EACH | \$273.00 | U A | | BC28E-10 | CANADIAN W/2 NEMA 5-20R, 10FT | EACH | \$150.00 | U A | |
| BC24U-40 | CABLE WITH NEMA #L14-20R,40FT | EACH | \$300.00 | U A | | BC28E-20 | CANADIAN W/2 NEMA 5-20R, 20FT | EACH | \$193.00 | U A | |
| BC24U-50 | CABLE WITH NEMA #L14-20R,50FT | EACH | \$348.00 | U A | | BC28E-30 | CANADIAN W/2 NEMA 5-20R, 30FT | EACH | \$236.00 | U A | |
| BC24U-60 | CABLE WITH NEMA #L14-20R,60FT | EACH | \$391.00 | U A | | BC28E-40 | CANADIAN W/2 NEMA 5-20R, 40FT | EACH | \$261.00 | U A | |
| BC24U-75 | CABLE WITH NEMA #L14-20R,75FT | EACH | \$433.00 | U A | | BC28E-50 | CANADIAN W/2 NEMA 5-20R, 50FT | EACH | \$296.00 | U A | |
| BC24V-10 | CABLE WITH NEMA #L21-20R,10FT | EACH | \$262.00 | U A | | BC28E-60 | CANADIAN W/2 NEMA 5-20R, 60FT | EACH | \$339.00 | U A | |
| BC24V-20 | CABLE WITH NEMA #L21-20R,20FT | EACH | \$305.00 | U A | | BC28E-75 | CANADIAN W/2 NEMA 5-20R, 75FT | EACH | \$390.00 | U A | |
| BC24V-30 | CABLE WITH NEMA #L21-20R,30FT | EACH | \$348.00 | U A | | BC28F-10 | CANADIAN W/4 NEMA 5-20R, 10FT | EACH | \$214.00 | U A | |
| BC24V-40 | CABLE WITH NEMA #L21-20R,40FT | EACH | \$380.00 | U A | | BC28F-20 | CANADIAN W/4 NEMA 5-20R, 20FT | EACH | \$253.00 | U A | |
| BC24V-50 | CABLE WITH NEMA #L21-20R,50FT | EACH | \$445.00 | U A | | BC28F-30 | CANADIAN W/4 NEMA 5-20R, 30FT | EACH | \$300.00 | U A | |
| BC24V-60 | CABLE WITH NEMA #L21-20R,60FT | EACH | \$466.00 | U A | | BC28F-40 | CANADIAN W/4 NEMA 5-20R, 40FT | EACH | \$339.00 | U A | |
| BC24V-75 | CABLE WITH NEMA #L21-20R,75FT | EACH | \$530.00 | U A | | BC28F-50 | CANADIAN W/4 NEMA 5-20R, 50FT | EACH | \$364.00 | U A | |
| BC24W-10 | CABLE WITH NEMA #L21-30R,10FT | EACH | \$273.00 | U A | | BC28F-60 | CANADIAN W/4 NEMA 5-20R, 60FT | EACH | \$407.00 | U A | |
| BC24W-20 | CABLE WITH NEMA #L21-30R,20FT | EACH | \$338.00 | U A | | BC28F-75 | CANADIAN W/4 NEMA 5-20R, 75FT | EACH | \$454.00 | U A | |
| BC24W-30 | CABLE WITH NEMA #L21-30R,30FT | EACH | \$380.00 | U A | | BC28G-10 | CANADIAN W/8 NEMA 5-20R, 10FT | EACH | \$386.00 | U A | |
| BC24W-40 | CABLE WITH NEMA #L21-30R,40FT | EACH | \$424.00 | U A | | BC28G-20 | CANADIAN W/8 NEMA 5-20R, 20FT | EACH | \$424.00 | U A | |
| BC24W-50 | CABLE WITH NEMA #L21-30R,50FT | EACH | \$454.00 | U A | | BC28G-30 | CANADIAN W/8 NEMA 5-20R, 30FT | EACH | \$450.00 | U A | |
| BC24W-60 | CABLE WITH NEMA #L21-30R,60FT | EACH | \$530.00 | U A | | BC28G-40 | CANADIAN W/8 NEMA 5-20R, 40FT | EACH | \$493.00 | U A | |
| BC24W-75 | CABLE WITH NEMA #L21-30R,75FT | EACH | \$605.00 | U A | | BC28G-50 | CANADIAN W/8 NEMA 5-20R, 50FT | EACH | \$518.00 | U A | |
| BC24X-10 | CABLE FOR (DEC 10) PYLE,10FT | EACH | \$1,280.00 | U A | | BC28G-60 | CANADIAN W/8 NEMA 5-20R, 60FT | EACH | \$557.00 | U A | |
| BC24X-20 | CABLE FOR (DEC 10) PYLE,20FT | EACH | \$1,601.00 | U A | | BC28G-75 | CANADIAN W/8 NEMA 5-20R, 75FT | EACH | \$608.00 | U A | |
| BC24X-30 | CABLE FOR (DEC 10)PYLE,30FT | EACH | \$1,923.00 | U A | | BC28S-10 | 20ACBLW/RS3913,IBMA,16A, 10' | EACH | \$239.00 | U A | |
| BC24X-40 | CABLE FOR (DEC 10) PYLE,40FT | EACH | \$2,672.00 | U A | | BC28S-20 | 20ACBLW/RS3913,IBMA,16A, 20' | EACH | \$279.00 | U A | |
| BC24X-50 | CABLE FOR (DEC 10) PYLE,50FT | EACH | \$2,458.00 | U A | | BC28S-30 | 20ACBLW/RS3913,IBMA,16A, 30' | EACH | \$337.00 | U A | |
| BC24X-60 | CABLE FOR (DEC 10) PYLE, 60FT | EACH | \$2,790.00 | U A | | BC28S-40 | 20ACBLW/RS3913,IBMA,16A, 40' | EACH | \$378.00 | U A | |
| BC24X-75 | CABLE FOR (DEC 10) PYLE,75FT | EACH | \$3,256.00 | U A | | BC28S-50 | 20ACBLW/RS3913,IBMA,16A, 50' | EACH | \$423.00 | U A | |
| BC26D-10 | CABLE W/RS7428,IBME, 10FT | EACH | \$541.00 | U A | | BC28S-60 | 20ACBLW/RS3913,IBMA,16A, 60' | EACH | \$463.00 | U A | |
| BC26D-20 | CABLE W/RS7428,IBME, 20FT | EACH | \$605.00 | U A | | BC28S-75 | 20ACBLW/RS3913,IBMA,16A, 75' | EACH | \$552.00 | U A | |
| BC26D-30 | CABLE W/RS7428,IBME, 30FT | EACH | \$675.00 | U A | | BC28S-A0 | 20ACBLW/RS3913,IBMA,16A, 100' | EACH | \$663.00 | U A | |
| BC26D-40 | CABLE W/RS7428,IBME, 40FT | EACH | \$748.00 | U A | | BC28T-10 | 20ACBLW/RS3913U1,IBMA1,16A10' | EACH | \$239.00 | U A | |
| BC26D-50 | CABLE W/RS7428,IBME, 50FT | EACH | \$830.00 | U A | | BC28T-20 | 20ACBLW/RS3913U1,IBMA1,16A20' | EACH | \$279.00 | U A | |
| BC26D-60 | CABLE W/RS7428,IBME, 60FT | EACH | \$883.00 | U A | | BC28T-30 | 20ACBLW/RS3913U1,IBMA1,16A30' | EACH | \$337.00 | U A | |
| BC26D-75 | CABLE W/RS7428,IBME, 75FT | EACH | \$990.00 | U A | | BC28T-40 | 20ACBLW/RS3913U1,IBMA1,16A40' | EACH | \$378.00 | U A | |
| BC26E-10 | CABLE WITH NEMA #L6-30R,10FT | EACH | \$209.00 | U A | | BC28T-50 | 20ACBLW/RS3913U1,IBMA1,16A50' | EACH | \$421.00 | U A | |
| BC26E-20 | CABLE WITH NEMA #L6-30R,20FT | EACH | \$241.00 | U A | | BC28T-60 | 20ACBLW/RS3913U1,IBMA1,16A60' | EACH | \$476.00 | U A | |
| BC26E-30 | CABLE WITH NEMA #L6-30R,30FT | EACH | \$284.00 | U A | | BC28T-75 | 20ACBLW/RS3913U1,IBMA1,16A75' | EACH | \$552.00 | U A | |
| BC26E-40 | CABLE WITH NEMA #L6-30R,40FT | EACH | \$348.00 | U A | | BC28T-A0 | 20ACBLW/RS3913U1,IBMA1,16A100' | EACH | \$663.00 | U A | |
| BC26E-50 | CABLE WITH NEMA #L6-30R,50FT | EACH | \$369.00 | U A | | BC28U-10 | 15ACBLW/RS3913U2,IBMA2,12A10' | EACH | \$239.00 | U A | |
| BC26E-60 | CABLE WITH NEMA #L6-30R,60FT | EACH | \$423.00 | U A | | BC28U-20 | 15ACBLW/RS3913U2,IBMA2,12A20' | EACH | \$279.00 | U A | |
| BC26E-75 | CABLE WITH NEMA #L6-30R,75FT | EACH | \$488.00 | U A | | BC28U-30 | 15ACBLW/RS3913U2,IBMA2,12A30' | EACH | \$337.00 | U A | |
| BC26F-10 | 15A CBL L5-15R1,120V,12A,10' | EACH | \$169.00 | U A | | BC28U-40 | 15ACBLW/RS3913U2,IBMA2,12A40' | EACH | \$378.00 | U A | |
| BC26F-20 | 15A CBL L5-15R1,120V,12A,20' | EACH | \$213.00 | U A | | BC28U-50 | 15ACBLW/RS3913U2,IBMA2,12A50' | EACH | \$421.00 | U A | |
| BC26F-30 | 15A CBL L5-15R1,120V,12A,30' | EACH | \$269.00 | U A | | BC28U-60 | 15ACBLW/RS3913U2,IBMA2,12A60' | EACH | \$463.00 | U A | |
| BC26F-40 | 15A CBL L5-15R1,120V,12A,40' | EACH | \$315.00 | U A | | BC28U-75 | 15ACBLW/RS3913U2,IBMA2,12A75' | EACH | \$552.00 | U A | |
| BC26F-50 | 15A CBL L5-15R1,120V,12A,50' | EACH | \$361.00 | U A | | BC28U-A0 | 15ACBLW/RS3913U2,IBMA2,12A100' | EACH | \$663.00 | U A | |
| BC26F-60 | 15A CBL L5-15R1,120V,12A,60' | EACH | \$406.00 | U A | | BC28V-10 | 15ACBLW/RS3914,IBMB,12A, 10' | EACH | \$306.00 | U A | |
| BC26F-75 | 15A CBL L5-15R1,120V,12A,75' | EACH | \$497.00 | U A | | BC28V-20 | 15ACBLW/RS3914,IBMB,12A, 20' | EACH | \$348.00 | U A | |
| BC26F-A0 | 15A CBL L5-15R1,120V,12A,100' | EACH | \$617.00 | U A | | BC28V-30 | 15ACBLW/RS3914,IBMB,12A, 30' | EACH | \$409.00 | U A | |
| BC28D-10 | CANADIAN W/NEMA 5-20R, 10FT | EACH | \$147.00 | U A | | BC28V-40 | 15ACBLW/RS3914,IBMB,12A, 40' | EACH | \$453.00 | U A | |
| BC28D-20 | CANADIAN W/NEMA 5-20R, 20FT | EACH | \$193.00 | U A | | BC28V-50 | 15ACBLW/RS3914,IBMB,12A, 50' | EACH | \$509.00 | U A | |
| BC28D-30 | CANADIAN W/NEMA 5-20R, 30FT | EACH | \$236.00 | U A | | BC28V-60 | 15ACBLW/RS3914,IBMB,12A, 60' | EACH | \$562.00 | U A | |
| BC28D-40 | CANADIAN W/NEMA 5-20R, 40FT | EACH | \$253.00 | U A | | BC28V-75 | 15ACBLW/RS3914,IBMB,12A, 75' | EACH | \$636.00 | U A | |



Prices Effective 02-January-89 to 30-June-89
 To Order—Call DECdirect™ TOLL-FREE 800-344-4825, 8:30 a.m. to 8:00 p.m. ET in Continental U.S.A.

HARDWARE SPARES PRICE LIST

| PART NUMBER | DESCRIPTION | UNIT ORDER | UNIT PRICE | REP D L | REPLACEMENT PART NUMBER | PART NUMBER | DESCRIPTION | UNIT ORDER | UNIT PRICE | REP D L | REPLACEMENT PART NUMBER |
|-------------|-------------------------------|------------|------------|---------|-------------------------|-------------|-------------------------------|------------|------------|---------|-------------------------|
| BC28V-A0 | 15ACBLW/RS3914,IBMB,12A, 100' | EACH | \$705.00 | U A | | BC31C-A0 | REPO CABLE PCS+ TO PCS+ 100FT | EACH | \$87.00 | U A | |
| BC28W-10 | 30ACBLW/RS3933,IBMC,24A, 10' | EACH | \$269.00 | U A | | BC31C-B0 | REPO CABLE PCS+ TO PCS+ 200FT | EACH | \$168.00 | U A | |
| BC28W-20 | 30ACBLW/RS3933,IBMC,24A, 20' | EACH | \$313.00 | U A | | BC31D-50 | RS232 CABLE 50FT | EACH | \$56.00 | U A | |
| BC28W-30 | 30ACBLW/RS3933,IBMC,24A, 30' | EACH | \$372.00 | U A | | BC31F-50 | DATA CABLE RSU TO RSU 50FT | EACH | \$87.00 | U A | |
| BC28W-40 | 30ACBLW/RS3933,IBMC,24A, 40' | EACH | \$419.00 | U A | | BC31F-A0 | DATA CABLE RSU TO RSU 100FT | EACH | \$143.00 | U A | |
| BC28W-50 | 30ACBLW/RS3933,IBMC,24A, 50' | EACH | \$464.00 | U A | | BC31F-B0 | DATA CABLE RSU TO RSU 200FT | EACH | \$224.00 | U A | |
| BC28W-60 | 30ACBLW/RS3933,IBMC,24A, 60' | EACH | \$533.00 | U A | | BCC06-15 | 15' PC3XX TO H4000 INTER CBL | EACH | \$84.00 | 3 A | |
| BC28W-75 | 30ACBLW/RS3933,IBMC,24A, 75' | EACH | \$605.00 | U A | | BN29A-03 | 50HZ 10A BRKR SWISS 2PH 3M | EACH | \$179.00 | U A | |
| BC28X-10 | 30ACBLW/RS3934,IBMD,24A, 10' | EACH | \$344.00 | U A | | BN29A-06 | 50HZ 10A BRKR SWISS 2PH 6M | EACH | \$252.00 | U A | |
| BC28X-20 | 30ACBLW/RS3934,IBMD,24A, 20' | EACH | \$391.00 | U A | | BN29A-09 | 50HZ 10A BRKR SWISS 2PH 9M | EACH | \$233.00 | U A | |
| BC28X-30 | 30ACBLW/RS3934,IBMD,24A, 30' | EACH | \$461.00 | U A | | BN29A-12 | 50HZ 10A BRKR SWISS 2PH 12M | EACH | \$258.00 | U A | |
| BC28X-40 | 30ACBLW/RS3934,IBMD,24A, 40' | EACH | \$511.00 | U A | | BN29A-15 | 50HZ 10A BRKR SWISS 2PH 15M | EACH | \$287.00 | U A | |
| BC28X-50 | 30ACBLW/RS3934,IBMD,24A, 50' | EACH | \$562.00 | U A | | BN29A-18 | 50HZ 10A BRKR SWISS 2PH 18M | EACH | \$313.00 | U A | |
| BC28X-60 | 30ACBLW/RS3934,IBMD,24A, 60' | EACH | \$640.00 | U A | | BN29A-23 | 50HZ 10A BRKR SWISS 2PH 23M | EACH | \$352.00 | U A | |
| BC28X-75 | 30ACBLW/RS3934,IBMD,24A, 75' | EACH | \$716.00 | U A | | BN29A-30 | 50HZ 10A BRKR SWISS 2PH 30M | EACH | \$419.00 | U A | |
| BC28Y-10 | CBLW/RS JCS1034H,IBMF, 10FT | EACH | \$825.00 | U A | | BN29D-03 | 50HZ 10A BRKR 2UK 2PH 3M | EACH | \$172.00 | U A | |
| BC28Y-20 | CBLW/RS JCS1034H,IBMF, 20FT | EACH | \$1,012.00 | U A | | BN29D-06 | 50HZ 10A BRKR 2UK 2PH 6M | EACH | \$200.00 | U A | |
| BC28Y-30 | CBLW/RS JCS1034H,IBMF, 30FT | EACH | \$1,275.00 | U A | | BN29D-09 | 50HZ 10A BRKR 2UK 2PH 9M | EACH | \$227.00 | U A | |
| BC28Y-40 | CBLW/RS JCS1034H,IBMF, 40FT | EACH | \$1,474.00 | U A | | BN29D-12 | 50HZ 10A BRKR 2UK 2PH 12M | EACH | \$253.00 | U A | |
| BC28Y-50 | CBLW/RS JCS1034H,IBMF, 50FT | EACH | \$1,674.00 | U A | | BN29D-15 | 50HZ 10A BRKR 2UK 2PH 15M | EACH | \$278.00 | U A | |
| BC28Y-60 | CBLW/RS JCS1034H,IBMF, 60FT | EACH | \$1,873.00 | U A | | BN29D-18 | 50HZ 10A BRKR 2UK 2PH 18M | EACH | \$306.00 | U A | |
| BC28Y-75 | CBLW/RS JCS1034H,IBMF, 75FT | EACH | \$2,299.00 | U A | | BN29D-23 | 50HZ 10A BRKR 2UK 2PH 23M | EACH | \$347.00 | U A | |
| BC28Z-10 | 30A CBL W/L14-30R, 10 FT | EACH | \$231.00 | U A | | BN29D-30 | 50HZ 10A BRKR 2UK 2PH 30M | EACH | \$412.00 | U A | |
| BC28Z-20 | 30A CBL W/L14-30R, 20 FT | EACH | \$284.00 | U A | | BN29E-03 | 50HZ 10A BRKR 4UK 2PH 3M | EACH | \$214.00 | U A | |
| BC28Z-30 | 30A CBL W/L14-30R, 30 FT | EACH | \$338.00 | U A | | BN29E-06 | 50HZ 10A BRKR 4UK 2PH 6M | EACH | \$244.00 | U A | |
| BC28Z-40 | 30A CBL W/L14-30R, 40 FT | EACH | \$379.00 | U A | | BN29E-09 | 50HZ 10A BRKR 4UK 2PH 9M | EACH | \$272.00 | U A | |
| BC28Z-50 | 30A CBL W/L14-30R, 50 FT | EACH | \$428.00 | U A | | BN29E-12 | 50HZ 10A BRKR 4UK 2PH 12M | EACH | \$299.00 | U A | |
| BC28Z-60 | 30A CBL W/L14-30R, 60 FT | EACH | \$459.00 | U A | | BN29E-15 | 50HZ 10A BRKR 4UK 2PH 15M | EACH | \$324.00 | U A | |
| BC28Z-75 | 30A CBL W/L14-30R, 75 FT | EACH | \$530.00 | U A | | BN29E-18 | 50HZ 10A BRKR 4UK 2PH 18M | EACH | \$350.00 | U A | |
| BC29A-10 | 60A CBL W/RS6516FP, 10 FT | EACH | \$1,494.00 | U A | | BN29E-23 | 50HZ 10A BRKR 4UK 2PH 23M | EACH | \$391.00 | U A | |
| BC29A-20 | 60A CBL W/RS6516FP, 20 FT | EACH | \$1,762.00 | U A | | BN29F-03 | 50HZ 10A BRKR TS 2PH 3M | EACH | \$156.00 | U A | |
| BC29A-30 | 60A CBL W/RS6516FP, 30 FT | EACH | \$2,030.00 | U A | | BN29F-06 | 50HZ 10A BRKR TS 2PH 6M | EACH | \$188.00 | U A | |
| BC29A-40 | 60A CBL W/RS6516FP, 40 FT | EACH | \$2,297.00 | U A | | BN29F-09 | 50HZ 10A BRKR TS 2PH 9M | EACH | \$262.00 | U A | |
| BC29A-50 | 60A CBL W/RS6516FP, 50 FT | EACH | \$2,565.00 | U A | | BN29F-12 | 50HZ 10A BRKR TS 2PH 12M | EACH | \$241.00 | U A | |
| BC29B-10 | 60A CBL W/560C9W CONN, 10 FT | EACH | \$530.00 | U A | | BN29F-15 | 50HZ 10A BRKR TS 2PH 15M | EACH | \$263.00 | U A | |
| BC29B-20 | 60A CBL W/560C9W CONN, 20 FT | EACH | \$638.00 | U A | | BN29F-18 | 50HZ 10A BRKR TS 2PH 18M | EACH | \$291.00 | U A | |
| BC29B-30 | 60A CBL W/560C9W CONN, 30 FT | EACH | \$745.00 | U A | | BN29F-23 | 50HZ 10A BRKR TS 2PH 23M | EACH | \$338.00 | U A | |
| BC29B-40 | 60A CBL W/560C9W CONN, 40 FT | EACH | \$819.00 | U A | | BN29H-03 | 50HZ 15A BRKR 2INT 2PH 3M | EACH | \$172.00 | U A | |
| BC29B-50 | 60A CBL W/560C9W CONN, 50 FT | EACH | \$883.00 | U A | | BN29H-06 | 50HZ 15A BRKR 2INT 2PH 6M | EACH | \$200.00 | U A | |
| BC29B-60 | 60A CBL W/560C9W CONN, 60 FT | EACH | \$948.00 | U A | | BN29H-09 | 50HZ 15A BRKR 2INT 2PH 9M | EACH | \$231.00 | U A | |
| BC29B-75 | 60A CBL W/560C9W CONN, 75 FT | EACH | \$1,044.00 | U A | | BN29H-12 | 50HZ 15A BRKR 2INT 2PH 12M | EACH | \$253.00 | U A | |
| BC29C-10 | CABLE WITH NEMA #6-15R, 10 FT | EACH | \$153.00 | U A | | BN29H-15 | 50HZ 15A BRKR 2INT 2PH 15M | EACH | \$278.00 | U A | |
| BC29C-20 | CABLE WITH NEMA #6-15R, 20 FT | EACH | \$176.00 | U A | | BN29H-18 | 50HZ 15A BRKR 2INT 2PH 18M | EACH | \$305.00 | U A | |
| BC29C-30 | CABLE WITH NEMA #6-15R, 30 FT | EACH | \$201.00 | U A | | BN29H-23 | 50HZ 15A BRKR 2INT 2PH 23M | EACH | \$347.00 | U A | |
| BC29C-40 | CABLE WITH NEMA #6-15R, 40 FT | EACH | \$225.00 | U A | | BN29H-30 | 50HZ 15A BRKR 2INT 2PH 30M | EACH | \$412.00 | U A | |
| BC29C-50 | CABLE WITH NEMA #6-15R, 50 FT | EACH | \$250.00 | U A | | BN29J-03 | 50HZ 15A BRKR 4INT 2PH 3M | EACH | \$204.00 | U A | |
| BC29C-60 | CABLE WITH NEMA #6-15R, 60 FT | EACH | \$268.00 | U A | | BN29J-06 | 50HZ 15A BRKR 4INT 2PH 6M | EACH | \$231.00 | U A | |
| BC29C-75 | CABLE WITH NEMA #6-15R, 75 FT | EACH | \$303.00 | U A | | BN29J-09 | 50HZ 15A BRKR 4INT 2PH 9M | EACH | \$257.00 | U A | |
| BC31A-50 | DATA CABLE PCS+ TO PCS+ 50FT | EACH | \$66.00 | U A | | BN29J-12 | 50HZ 15A BRKR 4INT 2PH 12M | EACH | \$284.00 | U A | |
| BC31A-A0 | DATA CABLE PCS+ TO PCS+ 100FT | EACH | \$107.00 | U A | | BN29J-15 | 50HZ 15A BRKR 4INT 2PH 15M | EACH | \$311.00 | U A | |
| BC31A-B0 | DATA CABLE PCS+ TO PCS+ 200FT | EACH | \$173.00 | U A | | BN29J-18 | 50HZ 15A BRKR 4INT 2PH 18M | EACH | \$338.00 | U A | |
| BC31B-50 | DATA CABLE PCS+ TO RSU 50FT | EACH | \$66.00 | U A | | BN29J-23 | 50HZ 15A BRKR 4INT 2PH 23M | EACH | \$380.00 | U A | |
| BC31B-A0 | DATA CABLE PCS+ TO RSU 100FT | EACH | \$117.00 | U A | | BN29K-03 | 50HZ 15A BRKR TS 2PH 3M | EACH | \$156.00 | U A | |
| BC31B-B0 | DATA CABLE PCS+ TO RSU 200FT | EACH | \$194.00 | U A | | BN29K-06 | 50HZ 15A BRKR TS 2PH 6M | EACH | \$188.00 | U A | |
| BC31C-50 | REPO CABLE PCS+ TO PCS+ 50 FT | EACH | \$77.00 | U A | | BN29K-09 | 50HZ 15A BRKR TS 2PH 9M | EACH | \$210.00 | U A | |



Prices Effective 02-January-89 to 30-June-89

To Order—Call DECdirect™ TOLL-FREE 800-344-4825, 8:30 a.m. to 8:00 p.m. ET in Continental U.S.A.

HARDWARE SPARES PRICE LIST

| PART NUMBER | DESCRIPTION | UNIT ORDER | UNIT PRICE | REP D L | REPLACEMENT PART NUMBER | PART NUMBER | DESCRIPTION | UNIT ORDER | UNIT PRICE | REP D L | REPLACEMENT PART NUMBER |
|-------------|------------------------------|------------|------------|---------|-------------------------|-------------|-------------------------------|------------|-------------|---------|-------------------------|
| BN29K-12 | 50HZ 15A BRKR TS 2PH 12M | EACH | \$237.00 | U A | | BN29X-09 | 50HZ 15A BRKR IEC309 3PH 9M | EACH | \$496.00 | U A | |
| BN29K-15 | 50HZ 15A BRKR TS 2PH 15M | EACH | \$264.00 | U A | | BN29X-12 | 50HZ 15A BRKR IEC309 3PH 12M | EACH | \$550.00 | U A | |
| BN29K-18 | 50HZ 15A BRKR TS 2PH 18M | EACH | \$291.00 | U A | | BN29X-15 | 50HZ 15A BRKR IEC309 3PH 15M | EACH | \$603.00 | U A | |
| BN29K-23 | 50HZ 15A BRKR TS 2PH 23M | EACH | \$330.00 | U A | | BN29X-18 | 50HZ 15A BRKR IEC309 3PH 18M | EACH | \$657.00 | U A | |
| BN29L-03 | 50HZ 15A, IEC309, 3W, 3M | EACH | \$171.00 | U A | | BN29X-23 | 50HZ 15A BRKR IEC309 3PH 23M | EACH | \$710.00 | U A | |
| BN29L-06 | 50HZ 15A, IEC309, 3W, 6M | EACH | \$209.00 | U A | | BN29Z-03 | 50HZ 15A, RSF34962, 4W, 03M | EACH | \$889.00 | U A | |
| BN29L-09 | 50HZ 15A, IEC309, 3W, 9M | EACH | \$241.00 | U A | | BN29Z-06 | 50HZ 15A, RSF34962, 4W, 6M | EACH | \$948.00 | U A | |
| BN29L-12 | 50HZ 15A, IEC309, 3W, 12M | EACH | \$273.00 | U A | | BN29Z-09 | 50HZ 15A, RSF34962, 4W, 9M | EACH | \$1,005.00 | U A | |
| BN29L-15 | 50HZ 15A, IEC309, 3W, 15M | EACH | \$305.00 | U A | | BN29Z-12 | 50HZ 15A, RSF34962, 4W, 12M | EACH | \$1,061.00 | U A | |
| BN29L-18 | 50HZ 15A, IEC309, 3W, 18M | EACH | \$346.00 | U A | | BN29Z-15 | 50HZ 15A, RSF34962, 4W, 15M | EACH | \$1,117.00 | U A | |
| BN29L-23 | 50HZ 15A, IEC309, 3W, 23M | EACH | \$372.00 | U A | | BN29Z-18 | 50HZ 15A, RSF34962, 4W, 18M | EACH | \$1,173.00 | U A | |
| BN29M-03 | 50HZ 20A BRKR TS 2PH 3M | EACH | \$156.00 | U A | | BN29Z-23 | 50HZ 15A, RSF34962, 4W, 23M | EACH | \$1,229.00 | U A | |
| BN29M-06 | 50HZ 20A BRKR TS 2PH 6M | EACH | \$185.00 | U A | | DDV11-B | LSI EXPANDER BACKPLANE 9X6 | EACH | \$494.00 | Y 3 A | |
| BN29M-09 | 50HZ 20A BRKR TS 2PH 9M | EACH | \$210.00 | U A | | DSRVB-A2 | DS200,RS232 8 TRMSV,120V | EACH | \$3,625.00 | Y 3 A | |
| BN29M-12 | 50HZ 20A BRKR TS 2PH 12M | EACH | \$237.00 | U A | | DSRVB-B2 | DS200,RS423 8 LINE TRMSV,120V | EACH | \$3,200.00 | Y 3 A | |
| BN29M-15 | 50HZ 20A BRKR TS 2PH 15M | EACH | \$264.00 | U A | | F1001-00 | MEM CONT. LOGIC MODULE | EACH | \$12,938.00 | Y 3 A | |
| BN29M-18 | 50HZ 20A BRKR TS 2PH 18M | EACH | \$291.00 | U A | | F1002-00 | SHIFTER LOGIC MODULE | EACH | \$23,770.00 | Y 3 A | |
| BN29M-23 | 50HZ 20A BRKR TS 2PH 23M | EACH | \$330.00 | U A | | F1003-00 | ALU SLICE #1 MODULE | EACH | \$20,815.00 | Y 3 A | |
| BN29N-03 | 50HZ 10A BRKR TS 3PH 3M | EACH | \$207.00 | U A | | F1004-00 | ALU SLICE #0 MODULE | EACH | \$20,812.00 | Y 3 A | |
| BN29N-06 | 50HZ 10A BRKR TS 3PH 6M | EACH | \$233.00 | U A | | F1005-00 | ADDRESS DTA PATH MODULE | EACH | \$16,463.00 | Y 3 A | |
| BN29N-09 | 50HZ 10A BRKR TS 3PH 9M | EACH | \$260.00 | U A | | F1006-00 | CACHE MODULE FOR CPU | EACH | \$12,601.00 | Y 3 A | |
| BN29N-12 | 50HZ 10A BRKR TS 3PH 12M | EACH | \$287.00 | U A | | F1007-00 | DECODER MODULE | EACH | \$42,000.00 | Y 3 A | |
| BN29N-15 | 50HZ 10A BRKR TS 3PH 15M | EACH | \$313.00 | U A | | F1008-00 | MICRO SEQUENCER LOGIC MOD | EACH | \$23,226.00 | Y 3 A | |
| BN29N-18 | 50HZ 10A BRKR TS 3PH 18M | EACH | \$341.00 | U A | | F1009-00 | 16K WORD WRITE CONT STORE | EACH | \$26,367.00 | Y 3 A | |
| BN29N-23 | 50HZ 10A BRKR TS 3PH 23M | EACH | \$380.00 | U A | | F1010-00 | CLOCK GENERATION & CONSOLE | EACH | \$14,409.00 | Y 3 A | |
| BN29P-03 | 50HZ 15A BRKR TS 3PH 3M | EACH | \$207.00 | U A | | F1011-00 | NBI(NMI TO BI INTERFACE MOD) | EACH | \$14,483.00 | Y 3 A | |
| BN29P-06 | 50HZ 15A BRKR TS 3PH 6M | EACH | \$241.00 | U A | | F1015-00 | DECODER F MODULE | EACH | \$18,375.00 | Y 3 A | |
| BN29P-09 | 50HZ 15A BRKR TS 3PH 9M | EACH | \$262.00 | U A | | F1021-00 | MEMORY CONTROL MODULE | EACH | \$32,466.00 | 3 A | |
| BN29P-12 | 50HZ 15A BRKR TS 3PH 12M | EACH | \$295.00 | U A | | F1026-00 | PBIA LOAD MODULE | EACH | \$2,814.00 | 3 A | |
| BN29P-15 | 50HZ 15A BRKR TS 3PH 15M | EACH | \$313.00 | U A | | F1028-00 | MICRO SEQUENCER MODULE | EACH | \$38,247.00 | 3 A | |
| BN29P-18 | 50HZ 15A BRKR TS 3PH 18M | EACH | \$341.00 | U A | | F1031-00 | PBIA NMI TO BI MODULE | EACH | \$9,896.00 | 3 A | |
| BN29P-23 | 50HZ 15A BRKR TS 3PH 23M | EACH | \$380.00 | U A | | F1032-00 | CONSOLE INTERFACE MODULE | EACH | \$27,466.00 | 3 A | |
| BN29R-03 | 50HZ 20A BRKR TS 3PH 3M | EACH | \$218.00 | U A | | F1033-00 | CLOCK MODULE | EACH | \$25,247.00 | 3 A | |
| BN29R-06 | 50HZ 20A BRKR TS 3PH 6M | EACH | \$264.00 | U A | | F1034-00 | NMI BUS WINDOW MODULE | EACH | \$32,467.00 | 3 A | |
| BN29R-09 | 50HZ 20A BRKR TS 3PH 9M | EACH | \$308.00 | U A | | F1036-00 | CACHE CNTL SEQUENCER MODULE | EACH | \$27,247.00 | 3 A | |
| BN29R-12 | 50HZ 20A BRKR TS 3PH 12M | EACH | \$355.00 | U A | | G057-00 | PRE AMP, TS04 | EACH | \$616.00 | Y 3 A | |
| BN29R-15 | 50HZ 20A BRKR TS 3PH 15M | EACH | \$399.00 | U A | | G066-00 | READ AMP 9-CH | EACH | \$1,773.00 | Y 3 A | |
| BN29R-18 | 50HZ 20A BRKR TS 3PH 18M | EACH | \$445.00 | U A | | G104-00 | SENSE INHIBIT | EACH | \$747.00 | Y 3 A | |
| BN29R-23 | 50HZ 20A BRKR TS 3PH 23M | EACH | \$513.00 | U A | | G110-00 | CONTROL AND DATA LOOPS | EACH | \$565.00 | Y 3 A | |
| BN29S-03 | 50HZ 32A BRKR TS 3PH 3M | EACH | \$251.00 | U A | | G111-00 | SENSE INHIBIT | EACH | \$1,234.00 | Y 3 A | |
| BN29S-06 | 50HZ 32A BRKR TS 3PH 6M | EACH | \$317.00 | U A | | G114-00 | 16K SENSE/INHIBIT G112 W 8881 | EACH | \$1,831.00 | Y 3 A | |
| BN29S-09 | 50HZ 32A BRKR TS 3PH 9M | EACH | \$382.00 | U A | | G116-00 | SENSE/INHIBIT BIT MODULE | EACH | \$1,946.00 | Y 3 A | |
| BN29S-12 | 50HZ 32A BRKR TS 3PH 12M | EACH | \$451.00 | U A | | G157-00 | TS04 READ/WRITE | EACH | \$380.00 | Y 3 A | |
| BN29S-15 | 50HZ 32A BRKR TS 3PH 15M | EACH | \$517.00 | U A | | G158-00 | REEL SERVO , TS04 | EACH | \$804.00 | Y 3 A | |
| BN29S-18 | 50HZ 32A BRKR TS 3PH 18M | EACH | \$582.00 | U A | | G159-00 | CAPSTAN SERVO | EACH | \$926.00 | Y 3 A | |
| BN29S-23 | 50HZ 32A BRKR TS 3PH 23M | EACH | \$691.00 | U A | | G180-00 | LOW DENSITY | EACH | \$407.00 | Y 3 A | |
| BN29W-03 | 50HZ 32A BRKR IEC309 5W, 3M | EACH | \$495.00 | U A | | G227-00 | DRIVE XY | EACH | \$642.00 | Y 3 A | |
| BN29W-06 | 50HZ 32A BRKR IEC309 5W, 6M | EACH | \$560.00 | U A | | G231-00 | MEMORY DRIVER PDP-11 | EACH | \$590.00 | Y 3 A | |
| BN29W-09 | 50HZ 32A BRKR IEC309 5W, 9M | EACH | \$624.00 | U A | | G233-00 | 8K X-Y | EACH | \$1,167.00 | Y 3 A | |
| BN29W-12 | 50HZ 32A BRKR IEC309 5W, 12M | EACH | \$689.00 | U A | | G235-00 | 16K X-Y DRIVE | EACH | \$1,831.00 | Y 3 A | |
| BN29W-15 | 50HZ 32A BRKR IEC309 5W, 15M | EACH | \$753.00 | U A | | G236-00 | 32K XY DRIVE | EACH | \$902.00 | Y 3 A | |
| BN29W-18 | 50HZ 32A BRKR IEC309 5W, 18M | EACH | \$817.00 | U A | | G5036-00 | WRAP AROUND TST MOD FOR M7809 | EACH | \$435.00 | 3 A | |
| BN29W-23 | 50HZ 32A BRKR IEC309 5W, 23M | EACH | \$881.00 | U A | | G650-00 | 16K 12 BIT BASE BRD/LOG/MM8- | EACH | REPLACED | Y 3 A | SPMM8-AB |
| BN29X-03 | 50HZ 15A BRKR IEC309 3PH 3M | EACH | \$389.00 | U A | | G727-00 | SHORT GRANT CONTINUITY | EACH | \$62.00 | 3 A | |
| BN29X-06 | 50HZ 15A BRKR IEC309 3PH 6M | EACH | \$443.00 | U A | | G7273-00 | BUS GRANT&NON-PROCESSOR GRANT | EACH | \$64.00 | 3 A | |



Prices Effective 02-January-89 to 30-June-89

To Order—Call DECdirect™ TOLL-FREE 800-344-4825, 8:30 a.m. to 8:00 p.m. ET in Continental U.S.A.

HARDWARE SPARES PRICE LIST

| PART NUMBER | DESCRIPTION | UNIT ORDER | UNIT PRICE | REP D L | REPLACEMENT PART NUMBER | PART NUMBER | DESCRIPTION | UNIT ORDER | UNIT PRICE | REP D L | REPLACEMENT PART NUMBER |
|-------------|-------------------------------|------------|------------|---------|-------------------------|-------------|-------------------------------|------------|-------------|---------|-------------------------|
| G7360-00 | G736/2 SOCKETS | EACH | \$53.00 | 3 A | | H7007-AD | AC SURGE SUPPRESSOR,277/480V | EACH | \$295.00 | U A | |
| G772-00 | POWER CONNECTOR | EACH | \$57.00 | 3 A | | H7007-BA | DATA LINE SURGE SUPPRESSR,T/S | EACH | \$116.00 | U A | |
| G8000-00 | 8.5V RECTIFIER | EACH | \$118.00 | 3 A | | H7007-BB | DATA LINE SURGE SUPPRESSR,T/S | EACH | \$145.00 | U A | |
| G8018-00 | REGULATOR FOR 8A400 | EACH | \$3,004.00 | Y 3 A | | H7007-CA | DATA LINE SURGE SUPP.,PC BRD | EACH | \$59.00 | U A | |
| G8019-00 | POWER DISTRIBUTION BD. CONTR. | EACH | \$450.00 | Y 3 A | | H7007-DA | SURGE SUPP COMBO TS/AC LINE | EACH | \$295.00 | U A | |
| G821-00 | PLUS 5 REGULATOR CONTROL | EACH | \$499.00 | Y 3 A | | H7007-DB | SURGE SUPP RS232/AC LINE | EACH | \$316.00 | U A | |
| G840-00 | LIGHT PEN AMPLIFIER | EACH | \$795.00 | 3 A | | H7007-LB | POWER LINE SURGE SUPP 120V 8A | EACH | \$73.00 | U A | |
| G9341-00 | TU10 BRAKE ACTUATOR | EACH | \$468.00 | Y 3 A | | H7007-MA | 24 LINE ENCL.TS I/O 25P DCONN | EACH | \$288.00 | U A | |
| G938-00 | RK05J HEAD POSITION SERVO | EACH | \$408.00 | Y 3 A | | H7007-MB | 8 LINE ENCL.TS I/O 25P DCONN. | EACH | \$176.00 | U A | |
| H034-00 | DBL SYS UNIT CASTING 12-11439 | EACH | REPLACED | 3 A | 12-11439-00 | H7007-MH | DATALINE SURGE SUPP RS232 PC | EACH | \$69.00 | U A | |
| H0341-00 | CARD CAGE FOR 9X6 BACKPLANE | EACH | \$120.00 | 3 A | | H7007-MK | DATALINE SURGE SUPP RS423 PC | EACH | \$72.00 | U A | |
| H037-00 | MEDIUM DUTY COMB. DOOR LOCK | EACH | REPLACED | U A | H038-00 | H7007-PA | POWER+DATALINE SURGE SUPP TS | EACH | \$137.00 | U A | |
| H038-00 | HEAVY DUTY COMB. DOOR LOCK | EACH | \$298.00 | U A | | H7007-PB | POWER+DATA SURGE SUPP DCONN. | EACH | \$137.00 | U A | |
| H214-00 | 11/05 MEM STACK 8K | EACH | REPLACED | Y 3 A | H215-00 | H7007-PC | POWER+DATA SURGE SUPP 8ARS423 | EACH | \$149.00 | U A | |
| H215-00 | 8K 18BIT PARITY MEMORY STACK | EACH | \$1,702.00 | Y 3 A | | H7060-A | CNTRL & START-UP POWER | EACH | \$2,035.00 | Y 3 A | |
| H217-C | MEMORY STK,16384 WORD 18B | EACH | \$2,055.00 | Y 3 A | | H7061-A | INTERFACE LOGIC MODULE | EACH | \$1,825.00 | Y 3 A | |
| H217-D | MEMORY STK, 16384 WORD 16B | EACH | REPLACED | Y 3 A | H217-C | H7062-A | N BOX TRANSLATOR | EACH | \$957.00 | Y 3 A | |
| H219-A | 8KX12 BIT MEM PLUG TO G649 MM | EACH | REPLACED | Y 3 A | SPMM8-AA | H7066-A | BI EXP LOGIC MODULE | EACH | \$3,693.00 | 3 A | |
| H219-B | MEMORY STK 12B | EACH | REPLACED | Y 3 A | SPMM8-AB | H7100-A | POWER SUPPLY 115V | EACH | \$2,646.00 | Y 3 A | |
| H222-A | MEMORY STK 18B | EACH | REPLACED | Y 3 A | SMM11-DP | H7100-B | POWER SUPPLY 230V | EACH | \$2,725.00 | Y 3 A | |
| H224-C | MEMORY STK 19B | EACH | \$3,783.00 | Y 3 A | | H7104-C | POWER SUPPLY ASSY, 120V | EACH | \$3,825.00 | Y 3 A | |
| H3006-00 | 8-LINE RS232 DIST PANEL DZ11 | EACH | \$691.00 | Y 3 A | | H7104-D | POWER SUPPLY ASSY, 240V | EACH | \$3,825.00 | Y 3 A | |
| H315-00 | MODEM TEST | EACH | \$83.00 | Y 3 A | | H7110-00 | LA120 PS 120V 60HZ | EACH | \$855.00 | Y 3 A | |
| H317-E | H317-E CABLE BOX ASSY. | EACH | \$901.00 | Y 3 A | | H7111-A | POWER SUPPLY TOD 120V | EACH | \$765.00 | Y 3 A | |
| H3248-00 | SINGLE RS232 LOOP BACK SYNC | EACH | \$44.00 | 3 A | | H7111-B | POWER SUPPLY TOD 240V | EACH | \$765.00 | Y 3 A | |
| H325-00 | CONN. MODEM TEST | EACH | \$103.00 | 3 A | | H7140-AA | H7140 W 120V LINECORD 50/60HZ | EACH | \$9,997.00 | Y 3 A | |
| H3250-00 | DDS TEST CONN, NO NEW SYNC | EACH | \$123.00 | 3 A | | H7140-AB | H7140 W 240V LINECORD 50/60HZ | EACH | \$7,295.00 | Y 3 A | |
| H3251-00 | TEST CONNECTOR RS422 | EACH | \$50.00 | 3 A | | H7140-CA | H7140 EXCEPT +/-15V BATT 60HZ | EACH | \$10,386.00 | Y 3 A | |
| H3254-00 | M8203 TEST CONNECTOR J1 | EACH | \$104.00 | 3 A | | H7142-00 | POWER SUPPLY RA90 | EACH | \$600.00 | 3 A | |
| H3255-00 | M8203 TEST CONNECTOR J2 | EACH | \$89.00 | 3 A | | H7150-00 | LA120 PS:120V/240V | EACH | \$705.00 | Y 3 A | |
| H3257-00 | MALE TERMINATOR FOR INT MODEM | EACH | \$53.00 | 3 A | | H716-00 | POWER SUPPLY | EACH | REPLACED | 3 A | H716-B |
| H3258-00 | FEMALE TERM FOR INT MODEM | EACH | \$53.00 | 3 A | | H716-B | 19" H716 (120V RECEPTACLE) | EACH | \$438.00 | 3 A | |
| H3259-00 | TEST CONNECTOR | EACH | \$39.00 | 3 A | | H7170-A | MPS 120V 3-PHASE 2.8KW | EACH | \$3,135.00 | Y 3 A | |
| H3263-00 | KA630 CONF. CONN. & BATT CONN | EACH | \$151.00 | 3 A | | H7176-A | 120V 3-PHASE 2800W 300V PS | EACH | \$3,182.00 | Y 3 A | |
| H3270-00 | DLV11-J LOOPBACK TEST PLUG | EACH | \$26.00 | 3 A | | H7177-A | AC INPUT BOX,208V IN,3PH WYE | EACH | \$3,225.00 | 3 A | |
| H3272-00 | STAGGERED TURN-AROUND CONN. | EACH | \$88.00 | 3 A | | H7180-A | FLOAT. 5 OR 5.2V 200A SWITCH | EACH | \$2,736.00 | Y 3 A | |
| H3275-00 | CONN. 1 30-PIN,2 10-PIN | EACH | \$567.00 | 3 A | | H7186-A | +/-5V @ 85A SWITCH REG | EACH | \$2,444.00 | Y 3 A | |
| H3277-00 | TURN-AROUND TEST CONNECTOR | EACH | \$74.00 | 3 A | | H7187-A | +/-2.5V 100A SWITCH REG | EACH | \$2,336.00 | Y 3 A | |
| H3280-AA | CONNECTOR PCS+ TO PCS+ | EACH | \$56.00 | U A | | H7188-AB | H7188-A EMM WITH PROM | EACH | \$3,355.00 | Y 3 A | |
| H3280-AB | CONNECTORS PCS+ TO RSV | EACH | \$77.00 | U A | | H7189-A | BI POWER REGULATOR | EACH | \$6,020.00 | Y 3 A | |
| H3280-AC | CONNECTORS REPO IN/OUT | EACH | \$66.00 | U A | | H720-E | PDP 11/20 POWER SUPPLY, 120V | EACH | \$2,086.00 | Y 3 A | |
| H3280-AD | CONNECTORS RSU TO RSU | EACH | \$87.00 | U A | | H720-F | PDP 11/20 POWER SUPPLY, 240V | EACH | \$2,086.00 | Y 3 A | |
| H403-B | BA11-SA/SB,AC INPUT FILTER | EACH | \$217.00 | 3 A | | H7200-00 | 5V POWER MODULE:60A,300V,200W | EACH | \$1,527.00 | Y 3 A | |
| H404-C | UNIVERSAL AC INPUT ASSEMBLY | EACH | \$866.00 | 3 A | | H7202-B | 11730 POWER SUPPLY:120/240V | EACH | \$3,948.00 | Y 3 A | |
| H405-A | POWER INPUT BOX: 3PH 120V 16A | EACH | \$1,905.00 | Y 3 A | | H7202-D | H7200,H7216,120V/240V | EACH | \$2,635.00 | 3 A | |
| H405-B | POWER INPUT BOX:3PH DELTA 380 | EACH | \$2,147.00 | Y 3 A | | H7202-J | H7202-B PACKAGED FOR LCN | EACH | \$2,800.00 | 3 A | |
| H405-E | AC INPUT BOX | EACH | \$3,510.00 | Y 3 A | | H7204-BA | H7203,H7216-A,H7217,120V | EACH | \$4,188.00 | Y 3 A | |
| H405-F | AC INPUT BOX 50HZ | EACH | \$3,774.00 | Y 3 A | | H7206-A | POWER & LOGIC BOX,208/300VDC | EACH | \$4,798.00 | Y 3 A | |
| H4080-00 | ETHERNET LOOP BACK CONNECTOR | EACH | \$566.00 | 3 A | | H7211-00 | COMM OPT PS:+15V 2A-15V 3A | EACH | \$670.00 | Y 3 A | |
| H604-00 | DECPACK HEAD POS. SERVO PWR A | EACH | \$205.00 | Y 3 A | | H7213-00 | MEMORY PWR MODULE:+5V 15A,+12 | EACH | \$745.00 | Y 3 A | |
| H606-00 | POWER BOARD (TU16) | EACH | \$830.00 | Y 3 A | | H7214-A | 600W +5V REGULATOR | EACH | \$2,996.00 | Y 3 A | |
| H607-00 | TAPE MOTION BOARD | EACH | \$3,956.00 | Y 3 A | | H7215-A | 300W -5V REGULATOR | EACH | \$3,530.00 | Y 3 A | |
| H7007-AA | AC SURGE SUPPRESSOR,120V 12A | EACH | \$188.00 | U A | | H7216-00 | -5.3V 10A,+12.4V 2.0A SWITCH | EACH | \$585.00 | Y 3 A | |
| H7007-AB | AC SURGE SUPPRESSOR,120/208V | EACH | \$316.00 | U A | | H7216-A | +12V 3A SWITCHER | EACH | \$723.00 | 3 A | |
| H7007-AC | AC SURGE SUPPRESSOR, 120/240V | EACH | \$268.00 | U A | | H7217-00 | COMMUNICATION REGULATOR,+15V | EACH | \$667.00 | 3 A | |

digital

Prices Effective 02-January-89 to 30-June-89

To Order—Call DECdirect™ TOLL-FREE 800-344-4825, 8:30 a.m. to 8:00 p.m. ET in Continental U.S.A.

SPARES PRICE LIST A-5

HARDWARE SPARES PRICE LIST

| PART NUMBER | DESCRIPTION | UNIT ORDER | UNIT PRICE | REP D | L | REPLACEMENT PART NUMBER | PART NUMBER | DESCRIPTION | UNIT ORDER | UNIT PRICE | REP D | L | REPLACEMENT PART NUMBER | |
|-------------|--------------------------------|------------|-------------|-------|---|-------------------------|-------------|------------------------------|------------|-------------|-------|---|-------------------------|--|
| H722-00 | 50HZ 2KVA ISOLATION TRANSFORME | EACH | \$406.00 | 3 | A | | H7230-D | 48V 5 AMP-HR BATTERY W/CHGR | EACH | \$880.00 | 3 | A | | |
| H7225-AA | 500VA 90-130V 60HZ INPUT CVT | EACH | \$488.00 | U | A | | H7231-A | H7230-A + H7240-A,120V/240V | EACH | REPLACED | 3 | A | H7231-B | |
| H7225-AC | 1000VA 90-130V 60HZ INPUT CVT | EACH | \$712.00 | U | A | | H7231-B | H7230-A & H7240-A, 120V/240V | EACH | \$3,905.00 | 3 | A | | |
| H7225-AE | 2500VA 90-130V 60HZ INPUT CVT | EACH | \$1,344.00 | U | A | | H7240-A | 48V TO 300V ISOLATED CONVTR. | EACH | \$1,010.00 | Y | 3 | A | |
| H7225-BE | 2000VA 90-130V 60HZ INPUT CVT | EACH | \$1,205.00 | U | A | | H7250-00 | 1250W 300VDC SUPPLY,120/240 | EACH | \$1,430.00 | Y | 3 | A | |
| H7225-BG | 3000VA 90-130V 60HZ INPUT CVT | EACH | \$1,526.00 | U | A | | H7251-00 | POWER MOD # 1 | EACH | \$1,380.00 | Y | 3 | A | |
| H7226-JC | CVC 5KVA 208/240IN 60HZ PLUG | EACH | \$2,672.00 | U | A | | H7253-00 | POWER MOD # 3 | EACH | \$2,160.00 | Y | 3 | A | |
| H7226-KC | CVC 7.5KVA 208/240IN 60HZPLUG | EACH | \$3,422.00 | U | A | | H7270-A | 110V PC500 PS MOD. | EACH | \$486.00 | Y | 3 | A | |
| H7226-LC | CVC 10KVA 208/240IN 60HZ JB | EACH | \$4,279.00 | U | A | | H7270-B | 220V PC500 PS MOD. | EACH | \$486.00 | Y | 3 | A | |
| H7227-KA | PDS VAX CAB REPOS STATION | EACH | REPLACED | U | A | H7317-JA | H7271-00 | 300VDC POWER REG. | EACH | \$302.00 | 3 | A | | |
| H7227-KB | BUILDING INTERFACE ALARM | EACH | \$852.00 | U | A | | H7280-A | POWER SUPPLY 120V | EACH | \$637.00 | Y | 3 | A | |
| H7227-KC | 50 FT CABLE FOR H7227-KA | EACH | \$134.00 | U | A | | H7310-AA | ENVIRONMENTAL MONITOR SYSTEM | EACH | \$3,495.00 | U | A | | |
| H7227-KD | WALL-MOUNTED EMERG. POWER OFF | EACH | REPLACED | U | A | H7317-JA | H7310-AB | H7310AA W/H7317PA PKG | EACH | \$5,495.00 | U | A | | |
| H7227-KE | EMER POWER OFF W/TEMP DISP | EACH | REPLACED | U | A | H7317-JB | H7317-AA | PDS+ VAX CAB 15 KVA 208V 42P | EACH | \$12,949.00 | U | A | | |
| H7227-KF | EMER POWER OFF W/TEMP & HUMID | EACH | REPLACED | U | A | H7317-JC | H7317-AB | PDS+ VAX CAB 30KVA 208V 42P | EACH | \$14,989.00 | U | A | | |
| H7228-AA | PCS 15 KVA 208V 42 POLE | EACH | \$17,131.00 | U | A | | H7317-AC | PDS+ VAX CAB 50KVA 208V 42P | EACH | \$17,029.00 | U | A | | |
| H7228-AB | PCS 30 KVA 208V 42 POLE | EACH | \$19,273.00 | U | A | | H7317-AJ | PDS+ VAX CAB 50KVA 208V 84P | EACH | \$18,049.00 | U | A | | |
| H7228-AC | PCS 50KVA 208V 42 POLE | EACH | \$20,344.00 | U | A | | H7317-BA | PDS+ VAX CAB 15KVA 220V 42P | EACH | \$12,949.00 | U | A | | |
| H7228-AJ | PCS 50KVA 208V 84 POLE | EACH | \$21,415.00 | U | A | | H7317-BB | PDS+ VAX CAB 30KVA 220V 42P | EACH | \$14,989.00 | U | A | | |
| H7228-AK | H7228-AC W/CABLES FOR VAX8600 | EACH | \$24,628.00 | U | A | | H7317-BC | PDS+ VAX CAB 50KVA 220V 42P | EACH | \$17,029.00 | U | A | | |
| H7228-BA | PCS 15KVA 220V 42 POLE | EACH | \$17,131.00 | U | A | | H7317-BJ | PDS+ VAX CAB 50KVA 220V 84P | EACH | \$18,049.00 | U | A | | |
| H7228-BB | PCS 30KVA 220V 42 POLE | EACH | \$19,273.00 | U | A | | H7317-CA | PDS+ VAX CAB 15KVA 600V 42P | EACH | \$12,949.00 | U | A | | |
| H7228-BC | PCS 50KVA 220V 42 POLE | EACH | \$20,344.00 | U | A | | H7317-CB | PDS+ VAX CAB 30KVA 600V 42P | EACH | \$14,989.00 | U | A | | |
| H7228-BJ | PCS 50KVA 220V 84 POLE | EACH | \$21,415.00 | U | A | | H7317-CC | PDS+ VAX CAB 50KVA 600V 42P | EACH | \$17,029.00 | U | A | | |
| H7228-DA | PCS 15KVA 240V 42 POLE | EACH | \$17,131.00 | U | A | | H7317-CD | PDS+ VAX CAB 75KVA 600V 84P | EACH | \$19,375.00 | U | A | | |
| H7228-DB | PCS 30KVA 240V 42 POLE | EACH | \$19,273.00 | U | A | | H7317-CE | PDS+ VAX CAB 100KVA 600V 84P | EACH | \$20,395.00 | U | A | | |
| H7228-DC | PCS 50KVA 240V 42 POLE | EACH | \$20,344.00 | U | A | | H7317-CJ | PDS+ VAX CAB 50KVA 600V 84P | EACH | \$18,049.00 | U | A | | |
| H7228-DJ | PCS 50KVA 240V 84 POLE | EACH | \$21,415.00 | U | A | | H7317-DA | PDS+ VAX CAB 15KVA 240V 42P | EACH | \$12,949.00 | U | A | | |
| H7228-EA | PCS 15KVA 440V 42 POLE | EACH | \$17,131.00 | U | A | | H7317-DB | PDS+ VAX CAB 30KVA 240V 42P | EACH | \$14,989.00 | U | A | | |
| H7228-EB | PCS 30KVA 440V 42 POLE | EACH | \$19,273.00 | U | A | | H7317-DC | PDS+ VAX CAB 50KVA 240V 42P | EACH | \$17,029.00 | U | A | | |
| H7228-EC | PCS 50KVA 440V 42 POLE | EACH | \$20,344.00 | U | A | | H7317-DJ | PDS+ VAX CAB 50KVA 240V 84P | EACH | \$18,049.00 | U | A | | |
| H7228-ED | PCS 75KVA 440V 84 POLE | EACH | \$22,486.00 | U | A | | H7317-EA | PDS+ VAX CAB 15KVA 440V 42P | EACH | \$12,949.00 | U | A | | |
| H7228-EE | PCS 100KVA 440V 84 POLE | EACH | \$24,199.00 | U | A | | H7317-EB | PDS+ VAX CAB 30KVA 440V 42P | EACH | \$14,989.00 | U | A | | |
| H7228-EJ | PCS 50KVA 440V 84 POLE | EACH | \$21,415.00 | U | A | | H7317-EC | PDS+ VAX CAB 50KVA 440V 42P | EACH | \$17,029.00 | U | A | | |
| H7228-FA | PCS 15KVA 460V 42 POLE | EACH | \$17,131.00 | U | A | | H7317-ED | PDS+ VAX CAB 75KVA 440V 84P | EACH | \$19,375.00 | U | A | | |
| H7228-FB | PCS 30KVA 460V 42 POLE | EACH | \$19,273.00 | U | A | | H7317-EE | PDS+ VAX CAB 100KVA 440V 84P | EACH | \$20,395.00 | U | A | | |
| H7228-FC | PCS 50KVA 460V 42 POLE | EACH | \$20,344.00 | U | A | | H7317-EJ | PDS+ VAX CAB 50KVA 440V 84P | EACH | \$18,049.00 | U | A | | |
| H7228-FD | PCS 75KVA 460V 84 POLE | EACH | \$22,486.00 | U | A | | H7317-FA | PDS+ VAX CAB 15KVA 460V 42P | EACH | \$12,949.00 | U | A | | |
| H7228-FE | PCS 100KVA 460V 84 POLE | EACH | \$24,199.00 | U | A | | H7317-FB | PDS+ VAX CAB 30KVA 460V 42P | EACH | \$14,989.00 | U | A | | |
| H7228-FJ | PCS 50KVA 460V 84 POLE | EACH | \$21,415.00 | U | A | | H7317-FC | PDS+ VAX CAB 50KVA 460V 42P | EACH | \$17,029.00 | U | A | | |
| H7228-HA | PCS 15KVA 480V 42 POLE | EACH | \$17,131.00 | U | A | | H7317-FD | PDS+ VAX CAB 75KVA 460V 84P | EACH | \$19,375.00 | U | A | | |
| H7228-HB | PCS 30KVA 480V 42 POLE | EACH | \$19,273.00 | U | A | | H7317-FE | PDS+ VAX CAB 100KVA 460V 84P | EACH | \$20,395.00 | U | A | | |
| H7228-HC | PCS 50KVA 480V 42 POLE | EACH | \$20,344.00 | U | A | | H7317-FJ | PDS+ VAX CAB 50KVA 460V 84P | EACH | \$18,049.00 | U | A | | |
| H7228-HD | PCS 75KVA 480V POLE | EACH | \$22,486.00 | U | A | | H7317-HA | PDS+ VAX CAB 15KVA 480V 42P | EACH | \$12,949.00 | U | A | | |
| H7228-HE | PCS 100KVA 480V 84 POLE | EACH | \$24,199.00 | U | A | | H7317-HB | PDS+ VAX CAB 30KVA 480V 42P | EACH | \$14,989.00 | U | A | | |
| H7228-HJ | PCS 50KVA 480V 84 POLE | EACH | \$21,415.00 | U | A | | H7317-HC | PDS+ VAX CAB 50KVA 480V 84P | EACH | \$17,029.00 | U | A | | |
| H7228-HK | H7228-HC W/CABLES FOR VAX8600 | EACH | \$24,628.00 | U | A | | H7317-HD | PDS+ VAX CAB 75KVA 480V 84P | EACH | \$19,375.00 | U | A | | |
| H7228-LA | PCS 50HZ 15KVA 380/415V 42 P | EACH | \$17,131.00 | U | A | | H7317-HE | PDS+ VAX CAB 100KVA 480V 84P | EACH | \$20,395.00 | U | A | | |
| H7228-LB | PCS 50HZ 30KVA 380/415V 42 P | EACH | \$19,273.00 | U | A | | H7317-HJ | PDS+ VAX CAB 50KVA 480V 84P | EACH | \$18,049.00 | U | A | | |
| H7228-LC | 1CS 50HZ 50KVA 380/415V 42 P | EACH | \$20,344.00 | U | A | | H7317-JA | REPO WALL MOUNTED | EACH | \$255.00 | U | A | | |
| H7228-LD | PCS 50HZ 75KVA 380/415V 42 P | EACH | \$22,486.00 | U | A | | H7317-JB | REPO W/TEMP MONITORING | EACH | \$785.00 | U | A | | |
| H7229-AA | 500 VA STANDBY UPS MODEL I | EACH | \$1,321.00 | U | A | | H7317-JC | REPO W/TEMP & HUMIDITY MON. | EACH | \$994.00 | U | A | | |
| H7229-AC | 1000 VA STANDBY UPS MODEL II | EACH | \$1,627.00 | U | A | | H7317-JD | REPO W/TEMP MONITOR TO PDS+ | EACH | \$785.00 | U | A | | |
| H7229-AD | 1440 VA STANDBY UPS MODEL III | EACH | \$2,300.00 | U | A | | H7317-JE | REPO W/TEMP HUMIDITY TO PCS+ | EACH | \$994.00 | U | A | | |
| H7230-A | 48V 5 AMPHR BATT W/CHARGER | EACH | REPLACED | 3 | A | H7231-B | H7317-JF | REPO W/TEMP MON TO RSUS | EACH | \$852.00 | U | A | | |



Prices Effective 02-January-89 to 30-June-89
 To Order—Call DECdirect™ TOLL-FREE 800-344-4825, 8:30 a.m. to 8:00 p.m. ET in Continental U.S.A.

HARDWARE SPARES PRICE LIST

| PART NUMBER | DESCRIPTION | UNIT ORDER | UNIT PRICE | REP D | L | REPLACEMENT PART NUMBER | PART NUMBER | DESCRIPTION | UNIT ORDER | UNIT PRICE | REP D | L | REPLACEMENT PART NUMBER |
|-------------|------------------------------|------------|-------------|-------|---|-------------------------|-------------|-------------------------------|------------|-------------|-------|---|-------------------------|
| H7317-JG | REPO W/TEMP & HUM TO RSU | EACH | \$1,015.00 | U | A | | H7318-LB | PCS+ 30KVA 380/415V 50HZ | EACH | \$24,475.00 | U | A | |
| H7317-KB | BIA BUILDING INTERFACE ADAPT | EACH | \$505.00 | U | A | | H7318-LC | PCS+ 50 KVA 380/415V 50HZ | EACH | \$25,495.00 | U | A | |
| H7317-KC | TEMP PROBE WALL MOUNTED | EACH | \$199.00 | U | A | | H7318-LD | PCS+ 30 KVA 380/415V 50HZ | EACH | \$27,535.00 | U | A | |
| H7317-KE | RSU REMOTE SENSING UNIT | EACH | \$954.00 | U | A | | H740-D | RACK MT 8/M & 11/05 PWR SUPPL | EACH | \$1,594.00 | Y | 3 | A |
| H7317-KF | WATER DETECTOR PROBE | EACH | \$505.00 | U | A | | H742-A | PS CHASSIS 11/45 115 VAC | EACH | \$3,819.00 | Y | 3 | A |
| H7317-KJ | EIA DRY CONTACT SENSOR | EACH | \$66.00 | U | A | | H7420-A | POW SUPPLY HI POW H742-A 115V | EACH | \$2,325.00 | Y | 3 | A |
| H7317-KK | EIA 1 MILLIAMP CURRENT SENSE | EACH | \$66.00 | U | A | | H7420-B | POW SUPPLY HI POW H742-B 230V | EACH | \$2,325.00 | Y | 3 | A |
| H7317-KL | EIA 12 VOLT AC/DC INTFACE | EACH | \$66.00 | U | A | | H7423-AA | TM/TS78 POWER SUPPLY | EACH | \$1,592.00 | Y | 3 | A |
| H7317-KM | EIA 24V AC/DC INTERFACE | EACH | \$66.00 | U | A | | H743-BB | POWER SUPPLY RK05 230V | EACH | \$1,675.00 | Y | 3 | A |
| H7317-KN | EIA FREQUENCY INTERFACE | EACH | \$179.00 | U | A | | H744-00 | 25 AMPERE POWER REGLATOR +5V | EACH | \$711.00 | Y | 3 | A |
| H7317-KP | EIA 5 VOLT INTERFACE | EACH | \$66.00 | U | A | | H7440-00 | POA1 H7440 | EACH | \$734.00 | Y | 3 | A |
| H7317-KR | EIA 4-20 MILLIAMP INTERFACE | EACH | \$168.00 | U | A | | H7441-00 | POWER SUPPLY | EACH | REPLACED | Y | 3 | A |
| H7317-KS | EIA ANALOG BUFFER 0-12V AC | EACH | \$194.00 | U | A | | H7441-YA | FCC 5V 32A REGULATOR | EACH | \$1,036.00 | Y | 3 | A |
| H7317-KT | E/A ISOLATED BUFFER 0-S AMP | EACH | \$194.00 | U | A | | H745-00 | POWER REGULATOR | EACH | \$468.00 | Y | 3 | A |
| H7317-KV | FOUR POLE RELAY OUTPUT | EACH | \$66.00 | U | A | | H7476-00 | +/-15V2A TRACKING LINEAR REG | EACH | \$353.00 | Y | 3 | A |
| H7317-KW | FOUR POLE RELAY MECH LATCH | EACH | \$255.00 | U | A | | H7490-00 | +5V LINEAR REG. NEEDS 8 VAC | EACH | REPLACED | Y | 3 | A |
| H7317-KY | 12 VOLT AUX POWER ADAPTER | EACH | \$459.00 | U | A | | H7490-YA | 5V 5A LINEAR REG. NEEDS 8 VAC | EACH | \$572.00 | Y | 3 | A |
| H7317-KZ | AC PWR ADAPTER 120V/16V OUT | EACH | \$45.00 | U | A | | H750-00 | POWER SUPPLY ASSY | EACH | \$3,504.00 | Y | 3 | A |
| H7317-LA | PDS+ VAX CAB 15 KVA 380/415 | EACH | \$12,949.00 | U | A | | H754-00 | + 20 VOLT REGULATOR | EACH | \$978.00 | Y | 3 | A |
| H7317-LB | PDS+ VAX CAB 30 KVA 380/415 | EACH | \$14,989.00 | U | A | | H756-00 | POW SUPPLY 5V 25 AMP | EACH | \$832.00 | Y | 3 | A |
| H7317-LC | PDS+ VAX CAB 50 KVA 380/415 | EACH | \$17,029.00 | U | A | | H764-00 | POWER SUPPLY-RP04 | EACH | REPLACED | Y | 3 | A |
| H7317-LD | PDS+ VAX CAB 75 KVA 380/415 | EACH | \$19,375.00 | U | A | | H765-A | POW SUPPLY BA11-K 115V | EACH | \$3,226.00 | Y | 3 | A |
| H7317-LE | PDS+ VAX CAB 100 KVA 380/415 | EACH | \$20,395.00 | U | A | | H765-B | POW SUPPLY BA11-K 230V | EACH | \$3,091.00 | Y | 3 | A |
| H7317-PA | PCS+ MONITORING PACKAGE | EACH | \$2,315.00 | U | A | | H7660-C | POWER SUPPLY (60HZ) | EACH | \$3,019.00 | Y | 3 | A |
| H7318-AA | PCS+ 15KVA 208V 42 POLE | EACH | \$23,455.00 | U | A | | H7660-D | POWER SUPPLY (50HZ) | EACH | \$3,019.00 | Y | 3 | A |
| H7318-AB | PCS+ 30KVA 208V 42 POLE | EACH | \$24,475.00 | U | A | | H771-A | POW SUPPLY RX01 (RX11) 60HZ | EACH | \$1,011.00 | Y | 3 | A |
| H7318-AC | PCS+ 50KVA 208V 42 POLE | EACH | \$25,495.00 | U | A | | H771-C | RX01 POWER SUPPLY LOW V 50HZ | EACH | \$858.00 | Y | 3 | A |
| H7318-AJ | PCS+ 50KVA 208V 84 POLE | EACH | \$26,515.00 | U | A | | H771-D | RX01 POWER SUPPLY HIGH V 50HZ | EACH | \$858.00 | Y | 3 | A |
| H7318-BA | PCS+ 15KVA 220V 42 POLE | EACH | \$23,455.00 | U | A | | H772-A | POWER SUPPLY,ICS,60HZ,OUT=5V, | EACH | \$2,514.00 | Y | 3 | A |
| H7318-BB | PCS+ 30KVA 220V 42 POLE | EACH | \$24,475.00 | U | A | | H777-CA | H777-AA EXCEPT +5V 32A | EACH | \$2,218.00 | Y | 3 | A |
| H7318-BC | PCS+ 50KVA 220V 42 POLE | EACH | \$25,495.00 | U | A | | H777-DA | 11/04 POWER SUPPLY,+5V 32A | EACH | \$1,940.00 | Y | 3 | A |
| H7318-BJ | PCS+ 50KVA 220V 84 POLE | EACH | \$26,515.00 | U | A | | H780-A | POWER SUPPLY 11V05 | EACH | \$1,038.00 | Y | 3 | A |
| H7318-DA | PCS+ 15KVA 240V 42 POLE | EACH | \$23,455.00 | U | A | | H780-E | H780.11/03 SLAVE CONSOLE 120V | EACH | \$1,222.00 | Y | 3 | A |
| H7318-DB | PCS+ 30KVA 240V 42 POLE | EACH | \$24,475.00 | U | A | | H7834-00 | H7834 POWER SUPPLY LA34 | EACH | \$442.00 | Y | 3 | A |
| H7318-DC | PCS+ 50KVA 240V 42 POLE | EACH | \$25,495.00 | U | A | | H7835-00 | VT103 UNIVERSAL POWER SUPPLY | EACH | \$1,365.00 | Y | 3 | A |
| H7318-DJ | PCS+ 50KVA 240V 84 POLE | EACH | \$26,515.00 | U | A | | H7836-B | POWER SUPPLY ASSY 240V | EACH | \$382.00 | Y | 3 | A |
| H7318-EA | PCS+ 15KVA 440V 42 POLE | EACH | \$23,455.00 | U | A | | H7837-00 | LA100 SUPPLY:120/240V, OUTPUT | EACH | REPLACED | Y | 3 | A |
| H7318-EB | PCS+ 30KVA 440V 42 POLE | EACH | \$24,475.00 | U | A | | H7837-AA | FCC-COMP. H7837,120V/240V | EACH | REPLACED | Y | 3 | A |
| H7318-EC | PCS+ 50KVA 440V 42 POLE | EACH | \$25,495.00 | U | A | | H7842-A | SMALL SYS UNIT P.S.:130 WATTS | EACH | REPLACED | Y | 3 | A |
| H7318-ED | PCS+ 75KVA 440V 84 POLE | EACH | \$27,535.00 | U | A | | H7842-D | SMALL SYS UNIT POW SUP | EACH | \$375.00 | Y | 3 | A |
| H7318-EE | PCS+ 100KVA 440V 84 POLE | EACH | \$28,555.00 | U | A | | H7844-00 | POWER SUPPLY 120/240,OUTPUT | EACH | REPLACED | Y | 3 | A |
| H7318-EJ | PCS+ 50KVA 440V 84 POLE | EACH | \$26,515.00 | U | A | | H7845-BA | 120V SMALL SYS PWR SUP:85WATT | EACH | \$414.00 | Y | 3 | A |
| H7318-FA | PCS+ 15KVA 460V 42 POLE | EACH | \$23,455.00 | U | A | | H7845-BB | 240V SMALL SYS PWR SUP:85WATT | EACH | \$414.00 | Y | 3 | A |
| H7318-FB | PCS+ 30KVA 460V 42 POLE | EACH | \$24,475.00 | U | A | | H7847-AA | POWER SUPPLY 120/240V | EACH | \$372.00 | Y | 3 | A |
| H7318-FC | PCS+ 50KVA 460V 42 POLE | EACH | \$25,495.00 | U | A | | H7848-BA | VS400 PWR SUPPLY 120V | EACH | \$509.00 | Y | 3 | A |
| H7318-FD | PCS+ 75KVA 460V 84 POLE | EACH | \$27,535.00 | U | A | | H7848-BB | VS400 PWR SUPPLY 240V | EACH | \$509.00 | Y | 3 | A |
| H7318-FE | PCS+ 100KVA 460V 84 POLE | EACH | \$28,555.00 | U | A | | H785-00 | POWER SUPPLY 120V | EACH | \$1,426.00 | Y | 3 | A |
| H7318-FJ | PCS+ 50KVA 460V 84 POLE | EACH | \$26,515.00 | U | A | | H7850-00 | BATTERY BACK-UP REG | EACH | \$1,301.00 | Y | 3 | A |
| H7318-HA | PCS+ 15KVA 480V 42 POLE | EACH | \$23,455.00 | U | A | | H786-00 | BA11-NC/D PS:120/240V 50/60 H | EACH | \$1,067.00 | Y | 3 | A |
| H7318-HB | PCS+ 30KVA 480V 42 POLE | EACH | \$24,475.00 | U | A | | H7861-00 | BA11-SA/SB PS:120/240V 50/60H | EACH | \$2,031.00 | Y | 3 | A |
| H7318-HC | PCS+ 50KVA 480V 42 POLE | EACH | \$25,495.00 | U | A | | H7862-00 | LARGE SYS UNIT P.S.:210 WATTS | EACH | REPLACED | Y | 3 | A |
| H7318-HD | PCS+ 75KVA 480V POLE | EACH | \$27,535.00 | U | A | | H7862-C | H7862 EXCEPT +5V 2-20A,+12V | EACH | \$1,584.00 | Y | 3 | A |
| H7318-HE | PCS+ 100KVA 480V 84 POLE | EACH | \$28,555.00 | U | A | | H7863-A | RC25 PS; 5V 15.8A,-5.2V 3,0A | EACH | \$1,180.00 | Y | 3 | A |
| H7318-HJ | PCS+ 50KVA 480V 84 POLE | EACH | \$26,515.00 | U | A | | H7868-A | POWER SUPPLY 120V | EACH | \$957.00 | Y | 3 | A |
| H7318-LA | PCS+ 15KVA 380/415V 50HZ | EACH | \$23,455.00 | U | A | | H7868-B | POWER SUPPLY,240V | EACH | \$957.00 | Y | 3 | A |



Prices Effective 02-January-89 to 30-June-89

To Order—Call DECdirect™ TOLL-FREE 800-344-4825, 8:30 a.m. to 8:00 p.m. ET in Continental U.S.A.

HARDWARE SPARES PRICE LIST

| PART NUMBER | DESCRIPTION | UNIT ORDER | UNIT PRICE | REP D | L | REPLACEMENT PART NUMBER | PART NUMBER | DESCRIPTION | UNIT ORDER | UNIT PRICE | REP D | L | REPLACEMENT PART NUMBER |
|-------------|-------------------------------|------------|------------|-------|---|-------------------------|-------------|--------------------------------|------------|-------------|-------|---|-------------------------|
| H800-W | CONNECTOR BLOCK,12-02244 | EACH | REPLACED | 3 | A | 12-02244-00 | L0105-00 | HSC50 PIOC(F11 PROC &I/O CTL) | EACH | \$9,393.00 | Y | 3 | A |
| H803-00 | 288 PIN CONNECTOR | EACH | REPLACED | 3 | A | 12-05348-13 | L0106-AA | 128KB DATA & CONT, 256KB PGM | EACH | \$7,371.00 | Y | 3 | A |
| H8030-00 | CONN BLK 72PIN DBL HGHT NTHD | EACH | REPLACED | 3 | A | 12-11425-00 | L0107-00 | HSC50 KPLI (PLI PORT CONTROL) | EACH | REPLACED | Y | 3 | A |
| H807-00 | CONNECTOR BLOCK M SERIES | EACH | REPLACED | 3 | A | 12-09123-00 | L0107-YA | HSC50 KPLI (PLI PORT CONTROL) | EACH | \$5,754.00 | Y | 3 | A |
| H810-00 | WIRE WRAP HAND TOOL | EACH | \$126.00 | 3 | A | | L0108-YA | HSC50 KSDI(CONNECTS TO 4 DISK) | EACH | REPLACED | Y | 3 | A |
| H811-00 | (24) HAND WRAPPING TOOL | EACH | \$76.00 | 3 | A | | L0108-YB | HSC50 KSTI(4 TAPE FORMATTERS) | EACH | REPLACED | Y | 3 | A |
| H811-A | (30) HAND WRAPPING TOOL | EACH | \$96.00 | 3 | A | | L0109-00 | HSC50 PACKET BUFFER BOARD | EACH | \$3,822.00 | Y | 3 | A |
| H812-00 | (24) HAND UNWRAPPING TOOL | EACH | \$25.00 | 3 | A | | L0111-00 | J-11 I/O CTRL PROCESSOR MOD | EACH | \$8,162.00 | Y | 3 | A |
| H812-A | (30) HAND UNWRAPPING TOOL | EACH | \$36.00 | 3 | A | | L0115-00 | 16MB MOTHER BOARD | EACH | \$2,500.00 | Y | 3 | A |
| H851-00 | EDGE CONNECTOR, 8/E | EACH | \$30.00 | 3 | A | | L0116-AA | 4MB MEMORY ARRAY CARD | EACH | \$5,100.00 | Y | 3 | A |
| H8581-00 | 6A IEC 320 PLUG, FEMALE PINS | EACH | \$5.00 | U | A | | L0117-AA | STD2 MEM FOR HSC70:521KB DATA | EACH | \$14,517.00 | Y | 3 | A |
| H861-00 | DM11-BB TEST CONNECTOR | EACH | \$53.00 | 3 | A | | L0118-00 | 32 NODE CLUSTER LINK MODULE | EACH | \$3,293.00 | Y | 3 | A |
| H8611-00 | CONN TEST DH11-AD +AE | EACH | \$40.00 | 3 | A | | L0122-00 | MOTHER BOARD W/LOGIC | EACH | \$4,804.00 | 3 | A | |
| H8612-00 | CONNECTOR TEST-DV11 | EACH | \$56.00 | 3 | A | | L0200-BA | 4MB MOS ARRAY, 256K PARTS | EACH | \$4,200.00 | Y | 3 | A |
| H863-00 | CONNECTOR BLOCK, NOTCHED | EACH | REPLACED | 3 | A | 12-10258-01 | L0201-00 | CSL CONSOLE CONTROL | EACH | \$6,984.00 | Y | 3 | A |
| H870-00 | MASS BUS TERMINATOR-H854 | EACH | \$46.00 | Y | 3 | A | L0202-00 | SBS SBIA SBI INTERFACE | EACH | \$6,399.00 | Y | 3 | A |
| H873-00 | 11/55 CORE BUS TERMINATOR | EACH | \$114.00 | 3 | A | | L0203-00 | SBA SBIA ABUS INTERFACE | EACH | \$7,442.00 | Y | 3 | A |
| H8800-00 | CONN | EACH | \$161.00 | 3 | A | | L0204-00 | MCD MBOX DATA PATH | EACH | \$17,225.00 | Y | 3 | A |
| H8821-00 | 2 H882 CONNS ON PCB | EACH | \$85.00 | 3 | A | | L0205-00 | MAP MBOX ADDR PATH | EACH | \$15,137.00 | Y | 3 | A |
| H8822-00 | 50-12683,12-13508-01,12-13508 | EACH | \$296.00 | 3 | A | | L0206-00 | IDP IBOX DATA PATH | EACH | \$15,741.00 | Y | 3 | A |
| H911-BP | MTNG PANEL H911-B W/POWR BUSS | EACH | \$495.00 | 3 | A | | L0207-00 | ICA IBOX CNTRL A | EACH | \$10,224.00 | Y | 3 | A |
| H919-00 | PDP8-E BUS CONNECTOR BLOCK AS | EACH | \$845.00 | 3 | A | | L0208-00 | IBD IBOX INSTRUCTION BUFFER | EACH | \$23,093.00 | Y | 3 | A |
| H9194-00 | BUS CONN 8/A 8+4 SLOTS | EACH | \$1,631.00 | Y | 3 | A | L0209-00 | EDP EBOX DATA PATH | EACH | \$14,949.00 | Y | 3 | A |
| H9271-00 | LSI BACKPLANE ASSY W/O ETCH | EACH | \$205.00 | 3 | A | | L0210-00 | EBC EBOX BUFFER | EACH | \$6,336.00 | Y | 3 | A |
| H933-C | SYS UNIT W 3 H803 | EACH | \$125.00 | 3 | A | | L0211-00 | EBD EBOX CONTROL | EACH | \$5,741.00 | Y | 3 | A |
| H933-CB | SYSTEM UNIT WITH 3 H863 | EACH | \$125.00 | Y | 3 | A | L0212-00 | FBA FBOX FLOATING PT | EACH | \$15,288.00 | Y | 3 | A |
| H934-CB | DBL SYS UNIT W/6-H863,3-H8030 | EACH | \$225.00 | 3 | A | | L0213-00 | FBM FBOX FLOATING PT | EACH | \$14,112.00 | Y | 3 | A |
| H9544-MG | BA11-A SLIDE KIT | EACH | \$185.00 | 3 | A | | L0214-00 | ICB IBOX CNTRL B | EACH | \$5,769.00 | Y | 3 | A |
| KDF11-BF | M8189,KTF11AA,8K BOOT/DIA ROM | EACH | REPLACED | Y | 3 | A | L0215-00 | CSA CONTROL STORE ARRAY BD | EACH | \$17,081.00 | Y | 3 | A |
| KDF11-BH | KDF11-BF + BOOT FROM TK50 | EACH | REPLACED | Y | 3 | A | L0216-00 | CSB CONTROL STORAGE ARRAY | EACH | \$18,440.00 | Y | 3 | A |
| KDF11-BJ | KDF11-BF + KDF11-B3 BOOT ROM | EACH | \$1,790.00 | Y | 3 | A | L0217-00 | CLK CLOCK | EACH | \$7,416.00 | Y | 3 | A |
| KDF11-CC | KDF11-CA W/ROMS FOR IVIS | EACH | \$1,704.00 | Y | 3 | A | L0218-00 | FBOX JUMPER MODULE | EACH | \$3,560.00 | Y | 3 | A |
| KPV11-A | POWER FAIL/REAL TIME CLOCK | EACH | REPLACED | Y | 3 | A | L0219-00 | EBE EBOX CONTROL | EACH | \$6,011.00 | Y | 3 | A |
| KPV11-B | PWR FAIL/RTC GEN W/BUS TERM | EACH | \$450.00 | Y | 3 | A | L0220-00 | MCC CACHE CONTROL | EACH | \$18,891.00 | Y | 3 | A |
| L0001-00 | FLOATING POINT ACCELERATOR | EACH | \$8,925.00 | Y | 3 | A | L0222-00 | MTM MEM ARRAY TERM. BD | EACH | \$1,657.00 | Y | 3 | A |
| L0002-00 | DATA PATH & MICRO SEQUENCER | EACH | \$5,764.00 | Y | 3 | A | L0223-00 | FTM FBOX TERMINATOR BD | EACH | \$1,562.00 | Y | 3 | A |
| L0003-00 | MEMORY INTERFACE & CACHE | EACH | \$6,471.00 | Y | 3 | A | L0224-00 | STM SBI/A-BUS TERM. BD | EACH | \$1,210.00 | Y | 3 | A |
| L0003-YA | COST REDUCED MEM INTERFACE | EACH | \$5,861.00 | Y | 3 | A | L0225-00 | MEM MOTHER BD W/NO DAUGHTER | EACH | \$2,625.00 | Y | 3 | A |
| L0004-00 | UNIBUS INTERFACE | EACH | \$3,820.00 | Y | 3 | A | L0226-BA | MS86 4MB,ECC MOS ARRAY,35MHZ | EACH | REPLACED | Y | 3 | A |
| L0005-00 | COMPLETE CONTROL STORE | EACH | REPLACED | Y | 3 | A | L0230-00 | MCC (M-BOX CACHE CONTROL) | EACH | \$40,950.00 | Y | 3 | A |
| L0006-YA | 11750 MAINT. TOOL, 4-LAYER | EACH | \$3,750.00 | Y | 3 | A | L0231-00 | CLOCK FOR KA86 | EACH | \$38,850.00 | Y | 3 | A |
| L0007-00 | MASSBUS ADAPTER | EACH | \$6,813.00 | Y | 3 | A | L0235-00 | 64MB MEM MOTHER BD/NO DTR BD | EACH | \$5,004.00 | 3 | A | |
| L0008-YA | 11750 PATCHABLE CONTROL STORE | EACH | \$3,600.00 | Y | 3 | A | L0400-00 | CDP (CI750 DATA PATH MODULE) | EACH | \$3,639.00 | Y | 3 | A |
| L0008-YB | L0008-YA W 1K OF WCS,HEX 12 | EACH | \$4,109.00 | Y | 3 | A | L8000-00 | STRUCTURE MEMORY | EACH | \$5,386.00 | 3 | A | |
| L0009-00 | CCI (CMI TO CIPA INTERFACE) | EACH | \$3,161.00 | Y | 3 | A | L8001-00 | RENDERING CONTROLLER | EACH | \$10,876.00 | 3 | A | |
| L0010-00 | UNIBUS INTERFACE (VERSION #2) | EACH | \$7,350.00 | Y | 3 | A | L8002-00 | STRUCTURE WALKER | EACH | \$11,751.00 | 3 | A | |
| L0011-00 | COMET MEMORY CONTROL | EACH | \$2,789.00 | Y | 3 | A | L8003-00 | FRAME BUFFER | EACH | \$10,281.00 | 3 | A | |
| L0014-00 | CMI PARALLEL INTERFACE,HEX 12 | EACH | \$7,350.00 | Y | 3 | A | L8004-00 | VIDEO CONTROLLER | EACH | \$6,941.00 | 3 | A | |
| L0016-00 | 64K MEMORY CONTRL,4-LAYER HEX | EACH | \$3,515.00 | Y | 3 | A | L9101-00 | EXTENDER 4-LAYER HEX 12 | EACH | \$845.00 | 3 | A | |
| L0022-00 | 256K MEM CONTROL FOR MS750 | EACH | \$2,371.00 | Y | 3 | A | L9102-00 | EXTENDER BOARD FOR CI780 | EACH | \$2,173.00 | 3 | A | |
| L0100-00 | ILI(CI LINK INTERFACE) HEX 12 | EACH | \$5,073.00 | Y | 3 | A | L9102-YA | L0100 EXTENDER CARD | EACH | \$2,545.00 | 3 | A | |
| L0101-00 | IPB(CI CNL STORE&PACKET BUF) | EACH | \$4,500.00 | Y | 3 | A | L9200-00 | 3.8AMP LOAD BOARD FOR 8600 | EACH | \$1,119.00 | 3 | A | |
| L0101-YA | L0101 W/ L0118 MICROCODE | EACH | \$1,807.00 | 3 | A | | LK001-A | LA36 KEYBOARD W/O NUMERIC PAD | EACH | \$209.00 | Y | 3 | A |
| L0102-00 | IDP (CI DATA PATH),HEX 12 | EACH | \$3,405.00 | Y | 3 | A | LK001-B | LA36 KEYBD. CNL PNL & NUM PA | EACH | REPLACED | Y | 3 | A |
| L0104-00 | ISI (CI SBI INTERFACE FOR CI) | EACH | \$3,177.00 | Y | 3 | A | LK03-A | 14 KEY NUMERIC PAD | EACH | \$99.00 | Y | 3 | A |



Prices Effective 02-January-89 to 30-June-89

To Order—Call DECdirect™ TOLL-FREE 800-344-4825, 8:30 a.m. to 8:00 p.m. ET in Continental U.S.A.

HARDWARE SPARES PRICE LIST

| PART NUMBER | DESCRIPTION | UNIT ORDER | UNIT PRICE | REP D | L | REPLACEMENT PART NUMBER | PART NUMBER | DESCRIPTION | UNIT ORDER | UNIT PRICE | REP D | L | REPLACEMENT PART NUMBER |
|-------------|-------------------------------|------------|------------|-------|---|-------------------------|-------------|-------------------------------|------------|------------|-------|---|-------------------------|
| M040-00 | M040 E | EACH | \$200.00 | Y | 3 | A | M7071-00 | WAVEFORM GENERATOR | EACH | \$1,149.00 | Y | 3 | A |
| M044-00 | 4-100MA SOLENOID DRIVER | EACH | \$108.00 | Y | 3 | A | M7081-00 | PRINTER LOGIC AND POWER BOARD | EACH | \$1,395.00 | Y | 3 | A |
| M050-00 | INDICATOR AND RELAY DRIVER | EACH | \$82.00 | Y | 3 | A | M7081-YB | M7081 W/ROMS FOR LAS12 | EACH | \$1,493.00 | Y | 3 | A |
| M105-00 | ADDRESS SELECTOR | EACH | \$120.00 | Y | 3 | A | M7081-YD | M7081 W/INCREASED HEAD DRIVE | EACH | \$924.00 | Y | 3 | A |
| M111-00 | INVERTER | EACH | \$89.00 | Y | 3 | A | M7090-00 | 11/44 CONSOLE INTERFACE | EACH | \$1,240.00 | Y | 3 | A |
| M112-00 | NOR GATE | EACH | \$245.00 | Y | 3 | A | M7091-00 | KE44-A CIS CONTROL STORE | EACH | \$3,449.00 | Y | 3 | A |
| M113-00 | 093085NPUT NAND GATE | EACH | \$234.00 | Y | 3 | A | M7092-00 | KE44-A CIS DATA PATH/LOGIC | EACH | \$5,145.00 | Y | 3 | A |
| M115-00 | INPUT NAND GATE | EACH | \$106.00 | Y | 3 | A | M7093-00 | FLOATING POINT HEX (FP11-F) | EACH | \$3,255.00 | Y | 3 | A |
| M116-00 | NORGATE, 6 QUAD | EACH | \$202.00 | Y | 3 | A | M7094-00 | DATA PATH HEX (KD11-Z) | EACH | \$3,119.00 | Y | 3 | A |
| M117-00 | INPUT NAND GATE | EACH | \$96.00 | Y | 3 | A | M7095-00 | CONT MODULE HEX (KD11-Z) | EACH | \$3,990.00 | Y | 3 | A |
| M121-00 | GATES | EACH | \$48.00 | Y | 3 | A | M7096-00 | MULTIFUNCTION HEX (KD11-Z) | EACH | \$2,863.00 | Y | 3 | A |
| M127-00 | 2-2-2-3-ANDINOR GATE | EACH | \$122.00 | Y | 3 | A | M7097-00 | KE44-A CIS WORD CACHE | EACH | \$4,330.00 | Y | 3 | A |
| M135-00 | 3 INPUT HAND GATE | EACH | \$62.00 | Y | 3 | A | M7098-00 | KD11-Z, UNIBUS INTERFACE, HEX | EACH | \$2,977.00 | Y | 3 | A |
| M161-00 | BINARY TO OCTAL DECORDER | EACH | \$101.00 | Y | 3 | A | M710-00 | PUNCH CONTROL | EACH | \$530.00 | Y | 3 | A |
| M163-00 | DUAL BINARY TO DECIMAL DECODE | EACH | \$49.00 | Y | 3 | A | M7104-00 | DATA BUF & STATUS | EACH | \$3,389.00 | Y | 3 | A |
| M1705-00 | DUAL 12-BIT WORD OMN.OUT.INTE | EACH | \$901.00 | Y | 3 | A | M7105-00 | MAJOR REGISTER | EACH | \$1,689.00 | Y | 3 | A |
| M1710-00 | UNIBUS FOUNDATION MODULE | EACH | \$694.00 | Y | 3 | A | M7110-00 | SYNCH MODEM INTERFACE | EACH | \$884.00 | Y | 3 | A |
| M203-00 | 8-R/S FLIP FLOPS | EACH | \$297.00 | Y | 3 | A | M7133-00 | KDF11-UA 16 BIT UNIBUS CPU | EACH | REPLACED | Y | 3 | A |
| M205-00 | 5-"D" FLIP FLOPS | EACH | \$110.00 | Y | 3 | A | M7133-YA | KDF11-UA CPU,LINE CLOCK,2 SER | EACH | \$3,217.00 | Y | 3 | A |
| M208-00 | 8 BIT SHIFT REGISTER | EACH | \$50.00 | Y | 3 | A | M7134-00 | UNIBUS MAP FOR 11/24,HEX | EACH | \$1,203.00 | Y | 3 | A |
| M216-00 | FLIP FLOP | EACH | \$109.00 | Y | 3 | A | M7135-00 | MICROVAX I DATAPATH WF FLT PT | EACH | \$3,632.00 | Y | 3 | A |
| M238-00 | SYNCHRONOUS U/D COUNTER | EACH | \$311.00 | Y | 3 | A | M7135-YA | MICROVAX I DATA PATH WD FLT P | EACH | \$3,632.00 | Y | 3 | A |
| M304-00 | ONE SHOT DELAY | EACH | \$119.00 | Y | 3 | A | M7136-00 | MEM CONTROL (MICROVAX) | EACH | \$2,663.00 | Y | 3 | A |
| M307-00 | 2 INTEGRATING ONE SHOT | EACH | \$145.00 | Y | 3 | A | M7147-00 | MODEM CONTROL | EACH | \$608.00 | Y | 3 | A |
| M3104-00 | 8-LINE ASYNC MUX, DMA (DHW11) | EACH | \$1,386.00 | Y | 3 | A | M7161-YA | M7161 W/BLASTED ROM'S,4-LAYER | EACH | REPLACED | Y | 3 | A |
| M3105-00 | DHU11-A, 16-LN ASYNC MUX,DMA | EACH | \$4,515.00 | Y | 3 | A | M7162-00 | UDA #2 (UNIBUS DISK ADAPTER) | EACH | REPLACED | Y | 3 | A |
| M3106-00 | DZQ11.4LN DBL BUF ASYNC MUX | EACH | \$683.00 | Y | 3 | A | M7164-00 | QDA PROCESSOR, QUAD | EACH | \$3,209.00 | Y | 3 | A |
| M3106-PA | 4 LN DBL BFR ASYNC MUX W/HNDL | EACH | \$900.00 | Y | 3 | A | M7165-00 | QDA SDI, QUAD | EACH | \$5,190.00 | Y | 3 | A |
| M3107-00 | QBUS 8 LINE ASYNC MUX MODULE, | EACH | \$1,520.00 | Y | 3 | A | M7166-00 | EXPANDS BI BUS TO UNIBUS | EACH | \$172.00 | Y | 3 | A |
| M3108-00 | 2-LINE SYNCHRONOUS COMM DEV | EACH | \$3,950.00 | Y | 3 | A | M7168-00 | 4 PLANE COLOR BITMAP | EACH | \$1,938.00 | Y | 3 | A |
| M3108-PA | 2-LINE SYNC COMM MOD FOR | EACH | \$4,650.00 | Y | 3 | A | M7169-00 | Q22 BUS VIDEO CONTRL MODULE | EACH | \$2,646.00 | Y | 3 | A |
| M3110-00 | PROTOCOL ASSIST #1 SPEC CHAR | EACH | \$2,235.00 | Y | 3 | A | M7196-00 | TSV05 CNTRL FOR Q/Q22 BUS | EACH | \$3,033.00 | Y | 3 | A |
| M3111-00 | PROTOCOL ASSIST #2 SPEC CHAR | EACH | \$1,918.00 | Y | 3 | A | M7199-AA | 4MB ECC ARRAY 256K DRAMS | EACH | \$3,148.00 | Y | 3 | A |
| M3112-00 | CONSOLE BOOT TERMINATOR, HEX | EACH | \$1,570.00 | Y | 3 | A | M7210-00 | KE11-A DATA CONTROL | EACH | \$600.00 | Y | 3 | A |
| M3118-YA | QUAD ASYNC 16 LN MOD W/HNDL | EACH | \$2,200.00 | Y | 3 | A | M7212-00 | ALINES, BUS REPEATER | EACH | \$489.00 | Y | 3 | A |
| M3118-YB | QUAD ASYNC 16 LN.HNDL.RS422 | EACH | \$2,200.00 | Y | 3 | A | M7213-00 | CARD, REPEATER MASTER | EACH | \$394.00 | Y | 3 | A |
| M3119-YA | 8 LINE ASYNC MUX.W/MODEM CNTR | EACH | \$1,525.00 | Y | 3 | A | M7219-00 | INTERFACE, KC11 BUS | EACH | \$688.00 | Y | 3 | A |
| M3127-PA | ETHERNET/THINWIRE S-BOX ADAPT | EACH | \$2,950.00 | Y | 3 | A | M7226-00 | DN11 | EACH | \$294.00 | Y | 3 | A |
| M401-00 | CLOCK | EACH | \$121.00 | Y | 3 | A | M7228-00 | KW11-P REAL TIME CLOCK | EACH | \$1,094.00 | Y | 3 | A |
| M4050-00 | CRYSTAL CLOCK | EACH | \$162.00 | Y | 3 | A | M7229-00 | DR11-B INTERFACE FOR DA11-B | EACH | \$549.00 | Y | 3 | A |
| M4540-00 | M454 W MORE FREQ AVILABLE | EACH | \$310.00 | Y | 3 | A | M7231-00 | DATA PATHS, KD11-A | EACH | \$1,136.00 | Y | 3 | A |
| M5901-00 | 16 CH EIA TRANSCEIVER DJ11 | EACH | \$628.00 | Y | 3 | A | M7232-00 | U WORD | EACH | \$919.00 | Y | 3 | A |
| M5903-00 | DRIVE TRANCEIVER | EACH | \$354.00 | Y | 3 | A | M7233-00 | KD11-A IR DECODE | EACH | \$1,085.00 | Y | 3 | A |
| M5904-00 | MASS BUS CONTROL TRANSCEIVER | EACH | \$571.00 | Y | 3 | A | M7234-00 | KD11-A TIMING | EACH | \$1,245.00 | Y | 3 | A |
| M5906-00 | 16 CH EIA CONV + PRIORITY BRD | EACH | \$244.00 | Y | 3 | A | M7235-00 | KD11-A STATUS PROCESSOR | EACH | \$1,315.00 | Y | 3 | A |
| M5922-00 | MASS BUS TRANSCEIVER, PORT A | EACH | \$534.00 | Y | 3 | A | M7236-00 | KT11-D MEMORY MANAGEMENT | EACH | \$2,828.00 | Y | 3 | A |
| M5923-00 | MASS BUS TRANSCEIVER, PORT B | EACH | \$376.00 | Y | 3 | A | M7237-00 | STACK LIMIT REGISTER | EACH | \$440.00 | Y | 3 | A |
| M594-00 | CONVERTER, EIA LEVEL | EACH | \$133.00 | Y | 3 | A | M7238-00 | KE11-E EIS BRD | EACH | \$2,284.00 | Y | 3 | A |
| M595-00 | 301/303 CONVERTER | EACH | \$122.00 | Y | 3 | A | M7246-00 | MODEM CONTROL SCAN | EACH | \$508.00 | Y | 3 | A |
| M5960-00 | REPLACEMENT M596 | EACH | \$330.00 | Y | 3 | A | M7247-00 | MODEM CONTROL MUX | EACH | \$713.00 | Y | 3 | A |
| M611-00 | HIGH SPEED POWER INVERTER | EACH | \$122.00 | Y | 3 | A | M7248-00 | UNIBUS REPEATER | EACH | \$192.00 | Y | 3 | A |
| M627-00 | POWER AMPLIFIER | EACH | \$200.00 | Y | 3 | A | M7251-00 | XOR AND CRC BLOCK | EACH | \$1,418.00 | Y | 3 | A |
| M6870-00 | 16 BIT DC SING-SHOT OUTPUT | EACH | \$1,001.00 | Y | 3 | A | M7255-00 | RK11-D DISK CONTROL | EACH | \$1,491.00 | Y | 3 | A |
| M688-00 | UNIBUS POWER FAIL DRIVERS | EACH | \$336.00 | Y | 3 | A | M7258-00 | LP/LS11 INTERFACE | EACH | \$1,156.00 | Y | 3 | A |
| M7025-00 | KW11-K REAL TIME CLOCK | EACH | REPLACED | Y | 3 | A | M7259-00 | MODULE, PARITY CONTROL | EACH | \$282.00 | Y | 3 | A |
| | | | | | | SKW11-K | | | | | | | |

digital

Prices Effective 02-January-89 to 30-June-89

To Order—Call DECdirect™ TOLL-FREE 800-344-4825, 8:30 a.m. to 8:00 p.m. ET in Continental U.S.A.

SPARES PRICE LIST A-9

HARDWARE SPARES PRICE LIST

| PART NUMBER | DESCRIPTION | UNIT ORDER | UNIT PRICE | REP D | L | REPLACEMENT PART NUMBER | PART NUMBER | DESCRIPTION | UNIT ORDER | UNIT PRICE | REP D | L | REPLACEMENT PART NUMBER | |
|-------------|-------------------------------|------------|-------------|-------|---|-------------------------|-------------|--------------------------------|------------|-------------|-------|---|-------------------------|-------------|
| M7260-00 | DATA PATHS | EACH | \$1,385.00 | Y | 3 | A | M7508-00 | 29116 IMAGE GEN. PROC. | EACH | \$2,600.00 | | 3 | A | |
| M7261-00 | CONTROL LOGIC E MICROPROGRAM | EACH | \$1,326.00 | Y | 3 | A | M7509-00 | G-BUS/PRINT ENGINE INTERFACE | EACH | \$1,515.00 | | 3 | A | |
| M7263-00 | KD11-D PROCESSOR MOD HEX | EACH | \$2,145.00 | Y | 3 | A | M7510-AA | H. LINE PROC W/256KB FONT RAM | EACH | \$2,042.00 | | 3 | A | |
| M7264-00 | LS1-11 | EACH | REPLACED | Y | 3 | A | M7513-00 | RD/RX DISK EXPANDER FOR RQDXX | EACH | \$240.00 | Y | 3 | A | |
| M7264-YC | M7264-YA ETCH REV. F OR LATER | EACH | \$1,058.00 | Y | 3 | A | M7516-00 | Q-BUS TO ETHERNET ADAPT,DUAL | EACH | \$2,500.00 | Y | 3 | A | |
| M727-00 | STATE CONTROL | EACH | \$354.00 | Y | 3 | A | M7516-PA | M7516 WITH S-BOX HANDLE | EACH | \$2,500.00 | Y | 3 | A | |
| M7270-00 | KD11-HA, M7264-YA DOUBLE 8.5 | EACH | \$882.00 | Y | 3 | A | M7522-00 | RX50 CONTROL FOR UNIBUS,QUAD | EACH | \$1,260.00 | Y | 3 | A | |
| M7277-00 | SCANNERS & NPR,DH11,HEX 8.5 | EACH | \$1,518.00 | Y | 3 | A | M7540-00 | FP785,FLOAT PT FRACT NORMALIZ | EACH | \$2,926.00 | Y | 3 | A | |
| M7278-00 | REG & BYTE CNT | EACH | \$1,156.00 | Y | 3 | A | M7541-00 | FP785,FM,H,FLOAT PT FRACT MULT | EACH | \$2,251.00 | Y | 3 | A | |
| M7279-00 | 1ST IN 1ST OUT BUFFER DH11,DJ | EACH | \$1,209.00 | Y | 3 | A | M7542-00 | FP785,FML,FLOAT PT FRACT MULT | EACH | \$2,453.00 | Y | 3 | A | |
| M7280-00 | MULTIPLE UART CARD | EACH | \$1,184.00 | Y | 3 | A | M7543-00 | FP785,FAD,FLOAT PT FRAC ADDER | EACH | \$2,708.00 | Y | 3 | A | |
| M7281-00 | RELAY DISTRIBUTE | EACH | \$1,531.00 | Y | 3 | A | M7544-00 | RELAY CONTROL FOR UNIBUS,QUAD | EACH | \$3,087.00 | Y | 3 | A | |
| M7282-00 | MODULE INPUT SCAN | EACH | \$584.00 | Y | 3 | A | M7546-00 | Q-BUS TAPE CNTRL, DBL 8.5 | EACH | \$1,045.00 | Y | 3 | A | |
| M7285-00 | DJ11 MUX CONTROL | EACH | \$1,317.00 | Y | 3 | A | M7547-00 | UNIBUS TMSCP TAPE CNTRLR,QUAD | EACH | \$2,000.00 | Y | 3 | A | |
| M7288-00 | DH11 LINE PARAMETERS CONTROL | EACH | \$1,598.00 | Y | 3 | A | M7551-AA | 1MB Q22 MEM,PAR,CSR,64K CHIPS | EACH | \$1,240.00 | Y | 3 | A | |
| M7289-00 | DH11 RECV SCANNER | EACH | \$685.00 | Y | 3 | A | M7551-BA | 2MB Q22 MEM,PAR,CSR,256K CHIP | EACH | \$1,430.00 | Y | 3 | A | |
| M7294-00 | DATA BUFFER & CONT RH11 | EACH | \$1,037.00 | Y | 3 | A | M7551-CA | 4MB Q22 MEM,PAR,CSR,256K CHIP | EACH | \$2,470.00 | Y | 3 | A | |
| M7295-00 | BUS CONTROL RH11 | EACH | \$852.00 | Y | 3 | A | M7553-00 | Q-BUS CONSOLE MODULE | EACH | \$4,838.00 | | 3 | A | |
| M7296-00 | CONTROL & STATUS REG | EACH | \$163.00 | Y | 3 | A | M7554-00 | J11 CPU,512KB MEM,2 SER. LINE | EACH | \$5,250.00 | Y | 3 | A | |
| M7297-00 | PARITY CONTROL | EACH | \$151.00 | Y | 3 | A | M7554-02 | J11 CPU,15MHZ,1.5MB MEM,2 SER | EACH | \$6,450.00 | | 3 | A | |
| M7361-00 | ML11 ASYNC CONTROL, HEX | EACH | \$1,242.00 | Y | 3 | A | M7555-00 | RD/RX CONTROL MODULE (RQDX3) | EACH | \$1,932.00 | Y | 3 | A | |
| M7362-00 | ML11 SYNC CONTROL, HEX | EACH | \$1,308.00 | Y | 3 | A | M7555-PA | FP785,FCT,FLOAT PT ACC CNTRL | EACH | \$2,532.00 | | 3 | A | |
| M7363-00 | ML11 ARRAY DATA,4-LAYER HEX | EACH | \$1,098.00 | Y | 3 | A | M7556-00 | MINIMUM LOAD MODULE,+5V,1A-15 | EACH | \$106.00 | | 3 | A | |
| M7454-00 | TU80 UNIBUS INTERFACE | EACH | \$2,730.00 | Y | 3 | A | M7559-00 | TQK70 TAPE CONTROLLER | EACH | \$1,700.00 | Y | 3 | A | |
| M7455-00 | TSU05 CNTRL FOR UNIBUS, HEX | EACH | \$4,422.00 | Y | 3 | A | M7602-00 | VCB01 QBUS VIDEO SUB SYS MOD. | EACH | REPLACED | Y | 3 | A | M7602-YA |
| M7459-00 | TRS.TERMINATOR & SILO,4-LAYER | EACH | \$1,954.00 | Y | 3 | A | M7602-YA | QVSS BIT MAP GRAPHICS OPTION | EACH | \$2,605.00 | Y | 3 | A | |
| M7460-00 | KA785, SBL, LOW BITS INTER. | EACH | \$2,991.00 | Y | 3 | A | M7605-00 | 1/4" STREAMING TADR. CONT | EACH | REPLACED | Y | 3 | A | 30-22971-01 |
| M7461-00 | KA785,SBH,HIGH BITS INTER. | EACH | \$3,332.00 | Y | 3 | A | M7607-AA | 1MB MEMORY FOR MS630-AA | EACH | \$4,200.00 | Y | 3 | A | |
| M7462-00 | KA785,CAM,CACHE ADD MATRIX | EACH | \$5,221.00 | Y | 3 | A | M7608-AA | 2MB MEMORY FOR MS630-BA | EACH | \$2,445.00 | Y | 3 | A | |
| M7463-00 | KA785,CDM,CACHE DATA MATRIX | EACH | \$5,026.00 | Y | 3 | A | M7608-BA | 4MB MEMORY FOR MS630-BB | EACH | \$2,288.00 | Y | 3 | A | |
| M7464-00 | KA785,TBM,CPU TRANSLATION BUF | EACH | \$3,962.00 | Y | 3 | A | M7609-AA | 8MB MEMORY FOR MS630-CA | EACH | \$5,793.00 | Y | 3 | A | |
| M7465-00 | KA785,IDP,CPU INSTR DATA PATH | EACH | \$2,381.00 | Y | 3 | A | M7621-AA | MS650-AA 8MB MEMORY | EACH | \$6,000.00 | Y | 3 | A | |
| M7466-00 | KA785,IRC,CPU INSTRUCT DECODE | EACH | \$3,698.00 | Y | 3 | A | M7622-AA | 16MB MEM,1MB RAM CHIP ARRAY= | EACH | \$12,800.00 | | 3 | A | |
| M7467-00 | KA785,DBP,CPU DATA PATH "B" | EACH | \$2,984.00 | Y | 3 | A | M763-00 | BUFFER WRITE | EACH | \$537.00 | Y | 3 | A | |
| M7468-00 | KA785,DEP,CPU DATA PATH "E" | EACH | \$2,516.00 | Y | 3 | A | M7658-PA | DRQ3B-SA MOD ASSY FOR S-BOX | EACH | \$2,100.00 | | 3 | A | |
| M7468-YA | DEP.DATAPATH MODULE,16-31 BIT | EACH | \$2,516.00 | Y | 3 | A | M7676-00 | FALCON CIRCUIT BOARD | EACH | \$610.00 | Y | 3 | A | |
| M7469-00 | KA785,DDP,CPU DATA PATH "D" | EACH | \$3,218.00 | Y | 3 | A | M7677-YA | MONITORS FAN, BLOWER,I/O DIST | EACH | \$392.00 | | 3 | A | |
| M7469-YA | DDP.DATAPATH MODULE,08-15 BIT | EACH | \$3,218.00 | Y | 3 | A | M7680-00 | RK05 | EACH | \$322.00 | Y | 3 | A | |
| M7470-00 | KA785,DCP,CPU DATA PATH | EACH | \$2,704.00 | Y | 3 | A | M7681-00 | CYLINDER ADDRESS + TRACK DIFF | EACH | \$393.00 | Y | 3 | A | |
| M7470-YA | DCP.DATAPATH MODULE,00-07 BIT | EACH | \$2,704.00 | Y | 3 | A | M7684-00 | CONTROL SEQUENCER | EACH | \$1,352.00 | Y | 3 | A | |
| M7471-00 | KA785,DAP,CPU DATA PATH "A" | EACH | \$2,060.00 | Y | 3 | A | M7686-YA | RM02.3.5 CONTROL INTRFACE HEX | EACH | \$1,203.00 | Y | 3 | A | |
| M7471-YA | DAP.DATAPATH CONTROL MODULE | EACH | \$2,060.00 | Y | 3 | A | M7689-00 | CONTROL_FUNCTION | EACH | \$624.00 | Y | 3 | A | |
| M7472-00 | KA785,CEH,COND CODES HIGH BIT | EACH | \$2,819.00 | Y | 3 | A | M7701-00 | DEC PAK CONTROL & INTERLOCK | EACH | \$351.00 | Y | 3 | A | |
| M7473-00 | KA785,ICL,INTR.CONT,LOW BITS | EACH | \$2,532.00 | Y | 3 | A | M7705-00 | RK06 DRIVE CONTROL LOGIC | EACH | \$775.00 | Y | 3 | A | |
| M7474-00 | KA785,CLK,CPU CLOCK | EACH | \$5,662.00 | Y | 3 | A | M7706-00 | RK08 INTERFACE + TIMING | EACH | \$815.00 | Y | 3 | A | |
| M7475-00 | KA785,JCS,JOINT CONT.STORE | EACH | \$12,600.00 | Y | 3 | A | M7726-00 | RX01 CONTROLLER | EACH | \$991.00 | Y | 3 | A | |
| M7476-00 | KA785,USC,MICRO SEQUENCER | EACH | \$2,326.00 | Y | 3 | A | M7727-00 | RX01 R/W CONTROL | EACH | \$565.00 | Y | 3 | A | |
| M7477-00 | KA785,CIB CPU CONSOLE INTR | EACH | \$2,615.00 | Y | 3 | A | M7728-00 | LOGIC BOARD (LA36) | EACH | REPLACED | Y | 3 | A | M7728-YC |
| M7478-AA | 32 BIT SBC W/1MB FLT. POINT | EACH | \$5,245.00 | Y | 3 | A | M7728-YC | M7728 ETCH REV L AND LATER | EACH | \$781.00 | Y | 3 | A | |
| M7485-YA | M7485 W/BLASTED ROMS,4-LAYER | EACH | \$2,588.00 | Y | 3 | A | M7730-00 | FK06 DUCIL PORT LOGIC BOARD | EACH | \$442.00 | Y | 3 | A | |
| M7486-00 | UDA SI | EACH | \$3,712.00 | Y | 3 | A | M7735-00 | MODULE LAXX-KV | EACH | \$205.00 | Y | 3 | A | |
| M7504-00 | DEQNA Q-BUS TO ETHERNET ADAPT | EACH | \$1,763.00 | Y | 3 | A | M7740-00 | Q22 TO LESI BUS ADAPTOR | EACH | \$1,050.00 | Y | 3 | A | |
| M7504-PA | M7504-YA W/S-BOX BULKHEAD HND | EACH | \$2,650.00 | Y | 3 | A | M7744-00 | RX02 CONTROL HEX | EACH | REPLACED | Y | 3 | A | M7744-YC |
| M7506-BA | MSV11-MB 1MB RAM,256K DIPS | EACH | \$630.00 | Y | 3 | A | M7744-YC | M7744 WITH FCC COMPLIANCE,HEX | EACH | \$782.00 | Y | 3 | A | |
| M7507-00 | 2.5MG FULL PAGE BITMAP MEM. | EACH | \$2,241.00 | | 3 | A | M7745-YA | M7745 WITH FCC COMPLIANCE,HEX | EACH | \$673.00 | Y | 3 | A | |



Prices Effective 02-January-89 to 30-June-89

To Order—Call DECdirect™ TOLL-FREE 800-344-4825, 8:30 a.m. to 8:00 p.m. ET in Continental U.S.A.

HARDWARE SPARES PRICE LIST

| PART NUMBER | DESCRIPTION | UNIT ORDER | UNIT PRICE | REP D | L | REPLACEMENT PART NUMBER | PART NUMBER | DESCRIPTION | UNIT ORDER | UNIT PRICE | REP D | L | REPLACEMENT PART NUMBER | |
|-------------|----------------------------------|------------|------------|-------|---|-------------------------|-------------|-------------------------------|------------|------------|-------|---|-------------------------|----------|
| M7761-00 | TU60 CASSETTE SERVO & READ | EACH | \$767.00 | Y | 3 | A | M7908-00 | TRACK POSITIONING OSCILL | EACH | \$665.00 | Y | 3 | A | |
| M7762-00 | RL11, RL01 CONTROL | EACH | \$3,669.00 | Y | 3 | A | M7940-00 | SERIAL LINE 11V03 | EACH | \$551.00 | Y | 3 | A | |
| M7773-00 | ASYNCHRONOUS LOGIC-RP04 | EACH | \$686.00 | Y | 3 | A | M7941-00 | 16 BIT PARALLEL LINE UNIT 11V | EACH | \$445.00 | Y | 3 | A | |
| M7774-00 | REGISTER LOGIC-RP04 | EACH | \$371.00 | Y | 3 | A | M7942-00 | 4-K 16 BIT PROM 11V03 | EACH | \$221.00 | Y | 3 | A | |
| M7776-00 | ERROR CORRECT LOGIC-RP0H | EACH | \$977.00 | Y | 3 | A | M7942-YC | MRV11-VC, VT72, BOOTSTRAP DIA | EACH | REPLACED | Y | 3 | A | SPMRV-VC |
| M7786-00 | SEEK & SEARCH CNTL LOGIC | EACH | \$352.00 | Y | 3 | A | M7944-00 | 4K 16BIT RAM 11V03 | EACH | \$704.00 | Y | 3 | A | |
| M7787-00 | INTERFACE CONTROL | EACH | \$558.00 | Y | 3 | A | M7946-00 | RXV11 | EACH | \$465.00 | Y | 3 | A | |
| M7788-00 | INTERFACE TRANSMITTER | EACH | \$106.00 | Y | 3 | A | M795-00 | WC & CMA | EACH | \$338.00 | Y | 3 | A | |
| M7789-00 | INTERFACE RECEIVER | EACH | \$106.00 | Y | 3 | A | M7950-00 | DMA PT MOD | EACH | \$704.00 | Y | 3 | A | |
| M7792-00 | PORT MODULE | EACH | \$1,629.00 | Y | 3 | A | M7954-00 | INTERFACE LS111 BUS TO INST. | EACH | \$840.00 | Y | 3 | A | |
| M7793-00 | LINK MODULE | EACH | \$1,899.00 | Y | 3 | A | M7957-00 | 4 LINE DBL BUF ASYNC MUX EIA | EACH | \$928.00 | Y | 3 | A | |
| M7800-YA | M7800 WITHOUT EIA CHIPS | EACH | \$652.00 | Y | 3 | A | M7958-00 | I/O CONTROL MODULE | EACH | \$1,234.00 | Y | 3 | A | |
| M7807-00 | EIA LEVEL CONVERT | EACH | \$875.00 | Y | 3 | A | M796-00 | UNIBUS MASTER CONTROL | EACH | \$223.00 | Y | 3 | A | |
| M7808-00 | M DEM MUX CONTROL | EACH | REPLACED | Y | 3 | A | M798-00 | UNIBUS DRIVERS | EACH | \$69.00 | Y | 3 | A | |
| M7810-00 | PC11-INTERFACE | EACH | \$473.00 | Y | 3 | A | M7982-00 | UNIBUS TO SERIAL CONTROLLER | EACH | \$537.00 | Y | 3 | A | |
| M7812-00 | DQ11-AA BUS SELECTOR CSR SHIF | EACH | \$1,566.00 | Y | 3 | A | M7983-00 | 32KX16 CONTROLLER | EACH | \$1,143.00 | Y | 3 | A | |
| M7813-00 | DQ11-AA CHAR COUNT BUSS ADR S | EACH | \$1,750.00 | Y | 3 | A | M8012-00 | KRYP Q-BUS TERM BOOTSTRAP | EACH | REPLACED | Y | 3 | A | M8012-YA |
| M7814-00 | 2DMA DATA MUX | EACH | \$2,069.00 | Y | 3 | A | M8012-YA | Q-BUS TERMINATOR | EACH | \$840.00 | Y | 3 | A | |
| M7815-00 | DQ11-AA MODEM CONT (DQ11-BA) | EACH | \$185.00 | Y | 3 | A | M8016-00 | POWER FAIL, CLOCK MODULE | EACH | \$450.00 | Y | 3 | A | |
| M7817-00 | DQ11-AB CHAR DET & SEQ CONT (| EACH | \$1,407.00 | Y | 3 | A | M8017-00 | DLV11-E ASYNC INTERFACE MOD | EACH | REPLACED | Y | 3 | A | SPDLV-E |
| M7818-00 | DQ11-AA HARDWARE CHAR DET & N | EACH | \$845.00 | Y | 3 | A | M8017-AA | DLV11-E & DLV11-EC ETCH REV D | EACH | \$462.00 | Y | 3 | A | |
| M7819-00 | M7800 WITHOUT BUF ASYNC EIA DZ11 | EACH | \$1,974.00 | Y | 3 | A | M8020-PA | Q-BUS 1 LINE SERIAL SYNC CONT | EACH | \$660.00 | Y | 3 | A | |
| M7820-00 | CONTROL, INTERRUPT | EACH | REPLACED | Y | 3 | A | M8027-00 | Q-BUS UNIVERSAL PRINTER INTER | EACH | \$525.00 | Y | 3 | A | |
| M7821-00 | INTERRUPT CONTROL | EACH | \$305.00 | Y | 3 | A | M8028-00 | DLV11-A, C.ASYNC INTERFACE 20 | EACH | \$389.00 | Y | 3 | A | |
| M783-00 | UNIBUS DRIVERS | EACH | \$355.00 | Y | 3 | A | M8029-00 | RXV21, Q-BUS RX02 INTERFACE | EACH | \$562.00 | Y | 3 | A | |
| M7833-00 | ASYNC MUX LINE CARD HEX (DV11 | EACH | \$2,028.00 | Y | 3 | A | M8043-00 | DLV11-J, 4LINE PERIPH INTER. | EACH | \$609.00 | Y | 3 | A | |
| M7836-00 | DV11 ALU & TRANSFER BUS | EACH | \$1,783.00 | Y | 3 | A | M8044-CA | MSV11-DC 16K 16BIT MOS RAM 16 | EACH | REPLACED | Y | 3 | A | SPMSV-DC |
| M7837-00 | DV11 UNIBUS DATA & NPR CONT | EACH | \$1,187.00 | Y | 3 | A | M8044-DA | MSV11-DD 32K 16BIT MOS RAM 16 | EACH | REPLACED | Y | 3 | A | SPMSV-DD |
| M7838-00 | DV11 ROM RAM & BRANCH | EACH | \$2,240.00 | Y | 3 | A | M8044-EA | 24K 16BIT MOS RAM, 16K CHIPS | EACH | \$1,592.00 | Y | 3 | A | |
| M7839-00 | SYNC MUX LINE CARD | EACH | \$2,268.00 | Y | 3 | A | M8047-AA | MXV11-AA, 4K RAM | EACH | \$735.00 | Y | 3 | A | |
| M784-00 | UNIBUS RECEIVERS | EACH | \$200.00 | Y | 3 | A | M8047-CA | 16K RAM, 2 ASYNC EIA SLU | EACH | \$945.00 | Y | 3 | A | |
| M7840-00 | KE11-B | EACH | \$2,048.00 | Y | 3 | A | M8047-HA | MXV11-HA:16KW RAM,2 ASYNC EIA | EACH | \$1,353.00 | Y | 3 | A | |
| M7843-00 | DIGITAL I/O DR11-K | EACH | \$987.00 | Y | 3 | A | M8048-00 | MRV11-C UNIVERSAL PROM/ROM MO | EACH | REPLACED | Y | 3 | A | M8578-00 |
| M7846-00 | RX01 UNIBUS | EACH | \$639.00 | Y | 3 | A | M8049-00 | HI-DENSITY PARALLEL LINE UNIT | EACH | \$473.00 | Y | 3 | A | |
| M785-00 | UNIBUS DRIVERS & RECEIVER | EACH | \$120.00 | Y | 3 | A | M8050-00 | 16 BIT FLIP-FLOP RELAY | EACH | \$1,416.00 | Y | 3 | A | |
| M7850-00 | MEM PARITY BOARD FOR G651 | EACH | \$1,125.00 | Y | 3 | A | M8053-MA | M8053 W DDCMP CTL ROM,QUAD | EACH | \$1,871.00 | Y | 3 | A | |
| M7855-00 | UNIBUS EXERCISER PDP11 | EACH | \$2,089.00 | Y | 3 | A | M8059-FA | MSV11-LF:64K 18BIT MOS RAM | EACH | \$1,050.00 | Y | 3 | A | |
| M7856-00 | DL11-W SLU/RTC OPT QUAD | EACH | \$809.00 | Y | 3 | A | M8059-KA | MSV11-LK:128K 18BIT MOS RAM | EACH | \$735.00 | Y | 3 | A | |
| M7859-00 | CONSOLE PROGRAMMER | EACH | \$1,084.00 | Y | 3 | A | M8061-00 | RL01/02 DISK CONTROL | EACH | \$4,095.00 | Y | 3 | A | |
| M786-00 | GENERAL DEVICE INTERFACE | EACH | \$693.00 | Y | 3 | A | M8063-BA | DC310, 2 SER, 1 PARA LI.UNIT | EACH | \$830.00 | Y | 3 | A | |
| M7867-00 | SYNC MODEM DUP11-DA | EACH | \$1,384.00 | Y | 3 | A | M8064-MA | M8064 W DDCMP,INTEGRAL MODEM | EACH | \$2,024.00 | Y | 3 | A | |
| M787-00 | KW11-L LINE FREQ. INTER CLOCK | EACH | \$397.00 | Y | 3 | A | M8067-KA | MSV11-PK:256KB MOS MEM | EACH | \$1,050.00 | Y | 3 | A | |
| M7872-00 | U WORD BOARD | EACH | \$3,116.00 | Y | 3 | A | M8067-LA | MSV11-PL:512KB MOS MEM | EACH | \$945.00 | Y | 3 | A | |
| M7873-00 | 11 DDO DATA PATH | EACH | \$2,972.00 | Y | 3 | A | M8090-00 | MASTER CONT FOR ICS11 | EACH | \$586.00 | Y | 3 | A | |
| M7874-00 | CACHE KIT FOR 11PDO | EACH | \$2,792.00 | Y | 3 | A | M8094-00 | REMOTE MASTER CONTROL ICR11 | EACH | \$1,321.00 | Y | 3 | A | |
| M7875-00 | CACHE/KT FOR 11 PDO | EACH | \$3,576.00 | Y | 3 | A | M8096-00 | ICR11 REMOTE SLAVE CONTROL | EACH | \$1,045.00 | Y | 3 | A | |
| M7876-00 | 11PDO TIMING BOARD | EACH | \$2,589.00 | Y | 3 | A | M8098-00 | ICR11 REMOTE MODEM CONTROL | EACH | \$1,861.00 | Y | 3 | A | |
| M7877-00 | 11PDQ STATUS BOARD | EACH | \$2,758.00 | Y | 3 | A | M8101-00 | GENERAL REGS + ALU. CONTROL | EACH | \$1,535.00 | Y | 3 | A | |
| M7878-00 | FP11-E,FNUA FLOATING POINT.NE | EACH | \$1,331.00 | Y | 3 | A | M8104-00 | PROCESSOR DATA&UNIBUS REGS | EACH | \$1,767.00 | Y | 3 | A | |
| M7881-00 | LOW DATA PATH | EACH | \$2,760.00 | Y | 3 | A | M8105-00 | TRAP & MISC CONTROL | EACH | \$1,672.00 | Y | 3 | A | |
| M7891-BA | MS11-LB, 64K 18BIT MOS MEM | EACH | REPLACED | Y | 3 | A | M8108-YA | ROM BOARD | EACH | \$1,903.00 | Y | 3 | A | |
| M7892-00 | CASSETTE INTERFACE PR | EACH | \$1,642.00 | Y | 3 | A | M8109-00 | TIMING GENERATOR | EACH | \$2,295.00 | Y | 3 | A | |
| M7899-00 | DZ32-A MODEM CONTROL | EACH | \$2,438.00 | Y | 3 | A | M8119-00 | UNIBUS CONSOL CONTROL | EACH | \$2,424.00 | Y | 3 | A | |
| M7906-00 | SERVO ANALOG | EACH | \$618.00 | Y | 3 | A | M8123-00 | KB11-C.ROM&ADDRESSCONTROL,HEX | EACH | \$2,054.00 | Y | 3 | A | |
| M7907-00 | SERVO CONTROL | EACH | \$561.00 | Y | 3 | A | M8126-00 | FRACTION PROCESSOR HIGH ORDER | EACH | \$2,687.00 | Y | 3 | A | |

digital

Prices Effective 02-January-89 to 30-June-89

To Order—Call DECdirect™ TOLL-FREE 800-344-4825, 8:30 a.m. to 8:00 p.m. ET in Continental U.S.A.

SPARES PRICE LIST A-11

SPARES PRICE LIST A-12

M8127-00 — M8315-00

HARDWARE SPARES PRICE LIST

| PART NUMBER | DESCRIPTION | UNIT ORDER | UNIT PRICE | REP D L | REPLACEMENT PART NUMBER | PART NUMBER | DESCRIPTION | UNIT ORDER | UNIT PRICE | REP D L | REPLACEMENT PART NUMBER |
|-------------|-------------------------------|------------|------------|---------|-------------------------|-------------|-------------------------------|------------|-------------|---------|-------------------------|
| M8127-00 | FRACTION PROCESSOR LOW ORDER | EACH | \$2,863.00 | Y 3 A | | M8220-00 | CAM CPU CACHE ADAPTER MATRIX | EACH | \$2,812.00 | Y 3 A | |
| M8128-00 | FRACTION PROCESSOR ROM CONTRO | EACH | \$2,249.00 | Y 3 A | | M8221-00 | CDM CPU CACHE DATA MATRIX | EACH | \$3,193.00 | Y 3 A | |
| M8129-00 | FRACTION PROCESSOR EXPONENT P | EACH | \$2,293.00 | Y 3 A | | M8222-00 | TBM CPU TRANSLATION BUFFER MA | EACH | \$1,634.00 | Y 3 A | |
| M8130-00 | MODIFIED M8100 | EACH | \$1,937.00 | Y 3 A | | M8223-00 | IRC CPU INSTRUCT DECODE&CLOCK | EACH | \$1,216.00 | Y 3 A | |
| M8131-00 | MODIFIED M8101 | EACH | \$1,696.00 | Y 3 A | | M8224-00 | IDP CPU INTERUCTION DATA PATH | EACH | \$1,495.00 | Y 3 A | |
| M8132-00 | MODIFIED M8102 | EACH | \$1,611.00 | Y 3 A | | M8225-00 | DEP DATA PATH E | EACH | \$1,452.00 | Y 3 A | |
| M8134-00 | MODIFIED M8104 PDR | EACH | \$1,859.00 | Y 3 A | | M8226-00 | DDP DATA PATH D | EACH | \$1,344.00 | Y 3 A | |
| M8135-00 | MODIFIED M8105 TMC | EACH | \$1,611.00 | Y 3 A | | M8227-00 | DCP DATA PATH C | EACH | \$1,543.00 | Y 3 A | |
| M8136-00 | MODIFIED M8106 UNC | EACH | \$1,611.00 | Y 3 A | | M8228-00 | P.C. DESIGN DATA BASE | EACH | \$1,404.00 | Y 3 A | |
| M8137-00 | MODIFIED M8107 SAP | EACH | \$2,418.00 | Y 3 A | | M8229-00 | DAP DATA PATH A | EACH | \$1,259.00 | Y 3 A | |
| M8138-00 | MODIFIED M8108 SSR | EACH | \$1,696.00 | Y 3 A | | M8230-00 | CPU CONDITION CODE | EACH | \$1,377.00 | Y 3 A | |
| M8138-YA | SYS STATUS REG | EACH | \$1,696.00 | Y 3 A | | M8231-00 | CPU TRAPS AND INTERRUPTS CONT | EACH | \$1,334.00 | Y 3 A | |
| M8139-00 | MODIFIED M8109 TIG | EACH | \$2,339.00 | Y 3 A | | M8232-00 | CLK CPU CLOCK | EACH | \$1,253.00 | Y 3 A | |
| M8140-00 | SEGMENT + CONSOLE CONT | EACH | \$1,611.00 | Y 3 A | | M8233-00 | WCS CPU WRITEABLE CONTROL STO | EACH | REPLACED | Y 3 A | M8238-00 |
| M8141-00 | MAPPING BOX | EACH | \$2,318.00 | Y 3 A | | M8234-00 | PCS CPU PROM CONTROL STORE | EACH | \$3,911.00 | Y 3 A | |
| M8142-00 | CACHE CONTROL BRD | EACH | \$2,256.00 | Y 3 A | | M8235-00 | MICRO SEQUENCER CONTROL | EACH | \$1,184.00 | Y 3 A | |
| M8143-00 | CACH ADM. ADD MEM. BD. 4 LAYE | EACH | \$2,544.00 | Y 3 A | | M8236-00 | CIB CONSOLE INTERFACE | EACH | \$1,581.00 | Y 3 A | |
| M8144-00 | CACHE DATA MEMORY | EACH | \$2,471.00 | Y 3 A | | M8237-00 | TERMINATOR SILO | EACH | \$1,055.00 | Y 3 A | |
| M8145-00 | CACHE DATA PATH | EACH | \$2,513.00 | Y 3 A | | M8238-00 | KU780-A 2K WCS,4-LAYER HEX 12 | EACH | \$11,550.00 | Y 3 A | |
| M8148-00 | MJ11-A, MEMORY CONT. & TIMING | EACH | REPLACED | Y 3 A | M8147-00 | M8254-00 | INTERPROCESSOR BUFFER | EACH | \$3,252.00 | Y 3 A | |
| M8150-00 | RH70 MASSBUS DATA PATH | EACH | \$2,935.00 | Y 3 A | | M8256-00 | RX211 UNIBUS RX02 INTERFACE Q | EACH | \$627.00 | Y 3 A | |
| M8151-00 | RH70 CONTROL + STATUS | EACH | \$1,479.00 | Y 3 A | | M8258-00 | MULTIPOINT PORT INTER | EACH | \$2,127.00 | Y 3 A | |
| M8152-00 | RH70 ADDRESS + WORD COUNT | EACH | \$936.00 | Y 3 A | | M8259-00 | MULTIPOINT PORT CONT | EACH | \$2,178.00 | Y 3 A | |
| M8153-00 | RH70 UNIBUS CONTROL | EACH | \$1,479.00 | Y 3 A | | M8260-00 | MULTIPOINT ARRAY | EACH | \$1,848.00 | Y 3 A | |
| M8158-00 | MK11 ADDRESS BUFFER 4 LAYER | EACH | \$770.00 | Y 3 A | | M8261-00 | MULTIPOINT SYNCHRONIZER | EACH | \$2,260.00 | Y 3 A | |
| M8159-00 | 11/70 MOSARRAY MEMORY | EACH | REPLACED | Y 3 A | M8164-00 | M8265-00 | DATA PATH,HEX(KD11EA) | EACH | \$2,567.00 | Y 3 A | |
| M8160-00 | MK11, CONTROL A | EACH | \$1,461.00 | Y 3 A | | M8266-00 | CONTROL,HEX(KD11EA) | EACH | \$2,324.00 | Y 3 A | |
| M8161-00 | MK11, CONTROL B | EACH | \$2,035.00 | Y 3 A | | M8267-00 | HEX(FP11A) | EACH | \$3,191.00 | Y 3 A | |
| M8164-00 | MK11,MKA11 DATA BUFFER | EACH | \$1,026.00 | Y 3 A | | M8268-00 | CACHE HEX MODULE | EACH | \$4,487.00 | Y 3 A | |
| M8186-00 | KDF11,CPU,DOUBLE 8.5 | EACH | \$1,197.00 | Y 3 A | | M827-00 | CLOCK AND STATES, KE11-A | EACH | \$599.00 | Y 3 A | |
| M8188-00 | FPF11 FLOATING POINT PROCESSR | EACH | \$1,050.00 | Y 3 A | | M8270-00 | YSI SBI INTERFACE | EACH | \$1,854.00 | Y 3 A | |
| M8190-AB | 15MHZ QUAD CPU MOD, DCJ11-AA | EACH | \$5,250.00 | Y 3 A | | M8271-00 | YMD UNIBUS MAP AND DATA PATH | EACH | \$1,652.00 | Y 3 A | |
| M8190-AE | 18MHZ QUAD CPU MOD, DCJ11-AA | EACH | \$8,400.00 | Y 3 A | | M8272-00 | UNIBUS ADAPTER ADDRESS | EACH | \$2,038.00 | Y 3 A | |
| M8191-00 | UNIBUS ADAPT FOR KDJ11B W/MAP | EACH | \$2,625.00 | Y 3 A | | M8273-00 | UNIBUS ADAPTER CONTROL | EACH | \$1,567.00 | Y 3 A | |
| M8192-00 | DUAL HEIGHT CPU BRD | EACH | REPLACED | Y 3 A | M8192-YB | M8274-00 | RH780 EXTENDED SILO MASSBUS | EACH | \$1,089.00 | Y 3 A | |
| M8192-YB | DUAL HEIGHT CPU BRD (KDJ11-A) | EACH | \$2,495.00 | Y 3 A | | M8275-00 | MSI MASSBUS ADAPTER SBI INTER | EACH | \$1,716.00 | Y 3 A | |
| M8200-YA | INTERPROCESSOR LINKUP | EACH | \$2,022.00 | Y 3 A | | M8276-00 | MIR MASSBUS INTERNAL REGISTER | EACH | \$1,780.00 | Y 3 A | |
| M8200-YB | INTERPROCESSOR LINKUP | EACH | \$2,166.00 | Y 3 A | | M8277-00 | MASSBUS ADAPTER DATA PATH | EACH | REPLACED | Y 3 A | M8274-00 |
| M8200-YC | INTERPROCESSOR LINKUP | EACH | \$2,022.00 | Y 3 A | | M8278-00 | MCB MASSBUS ADAPTER CONTROL | EACH | \$1,424.00 | Y 3 A | |
| M8201-00 | IPL SLU LO | EACH | \$1,164.00 | Y 3 A | | M8285-00 | FOATING POINT FRACTION NORMAL | EACH | \$2,169.00 | Y 3 A | |
| M8202-YA | IPL SLU HI [1 MB] | EACH | \$1,811.00 | Y 3 A | | M8286-00 | FLOATING POINT FRACTION MULTI | EACH | \$1,859.00 | Y 3 A | |
| M8202-YD | IPL SLU HI [65 KB] | EACH | \$1,449.00 | Y 3 A | | M8287-00 | FLOATING POINT FRACTION ADDER | EACH | \$2,036.00 | Y 3 A | |
| M8202-YE | LINE UNIT | EACH | \$4,649.00 | Y 3 A | | M8288-00 | FLOATING POINT ACCELERATOR C | EACH | \$1,592.00 | Y 3 A | |
| M8203-00 | DMP11 MULTIDROP LINE UNIT, RS | EACH | \$2,582.00 | Y 3 A | | M8289-00 | FMH | EACH | \$1,961.00 | Y 3 A | |
| M8204-00 | IOP MICRO PROCESSOR | EACH | \$2,449.00 | Y 3 A | | M8291-00 | CR11 CM11 CONTROL | EACH | \$1,001.00 | Y 3 A | |
| M8206-00 | MICROPROC DMC11 CODE 4K RAM | EACH | \$4,745.00 | Y 3 A | | M8293-00 | M7293 W NO 8838'S | EACH | \$675.00 | Y 3 A | |
| M8207-RA | MICROPROCESSOR BASED SYNCH | EACH | \$3,377.00 | Y 3 A | | M8294-00 | 32K TIMING UNIBUS INTFACE | EACH | \$478.00 | Y 3 A | |
| M8207-YA | DMP11 MICROPROC.,DDCMP CONTRL | EACH | \$4,068.00 | Y 3 A | | M8296-00 | SYNC BACKPLANE INTERCON | EACH | \$4,032.00 | Y 3 A | |
| M8210-00 | 32KW (72 BIT WORD) MOS MEM | EACH | \$2,040.00 | Y 3 A | | M8297-00 | DR780 CONTROL 4 LAYER,HEX | EACH | \$3,533.00 | Y 3 A | |
| M8212-00 | MDT MEMORY DATA PATH | EACH | \$2,324.00 | Y 3 A | | M8297-YA | DR780 CONTROL MOD FOR CI780 | EACH | \$4,617.00 | Y 3 A | |
| M8213-00 | MCN MEMORY CONTROLLER | EACH | \$2,828.00 | Y 3 A | | M8298-00 | DR780 MICROPROCESSOR | EACH | \$5,158.00 | Y 3 A | |
| M8214-00 | MEMORY SBI BOARD | EACH | \$2,882.00 | Y 3 A | | M8299-00 | DR780 SILO,HEX,12 | EACH | \$4,016.00 | Y 3 A | |
| M8217-00 | UNIBUS TO LSI-11 BUS CONVERTE | EACH | \$809.00 | Y 3 A | | M8300-00 | REGISTER, MAJOR | EACH | \$1,125.00 | Y 3 A | |
| M8218-00 | SBL-LOW BIT INTERFACE | EACH | \$1,527.00 | Y 3 A | | M8310-00 | CONTROL, MAJOR REGISTER | EACH | \$800.00 | Y 3 A | |
| M8219-00 | SBH CPU HIGH BITS INTERFACE | EACH | \$1,463.00 | Y 3 A | | M8315-00 | CPU OMNIBUS 8E INSTRUCT | EACH | \$1,250.00 | Y 3 A | |



Prices Effective 02-January-89 to 30-June-89
To Order—Call DECdirect™ TOLL-FREE 800-344-4825, 8:30 a.m. to 8:00 p.m. ET in Continental U.S.A.

HARDWARE SPARES PRICE LIST

| PART NUMBER | DESCRIPTION | UNIT ORDER | UNIT PRICE | REP D | L | REPLACEMENT PART NUMBER | PART NUMBER | DESCRIPTION | UNIT ORDER | UNIT PRICE | REP D | L | REPLACEMENT PART NUMBER | |
|-------------|-------------------------------|------------|------------|-------|---|-------------------------|-------------|-------------------------------|---------------------------|------------|----------|---|-------------------------|---|
| M8316-00 | 8A XTAL CLOCK OPT BRD #1 | EACH | \$830.00 | Y | 3 | A | M8728-AA | 64K X 39 MOS MEM ARRAY | EACH | \$2,520.00 | Y | 3 | A | |
| M8317-00 | 8A MEM EXT PWR FAIL OPT BRD # | EACH | REPLACED | Y | 3 | A | M873-YA | BOOTSTRAP LOADER | EACH | \$728.00 | Y | 3 | A | |
| M8317-YB | M8317 ETCH REV E, LUG JUMPERS | EACH | \$690.00 | Y | 3 | A | M8739-00 | UNIBUS INTERFACE, QUAD | EACH | \$1,050.00 | Y | 3 | A | |
| M8320-AA | LOADS, BUS | EACH | \$200.00 | Y | 3 | A | M8743-AA | 512KB (256K X 2) ECC RAM | EACH | \$3,150.00 | Y | 3 | A | |
| M833-00 | TIMING GENERATOR | EACH | REPLACED | Y | 3 | A | M8743-BA | 1MB(512K X 2)ECC RAM | EACH | \$1,865.00 | Y | 3 | A | |
| M8330-00 | TIMING GENERATOR | EACH | \$513.00 | Y | 3 | A | M8750-CA | 1MB ECC/64K/MOS ARRAY | EACH | \$1,335.00 | Y | 3 | A | |
| M8330-YB | TIMING GENERATOR | EACH | REPLACED | Y | 3 | A | M890-00 | CONTROL, MOTION | EACH | \$686.00 | Y | 3 | A | |
| M8340-00 | DECODER AND STEPCOUNTER | EACH | \$764.00 | Y | 3 | A | M8901-00 | DATA SYNCHRONIZER-TM02 | EACH | REPLACED | Y | 3 | A | |
| M8341-00 | MULTIPLEXORS & TIMING GENERAT | EACH | \$798.00 | Y | 3 | A | M8901-YB | DATA SYNC. TU16, QUAD 8.5 | EACH | \$885.00 | Y | 3 | A | |
| M8350-00 | POSITIVE 10 BUS INTERFACE | EACH | \$105.00 | Y | 3 | A | M8901-YD | DATA SYNC FOR 125 IPS DRIVE | EACH | \$860.00 | Y | 3 | A | |
| M8357-00 | RX8E INTERFACE | EACH | \$243.00 | Y | 3 | A | M8902-00 | TM02 TAPE CONTROL, PE, QUAD | EACH | \$650.00 | Y | 3 | A | |
| M8366-00 | LQP8E CONTROL | EACH | \$489.00 | Y | 3 | A | M8904-00 | TAPE CONT NRZ1 (TM02) | EACH | \$799.00 | Y | 3 | A | |
| M837-00 | EXTENSION, MEMORY FINE SHARE | EACH | \$762.00 | Y | 3 | A | M8905-YB | MAINTENANCE REGISTER-TM03 | EACH | \$645.00 | Y | 3 | A | |
| M8373-AA | 256K X 39BIT MOS 1MB ARRAY | EACH | \$1,038.00 | Y | 3 | A | M8906-00 | 16-BIT FIDDLER (TM02) | EACH | \$458.00 | Y | 3 | A | |
| M8374-AA | 4MB INTERLEAVED MEM EXP | EACH | \$2,213.00 | Y | 3 | A | M8907-00 | CONN TERM | EACH | \$227.00 | Y | 3 | A | |
| M8375-00 | MEMORY CONTROL,4-LAYER HEX 12 | EACH | \$2,843.00 | Y | 3 | A | M8908-00 | RECEIVER/TERM | EACH | \$281.00 | Y | 3 | A | |
| M8376-00 | SBI INTERFACE,4-LAYER HEX 12 | EACH | \$2,197.00 | Y | 3 | A | M8908-YA | TAPE CONT NRZ1 (TM02) | EACH | \$337.00 | Y | 3 | A | |
| M8388-00 | RB730 INTEG. DISK CONT. HEX | EACH | \$4,523.00 | Y | 3 | A | M8909-00 | MASS BUSS INTFACE (TM02) | EACH | REPLACED | Y | 3 | A | |
| M8389-00 | FLOATING POINT ACCELERATOR | EACH | \$4,195.00 | Y | 3 | A | M8909-YA | MASS BUSS INTFACE (TM02+TM03) | EACH | \$1,369.00 | Y | 3 | A | |
| M8390-00 | DAP (DATA PATH) | EACH | \$3,069.00 | Y | 3 | A | M8910-00 | LOGIC & WRITE BD (TU16) | EACH | \$844.00 | Y | 3 | A | |
| M8391-00 | MCT (MEM CONTROLLER) HEX | EACH | REPLACED | Y | 3 | A | M8911-00 | SLAVE CLOCK MOTION DELAY (TU1 | EACH | \$447.00 | Y | 3 | A | |
| M8391-YA | MEM CONTR W BATTERY BACKUP | EACH | \$3,204.00 | Y | 3 | A | M8912-00 | SLAVE TEST FUNCT GEN (TU16) | EACH | \$647.00 | Y | 3 | A | |
| M8394-00 | WRITEABLE CONTROL STORE,HEX | EACH | \$2,881.00 | Y | 3 | A | M8913-00 | DATA DRIVER | EACH | \$228.00 | Y | 3 | A | |
| M8396-00 | DFM32 I/O MUX, HEX | EACH | \$2,700.00 | Y | 3 | A | M8913-YA | TERMINATED DATA DRIVER | EACH | REPLACED | Y | 3 | A | |
| M8436-BA | M8436 W 32K 12 BIT MEMORY | EACH | \$2,370.00 | Y | 3 | A | M8915-00 | M8915-18 BIT SIDDLER-TM03 | EACH | REPLACED | 3 | A | M9039-00 M8915-YA | |
| M8437-AA | M8437 W ROM SET "A" | EACH | \$683.00 | Y | 3 | A | M8915-YA | UNIVERSAL DATA FORMATTER | EACH | \$1,016.00 | | 3 | A | |
| M847-00 | M8E BOOTSTRAP LEADER | EACH | \$1,032.00 | Y | 3 | A | M8916-00 | LOGIC AND WRITE BOARD | EACH | \$2,164.00 | Y | 3 | A | |
| M849-00 | SHIELD, RFJ | EACH | \$59.00 | Y | 3 | A | M8922-00 | PE CONTROL, TS04 | EACH | \$568.00 | Y | 3 | A | |
| M8536-00 | CHANNEL CTR LOGIC | EACH | \$2,135.00 | Y | 3 | A | M8923-00 | READ CONTROL | EACH | \$278.00 | Y | 3 | A | |
| M8541-00 | CONTROL RAW ADDRESS | EACH | \$2,621.00 | Y | 3 | A | M8924-00 | PE FORMAT | EACH | \$861.00 | Y | 3 | A | |
| M8552-00 | 10/11 DATA PATCH 4 | EACH | \$1,512.00 | Y | 3 | A | M8929-00 | TS04 WRITE CONTROL | EACH | \$562.00 | Y | 3 | A | |
| M8553-00 | 10/11 BUS AND DATA CONTROL | EACH | \$1,360.00 | Y | 3 | A | M8931-00 | SLAVE CLOCK AND MOTION DELAY | EACH | \$627.00 | Y | 3 | A | |
| M8554-00 | 10/11 BUS + DATA CONTROL EXT | EACH | \$563.00 | Y | 3 | A | M8932-00 | TAPE CONTROL P.E. | EACH | \$770.00 | Y | 3 | A | |
| M8578-00 | UNIVERSAL Q-22 BUS EPROM | EACH | \$473.00 | Y | 3 | A | M8933-00 | MODULE TAPE CONTROL TM03 | EACH | \$1,633.00 | Y | 3 | A | |
| M8629-BA | 64K 36BIT ECC MOS RAM | EACH | \$6,300.00 | Y | 3 | A | M8934-00 | TAPE CONTROL, NRZ1 | EACH | \$804.00 | Y | 3 | A | |
| M8634-PA | Q-BUS INTERFACE TO IEEE488/IE | EACH | \$2,420.00 | Y | 3 | A | M8937-00 | TM03, CONTROL AND WRITE DRIVE | EACH | \$887.00 | Y | 3 | A | |
| M8637-BA | MSV11-JB 1MB ECC RAM MEM | EACH | REPLACED | Y | 3 | A | M8940-00 | MTA (MAGTAPE ADAPTOR) | EACH | \$1,222.00 | Y | 3 | A | |
| M8637-CA | MSV11-JC 2MB ECC RAM MEM | EACH | REPLACED | Y | 3 | A | M8950-00 | TM78, READ CHANNEL | EACH | \$735.00 | Y | 3 | A | |
| M8637-DA | MSV11-JD 1MB ECC RAM MEM | EACH | \$1,805.00 | Y | 3 | A | M8951-00 | TM78 ERROR CORRECTION BOARD | EACH | \$869.00 | Y | 3 | A | |
| M8637-EA | MSV11-JE 2MB ECC RAM MEM | EACH | \$2,400.00 | Y | 3 | A | M8952-00 | CRC + ACRC, TM78 | EACH | \$738.00 | Y | 3 | A | |
| M8639-00 | Q-BUS RXD INTERFACE | EACH | REPLACED | Y | 3 | A | M7555-00 | M8953-00 | READ PATH SEQUENCER, TM78 | EACH | \$951.00 | Y | 3 | A |
| M8639-YA | Q-BUS CONTROL | EACH | \$2,403.00 | Y | 3 | A | M8955-00 | TM78 PORT | EACH | \$817.00 | Y | 3 | A | |
| M8639-YB | Q-BUS CTRL FOR RD51/RD52 | EACH | \$2,605.00 | Y | 3 | A | M8956-00 | MASS BUSS DATA PORT, TM78 | EACH | \$726.00 | Y | 3 | A | |
| M8650-00 | KL8/EA ASYNCH DATA CONTROL | EACH | \$815.00 | Y | 3 | A | M8957-00 | MASS BUSS CONTROL, TM78 | EACH | \$760.00 | Y | 3 | A | |
| M8655-00 | TERMINAL CONTR KL8-JA | EACH | \$677.00 | Y | 3 | A | M8958-00 | TM78 TRANSLATOR | EACH | \$565.00 | Y | 3 | A | |
| M8656-00 | KEYBOARD INTERFACE | EACH | \$364.00 | Y | 3 | A | M8959-00 | WRITE MICROCONTROLLER, TM78 | EACH | \$1,158.00 | Y | 3 | A | |
| M8657-00 | CONTROL MOD | EACH | REPLACED | Y | 3 | A | M8960-00 | TM78 MICROCOMPUTER (8085) | EACH | \$2,493.00 | Y | 3 | A | |
| M8657-YA | VT71 CONTROL SECTION | EACH | \$606.00 | Y | 3 | A | M8962-00 | MICROPROCESSOR, TS04 | EACH | \$525.00 | Y | 3 | A | |
| M8658-00 | VIDO MOD | EACH | REPLACED | Y | 3 | A | M8963-00 | TS04 MICROPORCESSOR STACK | EACH | \$480.00 | Y | 3 | A | |
| M8658-YA | VT71 VIDEO | EACH | \$954.00 | Y | 3 | A | M8964-00 | ROM BOARD | EACH | \$900.00 | Y | 3 | A | |
| M8659-00 | VT71 BUS GRANT BRD | EACH | \$74.00 | | 3 | A | M8965-00 | I/O SHIFT REGISTER CONT, TS04 | EACH | \$356.00 | | 3 | A | |
| M8685-00 | DATA SEQUENCER, 4-LAYER HEX | EACH | \$749.00 | Y | 3 | A | M8966-00 | TS04 I/O SILO, FRAME COUNT. | EACH | \$797.00 | Y | 3 | A | |
| M8687-00 | RM05 DRIVE INTERFACE, HEX | EACH | \$162.00 | | 3 | A | M8967-00 | I/O CONTROL, TS04 | EACH | \$520.00 | Y | 3 | A | |
| M8716-00 | DR11-W, DMA INTERFACE | EACH | \$1,418.00 | Y | 3 | A | M8968-00 | TS04 ROM EXTENSION BOARD | EACH | \$1,513.00 | Y | 3 | A | |
| M8719-00 | UNIBUS TO DBUS CABLE I/O | EACH | \$3,935.00 | Y | 3 | A | M8970-00 | STI INTERFACE MICRO BD (QUAD) | EACH | \$2,246.00 | Y | 3 | A | |

Prices Effective 02-January-89 to 30-June-89

To Order—Call DECdirect™ TOLL-FREE 800-344-4825, 8:30 a.m. to 8:00 p.m. ET in Continental U.S.A.

HARDWARE SPARES PRICE LIST

| PART NUMBER | DESCRIPTION | UNIT ORDER | UNIT PRICE | REP D | L | REPLACEMENT PART NUMBER | PART NUMBER | DESCRIPTION | UNIT ORDER | UNIT PRICE | REP D | L | REPLACEMENT PART NUMBER | |
|-------------|-------------------------------|------------|-------------|-------|---|-------------------------|-------------|-------------------------------|------------|------------|-------|---|-------------------------|------------|
| M8971-00 | STI INTERFACE DRIVER BD (QUAD | EACH | \$3,880.00 | Y | 3 | A | RL02K-RF | RL02 REF AMP/TIMING CARTRIDGE | EACH | \$413.00 | 3 | A | | |
| M8972-00 | TA78 MICROCOMPUTER, QUAD | EACH | \$2,849.00 | Y | 3 | A | RP04-TC | RP04 INTERFACE FOR RP06-TA | EACH | \$936.00 | Y | 3 | A | |
| M8973-00 | 8085 EXTENDED MEMORY,DBL8.5 | EACH | \$2,143.00 | Y | 3 | A | RS04-TA | TIME TRACK WRITE TESTER NO/SE | EACH | \$617.00 | 3 | A | | |
| M9001-00 | TU16 CABLE CARD | EACH | \$277.00 | Y | 3 | A | S861-C | PWR. CONT'L 120V 24A | EACH | REPLACED | 3 | A | 00861-C | |
| M9001-YA | M9001/8 LINES GROUND | EACH | \$194.00 | Y | 3 | A | S861-D | PWR. CONT'L 120V 24A 3 PHASE | EACH | REPLACED | 3 | A | 4A-00861-D | |
| M9001-YB | M9001 TERMINATED | EACH | \$119.00 | Y | 3 | A | S861-E | PWR. CONT'L 240V 15A 3 PHASE | EACH | REPLACED | 3 | A | 00861-E | |
| M9001-YC | M9001-YA TERMINATED | EACH | REPLACED | Y | 3 | A | S869-D | P-CNTL W/PWR SEQ 240V12A 3PHS | EACH | REPLACED | 3 | A | 00869-D | |
| M9014-00 | ADAPTOR BOARD RR11-C | EACH | \$175.00 | 3 | A | M9039-00 | S869-E | P-CNTL W/PWR SEQ 240V12A 3PHS | EACH | REPLACED | 3 | A | 00869-E | |
| M903-00 | CONNECTOR (FLEX PRINT) | EACH | \$27.00 | 3 | A | | S871-A | PWR. CONT'L UNFLT 120V 12A | EACH | REPLACED | 3 | A | 00871-A | |
| M9039-00 | TE16 TERMINATOR, HEX BRD | EACH | \$1,088.00 | Y | 3 | A | S871-B | PWR. CONT'L UNFLT 240V 8A | EACH | REPLACED | 3 | A | 00874-B | |
| M9040-00 | 11780 CPU SBI TERMINATOR,HEX | EACH | \$691.00 | 3 | A | | S871-C | 19" PWR. CONT'L 120V 16A | EACH | REPLACED | 3 | A | 4A-00871-C | |
| M9041-00 | MASS BUS PADDLE CARD | EACH | \$196.00 | 3 | A | | S874-A | PWR. CONT'L FLTRD, 120V 12A | EACH | REPLACED | 3 | A | 00874-A | |
| M9042-00 | UNIBUS PADDLE CARD | EACH | \$80.00 | 3 | A | | S874-B | PWR CNTL FLTRD 220-240V 12A | EACH | REPLACED | 3 | A | 00874-B | |
| M9043-00 | 11780,SBI(BACKPLANE TERM),HEX | EACH | \$327.00 | 3 | A | | S874-C | PWR. CONT'L FLTRD 120V 16A | EACH | REPLACED | 3 | A | 00874-C | |
| M9044-00 | UBA UNIBUS TERMINAL | EACH | \$144.00 | 3 | A | | S874-D | PWR. CONT'L FLTRD 120V 24A | EACH | REPLACED | 3 | A | 00874-D | |
| M9045-00 | BDI PADDLE CARD FOR MA780 | EACH | \$691.00 | 3 | A | | S874-E | PWR CNTL FLTRD 220-240V 24A | EACH | REPLACED | 3 | A | S874-K | |
| M9046-00 | DR780 PADDLE CARD, HEX 12 | EACH | \$228.00 | 3 | A | | S874-F | 220/240V FILTERED POWER CNTL | EACH | REPLACED | 3 | A | 4A-00874-F | |
| M9047-00 | QBUS GRANT CONTINUITY | EACH | \$42.00 | 3 | A | | S874-K | PWR CNTL FLTRD 240V 24A | EACH | REPLACED | 3 | A | 00874-E | |
| M9049-00 | ELEM POWER SUPPLY LOAD BOARD | EACH | \$147.00 | 3 | A | | S877-B | PWR. CONT'L FLTRD 240V 12A | EACH | REPLACED | 3 | A | 00877-B | |
| M9058-00 | SIGNAL DIST FOR RD52 AND RX50 | EACH | \$282.00 | 3 | A | | S877-D | PWR. CONT'L FLTRD 120V 124A | EACH | REPLACED | 3 | A | 00877-D | |
| M908-00 | CONNECTOR MODULE | EACH | \$95.00 | 3 | A | | S877-E | PWR. CONT'L FLTRD 240V 24A | EACH | REPLACED | 3 | A | 00877-E | |
| M920-00 | UNIBUS 1" JUMPER CABLE | EACH | \$87.00 | 3 | A | | S881-A | PWR CNTL 3PH FLTRD 120V 24A | EACH | REPLACED | 3 | A | 30-24374-01 | |
| M9202-00 | M9192-M9292, 1" APART W/2"C | EACH | \$180.00 | Y | 3 | A | S881-B | PWR CNTL 3PH FLTRD 240V 16A | EACH | REPLACED | 3 | A | 30-24374-02 | |
| M930-00 | PDP-11 BUS TERMINATOR | EACH | \$109.00 | Y | 3 | A | SBA32-00 | BA32 EXPANDER BOX SPARES KIT | EACH | REPLACED | 3 | A | 4A-BA32-00 | |
| M9300-00 | UNIBUS B TERMINATOR | EACH | \$183.00 | Y | 3 | A | SDKC8-AA | DKC8-AA SPARE MOD KIT(M8316) | EACH | REPLACED | 3 | A | M8316-00 | |
| M9301-YC | BOOTSTRAP LOADER | EACH | \$770.00 | Y | 3 | A | SDL11-W | DL11-W SPARE MOD KIT(M7856) | EACH | REPLACED | Y | 3 | A | M7856-00 |
| M9301-YH | M9301 W 11/60 BOOTSTRAP | EACH | \$770.00 | Y | 3 | A | SDR11-C | GENERAL PURPOSE INTERFACE | EACH | REPLACED | 3 | A | 4A-DR11-C | |
| M9302-00 | UNIBUS TERMINATOR | EACH | \$371.00 | Y | 3 | A | SDR11-W | DR11-W SPARE MODULE (M8716) | EACH | REPLACED | Y | 3 | A | M8716-00 |
| M9312-00 | BOOTSTRAP TERMINATOR | EACH | \$1,075.00 | Y | 3 | A | SDV11-AA | SPARE MODULE KIT | EACH | REPLACED | 3 | A | 4A-DV11-AA | |
| M9313-00 | UNIBUS EXERCIZER & TERMINATOR | EACH | \$809.00 | Y | 3 | A | SEKIT-AA | SYSTEMS ENGR. TOOL KIT 60HZ | EACH | REPLACED | 3 | A | 4A-SEKIT-AA | |
| M935-00 | INTERNAL BUS, 8/E | EACH | \$133.00 | 3 | A | | SEKIT-AB | SYSTEMS ENGR. TOOL KIT 50 HZ | EACH | REPLACED | 3 | A | 4A-SEKIT-AB | |
| M9400-YA | REV11-A LSI BUS,REF/BOOT,TERM | EACH | \$378.00 | Y | 3 | A | SEKIT-MS | METRIC SUPPLEMENT TOOL ROLL | EACH | REPLACED | 3 | A | 4A-SEKIT-MS | |
| M9400-YB | REV11 LSI BUS, 120-OHM TERM | EACH | \$167.00 | 3 | A | | SH765-00 | H765-A,B SPARES KIT | EACH | REPLACED | 3 | A | 4A-H765-00 | |
| M9400-YC | REV11-C LSI BUS, REF/BOOT | EACH | \$378.00 | Y | 3 | A | SKD11-D | KD11-D SPARE MOD KIT(M7263) | EACH | REPLACED | Y | 3 | A | M7263-00 |
| M9400-YD | LSI BUS, HEADER ALONE(2 H854) | EACH | \$93.00 | 3 | A | | SKD11-EA | 1134A CPU SPARES KIT | EACH | REPLACED | 3 | A | 4A-KD11-EA | |
| M9400-YE | LSI BUS,250-OHM TERM(2 H854) | EACH | \$105.00 | 3 | A | | SKD11-F | KD11-F SPARE MOD KIT(M7264) | EACH | REPLACED | Y | 3 | A | 4A-KD11-F |
| M9401-00 | LSI-11 MIRROR IMAGE CABLE CON | EACH | \$119.00 | 3 | A | | SKD11-H | KD11-H SPARE MODULE(M7264-YC) | EACH | REPLACED | Y | 3 | A | M7264-YC |
| M9403-00 | DW11-B Q-BUS CONNECTOR | EACH | \$301.00 | 3 | A | | SKD11-Z | KD11-Z SPARES KIT | EACH | REPLACED | 3 | A | 4A-KD11-Z | |
| M974-00 | DM11 MAINTENANCE JUMPER | EACH | \$108.00 | 3 | A | | SKE44-A | KE44-A CIS SPARES KIT | EACH | REPLACED | 3 | A | 4A-KE44-A | |
| M993-00 | CABLE CONTROL (RK8-E) | EACH | \$109.00 | 3 | A | | SKW11-K | KW11-K DUAL PROG REAL TIME CL | EACH | REPLACED | 3 | A | 4A-KW11-K | |
| MB20-M | MEMORY 32K X 19 | EACH | \$9,332.00 | Y | 3 | A | SLA12-00 | LA12 SPARES KIT | EACH | REPLACED | 3 | A | 4A-LA12-00 | |
| MF20-M | ARRAY CARD,256K 11-BIT | EACH | \$12,728.00 | Y | 3 | A | SLA50-00 | LA50 SPARES KIT | EACH | REPLACED | 3 | A | 4A-LA50-00 | |
| MG20-M | 11-BIT MEM ARRAY(M8570-AA) | EACH | \$7,350.00 | Y | 3 | A | SLA75-A2 | LA75 SPARES KIT, 120V | EACH | REPLACED | 3 | A | 4A-LA75-A2 | |
| MS780-FD | 1MB ECC/64K/MOS 11780 EXP MEM | EACH | REPLACED | 3 | A | M8373-AA | SLA75-A4 | LA75 SPARES KIT, 220/240V | EACH | REPLACED | 3 | A | 4A-LA75-A4 | |
| PC500-UA | VAXMATE ENHANCED CPU KIT | EACH | REPLACED | 3 | A | 54-17158-01 | SLA75-A5 | LA75 SPARES KIT, 100V | EACH | REPLACED | 3 | A | 4A-LA75-A5 | |
| RCD31-E | RD31 CONTROLLER FOR PC500 | EACH | \$636.00 | Y | 3 | A | SLAXX-KG | EIA INT FOR LA36, 9' CABLE | EACH | REPLACED | 3 | A | 4A-LAXX-KG | |
| RK05-LA | RK05 LAMP ASSEMBLY KIT | EACH | \$76.00 | 3 | A | | SLAXX-LG | EIA W/MOD CONT F LA35,36' CBL | EACH | REPLACED | 3 | A | 4A-LAXX-LG | |
| RK05-TA | READ/WRITE POSITION TESTER | EACH | \$2,500.00 | Y | 3 | A | SLAXX-NW | BUFFERED EIA INT FOR LA180 | EACH | REPLACED | 3 | A | 4A-LAXX-NW | |
| RK05K-AC | RK05 ALIGNMENT CARTRIDGE | EACH | \$301.00 | 3 | A | | SLG01-00 | LG01 SPARES KIT | EACH | REPLACED | 3 | A | 4A-LG01-00 | |
| RK06-TB | RK06 EXERCISER, 50HZ | EACH | REPLACED | 3 | A | RK6/7-TB | SLG02-00 | LG02 SPARES KIT | EACH | REPLACED | 3 | A | 4A-LG02-00 | |
| RK06K-AC | RK06 ALIGNMENT CARTRIDGE | EACH | \$1,197.00 | 3 | A | | SLN01-TK | LN01 TOOL KIT | EACH | REPLACED | 3 | A | 4A-LN01-TK | |
| RK07K-AC | RK07 ALIGNMENT CARTRIDGE | EACH | \$1,557.00 | 3 | A | | SLN03-A2 | LN03-A2 SPARES KIT, 120V 60HZ | EACH | REPLACED | 3 | A | 4A-LN03-A2 | |
| RK6/7-TA | RK6/7 FIELD TESTER (115V,60HZ | EACH | \$7,578.00 | Y | 3 | A | SLN03-A3 | LN03-A3 SPARES KIT, 240V 50HZ | EACH | REPLACED | 3 | A | 4A-LN03-A3 | |
| RK6/7-TB | RK6/7 FIELD TESTER (230V,50HZ | EACH | \$7,578.00 | 3 | A | | SMM11-DP | MM11-DP SPARE MEMORY KIT | EACH | REPLACED | Y | 3 | A | 4A-MM11-DP |
| RL01K-AT | ALIGNMENT TOOL | EACH | \$381.00 | 3 | A | | SMS10-BA | MS10-BA SPARE MEM (M8629-BA) | EACH | REPLACED | Y | 3 | A | M8629-BA |



Prices Effective 02-January-89 to 30-June-89

To Order—Call DECdirect™ TOLL-FREE 800-344-4825, 8:30 a.m. to 8:00 p.m. ET in Continental U.S.A.

HARDWARE SPARES PRICE LIST

| PART NUMBER | DESCRIPTION | UNIT ORDER | UNIT PRICE | REP D | L | REPLACEMENT PART NUMBER | PART NUMBER | DESCRIPTION | UNIT ORDER | UNIT PRICE | REP D | L | REPLACEMENT PART NUMBER | | |
|-------------|---------------------------------|------------|------------|-------|---|-------------------------|----------------------|--------------------------------|-------------------------------|-------------|-------------|---|-------------------------|------------|------------|
| SMS11-LB | MS11-LB SPARE MEM (M7891-BA) | EACH | REPLACED | Y | 3 | A | 4A-MS11-LB | SRD51-A | RD51-A SPARE DRIVE, 10MB | EACH | REPLACED | Y | 3 | A | 4A-RD51-A |
| SMS11-PB | MS11-PB SPARE MOD (M8743-BA) | EACH | REPLACED | Y | 3 | A | M8743-BA | SRD52-A | RD52-A SPARE DRIVE (31 MB) | EACH | REPLACED | 3 | A | 4A-RD52-A | |
| SP861-B | 861-B SPARES KIT | EACH | REPLACED | 3 | A | 4A-00861-B | SRD53-00 | RD53 SPARES KIT | EACH | REPLACED | 3 | A | 4A-RD53-00 | | |
| SP861-C | 861-C SPARES KIT | EACH | REPLACED | 3 | A | 4A-00861-C | SRD53-A | RD53-A SPARE DRIVE | EACH | REPLACED | 3 | A | 4A-RD53-A | | |
| SP869-D | 869-D SPARES KIT, 120V 50/60HZ | EACH | REPLACED | 3 | A | 4A-00869-D | SRD54-A | RD54-A SPARE DRIVE | EACH | REPLACED | 3 | A | 4A-RD54-A | | |
| SP869-E | 869-E SPARES KIT, 240V 50/60HZ | EACH | REPLACED | 3 | A | 4A-00869-E | SRL02-A | RL02-A SPARES KIT | EACH | REPLACED | 3 | A | 4A-RL02-A | | |
| SP872-A | 872-A SPARES KIT, 120V 12A | EACH | REPLACED | 3 | A | 00874-A | SRM05-AC | RM05-AC SPARES KIT 60HZ | EACH | REPLACED | 3 | A | 4A-RM05-AC | | |
| SP872-B | 872-B SPARES KIT, 240V 12A | EACH | REPLACED | 3 | A | 00874-B | SRM05-AD | RM05-AD SPARES KIT, 50HZ | EACH | REPLACED | 3 | A | 4A-RM05-AD | | |
| SP872-C | 872-C SPARES KIT, 120V 16A | EACH | REPLACED | 3 | A | 00874-C | SRX01-A | RX01 60HZ SPARES KIT | EACH | REPLACED | 3 | A | 4A-RX01-A | | |
| SP872-D | 872-D SPARES KIT, 120V 24A | EACH | REPLACED | 3 | A | 00874-D | SRX01-D | RX01 50HZ SPARES KIT | EACH | REPLACED | 3 | A | 4A-RX01-D | | |
| SP872-E | 872-E SPARES KIT, 240V 24A | EACH | REPLACED | 3 | A | 00874-E | SRX02-A | RX02 SPARE PARTS KIT 60HZ | EACH | REPLACED | 3 | A | 4A-RX02-A | | |
| SP874-A | 874-A SPARES KIT, 120V 12A | EACH | REPLACED | 3 | A | 00874-A | SRX02-D | RX02 SPARE PARTS KIT 50HZ | EACH | REPLACED | 3 | A | 4A-RX02-D | | |
| SP874-B | 874-B SPARES KIT, 240V 12A | EACH | REPLACED | 3 | A | 00874-B | SRX33-A | RX33-A SPARE DRIVE (1.2MB) | EACH | REPLACED | 3 | A | 4A-RX33-A | | |
| SP874-C | 874-C SPARES KIT, 120V 16A | EACH | REPLACED | 3 | A | 00874-C | SRX50-AA | RX50-AA SPARE DRIVE | EACH | REPLACED | Y | 3 | A | 4A-RX50-AA | |
| SP874-D | 874-D SPARES KIT, 120V 12A | EACH | REPLACED | 3 | A | 00874-D | STA81-00 | TA81 SPARES KIT | EACH | REPLACED | 3 | A | 4A-TA81-00 | | |
| SP874-E | 874-E SPARES KIT, 240V 24A | EACH | REPLACED | 3 | A | 00874-E | STE16-E | 9-TRACK SPARES KIT | EACH | REPLACED | 3 | A | 4A-TE16-E | | |
| SPAAXV-C | AAV11-C SPARE MOD KIT(A6006) | EACH | REPLACED | Y | 3 | A | 30-18691-00 | STKIT-AA | SYSTEMS TERM. TOOL KIT 60HZ | EACH | REPLACED | 3 | A | 4A-TKIT-AA | |
| SPAXV-C | AXV11-C SPARE MOD KIT(A026) | EACH | REPLACED | Y | 3 | A | 30-18889-00 | STKIT-AB | SYSTEMS TERM TOOL KIT 50HZ | EACH | REPLACED | 3 | A | 4A-TKIT-AB | |
| SPDLV-00 | DLV11 SPARE MODULE KIT(M7940) | EACH | REPLACED | Y | 3 | A | M7940-00 | STM03-00 | TM03 SPARES KIT | EACH | REPLACED | 3 | A | 4A-TM03-00 | |
| SPDLV-E | DLV11-E SPARE MOD KIT (M8017) | EACH | REPLACED | Y | 3 | A | M8017-AA | STM78-00 | TM78 SPARES KIT 240V,50/60HZ | EACH | REPLACED | 3 | A | 4A-TM78-00 | |
| SPDLV-F | DLV11-F SPARE MOD KIT (M8028) | EACH | REPLACED | Y | 3 | A | M8028-00 | STS05-00 | TS05 SPARES KIT, 50/60HZ 120V | EACH | REPLACED | 3 | A | 4A-TS05-00 | |
| SPDLV-J | DLV11-J SPARE MOD KIT (M8043) | EACH | REPLACED | Y | 3 | A | M8043-00 | STS78-BB | TS78-BB SPARES KIT | EACH | REPLACED | 3 | A | 4A-TS78-BB | |
| SPDRV-00 | DRV11-C SPARE MODULE KIT(M7941) | EACH | REPLACED | Y | 3 | A | M7941-00 | STU58-S | TU58 SERIAL SPARES KIT | EACH | REPLACED | 3 | A | 4A-TU58-S | |
| SPDRV-B | DRV11-B SPARE MEM KIT (M7950) | EACH | REPLACED | Y | 3 | A | M7950-00 | STU58-XA | SPARE DRIVE & CABLE ASSY. | EACH | REPLACED | Y | 3 | A | 4A-TU58-XA |
| SPDRV-J | DRV11-J SPARE MOD KIT (M8049) | EACH | REPLACED | Y | 3 | A | M8049-00 | STU58-XB | SPARE SERIAL ELECTRONICS | EACH | REPLACED | Y | 3 | A | 4A-TU58-XB |
| SPKK8-A | KK8-A SPARE MODULE KIT(M8315) | EACH | REPLACED | Y | 3 | A | M8315-00 | STU77-00 | TU77-AF,AJ SPARES KIT | EACH | REPLACED | 3 | A | 4A-TU77-00 | |
| SPKLB-JA | KL8-JA SPARE MODULE KIT(M8655) | EACH | REPLACED | Y | 3 | A | M8655-00 | STU78-00 | TU78-AF/J SPARES 240V 50/60HZ | EACH | REPLACED | 3 | A | 4A-TU78-00 | |
| SPKM8-AA | KM8-AA SPARE MODULE KIT | EACH | REPLACED | 3 | A | M8317-YB | STU79-00 | TU79-AF/-AJ SPARES KIT 240V 5 | EACH | REPLACED | 3 | A | 4A-TU79-00 | | |
| SPKM8-AC | KM8-AC SPARE MODULE (M8317-YB) | EACH | REPLACED | Y | 3 | A | M8317-YB | STU80-00 | TU80-A SPARES KIT, 120V/240V | EACH | REPLACED | 3 | A | 4A-TU80-00 | |
| SPKWW-C | KW11-C SPARE MODULE KIT | EACH | REPLACED | Y | 3 | A | 30-18690-00 | STU81-00 | TU81 SPARES KIT 120/240 50/60 | EACH | REPLACED | 3 | A | 4A-TU81-00 | |
| SPMM8-AB | MM8-AB SPARE MEMORY KIT | EACH | REPLACED | Y | 3 | A | 4A-MM8-AB | T1001-00 | KA820-AA CPU MODULE | EACH | \$26,250.00 | Y | 3 | A | |
| SPMRV-AA | MRV11-AA SPARE MOD KIT(M7942) | EACH | REPLACED | Y | 3 | A | M7942-00 | T1001-YA | KA825-AA CPU MODULE | EACH | \$29,000.00 | Y | 3 | A | |
| SPMRV-C | MRV11-C SPARE MODULE (M8048) | EACH | REPLACED | Y | 3 | A | M8578-00 | T1002-00 | BI- DISK- ADAPTER I (BDA) | EACH | \$4,638.00 | Y | 3 | A | |
| SPMSV-DC | MSV11-DC SPARE MEM(M8044-CA) | EACH | REPLACED | Y | 3 | A | 4A-SPMSV-DC | T1003-00 | BI-DISK-ADAPTER TO SDI | EACH | \$5,549.00 | Y | 3 | A | |
| SPMSV-DD | MSV11-DD SPARE MEM (M8044-DA) | EACH | REPLACED | Y | 3 | A | 4A-MSV11-DD | T1008-BA | 2MB 39BIT ECC MOS RAM | EACH | \$7,245.00 | Y | 3 | A | |
| SPMSV-DE | MSV11-DE SPARE MEM KIT | EACH | REPLACED | 3 | A | M8044-EA | T1010-00 | BUA(BI UNIBUS ADAPTER) MODULE | EACH | \$6,300.00 | Y | 3 | A | | |
| SPMSV-LF | MSV11-LF SPARE MEM (M8059-FA) | EACH | REPLACED | Y | 3 | A | M8059-FA | T1012-00 | BI COMBO MOD. CON. TO BKPLANE | EACH | \$3,518.00 | Y | 3 | A | |
| SPMSV-LK | MSV11-LK SPARE MEM (M8059-KA) | EACH | REPLACED | Y | 3 | A | M8059-KA | T1014-A | BI TO LESI ADAPTOR(KLESI-B) | EACH | \$8,461.00 | Y | 3 | A | |
| SPMSV-PK | MSV11-PK SPARE MEM (M8067-KA) | EACH | REPLACED | Y | 3 | A | M8067-KA | T1015-00 | PORT CONTROL | EACH | \$11,550.00 | Y | 3 | A | |
| SPMSV-PL | MSV11-PL SPARE MEM (M8067-LA) | EACH | REPLACED | Y | 3 | A | M8067-LA | T1017-00 | BI-BUS TO CI750 INTERF CONT | EACH | \$3,591.00 | Y | 3 | A | |
| SPMSV-QA | 1MB Q-BUS MEM KIT (M7551-AA) | EACH | REPLACED | 3 | A | M7551-AA | T1018-00 | BI ADAPTOR DATA TRANS. MODULE | EACH | \$2,648.00 | Y | 3 | A | | |
| SPMSV-QB | 2MB Q-BUS MEM KIT (M7551-BA) | EACH | REPLACED | 3 | A | M7551-BA | T1019-AA | 4MB ECC MEM ARRAY, | EACH | \$4,700.00 | Y | 3 | A | | |
| SPMSV-QC | 4MB Q-BUS MEM KIT (M7551-CA) | EACH | REPLACED | 3 | A | M7551-CA | T1020-00 | MEM INTERCONNECT | EACH | \$6,983.00 | Y | 3 | A | | |
| SR80-AA | R80-AA SPARES KIT 120V/60HZ | EACH | REPLACED | 3 | A | 4A-R80-AA | T1022-00 | VAXBI TO DRB BUS CONVERTER MOD | EACH | \$5,250.00 | Y | 3 | A | | |
| SRA60-AA | RA60-AA SPARES KIT 120/240V | EACH | REPLACED | 3 | A | 4A-RA60-AA | T1023-00 | DRB32 TO DR11-W MODULE | EACH | \$3,446.00 | Y | 3 | A | | |
| SRA70-A | RA70-A SPARES KIT | EACH | REPLACED | 3 | A | 4A-RA70-A | T1024-00 | DRB TO EXT DRB32 BUS ADP MOD | EACH | \$3,675.00 | Y | 3 | A | | |
| SRA80-A | RA80-(A) SPARES KIT 120V/60HZ | EACH | REPLACED | 3 | A | 4A-RA80-A | T1025-00 | CI FRONT END + PACKET BUFFER | EACH | \$11,025.00 | Y | 3 | A | | |
| SRA80-D | RA80-(D) SPARES KIT 240V/50HZ | EACH | REPLACED | 3 | A | 4A-RA80-D | T1030-CA | KA800 CPU BD. ACP | EACH | \$8,314.00 | 3 | A | | | |
| SRA81-AA | RA81-AA SPARES KIT 120V 60HZ | EACH | REPLACED | 3 | A | 4A-RA81-AA | T1030-DA | BI MVAX ATTACHED PROCESSOR | EACH | \$7,500.00 | 3 | A | | | |
| SRA81-AD | RA81-AD SPARES KIT 240V 50HZ | EACH | REPLACED | 3 | A | 4A-RA81-AD | T1031-00 | DISK CONTROLLER FOR KA800-AA | EACH | \$7,080.00 | 3 | A | | | |
| SRA82-AA | RA82-AA SPARES KIT 120V 60HZ | EACH | REPLACED | 3 | A | 4A-RA82-AA | T1032-00 | AIE I/O EXT MOD FOR KA800-AA | EACH | REPLACED | Y | 3 | A | T1034-00 | |
| SRA82-AD | RA82-AD SPARES KIT 240V 50HZ | EACH | REPLACED | 3 | A | 4A-RA82-AD | T1033-AA | 2MB OF 36BIT,256K CHIP_RAM | EACH | \$2,500.00 | 3 | A | | | |
| SRD31-A | RD31-A SPARE KIT | EACH | REPLACED | 3 | A | 4A-RD31-A | T1034-00 | NI ADPTR BD W/TK50 CNTLR | EACH | \$3,900.00 | Y | 3 | A | | |
| SRD32-A | RD32-A SPARE DRIVE | EACH | REPLACED | 3 | A | 4A-RD32-A | T1040-AA | 16MB ECC MEMORY W/1MB RAMS | EACH | \$12,000.00 | Y | 3 | A | | |
| SRD51-00 | RD51 SPARES KIT | EACH | REPLACED | 3 | A | 4A-RD51-00 | T1043-00 | XMI TO BI ADAPTER (XBIB) | EACH | \$4,559.00 | Y | 3 | A | | |

Prices Effective 02-January-89 to 30-June-89

To Order—Call DECdirect™ TOLL-FREE 800-344-4825, 8:30 a.m. to 8:00 p.m. ET in Continental U.S.A.

SPARES PRICE LIST A-15

HARDWARE SPARES PRICE LIST

| PART NUMBER | DESCRIPTION | UNIT ORDER | UNIT PRICE | REP D L | REPLACEMENT PART NUMBER | PART NUMBER | DESCRIPTION | UNIT ORDER | UNIT PRICE | REP D L | REPLACEMENT PART NUMBER |
|-------------|--------------------------------|------------|-------------|---------|-------------------------|-------------|-------------------------------|------------|------------|---------|-------------------------|
| T1044-00 | 16-LINE ASYNC MUX FOR BI | EACH | \$6,200.00 | 3 | A | 10-00030-00 | .1 MFD 100V 20% Z5U DIS | QTY OF 10 | \$1.00 | 3 | A |
| T1045-00 | PORT CONTROLLER MODULE | EACH | \$12,001.00 | Y | 3 A | 10-00034-00 | .1 MFD 1000V V% 2-PAPR/OI | EACH | \$21.00 | 3 | A |
| T1046-00 | CI FRONT END + PACKET BUFFER | EACH | \$9,500.00 | Y | 3 A | 10-00042-00 | 1000.0 MMF 100V 5%200PPM DM1 | QTY OF 10 | \$4.00 | 3 | A |
| T2011-00 | KA62A-AA CPU MODULE | EACH | \$54,000.00 | Y | 3 A | 10-00051-00 | .047 MFD 100V 10% 663F MYL | QTY OF 10 | \$2.00 | 3 | A |
| T2012-00 | XMI TO BI ADAPTER MODULE | EACH | \$6,017.00 | Y | 3 A | 10-00052-00 | .068 MFD 100V 10% 663UW MYL | QTY OF 10 | \$2.00 | 3 | A |
| T2014-BA | 32MB MEMORY MODULE | EACH | \$23,900.00 | Y | 3 A | 10-00054-00 | 1500.0 MMF 250V 10% Z5P DIS | QTY OF 10 | \$.63 | 3 | A |
| TK50-AX | TK50-AA PACKAGED | EACH | \$2,802.00 | Y | 3 A | 10-00055-00 | 2200. MMF 250V 20% Y5S DISC | QTY OF 10 | \$.63 | 3 | A |
| TK70-AX | TK70-AA WITH NO CARTRIDGE | EACH | \$5,600.00 | Y | 3 A | 10-00061-00 | 8200.0 MMF 100V 10% 663UW MYL | QTY OF 10 | \$2.00 | 3 | A |
| TU58-XB | MODULE W SERIAL INTERFACE | EACH | REPLACED | Y | 3 A | 10-00063-00 | MFD 150V 10% 110D PCTA | EACH | \$14.00 | 3 | A |
| UBE-00 | UNIBUS EXERCISER (M7855) | EACH | REPLACED | Y | 3 A | 10-00064-00 | 3.9MFD 0V 10% 150D S.T | QTY OF 10 | \$4.00 | 3 | A |
| W023-00 | CONNECTOR MODULE W/OUT CABLE | EACH | \$24.00 | 3 | A | 10-00067-00 | /REPLACED BY 10-05306 PER S.A | QTY OF 10 | REPLACED | 3 | A |
| W130-00 | MAINT BOARD PDP11/20 | EACH | \$512.00 | 3 | A | 10-00075-00 | 25 MFD 25V G% 30D AL E | QTY OF 10 | \$2.00 | 3 | A |
| W131-00 | W130 MAINT BOARD EXPANSION | EACH | \$567.00 | 3 | A | 10-00076-00 | 39 MFD 0V 10% 150D S.T | QTY OF 10 | \$4.00 | 3 | A |
| W404-00 | DTR JUMPER | EACH | \$30.00 | 3 | A | 10-00080-00 | 50 MFD 50V G% 30D AL E | QTY OF 10 | \$4.00 | 3 | A |
| W7410-00 | 16 BIT SS DC CONTACT SENSE | EACH | \$378.00 | Y | 3 A | 10-00082-00 | 68 MFD 5V 10% 150D S.T | EACH | \$5.00 | 3 | A |
| W7430-00 | 16 BIT SS DC CONTACT INTRUPT | EACH | \$686.00 | Y | 3 A | 10-00084-00 | 150 MFD 5V 20% 150D S.T | EACH | \$6.00 | 3 | A |
| W7431-00 | 16 BIT SS AC CONT INTERRUPT IC | EACH | \$244.00 | 3 | A | 10-00098-00 | 35,000 MFD 25V H% 36D AL E | EACH | \$37.00 | 3 | A |
| W7440-00 | 16 BIT GEN PUR COUNT ICMDC | EACH | \$284.00 | 3 | A | 10-00098-01 | 35,000 MFD 25V H% 36D AL E | EACH | \$33.00 | 3 | A |
| W900-00 | LAYER EXTENDER BOARD, 11/45 | EACH | \$305.00 | 3 | A | 10-01383-00 | 4700.0 MMF 100V 3%200PPM DM1 | EACH | \$6.00 | 3 | A |
| W9017-00 | UNIVERSAL EXTENDER BOARD | EACH | \$503.00 | 3 | A | 10-01476-00 | 10 MFD 35V10% 150D S.T.A | EACH | \$5.00 | 3 | A |
| W9025-00 | EXTENDER MODULE,4-LAYER HEX | EACH | REPLACED | 3 | A | 10-01610-00 | .01 MFD 50V Z5U 309CE | QTY OF 10 | \$.83 | 3 | A |
| W904-00 | MULTILAYER EXT HEX 11/40 TEST | EACH | \$282.00 | 3 | A | 10-01610-01 | .01 MFD 100V OR 50V Z5U DI | QTY OF 10 | \$.63 | 3 | A |
| W9042-00 | FP11A EXTENDER BOARD | EACH | \$278.00 | 3 | A | 10-01837-00 | 2700.0 MMF 100V 5%200PPM DM2 | QTY OF 10 | \$2.00 | 3 | A |
| W9044-00 | 16.5" HEX EXTENDER | EACH | \$851.00 | 3 | A | 10-01785-00 | 5000.0 MMF 100V 20% Z5U DIS | QTY OF 10 | \$.63 | 3 | A |
| W9511-00 | LSI QUAD W/WRAP BD W/O SOCKET | EACH | \$341.00 | 3 | A | 10-01776-00 | MFD 35V 10% 150D S.T | QTY OF 10 | \$4.00 | 3 | A |
| W974-00 | SINGLE, 36 PINS | EACH | \$34.00 | 3 | A | 10-01796-00 | 50 MFD 25V G% 30D AL E | QTY OF 10 | \$2.00 | 3 | A |
| W980-00 | MODULE EXTENDER | EACH | \$58.00 | 3 | A | 10-02153-00 | .1 MFD 1000V V% DUAL PAPE | EACH | \$18.00 | 3 | A |
| W9800-00 | HEX EXTENDER | EACH | \$326.00 | 3 | A | 10-02427-00 | 15.0 MMF 100V 5%200PPM DM1 | QTY OF 10 | \$1.00 | 3 | A |
| W982-00 | EXTENDER | EACH | \$67.00 | 3 | A | 10-02433-00 | 22 MFD 35V 20% 150D S.T | EACH | \$6.00 | 3 | A |
| W983-00 | DOUBLE EXTENDER | EACH | \$96.00 | 3 | A | 10-02627-00 | 2.2MFD 20V 10% 150D S.T | QTY OF 10 | \$4.00 | 3 | A |
| W984-00 | DOUBLE EXTENDER BOARD | EACH | \$195.00 | Y | 3 A | 10-02781-00 | 100 MFD 25V G% 30D AL E | QTY OF 10 | \$4.00 | 3 | A |
| W987-00 | DOUBLE-SIDE QUAD EXTENDER | EACH | \$207.00 | 3 | A | 10-02839-00 | KC15 20MFD50V G% 30D AL E | QTY OF 10 | \$2.00 | 3 | A |
| | | | | | | 10-02895-00 | /REPLACED BY 10-01383 PER S.A | QTY OF 10 | REPLACED | 3 | A |
| | | | | | | 10-04815-00 | 100 MFD 20V 10% 150D S.T | EACH | \$6.00 | 3 | A |
| | | | | | | 10-05820-00 | 22.0 MMF 100V 5%200PPM DM1 | QTY OF 10 | \$1.00 | 3 | A |
| | | | | | | 10-05965-00 | .47 MFD 35V 10% 150D S.T | QTY OF 10 | \$4.00 | 3 | A |
| | | | | | | 10-09189-00 | 22,000 MFD 50V G% 36D AL E | EACH | \$34.00 | 3 | A |
| | | | | | | 10-09190-00 | 80,000 MFD 15V G% 36D AL E | EACH | \$36.00 | 3 | A |
| | | | | | | 10-09433-00 | 190 MFD 2V G% 30D AL E | QTY OF 10 | \$2.00 | 3 | A |
| | | | | | | 10-09966-00 | 19,000 MFD 40V G% 36D AL E | EACH | \$21.00 | 3 | A |
| | | | | | | 10-09967-00 | 50,000 MFD 25V G% 36D AL E | EACH | \$38.00 | 3 | A |
| | | | | | | 10-10031-03 | .22 MFD 50V 10% M. POLYCARB | QTY OF 10 | \$2.00 | 3 | A |
| | | | | | | 10-10185-01 | 10,800 MFD 20V H% 36D AL E | EACH | \$12.00 | 3 | A |
| | | | | | | 10-10187-00 | 14,000 MFD 40V G% 36D AL E | EACH | \$20.00 | 3 | A |
| | | | | | | 10-10197-00 | 18,000 MFD 10V H% 36D AL E | EACH | \$12.00 | 3 | A |
| | | | | | | 10-10279-00 | .47 MFD 25V 20% 2C023 CER | QTY OF 10 | \$2.00 | 3 | A |
| | | | | | | 10-10426-00 | 37,000 MFD 15V G% 36D AL E | EACH | \$20.00 | 3 | A |
| | | | | | | 10-10509-01 | 500 MFD 25V G% 601D AL E | EACH | \$7.00 | 3 | A |
| | | | | | | 10-10510-00 | 6000. MFD 50V G% 36D AL E | EACH | \$17.00 | 3 | A |
| | | | | | | 10-10646-00 | .015 MFD 50V 2% M.POLYCAR | EACH | \$4.00 | 3 | A |
| | | | | | | 10-10702-00 | 24,000 MFD 50V G% 36D AL E | EACH | \$39.00 | 3 | A |
| | | | | | | 10-10703-00 | 4500 MFD MIN. 25V 5400 MAX 3 | EACH | \$12.00 | 3 | A |
| | | | | | | 10-10704-00 | 6000 MFD 0V G% 36D AL E | EACH | \$12.00 | 3 | A |
| | | | | | | 10-10851-00 | 8400 MFD 50V G% 36D AL E | EACH | \$17.00 | 3 | A |
| | | | | | | 10-10858-00 | 31,000 MFD 50V G% 36D AL E | EACH | \$39.00 | 3 | A |

10 CLASS Capacitors

| | | | | | |
|-------------|-----------------------------|-----------|--------|---|---|
| 10-00006-00 | 10.0 MMF 100V 5%200PPM DM1 | QTY OF 10 | \$1.00 | 3 | A |
| 10-00009-00 | 33.0 MMF 100V 5%200PPM DM1 | QTY OF 10 | \$1.00 | 3 | A |
| 10-00010-00 | 39.0 MMF 100V 5%200PPM DM1 | QTY OF 10 | \$1.00 | 3 | A |
| 10-00011-00 | 47.0 MMF 100V 5%200PPM DM1 | QTY OF 10 | \$1.00 | 3 | A |
| 10-00012-00 | 56.0 MMF 100V 5%200PPM DM1 | QTY OF 10 | \$1.00 | 3 | A |
| 10-00013-00 | 62.0 MMF 100V 5%200PPM DM1 | QTY OF 10 | \$1.00 | 3 | A |
| 10-00015-00 | 82.0 MMF 100V 5%200PPM DM1 | QTY OF 10 | \$1.00 | 3 | A |
| 10-00016-00 | 100.0 MMF 100V 5%200PPM DM1 | QTY OF 10 | \$1.00 | 3 | A |
| 10-00018-00 | 120.0 MMF 100V 5%200PPM DM1 | QTY OF 10 | \$1.00 | 3 | A |
| 10-00019-00 | 150.0 MMF 100V 5%200PPM DM1 | QTY OF 10 | \$1.00 | 3 | A |
| 10-00021-00 | 220.0 MMF 100V 5%200PPM DM1 | QTY OF 10 | \$1.00 | 3 | A |
| 10-00023-00 | 330.0 MMF 100V 5%200PPM DM1 | QTY OF 10 | \$1.00 | 3 | A |
| 10-00024-00 | 470.0 MMF 100V 5%200PPM DM1 | QTY OF 10 | \$2.00 | 3 | A |
| 10-00025-00 | 560.0 MMF 100V 5%200PPM DM1 | QTY OF 10 | \$1.00 | 3 | A |
| 10-00026-00 | 680.0 MMF 100V 5%200PPM DM1 | QTY OF 10 | \$2.00 | 3 | A |



Prices Effective 02-January-89 to 30-June-89

To Order—Call DECdirect™ TOLL-FREE 800-344-4825, 8:30 a.m. to 8:00 p.m. ET in Continental U.S.A.

HARDWARE SPARES PRICE LIST

| PART NUMBER | DESCRIPTION | UNIT ORDER | UNIT PRICE | REP D | L | REPLACEMENT PART NUMBER | PART NUMBER | DESCRIPTION | UNIT ORDER | UNIT PRICE | REP D | L | REPLACEMENT PART NUMBER |
|------------------------|-------------------------------|------------|------------|-------|---|-------------------------|-------------|-------------------------------|------------|------------|-------|---|-------------------------|
| 10-10859-00 | 2200 MFD G% 36D AL E | EACH | \$11.00 | 3 | A | | 11-03448-00 | /REPLACED BY 11-05796 (1N4004 | QTY OF 10 | REPLACED | 3 | A | 11-05796-00 |
| 10-10978-32 | .047 MFD 50V 10% 2C067CER. | QTY OF 10 | \$1.00 | 3 | A | | 11-04860-00 | 1N 746A VZ= 3.3 5% | QTY OF 10 | \$1.00 | 3 | A | |
| 10-10978-36 | .1 MFD 50V 10% 2C067 CE | EACH | \$2.00 | 3 | A | | 11-04861-00 | /REPLACED BY 1105796 | QTY OF 10 | REPLACED | 3 | A | 11-05796-00 |
| 10-11032-00 | 1 MFD 100V 10% 277P MYLR | EACH | \$6.00 | 3 | A | | 11-05275-00 | D 672 TR= 15NS PIV= 60V S | QTY OF 10 | \$.83 | 3 | A | |
| 10-11248-00 | 48 MFD330VAC 10% MOTOR STA | EACH | \$23.00 | 3 | A | | 11-05397-00 | DM 2 ASSY@100V & 25A | EACH | \$107.00 | 3 | A | |
| 10-11363-00 | 7700 MFD 50V G% 36D AL E | EACH | \$18.00 | 3 | A | | 11-05610-00 | MCL1301 CL@1MA FROM10-80V | EACH | \$5.00 | 3 | A | |
| 10-11545-00 | 33,000 MFD 60V G% 36D AL E | EACH | \$51.00 | 3 | A | | 11-05648-00 | 1N 4744 VZ= 15.0 10% W | QTY OF 10 | \$1.00 | 3 | A | |
| 10-11578-00 | 110,000 MFD 10V G% 32D AL E | EACH | \$42.00 | 3 | A | | 11-05796-00 | 1N 4004 PIV=400 I= 1A D041 S | QTY OF 10 | \$1.00 | 3 | A | |
| 10-11607-00 | 1900 MFD 40V G% 39D AL E | EACH | \$6.00 | 3 | A | | 11-05799-00 | DM 5 ASSY@200V & 25A | EACH | \$49.00 | 3 | A | |
| 10-11643-00 | 18,000 MFD 25V G% 36D AL EL | EACH | \$19.00 | 3 | A | | 11-05871-00 | 1/4M5.1AZ1 = 5.1 % .25W | QTY OF 10 | \$4.00 | 3 | A | |
| 10-11655-00 | 58.5MFD165VAC 10% MOTOR STA | EACH | \$8.00 | 3 | A | | 11-05873-00 | .4M5.1Z1 VZ= 5.1 % .400 | QTY OF 10 | \$2.00 | 3 | A | |
| 10-11848-00 | 7. MFD 200V 10% 430P MYLR | EACH | \$18.00 | 3 | A | | 11-09465-00 | MCR 649P2SCR@ 50V I=20A T04 | EACH | \$11.00 | 3 | A | |
| 10-11849-01 | 600. MFD 25V G%500D AL E | QTY OF 10 | \$4.00 | 3 | A | | 11-09502-00 | 1N 4742 VZ= 12.0 10% W | QTY OF 10 | \$1.00 | 3 | A | |
| 10-11895-00 | .15 MFD 35V 10% 150D S.T | QTY OF 10 | \$2.00 | 3 | A | | 11-09502-02 | 1N 4742A VZ=12.0 5% 1W | QTY OF 10 | \$1.00 | 3 | A | |
| 10-12312-00 | .47 MFD 50V X% CER. | QTY OF 10 | \$4.00 | 3 | A | | 11-09991-01 | 4M6.8AZ1 VZ= 6.8 % .40W | QTY OF 10 | \$4.00 | 3 | A | |
| 10-12607-00 | 560 MFD 20V H% 672D AL E | EACH | \$4.00 | 3 | A | | 11-10051-00 | DM 6 ASSY@200V & 25A #990- | EACH | \$15.00 | 3 | A | |
| 10-12607-01 | 1200 MFD 6.3V H% 672D AL E | EACH | \$4.00 | 3 | A | | 11-09468-00 | 1N 967A VZ= 18.0 10% .40W | QTY OF 10 | \$1.00 | 3 | A | |
| 10-12607-02 | 180 MFD 50V H% 672D AL E | EACH | \$4.00 | 3 | A | | 11-10324-00 | LED 1MCD@10MA #MV5054-1#HP488 | QTY OF 10 | \$2.00 | 3 | A | |
| 10-12607-04 | 270 MFD 40V + 100-10% AL | QTY OF 10 | \$2.00 | 3 | A | | 11-10420-00 | 1N 5624 PIV=200 I= 5A | QTY OF 10 | \$2.00 | 3 | A | |
| 10-12607-05 | 20MFD 200V H% 672D AL E | EACH | \$4.00 | 3 | A | | 11-10615-00 | MR 752 PIV=200 I=22A A264 S | QTY OF 10 | \$4.00 | 3 | A | |
| 10-12740-00 | 3900 MFD 6V 432D AL E | EACH | \$33.00 | 3 | A | | 11-10615-01 | PIV=600 I=6A S | QTY OF 10 | \$5.00 | 3 | A | |
| 10-12784-00 | .047 MFD 50V + 80-20% | QTY OF 10 | \$.83 | 3 | A | | 11-10713-00 | SZ710910 VZ= 5.1 2% | QTY OF 10 | \$2.00 | 3 | A | |
| 10-13102-00 | 10 MFD 370V 6% NON-PC | EACH | \$32.00 | 3 | A | | 11-10714-00 | NSS3514 FWR@400 I=20A (TRW) | EACH | \$13.00 | 3 | A | |
| 10-13466-08 | 680.0 MMF 50V 10% X7RC | QTY OF 10 | \$.63 | 3 | A | | 11-10715-00 | NSR8117 PIV= 75 I=20A T03 S | EACH | \$11.00 | 3 | A | |
| 10-13466-09 | 1000.0 MMF 50V 10% X7R | QTY OF 10 | \$.83 | 3 | A | | 11-10766-00 | 1N 5248B VZ= 18.0 5% .50W | QTY OF 10 | \$1.00 | 3 | A | |
| 10-13466-12 | 2200.0 MMF 50V 10% | QTY OF 10 | \$.83 | 3 | A | | 11-10856-00 | 1N 970B VZ= 24.0 5% .40W | QTY OF 10 | \$1.00 | 3 | A | |
| 10-13466-22 | .1 MFD 50V +80-20% Z5U CER | QTY OF 10 | \$.83 | 3 | A | | 11-10864-00 | LED 2MCD@10MA | QTY OF 10 | \$2.00 | 3 | A | |
| 10-13530-00 | 66,000 MFD 30V + 75 - 10% | EACH | \$42.00 | 3 | A | | 11-10925-00 | ITTZ429 VZ= 5.1 2% .40W | QTY OF 10 | \$2.00 | 3 | A | |
| 10-14022-02 | 3 MED 660VAC 6% NON PCB DI | EACH | \$14.00 | 3 | A | | 11-10968-00 | 2N 5062 SCR@100V I=.8A T09 | QTY OF 10 | \$1.00 | 3 | A | |
| 10-14260-03 | 8200 MFD 6.3V + 75-10% AL | EACH | \$8.00 | 3 | A | | 11-10986-00 | D 674 VZ= 6.3 2% | EACH | \$4.00 | 3 | A | |
| 10-14761-00 | 40MFD 260V +20% | EACH | \$45.00 | 3 | A | | 11-11205-00 | SCREENED VZ= 5.7 2% .40W | QTY OF 10 | \$2.00 | 3 | A | |
| 10-14861-00 | 590 MFD 200V E% AL EL | EACH | \$14.00 | 3 | A | | 11-11577-00 | 1N 4454 TR= 4NS PIV= 50 S | QTY OF 10 | \$1.00 | 3 | A | |
| 10-15202-01 | .0081 MFD 1600V 10% POLYPROP | QTY OF 10 | \$2.00 | 3 | A | | 11-11854-01 | MR 817 PIV=800 I= 1A D041 | EACH | \$5.00 | 3 | A | |
| 10-15466-00 | 800 MFD 6.3V+75-10% | EACH | \$7.00 | 3 | A | | 11-11907-00 | LED 5MW 20MA IF=50MA | EACH | \$5.00 | 3 | A | |
| 10-16117-00 | 1600 MFD 200V + 50-10% AL | EACH | \$20.00 | 3 | A | | 11-12553-00 | H 683-2 RECT.ASSY VFM=80@10MA | EACH | \$12.00 | 3 | A | |
| 10-16233-00 | 14.000 MFD 28V 20% AL | EACH | \$21.00 | 3 | A | | 11-12594-01 | A115B PIV=200 I=3A | QTY OF 10 | \$5.00 | 3 | A | |
| 10-16924-00 | CAP. 297 MFD MOTOR START 115V | EACH | \$19.00 | 3 | A | | 11-12594-02 | A115M PIV=600 I=3A | QTY OF 10 | \$5.00 | 3 | A | |
| 10-16924-01 | 297 TO 324MFD 165V | EACH | \$40.00 | 3 | A | | 11-12595-00 | A114F PIV=50 I=1A | QTY OF 10 | \$1.00 | 3 | A | |
| 10-17233-00 | 50MFD 330V 6% POLYPR | EACH | \$50.00 | 3 | A | | 11-12595-01 | A114B PIV=200 I= 1A | QTY OF 10 | \$2.00 | 3 | A | |
| 10-19003-02 | 53 TO 64 MFD 330V | EACH | \$38.00 | 3 | A | | 11-12595-02 | A114M PIV=600 I=1A | QTY OF 10 | \$2.00 | 3 | A | |
| 11 CLASS Diodes | | | | | | | | | | | | | |
| 11-00100-00 | D 003 TR= 50NS PIV= 25V G | QTY OF 10 | \$2.00 | 3 | A | | 11-13889-00 | RECTIFIER PIV=100 I=2 | EACH | \$64.00 | 3 | A | |
| 11-00113-00 | D 662 0S 600PCB(STABISTOR | QTY OF 10 | \$.83 | 3 | A | | 11-14103-01 | LED 50MCD@20MA AMBER | QTY OF 10 | \$4.00 | 3 | A | |
| 11-00114-00 | D 664 QS/75PCB PIV= 25V S | QTY OF 10 | \$.63 | 3 | A | | 11-14192-00 | TR=200NS COM CATHODE | EACH | \$11.00 | 3 | A | |
| 11-00122-00 | 1N 748A VZ= 3.9 5% | QTY OF 10 | \$1.00 | 3 | A | | 11-14384-00 | LED 105MW 35MA GREEN | QTY OF 10 | \$2.00 | 3 | A | |
| 11-00124-00 | 1N 750A VZ= 4.7 5% .40W | QTY OF 10 | \$1.00 | 3 | A | | 11-14588-00 | NSR 8140 SA,PIV=50 I=4A TO3 | EACH | \$6.00 | 3 | A | |
| 11-00134-00 | 1N 2970B VZ= 6.8 5% 0W | EACH | \$4.00 | 3 | A | | 11-14589-00 | LED,4-DIGIT,10MA,3V, RED | EACH | \$25.00 | 3 | A | |
| 11-01938-00 | 1N 4370A VZ= 2.4 5% .40W | QTY OF 10 | \$1.00 | 3 | A | | 11-14602-00 | UES1302 PIV=100V I=4A | QTY OF 10 | \$4.00 | 3 | A | |
| 11-02421-00 | 1N 753A VZ= 6.2 5% .40W | QTY OF 10 | \$1.00 | 3 | A | | 11-14893-00 | UES1301 PIV=50 I=6A | QTY OF 10 | \$4.00 | 3 | A | |
| 11-03041-00 | DEC 777 QS=12PCB PIV= 8VS | QTY OF 10 | \$2.00 | 3 | A | | 11-14913-00 | VZ=18.0 10% 1W | EACH | \$6.00 | 3 | A | |
| 11-03341-00 | MR1033B PIV=300 I= 3A Z44 S | EACH | \$4.00 | 3 | A | | 11-14974-00 | 1N 4741A VZ= 11.0 5% 1W | QTY OF 10 | \$1.00 | 3 | A | |



Prices Effective 02-January-89 to 30-June-89
 To Order—Call DECdirect™ TOLL-FREE 800-344-4825, 8:30 a.m. to 8:00 p.m. ET in Continental U.S.A.

HARDWARE SPARES PRICE LIST

| PART NUMBER | DESCRIPTION | UNIT ORDER | UNIT PRICE | REP D L | REPLACEMENT PART NUMBER | PART NUMBER | DESCRIPTION | UNIT ORDER | UNIT PRICE | REP D L | REPLACEMENT PART NUMBER |
|-----------------------------------|--------------------------------|------------|------------|---------|-------------------------|-------------|-------------------------------|------------|------------|---------|-------------------------|
| 11-15112-00 | A114NX93 PIV=800 I=2A | QTY OF 10 | \$4.00 | 3 A | | 12-09782-00 | SW.MICRO 1P 1A @125V,AG CR | EACH | \$17.00 | 3 A | |
| 11-15182-00 | 1N 5626 PIV=600 I= 3A | QTY OF 10 | \$4.00 | 3 A | | 12-09786-00 | MOTOR,LOW INERTIA | EACH | \$1,285.00 | 3 A | |
| 11-15272-00 | UES1303 PIV=150 I=6A | EACH | \$5.00 | 3 A | | 12-09864-00 | RLY,REED, 4V COIL,DPST,LOW L | EACH | \$42.00 | 3 A | |
| 11-15369-00 | VM 18 PIV=100 I=1A | QTY OF 10 | \$2.00 | 3 A | | 12-09877-00 | WASHER, TAPE GUIDE | EACH | \$11.00 | 3 A | |
| 11-15529-00 | UES2601 PIV=50V I=30A | EACH | \$29.00 | 3 A | | 12-09956-00 | MUFFLER 3IN LGX1-13/16 M02/01 | EACH | \$15.00 | 3 A | |
| 11-16475-00 | 1N 4148 PIV=75 DO35 | QTY OF 10 | \$4.41 | 3 A | | 12-10001-00 | HEAT SINK - 2201 RED | EACH | \$11.00 | 3 A | |
| 11-17373-00 | LED ASSY GREEN | QTY OF 10 | \$2.00 | 3 A | | 12-10021-00 | RING, COMPRESSION | EACH | \$15.00 | 3 A | |
| 11-17373-01 | LED ASSY RED | QTY OF 10 | \$2.00 | 3 A | | 12-10027-00 | BRAKE | EACH | \$147.00 | 3 A | |
| 11-17721-00 | VOLT. TRANS. SUPPRESS. 250V@5A | EACH | \$12.00 | 3 A | | 12-10030-00 | WASHER THRUST | QTY OF 10 | \$5.00 | 3 A | |
| 11-18585-00 | VZ= 5.2 400MW 1N5953 DO-35 | QTY OF 10 | \$1.00 | 3 A | | 12-10042-00 | SWIT MINI SPECTROL 87-9-168 | EACH | \$26.00 | 3 A | |
| 12 CLASS Electromechanical | | | | | | 12-10042-01 | SW.ROT 1P 10POS DRY #87 111 | EACH | \$17.00 | 3 A | |
| 12-02244-00 | CONN,CARD 144PIN H8 | EACH | \$55.00 | 3 A | | 12-10043-00 | SWIT MINI ROT SPEC 87-11-167 | EACH | \$15.00 | 3 A | |
| 12-02556-00 | LAMP, PILOT IND DEVICES #1020 | EACH | \$4.00 | 3 A | | 12-10114-00 | KNDB BLK W/POINT;/4DI PS70PL- | EACH | \$4.00 | 3 A | |
| 12-04722-00 | SW,TOG P 6A ON/NONE/OFF | EACH | \$7.00 | 3 A | | 12-10145-00 | GUIDE ROLLER ASSBLY RC-3240 | EACH | \$121.00 | 3 A | |
| 12-04760-00 | BELT- 160XL025 | EACH | \$13.00 | 3 A | | 12-10191-00 | CKT BKR 10.0 A 250V 2P MAGNET | EACH | \$50.00 | 3 A | |
| 12-04899-00 | TAPE SPROCKET | EACH | \$101.00 | 3 A | | 12-10191-01 | CKT BKR 5.0 A 250V 2P MAGNET | EACH | \$46.00 | 3 A | |
| 12-05303-00 | LAMP, PILOT IND DEVICES #1020 | QTY OF 10 | \$4.00 | 3 A | | 12-10191-06 | CKT BKR 20.0 A 250V 2P MAGNET | EACH | \$45.00 | 3 A | |
| 12-05317-07 | SW,RKR BUTTON OLIVE GRAY | QTY OF 10 | \$1.00 | 3 A | | 12-10198-00 | RLY,G.P., 24V COIL,DPDT,10A | EACH | \$25.00 | 3 A | |
| 12-05348-13 | CONN, CARD 288PIN UNSLOTTED | EACH | \$25.00 | 3 A | | 12-10199-00 | THERMOSTAT,O@194,W/RESET BUTT | EACH | \$8.00 | 3 A | |
| 12-05375-00 | SW,RKR,SPDT, 3A@125V,MOMENTAR | EACH | \$7.00 | 3 A | | 12-10209-00 | SW,TOG P.01A SUBMINI | EACH | \$7.00 | 3 A | |
| 12-05458-00 | /REPLACED BY 12-02556-00 | QTY OF 10 | REPLACED | 3 A | 12-02556-00 | 12-10242-01 | CKT BKR 1.0 A 32V 1P THERMA | EACH | \$15.00 | 3 A | |
| 12-05747-00 | FUSE, SUB-MINI, 5.000A, 125V | QTY OF 10 | \$4.00 | 3 A | | 12-10242-05 | CKT BKR 5.0 A 32V 1P THERMA | EACH | \$11.00 | 3 A | |
| 12-05849-06 | SW,RKR HANDLE RUSSET ORANGE 0 | QTY OF 10 | \$2.00 | 3 A | | 12-10258-01 | CONN, CARD 288PIN OPEN ENTRY | EACH | \$25.00 | 3 A | |
| 12-05849-12 | SW,RKR HANDLE AMBER 41 | QTY OF 10 | \$2.00 | 3 A | | 12-10316-02 | /REPLACED BY 12-10316-04 | EACH | REPLACED | 3 A | 12-10316-04 |
| 12-05941-00 | SW,RKR,DPDT, 3A@125V,MAINTAIN | EACH | \$11.00 | 3 A | | 12-10316-04 | MOTOR GEAR CCW 4.3RPM .16A SW | EACH | \$57.00 | 3 A | |
| 12-05944-00 | MOTOR,VACUUM-LAMB#115475 | EACH | \$137.00 | 3 A | | 12-10332-00 | SW,TOG P #CUT.HAM8906K24 | EACH | \$44.00 | 3 A | |
| 12-09070-00 | FUSE, SUB-MINI, 5.000A, 125V | QTY OF 10 | \$4.00 | 3 A | | 12-10336-00 | ASSY SENSOR TU-10 EOT-BOT | EACH | REPLACED | 3 A | 12-11720-00 |
| 12-09123-00 | CONN, CARD 36 PIN | EACH | \$11.00 | 3 A | | 12-10346-00 | REEL TAPE 10-1/2IN #A-427A | EACH | \$19.00 | 3 A | |
| 12-09159-00 | FUSE, SUB-MINI, .500A, 125V | QTY OF 10 | \$6.00 | 3 A | | 12-10397-00 | RH10 RLY 6V COIL,SPST,.50A | EACH | \$36.00 | 3 A | |
| 12-09169-00 | LAMP, 15V @ .040AMP MAX, .075 | QTY OF 10 | \$4.00 | 3 A | | 12-10477-00 | SENSOR,LOW PRESSURE,10 H20 | EACH | \$39.00 | 3 A | |
| 12-09195-01 | 9-LAMP TOOL 1.76 | EACH | \$36.00 | 3 A | | 12-10616-00 | SPINDLE ASSY, RK05 | EACH | \$454.00 | 3 A | |
| 12-09219-00 | LAMP 2309G BLUE | QTY OF 10 | \$4.00 | 3 A | | 12-10626-00 | SWITCH, SLIDE | EACH | \$7.00 | 3 A | |
| 12-09219-01 | LAMP 6V@200MA,T1-3/4PINS#231 | QTY OF 10 | \$4.00 | 3 A | | 12-10641-00 | BATTERY,4CELL RECHGBLE NTCD | EACH | \$27.00 | 3 A | |
| 12-09340-00 | MATE-N-LOK 8PIN HSG SKT | QTY OF 2 | \$1.00 | 3 A | | 12-10681-00 | AIR DUCT,PLASTIC MOLDING RK05 | QTY OF 10 | \$5.00 | 3 A | |
| 12-09340-01 | MATE-N-LOK 8PIN HSG SKT | QTY OF 2 | \$1.00 | 3 A | | 12-10683-00 | RLY,G.P., 12V COIL,3PDT,10A | EACH | \$20.00 | 3 A | |
| 12-09349-00 | RLY,G.P., 12V COIL,DPDT, 5A | EACH | \$20.00 | 3 A | | 12-10683-01 | RLY,G.P., 6V COIL,3PDT,10A | EACH | \$18.00 | 3 A | |
| 12-09350-03 | MATE-N-LOK 3PIN HSG SKT | QTY OF 5 | \$72 | 3 A | | 12-10710-00 | BEZEL CONSOLE 11/45 | EACH | \$64.00 | 3 A | |
| 12-09365-00 | MOTOR, PUNCH PC04/PC05 | EACH | \$133.00 | 3 A | | 12-10719-00 | FAN,BOXER,115AC,25-35 CU FT | EACH | REPLACED | 3 A | 12-10719-03 |
| 12-09369-00 | MOTOR, STEP SLOW SN HS50E | EACH | \$217.00 | 3 A | | 12-10719-03 | FAN,TUBE AXIAL,115V 25-35 CFM | EACH | \$118.00 | 3 A | |
| 12-09388-00 | FILTER, AIR ABSOLUTE 1D-25-2 | EACH | \$102.00 | 3 A | | 12-10744-00 | DUCK BILL (GUIDE FOR CARTRIDG | EACH | \$13.00 | 3 A | |
| 12-09403-00 | FAN | EACH | REPLACED | 3 A | 12-09403-02 | 12-10753-00 | SW,ROT 2P 3POS | EACH | \$33.00 | 3 A | |
| 12-09403-02 | FAN,117CFM, BALL BEARING,STD | EACH | \$90.00 | 3 A | | 12-10755-00 | SW,LEVER 1P 11A | EACH | \$4.00 | 3 A | |
| 12-09456-00 | /REPLACED BY 12-09456-01 | QTY OF 10 | REPLACED | 3 A | 12-09456-01 | 12-10755-02 | SW,LEVER 1P 10A W/BENT ACTUN | EACH | \$11.00 | 3 A | |
| 12-09456-01 | MATE-N-LOK SKT PCB TAB LOOSE | QTY OF 10 | \$1.00 | 3 A | | 12-10756-00 | SWIT,SOLIDSTATE VANE 1POLE16, | EACH | \$67.00 | 3 A | |
| 12-09590-00 | SW,TOG,SPDT, 5A@120V, ON-NONE | EACH | \$11.00 | 3 A | | 12-10773-00 | KNOB CONTROL Y4 SHAFT D FLAT | QTY OF 10 | \$4.00 | 3 A | |
| 12-09602-00 | MOTOR, KAD T6DHO-7 40 CYCLE | EACH | \$275.00 | 3 A | | 12-10775-00 | SWIT ROTARY D SHAFT 8P S PC T | EACH | \$29.00 | 3 A | |
| 12-09614-00 | SW,RKR,DPDT, 3A@125V,MAINTAIN | EACH | \$12.00 | 3 A | | 12-10786-00 | SW,RKR KNOB FOR 11/05 | QTY OF 10 | \$2.00 | 3 A | |
| 12-09637-00 | LAMP, PILOT #3590A20 LINE-O-L | EACH | \$8.00 | 3 A | | 12-10790-00 | SW,SWITCH 1P | EACH | \$51.00 | 3 A | |
| 12-09677-00 | MOTOR, REEL 4010-7 | EACH | \$221.00 | 3 A | | 12-10796-01 | SW,KNOB PER 92-00001-39 | QTY OF 10 | \$4.00 | 3 A | |
| 12-09698-00 | SW,SLIDE,DPST, 25A@30V,SNAP M | EACH | \$8.00 | 3 A | | 12-10796-02 | SW,KNOB PER 92-00001-40 | QTY OF 10 | \$4.00 | 3 A | |
| 12-09711-01 | SW,RKR LT OLIVE GREEN | QTY OF 10 | \$4.00 | 3 A | | 12-10796-03 | SW,KNOB PER 92-00001-68 | QTY OF 10 | \$6.00 | 3 A | |
| | | | | | | 12-10796-04 | SW,KNOB PER 92-00001-60 | QTY OF 10 | \$5.00 | 3 A | |
| | | | | | | 12-10796-05 | SW,KNOB PER 92-00001-31 | QTY OF 10 | \$4.00 | 3 A | |
| | | | | | | 12-10796-08 | SW,KNOB PER 92-00001-64 | QTY OF 10 | \$5.00 | 3 A | |
| | | | | | | 12-10800-00 | RLY,MTR START,OP=3.4A CL=4.0A | EACH | \$13.00 | 3 A | |



Prices Effective 02-January-89 to 30-June-89
To Order—Call DECdirect™ TOLL-FREE 800-344-4825, 8:30 a.m. to 8:00 p.m. ET in Continental U.S.A.

HARDWARE SPARES PRICE LIST

| PART NUMBER | DESCRIPTION | UNIT ORDER | UNIT PRICE | REP D | L | REPLACEMENT PART NUMBER | PART NUMBER | DESCRIPTION | UNIT ORDER | UNIT PRICE | REP D | L | REPLACEMENT PART NUMBER |
|-------------|-------------------------------|------------|------------|-------|---|-------------------------|----------------------|---------------------------------|------------|------------|-------|---|-------------------------|
| 12-10803-01 | FILTER,AIR FOR RS03, 3/4" THI | EACH | \$131.00 | 3 | A | | 12-11239-00 | LAMP 28V 40MAAT1-3/4 WITH TU | QTY OF 10 | \$4.00 | 3 | A | |
| 12-10806-00 | SOLENOID,ROTARY | EACH | \$74.00 | 3 | A | | 12-1240-00 | FAN, 270CFM,115VAC,3380RPM,FR | EACH | \$127.00 | 3 | A | |
| 12-10807-00 | BLOWER,CENTRIFUGAL,RS03/04 | EACH | \$129.00 | 3 | A | | 12-11255-00 | FILTER,FOAM RUBBER FOR RS03 | EACH | \$23.00 | 3 | A | |
| 12-10807-01 | BLOWER,CENTRIFUGAL,RK06 | EACH | \$141.00 | 3 | A | | 12-11255-18 | FILTER,AIR FOAM | EACH | \$20.00 | 3 | A | |
| 12-10808-00 | MOTOR,INDUCTION | EACH | \$131.00 | 3 | A | | 12-11263-00 | LAMP,PWR ON INDICATOR,RED W/2 | EACH | \$6.00 | 3 | A | |
| 12-10812-00 | BELT,318 IN WIDE 6 IN LONG | EACH | \$7.00 | 3 | A | | 12-11279-00 | COUPLING,CASSETTE DRIVE FOR T | EACH | \$5.00 | 3 | A | |
| 12-10821-02 | MATE-N-LOK 2PIN HOUSING,SKT | QTY OF 10 | \$.72 | 3 | A | | 12-11289-00 | EOT SENSOR FOR TU60 (W/LAMP E | EACH | \$57.00 | 3 | A | |
| 12-10823-00 | MATE-N-LOK PIN W/PCB TAB | QTY OF 10 | \$.72 | 3 | A | | 12-11334-00 | SW,PB LT CAP WHITE | QTY OF 10 | \$1.00 | 3 | A | |
| 12-10824-00 | THERMOSTAT,O@215,C@156,SPST | EACH | \$7.00 | 3 | A | | 12-11334-01 | LIGHT CAP FOR RK05& RS03 WARN | QTY OF 10 | \$1.00 | 3 | A | |
| 12-10830-07 | CKT BKR 7.0 A 240V 1P THERMA | EACH | \$15.00 | 3 | A | | 12-11348-00 | FUSE HOLDER PANEL, 250V, 20AM | EACH | \$4.00 | 3 | A | |
| 12-10839-00 | SWIT SUBMINIATURE SP ST | EACH | \$8.00 | 3 | A | | 12-11425-00 | CONN,CARD 72 PIN | EACH | \$12.00 | 3 | A | |
| 12-10840-00 | SW,RKR P.4A | EACH | \$6.00 | 3 | A | | 12-11435-00 | SOLENOID,ROTARY FOR RK05 DOOR | EACH | \$70.00 | 3 | A | |
| 12-10841-00 | SW,RKR P.4A MOM | EACH | \$6.00 | 3 | A | | 12-11439-00 | DBL SYS UNIT CASTING | EACH | \$24.00 | 3 | A | |
| 12-10843-00 | MOUNT, SHOCK | QTY OF 10 | \$5.00 | 3 | A | | 12-11475-00 | BEARING TIRE ASSEM. FOR RK05 | EACH | \$63.00 | 3 | A | |
| 12-10902-00 | THERMOSTAT,O@ 85,C@130,SPST,S | EACH | \$23.00 | 3 | A | | 12-11477-00 | MOTOR DC PERMANENT MAGNET | EACH | \$121.00 | 3 | A | |
| 12-10929-00 | FUSE, SUB-MINI, 15.000A, 32V | QTY OF 10 | \$5.00 | 3 | A | | 12-11563-00 | MOTOR STEPPING, 15 DEGREE 16VD | EACH | \$87.00 | 3 | A | |
| 12-10929-01 | FUSE, SUB-MINI, 10.000A, 125V | QTY OF 10 | \$4.00 | 3 | A | | 12-11581-00 | BELT,-V-POLYFLEX | EACH | \$6.00 | 3 | A | |
| 12-10929-02 | FUSE, SUB-MINI .000A, 125V | QTY OF 10 | \$4.00 | 3 | A | | 12-11582-00 | BLOWER 3 STAGE 50IN,W.G.80CFM | EACH | \$141.00 | 3 | A | |
| 12-10929-03 | FUSE, SUB-MINI .750A, 125V | QTY OF 10 | \$5.00 | 3 | A | | 12-11583-00 | BELT TIMING, 200PITCH LGT H.4 | EACH | \$17.00 | 3 | A | |
| 12-10929-04 | FUSE, SUB-MINI .250A, 125V | QTY OF 10 | \$5.00 | 3 | A | | 12-11583-01 | BELT,TIMING,3/8" WX49.8" L .2"P | EACH | \$8.00 | 3 | A | |
| 12-10929-05 | FUSE,SUB-MINI 2.500A,125V | QTY OF 10 | \$4.00 | 3 | A | | 12-11618-00 | HOUSING,POSITION TRANSDUCER | EACH | \$7.00 | 3 | A | |
| 12-10929-06 | FUSE, SUB-MINI, 2.000A,125V | EACH | \$5.00 | 3 | A | | 12-11621-00 | SW,RKR,DPST, 6A@125V, ON-NON | EACH | \$6.00 | 3 | A | |
| 12-10930-01 | FAN 230VAC #756 OR #WS2107F | EACH | REPLACED | 3 | A | 12-10930-02 | CARD GUIDE | QTY OF 10 | \$1.00 | 3 | A | | |
| 12-10930-02 | FAN,TUBE AXIAL 4.5" 100CFM | EACH | \$84.00 | 3 | A | | 12-11638-00 | FUSEHOLDER, 250 V, 15 AMPS | EACH | \$5.00 | 3 | A | |
| 12-10985-00 | BRUSH ASSY FOR RK05 | EACH | \$63.00 | 3 | A | | 12-11639-00 | MOTOR,115VCAPACITOR START,IND | EACH | \$156.00 | 3 | A | |
| 12-10990-00 | SW,TOG DPST ON(O)FON #7561K | EACH | \$12.00 | 3 | A | | 12-11649-00 | BEARING, BALL, SELF-ALIGN, BR | QTY OF 10 | \$4.00 | 3 | A | |
| 12-11027-00 | SELF-LOCKING SOCKET SET SCREW | QTY OF 10 | \$4.00 | 3 | A | | 12-11650-00 | BEARING,BALL, SELF-ALIGN W/HE | EACH | \$20.00 | 3 | A | |
| 12-11037-02 | CKT BKR 30.0 A 240V 4P SERIES | EACH | \$120.00 | 3 | A | | 12-11651-00 | CLUTCH,ROLLER WITH INTEGRAL | EACH | REPLACED | 3 | A | 70-11446-00 |
| 12-11048-00 | BRUSH FOR REEL MOTOR OF TU10 | EACH | \$18.00 | 3 | A | | 12-11656-00 | GEAR, IDLER, 48 TOOTH | QTY OF 10 | \$5.00 | 3 | A | |
| 12-11068-00 | LAMP,T-1 5VDC,115A | EACH | \$8.00 | 3 | A | | 12-11659-00 | RLY,MTR START,OP=6.8A CL=8.2A | EACH | \$18.00 | 3 | A | |
| 12-11079-00 | SW,PB,SPDT, 1A@115V,MOM. | EACH | \$13.00 | 3 | A | | 12-11662-04 | TRACTOR, LEFT HAND | EACH | REPLACED | 3 | A | 12-18685-02 |
| 12-11111-00 | MOTOR,CASSETTE #26PL11-216 | EACH | \$134.00 | 3 | A | | 12-11662-05 | TRACTOR, RIGHT HAND | EACH | REPLACED | 3 | A | 12-18685-02 |
| 12-11142-00 | CKT BKR 20.0 A 277V 3P SERIES | EACH | \$68.00 | 3 | A | | 12-11714-00 | FAN, 200+CFM,BALL BRNG,115V | EACH | \$127.00 | 3 | A | |
| 12-11142-01 | CKT BKR 20.0 A 277V 3P SERIES | EACH | \$58.00 | 3 | A | | 12-11720-00 | SENSOR, EOT/BOT, MAGNETIC TAP | EACH | \$75.00 | 3 | A | |
| 12-11147-00 | CONTACTOR, 30A,3P DBL BRK,600 | EACH | \$58.00 | 3 | A | | 12-11722-00 | PHOTOCELL,COMPLETE ASSY | EACH | \$168.00 | 3 | A | |
| 12-11147-01 | CONTACTOR, 30A,3P DBL BRK,600 | EACH | \$58.00 | 3 | A | | 12-11722-01 | PHOTOCELL LIGHT SOURCE 3.2V | EACH | \$123.00 | 3 | A | |
| 12-11164-01 | SW,DIP P 1A 5POS | EACH | \$14.00 | 3 | A | | 12-11722-04 | PHOTOCELL LAMP ASSY 5VDC 25MA | EACH | \$59.00 | 3 | A | |
| 12-11164-03 | SW,DIP P 1A 7POS | EACH | \$14.00 | 3 | A | | 12-11751-00 | FUSE, SUB-MINI, 2.000A, 125V | QTY OF 10 | \$4.00 | 3 | A | |
| 12-11164-04 | SW,DIP P 1A 8POS | EACH | \$7.00 | 3 | A | | 12-11825-02 | SLIDE,CHASSIS TILT 3POSITION | EACH | \$150.00 | 3 | A | |
| 12-11164-05 | SW,DIP 1P 1A 9POS | EACH | \$5.00 | 3 | A | | 12-11856-00 | KEYBOARD,20KEY,4X5 ARRAY | EACH | \$44.00 | 3 | A | |
| 12-11164-06 | SW,DIP P 1A 10POS | EACH | \$11.00 | 3 | A | | 12-11856-05 | KEYBOARD,NUMERIC | EACH | \$67.00 | 3 | A | |
| 12-11179-00 | RLY,REED, 48V COIL,SPST, .50A | EACH | \$32.00 | 3 | A | | 12-11857-02 | BAR,SPACER FOR LK02 | EACH | \$5.00 | 3 | A | |
| 12-11180-00 | SW,TOG P 5A ON/OFF/ON | EACH | REPLACED | 3 | A | 12-11180-02 | SW,KEY BD CAP TILTED | QTY OF 10 | \$1.00 | 3 | A | | |
| 12-11180-02 | SW,TOG 1 PDT ON-OFF-ON | EACH | \$8.00 | 3 | A | | 12-11901-00 | CRT FOR VT50 | EACH | \$106.00 | 3 | A | |
| 12-11189-00 | SOLENOID,12V SP-620WITH CONIC | EACH | \$25.00 | 3 | A | | 12-12005-00 | SW, KEY BD PLUNGER,SHIFT LOCK | QTY OF 10 | \$1.00 | 3 | A | |
| 12-11193-00 | CONN, POWER 02P03W PLUG NEMA | EACH | \$21.00 | 3 | A | | 12-12006-00 | WIRE,CAM FOR LK02 KYSW MECH | QTY OF 10 | \$.41 | 3 | A | |
| 12-11196-00 | CKT BKR 20,20,30A 277V 3P SER | EACH | \$59.00 | 3 | A | | 12-12008-00 | SPOOL,PRINTER RIBBON,LA180,3. | EACH | \$6.00 | 3 | A | |
| 12-11196-02 | CKT BKR 20,20,30A 277V 3P SER | EACH | \$59.00 | 3 | A | | 12-12009-00 | WINDOW,PRINT,ACOUSTIC BAFFLE, | EACH | \$14.00 | 3 | A | |
| 12-11196-04 | CKT BKR 20,20,30A 250V SERIES | EACH | \$58.00 | 3 | A | | 12-12020-00 | CONN,POWER 5PIN RCPT W/36 DE | EACH | \$616.00 | U | A | |
| 12-11204-00 | CONN,POWER 2PIN RCPT, DUPLEX | EACH | \$23.00 | 3 | A | | 12-12020-01 | CONN,POWER 5PIN RCPT | EACH | \$441.00 | U | A | |
| 12-11204-01 | CONN,POWER 2PIN RCPT, DUPLEX | EACH | \$11.00 | 3 | A | | 12-12030-00 | SW,RKR,DPDT, 6A@125V, ON-NON | EACH | \$11.00 | 3 | A | |
| 12-11204-03 | CONN,POWER 02P03W RCPT NEMA | EACH | \$8.00 | 3 | A | | 12-12035-00 | FILTER FOAM 28.5X8.4X318 | EACH | \$17.00 | 3 | A | |
| 12-11222-01 | RLY,PWR,120V COIL,DPDT,10A | EACH | \$74.00 | 3 | A | | 12-12035-01 | FOAM,FILTER,21X26.38X3/8 | EACH | \$8.00 | 3 | A | |
| 12-11222-02 | RLY,PWR,230V COIL,DPDT,10A | EACH | \$68.00 | 3 | A | | 12-12040-00 | MOTOR,24VDC PERMANENT MAGNET | EACH | \$143.00 | 3 | A | |
| 12-11237-00 | FUSE, SLO BLOW, .750A, 250V | QTY OF 10 | \$4.00 | 3 | A | | 12-12124-00 | CKT BKR 30.A 240V 2P SERIES | EACH | \$58.00 | 3 | A | |



Prices Effective 02-January-89 to 30-June-89

To Order—Call DECdirect™ TOLL-FREE 800-344-4825, 8:30 a.m. to 8:00 p.m. ET in Continental U.S.A.

HARDWARE SPARES PRICE LIST

| PART NUMBER | DESCRIPTION | UNIT ORDER | UNIT PRICE | REP D L | REPLACEMENT PART NUMBER | PART NUMBER | DESCRIPTION | UNIT ORDER | UNIT PRICE | REP D L | REPLACEMENT PART NUMBER |
|-------------|-------------------------------|------------|------------|---------|-------------------------|---------------------|-------------------------------|------------|------------|---------|-------------------------|
| 12-12124-01 | CKT BKR 20.0 A 240V 2P SERIES | EACH | \$50.00 | 3 A | | 12-12714-02 | SW,PB CAP,RED,BLK,"FAULT" | QTY OF 10 | \$4.00 | 3 A | |
| 12-12124-03 | CKT BKR 10.0 A 240V 2P SERIES | EACH | \$55.00 | 3 A | | 12-12714-03 | SW,PB CAP,WHT/BLK,"A" | QTY OF 10 | \$4.00 | 3 A | |
| 12-12124-04 | CKT BKR 15.0 A 240V 2P SERIES | EACH | \$59.00 | 3 A | | 12-12714-04 | SW,PB,CAP,WHT/BLK,"B" | QTY OF 10 | \$4.00 | 3 A | |
| 12-12124-05 | CKT BKR 20.0 A 240V 2P SERIES | EACH | \$55.00 | 3 A | | 12-12716-00 | LAMP,WEDGE,6.3V,.2A,.4MSCP,T1 | QTY OF 10 | \$4.00 | 3 A | |
| 12-12124-06 | CKT BKR 20.0A 1P | EACH | \$58.00 | 3 A | | 12-12716-01 | BULB, WEDGE LAMP | QTY OF 10 | \$4.00 | 3 A | |
| 12-12124-07 | CKT BKR 20.0 A 240V 2P SERIES | EACH | \$50.00 | 3 A | | 12-12716-02 | LAMP WEDGE,28/24V,04A,30MSCP | QTY OF 10 | \$2.00 | 3 A | |
| 12-12124-08 | CKT BKR 15.0 A 240V 2P SERIES | EACH | \$50.00 | 3 A | | 12-12717-01 | SW,PB 1P 3A | EACH | \$23.00 | 3 A | |
| 12-12159-01 | CLIP,TEST,16PIN IC | EACH | \$37.00 | 3 A | | 12-12717-05 | SW, PB 1P 3A W/14V LAMP | EACH | \$17.00 | 3 A | |
| 12-12175-01 | FILTER,AIR,HIGH EFFICIENCY 40 | EACH | \$125.00 | 3 A | | 12-12717-06 | SW,PB LT 1P MOM | EACH | \$18.00 | 3 A | |
| 12-12177-00 | PORT,OUTLET | EACH | \$18.00 | 3 A | | 12-12732-00 | CKT BKR 3.0 A 240V 2P MAGNET | EACH | \$59.00 | 3 A | |
| 12-12178-00 | PORT,INLET | QTY OF 10 | \$5.00 | 3 A | | 12-12732-01 | CKT BKR 6.0 A 240V 2P MAGNET | EACH | \$55.00 | 3 A | |
| 12-12255-00 | SN,PB P .1A@125VAC,MOM | EACH | \$6.00 | 3 A | | 12-12748-00 | FILTER,LINE,115/250V,10A | EACH | \$26.00 | 3 A | |
| 12-12255-01 | SW,PB P 10A @125VAC,MOM | EACH | \$5.00 | 3 A | | 12-12749-00 | LIGHT,PNL INDICATOR,LED,RED | EACH | \$17.00 | 3 A | |
| 12-12265-00 | CONN,POWER 02P03W RCPT NEMA | EACH | \$8.00 | 3 A | | 12-12749-01 | LIGHT,PNL INDICATOR,LED,GRN | EACH | \$11.00 | 3 A | |
| 12-12266-00 | CONTACTOR 3P, 40A, 600V,230V | EACH | \$67.00 | 3 A | | 12-12787-00 | THERMOSTAT,O@212,C@182,NC | EACH | \$5.00 | 3 A | |
| 12-12266-01 | CONTACTOR 3P, 40A, 600V,120V | EACH | \$67.00 | 3 A | | 12-12873-00 | CKT BKR 1.75A 250V 2P SHUNT | EACH | \$51.00 | 3 A | |
| 12-12267-00 | RLY,REED, 48V COIL,SPST,2.5A | EACH | \$23.00 | 3 A | | 12-12877-00 | FILTER,LINE,115/250V,47-400HZ | EACH | \$20.00 | 3 A | |
| 12-12292-00 | MAG HD,CASSETTE,2TRK READ/WRI | EACH | \$231.00 | 3 A | | 12-12877-01 | FILTER,LINE,115/250V,47-400HZ | EACH | \$21.00 | 3 A | |
| 12-12320-00 | FILTER,LINE 30A 115/250V 5W | EACH | \$163.00 | 3 A | | 12-12883-00 | HOSE,FLEXIBLE,2-1/4"ID,GLASS | EACH | \$18.00 | 3 A | |
| 12-12321-00 | CKT BKR 15A 240V 4P | EACH | \$159.00 | 3 A | | 12-12889-00 | BLOWER,CENTRIFUGAL,DOUBLE,RK0 | EACH | \$483.00 | 3 A | |
| 12-12392-01 | FILTER,FOAM 3/8X18X9.4 | EACH | \$7.00 | 3 A | | 12-12893-00 | FUSE HOLDER, 20A, 300V, PNL M | EACH | \$4.00 | 3 A | |
| 12-12392-02 | FILTER,FOAM 1/4X16X9 | EACH | \$6.00 | 3 A | | 12-12904-00 | FILTER,AIR,HEPA, 32CF-RK06 | EACH | \$139.00 | 3 A | |
| 12-12405-00 | CARD GUIDE,NYLON | QTY OF 10 | \$83 | 3 A | | 12-12944-00 | FILTER,FOAM 30PPI, 7.38X 3.75 | QTY OF 10 | \$4.00 | 3 A | |
| 12-12405-04 | CARD GUIDE,NYLON | QTY OF 10 | \$1.00 | 3 A | | 12-12948-00 | SPINDLE ASSY,RK06 | EACH | \$1,049.00 | 3 A | |
| 12-12442-00 | FUSE, SLO BLOW, 4.0A, 125V | QTY OF 10 | \$6.00 | 3 A | | 12-12973-00 | SPRING,CARTRIDGE RETAINING,MU | QTY OF 10 | \$4.00 | 3 A | |
| 12-12446-00 | PULLEY,TIMING BELT 30TOOTH | EACH | \$4.00 | 3 A | | 12-13013-00 | FAN,13SCFM,SLEEVE BRNG,115VAC | EACH | \$75.00 | 3 A | |
| 12-12499-00 | BATTERY,12V 5A LEAD ACID | EACH | \$126.00 | 3 A | | 12-13070-00 | FILTER,LINE 110-220V,50-60HZ | EACH | \$63.00 | 3 A | |
| 12-12510-00 | SPRING,COMPRESSION .52ODX.094 | QTY OF 10 | \$2.00 | 3 A | | 12-13091-00 | SW,KEY,FOR SPANNER HEAD 12-13 | EACH | \$7.00 | 3 A | |
| 12-12544-00 | CARRIAGE,PRINT HEAD FOR LA180 | EACH | \$7.00 | 3 A | | 12-13097-00 | FILTER, AIR, HEPA, 33CFM | EACH | \$58.00 | 3 A | |
| 12-12560-00 | SW,ROT P .5A 3POS 1 SECT | EACH | \$25.00 | 3 A | | 12-13113-01 | HANDLE, MODULE, ARM EJECTOR | EACH | REPLACED | 3 A | 4A-HANDL-02 |
| 12-12560-01 | SW, ROT 1P 3 POS | EACH | \$25.00 | 3 A | | 12-13119-00 | HUB,QUICK RELEASE FOR TU10/16 | EACH | \$187.00 | 3 A | |
| 12-12561-00 | FAN GUARD,6" FLAT | EACH | \$5.00 | 3 A | | 12-13185-00 | FAN, 75CFM HOWARD 2455 | EACH | \$58.00 | 3 A | |
| 12-12570-00 | SW,ROT KNOB | QTY OF 10 | \$4.00 | 3 A | | 12-13185-03 | FAN,70CFM,115V,TUBE AXIAL,LOW | EACH | \$42.00 | 3 A | |
| 12-12579-00 | /REPLACED BY 12-12581-02 | EACH | REPLACED | 3 A | 12-12581-02 | BLOWER, CENTRIFUGAL | EACH | \$286.00 | 3 A | | |
| 12-12581-00 | FAN, 35CFM,115VAC,3"DIA | EACH | \$30.00 | 3 A | | 12-13216-00 | FUSE, RECTIFIER 5A, 65V | EACH | \$5.00 | 3 A | |
| 12-12581-01 | FAN, 35CFM,115VAC,3"DIA W/GUA | EACH | \$46.00 | 3 A | | 12-13237-01 | | EACH | \$5.00 | 3 A | |
| 12-12581-02 | FAN, 35CFM,115VAC,3"DIA W/GUA | EACH | \$34.00 | 3 A | | 12-13365-02 | SHIELD,HEAT,PLASTIC MOLDED,B | QTY OF 10 | REPLACED | 3 A | 12-13365-03 |
| 12-12635-00 | BELT,WOVEN,ENDLESS,1/2"WX28-1 | EACH | \$11.00 | 3 A | | 12-13365-03 | SHIELD,HEAT,PLASTIC MOLDED | QTY OF 10 | \$2.00 | 3 A | |
| 12-12635-01 | BELT,WOVEN,ENDLESS,1/2WX29-1/ | EACH | \$8.00 | 3 A | | 12-13369-00 | BELT,WOVEN,ENDLESS,375WX27.14 | EACH | \$26.00 | 3 A | |
| 12-12635-03 | BELT,WOVEN,ENDLESS,1/2" WX35 | EACH | \$14.00 | 3 A | | 12-13435-00 | SW,PB FOR HANDLE RELEASE | EACH | REPLACED | 3 A | 70-14297-00 |
| 12-12635-05 | BELT,WOVEN,ENDLESS,375WX36.8 | EACH | \$14.00 | 3 A | | 12-13441-00 | DISC,CONE EXPANDED-MOLDED | EACH | \$5.00 | 3 A | |
| 12-12635-06 | BELT,WOVEN,ENDLESS, (60HZ) | EACH | \$21.00 | 3 A | | 12-13447-00 | MOTOR,A.C. | EACH | \$64.00 | 3 A | |
| 12-12635-07 | BELT,WOVEN,ENDLESS, (50HZ) | EACH | \$21.00 | 3 A | | 12-13454-00 | BELT,DRIVE-FLAT NEOPRENE 23.2 | EACH | \$7.00 | 3 A | |
| 12-12640-00 | CONTACT,GROUNDING,RK06 | EACH | \$11.00 | 3 A | | 12-13454-01 | BELT,DRIVE-FLAT NEOPRENE 23.4 | EACH | \$7.00 | 3 A | |
| 12-12691-00 | SW, PB CAP "O/READY" | EACH | \$4.00 | 3 A | | 12-13519-00 | BEARING,BALL DBL SHIELD 6250D | EACH | \$6.00 | 3 A | |
| 12-12691-01 | SW, PB CAP "1/READY" | EACH | \$4.00 | 3 A | | 12-13522-00 | BEARING,BALL DBL SHIELD.8750D | EACH | \$5.00 | 3 A | |
| 12-12691-02 | SW, PB CAP "2/READY" | EACH | \$4.00 | 3 A | | 12-13686-00 | CHASSIS SLIDE SET INCLUDED 1 | EACH | \$92.00 | 3 A | |
| 12-12691-03 | SW, PB CAP "3/READY" | EACH | \$4.00 | 3 A | | 12-13833-00 | SCREW,BRASS TIPPED,SOCKET SET | QTY OF 10 | \$1.00 | 3 A | |
| 12-12691-04 | SW, PB CAP "4/READY" | EACH | \$4.00 | 3 A | | 12-13886-00 | SPRING,COMPRESSION,.90LGX.016 | EACH | \$7.00 | 3 A | |
| 12-12691-05 | SW, PB CAP "5/READY" | EACH | \$4.00 | 3 A | | 12-13893-00 | BLOWER,CENTRIFUGAL | EACH | \$321.00 | 3 A | |
| 12-12691-06 | SW, PB CAP "6/READY" | EACH | \$4.00 | 3 A | | 12-13915-00 | RLY,REED, 5V COIL, SPDT | EACH | \$11.00 | 3 A | |
| 12-12691-07 | SW, PB CAP "7/READY" | EACH | \$4.00 | 3 A | | 12-14005-00 | BELT,DRIVE-FLAT NEOPRENE 23"L | EACH | \$7.00 | 3 A | |
| 12-12707-00 | FILTER,AIR,FOAM 30PPI,16.75X4 | EACH | \$6.00 | 3 A | | 12-14005-01 | BELT,DRIVE-FLAT NEOPRENE 23"L | EACH | \$7.00 | 3 A | |
| 12-12714-00 | SW,PB CAP,YEL/BLK,"RUN STOP" | QTY OF 10 | \$4.00 | 3 A | | 12-14011-00 | SW,MICRO 1P 5A | EACH | \$6.00 | 3 A | |
| 12-12714-01 | SW,PB CAP,YEL/BLK"WRITE PROT" | QTY OF 10 | \$4.00 | 3 A | | 12-14027-01 | CAP,PB SW,W/LT BLK NO LEGEND | EACH | \$13.00 | 3 A | |
| | | | | | | 12-14027-02 | CAP,PB SW,W/LT BLK "ONLINE" | EACH | \$13.00 | 3 A | |



Prices Effective 02-January-89 to 30-June-89

To Order—Call DECdirect™ TOLL-FREE 800-344-4825, 8:30 a.m. to 8:00 p.m. ET in Continental U.S.A.

HARDWARE SPARES PRICE LIST

| PART NUMBER | DESCRIPTION | UNIT ORDER | UNIT PRICE | REP D | L | REPLACEMENT PART NUMBER | PART NUMBER | DESCRIPTION | UNIT ORDER | UNIT PRICE | REP D | L | REPLACEMENT PART NUMBER |
|-------------|-------------------------------|------------|------------|-------|---|-------------------------|-------------|--------------------------------|------------|------------|-------|---|-------------------------|
| 12-14027-03 | CAP,PB SW,W/LT BLK "INIT" | EACH | \$13.00 | 3 | A | | 12-15296-00 | BASE,HOUSING-OUTER SKIN | EACH | REPLACED | 3 | A | 12-15296-01 |
| 12-14027-04 | CAP,PB SW,W/LT RED "FAULT" | EACH | \$13.00 | 3 | A | | 12-15296-01 | BASE,HOUSING-OUTER SKIN | EACH | \$24.00 | 3 | A | |
| 12-14032-00 | SW,TOG 4P 5A ON/NONE/ON | EACH | \$20.00 | 3 | A | | 12-15297-00 | BEZEL,KEYBRD-MTG PANEL | EACH | REPLACED | 3 | A | 12-15297-01 |
| 12-14045-02 | FILTER,AIR 8-5/16 X 13 | EACH | \$6.00 | 3 | A | | 12-15297-01 | BEZEL,KEYBRD-MTG PANEL | EACH | \$13.00 | 3 | A | |
| 12-14045-06 | FILTER, AIR 38-1/2 X17-11/16 | EACH | \$19.00 | 3 | A | | 12-15298-00 | COVER, ACCESS | EACH | \$8.00 | 3 | A | |
| 12-14074-00 | STRAP,THERMAL | QTY OF 10 | \$4.00 | 3 | A | | 12-15299-00 | BEZEL, TOP REMOVABLE | EACH | \$5.00 | 3 | A | |
| 12-14089-00 | MOTOR,20VDC PERMANET MAGNET | EACH | \$95.00 | 3 | A | | 12-15315-00 | SHAFT,CARR,1/2" DIA X17.25" LG | EACH | \$15.00 | 3 | A | |
| 12-14155-03 | SW,SLIDE 3P 10.1A @125V,5A @ | EACH | \$18.00 | 3 | A | | 12-15317-00 | BEARING,SELF ALIGNING,OIL IMP | QTY OF 10 | \$2.00 | 3 | A | |
| 12-14283-00 | CONTACTOR, 20A, 2P 120V | EACH | \$50.00 | 3 | A | | 12-15319-00 | SPRING,TORSION WIRE D=.034 LA | EACH | \$4.00 | 3 | A | |
| 12-14283-01 | CONTACTOR, 20A, 2P 240V | EACH | \$50.00 | 3 | A | | 12-15330-00 | ROLLER-BAIL BAR ASSY | QTY OF 10 | \$4.00 | 3 | A | |
| 12-14314-00 | CONN 2 POS JUMPER | EACH | \$2.00 | 3 | A | | 12-15331-00 | ARM,BAIL BAR,LA34 | QTY OF 10 | \$2.00 | 3 | A | |
| 12-14332-00 | SW, ARRAY CAP ADAPTER | QTY OF 10 | \$4.10 | 3 | A | | 12-15331-01 | ARM,BAIL BAR,LA34 | QTY OF 10 | \$2.00 | 3 | A | |
| 12-14333-87 | KEYCAP,KEYBD ARRAY,SKULPT,PF1 | QTY OF 10 | \$83 | 3 | A | | 12-15332-00 | BAR,BAIL,LA34 | EACH | \$5.00 | 3 | A | |
| 12-14333-W5 | SW, KEY BD CAP BLANK FLAT STY | QTY OF 10 | \$1.00 | 3 | A | | 12-15333-00 | EDGE,TEAR,LA34 | EACH | \$6.00 | 3 | A | |
| 12-14360-02 | CKT BKR 2.5A 250V 3P SERIES | EACH | \$101.00 | 3 | A | | 12-15336-00 | CONN,TEST,W/BALL CHAIN | EACH | \$21.00 | 3 | A | |
| 12-14380-00 | RLY, G.P. SPST, 0.5A | EACH | \$34.00 | 3 | A | | 12-15336-01 | LOOP BACK CONN ASSY | EACH | \$25.00 | 3 | A | |
| 12-14405-00 | DOOR, TAPE TRANSPORT, FRONT | EACH | \$141.00 | 3 | A | | 12-15336-02 | CONN, TEST, SHEILDDED | EACH | \$26.00 | 3 | A | |
| 12-14415-01 | FUSE,REG BLOW,.250A 250V | QTY OF 10 | \$2.00 | 3 | A | | 12-15336-04 | CONN, TEST ASSY | EACH | \$12.00 | 3 | A | |
| 12-14458-00 | CKT BKR 30.0A 250V | EACH | \$109.00 | 3 | A | | 12-15336-06 | CONN,D SUB 25POS | EACH | \$48.00 | 3 | A | |
| 12-14458-01 | CKT,BKR 15.0A,250V 4P SERIES | EACH | \$113.00 | 3 | A | | 12-15346-00 | PULLEY,RIBBON DRIVE LA34 | QTY OF 10 | \$1.00 | 3 | A | |
| 12-14545-00 | SW,RKR 2P15A | EACH | \$7.00 | 3 | A | | 12-15347-00 | LEVER, RELEASE | QTY OF 10 | \$1.00 | 3 | A | |
| 12-14563-00 | BEZEL,PLASTIC MOLDED FOR KYBD | EACH | \$19.00 | 3 | A | | 12-15348-00 | CABLE,RIBBON DRIVE ASSY. | EACH | \$4.00 | 3 | A | |
| 12-14606-00 | BRAKE, ELEC. DISK | EACH | \$84.00 | 3 | A | | 12-15349-00 | ARM,ROCKER LA34 | QTY OF 10 | \$1.00 | 3 | A | |
| 12-14614-01 | FILTER,EMI,40 POS,BULKHEAD MT | EACH | \$126.00 | 3 | A | | 12-15350-00 | GEAR, CLUSTER | EACH | \$2.00 | 3 | A | |
| 12-14614-02 | FILTER BULK MTG HEAD | EACH | \$107.00 | 3 | A | | 12-15351-00 | KNOB,LA34 PLATEN | QTY OF 10 | \$4.00 | 3 | A | |
| 12-14740-00 | PLUNGER,NYLATCH,SPECIAL FOR V | QTY OF 10 | \$1.00 | 3 | A | | 12-15352-00 | CLUTCH, GEAR LA00 | QTY OF 10 | \$4.00 | 3 | A | |
| 12-14811-00 | SCREW, CAPTIVE,HEX HD, 6-32 X | QTY OF 10 | REPLACED | 3 | A | 90-08911-01 | 12-15353-00 | BEARING PLASTIC | QTY OF 10 | REPLACED | 3 | A | 12-15353-01 |
| 12-14812-00 | COVER, HEAD, LEFT | EACH | \$43.00 | 3 | A | | 12-15353-01 | BEARING, PLASTIC | QTY OF 10 | \$2.00 | 3 | A | |
| 12-14815-00 | COVER, HUB | EACH | REPLACED | 3 | A | 12-14815-01 | 12-15354-01 | CLUTCH, HUB, PAPER DRIVE | QTY OF 10 | \$1.00 | 3 | A | |
| 12-14816-00 | RING, CENTER | EACH | REPLACED | 3 | A | 12-14816-01 | 12-15356-00 | ROLLER,FRONT PAPER FEED | EACH | \$5.00 | 3 | A | |
| 12-14816-01 | RING, CENTER | EACH | \$4.00 | 3 | A | | 12-15357-00 | SHAFT IDLER PULLEY | QTY OF 10 | \$4.00 | 3 | A | |
| 12-14817-00 | SCREW,HEX ,SLOT 6-32X | QTY OF 10 | \$2.00 | 3 | A | | 12-15358-00 | SHAFT, FRICTION | EACH | \$11.00 | 3 | A | |
| 12-14828-00 | COM 25 POS RCPT. | EACH | REPLACED | 3 | A | 12-14828-04 | 12-15359-00 | ROLLER,REAR PAPER FEED | EACH | \$5.00 | 3 | A | |
| 12-14828-04 | CONN, D SUB COMPOSITE ASSY. | EACH | \$51.00 | 3 | A | | 12-15362-00 | BELT,TIMING .080 PITCH LGTH 3 | EACH | \$7.00 | 3 | A | |
| 12-14842-00 | CKT BKR 20.0A 240V | EACH | \$30.00 | 3 | A | | 12-15397-00 | STUD,COMBINATION PULLEY | QTY OF 10 | \$2.00 | 3 | A | |
| 12-14899-03 | CONN, POWER 02P03W RCPT NEMA | EACH | \$5.00 | 3 | A | | 12-15398-00 | GROMMET,11/32 I.D.3/4 OD 3/16 | QTY OF 10 | \$83 | 3 | A | |
| 12-14931-00 | CKT BKR 1.8A 24V | EACH | \$15.00 | 3 | A | | 12-15400-00 | CLUTCH DISK | QTY OF 10 | \$83 | 3 | A | |
| 12-14946-00 | RING, RUBBER | EACH | \$8.00 | 3 | A | | 12-15401-00 | PAPER GUIDE | EACH | \$6.00 | 3 | A | |
| 12-15006-06 | SKT,IC 24PIN DIP TIN SOLDER | QTY OF 10 | \$2.00 | 3 | A | | 12-15434-00 | BLOWER,CENTRIFUGAL 340CFM @.5 | EACH | \$402.00 | 3 | A | |
| 12-15006-07 | SKT,IC 28PIN DIP TIN SOLDER | QTY OF 10 | \$2.00 | 3 | A | | 12-15452-00 | SCREW,LEVER | QTY OF 10 | \$2.00 | 3 | A | |
| 12-15006-08 | SOCKET 40PIN IC LOW PROFILE | QTY OF 10 | \$4.00 | 3 | A | | 12-15453-00 | SPACER,LEVER | QTY OF 10 | \$1.00 | 3 | A | |
| 12-15010-00 | CATCH SPRING | QTY OF 10 | \$63 | 3 | A | | 12-15506-00 | ROD CAP FOR LA00 | QTY OF 10 | \$1.00 | 3 | A | |
| 12-15041-00 | THERMOSTAT 0 @190 | EACH | \$29.00 | 3 | A | | 12-15508-00 | SPRING,LATCH | QTY OF 10 | \$72 | 3 | A | |
| 12-15041-01 | THERMOSTAT 0 @ 220 | EACH | \$11.00 | 3 | A | | 12-15512-00 | LATCH,PLATEN,LEFT | QTY OF 10 | \$1.00 | 3 | A | |
| 12-15053-00 | COVER,MOLDED PLASTIC LAMP | QTY OF 10 | \$2.00 | 3 | A | | 12-15512-01 | LATCH,PLATEN,RIGHT | QTY OF 10 | \$1.00 | 3 | A | |
| 12-15054-00 | FAN,TUBE AXIAL 3.5" 30CFM | EACH | \$114.00 | 3 | A | | 12-15523-00 | BEARING,BALL,FLANGED,LA34 | EACH | \$8.00 | 3 | A | |
| 12-15183-00 | CONN, POWER 02P03W PLUG NEMA | EACH | \$14.00 | 3 | A | | 12-15524-00 | BUSHING | QTY OF 10 | \$72 | 3 | A | |
| 12-15232-00 | SW,TOG 2P 25A ON/NONE/OFF | EACH | \$7.00 | 3 | A | | 12-15548-00 | SHAFT,RIBBON DRIVE FOR LA00 | QTY OF 10 | REPLACED | 3 | A | 74-24202-00 |
| 12-15239-00 | PULLEY, 20 TOOTH MOLD | EACH | \$2.00 | 3 | A | | 12-15551-00 | SPRING,WIRE FOR LA-34 | QTY OF 10 | \$63 | 3 | A | |
| 12-15278-00 | CABLE,FLEX NOMEX SHEET MODULE | EACH | \$5.00 | Y | 3 | A | 12-15552-00 | SPRING,CLUTCH FOR LA34 | QTY OF 10 | \$63 | 3 | A | |
| 12-15288-00 | TRACTOR,GEAR-LA34 | QTY OF 10 | \$1.00 | 3 | A | | 12-15553-00 | SPRING TORSION FOR LA00 | QTY OF 10 | \$1.00 | 3 | A | |
| 12-15291-00 | COVER,HOUSING-OUTER SKIN | EACH | \$25.00 | 3 | A | | 12-15556-00 | CAM FOR LA00 | QTY OF 10 | REPLACED | 3 | A | 74-22987-00 |
| 12-15292-00 | INSERT,REAR PANEL FOR PWR SUP | EACH | \$6.00 | 3 | A | | 12-15558-00 | MOTOR, LA34 | EACH | \$70.00 | 3 | A | |
| 12-15293-00 | GUIDE,PAPER EDGE | QTY OF 10 | \$2.00 | 3 | A | | 12-15562-00 | WASHER,CLUTCH | QTY OF 10 | \$41 | 3 | A | |
| 12-15295-00 | SWITCH,FILLER PLUG | QTY OF 10 | \$1.00 | 3 | A | | 12-15592-00 | PULLEY,IDLER TIMING FOR LA-34 | QTY OF 10 | \$1.00 | 3 | A | |

digital

Prices Effective 02-January-89 to 30-June-89

To Order—Call DECdirect™ TOLL-FREE 800-344-4825, 8:30 a.m. to 8:00 p.m. ET in Continental U.S.A.

SPARES PRICE LIST A-21

SPARES PRICE LIST A-22

12-15602-00 — 12-19181-00

HARDWARE SPARES PRICE LIST

| PART NUMBER | DESCRIPTION | UNIT ORDER | UNIT PRICE | REP D L | REPLACEMENT PART NUMBER | PART NUMBER | DESCRIPTION | UNIT ORDER | UNIT PRICE | REP D L | REPLACEMENT PART NUMBER |
|-------------|----------------------------------|------------|------------|---------|-------------------------|-------------|----------------------------------|------------|------------|---------|-------------------------|
| 12-15602-00 | MOTOR, 12VDC SERVO | EACH | REPLACED | 3 A | STU58-XA | 12-16821-00 | HOUSING, BACKPLANE CONN., 1X.1 | EACH | \$5.00 | 3 A | |
| 12-15603-00 | DUST CAP FOR LA34 ENCODER | QTY OF 10 | \$2.00 | 3 A | | 12-16870-01 | THERMOSTAT, 0 @ 128.C @ 105 | EACH | \$26.00 | 3 A | |
| 12-15604-00 | BACKPLATE FOR LA34 ENCODER | QTY OF 10 | \$2.00 | 3 A | | 12-16885-01 | CONN, POWER 02P05W RCPT NEMA | EACH | \$24.00 | 3 A | |
| 12-15633-00 | MOTOR, PERMANENT MAGNET 24VDC | EACH | \$46.00 | 3 A | | 12-16886-00 | CONN, POWER 02P03W PLUG NEMA | EACH | \$20.00 | 3 A | |
| 12-15635-01 | TRANSUDUCER, MINATURE AUDIO | EACH | \$5.00 | 3 A | | 12-16901-00 | SW, SLIDE 2P 2A | EACH | \$8.00 | 3 A | |
| 12-15651-00 | PLUG TRACTOR FOR LA00 | QTY OF 10 | \$.83 | 3 A | | 12-16902-00 | MOUNT, SHOCK, RUBBER | EACH | \$30.00 | 3 A | |
| 12-15655-00 | SW PB. SPDT WHITE "PUSH MOM" | EACH | \$11.00 | 3 A | | 12-16971-00 | CHASSIS SLIDE FOR BA11-A | EACH | \$193.00 | 3 A | |
| 12-15672-00 | BUMPER, ADHESIVE BACK FOR LA34 | QTY OF 10 | \$1.00 | 3 A | | 12-16988-02 | HANDLE, HEX MODULE .10-1/2 | EACH | REPLACED | 3 A | 4A-HANDL-01 |
| 12-15701-00 | SPRING, EXT 1.12LGX.240OD | QTY OF 10 | \$1.00 | 3 A | | 12-17051-01 | SW, RKR 2PST ON-NONE-OFF | EACH | \$7.00 | 3 A | |
| 12-15711-00 | CLIP, SPRING FOR LA34 | QTY OF 10 | \$1.00 | 3 A | | 12-17051-04 | SW, RKR 2PST ON-NONE-OFF | EACH | REPLACED | 3 A | 12-22355-09 |
| 12-15719-00 | WINDOW, SAFETY FOR LA00 | EACH | \$5.00 | 3 A | | 12-17051-05 | SW, RKR 2PST ON-NON-OFF | EACH | REPLACED | 3 A | 12-22355-10 |
| 12-15781-00 | ACTUATOR, PAPER OUT, NYLON & GLA | QTY OF 10 | \$.72 | 3 A | | 12-17094-00 | BEZEL, PLASTIC 11-44 | EACH | \$19.00 | 3 A | |
| 12-15782-00 | SHAFT, PAPER OUT | QTY OF 10 | \$1.00 | 3 A | | 12-17437-01 | FAN, TUBE AXIAL 43CFM | EACH | \$109.00 | 3 A | |
| 12-15798-00 | SHIELD, HEAT, PRINT HEAD | QTY OF 10 | \$2.00 | 3 A | | 12-17474-00 | MOTOR, STEPPER ASSY | EACH | \$62.00 | 3 A | |
| 12-15915-00 | BELT, TIMING .080 PITCH | QTY OF 10 | \$4.00 | 3 A | | 12-17474-01 | MOTOR, STEPPER W/DRIVE GEAR | EACH | \$65.00 | 3 A | |
| 12-15916-00 | PULLEY, DRIVE 18 TEETH .080PI | QTY OF 10 | REPLACED | 3 A | 74-24735-00 | 12-17556-00 | FAN, TUBE AXIAL 4.5" 90CFM .2V | EACH | \$140.00 | 3 A | |
| 12-15926-00 | BUSHING, BELT TENSION | EACH | \$19.00 | 3 A | | 12-17556-01 | FAN, TUBE AXIAL 4.5" 105CFM | EACH | \$122.00 | 3 A | |
| 12-15935-00 | GASKET, THERMAL: 50" X.80" | QTY OF 10 | \$1.00 | 3 A | | 12-17594-00 | STANDOFF, POLYCARB 3/8" | QTY OF 10 | \$1.00 | 3 A | |
| 12-15936-00 | HEAT SINK, FORCED CONVECTION | QTY OF 10 | \$2.00 | 3 A | | 12-17630-00 | GROMMET W/RECESSED HEAD | QTY OF 10 | REPLACED | 3 A | 12-17630-01 |
| 12-15937-00 | BEARING SLEEVE .441X.626 | QTY OF 10 | \$4.00 | 3 A | | 12-17630-01 | GROMMET, SNAP-IN PLOYCARBONATE | EACH | \$5.00 | 3 A | |
| 12-15984-00 | LINE FILTER 115/250VAC | EACH | \$27.00 | 3 A | | 12-17631-00 | PLUNGER W/TAMPER PROOF HEAD | QTY OF 10 | \$1.00 | 3 A | |
| 12-16021-00 | TRACTOR SCALE | QTY OF 10 | \$6.00 | 3 A | | 12-17632-01 | SW, TOG 2P 6A ON/NONE/OFF | EACH | \$8.00 | 3 A | |
| 12-16022-00 | CAP, TRACTOR-LEFT | QTY OF 10 | \$4.00 | 3 A | | 12-17665-01 | FILTER, AIR FOAM 020PI 150THK | QTY OF 10 | \$2.00 | 3 A | |
| 12-16023-00 | CAP, TRACTOR-RIGHT | QTY OF 10 | \$4.00 | 3 A | | 12-17715-02 | FAN, TUBE AXIAL 4.5" 120CFM | EACH | \$76.00 | 3 A | |
| 12-16032-00 | SPRING, COMPRESSION, 1.100LG | QTY OF 10 | \$2.00 | 3 A | | 12-17715-04 | FAN, TUBE AXIAL 4.5" 120CFM | EACH | \$76.00 | 3 A | |
| 12-16065-00 | WASHER, PLASTIC .325SQ.X.09TH | QTY OF 10 | \$.63 | 3 A | | 12-17786-00 | SW, MICRO 1 PDT NC-NO | EACH | \$13.00 | 3 A | |
| 12-16103-02 | FAN, TUBE AXIAL 100CFM | EACH | \$46.00 | 3 A | | 12-17800-F8 | KEYCAP, KEYBD ARRAY, SKULPT | QTY OF 10 | \$1.00 | 3 A | |
| 12-16147-00 | SW, KEY BD, CAP ADAPTER, SPEC. | QTY OF 10 | \$.83 | 3 A | | 12-17894-00 | SPACER, NYLON, 625"HGT | QTY OF 10 | \$1.00 | 3 A | |
| 12-16193-00 | GEAR, TRACTOR IDLER | QTY OF 10 | \$1.00 | 3 A | | 12-17916-02 | FAN, TUBE AXIAL 230V 120CFM | EACH | \$83.00 | 3 A | |
| 12-16194-00 | GEAR, TRACTOR ASSY DRIVE | QTY OF 10 | \$1.00 | 3 A | | 12-18106-01 | FAN, TUBE AXIAL 6.0" 240CFM | EACH | \$326.00 | 3 A | |
| 12-16197-00 | SCREW, PIVOT | EACH | \$19.00 | 3 A | | 12-18199-00 | SW, ENCODER BUTTON | QTY OF 10 | \$4.00 | 3 A | |
| 12-16231-00 | ROLLER ASSY, DRIVE | EACH | \$11.00 | 3 A | | 12-18204-02 | GROUNDING ASSY | EACH | \$64.00 | 3 A | |
| 12-16271-00 | FILTER, AIR FOAM 020PI.50THK | EACH | \$6.00 | 3 A | | 12-18248-00 | BATTERY, 1.5V 180MA NI-CAD | EACH | \$25.00 | 3 A | |
| 12-16297-00 | FILTER, EMI FOR 50HZ PS | EACH | \$64.00 | 3 A | | 12-18360-00 | SPRING, TORSION, LEFT HAND | QTY OF 10 | \$2.00 | 3 A | |
| 12-16304-00 | LEVER, SW, RELEASE FOR PAPER | QTY OF 10 | \$1.00 | 3 A | | 12-18413-00 | FILTER, EMI/RFI 115/240V | EACH | \$42.00 | 3 A | |
| 12-16305-00 | SPRING, TORSION FOR PAPER OUT | QTY OF 10 | \$.20 | 3 A | | 12-18416-00 | FILTER, EMI/RFI 115/250V 47-63 | EACH | \$61.00 | 3 A | |
| 12-16306-00 | SWITCH ACTUATOR FOR PAPER OUT | QTY OF 10 | \$1.00 | 3 A | | 12-18428-00 | RFI SUPPRESSION MULTISECTION | EACH | \$20.00 | 3 A | |
| 12-16335-00 | SLEEVE, RETAINER .380ODX171ID | QTY OF 10 | \$.83 | 3 A | | 12-18668-00 | DUAL SPEED BLOWER, 120V50/60HZ | EACH | \$177.00 | 3 A | |
| 12-16371-00 | SW, MICRO 1 PDT NO-NC | EACH | \$5.00 | 3 A | | 12-18685-02 | TRACTOR, R.H. + L.H. (PAIR) | EACH | \$36.00 | 3 A | |
| 12-16382-00 | FILTER, LINE 120-240V 12A, EMI | EACH | REPLACED | 3 A | 12-16382-01 | 12-18685-05 | TRACTOR, R.H. & L.H. (PAIR) | EACH | \$64.00 | 3 A | |
| 12-16382-01 | FILTER, LINE 120-240V 12A, EMI | EACH | \$71.00 | 3 A | | 12-18785-00 | SW, TOG 2PST ON-NONE-OFF | EACH | \$6.00 | 3 A | |
| 12-16434-01 | CKT BKR 06.00A 065V 2P | EACH | \$55.00 | 3 A | | 12-18817-01 | CARD EDGE 90PIN T-BAR | EACH | \$23.00 | 3 A | |
| 12-16458-00 | SW, STRIP 1P 3A 16POS BINARYCO | EACH | \$34.00 | 3 A | | 12-18818-01 | CARD EDGE 90PIN | EACH | \$25.00 | 3 A | |
| 12-16462-02 | TRACTOR R.H.&L.H. (PAIR) | EACH | REPLACED | 3 A | 12-18685-02 | 12-18826-00 | CONN TELE 4POS JACK | EACH | \$5.00 | 3 A | |
| 12-16521-00 | PCB, HEADER 4PIN | QTY OF 10 | \$1.00 | 3 A | | 12-18828-00 | BLOWER, CENTRIFUGAL 120VAC60HZ | EACH | \$228.00 | 3 A | |
| 12-16524-00 | CAP, PB SW WHITE | QTY OF 10 | \$.83 | 3 A | | 12-18835-00 | BELT, WOVEN, ENDLESS, 1/8WX14.87 | QTY OF 10 | \$4.00 | 3 A | |
| 12-16552-00 | SW, RKR, LT 2PST ON-NONE-OFF16A | EACH | \$12.00 | 3 A | | 12-18871-00 | FILTER, AIR GLASS FRAMED | EACH | \$71.00 | 3 A | |
| 12-16563-00 | FAN, TUBE AXIAL 35V 75HZ | EACH | \$155.00 | 3 A | | 12-18925-00 | BEARING, FLING, 624ODX .440IDX | EACH | \$8.00 | 3 A | |
| 12-16577-00 | BRAKE, 110 VOLT | EACH | \$106.00 | 3 A | | 12-18997-00 | SW, MICRO 1PDT MOM NC-NO 50MA | EACH | \$12.00 | 3 A | |
| 12-16578-00 | MOTOR, 115VAC CAP START | EACH | \$131.00 | 3 A | | 12-19032-00 | CONN 16PIN | QTY OF 10 | \$2.00 | 3 A | |
| 12-16578-02 | MOTOR, 220VAC CAP, START | EACH | \$154.00 | 3 A | | 12-19066-00 | CONN 40PIN | EACH | \$19.00 | 3 A | |
| 12-16687-00 | SW, REED, MINI MAGNETIC ASSY | EACH | \$6.00 | 3 A | | 12-19178-00 | CONN, PWR RCPT NEMA L21-30R | EACH | \$21.00 | U A | |
| 12-16692-00 | BATTERY, 4CELL, 4.80V NICKEL-CA | EACH | \$49.00 | 3 A | | 12-19179-00 | CONN, PWR RCPT NEMA L21-20R | EACH | \$15.00 | U A | |
| 12-16782-00 | CLUTCH ASSY, ROLLER | EACH | REPLACED | 3 A | 70-11446-00 | 12-19180-00 | CONN, PWR RCPT NEMA L05-30R | EACH | \$13.00 | U A | |
| 12-16817-00 | SN, OPTICAL ASSY | EACH | \$57.00 | 3 A | | 12-19181-00 | CONN, PWR RCPT NEMA 05-20R | EACH | \$13.00 | U A | |



Prices Effective 02-January-89 to 30-June-89

To Order—Call DECdirect™ TOLL-FREE 800-344-4825, 8:30 a.m. to 8:00 p.m. ET in Continental U.S.A.

HARDWARE SPARES PRICE LIST

| PART NUMBER | DESCRIPTION | UNIT ORDER | UNIT PRICE | REP D | L | REPLACEMENT PART NUMBER | PART NUMBER | DESCRIPTION | UNIT ORDER | UNIT PRICE | REP D | L | REPLACEMENT PART NUMBER |
|-------------|--------------------------------|------------|------------|-------|---|-------------------------|---------------------------|--------------------------------|------------|------------|-------|---|-------------------------|
| 12-19197-00 | BLOWER, CENTRI 1500CFM 60HZ | EACH | \$874.00 | 3 | A | | 12-23034-05 | FILTER, AIR ALUM FRAMED | EACH | \$16.00 | 3 | A | |
| 12-19197-01 | BLOWER, CENTRI 1500DFM 50HZ | EACH | \$874.00 | 3 | A | | 12-23395-01 | FAN, TUBE AXIAL 5.0" 100CFM | EACH | \$147.00 | 3 | A | |
| 12-19245-00 | BATTERY,3CELL, 3.75V .18MA NIC | EACH | \$19.00 | 3 | A | | 12-23555-01 | FILTER,POWER BUS | EACH | \$96.00 | 3 | A | |
| 12-19245-01 | BATTERY, 3CELL, 3.75V .18MA | EACH | \$38.00 | 3 | A | | 12-23609-04 | FAN,TUBE AXIAL 4.5" | EACH | \$80.00 | 3 | A | |
| 12-19266-00 | ENCODER,MAG/MOTOR ASY W/DRIVE | EACH | \$121.00 | 3 | A | | 12-23676-01 | SENSOR,AIR FLOW | EACH | \$122.00 | 3 | A | |
| 12-19281-00 | LAMP,NEON,TYPE NE51H, 115V | QTY OF 10 | \$4.00 | 3 | A | | 12-23970-01 | BLOWER ASSY,DC BRUSHLESS RA90 | EACH | \$453.00 | 3 | A | |
| 12-19283-00 | FUSE, 250V, LOW BK. CAP. | QTY OF 10 | \$1.00 | 3 | A | | 12-24023-01 | CABLE ASSY,W/WRIST STRAP | EACH | \$141.00 | 3 | A | |
| 12-19283-04 | FUSE 5X20 2.50 A 250V SURGE | EACH | \$8.00 | 3 | A | | 12-24023-02 | CABLE ASSY,ESD WRIST STRAP | EACH | \$141.00 | 3 | A | |
| 12-19283-19 | FUSE, 0.5A 250V | QTY OF 10 | \$4.00 | 3 | A | | 12-24301-01 | INDICATOR LAMP,220VAC,GREEN L | EACH | \$12.00 | 3 | A | |
| 12-19284-00 | FUSE, 1A250V, HGH BRK CAP | QTY OF 10 | \$2.00 | 3 | A | | 12-24301-02 | INDICATOR LAMP,220VAC,RED LEN | EACH | \$10.00 | 3 | A | |
| 12-19284-05 | FUSE, 250V, HIGH BK. CAP. | QTY OF 10 | \$2.00 | 3 | A | | 12-24625-01 | BLOWER, CENT, FWD CURVD | EACH | \$580.00 | Y | 3 | A |
| 12-19284-07 | FUSE, 250V, HIGH BK. CAP. | QTY OF 10 | \$2.00 | 3 | A | | 12-24693-01 | SPRING, DAMPER | EACH | \$49.00 | 3 | A | |
| 12-19321-02 | CONN, POWER 3P5W RCPT 208V60A | EACH | \$498.00 | U | A | | 12-24701-06 | FAN,TUBE AXIAL 3.64" 45CFM | EACH | \$60.00 | 3 | A | |
| 12-19323-01 | CONN,PWR RCPT NEMA L06-30R | EACH | \$14.00 | U | A | | 12-25024-11 | SENSOR,AIR FLOW TEMP | EACH | \$111.00 | 3 | A | |
| 12-19324-01 | CONN,PWR RCPT NEMA L06-20R | EACH | \$25.00 | U | A | | 12-25024-14 | SENSOR,AIR FLOW TEMP BI EXP | EACH | \$150.00 | 3 | A | |
| 12-19477-01 | CONN,COAX 2LINES BNC W/FILTER | EACH | \$74.00 | 3 | A | | 12-25083-01 | CONN, LOOPBACK 6PIN | EACH | \$13.00 | 3 | A | |
| 12-19486-01 | SENSOR, AIR FLOW W/LED | EACH | REPLACED | 3 | A | 12-22805-02 | SW,RKR,MINI DPST ON-OFF | EACH | \$19.00 | 3 | A | | |
| 12-19526-01 | MTG PKG, TEMPERATURE THERM. | EACH | \$114.00 | 3 | A | | 12-25534-01 | CONN, COAX BNC 500HMS | EACH | REPLACED | 3 | A | 4A-H8223-00 |
| 12-19526-02 | THERMAL SENSOR | EACH | \$101.00 | 3 | A | | 12-25547-01 | SW,RKR,ILLUM,DPST,0.5VA, | EACH | \$25.00 | 3 | A | |
| 12-19608-01 | CONN,HI V 7POS SOCKET CRT | EACH | \$10.00 | 3 | A | | 12-25628-01 | CONN, LOOPBACK, MOUSE | EACH | \$38.00 | 3 | A | |
| 12-19857-01 | STANDOFF,NYLON X.750LG | QTY OF 10 | \$.83 | 3 | A | | 12-26148-01 | CONN,PWR RCPT 4P 5W 60A 60HZ | EACH | \$313.00 | U | A | |
| 12-19907-01 | CONN COAX 2LINE ATTENUATOR | EACH | \$99.00 | 3 | A | | 12-26148-02 | CONN,PWR RCPT 4P 5W 30A 50HZ | EACH | \$184.00 | U | A | |
| 12-19910-01 | CKT BKR 8.0A 250V 2P MAGNETIC | EACH | \$114.00 | 3 | A | | 12-27450-01 | SHOCK-VIBRATION MOUNT | EACH | \$21.00 | 3 | A | |
| 12-19912-02 | CKT BKR 4.0 A 250V IP SERIES | EACH | \$23.00 | 3 | A | | 12-27848-01 | BLOWER,BACKWD INCLIN | EACH | \$1,000.00 | 3 | A | |
| 12-20083-02 | CKT BKR 50.0 A 480V 1P | EACH | \$223.00 | 3 | A | | 12-28791-01 | SEAL,CRT .177DIA NEOPRENE | EACH | \$25.00 | 3 | A | |
| 12-20083-03 | CKT BKR 30.0 A 480V 1P | EACH | \$223.00 | 3 | A | | 12-28791-02 | SEAL,REAR COVER .156DIA X40.75 | EACH | \$25.00 | 3 | A | |
| 12-20113-01 | SPRING,COMPRESSION, 300DX | QTY OF 10 | \$.41 | 3 | A | | 12-28791-03 | BEZEL, .16DIA X56.00LG SEAL | EACH | \$25.00 | 3 | A | |
| 12-20113-03 | SPRING,COMPRESSION, 480ODX1.5 | QTY OF 10 | \$.83 | 3 | A | | 12-29221-01 | FAN 115V 50/60HZ 106CFM | EACH | \$80.00 | 3 | A | |
| 12-20114-01 | FASTNER,WIRE PUSH MTG | QTY OF 10 | \$2.00 | 3 | A | | 12-29309-01 | FAN,106CFM 230V 50/60HZ | EACH | \$80.00 | 3 | A | |
| 12-20160-01 | PAD RUBBER 1.75X.38X.125 | QTY OF 10 | \$.72 | 3 | A | | 12-29415-01 | ELASTOMER,CONDUCTIVE | EACH | \$236.00 | 3 | A | |
| 12-20292-01 | WASHER,PLASTIC FOR12-20243-01 | QTY OF 10 | \$2.00 | 3 | A | | 12-29625-01 | THERMOSTAT NC O@163 | EACH | \$143.00 | 3 | A | |
| 12-20293-01 | CAP,SNAP OFF WHITE | QTY OF 10 | \$2.00 | 3 | A | | 12-29627-01 | THERMOSTAT NO C@140 O@125 | EACH | \$110.00 | 3 | A | |
| 12-20365-03 | CONN,D SUB 25PIN ASSY RT ANG | EACH | \$55.00 | 3 | A | | 12-29628-01 | THERMOSTAT NC O@160 | EACH | \$143.00 | 3 | A | |
| 12-20398-01 | CONN,D SUB 9PIN ASSY RT ANGLE | EACH | \$6.00 | 3 | A | | 12-29667-01 | FAN, 120V 235CFM 6.0"DIA | EACH | \$211.00 | 3 | A | |
| 12-20398-02 | CONN,D SUB 15PIN ASSY RT ANG | EACH | \$6.00 | 3 | A | | 12-29667-02 | FAN, 230V 235CFM 6.0"DIA | EACH | \$219.00 | 3 | A | |
| 12-20398-03 | CONN,D SUB 25PIN ASSY RT ANG | EACH | \$7.00 | 3 | A | | | | | | | | |
| 12-20523-01 | CONN,POWER 04P4W RCPT 600V30A | EACH | \$369.00 | U | A | | | | | | | | |
| 12-20936-01 | CKT BKR 2.0 A 250V 2P MAGN. | EACH | \$109.00 | 3 | A | | | | | | | | |
| 12-21119-01 | BLOWER,CENTRIFUGAL 200CFM 12V | EACH | \$345.00 | 3 | A | | | | | | | | |
| 12-21126-01 | FUSE=HOLDER 12A, 250V | QTY OF 10 | \$4.00 | 3 | A | | | | | | | | |
| 12-21126-03 | FUSE CARRIER 3AG FUSE | QTY OF 10 | \$4.00 | 3 | A | | | | | | | | |
| 12-21126-04 | FUSE CARRIER 5X20 MM FUSE | EACH | \$5.00 | 3 | A | | | | | | | | |
| 12-21246-01 | LOOP BACK CONNECTOR 62 PIN | EACH | \$25.00 | 3 | A | | | | | | | | |
| 12-21974-01 | MUFFLER,AIR MOVING | EACH | \$362.00 | 3 | A | | | | | | | | |
| 12-22271-01 | FAN, TUBE AXIAL 4.5" | EACH | \$105.00 | 3 | A | | | | | | | | |
| 12-22307-01 | BLOWER,CENT,FWD CURVD 1450CFM | EACH | \$1,230.00 | 3 | A | | | | | | | | |
| 12-22307-03 | BLOWER,CENT,FWD CURVD 1450CFM | EACH | \$1,043.00 | 3 | A | | | | | | | | |
| 12-22355-09 | SW, RKR DPST ON-OFF 16A/250V | EACH | \$11.00 | 3 | A | | | | | | | | |
| 12-22355-10 | SW,RKR DPST ON-NONE-OFF | EACH | \$13.00 | 3 | A | | | | | | | | |
| 12-22707-01 | BLOWER,FORWD CURVED 300CFM | EACH | REPLACED | 3 | A | 12-22707-02 | | | | | | | |
| 12-22707-02 | BLOWER,FORWD CURVED,300CFM 24 | EACH | \$548.00 | 3 | A | | | | | | | | |
| 12-22805-01 | SENSOR, AIR FLOW W/LED | EACH | \$108.00 | 3 | A | | | | | | | | |
| 12-22805-02 | SENSOR,AIR FLOW W/LED | EACH | \$150.00 | 3 | A | | | | | | | | |
| 12-22845-01 | SW,SUBMINI,SPDT,LEV ACTUATOR | EACH | \$30.00 | 3 | A | | | | | | | | |
| 12-23034-01 | FILTER,AIR ALUM FRAMED | EACH | \$24.00 | 3 | A | | | | | | | | |
| | | | | | | | 13 CLASS Resistors | | | | | | |
| | | | | | | | 13-00005-01 | R NETWORK 13-1K RESISTORS 5% | EACH | \$8.00 | 3 | A | |
| | | | | | | | 13-00005-03 | R NETWORK 13-10K RESISTORS 5% | EACH | \$7.00 | 3 | A | |
| | | | | | | | 13-00005-07 | R NETWORK 15-4.7K RESISTORS | QTY OF 10 | \$4.00 | 3 | A | |
| | | | | | | | 13-00219-00 | 68 /4W 5% C | QTY OF 10 | \$.41 | 3 | A | |
| | | | | | | | 13-00243-00 | 120 /2W 5% C | QTY OF 10 | \$1.00 | 3 | A | |
| | | | | | | | 13-00249-00 | 150 /2W 5% C | QTY OF 10 | \$.63 | 3 | A | |
| | | | | | | | 13-00250-00 | 150 /4W 5% C | QTY OF 10 | \$.41 | 3 | A | |
| | | | | | | | 13-00271-00 | 220 /4W 5% C | QTY OF 10 | \$.41 | 3 | A | |
| | | | | | | | 13-00316-00 | 470 /4W 5% C | QTY OF 10 | \$.41 | 3 | A | |
| | | | | | | | 13-00341-00 | ORDER 13-04693-00 | QTY OF 10 | REPLACED | 3 | A | 13-04693-00 |
| | | | | | | | 13-00426-00 | 2.7 K 1/4W 5% C | QTY OF 10 | \$.41 | 3 | A | |
| | | | | | | | 13-00447-00 | 4.7 K 1/4W 5% C | QTY OF 10 | \$.41 | 3 | A | |
| | | | | | | | 13-01322-00 | 180 /4W 5% C | QTY OF 10 | \$.41 | 3 | A | |
| | | | | | | | 13-01422-00 | 7.5 K 1/4W 5% C | QTY OF 10 | \$.41 | 3 | A | |
| | | | | | | | 13-01522-00 | 27 /4W 5% C | QTY OF 10 | \$.41 | 3 | A | |



Prices Effective 02-January-89 to 30-June-89
 To Order—Call DECdirect™ TOLL-FREE 800-344-4825, 8:30 a.m. to 8:00 p.m. ET in Continental U.S.A.

HARDWARE SPARES PRICE LIST

| PART NUMBER | DESCRIPTION | UNIT ORDER | UNIT PRICE | REP D L | REPLACEMENT PART NUMBER | PART NUMBER | DESCRIPTION | UNIT ORDER | UNIT PRICE | REP D L | REPLACEMENT PART NUMBER |
|-------------|--------------------------------|------------|------------|---------|-------------------------|-------------|------------------|------------|------------|---------|-------------------------|
| 15-09605-00 | DEC4920 NPN 30WC SI 80 20 | QTY OF 10 | \$4.00 | 3 A | | 15-20093-01 | BC237B NPN TO-92 | QTY OF 10 | \$2.00 | 3 A | |
| 15-09605-01 | DEC4920-1 PNP 30WC SI 80 20 | EACH | \$5.00 | 3 A | | | | | | | |
| 15-09632-00 | DEC2007 NPN 5WC SI 35 | QTY OF 10 | \$6.00 | 3 A | | | | | | | |
| 15-09649-00 | DEC3762 PNP 4WC SI 40 30 | EACH | REPLACED | 3 A | 15-09649-01 | | | | | | |
| 15-09649-01 | 3762 PNP 4W SI 40 35 | EACH | \$5.00 | 3 A | | | | | | | |
| 15-09700-00 | 2N 4036 PNP 7WC SI 80100 | EACH | \$6.00 | 3 A | | | | | | | |
| 15-10008-00 | 2N 3055A NPN 115WC SI 60 20 | EACH | \$5.00 | 3 A | | | | | | | |
| 15-10015-00 | 4008 NPN 600MW SI4CORED | EACH | \$7.00 | 3 A | | | | | | | |
| 15-10062-00 | DEC3734 NPN 4WC SI 30 25 | QTY OF 10 | \$4.00 | 3 A | | | | | | | |
| 15-10070-00 | TRIAC@400V,I> 8A #RCA40669 | EACH | \$4.00 | 3 A | | | | | | | |
| 15-10196-00 | 2N 5302/HSNPN 200WC SI 60 40 | EACH | \$13.00 | 3 A | | | | | | | |
| 15-10334-00 | DEC4502 PNP 200WC SI 90 25 | EACH | \$15.00 | 3 A | | | | | | | |
| 15-10335-00 | DEC 802 NPN 200WC SI 90 25 | EACH | \$12.00 | 3 A | | | | | | | |
| 15-10414-00 | D 45C6 PNP 30WT SI 45 20 | QTY OF 10 | \$5.00 | 3 A | | | | | | | |
| 15-10421-00 | D 44C8 NPN 30WT SI 60 20 | QTY OF 10 | \$4.00 | 3 A | | | | | | | |
| 15-10555-00 | MJE3055 NPN 90WC SI 60 20 | EACH | \$4.00 | 3 A | | | | | | | |
| 15-10598-00 | DEC45C8 PNP 27WT SI 60 20 | QTY OF 10 | \$4.00 | 3 A | | | | | | | |
| 15-10705-01 | B 05 NPN 500MW SI 60 50 | QTY OF 10 | \$1.00 | 3 A | | | | | | | |
| 15-10706-00 | XA 55 PNP 500MW SI 60 50 | QTY OF 10 | \$1.00 | 3 A | | | | | | | |
| 15-10706-01 | B 55 PNP 500MW SI 60 50 | QTY OF 10 | \$1.00 | 3 A | | | | | | | |
| 15-10707-00 | D 44H8 NPN 25W SI 60@2A | EACH | \$4.00 | 3 A | | | | | | | |
| 15-10708-00 | D 45H8 PNP 50WT SI 60 60 | EACH | \$6.00 | 3 A | | | | | | | |
| 15-10708-01 | D 45H8CPNP 50WT SI 60 60 | EACH | \$6.00 | 3 A | | | | | | | |
| 15-10708-02 | D 45H8BPNP 50WT SI 60 60 | EACH | \$4.00 | 3 A | | | | | | | |
| 15-10712-00 | MJ 900 PNP 90WC SI 60 1K | EACH | \$7.00 | 3 A | | | | | | | |
| 15-10727-00 | OPTO COUPLED RELA | EACH | \$11.00 | 3 A | | | | | | | |
| 15-10727-01 | OPTO COUPLED ISOLA | EACH | \$7.00 | 3 A | | | | | | | |
| 15-10765-00 | TRLAC@100V,I8A #SCL46A | QTY OF 10 | \$4.00 | 3 A | | | | | | | |
| 15-10877-00 | 2N 6028 UJT 300MW R67B | QTY OF 10 | \$4.00 | 3 A | | | | | | | |
| 15-10928-00 | C32AX135 SCR@100V I=25A | EACH | \$11.00 | 3 A | | | | | | | |
| 15-10969-00 | 2N 5038 NPN 140WC SI 90 50 | EACH | \$14.00 | 3 A | | | | | | | |
| 15-11102-00 | 4011 QUAD CORE DRIVER | EACH | REPLACED | 3 A | 15-13265-00 | | | | | | |
| 15-11282-00 | MJ2500 PNP 150WC SI 60 5 1K | EACH | \$8.00 | 3 A | | | | | | | |
| 15-11349-00 | TIP 640 (OR MJ3000) NPN DARLI | EACH | \$5.00 | 3 A | | | | | | | |
| 15-11686-00 | DEC5433 FET N 350MW 10 25 | EACH | \$4.00 | 3 A | | | | | | | |
| 15-11906-00 | PHOTOXTOR 2MA H=5 #SD1440-2 | EACH | \$5.00 | 3 A | | | | | | | |
| 15-12589-00 | PNP 40W SI 60 25 | QTY OF 10 | \$4.00 | 3 A | | | | | | | |
| 15-12590-00 | NPN 40W SI 60 25 | QTY OF 10 | \$4.00 | 3 A | | | | | | | |
| 15-12652-00 | 2N 6490 PNP 50W SI 60 40 | EACH | \$6.00 | 3 A | | | | | | | |
| 15-12782-00 | NPN 100W S1325 15 | EACH | \$13.00 | 3 A | | | | | | | |
| 15-12790-00 | D 44C11 NPN 30W SI 80 40 | QTY OF 10 | \$4.00 | 3 A | | | | | | | |
| 15-12971-00 | A5T4260 PNP 500MW SI-15 20 | QTY OF 10 | \$4.00 | 3 A | | | | | | | |
| 15-13265-00 | 3725 QUAD CORE DRIVER | EACH | \$6.00 | 3 A | | | | | | | |
| 15-13697-00 | 2N 5640 FET N CHNLL | QTY OF 10 | \$2.00 | 3 A | | | | | | | |
| 15-14195-00 | 2N 6547 NPN 400V SI 15A | EACH | \$15.00 | 3 A | | | | | | | |
| 15-14271-01 | 44Q5 NPN 31W 31225 30 | QTY OF 10 | \$4.00 | 3 A | | | | | | | |
| 15-14508-00 | TIP 121 NPN 65W SI80 1000 | QTY OF 10 | \$5.00 | 3 A | | | | | | | |
| 15-14509-00 | TIP 125 NPN 65W SI 60 500 | QTY OF 10 | \$4.00 | 3 A | | | | | | | |
| 15-16490-00 | MPSU05 NPN 10W SI 2A | QTY OF 10 | \$2.00 | 3 A | | | | | | | |
| 15-16532-00 | NPN 125W S1250 25 | EACH | \$5.00 | 3 A | | | | | | | |
| 15-17534-00 | BU 407D NPN POWER TRANS | QTY OF 10 | \$4.00 | 3 A | | | | | | | |
| 15-19535-01 | D40D7 NPN 50MW 60V 1A | QTY OF 10 | \$4.00 | 3 A | | | | | | | |
| 15-20089-01 | MDS 20 NPN 2W 250V 1.5A | QTY OF 10 | \$4.00 | 3 A | | | | | | | |
| 15-20090-01 | 13006 NPN 80W 300V 8A | EACH | \$6.00 | 3 A | | | | | | | |
| 15-20092-01 | MTP5N05 FET TO-220 | EACH | \$7.00 | 3 A | | | | | | | |
| 16-02723-00 | 1000 UH 5% 140MA #WEE100 | QTY OF 10 | \$4.00 | 3 A | | | | | | | |
| 16-05528-00 | DELAY= 30NS,0TAPS DL5184 | EACH | \$15.00 | 3 A | | | | | | | |
| 16-05529-00 | DELAY=25-250NS,10TAPS DL518 | EACH | \$67.00 | 3 A | | | | | | | |
| 16-09428-00 | DELAY= 50NS,0TAPS D0150 | EACH | \$19.00 | 3 A | | | | | | | |
| 16-09478-00 | PULSE XFMR 17Z-5SPRAGUE BALU | EACH | \$51.00 | 3 A | | | | | | | |
| 16-09478-01 | PULSE XFMR,QUAD,DIP, #17Z- | EACH | \$15.00 | 3 A | | | | | | | |
| 16-09559-00 | DELAY= 00NS,0TAPS D10100 | EACH | \$20.00 | 3 A | | | | | | | |
| 16-09620-00 | 2.2 UH #RFC52 | QTY OF 10 | \$4.00 | 3 A | | | | | | | |
| 16-09651-00 | PULSE XFMR T-20 8010 DUALLIN | EACH | \$11.00 | 3 A | | | | | | | |
| 16-09996-00 | PULSE XFMR BH001-0107 DEC5 2 | EACH | \$8.00 | 3 A | | | | | | | |
| 16-10033-00 | DELAY=10-100NS,9TAPS | EACH | \$27.00 | 3 A | | | | | | | |
| 16-10080-00 | DELAY= 8NS,0TAPS | EACH | \$20.00 | 3 A | | | | | | | |
| 16-10177-00 | XFMR P=AB S= 24@.05A+#MMC395 | EACH | \$121.00 | 3 A | | | | | | | |
| 16-10573-00 | 120.0 UH INDUCTOR | EACH | \$27.00 | 3 A | | | | | | | |
| 16-10601-01 | XFMR P=35V SCREWS 1D1RECTIO | EACH | \$109.00 | 3 A | | | | | | | |
| 16-10662-00 | 100.0 UH 10% 165MA #DD1 0 | QTY OF 10 | \$4.00 | 3 A | | | | | | | |
| 16-10717-00 | 80.0 UH 20A | EACH | \$51.00 | 3 A | | | | | | | |
| 16-10849-00 | 170.0 UH 7.5A #MMC434 | EACH | \$21.00 | 3 A | | | | | | | |
| 16-10850-00 | 44. UH 25A #MMC434 | EACH | \$26.00 | 3 A | | | | | | | |
| 16-10961-00 | XFMR,SATURATING(INHIBIT) | EACH | \$20.00 | 3 A | | | | | | | |
| 16-10962-00 | XFMR,SATURATING(Y.7) | EACH | \$42.00 | 3 A | | | | | | | |
| 16-10963-00 | 400 UH 90MA,30HMS | EACH | \$8.00 | 3 A | | | | | | | |
| 16-11000-00 | .22UH VARIABLE L#WEEVL.2 | EACH | \$21.00 | 3 A | | | | | | | |
| 16-11031-00 | 100 UH 0A#1300-010 | EACH | \$53.00 | 3 A | | | | | | | |
| 16-11178-00 | XFMR P=AB S= 24@9MA #PFD4100 | EACH | \$17.00 | 3 A | | | | | | | |
| 16-11197-00 | DELAY=50-500NS,10TAPS \$\$\$\$ | EACH | \$27.00 | 3 A | | | | | | | |
| 16-11243-00 | DELAY=25-250NS,10TAPS RCL#L-1 | EACH | \$27.00 | 3 A | | | | | | | |
| 16-11300-00 | DELAY= 10-125NS,6TAPS FAST R | EACH | \$27.00 | 3 A | | | | | | | |
| 16-11327-00 | DELAY= 25NS,0 TAPS | EACH | \$20.00 | 3 A | | | | | | | |
| 16-11444-00 | BALUM 20MHZ@1KHZ & 1VRMS | EACH | \$108.00 | 3 A | | | | | | | |
| 16-11646-00 | XFMR P=AB S=20DC @220MA | EACH | \$58.00 | 3 A | | | | | | | |
| 16-11868-00 | 500 UH 20% 5A | EACH | \$21.00 | 3 A | | | | | | | |
| 16-12119-00 | XFMR,INHIBIT,DUAL 9PIN SIP | EACH | \$7.00 | 3 A | | | | | | | |
| 16-12256-00 | XFMR P=AB S= 42DC@2.67A+ 60H | EACH | \$196.00 | 3 A | | | | | | | |
| 16-12342-00 | XFMR P=AB S=48CT | EACH | \$43.00 | 3 A | | | | | | | |
| 16-12398-00 | XFMR P= AB 3= 26DC@3.5A | EACH | \$260.00 | 3 A | | | | | | | |
| 16-12463-00 | DELAY= 50NS,10TAPS | EACH | \$33.00 | 3 A | | | | | | | |
| 16-12521-00 | XFMR P=AB S= 24DC + 50H | EACH | \$119.00 | 3 A | | | | | | | |
| 16-12522-00 | XFMR P=AB S= 24DC + 60H | EACH | \$116.00 | 3 A | | | | | | | |
| 16-12584-00 | 50 UH 30A | EACH | \$25.00 | 3 A | | | | | | | |
| 16-12592-00 | PULSE XFMR,RATIO 4:1 | EACH | \$25.00 | 3 A | | | | | | | |
| 16-12593-00 | 500 UH 6A | EACH | \$25.00 | 3 A | | | | | | | |
| 16-12920-02 | PULSE XFMR 30KHZ VT61 | EACH | \$8.00 | 3 A | | | | | | | |
| 16-13120-00 | DELAY=200 NS, 10TAPS | EACH | \$20.00 | 3 A | | | | | | | |
| 16-13713-00 | CHOKE, 5 UH 32A | EACH | \$13.00 | 3 A | | | | | | | |



Prices Effective 02-January-89 to 30-June-89
 To Order—Call DECdirect™ TOLL-FREE 800-344-4825, 8:30 a.m. to 8:00 p.m. ET in Continental U.S.A.

HARDWARE SPARES PRICE LIST

| PART NUMBER | DESCRIPTION | UNIT ORDER | UNIT PRICE | REP D | L | REPLACEMENT PART NUMBER | PART NUMBER | DESCRIPTION | UNIT ORDER | UNIT PRICE | REP D | L | REPLACEMENT PART NUMBER |
|------------------------|-------------------------------|------------|------------|-------|---|-------------------------|--------------------------|-------------------------------|------------|------------|-------|---|-------------------------|
| 16-13714-00 | 2 UH 20A | EACH | \$7.00 | 3 | A | | 17-00280-00 | CABLE,ASSY 16COND,CT-150 | EACH | \$15.00 | 3 | A | |
| 16-13897-00 | XFMR P=AB S=11.5@6A | EACH | \$113.00 | 3 | A | | 17-00282-00 | CABLE,ASSY 20COND. PC350 | EACH | \$19.00 | 3 | A | |
| 16-14159-00 | DELAY 50NS, TAPS | EACH | \$23.00 | 3 | A | | 17-00282-01 | CABLE ASSY, 20 COND, 12 IN. | EACH | \$21.00 | 3 | A | |
| 16-14204-00 | PULSE XFMR 20312 BASE DRIVE | EACH | \$19.00 | 3 | A | | 17-00285-00 | CABLE,ASSY 34COND,CT-150 | EACH | \$25.00 | 3 | A | |
| 16-14272-00 | PULSE XFMR, 4 WOUND | EACH | \$12.00 | 3 | A | | 17-00286-00 | CABLE ASSY, 34 COND, 7 IN. | EACH | \$24.00 | 3 | A | |
| 16-14273-00 | PULSE XFMR, TRI-WOUND | EACH | \$12.00 | 3 | A | | 17-00286-01 | CABLE ASSY, 34 COND, 12 IN | EACH | \$24.00 | 3 | A | |
| 16-14510-00 | XFMR P=AB S=21V 60HZ | EACH | \$163.00 | 3 | A | | 17-00294-00 | CABLE, ASSY, CT150 KEYBOARD | EACH | \$9.00 | 3 | A | |
| 16-14510-01 | XFMR P=AB S=21V 50HZ | EACH | \$201.00 | 3 | A | | 17-00307-01 | CABLE ASSY,16 COND. W/CONN | EACH | \$40.00 | 3 | A | |
| 16-14778-00 | XFMR P-AB S=6.0 @ 100MA | EACH | \$13.00 | 3 | A | | 17-00318-01 | CABLE ASSY,CT25 MOTHERBRD PWR | EACH | REPLACED | 3 | A | 17-00318-02 |
| 16-15099-00 | TRANSFORMER P=120 S=18@ .1A | EACH | \$123.00 | 3 | A | | 17-00318-02 | CABLE ASSY, MOTHERBOARD PWR | EACH | \$24.00 | 3 | A | |
| 16-15251-00 | 42.0 UH VARIABLE L 11A | EACH | \$11.00 | 3 | A | | 17-00342-01 | CABLE ASSY, DC POWER 3.0"LG | EACH | \$10.00 | 3 | A | |
| 16-15252-00 | 210.0 UH VARIABLE 2.75A | EACH | \$8.00 | 3 | A | | 17-00342-02 | CABLE ASSY, DC POWER 7.5"LG | EACH | \$12.00 | 3 | A | |
| 16-15253-00 | XFMR P=AB S=25V | EACH | \$14.00 | 3 | A | | 17-00397-01 | CABLE ASSY, COIL CORD 14' LG | EACH | \$36.00 | 3 | A | |
| 16-15559-00 | XFMR P=240/360DC S=5/+21@45W | EACH | \$23.00 | 3 | A | | 17-00427-01 | CABLE ASSY 30COND 28AWG BRAID | EACH | \$95.00 | 3 | A | |
| 16-15668-00 | XFMR P=245-360V S=5V @ 2.5A | EACH | REPLACED | 3 | A | 16-15668-01 | 17-00428-02 | CABLE ASSY, 16 COND, FLAT,19 | EACH | \$38.00 | 3 | A | |
| 16-15668-01 | XFMR P=240/480 S=120 | EACH | \$25.00 | 3 | A | | 17-00463-01 | CBL,COAX,ASSY,SI SHIELDED RIB | EACH | \$260.00 | 3 | A | |
| 16-16237-00 | XFMR P=AB S=15@150MA 50HZ | EACH | \$24.00 | 3 | A | | 17-00465-03 | CBL,COAX,ASSY,SI SHIELDED RIB | EACH | \$187.00 | 3 | A | |
| 16-16309-02 | XFMR,HORIZONTAL DRIVE | QTY OF 10 | \$4.00 | 3 | A | | 17-00465-04 | CABLE,COAX,ASSY,SI SHIELD. RI | EACH | \$185.00 | 3 | A | |
| 16-16463-00 | XFMR, FLYBACK | EACH | REPLACED | 3 | A | 70-17363-01 | 17-00718-01 | CABLE ASSY, MOTHERBOARD PWR | EACH | \$48.00 | 3 | A | |
| 16-16536-00 | XFMR HORIZONTAL WIDTH | QTY OF 10 | \$5.00 | 3 | A | | 17-00717-01 | CABLE ASSY, CI CONN | EACH | \$150.00 | 3 | A | |
| 16-16538-00 | COIL,HORIZONTAL,LINEAR | QTY OF 10 | \$4.00 | 3 | A | | 17-00861-01 | CABLE ASSY, 50COND, SIGNAL | EACH | \$29.00 | 3 | A | |
| 16-17186-01 | XFMR P=A S=5/+12/-23V@.5A | EACH | \$18.00 | 3 | A | | 17-00862-01 | CABLE ASSY, I/O | EACH | \$34.00 | 3 | A | |
| 16-17492-00 | XFMR S=240-360V S=5/+24V | EACH | \$103.00 | 3 | A | | 17-00951-02 | CABLE, COAX | EACH | \$286.00 | Y | 3 | A |
| 16-18013-00 | 10.0 UH 20A | QTY OF 10 | \$2.00 | 3 | A | | 17-00958-01 | CABLE ASSY, COAX SHLD | EACH | \$172.00 | 3 | A | |
| 16-18238-02 | BEAD,FERRITE .138OD X .330LG | QTY OF 10 | \$4.1 | 3 | A | | 17-01096-06 | WIRE HARN ASSY 04COND | EACH | REPLACED | 3 | A | 70-22492-02 |
| 16-18437-00 | BEAD,FERRITE .23600 X .394LG | QTY OF 10 | \$4.1 | 3 | A | | 17-01190-01 | WIRE HARN, ASSY. | EACH | \$15.00 | 3 | A | |
| 16-20097-01 | XFMR,FLYBACK,HIGH VOLTAGE | EACH | \$19.00 | 3 | A | | 17-01276-01 | PWR CORD,TERM MALE PLUG-RING | EACH | \$25.00 | 3 | A | |
| 16-23370-01 | XFMR, POWER 120VAC 47-63HZ | EACH | \$60.00 | 3 | A | | 17-01276-02 | PWR CORD,TERM SHR PLUG-MATNLO | EACH | \$21.00 | 3 | A | |
| 16-24764-01 | XFMR P=6KV 50-60HZ | EACH | \$2,310.00 | 3 | A | | 17-01278-03 | PWR CORD,TERM SHR PLUG-MATENL | EACH | \$21.00 | 3 | A | |
| 16-28393-01 | XFMR,AUTO,3PHASE 50HZ 4.5KVA | EACH | \$450.00 | 3 | A | | 17-01395-01 | DISPLAY STATION CABLE | EACH | \$175.00 | 3 | A | |
| 17 CLASS Cables | | | | | | | 17-01479-01 | CABLE, COAX | EACH | \$196.00 | 3 | A | |
| 17-00021-00 | SHIELD,ELECTROMAG,7-1/2X15 | EACH | \$50.00 | 3 | A | | 17-01943-01 | CABLE ASSY,12 COND,MOLDED,SHL | EACH | \$527.00 | 3 | A | |
| 17-00083-02 | PWR CORD,TERM 75IN,14-3 125V | EACH | \$13.00 | 3 | A | | 18 CLASS Crystals | | | | | | |
| 17-00083-07 | PWR CORD,TERM 75IN,16-3 125V | EACH | \$13.00 | 3 | A | | 18-05501-01 | XTAL 1.000 MHZ | EACH | \$38.00 | 3 | A | |
| 17-00083-09 | PWR CORD,TERM 75IN,18-3 125V | EACH | \$13.00 | 3 | A | | 18-05501-05 | XTAL 1.152 MHZ | EACH | \$30.00 | 3 | A | |
| 17-00083-10 | VT100 POWER CORD | EACH | \$13.00 | 3 | A | | 18-05501-07 | XTAL 4.608 MHZ | EACH | \$13.00 | 3 | A | |
| 17-00083-11 | PWR CORD, TERM 3-18 SJT 125V | EACH | \$8.00 | 3 | A | | 18-05501-13 | XTAL 1.008 MHZ | EACH | \$46.00 | 3 | A | |
| 17-00083-23 | PWR CORD,TERM.108IN,14-3,125V | EACH | \$26.00 | 3 | A | | 18-05502-07 | XTAL 19.2 KHZ | EACH | \$63.00 | 3 | A | |
| 17-00083-24 | PWR CORD,TERM.108IN,14-3,250V | EACH | \$26.00 | 3 | A | | 18-05505-01 | XTAL 614.4 KHZ | EACH | \$34.00 | 3 | A | |
| 17-00083-44 | PWR CORD TERM 18-3SJT | EACH | \$40.00 | 3 | A | | 18-09880-00 | XTAL 20 MHZ | EACH | \$14.00 | 3 | A | |
| 17-00087-00 | 20 CON. FLAT CABLE, 4" | EACH | \$95.00 | 3 | A | | 18-09880-02 | XTAL 19.661 MHZ | EACH | \$14.00 | 3 | A | |
| 17-00087-01 | CABLE,RIBBON,20 COND,ASSY 12" | EACH | \$107.00 | 3 | A | | 18-09880-06 | XTAL 18.000 MHZ | EACH | \$14.00 | 3 | A | |
| 17-00107-01 | CABLE ASSY. | EACH | \$38.00 | 3 | A | | 18-09880-07 | XTAL 20.277 MHZ | EACH | \$14.00 | 3 | A | |
| 17-00119-02 | WIRE HARN ASSY 16COND 26AWG | EACH | \$18.00 | 3 | A | | 18-09880-10 | XTAL 15.206 MHZ | EACH | \$15.00 | 3 | A | |
| 17-00120-00 | CABLE,ASSY,W/16 PIN CONN | EACH | \$25.00 | 3 | A | | 18-10694-00 | XTAL 33.333 MHZ | EACH | \$30.00 | 3 | A | |
| 17-00150-01 | PWR CORD,18-3,RETRACTILE 11" | EACH | \$13.00 | 3 | A | | 18-10694-03 | XTAL 2.88 MHZ | EACH | \$38.00 | 3 | A | |
| 17-00150-02 | PWR CORD,18-3 | EACH | \$13.00 | 3 | A | | 18-10694-04 | XTAL 3.090 MHZ | EACH | \$63.00 | 3 | A | |
| 17-00165-01 | CABLE,ASSY,18 COND,MULTI AWG | EACH | \$55.00 | 3 | A | | 18-10694-06 | XTAL 24.88332 MHZ | EACH | \$12.00 | 3 | A | |
| 17-00199-00 | PWR CORD, TERM .2M,18-3, 250V | EACH | \$13.00 | 3 | A | | | | | | | | |
| 17-00209-00 | PWR CORD, TERM 2.5M, .75MM-3 | EACH | \$18.00 | 3 | A | | | | | | | | |
| 17-00210-00 | PWR CORD,TERM,2.5M .75-3,250V | EACH | \$13.00 | 3 | A | | | | | | | | |



Prices Effective 02-January-89 to 30-June-89

To Order—Call DECdirect™ TOLL-FREE 800-344-4825, 8:30 a.m. to 8:00 p.m. ET in Continental U.S.A.

HARDWARE SPARES PRICE LIST

| PART NUMBER | DESCRIPTION | UNIT ORDER | UNIT PRICE | REP D | L | REPLACEMENT PART NUMBER | PART NUMBER | DESCRIPTION | UNIT ORDER | UNIT PRICE | REP D | L | REPLACEMENT PART NUMBER |
|----------------------|-------------------------------|------------|------------|-------|---|-------------------------|-------------|-------------------------------|------------|------------|-------|---|-------------------------|
| 18-11110-00 | XTAL 2.304 MHZ | EACH | \$27.00 | 3 | A | | 19-10046-00 | 7442 DECODER-1 OF 10,B | QTY OF 10 | \$2.00 | 3 | A | |
| 18-11163-00 | XTAL 5.0688 MHZ | EACH | \$21.00 | 3 | A | | 19-10087-00 | DEC 4015 FF-D QUAD,15MHZ,C | EACH | \$7.00 | 3 | A | |
| 18-11660-00 | OSCILLATOR, CRYSTAL 20MHZ, 14 | EACH | \$43.00 | 3 | A | | 19-10091-00 | DEC 7437 NAND GATE-QUAD 2I | QTY OF 10 | \$2.00 | 3 | A | |
| 18-11660-01 | OSCILLATOR, CRYSTAL, 10MHZ, 1 | EACH | \$42.00 | 3 | A | | 19-10153-00 | DEC 74150 MUX 1 OF 16 | QTY OF 10 | \$6.00 | 3 | A | |
| 18-11660-02 | OSCILLATOR, CRYSTAL, 5.0688MH | EACH | \$43.00 | 3 | A | | 19-10155-00 | DEC 7408 AND GATE,POS.QUAD | QTY OF 10 | \$2.00 | 3 | A | |
| 18-11660-05 | OCILLATOR XTAL 33.330 MHZ.1 | EACH | \$46.00 | 3 | A | | 19-10206-00 | DEC 402 SHIFT REG.,MSO QU | EACH | \$21.00 | 3 | A | |
| 18-11660-08 | OSCILLATOR, CRYSTAL 2.619MHZ, | EACH | \$140.00 | 3 | A | | 19-10224-00 | DEC 7485 COMPARATOR-4BIT | QTY OF 10 | \$4.00 | 3 | A | |
| 18-11660-12 | OSCILLATOR, XTAL | EACH | \$34.00 | 3 | A | | 19-10230-00 | 74121 ONE SHOT | QTY OF 10 | \$2.00 | 3 | A | |
| 18-11660-20 | OSCILLATOR,XTAL 14PIN DIP | EACH | \$18.00 | 3 | A | | 19-10236-00 | DEC 7426 NAND GATE-QUAD 2I | QTY OF 10 | \$2.00 | 3 | A | |
| 18-11689-00 | XTAL 1.689600 MHZ | EACH | \$19.00 | 3 | A | | 19-10257-00 | 2602 ONE SHOT-DUAL | QTY OF 10 | REPLACED | 3 | A | 19-10951-00 |
| 18-12131-00 | OSCILLATOR,CRYSTAL 13.824MHZ | EACH | \$39.00 | 3 | A | | 19-10268-00 | DEC 75107B RECEIVER,LINE,DU | EACH | \$6.00 | 3 | A | |
| 18-12396-00 | XTAL 2.4576 MHZ | EACH | \$25.00 | 3 | A | | 19-10282-00 | 301AN OP AMP | QTY OF 10 | \$2.00 | 3 | A | |
| 18-12396-03 | XTAL 4.000 MHZ | EACH | \$13.00 | 3 | A | | 19-10298-00 | 741 OP AMP GEN PURP. | QTY OF 10 | \$2.00 | 3 | A | |
| 18-12396-08 | XTAL 8.000 MHZ | EACH | \$11.00 | 3 | A | | 19-10322-00 | DEC 488L DRIVER,LINE,QUAD | EACH | \$6.00 | 3 | A | |
| 18-14830-00 | OSCILLATOR,CRYSTAL 24.073MHZ | EACH | \$36.00 | 3 | A | | 19-10323-00 | DEC 489L RECEIVER,LINE,QU | EACH | \$6.00 | 3 | A | |
| 19 CLASS IC's | | | | | | | | | | | | | |
| 19-05521-00 | 540G SENSE AMP,CORE M | EACH | \$7.00 | 3 | A | | 19-10389-00 | DEC 7314 NOR GATE-SINGLE 7 | QTY OF 10 | \$4.00 | 3 | A | |
| 19-05547-00 | DEC 7474 FF-D DUAL,EDGE TR | QTY OF 10 | \$2.00 | 3 | A | | 19-10390-00 | DEC 7380 NOR GATE-QUAD 2IN | QTY OF 10 | \$6.00 | 3 | A | |
| 19-05575-00 | 7400 NAND GATE-QUAD 2I | QTY OF 10 | \$2.00 | 3 | A | | 19-10391-00 | DEC 5314 NOR GATE-SINGLE 7 | QTY OF 10 | \$6.00 | 3 | A | |
| 19-05576-00 | 7410 NAND GATE-TRIPLE | QTY OF 10 | \$2.00 | 3 | A | | 19-10393-00 | DEC 7384 OR GATE-QUAD 2IN, | QTY OF 10 | \$4.00 | 3 | A | |
| 19-05585-00 | 7476 FF-JK DUAL,MASTER | QTY OF 10 | \$2.00 | 3 | A | | 19-10396-00 | DEC 7489 MEMORY READ/WRITE | EACH | \$8.00 | 3 | A | |
| 19-05586-00 | 74H40 NAND GATE-DUAL 4I | EACH | \$10.00 | 3 | A | | 19-10409-00 | DEC 74H103 FF-JK DUAL,EDGE T | QTY OF 10 | \$6.00 | 3 | A | |
| 19-09051-00 | 7490 COUNTER,ASYNCH UP | QTY OF 10 | \$4.00 | 3 | A | | 19-10415-00 | 723 VOLT,REG,VAR 2 | QTY OF 10 | \$6.00 | 3 | A | |
| 19-09054-00 | 7493 COUNTER,ASYNCH UP | QTY OF 10 | \$2.00 | 3 | A | | 19-10436-00 | DEC 74123 ONE SHOT-DUAL,RET | QTY OF 10 | \$4.00 | 3 | A | |
| 19-09055-00 | DEC 7495 SHIFT REG.,4BIT P | QTY OF 10 | \$4.00 | 3 | A | | 19-10454-00 | DEC 9318 ENCODER, 8 INPUT | QTY OF 10 | \$6.00 | 3 | A | |
| 19-09063-00 | DEC 74H55 A-0-I XPNDBLE GAT | EACH | \$10.00 | 3 | A | | 19-10459-00 | UART ASYNCH.RCVR & TRANSM.(-0 | EACH | \$25.00 | 3 | A | |
| 19-09373-00 | 9601 ONE SHOT,RETRIGGE | QTY OF 10 | \$4.00 | 3 | A | | 19-10459-01 | UART WSTRN DIG #TR1602A (1.5 | EACH | \$29.00 | 3 | A | |
| 19-09486-00 | DEC 384 OR GATE-QUAD 2IN, | QTY OF 10 | \$4.00 | 3 | A | | 19-10460-00 | DEC 309 VOLT,REG, FIX | EACH | \$6.00 | 3 | A | |
| 19-09490-00 | RK11 8281 COUNTER,ASYNCH UP | EACH | \$6.00 | 3 | A | | 19-10531-00 | DEC 74S181 ALU-4BIT | EACH | \$14.00 | 3 | A | |
| 19-09615-00 | DEC 8271 SHIFT REG.,4BIT P | QTY OF 10 | \$6.00 | 3 | A | | 19-10533-00 | 74S03 NAND GATE-QUAD 2I | QTY OF 10 | \$2.00 | 3 | A | |
| 19-09667-00 | 74H74 FF-D DUAL,EDGE TR | QTY OF 10 | \$6.00 | 3 | A | | 19-10534-00 | 74S04 INVERTER GATE-HEX | QTY OF 10 | \$2.00 | 3 | A | |
| 19-09686-00 | 7404 INVERTER GATE-HEX | QTY OF 10 | \$2.00 | 3 | A | | 19-10535-00 | 74S05 INVERTER GATE-HEX | QTY OF 10 | \$2.00 | 3 | A | |
| 19-09705-00 | DEC 8881-INAND GATE-QUAD 2I | QTY OF 10 | \$4.00 | 3 | A | | 19-10536-00 | 74S10 NAND GATE-TRIPLE | QTY OF 10 | \$2.00 | 3 | A | |
| 19-09712-00 | DEC 8242 COMPARATOR-4BIT | QTY OF 10 | \$4.00 | 3 | A | | 19-10537-00 | 74S11 AND GATE-TRIPLE 3 | QTY OF 10 | \$2.00 | 3 | A | |
| 19-09713-00 | DEC 8815 NOR GATE-DUAL 4IN | QTY OF 10 | \$2.00 | 3 | A | | 19-10539-00 | 74S20 NAND GATE-DUAL 4I | QTY OF 10 | \$2.00 | 3 | A | |
| 19-09854-00 | DEC 8251-1BCD-DECIMAL DCDR | EACH | \$6.00 | 3 | A | | 19-10541-00 | 74S40 NAND GATE-DUAL 4I | QTY OF 10 | \$2.00 | 3 | A | |
| 19-09927-00 | 74H87 COMPLEMENTER-4BIT | EACH | \$6.00 | 3 | A | | 19-10544-00 | 74S74 FF-D DUAL,EDGE TR | QTY OF 10 | \$4.00 | 3 | A | |
| 19-09928-00 | 7416 INVERTER GATE-HEX | QTY OF 10 | \$2.00 | 3 | A | | 19-10544-01 | DUAL,EDGE TRIGGER,SYNCH. | QTY OF 10 | \$4.00 | 3 | A | |
| 19-09929-00 | 7417 BUFFER GATE-HEX 1 | QTY OF 10 | \$2.00 | 3 | A | | 19-10548-00 | 74S157 MUX 1 OF 2 (QUA | EACH | \$4.00 | 3 | A | |
| 19-09930-00 | 7405 INVERTER GATE-HEX | QTY OF 10 | \$2.00 | 3 | A | | 19-10549-00 | 74S158 MUX 1 OF 2 (QUA | EACH | \$4.00 | 3 | A | |
| 19-09932-01 | 7483A ADDER-4BIT W/LOOK | QTY OF 10 | \$4.00 | 3 | A | | 19-10623-00 | 74194 SHIFT REG.,4BIT R | QTY OF 10 | \$6.00 | 3 | A | |
| 19-09934-00 | 8266 MUS 1 OF 2 (QUA | EACH | \$6.00 | 3 | A | | 19-10644-00 | 733 DIFFERENTIAL AMP, | QTY OF 10 | \$4.00 | 3 | A | |
| 19-09937-00 | 74153 MUX 1 OF 4 (DUA | QTY OF 10 | \$4.00 | 3 | A | | 19-10645-00 | RK11 DRIVER,PERIPH,DU | QTY OF 10 | \$2.00 | 3 | A | |
| 19-09972-00 | DEC 6314 NOR GATE-SINGLE 7 | QTY OF 10 | \$4.00 | 3 | A | | 19-10649-00 | 8885 NOR GATE-QUAD 2IN | QTY OF 10 | \$6.00 | 3 | A | |
| 19-09982-00 | DEC 74181 ALU-4BIT | EACH | \$6.00 | 3 | A | | 19-10650-00 | 74161 COUNTER,SYNCHR. U | QTY OF 10 | \$4.00 | 3 | A | |
| 19-09989-00 | DEC 7413 NAND GATE-DUAL 4I | QTY OF 10 | \$2.00 | 3 | A | | 19-10651-00 | DEC 74175 FF-D QUAD | QTY OF 10 | \$4.00 | 3 | A | |
| 19-10010-00 | DEC 2501 16 DIODE ARRAY,CO | EACH | \$6.00 | 3 | A | | 19-10653-00 | MEMORY READ/WRITE | EACH | \$13.00 | 3 | A | |
| 19-10011-00 | DEC 7486 X-OR GATE-QUAD 2I | QTY OF 10 | \$2.00 | 3 | A | | 19-10656-00 | 74155 DECODER-2 OF 4(DU | QTY OF 10 | \$4.00 | 3 | A | |
| 19-10018-00 | DEC 74193 COUNTER,SYNCHR. U | QTY OF 10 | \$4.00 | 3 | A | | 19-10687-00 | DEC 7528 SENSE AMP,CORE M | EACH | \$6.00 | 3 | A | |
| 19-10035-00 | DEC 74197 COUNTER,ASYNCH UP | QTY OF 10 | \$4.00 | 3 | A | | 19-10725-00 | 75108B RECEIVER,LINE,DU | EACH | \$6.00 | 3 | A | |
| 19-10041-00 | DEC 74164 SHIFT REG.,8BIT S | QTY OF 10 | \$6.00 | 3 | A | | 19-10738-00 | DEC 74170 MEMORY READ/WRITE | EACH | \$6.00 | 3 | A | |
| | | | | | | | 19-10741-00 | 7406 INVERTER GATE-HEX | QTY OF 10 | \$2.00 | 3 | A | |
| | | | | | | | 19-10818-00 | 3106/7MEMORY (EITHER-0 | EACH | REPLACED | 3 | A | 19-10818-02 |
| | | | | | | | 19-10818-02 | 3106 MEMORY READ/WRITE | EACH | \$12.00 | 3 | A | |
| | | | | | | | 19-10837-00 | 8093 BUFFER GATE-QUAD | QTY OF 10 | \$4.00 | 3 | A | |
| | | | | | | | 19-10878-00 | 7427 NOR GATE-TRIPLE 3 | QTY OF 10 | \$2.00 | 3 | A | |



Prices Effective 02-January-89 to 30-June-89
To Order—Call DECdirect™ TOLL-FREE 800-344-4825, 8:30 a.m. to 8:00 p.m. ET in Continental U.S.A.

HARDWARE SPARES PRICE LIST

| PART NUMBER | DESCRIPTION | UNIT ORDER | UNIT PRICE | REP D L | REPLACEMENT PART NUMBER | PART NUMBER | DESCRIPTION | UNIT ORDER | UNIT PRICE | REP D L | REPLACEMENT PART NUMBER |
|-------------|------------------------------|------------|------------|---------|-------------------------|---------------------|-------------------------------|------------|------------|---------|-------------------------|
| 19-10950-00 | 74S74 FF-D DUAL (-45 VE | QTY OF 10 | \$4.00 | 3 A | | 19-12697-00 | LS174 FF-D HEX W/CLEAR | EACH | \$4.00 | 3 A | |
| 19-10951-00 | 9602 ONE SHOT-DUAL | QTY OF 10 | \$4.00 | 3 A | | 19-12729-00 | DC 004 PROTOCOL,REG. SEL | EACH | \$8.00 | 3 A | |
| 19-10957-00 | 74S175 FF-D QUAD COMMON | EACH | \$6.00 | 3 A | | 19-12730-00 | DC 003 INTERRUPT,2 CIRCU | EACH | \$17.00 | 3 A | |
| 19-11113-00 | DEC 11380 NOR GATE-QUAD 2IN | QTY OF 10 | \$6.00 | 3 A | | 19-12731-00 | DEC 8646A TRANSCEIVER,4BIT | EACH | \$15.00 | 3 A | |
| 19-11116-00 | DEC 8837 RECEIVER,BUS,HEX | EACH | \$6.00 | 3 A | | 19-12741-00 | 82S112 MEMORY READ/WRITE | EACH | \$55.00 | 3 A | |
| 19-11117-00 | DEC 8838 TRANSCEIVER,BUS, | EACH | \$6.00 | 3 A | | 19-12746-00 | DEC 74S37 NAND GATE-QUAD 2I | QTY OF 10 | \$2.00 | 3 A | |
| 19-11144-00 | DEC 2505 OP AMP, 1% SETTLE | EACH | \$43.00 | 3 A | | 19-12792-00 | DEC 7915 VOLT,REG,FIX | EACH | \$6.00 | 3 A | |
| 19-11291-00 | 82S62 PARITY TREE,9BIT | EACH | \$4.00 | 3 A | | 19-12796-00 | 74148 EXCODER,PRIORITY, | EACH | \$6.00 | 3 A | |
| 19-11297-00 | 5082-7730 SEGMENT DISPLAY | EACH | \$12.00 | 3 A | | 19-12799-00 | LS00 NAND-GATE-QUAD 2I | QTY OF 10 | \$2.00 | 3 A | |
| 19-11315-00 | 8234 MUX 1 OF 4 | QTY OF 10 | \$4.00 | 3 A | | 19-12801-00 | LS02 NOR-GATE-QUAD 2IN | QTY OF 10 | \$2.00 | 3 A | |
| 19-11324-00 | 7414 NAND GATE-HEX 1IN | QTY OF 10 | \$4.00 | 3 A | | 19-12802-00 | LS03 NAND-GATE-QUAD 2I | QTY OF 10 | \$1.00 | 3 A | |
| 19-11330-00 | 74173 FF-D QUAD,TRISTAT | EACH | \$4.00 | 3 A | | 19-12803-00 | LS04 INVERTER GATE-HEX | QTY OF 10 | \$2.00 | 3 A | |
| 19-11341-00 | 75113 DRIVER,LINE,DUAL | EACH | \$6.00 | 3 A | | 19-12805-00 | LS08 AND GATE-QUAD 2IN | QTY OF 10 | \$2.00 | 3 A | |
| 19-11399-00 | 0102 NOR GATE,QUAD 2IN | EACH | \$6.00 | 3 A | | 19-12807-00 | LS10 NAND GATE-TRIPLE | QTY OF 10 | \$2.00 | 3 A | |
| 19-11415-00 | 0125 ECL TO TTL TRANSLT | EACH | \$6.00 | 3 A | | 19-12812-00 | LS22 NAND GATE-DUAL 4IN,POS | QTY OF 10 | \$1.00 | 3 A | |
| 19-11416-00 | 0131 DUAL D MSTR/SL,FF | EACH | \$6.00 | 3 A | | 19-12813-00 | LS27 NOR GATE-TRIPLE 3 | QTY OF 10 | \$2.00 | 3 A | |
| 19-11469-00 | DEC 8640 RECEIVER,BUS,QUA | EACH | \$6.00 | 3 A | | 19-12815-00 | LS30 NAND GATE-SINGLE 8 IN | QTY OF 10 | \$2.00 | 3 A | |
| 19-11521-00 | 7432 OR GATE-QUAD 2IN, | QTY OF 10 | \$2.00 | 3 A | | 19-12818-00 | LS38 NAND BUFFER-QUAD 2 IN | QTY OF 10 | \$2.00 | 3 A | |
| 19-11527-00 | 8097 BUFFER GATE-HEX 2 | QTY OF 10 | \$4.00 | 3 A | | 19-12820-00 | LS51 A-O-I GATE 2-WIDE | QTY OF 10 | \$2.00 | 3 A | |
| 19-11579-00 | 8641 TRANSCEIVER,BUS, | EACH | \$8.00 | 3 A | | 19-12824-00 | LS74 FF-D DUAL,EDGE TR | QTY OF 10 | \$2.00 | 3 A | |
| 19-11637-00 | 74132 NAND GATE-QUAD 2 | QTY OF 10 | \$4.00 | 3 A | | 19-12829-00 | LS86 X-OR GATE-QUAD 2I | QTY OF 10 | \$2.00 | 3 A | |
| 19-11641-00 | SN 74S257 MUX,QUAD 2 TO 1 | EACH | \$6.00 | 3 A | | 19-12834-00 | LS112 FF-JK DUAL,EDGE T | QTY OF 10 | \$2.00 | 3 A | |
| 19-11675-00 | 74S138 DECODER-THREE INP | EACH | \$4.00 | 3 A | | 19-12842-00 | LS138 DECODER-THREE INP | EACH | \$4.00 | 3 A | |
| 19-11712-00 | 74S51 AND-OR GATE-INVER | QTY OF 10 | \$2.00 | 3 A | | 19-12843-00 | LS139 DECODER, 2 OF 4(DUAL) | QTY OF 10 | \$4.00 | 3 A | |
| 19-11911-00 | DEC 74S124 OSCILLATOR,DUAL V | EACH | \$6.00 | 3 A | | 19-12844-00 | LS151 MUX 1 OF 8 & DA | EACH | \$4.00 | 3 A | |
| 19-11944-00 | 555CN TIMER,FUNCT.BLOC | QTY OF 10 | \$4.00 | 3 A | | 19-12845-00 | LS153 MUX 1 OF 4 (DUA | EACH | \$4.00 | 3 A | |
| 19-11998-00 | 4N26 OPTO COUPLED ISLT | EACH | \$4.00 | 3 A | | 19-12846-00 | LS155 DECODER,2 OF 4(DU | QTY OF 10 | \$4.00 | 3 A | |
| 19-12048-00 | DEC 7812-00 VOLT,REG,FIX | EACH | \$6.00 | 3 A | | 19-12847-00 | DEC LS157 MUX 1 OF 2 (QUA | EACH | \$4.00 | 3 A | |
| 19-12048-02 | DEC 7812-02 VOLT,REG,FIX | EACH | \$6.00 | 3 A | | 19-12851-00 | LS169 COUNTER,SYNCH. UP/DOWN | QTY OF 10 | \$4.00 | 3 A | |
| 19-12048-05 | 7812 VOLT REG,FIX+12V1.50A | QTY OF 10 | \$2.00 | 3 A | 19-12048-06 | DEC LS175 FF-D QUAD | EACH | \$4.00 | 3 A | | |
| 19-12048-06 | DEC 7812 VOLT REG,FIX + 1 | QTY OF 10 | \$2.00 | 3 A | | 19-12854-00 | LS193 COUNTER,SYNCHR,4B | QTY OF 10 | \$4.00 | 3 A | |
| 19-12068-00 | 74128 DRIVER,LINE,QUAD | QTY OF 10 | \$2.00 | 3 A | | 19-12858-00 | LS221 ONE SHOT-DUAL,SCH | EACH | \$6.00 | 3 A | |
| 19-12069-00 | MEMORY READ/WRITE | EACH | \$13.00 | 3 A | | 19-12860-00 | LS259 LATCH 8BIT | EACH | \$6.00 | 3 A | |
| 19-12089-00 | 74S85 CMPRTR,4BIT MAGNI | EACH | \$11.00 | 3 A | | 19-12863-00 | LS273 FF-D OCTAL W/CLEAR | QTY OF 10 | \$4.00 | 3 A | |
| 19-12097-00 | SN 74S182 LOOK AHD CARRY GE | EACH | \$15.00 | 3 A | | 19-12864-00 | LS279 LATCH,QUAD-S-R | EACH | \$5.00 | 3 A | |
| 19-12098-00 | 0026 DRIVER,MOS CLOCK | EACH | \$14.00 | 3 A | | 19-12871-00 | LS375 LATCH | QTY OF 10 | \$2.00 | 3 A | |
| 19-12099-00 | 8833 TRANSCEIVER,BUS, | EACH | \$6.00 | 3 A | | 19-12951-00 | DM 8556 COUNTER,BINARY,4B | EACH | \$7.00 | 3 A | |
| 19-12107-00 | 324 OP AMP,QUAD | EACH | \$4.00 | 3 A | | 19-12955-00 | 75322 DRIVER,MOS MEMOR | EACH | \$21.00 | 3 A | |
| 19-12108-00 | 339 VOLT CMPRTR,QUAD | EACH | \$6.00 | 3 A | | 19-13017-00 | 3046 XSISTOR ARRAY,3 I | QTY OF 10 | \$4.00 | 3 A | |
| 19-12388-00 | 74S02 NOR GATE-QUAD 2IN | QTY OF 10 | \$2.00 | 3 A | | 19-13040-00 | DC 005 TRANSCEIVER 4BIT | EACH | \$13.00 | 3 A | |
| 19-12389-00 | 74S08 AND GATE-QUAD 2IN | QTY OF 10 | \$2.00 | 3 A | | 19-13105-00 | PB 8224C DRIVER/GEN CLOC | EACH | \$19.00 | 3 A | |
| 19-12395-00 | DM 8136 COMPARATOR-6BIT | EACH | \$8.00 | 3 A | | 19-13109-00 | 8228 BUFFER,DATA BASE | EACH | \$21.00 | 3 A | |
| 19-12401-00 | AD562 DAC,12BIT,MULT | EACH | \$192.00 | 3 A | | 19-13130-00 | DEC 489A RECEIVER,LINE,QU | EACH | \$4.00 | 3 A | |
| 19-12536-00 | DEC 7805 VOLT,REG,FIX | EACH | \$6.00 | 3 A | | 19-13245-00 | 2901 BIPOLAR MICROPROCE | EACH | \$53.00 | 3 A | |
| 19-12536-01 | 7805 VOLT REG. FIX | QTY OF 10 | \$2.00 | 3 A | | 19-13340-00 | 74S32 OR GATE QUAD 2IN | QTY OF 10 | \$2.00 | 3 A | |
| 19-12549-00 | 380 NOR GATE-QUAD 2IN | QTY OF 10 | \$6.00 | 3 A | | 19-13414-00 | LS14 INVERTER GATE-HEX | QTY OF 10 | \$4.00 | 3 A | |
| 19-12586-00 | DM 85S68N REGISTER,64BIT ED | EACH | \$15.00 | 3 A | | 19-13462-00 | OCTAL BUFFER INVERTING TRI-ST | EACH | \$5.00 | 3 A | |
| 19-12646-00 | LS253 MUX 1 OF 4 (DUA | EACH | \$4.00 | 3 A | | 19-13667-00 | DP 8212N BUFFER 8 BIT TRI | EACH | \$13.00 | 3 A | |
| 19-12647-00 | LS257 MUX 1 OF 2 (QUA | EACH | \$4.00 | 3 A | | 19-13730-00 | DC 01 PRIORITY ARBITRAT | EACH | \$46.00 | 3 A | |
| 19-12648-00 | LS251 MUX 8 INPUT TRI-S | QTY OF 10 | \$4.00 | 3 A | | 19-13750-00 | MC 8500P REGISTER,ERROR PA | EACH | \$57.00 | 3 A | |
| 19-12649-00 | LS75 LATCH 4BIT,BISTA | QTY OF 10 | \$4.00 | 3 A | | 19-13777-00 | LS240 DRIVER,LINE,OCTA | EACH | \$7.00 | 3 A | |
| 19-12660-00 | 74S253 MUX 1 OF 4 (DUA | EACH | \$6.00 | 3 A | | 19-13888-00 | 102A EQUALS CHECKER 8 BIT | EACH | \$21.00 | 3 A | |
| 19-12664-00 | 75110 DRIVER,LINE,DUA | EACH | \$6.00 | 3 A | | 19-13933-00 | 3403 OP AMP,QUAD | QTY OF 10 | \$2.00 | 3 A | |
| 19-12666-00 | BUFFER GATE-QUAD | QTY OF 10 | \$2.00 | 3 A | | 19-13939-00 | COUNTER,SYNCHR,UP/DOWN,4BIT | EACH | \$5.00 | 3 A | |
| 19-12693-00 | 25S10 SHIFTER,4BIT TRI- | EACH | \$11.00 | 3 A | | 19-13949-00 | LS93 COUNTER, DECADE, 4BIT | QTY OF 10 | \$4.00 | 3 A | |



Prices Effective 02-January-89 to 30-June-89

To Order—Call DECdirect™ TOLL-FREE 800-344-4825, 8:30 a.m. to 8:00 p.m. ET in Continental U.S.A.

HARDWARE SPARES PRICE LIST

| PART NUMBER | DESCRIPTION | UNIT ORDER | UNIT PRICE | REP D | L | REPLACEMENT PART NUMBER | PART NUMBER | DESCRIPTION | UNIT ORDER | UNIT PRICE | REP D | L | REPLACEMENT PART NUMBER |
|-------------|-------------------------------|------------|------------|-------|---|-------------------------|----------------|-------------------------------|------------|------------|-------|---|-------------------------|
| 19-13950-00 | LS156 DECODER,2 OF 4(DU | QTY OF 10 | \$4.00 | 3 | A | | 19-14717-00 | DC 643 BIPOLAR,LS,400-GAT | EACH | \$138.00 | 3 | A | |
| 19-14036-00 | TTL ECL MUX, INTERFACE | EACH | \$40.00 | 3 | A | | 19-14719-00 | DC 645 BIPOLAR,LS,400-GAT | EACH | \$138.00 | 3 | A | |
| 19-14038-00 | DE 010 BIPOLAR,MEM ADDRESS | EACH | \$36.00 | 3 | A | | 19-14720-00 | DC 646 BIPOLAR,LS,400-GAT | EACH | \$138.00 | 3 | A | |
| 19-14082-00 | COUNTER,SYNCH UP/DOWN 4BIT | EACH | \$6.00 | 3 | A | | 19-14721-00 | DC 647 BIPOLAR,LS,400-GAT | EACH | \$138.00 | 3 | A | |
| 19-14084-00 | 74S299 SHIFT REG.,8BIT R/L | EACH | \$15.00 | 3 | A | | 19-14722-00 | DC 648 BIPOLAR,LS,400-GAT | EACH | \$138.00 | 3 | A | |
| 19-14156-00 | LM393 VOLT COMPARATOR DU | QTY OF 10 | \$4.00 | 3 | A | | 19-14723-00 | DC 649 BIPOLAR,LS,400-GAT | EACH | \$138.00 | 3 | A | |
| 19-14194-00 | OFTP-COUPLED ISOLATOR 6 PIN | QTY OF 10 | \$4.00 | 3 | A | | 19-14725-00 | DC 651 BIPOLOR,LS,400-GATE | EACH | \$114.00 | 3 | A | |
| 19-14213-00 | 81LS97 BUFFER GATE-OCTAL | QTY OF 10 | \$6.00 | 3 | A | | 19-15123-00 | 26L32 RECEIVER,QUAD | EACH | \$5.00 | 3 | A | |
| 19-14214-00 | LS374 FF-D OCTAL EDGE TRIGGER | QTY OF 10 | \$6.00 | 3 | A | | 19-15123-03 | RECEIVER,LINE 26LS323 | EACH | \$6.00 | 3 | A | |
| 19-14250-00 | 3524 MODULATOR-REGULATING | EACH | \$19.00 | 3 | A | | 19-15193-00 | LS244 DRIVER, LINE, OCTAL | QTY OF 10 | \$4.00 | 3 | A | |
| 19-14392-00 | 556 TIMER-DUAL | QTY OF 10 | \$6.00 | 3 | A | | 19-15218-00 | TRANSCEIVER,BUS,OCTAL,TRI-ST | EACH | \$6.00 | 3 | A | |
| 19-14423-01 | CUSTOM LSI-BIPOLAR | EACH | \$55.00 | 3 | A | | 19-15219-00 | FF-D OCTAL-TRANSPARENT | EACH | \$5.00 | 3 | A | |
| 19-14424-01 | CUSTOM LSI-BIPOLAR | EACH | \$55.00 | 3 | A | | 19-15261-00 | 2841B DRIVER,1.5A QUAD | EACH | \$18.00 | 3 | A | |
| 19-14438-00 | DC013 UNIBUS INTERRUPT-B | EACH | \$57.00 | 3 | A | | 19-15415-00 | 9636 DRIVER,DUAL,EIA RS-423 | EACH | \$6.00 | 3 | A | |
| 19-14451-00 | 74LS393 COUNTER,BINARY,4BIT | QTY OF 10 | \$2.00 | 3 | A | | 19-15416-00 | 9637 RECEIVER,DUAL,RS-422/3 | EACH | \$6.00 | 3 | A | |
| 19-14466-00 | 3130E OP AMP MOS/FET IN,CMOS | QTY OF 10 | REPLACED | 3 | A | 19-14466-B0 | | | | | | | |
| 19-14466-B0 | 3130E OPAMP MOS/FET BURNED-IN | EACH | \$5.00 | 3 | A | | 19-15417-00 | 9638 DRIVER,DUAL,EIA RS-422 | EACH | \$5.00 | 3 | A | |
| 19-14517-00 | 7912 VOLT REG, FIX-1 | EACH | \$5.00 | 3 | A | | 19-15697-00 | RAM 256X4 TRI-STATE | EACH | \$49.00 | 3 | A | |
| 19-14517-01 | 7912CTVOLT,REG,-12V NEGATIVE | QTY OF 10 | \$4.00 | 3 | A | | 19-15721-00 | PHOTO SWITCH W/LED | EACH | \$38.00 | 3 | A | |
| 19-14519-00 | CURRENT REGULATOR | EACH | \$25.00 | 3 | A | | 19-15758-01 | LS166 SHIFT REG. 8BIT | EACH | REPLACED | 3 | A | 19-15758-B1 |
| | | | | | | | 19-15758-B1 | LS166 SHIFT REG. 8BIT PA | EACH | \$8.00 | 3 | A | |
| 19-14558-00 | SN 74S132N NAND GATE QUAD 2I | EACH | \$4.00 | 3 | A | | 19-15932-00 | LS125 BUFFER QUAD BUS | QTY OF 10 | \$2.00 | 3 | A | |
| 19-14560-00 | LS368 DRIVER,BUS,HEX,TR | QTY OF 10 | \$4.00 | 3 | A | | 19-16028-01 | DRIVER,TTL TO MOS,DUAL FAST | EACH | \$5.00 | 3 | A | |
| 19-14681-00 | DC 607 BIPOLAR,LS,400-GAT | EACH | \$138.00 | 3 | A | | 19-16819-00 | 3527A MODULATOR,REGULAT'G PUL | EACH | \$23.00 | 3 | A | |
| 19-14682-00 | DC 608 BIPOLAR,LS,400-GAT | EACH | \$138.00 | 3 | A | | 19-18394-00 | SG 3551 CURRENT SENSE W/LATCH | EACH | \$19.00 | 3 | A | |
| 19-14683-00 | DC 609 BIPOLAR,LS,400-GAT | EACH | \$138.00 | 3 | A | | 19-18708-00 | TRANSCEIVER,BI-DIREC. | EACH | \$7.00 | 3 | A | |
| 19-14684-00 | DC 610 BIPOLAR,LS,400-GAT | EACH | \$138.00 | 3 | A | | 19-19189-00 | COMPARATOR,8BIT BIPOLAR | EACH | \$8.00 | 3 | A | |
| 19-14685-00 | DC 611 BIPOLAR,LS,400-GAT | EACH | \$138.00 | 3 | A | | 19-19191-00 | DC 715 BIPOLAR,400 GATE ARRAY | EACH | \$97.00 | 3 | A | |
| 19-14686-00 | DC 612 BIPOLAR,LS,400-GAT | EACH | \$138.00 | 3 | A | | 19-19192-00 | DC 716 BIPOLAR,400 GATE ARRAY | EACH | \$97.00 | 3 | A | |
| 19-14687-00 | DC 613 BIPOLAR,LS,400-GAT | EACH | \$138.00 | 3 | A | | 19-19193-00 | DC 717 BIPOLAR,400 GATE ARRAY | EACH | \$97.00 | 3 | A | |
| 19-14688-00 | DC 614 BIPOLAR,LS,400-GAT | EACH | \$138.00 | 3 | A | | 19-19235-00 | TDA 1170AMP,VERTICAL DEFLECTN | EACH | \$8.00 | 3 | A | |
| 19-14689-00 | DC 615 BIPOLAR,LS,400-GAT | EACH | \$138.00 | 3 | A | | 19-19542-01 | 9639 RECEIVER,LINE,DUAL | EACH | \$5.00 | 3 | A | |
| 19-14690-00 | DC 616 BIPOLAR,LS,400-GAT | EACH | \$138.00 | 3 | A | | 19-19765-01 | 75114 LINE DRIVER,DUAL DIFFER | EACH | \$5.00 | 3 | A | |
| 19-14691-00 | DC 617 BIPOLAR,LS,400-GAT | EACH | \$138.00 | 3 | A | | | | | | | | |
| 19-14692-00 | DC 618 BIPOLAR,LS,400-GAT | EACH | \$138.00 | 3 | A | | | | | | | | |
| 19-14693-00 | DC 619 BIPOLAR,LS,400-GAT | EACH | \$138.00 | 3 | A | | | | | | | | |
| 19-14694-00 | DC 620A BIPOLAR,LS,400-GAT | EACH | \$138.00 | 3 | A | | | | | | | | |
| 19-14695-00 | DC 621 BIPOLAR,LS,400-GAT | EACH | \$138.00 | 3 | A | | | | | | | | |
| 19-14696-00 | DC 622 BIPOLAR,LS,400-GAT | EACH | \$138.00 | 3 | A | | | | | | | | |
| 19-14697-00 | DC 623 BIPOLAR,LS,400-GAT | EACH | REPLACED | 3 | A | 19-14725-00 | | | | | | | |
| 19-14698-00 | DC 624 BIPOLAR,LS,400-GAT | EACH | \$138.00 | 3 | A | | | | | | | | |
| 19-14699-00 | DC 625 BIPOLAR,LS,400-GAT | EACH | \$138.00 | 3 | A | | | | | | | | |
| 19-14700-00 | DC 626 BIPOLAR,LS,400-GAT | EACH | \$138.00 | 3 | A | | | | | | | | |
| 19-14701-00 | DC 627 BIPOLAR,LS,400-GAT | EACH | \$138.00 | 3 | A | | | | | | | | |
| 19-14702-00 | DC 628 BIPOLAR,LS,400-GAT | EACH | \$138.00 | 3 | A | | | | | | | | |
| 19-14703-00 | DC 629 BIPOLAR,LS,400-GAT | EACH | \$138.00 | 3 | A | | | | | | | | |
| 19-14704-00 | DC 630 BIPOLAR,LS,400-GAT | EACH | \$138.00 | 3 | A | | | | | | | | |
| 19-14705-00 | DC 631 BIPOLAR,LS,400-GAT | EACH | \$138.00 | 3 | A | | | | | | | | |
| 19-14706-00 | DC 632 BIPOLAR,LS,400-GAT | EACH | \$138.00 | 3 | A | | | | | | | | |
| 19-14707-00 | DC 633 BIPOLAR,LS,400-GAT | EACH | \$138.00 | 3 | A | | | | | | | | |
| 19-14710-00 | DC 636 BIPOLAR,LS,400-GAT | EACH | \$138.00 | 3 | A | | | | | | | | |
| 19-14711-00 | DC 637 BIPOLAR,LS,400-GAT | EACH | \$138.00 | 3 | A | | | | | | | | |
| 19-14712-00 | DC 638 BIPOLAR,LS,400-GAT | EACH | \$138.00 | 3 | A | | | | | | | | |
| 19-14713-00 | DC 639 BIPOLAR,LS,400-GAT | EACH | \$138.00 | 3 | A | | | | | | | | |
| 19-14715-00 | DC 641 BIPOLAR,LS,400-GAT | EACH | \$138.00 | 3 | A | | | | | | | | |
| 19-14716-00 | DC 642 BIPOLAR,LS,400-GAT | EACH | \$138.00 | 3 | A | | | | | | | | |
| | | | | | | | 21 CLASS MOS's | | | | | | |
| | | | | | | | 21-11188-00 | 3341 64X4 FIFO MEMORY | EACH | \$26.00 | 3 | A | |
| | | | | | | | 21-11188-01 | 3341-01 64X4 FIFO MEMOR | EACH | \$21.00 | 3 | A | |
| | | | | | | | 21-11318-01 | 2102-1 RAM,1024BIT,STA | EACH | \$18.00 | 3 | A | |
| | | | | | | | 21-11318-02 | 2102-2 RAM,1024BIT,STA | EACH | \$14.00 | 3 | A | |
| | | | | | | | 21-11450-00 | UART 40K BAUD VARIATION OF 19 | EACH | REPLACED | 3 | A | 21-15579-00 |
| | | | | | | | 21-11549-01 | LSI-11 DATA CHIP WAIVER SPEC | EACH | REPLACED | 3 | A | 21-15579-00 |
| | | | | | | | 21-11556-00 | PR 1472B PROG.SYNCH.ASYNCH.RE | EACH | \$70.00 | 3 | A | |
| | | | | | | | 21-11557-00 | PT 1482B PROG.SYNCH.TRANS,P/S | EACH | \$78.00 | 3 | A | |
| | | | | | | | 21-11644-00 | C8008-1 CENTRAL PROCESSOR | EACH | \$167.00 | 3 | A | |
| | | | | | | | 21-12323-00 | RAM, 256X4, TRI-S | EACH | \$23.00 | 3 | A | |
| | | | | | | | 21-12517-00 | LSI COMM.DEVICE,SYNCHRONOUS | EACH | \$124.00 | 3 | A | |
| | | | | | | | 21-12622-00 | BAUD RATE GEN,PROGRAMMABLE,2. | EACH | \$64.00 | 3 | A | |
| | | | | | | | 21-12623-00 | DUAL BAUD RATE GEN/PROG DIVID | EACH | \$58.00 | 3 | A | |
| | | | | | | | 21-12623-02 | DUAL BAUD RATE GEN/PROG DIVID | EACH | \$48.00 | 3 | A | |
| | | | | | | | 21-12623-03 | DUAL BAUD GEN/PROG DIV. MOS | EACH | \$24.00 | 3 | A | |



Prices Effective 02-January-89 to 30-June-89
 To Order—Call DECdirect™ TOLL-FREE 800-344-4825, 8:30 a.m. to 8:00 p.m. ET in Continental U.S.A.

HARDWARE SPARES PRICE LIST

| PART NUMBER | DESCRIPTION | UNIT ORDER | UNIT PRICE | REP D | L | REPLACEMENT PART NUMBER | PART NUMBER | DESCRIPTION | UNIT ORDER | UNIT PRICE | REP D | L | REPLACEMENT PART NUMBER |
|-------------|----------------------------|------------|------------|-------|---|-------------------------|-------------|------------------------|------------|------------|-------|---|-------------------------|
| 23-11F1-00 | F1-01 | EACH | \$42.00 | 3 | A | | 23-148E4-00 | E4-01,2,3,4,5ROM-EPROM | EACH | REPLACED | 3 | A | 23-279E4-00 |
| 23-120F1-00 | F1-01 PROM, 1024X 4 | EACH | \$19.00 | 3 | A | | 23-148F1-00 | F1-01 PROM, 1024X 4 | EACH | \$19.00 | 3 | A | |
| 23-121A2-00 | A2-01,A2-02 | EACH | \$20.00 | 3 | A | | 23-149F1-00 | F1-01 PROM, 1024X 4 | EACH | \$19.00 | 3 | A | |
| 23-121F1-00 | F1-01 PROM, 1024X 4 | EACH | \$19.00 | 3 | A | | 23-14A9-00 | A9-01 | EACH | \$33.00 | 3 | A | |
| 23-122A2-00 | A2-01,A2-02 | EACH | \$20.00 | 3 | A | | 23-14F1-00 | F1-02 PROM, 1024X 4 | EACH | \$17.00 | 3 | A | |
| 23-122F1-00 | F1-01 PROM, 1024X 4 | EACH | \$19.00 | 3 | A | | 23-150F1-00 | F1-01 PROM, 1024X 4 | EACH | \$19.00 | 3 | A | |
| 23-123A1-00 | A1-07 | EACH | \$26.00 | 3 | A | | 23-153A1-00 | A1-07 PROM, 32X 8 | EACH | \$7.00 | 3 | A | |
| 23-123F1-00 | F1-01 PROM, 1024X 4 | EACH | \$19.00 | 3 | A | | 23-154A1-00 | A1-07 PROM, 32X 8 | EACH | \$7.00 | 3 | A | |
| 23-124A9-00 | A9-01 | EACH | \$18.00 | 3 | A | | 23-154F2-00 | F2-01 PROM, 2048X 4 | EACH | \$24.00 | 3 | A | |
| 23-124F1-00 | F1-01 PROM, 1024X 4 | EACH | \$19.00 | 3 | A | | 23-155E6-00 | E6-01,E6-02,E6-03 | EACH | \$55.00 | 3 | A | |
| 23-125F1-00 | F1-01 PROM, 1024X 4 | EACH | \$19.00 | 3 | A | | 23-155F2-00 | F2-01 PROM, 2048X 4 | EACH | \$24.00 | 3 | A | |
| 23-126A9-00 | A9-01 | EACH | \$18.00 | 3 | A | | 23-156E6-00 | E6-01,E6-02,E6-03 | EACH | \$55.00 | 3 | A | |
| 23-126E4-00 | E4-01,2,3,4,5,6,8ROM-EPROM | EACH | \$46.00 | 3 | A | | 23-158A1-00 | A1-07 PROM, 32X 8 | EACH | \$7.00 | 3 | A | |
| 23-126F1-00 | F1-01 PROM, 1024X 4 | EACH | \$19.00 | 3 | A | | 23-158A2-00 | A2-01,A2-02,A2-04 | EACH | \$20.00 | 3 | A | |
| 23-126F3-00 | F3-01 | EACH | \$56.00 | 3 | A | | 23-159A2-00 | A2-01,A2-02,A2-04 | EACH | \$20.00 | 3 | A | |
| 23-127A9-00 | A9-01 | EACH | \$18.00 | 3 | A | | 23-15B1-00 | B1-01 PROM, 256X 8 | EACH | \$17.00 | 3 | A | |
| 23-127E4-00 | E4-01,2,3,4,5,6,8ROM-EPROM | EACH | \$46.00 | 3 | A | | 23-15F1-00 | F1-02 PROM, 1024X 4 | EACH | \$17.00 | 3 | A | |
| 23-127F1-00 | F1-01 PROM, 1024X 4 | EACH | \$19.00 | 3 | A | | 23-160A2-00 | A2-05 | EACH | \$27.00 | 3 | A | |
| 23-128A9-00 | A9-01 | EACH | \$18.00 | 3 | A | | 23-161A2-00 | A2-05 | EACH | \$17.00 | 3 | A | |
| 23-128E4-00 | E4-01,2,3,4,5,6,8ROM-EPROM | EACH | \$46.00 | 3 | A | | 23-162A2-00 | A2-05 | EACH | \$27.00 | 3 | A | |
| 23-128F1-00 | F1-01 PROM, 1024X 4 | EACH | \$19.00 | 3 | A | | 23-163A2-00 | A2-05 | EACH | \$27.00 | 3 | A | |
| 23-129A9-00 | A9-01 | EACH | \$18.00 | 3 | A | | 23-164A2-00 | A2-05 | EACH | \$27.00 | 3 | A | |
| 23-129F1-00 | F1-01 PROM, 1024X 4 | EACH | \$19.00 | 3 | A | | 23-165A2-00 | A2-02,A2-04 | EACH | \$27.00 | 3 | A | |
| 23-12B1-00 | B1-01 OR CUSTOM MASKED ROM | EACH | \$17.00 | 3 | A | | 23-166A2-00 | A2-02,A2-04 | EACH | \$27.00 | 3 | A | |
| 23-12E1-00 | ROM | EACH | \$33.00 | 3 | A | | 23-167A2-00 | A2-02,A2-04 | EACH | \$27.00 | 3 | A | |
| 23-12E5-00 | E5-02 | EACH | REPLACED | 3 | A | 4A-VT22X-WA | 23-168A2-00 | A2-02,A2-04 | EACH | \$27.00 | 3 | A | |
| 23-12E6-00 | E6-02 UVEPROM, 32KX 8 | EACH | REPLACED | 3 | A | 4A-VT24X-WA | 23-169A2-00 | A2-02,A2-04 | EACH | \$27.00 | 3 | A | |
| 23-130A9-00 | A9-01 | EACH | \$18.00 | 3 | A | | 23-169F1-00 | F1-01 PROM, 1024X 4 | EACH | \$19.00 | 3 | A | |
| 23-130F1-00 | F1-01 PROM, 1024X 4 | EACH | \$19.00 | 3 | A | | 23-16B1-00 | B1-01 PROM, 256X 8 | EACH | \$17.00 | 3 | A | |
| 23-131A9-00 | A9-01 | EACH | \$18.00 | 3 | A | | 23-16F1-00 | F1-01 | EACH | \$42.00 | 3 | A | |
| 23-131E2-00 | E2-01 ROM, 2048X 8 | EACH | \$14.00 | 3 | A | | 23-170A2-00 | A2-02,A2-04 | EACH | \$27.00 | 3 | A | |
| 23-131F1-00 | F1-01 PROM, 1024X 4 | EACH | \$19.00 | 3 | A | | 23-170F1-00 | F1-01 PROM, 1024X 4 | EACH | \$19.00 | 3 | A | |
| 23-131F3-00 | F3-03 | EACH | \$48.00 | 3 | A | | 23-172A2-00 | A2-02,A2-04 | EACH | \$27.00 | 3 | A | |
| 23-132F1-00 | F1-01 PROM, 1024X 4 | EACH | \$19.00 | 3 | A | | 23-172F1-00 | F1-01 PROM, 1024X 4 | EACH | \$19.00 | 3 | A | |
| 23-132F3-00 | F3-03 | EACH | \$48.00 | 3 | A | | 23-173A1-00 | A1-03,A1-04,A1-05 | EACH | \$6.00 | 3 | A | |
| 23-133F1-00 | F1-01 PROM, 1024X 4 | EACH | \$19.00 | 3 | A | | 23-173A2-00 | A2-02,A2-04 | EACH | \$27.00 | 3 | A | |
| 23-134F1-00 | F1-01 PROM, 1024X 4 | EACH | \$19.00 | 3 | A | | 23-173F3-00 | F3-03 PROM,1024X8 | EACH | \$36.00 | 3 | A | |
| 23-135F1-00 | F1-01 PROM, 1024X 4 | EACH | \$19.00 | 3 | A | | 23-174A2-00 | A2-02,A2-04 | EACH | \$27.00 | 3 | A | |
| 23-136F1-00 | F1-01 PROM, 1024X 4 | EACH | \$19.00 | 3 | A | | 23-174F3-00 | F3-03 PROM,1024X8 | EACH | \$36.00 | 3 | A | |
| 23-137F1-00 | F1-01 PROM, 1024X 4 | EACH | \$19.00 | 3 | A | | 23-175A2-00 | A2-02,A2-04 | EACH | \$27.00 | 3 | A | |
| 23-138F1-00 | F1-01 PROM, 1024X 4 | EACH | \$19.00 | 3 | A | | 23-175F3-00 | F3-03 PROM,1024X8 | EACH | \$36.00 | 3 | A | |
| 23-139E2-00 | E2-02 ROM, 2048X8 | EACH | \$15.00 | 3 | A | | 23-176A2-00 | A2-02,A2-04 | EACH | \$27.00 | 3 | A | |
| 23-139F1-00 | F1-01 PROM, 1024X 4 | EACH | \$19.00 | 3 | A | | 23-177A1-00 | A1-07 | EACH | \$7.00 | 3 | A | |
| 23-13B1-00 | B1-01 PROM, 256X 8 | EACH | \$17.00 | 3 | A | | 23-179E4-00 | ROM | EACH | REPLACED | 3 | A | EQ-01393-01 |
| 23-13F1-00 | F1-01 | EACH | \$42.00 | 3 | A | | 23-17B1-00 | B1-01 PROM, 256X 8 | EACH | \$17.00 | 3 | A | |
| 23-140E2-00 | E2-02 ROM, 2048X8 | EACH | \$15.00 | 3 | A | | 23-17F1-00 | F1-01 | EACH | \$42.00 | 3 | A | |
| 23-140F1-00 | F1-01 PROM, 1024X 4 | EACH | \$19.00 | 3 | A | | 23-180E2-00 | E2-02 | EACH | \$23.00 | 3 | A | |
| 23-141F1-00 | F1-01 PROM, 1024X 4 | EACH | \$19.00 | 3 | A | | 23-180E4-00 | E4-01,E4-02,E4-03 | EACH | REPLACED | 3 | A | EQ-01393-01 |
| 23-142F1-00 | F1-01 PROM, 1024X 4 | EACH | \$19.00 | 3 | A | | 23-181E2-00 | E2-02 | EACH | \$18.00 | 3 | A | |
| 23-143F1-00 | F1-01 PROM, 1024X 4 | EACH | \$19.00 | 3 | A | | 23-181E4-00 | E4-01,E4-02,E4-03 | EACH | REPLACED | 3 | A | EQ-01393-01 |
| 23-144F1-00 | F1-01 PROM, 1024X 4 | EACH | \$19.00 | 3 | A | | 23-182E2-00 | E2-02 | EACH | \$15.00 | 3 | A | |
| 23-145F1-00 | F1-01 PROM, 1024X 4 | EACH | \$17.00 | 3 | A | | 23-182E4-00 | E4-01,E4-02,E4-03 | EACH | REPLACED | 3 | A | EQ-01393-01 |
| 23-146F1-00 | F1-01 PROM, 1024X 4 | EACH | \$19.00 | 3 | A | | 23-182E5-00 | E5-01 ROM, 16KX 8 | EACH | \$38.00 | 3 | A | |
| 23-147E4-00 | E4-02,E4-05 ROM-EPROM | EACH | REPLACED | 3 | A | 23-278E4-00 | 23-183E2-00 | E2-02 | EACH | \$15.00 | 3 | A | |
| 23-147F1-00 | F1-01 PROM, 1024X 4 | EACH | \$19.00 | 3 | A | | 23-183E5-00 | E5-01 ROM, 16KX 8 | EACH | \$38.00 | 3 | A | |



Prices Effective 02-January-89 to 30-June-89

To Order—Call DECdirect™ TOLL-FREE 800-344-4825, 8:30 a.m. to 8:00 p.m. ET in Continental U.S.A.

HARDWARE SPARES PRICE LIST

| PART NUMBER | DESCRIPTION | UNIT ORDER | UNIT PRICE | REP D | L | REPLACEMENT PART NUMBER | PART NUMBER | DESCRIPTION | UNIT ORDER | UNIT PRICE | REP D | L | REPLACEMENT PART NUMBER |
|-------------|-------------------------------|------------|------------|-------|---|-------------------------|-------------|-------------------------------|------------|------------|-------|---|-------------------------|
| 23-184E4-00 | E4-05 UVEPROM, 8192X 8 | EACH | REPLACED | 3 | A | 23-381E4-00 | 23-24C6-00 | C6-01 | EACH | \$40.00 | 3 | A | |
| 23-185A2-00 | A2-02,A2-04 | EACH | \$30.00 | 3 | A | | 23-24F1-00 | F1-01 | EACH | \$42.00 | 3 | A | |
| 23-186A2-00 | A2-02,A2-04 | EACH | \$30.00 | 3 | A | | 23-251E5-00 | E5-01, E5-02, E5-03 | EACH | REPLACED | 3 | A | 4A-VT22X-WA |
| 23-186E2-00 | E2-02 ROM, 2048X 8 | EACH | \$14.00 | 3 | A | | 23-257A2-00 | A2-01,A2-02,A2-04 | EACH | \$30.00 | 3 | A | |
| 23-187A2-00 | A2-02,A2-04 | EACH | \$30.00 | 3 | A | | 23-258A2-00 | A2-01,A2-02,A2-04 | EACH | \$23.00 | 3 | A | |
| 23-187E2-00 | E2-02 ROM, 2048X 8 | EACH | \$14.00 | 3 | A | | 23-259A2-00 | A2-01,A2-02,A2-04 | EACH | \$23.00 | 3 | A | |
| 23-188A2-00 | A2-02,A2-04 | EACH | \$30.00 | 3 | A | | 23-25B1-00 | B1-01 PROM, 256X 8 | EACH | \$17.00 | 3 | A | |
| 23-189A1-00 | A1-07 PROM, 32X 8 | EACH | \$7.00 | 3 | A | | 23-25C6-00 | C6-01 | EACH | \$40.00 | 3 | A | |
| 23-189A2-00 | A2-02,A2-04 | EACH | \$30.00 | 3 | A | | 23-25F1-00 | F1-01 | EACH | \$42.00 | 3 | A | |
| 23-18E2-00 | E2-03 | EACH | \$27.00 | 3 | A | | 23-260A2-00 | A2-01,A2-02,A2-04 | EACH | \$23.00 | 3 | A | |
| 23-18F1-00 | F1-01 | EACH | \$42.00 | 3 | A | | 23-269F3-00 | F3-03 PROM, 1024X 8 | EACH | REPLACED | 3 | A | 23-296F3-00 |
| 23-190A2-00 | A2-02,A2-04 | EACH | \$30.00 | 3 | A | | 23-26B1-00 | B1-01 PROM, 256X 8 | EACH | \$17.00 | 3 | A | |
| 23-190F1-00 | F1-01 PROM, 1024X 4 | EACH | \$19.00 | 3 | A | | 23-270F3-00 | F3-03 PROM, 1024X 8 | EACH | REPLACED | 3 | A | 23-297F3-00 |
| 23-195F1-00 | F1-01 | EACH | \$20.00 | 3 | A | | 23-271F3-00 | F3-03 PROM, 1024X 8 | EACH | REPLACED | 3 | A | 23-298F3-00 |
| 23-19B1-00 | B1-01 PROM, 256X 8 | EACH | \$17.00 | 3 | A | | 23-272F3-00 | F3-03 PROM, 1024X 8 | EACH | REPLACED | 3 | A | 23-299F3-00 |
| 23-19F1-00 | F1-01 | EACH | \$42.00 | 3 | A | | 23-273F3-00 | F3-03 PROM, 1024X 8 | EACH | REPLACED | 3 | A | 23-300F3-00 |
| 23-1B5-00 | LSI-11 MICROM 0 FIN. SPEC. | EACH | \$120.00 | 3 | A | | 23-274E2-00 | E2-04 | EACH | \$106.00 | 3 | A | |
| 23-1B9-00 | B9-01 | EACH | \$46.00 | 3 | A | | 23-274F3-00 | F3-03 PROM, 1024X 8 | EACH | REPLACED | 3 | A | 23-301F3-00 |
| 23-1C3-00 | C3-01 | EACH | REPLACED | 3 | A | 23-2C4-00 | 23-275E2-00 | E2-04 | EACH | \$33.00 | 3 | A | |
| 23-1E6-00 | E6-01 ROM, 32KX 8 | EACH | REPLACED | 3 | A | 4A-VT24X-WA | 23-276E2-00 | E2-04 | EACH | \$33.00 | 3 | A | |
| 23-1J5-00 | J5-01, J5-02 PAL/HAL | EACH | \$44.00 | 3 | A | | 23-277E2-00 | E2-04 | EACH | \$33.00 | 3 | A | |
| 23-1K3-00 | K3-01, K3-02 PAL/HAL | EACH | \$44.00 | 3 | A | | 23-278E4-00 | E4-02, E4-05 ROM-EPROM | EACH | \$46.00 | 3 | A | |
| 23-20B1-00 | B1-01 PROM, 256X 8 | EACH | \$17.00 | 3 | A | | 23-279E4-00 | E4-01,E4-02,-03,-05 ROM-EPROM | EACH | \$46.00 | 3 | A | |
| 23-20F1-00 | F1-01 | EACH | \$42.00 | 3 | A | | 23-27B1-00 | B1-01 PROM, 256X 8 | EACH | \$17.00 | 3 | A | |
| 23-218F3-00 | F3-03 PROM, 1024 X 8 | EACH | REPLACED | 3 | A | 23-296F3-00 | 23-27F1-00 | F1-01 | EACH | \$42.00 | 3 | A | |
| 23-219F3-00 | F3-03 PROM, 1024 X 8 | EACH | REPLACED | 3 | A | 23-297F3-00 | 23-280E2-00 | E2-02 | EACH | \$33.00 | 3 | A | |
| 23-21E4-00 | E4-01,E4-02,E4-03 | EACH | \$61.00 | 3 | A | | 23-289F3-00 | F3-03 PROM, 1024X8 | EACH | REPLACED | 3 | A | 23-296F3-00 |
| 23-21F1-00 | F1-01 | EACH | \$42.00 | 3 | A | | 23-28B1-00 | B1-01 PROM, 256X 8 | EACH | \$17.00 | 3 | A | |
| 23-220A2-00 | A2-02,A2-04 | EACH | \$30.00 | 3 | A | | 23-28E4-00 | E4-02 | EACH | \$80.00 | 3 | A | |
| 23-220E5-00 | E5-01,E5-02,E5-03 | EACH | \$84.00 | 3 | A | | 23-28F5-00 | F5-01 PROM, 4096 X 4 | EACH | \$48.00 | 3 | A | |
| 23-220F3-00 | F3-03 PROM, 1024 X 8 | EACH | REPLACED | 3 | A | 23-298F3-00 | 23-290F3-00 | F3-03 PROM, 1024X 8 | EACH | REPLACED | 3 | A | 23-297F3-00 |
| 23-221E5-00 | E5-01,E5-02,E5-03 | EACH | \$84.00 | 3 | A | | 23-291F3-00 | F3-03 PROM, 1024X 8 | EACH | REPLACED | 3 | A | 23-298F3-00 |
| 23-221F3-00 | F3-03 PROM, 1024 X 8 | EACH | REPLACED | 3 | A | 23-299F3-00 | 23-292F3-00 | F3-01 PROM, 1024X 8 | EACH | REPLACED | 3 | A | 23-299F3-00 |
| 23-222E5-00 | E5-01,E5-02,E5-03 | EACH | \$84.00 | 3 | A | | 23-293F3-00 | F3-03 PROM, 1024X 8 | EACH | REPLACED | 3 | A | 23-300F3-00 |
| 23-222F3-00 | F3-03 PROM, 1024 X 8 | EACH | REPLACED | 3 | A | 23-300F3-00 | 23-294F3-00 | F3-03 PROM, 1024X 8 | EACH | REPLACED | 3 | A | 23-301F3-00 |
| 23-223E5-00 | E5-01,E5-02,E5-03 | EACH | \$84.00 | 3 | A | | 23-296F3-00 | F3-03 PROM, 1024X 8 | EACH | \$38.00 | 3 | A | |
| 23-223F3-00 | F3-03 PROM, 1024 X 8 | EACH | REPLACED | 3 | A | 23-301F3-00 | 23-297F3-00 | F3-03 PROM, 1024X 8 | EACH | \$38.00 | 3 | A | |
| 23-225E4-00 | E4-01,E4-02,E4-03 ROM, 8192X8 | EACH | \$27.00 | 3 | A | | 23-298F3-00 | F3-03 PROM, 1024X 8 | EACH | \$38.00 | 3 | A | |
| 23-226E4-00 | E4-01,E4-02,E4-03 ROM, 8192X8 | EACH | \$27.00 | 3 | A | | 23-299F3-00 | F3-03 PROM, 1024X 8 | EACH | \$38.00 | 3 | A | |
| 23-22B1-00 | B1-01 PROM, 256X 8 | EACH | \$17.00 | 3 | A | | 23-29B1-00 | B1-01 PROM, 256X 8 | EACH | \$17.00 | 3 | A | |
| 23-22F1-00 | F1-01 | EACH | \$42.00 | 3 | A | | 23-29F5-00 | F5-01 PROM, 4096 X 4 | EACH | \$48.00 | 3 | A | |
| 23-233F1-00 | F1-01 (CPU,DIAG,CACHE) | EACH | REPLACED | 3 | A | 23-616F1-00 | 23-2B4-00 | B4-01 | EACH | \$61.00 | 3 | A | |
| 23-234E4-00 | E4-01, E4-02, E4-03 | EACH | REPLACED | 3 | A | EQ-01393-01 | 23-2B5-00 | LSI-11 MICROM 1 FIN. SPEC. | EACH | \$90.00 | 3 | A | |
| 23-236F1-00 | F1-01 PROM, 1024X 4 | EACH | \$19.00 | 3 | A | | 23-2C4-00 | LSI-11 CONTROL CHIP FIN. SPEC | EACH | \$219.00 | 3 | A | |
| 23-237E2-00 | E2-02 ROM | EACH | \$15.00 | 3 | A | | 23-2E6-00 | E6-01 ROM, 32KX 8 | EACH | REPLACED | 3 | A | 4A-VT24X-WA |
| 23-237F1-00 | F1-01 PROM, 1024X 4 | EACH | \$19.00 | 3 | A | | 23-300F3-00 | F3-03 PROM, 1024X 8 | EACH | \$38.00 | 3 | A | |
| 23-238E2-00 | E2-02 | EACH | \$15.00 | 3 | A | | 23-301F3-00 | F3-03 PROM, 1024X 8 | EACH | \$38.00 | 3 | A | |
| 23-239E2-00 | E2-02 | EACH | \$15.00 | 3 | A | | 23-303A2-00 | A2-02,A2-04 | EACH | \$17.00 | 3 | A | |
| 23-239F1-00 | F1-01 PROM, 1024X 4 | EACH | \$19.00 | 3 | A | | 23-304A2-00 | A2-02,A2-04 | EACH | \$17.00 | 3 | A | |
| 23-23B1-00 | B1-01 PROM, 256X 8 | EACH | \$17.00 | 3 | A | | 23-30B1-00 | B1-01 PROM, 256X 8 | EACH | \$17.00 | 3 | A | |
| 23-23F1-00 | F1-01 | EACH | \$46.00 | 3 | A | | 23-30F5-00 | F5-01 PROM, 4096 X 4 | EACH | \$48.00 | 3 | A | |
| 23-248E5-00 | E5-01, E5-02, E5-03 | EACH | REPLACED | 3 | A | 4A-VT22X-WA | 23-312F4-00 | F4-09 | EACH | \$68.00 | 3 | A | |
| 23-248F1-00 | F1-01 (CPU,DIAG,NON-CACHE) | EACH | \$27.00 | 3 | A | | 23-313F4-00 | F4-09 | EACH | \$68.00 | 3 | A | |
| 23-249F1-00 | F1-01 | EACH | \$20.00 | 3 | A | | 23-31E2-00 | E2-02 | EACH | REPLACED | 3 | A | 23-61E2-00 |
| 23-24B1-00 | B1-01 PROM, 256X 8 | EACH | \$17.00 | 3 | A | | 23-31F5-00 | F5-01 PROM, 4096 X 4 | EACH | \$48.00 | 3 | A | |



Prices Effective 02-January-89 to 30-June-89

To Order—Call DECdirect™ TOLL-FREE 800-344-4825, 8:30 a.m. to 8:00 p.m. ET in Continental U.S.A.

HARDWARE SPARES PRICE LIST

| PART NUMBER | DESCRIPTION | UNIT ORDER | UNIT PRICE | REP D | L | REPLACEMENT PART NUMBER | PART NUMBER | DESCRIPTION | UNIT ORDER | UNIT PRICE | REP D | L | REPLACEMENT PART NUMBER |
|-------------|-------------------------------|------------|------------|-------|---|-------------------------|-------------|--------------------------|------------|------------|-------|---|-------------------------|
| 23-329F4-00 | F4-09 | EACH | \$68.00 | 3 | A | | 23-41A9-00 | A9-01 | EACH | \$44.00 | 3 | A | |
| 23-32C6-00 | C6-01 FPLA,16X48X 8 | EACH | \$45.00 | 3 | A | | 23-41E4-00 | E4-01, E4-02, E4-03 | EACH | REPLACED | 3 | A | 23-225E4-00 |
| 23-32E2-00 | E2-02 | EACH | \$21.00 | 3 | A | | 23-422A2-00 | A2-02, A2-04 PROM, 256X4 | EACH | \$8.00 | 3 | A | |
| 23-32F5-00 | F5-01 PROM, 4096 X 4 | EACH | \$48.00 | 3 | A | | 23-423A2-00 | A2-02, A2-04 PROM, 256X4 | EACH | \$8.00 | 3 | A | |
| 23-338A1-00 | A1-07 | EACH | \$13.00 | 3 | A | | 23-424A2-00 | A2-02, A2-04 PROM, 256X4 | EACH | \$8.00 | 3 | A | |
| 23-339E2-00 | E2-04 EPROM, 2048X8 | EACH | \$15.00 | 3 | A | | 23-42E2-00 | CONTROL ROM 1 | EACH | \$37.00 | 3 | A | |
| 23-33E2-00 | E2-02 | EACH | \$21.00 | 3 | A | | 23-42E4-00 | E4-01,E4-02,E4-03 | EACH | REPLACED | 3 | A | 23-226E4-00 |
| 23-33F5-00 | F5-01 PROM, 4096 X 4 | EACH | \$48.00 | 3 | A | | 23-435A9-00 | A9-01 PROM, 512X 4 | EACH | \$13.00 | 3 | A | |
| 23-340E2-00 | E2-04 EPROM, 2048X9 | EACH | \$15.00 | 3 | A | | 23-436A9-00 | A9-01 PROM, 512X 4 | EACH | \$13.00 | 3 | A | |
| 23-345A2-00 | A2-02, A2-04 PROM, 256X4 | EACH | \$8.00 | 3 | A | | 23-437A2-00 | A2-05 PROM, 256X 4 | EACH | \$8.00 | 3 | A | |
| 23-345A9-00 | A9-01 | EACH | \$20.00 | 3 | A | | 23-437A9-00 | A9-01 PROM, 512X 4 | EACH | \$13.00 | 3 | A | |
| 23-346A9-00 | A9-01 | EACH | \$20.00 | 3 | A | | 23-438A2-00 | A2-05 PROM, 256X 4 | EACH | \$8.00 | 3 | A | |
| 23-347A9-00 | A9-01 | EACH | \$20.00 | 3 | A | | 23-439A9-00 | A9-01 PROM, 512X 4 | EACH | \$13.00 | 3 | A | |
| 23-348A9-00 | A9-01 | EACH | \$20.00 | 3 | A | | 23-440A9-00 | A9-01 PROM, 512X 4 | EACH | \$13.00 | 3 | A | |
| 23-349A9-00 | A9-04 | EACH | \$18.00 | 3 | A | | 23-441A9-00 | A9-01 | EACH | \$14.00 | 3 | A | |
| 23-34A9-00 | A9-01 | EACH | \$44.00 | 3 | A | | 23-442A9-00 | A9-01 | EACH | \$14.00 | 3 | A | |
| 23-34B1-00 | B1-01 PROM, 256X 8 | EACH | \$17.00 | 3 | A | | 23-443A9-00 | A9-01 PROM, 512X 4 | EACH | \$13.00 | 3 | A | |
| 23-34E2-00 | E2-02 | EACH | \$21.00 | 3 | A | | 23-444A2-00 | A2-02,A2-04 | EACH | \$8.00 | 3 | A | |
| 23-34F5-00 | F5-01 PROM, 4096 X 4 | EACH | \$48.00 | 3 | A | | 23-444A9-00 | A9-01 PROM, 512X 4 | EACH | \$13.00 | 3 | A | |
| 23-35A9-00 | A9-01 | EACH | \$49.00 | 3 | A | | 23-445A2-00 | A2-02,A2-04 | EACH | \$7.00 | 3 | A | |
| 23-35F5-00 | F5-01 PROM, 4096 X 4 | EACH | \$48.00 | 3 | A | | 23-445A9-00 | A9-01 PROM, 512X 4 | EACH | \$13.00 | 3 | A | |
| 23-36A1-00 | A1-03,A1-04 | EACH | \$26.00 | 3 | A | | 23-446A9-00 | A9-01 PROM, 512X 4 | EACH | \$17.00 | 3 | A | |
| 23-36A9-00 | A9-01 | EACH | \$44.00 | 3 | A | | 23-446F1-00 | F1-02 | EACH | \$20.00 | 3 | A | |
| 23-36B1-00 | B1-01 PROM, 256X 8 | EACH | \$17.00 | 3 | A | | 23-44F1-00 | F1-01 PROM, 1024X 4 | EACH | \$19.00 | 3 | A | |
| 23-36E4-00 | E4-01,E4-02,E4-03 | EACH | \$65.00 | 3 | A | | 23-45E2-00 | E2-01 | EACH | \$37.00 | 3 | A | |
| 23-36F5-00 | F5-01 PROM, 4096 X 4 | EACH | \$48.00 | 3 | A | | 23-45F1-00 | F1-01 PROM, 1024X 4 | EACH | \$19.00 | 3 | A | |
| 23-371A2-00 | A2-02,A2-04 | EACH | \$8.00 | 3 | A | | 23-467A2-00 | A2-05 PROM | EACH | \$11.00 | 3 | A | |
| 23-372A2-00 | A2-02,A2-04 PROM, 256X 4 | EACH | \$8.00 | 3 | A | | 23-468A2-00 | A2-05 | EACH | \$11.00 | 3 | A | |
| 23-37A9-00 | A9-01 | EACH | \$44.00 | 3 | A | | 23-469A2-00 | A2-02,A2-04 PROM | EACH | \$11.00 | 3 | A | |
| 23-37B1-00 | B1-01 PROM, 256X 8 | EACH | \$17.00 | 3 | A | | 23-46E2-00 | E2-01 | EACH | \$37.00 | 3 | A | |
| 23-380E4-00 | E4-05 EPROM, 8192X8 | EACH | \$69.00 | 3 | A | | 23-46F1-00 | F1-01 PROM, 1024X 4 | EACH | \$19.00 | 3 | A | |
| 23-381E4-00 | E4-05 EPROM, 8192X 8 | EACH | \$77.00 | 3 | A | | 23-473F1-00 | F1-01 PROM, 1024X 4 | EACH | \$19.00 | 3 | A | |
| 23-38A9-00 | A9-01 | EACH | \$44.00 | 3 | A | | 23-474F1-00 | F1-01 PROM, 1024X 4 | EACH | \$19.00 | 3 | A | |
| 23-38E2-00 | E2-01 ROM, 2048X 8 | EACH | \$14.00 | 3 | A | | 23-475F1-00 | F1-01 PROM, 1024X 4 | EACH | \$19.00 | 3 | A | |
| 23-38E4-00 | E4-01,E4-02,E4-03 ROM 8192X B | EACH | \$18.00 | 3 | A | | 23-477F1-00 | F1-01 PROM, 1024X 4 | EACH | \$19.00 | 3 | A | |
| 23-390E2-00 | E2-05 EPROM, 2048X 8 | EACH | \$25.00 | 3 | A | | 23-481A9-00 | A9-01 | EACH | \$18.00 | 3 | A | |
| 23-391E2-00 | E2-05 EPROM, 2048X 8 | EACH | \$25.00 | 3 | A | | 23-482A9-00 | A9-01 | EACH | \$18.00 | 3 | A | |
| 23-392E2-00 | E2-05 EPROM, 2048X 8 | EACH | \$25.00 | 3 | A | | 23-48E5-00 | E5-01 ROM, 16KX 8 | EACH | REPLACED | 3 | A | 4A-VT24X-WA |
| 23-395E4-00 | E4-01,E4-02,E4-03,E4-05 ROM | EACH | \$95.00 | 3 | A | | 23-48F1-00 | F1-01 PROM, 1024X 4 | EACH | \$19.00 | 3 | A | |
| 23-396E4-00 | E4-01,E4-02,E4-03,E4-05 ROM | EACH | \$95.00 | 3 | A | | 23-494A2-00 | A2-05 | EACH | \$11.00 | 3 | A | |
| 23-397E4-00 | E4-01,E4-02,E4-03,E4-05 ROM | EACH | \$95.00 | 3 | A | | 23-49E5-00 | E5-01 ROM, 16KX 8 | EACH | REPLACED | 3 | A | 4A-VT24X-WA |
| 23-39A9-00 | A9-01 | EACH | \$44.00 | 3 | A | | 23-49F1-00 | F1-01 PROM, 1024X 4 | EACH | \$19.00 | 3 | A | |
| 23-39D1-00 | LOW BYTE PROM | EACH | REPLACED | 3 | A | 23-131F3-00 | 23-4E2-00 | E2-01 | EACH | REPLACED | 3 | A | 23-38E4-00 |
| 23-39E2-00 | CONTROL ROM 2 | EACH | \$37.00 | 3 | A | | 23-4E4-00 | E4-02 ROM 64K | EACH | \$74.00 | 3 | A | |
| 23-39E5-00 | E5-01 | EACH | REPLACED | 3 | A | 4A-VT22X-WA | 23-4E5-00 | E5-02 EPROM, 16KX 8 | EACH | REPLACED | 3 | A | 4A-VT24X-WA |
| 23-3B5-00 | LSI-11 MICROM 2 FIN SPEC | EACH | \$397.00 | 3 | A | | 23-4E6-00 | E6-01 ROM, 32KX 8 | EACH | REPLACED | 3 | A | 4A-VT24X-WA |
| 23-3E2-00 | E2-01 | EACH | REPLACED | 3 | A | 23-38E4-00 | 23-51F1-00 | F1-01 PROM, 1024X 4 | EACH | \$19.00 | 3 | A | |
| 23-3E5-00 | E5-02 EPROM, 16KX 8 | EACH | REPLACED | 3 | A | 4A-VT24X-WA | 23-52C6-00 | C6-01 FPLA, 16X48X 8 | EACH | \$45.00 | 3 | A | |
| 23-3E6-00 | E6-01 ROM, 32KX 8 | EACH | REPLACED | 3 | A | 4A-VT24X-WA | 23-52F1-00 | F1-01 PROM, 1024X 4 | EACH | \$19.00 | 3 | A | |
| 23-400A9-00 | A9-01 PROM, 512X 4 | EACH | \$12.00 | 3 | A | | 23-53A9-00 | A9-01 | EACH | \$18.00 | 3 | A | |
| 23-405A9-00 | A9-01 PROM, 512X 4 | EACH | \$12.00 | 3 | A | | 23-53C6-00 | C6-02 FPLA, 16X48X 8 | EACH | \$45.00 | 3 | A | |
| 23-407A9-00 | A9-01 PROM, 512X 4 | EACH | \$12.00 | 3 | A | | 23-53F1-00 | F1-01 PROM, 1024X 4 | EACH | \$19.00 | 3 | A | |
| 23-40A1-00 | A1-03,A1-04,A1-05 | EACH | \$26.00 | 3 | A | | 23-54F1-00 | F1-01 PROM, 1024X 4 | EACH | \$19.00 | 3 | A | |
| 23-40A9-00 | A9-01 | EACH | \$44.00 | 3 | A | | 23-55B1-00 | B1-01 | EACH | \$17.00 | 3 | A | |
| 23-40D1-00 | HIGH BYTE PROM | EACH | REPLACED | 3 | A | 23-132F3-00 | 23-55E4-00 | E4-02 | EACH | \$46.00 | 3 | A | |



Prices Effective 02-January-89 to 30-June-89
 To Order—Call DECdirect™ TOLL-FREE 800-344-4825, 8:30 a.m. to 8:00 p.m. ET in Continental U.S.A.

HARDWARE SPARES PRICE LIST

| PART NUMBER | DESCRIPTION | UNIT ORDER | UNIT PRICE | REP D | L | REPLACEMENT PART NUMBER | PART NUMBER | DESCRIPTION | UNIT ORDER | UNIT PRICE | REP D | L | REPLACEMENT PART NUMBER |
|-------------|------------------------|------------|------------|-------|---|-------------------------|-------------|------------------------------|------------|------------|-------|---|-------------------------|
| 23-55F1-00 | F1-01 PROM, 1024X 4 | EACH | \$19.00 | 3 | A | | 23-6E2-00 | E2-01 | EACH | REPLACED | 3 | A | 23-38E4-00 |
| 23-56E4-00 | E4-01,E4-02,E4-03 | EACH | \$46.00 | 3 | A | | 23-6E5-00 | E5-02 EPROM, 16KX 8 | EACH | REPLACED | 3 | A | 4A-VT24X-WA |
| 23-56E6-00 | E6-01 ROM, 32KX 8 | EACH | \$59.00 | 3 | A | | 23-6E6-00 | E6-01 ROM, 32KX 8 | EACH | REPLACED | 3 | A | 4A-VT24X-WA |
| 23-56F1-00 | F1-01 PROM, 1024X 4 | EACH | \$19.00 | 3 | A | | 23-6J5-00 | J5-01, J5-02 PAL/HAL | EACH | \$44.00 | 3 | A | |
| 23-57E4-00 | E4-01,E4-02,E4-03 | EACH | REPLACED | 3 | A | EQ-01393-01 | 23-700A9-00 | A9-01 PROM, 512X 4 | EACH | \$14.00 | 3 | A | |
| 23-57E6-00 | E6-01 ROM, 32KX 8 | EACH | \$59.00 | 3 | A | | 23-701A9-00 | A9-01 PROM, 512X 4 | EACH | \$14.00 | 3 | A | |
| 23-57F1-00 | F1-01 PROM, 1024X 4 | EACH | \$19.00 | 3 | A | | 23-70A6-00 | A6-01 | EACH | \$34.00 | 3 | A | |
| 23-586A9-00 | A9-01 PROM, 512X 4 | EACH | \$14.00 | 3 | A | | 23-70F1-00 | F1-01 PROM, 1024X 4 | EACH | \$19.00 | 3 | A | |
| 23-589A9-00 | A9-01 PROM, 512X 4 | EACH | \$14.00 | 3 | A | | 23-715A9-00 | A9-01 PROM, 512X4 | EACH | \$13.00 | 3 | A | |
| 23-58C6-00 | C6-02 | EACH | \$56.00 | 3 | A | | 23-717A9-00 | A9-01 PROM, 512X4 | EACH | \$13.00 | 3 | A | |
| 23-58E4-00 | E4-01,E4-02,E4-03 | EACH | REPLACED | 3 | A | EQ-01393-01 | 23-718A9-00 | A9-01 PROM, 512X4 | EACH | \$13.00 | 3 | A | |
| 23-58E6-00 | E6-01 ROM, 32KX 8 | EACH | \$59.00 | 3 | A | | 23-719A9-00 | A9-01 PROM, 512X4 | EACH | \$13.00 | 3 | A | |
| 23-58F1-00 | F1-01 PROM, 1024X 4 | EACH | \$19.00 | 3 | A | | 23-71A6-00 | A6-01 | EACH | \$34.00 | 3 | A | |
| 23-590A9-00 | A9-01 PROM, 512X 4 | EACH | \$14.00 | 3 | A | | 23-71E5-00 | E5-01 ROM, 16KX 8 | EACH | REPLACED | 3 | A | 4A-VT24X-WA |
| 23-599A9-00 | A9-01 PROM, 512X 4 | EACH | \$14.00 | 3 | A | | 23-71F1-00 | F1-01 PROM, 1024X 4 | EACH | \$19.00 | 3 | A | |
| 23-59E2-00 | E2-01 | EACH | \$21.00 | 3 | A | | 23-720A9-00 | A9-01 PROM, 512X4 | EACH | \$13.00 | 3 | A | |
| 23-59E4-00 | E4-01,E4-02,E4-03 | EACH | REPLACED | 3 | A | EQ-01393-01 | 23-72A6-00 | A6-01 | EACH | REPLACED | 3 | A | 23-71A6-00 |
| 23-59E6-00 | E6-01 ROM, 32KX 8 | EACH | \$59.00 | 3 | A | | 23-72E5-00 | E5-01 ROM, 16KX 8 | EACH | REPLACED | 3 | A | 4A-VT24X-WA |
| 23-59F1-00 | F1-01 PROM, 1024X 4 | EACH | \$19.00 | 3 | A | | 23-72F1-00 | F1-01 PROM, 1024X 4 | EACH | \$19.00 | 3 | A | |
| 23-5E2-00 | E2-01 | EACH | REPLACED | 3 | A | 23-38E4-00 | 23-733A9-00 | A9-01 PROM, 512X4 | EACH | \$13.00 | 3 | A | |
| 23-5E5-00 | E5-02 EPROM, 16KX 8 | EACH | REPLACED | 3 | A | 4A-VT24X-WA | 23-734A9-00 | A9-01 PROM, 512X4 | EACH | \$13.00 | 3 | A | |
| 23-5E6-00 | E6-01 ROM, 32KX 8 | EACH | REPLACED | 3 | A | 4A-VT24X-WA | 23-73F1-00 | F1-01 PROM, 1024X 4 | EACH | \$19.00 | 3 | A | |
| 23-5J5-00 | J5-01, J5-02 PAL/HAL | EACH | \$44.00 | 3 | A | | 23-748A9-00 | A9-01 PROM, 512X 4 | EACH | \$14.00 | 3 | A | |
| 23-602A9-00 | A9-01 PROM, 512X 4 | EACH | \$14.00 | 3 | A | | 23-749A9-00 | A9-01 PROM, 512X 4 | EACH | \$14.00 | 3 | A | |
| 23-603A9-00 | A9-01 PROM, 512X 4 | EACH | \$14.00 | 3 | A | | 23-74F1-00 | F1-01 PROM, 1024X 4 | EACH | \$19.00 | 3 | A | |
| 23-607A9-00 | A9-01 PROM, 512X 4 | EACH | \$14.00 | 3 | A | | 23-751A9-00 | A9-01 (RL01) | EACH | \$38.00 | 3 | A | |
| 23-608A9-00 | A9-01 PROM, 512X 4 | EACH | \$14.00 | 3 | A | | 23-752A9-00 | A9-01 (RK06.07) | EACH | \$32.00 | 3 | A | |
| 23-60E4-00 | E4-01,E4-03 ROM,8192X8 | EACH | \$55.00 | 3 | A | | 23-753A9-00 | A9-01 (RX01) | EACH | \$32.00 | 3 | A | |
| 23-60F1-00 | F1-01 PROM, 1024X 4 | EACH | \$19.00 | 3 | A | | 23-755A9-00 | A9-01 (RP02.3,4,5,6,RM02,03) | EACH | \$32.00 | 3 | A | |
| 23-616F1-00 | F1-01 (CPU,DIAG,CACHE) | EACH | \$27.00 | 3 | A | | 23-756A9-00 | A9-01 (RK03,05,05J,TU55,56) | EACH | \$32.00 | 3 | A | |
| 23-61E2-00 | E2-02 | EACH | \$21.00 | 3 | A | | 23-757A9-00 | A9-01 (TU16,77,TE16,TM02,03) | EACH | \$32.00 | 3 | A | |
| 23-61F1-00 | F1-01 PROM, 1024X 4 | EACH | \$19.00 | 3 | A | | 23-758A9-00 | A9-01 (TU10,TE10,TS03,TS04) | EACH | \$32.00 | 3 | A | |
| 23-622A9-00 | A9-01 | EACH | \$14.00 | 3 | A | | 23-759A9-00 | A9-01 (RS03,04) | EACH | \$32.00 | 3 | A | |
| 23-62F1-00 | F1-01 PROM, 1024X 4 | EACH | \$19.00 | 3 | A | | 23-75F1-00 | F1-01 PROM, 1024X 4 | EACH | \$19.00 | 3 | A | |
| 23-636A9-00 | A9-01 | EACH | \$14.00 | 3 | A | | 23-760A9-00 | A9-01 (PC05) | EACH | \$27.00 | 3 | A | |
| 23-63F1-00 | F1-01 PROM, 1024X 4 | EACH | \$19.00 | 3 | A | | 23-761A9-00 | A9-01 (TU60) | EACH | \$32.00 | 3 | A | |
| 23-645A2-00 | A2-05 PROM, 256X4 | EACH | \$6.00 | 3 | A | | 23-765A9-00 | A9-01 (TU58) | EACH | \$20.00 | 3 | A | |
| 23-64E4-00 | E4-01,E4-03 ROM,8192X8 | EACH | \$55.00 | 3 | A | | 23-767A9-00 | RA81-AA A9-01 PROM | EACH | \$19.00 | 3 | A | |
| 23-64F1-00 | F1-01 PROM, 1024X 4 | EACH | \$19.00 | 3 | A | | 23-76F1-00 | F1-01 PROM, 1024X 4 | EACH | \$19.00 | 3 | A | |
| 23-656A2-00 | A2-05 | EACH | \$11.00 | 3 | A | | 23-774F1-00 | F1-01 PROM, 1024X 4 | EACH | \$15.00 | 3 | A | |
| 23-65C6-00 | C6-02 FPLA,16X48X8 | EACH | \$45.00 | 3 | A | | 23-777A9-00 | A9-01 PROM, 512X4 | EACH | \$13.00 | 3 | A | |
| 23-65F1-00 | F1-01 PROM, 1024X 4 | EACH | \$19.00 | 3 | A | | 23-778A9-00 | A9-01 PROM, 512X 4 | EACH | \$14.00 | 3 | A | |
| 23-66C6-00 | C6-02 FPLA,16X48X8 | EACH | \$45.00 | 3 | A | | 23-77C6-00 | C6-01 FPLA, 16X48X8 | EACH | \$27.00 | 3 | A | |
| 23-66F1-00 | F1-01 PROM, 1024X 4 | EACH | \$19.00 | 3 | A | | 23-77F1-00 | F1-01 PROM, 1024X 4 | EACH | \$19.00 | 3 | A | |
| 23-67C6-00 | C6-02 FPLA,16X48X8 | EACH | \$45.00 | 3 | A | | 23-780A9-00 | A9-01 PROM, 512X 4 | EACH | \$14.00 | 3 | A | |
| 23-67F1-00 | F1-01 PROM, 1024X 4 | EACH | \$19.00 | 3 | A | | 23-781A9-00 | A9-01 PROM, 512X 4 | EACH | \$14.00 | 3 | A | |
| 23-685A9-00 | A9-01 PROM, 512X 4 | EACH | \$14.00 | 3 | A | | 23-78F1-00 | F1-01 PROM, 1024X 4 | EACH | \$19.00 | 3 | A | |
| 23-687A9-00 | A9-01 PROM, 512X 4 | EACH | \$14.00 | 3 | A | | 23-79F1-00 | F1-01 PROM, 1024X 4 | EACH | \$19.00 | 3 | A | |
| 23-687A9-00 | A9-01 PROM, 512X 4 | EACH | \$14.00 | 3 | A | | 23-7E2-00 | E2-01 | EACH | \$21.00 | 3 | A | |
| 23-68C6-00 | C6-02 FPLA,16X48X8 | EACH | \$45.00 | 3 | A | | 23-7E5-00 | E5-02 EPROM, 16KX 8 | EACH | REPLACED | 3 | A | 4A-VT24X-WA |
| 23-68F1-00 | F1-01 PROM, 1024X 4 | EACH | \$19.00 | 3 | A | | 23-7E6-00 | E6-01 ROM, 32KX 8 | EACH | REPLACED | 3 | A | 4A-VT24X-WA |
| 23-699A9-00 | A9-01 PROM, 512X 4 | EACH | \$14.00 | 3 | A | | 23-7J5-00 | J5-01, J5-02 PAL/HAL | EACH | \$44.00 | 3 | A | |
| 23-69B1-00 | B1-01 | EACH | \$21.00 | 3 | A | | 23-80F1-00 | F1-01 PROM, 1024X 4 | EACH | \$19.00 | 3 | A | |
| 23-69E2-00 | E2-02 E2-04 ROM E PROM | EACH | \$15.00 | 3 | A | | 23-811A9-00 | A9-01 (RX02) | EACH | \$38.00 | 3 | A | |
| 23-69F1-00 | F1-01 PROM, 1024X 4 | EACH | \$19.00 | 3 | A | | 23-81E5-00 | E5-01 ROM, 16KX 8 | EACH | REPLACED | 3 | A | 4A-VT22X-WA |
| 23-69K5-00 | PAL FOR L0108 MODULE | EACH | \$15.00 | 3 | A | | | | | | | | |



Prices Effective 02-January-89 to 30-June-89

To Order—Call DECdirect™ TOLL-FREE 800-344-4825, 8:30 a.m. to 8:00 p.m. ET in Continental U.S.A.

HARDWARE SPARES PRICE LIST

| PART NUMBER | DESCRIPTION | UNIT ORDER | UNIT PRICE | REP D L | REPLACEMENT PART NUMBER | PART NUMBER | DESCRIPTION | UNIT ORDER | UNIT PRICE | REP D L | REPLACEMENT PART NUMBER |
|-------------|-------------------------------|------------|------------|---------|-------------------------|------------------------------|--------------------------------|------------|------------|---------|-------------------------|
| 23-81F1-00 | F1-01 PROM, 1024X 4 | EACH | \$19.00 | 3 A | | 23-A11A2-00 | A2-01, A2-02, A2-04 | EACH | \$49.00 | 3 A | |
| 23-82A6-00 | A6-01 | EACH | \$34.00 | 3 A | | 23-A22A2-00 | A2-02, A2-04 | EACH | \$27.00 | 3 A | |
| 23-82E5-00 | E5-01 ROM, 16KX 8 | EACH | REPLACED | 3 A | 4A-VT22X-WA | 23-B43A2-00 | A2-01, A2-04 | EACH | \$23.00 | 3 A | |
| 23-82F1-00 | F1-01 PROM, 1024X 4 | EACH | \$19.00 | 3 A | | 23-C84A2-00 | A2-01, A2-02, A2-04 | EACH | \$20.00 | 3 A | |
| 23-83F1-00 | F1-01 PROM, 1024X 4 | EACH | \$19.00 | 3 A | | 23-E40A9-00 | A9-01 PROM, 512X 4 | EACH | \$10.00 | 3 A | |
| 23-83J5-00 | J5-01 PAL, LOGIC, CONTACT LSI | EACH | \$43.00 | 3 A | | 23-E41A9-00 | A9-01 PROM, 512X 4 | EACH | \$10.00 | 3 A | |
| 23-846A9-00 | A9-01 | EACH | \$14.00 | 3 A | | 23-E42A9-00 | A9-01 PROM, 512X 4 | EACH | \$10.00 | 3 A | |
| 23-848A9-00 | A9-01 PROM, 512X 4 | EACH | \$13.00 | 3 A | | 23-E43A9-00 | A9-01 PROM, 512X 4 | EACH | \$10.00 | 3 A | |
| 23-84F1-00 | F1-01 PROM, 1024X 4 | EACH | \$19.00 | 3 A | | 23-E44A9-00 | A9-01 PROM, 512X 4 | EACH | \$10.00 | 3 A | |
| 23-84J5-00 | J5-01 PAL, LOGIC, CONTACT LSI | EACH | \$43.00 | 3 A | | 23-E45A9-00 | A9-01 PROM, 512X 4 | EACH | \$10.00 | 3 A | |
| 23-85E5-00 | E5-02 EPROM, 16KX 8 | EACH | REPLACED | 3 A | 4A-VT22X-WA | | | | | | |
| 23-85F1-00 | F1-01 PROM, 1024X 4 | EACH | \$19.00 | 3 A | | | | | | | |
| 23-85F3-00 | F3-01 PROM, 1024X 8 | EACH | \$55.00 | 3 A | | | | | | | |
| 23-86E2-00 | E2-02 ROM 2K | EACH | \$21.00 | 3 A | | | | | | | |
| 23-86E5-00 | E5-02 UVEPROM, 16KX 8 | EACH | REPLACED | 3 A | 4A-VT22X-WA | | | | | | |
| 23-86F1-00 | F1-01 PROM, 1024X 4 | EACH | \$19.00 | 3 A | | | | | | | |
| 23-87F1-00 | F1-01 PROM, 1024X 4 | EACH | \$19.00 | 3 A | | | | | | | |
| 23-88A6-00 | A6-01 | EACH | \$44.00 | 3 A | | | | | | | |
| 23-88C6-00 | C6-01 FPLA, 16X48X8 | EACH | \$50.00 | 3 A | | | | | | | |
| 23-88F1-00 | F1-01 PROM, 1024X 4 | EACH | \$19.00 | 3 A | | | | | | | |
| 23-89A1-00 | A1-03, A1-04, A1-05 | EACH | \$23.00 | 3 A | | | | | | | |
| 23-89C6-00 | C6-01 FPLA, 16X48X8 | EACH | \$50.00 | 3 A | | | | | | | |
| 23-89F1-00 | F1-01 PROM, 1024X 4 | EACH | \$19.00 | 3 A | | | | | | | |
| 23-8E5-00 | E5-02 EPROM, 16KX 8 | EACH | REPLACED | 3 A | 4A-VT24X-WA | | | | | | |
| 23-8E6-00 | E6-01 ROM, 32KX 8 | EACH | \$46.00 | 3 A | | | | | | | |
| 23-905A9-00 | A9-01 PROM, 512X4 | EACH | \$14.00 | 3 A | | | | | | | |
| 23-908A9-00 | A9-01 PROM, 512X4 | EACH | \$14.00 | 3 A | | | | | | | |
| 23-90F1-00 | F1-01 PROM, 1024X 4 | EACH | \$19.00 | 3 A | | | | | | | |
| 23-91A5-01 | A5-01 LSI-11 MICROM 2 KEV-11 | EACH | REPLACED | 3 A | 23-3B5-00 | | | | | | |
| 23-91F1-00 | F1-01 PROM, 1024X 4 | EACH | \$19.00 | 3 A | | | | | | | |
| 23-92F1-00 | F1-01 PROM, 1024X 4 | EACH | \$19.00 | 3 A | | | | | | | |
| 23-93E2-00 | E2-02, E2-04 PROM | EACH | \$15.00 | 3 A | | | | | | | |
| 23-93F1-00 | F1-01 PROM, 1024X 4 | EACH | \$19.00 | 3 A | | | | | | | |
| 23-94A1-00 | A1-07 | EACH | \$24.00 | 3 A | | | | | | | |
| 23-94E2-00 | E2-03, E2-04 PROM | EACH | \$15.00 | 3 A | | | | | | | |
| 23-94F1-00 | F1-01 PROM, 1024X 4 | EACH | \$19.00 | 3 A | | | | | | | |
| 23-95A1-00 | A1-07 | EACH | \$20.00 | 3 A | | | | | | | |
| 23-95E2-00 | E2-02 | EACH | \$15.00 | 3 A | | | | | | | |
| 23-95F1-00 | F1-01 PROM, 1024X 4 | EACH | \$19.00 | 3 A | | | | | | | |
| 23-95F3-00 | F3-03 | EACH | \$48.00 | 3 A | | | | | | | |
| 23-969A9-00 | A9-01 PROM, 512X4 | EACH | \$23.00 | 3 A | | | | | | | |
| 23-96A6-00 | A6-01 | EACH | \$30.00 | 3 A | | | | | | | |
| 23-96E2-00 | E2-02 | EACH | \$15.00 | 3 A | | | | | | | |
| 23-96F1-00 | F1-01 PROM, 1024X 4 | EACH | \$19.00 | 3 A | | | | | | | |
| 23-97F1-00 | F1-01 PROM, 1024X 4 | EACH | \$19.00 | 3 A | | | | | | | |
| 23-98E2-00 | E2-02 | EACH | \$15.00 | 3 A | | | | | | | |
| 23-98F1-00 | F1-01 PROM, 1024X 4 | EACH | \$19.00 | 3 A | | | | | | | |
| 23-991A9-00 | A0-09 PROM, 512X4 | EACH | \$14.00 | 3 A | | | | | | | |
| 23-99A9-00 | A9-03 PROM, 512X 4 | EACH | \$12.00 | 3 A | | | | | | | |
| 23-99E2-00 | E2-02 | EACH | \$15.00 | 3 A | | | | | | | |
| 23-99F1-00 | F1-01 PROM, 1024X 4 | EACH | \$19.00 | 3 A | | | | | | | |
| 23-9E1-00 | E1-01 | EACH | \$39.00 | 3 A | | | | | | | |
| 23-9E5-00 | E5-02 EPROM, 16KX 8 | EACH | REPLACED | 3 A | 4A-VT24X-WA | | | | | | |
| 23-9E6-00 | E6-02 UVEPROM, 32KX 8 | EACH | REPLACED | 3 A | 4A-VT24X-WA | | | | | | |
| 23-9J5-00 | J5-01, J5-02 PAL/ HAL | EACH | \$44.00 | 3 A | | | | | | | |
| | | | | | | 29 CLASS Vendor Parts | | | | | |
| | | | | | | 29-10193-00 | BLOWER PAMOTOR | EACH | \$88.00 | 3 A | |
| | | | | | | 29-10482-00 | HEX KEY SET | EACH | \$8.00 | 3 A | |
| | | | | | | 29-10562-00 | DRIVER HANDLE | EACH | \$8.00 | 3 A | |
| | | | | | | 29-10865-00 | SCREWDRIVER 5/32" ALLEN | EACH | \$9.00 | 3 A | |
| | | | | | | 29-11625-00 | EXTENSION, 7" | EACH | \$8.00 | 3 A | |
| | | | | | | 29-11630-00 | BALLDRIVER 5/32" | EACH | REPLACED | 3 A | 29-26116-00 |
| | | | | | | 29-11635-00 | TACHOMETER | EACH | \$654.00 | 3 A | |
| | | | | | | 29-11636-00 | GAUGE, 5PSIG | EACH | \$193.00 | 3 A | |
| | | | | | | 29-11647-00 | ACCESSORIES, PORTABLE ACCURACY | EACH | \$122.00 | 3 A | |
| | | | | | | 29-11650-00 | GAUGE, 0-40" WATER | EACH | \$114.00 | 3 A | |
| | | | | | | 29-11691-00 | TAPE, MASTER OUTPUT, 1200' | EACH | \$340.00 | 3 A | |
| | | | | | | 29-11696-00 | TAPE, MASTER OUTPUT | EACH | \$187.00 | 3 A | |
| | | | | | | 29-11760-00 | HUB REPAIR KIT | EACH | \$70.00 | 3 A | |
| | | | | | | 29-11762-00 | KIT, VELOSTAT PART F/S | EACH | REPLACED | 3 A | 29-26246-00 |
| | | | | | | 29-12432-00 | BELT 100X XL037 | EACH | \$30.00 | 3 A | |
| | | | | | | 29-12519-00 | BELT | EACH | \$27.00 | 3 A | |
| | | | | | | 29-13180-00 | RELAY DPDT 25A STV PR11 | EACH | \$110.00 | 3 A | |
| | | | | | | 29-13212-00 | SCDRVR, TORQUE 2-36IN/L | EACH | REPLACED | 3 A | 29-17381-00 |
| | | | | | | 29-13245-00 | BELT, SPINDLE DRIVE 60H | EACH | \$48.00 | 3 A | |
| | | | | | | 29-13515-00 | GAUGE, THICKNESS | EACH | \$17.00 | 3 A | |
| | | | | | | 29-15026-00 | SWITCH MICRO | EACH | \$8.00 | 3 A | |
| | | | | | | 29-15044-00 | PCBA STACK DECODER | EACH | \$1,221.00 | Y 3 A | |
| | | | | | | 29-15048-00 | PCBA DRIVE SWITCH | EACH | \$1,398.00 | Y 3 A | |
| | | | | | | 29-15049-00 | PCBA DATA REGISTER | EACH | \$999.00 | Y 3 A | |
| | | | | | | 29-15051-00 | PCBA ADDRESS DECODER | EACH | \$669.00 | 3 A | |
| | | | | | | 29-15052-00 | PCBA LINE DRIVER | EACH | \$380.00 | 3 A | |
| | | | | | | 29-15062-00 | PCBA LINE RECEIVER | EACH | \$772.00 | 3 A | |
| | | | | | | 29-15064-00 | PCBA HOLD REGISTER | EACH | \$529.00 | 3 A | |
| | | | | | | 29-15088-00 | RESISTOR | EACH | \$106.00 | 3 A | |
| | | | | | | 29-15090-00 | DIODE 3.3V 400MW 5% | EACH | \$11.00 | 3 A | |
| | | | | | | 29-15092-00 | DIODE CD 6030 | QTY OF 10 | \$4.00 | 3 A | |
| | | | | | | 29-15099-00 | DIODE | QTY OF 10 | \$6.00 | 3 A | |
| | | | | | | 29-15100-00 | TRANSISTOR | QTY OF 10 | \$4.00 | 3 A | |
| | | | | | | 29-15108-00 | TRANSISTOR | EACH | \$6.00 | 3 A | |
| | | | | | | 29-15111-00 | TRANSISTOR | EACH | \$8.00 | 3 A | |
| | | | | | | 29-15121-00 | IC | EACH | \$29.00 | 3 A | |
| | | | | | | 29-15843-00 | KEY | QTY OF 10 | \$5.00 | 3 A | |
| | | | | | | 29-16141-00 | GOGGLES, IMPACT CLEAR LENS | EACH | \$6.00 | 3 A | |
| | | | | | | 29-16280-00 | SWITCH, MICRO | EACH | \$24.00 | 3 A | |
| | | | | | | 29-16871-00 | MAGNASEE | EACH | \$26.00 | 3 A | |



Prices Effective 02-January-89 to 30-June-89

To Order—Call DECdirect™ TOLL-FREE 800-344-4825, 8:30 a.m. to 8:00 p.m. ET in Continental U.S.A.

HARDWARE SPARES PRICE LIST

| PART NUMBER | DESCRIPTION | UNIT ORDER | UNIT PRICE | REP D | L | REPLACEMENT PART NUMBER | PART NUMBER | DESCRIPTION | UNIT ORDER | UNIT PRICE | REP D | L | REPLACEMENT PART NUMBER |
|-------------|-----------------------------|------------|------------|-------|---|-------------------------|------------------------|-------------------------|------------|------------|-------|-------------|-------------------------|
| 29-17381-00 | TORQUE SCREWDRIVER 1-36 LBS | EACH | \$280.00 | 3 | A | | 29-21471-00 | PCBA POWER DIST | EACH | \$78.00 | 3 | A | |
| 29-17612-00 | CONTACT, GROUND | EACH | \$13.00 | 3 | A | | 29-21472-00 | TRACTOR LEFT | EACH | \$624.00 | 3 | A | |
| 29-17613-00 | RETAINER, CONTACT | EACH | \$19.00 | 3 | A | | 29-21473-00 | TRACTOR RIGHT | EACH | \$624.00 | 3 | A | |
| 29-17912-00 | FUSE 14 800316-080 | QTY OF 10 | \$1.00 | 3 | A | | 29-21475-00 | PCBA SENSOR HB | EACH | REPLACED | 3 | A | 29-24196-00 |
| 29-18283-00 | BELT, RP07 60HZ/RP03 50HZ | EACH | \$36.00 | 3 | A | | 29-21476-00 | PCBA EMITTER HB | EACH | REPLACED | 3 | A | 29-24196-00 |
| 29-18504-00 | BIT, ALLEN 5/64" | EACH | \$6.00 | 3 | A | | 29-21477-00 | PCBA SENSOR PD | EACH | REPLACED | 3 | A | 29-24076-00 |
| 29-18505-00 | BIT, ALLEN 3/32" | EACH | \$6.00 | 3 | A | | 29-21478-00 | PCBA EMITTER PD | EACH | REPLACED | 3 | A | 29-24076-00 |
| 29-18610-00 | GAUGE, RD/WR SET UP TU1 | EACH | REPLACED | 3 | A | 96-05494-00 | ORDER 11-10051 | EACH | REPLACED | 3 | A | 11-10051-00 | |
| 29-18939-00 | EXTENDER, PCBA 29 | EACH | \$339.00 | 3 | A | | 29-21624-00 | PULLEY, DRUM MOTOR | EACH | \$81.00 | 3 | A | |
| 29-19224-00 | TAPE, MASTER SKEW 1200' | EACH | \$751.00 | 3 | A | | 29-21633-00 | ORDER 90-07215 | QTY OF 10 | REPLACED | 3 | A | 90-07215-00 |
| 29-19558-00 | WAND, DISK CLEANING 12 EACH | PKG | \$5.00 | 3 | A | | 29-21798-00 | ORDER 90-07999 | QTY OF 10 | REPLACED | 3 | A | 90-07999-00 |
| 29-19663-00 | MIRROR INSPECT W/LIGHT | EACH | \$29.00 | 3 | A | | 29-21801-00 | ORDER 90-07220 | QTY OF 10 | REPLACED | 3 | A | 90-07220-00 |
| 29-20091-00 | ORDER 29-17912 | QTY OF 10 | REPLACED | 3 | A | 29-17912-00 | ORDER 90-07208 | QTY OF 10 | REPLACED | 3 | A | 90-07208-00 | |
| 29-20126-00 | BEARING CHAR DM | EACH | \$14.00 | 3 | A | | 29-21832-00 | BALL DRIVER SET, 12 PIE | EACH | \$122.00 | 3 | A | |
| 29-20273-00 | MICROSCOPE 40X | EACH | \$95.00 | 3 | A | | 29-21849-00 | BELT, DRUM DRIVE 96 CHA | EACH | \$20.00 | 3 | A | |
| 29-20393-00 | DIODE SWITCHING 14 | QTY OF 10 | \$5.00 | 3 | A | | 29-21860-00 | FAN220VAC13AMP | EACH | \$150.00 | 3 | A | |
| 29-20396-00 | SWITCH, ROCKET SPDT | EACH | \$8.00 | 3 | A | | 29-21863-00 | BRUSH, VACUUM MOTOR | EACH | \$7.00 | 3 | A | |
| 29-20496-00 | ORDER 29-12432 | EACH | REPLACED | 3 | A | 29-12432-00 | ORDER 29-21849 | EACH | REPLACED | 3 | A | 29-21849-00 | |
| 29-20678-00 | GAUGE, 0-60" H20 PRESSU | EACH | \$168.00 | 3 | A | | 29-21895-00 | SWITCH ASSY FORM SLCT | EACH | \$442.00 | 3 | A | |
| 29-20681-00 | SWITCH, SNAP SPDT 1A 12 | EACH | \$14.00 | 3 | A | | 29-21898-00 | PCBA DAVFU LSP10-V/W | EACH | REPLACED | 3 | A | 29-21121-00 |
| 29-20906-00 | WRENCH, TORQUE 5-150IN/ | EACH | \$218.00 | 3 | A | | 29-21904-00 | ALIGNMENT TOOL, TAPE PA | EACH | \$730.00 | 3 | A | |
| 29-20907-00 | EXTENSION, 6" 1/4" DRIV | EACH | \$23.00 | 3 | A | | 29-21929-00 | O-RING | EACH | \$19.00 | 3 | A | |
| 29-20995-00 | BIT, ALLEN 3/16" RK05 | EACH | \$37.00 | 3 | A | | 29-21936-00 | ORDER 29-12519 | EACH | REPLACED | 3 | A | 29-12519-00 |
| 29-21108-00 | ORDER 12-11863-01 | QTY OF 10 | REPLACED | 3 | A | 12-11863-01 | PULLER, CAPSTAN 38 | EACH | \$255.00 | 3 | A | | |
| 29-21110-00 | ORDER 12-11860-00 | QTY OF 10 | REPLACED | 3 | A | 12-11860-00 | THYRISTOR, 200V 15A 14 | EACH | \$19.00 | 3 | A | | |
| 29-21112-00 | PCBA LOGIC LP05 | EACH | \$1,313.00 | Y | 3 | A | 29-21964-00 | HUB REPAIR KIT | EACH | \$81.00 | 3 | A | |
| 29-21113-00 | PCBA SERVO LO05 | EACH | \$804.00 | Y | 3 | A | 29-22020-00 | TAPE, MASTER SKEW 7" RE | EACH | \$424.00 | 3 | A | |
| 29-21114-00 | PCBA HMMR DRVR | EACH | \$609.00 | Y | 3 | A | 29-22039-00 | GAUGE, DEPTH 0 TO 3" | EACH | \$253.00 | 3 | A | |
| 29-21116-00 | HAMMER, MKIVB | EACH | \$273.00 | 3 | A | | 29-22072-00 | PCBA SEQUENCE | EACH | \$737.00 | Y | 3 | A |
| 29-21117-00 | LAMP 12V 30MA 14 800785 | EACH | \$8.00 | 3 | A | | 29-22073-00 | PCBA SERVO CONTROL | EACH | \$569.00 | Y | 3 | A |
| 29-21119-00 | BELT, DRUM DRIVE 64 CHA | EACH | \$19.00 | 3 | A | | 29-22078-00 | PCBA DETECTOR/SELECT 1 | EACH | \$843.00 | Y | 3 | A |
| 29-21120-00 | MOTOR RIBBON | EACH | \$111.00 | 3 | A | | 29-22080-00 | SWITCH,SUBMIN E63-10A | EACH | \$15.00 | 3 | A | |
| 29-21121-00 | PCBA VERT FRMT | EACH | \$686.00 | Y | 3 | A | 29-22082-00 | SWITCH, TOGGLE SPDT | EACH | \$20.00 | 3 | A | |
| 29-21124-00 | MOTOR, DRUM | EACH | \$230.00 | 3 | A | | 29-22083-00 | SWITCH, TOGGLE SPDT | EACH | \$32.00 | 3 | A | |
| 29-21126-00 | DISC ENCODER | EACH | \$36.00 | 3 | A | | 29-22086-00 | FILTER, ASSY | EACH | \$152.00 | 3 | A | |
| 29-21127-00 | SWITCH, PAPER OUT LOWER | EACH | REPLACED | 3 | A | 29-22837-00 | DUCT ASSY, AIR | EACH | \$95.00 | 3 | A | | |
| 29-21140-00 | RELAY 12VDC DPDT 30A 12 | EACH | \$82.00 | 3 | A | | 29-22089-00 | POWER SUPPLY ASSY | EACH | \$5,255.00 | Y | 3 | A |
| 29-21145-00 | XDUCER | EACH | REPLACED | 3 | A | 29-23666-00 | FILTER, RFI 30A | EACH | \$301.00 | 3 | A | | |
| 29-21147-00 | COIL ASSY, VEL TRANSDUC | EACH | \$340.00 | 3 | A | | 29-22095-00 | DOOR ASSY | EACH | \$543.00 | 3 | A | |
| 29-21148-00 | I/O HARNESS ASSY | EACH | \$363.00 | 3 | A | | 29-22100-00 | PCBA SERVO PREAMP | EACH | \$526.00 | Y | 3 | A |
| 29-21222-00 | PCBA SELP TEST | EACH | \$630.00 | Y | 3 | A | 29-22102-00 | CAM | EACH | \$51.00 | 3 | A | |
| 29-21230-00 | LAMP 29 43007018-4 | EACH | \$19.00 | 3 | A | | 29-22104-00 | HEAD ASSY AD 200MB | EACH | \$311.00 | Y | 3 | A |
| 29-21275-00 | FILTER, PRE | EACH | \$7.00 | 3 | A | | 29-22105-00 | HEAD ASSY, AU 200MB | EACH | \$296.00 | Y | 3 | A |
| 29-21276-00 | FILTER ABSOLUTE | EACH | \$229.00 | 3 | A | | 29-22106-00 | HEAD ASSY, BD 200MB | EACH | \$296.00 | Y | 3 | A |
| 29-21277-00 | HEAD ASSY AV | EACH | \$486.00 | Y | 3 | A | 29-22107-00 | HEAD ASSY, BU 200MB | EACH | \$296.00 | Y | 3 | A |
| 29-21284-00 | TOOL, HEAD ALIGNMENT 29 | EACH | \$891.00 | 3 | A | | 29-22108-00 | HEAD ASSY, A SERVO 200M | EACH | \$400.00 | Y | 3 | A |
| 29-21285-00 | INSTALLATION TOOL HEAD | EACH | \$144.00 | 3 | A | | 29-22110-00 | T-BLOCK ASSY, CARRIAGE | EACH | \$1,199.00 | Y | 3 | A |
| 29-21287-00 | ALIGNMENT TOOL HEAD 29 | EACH | \$236.00 | 3 | A | | 29-22111-00 | GROUND ASSY, CARRIAGE | EACH | \$81.00 | 3 | A | |
| 29-21290-00 | ABSOLUTE FILTER GAUGE 0-5" | EACH | \$146.00 | 3 | A | | 29-22114-00 | ROD ASSY, TACH | EACH | \$84.00 | 3 | A | |
| 29-21291-00 | EXTENDER JUMP CARD, PCB | EACH | \$599.00 | 3 | A | | 29-22117-00 | BOBBIN ASSY | EACH | \$362.00 | 3 | A | |
| 29-21292-00 | CE PACK 3336 | EACH | \$5,591.00 | Y | 3 | A | 29-22120-00 | FLEX CONDUCTOR ASSY | EACH | \$193.00 | 3 | A | |
| 29-21335-00 | LUBRICATOR ASSY | EACH | \$15.00 | 3 | A | | 29-22121-00 | SPINDLE ASSY | EACH | \$2,636.00 | Y | 3 | A |
| 29-21380-00 | BELT SPNDL DR60 | EACH | \$42.00 | 3 | A | | 29-22123-00 | SENSOR ASSY, PACK COVER | EACH | \$121.00 | 3 | A | |
| 29-21412-00 | EXTRACTOR 29 | EACH | \$93.00 | 3 | A | | 29-22124-00 | GROUND ASSY, SPINDLE | EACH | \$71.00 | 3 | A | |
| 29-21470-00 | LAMP, LED, 14 801082-00 | EACH | \$11.00 | 3 | A | | 29-22125-00 | LOCK ASSY, SPINDLE | EACH | \$70.00 | 3 | A | |



Prices Effective 02-January-89 to 30-June-89

To Order—Call DECdirect™ TOLL-FREE 800-344-4825, 8:30 a.m. to 8:00 p.m. ET in Continental U.S.A.

HARDWARE SPARES PRICE LIST

| PART NUMBER | DESCRIPTION | UNIT ORDER | UNIT PRICE | REP D | L | REPLACEMENT PART NUMBER | PART NUMBER | DESCRIPTION | UNIT ORDER | UNIT PRICE | REP D | L | REPLACEMENT PART NUMBER |
|-------------|---------------------------|------------|------------|-------|---|-------------------------|-------------|---------------------------|------------|------------|-------|---|-------------------------|
| 29-22126-00 | BELT, FLAT 50HZ | EACH | \$21.00 | 3 | A | | 29-22539-00 | PLATE,LT PRESSURE | EACH | \$93.00 | 3 | A | |
| 29-22131-00 | SWITCH ASSY, COVER PM | EACH | \$32.00 | 3 | A | | 29-22540-00 | SPRING, PAPER PRESSURE | EACH | \$2.00 | 3 | A | |
| 29-22133-00 | PULLEY 60HZ | EACH | \$108.00 | 3 | A | | 29-22541-00 | BELT, DRUM 96 CHAR | EACH | \$20.00 | 3 | A | |
| 29-22138-00 | PCBA -5.2V REGULATOR | EACH | \$479.00 | Y | 3 | A | 29-22544-00 | PIN,DOWEL | QTY OF 10 | \$2.00 | 3 | A | |
| 29-22140-00 | PCBA -15V REGULATOR | EACH | \$404.00 | Y | 3 | A | 29-22771-00 | KIT, RK06 TOOLS SPECIAL | EACH | \$747.00 | 3 | A | |
| 29-22146-00 | RECTIFIER, FW BRIDGE | EACH | \$171.00 | 3 | A | | 29-22772-00 | SCREWDRIVER TORX HEAD T15 | EACH | \$107.00 | 3 | A | |
| 29-22153-00 | 22000 MFD 40V | EACH | \$86.00 | 3 | A | | 29-22773-00 | SCREWDRIVER TORX HEAD T9 | EACH | \$26.00 | 3 | A | |
| 29-22161-00 | PCBA DYNAMIC BRAKE | EACH | \$611.00 | Y | 3 | A | 29-22775-00 | DISK, STROBE 75IPS | EACH | \$6.00 | 3 | A | |
| 29-22162-00 | CIRCUIT BREAKER,3 POLE | EACH | \$176.00 | 3 | A | | 29-22777-00 | CAPSTAN | EACH | \$299.00 | 3 | A | |
| 29-22163-00 | RELAY, POWER | EACH | \$92.00 | 3 | A | | 29-22789-00 | CASE, METAL W/LATCH | EACH | \$20.00 | 3 | A | |
| 29-22179-00 | HEAD ALIGNMENT TOOL 19 | EACH | \$691.00 | 3 | A | | 29-22797-00 | BIT, 2 PHILLIPS | EACH | \$8.00 | 3 | A | |
| 29-22180-00 | HEAD INSTALLATION TOOL | EACH | \$702.00 | 3 | A | | 29-22837-00 | SWITCH, PAPER OUT | EACH | \$97.00 | 3 | A | |
| 29-22181-00 | HEAD TPRQUE TOOL 19 | EACH | \$883.00 | 3 | A | | 29-22838-00 | PCBA VDE HAMMER SUPPLY | EACH | \$522.00 | 3 | A | |
| 29-22182-00 | REPLACEMENT, TORQUE SHA | EACH | \$247.00 | 3 | A | | 29-22839-00 | PCBA REGULATOR | EACH | \$716.00 | Y | 3 | A |
| 29-22183-00 | KIT, MECHANICAL ALIGN 1 | EACH | \$4,696.00 | 3 | A | | 29-22844-00 | PCBA SERVO | EACH | \$1,149.00 | Y | 3 | A |
| 29-22190-00 | EXTENDER, PCBA 19 | EACH | \$785.00 | 3 | A | | 29-22845-00 | ORDER 29-21473 | EACH | REPLACED | 3 | A | 29-21473-00 |
| 29-22191-00 | GAUGE, ABSOLUTE FILTER | EACH | \$557.00 | 3 | A | | 29-22846-00 | ORDER 29-21472 | EACH | REPLACED | 3 | A | 29-21472-00 |
| 29-22193-00 | CE PACK | EACH | \$5,659.00 | 3 | A | | 29-22848-00 | SWITCH, SPDT 5A 250V W/ | EACH | \$14.00 | 3 | A | |
| 29-22195-00 | SWITCH, UP SPEED | EACH | \$78.00 | 3 | A | | 29-22849-00 | LAMP, INDICATOR 14 | EACH | \$15.00 | 3 | A | |
| 29-22196-00 | ACTUATOR, SWITCH | EACH | \$20.00 | 3 | A | | 29-22850-00 | SPRING, TRACTOR, LOWER | QTY OF 10 | \$5.00 | 3 | A | |
| 29-22227-00 | HEAD ASSY, BD 100MB | EACH | \$246.00 | Y | 3 | A | 29-22851-00 | SWITCH, TOGGLE | EACH | \$27.00 | 3 | A | |
| 29-22237-00 | SHAFT ASSY LOCK | EACH | \$307.00 | 3 | A | | 29-22852-00 | SWITCH, MOM (FORMS RESE | EACH | \$14.00 | 3 | A | |
| 29-22241-00 | FUSE, 12A SB FIBER | EACH | \$6.00 | 3 | A | | 29-22853-00 | CKT BKR 20A 250VAC 50/6 | EACH | \$64.00 | 3 | A | |
| 29-22262-00 | BAR STATIC ELIMINATOR | EACH | \$139.00 | 3 | A | | 29-22855-00 | POWER SUPPLY, STAT ELIM | EACH | \$214.00 | 3 | A | |
| 29-22263-00 | POWER SUPPLY STAT ELIM | EACH | \$188.00 | 3 | A | | 29-22856-00 | TRANSFORMER, MAIN POWER | EACH | \$697.00 | 3 | A | |
| 29-22265-00 | TENSIOMETER, BELT 5M SE | EACH | \$11.00 | 3 | A | | 29-22857-00 | MOTOR, PAPER FEED | EACH | \$968.00 | 3 | A | |
| 29-22267-00 | GEAR IDLER RIBBON DRIVE | EACH | \$21.00 | 3 | A | | 29-22858-00 | MOTOR, BLOWER 115V 50/6 | EACH | \$108.00 | 3 | A | |
| 29-22276-00 | SWITCH POWER | EACH | \$45.00 | 3 | A | | 29-22864-00 | CLAMP, TRACTOR LOCKING | EACH | \$34.00 | 3 | A | |
| 29-22284-00 | RING EXPANSION | EACH | \$15.00 | 3 | A | | 29-22875-00 | PCBA HRV RECEIVER | EACH | \$290.00 | Y | 3 | A |
| 29-22286-00 | SENSOR ASSY PHOTO | EACH | \$131.00 | 3 | A | | 29-22877-00 | PCBA ASHV POWER SUPPLY | EACH | \$344.00 | Y | 3 | A |
| 29-22309-00 | PCBA LONG LINE 1/0 REC/ | EACH | \$599.00 | 3 | A | | 29-22879-00 | PCBA 5SKV POWER SUPPLY | EACH | \$285.00 | Y | 3 | A |
| 29-22311-00 | BIT, TORQUE HEAD ALIGN | EACH | \$38.00 | 3 | A | | 29-22880-00 | PCBA HTVV TRANSMITTER | EACH | \$244.00 | Y | 3 | A |
| 29-22313-00 | MOTOR,BLOWER 115V 50/60HZ | EACH | \$517.00 | 3 | A | | 29-22881-00 | PCBA HFRV FINE SERVO | EACH | \$915.00 | Y | 3 | A |
| 29-22369-00 | SWITCH SPDT W/ACTUATOR | EACH | \$11.00 | 3 | A | | 29-22882-00 | PCBA EKPV FAULT REGISTER | EACH | \$473.00 | Y | 3 | A |
| 29-22399-00 | HINGE, REAR PANEL | EACH | \$17.00 | 3 | A | | 29-22885-00 | PCBA HLRV DATA LATCH | EACH | \$554.00 | Y | 3 | A |
| 29-22414-00 | DISC ENCORDER | EACH | \$21.00 | 3 | A | | 29-22886-00 | PCBA CLSV WRITE PLOT | EACH | \$468.00 | Y | 3 | A |
| 29-22415-00 | PCBA REGULATOR | EACH | \$834.00 | Y | 3 | A | 29-22887-00 | PCBA ELTV A-CONT/SECTOR | EACH | \$294.00 | Y | 3 | A |
| 29-22416-00 | PCBA SERVO | EACH | \$1,220.00 | Y | 3 | A | 29-22890-00 | PCBA FLWV DIFF GENERATOR | EACH | \$248.00 | Y | 3 | A |
| 29-22417-00 | PCBA LOGIC | EACH | \$1,415.00 | Y | 3 | A | 29-22891-00 | PCBA ELXV NRZ TO MFM | EACH | \$300.00 | Y | 3 | A |
| 29-22418-00 | PCBA SENSOR | EACH | REPLACED | 3 | A | 29-24075-00 | 29-22892-00 | PCBA BLZV READ PLOT | EACH | \$775.00 | Y | 3 | A |
| 29-22419-00 | PCBA EMITTER | EACH | REPLACED | 3 | A | 29-24075-00 | 29-22894-00 | PCBA FZQN SERVO PREAMP | EACH | \$374.00 | Y | 3 | A |
| 29-22420-00 | PCBA CONTROL RIBBON | EACH | \$474.00 | 3 | A | | 29-22895-00 | HEAD AND ARM ASSY | EACH | \$400.00 | Y | 3 | A |
| 29-22421-00 | PCBA DESKEW IDLER | EACH | \$77.00 | 3 | A | | 29-22896-00 | HEAD AND ARM ASSY | EACH | \$400.00 | 3 | A | |
| 29-22422-00 | KIT, ACTIVE RIB CNTRL | EACH | \$760.00 | 3 | A | | 29-22897-00 | HEAD AND ARM ASSY | EACH | \$400.00 | 3 | A | |
| 29-22423-00 | ORDER 29-22838 | EACH | REPLACED | 3 | A | 29-22838-00 | 29-22898-00 | PCBA NZJN HD SEL/RD AMP | EACH | \$899.00 | Y | 3 | A |
| 29-22424-00 | CAPACITOR PACK | EACH | \$1,009.00 | 3 | A | | 29-22900-00 | SPINDLE ASSY | EACH | \$1,245.00 | Y | 3 | A |
| 29-22425-00 | MOTOR DESKEW | EACH | \$59.00 | 3 | A | | 29-22903-00 | BRAKE ASSY HYSTERESIS | EACH | \$400.00 | 3 | A | |
| 29-22426-00 | TRANSFORMER POWER SUPPL | EACH | \$662.00 | 3 | A | | 29-22904-00 | CONTROL PANEL ASSY | EACH | \$276.00 | 3 | A | |
| 29-22427-00 | MOTOR TACHOMETER PF | EACH | \$863.00 | 3 | A | | 29-22909-00 | SENSOR ASSY, SPEED | EACH | \$92.00 | 3 | A | |
| 29-22445-00 | SOCKET SET, SPECIAL 3/8 | EACH | \$116.00 | 3 | A | | 29-22910-00 | CARRIAGE AND COIL ASSY | EACH | \$699.00 | Y | 3 | A |
| 29-22446-00 | PCBA CAM SENSOR | EACH | \$268.00 | 3 | A | | 29-22911-00 | MOTOR, DRIVE 60HZ 3600R | EACH | \$397.00 | 3 | A | |
| 29-22495-00 | SCREW, SHOULDER SPECIAL | EACH | \$13.00 | 3 | A | | 29-22914-00 | TOOL SENSOR HEIGHT ADJU | EACH | \$611.00 | 3 | A | |
| 29-22521-00 | SCDRVR, TORQUE 125"/OZ | EACH | \$205.00 | 3 | A | | 29-22915-00 | BELT DRIVE 60HZ | EACH | \$20.00 | 3 | A | |
| 29-22522-00 | BIT, 3/32" ALLEN FEMALE | EACH | \$19.00 | 3 | A | | 29-22919-00 | SWITCH INTERLOCK | EACH | \$30.00 | 3 | A | |
| 29-22536-00 | PLATE, RT PRESSURE | EACH | \$93.00 | 3 | A | | 29-22920-00 | SWITCH, MINI | EACH | \$27.00 | 3 | A | |

Prices Effective 02-January-89 to 30-June-89

To Order—Call DECdirect™ TOLL-FREE 800-344-4825, 8:30 a.m. to 8:00 p.m. ET in Continental U.S.A.

HARDWARE SPARES PRICE LIST

| PART NUMBER | DESCRIPTION | UNIT ORDER | UNIT PRICE | REP D | L | REPLACEMENT PART NUMBER | PART NUMBER | DESCRIPTION | UNIT ORDER | UNIT PRICE | REP D | L | REPLACEMENT PART NUMBER |
|-------------|------------------------------|------------|------------|-------|---|-------------------------|-------------|-----------------------------|------------|------------|-------|---|-------------------------|
| 29-22925-00 | FILTER AIR 15.77 X 11 | EACH | \$170.00 | 3 | A | | 29-23110-00 | BELT 60HZ DRIVE | EACH | \$29.00 | 3 | A | |
| 29-22929-00 | SWITCH SOLID STATE AC | EACH | \$121.00 | 3 | A | | 29-23122-00 | MOTOR, 50HZ DRIVE | EACH | \$699.00 | 3 | A | |
| 29-22933-00 | EXTENDER, PCBA 42 | EACH | \$379.00 | 3 | A | | 29-23134-00 | SOCKET 5/16" FOR 1/4" DRIVE | EACH | \$6.00 | 3 | A | |
| 29-22934-00 | CARR/SPINDLE ADJ TOOL | EACH | \$677.00 | 3 | A | | 29-23135-00 | SOCKET 3/8" FOR 1/4" DRIVE | EACH | \$6.00 | 3 | A | |
| 29-22935-00 | HEAD ADJUST TOOL | EACH | \$160.00 | 3 | A | | 29-23189-00 | EXTENSION, TUNING WAND | QTY OF 10 | \$5.00 | 3 | A | |
| 29-22936-00 | BIT 1/4 HEX HD ADJ 42 | EACH | \$50.00 | 3 | A | | 29-23190-00 | WRENCH, ALIGN VIDEO | EACH | REPLACED | 3 | A | 29-26128-00 |
| 29-22937-00 | 270-324MFD 110/125 VAC | EACH | \$20.00 | 3 | A | | 29-23206-00 | REEL MOTOR CENTERING TOOL | EACH | \$193.00 | 3 | A | |
| 29-22938-00 | 6 MFD 660VAC 6% | EACH | \$36.00 | 3 | A | | 29-23207-00 | BAR, LOCATING | EACH | \$70.00 | 3 | A | |
| 29-22998-00 | GAUGE, HUB HEIGHT ADJUS | EACH | \$70.00 | 3 | A | | 29-23208-00 | HUB MACHINED | EACH | \$140.00 | 3 | A | |
| 29-22999-00 | GAUGE COMBO SPAN WRNCH | EACH | \$120.00 | 3 | A | | 29-23209-00 | FLANGE, FRONT | EACH | \$67.00 | 3 | A | |
| 29-23001-00 | INSERT RM03 TOOLS | EACH | \$113.00 | 3 | A | | 29-23211-00 | PCBA INTERCONNECT D1 | EACH | \$945.00 | 3 | A | |
| 29-23009-00 | MOTOR PAPER PULLER | EACH | \$139.00 | 3 | A | | 29-23213-00 | PCBA INTERCONNECT F1 | EACH | \$554.00 | Y | 3 | A |
| 29-23010-00 | ROLLER DRIVE PAPER PULL | EACH | \$7.00 | 3 | A | | 29-23214-00 | CONTROL PANEL | EACH | REPLACED | 3 | A | 29-23779-00 |
| 29-23011-00 | ROLLER PRESSURE | EACH | \$5.00 | 3 | A | | 29-23215-00 | DOOR ASSY,BUFF | EACH | \$582.00 | 3 | A | |
| 29-23012-00 | TINSEL, STAT ELIM | EACH | \$14.00 | 3 | A | | 29-23216-00 | SENSE ASSY, REEL | EACH | \$110.00 | 3 | A | |
| 29-23014-00 | RING RETAINING | QTY OF 10 | \$2.00 | 3 | A | | 29-23217-00 | SENSE ASSY PACK | EACH | \$170.00 | 3 | A | |
| 29-23015-00 | RING, RETAINING | QTY OF 10 | \$5.00 | 3 | A | | 29-23218-00 | MODULE EXTENDER, PCBA | EACH | \$899.00 | 3 | A | |
| 29-23016-00 | LENS, POWER ON/ALARM CL | EACH | \$21.00 | 3 | A | | 29-23219-00 | SPRING, COMPRESSION | QTY OF 10 | \$1.00 | 3 | A | |
| 29-23017-00 | LENS, READY/ON LINE | EACH | \$21.00 | 3 | A | | 29-23220-00 | MUFFLER | EACH | \$107.00 | 3 | A | |
| 29-23018-00 | LENS, PAPER STEP | EACH | \$17.00 | 3 | A | | 29-23222-00 | SPRING, BELLVILLE | QTY OF 10 | \$1.00 | 3 | A | |
| 29-23019-00 | LENS, TOP OF FORM | EACH | \$17.00 | 3 | A | | 29-23223-00 | WASHER | EACH | \$5.00 | 3 | A | |
| 29-23020-00 | SPRING EXTENSION | QTY OF 10 | \$5.00 | 3 | A | | 29-23226-00 | PCBA WRITE | EACH | \$1,327.00 | Y | 3 | A |
| 29-23023-00 | BELT PAPER PULLER DRIVE | EACH | \$15.00 | 3 | A | | 29-23227-00 | PCBA DATA L | EACH | \$2,247.00 | Y | 3 | A |
| 29-23028-00 | RAIL, LOWER CARR GUIDE | EACH | \$123.00 | 3 | A | | 29-23228-00 | TUBE FITTING, LOWER | EACH | \$116.00 | 3 | A | |
| 29-23033-00 | LAMP T-1 3/4,B1-PIN,6V-20A | EACH | \$6.00 | 3 | A | | 29-23229-00 | PCBA CONTROL M | EACH | REPLACED | Y | 3 | A |
| 29-23034-00 | BELT TIMING 240XL037 | EACH | \$38.00 | 3 | A | | 29-23230-00 | PCBA CAPSTAN SERVO | EACH | \$1,790.00 | Y | 3 | A |
| 29-23035-00 | SWITCH IND WHITE | EACH | \$23.00 | 3 | A | | 29-23231-00 | PCBA REEL SERVO | EACH | \$2,905.00 | Y | 3 | A |
| 29-23036-00 | SENSOR,OPTO 43 102057-001 | EACH | \$59.00 | 3 | A | | 29-23232-00 | PCBA 9TRK PREA. | EACH | \$1,215.00 | Y | 3 | A |
| 29-23037-00 | BELT 98T PAPER FEED | EACH | \$48.00 | 3 | A | | 29-23233-00 | HEAD RD/WR | EACH | \$2,003.00 | 3 | A | |
| 29-23038-00 | SWITCH PB 10M401 | EACH | \$26.00 | 3 | A | | 29-23234-00 | MOTOR ASSY CAP | EACH | \$1,851.00 | Y | 3 | A |
| 29-23039-00 | PCBA LOGIC A1 | EACH | REPLACED | Y | 3 | A | 29-23235-00 | WRITE PROTECT A | EACH | \$155.00 | 3 | A | |
| 29-23040-00 | MOTOR PAPER FEED | EACH | \$350.00 | 3 | A | 29-24700-00 | 29-23236-00 | MOTOR ASSY, REEL | EACH | \$659.00 | Y | 3 | A |
| 29-23041-00 | IRONER PAPER | EACH | \$77.00 | 3 | A | | 29-23237-00 | REEL ASSY, VACUUM | EACH | \$240.00 | 3 | A | |
| 29-23043-00 | PCBA,LOGIC A W/LONG LINE | EACH | \$859.00 | 3 | A | | 29-23238-00 | SWITCH PRESSURE | EACH | \$96.00 | 3 | A | |
| 29-23044-00 | PCBA POWER SUPPLY | EACH | \$688.00 | Y | 3 | A | 29-23239-00 | SWITCH, PRESSURE | EACH | \$119.00 | 3 | A | |
| 29-23045-00 | FIELD KIT,RS232 | EACH | \$826.00 | 3 | A | | 29-23240-00 | SWITCH,PRESSURE | EACH | \$110.00 | 3 | A | |
| 29-23046-00 | PCBA HAMMER DRIVER | EACH | \$752.00 | Y | 3 | A | 29-23241-00 | CLEANER, TAPE | EACH | \$205.00 | 3 | A | |
| 29-23047-00 | PCBA LOGIC B4 | EACH | REPLACED | Y | 3 | A | 29-23242-00 | EOT/BOT SENSE ASSY | EACH | \$128.00 | 3 | A | |
| 29-23048-00 | MOTOR SHUTTLE DRIVE ASSY | EACH | \$502.00 | 3 | A | | 29-23243-00 | TIP ASSY. | EACH | \$118.00 | 3 | A | |
| 29-23049-00 | PCBA RIBBON CONTROL | EACH | \$477.00 | Y | 3 | A | 29-23246-00 | TRANSDUCER ASSY VAC. | EACH | \$1,605.00 | Y | 3 | A |
| 29-23050-00 | POWER SUPPLY ASSY | EACH | \$2,147.00 | 3 | A | | 29-23247-00 | CIRCUIT BREAKER | EACH | \$180.00 | 3 | A | |
| 29-23051-00 | MOTOR RIBBON DRIVE ASSY | EACH | \$244.00 | 3 | A | | 29-23248-00 | VALVE ASSY, VACUUM | EACH | \$411.00 | 3 | A | |
| 29-23053-00 | EXTENDER PCBA 43 | EACH | \$278.00 | 3 | A | | 29-23249-00 | VALVE ASSY, PRESSURE | EACH | \$278.00 | Y | 3 | A |
| 29-23055-00 | SWITCH PAPER OUT | EACH | \$128.00 | 3 | A | | 29-23250-00 | BEARING, AIR | EACH | \$124.00 | 3 | A | |
| 29-23056-00 | COIL ASSY HAMMER BANK | EACH | \$23.00 | 3 | A | | 29-23251-00 | BEARING, AIR | EACH | \$138.00 | 3 | A | |
| 29-23057-00 | BLOWER HAMMER BANK | EACH | \$111.00 | 3 | A | | 29-23252-00 | BEARING, AIR | EACH | \$183.00 | 3 | A | |
| 29-23058-00 | MINI EXERCISER/TESTER 43 | EACH | \$658.00 | 3 | A | | 29-23253-00 | BLOWER ASSY W/P | EACH | \$588.00 | 3 | A | |
| 29-23059-00 | HOUSING TRACTOR LA | QTY OF 10 | \$5.00 | 3 | A | | 29-23254-00 | MOTOR AC | EACH | \$570.00 | 3 | A | |
| 29-23060-00 | PINION TRACTOR LAT ADJ | EACH | REPLACED | 3 | A | 29-23059-00 | 29-23255-00 | GUIDE PLATE "R" | EACH | \$102.00 | 3 | A | |
| 29-23061-00 | KNOB TRACTOR LAT ADJ | QTY OF 10 | REPLACED | 3 | A | 29-23059-00 | 29-23256-00 | GUIDE PLATE "C" | EACH | \$117.00 | 3 | A | |
| 29-23068-00 | SPRING PAPER TENSION - LPR11 | EACH | \$160.00 | 3 | A | | 29-23257-00 | COMPRESSOR | EACH | \$484.00 | Y | 3 | A |
| 29-23072-00 | CONTROL PANEL ASSY | EACH | \$681.00 | 3 | A | | 29-23258-00 | TRANSFORMER | EACH | \$488.00 | 3 | A | |
| 29-23107-00 | HEAD AND ARM ASSY UPPER | EACH | \$526.00 | Y | 3 | A | 29-23259-00 | FILTER, AIR | EACH | \$107.00 | 3 | A | |
| 29-23108-00 | HEAD AND ARM ASSY, SERV | EACH | \$572.00 | Y | 3 | A | 29-23279-00 | FILTER, RF1 | EACH | \$27.00 | 3 | A | |
| 29-23109-00 | HEAD AND ARM ASSY LOWER | EACH | \$556.00 | 3 | A | | 29-23280-00 | MOTOR, GEAR DRIVE | EACH | \$242.00 | 3 | A | |



Prices Effective 02-January-89 to 30-June-89
 To Order—Call DECdirect™ TOLL-FREE 800-344-4825, 8:30 a.m. to 8:00 p.m. ET in Continental U.S.A.

HARDWARE SPARES PRICE LIST

| PART NUMBER | DESCRIPTION | UNIT ORDER | UNIT PRICE | REP D | L | REPLACEMENT PART NUMBER | PART NUMBER | DESCRIPTION | UNIT ORDER | UNIT PRICE | REP D | L | REPLACEMENT PART NUMBER |
|-------------|-------------------------------|------------|------------|-------|---|-------------------------|-------------|------------------------|------------|------------|-------|---|-------------------------|
| 29-23281-00 | ARM, CARTRIDGE LOAD | EACH | \$67.00 | 3 | A | | 29-23384-00 | FAN ASSY | EACH | \$126.00 | 3 | A | |
| 29-23283-00 | GUIDE, AIR | EACH | \$155.00 | 3 | A | | 29-23385-00 | HARN/SWITCH | EACH | \$71.00 | 3 | A | |
| 29-23284-00 | MOTOR,50HZ,HUB | EACH | \$259.00 | 3 | A | | 29-23386-00 | PULLEY AND DRIVE ASSY | EACH | \$230.00 | 3 | A | |
| 29-23285-00 | MOTOR,60HZ, HUB | EACH | \$158.00 | 3 | A | | 29-23387-00 | SHAFT ASSY, IDLER | EACH | \$109.00 | 3 | A | |
| 29-23286-00 | CATCH, SPRING | QTY OF 10 | \$1.00 | 3 | A | | 29-23388-00 | MOTOR ASSY, BAND | EACH | \$425.00 | 3 | A | |
| 29-23287-00 | MOTOR, AC | EACH | \$461.00 | 3 | A | | 29-23389-00 | MOTOR ASSY, PAPER | EACH | \$289.00 | 3 | A | |
| 29-23288-00 | RECEPTACLE, FASTENER | EACH | \$24.00 | 3 | A | | 29-23390-00 | SPROCKET ASSY, RIGHT | EACH | \$67.00 | 3 | A | |
| 29-23295-00 | BELT,BLOWER,50HZ HI ALT | EACH | \$51.00 | 3 | A | | 29-23391-00 | SPROCKET ASSY | EACH | \$121.00 | 3 | A | |
| 29-23296-00 | BELT,BLOWER,60HZ,HI ALT | EACH | REPLACED | 3 | A | 29-23989-00 | 29-23392-00 | SWITCH/HARN ASSY | EACH | \$50.00 | 3 | A | |
| 29-23297-00 | SWITCH, INTERLOCK | EACH | \$24.00 | 3 | A | | 29-23393-00 | FLSS W/O VFU | EACH | \$173.00 | 3 | A | |
| 29-23298-00 | BLOWER ASSY | EACH | \$394.00 | 3 | A | | 29-23394-00 | PCBA,RECTIFIER | EACH | \$786.00 | Y | 3 | A |
| 29-23299-00 | PULLEY,60HZ,LO ALT | EACH | \$232.00 | 3 | A | | 29-23395-00 | PCBA, HAMMER DRIVE | EACH | \$1,108.00 | Y | 3 | A |
| 29-23300-00 | PULLEY,60HZ,HI ALT | EACH | \$242.00 | 3 | A | | 29-23396-00 | HARNSS, I/O STD. | EACH | \$151.00 | 3 | A | |
| 29-23303-00 | BELT,BLOWER,50HZ | EACH | REPLACED | 3 | A | 29-23990-00 | 29-23397-00 | PCBA, INTERLOCK TRANS | EACH | \$86.00 | 3 | A | |
| 29-23304-00 | BELT, COMPRESSOR, 60 HZ | EACH | REPLACED | 3 | A | 29-23994-00 | 29-23398-00 | HARNSS, PWR SUPL UNIV | EACH | \$92.00 | 3 | A | |
| 29-23305-00 | BELT,BLOWER,60HZ, LO ALT | EACH | REPLACED | 3 | A | 29-23988-00 | 29-23399-00 | HMMR BNK INTER HARN/SW | EACH | \$84.00 | 3 | A | |
| 29-23308-00 | RELAY,SOLID STATE | EACH | \$113.00 | 3 | A | | 29-23400-00 | PCBA, PROCESS | EACH | \$1,011.00 | Y | 3 | A |
| 29-23309-00 | CAPACITOR,8447000 MFD 15WVD | EACH | \$97.00 | 3 | A | | 29-23401-00 | PCBA, TIMING/STATUS | EACH | \$874.00 | Y | 3 | A |
| 29-23310-00 | CAPACITOR,8461000 MFD 50WVD | EACH | \$207.00 | 3 | A | | 29-23402-00 | POWER BOARD | EACH | \$1,011.00 | Y | 3 | A |
| 29-23311-00 | RECTIFIER, BRIDGE, 25A | EACH | \$103.00 | 3 | A | | 29-23403-00 | PROM PROCESSOR | EACH | \$195.00 | 3 | A | |
| 29-23312-00 | RECTIFIER,BRIDGE,10A | EACH | \$74.00 | 3 | A | | 29-23404-00 | PCBA MOTHERBOARD | EACH | \$575.00 | 3 | A | |
| 29-23320-00 | RESISTOR, 330 OHM 120W | QTY OF 10 | \$5.00 | 3 | A | | 29-23405-00 | FLSS PROMS | EACH | \$56.00 | 3 | A | |
| 29-23321-00 | CABLE, FLAT RBBN | EACH | \$42.00 | 3 | A | | 29-23406-00 | SOLENOID ASSY | EACH | \$88.00 | 3 | A | |
| 29-23322-00 | THREAD BLOCK 2 | EACH | \$11.00 | 3 | A | | 29-23407-00 | DRIVE ASSY, RIBBON | EACH | \$101.00 | 3 | A | |
| 29-23323-00 | THREAD BLOCK 4 | EACH | \$13.00 | 3 | A | | 29-23408-00 | CTL PANEL ASSY | EACH | \$340.00 | 3 | A | |
| 29-23324-00 | THREAD BLOCK 1 | EACH | \$56.00 | 3 | A | | 29-23409-00 | HAMMER MODULE KIT | EACH | \$254.00 | 3 | A | |
| 29-23325-00 | THREAD BLOCK 5 | EACH | \$48.00 | 3 | A | | 29-23410-00 | PULLEY, PAP FD FIELD | EACH | \$25.00 | 3 | A | |
| 29-23326-00 | THREAD BLOCK 6 | EACH | \$56.00 | 3 | A | | 29-23411-00 | TRANSDUCER/BRACKET | EACH | \$86.00 | 3 | A | |
| 29-23328-00 | PCBA POWER REGULATOR | EACH | \$1,367.00 | Y | 3 | A | 29-23412-00 | ROLLERS, RIBBON | EACH | \$82.00 | 3 | A | |
| 29-23329-00 | BLOWER ASSY, 60HZ | EACH | \$1,049.00 | 3 | A | | 29-23413-00 | ARM, PIVOT W/RBN | EACH | \$144.00 | 3 | A | |
| 29-23333-00 | PRE-FILTER(BOX OF 12) | EACH | \$142.00 | 3 | A | | 29-23414-00 | GUIDE, EDGE & BEARING | EACH | \$24.00 | 3 | A | |
| 29-23334-00 | FILTER, ABSOLUTE | EACH | REPLACED | 3 | A | 29-26404-00 | 29-23415-00 | MOUNT, BEARING RIGHT | EACH | \$27.00 | 3 | A | |
| 29-23335-00 | MOTOR/BRAKE ASSY, 60HZ | EACH | \$1,209.00 | Y | 3 | A | 29-23416-00 | KIT, SCREW/NUT/WASHER | EACH | \$53.00 | 3 | A | |
| 29-23337-00 | PCBA EXTENDER CARD Z | EACH | \$615.00 | 3 | A | | 29-23417-00 | KIT, SPRING/RET RING | EACH | \$75.00 | 3 | A | |
| 29-23338-00 | PCBA CAPACITOR ASSY | EACH | \$973.00 | 3 | A | | 29-23418-00 | KIT,MISC HARDWARE | EACH | \$48.00 | 3 | A | |
| 29-23339-00 | PCBA RECTIFIER ASSY | EACH | \$2,293.00 | Y | 3 | A | 29-23419-00 | PCBA INTERFACE (STD) | EACH | \$786.00 | Y | 3 | A |
| 29-23340-00 | PCBA EMA DRIVER | EACH | \$1,439.00 | Y | 3 | A | 29-23420-00 | RIBBON MASK ASSY | EACH | \$15.00 | 3 | A | |
| 29-23341-00 | PCBA ANALOG B | EACH | \$1,470.00 | Y | 3 | A | 29-23421-00 | SWITCH, HAMMER BAND | EACH | \$19.00 | 3 | A | |
| 29-23342-00 | PCBA ANALOG C | EACH | \$1,864.00 | Y | 3 | A | 29-23422-00 | FUSE,3AG 20 AMP SLD | EACH | \$6.00 | 3 | A | |
| 29-23343-00 | PCBA SERVO CONTROL | EACH | \$2,778.00 | Y | 3 | A | 29-23423-00 | BELT, TIMING | EACH | \$19.00 | 3 | A | |
| 29-23344-00 | PCBA ANALOG A | EACH | \$1,247.00 | Y | 3 | A | 29-23424-00 | SWITCH, TOGGLE 2 POS | EACH | \$20.00 | 3 | A | |
| 29-23345-00 | PCBA CMND/INDX/SECTOR | EACH | \$1,446.00 | Y | 3 | A | 29-23425-00 | SWITCH, TOGGLE 3 POS | EACH | \$21.00 | 3 | A | |
| 29-23346-00 | PCBA DEV CONT 2 | EACH | \$2,434.00 | Y | 3 | A | 29-23426-00 | CIRCUIT BREAKER | EACH | \$21.00 | 3 | A | |
| 29-23347-00 | PCBA DEV CONT 1 | EACH | \$1,946.00 | Y | 3 | A | 29-23427-00 | CAP,27000 UF 75V | EACH | \$64.00 | 3 | A | |
| 29-23348-00 | PCBA MASSBUS INTERFACE | EACH | \$1,259.00 | Y | 3 | A | 29-23428-00 | CAP,33000 UF 15V | EACH | \$89.00 | 3 | A | |
| 29-23349-00 | PCBA DATA ENCDR | EACH | \$1,677.00 | Y | 3 | A | 29-23429-00 | DIODE, LED DISPLAY | EACH | \$20.00 | 3 | A | |
| 29-23350-00 | PCBA I/F CONT. | EACH | \$2,336.00 | Y | 3 | A | 29-23431-00 | SWITCH | EACH | \$17.00 | 3 | A | |
| 29-23351-00 | PCBA SERDES/ECC | EACH | \$2,046.00 | Y | 3 | A | 29-23432-00 | SWITCH, LED | EACH | \$36.00 | 3 | A | |
| 29-23352-00 | PCBA R/W SAFETY | EACH | \$1,154.00 | Y | 3 | A | 29-23433-00 | PCBA INTERF LL | EACH | \$974.00 | Y | 3 | A |
| 29-23353-00 | PCBA R/W ANALOG | EACH | \$1,687.00 | Y | 3 | A | 29-23434-00 | FLSS W/VFU | EACH | \$192.00 | 3 | A | |
| 29-23361-00 | CAP PLUG, AIR | EACH | \$5.00 | 3 | A | | 29-23435-00 | CIRCUIT BREAKER | EACH | \$21.00 | 3 | A | |
| 29-23365-00 | CAM, PRE D1 (HOSE/TUBING KIT) | EACH | \$61.00 | 3 | A | | 29-23437-00 | HARNSS I/O L/L | EACH | \$247.00 | 3 | A | |
| 29-23368-00 | FILTER, PRE, FO | QTY OF 10 | \$5.00 | 3 | A | | 29-23438-00 | PCBA INTERFACE | EACH | \$863.00 | Y | 3 | A |
| 29-23382-00 | BELT, RIBBON DRIVE | QTY OF 10 | REPLACED | 3 | A | 29-24027-00 | 29-23439-00 | BAND, AMER/UK | EACH | \$683.00 | 3 | A | |
| 29-23383-00 | BUSHING, MOUNT, LEFT | EACH | \$7.00 | 3 | A | | 29-23440-00 | BAND, AMER/UK | EACH | \$528.00 | 3 | A | |



Prices Effective 02-January-89 to 30-June-89

To Order—Call DECdirect™ TOLL-FREE 800-344-4825, 8:30 a.m. to 8:00 p.m. ET in Continental U.S.A.

HARDWARE SPARES PRICE LIST

| PART NUMBER | DESCRIPTION | UNIT ORDER | UNIT PRICE | REP D | L | REPLACEMENT PART NUMBER | PART NUMBER | DESCRIPTION | UNIT ORDER | UNIT PRICE | REP D | L | REPLACEMENT PART NUMBER |
|-------------|------------------------|------------|-------------|-------|---|-------------------------|------------------|-----------------------------|------------|------------|-------|---|-------------------------|
| 29-23451-00 | BAND PROM, AMER (64) | EACH | \$43.00 | 3 | A | | 29-23666-00 | TRANSDUCER | EACH | \$74.00 | 3 | A | |
| 29-23452-00 | BAND PROM, AMER (96) | EACH | \$43.00 | 3 | A | | 29-23762-00 | PCBA DATA READ | EACH | \$2,042.00 | Y | 3 | A |
| 29-23453-00 | BAND PROM, UK (64) | EACH | \$43.00 | 3 | A | | 29-23763-00 | PCBA WRITE | EACH | \$1,070.00 | Y | 3 | A |
| 29-23454-00 | BAND PROM, UK (96) | EACH | \$43.00 | 3 | A | | 29-23764-00 | PCBA CONTROL M2 | EACH | \$1,499.00 | Y | 3 | A |
| 29-23475-00 | HUB ASSY 75 IPS | EACH | \$400.00 | 3 | A | | 29-23765-00 | PCBA CAPSTAN | EACH | \$1,508.00 | Y | 3 | A |
| 29-23533-00 | SWITCH, SOLID ST 30A | EACH | \$173.00 | 3 | A | | 29-23766-00 | PCBA PREAMP | EACH | \$952.00 | Y | 3 | A |
| 29-23534-00 | SWITCH, SOLID ST 15A | EACH | \$144.00 | 3 | A | | 29-23767-00 | HEAD, RD/WR | EACH | \$1,734.00 | 3 | A | |
| 29-23538-00 | TRANSFORMER ASSY. | EACH | \$188.00 | 3 | A | | 29-23768-00 | MOTOR ASSY, CAPSTAN | EACH | \$1,270.00 | Y | 3 | A |
| 29-23539-00 | RECTIFIER, BRIDGE | EACH | \$27.00 | 3 | A | | 29-23769-00 | PCBA MIA | EACH | \$1,764.00 | Y | 3 | A |
| 29-23540-00 | PCBA AZCN, PWR AMP | EACH | \$732.00 | Y | 3 | A | 29-23770-00 | PCBA INTERCONNECT F1 | EACH | \$321.00 | Y | 3 | A |
| 29-23541-00 | PCBA 5YEN,CAP BRD | EACH | \$1,107.00 | Y | 3 | A | 29-23771-00 | CONTROLS ASSY | EACH | \$420.00 | 3 | A | |
| 29-23542-00 | POWER CONTACTOR | EACH | \$113.00 | 3 | A | | 29-23774-00 | PCBA CONTROL M2 | EACH | \$779.00 | Y | 3 | A |
| 29-23543-00 | PCBA AYEN, RELAY BRD. | EACH | \$627.00 | Y | 3 | A | 29-23779-00 | CONTROL ASSY | EACH | \$361.00 | 3 | A | |
| 29-23551-00 | CIRCUIT BRKR. AC MAIN | EACH | \$127.00 | 3 | A | | 29-23790-00 | BAR, INPUT MAIN (30AMP) | EACH | \$655.00 | 3 | A | |
| 29-23553-00 | PCBA DMSV, AN. SERV. | EACH | \$593.00 | Y | 3 | A | 29-23791-00 | BAR, INPUT MAIN (50AMP) | EACH | \$655.00 | 3 | A | |
| 29-23554-00 | PCBA, READ AMP. | EACH | \$833.00 | Y | 3 | A | 29-23792-00 | BAR, INPUT MAIN (90AMP) | EACH | \$752.00 | 3 | A | |
| 29-23555-00 | PCBA,WRITE DRIVER | EACH | \$508.00 | Y | 3 | A | 29-23793-00 | BAR, INPUT MAIN (100AMP) | EACH | \$795.00 | 3 | A | |
| 29-23556-00 | PCBA, R/W CONTROL | EACH | \$449.00 | Y | 3 | A | 29-23794-00 | BAR, INPUT MAIN (150AMP) | EACH | \$919.00 | 3 | A | |
| 29-23557-00 | PCBA, DIF/HEAD REG | EACH | \$510.00 | Y | 3 | A | 29-23795-00 | BAR, INPUT MAIN (175AMP) | EACH | \$962.00 | 3 | A | |
| 29-23558-00 | PCBA, ACCESS CNTRL. | EACH | \$534.00 | Y | 3 | A | 29-23798-00 | POWER SUPPLY, UNREG. | EACH | \$585.00 | 3 | A | |
| 29-23559-00 | SPINDLE ASSY | EACH | \$2,675.00 | Y | 3 | A | 29-23799-00 | SWITCH, FAN/THERMO | EACH | \$201.00 | 3 | A | |
| 29-23560-00 | SENSOR PACK ASSY | EACH | \$114.00 | 3 | A | | 29-23800-00 | ALARM, SONALERT | EACH | \$61.00 | 3 | A | |
| 29-23561-00 | TRANS/CONN. ASSY | EACH | \$313.00 | 3 | A | | 29-23807-00 | LENS (RED) | EACH | \$6.00 | 3 | A | |
| 29-23565-00 | CAM | EACH | \$113.00 | 3 | A | | 29-23808-00 | LENS (YELLOW) | EACH | \$6.00 | 3 | A | |
| 29-23566-00 | PCBA, REG. 5V | EACH | \$434.00 | Y | 3 | A | 29-23809-00 | LENS (GREEN) | EACH | \$6.00 | 3 | A | |
| 29-23567-00 | PCBA, 4XFN MB | EACH | \$670.00 | Y | 3 | A | 29-23810-00 | LAMP 18V | EACH | \$6.00 | 3 | A | |
| 29-23568-00 | PCBA, BXGN SHS | EACH | \$443.00 | Y | 3 | A | 29-23811-00 | COVER, GUARD | EACH | \$6.00 | 3 | A | |
| 29-23569-00 | PCBA, SZGN SER CONN | EACH | \$39.00 | 3 | A | | 29-23812-00 | SWITCH ASSY | EACH | \$201.00 | 3 | A | |
| 29-23570-00 | SPEED SENSOR ASSY. | EACH | \$95.00 | 3 | A | | 29-23813-00 | PCBA, MOTHER BD FRONT DOOR | EACH | \$1,253.00 | 3 | A | |
| 29-23571-00 | FLEX CONDUCTOR | EACH | \$121.00 | 3 | A | | 29-23814-00 | PCBA, ERROR MON MOD | EACH | \$230.00 | 3 | A | |
| 29-23572-00 | ACTUATOR ASSY. | EACH | \$2,735.00 | 3 | A | | 29-23815-00 | PCBA, GRD CUR MON MOD. | EACH | \$355.00 | 3 | A | |
| 29-23573-00 | BLOWER MOTOR | EACH | \$824.00 | 3 | A | | 29-23816-00 | PCBA, CUR/KVA SELECT MOD. | EACH | \$173.00 | 3 | A | |
| 29-23574-00 | DRIVE MOTOR 60HZ | EACH | \$1,107.00 | Y | 3 | A | 29-23817-00 | PCBA CUR/KVA MONITOR | EACH | \$268.00 | 3 | A | |
| 29-23575-00 | BELT, DRIVE 60HZ | EACH | \$39.00 | 3 | A | | 29-23818-00 | PCBA INTERNAL ALARM MOD | EACH | \$251.00 | 3 | A | |
| 29-23577-00 | PCBA, ACCESS CONT. | EACH | \$279.00 | 3 | A | | 29-23819-00 | PCBA INTERNAL ALARM DUR | EACH | \$167.00 | 3 | A | |
| 29-23578-00 | SWITCH, TOGGLE | EACH | \$36.00 | 3 | A | | 29-23821-00 | PCBA LAMP DRIVER MOD | EACH | \$251.00 | 3 | A | |
| 29-23584-00 | DRIVE BELT 50HZ | EACH | \$45.00 | 3 | A | | 29-23822-00 | PCBA MAIN LOGIC MOD. | EACH | \$554.00 | 3 | A | |
| 29-23590-00 | FILTER, ALUM WAS | EACH | \$20.00 | 3 | A | | 29-23823-00 | PCBA PWR SUP MOD | EACH | \$260.00 | 3 | A | |
| 29-23591-00 | FILTER, AIR | EACH | \$297.00 | 3 | A | | 29-23824-00 | PCBA PWR BLOCK INTERFACE BD | EACH | \$412.00 | 3 | A | |
| 29-23595-00 | HOSE, MANOM W/FITTING | EACH | \$36.00 | 3 | A | | 29-23825-00 | PCBA DISPLAY PNL DTR BRD | EACH | \$384.00 | 3 | A | |
| 29-23596-00 | HDA (RP07) | EACH | \$17,567.00 | Y | 3 | A | 29-23826-00 | PCBA CLOCK MODULE | EACH | \$167.00 | 3 | A | |
| 29-23597-00 | SPINDLE GRND ASSY | EACH | \$164.00 | 3 | A | | 29-23827-00 | PCBA DVM MODULE | EACH | \$211.00 | 3 | A | |
| 29-23598-00 | CIRCUIT BRKR AC | EACH | \$202.00 | 3 | A | | 29-23828-00 | SWITCH ASSY, FRONT PNL | EACH | \$352.00 | 3 | A | |
| 29-23609-00 | CABLE SWAPPING | EACH | \$631.00 | 3 | A | | 29-23829-00 | BATTERY 12V, 6AH | EACH | \$108.00 | 3 | A | |
| 29-23610-00 | SCREW, BACKSTOP | QTY OF 10 | \$5.00 | 3 | A | | 29-23834-00 | SWITCH/HARNESS, REPO. | EACH | \$70.00 | 3 | A | |
| 29-23619-00 | PCBA MOTHERBOARD | EACH | \$397.00 | 3 | A | | 29-23835-00 | CABLE, REPO EXTENSION (50') | EACH | \$121.00 | 3 | A | |
| 29-23620-00 | HMMR MODULE LOWER | EACH | \$260.00 | 3 | A | | 29-23890-00 | PCBA, RECT CCBN | EACH | \$557.00 | 3 | A | |
| 29-23621-00 | HMMR MODULE UPPER | EACH | REPLACED | 3 | A | 29-24296-00 | PCBA, LOGIC FCFN | EACH | \$404.00 | 3 | A | | |
| 29-23622-00 | KIT HEADER HMMR DRV | EACH | \$26.00 | 3 | A | | 29-23892-00 | PCBA, RELAY FCFN | EACH | \$187.00 | 3 | A | |
| 29-23623-00 | KIT HEADER TIMING/STAT | EACH | \$29.00 | 3 | A | | 29-23893-00 | DRIVE MOTOR/BRAKE ASSY 60HZ | EACH | \$1,196.00 | 3 | A | |
| 29-23624-00 | HARNESS ASSY PAP LOW | EACH | \$63.00 | 3 | A | | 29-23894-00 | DRIVE MOTOR/BRAKE ASSY 50HZ | EACH | \$1,196.00 | 3 | A | |
| 29-23625-00 | KIT PROM PROC W/O VFU | EACH | \$168.00 | 3 | A | | 29-23915-00 | PCBA,HMMR DRVR | EACH | \$998.00 | 3 | A | |
| 29-23656-00 | HEAD/ARM ASSY | EACH | \$313.00 | Y | 3 | A | 29-23916-00 | SHUTTLE ASSY | EACH | \$4,280.00 | Y | 3 | A |
| 29-23657-00 | HEAD/ARM ASSY | EACH | \$284.00 | Y | 3 | A | 29-23917-00 | MOTOR ASSY,SHUTTLE | EACH | \$593.00 | 3 | A | |
| 29-23658-00 | HEAD/ARM ASSY | EACH | \$271.00 | Y | 3 | A | 29-23918-00 | PCBA,LOGIC A4 | EACH | REPLACED | 3 | A | 29-24700-00 |



HARDWARE SPARES PRICE LIST

| PART NUMBER | DESCRIPTION | UNIT ORDER | UNIT PRICE | REP D | L | REPLACEMENT PART NUMBER | PART NUMBER | DESCRIPTION | UNIT ORDER | UNIT PRICE | REP D | L | REPLACEMENT PART NUMBER |
|-------------|-------------------------|------------|------------|-------|-----|-------------------------|-------------|--------------------------------|------------|------------|-------|-----|-------------------------|
| 29-23919-00 | PCBA, LOGIC B7 | EACH | REPLACED | | 3 A | 29-24701-00 | 29-24096-00 | PUMP AIR | EACH | \$562.00 | | 3 A | |
| 29-23920-00 | PCBA, PWR SUP 600LPM | EACH | \$878.00 | Y | 3 A | | 29-24097-00 | TRANSFORMER ASSY | EACH | \$284.00 | | 3 A | |
| 29-23921-00 | POWER SUPPLY ASSY | EACH | \$2,632.00 | Y | 3 A | | 29-24098-00 | COMPL ARM BUMP | EACH | \$7.00 | | 3 A | |
| 29-23922-00 | ALIGN TOOL, HMMR TIP 43 | EACH | \$198.00 | | 3 A | | 29-24100-00 | PANEL, FRONT | EACH | REPLACED | | 3 A | 29-25064-00 |
| 29-23923-00 | COIL ASSY, HMMR BANK | EACH | \$63.00 | | 3 A | | 29-24101-00 | GUIDE, ROLLER | EACH | \$155.00 | | 3 A | |
| 29-23924-00 | SPRING ASSY, HMMR | EACH | \$71.00 | | 3 A | | 29-24105-00 | CONNECTOR PARA. LOOPBACK | EACH | \$29.00 | | 3 A | |
| 29-23925-00 | MASK ASSY RBBN | EACH | \$198.00 | | 3 A | | 29-24113-00 | SPRING GROUND | EACH | \$15.00 | | 3 A | |
| 29-23927-00 | CIRCUIT BRKR | EACH | \$133.00 | | 3 A | | 29-24115-00 | DIP SHUNT | EACH | \$6.00 | | 3 A | |
| 29-23931-00 | ROD, STAT ELIM | EACH | REPLACED | | 3 A | 29-24702-00 | 29-24116-00 | INDEX SENSOR | EACH | \$58.00 | | 3 A | |
| 29-23932-00 | TRANSFORMER, STAT ELIM | EACH | REPLACED | | 3 A | 29-24702-00 | 29-24118-00 | MOTOR, BAND DR ASSY | EACH | \$566.00 | | 3 A | |
| 29-23933-00 | SCREW, HMMR SPR | EACH | REPLACED | | 3 A | 29-24197-00 | 29-24121-00 | BELT RIB DRIVE | EACH | \$15.00 | | 3 A | |
| 29-23988-00 | BELT, BLOWER 60HZ | EACH | \$30.00 | | 3 A | | 29-24122-00 | RIBBON DRIVE ASSY | EACH | \$126.00 | | 3 A | |
| 29-23989-00 | BELT, BLOWER | EACH | \$51.00 | | 3 A | | 29-24192-00 | WRENCH, TORQUE HEX ADAPTER | QTY OF 10 | \$5.00 | | 3 A | |
| 29-23990-00 | BELT, BLOWER, 50HZ | EACH | \$27.00 | | 3 A | | 29-24193-00 | WRENCH TORQUE CAM-OVER | EACH | \$149.00 | | 3 A | |
| 29-23991-00 | BELT, BLOWER | EACH | \$28.00 | | 3 A | | 29-24194-00 | SCREWDRIVER, FLAT 10" BLADE | EACH | \$7.00 | | 3 A | |
| 29-23994-00 | BELT, COMPRESSOR | EACH | \$36.00 | | 3 A | | 29-24195-00 | KIT, SERVICE HAND HELD TERMINL | EACH | REPLACED | Y | 3 A | 29-24945-00 |
| 29-23995-00 | BELT, COMPRESSOR | EACH | \$33.00 | | 3 A | | 29-24196-00 | HMMR BANK EMITTER/SENSOR KIT | EACH | \$107.00 | | 3 A | |
| 29-23996-00 | BELT, COMPRESSOR | EACH | \$28.00 | | 3 A | | 29-24197-00 | SCRW HMMR, SPR/SN45,000 +UP | EACH | \$8.00 | | 3 A | |
| 29-24013-00 | 26 BLOWER ASSY | EACH | \$400.00 | | 3 A | | 29-24210-00 | TAPE CLEANER ASSY | EACH | \$210.00 | | 3 A | |
| 29-24026-00 | ADJ. TOOL CAR RES/THR B | EACH | \$804.00 | | 3 A | | 29-24211-00 | SENSOR, FILE, PROTECT | EACH | \$82.00 | | 3 A | |
| 29-24027-00 | BELT RIBBON DR | QTY OF 10 | \$5.00 | | 3 A | | 29-24212-00 | HUB ASSY | EACH | \$107.00 | | 3 A | |
| 29-24028-00 | MECHANISM ASSY. | EACH | \$1,591.00 | Y | 3 A | | 29-24213-00 | KIT, MOTOR INSTALLATION | EACH | \$877.00 | Y | 3 A | |
| 29-24029-00 | PCBA, INTERFACE | EACH | \$888.00 | Y | 3 A | | 29-24214-00 | COMPRESSOR | EACH | REPLACED | | 3 A | 29-25046-00 |
| 29-24030-00 | PCBA, DIGITAL | EACH | \$720.00 | Y | 3 A | | 29-24215-00 | KIT, MAG HEAD INSTALLATION | EACH | \$1,728.00 | Y | 3 A | |
| 29-24031-00 | PCBA, ANALOG | EACH | \$688.00 | Y | 3 A | | 29-24216-00 | PANEL ASSY | EACH | \$290.00 | | 3 A | |
| 29-24032-00 | PCBA, PWR SUPPLY | EACH | \$754.00 | Y | 3 A | | 29-24217-00 | TAPE GUIDE UPPER A/B | EACH | \$96.00 | | 3 A | |
| 29-24033-00 | PLATEN ASSY | EACH | \$119.00 | | 3 A | | 29-24218-00 | GUIDE, SPRING UPPER | EACH | \$21.00 | | 3 A | |
| 29-24034-00 | PCBA, MOTHER | EACH | \$445.00 | Y | 3 A | | 29-24219-00 | TRANSDUCER | EACH | \$183.00 | | 3 A | |
| 29-24035-00 | CONTROL PANEL | EACH | \$341.00 | Y | 3 A | | 29-24220-00 | POWER SUPPLY 50/60HZ | EACH | REPLACED | Y | 3 A | 29-26372-00 |
| 29-24036-00 | FAN INVERTER DC | EACH | \$242.00 | | 3 A | | 29-24221-00 | FORMATTER CONTROL PWA | EACH | \$2,882.00 | Y | 3 A | |
| 29-24037-00 | PROM, DOT COL CNTR | EACH | \$102.00 | | 3 A | | 29-24222-00 | READ/WRITE SERVO PWA | EACH | \$3,862.00 | Y | 3 A | |
| 29-24038-00 | PROM, CHAR COL CNTR | EACH | \$102.00 | | 3 A | | 29-24223-00 | POWER AMP PWA | EACH | \$1,063.00 | Y | 3 A | |
| 29-24039-00 | PROM, CONTROLLER | EACH | \$102.00 | | 3 A | | 29-24224-00 | HUB ASSY | EACH | \$126.00 | | 3 A | |
| 29-24046-00 | KIT, MISC HARDWARE | EACH | \$108.00 | | 3 A | | 29-24225-00 | TAPE GUIDE LOWER A/B | EACH | \$96.00 | | 3 A | |
| 29-24047-00 | SPRING, BUFFER BOX DOOR | QTY OF 10 | \$1.00 | | 3 A | | 29-24226-00 | GUIDE, SPRING LOWER | EACH | \$21.00 | | 3 A | |
| 29-24075-00 | SENSOR KIT | EACH | \$263.00 | | 3 A | | 29-24227-00 | FILTER | EACH | \$21.00 | | 3 A | |
| 29-24076-00 | SENSOR KIT | EACH | \$297.00 | | 3 A | | 29-24228-00 | BLOWER | EACH | \$145.00 | | 3 A | |
| 29-24077-00 | SUPPLY HUB | EACH | \$281.00 | | 3 A | | 29-24230-00 | KIT, 1 SCREWS LA150 | EACH | \$56.00 | | 3 A | |
| 29-24078-00 | TACHOMETER ASSY | EACH | \$666.00 | | 3 A | | 29-24231-00 | KIT, 2E-RING LA150 | EACH | \$26.00 | | 3 A | |
| 29-24079-00 | COMP. ARM ASSY | EACH | \$173.00 | | 3 A | | 29-24232-00 | KIT, 3 SPRING LA50 | EACH | \$30.00 | | 3 A | |
| 29-24080-00 | HEAD ASSY | EACH | \$1,792.00 | | 3 A | | 29-24233-00 | PWR SWITCH RB | EACH | \$11.00 | | 3 A | |
| 29-24081-00 | GUIDE, ROLLER TAPE | EACH | \$146.00 | | 3 A | | 29-24234-00 | CONTROL PANEL | EACH | \$6.00 | | 3 A | |
| 29-24082-00 | SENSOR EOT/BOT | EACH | \$207.00 | | 3 A | | 29-24235-00 | PAPER COVER BK | EACH | \$6.00 | | 3 A | |
| 29-24083-00 | SENSOR TAPE | EACH | \$89.00 | | 3 A | | 29-24236-00 | CARRIER COVER (RA) | EACH | \$26.00 | | 3 A | |
| 29-24084-00 | SENSOR FILE | EACH | \$132.00 | | 3 A | | 29-24237-00 | CARRIER COVER (RB) | EACH | \$29.00 | | 3 A | |
| 29-24085-00 | POWER SUPPLY | EACH | \$684.00 | | 3 A | | 29-24238-00 | CPU LA50 | EACH | \$465.00 | Y | 3 A | |
| 29-24086-00 | MODULE | EACH | \$3,791.00 | Y | 3 A | | 29-24239-00 | TRANSFORMER (100/120V) | EACH | \$81.00 | | 3 A | |
| 29-24087-00 | FILTER AIR | EACH | \$23.00 | | 3 A | | 29-24240-00 | TRANSFORMER (220/240V) | EACH | \$88.00 | | 3 A | |
| 29-24088-00 | SWITCH, PWR | EACH | \$30.00 | | 3 A | | 29-24241-00 | TOP COVER (RA) | EACH | \$64.00 | | 3 A | |
| 29-24089-00 | GUIDE | EACH | \$127.00 | | 3 A | | 29-24242-00 | TOP COVER (RB) | EACH | REPLACED | | 3 A | 29-24241-00 |
| 29-24090-00 | SWITCH FRONT PANEL | EACH | \$313.00 | | 3 A | | 29-24243-00 | PAPER FEED GEAR C | QTY OF 10 | \$1.00 | | 3 A | |
| 29-24091-00 | HUB TAKE UP | EACH | \$64.00 | | 3 A | | 29-24244-00 | TENSION ARM BK | EACH | \$6.00 | | 3 A | |
| 29-24092-00 | RELAY | EACH | \$57.00 | | 3 A | | 29-24245-00 | CA T LE PULLEY | QTY OF 10 | \$1.00 | | 3 A | |
| 29-24094-00 | MOTOR-TAKE UP | EACH | \$674.00 | | 3 A | | 29-24246-00 | CA WIRE AK | EACH | \$8.00 | | 3 A | |
| 29-24095-00 | MOTOR ASSY | EACH | \$674.00 | | 3 A | | 29-24247-00 | CA TRANSISTOR AK | EACH | \$14.00 | | 3 A | |



Prices Effective 02-January-89 to 30-June-89
 To Order—Call DECdirect™ TOLL-FREE 800-344-4825, 8:30 a.m. to 8:00 p.m. ET in Continental U.S.A.

SPARES PRICE LIST A-42

29-24248-00 — 29-24521-00

HARDWARE SPARES PRICE LIST

| PART NUMBER | DESCRIPTION | UNIT ORDER | UNIT PRICE | REP D | L | REPLACEMENT PART NUMBER | PART NUMBER | DESCRIPTION | UNIT ORDER | UNIT PRICE | REP D | L | REPLACEMENT PART NUMBER |
|-------------|------------------------|------------|------------|-------|---|-------------------------|----------------------|-----------------------------|------------|------------|-------|---|-------------------------|
| 29-24248-00 | LEVER BK | EACH | \$7.00 | 3 | A | | 29-24306-00 | FAN ASSY | EACH | \$219.00 | 3 | A | |
| 29-24249-00 | LUB RING F | EACH | \$6.00 | 3 | A | | 29-24307-00 | FILTER LINE | EACH | \$70.00 | 3 | A | |
| 29-24250-00 | WIRE HOLDER | EACH | \$6.00 | 3 | A | | 29-24308-00 | MOTOR, BAND DRIVE | EACH | \$563.00 | 3 | A | |
| 29-24251-00 | CARRIAGE, METAL | QTY OF 10 | \$2.00 | 3 | A | | 29-24309-00 | MOTOR, BAND POS | EACH | \$116.00 | 3 | A | |
| 29-24252-00 | PLATEN, BK | EACH | \$48.00 | 3 | A | | 29-24310-00 | MOTOR, PAPER FEED | EACH | \$837.00 | 3 | A | |
| 29-24253-00 | CARRIER MOTOR BK | EACH | \$89.00 | 3 | A | | 29-24312-00 | PULLEY, PAPER FEED | EACH | \$32.00 | 3 | A | |
| 29-24254-00 | PF MOTOR AK | EACH | \$56.00 | 3 | A | | 29-24313-00 | BAR, STATIC | EACH | \$191.00 | 3 | A | |
| 29-24255-00 | PAPER, FEED GEAR-D | QTY OF 10 | \$1.00 | 3 | A | | 29-24314-00 | CCA, INTR, LONG LINE | EACH | \$878.00 | 3 | A | |
| 29-24256-00 | PAPER, FEED GEAR-B | QTY OF 10 | \$1.00 | 3 | A | | 29-24315-00 | POWER SP. (STACKER) | EACH | \$709.00 | 3 | A | |
| 29-24257-00 | CARRIER DR PULLEY | EACH | \$6.00 | 3 | A | | 29-24316-00 | SWITCH ASSY | EACH | \$399.00 | 3 | A | |
| 29-24258-00 | CONN. AK | EACH | \$27.00 | 3 | A | | 29-24317-00 | CLUTCH ASSY PAP ADJ. | EACH | \$158.00 | 3 | A | |
| 29-24259-00 | GUIDE, SHAFT | EACH | \$6.00 | 3 | A | | 29-24318-00 | CLUTCH PULLER | EACH | \$61.00 | 3 | A | |
| 29-24260-00 | RIBBON, WIRE ARM | EACH | \$6.00 | 3 | A | | 29-24319-00 | MOTOR, PAPER PULLER | EACH | \$139.00 | 3 | A | |
| 29-24261-00 | CARRIER, SHAFT | EACH | \$63.00 | 3 | A | | 29-24320-00 | MOTOR RIBBON DESKE | EACH | \$143.00 | 3 | A | |
| 29-24262-00 | CARRIER STOPPER | QTY OF 10 | \$1.00 | 3 | A | | 29-24321-00 | MOTOR, RIBBON DR | EACH | \$362.00 | 3 | A | |
| 29-24263-00 | ROLLER SHAFT, BK | EACH | \$8.00 | 3 | A | | 29-24322-00 | KIT, PROM PROCESSOR | EACH | \$615.00 | 3 | A | |
| 29-24264-00 | 5V, TRANSISTOR, AK | EACH | \$11.00 | 3 | A | | 29-24324-00 | CCA, POWER SUPPLY | EACH | \$1,336.00 | 3 | A | |
| 29-24265-00 | SPROCKET, BK | EACH | \$23.00 | 3 | A | | 29-24325-00 | CCA PROCESSOR PROM | EACH | \$2,021.00 | 3 | A | |
| 29-24266-00 | SPROCKET, BK | EACH | REPLACED | 3 | A | 29-25261-00 | CCA, TIMING + STATUS | EACH | \$1,775.00 | 3 | A | | |
| 29-24267-00 | SPROCKET R BK | EACH | REPLACED | 3 | A | 29-25260-00 | CCA HAMMER CONTROL | EACH | \$2,158.00 | 3 | A | | |
| 29-24268-00 | RELEASE LEVER SHAFT BK | EACH | \$24.00 | 3 | A | | 29-24329-00 | CCA, HAMMER DRIVER | EACH | \$2,250.00 | Y | 3 | A |
| 29-24269-00 | PINCH, ROLLER BK | EACH | \$6.00 | 3 | A | | 29-24330-00 | CCA, INTERFACE | EACH | \$818.00 | Y | 3 | A |
| 29-24270-00 | PAPER, FEED GEAR-E | QTY OF 10 | \$1.00 | 3 | A | | 29-24331-00 | CCA, PAPER FEED | EACH | \$1,069.00 | Y | 3 | A |
| 29-24271-00 | LEVER, RELEASE BK | EACH | \$6.00 | 3 | A | | 29-24332-00 | TRACTOR ASSY, LL | EACH | \$198.00 | 3 | A | |
| 29-24272-00 | HEAD BK | EACH | \$122.00 | Y | 3 | A | 29-24333-00 | TRACTOR ASSY, LR | EACH | \$377.00 | 3 | A | |
| 29-24273-00 | GUIDE, RIBBON BK | QTY OF 10 | \$1.00 | 3 | A | | 29-24334-00 | TRACTOR ASSY, UL | EACH | \$357.00 | 3 | A | |
| 29-24274-00 | FRAME, CARRIER BK | EACH | \$56.00 | 3 | A | | 29-24335-00 | TRANSDUCER ASSY. | EACH | \$101.00 | 3 | A | |
| 29-24275-00 | FRAME, CARRIER AK | EACH | \$15.00 | 3 | A | | 29-24336-00 | TRACTOR ASSY, UR | EACH | \$198.00 | 3 | A | |
| 29-24276-00 | CHG, GEAR ARM | EACH | \$14.00 | 3 | A | | 29-24343-00 | 45FAN 230V 50HZ | EACH | \$390.00 | 3 | A | |
| 29-24277-00 | RIBBON WIRE | EACH | \$6.00 | 3 | A | | 29-24354-00 | PRESSURE REGULATOR | EACH | \$119.00 | 3 | A | |
| 29-24278-00 | KNOB, PLATEN | QTY OF 10 | \$2.00 | 3 | A | | 29-24355-00 | DOOR INTERLOCK, SWITCH | EACH | \$36.00 | 3 | A | |
| 29-24279-00 | COVER BOTTOM RA | EACH | \$23.00 | 3 | A | | 29-24356-00 | SENSOR OT/BOT | EACH | \$59.00 | 3 | A | |
| 29-24280-00 | SWITCH, PWR RA | EACH | \$6.00 | 3 | A | | 29-24357-00 | CAPACITOR | EACH | \$56.00 | 3 | A | |
| 29-24281-00 | FOOT, RUBBER | QTY OF 10 | \$.41 | 3 | A | | 29-24358-00 | TACHOMETER 1 LINE | EACH | \$14.00 | 3 | A | |
| 29-24282-00 | SENSOR AK | EACH | \$23.00 | 3 | A | | 29-24359-00 | KIT, AIR BEARING REFURB | EACH | \$217.00 | 3 | A | |
| 29-24283-00 | SWITCH, PANEL RA | EACH | \$27.00 | 3 | A | | 29-24371-00 | TEMPLATE, VIDEO ALIGN. TOOL | EACH | \$21.00 | 3 | A | |
| 29-24284-00 | SWITCH, PANEL RB | EACH | \$37.00 | 3 | A | | 29-24501-00 | KIT, TOOL | EACH | REPLACED | 3 | A | SLN01-TK |
| 29-24285-00 | SENSOR AK-RB | EACH | \$19.00 | 3 | A | | 29-24502-00 | DRUM | EACH | \$633.00 | 3 | A | |
| 29-24287-00 | BELT, PAPER FEED | EACH | \$59.00 | 3 | A | | 29-24503-00 | PLUG DEV EMPTY | QTY OF 10 | \$1.00 | 3 | A | |
| 29-24288-00 | BELT, PAPER PULLER | EACH | \$19.00 | 3 | A | | 29-24504-00 | BLADE DR | EACH | \$61.00 | 3 | A | |
| 29-24291-00 | FUSE, 2A, PIGTAIL | EACH | \$6.00 | 3 | A | | 29-24505-00 | DEVELOPER | EACH | \$126.00 | 3 | A | |
| 29-24292-00 | FUSE, 5A, SLOW PS | EACH | \$7.00 | 3 | A | | 29-24506-00 | GEAR DRUM DR | EACH | \$24.00 | 3 | A | |
| 29-24293-00 | FUSE, 10A, B.G. | EACH | \$7.00 | 3 | A | | 29-24507-00 | GEAR DRUM | QTY OF 10 | REPLACED | 3 | A | 29-24508-00 |
| 29-24294-00 | FUSE, 15A, P.F. | EACH | \$7.00 | 3 | A | | 29-24508-00 | DRUM/IDLER GEAR | QTY OF 10 | \$2.00 | 3 | A | |
| 29-24295-00 | FUSE, 20A, P.S. | EACH | \$7.00 | 3 | A | | 29-24509-00 | GEAR TRANS. DEV | EACH | \$21.00 | 3 | A | |
| 29-24296-00 | KIT, HAMMER MOD | EACH | \$339.00 | 3 | A | | 29-24511-00 | GEAR ASY DEV | EACH | \$21.00 | 3 | A | |
| 29-24297-00 | LAMP, CONTROL PANEL | EACH | \$7.00 | 3 | A | | 29-24512-00 | CAM DEV DRIV | QTY OF 10 | \$2.00 | 3 | A | |
| 29-24298-00 | P.M. SENSOR, U.L. | EACH | \$126.00 | 3 | A | | 29-24513-00 | CAM FOL ASY DEV | EACH | \$71.00 | 3 | A | |
| 29-24299-00 | RELAY, 55V | EACH | \$57.00 | 3 | A | | 29-24514-00 | SPNG EXT DEV | QTY OF 10 | \$5.00 | 3 | A | |
| 29-24300-00 | R.E. SENSOR, PHOTO | EACH | \$162.00 | 3 | A | | 29-24515-00 | SPNG HSG FT MOD | QTY OF 10 | \$5.00 | 3 | A | |
| 29-24301-00 | R.E. SENSOR, EMITTER | EACH | REPLACED | 3 | A | 29-24739-00 | 29-24516-00 | BEARING SLV DEV | QTY OF 10 | \$2.00 | 3 | A | |
| 29-24302-00 | RIBBON SHIELD | EACH | \$29.00 | 3 | A | | 29-24517-00 | CLIP SPG DM MOD | EACH | \$6.00 | 3 | A | |
| 29-24303-00 | SWITCH PAPEROUT | EACH | \$48.00 | 3 | A | | 29-24519-00 | TAPE VIEWER, 3M PLAST. MAG. | EACH | \$181.00 | 3 | A | |
| 29-24304-00 | SWITCH MICRO DESKLIM | EACH | \$15.00 | 3 | A | | 29-24520-00 | FEED ROLL ASSY | EACH | \$188.00 | 3 | A | |
| 29-24305-00 | FUSE, 3A, SOLDR | EACH | \$6.00 | 3 | A | | 29-24521-00 | FD RLL ASY FT | EACH | \$109.00 | 3 | A | |



Prices Effective 02-January-89 to 30-June-89
 To Order—Call DECdirect™ TOLL-FREE 800-344-4825, 8:30 a.m. to 8:00 p.m. ET in Continental U.S.A.

HARDWARE SPARES PRICE LIST

| PART NUMBER | DESCRIPTION | UNIT ORDER | UNIT PRICE | REP D | L | REPLACEMENT PART NUMBER | PART NUMBER | DESCRIPTION | UNIT ORDER | UNIT PRICE | REP D | L | REPLACEMENT PART NUMBER |
|-------------|---------------------|------------|------------|-------|---|-------------------------|-------------|------------------------------|------------|------------|-------|---|-------------------------|
| 29-24522-00 | ROLL ASY FOAM | EACH | \$57.00 | 3 | A | | 29-24613-00 | PWB ASSY,C04-L | EACH | \$8.00 | 3 | A | |
| 29-24523-00 | RING AUG DRV | QTY OF 10 | \$5.00 | 3 | A | | 29-24614-00 | DEFLECT SUB ASSY | EACH | \$252.00 | Y | 3 | A |
| 29-24524-00 | WSHR THRU DEV | QTY OF 10 | \$1.00 | 3 | A | | 29-24615-00 | PC ASSY,CRT INPUT | EACH | \$38.00 | 3 | A | |
| 29-24525-00 | SOL DR BLD | EACH | \$77.00 | 3 | A | | 29-24620-00 | PCBA W/BRAKE | EACH | \$74.00 | 3 | A | |
| 29-24528-00 | SHLD CORD TOP | QTY OF 10 | \$1.00 | 3 | A | | 29-24621-00 | MODEM/COUPLER | EACH | \$754.00 | 3 | A | |
| 29-24529-00 | BAFFLE ASY | EACH | \$24.00 | 3 | A | | 29-24661-00 | COLOR CHART | EACH | \$24.00 | 3 | A | |
| 29-24536-00 | PWR SUP LASER | EACH | \$673.00 | 3 | A | | 29-24664-00 | TRACK ZERO SENSOR | EACH | \$34.00 | 3 | A | |
| 29-24538-00 | CLUTCH STKR | EACH | \$313.00 | 3 | A | | 29-24666-00 | COVER, FRONT RD51 | EACH | \$14.00 | 3 | A | |
| 29-24539-00 | CLUTCH REG DR | EACH | \$181.00 | 3 | A | | 29-24671-00 | HEAD SEPERATOR TOOL 97 | EACH | \$74.00 | 3 | A | |
| 29-24540-00 | SOL PAP FD | EACH | \$232.00 | 3 | A | | 29-24672-00 | 97 TOOL, HEAD INSERTION RA60 | EACH | \$80.00 | 3 | A | |
| 29-24542-00 | SOL OFFSET | EACH | \$103.00 | 3 | A | | 29-24700-00 | PCBA, LOGIC A6 | EACH | \$821.00 | 3 | A | |
| 29-24543-00 | EL LAMP | EACH | \$165.00 | 3 | A | | 29-24701-00 | PCBA, LOGIC B9 | EACH | \$878.00 | Y | 3 | A |
| 29-24544-00 | HTR UP QTZ RD | EACH | \$146.00 | 3 | A | | 29-24702-00 | KIT, ANTI-STATIC BRUSH | EACH | \$219.00 | 3 | A | |
| 29-24545-00 | HTR LWR RD | EACH | \$107.00 | 3 | A | | 29-24703-00 | INTERLOCK DEFEAT TOOL | EACH | \$2.00 | 3 | A | |
| 29-24546-00 | FUSE THML FSR | EACH | \$15.00 | 3 | A | | 29-24704-00 | 51AMP,PWA READ | EACH | \$2,870.00 | Y | 3 | A |
| 29-24547-00 | MST WM UP | EACH | \$101.00 | 3 | A | | 29-24705-00 | PWA SERVO CONTROL | EACH | \$1,912.00 | Y | 3 | A |
| 29-24549-00 | PWB POLY DRV | EACH | \$1,331.00 | 3 | A | | 29-24706-00 | PWA WRITE DRIVE | EACH | \$1,083.00 | Y | 3 | A |
| 29-24550-00 | PWB PXL CLK | EACH | \$927.00 | 3 | A | | 29-24707-00 | PWA MSCP | EACH | \$2,620.00 | Y | 3 | A |
| 29-24551-00 | PWP IOTC | EACH | \$1,432.00 | Y | 3 | A | 29-24708-00 | PWA FORMATTER WRITE | EACH | \$3,470.00 | Y | 3 | A |
| 29-24554-00 | PWB PRINT MOD | EACH | \$664.00 | 3 | A | | 29-24709-00 | PWA FORMATTER READ | EACH | \$5,632.00 | Y | 3 | A |
| 29-24557-00 | KIT,AUGER | EACH | \$89.00 | 3 | A | | 29-24718-00 | 50HZ COMPRESSOR | EACH | REPLACED | 3 | A | 29-25046-00 |
| 29-24558-00 | KIT,CM 30K | EACH | \$67.00 | 3 | A | | 29-24738-00 | RIBBON DRIVE SPOOL | EACH | \$82.00 | 3 | A | |
| 29-24561-00 | BLT MN BELT | EACH | \$50.00 | 3 | A | | 29-24739-00 | EMITTER, PHOTO | EACH | \$147.00 | 3 | A | |
| 29-24562-00 | BLT,STKR | EACH | \$24.00 | 3 | A | | 29-24740-00 | RIBBON EDGE SENSOR | EACH | \$194.00 | 3 | A | |
| 29-24564-00 | SPRNG SHTTR | EACH | \$15.00 | 3 | A | | 29-24746-00 | ADJUST TOOL | EACH | \$7.00 | 3 | A | |
| 29-24565-00 | SENSR E0S-S0S | EACH | \$679.00 | 3 | A | | 29-24752-00 | MAG HEAD 9 TRK | EACH | \$1,253.00 | Y | 3 | A |
| 29-24566-00 | FLTR FSR INFRD | EACH | \$315.00 | 3 | A | | 29-24753-00 | POWER SUPPLY | EACH | \$1,830.00 | Y | 3 | A |
| 29-24569-00 | SWITCH PAP EXT | EACH | \$42.00 | 3 | A | | 29-24755-00 | S.S. SWITCH 60HZ | EACH | \$368.00 | Y | 3 | A |
| 29-24570-00 | SWITCH FNT INT | EACH | \$48.00 | 3 | A | | 29-24794-00 | PRINTER LOOPBACK CONNECTOR | EACH | \$35.00 | 3 | A | |
| 29-24571-00 | GNP STP DRM | EACH | \$6.00 | 3 | A | | 29-24795-00 | 25 POSIT, FEM LOOPBACK CONN | EACH | \$14.00 | 3 | A | |
| 29-24572-00 | GEAR DEV DRV | EACH | \$27.00 | 3 | A | | 29-24806-00 | LOGIC MODULE | EACH | \$1,088.00 | Y | 3 | A |
| 29-24578-00 | OIL LAUNA 40 | EACH | \$53.00 | 3 | A | | 29-24807-00 | PAPER MOTOR ASSY | EACH | \$379.00 | 3 | A | |
| 29-24579-00 | OIL MOLLUB-ALLOY 90 | EACH | \$78.00 | 3 | A | | 29-24808-00 | PEN MOTOR ASSY | EACH | \$379.00 | 3 | A | |
| 29-24580-00 | OIL ESSO-BEACON 25 | EACH | \$232.00 | 3 | A | | 29-24810-00 | PEN CAROUSEL | EACH | \$100.00 | 3 | A | |
| 29-24582-00 | RIBBON DR. SPOOL | EACH | REPLACED | 3 | A | 29-24738-00 | 29-24812-00 | IDLER PULLEY | EACH | \$36.00 | 3 | A | |
| 29-24583-00 | KIT, PROC PROM | EACH | \$673.00 | 3 | A | | 29-24816-00 | PLASTIC WINDOW | EACH | \$71.00 | 3 | A | |
| 29-24584-00 | KIT HEADER (PROM) | EACH | \$50.00 | 3 | A | | 29-24824-00 | POWER MODULE ASSY | EACH | \$129.00 | 3 | A | |
| 29-24585-00 | KIT, HARDWARE | EACH | \$122.00 | 3 | A | | 29-24825-00 | TRANSFORMER | EACH | \$119.00 | 3 | A | |
| 29-24586-00 | KIT, SPRING | EACH | \$124.00 | 3 | A | | 29-24828-00 | FRONT PANEL | EACH | \$50.00 | 3 | A | |
| 29-24587-00 | KIT, HARDWARE PKG. | EACH | \$59.00 | 3 | A | | 29-24830-00 | TOP COVER | EACH | \$119.00 | 3 | A | |
| 29-24588-00 | PROM 96 CHAR | EACH | \$70.00 | 3 | A | | 29-24833-00 | PEN LIFT BAR | EACH | \$65.00 | 3 | A | |
| 29-24599-00 | CABLE,HARNESS | EACH | \$19.00 | 3 | A | | 29-24834-00 | SLIDER ROD | EACH | \$65.00 | 3 | A | |
| 29-24600-00 | CONNECTOR-DY | EACH | \$7.00 | 3 | A | | 29-24836-00 | CHASSIS | EACH | \$187.00 | 3 | A | |
| 29-24601-00 | COIL,DEGAUSS | EACH | \$17.00 | 3 | A | | 29-24841-00 | PEN HOLDER ASSY | EACH | \$93.00 | 3 | A | |
| 29-24602-00 | SIGNAL MODULE | EACH | \$183.00 | Y | 3 | A | 29-24842-00 | SOLENOID ASSY | EACH | \$77.00 | 3 | A | |
| 29-24603-00 | POWER SUPPLY ASSY | EACH | \$183.00 | Y | 3 | A | 29-24843-00 | CAROUSEL HSE ASSY | EACH | \$120.00 | 3 | A | |
| 29-24604-00 | PANEL BACK ASSY | EACH | \$107.00 | 3 | A | | 29-24844-00 | PAPER BAIL | EACH | \$26.00 | 3 | A | |
| 29-24605-00 | KIT,MISC.HDW. | EACH | \$122.00 | 3 | A | | 29-24845-00 | PINCH ROLLER | EACH | \$7.00 | 3 | A | |
| 29-24606-00 | CABINET,FRONT FRAME | EACH | \$89.00 | 3 | A | | 29-24854-00 | BELT | EACH | \$21.00 | 3 | A | |
| 29-24607-00 | CABINET,BACK COVER | EACH | \$122.00 | 3 | A | | 29-24856-00 | FUSE-0.6A(POWER) | QTY OF 10 | \$5.00 | 3 | A | |
| 29-24608-00 | CRT WITH ITC | EACH | \$755.00 | Y | 3 | A | 29-24857-00 | FUSE-0.3A(POWER) | QTY OF 10 | \$5.00 | 3 | A | |
| 29-24609-00 | GRN/BLUE DRIVE ASSY | EACH | \$11.00 | 3 | A | | 29-24858-00 | FUSE-0.3A54(POWER) | EACH | \$7.00 | 3 | A | |
| 29-24610-00 | RGB/SYNC INPUT ASSY | EACH | \$81.00 | 3 | A | | 29-24859-00 | FUSE-3.15A(LOGIC BD) | QTY OF 10 | \$5.00 | 3 | A | |
| 29-24611-00 | FILTER ASSY | EACH | \$30.00 | 3 | A | | 29-24860-00 | FUSE-0.8A(LOGIC BD) | QTY OF 10 | \$5.00 | 3 | A | |
| 29-24612-00 | CONTROL VOL ASSY | EACH | \$11.00 | 3 | A | | 29-24861-00 | FUSE-1.6A(LOGIC BD) | QTY OF 10 | \$5.00 | 3 | A | |



Prices Effective 02-January-89 to 30-June-89
 To Order—Call DECdirect™ TOLL-FREE 800-344-4825, 8:30 a.m. to 8:00 p.m. ET in Continental U.S.A.

HARDWARE SPARES PRICE LIST

| PART NUMBER | DESCRIPTION | UNIT ORDER | UNIT PRICE | REP D | L | REPLACEMENT PART NUMBER | PART NUMBER | DESCRIPTION | UNIT ORDER | UNIT PRICE | REP D | L | REPLACEMENT PART NUMBER |
|-------------|---------------------------|------------|------------|-------|-----|-------------------------|-------------|-------------------------|------------|------------|-------|-----|-------------------------|
| 29-24862-00 | DRIVE SHAFT ASSY | EACH | \$113.00 | | 3 A | | 29-25067-00 | LED DISPLAY 60 HZ | EACH | \$812.00 | | 3 A | |
| 29-24891-00 | POWER SUPPLY | EACH | \$575.00 | Y | 3 A | | 29-25070-00 | OPTICAL HOUSING | EACH | \$1,411.00 | Y | 3 A | |
| 29-24893-00 | LOGIC MODULE | EACH | \$632.00 | Y | 3 A | | 29-25071-00 | DEVELOPMENT UNIT | EACH | \$311.00 | Y | 3 A | |
| 29-24894-00 | CARRIAGE ASSY | EACH | \$303.00 | | 3 A | | 29-25072-00 | FUSING UNIT, 100V | EACH | \$363.00 | Y | 3 A | |
| 29-24895-00 | CARRIAGE MTR ASSY | EACH | \$167.00 | | 3 A | | 29-25073-00 | FUSING UNIT, 200V | EACH | \$363.00 | | 3 A | |
| 29-24896-00 | PAPERFEED MTR ASSY | EACH | \$131.00 | | 3 A | | 29-25074-00 | CLEANING UNIT | EACH | \$176.00 | | 3 A | |
| 29-24897-00 | PLATEN ASSEMBLY | EACH | \$123.00 | | 3 A | | 29-25075-00 | P.S. HIGH VOLTAGE | EACH | \$125.00 | | 3 A | |
| 29-24900-00 | RIBBON BRACKETS | EACH | \$6.00 | | 3 A | | 29-25076-00 | PAPER TRAY MTR. | EACH | \$48.00 | | 3 A | |
| 29-24901-00 | PAPER RELEASE LEVER | EACH | \$13.00 | | 3 A | | 29-25077-00 | PAPER HEIGHT SENSOR | EACH | \$15.00 | | 3 A | |
| 29-24902-00 | RIBBON DRIVE PULLEY | EACH | \$15.00 | | 3 A | | 29-25078-00 | UPPER TRANSP. ROLLER | EACH | \$11.00 | | 3 A | |
| 29-24903-00 | TAKE UP PULLEY | EACH | \$14.00 | | 3 A | | 29-25079-00 | LOWER TRANSP. ROLLER | EACH | REPLACED | | 3 A | 29-25344-00 |
| 29-24904-00 | RIBBON DRIVE MTR | EACH | \$107.00 | | 3 A | | 29-25080-00 | REGISTRATION SENSOR | EACH | REPLACED | | 3 A | 29-25379-00 |
| 29-24909-00 | PLATEN GEAR SLEEVE | EACH | \$8.00 | | 3 A | | 29-25081-00 | TRANSP. MAG. CLUTCH | EACH | \$51.00 | | 3 A | |
| 29-24910-00 | PLATEN SLEEVE SET SCREW | QTY OF 10 | \$2.00 | | 3 A | | 29-25082-00 | FEED MAG. CLUTCH | EACH | \$49.00 | | 3 A | |
| 29-24911-00 | CARRIAGE BELT | EACH | \$38.00 | | 3 A | | 29-25083-00 | MAIN MTR. ASSY | EACH | \$158.00 | | 3 A | |
| 29-24913-00 | PAPER FEED MTR BELT | EACH | \$15.00 | | 3 A | | 29-25084-00 | MAIN MTR. DRIVE BD | EACH | \$119.00 | | 3 A | |
| 29-24916-00 | RIBBON DRIVE SPRING | QTY OF 10 | \$2.00 | | 3 A | | 29-25085-00 | DRIVE BELT LONG | EACH | \$11.00 | | 3 A | |
| 29-24919-00 | PLATEN PAPER TENS SPRING | QTY OF 10 | \$5.00 | | 3 A | | 29-25086-00 | DRIVE BELT SHORT | EACH | \$7.00 | | 3 A | |
| 29-24921-00 | CARRIAGE MTR BELT | EACH | \$21.00 | | 3 A | | 29-25087-00 | OPC SENSOR | EACH | \$27.00 | | 3 A | |
| 29-24923-00 | BAIL BAR SPRING | QTY OF 10 | \$5.00 | | 3 A | | 29-25088-00 | ENG. DRIVE BD. | EACH | REPLACED | Y | 3 A | 29-25380-00 |
| 29-24926-00 | R/W BOARD | EACH | \$274.00 | Y | 3 A | | 29-25089-00 | POWER SUPPLY 100V | EACH | \$483.00 | Y | 3 A | |
| 29-24931-00 | P.W. MOTOR | EACH | \$321.00 | Y | 3 A | | 29-25090-00 | POWER SUPPLY 200V | EACH | \$483.00 | | 3 A | |
| 29-24932-00 | CARRIAGE MOTOR | EACH | \$393.00 | Y | 3 A | | 29-25091-00 | AC BRACKET ASSY 100V | EACH | \$134.00 | | 3 A | |
| 29-24933-00 | PLATEN KNOB | EACH | \$15.00 | | 3 A | | 29-25092-00 | AC BRACKET ASSY 200V | EACH | \$134.00 | | 3 A | |
| 29-24945-00 | HAND HELD TERMINAL | EACH | \$1,073.00 | Y | 3 A | | 29-25093-00 | OPC COUNTER | EACH | REPLACED | | 3 A | 29-26056-00 |
| 29-24951-00 | ENCODER | EACH | \$162.00 | | 3 A | | 29-25094-00 | TOTAL COUNTER | EACH | \$21.00 | | 3 A | |
| 29-24960-00 | TOP MASK | EACH | \$63.00 | | 3 A | | 29-25095-00 | FAN MTR. EXHAUST | EACH | \$100.00 | | 3 A | |
| 29-24961-00 | CLUTCH ASSY | EACH | \$56.00 | | 3 A | | 29-25096-00 | FAN MTR. OZONE | EACH | \$100.00 | | 3 A | |
| 29-24962-00 | CLUTCH ASSY | EACH | \$48.00 | | 3 A | | 29-25097-00 | TONER OVER SENSOR | EACH | \$26.00 | | 3 A | |
| 29-24963-00 | GEAR RIBBON | EACH | \$8.00 | | 3 A | | 29-25098-00 | INDICATOR PANEL BD | EACH | \$49.00 | | 3 A | |
| 29-24964-00 | REWIND ASSY | EACH | \$38.00 | | 3 A | | 29-25099-00 | SCANNER MTR. DR. BDL | EACH | \$126.00 | | 3 A | |
| 29-24965-00 | MOTOR, ASSY | EACH | \$217.00 | | 3 A | | 29-25100-00 | ZONER DIODE ASSY | EACH | \$15.00 | | 3 A | |
| 29-24966-00 | TOP COVER | EACH | \$177.00 | | 3 A | | 29-25101-00 | EXIT SENSOR | EACH | \$8.00 | | 3 A | |
| 29-24967-00 | INTERMEDIATE COVER | EACH | \$198.00 | | 3 A | | 29-25102-00 | FEED FOLLER | EACH | \$30.00 | | 3 A | |
| 29-24968-00 | CRADLE | EACH | \$30.00 | | 3 A | | 29-25103-00 | PREFEED ROLLER | EACH | \$7.00 | | 3 A | |
| 29-24969-00 | SHAFT REAR ROLLER | EACH | \$39.00 | | 3 A | | 29-25104-00 | SEP. ROLLER ASSY | EACH | \$38.00 | | 3 A | |
| 29-24970-00 | SHAFT FRONT FEED ROLLER | EACH | \$36.00 | | 3 A | | 29-25164-00 | PULLEY ASSEY | EACH | \$359.00 | | 3 A | |
| 29-24971-00 | PAPER FEED MOTOR | EACH | \$140.00 | | 3 A | | 29-25166-00 | PULLEY IDLER | EACH | \$38.00 | | 3 A | |
| 29-24972-00 | IDLER GEAR | EACH | \$21.00 | | 3 A | | 29-25169-00 | CCA MOTHERBOARD | EACH | \$741.00 | | 3 A | |
| 29-24973-00 | LEFT RIBBON FINGER | EACH | \$14.00 | | 3 A | | 29-25176-00 | PLATEN ASSY | EACH | \$663.00 | | 3 A | |
| 29-24974-00 | RIGHT RIBBON FINGER | EACH | \$14.00 | | 3 A | | 29-25205-00 | LD CONTROL BD | EACH | \$257.00 | | 3 A | |
| 29-24975-00 | CARD GUIDE BRKT | EACH | \$23.00 | | 3 A | | 29-25206-00 | DETECT BD | EACH | \$74.00 | | 3 A | |
| 29-24976-00 | CARD GUIDE | EACH | \$13.00 | | 3 A | | 29-25207-00 | SHIELD GLASS | EACH | \$25.00 | | 3 A | |
| 29-24977-00 | BRACKET ASSY PHOTO SENSOR | EACH | \$113.00 | | 3 A | | 29-25208-00 | FUSING HEADER, 115V | EACH | \$50.00 | | 3 A | |
| 29-24978-00 | TIMING BELT | EACH | \$91.00 | | 3 A | | 29-25209-00 | SECTOR GEAR LEVER ASSY | EACH | \$13.00 | | 3 A | |
| 29-24980-00 | PROXIMITY SW. MAG | EACH | \$34.00 | | 3 A | | 29-25210-00 | FEED ROLLER UNIT | EACH | \$76.00 | | 3 A | |
| 29-24981-00 | PROXIMITY SWITCH ASSY | EACH | \$86.00 | | 3 A | | 29-25211-00 | CHARGE/TRANSFER CORONA | EACH | \$26.00 | | 3 A | |
| 29-24985-00 | DEV. DRAWER COVER | EACH | \$17.00 | | 3 A | | 29-25212-00 | LD UNIT | EACH | \$374.00 | | 3 A | |
| 29-24986-00 | FRONT CARTRIDGE CASE | EACH | \$15.00 | | 3 A | | 29-25213-00 | CABLE, LD UNIT | EACH | \$49.00 | | 3 A | |
| 29-24987-00 | FRONT COVER | EACH | \$34.00 | | 3 A | | 29-25214-00 | POLY. SCANNER MTR. ASSY | EACH | \$387.00 | | 3 A | |
| 29-24988-00 | CONTROLLER | EACH | REPLACED | Y | 3 A | 29-25334-00 | 29-25215-00 | SEPARATION PAWL | EACH | \$12.00 | | 3 A | |
| 29-24992-00 | MAIN PCB | EACH | \$779.00 | Y | 3 A | | 29-25216-00 | TEMP. FUSE ASSY | EACH | \$20.00 | | 3 A | |
| 29-25035-00 | PWR SUP STATIC ELIM | EACH | \$309.00 | | 3 A | | 29-25217-00 | THERMISTOR ASSY | EACH | \$33.00 | | 3 A | |
| 29-25046-00 | PNEUMATIC ASSY. 50/60HZ | EACH | \$854.00 | | 3 A | | 29-25218-00 | PRESSURE ROLLER | EACH | \$81.00 | | 3 A | |
| 29-25064-00 | FRONT PANEL ASSY. | EACH | \$618.00 | | 3 A | | 29-25219-00 | HOT ROLLER | EACH | \$61.00 | | 3 A | |

HARDWARE SPARES PRICE LIST

| PART NUMBER | DESCRIPTION | UNIT ORDER | UNIT PRICE | REP D | L | REPLACEMENT PART NUMBER | PART NUMBER | DESCRIPTION | UNIT ORDER | UNIT PRICE | REP D | L | REPLACEMENT PART NUMBER |
|-------------|--------------------------|------------|------------|-------|---|-------------------------|-------------|-----------------------|------------|------------|-------|---|-------------------------|
| 29-25220-00 | CLEANING PAD | EACH | REPLACED | 3 | A | 29-26092-00 | 29-25545-00 | EHT CABLE ASSY | EACH | \$122.00 | 3 | A | |
| 29-25221-00 | TOP COVER | EACH | \$46.00 | 3 | A | | 29-25546-00 | METAL CHASSIS | EACH | \$302.00 | 3 | A | |
| 29-25222-00 | CONNECTOR ASSY RS232C | EACH | REPLACED | 3 | A | 29-26066-00 | 29-25547-00 | DEGAUSS CABLE ASSY | EACH | \$109.00 | 3 | A | |
| 29-25223-00 | CONTROLLER COVER | EACH | \$27.00 | 3 | A | | 29-25548-00 | ENCLOSURE | EACH | \$499.00 | 3 | A | |
| 29-25224-00 | ZONE FILTER ASSY | EACH | \$23.00 | 3 | A | | 29-25551-00 | TOOL KIT | EACH | \$725.00 | 3 | A | |
| 29-25225-00 | LEFT SIDE COVER | EACH | \$11.00 | 3 | A | | 29-25552-00 | SHUTTLE MOTOR BOBBIN | EACH | \$553.00 | 3 | A | |
| 29-25226-00 | INNER COVER ASSY | EACH | \$13.00 | 3 | A | | 29-25553-00 | HAMMERBANK/YOKE ASSY. | EACH | \$4,677.00 | 3 | A | |
| 29-25227-00 | EXIT UNIT | EACH | \$109.00 | 3 | A | | 29-25554-00 | PICO FUSE, 2 AMP | EACH | \$20.00 | 3 | A | |
| 29-25228-00 | QUENCHING LAMP UNIT | EACH | \$30.00 | 3 | A | | 29-25555-00 | PAPER DRIVE MOTOR | EACH | \$874.00 | 3 | A | |
| 29-25229-00 | SEP. UNIT | EACH | \$78.00 | 3 | A | | 29-25556-00 | HAMMER DRIVER PCB | EACH | \$1,173.00 | Y | 3 | A |
| 29-25230-00 | PAPER TRAY | EACH | REPLACED | 3 | A | 29-26083-00 | 29-25557-00 | FRONT PANEL PCB | EACH | \$687.00 | 3 | A | |
| 29-25260-00 | TRACTOR ASSY RIGHT HAND | EACH | \$6.00 | 3 | A | | 29-25558-00 | SWITCH PNEUMATIC | EACH | \$120.00 | 3 | A | |
| 29-25261-00 | TRACTOR ASSY LEFT HAND | EACH | \$6.00 | 3 | A | | 29-25559-00 | POSITION SENSOR ASSY. | EACH | \$477.00 | 3 | A | |
| 29-25290-00 | 8" PHILIPS SCREWDRIVER | EACH | \$17.00 | 3 | A | | 29-25560-00 | SEQUENCER PCB | EACH | \$715.00 | 3 | A | |
| 29-25296-00 | CLUTCH GAP ADJ. TOOL | EACH | \$15.00 | 3 | A | | 29-25561-00 | LG01 CONTROL PCB | EACH | \$833.00 | 3 | A | |
| 29-25308-00 | DRIVE SECTION KIT | EACH | \$82.00 | 3 | A | | 29-25562-00 | RIBBON DRIVE MOTOR | EACH | \$477.00 | 3 | A | |
| 29-25309-00 | SWITCH/SENSOR KIT | EACH | \$122.00 | 3 | A | | 29-25563-00 | BLOWER ASSY. | EACH | \$715.00 | 3 | A | |
| 29-25310-00 | SCREW RET. RING KIT | EACH | \$17.00 | 3 | A | | 29-25564-00 | SERIAL I/O PCB | EACH | \$764.00 | 3 | A | |
| 29-25311-00 | PAPER FEED & TRANS. KIT | EACH | \$27.00 | 3 | A | | 29-25565-00 | LOWER RH PUSHER | EACH | REPLACED | 3 | A | 29-26395-00 |
| 29-25319-00 | CONTROLLER | EACH | \$1,331.00 | Y | 3 | A | 29-25566-00 | UPPER LH PULLER | EACH | REPLACED | 3 | A | 29-26394-00 |
| 29-25335-00 | OPC CARTRIDGE | EACH | \$163.00 | 3 | A | | 29-25567-00 | UPPER RH PULLER | EACH | REPLACED | 3 | A | 29-26394-00 |
| 29-25337-00 | PRGAMP PCB | EACH | \$462.00 | 3 | A | | 29-25568-00 | LOWER LH PUSHER | EACH | REPLACED | 3 | A | 29-26395-00 |
| 29-25338-00 | MOTOR PCB | EACH | \$682.00 | 3 | A | | 29-25569-00 | PARALLEL I/O PCB | EACH | \$715.00 | Y | 3 | A |
| 29-25339-00 | DEVICE PCB | EACH | \$1,662.00 | Y | 3 | A | 29-25570-00 | PAPER DRIVE BELT | EACH | \$68.00 | 3 | A | |
| 29-25340-00 | SOLONOID | EACH | \$169.00 | 3 | A | | 29-25571-00 | PAPER MOTION SENSOR | EACH | \$156.00 | 3 | A | |
| 29-25341-00 | BRAKE ARM | EACH | \$80.00 | 3 | A | | 29-25572-00 | PLATEN OPEN SW | EACH | \$81.00 | 3 | A | |
| 29-25344-00 | LOWER TRANSPORT ROLLER | EACH | \$21.00 | 3 | A | | 29-25573-00 | POWER AMP PCB | EACH | \$1,402.00 | Y | 3 | A |
| 29-25345-00 | STI MODULE | EACH | \$5,796.00 | Y | 3 | A | 29-25574-00 | PAPER/STATUS PCB | EACH | \$890.00 | 3 | A | |
| 29-25346-00 | CONTROL PANEL | EACH | \$387.00 | 3 | A | | 29-25575-00 | SHUTTLE & RIBBON PCB | EACH | \$738.00 | 3 | A | |
| 29-25379-00 | REGISTRATION SENSOR | EACH | \$27.00 | 3 | A | | 29-25576-00 | PWR/CKT BREAKER | EACH | \$179.00 | 3 | A | |
| 29-25380-00 | ENG. DRIVE BOARD | EACH | \$389.00 | Y | 3 | A | 29-25577-00 | PWR SUPPLY PCB | EACH | \$590.00 | 3 | A | |
| 29-25420-00 | 16 GAUGE FUSE LINK WIRE | EACH | \$2.00 | 3 | A | | 29-25578-00 | FUSE-SLO BLO 5 AMP | EACH | \$15.00 | 3 | A | |
| 29-25421-00 | 4518 GAGE FUSE LINK | EACH | \$2.00 | 3 | A | | 29-25579-00 | FUSE - 2A | EACH | \$13.00 | 3 | A | |
| 29-25422-00 | GAUGE FUSE LINK WIRE | EACH | \$2.00 | 3 | A | | 29-25580-00 | FUSE - 12A | EACH | \$14.00 | 3 | A | |
| 29-25423-00 | GAUGE FUSE LINK WIRE | EACH | \$2.00 | 3 | A | | 29-25581-00 | RIBBON PLATFORM SW | EACH | \$120.00 | 3 | A | |
| 29-25428-00 | 451200 V SCR DRIVER MOD | EACH | \$207.00 | 3 | A | | 29-25582-00 | PAPER OUT SW | EACH | \$188.00 | 3 | A | |
| 29-25430-00 | 50 HZ STATUS PANEL | EACH | \$782.00 | 3 | A | | 29-25584-00 | SHUTTLE POS SENS KIT | EACH | \$662.00 | 3 | A | |
| 29-25431-00 | 45 HEAT SINK PAD | EACH | \$3.00 | 3 | A | | 29-25585-00 | RIBBON SHIELD ASSY. | EACH | \$248.00 | 3 | A | |
| 29-25492-00 | 10" CORD FOR WRIST STRAP | QTY OF 10 | \$33.00 | 3 | A | | 29-25586-00 | PLATTEN ASSY. | EACH | \$528.00 | 3 | A | |
| 29-25494-00 | INSULATED ALLIGATOR CLIP | QTY OF 10 | \$22.00 | 3 | A | | 29-25587-00 | HAMMER MODULE UPPER | EACH | \$315.00 | 3 | A | |
| 29-25496-00 | WRISTBAND, SMALL (GREY) | QTY OF 10 | \$16.00 | 3 | A | | 29-25588-00 | HAMMER MOD. LOWER | EACH | \$315.00 | 3 | A | |
| 29-25497-00 | WRISTBAND, MED (BEIGE) | QTY OF 10 | \$16.00 | 3 | A | | 29-25594-00 | FUSER HEATER - 230V | EACH | \$90.00 | 3 | A | |
| 29-25498-00 | WRISTBAND, LARGE (BLUE) | QTY OF 10 | \$16.00 | 3 | A | | 29-25797-00 | BUFF. TMSCP MODULE | EACH | \$6,156.00 | Y | 3 | A |
| 29-25504-00 | 45 SCR CONTROL | EACH | \$63.00 | 3 | A | | 29-25807-00 | REAR HEAT SOCK | EACH | \$15.00 | 3 | A | |
| 29-25526-00 | VACUUM CLEANER | EACH | \$554.00 | 3 | A | | 29-25808-00 | TEMP FUSE CABLE | EACH | \$39.00 | 3 | A | |
| 29-25527-00 | MAIN PCB | EACH | \$315.00 | 3 | A | | 29-25809-00 | THERMISTOR, FUSE | EACH | \$77.00 | 3 | A | |
| 29-25536-00 | VIDEO SUB ASSY | EACH | \$635.00 | Y | 3 | A | 29-25810-00 | OIL END SENSOR | EACH | \$77.00 | 3 | A | |
| 29-25537-00 | CRT SOCKET BOARD | EACH | \$233.00 | 3 | A | | 29-25811-00 | OIL PAD | EACH | \$116.00 | 3 | A | |
| 29-25538-00 | DEFLECTION BOARD | EACH | \$518.00 | Y | 3 | A | 29-25812-00 | CLEANING BLADE | EACH | \$103.00 | 3 | A | |
| 29-25539-00 | APP BOARD | EACH | \$658.00 | Y | 3 | A | 29-25813-00 | PCC CORONA WIRE | EACH | \$107.00 | 3 | A | |
| 29-25540-00 | MAINS BOARD | EACH | \$518.00 | Y | 3 | A | 29-25814-00 | CORONA WIRE CLEANER | EACH | \$6.00 | 3 | A | |
| 29-25541-00 | CONTROL UNIT | EACH | \$109.00 | 3 | A | | 29-25815-00 | RUBBER BELT | EACH | \$6.00 | 3 | A | |
| 29-25542-00 | CABLES ASSEMBLY | EACH | \$168.00 | 3 | A | | 29-25816-00 | CLEANING PAD | EACH | \$45.00 | 3 | A | |
| 29-25543-00 | LED AND MISCELLANEOUS | EACH | \$101.00 | 3 | A | | 29-25817-00 | QUENCH LAMP FILTER | EACH | \$45.00 | 3 | A | |
| 29-25544-00 | I.T.C. ASSEMBLY | EACH | \$2,307.00 | 3 | A | | 29-25818-00 | DRUM TEMP. SENS. | EACH | \$69.00 | 3 | A | |

digital

Prices Effective 02-January-89 to 30-June-89

To Order—Call DECdirect™ TOLL-FREE 800-344-4825, 8:30 a.m. to 8:00 p.m. ET in Continental U.S.A.

SPARES PRICE LIST A-45

HARDWARE SPARES PRICE LIST

| PART NUMBER | DESCRIPTION | UNIT ORDER | UNIT PRICE | REP D L | REPLACEMENT PART NUMBER | PART NUMBER | DESCRIPTION | UNIT ORDER | UNIT PRICE | REP D L | REPLACEMENT PART NUMBER |
|-------------|----------------------|------------|------------|---------|-------------------------|-------------|-------------------------|------------|------------|---------|-------------------------|
| 29-25819-00 | HOOK LINK CHAIN | EACH | \$6.00 | 3 A | | 29-25875-00 | ELECTRICAL KIT | EACH | \$691.00 | 3 A | |
| 29-25820-00 | PICK PAWL ASSY. | EACH | \$43.00 | 3 A | | 29-25876-00 | FUSING FAN | EACH | \$132.00 | 3 A | |
| 29-25821-00 | CLEANING BRUSH | EACH | \$82.00 | 3 A | | 29-25877-00 | DC P.S. | EACH | \$527.00 | 3 A | |
| 29-25822-00 | DRUM | EACH | \$392.00 | 3 A | | 29-25878-00 | TRANS. UNIT SW | EACH | \$25.00 | 3 A | |
| 29-25823-00 | RECEPT., CORONA | EACH | \$6.00 | 3 A | | 29-25879-00 | POWER PCK | EACH | \$300.00 | 3 A | |
| 29-25824-00 | DRUM FAN | EACH | \$127.00 | 3 A | | 29-25880-00 | TOTAL COUNTER | EACH | \$56.00 | 3 A | |
| 29-25825-00 | QUENCH LAMP | EACH | \$84.00 | 3 A | | 29-25881-00 | VACUUM FAN | EACH | \$138.00 | 3 A | |
| 29-25826-00 | SHIELD GLASS | EACH | \$59.00 | 3 A | | 29-25882-00 | SPRING KIT | EACH | \$120.00 | 3 A | |
| 29-25828-00 | AOM | EACH | \$1,412.00 | 3 A | | 29-25883-00 | RET. RING AND CLIPS KIT | EACH | \$111.00 | 3 A | |
| 29-25829-00 | SYNC DET. BD. | EACH | \$173.00 | 3 A | | 29-25884-00 | POWER SWITCH | EACH | \$48.00 | 3 A | |
| 29-25830-00 | CHARGE CORONA ASSY. | EACH | \$53.00 | 3 A | | 29-25885-00 | AC POWER CORD | EACH | \$297.00 | 3 A | |
| 29-25831-00 | T & D CORONA ASSY. | EACH | \$100.00 | 3 A | | 29-25886-00 | CONTR P.S. | EACH | \$301.00 | 3 A | |
| 29-25832-00 | REG. SENS PCB | EACH | \$90.00 | 3 A | | 29-25887-00 | TRANSFORMER PDV | EACH | \$377.00 | 3 A | |
| 29-25833-00 | PRE TRANS. LAMP | EACH | \$70.00 | 3 A | | 29-25888-00 | CIRCUIT BREAKER | EACH | \$112.00 | 3 A | |
| 29-25834-00 | POLYGON SCAN ASSY. | EACH | \$691.00 | 3 A | | 29-25889-00 | CIR BREAKER 1A | EACH | \$67.00 | 3 A | |
| 29-25835-00 | LASER DRIVE PS | EACH | \$297.00 | 3 A | | 29-25890-00 | RETURN SOLENOID | EACH | \$96.00 | 3 A | |
| 29-25836-00 | BEAM PWR DET. BD | EACH | \$111.00 | 3 A | | 29-25891-00 | MAIN CONTROL BOARD | EACH | \$460.00 | 3 A | |
| 29-25837-00 | FEED ROLLER KIT SET | EACH | \$151.00 | 3 A | | 29-25892-00 | PAPER DETECTOR | EACH | \$77.00 | 3 A | |
| 29-25838-00 | FEED MAG CLUTCH | EACH | \$111.00 | 3 A | | 29-25893-00 | MAIN MTR. ASSY. | EACH | \$461.00 | 3 A | |
| 29-25839-00 | REG MAG CLUTCH | EACH | \$173.00 | 3 A | | 29-25894-00 | TRANSFORMER FDS | EACH | \$111.00 | 3 A | |
| 29-25840-00 | CASSETTE MRR ASSY. | EACH | \$120.00 | 3 A | | 29-25895-00 | INVERSCON SOLEN. | EACH | \$70.00 | 3 A | |
| 29-25841-00 | ROLLER KIT SET | EACH | \$122.00 | 3 A | | 29-25896-00 | JUNC GATE SOLEN. | EACH | \$58.00 | 3 A | |
| 29-25842-00 | INDICATOR PANEL | EACH | \$25.00 | 3 A | | 29-25897-00 | VERT FEED SOLEN. | EACH | \$65.00 | 3 A | |
| 29-25843-00 | DEV. COLLECT. BOTTLE | EACH | \$33.00 | 3 A | | 29-25898-00 | SEQ CONT BD | EACH | \$247.00 | 3 A | |
| 29-25844-00 | COVER, SEP. GUIDE | EACH | \$6.00 | 3 A | | 29-25899-00 | PS UNIT | EACH | \$691.00 | 3 A | |
| 29-25845-00 | PHOTO INTERP. PACK | EACH | \$70.00 | 3 A | | 29-25900-00 | TRAY MOTOR | EACH | \$71.00 | 3 A | |
| 29-25846-00 | LED SENSOR TYPES | EACH | \$15.00 | 3 A | | 29-25901-00 | GEAR HD TRAY MTR | EACH | \$173.00 | 3 A | |
| 29-25847-00 | CLEANING UNIT | EACH | \$328.00 | 3 A | | 29-25902-00 | PAPER FEED MOTOR | EACH | \$201.00 | 3 A | |
| 29-25848-00 | FUSING UNIT | EACH | \$621.00 | 3 A | | 29-25903-00 | FEED MAG CLUTCH | EACH | \$111.00 | 3 A | |
| 29-25849-00 | TRANSPORT UNIT | EACH | \$350.00 | 3 A | | 29-25904-00 | TRANS MAG CLUTCH | EACH | \$111.00 | 3 A | |
| 29-25850-00 | DEVEL. UNIT | EACH | \$508.00 | 3 A | | 29-25905-00 | TIMING BELT | EACH | \$42.00 | 3 A | |
| 29-25851-00 | DEVICE CONTROLLER | EACH | \$639.00 | 3 A | | 29-25906-00 | TIMING BELT | EACH | \$25.00 | 3 A | |
| 29-25852-00 | FUSING HEADER 200V | EACH | \$84.00 | 3 A | | 29-25907-00 | FEED SOLENOID | EACH | \$17.00 | 3 A | |
| 29-25853-00 | FRONT HEAT SOCK | EACH | \$19.00 | 3 A | | 29-25908-00 | TIMING BELT | EACH | \$42.00 | 3 A | |
| 29-25854-00 | PAPER EXIT ASSY. | EACH | \$173.00 | 3 A | | 29-25909-00 | OPTICAL HOUSING | EACH | \$4,233.00 | 3 A | |
| 29-25855-00 | FUSING UNIT SEP PAWL | EACH | \$65.00 | 3 A | | 29-25911-00 | TONER DENS SENS | EACH | \$67.00 | 3 A | |
| 29-25856-00 | ANTI-STATIC BRUSH | EACH | \$17.00 | 3 A | | 29-25912-00 | DRIVE BELT DEVEL | EACH | \$20.00 | 3 A | |
| 29-25857-00 | DEV. REP. SOLENOID | EACH | \$55.00 | 3 A | | 29-25913-00 | FUSING TEMP CONTROL | EACH | \$138.00 | 3 A | |
| 29-25858-00 | MAIN MOTOR | EACH | \$215.00 | 3 A | | 29-25916-00 | PRINTHEAD | EACH | \$138.00 | 3 A | |
| 29-25859-00 | DRIVE BEL DRUM | EACH | \$17.00 | 3 A | | 29-25917-00 | TRACTOR ASSY. | EACH | \$70.00 | 3 A | |
| 29-25860-00 | SEP. PAWL SOLEN. | EACH | \$40.00 | 3 A | | 29-25918-00 | MECH. ASSY. | EACH | \$365.00 | Y 3 A | |
| 29-25861-00 | CLEANING BLADE SOL. | EACH | \$90.00 | 3 A | | 29-25919-00 | FRICTION RELEASE LEVER | QTY OF 10 | \$4.00 | 3 A | |
| 29-25862-00 | DR. BELT CLEAN/FUSE | EACH | \$19.00 | 3 A | | 29-25920-00 | SMUDGE GUARD | EACH | \$6.00 | 3 A | |
| 29-25863-00 | IND. PANEL PCB | EACH | \$173.00 | 3 A | | 29-25921-00 | LINE FEED MOTOR | EACH | \$58.00 | 3 A | |
| 29-25864-00 | OPER. PANEL PCB | EACH | \$242.00 | 3 A | | 29-25922-00 | CARRIAGE BLOCK | EACH | \$117.00 | 3 A | |
| 29-25865-00 | PUSH SWAC | EACH | \$48.00 | 3 A | | 29-25923-00 | PRINT HEAD CABLE | EACH | \$30.00 | 3 A | |
| 29-25866-00 | TONER DENS. CB | EACH | \$168.00 | 3 A | | 29-25924-00 | PINCH ROLLER | QTY OF 10 | \$4.00 | 3 A | |
| 29-25867-00 | DEV. MT. DR. BD. | EACH | \$173.00 | 3 A | | 29-25925-00 | PAPER OUT SENSOR | EACH | \$5.00 | 3 A | |
| 29-25868-00 | POLY MT. DR. BD. | EACH | \$173.00 | 3 A | | 29-25927-00 | ADJUST PLATE A | QTY OF 10 | \$1.00 | 3 A | |
| 29-25869-00 | MAIN MTR. DR. BD. | EACH | \$173.00 | 3 A | | 29-25928-00 | ADJUST PLATE B | QTY OF 10 | \$1.00 | 3 A | |
| 29-25870-00 | VID. CONTR. D. | EACH | \$846.00 | 3 A | | 29-25929-00 | ADJUST PLATE C | QTY OF 10 | \$1.00 | 3 A | |
| 29-25871-00 | PUSH SW HEATER | EACH | \$24.00 | 3 A | | 29-25930-00 | PAPER GUIDE | EACH | \$13.00 | 3 A | |
| 29-25872-00 | MAINT. COUNTER | EACH | \$194.00 | 3 A | | 29-25931-00 | PINCH ROLLER SPRING | QTY OF 10 | \$1.00 | 3 A | |
| 29-25873-00 | INTER-LOCK SW | EACH | \$32.00 | 3 A | | 29-25932-00 | TRACTOR LOCK LEVER | QTY OF 10 | \$4.00 | 3 A | |
| 29-25874-00 | STABILIZER LAMP | EACH | \$142.00 | 3 A | | 29-25933-00 | PAPER MOTOR STOPPER | QTY OF 10 | \$63 | 3 A | |



Prices Effective 02-January-89 to 30-June-89

To Order—Call DECdirect™ TOLL-FREE 800-344-4825, 8:30 a.m. to 8:00 p.m. ET in Continental U.S.A.

HARDWARE SPARES PRICE LIST

| PART NUMBER | DESCRIPTION | UNIT ORDER | UNIT PRICE | REP D L | REPLACEMENT PART NUMBER | PART NUMBER | DESCRIPTION | UNIT ORDER | UNIT PRICE | REP D L | REPLACEMENT PART NUMBER |
|-------------|----------------------------|------------|------------|---------|-------------------------|-------------|-------------------------------|------------|------------|---------|-------------------------|
| 29-25934-00 | DEFLECTOR | EACH | \$11.00 | 3 A | | 29-26058-00 | TOTAL COUNTER (LN03C.R.) | EACH | \$36.00 | 3 A | |
| 29-25935-00 | CARRIAGE PULLEY ARM | EACH | \$6.00 | 3 A | | 29-26060-00 | AC UNIT:200V (LN03C.R.) | EACH | \$183.00 | 3 A | |
| 29-25936-00 | MOTHER BOARD | EACH | \$83.00 | 3 A | | 29-26063-00 | COVER MAIN (LN03C.R.) | EACH | \$101.00 | 3 A | |
| 29-25937-00 | CARRIAGE BELT | EACH | \$5.00 | 3 A | | 29-26064-00 | COVER SIDE (LN03C.R.) | EACH | \$32.00 | 3 A | |
| 29-25938-00 | BAIL ROLLER HOLD PLATE | QTY OF 10 | \$4.00 | 3 A | | 29-26065-00 | CONTROLLER COVER (LN03C.R.) | EACH | \$158.00 | 3 A | |
| 29-25939-00 | PLATEN BUSH PLATE | QTY OF 10 | \$1.00 | 3 A | | 29-26066-00 | 91PCB:I/F (LN03C.R.) | EACH | \$92.00 | 3 A | |
| 29-25940-00 | CONTROL PANEL CABLE | EACH | \$12.00 | 3 A | | 29-26067-00 | MAIN MOTOR ASSY (LN03C.R.) | EACH | \$271.00 | 3 A | |
| 29-25941-00 | CARRIAGE SHAFT RIGHT | QTY OF 10 | \$1.00 | 3 A | | 29-26070-00 | OPT HOUS UN ASSY (LN03C.R.) | EACH | \$662.00 | Y 3 A | |
| 29-25942-00 | FREE LEVER SPRING PLATE | QTY OF 10 | \$1.00 | 3 A | | 29-26071-00 | LD UNIT (LN03C.R.) | EACH | \$336.00 | 3 A | |
| 29-25943-00 | PIN ROLLER SHFT | EACH | \$6.00 | 3 A | | 29-26072-00 | DETECT UNIT LN03C.R. | EACH | \$61.00 | 3 A | |
| 29-25944-00 | SHIFT GEAR CAM SUPP | QTY OF 10 | \$1.00 | 3 A | | 29-26073-00 | SCANNER MTR UN LN03C.R. | EACH | \$285.00 | 3 A | |
| 29-25945-00 | SHIFT GEAR CAM | QTY OF 10 | \$1.00 | 3 A | | 29-26074-00 | SCAN MTR DR BD (LN03C.R.) | EACH | \$106.00 | 3 A | |
| 29-25946-00 | GEAR COVER | QTY OF 10 | \$2.00 | 3 A | | 29-26075-00 | SHIELD LENS LNO3C.R. | EACH | \$44.00 | 3 A | |
| 29-25947-00 | TRACTOR CATCH A | QTY OF 10 | \$2.00 | 3 A | | 29-26076-00 | OPC SENSER ASSY (LN03C.R.) | EACH | \$48.00 | 3 A | |
| 29-25948-00 | SHAFT SPRING PLATE LEFT | QTY OF 10 | \$2.00 | 3 A | | 29-26077-00 | PAP FEED SENS ASSY LN03C.R. | EACH | \$27.00 | 3 A | |
| 29-25949-00 | IMPRESSION CONTR. LVR | QTY OF 10 | \$1.00 | 3 A | | 29-26078-00 | REGISTER SENS ASSY (LN03C.R.) | EACH | \$51.00 | 3 A | |
| 29-25950-00 | CARRIAGE SHAFT BUSH. | QTY OF 10 | \$1.00 | 3 A | | 29-26079-00 | TR RLLER ASSY LWR (LN03C.R.) | EACH | \$51.00 | 3 A | |
| 29-25951-00 | CARRIAGE SHFT | EACH | \$15.00 | 3 A | | 29-26082-00 | SCT GR LVR ASSY (LN03C.R.) | EACH | \$24.00 | 3 A | |
| 29-25952-00 | FELT WIPER | QTY OF 10 | \$2.00 | 3 A | | 29-26083-00 | PAPER TRAY (LN03C.R.) | EACH | \$101.00 | 3 A | |
| 29-25953-00 | CARRIAGE CAM | QTY OF 10 | \$1.00 | 3 A | | 29-26087-00 | DEV. UNIT ASSY (LN03C.R.) | EACH | \$420.00 | 3 A | |
| 29-25954-00 | TRACTOR CATCH B | QTY OF 10 | \$1.00 | 3 A | | 29-26089-00 | FUSING UNIT ASSY LN03C.R. | EACH | \$328.00 | Y 3 A | |
| 29-25955-00 | PLATEN ASSY. | EACH | \$65.00 | 3 A | | 29-26090-00 | SEPARATION PAWL (LN03C.R.) | EACH | \$12.00 | 3 A | |
| 29-25956-00 | CARRIAGE MOTOR | EACH | \$90.00 | 3 A | | 29-26092-00 | CLEANING PAD (LN03) | EACH | \$14.00 | 3 A | |
| 29-25957-00 | SENSOR ASSY. | EACH | \$32.00 | 3 A | | 29-26095-00 | PAPER EX UN ASSY LN03C.R. | EACH | \$133.00 | 3 A | |
| 29-25958-00 | POWER SUPPLY 120V | EACH | \$119.00 | 3 A | | 29-26096-00 | P.S.U. ASSY (LN03C.R.) | EACH | \$395.00 | Y 3 A | |
| 29-25959-00 | POWER SUPPLY 100V | EACH | \$119.00 | 3 A | | 29-26097-00 | HIGH VOLT PWR SUP (LN03C.R.) | EACH | \$153.00 | 3 A | |
| 29-25960-00 | POWER SUPPLY 220V/240V | EACH | \$120.00 | 3 A | | 29-26098-00 | ENGINE DR BOARD (LN03C.R.) | EACH | \$390.00 | Y 3 A | |
| 29-25961-00 | FUSE HOLDER | QTY OF 10 | \$4.00 | 3 A | | 29-26099-00 | P.S.U. ASSY:200V (LN03C.R.) | EACH | \$420.00 | Y 3 A | |
| 29-25962-00 | POWER SWITCH 100/120V | EACH | \$11.00 | 3 A | | 29-26116-00 | BALLPOINT HEX, 5/32" | EACH | \$8.00 | 3 A | |
| 29-25963-00 | IMPRESSION CTR. LEVER | QTY OF 10 | \$1.00 | 3 A | | 29-26128-00 | ALIGN TOOL/HEX & SCRDR TIPS | EACH | \$5.00 | 3 A | |
| 29-25964-00 | BAIL BAR ASSY. | EACH | \$13.00 | 3 A | | 29-26154-00 | LG02 CONTROL PCB (LG02) | EACH | \$873.00 | 3 A | |
| 29-25966-00 | MECH. ASSY. KIT | EACH | \$65.00 | 3 A | | 29-26159-00 | BULKHEAD PANEL ASSY (LG01/2) | EACH | \$345.00 | 3 A | |
| 29-25967-00 | COVER SET | EACH | \$141.00 | 3 A | | 29-26160-00 | TX78 ALIGN TOOL(TU78, TA78) | EACH | \$150.00 | 3 A | |
| 29-25968-00 | LOGIC BOARD | EACH | \$397.00 | Y 3 A | | 29-26164-00 | PRINTER MECH ASSY | EACH | \$1,423.00 | Y 3 A | |
| 29-25969-00 | CONTROL PANEL | EACH | \$74.00 | 3 A | | 29-26165-00 | RETAINING SPRING CAPACITOR | EACH | \$5.00 | 3 A | |
| 29-25970-00 | BAIL RELEASE LEVER | EACH | \$7.00 | 3 A | | 29-26166-00 | GROUNDING CONTACT BASE | EACH | \$7.00 | 3 A | |
| 29-25971-00 | PLATEN KNOB | EACH | \$5.00 | 3 A | | 29-26167-00 | SHOCK MOUNT MECH GRP | EACH | \$17.00 | 3 A | |
| 29-25972-00 | ACCESS COVER BK | EACH | \$40.00 | 3 A | | 29-26168-00 | SAFETY SCREW MECH GRP | EACH | \$5.00 | 3 A | |
| 29-25973-00 | PAPER COVER BK | EACH | \$50.00 | 3 A | | 29-26169-00 | GROUNDING CONT. REAR COVER | EACH | \$5.00 | 3 A | |
| 29-25974-00 | LOGIC BD ACCESS COVER BK | EACH | \$34.00 | 3 A | | 29-26170-00 | FRONT COVER | EACH | \$205.00 | 3 A | |
| 29-25975-00 | MISC./SCREW/NUT/WASHER KIT | EACH | \$109.00 | 3 A | | 29-26171-00 | MAIN BOARD | EACH | \$973.00 | Y 3 A | |
| 29-25976-00 | MISC SPRING KIT | EACH | \$46.00 | 3 A | | 29-26172-00 | BACK COVER GROUP | EACH | \$192.00 | 3 A | |
| 29-25977-00 | MISC E RING KIT | EACH | \$40.00 | 3 A | | 29-26173-00 | TRANSFORMER | EACH | \$190.00 | 3 A | |
| 29-25978-00 | MISC. GEAR KIT | EACH | \$48.00 | 3 A | | 29-26175-00 | FUSE HOLDER USA | EACH | \$16.00 | 3 A | |
| 29-25979-00 | TOP COVER | EACH | \$39.00 | 3 A | | 29-26176-00 | POWER MODULE | EACH | \$150.00 | 3 A | |
| 29-25992-00 | BALL | EACH | \$25.00 | 3 A | | 29-26177-00 | COVER PWR ON/OFF SWITCH | EACH | \$11.00 | 3 A | |
| 29-25993-00 | BALL DOOR | EACH | \$6.00 | 3 A | | 29-26178-00 | DOOR DIP SWITCH | EACH | \$25.00 | 3 A | |
| 29-25995-00 | STYLUS | EACH | \$146.00 | 3 A | | 29-26179-00 | SOUND DEADENING MATERIAL | EACH | \$80.00 | 3 A | |
| 29-25996-00 | CONTROLLER CURSOR | EACH | \$146.00 | 3 A | | 29-26180-00 | CONT. COVE OPEN MICROSWITCH | EACH | \$35.00 | 3 A | |
| 29-25997-00 | TABLET ASSY. | EACH | \$1,215.00 | 3 A | | 29-26181-00 | ENCLOSURE POWER MODULE | EACH | \$24.00 | 3 A | |
| 29-26017-00 | VACUUM CL BAGS AND FILTER | EACH | \$141.00 | 3 A | | 29-26182-00 | DRUM VOLTAGE SELECTOR | EACH | \$10.00 | 3 A | |
| 29-26053-00 | AC UNIT 100V (LN03C.R.) | EACH | \$149.00 | 3 A | | 29-26183-00 | BASE | EACH | \$98.00 | 3 A | |
| 29-26054-00 | FAN (LN03C.R.) | EACH | \$116.00 | 3 A | | 29-26184-00 | CONSOLE COVER PLATE | EACH | \$37.00 | 3 A | |
| 29-26055-00 | OZON FILTER (LN03C.R.) | EACH | \$14.00 | 3 A | | 29-26185-00 | GROMMEL-TRANSFORMER | EACH | \$5.00 | 3 A | |
| 29-26056-00 | OPC COUNTER (LN03C.R.) | EACH | \$102.00 | 3 A | | 29-26188-00 | CONSOLE | EACH | \$166.00 | 3 A | |



Prices Effective 02-January-89 to 30-June-89
 To Order—Call DECdirect™ TOLL-FREE 800-344-4825, 8:30 a.m. to 8:00 p.m. ET in Continental U.S.A.

HARDWARE SPARES PRICE LIST

| PART NUMBER | DESCRIPTION | UNIT ORDER | UNIT PRICE | REP D L | REPLACEMENT PART NUMBER | PART NUMBER | DESCRIPTION | UNIT ORDER | UNIT PRICE | REP D L | REPLACEMENT PART NUMBER |
|-------------|---------------------------|------------|------------|---------|-------------------------|-------------|-------------------------------|------------|------------|---------|-------------------------|
| 29-26189-00 | SWITCH-POWER ON/OFF | EACH | \$21.00 | 3 A | | 29-26492-00 | PAPER SEPARATOR | EACH | \$74.00 | 3 A | |
| 29-26191-00 | USA FUSE 1A 115V | EACH | \$5.00 | 3 A | | 29-26495-00 | SPRING PRELOAD | EACH | \$8.00 | 3 A | |
| 29-26192-00 | MICROSWITCH COVER OPEN | EACH | \$29.00 | 3 A | | 29-26497-00 | SPRING TENSION | EACH | \$9.00 | 3 A | |
| 29-26213-00 | LG02 CONTROLLER | EACH | REPLACED | 3 A | 29-26617-00 | SHIM ASSY | EACH | \$80.00 | 3 A | | |
| 29-26214-00 | SERIAL I/O ASSY. | EACH | \$439.00 | 3 A | | 29-26499-00 | RIGHT SPROCKET ASSY | EACH | \$42.00 | 3 A | |
| 29-26234-00 | LN03 CLEANING KIT | EACH | \$90.00 | 3 A | | 29-26501-00 | LEFT SPROCKET ASSY | EACH | \$42.00 | 3 A | |
| 29-26244-00 | DEVICE PCB | EACH | \$519.00 | 3 A | | 29-26502-00 | SPRING WASHER | EACH | \$9.00 | 3 A | |
| 29-26246-00 | ANTI-ST PORT WORK STATION | EACH | \$101.00 | 3 A | | 29-26505-00 | WEDGE TENSIONING | EACH | \$12.00 | 3 A | |
| 29-26254-00 | 26WRITING PCBA | EACH | \$1,925.00 | Y 3 A | | 29-26507-00 | CABLE TRAILING | EACH | \$96.00 | 3 A | |
| 29-26255-00 | 26PREAMP PCB | EACH | \$1,150.00 | Y 3 A | | 29-26508-00 | BAIL | EACH | \$21.00 | 3 A | |
| 29-26259-00 | HI FILTRATION VACUUM | EACH | \$601.00 | 3 A | | 29-26510-00 | BAIL WINDOW | EACH | \$46.00 | 3 A | |
| 29-26372-00 | TU80/81 UNIV.50/60HZ P.S. | EACH | \$2,743.00 | 3 A | | 29-26511-00 | PLATEN GEAR | EACH | \$46.00 | 3 A | |
| 29-26394-00 | UPPER L/UPPER R TRACTOR | EACH | \$361.00 | 3 A | | 29-26512-00 | CLUSTER GEAR | EACH | \$13.00 | 3 A | |
| 29-26395-00 | LOWER L/LOWER R TRACTOR | EACH | \$361.00 | 3 A | | 29-26513-00 | STAR PINCH WHEEL | EACH | \$21.00 | 3 A | |
| 29-26404-00 | 29FILTER ABSOLUTE | EACH | \$900.00 | 3 A | | 29-26514-00 | SIDE PLATE -LEFT | EACH | \$27.00 | 3 A | |
| 29-26424-00 | RV20 DRIVE BELT | EACH | \$16.00 | 3 A | | 29-26515-00 | PINCH WHEEL HOLDERS | EACH | \$9.00 | 3 A | |
| 29-26425-00 | SPINDLE | EACH | \$521.00 | 3 A | | 29-26516-00 | GUIDE MEDIA | EACH | \$50.00 | 3 A | |
| 29-26426-00 | RV20 CARRIAGE | EACH | \$5,000.00 | 3 A | | 29-26518-00 | FEET | EACH | \$14.00 | 3 A | |
| 29-26427-00 | RV20 ISI PCA | EACH | \$1,468.00 | 3 A | | 29-26519-00 | CABLE CLIP | EACH | \$10.00 | 3 A | |
| 29-26428-00 | R/W PCA (RV20) | EACH | \$1,834.00 | 3 A | | 29-26520-00 | PAPER SENSOR | EACH | \$10.00 | 3 A | |
| 29-26429-00 | ECC PCA (RV20) | EACH | \$2,400.00 | 3 A | | 29-26521-00 | SLIDER ROD | EACH | \$76.00 | 3 A | |
| 29-26430-00 | RV20 POW SUPPLY | EACH | \$3,108.00 | 3 A | | 29-26523-00 | PEN LATCH | EACH | \$15.00 | 3 A | |
| 29-26431-00 | RV20 MOTOR | EACH | \$485.00 | 3 A | | 29-26524-00 | PRELOAD ARM | EACH | \$11.00 | 3 A | |
| 29-26432-00 | RV20 TACH SENSOR | EACH | \$150.00 | 3 A | | 29-26525-00 | MOTOR CLAMP | EACH | \$15.00 | 3 A | |
| 29-26433-00 | GUARD BAND SENSOR | EACH | \$114.00 | 3 A | | 29-26526-00 | BELT | EACH | \$28.00 | 3 A | |
| 29-26434-00 | MAINT PANEL ASSY | EACH | \$400.00 | 3 A | | 29-26527-00 | CARRIAGE ASSY | EACH | \$500.00 | 3 A | |
| 29-26435-00 | RV20 SDC PCA | EACH | \$1,060.00 | 3 A | | 29-26528-00 | ENCODER STRIP | EACH | \$46.00 | 3 A | |
| 29-26436-00 | RV20 ESG OCA | EACH | \$1,620.00 | 3 A | | 29-26529-00 | PCA-RS232 | EACH | \$442.00 | 3 A | |
| 29-26437-00 | RV20 SS PCA | EACH | \$1,348.00 | 3 A | | 29-26530-00 | PCA CENTRONICS | EACH | \$442.00 | 3 A | |
| 29-26438-00 | PCA OPER PANEL | EACH | \$352.00 | 3 A | | 29-26532-00 | STEPPER MOTOR | EACH | \$150.00 | 3 A | |
| 29-26439-00 | MDS PCA | EACH | \$934.00 | 3 A | | 29-26533-00 | CARRIAGE MOTOR | EACH | \$100.00 | 3 A | |
| 29-26440-00 | SPINDLE BEARING | EACH | \$10.00 | 3 A | | 29-26534-00 | COVER CONNECTOR | EACH | \$18.00 | 3 A | |
| 29-26447-00 | RV20 PULLEY | EACH | \$126.00 | 3 A | | 29-26536-00 | KNOB-PLATEN | EACH | \$29.00 | 3 A | |
| 29-26448-00 | RV20 FILTER | EACH | \$20.00 | 3 A | | 29-26537-00 | CONTROL PANEL | EACH | \$150.00 | 3 A | |
| 29-26451-00 | ADAPTER HUB | EACH | \$12.00 | 3 A | | 29-26617-00 | LG02 CONTROLLER | EACH | \$2,306.00 | Y 3 A | |
| 29-26452-00 | START/STOP LENS | EACH | \$24.00 | 3 A | | 29-26618-00 | 91EXIT SENS. LN03A (LN03A-XX) | EACH | \$10.00 | 3 A | |
| 29-26453-00 | RV20 WRITE/PROT LENS | EACH | \$24.00 | 3 A | | 29-26619-00 | CPWRITE CURRENT ADJ METER | EACH | \$260.00 | 3 A | |
| 29-26454-00 | RV20 GRILL FILTER | EACH | \$108.00 | 3 A | | 29-26630-00 | LQP45 ASF MISC KIT | EACH | \$85.00 | 3 A | |
| 29-26455-00 | RV20 COOLING FAN | EACH | \$188.00 | 3 A | | 29-26649-00 | CONTROL LOGIC MODULE | EACH | \$1,440.00 | 3 A | |
| 29-26456-00 | DOOR LOCK SOLN (RV20) | EACH | \$147.00 | 3 A | | 29-26655-00 | DQPIN EXTRACTION TOOL RA81/60 | EACH | \$90.00 | 3 A | |
| 29-26457-00 | BASEPLATE TERM PCA | EACH | \$1,200.00 | 3 A | | 29-26656-00 | DIVERTER PAPER | EACH | \$17.00 | 3 A | |
| 29-26458-00 | RV20 ISI TERM | EACH | \$240.00 | 3 A | | 29-26657-00 | SPROCKET SHIELD RIGHT | EACH | \$10.00 | 3 A | |
| 29-26459-00 | LESI ADAPTER PCA (RV20) | EACH | \$1,253.00 | 3 A | | 29-26658-00 | SPROCKET SHIELD LEFT | EACH | \$10.00 | 3 A | |
| 29-26460-00 | RV20 BACKPLANE PCA | EACH | \$1,040.00 | 3 A | | 29-26659-00 | CAPPER | EACH | \$11.00 | 3 A | |
| 29-26461-00 | RV20 I/O PANEL | EACH | \$717.50 | 3 A | | 29-26660-00 | PIVOT CAPPER | EACH | \$10.00 | 3 A | |
| 29-26469-00 | CARRIAGE LOCK SOLN (RV20) | EACH | \$138.00 | 3 A | | 29-26661-00 | SPRING ENCODER | EACH | \$10.00 | 3 A | |
| 29-26476-00 | RV20 ELECTR BRUSH | EACH | \$16.00 | 3 A | | 29-26662-00 | PRIMER ASSY | EACH | \$109.00 | 3 A | |
| 29-26481-00 | SPRING BALL | EACH | \$9.00 | 3 A | | 29-26663-00 | SHAFT PINCH WHEEL | EACH | \$27.00 | 3 A | |
| 29-26483-00 | BASE | EACH | \$92.00 | 3 A | | 29-26664-00 | SIDE PLATE-R | EACH | \$80.00 | 3 A | |
| 29-26484-00 | PLATEN | EACH | \$150.00 | 3 A | | 29-26665-00 | PLUG TOP CASE | EACH | \$10.00 | 3 A | |
| 29-26486-00 | LEAD FRAME BRUSH | EACH | \$24.00 | 3 A | | 29-26666-00 | PINCH WHEEL | EACH | \$10.00 | 3 A | |
| 29-26487-00 | SPRING PINCHWHEEL | EACH | \$10.00 | 3 A | | 29-26667-00 | VIDEO SUB ASSY | EACH | \$590.00 | 3 A | |
| 29-26489-00 | US POWER MODULE 120V/60HZ | EACH | \$127.00 | 3 A | | 29-26668-00 | MAIN SUB ASSY | EACH | \$1,136.00 | 3 A | |
| 29-26490-00 | TOP CASE ASSY | EACH | \$173.00 | 3 A | | 29-26669-00 | MAIN SUB ASSY 240V | EACH | \$1,136.00 | 3 A | |
| 29-26491-00 | FRONT COVER ASSY | EACH | \$80.00 | 3 A | | 29-26670-00 | RF SHIELD | EACH | \$64.00 | 3 A | |



Prices Effective 02-January-89 to 30-June-89
 To Order—Call DECdirect™ TOLL-FREE 800-344-4825, 8:30 a.m. to 8:00 p.m. ET in Continental U.S.A.

HARDWARE SPARES PRICE LIST

| PART NUMBER | DESCRIPTION | UNIT ORDER | UNIT PRICE | REP D | L | REPLACEMENT PART NUMBER | PART NUMBER | DESCRIPTION | UNIT ORDER | UNIT PRICE | REP D | L | REPLACEMENT PART NUMBER |
|-------------|------------------------------|------------|------------|-------|---|-------------------------|-------------|-------------------------------|------------|------------|-------|---|-------------------------|
| 29-26671-00 | CRT SUB ASSY | EACH | \$1,701.00 | 3 | A | | 29-26751-00 | 45KEYBOARD | EACH | \$87.00 | 3 | A | |
| 29-26672-00 | CRT ASSY VR150 | EACH | \$650.00 | 3 | A | | 29-26756-00 | 45MAIN PROCESSOR BD M4 | EACH | \$1,260.00 | 3 | A | |
| 29-26673-00 | VIDEO BOARD | EACH | \$243.00 | 3 | A | | 29-26757-00 | 45PROCESSOR BD M3 | EACH | \$2,115.00 | 3 | A | |
| 29-26674-00 | MAIN BOARD | EACH | \$556.00 | 3 | A | | 29-26758-00 | 45LOGIC PWR BRD P4 | EACH | \$765.00 | 3 | A | |
| 29-26675-00 | TILT SWIVEL VR150-AA | EACH | \$208.00 | 3 | A | | 29-26759-00 | 45LED DISPLAY ASSY | EACH | \$192.00 | 3 | A | |
| 29-26676-00 | TILT SWIVEL VR150-A3 | EACH | \$208.00 | 3 | A | | 29-26763-00 | 45LCD | EACH | \$960.00 | 3 | A | |
| 29-26677-00 | CRT SUB ASSY SO. HEMISPHERE | EACH | \$1,701.00 | 3 | A | | 29-26764-00 | 45INTERFACE BD I3 | EACH | \$864.00 | 3 | A | |
| 29-26678-00 | TILT SWIVEL VR160-DA | EACH | \$380.00 | 3 | A | | 29-26779-00 | 45BATTERY FUSE 2A | EACH | \$16.00 | 3 | A | |
| 29-26679-00 | TILT SWIVEL VR160-D3/D4 | EACH | \$380.00 | 3 | A | | 29-26780-00 | 45FUSE 3.2A SLO BLO | EACH | \$6.00 | 3 | A | |
| 29-26680-00 | VR160 MISC HDW KIT | EACH | \$135.00 | 3 | A | | 29-26781-00 | 45LAMP | EACH | \$23.00 | 3 | A | |
| 29-26681-00 | VR150 MISC HDW KIT | EACH | \$104.00 | 3 | A | | 29-26786-00 | 45FAN ASSY 60 HZ | EACH | \$373.00 | 3 | A | |
| 29-26682-00 | TOP CASE ASSY LJ252 | EACH | \$173.00 | 3 | A | | 29-26793-00 | EUR POWER MODULE 220V/50HZ | EACH | \$149.00 | 3 | A | |
| 29-26683-00 | PRELOAD ROLLER | EACH | \$12.00 | 3 | A | | 29-26794-00 | UK POWER MODULE 240V/50HZ | EACH | \$149.00 | 3 | A | |
| 29-26684-00 | HUB PINCH WHEEL | EACH | \$11.00 | 3 | A | | 29-26795-00 | SWIT POWER MODULE 220V/50HZ | EACH | \$149.00 | 3 | A | |
| 29-26701-00 | LQP45 PRINTER MISC KIT | EACH | \$80.00 | 3 | A | | 29-26796-00 | DEN POWER MODULE | EACH | \$149.00 | 3 | A | |
| 29-26707-00 | TIMING BELT | EACH | \$22.00 | 3 | A | | 29-26797-00 | AUS POWER MODULE 240V/50HZ | EACH | \$149.00 | 3 | A | |
| 29-26708-00 | SHUTTLE/SHROUD INT. SWT. | EACH | \$67.00 | 3 | A | | 29-26798-00 | JA POWER MODULE 100V/50HZ | EACH | \$149.00 | 3 | A | |
| 29-26709-00 | CIRCUIT BREAKER AC PWR ON/O | EACH | \$23.00 | 3 | A | | 29-26799-00 | ISR POWER MODULE | EACH | \$149.00 | 3 | A | |
| 29-26710-00 | PAPER OUT LIMIT SWITCH | EACH | \$64.00 | 3 | A | | 29-26801-00 | 14CCA, LED DRIVER STACKER | EACH | \$302.00 | 3 | A | |
| 29-26711-00 | COVER INTERLOCK SWITCH | EACH | \$68.00 | 3 | A | | 29-26803-00 | PULLEY AASY.MOTOR.STACKER | EACH | \$235.00 | 3 | A | |
| 29-26712-00 | STRIKERBAR SWITCH ASM. | EACH | \$30.00 | 3 | A | | 29-26804-00 | CCA PAPER FEED | EACH | \$1,822.00 | 3 | A | |
| 29-26714-00 | BRUSHLESS FAN | EACH | \$156.00 | 3 | A | | 29-26805-00 | PROM, 64 CHAR US | EACH | \$80.00 | 3 | A | |
| 29-26715-00 | SHUTTLE MOTOR ASM KIT | EACH | \$600.00 | 3 | A | | 29-26806-00 | TRACTOR ASSY. UL | EACH | \$706.00 | 3 | A | |
| 29-26716-00 | TRACTOR (LOWER LEFT) | EACH | \$188.00 | 3 | A | | 29-26807-00 | TRACTOR ASSY.UR | EACH | \$562.00 | 3 | A | |
| 29-26717-00 | TRACTOR (LOWER RIGHT) | EACH | \$188.00 | 3 | A | | 29-26808-00 | TRACTOR ASSY.LL | EACH | \$562.00 | 3 | A | |
| 29-26718-00 | TRACTOR (UPPER LEFT) | EACH | \$159.00 | 3 | A | | 29-26809-00 | TRACTOR ASSY .LR | EACH | \$706.00 | 3 | A | |
| 29-26719-00 | TRACTOR (UPPER RIGHT) | EACH | \$159.00 | 3 | A | | 29-26810-00 | CCA SWITCH ARRAY CONTROLPANEL | EACH | \$548.00 | 3 | A | |
| 29-26720-00 | PCB SM DISP PANEL | EACH | \$169.00 | 3 | A | | 29-26811-00 | CCA STADKER.POWER AND LOGIC | EACH | \$600.00 | 3 | A | |
| 29-26721-00 | PCB SC PANEL INTF | EACH | \$68.00 | 3 | A | | 29-26812-00 | MOTOR ASSY.PAPER FEED | EACH | \$2,050.00 | 3 | A | |
| 29-26722-00 | PCB PWR SUPPLY FLTR | EACH | \$150.00 | 3 | A | | 29-26813-00 | CCA, BAND GATE ELEC. | EACH | \$930.00 | 3 | A | |
| 29-26723-00 | PCB SM SERIAL INTF | EACH | \$151.00 | 3 | A | | 29-26814-00 | BLOWER, HAMMER BANK | EACH | \$600.00 | 3 | A | |
| 29-26724-00 | PCB SP SUPPLY DISCH | EACH | \$351.00 | 3 | A | | 29-26815-00 | CCA, TIMING OVERLAP | EACH | \$753.00 | 3 | A | |
| 29-26725-00 | RIBBON DRIVE MOTOR | EACH | \$150.00 | 3 | A | | 29-26816-00 | MOTOR AC GEARED STACKER | EACH | \$400.00 | 3 | A | |
| 29-26726-00 | LINE FEED MOTOR ASM. | EACH | \$400.00 | 3 | A | | 29-26817-00 | PAPER TENSION ASSY | EACH | \$1,060.00 | 3 | A | |
| 29-26727-00 | LVT COIL ASM | EACH | \$126.00 | 3 | A | | 29-26818-00 | MOTOR BAND DRIVE | EACH | \$649.00 | 3 | A | |
| 29-26728-00 | RIBBON WELD SENSOR | EACH | \$62.00 | 3 | A | | 29-26822-00 | TRACTOR PINS | EACH | \$5.00 | 3 | A | |
| 29-26729-00 | PCB SH ACTR DRVR | EACH | \$769.29 | 3 | A | | 29-26823-00 | BELT & LINK ASSY | EACH | \$150.00 | 3 | A | |
| 29-26730-00 | PCB SM IMG PROC | EACH | \$400.00 | 3 | A | | 29-26824-00 | TRACTOR CABLE | EACH | \$70.00 | 3 | A | |
| 29-26731-00 | PCB SM IMG HRDW | EACH | \$583.00 | 3 | A | | 29-26825-00 | TRANSDUCER ASSY | EACH | \$600.00 | 3 | A | |
| 29-26732-00 | PCB SP SUPPLY REG | EACH | \$778.04 | 3 | A | | 29-26827-00 | CCA TIMING AND STATUS | EACH | \$1,657.00 | 3 | A | |
| 29-26733-00 | PCB SM SYS PROC | EACH | \$486.00 | 3 | A | | 29-26828-00 | BAND DRIVE MOTOR BLOWER | EACH | \$400.00 | 3 | A | |
| 29-26734-00 | PCB SP SUPPLY MSTR | EACH | \$1,169.03 | 3 | A | | 29-26829-00 | PULLEY,CABLE STACKER | EACH | \$97.00 | 3 | A | |
| 29-26735-00 | PCB SM MTR CTRL | EACH | \$449.00 | 3 | A | | 29-26830-00 | CLUTCH ASSY | EACH | \$246.00 | 3 | A | |
| 29-26736-00 | PRINT MODULE | EACH | \$770.25 | 3 | A | | 29-26831-00 | CAPACITOR PACK ASSY | EACH | \$754.00 | 3 | A | |
| 29-26737-00 | RIBBON SHIELD | EACH | \$80.00 | 3 | A | | 29-26832-00 | CCA PHOTO PICK-UP STACKER | EACH | \$302.00 | 3 | A | |
| 29-26738-00 | PICO FUSE 3AMP | EACH | \$10.00 | 3 | A | | 29-26841-00 | CCA INTERFACE | EACH | \$900.00 | 3 | A | |
| 29-26739-00 | FUSE 3A | EACH | \$5.00 | 3 | A | | 29-26850-00 | 5A,FAST FUSE | EACH | \$5.00 | 3 | A | |
| 29-26741-00 | FUSE 0.50 | EACH | \$5.00 | 3 | A | | 29-26851-00 | FUSE, 1A, STACKER, LOGIC | EACH | \$10.00 | 3 | A | |
| 29-26742-00 | FUSE 3A | EACH | \$5.00 | 3 | A | | 29-26852-00 | 100K UF 60V CAP | EACH | \$188.00 | 3 | A | |
| 29-26744-00 | (SMSM) PROMS | EACH | \$312.00 | 3 | A | | 29-26853-00 | PAPER FEED BELT | EACH | \$65.00 | 3 | A | |
| 29-26745-00 | (SMIM) PROMS | EACH | \$351.00 | 3 | A | | 29-26856-00 | TRANSFORMER STACKER | EACH | \$168.00 | 3 | A | |
| 29-26746-00 | 91CAM:PRESSURE RELEASE-LEFT | EACH | \$5.00 | 3 | A | | 29-26857-00 | MOTOR, STACKER, SHELF | EACH | \$242.00 | 3 | A | |
| 29-26747-00 | 91CAM:PRESSURE RELEASE-RIGHT | EACH | \$5.00 | 3 | A | | 29-26858-00 | SWITCH, CUTOFF STACKER | EACH | \$37.00 | 3 | A | |
| 29-26748-00 | 91VIDEO I/F CABLE | EACH | \$56.00 | 3 | A | | 29-26859-00 | AC STACKER FUSE | EACH | \$10.00 | 3 | A | |
| 29-26750-00 | 91SHIELD PLATE STAY | EACH | \$6.00 | 3 | A | | 29-26860-00 | BEARING, TRACTOR | EACH | \$20.00 | 3 | A | |



Prices Effective 02-January-89 to 30-June-89
 To Order—Call DECdirect™ TOLL-FREE 800-344-4825, 8:30 a.m. to 8:00 p.m. ET in Continental U.S.A.

HARDWARE SPARES PRICE LIST

| PART NUMBER | DESCRIPTION | UNIT ORDER | UNIT PRICE | REP D L | REPLACEMENT PART NUMBER | PART NUMBER | DESCRIPTION | UNIT ORDER | UNIT PRICE | REP D L | REPLACEMENT PART NUMBER |
|---------------------------------------|---------------------------------|------------|-------------|---------|-------------------------|-------------|-------------|------------|------------|---------|-------------------------|
| 29-26861-00 | NYLON GAGE | EACH | \$6.00 | 3 | A | | | | | | |
| 29-26960-01 | 91EXIT COVER (PLASTIC) ASSY | EACH | \$80.00 | 3 | A | | | | | | |
| 29-81384-00 | 14I/O HARNESS | EACH | \$291.00 | 3 | A | | | | | | |
| 29-90007-00 | SERIAL BOARD | EACH | \$351.00 | Y | 3 | A | | | | | |
| 29-90011-00 | CABLE CONSOLE | EACH | \$80.00 | 3 | A | | | | | | |
| 29-90028-00 | LQPX5 TRACTOR MISC KIT | EACH | \$12.00 | 3 | A | | | | | | |
| 30 CLASS Purchased Assemblies | | | | | | | | | | | |
| 30-09356-00 | PUNCH, PAPER TAPE | EACH | \$1,356.00 | Y | 3 | A | | | | | |
| 30-10166-00 | KEYBD TTL PAR 7 BIT 01-02-639 | EACH | REPLACED | 3 | A | 54-10541-00 | | | | | |
| 30-10638-01 | ENCODER LINEAR BLOCK | EACH | \$256.00 | 3 | A | | | | | | |
| 30-10638-02 | SCALE, GLASS; PART OF LINEAR | EACH | \$124.00 | 3 | A | | | | | | |
| 30-10638-03 | BULB ASSY,POTTED | EACH | \$74.00 | 3 | A | | | | | | |
| 30-10642-01 | TRANSDUCER,OPTICA SECTOR | EACH | \$137.00 | 3 | A | | | | | | |
| 30-10654-03 | REFER TO ONLY AS H213 4KX16 | EACH | REPLACED | 3 | A | H213-00 | | | | | |
| 30-10863-01 | HEAD, DISC RECORDING, "B" UP LO | EACH | \$160.00 | 3 | A | | | | | | |
| 30-10863-02 | HEAD, DISC RECORDING, "B" DOWN | EACH | \$160.00 | 3 | A | | | | | | |
| 30-11070-00 | DISPLAY,ALPHANUMERICAL W/MEMR | EACH | \$1,121.00 | Y | 3 | A | | | | | |
| 30-13145-01 | HEAD, DISC RECORDING UP | EACH | \$165.00 | 3 | A | | | | | | |
| 30-13145-02 | HEAD, DISC RECORDING DOWN | EACH | \$165.00 | 3 | A | | | | | | |
| 30-13992-02 | DISK PACK ASSY | EACH | \$2,539.00 | 3 | A | | | | | | |
| 30-14278-03 | STATIC ELIMINATOR | EACH | REPLACED | 3 | A | 29-24702-00 | | | | | |
| 30-14590-02 | PC BOARD ASSY.(BALL BROS.) | EACH | \$340.00 | 3 | A | | | | | | |
| 30-14903-00 | MF20 POWER SUPPLY | EACH | \$7,250.00 | 3 | A | | | | | | |
| 30-14957-00 | ALIGNMENT DISKETTE RX01 | EACH | \$116.00 | 3 | A | | | | | | |
| 30-16080-00 | MONITOR ASSY,CRT,DIRECT DRIVE | EACH | REPLACED | 3 | A | 70-18349-01 | | | | | |
| 30-16080-02 | PC BRD ASSY, (ELSTON) | EACH | REPLACED | Y | 3 | A | 70-17362-01 | | | | |
| 30-17108-00 | DISK PACK,RM05 CE ALIGNMENT | EACH | \$4,519.00 | 3 | A | | | | | | |
| 30-17205-01 | P.S. SWITCH,(5V 6A) | EACH | \$525.00 | 3 | A | | | | | | |
| 30-18691-00 | CONVERTER,D-A,12 BIT 4CHANNEL | EACH | \$1,645.00 | Y | 3 | A | | | | | |
| 30-18693-00 | CONVERTER,A-D 12BIT,16CHANNEL | EACH | \$1,735.00 | Y | 3 | A | | | | | |
| 30-20038-01 | MOUSE, HAND HELD 3-BUTTON | EACH | \$525.00 | Y | 3 | A | | | | | |
| 30-21383-01 | P.S. 75W MULTI OUTPUT | EACH | \$151.00 | 3 | A | | | | | | |
| 30-21749-01 | BA23 POWER SUPPLY, 5V 230W | EACH | \$591.00 | Y | 3 | A | | | | | |
| 30-22969-01 | SUBSYSTEM, TAPE/CART/CABNT/DR | EACH | \$2,805.00 | Y | 3 | A | | | | | |
| 30-22971-01 | CONT/TAPE/CART/SUBSYSTEM QBUS | EACH | \$1,150.00 | Y | 3 | A | | | | | |
| 30-23225-01 | POWER/FILTER ASSY,AC | EACH | \$549.00 | 3 | A | | | | | | |
| 30-23506-01 | RA90 UNIVERSAL P.S. | EACH | \$600.00 | Y | 3 | A | | | | | |
| 30-23616-01 | BA123 POWER SUPPLY/FAN 460W | EACH | REPLACED | Y | 3 | A | 30-28231-01 | | | | |
| 30-23925-01 | BI POWER SUPPLY | EACH | \$1,191.00 | 3 | A | | | | | | |
| 30-23959-01 | COND, PWR LINE 120V,60HZ | EACH | \$891.00 | Y | 3 | A | | | | | |
| 30-23959-02 | COND, PWR LINE 120V,50HZ | EACH | \$891.00 | 3 | A | | | | | | |
| 30-24022-01 | AC INPUT BOX 15A 240V | EACH | \$765.00 | 3 | A | | | | | | |
| 30-24022-02 | AC INPUT BOX 20A 120V | EACH | \$680.00 | 3 | A | | | | | | |
| 30-24374-01 | CNTRL,PWR 120V 3 PH 9 OUTLET | EACH | \$2,150.00 | 3 | A | | | | | | |
| 30-24374-02 | CNTRL,PWR 240V 3PHASE 9OUTLET | EACH | \$2,150.00 | 3 | A | | | | | | |
| 30-24453-01 | OPERATOR CONTOL PANEL RA90 | EACH | \$324.00 | 3 | A | | | | | | |
| 30-25560-01 | HIGH VOLT. PWR. SUPPLY | EACH | \$758.00 | Y | 3 | A | | | | | |
| 30-26570-01 | P.S. MODULE,H7423AA,300W | EACH | \$1,000.00 | 3 | A | | | | | | |
| 30-27655-01 | PRINTHEAD,DOT MATRIX 7 WIRE | EACH | \$292.00 | Y | 3 | A | | | | | |
| 30-28231-01 | P.S. 120/240V 50/60HZ BA123 | EACH | \$2,185.00 | 3 | A | | | | | | |
| 30-28308-01 | SFX POWER SUPPLY | EACH | \$2,382.00 | 3 | A | | | | | | |
| 34 CLASS ESD Module Containers | | | | | | | | | | | |
| 34-23566-01 | CONTAINER, F.L SERIES COND | EACH | \$58.00 | Y | 3 | A | | | | | |
| 34-24071-01 | CONTAINER, T SERIES COND | EACH | \$63.00 | Y | 3 | A | | | | | |
| 47 CLASS Machine Tools | | | | | | | | | | | |
| 47-00038-00 | CRIMPER,TAPE 1/2" MAG,AUTO LO | EACH | \$125.00 | 3 | A | | | | | | |
| 47-00116-02 | HANDLE, SURFACE MOUNT CONN | EACH | \$61.00 | 3 | A | | | | | | |
| 48 CLASS Raw Fab Materials | | | | | | | | | | | |
| 48-50023-00 | CELLU ACET,SILVER ,.0005" | EACH | \$10.00 | 3 | A | | | | | | |
| 48-50023-01 | CELLU ACET,AMBER ,.001" | EACH | \$7.00 | 3 | A | | | | | | |
| 48-50023-02 | CELLU ACET,PURPLE ,.0015" | EACH | \$7.00 | 3 | A | | | | | | |
| 48-50023-03 | CELLU ACET,RED ,.002" | EACH | \$10.00 | 3 | A | | | | | | |
| 48-50023-04 | CELLU ACET,GREEN ,.003" | EACH | \$10.00 | 3 | A | | | | | | |
| 48-50023-05 | CELLU ACET,TAN ,.004" | EACH | \$10.00 | 3 | A | | | | | | |
| 48-50023-06 | CELLU ACET,BLUE ,.005" | EACH | \$10.00 | 3 | A | | | | | | |
| 48-50023-07 | CELLU ACET,TRAN MATT,.0075" | EACH | \$10.00 | 3 | A | | | | | | |
| 48-50023-08 | CELLU ACET,BROWN ,.010" | EACH | \$14.00 | 3 | A | | | | | | |
| 48-50023-11 | CELLU ACET,YELLOW ,.020" | EACH | \$14.00 | 3 | A | | | | | | |
| 48-50023-12 | CELLU ACET,WHITE ,.025" | EACH | \$14.00 | 3 | A | | | | | | |
| 48-50023-13 | CELLU ACET,CORAL ,.030" | EACH | \$14.00 | 3 | A | | | | | | |
| 4A CLASS Kits | | | | | | | | | | | |
| 4A-00861-B | 861-B SPARES KIT | EACH | \$300.00 | 3 | A | | | | | | |
| 4A-00861-C | 861-C SPARES KIT | EACH | \$290.00 | 3 | A | | | | | | |
| 4A-00861-D | PWR CONT'L 120V 24A 3PHASE | EACH | \$1,212.00 | 3 | A | | | | | | |
| 4A-00869-D | 869-D SPARES KIT,120V | EACH | \$427.00 | 3 | A | | | | | | |
| 4A-00869-E | 869-E SPARES KIT,240V | EACH | \$475.00 | 3 | A | | | | | | |
| 4A-00871-C | 19" PWR CONT'L 120V 16A | EACH | \$468.00 | 3 | A | | | | | | |
| 4A-00874-F | 220/240V FILTERED POWER CONT' | EACH | \$559.00 | 3 | A | | | | | | |
| 4A-11751-C | 11751 CPU KIT W/64K MEM CONT. | EACH | \$17,764.00 | 3 | A | | | | | | |
| 4A-11780-00 | KA780,KC780,DW780 SPARES KIT | EACH | \$28,929.00 | 3 | A | | | | | | |
| 4A-11785-00 | KA785 REV 3,KC785 SPARES KIT | EACH | \$51,041.00 | 3 | A | | | | | | |
| 4A-11785-AA | KA785, KC785 SPARES KIT | EACH | \$51,041.00 | 3 | A | | | | | | |
| 4A-630Q1-D2 | SYS SPARES KT FOR DH-630Q1-D2 | EACH | \$13,395.00 | 3 | A | | | | | | |
| 4A-630Q2-D2 | SYS SPARES KT FOR DH-630Q2-D2 | EACH | \$15,292.00 | 3 | A | | | | | | |
| 4A-630Q2-F2 | SYS SPARES KT FOR DH-630Q2-F2 | EACH | \$14,880.00 | 3 | A | | | | | | |
| 4A-630Q3-E2 | SYS SPARES KT FOR DH-630Q3-E2 | EACH | \$20,742.00 | 3 | A | | | | | | |
| 4A-630Q3-F2 | SYS SPARES KT FOR DH-630Q3-F2 | EACH | \$18,950.00 | 3 | A | | | | | | |
| 4A-630Q4-E2 | SYS SPARES KT FOR DH-630Q4-E2 | EACH | \$20,331.00 | 3 | A | | | | | | |
| 4A-630Q4-F2 | SYS SPARES KT FOR DH-630Q4-F2 | EACH | \$21,469.00 | 3 | A | | | | | | |
| 4A-630Q4-H2 | SYS SPARES KT FOR DH-630Q4-H2 | EACH | \$25,968.00 | 3 | A | | | | | | |
| 4A-630Q5-E2 | SYS SPARES KT FOR DH-630Q5-E2 | EACH | \$21,592.00 | 3 | A | | | | | | |



Prices Effective 02-January-89 to 30-June-89
 To Order—Call DECdirect™ TOLL-FREE 800-344-4825, 8:30 a.m. to 8:00 p.m. ET in Continental U.S.A.

HARDWARE SPARES PRICE LIST

| PART NUMBER | DESCRIPTION | UNIT ORDER | UNIT PRICE | REP D L | REPLACEMENT PART NUMBER | PART NUMBER | DESCRIPTION | UNIT ORDER | UNIT PRICE | REP D L | REPLACEMENT PART NUMBER |
|-------------|-------------------------------|------------|--------------|---------|-------------------------|-------------|-------------------------------|------------|--------------|---------|-------------------------|
| 4A-630Q5-F2 | SYS SPARES KT FOR DH-630Q5-F2 | EACH | \$20,843.00 | 3 A | | 4A-H7202-B | H7202-B P.S. SPARES KIT | EACH | \$2,352.00 | 3 A | |
| 4A-630QX-AA | MVII KERNEL SPARES KIT Q1,Q2 | EACH | \$12,010.00 | 3 A | | 4A-H7224-00 | H7224 PDS SPARES KIT | EACH | \$3,608.00 | 3 A | |
| 4A-630QX-AB | MVII KERNEL SPARES KIT Q3,Q4 | EACH | \$15,342.00 | 3 A | | 4A-H7227-AA | PDS SPARES KIT,60HZ | EACH | \$3,821.00 | 3 A | |
| 4A-630QX-AC | MVII KERNEL SPARES KIT Q5,QZ | EACH | \$16,984.00 | 3 A | | 4A-H7227-LA | PDS SPARES KIT,50HZ | EACH | \$3,833.00 | 3 A | |
| 4A-630QZ-A2 | SYS SPARES KT FOR RF-630QZ-A2 | EACH | \$20,614.00 | 3 A | | 4A-H7317-00 | H7317 SPARES KIT | EACH | \$5,030.00 | 3 A | |
| 4A-640QX-A3 | MICROVAX 3300/3400 240V KIT | EACH | \$20,481.00 | 3 A | | 4A-H7318-AA | H7318 SPARES KIT | EACH | \$1,382.00 | 3 A | |
| 4A-640QX-AA | MICROVAX 3300/3400 120V KIT | EACH | \$20,481.00 | 3 A | | 4A-H765-00 | H765-A/-B SPARES KIT | EACH | \$1,884.00 | 3 A | |
| 4A-640QX-B3 | VAXSERVER 3300/3400 240V KIT | EACH | \$15,081.00 | 3 A | | 4A-H8223-00 | T-CONNECTOR (12-25534-01) | EACH | \$15.00 | 3 A | |
| 4A-640QX-BA | VAXSERVER 3300/3400 120V KIT | EACH | \$15,081.00 | 3 A | | 4A-H9400-AA | BI BACKPLANE SPARE | EACH | \$2,000.00 | 3 A | |
| 4A-650QX-AA | MICROVAX 3000 KERNEL KIT | EACH | \$27,300.00 | 3 A | | 4A-HANDL-01 | HANDL,HEX MOD,10-1/2 SP KIT | EACH | \$11.00 | 3 A | |
| 4A-650QX-BA | VAXSERVER 3000 KERNEL KIT | EACH | \$27,300.00 | 3 A | | 4A-HANDL-02 | HANDL,MODULE,ARM EJECT SP KIT | EACH | \$13.00 | 3 A | |
| 4A-886CA-AA | CPU SPARES MODULE KIT | EACH | \$243,000.00 | 3 A | | 4A-HSC50-AA | HSC50-AA SPARES KIT 60HZ | EACH | \$30,791.00 | 3 A | |
| 4A-ADV11-C | ADV11-C SPARE MOD KIT(A8008) | EACH | REPLACED | Y 3 A | 30-18693-00 | 4A-HSC50-AB | HSC50-AB SPARES KIT 50HZ | EACH | \$30,791.00 | 3 A | |
| 4A-BA123-00 | BA123 SPARES KIT | EACH | \$2,589.00 | 3 A | | 4A-HSC5X-BA | HSC50 DISK DATA CHANNEL | EACH | \$10,500.00 | 3 A | |
| 4A-BA32-00 | BA32 EXPANDER BOX SPARES KIT | EACH | \$4,646.00 | 3 A | | 4A-HSC5X-CA | HSC50 TAPE DATA CHANNEL | EACH | \$10,500.00 | 3 A | |
| 4A-BDV11-AA | BDV11-AA SPARE MOD (M8012-YA) | EACH | REPLACED | Y 3 A | M8012-YA | 4A-HSC5X-EA | HSC5X-EA SPARES KIT | EACH | REPLACED | 3 A | 70-20184-01 |
| 4A-BLVB1-CA | VAX BI EXTENDER BOARD | EACH | \$3,678.00 | 3 A | | 4A-HSC5X-EB | HSC5X-EB SPARES KIT | EACH | REPLACED | 3 A | 70-20184-02 |
| 4A-CI750-00 | CI750 SPARES KIT 120/240V | EACH | \$9,976.00 | 3 A | | 4A-HSC70-AA | HSC70-AA SPARES KIT 60HZ | EACH | \$47,460.00 | 3 A | |
| 4A-CI780-00 | CI780 SPARES KIT | EACH | \$14,440.00 | 3 A | | 4A-HSC70-AB | HSC70-AB SPARES KIT 50HZ | EACH | \$47,460.00 | 3 A | |
| 4A-CIBCA-AA | CIBCA SPARES KIT | EACH | \$18,275.00 | 3 A | | 4A-IBV11-A | IBV11-A SPARE MODULE (M7954) | EACH | REPLACED | Y 3 A | M7954-00 |
| 4A-CIBCI-AA | CIBCI MODULE SPARES KIT | EACH | \$18,044.00 | 3 A | | 4A-KA730-00 | KA730 SPARES KIT MINUS FAN | EACH | \$7,473.00 | 3 A | |
| 4A-DB88-AA | DB88-AA SPARES KIT | EACH | \$17,172.00 | 3 A | | 4A-KA750-C | 11750 CPU KIT W/64K MEM CONT. | EACH | \$17,784.00 | 3 A | |
| 4A-DB88-BA | DB88-BA SPARES KIT | EACH | \$13,250.00 | 3 A | | 4A-KA85-AA | KA85-AA CPU SPARES KIT | EACH | \$38,227.00 | 3 A | |
| 4A-DCSAX-LA | DCSAX-LA SPARE MOD KIT(M3100) | EACH | \$475.00 | 3 A | | 4A-KA86-AA | KA86-AA CPU KIT | EACH | \$62,303.00 | 3 A | |
| 4A-DCSAX-LB | DCSAX-LB SPARE MOD KIT(M3101) | EACH | \$744.00 | 3 A | | 4A-KA865-AA | 8650 CPU SPARES KIT | EACH | \$205,097.00 | 3 A | |
| 4A-DCSAX-LC | DCSAX-LC SPARE MOD KIT(M3102) | EACH | \$429.00 | 3 A | | 4A-KA88-AA | KA88-AA CPU SPARES KIT | EACH | \$181,391.00 | 3 A | |
| 4A-DEBET-AA | ETHERNET/BRIDGE/LOCAL/120V | EACH | \$8,800.00 | 3 A | | 4A-KD11-EA | 1134A CPU SPARES KIT FOR KD11 | EACH | \$3,726.00 | 3 A | |
| 4A-DECSA-CA | DECSA-CA SPARES KIT 120/240V | EACH | \$12,495.00 | 3 A | | 4A-KD11-F | KD11-F SPARES MODULE KIT | EACH | \$1,210.00 | 3 A | |
| 4A-DECSA-DA | DECSA-DA SPARES KIT 120/240V | EACH | \$12,772.00 | 3 A | | 4A-KD11-Z | KD11-Z SPARES KIT | EACH | \$10,800.00 | 3 A | |
| 4A-DECSA-EA | DECSA-EA SPARES KIT | EACH | \$12,049.00 | 3 A | | 4A-KD32-AA | MICROVAX I SPARES WG FLT PT | EACH | \$6,295.00 | 3 A | |
| 4A-DECSA-FA | DECSA-FA SPARES KIT 120/240V | EACH | \$12,406.00 | 3 A | | 4A-KD32-AB | MICROVAX I SPARES WD FLT PT | EACH | \$6,295.00 | 3 A | |
| 4A-DELNI-AA | LOCAL NTRWK INTERCON,120/240V | EACH | \$1,375.00 | 3 A | | 4A-KDA50-QA | KDA50-QA SPARES KIT | EACH | \$6,597.00 | 3 A | |
| 4A-DEMPR-AA | THNWR ENET MLTPRT RPTR 120V | EACH | \$3,100.00 | 3 A | | 4A-KDB50-00 | KDB50 SPARES KIT | EACH | \$7,140.00 | 3 A | |
| 4A-DEMPR-AB | THNWR ENET MLTPRT RPTR 240V | EACH | \$3,100.00 | 3 A | | 4A-KDF11-AA | DUAL HEIGHT CPU SPARE MOD KIT | EACH | \$1,407.00 | Y 3 A | |
| 4A-DESTA-AA | THINWIRE ENET STATION ADAPTOR | EACH | \$275.00 | 3 A | | 4A-KDF11-BA | KDF11-BA SPARE MOD KIT(M8189) | EACH | \$1,838.00 | Y 3 A | |
| 4A-DHV11-M | DHV11-M SPARE MOD KIT(M3104) | EACH | REPLACED | 3 A | M3104-00 | 4A-KDF11-CB | KDF11-CB SPARE MODULE KIT | EACH | \$1,443.00 | Y 3 A | |
| 4A-DR11-C | SPARES GENERAL PURPOSE INTERF | EACH | \$340.00 | 3 A | | 4A-KDJ11-BA | KDJ11-BA SPARE MODULE CPU KIT | EACH | REPLACED | 3 A | 4A-KDJ11-BF |
| 4A-DR750-00 | DR750 SPARE MODULE KIT(L0014) | EACH | REPLACED | Y 3 A | L0014-00 | 4A-KDJ11-BC | KDJ11-BC SPARE MODULE CPU KIT | EACH | REPLACED | 3 A | M8190-AB |
| 4A-DR780-00 | DR780 MODULE SPARES KIT | EACH | \$12,361.00 | 3 A | | 4A-KDJ11-BF | KDJ11-BF SPARE MODULE CPU KIT | EACH | REPLACED | 3 A | M8190-AE |
| 4A-DSRVB-A2 | DS200,RS232 8 LINE TRMSV,120V | EACH | REPLACED | 3 A | DSRVB-A2 | 4A-KDJ11-CA | KDJ11-CA CPU SPARES KIT | EACH | \$3,051.00 | 3 A | |
| 4A-DSRVB-B2 | DS200,RS423 8 LINE TRMSV,120V | EACH | REPLACED | 3 A | DSRVB-B2 | 4A-KE44-A | KE44-A CIS SPARES KIT | EACH | \$6,715.00 | 3 A | |
| 4A-DV11-AA | DV11-AA SPARES MODULE KIT | EACH | \$4,872.00 | 3 A | | 4A-KEF11-AA | KEF11-AA SPARES KIT | EACH | \$225.00 | 3 A | |
| 4A-DW750-00 | DW750 SPARE MODULE KIT(L0010) | EACH | REPLACED | Y 3 A | L0010-00 | 4A-KLESI-QA | SPARE KLESI-QA MODULE AND CAB | EACH | \$1,575.00 | 3 A | |
| 4A-DW780-00 | DW780 SPARES KIT 120/240V | EACH | \$6,782.00 | 3 A | | 4A-KTJ11-B | KTJ11-B SPARE MODULE CPU KIT | EACH | REPLACED | 3 A | M8191-00 |
| 4A-DWMBA-CA | DWMBA SPARES KIT | EACH | \$9,518.00 | 3 A | | 4A-KW11-K | KE11-K SPARES DUAL RTC | EACH | \$1,150.00 | 3 A | |
| 4A-DZQ11-M | DZQ11-M SPARE MODULE (M3106) | EACH | REPLACED | 3 A | M3106-00 | 4A-LA100-AA | KEYBD/SEND-REC SPARES KIT | EACH | \$1,582.00 | 3 A | |
| 4A-FP287-00 | FLOATING POINT PROCESSOR KIT | EACH | \$520.00 | 3 A | | 4A-LA100-PC | LA100-PC SPARES KIT | EACH | \$1,340.00 | 3 A | |
| 4A-FP780-00 | FP780 SPARES KIT | EACH | \$6,744.00 | 3 A | | 4A-LA100-RA | READ ONLY SPARES KIT | EACH | \$1,434.00 | 3 A | |
| 4A-FP785-AA | FP785 CPU SPARES KIT | EACH | \$11,332.00 | 3 A | | 4A-LA12-00 | LA12 SPARES KIT | EACH | \$1,339.00 | 3 A | |
| 4A-FP86-AA | FP86-AA FLOATING POINT KIT | EACH | \$29,400.00 | 3 A | | 4A-LA120-AA | LA120 SPARES KIT 120V/60HZ | EACH | \$1,855.00 | 3 A | |
| 4A-FPJ11-AA | FLOATING POINT CHIP | EACH | \$525.00 | 3 A | | 4A-LA120-RA | LA120-RA SPARES KIT 120/240V | EACH | \$2,018.00 | 3 A | |
| 4A-H4005-00 | 802.3/ETHERNET TRANSCEIVER SP | EACH | \$225.00 | 3 A | | 4A-LA120-UP | LA120 KIT 120/240V,50/60HZ | EACH | \$2,275.00 | 3 A | |
| 4A-H7100-00 | H7100 SPARES KIT 120/240V | EACH | \$2,107.00 | 3 A | | 4A-LA12X-CB | LA120 DATA CHANNEL INTERFACE | EACH | \$79.00 | 3 A | |
| 4A-H7104-00 | H7104 P.S. SPARES KIT 120/240 | EACH | \$1,923.00 | 3 A | | 4A-LA210-00 | LA210 SPARES KIT | EACH | \$1,115.00 | 3 A | |
| 4A-H7140-00 | H7140 SPARES KIT | EACH | \$4,326.00 | 3 A | | 4A-LA50-00 | LA50 SPARES KIT | EACH | \$584.00 | 3 A | |

Prices Effective 02-January-89 to 30-June-89

To Order—Call DECdirect™ TOLL-FREE 800-344-4825, 8:30 a.m. to 8:00 p.m. ET in Continental U.S.A.

SPARES PRICE LIST A-51

HARDWARE SPARES PRICE LIST

| PART NUMBER | DESCRIPTION | UNIT ORDER | UNIT PRICE | REP D | L | REPLACEMENT PART NUMBER | PART NUMBER | DESCRIPTION | UNIT ORDER | UNIT PRICE | REP D | L | REPLACEMENT PART NUMBER | |
|-------------|-------------------------------|------------|-------------|-------|---|-------------------------|-------------|-------------------------------|------------|-------------|-------|---|-------------------------|-------------|
| 4A-LA75-A2 | LA75-A2 SPARES KIT,120V | EACH | \$654.00 | 3 | A | | 4A-MSV11-DD | MSV11-DD SPARE MEM (M8044-DA) | EACH | \$1,000.00 | 3 | A | | |
| 4A-LA75-A4 | LA75-A4 SPARES KIT,220/240V | EACH | \$654.00 | 3 | A | | 4A-MV200-01 | MICROVAX II SPARES KIT | EACH | \$20,351.00 | 3 | A | | |
| 4A-LA75-A5 | LA75-A5 SPARES KIT,100V | EACH | \$654.00 | 3 | A | | 4A-MV200-20 | QUANTITY 20 OF 4A-MV200-01 | EACH | 407,020.00 | 3 | A | | |
| 4A-LAS12-X | LAS12 SPARES KIT (BASIC) | EACH | \$2,213.00 | 3 | A | | 4A-MXV11-AA | MXV11-AA SPARE MOD(M8047-AA) | EACH | REPLACED | Y | 3 | A | M8047-AA |
| 4A-LAXX-KG | EIA INTO FOR LA36,9' CABLE | EACH | \$75.00 | 3 | A | | 4A-MXV11-AC | MXV11-AC SPARE MOD(M8047-CA) | EACH | REPLACED | Y | 3 | A | M8047-CA |
| 4A-LAXX-LG | EIA W/MOD CONT F LA35,36' CAB | EACH | \$130.00 | 3 | A | | 4A-PC100-00 | PC100 SPARES KIT 120/240V | EACH | \$2,210.00 | | 3 | A | |
| 4A-LAXX-NW | BUFFERED EIA INT FOR LA180 | EACH | \$605.00 | 3 | A | | 4A-PC100-B2 | PC100-B SPARES KIT,120V | EACH | \$2,156.00 | | 3 | A | |
| 4A-LG01-00 | LG01 SPARES KIT | EACH | \$8,062.00 | 3 | A | | 4A-PC1XX-AA | PC1XX-AA SPARE MEMORY KIT | EACH | REPLACED | Y | 3 | A | 54-15490-AA |
| 4A-LG02-00 | LG02 SPARES KIT | EACH | \$10,032.00 | 3 | A | | 4A-PC1XX-AB | PC1XX-AB SPARE MEMORY KIT | EACH | REPLACED | Y | 3 | A | 54-15490-BA |
| 4A-LG31-A2 | LG31-A2 SPARES KIT | EACH | \$6,605.00 | 3 | A | | 4A-PC1XX-AC | PC1XX-AC SPARES MEMORY KIT | EACH | REPLACED | | 3 | A | 54-15961-AA |
| 4A-LJ250-CA | LJ250 SPARES KIT,120V | EACH | \$1,247.00 | 3 | A | | 4A-PC1XX-AD | PC1XX-AD SPARES MEMORY KIT | EACH | REPLACED | | 3 | A | 54-15961-BA |
| 4A-LJ252-CA | LJ252 SPARES KIT,120V | EACH | \$1,247.00 | 3 | A | | 4A-PC238-AA | DMIII SYSTEM BOX SPARES 120V | EACH | \$1,589.00 | | 3 | A | |
| 4A-LK10X-WA | M KEYBOARD,NUMERIC PAD W/CBL | EACH | \$267.00 | 3 | A | | 4A-PC238-AB | DMIII SYSTEM BOX SPARES 240V | EACH | \$1,589.00 | | 3 | A | |
| 4A-LK201-AA | LK201-AA SPARE KEYBOARD | EACH | \$210.00 | Y | 3 | A | 4A-PC278-00 | PC278 SPARES KIT 120/240V | EACH | \$2,388.00 | | 3 | A | |
| 4A-LK201-AE | LK201-AE SPARE KEYBOARD | EACH | \$210.00 | 3 | A | | 4A-PC350-00 | PC350 SPARES KIT 120/240V | EACH | \$4,591.00 | | 3 | A | |
| 4A-LK201-AG | LK201-AG SPARE KEYBOARD | EACH | \$210.00 | 3 | A | | 4A-PC380-AA | PC380-AA SPARES KIT, 120/240V | EACH | \$5,377.00 | | 3 | A | |
| 4A-LK201-AK | LK201-AK SPARE KEYBOARD | EACH | \$210.00 | 3 | A | | 4A-PC500-AA | PC500 SPARES KIT, 110V | EACH | \$3,387.00 | | 3 | A | |
| 4A-LK201-AP | LK201-AP SPARE KEYBOARD | EACH | \$210.00 | 3 | A | | 4A-PC500-AB | PC500 SPARES KIT, 220V | EACH | \$3,387.00 | | 3 | A | |
| 4A-LK201-BA | LK201-BA SPARE KEYBOARD | EACH | \$210.00 | 3 | A | | 4A-PC50X-AA | PC50X-AA SPARES KIT | EACH | \$1,295.00 | | 3 | A | |
| 4A-LK201-LA | SPARE KEYBOARD, USA | EACH | \$200.00 | 3 | A | | 4A-PM113-00 | RK07 P.M. KIT | EACH | \$161.00 | | 3 | A | |
| 4A-LK201-NA | SPARE KEYBOARD, USA/UK | EACH | \$200.00 | 3 | A | | 4A-PM114-00 | RL01 P.M. KIT | EACH | \$100.00 | | 3 | A | |
| 4A-LK201-PE | SPARE WPS/US/UK LK201-PE KEYB | EACH | \$200.00 | 3 | A | | 4A-PM115-00 | RL02 P.M. KIT | EACH | \$77.00 | | 3 | A | |
| 4A-LK201-RE | LK201 SPARE KEYBOARD, ENGLISH | EACH | \$200.00 | 3 | A | | 4A-PM116-00 | RM02/03 P.M. KIT | EACH | \$344.00 | | 3 | A | |
| 4A-LK250-AA | ENGLISH KEYBOARD SPARES KIT | EACH | \$263.00 | 3 | A | | 4A-PM123-00 | TE10N/10W/TE16 P.M. KIT | EACH | \$360.00 | | 3 | A | |
| 4A-LN01-TK | LN01 TOOL KIT | EACH | \$2,242.00 | 3 | A | | 4A-PM130-00 | TU77 P.M. KIT | EACH | \$321.00 | | 3 | A | |
| 4A-LN03-A2 | LN03-A2 SPARES KIT,120V | EACH | \$3,495.00 | 3 | A | | 4A-R80-AA | R80-AA SPARES KIT,120V | EACH | \$1,470.00 | | 3 | A | |
| 4A-LN03-A3 | LN03-A3 SPARES KIT,240V | EACH | \$3,495.00 | 3 | A | | 4A-RA60-AA | RA60-AA SPARES KIT,120/240V | EACH | \$8,839.00 | | 3 | A | |
| 4A-LPS40-A3 | LPS40 SPARES KIT | EACH | \$25,148.00 | 3 | A | | 4A-RA70-A | RA70-A SPARES KIT | EACH | \$8,117.00 | | 3 | A | |
| 4A-LPV11-00 | LPV11 SPARE MODULE KIT | EACH | REPLACED | Y | 3 | A | 4A-RA80-A | RA80-AA SPARES KIT, 120V 60HZ | EACH | \$9,458.00 | | 3 | A | |
| 4A-LQP45-A | LQP45 SPARES KIT,120V | EACH | \$2,383.00 | 3 | A | M8027-00 | 4A-RA80-D | RA80-AD SPARES KIT,240V 50HZ | EACH | \$9,458.00 | | 3 | A | |
| 4A-LV55X-AA | VAXSTATION II KERNEL KIT | EACH | \$13,878.00 | 3 | A | | 4A-RA81-AA | RA81-AA SPARES KIT,120V | EACH | \$11,174.00 | | 3 | A | |
| 4A-LV55X-AB | VAXSTATION II GPX KERNEL KIT | EACH | \$16,639.00 | 3 | A | | 4A-RA81-AD | RA81-AD SPARES KIT,240V | EACH | \$11,174.00 | | 3 | A | |
| 4A-MS011-00 | MS011 SPARE MODULE KIT | EACH | \$431.00 | Y | 3 | A | 4A-RA82-AA | RA82-AA SPARES KIT,120V | EACH | \$8,011.50 | | 3 | A | |
| 4A-MA780-AS | MA780 SPARES KIT | EACH | \$6,545.00 | 3 | A | | 4A-RA82-AD | RA82-AD SPARES KIT,240V | EACH | \$8,011.50 | | 3 | A | |
| 4A-MDECS-AA | MDECS-AA SP MOD KIT M8743-AA | EACH | REPLACED | 3 | A | M8743-AA | 4A-RD31-A | RD31-A SPARES KIT | EACH | \$1,095.00 | | 3 | A | |
| 4A-MM11-DP | MM11-DP SPARE MEMORY KIT | EACH | \$5,750.00 | 3 | A | | 4A-RD32-A | RD32-A SPARES DRIVE | EACH | \$1,621.00 | | 3 | A | |
| 4A-MM8-AB | MM8-AB SPARE MEMORY KIT | EACH | \$3,680.00 | 3 | A | | 4A-RD51-00 | RD51 SPARES KIT | EACH | \$339.00 | | 3 | A | |
| 4A-MS11-LB | MS11-LB SPARE MEM (M7891-BA) | EACH | \$1,190.00 | 3 | A | | 4A-RD51-A | RD51-A SPARE DRIVE,10MB | EACH | \$1,360.00 | | 3 | A | |
| 4A-MS630-AA | 1MB DUAL SP MOD KIT M7607-AA | EACH | REPLACED | 3 | A | M7607-AA | 4A-RD52-A | RD52-A SPARE DRIVE,31MB | EACH | \$3,465.00 | | 3 | A | |
| 4A-MS630-BA | 2MB QUAD SP MOD KIT M7608-AA | EACH | REPLACED | 3 | A | M7608-AA | 4A-RD53-00 | RD53 SPARES KIT | EACH | \$2,298.00 | | 3 | A | |
| 4A-MS630-BB | 4MB QUAD SP MOD KIT M7608-BA | EACH | REPLACED | 3 | A | M7608-BA | 4A-RD53-A | RD53-A SPARE DRIVE | EACH | \$3,800.00 | | 3 | A | |
| 4A-MS730-CA | MS730-CA SPARE MOD(M8750-CA) | EACH | REPLACED | Y | 3 | A | 4A-RD54-A | RD54-A SPARE DRIVE | EACH | \$4,950.00 | | 3 | A | |
| 4A-MS750-AA | MS750-AA SPARE MEM (M8728-AA) | EACH | REPLACED | Y | 3 | A | 4A-RF30-A | RF30-EA SPARE DRIVE | EACH | \$5,500.00 | | 3 | A | |
| 4A-MS750-CA | MS750-CA SPARE MOD(M8750-CA) | EACH | REPLACED | Y | 3 | A | 4A-RH780-00 | RH780 SPARES KIT | EACH | \$5,400.00 | | 3 | A | |
| 4A-MS780-A | MS780-A MEMORY SPARES KIT | EACH | REPLACED | 3 | A | 4A-MS780-C | 4A-RK07-00 | RK07 SPARES KIT | EACH | \$5,458.00 | | 3 | A | |
| 4A-MS780-C | MS780-C MEMORY SPARES KIT | EACH | \$8,866.00 | 3 | A | | 4A-RL02-A | RL02-A SPARES KIT | EACH | \$3,375.00 | | 3 | A | |
| 4A-MS780-E | 1MB MEMORY SPARES KIT | EACH | \$4,982.00 | 3 | A | | 4A-RM05-AC | RM05-AC SPARES KIT,60HZ | EACH | \$20,400.00 | | 3 | A | |
| 4A-MS780-FD | MS780-FD SPARE MEM (M8373-AA) | EACH | REPLACED | Y | 3 | A | 4A-RM05-AD | RM05-AD SPARES KIT,50HZ | EACH | \$20,400.00 | | 3 | A | |
| 4A-MS780-H | 4MB MEMORY SPARES KIT | EACH | \$7,922.00 | 3 | A | M8373-AA | 4A-RQDX2-00 | RQDX2 SP MOD. KIT (M8639-YB) | EACH | REPLACED | | 3 | A | M8639-YB |
| 4A-MS780-JD | MS780-JD SP MOD. (M8374-AA) | EACH | REPLACED | 3 | A | M8374-AA | 4A-RQDX3-00 | RQDX3 SPARE MOD. KIT (M7555) | EACH | REPLACED | | 3 | A | M7555-00 |
| 4A-MS86-BA | MS86-BA SPARE MEMORY KIT | EACH | REPLACED | 3 | A | L0200-BA | 4A-RUC25-00 | RUC25 SPARES KIT, 120/240V | EACH | \$11,520.00 | | 3 | A | |
| 4A-MS86-CA | MS86-CA SPARES MEMORY KIT | EACH | \$3,875.00 | 3 | A | | 4A-RV20-00 | RV20 SPARES KIT | EACH | \$21,052.00 | | 3 | A | |
| 4A-MS86-DA | 64MB MEMORY SPARES KIT | EACH | \$16,203.00 | 3 | A | | 4A-RX01-A | RX01 SPARES KIT,60HZ | EACH | \$2,613.00 | | 3 | A | |
| 4A-MS88-CA | 16MB MEMORY SPARES KIT | EACH | \$4,150.00 | 3 | A | | 4A-RX01-D | RX01 SPARES KIT,50HZ | EACH | \$2,613.00 | | 3 | A | |
| 4A-MS88-DA | 64MB MEMORY SPARES KIT | EACH | \$15,603.00 | 3 | A | | 4A-RX02-A | RX02 SPARES KIT,60HZ | EACH | \$2,475.00 | | 3 | A | |



Prices Effective 02-January-89 to 30-June-89
 To Order—Call DECdirect™ TOLL-FREE 800-344-4825, 8:30 a.m. to 8:00 p.m. ET in Continental U.S.A.

HARDWARE SPARES PRICE LIST

| PART NUMBER | DESCRIPTION | UNIT ORDER | UNIT PRICE | REP D | L | REPLACEMENT PART NUMBER | PART NUMBER | DESCRIPTION | UNIT ORDER | UNIT PRICE | REP D | L | REPLACEMENT PART NUMBER |
|-------------|-------------------------------|------------|------------|-------|---|-------------------------|-------------|-------------------------------|------------|------------|-------|---|-------------------------|
| 54-11021-00 | LA180 POWER BRD | EACH | REPLACED | Y | 3 | A | 54-11736-00 | PLUS 5 VOLT REG | EACH | \$1,027.00 | | 3 | A |
| 54-11023-00 | LA180 PCB W/CONT ROM | EACH | REPLACED | Y | 3 | A | 54-11023-02 | BATTERY CHARGER | EACH | \$363.00 | Y | 3 | A |
| 54-11023-01 | BOARD LA180 LOGIC | EACH | REPLACED | Y | 3 | A | 54-12763-00 | BATTERY CHARGER TOD | EACH | REPLACED | | 3 | A |
| 54-11023-02 | LA180/LS120 PCB W/O ROMS | EACH | \$675.00 | Y | 3 | A | 54-12763-01 | TODPS AND BACKUP | EACH | \$151.00 | | 3 | A |
| 54-11042-00 | POWER AMP RK06 | EACH | \$1,095.00 | Y | 3 | A | 54-12855-00 | S-BUS TERMINATOR | EACH | \$182.00 | | 3 | A |
| 54-11049-00 | PHOTOXTOR BRD | EACH | \$33.00 | | 3 | A | 54-12932-00 | SYS CONTROL PANEL | EACH | \$335.00 | | 3 | A |
| 54-11060-YA | READ/WRITE MODULE RK07 | EACH | \$277.00 | Y | 3 | A | 54-12985-00 | LIGHTS SW | EACH | \$128.00 | Y | 3 | A |
| 54-11086-00 | +15V REGULATOR (BA11-K) | EACH | \$337.00 | Y | 3 | A | 54-12989-00 | ETCHED BACK PLANE MOTHER BD. | EACH | \$543.00 | Y | 3 | A |
| 54-11086-YA | POWER LINE 115 V. REG | EACH | \$163.00 | Y | 3 | A | 54-13009-00 | VT100 BASIC VIDEO | EACH | REPLACED | Y | 3 | A |
| 54-11170-04 | VT52 KEYBOARD | EACH | \$540.00 | Y | 3 | A | 54-13009-01 | VT132 TERMINAL CONTROLLER | EACH | REPLACED | Y | 3 | A |
| 54-11294-00 | CONSOLE MOD 11/70 | EACH | \$1,134.00 | Y | 3 | A | 54-13009-03 | BASIC VIDEO | EACH | \$1,213.00 | Y | 3 | A |
| 54-11398-00 | FLOPPY DISK P.S. BRD [H771] | EACH | REPLACED | Y | 3 | A | 70-10718-00 | BASIC VIDEO | EACH | \$1,065.00 | Y | 3 | A |
| 54-11442-00 | INTERFACE EIA BRD (LA36) | EACH | \$34.00 | Y | 3 | A | 54-13016-00 | 869 PILOT CONT BRD | EACH | \$238.00 | Y | 3 | A |
| 54-11450-00 | VT55 POWER BRD | EACH | \$2,247.00 | Y | 3 | A | 54-13044-00 | PWR SUPPLY,MAIN BOARD, LA120 | EACH | \$230.00 | Y | 3 | A |
| 54-11497-00 | KY11-LA CONSOLE BRD | EACH | \$309.00 | Y | 3 | A | 54-13073-00 | MK-11 PC CONTROL BOARD | EACH | \$386.00 | | 3 | A |
| 54-11501-00 | REMOTE CONT TERMINATOR | EACH | \$164.00 | | 3 | A | 54-13087-00 | H7100 SNUBBER CARD | EACH | \$59.00 | | 3 | A |
| 54-11522-00 | PILOT CONTROL | EACH | \$184.00 | Y | 3 | A | 54-13089-00 | A.C. CONTROL BOARD | EACH | \$193.00 | Y | 3 | A |
| 54-11597-00 | 5V REGULATOR | EACH | REPLACED | Y | 3 | A | 70-11073-00 | VT100 ADVANCED VIDEO | EACH | \$126.00 | Y | 3 | A |
| 54-11599-00 | T20V REGULATOR H777 | EACH | REPLACED | Y | 3 | A | 54-11599-01 | VT132 ADVANCED VIDEO | EACH | \$341.00 | | 3 | A |
| 54-11599-01 | CORE REGULATOR H777 | EACH | \$363.00 | Y | 3 | A | 54-13184-YA | CAP, MOV BOARD 120V | EACH | \$65.00 | | 3 | A |
| 54-11601-00 | MOS REGULATOR 15V | EACH | REPLACED | Y | 3 | A | 54-11601-01 | 54-13184-YB | EACH | \$69.00 | | 3 | A |
| 54-11601-01 | MOS REGULATOR 15V | EACH | \$814.00 | Y | 3 | A | 54-13265-00 | MOS BATTERY BACKUP | EACH | \$497.00 | Y | 3 | A |
| 54-11625-00 | MODULE H779 | EACH | \$583.00 | Y | 3 | A | 54-13273-00 | FLOPPY CONT R/W | EACH | \$1,182.00 | Y | 3 | A |
| 54-11653-00 | T.O.F. | EACH | REPLACED | Y | 3 | A | 70-11151-00 | 54-13374-00 | EACH | \$654.00 | Y | 3 | A |
| 54-11668-00 | MOTHER BRD | EACH | \$216.00 | | 3 | A | 54-13382-00 | BIAS CONTROL | EACH | \$375.00 | | 3 | A |
| 54-11687-00 | SERNO PRE AMP RK06 | EACH | \$112.00 | | 3 | A | 54-13384-00 | EXPANSION BACKPLANE | EACH | REPLACED | | 3 | A |
| 54-11736-00 | POWER BOARD LA180 | EACH | \$1,101.00 | Y | 3 | A | 54-13384-01 | VT100 EXPANSION BACKPLANE | EACH | \$56.00 | Y | 3 | A |
| 54-11776-00 | H780 POWER SUPPLY | EACH | \$524.00 | Y | 3 | A | 54-13392-00 | POWER STATUS IND. | EACH | \$80.00 | | 3 | A |
| 54-11800-00 | CONSOLE PROGRAMMER 11/04 | EACH | REPLACED | Y | 3 | A | 54-11800-01 | 54-13396-00 | EACH | \$295.00 | Y | 3 | A |
| 54-11800-01 | KY11-LB CONSOLE BRD SYSTEM TE | EACH | \$1,541.00 | Y | 3 | A | 54-13404-00 | VT100 KEYBOARD W/O KEYCAPS | EACH | REPLACED | Y | 3 | A |
| 54-11808-00 | LIGHTS & SWITCHES BD | EACH | \$206.00 | | 3 | A | 54-13414-00 | + & - 5V BATTERY REGULATOR | EACH | \$407.00 | Y | 3 | A |
| 54-11815-00 | VT 52 CHARGEN CARD | EACH | \$96.00 | Y | 3 | A | 54-13417-00 | POSITIVE-NEGATIVE 15VOLT REG. | EACH | \$359.00 | | 3 | A |
| 54-11823-00 | OPERATING CONTROL PANEL RK06 | EACH | \$376.00 | | 3 | A | 54-13489-00 | TU58 ELECTRONICS, SERIAL | EACH | REPLACED | Y | 3 | A |
| 54-11846-00 | FRONT PANEL | EACH | \$174.00 | | 3 | A | 54-13491-00 | TU58 ELECTRONICS, PARALLEL | EACH | \$655.00 | Y | 3 | A |
| 54-11848-00 | ETCH BRD 54-11848 | EACH | \$272.00 | Y | 3 | A | 54-13534-00 | DC SERVO-POWER SUPPLY | EACH | \$491.00 | Y | 3 | A |
| 54-11893-00 | TRANSISTOR BOARD RK06 | EACH | \$99.00 | | 3 | A | 54-13536-00 | RL01/RL02 READ/WRITE | EACH | \$313.00 | Y | 3 | A |
| 54-12143-00 | SLAVE CONSOLE | EACH | REPLACED | Y | 3 | A | H780-E | 54-13596-00 | EACH | \$477.00 | Y | 3 | A |
| 54-12166-00 | LA180 MODULE | EACH | \$232.00 | Y | 3 | A | 54-13599-00 | +5V INVERTER BOARD | EACH | \$991.00 | Y | 3 | A |
| 54-12175-00 | DRIVE LOGIC RL01 | EACH | \$489.00 | Y | 3 | A | 54-13601-00 | +5V CONTROL BOARD | EACH | \$978.00 | Y | 3 | A |
| 54-12201-00 | PILOT CONTROL BOARD FOR 866 | EACH | REPLACED | Y | 3 | A | 54-13603-00 | MEMORY INVERTER BOARD | EACH | \$1,247.00 | Y | 3 | A |
| 54-12201-YA | REPLACEMENT FOR 54-12201-00 | EACH | \$242.00 | | 3 | A | 54-13605-00 | BIAS & INTERFACE BOARD | EACH | \$924.00 | Y | 3 | A |
| 54-12242-00 | POWER SUPPLY TU16 | EACH | \$1,706.00 | Y | 3 | A | 54-13607-00 | MEMORY REGULATOR BOARD | EACH | \$1,123.00 | Y | 3 | A |
| 54-12262-00 | TAPE MOTION BOARD ASSY | EACH | REPLACED | Y | 3 | A | H607-00 | 54-13609-00 | EACH | \$139.00 | | 3 | A |
| 54-12264-00 | TAPE MOTION POWER BOARD ASSY | EACH | REPLACED | Y | 3 | A | H607-00 | 54-13609-YA | EACH | \$119.00 | | 3 | A |
| 54-12385-00 | MODULE H785 | EACH | \$334.00 | | 3 | A | 54-13615-00 | 54-13615-00 | EACH | \$925.00 | Y | 3 | A |
| 54-12416-00 | 5012415 | EACH | \$111.00 | | 3 | A | 54-13692-00 | CAPSTAN DRIVER | EACH | \$137.00 | | 3 | A |
| 54-12528-00 | MONITOR BOARD | EACH | \$320.00 | | 3 | A | 54-13716-00 | 5VOLT AMP REG. | EACH | REPLACED | | 3 | A |
| 54-12530-00 | MASTER BOARD | EACH | \$454.00 | Y | 3 | A | 54-13716-01 | +5V REGULATOR | EACH | \$341.00 | | 3 | A |
| 54-12532-00 | CONTROL BRD H786 | EACH | \$345.00 | | 3 | A | 54-13747-00 | LA34 CONTROL BOARD | EACH | \$557.00 | Y | 3 | A |
| 54-12550-00 | MOTHER BOARD | EACH | \$578.00 | Y | 3 | A | 54-13747-02 | LA34-VA CONTROL BOARD | EACH | REPLACED | Y | 3 | A |
| 54-12554-00 | BIAS CONTROL | EACH | \$402.00 | Y | 3 | A | 54-13747-04 | LOGIC BOARD | EACH | \$431.00 | Y | 3 | A |
| 54-12556-00 | +12V REGULATOR | EACH | \$547.00 | Y | 3 | A | 54-13764-00 | PLUS OR MINUS 15V POWER SUP. | EACH | \$813.00 | Y | 3 | A |
| 54-12558-00 | PLUS OR MINUS 5V REGULATOR | EACH | REPLACED | Y | 3 | A | 54-13795-00 | 11750 CONTROL PANEL | EACH | \$657.00 | | 3 | A |
| 54-12560-00 | -5V REGULATOR | EACH | \$617.00 | Y | 3 | A | 54-13815-00 | POWER DIST. BOARD ASSY. | EACH | \$107.00 | | 3 | A |
| 54-12562-00 | STATUS CARD | EACH | \$96.00 | | 3 | A | 54-13885-02 | CONSOLE MODRLE, 2 JUMPERS | EACH | \$90.00 | | 3 | A |



Prices Effective 02-January-89 to 30-June-89

To Order—Call DECdirect™ TOLL-FREE 800-344-4825, 8:30 a.m. to 8:00 p.m. ET in Continental U.S.A.

HARDWARE SPARES PRICE LIST

| PART NUMBER | DESCRIPTION | UNIT ORDER | UNIT PRICE | REP D L | REPLACEMENT PART NUMBER | PART NUMBER | DESCRIPTION | UNIT ORDER | UNIT PRICE | REP D L | REPLACEMENT PART NUMBER |
|-------------|-------------------------------|------------|------------|---------|-------------------------|-------------|-------------------------------|------------|------------|---------|-------------------------|
| 54-13951-00 | ADAPTER BOARD | EACH | \$452.00 | Y 3 A | | 54-15278-01 | BACKPLANE MODULE | EACH | \$274.00 | Y 3 A | |
| 54-14025-00 | DRIVE LOGIC | EACH | \$728.00 | Y 3 A | | 54-15284-01 | RA80 MICRO PROCESSOR W/ROMS | EACH | \$2,174.00 | Y 3 A | |
| 54-14116-00 | EIA PROTECTION MODULE | EACH | \$138.00 | Y 3 A | | 54-15422-00 | KDF11-B SWITCHABLE BAUD PANEL | EACH | \$214.00 | Y 3 A | |
| 54-14174-00 | TM78 KEYPAD | EACH | \$292.00 | Y 3 A | | 54-15426-00 | DECMATE II SYSTEM BOARD | EACH | REPLACED | Y 3 A | 70-19973-00 |
| 54-14185-00 | VT101 TERMINAL CONTROL | EACH | \$789.00 | Y 3 A | | 54-15436-00 | PC27X-BA DMII RX78 INTERFACE | EACH | \$198.00 | Y 3 A | |
| 54-14185-01 | VT102 TERMINAL CONTROL | EACH | \$1,070.00 | Y 3 A | | 54-15451-00 | PC27X-AA/ABAPU Z80 OPT PC278 | EACH | \$311.00 | Y 3 A | |
| 54-14185-02 | VT131 TERMINAL CONTROL | EACH | \$1,084.00 | Y 3 A | | 54-15459-00 | RDC 50 ADAPTER | EACH | REPLACED | Y 3 A | 70-20779-01 |
| 54-14192-00 | AC DC LOWBOARD | EACH | \$183.00 | Y 3 A | | 54-15475-00 | LOGIC MODULE MAINT SPARE | EACH | REPLACED | Y 3 A | 4A-DELNI-AA |
| 54-14218-01 | EIA SERIAL LINE INTERFACE | EACH | \$49.00 | Y 3 A | | 54-15482-00 | PC100 RX50 CONTROLLER | EACH | \$326.00 | Y 3 A | |
| 54-14240-00 | H7476 REGULATOR | EACH | \$445.00 | Y 3 A | | 54-15488-KA | PC300 256KB MEMORY MODULE | EACH | \$625.00 | Y 3 A | |
| 54-14245-00 | H7838-A POWER SUPPLY | EACH | \$133.00 | Y 3 A | | 54-15490-AA | PC1XX-AA 64KB MEM PC100 | EACH | REPLACED | Y 3 A | 54-15961-BA |
| 54-14256-00 | LA100 LOGIC BOARD | EACH | \$582.00 | Y 3 A | | 54-15490-BA | PC1XX-AB 192KB MEM PC100 | EACH | REPLACED | Y 3 A | 54-15961-BA |
| 54-14256-06 | LOGIC BOARD | EACH | \$582.00 | Y 3 A | | 54-15495-01 | VT240 CONTROLLER BOARD | EACH | REPLACED | Y 3 A | 54-15495-02 |
| 54-14275-00 | VT125 PADDLE BOARD | EACH | \$200.00 | Y 3 A | | 54-15495-02 | VS240 MODULE | EACH | \$1,447.00 | Y 3 A | |
| 54-14277-00 | VT125 MONO BOARD | EACH | \$1,194.00 | Y 3 A | | 54-15500-00 | VR201 MONITOR BD | EACH | REPLACED | Y 3 A | 70-19584-00 |
| 54-14330-00 | LA120 PARALLEL ADAPTER | EACH | \$180.00 | Y 3 A | | 54-15539-01 | IEEE/2 DL/24 LINE INTERFACE | EACH | \$394.00 | Y 3 A | |
| 54-14340-00 | AIR FLOW SENSOR | EACH | \$117.00 | Y 3 A | | 54-15610-00 | BA23-A FRONT PANEL | EACH | \$129.00 | Y 3 A | |
| 54-14350-00 | STP CONN CARD | EACH | \$55.00 | Y 3 A | | 54-15624-01 | VR260 DEFLECTION BOARD | EACH | \$649.00 | Y 3 A | |
| 54-14438-01 | CONSOLE MODULE | EACH | \$165.00 | Y 3 A | | 54-15626-01 | VIDEO AMP BOARD | EACH | \$284.00 | Y 3 A | |
| 54-14438-02 | 11/730 CONSOLE MODULE | EACH | \$175.00 | Y 3 A | | 54-15628-00 | CONNECTOR BOARD MAINT SPARE | EACH | \$326.00 | Y 3 A | |
| 54-14438-03 | CONSOLE MODULE (11730-AE/AF) | EACH | \$110.00 | Y 3 A | | 54-15643-01 | VT240 MODEM | EACH | \$462.00 | Y 3 A | |
| 54-14569-00 | CHARGER BOARD | EACH | \$377.00 | Y 3 A | | 54-15688-01 | PC1XX-BA RNBW CLR GRAPH OPT | EACH | \$508.00 | Y 3 A | |
| 54-14571-00 | TOY BOARD | EACH | \$187.00 | Y 3 A | | 54-15690-00 | AC CONTROL BOARD | EACH | \$151.00 | Y 3 A | |
| 54-14583-00 | H7861 | EACH | \$1,072.00 | Y 3 A | | 54-15703-00 | PC1XX-BD COMM OPT PC100 | EACH | \$336.00 | Y 3 A | |
| 54-14610-00 | LA12 POWER SUPPLY | EACH | \$371.00 | Y 3 A | | 54-15961-AA | PC1XX-AC 128KB MEM PC100-P | EACH | REPLACED | Y 3 A | 54-15961-BA |
| 54-14630-00 | LA12 LOGIC BOARD | EACH | REPLACED | Y 3 A | 54-14630-02 | 54-15961-BA | PC1XX-AD 256KB MEM PC100-P | EACH | \$785.00 | Y 3 A | |
| 54-14630-02 | LA12 LOGIC BOARD | EACH | \$616.00 | Y 3 A | | 54-16019-00 | PC1XX-DA RD51 CONT PC100-P | EACH | \$792.00 | Y 3 A | |
| 54-14636-00 | RC25 CONTROLLER MODULE | EACH | \$3,150.00 | Y 3 A | | 54-16058-01 | CONSOLE DIST CARD | EACH | \$156.00 | Y 3 A | |
| 54-14645-00 | RC25 DRIVE CARD | EACH | \$2,754.00 | Y 3 A | | 54-16133-01 | POWER DISTRIBUTION BOARD | EACH | REPLACED | Y 3 A | 54-16133-02 |
| 54-14927-01 | OPERATOR CONTROL PANEL | EACH | \$290.00 | Y 3 A | | 54-16133-02 | POWER DISTRIBUTION MODULE | EACH | \$410.00 | Y 3 A | |
| 54-14966-00 | NI TRANSCEIVER MODULE | EACH | \$313.00 | Y 3 A | | 54-16152-01 | POWER DIST/H7204 POWER SUPPLY | EACH | \$203.00 | Y 3 A | |
| 54-14981-00 | H7107 OPT MOD | EACH | \$386.00 | Y 3 A | | 54-16157-01 | MPS BACKPLANE 1:INTERCONNECT | EACH | REPLACED | Y 3 A | 54-16157-02 |
| 54-15020-01 | MPS BACKPANEL NO. 1 | EACH | \$944.00 | Y 3 A | | 54-16157-02 | BACKPLANE POWER FOR H7189,H71 | EACH | \$836.00 | Y 3 A | |
| 54-15022-01 | MPS BACKPANEL NO. 2 | EACH | \$938.00 | Y 3 A | | 54-16159-01 | MPS BACKPLANE 2:INTERCONNECT | EACH | REPLACED | Y 3 A | 54-16159-02 |
| 54-15058-00 | RX50 CONTROLLER | EACH | \$532.00 | Y 3 A | | 54-16159-02 | BACKPLANE POWER FOR H7188,H71 | EACH | \$1,017.00 | Y 3 A | |
| 54-15084-00 | C.T. RAM 128 KB | EACH | REPLACED | Y 3 A | 54-15084-FA | 54-16188-01 | R82 SERVO CONTROL | EACH | \$2,520.00 | Y 3 A | |
| 54-15084-FA | C.T. RAM 128 KB | EACH | \$346.00 | Y 3 A | | 54-16190-01 | R82 HYBRID MODULE | EACH | \$3,548.00 | Y 3 A | |
| 54-15134-00 | RD50 CONTROL | EACH | REPLACED | Y 3 A | 54-15134-01 | 54-16192-01 | R82 READ/WRITE MODULE | EACH | \$1,308.00 | Y 3 A | |
| 54-15134-01 | RD52 CONTROL | EACH | \$954.00 | Y 3 A | | 54-16239-01 | PC380 EXT BIT MAP OPT/256KB | EACH | \$1,146.00 | Y 3 A | |
| 54-15138-00 | PC350 VIDEO GENERATOR | EACH | \$642.00 | Y 3 A | | 54-16469-01 | PATCH PANEL | EACH | REPLACED | Y 3 A | 70-21495-01 |
| 54-15142-00 | 11750 SYS REV LEVEL INPUT DEV | EACH | \$45.00 | Y 3 A | | 54-16489-01 | DECMATE III SYSTEM BD. | EACH | \$768.00 | Y 3 A | |
| 54-15146-00 | CT100 COLOR BIT MAP | EACH | \$940.00 | Y 3 A | | 54-16500-AA | 2MB SMU MEM ARRAY DAUGHTER BD | EACH | REPLACED | Y 3 A | 54-16500-BA |
| 54-15148-00 | ENCODING MODULE PC350 KEYBD | EACH | REPLACED | Y 3 A | 54-15148-01 | 54-16500-BA | 2MB DAUGHTER BOARD | EACH | \$1,250.00 | Y 3 A | |
| 54-15148-01 | ENCODING MODULE F.S. REPAIR | EACH | REPLACED | Y 3 A | 54-16941-01 | 54-16506-01 | DECMATE III ADPTER BD | EACH | \$65.00 | Y 3 A | |
| 54-15150-00 | VT180 PADDLE BOARD | EACH | \$92.00 | Y 3 A | | 54-16572-01 | CONTROL MODULE | EACH | \$733.00 | Y 3 A | |
| 54-15152-AA | VT18X CONTROL MODULE | EACH | \$740.00 | Y 3 A | | 54-16572-02 | CONTROL MODULE | EACH | \$715.00 | Y 3 A | |
| 54-15160-00 | RC25 DISK POWER SUPPLY | EACH | \$717.00 | Y 3 A | | 54-16574-01 | CONTROL PANEL | EACH | \$416.00 | Y 3 A | |
| 54-15247-00 | R81 MICRO PROCESSOR MODULE | EACH | \$2,127.00 | Y 3 A | | 54-16596-01 | CONSOLE BD FOR BA123-A | EACH | \$187.00 | Y 3 A | |
| 54-15253-00 | R81 READ/WRITE MODULE | EACH | \$1,184.00 | Y 3 A | | 54-16665-01 | SENSE OF TEMP. FOR BA123 | EACH | \$105.00 | Y 3 A | |
| 54-15264-01 | POST AMP/DATA SEPERATOR MODUL | EACH | \$985.00 | Y 3 A | | 54-16709-01 | BACKPLANE FOR THE MODULER POW | EACH | \$1,235.00 | Y 3 A | |
| 54-15266-01 | DRIVE LOGIC MODULE | EACH | \$887.00 | Y 3 A | | 54-16709-02 | SKIPJACK MPS BACKPLANE | EACH | REPLACED | Y 3 A | 54-16709-01 |
| 54-15268-01 | PREAMP MODULE | EACH | \$211.00 | Y 3 A | | 54-16802-AA | MS400-AA 2MB MEM | EACH | \$1,500.00 | Y 3 A | |
| 54-15270-01 | I/O MODULE | EACH | \$2,749.00 | Y 3 A | | 54-16802-BA | MS400-BA 4MB MEM | EACH | \$3,500.00 | Y 3 A | |
| 54-15272-00 | FRONT PANEL | EACH | REPLACED | Y 3 A | 54-15272-01 | 54-16804-01 | NETWORK INT OPT FOR VAXMATE | EACH | \$1,611.00 | Y 3 A | |
| 54-15272-01 | FRONT PANEL | EACH | \$348.00 | Y 3 A | | 54-16828-01 | CRT SWEEP CIRCUIT | EACH | \$203.00 | Y 3 A | |

digital

Prices Effective 02-January-89 to 30-June-89

To Order—Call DECdirect™ TOLL-FREE 800-344-4825, 8:30 a.m. to 8:00 p.m. ET in Continental U.S.A.

SPARES PRICE LIST A-55

SPARES PRICE LIST A-56

54-16853-AF — 70-09808-00

HARDWARE SPARES PRICE LIST

| PART NUMBER | DESCRIPTION | UNIT ORDER | UNIT PRICE | REP D L | REPLACEMENT PART NUMBER | PART NUMBER | DESCRIPTION | UNIT ORDER | UNIT PRICE | REP D L | REPLACEMENT PART NUMBER |
|---------------------------------------|-------------------------------|------------|-------------|---------|-------------------------|--|--------------------------------|------------|------------|---------|-------------------------|
| 54-16853-AF | 2MB MEM EXP MODULE 256K RAMS | EACH | REPLACED | Y 3 A | 4A-PC50X-AA | | | | | | |
| 54-16881-01 | PC500 INTEGRAL MODEM | EACH | \$645.00 | Y 3 A | | | | | | | |
| 54-16888-01 | VS2000 4-PLANE VIDEO BOARD | EACH | \$2,000.00 | Y 3 A | | | | | | | |
| 54-16903-01 | GRAPHIC BITMAP MODULE | EACH | \$1,194.00 | Y 3 A | | | | | | | |
| 54-16905-01 | MONO MONITOR PWR. SUP. MODULE | EACH | \$448.00 | Y 3 A | | | | | | | |
| 54-16907-01 | MONO. VIDEO AMPLIFIER MODULE | EACH | \$70.00 | Y 3 A | | | | | | | |
| 54-16909-01 | MONOCHROME CPU MODULE | EACH | \$459.00 | Y 3 A | | | | | | | |
| 54-16943-01 | 1MB DYNAMIC RAM | EACH | \$1,050.00 | Y 3 A | | | | | | | |
| 54-16947-01 | HORZ & VERT DEFLECTION MOD | EACH | \$1,218.00 | Y 3 A | | | | | | | |
| 54-16961-01 | PWR SUPPLY/MONITOR MODULE | EACH | REPLACED | Y 3 A | 70-24516-01 | | | | | | |
| 54-16963-01 | COLOR VIDEO AMPLIFIER MOD. | EACH | \$225.00 | Y 3 A | | | | | | | |
| 54-16965-01 | PANDA CG VIDEO BOARD (MOD.) | EACH | \$2,281.00 | Y 3 A | | | | | | | |
| 54-16975-01 | VIDEO SUB SYSTEM, IMAGE PROC | EACH | \$5,581.00 | Y 3 A | | | | | | | |
| 54-17040-01 | LOW VOLTAGE POWER SUPPLY | EACH | \$450.00 | Y 3 A | | | | | | | |
| 54-17052-AA | 16MB DAUGHTER BOARD | EACH | \$11,199.00 | Y 3 A | | | | | | | |
| 54-17102-01 | VIDEO DAUGHTER MODULE | EACH | \$2,123.00 | Y 3 A | | | | | | | |
| 54-17129-01 | DATA ONLY ASYNCH COMM INTFC | EACH | \$977.00 | Y 3 A | | | | | | | |
| 54-17131-01 | TTL TO DEC 423 LEVEL CONV | EACH | \$338.00 | Y 3 A | | | | | | | |
| 54-17158-01 | CPU BOARD FOR VAXMATE | EACH | \$1,557.00 | Y 3 A | | | | | | | |
| 54-17215-01 | TEAMMATE SYNC CONTROLLER | EACH | \$1,150.00 | Y 3 A | | | | | | | |
| 54-17230-01 | SYNC DRIVER/RECEIVER | EACH | \$340.00 | Y 3 A | | | | | | | |
| 54-17243-01 | XTC PWR SEQ MODULE | EACH | REPLACED | Y 3 A | 20-29176-01 | | | | | | |
| 54-17282-01 | VS2000 8-PLANE VIDEO BD. | EACH | \$5,000.00 | Y 3 A | | | | | | | |
| 54-17639-01 | TK50 CONTROLLER BD | EACH | \$1,611.00 | Y 3 A | | | | | | | |
| 54-17688-01 | CONTROL PANEL | EACH | \$120.00 | Y 3 A | | | | | | | |
| 54-17696-01 | AIO DISTRIBUTION BOARD | EACH | \$104.00 | Y 3 A | | | | | | | |
| 54-17758-01 | PREAMP CONTROL MODULE RA90 | EACH | \$420.00 | Y 3 A | | | | | | | |
| 54-18054-01 | POWER DIST. BD. | EACH | \$149.00 | Y 3 A | | | | | | | |
| 54-18054-02 | AC DIST PANEL | EACH | \$147.00 | Y 3 A | | | | | | | |
| 54-18172-01 | CLOCK ARBITER CARD FOR XMI | EACH | \$2,780.00 | Y 3 A | | | | | | | |
| 54-18300-AA | 12MB MEMORY MODULE | EACH | \$9,000.00 | Y 3 A | | | | | | | |
| 54-18434-01 | MPS 1 BACKPLANE | EACH | \$1,038.00 | Y 3 A | | | | | | | |
| 54-18462-01 | MPS2 LH BACKPLANE | EACH | \$1,353.00 | Y 3 A | | | | | | | |
| 54-18478-01 | MPS3 BACKPLANE | EACH | \$1,166.00 | Y 3 A | | | | | | | |
| 54-18482-01 | P BOX BACKPLANE | EACH | \$568.00 | Y 3 A | | | | | | | |
| 54-18572-01 | BI EXPANDER MPS BACKPLANE | EACH | \$1,210.00 | Y 3 A | | | | | | | |
| 54-18574-01 | TK50 PWR FILTER BOARD | EACH | REPLACED | Y 3 A | 20-28997-01 | | | | | | |
| 55 CLASS Overlays | | | | | | | | | | | |
| 55-09081-09 | KD11-B KM1 OVERLAY | EACH | \$32.00 | Y 3 A | | | | | | | |
| 55-09081-10 | KD11-B KM2 OVERLAY | EACH | \$29.00 | Y 3 A | | | | | | | |
| 55-09081-12 | KD11-A OVERLAY | EACH | \$29.00 | Y 3 A | | | | | | | |
| 55-09081-13 | KT11-D KE11-E,F OVERLAY | EACH | \$29.00 | Y 3 A | | | | | | | |
| 55-09974-00 | OVERLAY MAINTENANCE MODULE | EACH | \$36.00 | Y 3 A | | | | | | | |
| 57 CLASS LSI Hybrid Assemblers | | | | | | | | | | | |
| 57-00001-01 | HYBRID ASSY.FLOATING POINT | EACH | REPLACED | Y 3 A | 4A-KEF11-AA | | | | | | |
| | | | | | | 70 CLASS DEC Manufactured Parts//Cables | | | | | |
| | | | | | | 70-05745-02 | SHOE HD ASSY RELOAD TO 25 GRA | EACH | \$520.00 | Y 3 A | |
| | | | | | | 70-06322-00 | HUB ASSY 6PT CONT 70-6320 | EACH | REPLACED | Y 3 A | 74-07390-00 |
| | | | | | | 70-06758-01 | MAGTAPE HEAD 9 TRACK ASSY | EACH | REPLACED | Y 3 A | 70-09885-08 |
| | | | | | | 70-07273-00 | PRINT HEAD ASSY LA30 | EACH | REPLACED | Y 3 A | 70-09488-00 |
| | | | | | | 70-08288-8F | POWER CONTROL CABLE | EACH | \$83.00 | Y 3 A | |
| | | | | | | 70-08443-00 | LOGIC DM11 DIST PANEL | EACH | \$416.00 | Y 3 A | |
| | | | | | | 70-08513-00 | LOGIC, DN11-A | EACH | \$341.00 | Y 3 A | |
| | | | | | | 70-08612-0D | CABLE KEYBOARD | EACH | \$19.00 | Y 3 A | |
| | | | | | | 70-08612-0F | CABLE KEYBOARD RX8-A | EACH | \$23.00 | Y 3 A | |
| | | | | | | 70-08612-0M | KEYBOARD CABLE | EACH | \$25.00 | Y 3 A | |
| | | | | | | 70-08612-1F | CABLE KYBD 18IN (H763) PDP8A | EACH | \$27.00 | Y 3 A | |
| | | | | | | 70-08702-00 | LINEAR POSITIONER | EACH | \$1,500.00 | Y 3 A | |
| | | | | | | 70-09014-01 | TRANSPORT ASY DIE CAST (TU60) | EACH | \$1,162.00 | Y 3 A | |
| | | | | | | 70-09026-00 | CABLE | EACH | \$184.00 | Y 3 A | |
| | | | | | | 70-09026-02 | CONTROL CABLE ASSY | EACH | \$170.00 | Y 3 A | |
| | | | | | | 70-09062-00 | LOGIC DD11-B | EACH | \$561.00 | Y 3 A | |
| | | | | | | 70-09139-00 | MOTOR DRIVE ASSY TU60 (70-914 | EACH | \$143.00 | Y 3 A | |
| | | | | | | 70-09146-00 | SPINDLE ASSY (70-9014-01)-TU6 | EACH | \$122.00 | Y 3 A | |
| | | | | | | 70-09179-00 | LOGIC DJ11-AA, DJ11-AB, DJ11- | EACH | \$373.00 | Y 3 A | |
| | | | | | | 70-09180-00 | LOGIC ASSY | EACH | \$523.00 | Y 3 A | |
| | | | | | | 70-09397-00 | BACKPLANE ASSY., RH11 | EACH | \$452.00 | Y 3 A | |
| | | | | | | 70-09404-00 | HEAT SINK ASSY #3 (H761) | EACH | REPLACED | Y 3 A | 70-09404-01 |
| | | | | | | 70-09404-01 | REGULATED HEAT SINK ASSY-2.0V | EACH | \$1,612.00 | Y 3 A | |
| | | | | | | 70-09405-00 | HEAT SINK ASSY #2 (H761) | EACH | REPLACED | Y 3 A | 70-09405-01 |
| | | | | | | 70-09405-01 | REGULATED HEAT SINK ASSY-5.2V | EACH | \$1,933.00 | Y 3 A | |
| | | | | | | 70-09467-00 | LOGIC (DQ11-AA) | EACH | \$380.00 | Y 3 A | |
| | | | | | | 70-09488-00 | REPLACE PRINT HEAD LA30-L | EACH | \$422.00 | Y 3 A | |
| | | | | | | 70-09562-00 | CABLE PWR DIST | EACH | \$147.00 | Y 3 A | |
| | | | | | | 70-09570-00 | HARNESS OPT RH11 | EACH | \$80.00 | Y 3 A | |
| | | | | | | 70-09637-00 | CONTROL BOX (TU16) | EACH | \$424.00 | Y 3 A | |
| | | | | | | 70-09638-00 | VACUUM SYSTEM (TU16) | EACH | REPLACED | Y 3 A | 70-16687-00 |
| | | | | | | 70-09638-01 | VACUUM ASSY | EACH | REPLACED | Y 3 A | 70-16687-00 |
| | | | | | | 70-09640-00 | READ/WRITE INTLOCK TU16 | EACH | REPLACED | Y 3 A | 70-16659-00 |
| | | | | | | 70-09641-00 | TAPE REEL ASSY-TU16 | EACH | \$186.00 | Y 3 A | |
| | | | | | | 70-09642-00 | SENSOR ASSY-TU16 | EACH | \$81.00 | Y 3 A | |
| | | | | | | 70-09644-01 | MOTOR ASSY UPPER-TU16 | EACH | \$465.00 | Y 3 A | |
| | | | | | | 70-09644-02 | MOTOR ASSY LOWER-TU16 | EACH | \$453.00 | Y 3 A | |
| | | | | | | 70-09689-01 | RIBBON CHASSIS ASSY (LA36) | EACH | REPLACED | Y 3 A | 70-13859-00 |
| | | | | | | 70-09690-00 | DRIVE RIBBON ASSY (LA36) | EACH | REPLACED | Y 3 A | 70-11446-00 |
| | | | | | | 70-09691-00 | MOTOR DC & ENCODER ASSY (LA36) | EACH | \$351.00 | Y 3 A | |
| | | | | | | 70-09692-00 | CARRIAGE ASSY (LA36) | EACH | \$48.00 | Y 3 A | |
| | | | | | | 70-09694-00 | IDLER GEAR ASSEMBLY | EACH | \$8.00 | Y 3 A | |
| | | | | | | 70-09696-00 | PRINT MECH ASSY (LA36) | EACH | REPLACED | Y 3 A | 70-15023-00 |
| | | | | | | 70-09750-08 | KEYBOARD BEZEL ASSY (LA36) | EACH | \$743.00 | Y 3 A | |
| | | | | | | 70-09768-00 | COVER CHASSIS (BA11-K) | EACH | \$68.00 | Y 3 A | |
| | | | | | | 70-09778-00 | DISK ASSY (LA36) | EACH | \$18.00 | Y 3 A | |
| | | | | | | 70-09779-01 | XFORMER ASSY | EACH | \$230.00 | Y 3 A | |
| | | | | | | 70-09779-02 | XFORMER ASSY | EACH | \$218.00 | Y 3 A | |
| | | | | | | 70-09780-00 | MOTOR DC W/CONN PINS (LA36) | EACH | REPLACED | Y 3 A | 12-11477-00 |
| | | | | | | 70-09808-00 | HARNESS DUAL PORT (70-9732) | EACH | \$331.00 | Y 3 A | |



Prices Effective 02-January-89 to 30-June-89
 To Order—Call DECdirect™ TOLL-FREE 800-344-4825, 8:30 a.m. to 8:00 p.m. ET in Continental U.S.A.

HARDWARE SPARES PRICE LIST

| PART NUMBER | DESCRIPTION | UNIT ORDER | UNIT PRICE | REP D | L | REPLACEMENT PART NUMBER | PART NUMBER | DESCRIPTION | UNIT ORDER | UNIT PRICE | REP D | L | REPLACEMENT PART NUMBER |
|-------------|--------------------------------|------------|------------|-------|-----|-------------------------|-------------|--------------------------------|------------|------------|-------|---|-------------------------|
| 70-09811-01 | BOX AC INPUT 110V (11/05-S) | EACH | REPLACED | Y | 3 A | 70-14420-01 | 70-11916-00 | HOME LOCK SOLENOID ASSY (RK06) | EACH | REPLACED | 3 | A | 70-11916-01 |
| 70-09811-02 | BOX AC INPUT 220V (11/05-S) | EACH | REPLACED | | 3 A | 70-14420-02 | 70-11916-01 | HOME LOCK SOLENOID ASSY | EACH | \$165.00 | 3 | A | |
| 70-09819-00 | CABLE 9 TRK WRITE (TU16) | EACH | REPLACED | | 3 A | 70-09819-3B | 70-11917-00 | MAGNET HOUSING ASSY | EACH | \$315.00 | 3 | A | |
| 70-09819-3B | CABLE WRITE | EACH | \$72.00 | | 3 A | | 70-11918-00 | SPEED SENSOR ASSY | EACH | \$88.00 | 3 | A | |
| 70-09835-00 | MOTOR CAPSTAN ASSY-TU16 | EACH | \$571.00 | Y | 3 A | | 70-11918-01 | SPEED SENSOR ASSY | EACH | \$80.00 | 3 | A | |
| 70-09882-00 | PRINT HEAD ASSY (LA180) | EACH | REPLACED | | 3 A | 70-09883-00 | 70-11992-00 | PDP 1104/1134 CONSOLE POWER H | EACH | \$71.00 | 3 | A | |
| 70-09883-00 | PRINT HEAD LA36 | EACH | \$421.00 | Y | 3 A | | 70-12064-00 | MDL1 HARNESS RP05/RP06 | EACH | \$229.00 | 3 | A | |
| 70-09885-01 | PLATE HD 9 TRACK TU16 | EACH | REPLACED | | 3 A | 70-09885-05 | 70-12066-00 | MASS BUS CABLE | EACH | REPLACED | 3 | A | BC06S-2H |
| 70-09885-04 | PLATE HEAD 9 TRK TU10 | EACH | REPLACED | | 3 A | 70-09885-08 | 70-12107-00 | CABLE FRONT PANEL | EACH | \$19.00 | 3 | A | |
| 70-09885-05 | NARROW RADIUS 9 TRACK TU16 | EACH | \$2,001.00 | Y | 3 A | | 70-12114-00 | DISK MOTOR ASSY | EACH | \$507.00 | Y | 3 | A |
| 70-09885-08 | NARROW RADIUS 9 TRACK TU10 | EACH | \$1,806.00 | Y | 3 A | | 70-12115-00 | RK02 FRT COVER ASSY | EACH | \$168.00 | | 3 | A |
| 70-09895-00 | HARNESS CAPACITOR (LA36) | EACH | \$26.00 | | 3 A | | 70-12117-00 | POSITIONER ASSY | EACH | \$1,032.00 | Y | 3 | A |
| 70-09938-00 | TERMINAL ASSY (80-RJP04) | EACH | \$272.00 | Y | 3 A | | 70-12127-01 | TERMINAL BLOCK ASSY | EACH | \$32.00 | | 3 | A |
| 70-10092-00 | DC MOTOR & ENCODER ASSEMBLY | EACH | \$394.00 | Y | 3 A | | 70-12130-00 | POWER PANEL ASSY | EACH | \$712.00 | | 3 | A |
| 70-10121-02 | HARNESS, VAC MOTOR | EACH | \$38.00 | | 3 A | | 70-12137-00 | TRANSDUCER ASSY | EACH | \$180.00 | | 3 | A |
| 70-10230-00 | LOGIC 11/35 | EACH | \$544.00 | Y | 3 A | | 70-12142-00 | CABLE | EACH | \$14.00 | | 3 | A |
| 70-10277-00 | MOTOR ASSY TENNSION TU60 | EACH | \$130.00 | | 3 A | | 70-12214-2D | CABLE, CONSOLE TO M7859 (KY11) | EACH | \$29.00 | | 3 | A |
| 70-10329-00 | LOGIC ASSY CPU (KB11-B) | EACH | \$7,718.00 | Y | 3 A | | 70-12256-00 | BRACKET AND MOTOR ASSY | EACH | \$331.00 | | 3 | A |
| 70-10495-00 | MOTOR DC W/CONN PINS (70-1009) | EACH | REPLACED | | 3 A | 70-10092-00 | 70-12256-01 | BRACKET AND MOTOR ASSY | EACH | \$341.00 | | 3 | A |
| 70-10704-00 | TRANSFORMER ASSY H771-B | EACH | \$261.00 | | 3 A | | 70-12268-00 | SPEED XDUCER CABLE | EACH | REPLACED | 3 | A | 70-11918-00 |
| 70-10718-00 | BOARD POWER ASSY H771 | EACH | \$192.00 | Y | 3 A | | 70-12293-00 | TERMINATOR ASSEMBLY | EACH | \$109.00 | | 3 | A |
| 70-10756-00 | FAN ASSEMBLY | EACH | \$67.00 | | 3 A | | 70-12379-00 | CARRIAGE ASSY | EACH | \$248.00 | | 3 | A |
| 70-10757-00 | HOUSING WITH FOAM | EACH | \$62.00 | | 3 A | | 70-12415-00 | TRANSITION BRKT ASSY RK611 | EACH | \$53.00 | | 3 | A |
| 70-10758-00 | COVER ASSY LA180 | EACH | \$63.00 | | 3 A | | 70-12445-00 | BACKPLANE ASSY DD11-CF | EACH | \$301.00 | Y | 3 | A |
| 70-10859-00 | CRT ASSY | EACH | REPLACED | | 3 A | 12-11901-00 | 70-12498-00 | SPRING PLATE ASSY | EACH | \$45.00 | | 3 | A |
| 70-10906-00 | YOKE ASSY | EACH | \$77.00 | | 3 A | | 70-12524-00 | TRANSDUCER ASSY | EACH | \$226.00 | Y | 3 | A |
| 70-10918-01 | DIODE STICK G652 | QTY OF 10 | \$4.00 | | 3 A | | 70-12691-00 | CLAMP (RK05) | EACH | \$8.00 | | 3 | A |
| 70-11016-00 | CARRIAGE ASSEMBLY | EACH | \$32.00 | | 3 A | | 70-12844-00 | CABLE ROUND 36 CONDUCTOR | EACH | \$126.00 | | 3 | A |
| 70-11052-00 | MOV ASSY | EACH | \$13.00 | | 3 A | | 70-12909-00 | +5V REGULATOR ASSY | EACH | \$1,236.00 | Y | 3 | A |
| 70-11073-00 | +5V REG ASSY | EACH | \$1,253.00 | Y | 3 A | | 70-12910-00 | A/C INPUT ASSY, 230V | EACH | \$579.00 | | 3 | A |
| 70-11147-00 | STEPPING MOTOR ASSEMBLY | EACH | REPLACED | | 3 A | 12-11563-00 | 70-12912-00 | CAP BRD BRKT ASSY | EACH | \$301.00 | Y | 3 | A |
| 70-11151-00 | FORM CONT CABLE ASSY | EACH | \$101.00 | | 3 A | | 70-12940-00 | SPINDLE BRAKE ASSY | EACH | \$109.00 | | 3 | A |
| 70-11164-00 | BACK PLANE ASSY (DD11-DK) | EACH | \$640.00 | Y | 3 A | | 70-13009-00 | TRANSDUCER SHUTTER ASSY | EACH | \$97.00 | | 3 | A |
| 70-11217-25 | CABLE CARD READER INTERFACE (| EACH | \$263.00 | | 3 A | | 70-13077-00 | FLEXIBLE DRIVE ASSY (60HZ) | EACH | \$2,362.00 | Y | 3 | A |
| 70-11231-00 | BRACKET BEZEL RETAINER ASSY | EACH | \$12.00 | | 3 A | | 70-13077-01 | FLEXIBLE DRIVE ASSY (50HZ) | EACH | \$2,362.00 | Y | 3 | A |
| 70-11411-0J | 3M CABLE CONSOLE/BACKPLANE | EACH | \$25.00 | | 3 A | | 70-13301-00 | FLEX STRIP ASSY | EACH | \$125.00 | | 3 | A |
| 70-11411-0K | 3M CABLES LSI-11 | EACH | \$27.00 | | 3 A | | 70-13323-00 | MOSS POWER SUPPLY 115V W/O BA | EACH | \$5,306.00 | | 3 | A |
| 70-11411-1A | CONSOLE/BACKPLANE CABLE 13" | EACH | \$32.00 | | 3 A | | 70-13339-00 | TU16J CONTROL SWITCH BOX | EACH | REPLACED | 3 | A | 70-16688-00 |
| 70-11411-1D | 3M CABLE FOR KY11-LB | EACH | \$36.00 | | 3 A | | 70-13370-0C | LAXX-RJ-RK CABLE 24COND 3" LG | EACH | \$37.00 | | 3 | A |
| 70-11446-00 | RIBBON DRIVE ASSEMBLY | EACH | \$102.00 | | 3 A | | 70-13454-00 | HANDLE ASSY. | EACH | \$23.00 | | 3 | A |
| 70-11447-00 | COVER WITH FOAM | EACH | \$46.00 | | 3 A | | 70-13574-00 | HEAD PLATE 9TK ASSY | EACH | \$2,172.00 | Y | 3 | A |
| 70-11486-00 | TRANSFORMER ASSY | EACH | \$393.00 | | 3 A | | 70-13578-00 | REEL MOTOR ASSEMBLY | EACH | \$896.00 | | 3 | A |
| 70-11519-01 | KEY BOARD CABLE | EACH | \$215.00 | | 3 A | | 70-13585-01 | TE 16 9 TRACK NARROW RADIUS | EACH | \$2,015.00 | Y | 3 | A |
| 70-11523-00 | BACKPLANE ASSY DD11-PK | EACH | \$848.00 | Y | 3 A | | 70-13585-02 | TE 16 7 TRACK NARROW RADIUS | EACH | \$2,032.00 | | 3 | A |
| 70-11530-00 | TAPE KIT ASSY | EACH | \$21.00 | | 3 A | | 70-13613-00 | THERMAL SENSOR CABLE ASSY (EX | EACH | \$137.00 | | 3 | A |
| 70-11569-00 | REGULATOR ASSY | EACH | \$601.00 | | 3 A | | 70-13625-00 | BACKPLANE ASSY (MEMORY) | EACH | \$898.00 | Y | 3 | A |
| 70-11629-00 | INDICATOR LAMP ASSY | EACH | \$6.00 | | 3 A | | 70-13628-00 | BACKPLANE ASSY (CPU) | EACH | \$1,670.00 | Y | 3 | A |
| 70-11668-00 | FILTER | EACH | \$38.00 | | 3 A | | 70-13784-00 | H7440 ASSY | EACH | REPLACED | 3 | A | H7440-00 |
| 70-11733-00 | HARNESS FAN | EACH | REPLACED | | 3 A | 70-11733-01 | 70-13785-00 | TRANSFORMER ASSY | EACH | \$194.00 | | 3 | A |
| 70-11733-01 | HARNESS FAN (MODIFIED) | EACH | \$20.00 | | 3 A | | 70-13789-00 | HARNESS ASSY | EACH | \$19.00 | | 3 | A |
| 70-11805-00 | TRANSFORMER ASSY | EACH | \$146.00 | | 3 A | | 70-13790-00 | CAPACITOR ASSY | EACH | \$27.00 | | 3 | A |
| 70-11828-00 | E1 INTERFACE LA36 | EACH | REPLACED | | 3 A | LAXX-LG | 70-13791-00 | LINE FILTER ASSY | EACH | \$207.00 | | 3 | A |
| 70-11877-00 | BATTERY PACK ASSY RK06 | EACH | \$78.00 | | 3 A | | 70-13855-00 | LINE FILTER ASSY | EACH | \$32.00 | | 3 | A |
| 70-11915-00 | CARRIAGE AND COIL ASSY (RK06) | EACH | \$413.00 | Y | 3 A | | 70-13859-00 | RIBBON CHASSIS ASSY | EACH | \$112.00 | | 3 | A |
| 70-11915-01 | CARRIAGE, COIL ASSY | EACH | \$382.00 | Y | 3 A | | 70-13859-01 | RIBBON CHASSIS ASSEMBLY | EACH | REPLACED | 3 | A | 70-13859-00 |

Prices Effective 02-January-89 to 30-June-89

To Order—Call DECdirect™ TOLL-FREE 800-344-4825, 8:30 a.m. to 8:00 p.m. ET in Continental U.S.A.

SPARES PRICE LIST A-57

HARDWARE SPARES PRICE LIST

| PART NUMBER | DESCRIPTION | UNIT ORDER | UNIT PRICE | REP D | L | REPLACEMENT PART NUMBER | PART NUMBER | DESCRIPTION | UNIT ORDER | UNIT PRICE | REP D | L | REPLACEMENT PART NUMBER |
|-------------|--------------------------------|------------|------------|-------|---|-------------------------|-------------|------------------------------|------------|------------|-------|---|-------------------------|
| 70-13859-02 | RIBBON CHASSIS ASSY LA120 | EACH | REPLACED | 3 | A | 70-13859-00 | 70-15273-00 | 20 MA-ADAPTER ASSY | EACH | \$114.00 | Y | 3 | A |
| 70-13910-00 | KEYBOARD ARRAY ASSY | EACH | \$39.00 | 3 | A | | 70-15276-01 | KEYBOARD BEZEL | EACH | REPLACED | Y | 3 | A |
| 70-13949-00 | UNIT ASSY | EACH | \$143.00 | 3 | A | | 70-15343-00 | SOLENOID ASSY. | EACH | \$36.00 | 3 | A | 70-17630-03 |
| 70-13967-00 | DRIVE MOTOR ASSEMBLY | EACH | \$62.00 | 3 | A | | 70-15386-0J | EIA CABLE (LA120) | EACH | \$50.00 | 3 | A | |
| 70-14014-00 | ARM ASSY TS04 | EACH | \$527.00 | 3 | A | | 70-15386-3F | EIA CABLE ASSY (LA00) | EACH | \$57.00 | 3 | A | |
| 70-14038-00 | I/O CABLE | EACH | \$50.00 | 3 | A | | 70-15387-00 | SWITCHES HARNESS ASSY | EACH | \$23.00 | Y | 3 | A |
| 70-14039-00 | I/O CABLE | EACH | \$76.00 | 3 | A | | 70-15388-00 | SERVO MOTOR ASSY | EACH | \$184.00 | Y | 3 | A |
| 70-14040-00 | P/S SENSOR CABLE | EACH | \$6.00 | 3 | A | | 70-15389-00 | STEPPING MOTOR CABLE ASSY | EACH | REPLACED | 3 | A | 70-15389-01 |
| 70-14094-MB | CABLE 20 COND 6 METERS | EACH | \$50.00 | 3 | A | | 70-15389-01 | STEPPING MOTOR ASSY | EACH | \$88.00 | 3 | A | |
| 70-14115-01 | 54-12610-01 LOGIC BOARD ASSY | EACH | REPLACED | Y | 3 | A | 54-12610-01 | LOGIC POWER CABLE ASSY | EACH | \$29.00 | 3 | A | |
| 70-14136-00 | TRANSDUCER & CONNECTOR ASSY | EACH | \$126.00 | 3 | A | | 70-15490-00 | PRINT HEAD ASSY, LA34 | EACH | \$200.00 | Y | 3 | A |
| 70-14167-00 | TRANSFORMER ASSY. | EACH | \$334.00 | 3 | A | | 70-15503-00 | 20MA LOOPBACK | EACH | \$13.00 | 3 | A | |
| 70-14193-00 | FAN ASSEMBLY | EACH | \$131.00 | 3 | A | | 70-15514-00 | KEYBOARD KEYCAP ASSY LA34-DA | EACH | \$128.00 | Y | 3 | A |
| 70-14251-00 | 70-14251 BATTERY BACKUP REGUL | EACH | \$1,923.00 | Y | 3 | A | 70-15514-03 | KEYBOARD KEYCAP ASSY LA34-AA | EACH | \$109.00 | Y | 3 | A |
| 70-14257-00 | BACKPLANE ASSY DDV11-CK | EACH | \$184.00 | Y | 3 | A | 70-15527-00 | OPERATOR SWITCH ASSY | EACH | \$8.00 | 3 | A | |
| 70-14274-00 | BOX CONTROLLER ASSY MK11 | EACH | \$203.00 | Y | 3 | A | 70-15581-00 | HOUSING ASSY LA120 | EACH | \$51.00 | 3 | A | |
| 70-14287-00 | AC MOTOR ASSY | EACH | \$124.00 | Y | 3 | A | 70-15622-00 | PLENUM/FAN ASSY 115 VAC | EACH | \$154.00 | 3 | A | |
| 70-14288-00 | TRANSDUCER ADMITTER ASSY | EACH | \$32.00 | 3 | A | | 70-15622-01 | PLENUM/FAN ASSY 230 VAC | EACH | \$96.00 | 3 | A | |
| 70-14290-00 | TRACK LOCATING TRANSDUCER ASSY | EACH | \$93.00 | 3 | A | | 70-15637-00 | RL02 DATA HEAD "A" UP | EACH | \$202.00 | Y | 3 | A |
| 70-14291-00 | STEPPER MOTOR ASSY | EACH | \$122.00 | 3 | A | | 70-15637-01 | RL02 DATA HEAD "A" DOWN | EACH | \$202.00 | Y | 3 | A |
| 70-14295-00 | DISK CORE ASSY | EACH | \$17.00 | 3 | A | | 70-15666-00 | LIMIT SW ASSY | EACH | \$74.00 | 3 | A | |
| 70-14297-00 | HANDLE ASSY | EACH | \$40.00 | 3 | A | | 70-15672-00 | PRINT HEAD CABLE ASSY | EACH | \$27.00 | 3 | A | |
| 70-14320-0E | AIR FLOW SENSOR ASSY | EACH | \$96.00 | Y | 3 | A | 70-15727-00 | PLATIN ASSY | EACH | REPLACED | 3 | A | 70-15727-02 |
| 70-14411-00 | BDN-DATA (METRIC) | EACH | \$175.00 | Y | 3 | A | 70-15727-02 | PLATEN ASSY LA100 | EACH | \$53.00 | 3 | A | |
| 70-14411-01 | RK07 DISK HEAD | EACH | \$175.00 | Y | 3 | A | 70-15730-00 | KEYBOARD BEZEL ASSY | EACH | \$149.00 | 3 | A | |
| 70-14411-02 | BDN-SERVO (METRIC) | EACH | \$175.00 | Y | 3 | A | 70-15733-00 | FRICTION ASSY | EACH | \$71.00 | 3 | A | |
| 70-14420-01 | INPUT BOXES | EACH | \$509.00 | Y | 3 | A | 70-15733-01 | FRICTION ASSY LA100 | EACH | \$46.00 | 3 | A | |
| 70-14420-02 | INPUT BOXES | EACH | \$609.00 | Y | 3 | A | 70-15734-00 | CARRIAGE ASSY | EACH | \$49.00 | 3 | A | |
| 70-14482-00 | SWITCH PANEL ASSY | EACH | \$359.00 | 3 | A | | 70-15735-00 | PULLEY IDLER ASSY | EACH | \$13.00 | 3 | A | |
| 70-14533-01 | LA120 PRINT MECH W/O HEAD | EACH | \$557.73 | Y | 3 | A | 70-15737-00 | SERVO MOTOR/ENCODER ASSY | EACH | REPLACED | Y | 3 | A |
| 70-14569-00 | BLOWER ASSY. | EACH | \$308.00 | 3 | A | | 70-15738-00 | BAIL BAR ASSY | EACH | \$23.00 | 3 | A | |
| 70-14583-00 | TRANSFORMER ASSY | EACH | \$263.00 | 3 | A | | 70-15739-00 | LOGIC/POWER CABLE ASSY | EACH | \$13.00 | 3 | A | |
| 70-14652-00 | CABLE ASSY POWER | EACH | \$46.00 | 3 | A | | 70-15740-00 | CABLE ASSY SERVO MOTOR | EACH | \$6.00 | 3 | A | |
| 70-14653-00 | KEYBOARD ASSEMBLY | EACH | \$457.00 | 3 | A | | 70-15741-00 | KEYBOARD CABLE ASSY | EACH | REPLACED | 3 | A | 70-15741-0K |
| 70-14653-03 | KEYBOARD ASSY | EACH | \$289.00 | 3 | A | | 70-15741-0K | CABLE KEYBOARD ASSY 9.01IN | EACH | \$25.00 | 3 | A | |
| 70-14654-02 | ENCLOSURE ASSY, TOP | EACH | \$12.00 | 3 | A | | 70-15744-00 | GEAR PULLEY CLUSTER ASSY | EACH | \$15.00 | 3 | A | |
| 70-14907-00 | BATTERY PACK ASSY | EACH | \$78.00 | 3 | A | | 70-15763-00 | KEYBOARD/KEYCAP ASSY | EACH | REPLACED | Y | 3 | A |
| 70-14956-00 | UDA OPTION SUPPLY 60HZ/120V | EACH | \$3,059.00 | Y | 3 | A | 70-15763-01 | KEYBOARD/T CAP ASSY | EACH | REPLACED | Y | 3 | A |
| 70-14956-01 | UDA OPTION SUPPLY 50HZ/240V | EACH | \$3,059.00 | Y | 3 | A | 70-15764-00 | KEY PAD/KEY CAP ASSY | EACH | REPLACED | Y | 3 | A |
| 70-14957-00 | MEM OPTION SUPPORT 60HZ/120V | EACH | \$3,686.00 | Y | 3 | A | 70-15764-01 | LAS12-CA NUMERIC PAD (GREY) | EACH | REPLACED | Y | 3 | A |
| 70-14957-01 | MEM OPTION SUPPORT 50HZ/240V | EACH | \$3,686.00 | Y | 3 | A | 70-15765-00 | KEYBOARD/KEYCAP ASSY | EACH | \$323.00 | Y | 3 | A |
| 70-14974-01 | ENCLOSURE CRT TOP ASSY | EACH | \$63.00 | 3 | A | | 70-15765-03 | KEYBOARD/KEYCAP ASSY | EACH | \$242.00 | Y | 3 | A |
| 70-14976-00 | WORT BOX ASSY | EACH | \$44.00 | 3 | A | | 70-15765-04 | VT132 KEYBOARD MODULE | EACH | \$236.00 | Y | 3 | A |
| 70-14978-01 | PWR CABLE ASSY, VT100 | EACH | REPLACED | 3 | A | 70-14978-03 | 70-15765-10 | KEYBOARD/KEYCAP ASSY | EACH | \$397.00 | Y | 3 | A |
| 70-14978-03 | POWER CABLE ASSY VT100 | EACH | \$86.00 | 3 | A | | 70-15765-11 | KEYBOARD/KEYCAP ASSY | EACH | \$397.00 | Y | 3 | A |
| 70-14979-00 | POWER SUPPLY ASSY | EACH | \$865.00 | Y | 3 | A | 70-16165-0K | CABLE, 24 COND. DIP SOCKET | EACH | \$30.00 | 3 | A | |
| 70-14980-03 | BASE ENCLOSURE ASSY | EACH | \$56.00 | 3 | A | | 70-16215-00 | GROUND BRUSH ASSY | QTY OF 10 | REPLACED | 3 | A | 70-23215-01 |
| 70-15023-00 | PRINTER MECH ASSY | EACH | \$1,076.00 | 3 | A | | 70-16225-00 | HEAD DISK ASSY | EACH | \$6,170.00 | Y | 3 | A |
| 70-15050-00 | SPACE BAR ASSY | EACH | \$4.00 | 3 | A | | 70-16230-00 | WING PIVOT ASSY | EACH | \$25.00 | 3 | A | |
| 70-15053-00 | EMI FILTER ASSEMBLY | EACH | \$92.00 | 3 | A | | 70-16260-00 | LA34/LA38 PAPER TRACTORS | EACH | REPLACED | 3 | A | LA10X-EL |
| 70-15116-00 | SPINDLE ASSY | EACH | \$431.00 | Y | 3 | A | 70-16279-00 | CABLE ASSY RECEPTACLE | EACH | \$11.00 | 3 | A | |
| 70-15168-00 | POWER ENTRY BRKT ASSY (CVT) | EACH | \$89.00 | 3 | A | | 70-16303-00 | PRINT HEAD ADJUST ASSY | EACH | \$5.00 | 3 | A | |
| 70-15230-00 | TRANSFORMER ASSY | EACH | REPLACED | 3 | A | 16-23370-01 | 70-16478-00 | AC CABLE ASSY | EACH | \$196.00 | 3 | A | |
| 70-15230-01 | XFMR ASSY 240V | EACH | \$126.00 | 3 | A | | 70-16478-01 | 2201 H7140 AB, AC, CABLE | EACH | \$116.00 | 3 | A | |
| 70-15266-00 | XFMR ASSY 115V/60HZ, 240/50HZ | EACH | \$119.00 | 3 | A | | 70-16485-00 | CONSOLE | EACH | REPLACED | 3 | A | 54-13795-00 |



Prices Effective 02-January-89 to 30-June-89
 To Order—Call DECdirect™ TOLL-FREE 800-344-4825, 8:30 a.m. to 8:00 p.m. ET in Continental U.S.A.

HARDWARE SPARES PRICE LIST

| PART NUMBER | DESCRIPTION | UNIT ORDER | UNIT PRICE | REP D | L | REPLACEMENT PART NUMBER | PART NUMBER | DESCRIPTION | UNIT ORDER | UNIT PRICE | REP D | L | REPLACEMENT PART NUMBER | |
|-------------|-------------------------------|------------|------------|-------|---|-------------------------|-------------|-------------------------------|------------|------------|-------|---|-------------------------|-------------|
| 70-16486-00 | BACKPLANE | EACH | \$1,402.00 | Y | 3 | A | 70-17454-YA | CABLE FONT SELECT | EACH | \$14.00 | 3 | A | | |
| 70-16502-00 | 11/44 BACK PLANE ASSY | EACH | \$1,168.00 | | 3 | A | 70-17514-00 | BEZEL KEYBD INTERFACE (R.O.) | EACH | \$119.00 | 3 | A | | |
| 70-16530-00 | PWR ENTRY ASSY "SWITCHER" | EACH | \$121.00 | | 3 | A | 70-17599-00 | SWITCH PANEL ASSY (UPPER) | EACH | \$120.00 | 3 | A | | |
| 70-16537-00 | CABLE ASSY POWER SUPPLY | EACH | \$26.00 | | 3 | A | 70-17626-00 | RIBBON CHASIS ASSY LA120 | EACH | \$101.00 | 3 | A | | |
| 70-16558-00 | HEAD AND BASE ASSY | EACH | \$153.00 | | 3 | A | 70-17628-00 | INTERLOCK SWITCH ASSEMBLY | EACH | REPLACED | 3 | A | 70-17628-03 | |
| 70-16653-00 | NUM. KEYPAD LA34/38 OPT. ASSY | EACH | REPLACED | | 3 | A | 70-17628-03 | INTERLOCK SWITCH ASSY | EACH | \$13.00 | 3 | A | | |
| 70-16653-02 | NUMERIC KEYPAD OPTION ASSY | EACH | \$88.00 | | 3 | A | 70-17628-04 | INTERLOCK SWITCH ASSY | EACH | REPLACED | 3 | A | 70-17628-03 | |
| 70-16659-00 | READ/WRITE INTERLOCK ASSY | EACH | \$113.00 | | 3 | A | 70-17630-00 | KEYBOARD, KEYCAP ASSY | EACH | \$139.00 | 3 | A | | |
| 70-16677-00 | CAPSTAN MOTOR ASSEMBLY | EACH | \$541.00 | | 3 | A | 70-17630-01 | KEYBOARD/CAP ASSY | EACH | \$210.00 | Y | 3 | A | |
| 70-16687-00 | VACUUM ASSEMBLY | EACH | \$683.00 | Y | 3 | A | 70-17630-03 | KEYBOARD CAP ASSEMBLY | EACH | \$215.00 | Y | 3 | A | |
| 70-16688-00 | CONTROL BOX ASSY | EACH | \$202.00 | | 3 | A | 70-17740-01 | SPINDLE ASSEMBLY | EACH | \$2,191.00 | Y | 3 | A | |
| 70-16711-00 | TRANS/CAP POWER SUPPLY ASSY | EACH | \$1,887.00 | Y | 3 | A | 70-17742-01 | AIR FILTER ASSEMBLY | EACH | \$134.00 | 3 | A | | |
| 70-16713-00 | CABLE ASSY, PAPER OUT | QTY OF 10 | REPLACED | | 3 | A | 70-17853-00 | PLATE SIDE ASSY (RIGHT HAND) | EACH | \$109.00 | 3 | A | | |
| 70-16713-1A | CABLE ASSY PAPER OUT | QTY OF 10 | \$4.00 | | 3 | A | 70-17858-00 | CARRIAGE BEARING ASSY | EACH | REPLACED | 3 | A | 70-17859-01 | |
| 70-16723-02 | LOW VOLTAGE 60HZ | EACH | \$516.00 | Y | 3 | A | 70-17859-00 | CARRIAGE ASSY | EACH | REPLACED | 3 | A | 70-17859-01 | |
| 70-16723-03 | HIGH VOLTAGE 50HZ | EACH | \$516.00 | | 3 | A | 70-17859-01 | CARRIAGE ASSEMBLY | EACH | \$134.00 | 3 | A | | |
| 70-16724-00 | ACTUATOR ASSY. | EACH | \$40.00 | | 3 | A | 70-17863-00 | KEYBOARD/KEYCAP ASSY | EACH | REPLACED | Y | 3 | A | 70-17863-01 |
| 70-16732-00 | LOGIC DC POWER HARNESS ASSY | EACH | \$111.00 | | 3 | A | 70-17863-01 | KEYBOARD/KEYCAP ASSY KSR | EACH | \$246.00 | Y | 3 | A | |
| 70-16733-00 | LOGIC AC HARNESS | EACH | \$55.00 | | 3 | A | 70-17878-00 | LINE FILTER ASSY | EACH | REPLACED | 3 | A | 70-17878-01 | |
| 70-16733-01 | LOGIC AC HARNESS | EACH | \$61.00 | | 3 | A | 70-17878-01 | LINE FILTER ASSY. | EACH | \$63.00 | 3 | A | | |
| 70-16735-00 | SERVO PRE-AMP CABLE ASSY | EACH | \$37.00 | | 3 | A | 70-17886-00 | KEYBD INTERFACE/KEYCAPS ASSY | EACH | \$88.00 | 3 | A | | |
| 70-16737-00 | DATA 40 CABLE ASSY | EACH | \$38.00 | | 3 | A | 70-17914-00 | SOLENOID ASSY. | EACH | \$62.00 | 3 | A | | |
| 70-16737-01 | RA80 DATA 40 CABLE ASSY. | EACH | \$74.00 | | 3 | A | 70-17940-00 | PULLEY IDLER ASSY | EACH | \$39.00 | 3 | A | | |
| 70-16738-00 | DATA 20 CABLE ASSY | EACH | \$30.00 | | 3 | A | 70-17966-00 | ENCODER DISK ASSY | EACH | \$5.00 | 3 | A | | |
| 70-16738-01 | RA80 DATA 20 CABLE ASSY | EACH | \$40.00 | | 3 | A | 70-17968-00 | FRICTION FEED ASSY. | EACH | \$62.00 | 3 | A | | |
| 70-16739-00 | READ/WRITE CABLE ASSY | EACH | \$59.00 | | 3 | A | 70-17973-00 | BAIL BAR ASSY | EACH | \$19.00 | 3 | A | | |
| 70-16740-00 | CONTROL PANEL CABLE ASSY | EACH | \$45.00 | | 3 | A | 70-18079-00 | CONSOLE ASSY TU58 | EACH | \$250.00 | 3 | A | | |
| 70-16799-00 | KEYPAD ASSY LA120 R/O BROWN | EACH | \$170.00 | Y | 3 | A | 70-18080-00 | 11730-Z BACKPLANE ASSY | EACH | \$600.00 | 3 | A | | |
| 70-16810-00 | FAN+SHIELD ASSY VT103 | EACH | REPLACED | | 3 | A | 70-18117-00 | TWIN AIRFLOW SENSOR ASSY. | EACH | \$135.00 | 3 | A | | |
| 70-16894-00 | TIME OF YEAR BATTERY | EACH | \$69.00 | | 3 | A | 70-18324-00 | OPERATOR CONTROL PANEL ASSY. | EACH | \$282.00 | 3 | A | | |
| 70-16905-00 | 1124-L BACKPLANE ASSY | EACH | \$527.00 | | 3 | A | 70-18327-00 | PERSONALITY BD/STIFFENER ASSY | EACH | \$1,168.00 | Y | 3 | A | |
| 70-16925-00 | SUP UBA OPT W/+15V 60HZ/120V | EACH | \$3,102.00 | | 3 | A | 70-18331-01 | RA81. HHT LEADS | EACH | \$125.00 | 3 | A | | |
| 70-16940-00 | A.C. FILTER BOX ASSY. | EACH | \$768.00 | | 3 | A | 70-18332-01 | HOME SWITCH ASSEMBLY | EACH | \$107.00 | 3 | A | | |
| 70-16940-01 | OEM FILTER | EACH | \$652.00 | | 3 | A | 70-18340-01 | I/O BULKHEAD DRIVE | EACH | REPLACED | 3 | A | 70-18340-02 | |
| 70-16958-01 | 11/24 10.25 CONSOLE ASSY. | EACH | \$240.00 | | 3 | A | 70-18340-02 | I/O BULKHEAD DRIVE RA81/RA60 | EACH | \$247.00 | 3 | A | | |
| 70-16976-00 | SERVO BD/STIFFENER ASSY | EACH | \$775.00 | Y | 3 | A | 70-18349-01 | MONITOR ASSY.CRT.DIRECT DRIVE | EACH | \$180.00 | 3 | A | | |
| 70-16979-00 | I/O 60 CABLE ASSY | EACH | \$57.00 | | 3 | A | 70-18377-1E | PRINT HEAD CABLE ASSY | EACH | \$124.00 | 3 | A | | |
| 70-16980-00 | BELT TENSION SWITCH HARNESS | EACH | \$55.00 | | 3 | A | 70-18377-1F | PRINT HEAD CABLE ASSY | EACH | REPLACED | 3 | A | 70-18377-1E | |
| 70-16991-00 | SWITCH COVER ASSY. | EACH | \$186.00 | | 3 | A | 70-18396-YA | CABLE SPECIAL 16 PIN | EACH | \$26.00 | 3 | A | | |
| 70-17043-00 | STEPPER MOTOR SUB-ASSY | EACH | \$156.00 | | 3 | A | 70-18406-0H | KEYBRD CABLE ASSY LA12 | EACH | \$23.00 | 3 | A | | |
| 70-17051-00 | BRKT KEYBOARD ASSY | EACH | \$116.00 | Y | 3 | A | 70-18407-1E | EIA INTERNAL CABLE LA12 | EACH | \$50.00 | 3 | A | | |
| 70-17121-01 | TM78 POWER SUPPLY (240V) | EACH | REPLACED | | 3 | A | 70-18409-00 | PRINT HEAD ASSY (UPH) | EACH | REPLACED | Y | 3 | A | 70-19655-01 |
| 70-17141-00 | FAN ASSEMBLY FORMATTER | EACH | \$216.00 | | 3 | A | 70-18410-00 | INTERLOCK SENSOR CABLE | EACH | \$15.00 | 3 | A | | |
| 70-17149-00 | AC INPUT BOX ASSY VT101 | EACH | REPLACED | | 3 | A | 70-18411-00 | POWER ENTRY ASSY. | EACH | \$101.00 | 3 | A | | |
| 70-17189-0L | MONITOR CABLE | EACH | \$20.00 | | 3 | A | 70-18431-00 | KEYBOARD/KEYCAP ASSY. | EACH | REPLACED | Y | 3 | A | 70-18431-01 |
| 70-17362-00 | MONITOR P.C.B. ASSY | EACH | REPLACED | | 3 | A | 70-18431-01 | KEYBOARD/KEYCAP ASSY | EACH | \$213.00 | Y | 3 | A | |
| 70-17362-01 | MONITOR PC BD ASSY/EMITTER | EACH | \$158.00 | Y | 3 | A | 70-18432-00 | BOTTOM, ENCLOSURE ASSY | EACH | \$83.00 | 3 | A | | |
| 70-17363-00 | FLYBACK + CHOKE ASSY | EACH | REPLACED | | 3 | A | 70-18439-00 | TOP, ENCLOSURE ASSY | EACH | \$73.00 | 3 | A | | |
| 70-17363-01 | FLYBACK AND CHOKE ASSEMBLY | EACH | \$33.00 | | 3 | A | 70-18447-00 | 40-PIN FLAT CABLE ASSY. | EACH | \$48.00 | 3 | A | | |
| 70-17364-00 | CRT + YOKE ASSY | EACH | \$126.00 | | 3 | A | 70-18448-00 | 50-PIN FLAT CABLE ASSY. | EACH | \$45.00 | 3 | A | | |
| 70-17374-00 | P.S. BD + AC INPUT BOX ASSY | EACH | \$205.00 | Y | 3 | A | 70-18452-01 | POSITIONER ASSEMBLY | EACH | \$7,246.00 | Y | 3 | A | |
| 70-17382-08 | FLAT CABLE ASSY, 8 FT. | EACH | REPLACED | | 3 | A | 70-18455-6K | UDA BHD SDI CABLE ASSY | EACH | REPLACED | 3 | A | 17-00463-01 | |
| 70-17382-15 | CABLE, FLAT 15 FT. | EACH | REPLACED | | 3 | A | 70-18461-01 | PINION DATA HEAD (A-UP) | EACH | \$303.00 | 3 | A | | |
| 70-17391-0F | CABLE INTERNAL 20MA-ADAPTER | EACH | \$17.00 | | 3 | A | 70-18461-02 | PINION DATA HEAD (A-DOWN) | EACH | \$303.00 | 3 | A | | |
| 70-17454-0C | FONT SELECT LA100 | EACH | REPLACED | | 3 | A | 70-18461-03 | PINION DATA HEAD (B-UP) | EACH | \$303.00 | 3 | A | | |

digital

Prices Effective 02-January-89 to 30-June-89

To Order—Call DECdirect™ TOLL-FREE 800-344-4825, 8:30 a.m. to 8:00 p.m. ET in Continental U.S.A.

HARDWARE SPARES PRICE LIST

| PART NUMBER | DESCRIPTION | UNIT ORDER | UNIT PRICE | REP D | L | REPLACEMENT PART NUMBER | PART NUMBER | DESCRIPTION | UNIT ORDER | UNIT PRICE | REP D | L | REPLACEMENT PART NUMBER |
|-------------|-------------------------------|------------|------------|-------|-----|-------------------------|-------------|-------------------------------|------------|------------|-------|-----|-------------------------|
| 70-18461-04 | PINION DATA HEAD (B-DOWN) | EACH | \$303.00 | | 3 A | | 70-19505-01 | TOP ENC. ASSY W/FILLER PLATE | EACH | \$50.00 | | 3 A | |
| 70-18473-01 | SWITCH PLATE ASSEMBLY | EACH | \$255.00 | | 3 A | | 70-19506-00 | SWITCH ASSY, H7863 | EACH | \$111.00 | | 3 A | |
| 70-18474-01 | POWER MODULE ASSEMBLY | EACH | \$1,783.00 | Y | 3 A | | 70-19524-00 | WIRE FORM BRKT WELDMENT | EACH | \$6.00 | | 3 A | |
| 70-18476-01 | CAPACITOR/RECTIFIER ASSEMBLY | EACH | \$593.00 | Y | 3 A | | 70-19552-00 | FAN ASSY | EACH | \$219.00 | | 3 A | |
| 70-18477-01 | TRANSFORMER ASSEMBLY | EACH | \$726.00 | | 3 A | | 70-19573-00 | ENCLOSURE BOTTOM ASSY. | EACH | \$53.00 | | 3 A | |
| 70-18487-6B | SI CABLE,INTERNAL ASSY. | EACH | REPLACED | | 3 A | 17-00465-03 | 70-19578-03 | BEZEL ASSEMBLY | EACH | \$151.00 | | 3 A | |
| 70-18491-01 | HEAD/DISK ASSEMBLY | EACH | \$5,882.00 | Y | 3 A | | 70-19578-04 | BEZEL ASSEMBLY | EACH | \$151.00 | | 3 A | |
| 70-18491-02 | HEAD/DISK ASSEMBLY (18BIT) | EACH | \$5,882.00 | Y | 3 A | | 70-19578-05 | BEZEL ASSEMBLY | EACH | \$151.00 | | 3 A | |
| 70-18491-03 | HEAD/DISK ASSEMBLY WITH COMP | EACH | REPLACED | | 3 A | 70-18491-01 | 70-19579-00 | REAR COVER ASSY | EACH | \$48.00 | | 3 A | |
| 70-18491-04 | HEAD/DISK ASSY WITH COMP | EACH | REPLACED | | 3 A | 70-18491-02 | 70-19584-00 | MONITOR BOARD ASSY | EACH | \$175.00 | Y | 3 A | |
| 70-18526-1A | CABLE ASSY (C1780) | EACH | \$131.00 | | 3 A | | 70-19655-01 | PRINT HEAD ASSEMBLY LAMINATED | EACH | \$208.00 | Y | 3 A | |
| 70-18526-3A | CABLE ASSY (C1780) | EACH | \$218.00 | | 3 A | | 70-19659-01 | SMUDGE GUARD ASSEMBLY | EACH | \$6.00 | | 3 A | |
| 70-18526-8A | BULK HEAD CABLE C1780 | EACH | \$119.00 | | 3 A | | 70-19676-01 | BACKPLANE/CHASSIS BULKHD CBL | EACH | \$133.00 | | 3 A | |
| 70-18530-00 | 8/16 JUMPER CABLE | EACH | \$76.00 | | 3 A | | 70-19677-01 | BEZEL/CHASSIS BULKHEAD CABLE | EACH | \$130.00 | | 3 A | |
| 70-18600-00 | ANTI BACKLASH GEAR | EACH | \$20.00 | | 3 A | | 70-19677-01 | B/P TO STD P/S INTERCONNECT | EACH | \$113.00 | | 3 A | |
| 70-18602-00 | REAR PAPER ROLLER LA100 | EACH | \$8.00 | | 3 A | | 70-19684-01 | B/P TO P/S (-5VOLT/GND) CABLE | EACH | \$74.00 | | 3 A | |
| 70-18639-00 | HEAD LEVER SLIDE ASSEMBLY | QTY OF 10 | \$4.00 | | 3 A | | 70-19685-01 | B/P TO P/S (GND) CABLE | EACH | \$32.00 | | 3 A | |
| 70-18677-00 | TE16 PULSE SUPPRESSOR | QTY OF 10 | \$4.00 | | 3 A | | 70-19686-01 | POWER SUPPLY AC LINE CORD | EACH | \$50.00 | | 3 A | |
| 70-18696-00 | PLATEN ASSY | EACH | \$64.00 | | 3 A | | 70-19686-02 | PWR SUPPLY LINE CORD 240V 50H | EACH | \$50.00 | | 3 A | |
| 70-18703-00 | CARRIAGE ASSY | EACH | REPLACED | | 3 A | 70-18703-01 | 70-19686-08 | CABLE, DRIVE SEQ SHIELDED 8' | EACH | \$99.00 | | 3 A | |
| 70-18703-01 | CARRIAGE ASSEMBLY | EACH | \$89.00 | | 3 A | | 70-19690-12 | CABLE, DRIVE SEQ SHIELDED 12' | EACH | \$103.00 | | 3 A | |
| 70-18704-00 | PRINTER MECH ASSY | EACH | \$515.00 | Y | 3 A | | 70-19692-01 | PLUG | EACH | \$57.00 | | 3 A | |
| 70-18707-00 | SERVO MOTOR/ENCODER ASSY | EACH | REPLACED | | 3 A | 70-18960-00 | 70-19695-03 | LOGIC COVER ASSEMBLY (R80) | EACH | \$356.00 | | 3 A | |
| 70-18759-00 | SUPPLY +5V MEMORY OPT | EACH | \$3,059.00 | Y | 3 A | | 70-19706-0M | BACKPLANE TO BULKHEAD SI CAB | EACH | \$114.00 | | 3 A | |
| 70-18759-01 | SUPPLY +5V MEMORY OPT | EACH | \$3,059.00 | Y | 3 A | | 70-19713-01 | SEQUENCE BOX ASSEMBLY | EACH | \$108.00 | | 3 A | |
| 70-18762-00 | POWER SUPPLY ASSY | EACH | \$1,608.00 | Y | 3 A | | 70-19777-00 | FAN WIRE HARNESS ASSY | EACH | \$53.00 | | 3 A | |
| 70-18763-00 | AC INPUT ASSY | EACH | \$468.00 | | 3 A | | 70-19885-01 | FILTER LINE ASSY 50HZ | EACH | \$387.00 | | 3 A | |
| 70-18864-00 | SERVO MOTOR ENCODER ASSY. | EACH | \$142.00 | | 3 A | | 70-19936-00 | LINE FILTER ASSY | EACH | REPLACED | | 3 A | 70-19936-01 |
| 70-18960-00 | SERVO MOTOR/ENCODER ASSY. | EACH | \$141.00 | Y | 3 A | | 70-19936-01 | LINE FILTER ASSY. | EACH | \$55.00 | | 3 A | |
| 70-18977-2D | CABLE SHIELDED | EACH | \$46.00 | | 3 A | | 70-19973-00 | CPU ASSY, DECMATE | EACH | \$1,664.00 | Y | 3 A | |
| 70-18981-00 | PAN ASSY | EACH | \$172.00 | | 3 A | | 70-19974-00 | CPU ASSY, RAINBOW 100 | EACH | \$1,129.00 | Y | 3 A | |
| 70-19002-00 | PULLEY, SLEEVE ASSEMBLY | QTY OF 10 | REPLACED | | 3 A | 70-17859-01 | 70-19974-02 | CPU ASSY, RAIN 100B LANG CL1 | EACH | \$1,129.00 | Y | 3 A | |
| 70-19004-00 | KEYBOARD CHASSIS ASSY | EACH | \$97.00 | | 3 A | | 70-20033-01 | POWER SUPPLY ASSY (STD) 60HZ | EACH | \$5,678.00 | Y | 3 A | |
| 70-19005-00 | KEYCAP SET WITH U.S. LEGENDS | EACH | REPLACED | | 3 A | 70-21081-53 | 70-20033-02 | STD PWR SUPP ASSY 240V 50HZ | EACH | \$5,678.00 | Y | 3 A | |
| 70-19045-01 | SERVO BD AND STIFF ASSEMBLY | EACH | \$2,511.00 | Y | 3 A | | 70-20033-03 | STANDARD POWER SUPPLY ASSY | EACH | \$5,678.00 | Y | 3 A | |
| 70-19046-01 | PERSONALITY BD AND STIFF ASSY | EACH | \$1,435.00 | Y | 3 A | | 70-20033-04 | STANDARD POWER SUPPLY ASSY | EACH | \$5,678.00 | Y | 3 A | |
| 70-19049-01 | LOGIC CABLE | EACH | \$38.00 | | 3 A | | 70-20184-01 | POWER SUPPLY ASSY,120V 60HZ | EACH | \$2,969.00 | Y | 3 A | |
| 70-19052-01 | OPERATOR CONTROL PANEL CABLE | EACH | \$44.00 | | 3 A | | 70-20184-02 | POWER SUPP ASSY 240V 50HZ | EACH | \$2,969.00 | Y | 3 A | |
| 70-19053-01 | PRE/POST AMP INTERCONN. CABLE | EACH | \$46.00 | | 3 A | | 70-20191-01 | OUTLET DUCT ASSEMBLY | EACH | \$279.00 | | 3 A | |
| 70-19054-01 | POSITIONER POWER HARNESS | EACH | \$25.00 | | 3 A | | 70-20266-00 | SWITCH, PANEL ASSY. | EACH | \$293.00 | | 3 A | |
| 70-19055-01 | DC SPINDLE MOTOR POWER HARNES | EACH | \$13.00 | | 3 A | | 70-20309-00 | BEZEL ASSEMBLY | EACH | \$667.00 | | 3 A | |
| 70-19056-01 | DC SPINDLE MOTOR POWER HARNES | EACH | \$46.00 | | 3 A | | 70-20579-02 | BACKPLANE ASSY CPU | EACH | \$2,959.00 | Y | 3 A | |
| 70-19057-01 | DC POWER HARNESS | EACH | \$55.00 | | 3 A | | 70-20613-01 | POWER CONTROLLER ASSY, 50HZ | EACH | \$1,996.00 | | 3 A | |
| 70-19058-01 | DC UNREGULATED HARNESS | EACH | \$61.00 | | 3 A | | 70-20622-04 | BEZEL ASSEMBLY | EACH | REPLACED | | 3 A | 70-20622-20 |
| 70-19060-01 | DATA 26 CABLE ASSEMBLY | EACH | \$65.00 | | 3 A | | 70-20622-05 | BEZEL ASSEMBLY | EACH | REPLACED | | 3 A | 70-20622-21 |
| 70-19074-01 | PLUG LOOP BACK | EACH | \$33.00 | | 3 A | | 70-20622-06 | BEZEL ASSEMBLY | EACH | REPLACED | | 3 A | 70-20622-22 |
| 70-19122-00 | POWER CONTROLLER ASSY, 60HZ | EACH | \$1,748.00 | | 3 A | | 70-20622-20 | BEZEL ASSEMBLY | EACH | \$193.00 | | 3 A | |
| 70-19143-00 | A.C. FILTER ASSY H7863 | EACH | \$175.00 | | 3 A | | 70-20622-21 | BEZEL ASSEMBLY | EACH | \$193.00 | | 3 A | |
| 70-19193-01 | BACKPLANE ASSY, MEMORY | EACH | \$1,672.00 | | 3 A | | 70-20622-22 | BEZEL ASSEMBLY | EACH | \$193.00 | | 3 A | |
| 70-19194-00 | BACKPLANE ASSY, I/O | EACH | \$3,913.00 | | 3 A | | 70-20624-01 | MONITOR, PWR SUPPLY BOARD | EACH | \$223.00 | Y | 3 A | |
| 70-19195-01 | BACKPLANE ASSY, ABUS | EACH | \$1,801.00 | | 3 A | | 70-20625-01 | REAR COVER ASSY | EACH | REPLACED | | 3 A | 70-20625-02 |
| 70-19198-01 | BACKPLANE ASSY, CPU | EACH | \$4,786.00 | | 3 A | | 70-20625-02 | REAR COVER ASSY. | EACH | \$63.00 | | 3 A | |
| 70-19276-00 | CONSOLE DIST. PNL ASSY | EACH | \$667.00 | | 3 A | | 70-20650-01 | BACKPLANE, WIRED ASSY | EACH | \$878.00 | | 3 A | |
| 70-19499-00 | CHASSIS ASSEMBLY | EACH | REPLACED | Y | 3 A | 70-19499-01 | 70-20681-01 | SERVO MOTOR/HOUSING ASSY | EACH | \$113.00 | | 3 A | |
| 70-19499-01 | CHASSIS ASSY | EACH | \$433.00 | Y | 3 A | | 70-20684-01 | PLATEN ASSY | EACH | \$75.00 | | 3 A | |



Prices Effective 02-January-89 to 30-June-89

To Order—Call DECdirect™ TOLL-FREE 800-344-4825, 8:30 a.m. to 8:00 p.m. ET in Continental U.S.A.

HARDWARE SPARES PRICE LIST

| PART NUMBER | DESCRIPTION | UNIT ORDER | UNIT PRICE | REP D | L | REPLACEMENT PART NUMBER | PART NUMBER | DESCRIPTION | UNIT ORDER | UNIT PRICE | REP D | L | REPLACEMENT PART NUMBER |
|-------------|-------------------------------|------------|-------------|-------|---|-------------------------|-------------|-------------------------------|------------|-------------|-------|---|-------------------------|
| 70-20685-01 | CARRIAGE ASSY. | EACH | \$154.00 | | 3 | A | 70-22617-02 | CRT/CHASSIS/BEZEL ASSY, GRN | EACH | \$361.00 | | 3 | A |
| 70-20689-01 | MODULE ACCESS DOOR ASSEMBLY | EACH | \$419.00 | Y | 3 | A | 70-22617-03 | CRT/CHASSIS/BEZEL ASSY, AMB | EACH | \$368.00 | | 3 | A |
| 70-20693-01 | PRINTER MECH ASSY | EACH | \$376.00 | | 3 | A | 70-22623-04 | ROM CARTRIDGE VT330/340 | EACH | \$190.00 | | 3 | A |
| 70-20772-01 | FLYBACK ASSY | EACH | \$32.00 | | 3 | A | 70-22859-01 | LINE FILTER ASSY. | EACH | \$71.00 | | 3 | A |
| 70-20773-01 | LED ASSY | QTY OF 10 | \$2.00 | | 3 | A | 70-22939-01 | BLOWER/BEZEL ASSY RA90 | EACH | \$1,000.00 | | 3 | A |
| 70-20779-01 | RCD51-CA DISK CONTR. ASSY. | EACH | \$1,609.00 | Y | 3 | A | 70-22942-01 | ELECTRONIC CONTROL MODULERA90 | EACH | \$7,067.58 | Y | 3 | A |
| 70-20797-01 | TOP COVER ASSEMBLY | EACH | \$43.00 | | 3 | A | 70-22951-01 | HDA/CARRIER ASSY(RA90) | EACH | \$18,892.00 | Y | 3 | A |
| 70-20800-01 | BASE HOUSING ASSEMBLY | EACH | \$56.00 | | 3 | A | 70-23098-01 | BACKPLANE ASSY, CPU | EACH | \$8,899.00 | | 3 | A |
| 70-20805-01 | HEAD CABLE ASSEMBLY | EACH | \$90.00 | | 3 | A | 70-23099-01 | BACKPLANE ASSY, MEMORY | EACH | REPLACED | | 3 | A |
| 70-20810-01 | ROM CHIMNEY ASSEMBLY | EACH | \$76.00 | | 3 | A | 70-23138-01 | OC/BEZEL ASSEMBLY | EACH | \$337.00 | | 3 | A |
| 70-20811-01 | PLATEN ASSY | EACH | \$76.00 | | 3 | A | 70-23194-01 | GROUND BRUSH ASSEMBLY RA90 | EACH | \$22.00 | | 3 | A |
| 70-20814-01 | TCB BEZEL ASSY | EACH | REPLACED | Y | 3 | A | 70-23210-01 | BRAKE ASSY RA90 | EACH | \$149.00 | | 3 | A |
| 70-20814-02 | TERM. CONTROL BD. BEZEL ASSY | EACH | \$522.00 | Y | 3 | A | 70-23215-01 | GROUND BRUSH ASSEMBLY | EACH | \$13.00 | | 3 | A |
| 70-20816-01 | FAN ASSEMBLY | EACH | \$107.00 | | 3 | A | 70-23297-01 | I/O BOARD ASSY. | EACH | \$1,240.00 | Y | 3 | A |
| 70-21081-53 | KEYCAP SET WITH U.S LEGENDS | EACH | \$40.00 | | 3 | A | 70-23300-01 | CRT/BEZEL ASSY. | EACH | \$275.00 | | 3 | A |
| 70-21127-01 | BASE PLATE CHASSIS ASSY | EACH | \$7,164.00 | Y | 3 | A | 70-23300-02 | CRT/BEZEL ASSY. | EACH | \$284.00 | | 3 | A |
| 70-21151-01 | CONTROL PANEL ARRAY ASSY | EACH | \$48.00 | | 3 | A | 70-23351-01 | CABLE HOLDER KIT | EACH | \$20.00 | | 3 | A |
| 70-21168-01 | FAN HOLDER ASSEMBLY | EACH | \$270.00 | | 3 | A | 70-23360-01 | CRT CHASSIS ASSY | EACH | \$360.00 | | 3 | A |
| 70-21170-01 | HEAD/DISK ASSEMBLY (16 BIT) | EACH | \$6,896.16 | Y | 3 | A | 70-23360-02 | CRT, CHASSIS ASSY, GREEN | EACH | \$360.00 | | 3 | A |
| 70-21171-01 | CHASSIS SUB ASSEMBLY | EACH | \$575.00 | | 3 | A | 70-23360-03 | CRT, CHASSIS ASSY, AMBER | EACH | \$360.00 | | 3 | A |
| 70-21173-01 | MOTOR/BRAKE ASSEMBLY (60HZ) | EACH | \$648.00 | | 3 | A | 70-23361-01 | MONITOR, PWR SUPPLY BOARD | EACH | \$327.00 | Y | 3 | A |
| 70-21173-02 | MOTOR/BRAKE ASSEMBLY (50HZ) | EACH | \$648.00 | | 3 | A | 70-23362-01 | TRANSFORMER ASSY | EACH | \$101.00 | | 3 | A |
| 70-21184-01 | LINE FILTER ASSY, 60 HZ | EACH | \$287.00 | | 3 | A | 70-23363-01 | TERMINAL CONTROLLER BOARD | EACH | \$366.00 | Y | 3 | A |
| 70-21225-01 | ANTI-BACKLASH GEAR ASSEMBLY | EACH | \$20.00 | | 3 | A | 70-23417-01 | PLATE ASSY, MOUNTING | EACH | \$149.00 | | 3 | A |
| 70-21241-01 | INTERLOCK SWITCH ASSEMBLY | EACH | \$18.00 | | 3 | A | 70-23417-02 | PLATE ASSY, MOUNTING | EACH | \$121.00 | | 3 | A |
| 70-21249-01 | INTERMEDIATE COVER ASSEMBLY | EACH | \$70.00 | | 3 | A | 70-23573-01 | BACKPLANE ASSY, CPU-XA | EACH | \$8,586.00 | | 3 | A |
| 70-21266-01 | REAR BULKHEAD ASSY | EACH | \$208.00 | | 3 | A | 70-23688-01 | FRONT BEZEL ASSY. NO. HEMI. | EACH | \$1,000.00 | | 3 | A |
| 70-21300-01 | ENCLOSURE BOTTOM ASSY | EACH | \$15.00 | | 3 | A | 70-23688-02 | FRONT BEZEL ASSY. SO. HEMI. | EACH | \$1,000.00 | | 3 | A |
| 70-21452-01 | BELT TENSION SWITCH HARNESS | EACH | \$95.00 | | 3 | A | 70-23708-01 | TM-TS 78 POWER SUPPLY | EACH | REPLACED | | 3 | A |
| 70-21453-01 | LOGIC AC HARNESS | EACH | REPLACED | | 3 | A | 70-23766-01 | CONVERTER ASSY. | EACH | \$229.00 | | 3 | A |
| 70-21456-01 | LOGIC DC POWER HARNESS ASSY | EACH | \$131.00 | | 3 | A | 70-24011-01 | VIDEO DEFLECTION SOCKET HARN | EACH | \$47.00 | | 3 | A |
| 70-21467-01 | LOGIC SUB ASSEMBLY | EACH | \$597.00 | | 3 | A | 70-24012-01 | DEFLECTION LVPS HARNESS | EACH | \$46.00 | | 3 | A |
| 70-21469-01 | SERVO PRO-AMP CABLE ASSEMBLY | EACH | \$56.00 | | 3 | A | 70-24016-01 | HVPS DEFLECTION HARNESS | EACH | \$26.00 | | 3 | A |
| 70-21470-01 | READ/WRITE CABLE ASSEMBLY | EACH | \$48.00 | | 3 | A | 70-24018-01 | VIDEO ENCLOSURE ASSY. | EACH | \$928.00 | Y | 3 | A |
| 70-21477-01 | CABLE ASSY VIDEO/DEFLECTION | EACH | \$107.00 | | 3 | A | 70-24019-01 | CONTROL PANEL ASSY. | EACH | \$80.00 | | 3 | A |
| 70-21495-01 | CONNECTOR PLATE ASSY | EACH | \$366.00 | Y | 3 | A | 70-24020-01 | FRONT BEZEL ASSEMBLY | EACH | \$1,195.00 | | 3 | A |
| 70-21590-01 | SEQUENCE CABLE/PANEL ASSEMBLY | EACH | \$127.00 | | 3 | A | 70-24023-01 | CONNECTOR PANEL ASSY. | EACH | \$235.00 | | 3 | A |
| 70-21592-01 | CABLE SPRING ASSEMBLY | EACH | \$68.00 | | 3 | A | 70-24027-01 | SWITCH LVPS HARNESS | EACH | \$23.00 | | 3 | A |
| 70-21608-01 | DATA 40 CABLE ASSEMBLY | EACH | \$66.00 | | 3 | A | 70-24044-01 | SYSTEM BOARD ASSY. | EACH | \$3,803.00 | Y | 3 | A |
| 70-21609-01 | HHT CABLE | EACH | \$48.00 | | 3 | A | 70-24051-01 | COLLAR, ASSY | EACH | \$90.00 | | 3 | A |
| 70-21696-01 | BACKPLANE CPU ASSY, 18 LAYER | EACH | REPLACED | | 3 | A | 70-24067-01 | PR. BOX, SUBASSY 120V | EACH | \$1,375.00 | | 3 | A |
| 70-21696-02 | BACKPLANE CPU ASSY, 22 LAYER | EACH | \$12,279.00 | | 3 | A | 70-24067-02 | PR. BOX, SUBASSY 240V | EACH | \$1,126.00 | | 3 | A |
| 70-21700-01 | PANEL, CONSOLE DIST ASSY | EACH | \$337.00 | | 3 | A | 70-24240-01 | CRT/BEZEL/YOKE ASSY WHT | EACH | \$207.00 | | 3 | A |
| 70-21701-01 | BACKPLANE ASSY, MEMORY NAUTLS | EACH | \$2,558.00 | | 3 | A | 70-24240-02 | CRT/BEZEL/YOKE ASSY, GRN | EACH | \$203.00 | | 3 | A |
| 70-21861-01 | FRONT BEZEL ASSY | EACH | \$796.00 | | 3 | A | 70-24240-03 | CRT/BEZEL/YOKE ASSY, AMB | EACH | \$206.00 | | 3 | A |
| 70-21863-01 | BRIGHTNESS/CONTRAST ASSY | EACH | \$125.00 | | 3 | A | 70-24242-01 | TOP COVER ASSY | EACH | \$25.00 | | 3 | A |
| 70-21888-01 | FRONT PANEL ASSY | EACH | \$467.00 | | 3 | A | 70-24244-01 | POWER SUPPLY ASSY. | EACH | \$150.00 | | 3 | A |
| 70-21946-01 | HDA ASSEMBLY (RA70) | EACH | \$5,394.40 | Y | 3 | A | 70-24244-02 | PWR. SUP. 120/240V 50HZ | EACH | \$176.00 | | 3 | A |
| 70-22014-01 | DISTRIBUTION ASSY. | EACH | \$173.00 | | 3 | A | 70-24245-01 | BOTTOM ASSY. | EACH | \$32.00 | | 3 | A |
| 70-22015-01 | FRONT PLANE ASSY. | EACH | \$173.00 | | 3 | A | 70-24252-01 | DEPCA,MODULE,ASSY | EACH | \$600.00 | Y | 3 | A |
| 70-22115-01 | FAN TRAY ASSY. | EACH | \$342.00 | | 3 | A | 70-24268-01 | KA410 SYSTEM MODULE | EACH | \$5,990.00 | Y | 3 | A |
| 70-22474-01 | SHOE PLATE ASSY (RA70) | EACH | \$21.00 | | 3 | A | 70-24373-01 | CARD CAGE SYSTEM ASSY, 14 SLO | EACH | \$7,632.00 | Y | 3 | A |
| 70-22492-01 | 8 FT KDB CABLE ASSY | EACH | \$436.00 | | 3 | A | 70-24380-01 | 32-NODE AMPLIFIER BOX | EACH | \$1,807.00 | Y | 3 | A |
| 70-22494-01 | ELEC MODULE CLUSTER (RA70) | EACH | \$3,995.00 | Y | 3 | A | 70-24435-01 | OP CONTROL PANEL (BA27) | EACH | \$425.00 | | 3 | A |
| 70-22617-01 | CRT/CHASSIS/BEZEL ASSY. WHT | EACH | \$370.00 | | 3 | A | 70-24440-01 | FAN ASSEMBLY (BA27) | EACH | \$525.00 | | 3 | A |

digital

Prices Effective 02-January-89 to 30-June-89

To Order—Call DECdirect™ TOLL-FREE 800-344-4825, 8:30 a.m. to 8:00 p.m. ET in Continental U.S.A.

SPARES PRICE LIST A-61

HARDWARE SPARES PRICE LIST

| PART NUMBER | DESCRIPTION | UNIT ORDER | UNIT PRICE | REP D L | REPLACEMENT PART NUMBER | PART NUMBER | DESCRIPTION | UNIT ORDER | UNIT PRICE | REP D L | REPLACEMENT PART NUMBER |
|-------------------------------------|-------------------------------|------------|-------------|---------|-------------------------|-------------|-------------------------------|------------|------------|---------|-------------------------|
| 70-24457-01 | CABLE CPU POWER | EACH | \$150.00 | 3 A | | 74-11069-00 | WASHER ECCENTRIC LA36 (74-115 | EACH | REPLACED | 3 A | 70-11446-00 |
| 70-24458-01 | CABLE CPU LAMP AND SWITCH | EACH | \$124.00 | 3 A | | 74-11072-00 | BAR PRINT LA36 7009696 | EACH | REPLACED | 3 A | 74-17937-00 |
| 70-24459-01 | CABLE,CPU BACKPLANE FAN | EACH | \$112.00 | 3 A | | 74-11075-00 | SHAFT TRACTOR DR LA36 70-9696 | EACH | \$12.00 | 3 A | |
| 70-24460-01 | CABLE CPU/MNTR FAN & TH. SW. | EACH | \$101.00 | 3 A | | 74-11076-00 | SHAFT TRACTOR SUPP LA36 70969 | EACH | \$5.00 | 3 A | |
| 70-24460-02 | CABLE CPU/MNTR FAN. SW. | EACH | \$104.00 | 3 A | | 74-11084-00 | ROD LA36 (70-9690) | EACH | \$5.00 | 3 A | |
| 70-24461-01 | CABLE MNTR PWR | EACH | \$100.00 | 3 A | | 74-11090-00 | SPRING MAIN PAWL LA36 (709697 | QTY OF 10 | \$.83 | 3 A | |
| 70-24462-01 | CABLE MNTR WARNING LIGHT | EACH | \$99.00 | 3 A | | 74-11098-03 | COLLAR SIDE PLATE LA36.312 | QTY OF 10 | \$1.00 | 3 A | |
| 70-24463-01 | CABLE DISK FAN AND THERMAL SW | EACH | \$150.00 | 3 A | | 74-11103-00 | PIVOT RATCHET LA36 (70-9689) | QTY OF 10 | \$1.00 | 3 A | |
| 70-24464-01 | CABLE,DSK BX RX/RD PWR | EACH | \$80.00 | 3 A | | 74-11105-00 | SPRING UPPER PAWL LA36 709697 | QTY OF 10 | \$1.00 | 3 A | |
| 70-24464-02 | CABLE,DSK BX RD/RX POWER | EACH | \$80.00 | 3 A | | 74-11107-00 | BUSHING ECCENT LA36 (70-9692) | QTY OF 10 | \$6.00 | 3 A | |
| 70-24465-01 | CABLE,SWITCH PANEL DC POWER | EACH | \$80.00 | 3 A | | 74-11108-00 | BUSHING PLAIN LA36 (70-9696) | QTY OF 10 | \$5.00 | 3 A | |
| 70-24470-01 | CABLE 20 COND | EACH | \$80.00 | 3 A | | 74-11109-00 | CARRIAGE LA36 (70-9692) | EACH | \$6.00 | 3 A | |
| 70-24497-01 | CABLE 34 COND | EACH | \$97.00 | 3 A | | 74-11116-00 | HOUSING LA36 | EACH | \$64.00 | 3 A | |
| 70-24516-01 | PS/MONITOR & ARC PROTECT ASSY | EACH | \$677.00 | Y 3 A | | 74-11122-00 | COVER | EACH | REPLACED | 3 A | 70-11447-00 |
| 70-24577-01 | MONITOR,LOGIC BOARD | EACH | \$343.00 | Y 3 A | | 74-11123-00 | WASHER ECCENT LA36 (70-9690) | QTY OF 10 | \$1.00 | 3 A | |
| 70-24577-02 | MONITOR,LOGIC BOARD | EACH | \$379.00 | Y 3 A | | 74-11124-00 | COLLAR CLAMP | QTY OF 10 | \$1.00 | 3 A | |
| 70-24604-01 | BACKPLANE CPU ASSY 1 | EACH | \$11,515.00 | 3 A | | 74-11405-00 | DISK FRICTION LA36 (74-9689) | QTY OF 10 | \$4.00 | 3 A | |
| 70-24605-01 | BACKPLANE ASSY CPU 2 | EACH | \$11,427.00 | 3 A | | 74-11416-00 | ENCODER DUST COVER | QTY OF 10 | \$5.00 | 3 A | |
| 70-24606-01 | BACKPLANE CPU ASSY 3 | EACH | \$5,552.00 | 3 A | | 74-11425-00 | BUSH TRAC SHAFT RTAIN LA36 | QTY OF 10 | \$2.00 | 3 A | |
| 70-24626-01 | BACKPLANE,ASSY,MEMORY | EACH | \$1,775.00 | 3 A | | 74-11426-00 | BACKSTOP SPRING LA36 70-9690 | QTY OF 10 | \$1.00 | 3 A | |
| 70-24873-01 | POWER SUPPLY (BA27) | EACH | \$525.00 | 3 A | | 74-11432-00 | WHEEL RATCHET LA36 (70-9689) | QTY OF 10 | \$1.00 | 3 A | |
| 70-24905-01 | CURRENT SHARE CNTL MODULE | EACH | \$1,000.00 | 3 A | | 74-11437-00 | KNOB LINE FEED LA36 (70-9696) | EACH | \$4.00 | 3 A | |
| 74 CLASS Prefab Parts/Cables | | | | | | | | | | | |
| 74-07181-00 | PREFILTER | EACH | \$5.00 | 3 A | | 74-11439-00 | PIVOT LOWER LA36 (70-9696) | QTY OF 10 | \$1.00 | 3 A | |
| 74-07957-00 | CAPSTAN | EACH | \$155.00 | 3 A | | 74-11440-00 | DRIVE CLUTCH GEAR LA36 70-969 | QTY OF 10 | \$2.00 | 3 A | |
| 74-07958-00 | CLAMP-CAPSTAN | EACH | \$17.00 | 3 A | | 74-11441-00 | CLUTCH HUB LA36 (70-9696) | QTY OF 10 | \$2.00 | 3 A | |
| 74-07961-00 | ANGLE, SOLENOID SHAFT | EACH | \$6.00 | 3 A | | 74-11443-00 | CLUTCH WASHER LA36 (70-9696) | QTY OF 10 | \$1.00 | 3 A | |
| 74-07979-00 | KNOB | EACH | \$64.00 | 3 A | | 74-11517-00 | FRAME COVER LA30/LA36 | QTY OF 10 | \$4.00 | 3 A | |
| 74-07980-00 | REEL, SUPPORT | EACH | \$88.00 | 3 A | | 74-11575-00 | SHAFT IDLE SIDEPLN LA36 70-96 | QTY OF 10 | \$1.00 | 3 A | |
| 74-07983-00 | REEL, GUIDE | EACH | \$38.00 | 3 A | | 74-11576-00 | FRAME RIB IDLER/BUSHING (LA36 | EACH | \$11.00 | 3 A | |
| 74-08244-00 | PANEL, CONTROL PDP-8E | EACH | \$93.00 | 3 A | | 74-11577-00 | RIBBON CARRIAGE IDLE/BUSH LA3 | QTY OF 10 | \$6.00 | 3 A | |
| 74-08681-00 | PAWL | EACH | REPLACED | 3 A | 12-11146-00 | 74-11578-00 | RIBBON ECCENTRIC/CLUTCH (LA36 | EACH | REPLACED | 3 A | 70-11446-00 |
| 74-09216-01 | BRAKE & CLUTCH ASSY | EACH | \$208.00 | 3 A | | 74-11817-02 | HOSE VAC 55" | EACH | REPLACED | 3 A | 74-11817-03 |
| 74-09216-02 | BRAKE & CLUTCH ASSY | EACH | \$208.00 | 3 A | | 74-12158-00 | GUIDE PAPER (LA180-P) | EACH | \$11.00 | 3 A | |
| 74-09418-01 | PULLEY MOTOR 60 HZ | EACH | \$81.00 | 3 A | | 74-12366-00 | COVER CABLE KL10 (70-9859) | EACH | \$8.00 | 3 A | |
| 74-09418-02 | PULLEY MOTOR | EACH | \$8.00 | 3 A | | 74-12424-00 | PAPER OUT SWITCH | EACH | \$4.00 | 3 A | |
| 74-09479-00 | PRESSURE PLATE | EACH | \$6.00 | 3 A | | 74-12535-00 | RING | QTY OF 10 | \$1.00 | 3 A | |
| 74-09912-00 | TAPE,GUIDE | QTY OF 10 | REPLACED | 3 A | 74-09912-01 | 74-12666-00 | COVER (RX8-A+B) | EACH | \$154.00 | 3 A | |
| 74-10524-01 | FAB | EACH | \$13.00 | 3 A | | 74-12722-01 | TU16 HEAD NO CABLES | EACH | REPLACED | 3 A | 70-09885-05 |
| 74-10524-02 | FAB | EACH | \$12.00 | 3 A | | 74-13308-00 | BRACKET FILTER | EACH | \$23.00 | 3 A | |
| 74-10547-00 | SEAL INLET RING | QTY OF 10 | REPLACED | 3 A | 74-13836-00 | 74-13432-00 | BEZEL KYBD VT51/VT50-H | EACH | \$23.00 | 3 A | |
| 74-10881-00 | SOLENOID ASSY | EACH | \$38.00 | 3 A | | 74-13672-00 | RESERVOIR,OIL CARRIAGE LA36 | QTY OF 10 | \$1.00 | 3 A | |
| 74-11013-00 | PANEL LOUVERED ASSY-RS03 | EACH | \$57.00 | 3 A | | 74-13698-00 | WICK CARRIAGE OIL,LA36 | QTY OF 10 | \$1.00 | 3 A | |
| 74-11023-02 | DISC RS04 (16 INCHES) | EACH | \$3,539.00 | 3 A | | 74-13699-00 | SPRING,LA36,RESEVOIR | QTY OF 10 | \$1.00 | 3 A | |
| 74-11033-00 | SHAFT CARRIAGE LA36 (70-9696) | EACH | REPLACED | 3 A | 74-18139-00 | 74-13772-00 | OVERLAY MANT MODULE | EACH | \$25.00 | 3 A | |
| 74-11058-01 | INTERPOSER LH LA36 (70-9689) | QTY OF 10 | \$4.00 | 3 A | | 74-13836-00 | SEAL INLET RING FOR RK05 | QTY OF 10 | \$5.00 | 3 A | |
| 74-11058-02 | INTERPOSER RH LA36 (70-9689) | QTY OF 10 | \$4.00 | 3 A | | 74-14130-11 | RK06 MAGNETIC RECORDING HEAD- | EACH | \$204.00 | 3 A | |
| 74-11068-00 | RIBBON IDLER SHAFT LA36 70-96 | EACH | \$7.00 | 3 A | | 74-14130-12 | RK06 MAGNETIC RECORDING HEAD- | EACH | \$204.00 | 3 A | |
| | | | | | | 74-14130-13 | RK06 MAGNETIC RECORDING HEAD- | EACH | \$204.00 | 3 A | |
| | | | | | | 74-14346-00 | MOTOR PULLEY | EACH | \$17.00 | 3 A | |
| | | | | | | 74-14351-00 | FIXED WAY | EACH | \$37.00 | 3 A | |
| | | | | | | 74-14433-00 | SCREW TRACTOR LOCK | QTY OF 10 | \$1.00 | 3 A | |
| | | | | | | 74-14835-00 | SPRING PLAIN BUSHING | QTY OF 10 | \$1.00 | 3 A | |
| | | | | | | 74-14845-00 | BUSHING PLAIN REWORK | QTY OF 10 | \$2.00 | 3 A | |
| | | | | | | 74-14943-00 | DRIVE PULLEY 25T | QTY OF 10 | \$4.00 | 3 A | |
| | | | | | | 74-15047-00 | PANEL, PROGRAM | EACH | \$27.00 | 3 A | |



Prices Effective 02-January-89 to 30-June-89
 To Order—Call DECdirect™ TOLL-FREE 800-344-4825, 8:30 a.m. to 8:00 p.m. ET in Continental U.S.A.

HARDWARE SPARES PRICE LIST

| PART NUMBER | DESCRIPTION | UNIT ORDER | UNIT PRICE | REP D | L | REPLACEMENT PART NUMBER | PART NUMBER | DESCRIPTION | UNIT ORDER | UNIT PRICE | REP D | L | REPLACEMENT PART NUMBER |
|-------------|-------------------------------|------------|------------|-------|---|-------------------------|-------------|-----------------------------|------------|------------|-------|---|-------------------------|
| 74-15094-00 | REAR COVER | EACH | \$8.00 | 3 | A | | 74-23941-00 | CARTRIDGE GUIDE | EACH | \$18.00 | 3 | A | |
| 74-15125-00 | BUSHING ECCENTRIC | EACH | \$6.00 | 3 | A | | 74-23943-00 | BEZEL KEYBOARD (LA24) | EACH | \$13.00 | 3 | A | |
| 74-15282-00 | JUMPER FUSE-SW | EACH | \$10.00 | 3 | A | | 74-23944-00 | LID,FRONT HAND | QTY OF 10 | REPLACED | 3 | A | 70-17463-00 |
| 74-15294-00 | BRUSH GROUND | QTY OF 10 | \$7.00 | 3 | A | | 74-23954-00 | CARD CAGE | EACH | \$25.00 | 3 | A | |
| 74-15297-00 | FILTER, PAD | EACH | \$6.00 | 3 | A | | 74-23969-00 | WINDOW,FRONT | QTY OF 10 | \$1.00 | 3 | A | |
| 74-15302-00 | STRAP BRUSH HOLDER | QTY OF 10 | \$4.00 | 3 | A | | 74-24154-00 | SPRING,RIBBON TENSION | QTY OF 10 | \$2.00 | 3 | A | |
| 74-15802-00 | ORDER 70-13859-00 | QTY OF 10 | REPLACED | 3 | A | 70-13859-00 | 74-24155-00 | SPRING RETAINING BRACKET | QTY OF 10 | \$2.00 | 3 | A | |
| 74-16121-00 | PLUG FILTER | EACH | \$5.00 | 3 | A | | 74-24160-00 | SPACE BAR EQUALIZER CLIP | QTY OF 10 | \$1.00 | 3 | A | |
| 74-16123-00 | FOAM FILTER, LARGE | EACH | \$4.00 | 3 | A | | 74-24202-00 | SHAFT RIBBON DRIVE | QTY OF 10 | \$9.00 | 3 | A | |
| 74-16187-00 | GUAGE, PULLEY HEIGHT | EACH | \$67.00 | 3 | A | | 74-24378-00 | CARRIAGE | EACH | \$8.00 | 3 | A | |
| 74-16355-00 | PULLER KEYCAP | QTY OF 10 | \$4.00 | 3 | A | | 74-24701-00 | PULLEY,CARRIAGE DRIVE | QTY OF 10 | \$1.00 | 3 | A | |
| 74-16402-00 | CLAMP PULLEY U/O LAXX-KJ | QTY OF 10 | \$1.00 | 3 | A | | 74-24702-00 | LEVER,HEAD ADJUST | QTY OF 10 | \$2.00 | 3 | A | |
| 74-16672-00 | PAD FELT | QTY OF 10 | \$.63 | 3 | A | | 74-24703-00 | SLIDE,HEAD ADJUST | QTY OF 10 | \$2.00 | 3 | A | |
| 74-17178-00 | HEAD ASSY A UP | EACH | \$193.00 | 3 | A | | 74-24704-00 | SPRING,PRINT HEAD RETAINER | EACH | \$5.00 | 3 | A | |
| 74-17178-01 | HEAD ASSY A DOWN | EACH | \$193.00 | 3 | A | | 74-24720-00 | BEARING,ACTUATOR | EACH | \$5.00 | 3 | A | |
| 74-17450-00 | HATCH | EACH | \$25.00 | 3 | A | | 74-24721-00 | BEARING,CARRIAGE REAR | EACH | \$5.00 | 3 | A | |
| 74-17816-00 | BRACKET,RIGHT SHROUD MTG | EACH | \$15.00 | 3 | A | | 74-24731-00 | SPRING FRONT BEARING | QTY OF 10 | \$.83 | 3 | A | |
| 74-17817-00 | BRACKET,LEFT SHROUD MTG | EACH | \$14.00 | 3 | A | | 74-24735-00 | PULLEY,DRIVE 18 TEETH-080P | QTY OF 10 | \$1.00 | 3 | A | |
| 74-17901-00 | FLANGE,REAR | EACH | \$21.00 | 3 | A | | 74-25183-00 | CLAMP,RIBBON CABLE | QTY OF 10 | \$4.00 | 3 | A | |
| 74-18010-00 | CAPSTAN, TS04 | EACH | \$89.00 | 3 | A | | 74-25190-00 | CABLE, DRIVE | EACH | \$13.00 | 3 | A | |
| 74-18021-00 | CLAMP, CAPSTAN | EACH | \$17.00 | 3 | A | | 74-25208-00 | RIBBON DRIVE CABLE | EACH | \$5.00 | 3 | A | |
| 74-18137-00 | CLAMP SHAFT | QTY OF 10 | \$4.00 | 3 | A | | 74-25250-00 | LEVER | QTY OF 10 | \$2.00 | 3 | A | |
| 74-18139-00 | CARRIAGE SHAFT | EACH | \$32.00 | 3 | A | | 74-25252-00 | LEVER,BAIL BAR | QTY OF 10 | \$2.00 | 3 | A | |
| 74-18534-00 | DRIVE PULLEY 50HZ | EACH | REPLACED | 3 | A | 74-21078-01 | 74-25262-00 | ARM,BAIL BAR,R.H. | QTY OF 10 | \$1.00 | 3 | A | |
| 74-19028-01 | ENCLOSURE KEYBOARD BOTTOM | EACH | \$13.00 | 3 | A | | 74-25263-00 | ARM,BAIL BAR,L.H. | QTY OF 10 | \$1.00 | 3 | A | |
| 74-19479-00 | LOGO VT100 | QTY OF 10 | \$4.00 | 3 | A | | 74-25652-02 | 112684 SKID | EACH | \$5.00 | 3 | A | |
| 74-19612-00 | RIBBON RETAINER | QTY OF 10 | \$1.00 | 3 | A | | 74-25653-00 | GUIDE,SLIDE | EACH | \$5.00 | 3 | A | |
| 74-20024-00 | CLAMP SHAFT | QTY OF 10 | REPLACED | 3 | A | 74-18137-00 | 74-25654-00 | SLIDE,MOTHER BOARD | EACH | \$2.00 | 3 | A | |
| 74-20633-00 | BEARING, EXTRUDED TUBE | EACH | REPLACED | 3 | A | 70-11016-00 | 74-25720-00 | LEVER,HEAD RETAINING | QTY OF 10 | \$4.00 | 3 | A | |
| 74-20645-01 | LOCK, ROLLER | QTY OF 10 | \$1.00 | 3 | A | | 74-25723-00 | LEVER,ADJ PRINT HEAD | QTY OF 10 | \$1.00 | 3 | A | |
| 74-20648-00 | PUCK DRIVE | EACH | REPLACED | 3 | A | 12-16231-00 | 74-25724-00 | SLIDE,HEAD ADJUSTING | QTY OF 10 | \$4.00 | 3 | A | |
| 74-20649-00 | WHEEL, ENCODER | EACH | \$5.00 | 3 | A | | 74-26031-00 | VISOR,LA12 | EACH | \$5.00 | 3 | A | |
| 74-20736-00 | LEVER,GAP ADJUSTER | QTY OF 10 | \$2.00 | 3 | A | | 74-26032-00 | DETENT,VISOR | EACH | \$1.00 | 3 | A | |
| 74-20739-00 | CLAMP,SHAFT | QTY OF 10 | \$.41 | 3 | A | | 74-26033-00 | WINDOW,LA12 | EACH | \$19.00 | 3 | A | |
| 74-21078-00 | PULLEY,RX01 MOTOR,60HZ | EACH | \$43.00 | 3 | A | | 74-26053-00 | TOP ENCLOSURE,KEYBOARD | EACH | REPLACED | 3 | A | 74-26053-01 |
| 74-21078-01 | PULLEY,RX01 MOTOR,50HZ | EACH | \$43.00 | 3 | A | | 74-26053-01 | ENCLOSURE,TOP,KEYBOARD | EACH | \$12.00 | 3 | A | |
| 74-21147-00 | SPACER, BAIL BAR | QTY OF 10 | \$1.00 | 3 | A | | 74-26054-00 | BOTTOM ENCLOSURE,KEYBOARD | EACH | REPLACED | 3 | A | 70-21300-01 |
| 74-21455-02 | PULLEY, MOTOR(3.483 DIA,60HZ) | EACH | \$85.00 | 3 | A | | 74-26541-01 | WIRE TENSION FRAME | QTY OF 10 | \$2.00 | 3 | A | |
| 74-21455-03 | PULLEY,MOTOR(4.179DIA,50HZ) | EACH | \$85.00 | 3 | A | | 74-26542-01 | CLIP,SPRING,CRT | QTY OF 10 | \$.83 | 3 | A | |
| 74-21622-00 | PUSH ROD LATCH LEFT | QTY OF 10 | \$2.00 | 3 | A | | 74-26680-01 | BOTTOM | EACH | \$26.00 | 3 | A | |
| 74-21664-00 | CLIP SPRING | QTY OF 10 | \$.41 | 3 | A | | 74-26805-01 | SHAFT, TILT | QTY OF 10 | \$4.00 | 3 | A | |
| 74-21977-00 | GUIDE HINGE BRACKET | QTY OF 10 | \$.72 | 3 | A | | 74-26806-01 | BUTTON, SLIDE | QTY OF 10 | \$2.00 | 3 | A | |
| 74-22440-00 | SPRING BELT RELEASE | QTY OF 10 | \$1.00 | 3 | A | | 74-26807-01 | ANCHOR BRKT TILT | QTY OF 10 | \$1.00 | 3 | A | |
| 74-22555-00 | SHAFT,ROUND | QTY OF 10 | \$4.00 | 3 | A | | 74-26808-01 | BRACKET SLIDE | QTY OF 10 | \$.83 | 3 | A | |
| 74-22713-00 | BEZEL TU58 | EACH | \$18.00 | 3 | A | | 74-26810-01 | BEZEL, PC BOARD | QTY OF 10 | \$4.00 | 3 | A | |
| 74-22816-00 | FILTER FOAM | EACH | \$7.00 | 3 | A | | 74-27002-01 | THUMBWHEEL | QTY OF 10 | \$4.00 | 3 | A | |
| 74-22826-00 | SLIDE,TENSION ADJUST | EACH | \$6.00 | 3 | A | | 74-27151-01 | GUIDE, PAPER | QTY OF 10 | REPLACED | 3 | A | 70-19659-01 |
| 74-22870-00 | SUPPORT,TRACTOR PAPER | EACH | \$13.00 | 3 | A | | 74-27237-01 | END CAP,PAPER ROLL | QTY OF 10 | \$1.00 | 3 | A | |
| 74-22986-00 | LEVER, RELEASE | QTY OF 10 | \$1.00 | 3 | A | | 74-27720-01 | PLATE CONN, (40/50 PIN) | EACH | \$26.00 | 3 | A | |
| 74-22987-00 | CAM | QTY OF 10 | \$1.00 | 3 | A | | 74-28201-02 | CLIP, GROUNDING | EACH | \$15.00 | 3 | A | |
| 74-23820-00 | BEZEL TOP | EACH | \$6.00 | 3 | A | | 74-28268-01 | LEADER, CARTRIDGE (TAKE-UP) | QTY OF 10 | \$2.00 | 3 | A | |
| 74-23902-00 | LA34 PAPER GUIDE | QTY OF 10 | \$1.00 | 3 | A | | 74-28298-01 | CLIP,ADAPTER, CARD CAGE | EACH | \$5.00 | 3 | A | |
| 74-23937-00 | WINDOW CLEAR VIEW | EACH | \$12.00 | 3 | A | | 74-28401-01 | BRACKET,PANEL | QTY OF 10 | REPLACED | 3 | A | 70-20800-01 |
| 74-23938-00 | REFLECTOR VISOR CLIP | QTY OF 10 | \$.83 | 3 | A | | 74-29005-01 | PLATE, I/O COMMON | EACH | \$19.00 | 3 | A | |
| 74-23939-00 | REFLECTOR,VISOR | QTY OF 10 | \$4.00 | 3 | A | | 74-29036-01 | PLATEN KNOB | EACH | \$5.00 | 3 | A | |

digital

Prices Effective 02-January-89 to 30-June-89

To Order—Call DECdirect™ TOLL-FREE 800-344-4825, 8:30 a.m. to 8:00 p.m. ET in Continental U.S.A.

HARDWARE SPARES PRICE LIST

| PART NUMBER | DESCRIPTION | UNIT ORDER | UNIT PRICE | REP D L | REPLACEMENT PART NUMBER | PART NUMBER | DESCRIPTION | UNIT ORDER | UNIT PRICE | REP D L | REPLACEMENT PART NUMBER |
|-------------|----------------------------|------------|------------|---------|-------------------------|-------------|-------------------------------|------------|------------|---------|-------------------------|
| 74-29036-02 | PLATEN KNOB | EACH | \$5.00 | 3 A | | 90-07032-00 | TIE, CABLE, SST2 M | QTY OF 10 | \$.41 | 3 A | |
| 74-29690-01 | STRAP, L.H. GROUND | QTY OF 10 | \$.63 | 3 A | | 90-07207-00 | FUSE, .375A, 250V | QTY OF 10 | \$1.00 | 3 A | |
| 74-29691-01 | STRAP, R.H. GROUND | QTY OF 10 | \$2.00 | 3 A | | 90-07208-00 | FUSE,REG BLOW, .500A,250V | QTY OF 10 | \$1.00 | 3 A | |
| 74-29721-01 | FILTER, FOAM | EACH | \$19.00 | 3 A | | 90-07209-00 | FUSE,SLOW BLOW, .5A,250V | QTY OF 10 | \$1.00 | 3 A | |
| 74-29936-02 | GASKET, EMI SEALING, 14.8" | EACH | \$25.00 | 3 A | | 90-07210-00 | FUSE,REG. BLOW .75A | QTY OF 10 | \$1.00 | 3 A | |
| 74-29936-03 | GASKET, EMI SEALING, 17.3" | EACH | \$25.00 | 3 A | | 90-07211-00 | FUSE, REG BLOW 1.000A | QTY OF 10 | \$1.00 | 3 A | |
| 74-32697-01 | FILTER,FOAM | EACH | \$10.00 | 3 A | | 90-07212-00 | FUSE, SLO BLOW, 1.000A, 250V | QTY OF 10 | \$1.00 | 3 A | |
| 74-33422-01 | PANEL, REAR | EACH | \$152.00 | 3 A | | 90-07213-00 | FUSE, SLO BLO 1.5A 250V | QTY OF 10 | \$1.00 | 3 A | |
| 74-34494-01 | CLIP, ASSY. | EACH | \$18.00 | 3 A | | 90-07215-00 | FUSE,REG BLOW 2.00A 250V | QTY OF 10 | \$1.00 | 3 A | |
| 74-34608-01 | BLOCK,CABLE SEAL | EACH | \$49.00 | 3 A | | 90-07217-00 | FUSE, REG BLOW, 3.000A, 250V | QTY OF 10 | \$1.00 | 3 A | |
| 74-34609-01 | SEAL,VIDEO CONT. | EACH | \$42.00 | 3 A | | 90-07218-00 | FUSE, SLO BLOW, 3.000A, 250V | QTY OF 10 | \$1.00 | 3 A | |
| 74-34610-01 | SEAL,POWER SW. | EACH | \$42.00 | 3 A | | 90-07219-00 | FUSE, REG BLOW, 4.000A, 32V | QTY OF 10 | \$1.00 | 3 A | |
| 74-34639-01 | COVER,MEMBRANE | EACH | \$20.00 | 3 A | | 90-07219-02 | FUSE, REG BLO 4A, 250V GLASS | QTY OF 50 | \$1.00 | 3 A | |
| 74-34641-01 | SLEEVE,CABLE FRONT | EACH | \$47.00 | 3 A | | 90-07220-00 | FUSE, SLO BLOW, 4.000A, 250V | QTY OF 10 | \$1.00 | 3 A | |
| 74-34642-01 | SLEEVE,CABLE REAR | EACH | \$47.00 | 3 A | | 90-07221-00 | FUSE, REG BLOW, 5.000A, 250V | QTY OF 10 | \$1.00 | 3 A | |
| 74-34885-01 | SHIELD,ANI-GLARE | EACH | \$127.00 | 3 A | | 90-07222-00 | FUSE, SLO BLOW, 5.000A, 250V | QTY OF 10 | \$1.00 | 3 A | |
| | | | | | | 90-07223-00 | FUSE, SLO BLOW, 6.250A, 250V | QTY OF 10 | \$1.00 | 3 A | |
| | | | | | | 90-07224-00 | FUSE, SLO BLOW, 7.000A, 250V | QTY OF 10 | \$1.00 | 3 A | |
| | | | | | | 90-07225-00 | FUSE, SLO BLOW, 10.000A, 32V | QTY OF 10 | \$1.00 | 3 A | |
| | | | | | | 90-07226-00 | FUSE, REG BLOW, 15.000A, 32V | QTY OF 10 | \$1.00 | 3 A | |
| | | | | | | 90-07227-00 | FUSE, SLO BLOW, 15.000A, 32V | QTY OF 10 | \$1.00 | 3 A | |
| | | | | | | 90-07651-00 | WASHER,LOCK,EXTERN. TOOTH | QTY OF 50 | \$.63 | 3 A | |
| | | | | | | 90-07785-00 | RING,RETAIN'G,EXT,FOR 3/8"SHA | QTY OF 50 | \$.63 | 3 A | |
| | | | | | | 90-07786-00 | RETAINER, U-NUT, 10-32 | QTY OF 50 | \$1.00 | 3 A | |
| | | | | | | 90-07793-01 | SCREW,MACH PAN PHIL | QTY OF 10 | \$.20 | 3 A | |
| | | | | | | 90-07818-01 | SCREW,MACH PAN PHIL 6-32X | QTY OF 50 | \$.63 | 3 A | |
| | | | | | | 90-07879-00 | FUSE, SLO BLOW, 2.500A, 250V | QTY OF 10 | \$1.00 | 3 A | |
| | | | | | | 90-07880-00 | CABLE TIE | QTY OF 50 | \$.41 | 3 A | |
| | | | | | | 90-07999-00 | FUSE, REG BLOW, 6.000A 250V, | QTY OF 10 | \$1.00 | 3 A | |
| | | | | | | 90-08055-00 | NUT,ELA-STOP | QTY OF 50 | \$.63 | 3 A | |
| | | | | | | 90-08072-00 | WASH,LOCK,EXT TOOTH #8 | QTY OF 50 | \$.63 | 3 A | |
| | | | | | | 90-08137-00 | RING,RETAINING,EXTERNAL | QTY OF 50 | \$.63 | 3 A | |
| | | | | | | 90-08268-00 | COMPOUND,THERMAL JOINT | EACH | \$21.00 | 3 A | |
| | | | | | | 90-08279-01 | FUSE,REG BLOW (12A 250V) | QTY OF 10 | \$1.00 | 3 A | |
| | | | | | | 90-08290-00 | FUSE, SLO BLOW, 12.000A, 32V | QTY OF 10 | \$1.00 | 3 A | |
| | | | | | | 90-08298-00 | RING,RETAINER,EXT. | QTY OF 50 | \$.63 | 3 A | |
| | | | | | | 90-08332-00 | TAPE,SCOTCH COATED FABRIC 1/2 | EACH | \$116.00 | 3 A | |
| | | | | | | 90-08356-00 | WIRE IDENTIFIER (A-Z) | QTY OF 10 | \$4.00 | 3 A | |
| | | | | | | 90-08387-00 | FUSE, REG BLOW, 2.500A, 250V | QTY OF 10 | \$1.00 | 3 A | |
| | | | | | | 90-08389-00 | FUSE,REG BLOW, .125A, 250V | QTY OF 10 | \$1.00 | 3 A | |
| | | | | | | 90-08390-00 | FUSE, REG BLOW, 10.000A, 250V | QTY OF 10 | \$1.00 | 3 A | |
| | | | | | | 90-08451-00 | SCREW LOCK, ASSY. | QTY OF 50 | \$.41 | 3 A | |
| | | | | | | 90-08451-01 | SCREW LOCK,STANDOFF ONLY | QTY OF 50 | \$.63 | 3 A | |
| | | | | | | 90-08500-00 | RING,RETAINING,500ODX.423ID | QTY OF 50 | \$.63 | 3 A | |
| | | | | | | 90-08527-00 | FUSE, SLO BLO, 125A | QTY OF 10 | \$3.00 | 3 A | |
| | | | | | | 90-08835-00 | FUSE,REG BLOW, 20A 32V | QTY OF 10 | \$1.00 | 3 A | |
| | | | | | | 90-08838-00 | FUSE, REG BLOW, 10.000A, 32V | QTY OF 10 | \$1.00 | 3 A | |
| | | | | | | 90-08911-01 | SCREW, MACH PAN | QTY OF 10 | \$1.00 | 3 A | |
| | | | | | | 90-09093-00 | SPRING, EXTENSION, .25 DIA... | QTY OF 10 | \$1.00 | 3 A | |
| | | | | | | 90-09185-00 | JUMPER,WIRE,INSULATED,BLACK | QTY OF 50 | \$.63 | 3 A | |
| | | | | | | 90-09243-00 | NUT,KEP.6-32X5/16 AF | QTY OF 50 | \$.63 | 3 A | |
| | | | | | | 90-09257-00 | RING, RETAINING, REINFORCED, | QTY OF 50 | \$.63 | 3 A | |
| | | | | | | 90-09257-01 | RING, RETAINING, REINFORCED, | QTY OF 50 | \$.63 | 3 A | |
| | | | | | | 90-09273-00 | RING,RETAINING,EXTERNAL | QTY OF 50 | \$.63 | 3 A | |
| | | | | | | 90-09273-01 | RING,RETAIN'G,EXT .125 SHAFT | QTY OF 50 | \$.63 | 3 A | |

90 CLASS Expendable Parts

| | | | | |
|-------------|-------------------------------|-----------|--------|-----|
| 90-00020-01 | FUSE,REG BLOW 1.25A 250V | QTY OF 10 | \$1.00 | 3 A |
| 90-00032-11 | PIN,DOWEL 0.3750X1.500LG | QTY OF 50 | \$.63 | 3 A |
| 90-00049-08 | SCREW,HEX,SLOT,SEMS,6-32X.31 | QTY OF 50 | \$.63 | 3 A |
| 90-06010-02 | SCREW,FLAT,PHIL, 4-40X 5/ | QTY OF 50 | \$.63 | 3 A |
| 90-06011-01 | SCREW,PAN,PHIL, 4-40X 3/8 | QTY OF 50 | \$.63 | 3 A |
| 90-06015-01 | SCREW,PAN ,PHIL, 4-40X 3/ | QTY OF 50 | \$.63 | 3 A |
| 90-06021-01 | SCREW,PAN ,PHIL, 6-32X 5/ | QTY OF 50 | \$.63 | 3 A |
| 90-06022-01 | SCREW,PAN ,PHIL, 6-32X 3/ | QTY OF 50 | \$.63 | 3 A |
| 90-06023-01 | SCREW,PAN,PHIL 6-32X7/16 | QTY OF 50 | \$.63 | 3 A |
| 90-06024-01 | SCREW,PAN ,PHIL, 6-32X / | QTY OF 50 | \$.63 | 3 A |
| 90-06036-01 | SCREW,PAN PHILLIPS, 8-32X5/16 | QTY OF 50 | \$.63 | 3 A |
| 90-06037-01 | SCREW,PAN ,PHIL, 8-32X 3/ | QTY OF 50 | \$.63 | 3 A |
| 90-06039-01 | SCREW,PAN ,PHIL, 8-32X / | QTY OF 50 | \$.63 | 3 A |
| 90-06071-01 | SCREW,PAN ,PHIL, 10-32X 3/ | QTY OF 50 | \$.63 | 3 A |
| 90-06073-01 | SCREW,PAN ,PHIL, 10-32X / | QTY OF 50 | \$.63 | 3 A |
| 90-06073-03 | SCREW,TRUS,PHIL, 10-32X / | QTY OF 50 | \$.63 | 3 A |
| 90-06074-01 | SCREW,PAN ,PHIL, 10-32X 5/ | QTY OF 50 | \$.63 | 3 A |
| 90-06074-03 | SCREW,TRUS,PHIL, 10-32X 5/ | QTY OF 50 | \$.63 | 3 A |
| 90-06273-10 | SCREW,SET ,SKT , 2-56X / | QTY OF 50 | \$.63 | 3 A |
| 90-06453-00 | SCREW,HEX,SLOT,SEMS6-32X.375L | QTY OF 50 | \$.63 | 3 A |
| 90-06526-00 | PIN,ROLL,S.S., .094 DIA X.500 | QTY OF 50 | \$.41 | 3 A |
| 90-06561-01 | NUT,HEX 8-32X.307AF SS/NONE | QTY OF 50 | \$.41 | 3 A |
| 90-06565-01 | NUT,HEX EXT TOOTH LCKWSHR 10 | EACH | \$7.00 | 3 A |
| 90-06633-00 | WASHER,LOCK,INT.,2800D X .146 | QTY OF 50 | \$.63 | 3 A |
| 90-06656-00 | WASHER,FLAT,.312ODX.156IDX | QTY OF 50 | \$.63 | 3 A |
| 90-06659-00 | WASHER,FLAT,.375ODX.156IDX | QTY OF 10 | \$.63 | 3 A |
| 90-06706-00 | WASHER,NYLON,FLAT #4 | QTY OF 50 | \$.63 | 3 A |
| 90-06707-00 | WASH,NYLON FLAT #.6312ODX | QTY OF 50 | \$.63 | 3 A |
| 90-06970-00 | SPACER,FIBER,RND | QTY OF 50 | \$.63 | 3 A |
| 90-07031-00 | TIE, CABLE, SST1 M | QTY OF 10 | \$.41 | 3 A |



Prices Effective 02-January-89 to 30-June-89

To Order—Call DECdirect™ TOLL-FREE 800-344-4825, 8:30 a.m. to 8:00 p.m. ET in Continental U.S.A.

HARDWARE SPARES PRICE LIST

| PART NUMBER | DESCRIPTION | UNIT ORDER | UNIT PRICE | REP D L | REPLACEMENT PART NUMBER | PART NUMBER | DESCRIPTION | UNIT ORDER | UNIT PRICE | REP D L | REPLACEMENT PART NUMBER |
|-------------|--------------------------------|------------|------------|---------|-------------------------|--|-------------------------------|------------|------------|---------|-------------------------|
| 90-09279-00 | SPRING,EXT.1800D .022 WIRE | QTY OF 50 | \$1.00 | 3 | A | | | | | | |
| 90-09279-01 | SPRING,EXT.1800D.022 WIRE.62L | QTY OF 50 | \$.63 | 3 | A | | | | | | |
| 90-09313-01 | STANDOFFS | QTY OF 50 | \$.63 | 3 | A | | | | | | |
| 90-09320-00 | FUSE, SLO BLOW, Y.000A 32V | QTY OF 10 | \$1.00 | 3 | A | | | | | | |
| 90-09324-00 | PIN,ROLL 0.0940DX0.562LG | QTY OF 50 | \$.63 | 3 | A | | | | | | |
| 90-09505-00 | FUSE, FST BLOW, 2.000A, 250V | QTY OF 10 | \$1.00 | 3 | A | | | | | | |
| 90-09545-01 | SCREW,SEMS PAN PHIL 8-32X.50 | QTY OF 50 | \$.41 | 3 | A | | | | | | |
| 90-09568-00 | FUSE BLOCK, 15A, FAST-ON-TERM | QTY OF 10 | \$4.00 | 3 | A | | | | | | |
| 90-09579-00 | RING, RETAINING, EXTERNAL FOR | QTY OF 50 | \$.63 | 3 | A | | | | | | |
| 90-09580-00 | RING, RETAINING, EXTERNAL FOR | QTY OF 50 | \$.63 | 3 | A | | | | | | |
| 90-09580-01 | RING, RETAINING, EXTERNAL FOR | QTY OF 50 | \$.63 | 3 | A | | | | | | |
| 90-09580-02 | RING, EXTERNAL, RETAINING FOR | QTY OF 50 | \$.63 | 3 | A | | | | | | |
| 90-09581-00 | RING, RETAINING, EXTERNAL FOR | QTY OF 50 | \$.63 | 3 | A | | | | | | |
| 90-09601-00 | FASTNER,ON-SERT,6-32 | QTY OF 50 | \$.41 | 3 | A | | | | | | |
| 90-09619-00 | WASHER,NYLON,.625ODX.375IDX | QTY OF 50 | \$.63 | 3 | A | | | | | | |
| 90-09624-00 | FEET BUMPER SQ. ADHS. BACK | QTY OF 50 | \$.63 | 3 | A | | | | | | |
| 90-09644-00 | RING, RETAINING, FOR 1/4" SHAF | QTY OF 50 | \$.63 | 3 | A | | | | | | |
| 90-09670-04 | STANDOFF,PLASTIC SNAP-IN | QTY OF 50 | \$.41 | 3 | A | | | | | | |
| 90-09672-02 | SPACER,PLASTIC,.147X.250X.250 | QTY OF 50 | \$.41 | 3 | A | | | | | | |
| 90-09685-00 | FOOT,LEVELER,1-7/16 LG | QTY OF 10 | \$2.00 | 3 | A | | | | | | |
| 90-09703-02 | RING,RETAIN'G,EXT.,.375D SHAFT | QTY OF 50 | \$.63 | 3 | A | | | | | | |
| 90-09740-00 | FUSE, SLO BLOW, 1.50A, 250V, | QTY OF 10 | \$1.00 | 3 | A | | | | | | |
| 90-09747-00 | SUPPORT CIRCUIT BOARD | QTY OF 50 | REPLACED | 3 | A | 90-09670-04 | | | | | |
| 90-09747-01 | SUPPORT | QTY OF 50 | \$.63 | 3 | A | | | | | | |
| 90-09791-00 | FUSE,SLO BLOW 5A | QTY OF 10 | \$1.00 | 3 | A | | | | | | |
| 90-09798-01 | SPACER,CERAMIC,.186ODX.078IDX | QTY OF 50 | \$.63 | 3 | A | | | | | | |
| 90-09800-06 | SCREW,PAN,PHIL,TAP G6-19X.375 | QTY OF 50 | \$.63 | 3 | A | | | | | | |
| 90-09940-00 | INSERT,THREADED 6-32 | QTY OF 50 | \$.63 | 3 | A | | | | | | |
| 90-09964-00 | PLUNGER (CHASSIS) | QTY OF 50 | \$.63 | 3 | A | | | | | | |
| 90-09965-00 | PLUNGER (BASE) | QTY OF 50 | \$.63 | 3 | A | | | | | | |
| 90-09966-01 | GROMMET (CHASSIS) | QTY OF 50 | \$.63 | 3 | A | | | | | | |
| 90-09966-02 | GROMMET (BASE) | QTY OF 50 | \$.63 | 3 | A | | | | | | |
| 90-09988-00 | SCREW,SEMS,SLOT HEX HD | QTY OF 50 | \$.63 | 3 | A | | | | | | |
| 90-10016-00 | CLAMP,CABLE,ADH BACK | QTY OF 50 | \$.63 | 3 | A | | | | | | |
| 90-10019-00 | INSERT,SELF LOCKING 4X5/32 | QTY OF 50 | \$.63 | 3 | A | | | | | | |
| 90-10050-00 | RING,RETAINING,EXT, FOR 9/16 | QTY OF 50 | \$.63 | 3 | A | | | | | | |
| 90-10052-00 | RING,RETAINING, FOR 1/2" SHAF | QTY OF 50 | \$.41 | 3 | A | | | | | | |
| 90-10055-01 | GROMMET LATCH, PLASTIC | QTY OF 50 | \$.63 | 3 | A | | | | | | |
| 90-10056-00 | PLUNGER LATCH,NYLON | QTY OF 50 | \$.63 | 3 | A | | | | | | |
| 90-10057-00 | WASHER,INSULATING SHOULDER | QTY OF 50 | \$.63 | 3 | A | | | | | | |
| 90-10093-00 | PIN,GROOVE 0.1250DX0.500LG | QTY OF 50 | \$.63 | 3 | A | | | | | | |
| 90-10233-00 | CLIP,SPEED, COMPRESSION RING | QTY OF 50 | \$.41 | 3 | A | | | | | | |
| 90-10234-00 | CLIP,CONN. MTG | QTY OF 50 | \$.63 | 3 | A | | | | | | |
| 90-10270-02 | RING,COMPRESSION,.34ID | QTY OF 50 | \$.63 | 3 | A | | | | | | |
| 90-10311-00 | NUT,THD,FORM'G PUSH ON | QTY OF 50 | \$.63 | 3 | A | | | | | | |
| 90-10318-00 | RING,RETAIN'G .125D SHAFT | QTY OF 50 | \$.63 | 3 | A | | | | | | |
| 90-10434-01 | RECEPTACLE, CLIP-ON STEL | EACH | \$6.00 | 3 | A | | | | | | |
| 90-10477-01 | STANDOFF, 1/4 TURN NYLATCH | QTY OF 50 | \$.09 | 3 | A | | | | | | |
| | | | | | | 93 CLASS Tools, Fixtures | | | | | |
| | | | | | | 93-06056-00 | CARRIAGE ALIGNMENT FIXTURE | EACH | \$1,491.00 | 3 | A |
| | | | | | | 93-06058-00 | WRENCH ECCENTRIC BEARING | EACH | \$120.00 | 3 | A |
| | | | | | | 93-06076-00 | HEAD INSERTION AND REMOVAL TO | EACH | \$82.00 | 3 | A |
| | | | | | | 93-06087-00 | HEAD ALIGNMENT FIXTURE | EACH | \$222.00 | 3 | A |
| | | | | | | 93-06122-00 | SET OF 5 SHIMS FOR GLASS SHUT | EACH | \$16.00 | 3 | A |
| | | | | | | 93-06123-00 | 2 SHIMS FOR SPEED TRANSDUCER | EACH | \$7.00 | 3 | A |
| | | | | | | 93-06171-00 | HEAD SEPARATION ASSY TOOL | EACH | \$23.00 | 3 | A |
| | | | | | | 93-06240-00 | INDICATOR & HOLDER GLASS SHUT | EACH | \$461.00 | 3 | A |
| | | | | | | 93-06353-00 | SPACER GAUGE | EACH | \$68.00 | 3 | A |
| | | | | | | 93-06353-01 | SPACER GAUGE-50HZ | EACH | \$68.00 | 3 | A |
| | | | | | | 93-06353-02 | SPACER GAGE | EACH | \$68.00 | 3 | A |
| | | | | | | 93-06353-03 | SPACER GAGE | EACH | \$68.00 | 3 | A |
| | | | | | | 96 CLASS Extractors | | | | | |
| | | | | | | 96-06428-00 | 40 PIN IC IN PIN EXTRACTOR | EACH | \$59.00 | 3 | A |
| | | | | | | 96-07951-00 | HUB SETTING & INSPEC. GAUGE | EACH | \$158.00 | 3 | A |
| | | | | | | 96-07952-00 | ROLLER HEIGHT GAUGE | EACH | \$96.00 | 3 | A |
| | | | | | | 96-09225-00 | S.I.P. CHIP REMOVER | EACH | \$25.00 | 3 | A |
| | | | | | | 99 CLASS ESD Protective Packaging | | | | | |
| | | | | | | 99-07092-01 | STATIC SHIELDING BAG 6X4ID | QTY OF 10 | \$1.50 | 3 | A |
| | | | | | | 99-07092-02 | STATIC SHIELDING BAG 8X6ID | QTY OF 10 | \$1.50 | 3 | A |
| | | | | | | 99-07092-03 | STATIC SHIELDING BAG 12X8ID | QTY OF 10 | \$4.00 | 3 | A |
| | | | | | | 99-07092-04 | STATIC SHIELDING BAG 14X10ID | QTY OF 10 | \$4.00 | 3 | A |
| | | | | | | 99-07092-05 | STATIC SHIELDING BAG 18X12ID | QTY OF 10 | \$5.00 | 3 | A |
| | | | | | | 99-07092-06 | STATIC SHIELDING BAG 18X14ID | QTY OF 10 | \$6.00 | 3 | A |
| | | | | | | 99-07092-07 | STATIC SHIELDING BAG 24X18ID | QTY OF 10 | \$11.00 | 3 | A |
| | | | | | | 99-07092-08 | STATIC SHIELDING BAG 20X15ID | QTY OF 10 | \$7.00 | 3 | A |
| | | | | | | EQ CLASS Field Change Order Kits | | | | | |
| | | | | | | EQ-01072-00 | LA120-R0132 FCO KIT | EACH | \$14.00 | 3 | A |
| | | | | | | EQ-01112-01 | KS10-R0004 FCO KIT | EACH | \$181.00 | 3 | A |
| | | | | | | EQ-01125-00 | TE16-R0009 FCO KIT | EACH | REPLACED | 3 | A |
| | | | | | | EQ-01218-02 | 7417190-S0003 FCO KIT-60HZ | EACH | \$271.00 | 3 | A |
| | | | | | | EQ-01275-01 | RA81X-R0009 FCO KIT | EACH | \$12.00 | 3 | A |
| | | | | | | EQ-01278-01 | M8639-R0003 FCO KIT | EACH | REPLACED | 3 | A |
| | | | | | | EQ-01287-01 | 5415653-I0001 FCO KIT | EACH | REPLACED | 3 | A |
| | | | | | | EQ-01290-03 | VT240-R0001 FCO KIT | EACH | \$443.00 | 3 | A |
| | | | | | | EQ-01292-03 | VT240-R0003 FCO KIT | EACH | REPLACED | 3 | A |
| | | | | | | EQ-01310-01 | CI780-R00C1 FCO KIT | EACH | REPLACED | 3 | A |
| | | | | | | | | | | | EQ-01361-01 |
| | | | | | | | | | | | EQ-01291-01 |
| | | | | | | | | | | | 4A-VT24X-WA |
| | | | | | | | | | | | EQ-01344-01 |



Prices Effective 02-January-89 to 30-June-89
To Order—Call DECdirect™ TOLL-FREE 800-344-4825, 8:30 a.m. to 8:00 p.m. ET in Continental U.S.A.

HARDWARE SPARES PRICE LIST

| PART NUMBER | DESCRIPTION | UNIT ORDER | UNIT PRICE | REP D | L | REPLACEMENT PART NUMBER | PART NUMBER | DESCRIPTION | UNIT ORDER | UNIT PRICE | REP D | L | REPLACEMENT PART NUMBER |
|-------------|-------------------------------|------------|-------------|-------|---|-------------------------|-------------|-------------------------------|------------|-------------|-------|---|-------------------------|
| EQ-01310-02 | C1780-R00C1 FCO KIT | EACH | REPLACED | 3 | A | EQ-01344-02 | EQ-01508-01 | A2-W1154-10-1001 FCO KIT | EACH | \$3,192.00 | 3 | A | |
| EQ-01310-03 | C1780-R00C1 FCO KIT | EACH | REPLACED | 3 | A | EQ-01344-03 | EQ-01509-01 | DWBUA-1002 FCO KIT | EACH | \$214.00 | 3 | A | |
| EQ-01337-01 | FU750-R0001 FCO KIT | EACH | \$80.00 | 3 | A | | EQ-01511-01 | A2-W0955-10-1003 FCO DOC | EACH | \$23,093.00 | 3 | A | |
| EQ-01339-01 | DW780-S00C1 FCO KIT | EACH | \$1,663.00 | 3 | A | | EQ-01513-01 | VT330-1001 FCO KIT | EACH | \$190.00 | 3 | A | |
| EQ-01343-01 | C1750-R00C1 FCO KIT | EACH | REPLACED | 3 | A | EQ-01421-01 | EQ-01514-01 | VT340-1001 FCO KIT | EACH | \$190.00 | 3 | A | |
| EQ-01343-02 | C1750-R00C1 FCO KIT | EACH | REPLACED | 3 | A | EQ-01364-01 | EQ-01518-01 | F1021 PMCL FCO KIT | EACH | \$32,476.00 | 3 | A | |
| EQ-01344-01 | C1780-R00D1 FCO KIT | EACH | \$132.00 | 3 | A | | | | | | | | |
| EQ-01344-02 | C1780-R00D1 FCO KIT | EACH | REPLACED | 3 | A | EQ-01365-01 | | | | | | | |
| EQ-01344-03 | C1780-R00D1 FCO KIT | EACH | REPLACED | 3 | A | EQ-01365-02 | | | | | | | |
| EQ-01356-01 | HSC50-R0001 FCO KIT | EACH | \$403.00 | 3 | A | | | | | | | | |
| EQ-01361-01 | M8639-R0007 FCO KIT | EACH | \$151.00 | 3 | A | | | | | | | | |
| EQ-01364-01 | C1750-R00D1 FCO KIT | EACH | REPLACED | 3 | A | EQ-01421-02 | | | | | | | |
| EQ-01365-01 | C1780-R00E1 FCO KIT | EACH | REPLACED | 3 | A | AS-T213M-ME | | | | | | | |
| EQ-01365-02 | C1780-R00E1 FCO KIT | EACH | REPLACED | 3 | A | AS-T793L-ME | | | | | | | |
| EQ-01368-01 | HSC50-R008 FCO KIT | EACH | \$189.00 | 3 | A | | | | | | | | |
| EQ-01376-01 | VT220-I-001 FCO KIT | EACH | \$71.00 | 3 | A | | | | | | | | |
| EQ-01403-01 | C1780-F1-005 FCO KIT | EACH | REPLACED | 3 | A | EQ-01422-01 | FA-04128-00 | 5413009-S0008 FCO DOCUMENT | EACH | \$11.00 | 3 | A | |
| EQ-01403-02 | C1780-F1-005 FCO KIT | EACH | REPLACED | 3 | A | EQ-01422-02 | FA-04290-00 | VAX-R0005 FCO DOCUMENT | EACH | \$11.00 | 3 | A | |
| EQ-01404-01 | C1750-E1-I-004 FCO KIT | EACH | REPLACED | 3 | A | EQ-01421-01 | FA-04326-00 | VAX-R0006 FCO DOCUMENT | EACH | \$11.00 | 3 | A | |
| EQ-01404-02 | C1750-E1-I-004 FCO KIT | EACH | REPLACED | 3 | A | EQ-01421-02 | FA-04339-00 | KL10C-R012C/KL10E-R004C DOC | EACH | \$11.00 | 3 | A | |
| EQ-01409-01 | KA86-AA-AD-1007 FCO KIT | EACH | \$16,014.00 | 3 | A | EQ-01411-02 | FA-04340-00 | KS10-R0004 FCO DOCUMENT | EACH | \$11.00 | 3 | A | |
| EQ-01411-01 | 11780-8-I-008 FCO KIT | EACH | REPLACED | 3 | A | | FA-04351-00 | KL10A/B-R012C/KL10D-R004C DOC | EACH | \$11.00 | 3 | A | |
| EQ-01411-02 | 11780-8-I008 FCO KIT | EACH | \$187.00 | 3 | A | | FA-04354-00 | VAX-R0007 FCO DOCUMENT | EACH | \$11.00 | 3 | A | |
| EQ-01411-03 | 11780-8-I003 FCO KIT | EACH | \$120.00 | 3 | A | | FA-04363-01 | RH50-FCO DOCUMENT | EACH | \$11.00 | 3 | A | |
| EQ-01420-01 | CD-KITS-KA88-I-001 FCO KIT | EACH | \$3,146.00 | 3 | A | | FA-04386-00 | MA780-R0001 FCO DOCUMENT | EACH | \$11.00 | 3 | A | |
| EQ-01421-01 | C1750-E1-I-004 FCO KIT | EACH | \$150.00 | 3 | A | | | | | | | | |
| EQ-01421-02 | C1750-E1-I-004 FCO KIT | EACH | \$252.00 | 3 | A | | FA-04388-00 | VAX11750-R0005 FCO DOCUMENT | EACH | \$11.00 | 3 | A | |
| EQ-01421-03 | C1750-E1-I-004 FCO KIT | EACH | \$252.00 | 3 | A | | FA-04391-00 | FP750-R0001 FCO DOCUMENT | EACH | \$11.00 | 3 | A | |
| EQ-01422-01 | C1780-F1-I-005 FCO KIT | EACH | \$208.00 | 3 | A | | FA-04429-00 | VAX11782-R0001 FCO DOCUMENT | EACH | \$11.00 | 3 | A | |
| EQ-01422-02 | C1780-F1-I-005 FCO KIT | EACH | \$352.00 | 3 | A | | FA-04430-00 | DR780-R0001 FCO DOCUMENT | EACH | \$11.00 | 3 | A | |
| EQ-01422-03 | C1780-F1-0-005 FCO KIT | EACH | \$352.00 | 3 | A | | FA-04438-00 | RB730-R0001 FCO DOCUMENT | EACH | \$11.00 | 3 | A | |
| EQ-01424-01 | KA750-A-I-001 FCO KIT | EACH | \$3,825.00 | 3 | A | | | | | | | | |
| EQ-01437-01 | CIBCI-B1-1001 FCO KIT | EACH | \$236.00 | 3 | A | | FA-04439-00 | DW750-R0001 FCO DOCUMENT | EACH | \$11.00 | 3 | A | |
| EQ-01437-02 | CIBCI-B1-1001 FCO KIT | EACH | \$335.00 | 3 | A | | FA-04441-00 | VAX11750-R0004 FCO DOCUMENT | EACH | \$11.00 | 3 | A | |
| EQ-01437-03 | CIBCI-B1-1001 FCO KIT | EACH | \$335.00 | 3 | A | | FA-04454-00 | UDA50-S0003 FCO DOCUMENT | EACH | \$11.00 | 3 | A | |
| EQ-01437-04 | CIBCI-B1-1001 FCO KIT | EACH | \$335.00 | 3 | A | | FA-04462-00 | 7018078-S0001 FCO DOCUMENT | EACH | \$11.00 | 3 | A | |
| EQ-01437-05 | CIBCI-B1-1001 FCO KIT | EACH | \$335.00 | 3 | A | | FA-04464-01 | VAX11750-R0007 FCO DOC | EACH | \$11.00 | 3 | A | |
| EQ-01453-01 | 11750-1008 FCO KIT | EACH | \$65.00 | 3 | A | | | | | | | | |
| EQ-01453-02 | 11750-1008 FCO KIT | EACH | \$65.00 | 3 | A | | FA-04464-04 | L0008/YA/YB RPP | EACH | \$11.00 | 3 | A | |
| EQ-01454-01 | A2-Q1093-10-1001 FCO KIT | EACH | \$5,971.00 | 3 | A | | FA-04467-00 | RB730-R0002 FCO DOCUMENT | EACH | \$11.00 | 3 | A | |
| EQ-01454-02 | C1780-1006 FCO KIT | EACH | \$5,971.00 | 3 | A | | FA-04470-00 | DMF32-S0003 FCO DOCUMENT | EACH | \$11.00 | 3 | A | |
| EQ-01454-03 | CIBCI-1002 FCO KIT | EACH | \$50.00 | 3 | A | | FA-04483-01 | MH780-S00B1 FCO DOCUMENT | EACH | \$11.00 | 3 | A | |
| EQ-01454-04 | LO100 FCO DOC KIT | EACH | \$3,303.00 | Y | 3 | A | FA-04485-01 | 7015637-S0003 FCO DOCUMENT | EACH | \$11.00 | 3 | A | |
| EQ-01454-05 | LO118 FCO KIT | EACH | \$3,068.00 | 3 | A | | | | | | | | |
| EQ-01455-01 | TA78-1004/TU78-1032 FCO KIT | EACH | \$3,068.00 | 3 | A | | FA-04552-01 | DW750-R0002 FCO DOC | EACH | \$11.00 | 3 | A | |
| EQ-01459-01 | L0006-YA-1001 FCO KIT | EACH | \$3,500.00 | 3 | A | | FA-04553-01 | FP750-R0002 FCO DOC | EACH | \$11.00 | 3 | A | |
| EQ-01459-02 | L0006-YA-1001 FCO KIT | EACH | \$25.00 | 3 | A | | FA-04566-01 | VT240-R0001 FCO KIT | EACH | \$11.00 | 3 | A | |
| EQ-01460-01 | 85XBA-1003 FCO KIT | EACH | \$5,250.00 | 3 | A | | FA-04568-01 | VT240-R0003 FCO DOC | EACH | \$11.00 | 3 | A | |
| EQ-01461-01 | 85XBA-1004 FCO KIT | EACH | \$2,911.00 | 3 | A | | FA-04587-01 | KL10-PV-R0010 FCO DOC | EACH | \$11.00 | 3 | A | |
| EQ-01466-01 | 11730-1002 FCO KIT | EACH | \$88.00 | 3 | A | | | | | | | | |
| EQ-01475-01 | TK50-AX REV E1/HIGH DISK DRIV | EACH | REPLACED | 3 | A | TK50-AX | FA-04588-01 | C1750-R00B1 FCO DOC | EACH | \$11.00 | 3 | A | |
| EQ-01490-01 | A2-W0739-10-1001 FCO KIT | EACH | \$5,478.00 | 3 | A | | FA-04589-01 | C1780-R00C1 FCO DOC | EACH | \$11.00 | 3 | A | |
| EQ-01499-01 | DRB32-W-1001 FCO KIT | EACH | \$3,456.00 | 3 | A | | FA-04597-01 | 11785-R0001 FCO DOC | EACH | \$11.00 | 3 | A | |
| EQ-01501-01 | DELUA-1002 FCO KIT | EACH | \$75.00 | 3 | A | | FA-04618-01 | FU750-R0001 FCO DOC | EACH | \$11.00 | 3 | A | |
| EQ-01502-01 | 882BA-1004 FCO KIT | EACH | \$13,803.00 | 3 | A | | FA-04620-01 | DW780-S00C1 FCO DOC | EACH | \$11.00 | 3 | A | |
| | | | | | | | FA-04624-01 | C1750-R00C1 FCO DOC | EACH | \$11.00 | 3 | A | |
| | | | | | | | FA-04625-01 | C1780-R00D1 FCO KIT | EACH | \$11.00 | 3 | A | |
| | | | | | | | FA-04633-01 | CD-KITS-KA86-I-001 FCO DOC | EACH | \$11.00 | 3 | A | |
| | | | | | | | FA-04636-01 | 11785-R0002 FCO DOC | EACH | \$11.00 | 3 | A | |
| | | | | | | | FA-04641-01 | KA86AA-R-001 FCO KIT | EACH | \$11.00 | 3 | A | |

FA CLASS Field Change Order Documentation



Prices Effective 02-January-89 to 30-June-89

To Order—Call DECdirect™ TOLL-FREE 800-344-4825, 8:30 a.m. to 8:00 p.m. ET in Continental U.S.A.

HARDWARE SPARES PRICE LIST

| PART NUMBER | DESCRIPTION | UNIT ORDER | UNIT PRICE | REP D L | REPLACEMENT PART NUMBER | PART NUMBER | DESCRIPTION | UNIT ORDER | UNIT PRICE | REP D L | REPLACEMENT PART NUMBER |
|-------------|-------------------------------|------------|------------|---------|-------------------------|-------------|----------------------------|------------|------------|---------|-------------------------|
| FA-04641-03 | KA86AA/AD-R-001 FCO RPP | EACH | \$11.00 | 3 A | | FA-04709-01 | KA750-A-I-001 FCO DOC | EACH | \$11.00 | 3 A | |
| FA-04641-04 | KA86AA/AD-R001 FCO(L9200) RPP | EACH | \$11.00 | 3 A | | FA-04723-01 | CIBCI-B1-I001 FCO KIT | EACH | \$10.00 | 3 A | |
| FA-04645-01 | CI750-R00D1 FCO DOC | EACH | \$11.00 | 3 A | | FA-04739-01 | 11750-I008 FCO DOC | EACH | \$10.00 | 3 A | |
| FA-04646-01 | CI780-R00E1 FCO DOC | EACH | \$11.00 | 3 A | | FA-04740-01 | A2-W1093-10-I001 FCO DOC | EACH | \$10.00 | 3 A | |
| FA-04661-01 | FP785-D-R002 FCO DOC | EACH | \$11.00 | 3 A | | FA-04740-02 | CI780-I006 FCO DOC | EACH | \$10.00 | 3 A | |
| FA-04679-01 | LN03-I-001 FCO DOC | EACH | \$11.00 | 3 A | | FA-04740-03 | CIBCI-I002 FCO DOC | EACH | \$10.00 | 3 A | |
| FA-04682-01 | KA86-R-003 FCO DOC | EACH | \$11.00 | 3 A | | FA-04740-04 | HSC50-I009 FCO DOC | EACH | \$10.00 | 3 A | |
| FA-04682-02 | KA86-I-003 FCO RPP | EACH | \$11.00 | 3 A | | FA-04740-05 | HSC70-I001 FCO DOC | EACH | \$10.00 | 3 A | |
| FA-04688-01 | CI780-F1-I-005 FCO DOC | EACH | \$11.00 | 3 A | | FA-04745-01 | L0006-YA-I001 FCO-DOC | EACH | \$10.00 | 3 A | |
| FA-04689-01 | CI750-E1-I-004 FCO DOC | EACH | \$11.00 | 3 A | | FA-04746-01 | 85XBA-I003 FCO DOC | EACH | \$10.00 | 3 A | |
| FA-04691-01 | KA86-AA-AD-I-004 FCO DOC | EACH | \$11.00 | 3 A | | FA-04747-01 | 85XBA-I004 FCO DOC | EACH | \$10.00 | 3 A | |
| FA-04692-01 | KA86-AA-AD-I-005 FCO DOC | EACH | \$11.00 | 3 A | | FA-04753-01 | 11730-I002 FCO DOC | EACH | \$10.00 | 3 A | |
| FA-04693-01 | KA86-AA-AD-I006 FCO DOC | EACH | \$11.00 | 3 A | | FA-04783-01 | A2-W0739-10 - I001 FCO DOC | EACH | \$10.00 | 3 A | |
| FA-04694-01 | KA86-AA-AD-I007 FCO DOC | EACH | \$11.00 | 3 A | | FA-04805-01 | DWBUA-I002 FCO DOC | EACH | \$10.00 | 3 A | |
| FA-04694-02 | KA86-AA-AD-I007 FCO RPP | EACH | \$11.00 | 3 A | | | | | | | |
| FA-04696-01 | 11780-8-I-008 FCO DOC | EACH | \$11.00 | 3 A | | | | | | | |
| FA-04696-02 | 11780-8-I008 FCO DOC | EACH | \$10.00 | 3 A | | | | | | | |
| FA-04705-01 | CD-KITS-KA88-I001 FCO DOC | EACH | \$11.00 | 3 A | | | | | | | |
| FA-04706-01 | CI750-E1-I-004 FCO DOC | EACH | \$11.00 | 3 A | | | | | | | |
| FA-04707-01 | CI780-F1-I-005 FCO DOC | EACH | \$11.00 | 3 A | | | | | | | |



Prices Effective 02-January-89 to 30-June-89
 To Order—Call DECdirect™ TOLL-FREE 800-344-4825, 8:30 a.m. to 8:00 p.m. ET in Continental U.S.A.



Part B
Documentation and Diagnostics Price List

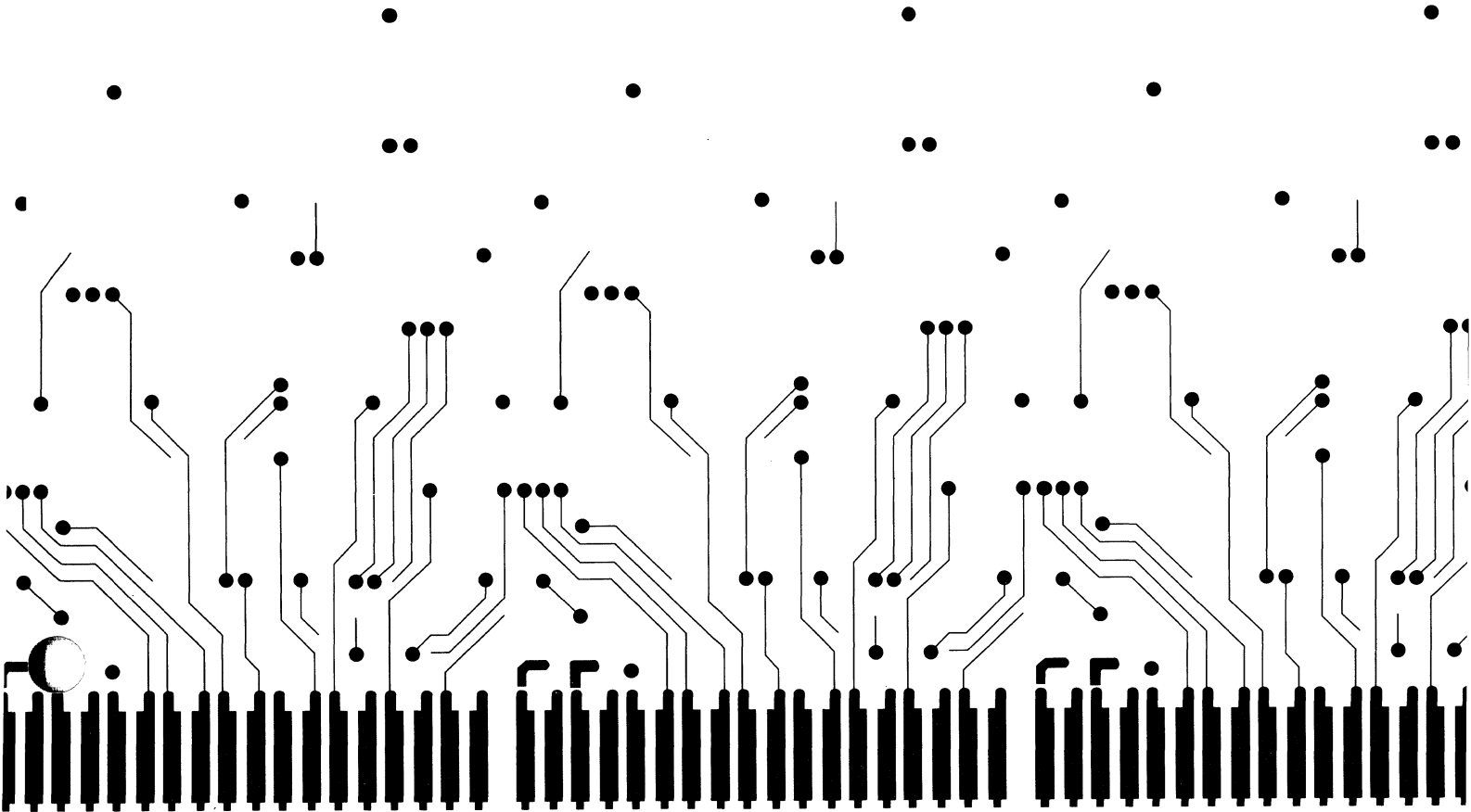

DOCUMENTATION AND DIAGNOSTICS PRICE LIST

| PART NUMBER | DESCRIPTION | UNIT ORDER | UNIT PRICE | REP D L | REPLACEMENT PART NUMBER | PART NUMBER | DESCRIPTION | UNIT ORDER | UNIT PRICE | REP D L | REPLACEMENT PART NUMBER |
|---|-------------------------------|------------|-------------|---------|-------------------------|-------------|-------------------------------|------------|-------------|---------|-------------------------|
| Z CLASS Diagnostic Software Kits | | | | | | ZK200-DZ | VENUS 8600/8650 DIAG LIC ONLY | EACH | \$1,890.00 | 3 B | ZK200-HH |
| Z2200-UZ | VAXB I 85-8800 MT/FL DIAG KIT | EACH | \$1,100.00 | 3 B | | ZK200-HH | VENUS 8600/8650 DIAG UPD SVC | EACH | \$5,250.00 | 3 B | |
| Z2200-UZ | VAXB I 8550 DIAG LICENSE ONLY | EACH | \$9,645.00 | 3 B | | ZK200-HQ | VENUS (8600) DIAG. UPD SVC | EACH | REPLACED | B | |
| Z2200-WW | VAXB I 85-8800 ANN SUBS MT/FL | EACH | \$550.00 | 3 B | | ZL200-GZ | VAXB I 82-8300 DIAG DOC KIT | EACH | \$126.00 | 3 A | |
| Z2201-HW | VAXB I 85-8800 MT/FL DIAG KIT | EACH | \$1,100.00 | 3 B | | ZL201-GZ | 0AXB I 85-8800 DIAG DOC KIT | EACH | \$126.00 | 3 A | |
| Z2201-UZ | VAXB I 8700 DIAG LICENSE ONLY | EACH | \$12,785.00 | 3 B | | ZM200-HW | VAXB I 85-8800 MT/FL DIAG KIT | EACH | \$1,100.00 | 3 B | |
| Z2201-WW | VAXB I 85-8800 ANN SUBS MT/FL | EACH | \$550.00 | 3 B | | ZM200-UZ | VAXB I 8800 DIAG LICENSE ONLY | EACH | \$16,430.00 | 3 B | |
| Z4A4A-GZ | VAXSTATION GPX BA23 DOC KIT | EACH | \$100.00 | 3 A | | ZM200-WW | VAXB I 85-8800 ANN SUBS MT/FL | EACH | \$550.00 | 3 B | |
| Z4A4B-GZ | VAX STATION/GPX-BA23 DOC KIT | EACH | \$105.00 | 3 A | | ZN055-C3 | MICROVAX I DIAG RX50 | EACH | \$630.00 | 3 B | |
| Z5200-HW | VAXB I 82-8300 MT/FL DIAG KIT | EACH | \$1,050.00 | 3 B | | ZN055-DZ | MICROVAX I DIAG LICENSE ONLY | EACH | \$158.00 | 3 B | |
| Z5200-UZ | VAXB I 8200 DIAG LICENSE ONLY | EACH | \$3,100.00 | 3 B | | ZNA02-GZ | MVII DIAG NETWORK SERVER DOC | EACH | \$105.00 | 3 A | |
| Z5200-WW | VAXB I 82-8300 ANN SUBS MT/FL | EACH | \$525.00 | 3 B | | ZNA02-P5 | MDM ETHER SRV KIT, VMS, TK50 | EACH | \$200.00 | 3 N | |
| Z7200-HW | VAXB I 82-8300 MT/FL DIAG KIT | EACH | \$1,050.00 | 3 B | | ZNA02-PH | MDM ETHER SRV KIT, VMS, RL02 | EACH | \$200.00 | 3 N | |
| Z7200-UZ | VAXB I 8300 DIAG LICENSE ONLY | EACH | \$4,210.00 | 3 B | | ZNA02-PM | MDM ETHER SRV KIT,VMS,MAGTAPE | EACH | \$200.00 | 3 N | |
| Z7200-WW | VAXB I 82-8300 ANN SUBS MT/FL | EACH | \$525.00 | 3 B | | ZNA03-C5 | MICROVAX TK50 DIAG. KIT | EACH | \$10,500.00 | 3 B | |
| Z9200-HW | VAXB I 85-8800 MT/FL DIAG KIT | EACH | \$1,100.00 | 3 B | | ZNA03-CM | MICROVAX 1600BPI DIAG KIT | EACH | \$10,500.00 | 3 B | |
| Z9200-UZ | VAXB I 8500 DIAG LICENSE ONLY | EACH | \$7,535.00 | 3 B | | ZNA03-H5 | MICROVAX DEVELOPMENT DIAG UPD | EACH | \$420.00 | 3 B | |
| Z9200-WW | VAXB I 85-8800 ANN SUBS MT/FL | EACH | \$550.00 | 3 B | | ZNA03-HM | MICROVAX DEVELOPMENT DIAG UPD | EACH | \$420.00 | 3 B | |
| ZA201-HW | VAX 8820-8840 MT/FL DIAG KIT | EACH | \$1,000.00 | 3 B | | ZNA06-C5 | MICROVAX II DIAG LIC TK50 | EACH | REPLACED | 3 B | ZNABX-C5 |
| ZA201-UZ | VAX 8820 DIAGNOSTIC LICENSE | EACH | \$17,200.00 | 3 B | | ZNA06-H5 | MICROVAX II DIAG UPD SVC TK50 | EACH | REPLACED | 3 B | ZNABX-H5 |
| ZA201-WW | VAX 8820-8840 ANN SUBS MT/FL | EACH | \$500.00 | 3 B | | ZNA07-H5 | MV DIAG MDM ENET MAINT TK50 | EACH | \$1,000.00 | 3 B | |
| ZA202-HW | VAX 8820-8840 MT/FL DIAG KIT | EACH | \$1,000.00 | 3 B | | ZNA07-HH | MV DIAG MDM ENET MAINT RL02 | EACH | \$1,000.00 | 3 B | |
| ZA202-UZ | VAX 8830 DIAGNOSTIC LICENSE | EACH | \$19,200.00 | 3 B | | ZNA07-HM | MV DIAG MDM ENET MAINT 1600MT | EACH | \$1,000.00 | 3 B | |
| ZA202-WW | VAX 8820-8840 ANN SUBS MT/FL | EACH | \$500.00 | 3 B | | ZNA07-UZ | MV DIAG ENET MAINT LICENSE | EACH | \$250.00 | 3 B | |
| ZA203-HW | VAX 8820-8840 MT/FL DIAG KIT | EACH | \$1,000.00 | 3 B | | ZNA07-W5 | MV DIAG MDM ENET UPDATE TK50 | EACH | \$300.00 | 3 B | |
| ZA203-UZ | VAX 8840 DIAGNOSTIC LICENSE | EACH | \$24,900.00 | 3 B | | ZNA07-WH | MV DIAG MDM ENET UPDATE RL02 | EACH | \$300.00 | 3 B | |
| ZA203-WW | VAX 8820-8840 ANN SUBS MT/FL | EACH | \$500.00 | 3 B | | ZNA07-WM | MV DIAG MDM ENET UPD 1600MT | EACH | \$300.00 | 3 B | |
| ZC200-CJ | VAX 11730 CMPLT DIAG-RA60 | EACH | \$5,250.00 | 3 B | | ZNA6B-GZ | VAX LAB H/W DOC -UG'S & -RC | EACH | \$105.00 | 3 A | |
| ZC200-CW | VAX 730 CMPLT RL02/TU58 DIAG | EACH | \$5,250.00 | 3 B | | ZNAAC-GZ | MV11 CUX2 H/W INFO DOC KIT | EACH | \$105.00 | 3 A | |
| ZC200-DZ | VAX 11/730 DIAG LIC. ONLY | EACH | \$525.00 | 3 B | | ZNABX-C3 | MICROVAX II DIAG LIC RX50 | EACH | \$2,625.00 | 3 B | |
| ZD201-CG | VAX 11750 COMPLETE TU58 DIAG | EACH | \$7,350.00 | 3 B | | ZNABX-C5 | MICROVAX II DIAG LIC TK50 | EACH | \$2,625.00 | 3 B | |
| ZD201-CW | VAX 11750 CMPLT MT/TU58 DIAG | EACH | \$7,350.00 | 3 B | | ZNABX-DZ | MICROVAX II DIAG LIC ONLY | EACH | \$158.00 | 3 B | |
| ZD201-DZ | VAX 11/750 DIAG LIC. ONLY | EACH | \$735.00 | 3 B | | ZNABX-GZ | MICROVAX FAMILY MAINT DOC | EACH | \$105.00 | 3 A | |
| ZD201-HG | VAX 11750 CMPLT TU58 DIAG UP | EACH | \$3,150.00 | 3 B | | ZNABX-H3 | MICROVAX II DIAG UPD SVC | EACH | \$714.00 | 3 B | |
| ZD201-HW | VAX750 CMPLT MT/TU58 DIAG UPD | EACH | \$3,150.00 | 3 B | | ZNABX-H5 | MICROVAX II DIAG UPD SVC TK50 | EACH | \$714.00 | 3 B | |
| ZE200-CM | VAX 11780 MAGTAPE CMPLT DIAG | EACH | \$9,450.00 | 3 B | | ZNAEF-C5 | MV3600/V3600/V3602 H/W INFO | EACH | \$300.00 | 3 N | |
| ZE200-CW | VAX 11780 CMPLT MT/FLP DIAG | EACH | \$9,450.00 | 3 B | | ZNAEF-GZ | MV3600/V3600/V3602 DIAG DOC | EACH | \$100.00 | 3 N | |
| ZE200-CY | VAX 11780 CMPLT FLP DIAG | EACH | \$9,450.00 | 3 B | | ZNAES-C5 | MV3500/V3500 H/W INFO KIT | EACH | \$300.00 | 3 A | |
| ZE200-DZ | VAX 11/780 DIAG LIC ONLY | EACH | \$945.00 | 3 B | | ZNAES-GZ | MV3500/V3500 DIAG DOC | EACH | \$100.00 | 3 A | |
| ZE200-HM | VAX 11780 CMPLT DIAG MT UPD | EACH | \$3,150.00 | 3 B | | ZNAEX-H5 | MV/VX 3XXX DIAGNOSTIC MEDIA | EACH | \$1,000.00 | 3 B | |
| ZE200-HW | VAX 780 CMPLT MT/FLP DIAG UPD | EACH | \$3,150.00 | 3 B | | ZNAEX-UZ | MV/VX 3XXX DIAGNOSTIC LICENSE | EACH | \$250.00 | 3 B | |
| ZE200-HY | VAX 11/780 CMPLT FLP DIAG UPD | EACH | \$3,150.00 | 3 B | | ZNAEX-WW | MV/VX 3XXX DIAGNOSTIC ANN UPD | EACH | \$300.00 | 3 B | |
| ZE210-CW | VAX 11/785 CMPLT DIAG-RX01/MT | EACH | \$12,600.00 | 3 B | | ZNAFR-C5 | MV3300 (BA215/640QR)H/W INFO | EACH | \$300.00 | 3 N | |
| ZE210-CY | VAX 11/785 CMPLT DIAG-RX01 | EACH | \$12,600.00 | 3 B | | ZNAFR-GZ | MICROVAX 3300 BA215/640QR H/W | EACH | \$100.00 | 3 N | |
| ZE210-DZ | VAX 11/785 DIAG LICENSE ONLY | EACH | \$1,260.00 | 3 B | | ZNAFS-C5 | MV3400 (640QS) H/W INFO KIT | EACH | \$300.00 | 3 N | |
| ZE210-HW | VAX 11/785 DIAG UPD SVC | EACH | \$3,150.00 | 3 B | | ZNAGX-HW | MV/VX 2000 SERV MAINT PACKAGE | EACH | \$500.00 | 3 B | |
| ZE210-HY | VAX 11/785 CMPLT FLP DIAG UPD | EACH | \$3,150.00 | 3 B | | ZNAGX-UZ | MV/VX 2000 DIAGNOSTIC LICENSE | EACH | \$150.00 | 3 B | |
| ZE215-CW | VAX 11/785 DIAG UPGRADE | EACH | \$3,150.00 | 3 B | | ZNAHH-C5 | IVAX 630 H/W INFO KIT TK50 | EACH | \$150.00 | 3 N | |
| ZJADX-GZ | PDP11 XDP DOC. KIT | EACH | \$53.00 | 3 A | | ZNAHH-GZ | IVAX 630 H/W INFORMATION KIT | EACH | \$105.00 | 3 N | |
| ZK200-CH | VENUS 8600/8650 COMPLETE DIAG | EACH | \$18,900.00 | 3 B | | ZNAHS-C5 | IVAX 620 DISK H/W INFO TK50 | EACH | \$150.00 | 3 N | |
| ZK200-CQ | VENUS (8600) COMPLETE DIAG. | EACH | REPLACED | B | ZK200-CH | ZNAHS-GZ | IVAX 620 DISK H/W INFO | EACH | \$105.00 | 3 A | |
| | | | | | | ZNAHT-GZ | IVAX 620 DISKLESS H/W INFO | EACH | \$105.00 | 3 A | |
| | | | | | | ZNARY-GZ | RTVAX 3200/3201 DISKLESS H/W | EACH | \$105.00 | 3 N | |
| | | | | | | ZNGHH-GZ | IVAX 630 H/W INFO GERMANY | EACH | \$105.00 | 3 A | |
| | | | | | | ZNGHS-GZ | IVAX 620 DISK H/W INFO GERMAN | EACH | \$105.00 | 3 A | |



Prices Effective 02-January-89 to 30-June-89

To Order—Call DECdirect™ TOLL-FREE 800-344-4825, 8:30 a.m. to 8:00 p.m. ET in Continental U.S.A.

DOCUMENTATION AND DIAGNOSTICS PRICE LIST

| PART NUMBER | DESCRIPTION | UNIT ORDER | UNIT PRICE | REP D L | REPLACEMENT PART NUMBER | PART NUMBER | DESCRIPTION | UNIT ORDER | UNIT PRICE | REP D L | REPLACEMENT PART NUMBER |
|---|-------------------------------|------------|------------|---------|-------------------------|-------------|-------------------------------|------------|------------|---------|-------------------------|
| ZNGHT-GZ | IVAX 620 DSKLESS INFO GERMANY | EACH | \$105.00 | 3 A | | AS-E163P-DE | RX13 VAX TM03-TE16/TU45/77 | EACH | REPLACED | 3 B | AS-E163Q-DE |
| ZNPHH-GZ | IVAX 630 H/W INFO FRANCE | EACH | \$105.00 | 3 A | | AS-E163Q-DE | RX13 VAX TM03-TE16/TU45/77 | EACH | \$116.00 | 3 B | |
| ZNPHS-GZ | IVAZ 620 DISK H/W INFO FRANCE | EACH | \$105.00 | 3 A | | AS-E164Q-DE | RX14 VAX DUP11 FLOPPY | EACH | REPLACED | 3 B | AS-E164T-DE |
| ZU200-HW | VAX 6210-6240 MT/FL DIAG KIT | EACH | \$1,000.00 | 3 B | | AS-E164T-DE | RX14 VAX DUP11 FLOPPY | EACH | \$116.00 | 3 B | |
| ZU200-UZ | VAX 6210 DIAGNOSTIC LICENSE | EACH | \$4,200.00 | 3 B | | AS-E165N-DE | RX15 VAX RK611 FLOPPY #1 | EACH | \$116.00 | 3 B | |
| ZU200-VWV | VAX 6210-6240 ANN SUBS MT/FL | EACH | \$500.00 | 3 B | | AS-E166M-DE | RX16 VAX RK611 LD DEV #2 | EACH | REPLACED | 3 B | AS-E166N-DE |
| ZU202-HW | VAX 6210-6240 MT/FL DIAG KIT | EACH | \$1,000.00 | 3 B | | AS-E166N-DE | RX16 VAX RK611 FLOPPY #2 | EACH | \$116.00 | 3 B | |
| ZU202-UZ | VAX 6220 DIAGNOSTIC LICENSE | EACH | \$5,200.00 | 3 B | | AS-E167V-DE | RX17 VAX GENERIC MT DIAG | EACH | REPLACED | 3 B | AS-E167W-DE |
| ZU202-VWV | VAX 6210-6240 ANN SUBS MT/FL | EACH | \$500.00 | 3 B | | AS-E167W-DE | RX17 GENERIC MT DIAG | EACH | \$110.00 | 3 B | |
| ZU203-HW | VAX 6210-6240 MT/FL DIAG KIT | EACH | \$1,000.00 | 3 B | | AS-E168W-DE | RX18 VAX USER MODE DIAG #1 | EACH | REPLACED | 3 B | AS-E168Z-DE |
| ZU203-UZ | VAX 6230 DIAGNOSTIC LICENSE | EACH | \$7,200.00 | 3 B | | AS-E168Z-DE | RX18 VAX USER MODE DIAG #1 | EACH | \$116.00 | 3 B | |
| ZU203-VWV | VAX 6210-6240 ANN SUBS MT/FL | EACH | \$500.00 | 3 B | | AS-E170M-DE | RX12 VAX RP04/5/6 DIAG | EACH | REPLACED | 3 B | AS-E170N-DE |
| ZU204-HW | VAX 6210-6240 MT/FL DIAG KIT | EACH | \$1,000.00 | 3 B | | AS-E170N-DE | RX12 VAX RP04/5/6 DIAG | EACH | \$116.00 | 3 B | |
| ZU204-UZ | VAX 6240 DIAGNOSTIC LICENSE | EACH | \$9,200.00 | 3 B | | AS-E660Y-DE | RX10 11780 DIAG DISK BUILDER | EACH | REPLACED | 3 B | AS-E660Z-DE |
| ZU204-VWV | VAX 6210-6240 ANN SUBS MT/FL | EACH | \$500.00 | 3 B | | AS-E660Z-DE | RX10 11780 DIAG DISK BUILDER | EACH | \$110.00 | 3 B | |
| ZYA05-P3 | MICRO-11 RX50 DIAG. KIT | EACH | \$714.00 | 3 A | | AS-E990N-DE | RX5 11780 RD MICRODIAG #1 | EACH | REPLACED | 3 B | AS-E990O-DE |
| ZYA05-P5 | CZTK2B0 MICRO-11 MAINT. TK50 | EACH | \$714.00 | 3 A | | AS-E990O-DE | RX5 11780 RD MICRODIAG #1 | EACH | \$116.00 | 3 B | |
| ZYA06-P3 | RX33 FORMATTER | EACH | \$89.00 | 3 A | | AS-E991T-DE | RX6 11780 RD MICRODIAG #2 | EACH | REPLACED | 3 B | AS-E991U-DE |
| ZYABX-GZ | MICRO-PDP11 FAMILY MAINTAINCE | EACH | \$105.00 | 3 N | | AS-E991U-DE | RX6 11780 RD MICRODIAG #2 | EACH | \$116.00 | 3 B | |
| ZYAHH-GZ | OPDP H/W INFO | EACH | \$105.00 | 3 A | | AS-F460I-DE | RX19 VAX RK611 FLOPPY #3 | EACH | \$116.00 | 3 B | |
| AM CLASS Diagnostics on RK06 | | | | | | AS-F715M-DE | RX22 MA780 MICRODIAG FLOPPY | EACH | REPLACED | 3 B | AS-F715N-DE |
| AM-FJ44F-MC | CZZRCFO RK6 V2 DIAG PKG | EACH | \$750.00 | 3 A | | AS-F715N-DE | RX22 MA780 MICRODIAG FLOPPY | EACH | \$116.00 | 3 B | |
| AM-S469Z-MC | CZZRBZ0 RK6 V2 DIAG PKG | EACH | REPLACED | 3 A | AM-FJ44F-MC | AS-F717W-DE | RX21 VAX USER MODE DIAG #2 | EACH | REPLACED | 3 B | AS-F717Y-DE |
| AP CLASS Diagnostic Mag Tape (800 BPI) | | | | | | AS-F717Y-DE | RX21 VAX USER MODE DIAG #2 | EACH | REPLACED | 3 B | AS-FJ74B-DE |
| AP-FK21B-MC | CZZ11B0 MMDP V2 2400' 1 OF 2 | EACH | \$375.00 | 3 A | | AS-F718N-DE | RX24 VAX PCL11/DR70 DIAG | EACH | \$116.00 | 3 B | |
| AP-FK22B-MC | CZZ12B0 MMDP V2 2400' 1 OF 2 | EACH | \$375.00 | 3 A | | AS-F719R-DE | RX23 VAX DMC11/DMR11 FLP | EACH | REPLACED | 3 B | AS-F719S-DE |
| AP-T071Y-MC | CZZ4T0 MMDP V2 MT9 1 OF 2 | EACH | REPLACED | 3 A | AP-T071Z-MC | AS-F719S-DE | RX23 VAX DMC11/DMR11 FLP | EACH | \$116.00 | 3 B | |
| AP-T071Z-MC | CZZZAT0 MMDP V2 2400' MT9 1/2 | EACH | \$375.00 | 3 A | | AS-F748X-DE | RX25 VAX 11 INSTR #2 | EACH | REPLACED | 3 B | AS-F748Z-DE |
| AP-T072Y-MC | CZZ5T0 MMDP V2 MT9 2 OF 2 | EACH | REPLACED | 3 A | AP-T072Z-MC | AS-F834H-DE | RX26 VAX LPA11 FLP #1 | EACH | \$116.00 | 3 B | |
| AP-T072Z-MC | CZZZ5U0 MMDP V2 2400' MT9 1/2 | EACH | \$375.00 | 3 A | | AS-F835I-DE | RX27 VAX LPA11 FLP #2 | EACH | REPLACED | 3 B | AS-F835K-DE |
| AQ CLASS Diagnostics on TK50 | | | | | | AS-F835K-DE | RX27 VAX LPA11 FLP #2 | EACH | \$116.00 | 3 B | |
| AQ-GM5AJ-DN | MVII DIAG MAINT TK50 | EACH | REPLACED | 3 B | AQ-GM5AP-DN | AS-F891F-DE | RX28 VAX DR780 FLP #1 | EACH | REPLACED | 3 B | AS-F891G-DE |
| AQ-GM5AP-DN | MVII DIAG MAINT TK50 | EACH | \$150.00 | 3 B | | AS-F891G-DE | RX28 VAX DR780 FLP #1 | EACH | \$116.00 | 3 B | |
| AS CLASS Diagnostics on RX01 Floppy | | | | | | AS-F892K-DE | RX29 VAX DR780 FLP #2 | EACH | REPLACED | 3 B | AS-F892L-DE |
| AS-E158S-DE | RX2 VAX 11780 MICRO DIAG #1 | EACH | REPLACED | 3 B | AS-E158T-DE | AS-F892L-DE | RX29 VAX DR780 FLP #2 | EACH | \$116.00 | 3 B | |
| AS-E158T-DE | RX2 VAX 11780 MICRO DIAG #1 | EACH | \$116.00 | 3 B | | AS-F893I-DE | RX30 VAX DR780 FLP #3 | EACH | REPLACED | 3 B | AS-F893J-DE |
| AS-E159V-DE | RX3 VAX 11780 MICRO DIAG #2 | EACH | REPLACED | 3 B | AS-E159W-DE | AS-F893J-DE | RX30 VAX DR780 FLP #3 | EACH | \$116.00 | 3 B | |
| AS-E159W-DE | RX3 VAX 11780 MICRO DIAG #2 | EACH | \$116.00 | 3 B | | AS-F901H-DE | RX32 VAX RM03/5 DIAG | EACH | REPLACED | 3 B | AS-F901I-DE |
| AS-E161Q-DE | RX8 VAX 11 INSTR #1 | EACH | REPLACED | 3 B | AS-E161R-DE | AS-F901I-DE | RX32 VAX RM03/5 DIAG | EACH | \$116.00 | 3 B | |
| | | | | | | AS-F983J-DE | RX33 VAX DR11C/DN11/DF11W FLP | EACH | \$116.00 | 3 B | |
| | | | | | | AS-F984H-DE | RX34 VAX DV11 FLP #1 | EACH | \$116.00 | 3 B | |
| | | | | | | AS-F985F-DE | RX35 VAX DV11 FLP #2 | EACH | REPLACED | 3 B | AS-F985G-DE |
| | | | | | | AS-F985G-DE | RX35 VAX DV11 FLP #2 | EACH | \$116.00 | 3 B | |
| | | | | | | AS-FF00B-DE | RX86 VAX DZ211/DZS11 DIAG | EACH | \$116.00 | 3 B | |
| | | | | | | AS-FF34B-DE | RX87 VAX LCP01/LN03 DIAG | EACH | \$116.00 | 3 B | |
| | | | | | | AS-FF35A-DE | RX88 VAX CPI32 DIAG | EACH | \$116.00 | 3 B | |
| | | | | | | AS-FG01D-DE | RX90 VAX DHU11/KMS11K DIAG | EACH | \$116.00 | 3 N | |
| | | | | | | AS-FG41D-ME | VAX FORMATRS RP/RK/RM/RA/RC | EACH | REPLACED | 3 N | AS-FG41F-ME |
| | | | | | | AS-FG41F-ME | VAX FORMATRS RP/RK/RM/RA/RC | EACH | \$116.00 | 3 A | |
| | | | | | | AS-FG42J-ME | VAX AUTOSIZER DIAG - UF#2 | EACH | \$116.00 | 3 N | |
| | | | | | | AS-FG99C-DE | RX67A VAX CI SOFTWARE FLP 2/2 | EACH | REPLACED | 3 B | AS-FG99D-DE |
| | | | | | | AS-FG99D-DE | RX67A VAX CI SOFTWARE FLP 2/3 | EACH | \$116.00 | 3 B | |
| | | | | | | AS-FH58E-DE | RX20 VAX UDA50 BAD BLOCK UTIL | EACH | REPLACED | 3 B | AS-FH58H-DE |
| | | | | | | AS-FH58H-DE | RX20 VAX UDA50 BAD BLOCK UTIL | EACH | \$110.00 | 3 B | |
| | | | | | | AS-FH59B-DE | RX53 VAX TK50 DIAGNOSTICS | EACH | \$116.00 | 3 B | |



Prices Effective 02-January-89 to 30-June-89
 To Order—Call DECdirect™ TOLL-FREE 800-344-4825, 8:30 a.m. to 8:00 p.m. ET in Continental U.S.A.

DOCUMENTATION AND DIAGNOSTICS PRICE LIST

| PART NUMBER | DESCRIPTION | UNIT ORDER | UNIT PRICE | REP D L | REPLACEMENT PART NUMBER | PART NUMBER | DESCRIPTION | UNIT ORDER | UNIT PRICE | REP D L | REPLACEMENT PART NUMBER |
|-------------|-------------------------------|------------|------------|---------|-------------------------|--|-------------------------------|------------|------------|---------|-------------------------|
| AS-FI19F-DE | RX11 VAX GENERIC DISK DIAG | EACH | \$116.00 | 3 B | | AS-T392B-ME | RX69 DR780 MICROCODE | EACH | REPLACED | 3 N | AS-T392C-ME |
| AS-FI61J-ME | RX7A VAX DIAG SUPER HELP FILE | EACH | \$116.00 | 3 N | | AS-T392C-ME | RX69 DR780 MICROCODE | EACH | \$116.00 | 3 N | |
| AS-FI76A-DE | RX67B VAX CI SOFTWARE FLP 3/3 | EACH | \$116.00 | 3 B | | AS-T489F-DE | RX8 11780 MICRO DIAG #3 | EACH | REPLACED | 3 B | AS-T489G-DE |
| AS-FJ74B-DE | RX21 VAX USER MODE DIAG #2 | EACH | \$116.00 | 3 B | | AS-T489G-DE | RX8 11780 MICRODIAG #3 | EACH | \$116.00 | 3 B | |
| AS-FK47A-DE | RX25 VAX 11 INSTR #2 | EACH | \$116.00 | 3 B | | AS-T532K-DE | RX70 VAX DEUNA/DELUA DIAG | EACH | \$116.00 | 3 B | |
| AS-S023N-DE | RX36 VAX DQS11/DR11B/W FLP | EACH | REPLACED | 3 B | AS-S023O-DE | | | EACH | \$116.00 | 3 B | |
| AS-S023O-DE | RX36 VAX DQS11 DR11B/W FLP | EACH | \$116.00 | 3 B | | AS-T533K-DE | RX71 VAX PRNTR/TERMINAL DIAG | EACH | \$116.00 | 3 B | |
| AS-S143N-DE | RX37 VAX TS11 FLOPPY | EACH | REPLACED | 3 B | AS-S143O-DE | AS-T599J-DE | RX72 VAX CI750/780 DIAG | EACH | REPLACED | 3 B | AS-T599K-DE |
| AS-S143O-DE | RX37 VAX TS11 FLOPPY | EACH | \$110.00 | 3 B | | AS-T599N-DE | RX72 VAX CI750/780 DIAG | EACH | \$116.00 | 3 B | |
| AS-S144L-DE | RX38 VAX DMP11 DIAG | EACH | REPLACED | 3 B | AS-S144O-DE | AS-T623B-DE | RX2A VAX 11785 MICRO DIAG #1 | EACH | REPLACED | 3 B | AS-T623C-DE |
| | | | | | | AS-T623C-DE | RX2A VAX 11785 MICRO DIAG #1 | EACH | \$116.00 | 3 B | |
| AS-S144O-DE | RX38 VAX DMP11/DZ11 DIAG | EACH | \$116.00 | 3 B | | AS-T624A-DE | VAX 11780 UDA50 DIAG | EACH | \$116.00 | 3 B | |
| AS-S145G-DE | RX39 VAX RM80 FLP | EACH | REPLACED | 3 B | AS-S145H-DE | AS-T644H-DE | RX67 VAX CI SOFTWARE FLOPPY 1 | EACH | REPLACED | 3 B | AS-T644I-DE |
| AS-S145H-DE | RX39 VAX RM80 FLP | EACH | \$116.00 | 3 B | | AS-T644I-DE | RX67 VAX CI SOFTWARE FLP 1/3 | EACH | \$116.00 | 3 B | |
| AS-S281E-DE | RX40 VAX DV11 FLP #3 | EACH | REPLACED | 3 B | AS-S281F-DE | AS-T679B-DE | RX3A VAX 11785 MICRO DIAG #2 | EACH | REPLACED | 3 B | AS-T679C-DE |
| AS-S281F-DE | RX40 VAX DV11 FLP #3 | EACH | \$116.00 | 3 B | | AS-T679C-DE | RX3A VAX 11785 MICRO DIAG #2 | EACH | \$116.00 | 3 B | |
| AS-S283H-DE | RX42 11780 EUROPEAN UDIAG#1 | EACH | REPLACED | 3 B | AS-S283I-DE | AS-T680D-DE | RX8A VAX 11785 MICRO DIAG #3 | EACH | REPLACED | 3 B | AS-T680E-DE |
| AS-S283I-DE | RX42 11780 EUROPEAN UDIAG#1 | EACH | \$116.00 | 3 B | | AS-T680E-DE | RX8A VAX 11785 MICRO DIAG #3 | EACH | \$116.00 | 3 B | |
| AS-S284M-DE | RX43 11780 EUROPEAN UDIAG#2 | EACH | REPLACED | 3 B | AS-S284N-DE | AS-T684A-DE | RX75 VAX IEU11A DIAG | EACH | \$116.00 | 3 B | |
| AS-S284N-DE | RX43 11780 EUROPEAN UDIAG#2 | EACH | \$116.00 | 3 B | | AS-T688C-DE | RX76 VAX VS100 DIAG | EACH | REPLACED | 3 B | AS-T688D-DE |
| AS-S395F-DE | RX44 RX02/RL02 DIAG | EACH | REPLACED | 3 B | AS-S395G-DE | AS-T688D-DE | RX76 VAX VS100 DIAG | EACH | \$116.00 | 3 B | |
| | | | | | | | | | | | |
| AS-S395G-DE | RX44 VAX RX50/RX02/RL02 DIAG | EACH | \$116.00 | 3 B | | | | | | | |
| AS-S396D-DE | RX45 VAX VS70 DIAG | EACH | \$116.00 | 3 B | | | | | | | |
| AS-S397I-DE | RX46 VAX KMC11-B DIAG | EACH | REPLACED | 3 B | AS-S397J-DE | AS-T690D-DE | RX77 VAX RC25 DIAG | EACH | REPLACED | 3 B | AS-T690F-DE |
| AS-S397J-DE | RX46 VAX KMC11-B DIAG | EACH | \$116.00 | 3 B | | AS-T690F-DE | RX77 VAX RC25 DIAG | EACH | \$116.00 | 3 B | |
| AS-S398J-DE | RX47 VAX SYS EXER/BUS INIT | EACH | REPLACED | 3 B | AS-S398K-DE | AS-T695S-ME | RX7 VAX 11780/785 DIAG SUPER | EACH | \$116.00 | 3 N | |
| | | | | | | AS-T790B-DE | RX22A VAX 11785 MA780 MICRO | EACH | REPLACED | 3 B | AS-T790C-DE |
| | | | | | | AS-T790C-DE | RX22A VAX 11785 MA780 MICRO | EACH | \$116.00 | 3 B | |
| AS-S398K-DE | RX47 VAX SYS EXERZR | EACH | \$116.00 | 3 B | | | | | | | |
| AS-S426C-DE | RX48 VAX DR511/DSS11 DIAG | EACH | \$116.00 | 3 B | | | | | | | |
| AS-S451D-DE | RX49 VAX IEC11 DIAG | EACH | \$116.00 | 3 B | | | | | | | |
| AS-S452E-DE | RX50 VAX TM78/TU78 DIAG | EACH | REPLACED | 3 B | AS-S452F-DE | AS-T791E-DE | RX5 VAX FP785 MICRO DIAG #4 | EACH | REPLACED | 3 B | AS-T791F-DE |
| AS-S452F-DE | RX50 VAX TM78/TU78 DIAG | EACH | \$110.00 | 3 B | | AS-T791F-DE | RX5 VAX FP785 MICRO DIAG #4 | EACH | \$116.00 | 3 B | |
| | | | | | | AS-T792A-DE | RX10 VAX 11785 ETKAX DIAG | EACH | \$116.00 | 3 B | |
| AS-S453F-DE | RX51 VAX RP07 DIAG | EACH | \$116.00 | 3 B | AS-S454J-DE | AS-T793N-ME | RX1A VAX 11785 CONSOLE | EACH | REPLACED | 3 N | AS-T793P-ME |
| AS-S454I-DE | RX52 VAX KMS11-BD DIAG | EACH | REPLACED | 3 B | | AS-T793P-ME | RX1A VAX 11785 CONSOLE | EACH | \$116.00 | 3 N | |
| AS-S454J-DE | RX52 VAX KMS11-BD DIAG | EACH | \$116.00 | 3 B | | | | | | | |
| AS-S525B-DE | RX55 VAX VS11 DIAG | EACH | \$116.00 | 3 B | | | | | | | |
| AS-S526M-DE | RX56 VAX DZ32 DIAGNOSTICS | EACH | REPLACED | 3 B | AS-S526N-DE | AS-T870A-DE | RX78 VAX KCT32 DIAGNOSTIC | EACH | REPLACED | 3 B | AS-T870B-DE |
| | | | | | | AS-T870B-DE | RX78 VAX KCT32 DIAGNOSTIC | EACH | \$116.00 | 3 B | |
| AS-S526N-DE | RX56 VAX DZ32 DIAGNOSTICS | EACH | \$116.00 | 3 B | | AS-T871A-DE | RX79 VX 11780 FEPCM DIAG | EACH | \$116.00 | 3 B | |
| AS-S527D-DE | RX57 VAX MA780 DIAG | EACH | \$116.00 | 3 B | | AS-T910B-DE | RX80 VAX DMZ32/DHU11 DIAG | EACH | REPLACED | 3 B | AS-T910E-DE |
| AS-S528B-DE | RX58 VAX KMS11-BL/BM DIAG | EACH | REPLACED | 3 B | AS-S528C-DE | AS-T910E-DE | RX80 VAX DMZ32 DIAG | EACH | \$116.00 | 3 B | |
| AS-S528C-DE | RX58 VAX KMS11-BL/BM DIAG | EACH | \$116.00 | 3 B | | | | | | | |
| AS-S993E-DE | RX60 VAX ML11 DIAG | EACH | \$116.00 | 3 B | | | | | | | |
| | | | | | | | | | | | |
| AS-T140J-DE | RX62 VAX INSTR #1 | EACH | REPLACED | 3 B | AS-T140K-DE | AS-T911D-DE | RX82 DUCT-DIAG UPD+CNFIG TOOL | EACH | REPLACED | 3 B | AS-T911F-DE |
| AS-T140K-DE | RX62 VAX INSTR #1 | EACH | \$110.00 | 3 B | | AS-T911F-DE | RX82 DUCT-DIAG UPD+CNFIG TOOL | EACH | \$116.00 | 3 B | |
| AS-T195E-DE | RX63 VAX CI780 DIAGNOSTICS | EACH | REPLACED | 3 B | AS-T195F-DE | AS-T944A-DE | RX83 VAX TS05 DIAG | EACH | REPLACED | 3 B | AS-T944B-DE |
| AS-T195F-DE | RX63 VAX CI780 DIAGNOSTICS | EACH | \$116.00 | 3 B | | AS-T944B-DE | RX83 VAX TS05 DIAG | EACH | \$116.00 | 3 B | |
| AS-T196H-DE | RX64 VAX DMF32 DIAGNOSTICS | EACH | REPLACED | 3 B | AS-T196J-DE | AS-U010D-DE | RX85 VAX TU81 DIAG | EACH | REPLACED | 3 B | AS-U010E-DE |
| | | | | | | | | | | | |
| AS-T196J-DE | RX64 VAX DMF32 DIAGNOSTICS | EACH | \$116.00 | 3 B | | | | | | | |
| AS-T197B-DE | RX65 VAX DMP11 DIAG #2 | EACH | REPLACED | 3 B | AS-T197C-DE | AS-U010E-DE | RX85 VAX TU81 DIAG | EACH | \$110.00 | 3 B | |
| AS-T197C-DE | RX65 VAX DMP11 DIAG #2 | EACH | \$116.00 | 3 B | | | | | | | |
| AS-T213R-ME | RX1 VAX11780 STANDARD CONSOLE | EACH | \$116.00 | 3 N | | | | | | | |
| AS-T214A-DE | RX9 VAX/780 MICRO DEBUG TOOLS | EACH | REPLACED | 3 B | AS-T214C-DE | | | | | | |
| | | | | | | | | | | | |
| AS-T214C-DE | RX9 VAX/780 MICRO DEBUG TOOLS | EACH | \$116.00 | 3 B | | | | | | | |
| AS-T215R-DE | RX41 11780 EUR RD CONSOLE | EACH | \$116.00 | 3 B | | | | | | | |
| AS-T216R-DE | RX4 VAX 11780 REMOTE CONSOLE | EACH | \$116.00 | 3 B | | | | | | | |
| AS-T299N-DE | RX66 VAX UDA50 SUBSYSTEM DIAG | EACH | \$116.00 | 3 B | | | | | | | |
| AS-T346B-DE | RX68 VMS DECADATAWAY DIAG MON | EACH | \$116.00 | 3 B | | | | | | | |
| | | | | | | | | | | | |
| | | | | | | AY CLASS Diagnostics on RK07 Disk | | | | | |
| | | | | | | AY-T539Q-MC | CZZSBQ0 RK7 V2 DIAG PKG | EACH | \$750.00 | 3 A | |
| | | | | | | AY-T539W-MC | CZZSBW0 RK7 V2 DIAG PKG | EACH | \$750.00 | 3 A | |



Prices Effective 02-January-89 to 30-June-89

To Order—Call DECdirect™ TOLL-FREE 800-344-4825, 8:30 a.m. to 8:00 p.m. ET in Continental U.S.A.

DOCUMENTATION AND DIAGNOSTICS PRICE LIST

| PART NUMBER | DESCRIPTION | UNIT ORDER | UNIT PRICE | REP D L | REPLACEMENT PART NUMBER | PART NUMBER | DESCRIPTION | UNIT ORDER | UNIT PRICE | REP D L | REPLACEMENT PART NUMBER |
|-------------------------------------|-------------------------------|------------|------------|---------|-------------------------|--|-------------------------------|------------|------------|---------|-------------------------|
| AZ CLASS Hardware Manuals | | | | | | | | | | | |
| AZ-FE08A-TN | MV11 BA123 OWNERS MANUAL | EACH | REPLACED | 3 A | ZNAAB-GZ | BA-FF51H-MC | CZZNNH0 DYDP40 V2 MAG 2/2 | EACH | \$150.00 | 3 A | |
| AZ-FE09A-TN | MV11 BA123 TECH MAN. | EACH | REPLACED | 3 A | ZNAAB-GZ | BA-FF52I-MC | CZZNOI0 DYDP41 V2 MINC-11 2/2 | EACH | \$150.00 | 3 A | |
| AZ-FI11A-MC | MV II SYS MAINTENANCE GDE | EACH | \$80.00 | 3 A | | BA-FF52M-MC | CZZNOM0 DYDP41 V2 MINC-11 | EACH | \$85.00 | 3 A | |
| AZ-GL0AA-MN | MVII-BA23 TECH MANUAL | EACH | REPLACED | 3 A | ZNAAA-GZ | BA-FF53G-MC | CZZNPG0 DYDP42 V2 LSI-11 #4 | EACH | \$150.00 | 3 A | |
| AZ-GL1AA-MN | MVII-BA23 OWNERS MANUAL | EACH | REPLACED | 3 A | ZNAAA-GZ | BA-FF53I-MC | CZZNP10 DYDP42 V2 LSI-11 #4 | EACH | \$85.00 | 3 A | |
| AZ-GLFAA-MN | VS11 630 QV TECH MAN | EACH | REPLACED | 3 A | AZ-GLFAB-MN | BA-FF53J-MC | CZZNPJ0 DYDP42 V2 LSI-11 #4 | EACH | \$85.00 | 3 A | |
| AZ-GLFAB-MN | VS11 630 QV OWNERS MANUAL | EACH | \$50.00 | 3 A | | BA-FF98G-MC | CZZNQG0 DYDP43 V2 MINC-11 1/2 | EACH | \$150.00 | 3 A | |
| AZ-GLNAA-MN | VS11 630 QV OWNERS MANUAL | EACH | REPLACED | 3 A | AZ-GLNAB-MN | BA-FG11E-MC | CZYAOD0 DDDP16 V2 RT950 #1 | EACH | \$150.00 | 3 A | |
| AZ-GLNAB-MN | VSII 630QV-A2/A3 OWNERS MAN | EACH | \$53.00 | 3 A | | BA-FG75E-MC | CZZNSE0 DYDP3 V2 LSI-11 #1 | EACH | \$150.00 | 3 A | |
| AZ-GM3AA-MN | MV11 MAINTENANCE GUIDE | EACH | REPLACED | 3 A | AZ-GM3AB-MN | BA-FG76C-MC | CZZNTC0 DYDP6 V2 COMM 1/3 | EACH | REPLACED | 3 A | BA-FG76E-MC |
| AZ-GN2AB-MC | MICRO PDP11 OWNERS MANUAL | EACH | \$53.00 | 3 A | | BA-FG76E-MC | CZZNTE0 DYDP6 V2 COMM 1/3 | EACH | \$150.00 | 3 A | |
| AZ-GN4AA-TE | VAX 8200 OWNERS MAN. | EACH | REPLACED | 3 A | AZ-GN4AC-TE | BA-FG90E-MC | CZZNRE0 DYDP44 V2 LSI-11 #2 | EACH | \$150.00 | 3 A | |
| AZ-GN4AC-TE | VAX 8200/8300 OWNERS MANUAL | EACH | \$40.00 | 3 A | | BA-FH96C-MC | CZZNUC0 DYDP14 MAG 1/2 | EACH | \$150.00 | 3 A | |
| AZ-GN5AA-TE | VAX 8200 INSTALLATION GUIDE | EACH | REPLACED | 3 A | AZ-GN5AC-TE | BA-FI29C-MC | CZZNVCO DYDP7 V2 COMM 2/3 | EACH | \$150.00 | 3 A | |
| AZ-GN5AB-TE | VAX 8500/8300 INSTALL GDE | EACH | REPLACED | 3 A | EK-8500I-IN | BA-FI59B-MC | CZZNWB0 DYDP16 I/O DEV 1/2 | EACH | \$150.00 | 3 A | |
| AZ-GN5AC-TE | VAX 8200 INST GUIDE | EACH | \$21.00 | 3 A | | BA-FI59D-MC | CZZNWD0 DYDP16 I/O DEV 1/2 | EACH | \$85.00 | 3 A | |
| AZ-GN6AA-TE | VAX 8200 MINI-REFERENCE | EACH | REPLACED | 3 A | AZ-GN6AB-TE | BA-FI59E-MC | CZZNWE0 DYDP16 I/O DEV 1/2 | EACH | \$85.00 | 3 A | |
| AZ-GN6AB-TE | VAX 8200/8300 POCKET REF | EACH | \$40.00 | 3 A | | BA-FI60B-MC | CZZNXB0 DYDP26 LSI-11 #3 | EACH | \$150.00 | 3 A | |
| AZ-GPTAA-MC | MICRO PDP11 TECH MANUAL | EACH | \$40.00 | 3 A | | BA-FI69B-MC | CZZNYB0 DYDP45 V2 CSS 2/2 | EACH | \$150.00 | 3 A | |
| | | | | | | BA-FJ21A-MC | CZZNZA0 DYDP1 XXDP V2 UTILITY | EACH | \$150.00 | 3 A | |
| BA CLASS Diagnostics on RX02 | | | | | | | | | | | |
| BA-F019Z-MC | CZZMAZ0 DYDP1 XXDP V2 UTILITY | EACH | \$158.00 | 3 A | | BA-FJ66B-MC | CZZOAB0DYDP12 V2 MID 11'S | EACH | \$150.00 | 3 A | |
| BA-F020P-MC | CZZMBP0 DYDP2 V2 RP04 | EACH | \$150.00 | 3 A | | BA-S172N-MC | CZZNEN0 DYDP31 V2 RM02/3/5 | EACH | \$150.00 | 3 A | |
| BA-F026U-MC | CZZMHU0 DYDP8 V2 RK06 | EACH | \$150.00 | 3 A | | BA-S968D-MA | ALVTAD0 DECMATE SYSTEM TEST | EACH | \$158.00 | 3 A | |
| BA-F026X-MC | CZZMHT0 DYDP8 V2 RK06 | EACH | \$150.00 | 3 A | | BA-S969D-MC | AKRXC0D DECMATE DIAG FLP | EACH | \$158.00 | 3 A | |
| BA-F027R-MC | CZZMIR0 DYDP9 V2 LPA | EACH | \$150.00 | 3 A | | BA-T171M-MC | CZZNFM0 DYDP32 V2 MEMORY | EACH | \$150.00 | 3 A | |
| BA-F028U-MC | CZZMJU0 DYDP10 V2 ROMS | EACH | \$150.00 | 3 A | | BA-T245J-MC | CZZNGJ0 DYDP33 V2 RM80 | EACH | \$150.00 | 3 A | |
| BA-F028Y-MC | DZZMJY0 DYDP10 V2 ROMS | EACH | \$85.00 | 3 A | | BA-T301O-MC | CZZNH00 DYDP34 V2 UDA | EACH | REPLACED | 3 A | BA-T301T-MC |
| BA-F029U-MC | CZZMKU0 DYDP11 V2 DISKS 1/3 | EACH | \$150.00 | 3 A | | BA-T301T-MC | CZZNHT0 DYDP34 V2 UDA | EACH | \$150.00 | 3 A | |
| BA-F030Y-MC | CZZMLY0 DYDP12 V2 MID 11'S | EACH | REPLACED | 3 A | BA-F030Z-MC | BA-T546K-MC | CZZNIK0 DYDP35 V2 UNA | EACH | \$150.00 | 3 A | |
| BA-F030Z-MC | CZZMLW0 DYDP12 V2 MID 11'S | EACH | \$150.00 | 3 A | | BA-T957L-MC | CZZNJL0 DYDP36 V2 DEC/X11 1/2 | EACH | \$150.00 | 3 A | |
| BA-F031W-MC | CZZMMW0 DYDP13 V2 11/70 1/2 | EACH | \$150.00 | 3 A | | BA-T965I-MC | CZZNKI0 DYDP37 V2 11/21 | EACH | \$150.00 | 3 A | |
| BA-F033X-MC | CZZMOX0 DYDP15 V2 SMALL-11 | EACH | \$150.00 | 3 A | | BA-T966I-MC | CZZNLI0 DYDP38 V2 TK25/TUS05 | EACH | \$150.00 | 3 A | |
| BA-F035U-MC | CZZMQU0 DYDP17 V2 FP/KMC-11 | EACH | \$150.00 | 3 A | | BA-U019I-MC | CZZNMI0 DYDP39 V2 DEC/X11 2/2 | EACH | \$150.00 | 3 A | |
| BA-F037U-MC | CZZMSU0 DYDP19 V2 DISKS 2/3 | EACH | \$150.00 | 3 A | | BB CLASS Diagnostics on Mag Tape (1600 BPI) | | | | | |
| BA-F246I-MA | AJRXI0 DEC 88 DIAG FLP 1 | EACH | \$158.00 | 3 A | | BB-E541S-DD | DDXLACO PERIPHERAL DIAG MGT | EACH | \$325.00 | 3 B | |
| BA-F286I-MA | AJRXI0 DEC 88 DIAG FLP 2 | EACH | \$158.00 | 3 A | | BB-E980G-DE | ESZXBG0 CNSL+FLPA BOOT ROM | EACH | \$341.00 | 3 B | |
| BA-F327W-MC | OZZMWW0 DYDP23 V2 MDA-11 | EACH | \$150.00 | 3 A | | BB-E980H-DE | ESZXB CNSL+FLPA BOOT ROM | EACH | \$341.00 | 3 B | |
| BA-F395V-MC | CZZMXV0 DYDP24 V2 I/O DEV 2/2 | EACH | \$150.00 | 3 A | | BB-E982H-DE | ESZXDH0 REMOTE CONSOLE DOC | EACH | REPLACED | 3 B | BB-E982I-DE |
| BA-F527Y-MC | CZZMY0 DYDP25 V2 DISK 3/3 | EACH | \$150.00 | 3 A | | BB-E982I-DE | ESZXD REMOTE CONSOLE DOC | EACH | \$341.00 | 3 B | |
| BA-F557Z-MC | CZZMYZO DYDP25 V2 DISKS 3/3 | EACH | \$85.00 | 3 A | | BB-E983O-DE | ESZXE MICRODIAG HARDCR DOC | EACH | REPLACED | 3 B | BB-E983P-DE |
| BA-F821U-MC | CZZNAU0 DYDP27 V2 CSS | EACH | \$150.00 | 3 A | | BB-E983P-DE | ESZXE MICRODIAG HARDCR DOC | EACH | \$341.00 | 3 B | |
| BA-F864R-MC | CZZNBR0 DYDP28 V2 11/44 | EACH | \$150.00 | 3 A | | BB-E988M-DE | EXZXKM0 MICRODIAG WCS/PCS DOC | EACH | REPLACED | 3 B | BB-E988P-DE |
| BA-F885N-MC | CZZNCN0 DYDP29 V2 11/70 2/2 | EACH | \$150.00 | 3 A | | BB-E988P-DE | EXZKK MICRODIAG WCS/PCS DOC | EACH | \$341.00 | 3 B | |
| BA-F886W-MC | CZZNDW0 DYDP30 V2 COMM 3/3 | EACH | \$150.00 | 3 A | | BB-F751Z-MC | CZZZ9V0 MSDP+ 1600 BPI MT9 | EACH | \$750.00 | 3 A | |
| BA-FF50D-MC | CZYAND0DDDP14 V2 LSI-11 #2 | EACH | \$150.00 | 3 A | | BB-FF15N-DE | VAX 8600/8650 MACRODIAG MGTP | EACH | REPLACED | 3 B | BB-FF15R-DE |
| | | | | | | BB-FF15R-DE | VAX 8600/8650 MACRODIAG MGTP | EACH | \$325.00 | 3 B | |
| | | | | | | BB-FF99N-MC | CZZ10N0 MSDP V2 1600 BPI MT9 | EACH | \$750.00 | 3 A | |
| | | | | | | BB-FG70A-DE | VAX CI - REV 6 FILES | EACH | \$341.00 | 3 B | |
| | | | | | | BB-FG70B-DE | CID020 CI/BCI UCODE+DIAGS | EACH | \$341.00 | 3 B | |



Prices Effective 02-January-89 to 30-June-89
 To Order—Call DECdirect™ TOLL-FREE 800-344-4825, 8:30 a.m. to 8:00 p.m. ET in Continental U.S.A.

DOCUMENTATION AND DIAGNOSTICS PRICE LIST

| PART NUMBER | DESCRIPTION | UNIT ORDER | UNIT PRICE | REP D | L | REPLACEMENT PART NUMBER | PART NUMBER | DESCRIPTION | UNIT ORDER | UNIT PRICE | REP D | L | REPLACEMENT PART NUMBER |
|-------------|------------------------------|------------|------------|-------|---|-------------------------|-------------|-------------------------------|------------|------------|-------|---|-------------------------|
| BB-FH03C-DE | VAX CIE SOFTWARE 1600 BPI | EACH | \$341.00 | 3 | B | | BE-FG02D-DE | TU58#75 VAX DHU11/KMS11K DIAG | EACH | \$89.00 | 3 | B | |
| BB-FH74A-DE | HSC70 OFF-LINE DIAG | EACH | \$341.00 | 3 | B | | BE-FG11E-MC | CZYA0E0 DDDP13 V2 RT950 #1 | EACH | \$89.00 | 3 | A | |
| BB-FI04A-ME | CI REV 7.0 FILES | EACH | \$341.00 | 3 | N | | BE-FG12F-MC | CZYAPF0 DDDP14 V2 RT950 #2 | EACH | \$85.00 | 3 | A | |
| BB-FI16H-DE | VAX 8600/8650 CNSL W/DIAG MT | EACH | REPLACED | 3 | B | BB-FI16K-DE | BE-FG12J-MC | CZYAPI0 DDDP14 V2 RT950 #2 | EACH | \$150.00 | 3 | A | |
| BB-FI16K-DE | VAX 8600/8650 CNSL W/DIAG MT | EACH | \$325.00 | 3 | B | | BE-FG43D-ME | VAX FORMATRS RP/RK/RM/RA/RC | EACH | REPLACED | 3 | N | BE-FG43H-ME |
| BB-FI80J-DE | VAX 11780 COMP DIAG SET MT | EACH | \$325.00 | 3 | B | | BE-FG43H-ME | VAX FORMATRS RP/RK/RM/RA/RC | EACH | \$110.00 | 3 | N | |
| BB-FJ50D-DE | VAX 11750 COMP DIAG SET MT | EACH | \$325.00 | 3 | B | | BE-FH00C-DE | TU58#57A VAX CIE SOFTWARE 2/2 | EACH | REPLACED | 3 | B | BE-FH00D-DE |
| BB-S027F-DE | ESZXYF0 MA780 UDIAG DOC | EACH | \$341.00 | 3 | B | | BE-FH00D-DE | TU58#57A VAX CIE SOFTWARE 2/3 | EACH | \$89.00 | 3 | B | |
| BB-T055Y-DE | VAX 11750 COMPLETE DIAG SET | EACH | REPLACED | 3 | B | BB-T055Z-DE | BE-FH60B-DE | TU58#76 VAX TK50 DIAGNOSTIC | EACH | \$89.00 | 3 | B | |
| BB-T874R-DE | VAX 11785 COMP DIAG SET MT | EACH | REPLACED | 3 | B | BB-T874T-DE | BE-FH61D-DE | TU58#32 UDA50 BAD BLOCK UTIL | EACH | REPLACED | 3 | B | BE-FH61F-DE |
| BB-T874T-DE | VAX 11785 COMP DIAG SET MT | EACH | \$325.00 | 3 | B | | BE-FH61F-DE | TU58#32 UDA50 BAD BLOCK UTIL | EACH | \$110.00 | 3 | B | |
| BB-X724R-DE | MT#1 VAX 725/730 COMP DIAG | EACH | REPLACED | 3 | B | BB-X724S-DE | BE-FI21C-ME | TU58#6 VAX 11750 DIAG SUPER | EACH | REPLACED | 3 | N | BE-FI21H-ME |
| BB-X724S-DE | MT#1 VAX 725/730 COMP DIAG | EACH | \$325.00 | 3 | B | | BE-FI21H-ME | TU58#6 VAX 11750 DIAG SUPER | EACH | REPLACED | 3 | N | BE-FI21J-ME |
| | | | | | | | BE-FI21J-ME | TU58#6 VAX 11750 DIAG SUPER | EACH | \$110.00 | 3 | N | |
| | | | | | | | BE-FI77A-DE | TU58#57A VAX CIE SOFTWARE 3/3 | EACH | \$89.00 | 3 | B | |
| | | | | | | | BE-S029P-DE | TU58#1 VAX 11750 MICRO DPM | EACH | REPLACED | 3 | B | BE-S029Q-DE |
| | | | | | | | BE-S029Q-DE | TU58#1 VAX 11750 MICRO DPM | EACH | \$85.00 | 3 | B | |
| | | | | | | | BE-S030M-DE | TU58#2 VAX 11750 MICRO MIC | EACH | REPLACED | 3 | B | BE-S030N-DE |
| | | | | | | | BE-S030N-DE | TU58#2 VAX 11750 MICRO MIC | EACH | \$89.00 | 3 | B | |
| | | | | | | | BE-S046P-MC | CZYCDQ0 DDDP56 V2 11/44 #1 | EACH | \$85.00 | 3 | A | |
| | | | | | | | BE-S047O-MC | CZYCEO0 DDDP57 V2 11/44 #2 | EACH | \$89.00 | 3 | A | |
| | | | | | | | BE-S066N-MC | CZYCFNO DDDP58 V2 RK06/7 #3 | EACH | \$85.00 | 3 | A | |
| | | | | | | | BE-S066O-MC | CZYCF00 DDDP58 V2 RK06/7 #3 | EACH | REPLACED | 3 | A | BE-S066N-MC |
| | | | | | | | BE-S198Q-DE | TU58#5 VAX750 CACHETB/MEM/EXR | EACH | REPLACED | 3 | B | BE-S198R-DE |
| | | | | | | | BE-S198R-DE | TU58#5 VAX750 CACHETB/MEM/EXR | EACH | \$85.00 | 3 | B | |
| | | | | | | | BE-S200M-DE | TU58#7 VAX 11 HARDWARE INSTR | EACH | REPLACED | 3 | B | BE-S200N-DE |
| | | | | | | | BE-S200N-DE | TU58#7 VAX 11 HARDWARE INSTR | EACH | \$85.00 | 3 | B | |
| | | | | | | | BE-S201U-DE | TU58#8 VAX 11 INSTR | EACH | REPLACED | 3 | B | BE-S201W-DE |
| | | | | | | | BE-S201W-DE | TU58#8 VAX 11 INSTR | EACH | \$89.00 | 3 | B | |
| | | | | | | | BE-S202W-DE | TU58#9 CR/DISK USER MODE | EACH | REPLACED | 3 | B | BE-S202Y-DE |
| | | | | | | | BE-S202Y-DE | TU58#9 CR/DISK USER MODE | EACH | \$110.00 | 3 | B | |
| | | | | | | | BE-S203K-DE | TU58#10 DMC11/DZ11 DIAG | EACH | REPLACED | 3 | B | BE-S203N-DE |
| | | | | | | | BE-S203N-DE | TU58#10 DMC11/DMR11 DIAG | EACH | \$89.00 | 3 | B | |
| | | | | | | | BE-S204C-DE | TU58#11 RK611 DIAG #1 | EACH | \$89.00 | 3 | B | |
| | | | | | | | BE-S205C-DE | TU58#12 RK611 DIAG #2 | EACH | \$89.00 | 3 | B | |
| | | | | | | | BE-S206E-DE | TU58#13 RK611 #3 | EACH | \$89.00 | 3 | B | |
| | | | | | | | BE-S207F-DE | TU58#14 RM03/RM05 DIAG | EACH | REPLACED | 3 | B | BE-S207F-DE |
| | | | | | | | BE-S207F-DE | TU58#14 RM03/RM05/RX50 DIAG | EACH | \$89.00 | 3 | B | |
| | | | | | | | BE-S208L-DE | TU58#15 VAX TE16/TU45/77DIAG | EACH | REPLACED | 3 | B | BE-S208M-DE |
| | | | | | | | BE-S208M-DE | TU58#15 VAX TE16/TU45/77DIAG | EACH | \$85.00 | 3 | B | |
| | | | | | | | BE-S273E-DE | TU58#16 RM80 DIAG | EACH | REPLACED | 3 | B | BE-S273F-DE |
| | | | | | | | BE-S273F-DE | TU58#16 VAX RM80 DIAG | EACH | \$89.00 | 3 | B | |
| | | | | | | | BE-S403E-DE | TU58#18 LPA11-K DIAG | EACH | \$89.00 | 3 | B | |
| | | | | | | | BE-S404F-DE | TU58#19 KMC11B/DMS11DA/DM11BA | EACH | REPLACED | 3 | B | BE-S404G-DE |
| | | | | | | | BE-S404G-DE | TU58#19 KMC11B/DMS11DA/DM11BA | EACH | \$89.00 | 3 | B | |
| | | | | | | | BE-S405J-DE | TU58#20 VAX SYS EXR/BUS INIT | EACH | REPLACED | 3 | B | BE-S405J-DE |
| | | | | | | | BE-S405J-DE | TU58#20 VAX SYS EXR/BUS INIT | EACH | \$89.00 | 3 | B | |
| | | | | | | | BE-S406C-DE | TU58#30 VAX DRS11/DSS11 DIAG | EACH | \$89.00 | 3 | B | |
| | | | | | | | BE-S457I-DE | TU58#21 VAX DR11C/DN11/DF11W | EACH | REPLACED | 3 | B | BE-S457J-DE |
| | | | | | | | BE-S457J-DE | TU58#21 VAX DR11C/DN11/DF11W | EACH | \$89.00 | 3 | B | |
| | | | | | | | BE-S458E-DE | TU58#22 VAX RX02/RL02 DIAG | EACH | REPLACED | 3 | B | BE-S458G-DE |
| | | | | | | | BE-S458G-DE | TU58#22 VAX RPOX/RX2/RL2 DIAG | EACH | \$89.00 | 3 | B | |
| | | | | | | | BE-S459J-DE | TU58#23 VAX DR11-W DIAG | EACH | REPLACED | 3 | B | BE-S459K-DE |
| | | | | | | | BE-S459K-DE | TU58#23 VAX DR11-W DIAG | EACH | \$89.00 | 3 | B | |
| | | | | | | | BE-S460E-DE | TU58#24 VAX TM78/TU78 DIAG | EACH | REPLACED | 3 | B | BE-S460F-DE |
| | | | | | | | | | | | | | |

digital Prices Effective 02-January-89 to 30-June-89
 To Order—Call DECdirect™ TOLL-FREE 800-344-4825, 8:30 a.m. to 8:00 p.m. ET in Continental U.S.A.

SPARES PRICE LIST B-5



DOCUMENTATION AND DIAGNOSTICS PRICE LIST

| PART NUMBER | DESCRIPTION | UNIT ORDER | UNIT PRICE | REP D L | REPLACEMENT PART NUMBER | PART NUMBER | DESCRIPTION | UNIT ORDER | UNIT PRICE | REP D L | REPLACEMENT PART NUMBER |
|-------------|-------------------------------|------------|------------|---------|-------------------------|---|-------------------------------|------------|------------|---------|-------------------------|
| BL-FH05F-ME | RX107 MICRODIAG #1 | EACH | REPLACED | 3 N | BL-FH05J-ME | | | | | | |
| BL-FH05J-ME | RX107 MICRODIAG #1 | EACH | \$89.00 | 3 N | | | | | | | |
| BL-FH11J-ME | RX104 DIAG SUPERVISOR | EACH | REPLACED | 3 N | BL-FH11L-ME | | | | | | |
| BL-FH11L-ME | RX104 DIAG SUPERVISOR | EACH | \$89.00 | 3 N | | | | | | | |
| BL-FH22D-ME | RX105 VAX DISK FORMATTERS | EACH | REPLACED | 3 N | BL-FH22F-ME | | | | | | |
| BL-FH22F-ME | RX105 VAX DISK FORMATTERS | EACH | \$89.00 | 3 N | | | | | | | |
| BL-FH23D-ME | RX106 VAX AUTOSIZER | EACH | REPLACED | 3 N | BL-FH23E-ME | | | | | | |
| BL-FH23E-ME | RX106 VAX AUTOSIZER | EACH | \$89.00 | 3 N | | | | | | | |
| BL-FH31C-ME | P/OS HARD DISK SYSTEM CONSOLE | EACH | \$89.00 | 3 N | | | | | | | |
| BL-FH32C-ME | P/OS HARD DISK SETUP CONSOLE | EACH | \$89.00 | 3 N | | | | | | | |
| BL-FH33C-ME | P/OS LIBRARIES CONSOLE | EACH | \$89.00 | 3 N | | | | | | | |
| BL-FH36B-ME | PRO/COMM CONSOLE 1/4 | EACH | \$89.00 | 3 N | | | | | | | |
| BL-FH37B-ME | PRO/COMM CONSOLE 2/4 | EACH | \$89.00 | 3 N | | | | | | | |
| BL-FH38B-ME | PRO/COMM CONSOLE 3/4 | EACH | \$89.00 | 3 N | | | | | | | |
| BL-FH39H-ME | COMMAND LANGUAGE 1/2 CONSOLE | EACH | REPLACED | 3 N | BL-FH39K-ME | | | | | | |
| BL-FH39K-ME | COMMAND LANGUAGE 1/2 CONSOLE | EACH | \$89.00 | 3 N | | | | | | | |
| BL-FH40C-ME | COMMAND LANGUAGE 2/2 CONSOLE | EACH | REPLACED | 3 N | BL-FH40D-ME | | | | | | |
| BL-FH40D-ME | COMMAND LANGUAGE 2/2 CONSOLE | EACH | \$89.00 | 3 N | | | | | | | |
| BL-FH41G-ME | RX100 CONSOLE TASKS | EACH | REPLACED | 3 N | BL-FH41K-ME | | | | | | |
| BL-FH41K-ME | RX100 CONSOLE TASKS | EACH | \$89.00 | 3 N | | | | | | | |
| BL-FH42F-ME | RX101 ISP MICROCODE | EACH | REPLACED | 3 N | BL-FH42J-ME | | | | | | |
| BL-FH42J-ME | RX101 ISP MICROCODE | EACH | \$89.00 | 3 N | | | | | | | |
| BL-FH43F-ME | RX102 BOOT COMMAND FILES | EACH | REPLACED | 3 N | BL-FH43H-ME | | | | | | |
| BL-FH43H-ME | RX102 BOOT COMMAND FILES | EACH | \$89.00 | 3 N | | | | | | | |
| BL-FH67H-ME | RX99 REVISION HISTORY | EACH | REPLACED | 3 N | BL-FH67K-ME | | | | | | |
| BL-FH67K-ME | RX99 REVISION HISTORY | EACH | \$89.00 | 3 N | | | | | | | |
| BL-FI09D-ME | VAX 8200/8300 REL NOTES | EACH | \$89.00 | 3 N | | | | | | | |
| BL-FI48E-ME | RX98 CI VMB SYSTEM CODE | EACH | REPLACED | 3 N | BL-FI48H-ME | | | | | | |
| BL-FI48H-ME | RX98 CI VMB SYSTEM CODE | EACH | \$89.00 | 3 N | | | | | | | |
| BL-FI92B-ME | P/OS SYSTEM SERVICES CONSOLE | EACH | \$89.00 | 3 N | | | | | | | |
| BL-FI94B-ME | P/OS DRIVERS CONSOLE | EACH | \$89.00 | 3 N | | | | | | | |
| BL-FJ00A-ME | PRO/COMM SYNERGY CONSOLE 4/4 | EACH | \$89.00 | 3 N | | | | | | | |
| BL-FJ11F-ME | VAX CIBCA MICROCODE UPD FLP | EACH | \$89.00 | 3 N | | | | | | | |
| BL-FJ41B-ME | VAX 8250/DRB32-C ERF FILE | EACH | \$89.00 | 3 N | | | | | | | |
| BL-FJ70A-ME | P/OS INSTALLATION CONSOLE | EACH | \$89.00 | 3 N | | | | | | | |
| BL-FJ72A-ME | P/OS BACKUP/RESTORE UTILITY | EACH | \$89.00 | 3 N | | | | | | | |
| BL-FK17A-ME | STANDALONE1 8XXXX CONSOLE KIT | EACH | \$89.00 | 3 N | | | | | | | |
| BL-FK18B-ME | STANDALONE2 DUAL 8XXXX CONSOL | EACH | \$89.00 | 3 N | | | | | | | |
| BL-FK19B-ME | STANDALONE2 SINGLE 8XXXX CONS | EACH | \$89.00 | 3 N | | | | | | | |
| BL-FN7AC-MC | CZFNAL0 PDP11 FORMTR RX50 | EACH | REPLACED | 3 A | BL-FN7AJ-MC | | | | | | |
| BL-FN7AJ-MC | CZFNAL0 M-11 FORMTR RX50 | EACH | \$89.00 | 3 A | | | | | | | |
| BL-GQ99A-MV | RBW HRD DIS UTILITY PRG | EACH | \$89.00 | 3 A | | | | | | | |
| BL-T308E-MH | PRO/INSTL & MAINT APPL V1.7 | EACH | \$89.00 | 3 A | | | | | | | |
| BL-T345C-MA | SYSTEM TEST DISKETTE-DRIVE 0 | EACH | \$89.00 | 3 A | | | | | | | |
| BL-T540D-MC | CZUFDD0 USER TESTS | EACH | \$89.00 | 3 A | | | | | | | |
| BL-T541D-MC | CZXD1D0 FIELD SERVICE TESTS 1 | EACH | \$89.00 | 3 A | | | | | | | |
| BL-T542D-MC | CZXD2D0 FIELD SERVICE TESTS 2 | EACH | \$89.00 | 3 A | | | | | | | |
| BL-T565D-MC | CZXD3D0 FIELD SERVICE TESTS 3 | EACH | \$89.00 | 3 A | | | | | | | |
| BL-T583D-MC | CZXD4D0 FIELD SERVICE TESTS 4 | EACH | \$89.00 | 3 A | | | | | | | |
| BL-T768A-MC | CNSBPA0 SBC11/21+ SYS DIAGPT1 | EACH | REPLACED | 3 A | BL-T768B-MC | | | | | | |
| BL-T768B-MC | CNSBPA0 SBC11/21+ SYS DIAGPT1 | EACH | \$85.00 | 3 A | | | | | | | |
| BL-T769A-MC | CNSBPA0 SBC11/21+ SYS DIAGPT2 | EACH | REPLACED | 3 A | BL-T769B-MC | | | | | | |
| BL-T769B-MC | CNSBPA0 SBC11/21+ SYS DIAGPT2 | EACH | \$85.00 | 3 A | | | | | | | |
| BL-T925A-MC | CZTKRA0 TK25 Q BUS | EACH | \$89.00 | 3 A | | | | | | | |
| BL-V174A-MV | EXT COMMS OPT DIAG DISK RX50 | EACH | \$89.00 | 3 A | | | | | | | |
| | | | | | | BM CLASS Diagnostics on TU81 Mag Tape (6250 BPI) | | | | | |
| | | | | | | BM-FJ93B-MC | TU81 11'S DIAG 6250 BPI 2400' | EACH | REPLACED | 3 A | BM-FJ93C-MC |
| | | | | | | BM-FJ93C-MC | TU81 11'S DIAG 6250 BPI 2400' | EACH | \$850.00 | 3 A | |
| | | | | | | BN CLASS Diagnostics on RX33 Floppy | | | | | |
| | | | | | | BN-FH74A-DE | HSC70 OFF-LINE DIAGS RX33 | EACH | \$89.00 | 3 B | |
| | | | | | | EK CLASS Hardware Manuals | | | | | |
| | | | | | | EK-00861-IP | 861-A/B/C/D/E/F IPB | EACH | \$21.00 | 3 A | |
| | | | | | | EK-00871-IP | 871 POWER CONTROLLER IPB | EACH | \$21.00 | 3 A | |
| | | | | | | EK-00872-IP | 872 POWER CONTROLLER IPB | EACH | \$21.00 | 3 A | |
| | | | | | | EK-00874-IP | 874 POWER CONTROLLER IPB | EACH | \$21.00 | 3 A | |
| | | | | | | EK-01103-IP | PDP-11/03 UNIT ASSEMBLY IPB | EACH | \$21.00 | 3 A | |
| | | | | | | EK-01123-IP | PDP-11/23 UNIT ASSEMBLY IPB | EACH | \$21.00 | 3 A | |
| | | | | | | EK-01124-MC | PDP-11/24 MAINTENANCE CARD | EACH | \$5.00 | 3 A | |
| | | | | | | EK-01144-IP | PDP-11/44 UNIT ASSEMBLY IPB | EACH | \$21.00 | 3 A | |
| | | | | | | EK-01170-IP | PDP-11/70 16 BIT COMPUTER IPB | EACH | \$21.00 | 3 A | |
| | | | | | | EK-09728-IP | 54-09728 REGULATOR BOARD IPB | EACH | \$21.00 | 3 A | |
| | | | | | | EK-100HL-RC | VT100 HOT LINE TROUBLESHOOT C | EACH | \$5.00 | 3 A | |
| | | | | | | EK-101HL-RC | VT101 HOT LINE TROUBLESHOOTIN | EACH | \$21.00 | 3 A | |
| | | | | | | EK-104AA-TM | VCB02 VIDEO SYS TECH MANUAL | EACH | \$120.00 | 3 A | |
| | | | | | | EK-11004-OP | PDP-11/04 SYSTEM USERS MANUAL | EACH | \$21.00 | 3 A | |
| | | | | | | EK-11005-TM | PDP-11/05/10 COMPUTER MANUAL | EACH | \$63.00 | 3 A | |
| | | | | | | EK-11024-TM | PDP-11/24 SYSTEM TECHNICAL MA | EACH | \$126.00 | 3 A | |
| | | | | | | EK-11034-MC | PDP-11/04/34 MAINTENANCE CARD | EACH | \$5.00 | 3 A | |
| | | | | | | EK-11034-UG | PDP-11/34 SYSTEM USERS GUIDE | EACH | \$42.00 | 3 A | |
| | | | | | | EK-11040-TM | PDP-11/40/35 SYSTEM MANUAL | EACH | \$84.00 | 3 A | |
| | | | | | | EK-11044-UG | PDP-11/44 SYSTEM USERS GUIDE | EACH | \$42.00 | 3 A | |
| | | | | | | EK-11045-MM | PDP-11/45 MAINTENANCE MANUAL | EACH | \$84.00 | 3 A | |
| | | | | | | EK-11070-MM | PDP-11/70 MAINTENANCE/INSTAL | EACH | \$126.00 | 3 A | |
| | | | | | | EK-11070-OP | PDP-11/70 SYSTEM USERS MANUAL | EACH | \$84.00 | 3 A | |
| | | | | | | EK-1123B-IN | PDP-11/23 PLUS SYS. INSTALLAT | EACH | \$21.00 | 3 A | |
| | | | | | | EK-1123B-IP | PDP-11/23B UNIT ASSEMBLY | EACH | \$21.00 | 3 A | |
| | | | | | | EK-1123B-SP | PDP-11/23 PLUS SITE PREPARATI | EACH | \$21.00 | 3 A | |
| | | | | | | EK-11235-TM | BA11-M & PDP-11/23S TECH MAN | EACH | \$84.00 | 3 A | |
| | | | | | | EK-1134A-TM | PDP-11/34A POWER SYSTEM DESCR | EACH | \$42.00 | 3 A | |
| | | | | | | EK-11730-UG | VAX-11/730 HARDWARE USER GUID | EACH | \$21.00 | 3 A | |
| | | | | | | EK-11751-UG | VAX-11/751 USERS GUIDE | EACH | \$42.00 | 3 A | |
| | | | | | | EK-11780-UG | VAX-11/780 HARDWARE USERS GUI | EACH | \$63.00 | 3 A | |
| | | | | | | EK-11782-IN | VAX-11/782 INSTALLATION GUIDE | EACH | \$21.00 | 3 A | |
| | | | | | | EK-11785-UG | VAX-11/785 USERS GUIDE | EACH | \$63.00 | 3 A | |
| | | | | | | EK-1184A-IP | PDP-11/84 BOX ASSEMBLY IPB | EACH | \$21.00 | 3 A | |
| | | | | | | EK-1184A-MG | PDP-11/84 SYS MAINT GUIDE | EACH | \$42.00 | 3 A | |

digital

Prices Effective 02-January-89 to 30-June-89

To Order—Call DECdirect™ TOLL-FREE 800-344-4825, 8:30 a.m. to 8:00 p.m. ET in Continental U.S.A.

SPARES PRICE LIST B-7

DOCUMENTATION AND DIAGNOSTICS PRICE LIST

| PART NUMBER | DESCRIPTION | UNIT ORDER | UNIT PRICE | REP D | L | REPLACEMENT PART NUMBER | PART NUMBER | DESCRIPTION | UNIT ORDER | UNIT PRICE | REP D | L | REPLACEMENT PART NUMBER |
|-------------|-------------------------------|------------|------------|-------|---|-------------------------|-------------|-------------------------------|------------|------------|-------|---|-------------------------|
| EK-1184A-TM | 11/84 TECH. MAN. | EACH | \$126.00 | 3 | A | | EK-8500X-IP | VAX 8500 ILLUSTRATED PARTS | EACH | \$80.00 | 3 | A | |
| EK-1184D-MG | PDP11/84D TECHNICAL MANUAL | EACH | \$80.00 | 3 | A | | EK-85XVS-MG | VAX 8500 MAINTENANCE GUIDE | EACH | \$126.00 | 3 | A | |
| EK-1184E-IP | PDP11/84E IPB | EACH | \$20.00 | 3 | A | | EK-8600H-UG | VAX 8600 HARDWARE USERS GUIDE | EACH | \$42.00 | 3 | A | |
| EK-1184E-TM | PDP11/84E TECHNICAL MANUAL | EACH | \$80.00 | 3 | A | | EK-8600I-IN | VAX 8600 INSTALL. MAN | EACH | \$42.00 | 3 | A | |
| EK-11MOS-TM | PDP-11/45/50 TROUBLESHOOTING | EACH | \$42.00 | 3 | A | | EK-861AB-MM | 861-A/B/C/D/E/F MAINTENANCE M | EACH | \$42.00 | 3 | A | |
| EK-11T23-OP | PDP-11/T23 SYSTEM MANUAL | EACH | \$21.00 | 3 | A | | EK-861AB-OP | 861-A/B/C/D/E/F USERS MANUAL | EACH | \$21.00 | 3 | A | |
| EK-11V23-IP | PDP-11/V23 UNIT ASSEMBLY IPB | EACH | \$21.00 | 3 | A | | EK-874DF-IP | 874-D/F POWER CONTROLLER IPB | EACH | \$20.00 | 3 | A | |
| EK-120HL-RC | LA120 HOT LINE TROUBLESHOOTIN | EACH | \$5.00 | 3 | A | | EK-8800H-UG | VAX 8700/8800 SYS HDW USRS GD | EACH | \$21.00 | 3 | A | |
| EK-13077-IP | 70-13077 FLEXIBLE DISK DRIVE | EACH | \$21.00 | 3 | A | | EK-8800I-IN | VAX 8800 INSTALLATION GUIDE | EACH | \$21.00 | 3 | A | |
| EK-153QS-IP | 153,183,630QS MV/IVAX BA213 | EACH | \$80.00 | 3 | A | | EK-8800P-SP | VAX 8800 SITE PREP GUIDE | EACH | \$40.00 | 3 | A | |
| EK-153QZ-IP | MICRO PDP11/53QZ RCK MNT IPB | EACH | \$20.00 | 3 | A | | EK-8800X-IP | VAX 8700/8800 SYSTEM IPB | EACH | \$60.00 | 3 | A | |
| EK-183QE-IP | MICRO 11/83QE CAB SYSTEM IPB | EACH | \$21.00 | 3 | A | | EK-881PC-UG | 881 PWR CTRL INSTL & USER GDE | EACH | \$20.00 | 3 | A | |
| EK-1LA34-IN | LAX34-AL TRACTOR OPTION INSTA | EACH | \$21.00 | 3 | A | | EK-8840A-IP | VAX 8820/8830/8840 IPB | EACH | \$80.00 | 3 | A | |
| EK-1LA36-MM | LA36 (BASIC MACHINE) MAINT MA | EACH | \$126.00 | 3 | A | | EK-8840H-UG | VAX 8820/8830/8840 USERS GDE | EACH | \$40.00 | 3 | A | |
| EK-1LP11-TM | LP11/LS11/LA11 LINE PRINTER M | EACH | \$42.00 | 3 | A | | EK-8840I-IN | VAX 8820/8830/8840 INST GDE | EACH | \$20.00 | 3 | A | |
| EK-1T23B-IP | PDP-11T23B UNIT ASSEMBLY | EACH | \$21.00 | 3 | A | | EK-8840P-SP | VAX 8820/8830/8840 SITE PREP | EACH | \$40.00 | 3 | A | |
| EK-1T23B-OP | PDP-11/23 PLUS SYSTEM MANUAL | EACH | \$42.00 | 3 | A | | EK-8A000-IP | PDP-8/A 12 BIT COMPUTER IPB | EACH | \$21.00 | 3 | A | |
| EK-1T7U7-TM | TU77 MAGNETIC TAPE TRANSPORT | EACH | \$42.00 | 3 | A | | EK-8A001-OP | PDP-8/A OPERATORS HANDBOOK | EACH | \$21.00 | 3 | A | |
| EK-1T7U8-TM | TU78 MAGNETIC TAPE TRANSPORT | EACH | REPLACED | 3 | A | EK-OTA79-TM | EK-8A002-MM | PDP-8/A MINIPROCESSOR USERS M | EACH | \$126.00 | 3 | A | |
| EK-1V23P-OP | PDP-11V23-PLUS SYSTEM MANUAL | EACH | \$42.00 | 3 | A | | EK-8E001-MM | PDP-8/E/F/M MAINTENANCE MANUA | EACH | \$84.00 | 3 | A | |
| EK-1VAXD-TM | VAX DIAGNOSTIC DESIGN GUIDE | EACH | \$126.00 | 3 | A | | EK-8E002-MM | PDP-8/E/F/M MAINTENANCE MANUA | EACH | \$84.00 | 3 | A | |
| EK-23BMB-TM | PDP-11/23B MOUNTING BOX TECH | EACH | \$42.00 | 3 | A | | EK-8E003-MM | PDP-8/E/F/M MAINTENANCE MANUA | EACH | \$84.00 | 3 | A | |
| EK-23BMB-UG | PDP-11/23B MOUNTING BOX USERS | EACH | \$21.00 | 3 | A | | EK-8PLGC-MC | V5200 8-PLANE GRPHS MNT ADVS | EACH | \$20.00 | 3 | A | |
| EK-2LA36-MM | LA36 (OPTION INFO) MAINT MANU | EACH | \$21.00 | 3 | A | | EK-9642J-IN | H9642JA/JB INSTALLATION GUIDE | EACH | \$21.00 | 3 | A | |
| EK-2TU77-TM | TU77 MAGTAPE TECH MANUAL V2 | EACH | \$126.00 | 3 | A | | EK-A0145-SM | LQP45 SERVICE MANUAL | EACH | \$80.00 | 3 | A | |
| EK-2TU78-TM | TU78 MAGNETIC TAPE TRANSPORT | EACH | REPLACED | 3 | A | EK-OTA79-TM | EK-AA11K-TM | AA11-K TECHNICAL MANUAL | EACH | \$42.00 | 3 | A | |
| EK-34105-IP | PDP-11/34 16 BIT COMPUTER (10 | EACH | \$21.00 | 3 | A | | EK-AD11K-OP | AD11-K USER MANUAL | EACH | \$21.00 | 3 | A | |
| EK-3490A-IN | H3490 I/O BULKHEAD INSTALL GD | EACH | \$21.00 | 3 | A | | EK-ADV11-OP | ADV11-A/KWV11-A/AAV11-A/DRV11 | EACH | \$21.00 | 3 | A | |
| EK-356HL-RC | LA36/LA35 HOT LINE TROUBLESHO | EACH | \$5.00 | 3 | A | | EK-AXV11-UG | LSI-11 ANALOG SYSTEM USERS GU | EACH | \$21.00 | 3 | A | |
| EK-620AA-HR | VAX 6200 REFERENCE MANUAL | EACH | \$40.00 | 3 | A | | EK-AXVAB-UG | AXV11C/KWV11C ANL RLTM CLCK | EACH | \$20.00 | 3 | A | |
| EK-620AA-IN | VAX 6200 INSTALLATION GDE | EACH | \$40.00 | 3 | A | | EK-BA11A-IP | BA11-A UNIT ASSEMBLY IPB | EACH | \$21.00 | 3 | A | |
| EK-620AA-OM | VAX 6200 OWNERS MANUAL | EACH | \$60.00 | 3 | A | | EK-BA11A-TM | BA11-A MOUNTING BOX & POWER T | EACH | \$84.00 | 3 | A | |
| EK-620AA-TM | VAX 6200 TECHNICAL MANUAL | EACH | \$120.00 | 3 | A | | EK-BA11F-IP | BA11-F MOUNTING BOX IPB | EACH | \$21.00 | 3 | A | |
| EK-630QB-IP | MICROVAX II 630QB IPB | EACH | \$21.00 | 3 | A | | EK-BA11K-IP | BA11-K MOUNTING BOX IPB | EACH | \$21.00 | 3 | A | |
| EK-630QE-IP | MICROVAX II 630QE IPB | EACH | \$21.00 | 3 | A | | EK-BA11K-OP | BA11-K MOUNTING BOX USERS MAN | EACH | \$21.00 | 3 | A | |
| EK-630QP-IP | MICROVAX II 630 QY IPB | EACH | \$21.00 | 3 | A | | EK-BA11K-TM | BA11-K MOUNTING BOX TECH MANU | EACH | \$84.00 | 3 | A | |
| EK-630QV-IP | 630 QV VAXSTATION II CPU BOX | EACH | \$21.00 | 3 | A | | EK-BA11L-IP | BA11-L MOUNTING BOX IPB | EACH | \$21.00 | 3 | A | |
| EK-630QW-IP | 630 QW VAXSTATION II WORLD IP | EACH | \$21.00 | 3 | A | | EK-BA11L-TM | BA11-L TECHNICAL MANUAL | EACH | \$84.00 | 3 | A | |
| EK-630QZ-IP | MICROVAX II 630QZ IPB | EACH | \$21.00 | 3 | A | | EK-BA11M-IP | BA11-M MOUNTING BOX IPB | EACH | \$21.00 | 3 | A | |
| EK-63XRA-IN | MICROVAX II UPGRADE INST. | EACH | \$21.00 | 3 | A | | EK-BA11N-IP | BA11-N MOUNTING BOX IPB | EACH | \$21.00 | 3 | A | |
| EK-650QF-IP | MVAX 3600 CABINET SYS IPB | EACH | \$40.00 | 3 | A | | EK-BA11N-TM | BA11-N MOUNTING BOX TECH MANU | EACH | \$84.00 | 3 | A | |
| EK-650QS-IP | MVAX 3500 PEDISTAL SYS IPB | EACH | \$40.00 | 3 | A | | EK-BA11N-UG | BA11-N MOUNTING BOX USERS MAN | EACH | \$21.00 | 3 | A | |
| EK-725CI-IN | VAX-11/725 INSTALLATION GUIDE | EACH | \$21.00 | 3 | A | | EK-BA123-IP | BA123-A BASIC ENCLOSURE IPB | EACH | \$42.00 | 3 | A | |
| EK-730CR-UG | VAX-11/730 CUSTOMER RUNNABLE | EACH | \$21.00 | 3 | A | | EK-BA123-MG | BA123 MAINTENANCE GUIDE | EACH | \$60.00 | 3 | A | |
| EK-730XA-UG | VAX-11/730XA DIAG USER GUIDE | EACH | \$21.00 | 3 | A | | EK-BA200-DG | BA200 SERIES MODULE DESIGN GD | EACH | \$40.00 | 3 | A | |
| EK-73CVS-IN | VAX-11/730 INSTALLATION | EACH | \$42.00 | 3 | A | | EK-BA213-IP | BA213 ENCLOSURE IPB | EACH | \$40.00 | 3 | A | |
| EK-73CVS-OP | VAX-11/730 OPERATOR MANUAL | EACH | \$21.00 | 3 | A | | EK-BA214-IP | BA214 ENCLOSURE IPB | EACH | \$20.00 | 3 | A | |
| EK-750YA-RM | VAX-11/750 MICRODIAGNOSTIC RE | EACH | \$42.00 | 3 | A | | EK-BA23A-IP | BA23-A UNIT ASSEMBLY IPB | EACH | \$42.00 | 3 | A | |
| EK-750YA-UG | VAX-11/750 SELF MAINT DIAGNOS | EACH | \$21.00 | 3 | A | | EK-BA23C-UG | BA23C-Q BUS EXP. INSTALL. GD. | EACH | \$21.00 | 3 | A | |
| EK-780EH-IN | MS780-EC/ED INSTALLATION PROC | EACH | \$20.00 | 3 | A | | EK-BDV11-TM | BDV11 TECHNICAL MANUAL | EACH | \$42.00 | 3 | A | |
| EK-780EH-RM | MS780-E/F & MS780-H/S MAINT. | EACH | \$42.00 | 3 | A | | EK-BF05A-IP | BF05-A EDITOR IPB | EACH | \$21.00 | 3 | A | |
| EK-780EH-TD | MS780E & MS780H TECH. DESC. | EACH | \$84.00 | 3 | A | | EK-CAB16-MC | CXA/CXB16 MAINTENANCE CARD | EACH | \$5.00 | 3 | A | |
| EK-8500H-UG | VAX 8500/8550 HARDWARE USR GD | EACH | \$42.00 | 3 | A | | EK-CAB16-TM | CXA/CXB16 TECHNICAL MANUAL | EACH | \$80.00 | 3 | A | |
| EK-8500I-IN | VAX 8500/8550 INSTALL. GUIDE | EACH | \$42.00 | 3 | A | | EK-CAB16-UG | CXA16/CXB16 USERS GUIDE | EACH | \$40.00 | 3 | A | |
| EK-8500P-SP | VAX 8500/8550 SITE PREP GUIDE | EACH | \$21.00 | 3 | A | | EK-CFFFM-UG | LN03 FONTFILE USER GUIDE | EACH | \$21.00 | 3 | A | |



Prices Effective 02-January-89 to 30-June-89

To Order—Call DECdirect™ TOLL-FREE 800-344-4825, 8:30 a.m. to 8:00 p.m. ET in Continental U.S.A.

DOCUMENTATION AND DIAGNOSTICS PRICE LIST

| PART NUMBER | DESCRIPTION | UNIT ORDER | UNIT PRICE | REP D L | REPLACEMENT PART NUMBER | PART NUMBER | DESCRIPTION | UNIT ORDER | UNIT PRICE | REP D L | REPLACEMENT PART NUMBER |
|-------------|-------------------------------|------------|------------|---------|-------------------------|-------------|-------------------------------|------------|------------|---------|-------------------------|
| EK-CI750-TD | C1750 TECHNICAL DESC MANUAL | EACH | \$126.00 | 3 A | | EK-DECSY-SR | DECONNECT SATELITE RM INST GD | EACH | \$7.00 | 3 A | |
| EK-CI750-UG | C1750 USERS GUIDE | EACH | \$21.00 | 3 A | | EK-DECSY-VG | DECONNECT INSTALLATION GUIDE | EACH | REPLACED | 3 A | EK-DECSY-SR |
| EK-CI780-TD | C1780 TECHNICAL DESCRIPTION | EACH | \$84.00 | 3 A | | EK-DECSY-WE | REMOTE WALL ENCLOSURE INST GD | EACH | \$4.00 | 3 A | |
| EK-CI780-UG | C1780 USERS GUIDE | EACH | \$21.00 | 3 A | | EK-DELNI-IP | DELNI INSTALLATION OWNERS MAN | EACH | \$21.00 | 3 A | |
| EK-CIBCI-UG | CIBCI ADAPTER USER/INSTALL | EACH | \$42.00 | 3 A | | EK-DELNI-IP | DELNI IPB | EACH | \$21.00 | 3 A | |
| EK-CIVAX-RM | C1750 & 780 REFERENCE MANUAL | EACH | \$21.00 | 3 A | | EK-DELNI-TM | DELNI ETHERNET TECH. MANUAL | EACH | \$42.00 | 3 A | |
| EK-CPE12-IN | INSTALLING & USING CORRESPOND | EACH | \$21.00 | 3 A | | EK-DELQA-IN | DELQA INSTALLATION GUIDE | EACH | \$40.00 | 3 A | |
| EK-CPE12-OP | CORRESPONDENT REFERENCE GUIDE | EACH | \$42.00 | 3 A | | EK-DELQA-UG | DELQA USERS GUIDE | EACH | \$40.00 | 3 A | |
| EK-CPE12-RC | LA12 REFERENCE CARD | EACH | \$5.00 | 3 A | | EK-DELUA-TD | DELUA TECHNICAL DESCRIPTION | EACH | \$80.00 | 3 A | |
| EK-CPE12-RM | CORRESPONDENT REFERENCE MANUA | EACH | \$42.00 | 3 A | | EK-DELUA-UG | DELUA USERS GUIDE | EACH | \$21.00 | 3 A | |
| EK-CPL12-IP | LA12 DECWRITER CORRESPONDENT | EACH | \$21.00 | 3 A | | EK-DEMPR-UG | DEMPR INSTALL & USER GUIDE | EACH | \$42.00 | 3 A | |
| EK-CPL12-PS | DECWRITER CORRESPONDENT SER.G | EACH | \$42.00 | 3 A | | EK-DEPCA-UG | VAXMATE PERS. WKSTA. HANDBOOK | EACH | \$21.00 | 3 A | |
| EK-CPL12-TM | DECWRITER CORRESPONDENT TECH | EACH | \$84.00 | 3 A | | EK-DEPCB-SV | DEPCA SERVICE GDE | EACH | \$80.00 | 3 A | |
| EK-CPL12-UG | DECWRITER CORRESPONDENT USE P | EACH | \$63.00 | 3 A | | EK-DEQNA-UG | DEQNA ETHERNET USERS GUIDE | EACH | \$21.00 | 3 A | |
| EK-CXY08-IN | CXY08-CF OPTION INST GDE | EACH | \$20.00 | 3 A | | EK-DEREP-IN | DEREP-AA INSTALLATION GUIDE | EACH | \$21.00 | 3 A | |
| EK-CXY08-MC | CXY08 MAINTENANCE CARD | EACH | \$5.00 | 3 A | | EK-DEREP-TM | DEREP TECHNICAL MANUAL | EACH | \$42.00 | 3 A | |
| EK-CXY08-TM | CXY08 TECHNICAL MANUAL | EACH | \$80.00 | 3 A | | EK-DERRP-IN | DEREP-RA REMOTE INSTALLATION | EACH | \$21.00 | 3 A | |
| EK-CXY08-UG | CXY08 USER GUIDE | EACH | \$40.00 | 3 A | | EK-DESTA-TM | DESTA TECH MANUAL | EACH | \$40.00 | 3 A | |
| EK-D200C-IN | DECSERVER 200 INSTALLATION GD | EACH | \$21.00 | 3 A | | EK-DEUNA-TM | DEUNA TECHNICAL MANUAL | EACH | \$84.00 | 3 A | |
| EK-D200H-IN | DECSERVER 200 INSTALL. MANUAL | EACH | \$21.00 | 3 A | | EK-DEUNA-UG | DEUNA USER'S GUIDE | EACH | \$42.00 | 3 A | |
| EK-DB11A-TM | DB11-A BUS REPEATER MANUAL | EACH | \$42.00 | 3 A | | EK-DEXRM-IN | DELNI RACKMOUNT OPT INSTALLAT | EACH | \$21.00 | 3 A | |
| EK-DB11H-TM | DB11-H BUS REPEATER TECH MANU | EACH | \$42.00 | 3 A | | EK-DF100-IS | DF100 INFORMATION SHEET | EACH | \$5.00 | 3 A | |
| EK-DB86X-TD | VAX 8600 DB86 SBIA TECH DESC. | EACH | \$84.00 | 3 A | | EK-DF112-UG | DF112 MODEM USERS GUIDE | EACH | \$42.00 | 3 A | |
| EK-DCJ11-UG | DCJ11 MICROPROCESSOR USER'S G | EACH | \$21.00 | 3 A | | EK-DF124-UG | DF124 MODEM FAMILY USER GUIDE | EACH | \$21.00 | 3 A | |
| EK-DCT11-UG | MICRO T-11 USERS GUIDE | EACH | \$126.00 | 3 A | | EK-DF126-IS | DF126 INFORMATION SHEET | EACH | \$5.00 | 3 A | |
| EK-DCTEM-UG | DCT11-EM EVALUATION MODULE US | EACH | \$42.00 | 3 A | | EK-DF126-UG | DF126 MODEM USERS GUIDE | EACH | \$21.00 | 3 A | |
| EK-DEBET-TM | LAN BRIDGE 100 TECH. MAN. | EACH | \$42.00 | 3 A | | EK-DF127-UG | DF127 MODEM USERS GUIDE | EACH | \$21.00 | 3 A | |
| EK-DEBET-UG | LAN BRIDGE 100 INST/USER GD. | EACH | \$21.00 | 3 A | | EK-DF129-UG | DF129 MODEM USERS GUIDE | EACH | \$21.00 | 3 A | |
| EK-DEBNX-TM | DEBNA/DEBNT TECH MANUAL | EACH | \$80.00 | 3 A | | EK-DF224-IG | SCHOLAR 2400 MODEM INST. GD. | EACH | \$21.00 | 3 A | |
| EK-DEC11-IN | PDP-11 DDS INSTALL MANUAL | EACH | \$21.00 | 3 A | | EK-DF224-OM | SCHOLAR 2400 MODEM OWNERS MAN | EACH | \$20.00 | 3 A | |
| EK-DECCS-SG | DEC CHANNEL-SRVR TRBLSHTNG GD | EACH | \$40.00 | 3 A | | EK-DF224-UG | DF224 SCHOLAR USERS GUIDE | EACH | REPLACED | 3 A | EK-DF224-OM |
| EK-DECM2-IN | DECMATE INSTALLATION GUIDE | EACH | \$21.00 | 3 A | | EK-DF100-RM | DF100-RM MODEM ENCLOSURE | EACH | \$42.00 | 3 A | |
| EK-DECM2-IP | PC278 DECMATE II SYS UNIT IPB | EACH | \$21.00 | 3 A | | EK-DFM16-UG | DFM SERIES INTELLIGENT COMM | EACH | \$63.00 | 3 A | |
| EK-DECM2-OM | DECMATE II OWNERS MANUAL | EACH | \$42.00 | 3 A | | EK-DFM5A-IN | MINI EXCHANGE INST GUIDE | EACH | \$21.00 | 3 A | |
| EK-DECM2-PS | DECMATE II POCKET SERVICE GUI | EACH | \$42.00 | 3 A | | EK-DFM5A-PS | MINI-EXCHANGE SYS POCK SVC GD | EACH | \$42.00 | 3 A | |
| EK-DECM2-RM | DECMATE 11 PROGRAMMER'S REF. | EACH | \$84.00 | 3 A | | EK-DFM5A-TM | MINI-EXCHANGE TECH MANUAL | EACH | \$42.00 | 3 A | |
| EK-DECNA-IN | DECNA CONTROLLER INSTALLATION | EACH | \$21.00 | 3 A | | EK-DHQ11-MC | DHQ11 MAINTENANCE CARD | EACH | \$5.00 | 3 A | |
| EK-DECON-IP | DECONNECT SYSTEM IPB | EACH | \$5.00 | 3 A | | EK-DHQ11-TM | DHQ11 TECH MANUAL | EACH | \$80.00 | 3 A | |
| EK-DECS2-TM | DECSERVER 200 TECH MANUAL | EACH | \$42.00 | 3 A | | EK-DHQ11-UG | DHQ11 USERS GUIDE | EACH | \$40.00 | 3 A | |
| EK-DECS5-KT | DECSERVER 500 KIT -IN,-RC,-IC | EACH | \$80.00 | 3 A | | EK-DHU11-MC | DHU11 MAINTENANCE CARD | EACH | \$5.00 | 3 A | |
| EK-DECS5-SP | DECSERVER 500 SITE PREP GUIDE | EACH | \$20.00 | 3 A | | EK-DHU11-TM | DHU11 INTERFACE TECH MAN. | EACH | \$84.00 | 3 A | |
| EK-DECS5-TM | DECSERVER 500 TECHNICAL MNL | EACH | \$80.00 | 3 A | | EK-DHU11-UG | DHU11 USERS GUIDE | EACH | \$42.00 | 3 A | |
| EK-DECSA-IN | ETHERNET COMM SERVER INSTALL. | EACH | \$21.00 | 3 A | | EK-DHV11-MC | DHV11 MAINTENANCE CARD | EACH | \$5.00 | 3 A | |
| EK-DECSA-OP | ETHERNET OPERATION & MAINT. | EACH | \$21.00 | 3 A | | EK-DHV11-UG | DHV11 TECHNICAL MANUAL | EACH | \$84.00 | 3 A | |
| EK-DECSA-SP | ETHERNET SITE PREP MANUAL | EACH | \$21.00 | 3 A | | EK-DHVCK-IN | DHV11 REMOTE DIST INSTALL | EACH | \$21.00 | 3 A | |
| EK-DECSA-TD | ETHERNET COMM.SERV. TECH DESC | EACH | \$84.00 | 3 A | | EK-DL11W-OP | DL11-W OPERATORS MANUAL | EACH | \$21.00 | 3 A | |
| EK-DECSY-CG | DECONNECT PLANNING GUIDE | EACH | \$13.00 | 3 A | | EK-DL11W-TM | DL11-W SERIAL LINE UNIT TECH | EACH | \$42.00 | 3 A | |
| EK-DECSY-DC | DECONNECT H3114-AA INST | EACH | \$2.00 | 3 A | | EK-DLV11-OP | DLV11-E/F USERS MANUAL | EACH | \$42.00 | 3 A | |
| EK-DECSY-DK | DECONNECT DOCUMENTATION SET | EACH | \$50.00 | 3 A | | EK-DLV11-UG | DLV11-J USERS GUIDE | EACH | \$21.00 | 3 A | |
| EK-DECSY-EG | DECONNECT EVALUATION GUIDE | EACH | \$21.00 | 3 A | | EK-DLVQM-TM | QMA DLV ASYNCHRONOUS LINE TEC | EACH | \$84.00 | 3 A | |
| EK-DECSY-FC | DECONNECT FACILITIES CABLING | EACH | \$5.00 | 3 A | | EK-DLVQM-UG | QMA DLV ASYNCHRONOUS LINE USE | EACH | \$21.00 | 3 A | |
| EK-DECSY-GD | DECONNECT SYS GENERAL DES | EACH | \$10.00 | 3 A | | EK-DM250-IN | RX50 DISKETTE DRIVE INSTALLAT | EACH | \$21.00 | 3 A | |
| EK-DECSY-II | DECONNECT H3111-A/B PLT INST | EACH | \$2.00 | 3 A | | EK-DM2CP-IN | DECMATE II CP/M BOARD INSTALL | EACH | \$21.00 | 3 A | |
| EK-DECSY-MI | DECONNECT MAINTENANCE INFOR | EACH | \$2.00 | 3 A | | EK-DM2DM-RC | DECMATE II DOCUMENTATION MAP | EACH | \$5.00 | 3 A | |
| EK-DECSY-OC | DECONNECT SYS OFFICE INST GD | EACH | \$10.00 | 3 A | | EK-DM2GO-IN | DECMATE 11 GRAPHICS INSTALLAT | EACH | \$21.00 | 3 A | |



Prices Effective 02-January-89 to 30-June-89
To Order—Call DECdirect™ TOLL-FREE 800-344-4825, 8:30 a.m. to 8:00 p.m. ET in Continental U.S.A.

DOCUMENTATION AND DIAGNOSTICS PRICE LIST

| PART NUMBER | DESCRIPTION | UNIT ORDER | UNIT PRICE | REP D L | REPLACEMENT PART NUMBER | PART NUMBER | DESCRIPTION | UNIT ORDER | UNIT PRICE | REP D L | REPLACEMENT PART NUMBER |
|-------------|----------------------------------|------------|------------|---------|-------------------------|-------------|-------------------------------|------------|------------|---------|-------------------------|
| EK-DM2GO-OM | DECMATE II GRAPHICS OWN. MAN | EACH | \$21.00 | 3 A | | EK-DS780-UG | VAX-11/780 USERS GUIDE | EACH | \$21.00 | 3 A | |
| EK-DM3BU-OM | DECMATE III OWNERS MANUAL | EACH | \$21.00 | 3 A | | EK-DSRVA-TM | DECSERVER 100 TERM. TECH MAN. | EACH | \$42.00 | 3 A | |
| EK-DM3PA-IN | DECMATE III PLUS INSTALL. GD. | EACH | \$21.00 | 3 A | | EK-DSRZA-RM | MUXSERVER 100 REFERENCE MAN. | EACH | \$21.00 | 3 A | |
| EK-DM3PA-OM | DECMATE III PLUS OWNER'S MAN. | EACH | REPLACED | 3 A | EK-DM3PB-OM | EK-DTC01-HR | DTC01 (DECTALK) DOCUMENT. MAP | EACH | \$5.00 | 3 A | |
| EK-DM3PB-IN | DEC MATE III PLUS INST GD | EACH | \$20.00 | 3 A | | EK-DTC01-IN | DECTALK DTC01 INSTALLATION MA | EACH | \$21.00 | 3 A | |
| EK-DM3PB-OM | DECMATE III PLUS OWNER'S MAN. | EACH | \$40.00 | 3 A | | EK-DTC01-IP | DTC01 DECTALK IPB | EACH | \$21.00 | 3 A | |
| EK-DMB32-TD | DMB32 TECHNICAL MANUAL | EACH | \$42.00 | 3 A | | EK-DTC01-OM | DECTALK OWNERS MANUAL | EACH | \$21.00 | 3 A | |
| EK-DMB32-UG | DMB32 USERS GUIDE | EACH | \$42.00 | 3 A | | EK-DTC01-PS | DTC01 (DECTALK) POCKET SVC GD | EACH | \$42.00 | 3 A | |
| EK-DMCLU-MM | DMCLU IPL SYNCH LINE MAINT MA | EACH | \$84.00 | 3 A | | EK-DTC01-RC | DECTALK DTC01 REFERENCE CARD | EACH | \$5.00 | 3 A | |
| EK-DMCMP-TM | DMC11 IPL MICROPROCESSOR TECH | EACH | \$84.00 | 3 A | | EK-DTC01-RM | DECTALK DTC01 PROGRAMMER REFE | EACH | \$84.00 | 3 A | |
| EK-DMF32-RM | DMF32 MAINTENANCE ADVISORY | EACH | \$84.00 | 3 A | | EK-DTC03-OM | DECTALK DTC03 TEXT TO SPEECH | EACH | \$42.00 | 3 A | |
| EK-DMF32-TD | DMF32 MULTI FUNCTION COMMU IN | EACH | \$42.00 | 3 A | | EK-DTC03-PS | DECTALK DTC03 POCKET SERVICE | EACH | \$42.00 | 3 A | |
| EK-DMF32-UG | DMF32 USERS GUIDE | EACH | \$42.00 | 3 A | | EK-DTC03-RC | DECTALK DTC03 PROG. REF. CARD | EACH | \$5.00 | 3 A | |
| EK-DMP11-TM | DMP SYNCHRONOUS CONTROLLER TE | EACH | \$84.00 | 3 A | | EK-DUP11-MM | DUP11 MAINTENANCE MANUAL | EACH | \$84.00 | 3 A | |
| EK-DMP11-UG | DMP11 SYNCHRONOUS CONTROLLER | EACH | \$42.00 | 3 A | | EK-DUP11-OP | DUP11 INTERFACE USERS MANUAL | EACH | \$21.00 | 3 A | |
| EK-DMR11-TM | DMR11 SYNCHRONOUS CONTROLLER | EACH | \$84.00 | 3 A | | EK-DUV11-OP | DUV11 LINE INTERFACE USERS MA | EACH | \$21.00 | 3 A | |
| EK-DMR11-UG | DMR-11 USERS GUIDE | EACH | \$42.00 | 3 A | | EK-DUV11-TM | DUV11 LINE INTERFACE TECHNICA | EACH | \$84.00 | 3 A | |
| EK-DMV11-TM | DMV11 SYNCH CONTROLLER TECH M | EACH | \$84.00 | 3 A | | EK-DUVQM-TM | QMA DUV11 LINE INTERFACE TECH | EACH | \$42.00 | 3 A | |
| EK-DMV11-UG | DMV11 SYNCHRONOUS USERS GUIDE | EACH | \$84.00 | 3 A | | EK-DUVQM-UG | QMA DUV11 LINE INTERFACE USER | EACH | \$42.00 | 3 A | |
| EK-DMVQM-TM | DMV11 QMA TECH MANUAL | EACH | \$84.00 | 3 A | | EK-DVQMA-UG | QMA DV11 COMM MULTIPLEXER USE | EACH | \$42.00 | 3 A | |
| EK-DMVQM-UG | DMV11 USERS GUIDE | EACH | \$42.00 | 3 A | | EK-DW11A-IN | DW11 INSTALLATION GUIDE | EACH | \$21.00 | 3 A | |
| EK-DMZ32-TD | DMZ32 TECHNICAL DESC. | EACH | \$84.00 | 3 A | | DMZ750-IN | DW750 INSTALLATION GUIDE | EACH | \$21.00 | 3 A | |
| EK-DMZ32-UG | DMZ32 USER GUIDE | EACH | \$42.00 | 3 A | | EK-DW750-TD | DW750 SECOND UNIBUS TECH DESC | EACH | \$42.00 | 3 A | |
| EK-DN200-TM | DN200 REMOTE BATCH STATION TE | EACH | \$84.00 | 3 A | | EK-DW780-TD | VAX-11/780 DW780 TECH DESCRP. | EACH | \$84.00 | 3 A | |
| EK-DNAPV-GD | DNA PHASE V GENERAL DESC | EACH | \$40.00 | 3 A | | EK-DWBUA-TM | DWBUA UNIBUS ADAPTER TECH. | EACH | \$84.00 | 3 A | |
| EK-DPM00-DM | DPM DIAGNOSTIC USERS GUIDE | EACH | \$42.00 | 3 A | | EK-DYS50-TM | DYS50 TECHNICAL MANUAL | EACH | \$42.00 | 3 A | |
| EK-DPM01-TM | DPM01 DECDATAWAY TERMINAL TEC | EACH | \$42.00 | 3 A | | EK-DYT01-TM | DYT01 DECDATAWAY TERMINAL INT | EACH | \$42.00 | 3 A | |
| EK-DPV11-TM | DPV-11 TECHNICAL MANUAL | EACH | \$84.00 | 3 A | | EK-DZ110-TM | DZ11 ASYNCH MX TECHNICAL MANU | EACH | \$84.00 | 3 A | |
| EK-DPV11-UG | DPV-11 SYNCHRONOUS INTERFACE | EACH | \$21.00 | 3 A | | EK-DZ110-UG | DZ11 USERS GUIDE | EACH | \$21.00 | 3 A | |
| EK-DPVQM-TM | QMA DPV11 SERIAL TECHNICAL MA | EACH | \$84.00 | 3 A | | EK-DZ11X-TM | DZ11-X TECHNICAL MANUAL | EACH | \$42.00 | 3 A | |
| EK-DPVQM-UG | QMA DPV11 SERIAL USER GUIDE | EACH | \$21.00 | 3 A | | EK-DZ11X-UG | DZ11-X USERS GUIDE | EACH | \$21.00 | 3 A | |
| EK-DR11B-OP | DR11-B/DA11-B INTERFACE USERS | EACH | \$21.00 | 3 A | | EK-DZM11-SV | DZM11 SERVICE MANUAL | EACH | \$80.00 | 3 A | |
| EK-DR11B-TM | DR11-B/DA11-B TECHNICAL MANUA | EACH | \$42.00 | 3 A | | EK-DZQ11-MC | DZQ11 MAINTENANCE CARD | EACH | \$5.00 | 3 A | |
| EK-DR11C-OP | DR11-C GENERAL DEVICE USERS M | EACH | \$21.00 | 3 A | | EK-DZQ11-TM | DZQ11-A ASYNCH MULTI TECH MAN | EACH | \$42.00 | 3 A | |
| EK-DR11C-PM | DR11-C PREVENTIVE MAINT MAN. | EACH | \$21.00 | 3 A | | EK-DZQ11-UG | DZQ11 ASYNCH MULTI USER GUIDE | EACH | \$21.00 | 3 A | |
| EK-DR11C-TM | DR11-C GENERAL DEVICE INTERFA | EACH | \$42.00 | 3 A | | EK-DZQMA-TM | QMA DZ11 ASYNCHRONOUS MULTIPL | EACH | \$42.00 | 3 A | |
| EK-DR11K-MM | DR11-K USERS AND MAINTENANCE | EACH | \$42.00 | 3 A | | EK-DZQMA-UG | QMA DZ11 ASYNCHRONOUS MULTIPL | EACH | \$21.00 | 3 A | |
| EK-DR11W-UG | DR11-W DIRECT MEMORY USERS MA | EACH | \$21.00 | 3 A | | EK-DZV11-TM | DZV11 ASYNCH MULTI TECH MAN | EACH | \$84.00 | 3 A | |
| EK-DR200-IN | DECROUTER 200 INSTALL. GUIDE | EACH | \$21.00 | 3 A | | EK-DZV11-UG | DZV11 USER'S GUIDE | EACH | \$21.00 | 3 A | |
| EK-DR750-RM | DR750 MAINTENANCE ADVISORY | EACH | \$42.00 | 3 A | | EK-DZVQM-TM | QMA DZV11 ASYNCHRONOUS MULTIP | EACH | \$84.00 | 3 A | |
| EK-DR750-UG | DR750 USERS GUIDE | EACH | \$21.00 | 3 A | | EK-E1170-MC | PDP-11/70 ELEC.CON.COMMANDS R | EACH | \$5.00 | 3 A | |
| EK-DR780-TD | DR780 GENERAL PURPOSE TECHNIC | EACH | \$84.00 | 3 A | | EK-ETHER-TD | ETHERNET INSTALLATION GUIDE | EACH | \$63.00 | 3 A | |
| EK-DR780-UG | DR780 GENERAL PURPOSE USERS G | EACH | \$21.00 | 3 A | | EK-FEPCM-TM | FEPCM TECHNICAL MANUAL | EACH | \$84.00 | 3 A | |
| EK-DRB32-IN | DRB32 HARDWARE INSTALL. GD. | EACH | \$21.00 | 3 A | | EK-FIBOP-IS | FIBER-OPTIC POCKET GUIDE | EACH | \$5.00 | 3 A | |
| EK-DRB32-OV | DRB32 OVERVIEW | EACH | \$21.00 | 3 A | | EK-FOAMB-UG | TEMPEST FIBER-OPTIC ADAPT. UG | EACH | \$21.00 | 3 A | |
| EK-DRB32-TM | DRB32 TECHNICAL MANUAL | EACH | \$42.00 | 3 A | | EK-FOAXA-IN | FIBER OPTIC ADAPTER | EACH | \$21.00 | 3 A | |
| EK-DRBOT-UG | DRB32 OUTPUT TESTER USER GD | EACH | \$21.00 | 3 A | | EK-FP11A-TM | FP11-A TECHNICAL MANUAL | EACH | \$42.00 | 3 A | |
| EK-DRQ3B-IN | DRQ3B-SF OPTION INST GDE | EACH | \$20.00 | 3 A | | EK-FP11C-MM | FP11-C MAINTENANCE MANUAL (11 | EACH | \$42.00 | 3 A | |
| EK-DRV11-OP | DRV11-P FOUNDATION MODULE USE | EACH | \$21.00 | 3 A | | EK-FP11C-OP | FP11-C FLOATING POINT USERS M | EACH | \$42.00 | 3 A | |
| EK-DRV1B-OP | DRV11-B INTFC USER MAN. | EACH | \$20.00 | 3 A | | EK-FP11F-TM | FP11-F FLOATING-POINT PROCESS | EACH | \$42.00 | 3 A | |
| EK-DRV1J-UG | DRV11-J INTERFACE USERS MANUA | EACH | \$21.00 | 3 A | | EK-FP730-TD | VAX-11/730 FP730 FPA TECHNICA | EACH | \$84.00 | 3 A | |
| EK-DRVWA-UG | DRV11-WA USERS GUIDE | EACH | \$21.00 | 3 A | | EK-FP750-IN | FP750 INSTALLATION PROCEDURE | EACH | \$21.00 | 3 A | |
| EK-DS725-UG | VAX-11/725 DIAG SYSTEM OVERVI | EACH | \$21.00 | 3 A | | EK-FP750-RM | FP750 MAINT ADVISORY | EACH | \$42.00 | 3 A | |
| EK-DS730-UG | VAX-11/730 DIAGNOSTIC OVERVIE | EACH | \$21.00 | 3 A | | EK-FP780-TD | VAX-11/780 FLT PT TECHNICAL D | EACH | \$84.00 | 3 A | |
| EK-DS780-TD | VAX-11/780 TECHNICAL DESCRIPTION | EACH | \$84.00 | 3 A | | EK-FP785-TD | FP785 FLOAT. PT ACC TECH DESC | EACH | \$84.00 | 3 A | |



Prices Effective 02-January-89 to 30-June-89

To Order—Call DECdirect™ TOLL-FREE 800-344-4825, 8:30 a.m. to 8:00 p.m. ET in Continental U.S.A.

DOCUMENTATION AND DIAGNOSTICS PRICE LIST

| PART NUMBER | DESCRIPTION | UNIT ORDER | UNIT PRICE | REP D | L | REPLACEMENT PART NUMBER | PART NUMBER | DESCRIPTION | UNIT ORDER | UNIT PRICE | REP D | L | REPLACEMENT PART NUMBER |
|-------------|-------------------------------|------------|------------|-------|---|-------------------------|--------------|-------------------------------|------------|------------|-------|---|-------------------------|
| EK-FP86X-TD | FP86 FBOX TECH DESC. | EACH | \$126.00 | 3 | A | | EK-KA88D-UG | VAX 8500/8550/8700/8800 DIAG | EACH | \$42.00 | 3 | A | |
| EK-FPF11-TM | FPF11 FLOATING-POINT PROCESSO | EACH | \$42.00 | 3 | A | | EK-KA88E-UG | VAX 8800 MICROCODE INTERP. GD | EACH | \$84.00 | 3 | A | |
| EK-FRETR-OM | DEFTR ETHERNET FREQ. OWN. MAN | EACH | \$21.00 | 3 | A | | EK-KA88F-UG | VAX 8800 SYS PRINTSET GDE | EACH | \$40.00 | 3 | A | |
| EK-FRETR-TD | DEFTR TECHNICAL DESCRIPTION | EACH | \$42.00 | 3 | A | | EK-KA88G-UG | VAX 8800 BACKPLANE X-REF GD. | EACH | \$84.00 | 3 | A | |
| EK-FS002-OP | UNIBUS VOLTAGE MARGIN TEST US | EACH | \$21.00 | 3 | A | | EK-KA88H-UG | VAX 8800 MACHINE CHECK GUIDE | EACH | \$63.00 | 3 | A | |
| EK-FS003-IN | PDP-11 INSTALLATION/ACCEPTANC | EACH | \$21.00 | 3 | A | | EK-KB11C-TM | KB11-C PROCESSOR MANUAL | EACH | \$126.00 | 3 | A | |
| EK-GPXII-IP | VAXSTATION II FAMILY IPB | EACH | \$42.00 | 3 | A | | EK-KBEVX-IN | KMS11-BD/BE VAX-11 INSTALLATI | EACH | \$21.00 | 3 | A | |
| EK-H2728-TM | H7227 & H7228 SYS TECH. MAN. | EACH | \$42.00 | 3 | A | | EK-KC750-IN | KC750 OPTIONS INSTALLATION GU | EACH | \$21.00 | 3 | A | |
| EK-H4000-IN | H400 ETHERNET TRANSCEIVER INS | EACH | \$21.00 | 3 | A | | EK-KC750-RM | VAX-11/750 DIAGNOSTICS MINI R | EACH | \$42.00 | 3 | A | |
| EK-H4000-TM | H4000 DEC ETHERNET TRANSCEIVE | EACH | \$42.00 | 3 | A | | EK-KC750-TM | KC750 MICRODIAGNOSTIC/TECHNIC | EACH | \$42.00 | 3 | A | |
| EK-H4TAP-IN | H4000 DIGITAL ETHERNET INST. | EACH | \$21.00 | 3 | A | | EK-KC750-UG | KC750 OPTIONS USER GUIDE | EACH | \$21.00 | 3 | A | |
| EK-H7110-IP | H7110 POWER SUPPLY IPB | EACH | \$21.00 | 3 | A | | EK-KC780-IN | KC780 OPTIONS HARDWARE INSTAL | EACH | \$21.00 | 3 | A | |
| EK-H7140-IP | H7140 POWER SUPPLY IPB | EACH | \$21.00 | 3 | A | | EK-KC780-TD | VAX-11/780 CONSOLE INTERFACE | EACH | \$42.00 | 3 | A | |
| EK-H7150-IP | H7150 POWER SUPPLY IPB | EACH | \$21.00 | 3 | A | | EK-KC780-TM | KC780 REMOTE DIAGNOSIS OPT.TE | EACH | \$84.00 | 3 | A | |
| EK-H7204-UG | BA11-AW/AX/H7204-B POWER SUPP | EACH | \$21.00 | 3 | A | | EK-KC780-UG | KC780 OPTION USERS GUIDE | EACH | \$21.00 | 3 | A | |
| EK-H7227-TM | H7227 POW. DIST. TECH. MANUAL | EACH | \$42.00 | 3 | A | | EK-KC785-TD | VAX-11/785 CONSOLE INTER TECH | EACH | \$84.00 | 3 | A | |
| EK-H7228-TM | H7228 POWER COND. TECH. MAN. | EACH | \$42.00 | 3 | A | | EK-KD11D-MM | KD11-D MAINTENANCE MANUAL | EACH | \$84.00 | 3 | A | |
| EK-H740D-IP | H740-D/DA POWER SUPPLY IPB | EACH | \$21.00 | 3 | A | | EK-KD11E-TM | KD11-E PROCESSOR MANUAL | EACH | \$84.00 | 3 | A | |
| EK-H740D-OP | H740-D POWER SUPPLY USERS MAN | EACH | \$21.00 | 3 | A | | EK-KD11Z-TM | PDP-11/44 SYSTEM TECHNICAL MA | EACH | \$126.00 | 3 | A | |
| EK-H7420-IP | H7420 POWER SUPPLY IPB | EACH | \$21.00 | 3 | A | | EK-KD11EA-MM | KD11-E/A MAINTENANCE MANUAL | EACH | \$84.00 | 3 | A | |
| EK-H7660-IP | H7660 ILLUSTRATED PARTS | EACH | \$20.00 | 3 | A | | EK-KD32A-OM | MICRO VAX OWNERS MANUAL | EACH | \$63.00 | 3 | A | |
| EK-H7844-IP | H7844 POWER SUPPLY IPB MANUAL | EACH | \$21.00 | 3 | A | | EK-KD32A-PG | MICROVAX I POCKET SERVICE GD. | EACH | \$42.00 | 3 | A | |
| EK-H9640-UG | H9640 SERIES CABINETS USERS G | EACH | \$21.00 | 3 | A | | EK-KD32A-TD | MICRO/VAX TECHNICAL DESC MAN. | EACH | \$126.00 | 3 | A | |
| EK-H9644-IP | H9644 ILLUSTRATED PARTS | EACH | \$40.00 | 3 | A | | EK-KDA5Q-UG | KDA5-Q USER GUIDE | EACH | \$21.00 | 3 | A | |
| EK-H9657-IP | H9657-E EXPANDER CABINET | EACH | \$20.00 | 3 | A | | EK-KDB50-UG | KDB50 DISK CONTR. USER GUIDE | EACH | \$40.00 | 3 | A | |
| EK-HSC50-IN | HSC50 INSTALLATION MANUAL | EACH | REPLACED | 3 | A | EK-HSCMN-IN | EK-KDFB2-IN | KDF11-B2 INSTALLATION GUIDE | EACH | \$21.00 | 3 | A | |
| EK-HSC50-IP | HSC50 STORAGE CONTROLLER IPB | EACH | \$21.00 | 3 | A | | EK-KDFEB-UG | KDF11-BA CPU MODULE USER GUID | EACH | \$63.00 | 3 | A | |
| EK-HSC70-IN | HSC70 INSTALLATION MANUAL | EACH | REPLACED | 3 | A | EK-HSCMN-IN | EK-KDJ1A-RC | KDJ11-A REFERENCE CARD | EACH | \$5.00 | 3 | A | |
| EK-HSC70-IP | HSC70 ILLUSTRATED PARTS | EACH | \$20.00 | 3 | A | | EK-KDJ1A-UG | KDJ11-A CPU MODULE USER'S GUI | EACH | \$63.00 | 3 | A | |
| EK-HSCMN-IN | HSC50 & HSC70 INST MANUAL | EACH | \$20.00 | 3 | A | | EK-KDJ1B-UG | KDJ11-B CPU MODULE USERS | EACH | \$63.00 | 3 | A | |
| EK-IDV1-PS | IDV11/IAV11 POCKET SERVICE GD | EACH | \$42.00 | 3 | A | | EK-KDJ1D-UG | KDJ11-DA CPU MODULE USER GD. | EACH | \$21.00 | 3 | A | |
| EK-IBQ01-UG | IBQ01 USERS GUIDE | EACH | \$60.00 | 3 | A | | EK-KDJUA-IN | MICRO PDP-1173-UA UPGRADE INS | EACH | \$21.00 | 3 | A | |
| EK-IBV11-UG | IBV11-A USERS MANUAL | EACH | \$21.00 | 3 | A | | EK-KDJUB-IN | PDP-11/73-UB UPGRADE INST. GU | EACH | \$21.00 | 3 | A | |
| EK-IEUQ1-UG | IEU11-A/IEQ11-A USERS GUIDE | EACH | \$42.00 | 3 | A | | EK-KDJUC-IN | MICRO PDP-11/73-UC UPGRADE IN | EACH | \$21.00 | 3 | A | |
| EK-IMGEN-UG | IMAGE GENERATOR USER GUIDE | EACH | \$21.00 | 3 | A | | EK-KE44A-TM | KE44-A CISP TECHNICAL MANUAL | EACH | \$84.00 | 3 | A | |
| EK-INDEC-CS | DEC CHANNEL SERVER INST GDE | EACH | \$20.00 | 3 | A | | EK-KE44A-UG | KE44-A CISP USERS GUIDE | EACH | \$40.00 | 3 | A | |
| EK-ISOPC-UG | LN03 PLUS INSTALL. & USERS GD | EACH | \$42.00 | 3 | A | | EK-KEP01-IP | RX50-D/R DISK DRIVE SUBSYSTEM | EACH | REPLACED | 3 | A | EK-ORX50-IP |
| EK-KA620-UG | KA620-A CPU MODULE USER GUIDE | EACH | \$42.00 | 3 | A | | EK-KK11A-TM | KK11-A CACHE MEMORY TECHNICAL | EACH | \$42.00 | 3 | A | |
| EK-KA630-UG | MICROVAX 630 USERS GUIDE | EACH | \$42.00 | 3 | A | | EK-KK11A-UG | KK11-A CACHE MEMORY USERS GUI | EACH | \$21.00 | 3 | A | |
| EK-KA640-TM | KA640 CPU TECHNICAL MANUAL | EACH | \$80.00 | 3 | A | | EK-KMC11-OP | KMC11 MICROPROCESSOR USERS MA | EACH | \$21.00 | 3 | A | |
| EK-KA650-UG | KA650 USERS GUIDE | EACH | \$40.00 | 3 | A | | EK-KMC1B-UG | KMC11-B GENERAL PURPOSE MICRO | EACH | \$21.00 | 3 | A | |
| EK-KA730-TD | VAX-11/730 CENTRAL PROCESSING | EACH | \$84.00 | 3 | A | | EK-KMS11-PS | KMS11 SYNCHRONOUS COMMUNICATI | EACH | \$42.00 | 3 | A | |
| EK-KA750-TD | VAX-11/750 CENTRAL PROCESSOR | EACH | \$126.00 | 3 | A | | EK-KMS1K-SV | KMS11-K DATA INT.FACE SER.MAN | EACH | \$42.00 | 3 | A | |
| EK-KA780-TD | VAX-11/780 KA780 CENTRAL PROC | EACH | \$126.00 | 3 | A | | EK-KMS1P-TM | KMS11-P SYNCHRONOUS COMM PROC | EACH | \$84.00 | 3 | A | |
| EK-KA785-TD | VAX 11/785 TECH. DESCRIPTION | EACH | \$126.00 | 3 | A | | EK-KMV11-TM | KMV11 PROGRAMMABLE TECHNICAL | EACH | \$42.00 | 3 | A | |
| EK-KA820-TM | KA820/KA825 PROC TECH MANUAL | EACH | \$126.00 | 3 | A | | EK-KMV11-UG | KMV11 PROGRAMMABLE USER GUIDE | EACH | \$42.00 | 3 | A | |
| EK-KA86C-TD | KA86 CONSOLE TECH. DESC. | EACH | \$84.00 | 3 | A | | EK-KMV1A-TM | KMV1A PROG. COMM. TECH. MAN. | EACH | \$42.00 | 3 | A | |
| EK-KA86D-RC | VAX 8600 CONSOLE COMMANDS | EACH | \$5.00 | 3 | A | | EK-KMV1A-UG | KMV1A PROGRAMMER USERS GUIDE | EACH | \$21.00 | 3 | A | |
| EK-KA86E-TD | KA86 EBOX TECH DESC. | EACH | \$126.00 | 3 | A | | EK-KU750-UG | KU750-YG OPTION USERS GUIDE | EACH | \$21.00 | 3 | A | |
| EK-KA86I-TD | KA86 IBOX TECH DESC. | EACH | \$126.00 | 3 | A | | EK-KUV11-TM | LSI-11 WCS USER'S GUIDE | EACH | \$42.00 | 3 | A | |
| EK-KA86K-TD | KA86 SYSTEM CLOCKS TECH. DESC | EACH | \$126.00 | 3 | A | | EK-KW11K-OP | KW11-K REAL TIME CLOCK USER M | EACH | \$21.00 | 3 | A | |
| EK-KA86M-TD | KA86 MBOX TECH DESC. | EACH | \$126.00 | 3 | A | | EK-KW11L-TM | KW11-L LINE TIME CLOCK MANUAL | EACH | \$42.00 | 3 | A | |
| EK-KA86P-TD | KA86 SYSTEM POWER TECH DESC. | EACH | \$84.00 | 3 | A | | EK-KW11P-MM | KW11-P CLOCK MANUAL (ETCH REV | EACH | \$42.00 | 3 | A | |
| EK-KA86S-TD | KA86 SYS DESC PROC. OVERVIEW | EACH | \$84.00 | 3 | A | | EK-KW11W-TM | KW11-W WATCHDOG TIMER MANUAL | EACH | \$42.00 | 3 | A | |
| EK-KA86V-TD | KA86 EMM TECH DESC. | EACH | \$42.00 | 3 | A | | EK-KW1PF-OP | KW11-P CLOCK USERS MANUAL | EACH | \$21.00 | 3 | A | |



Prices Effective 02-January-89 to 30-June-89

To Order—Call DECdirect™ TOLL-FREE 800-344-4825, 8:30 a.m. to 8:00 p.m. ET in Continental U.S.A.

DOCUMENTATION AND DIAGNOSTICS PRICE LIST

| PART NUMBER | DESCRIPTION | UNIT ORDER | UNIT PRICE | REP D | L | REPLACEMENT PART NUMBER | PART NUMBER | DESCRIPTION | UNIT ORDER | UNIT PRICE | REP D | L | REPLACEMENT PART NUMBER |
|-------------|-------------------------------|------------|------------|-------|---|-------------------------|-------------|--------------------------------|------------|------------|-------|---|-------------------------|
| EK-KXJCA-UG | KXJCA-CA USERS GUIDE | EACH | \$60.00 | 3 | A | | EK-LEP05-OM | TK50 TAPE DRIVE OWNERS MANUAL | EACH | \$21.00 | 3 | A | |
| EK-KXT11-UG | FALCON M8063 SBC-1V21 SINGLE- | EACH | \$21.00 | 3 | A | | EK-LEP06-OM | RD53-D -R OWNERS MANUAL | EACH | \$21.00 | 3 | A | |
| EK-KXTCA-HR | KDJ11-A USERS GUIDE | EACH | \$42.00 | 3 | A | | EK-LEP07-OM | RD54-D -R OWNERS MANUAL | EACH | \$21.00 | 3 | A | |
| EK-KXTCA-UG | KXT11-CA SBC USERS GUIDE | EACH | \$21.00 | 3 | A | | EK-LESIB-UG | KLESIB-B MDL USER & INSTL | EACH | \$20.00 | 3 | A | |
| EK-KY11R-UG | KY11R FAMILY ELECTRONIC CONSO | EACH | \$21.00 | 3 | A | | EK-LG02M-IP | LG01/LG02 LINEPRINTER IPB | EACH | \$21.00 | 3 | A | |
| EK-KY11B-MM | KY11-LB MAINT. MANUAL | EACH | \$42.00 | 3 | A | | EK-LG31A-IP | LG31 ILLUSTRATED PARTS | EACH | \$20.00 | 3 | A | |
| EK-L10EB-IN | LA10X-EB INSTALLATION GUIDE | EACH | \$21.00 | 3 | A | | EK-LG31E-PS | LG31 POCKET SERVICE GUIDE | EACH | \$20.00 | 3 | A | |
| EK-L10FF-IN | LA100 HEAD LIFT KIT INSTALLAT | EACH | \$21.00 | 3 | A | | EK-LG31E-TM | LG31 TECHNICAL MANUAL | EACH | \$40.00 | 3 | A | |
| EK-L1218-PS | LS120/LA180 POCKET SERVICE GU | EACH | \$42.00 | 3 | A | | EK-LGSYS-SP | US AREA MED & LG PREP GUIDE | EACH | \$21.00 | 3 | A | |
| EK-L12CA-IN | LA12-CA/LA12X-CB INSTALLATION | EACH | \$21.00 | 3 | A | | EK-LJ250-DK | LJ250/252 DOC KT(-RC,-RM,-UG) | EACH | \$60.00 | 3 | A | |
| EK-L34RO-UG | DECWRITER IV GRAPHIC PRINTER | EACH | \$21.00 | 3 | A | | EK-LJ250-IP | LJ250/252 ILLUSTRATED PARTS | EACH | \$40.00 | 3 | A | |
| EK-L34XL-UG | DECWRITER IV EXTENDED LOGIC U | EACH | \$21.00 | 3 | A | | EK-LJ250-PS | LJ250 POCKET SERVICE GUIDE | EACH | \$80.00 | 3 | A | |
| EK-LA100-IP | LA100 LETTER/WRITER LETTER PR | EACH | \$42.00 | 3 | A | | EK-LK201-IP | LK201 KEYBOARD IPB | EACH | \$21.00 | 3 | A | |
| EK-LA100-PS | LA100 SERIES POCKET SERVICE G | EACH | \$42.00 | 3 | A | | EK-LKIBM-IN | DEPCA LK250 KEYBD CABLE INST. | EACH | \$21.00 | 3 | A | |
| EK-LA100-RM | LA100 PROGRAMMER REF. MANUAL | EACH | \$42.00 | 3 | A | | EK-LN01S-IN | LN01 ELECTRONIC PRINTER INST | EACH | \$21.00 | 3 | A | |
| EK-LA100-TM | LA100 TECHNICAL MANUAL | EACH | \$126.00 | 3 | A | | EK-LN01S-OP | LN01 ELECTRONIC PRINTER OPERA | EACH | \$21.00 | 3 | A | |
| EK-LA120-IP | LA120 DECWRITER III IPB | EACH | \$21.00 | 3 | A | | EK-LN01S-RM | LN01 PROGRAMMER REFERENCE MAN | EACH | \$42.00 | 3 | A | |
| EK-LA120-PS | LA120 SERIES POCKET SERVICE G | EACH | \$42.00 | 3 | A | | EK-LN01S-TD | LN01 TECHNICAL DESC MANUAL | EACH | \$42.00 | 3 | A | |
| EK-LA120-RG | LA120 OPERATOR REFERENCE CARD | EACH | \$5.00 | 3 | A | | EK-LN03A-IP | LN03A LASER PRINTER IPB | EACH | \$21.00 | 3 | A | |
| EK-LA120-SV | LA120 SERIES SERVICE GUIDE | EACH | \$42.00 | 3 | A | | EK-LN03A-PS | LN03A POCKET SERVICE GUIDE | EACH | \$42.00 | 3 | A | |
| EK-LA120-TM | LA120 TECHNICAL MANUAL | EACH | \$84.00 | 3 | A | | EK-LN03A-TM | LN03A TECHNICAL MANUAL | EACH | \$84.00 | 3 | A | |
| EK-LA120-UG | LA120 USERS GUIDE | EACH | \$42.00 | 3 | A | | EK-LN03R-IP | LN03R ILLUSTRATED PARTS | EACH | \$40.00 | 3 | A | |
| EK-LA12A-IN | LA12X-AL INSTALLATION GUIDE | EACH | \$21.00 | 3 | A | | EK-LN03R-OG | LN03R SCRIPTWRITER USERS GDE | EACH | \$20.00 | 3 | A | |
| EK-LA180-IP | LA180 DECPRINTER I IPB | EACH | \$42.00 | 3 | A | | EK-LN03R-RC | LN03R SCRIPTWRITER FLIP CARD | EACH | \$5.00 | 3 | A | |
| EK-LA180-MM | LA180 DECPRINTER I MAINTENANC | EACH | \$126.00 | 3 | A | | EK-LN03R-RG | LN03R POSTSCRIPT QUICK REF | EACH | \$20.00 | 3 | A | |
| EK-LA180-OP | LA180 DECPRINTER I USERS MANU | EACH | \$21.00 | 3 | A | | EK-LN03R-SP | LN03R PROGRAMER SUPPLEMENT | EACH | \$80.00 | 3 | A | |
| EK-LA210-IN | LA210 INSTALLATION GUIDE | EACH | REPLACED | 3 | A | EK-LA210-UP | EK-LN03R-UG | LN03R SCRIPTWRITER INST GDE | EACH | \$20.00 | 3 | A | |
| EK-LA210-IP | LA210 LETTERPRINTER IPB | EACH | \$42.00 | 3 | A | | EK-LN03S-RM | LN03 PLUS REFERENCE MANUAL | EACH | \$42.00 | 3 | A | |
| EK-LA210-PS | LA210 POCKET SERVICE GUIDE | EACH | \$42.00 | 3 | A | | EK-LN03S-UG | LN03 PLUS USER GUIDE | EACH | \$21.00 | 3 | A | |
| EK-LA210-RC | LA210 OPERATOR PROG. GUIDE | EACH | REPLACED | 3 | A | EK-LA210-UP | EK-LN100-PS | LN100 POCKET SERVICE GUIDE | EACH | \$42.00 | 3 | A | |
| EK-LA210-RG | LA210 LETTERPRINTER REF.GUIDE | EACH | REPLACED | 3 | A | EK-LA210-UP | EK-LN100-UG | LN01S ELEC. PRINTER DOC. | EACH | \$21.00 | 3 | A | |
| EK-LA210-RM | LA210 PROGRAMMER REF. MANUAL | EACH | REPLACED | 3 | A | EK-LA210-UP | EK-LP100-IN | LP100 LINE PRINTER INSTALLATIO | EACH | REPLACED | 3 | A | EK-LP1PC-UG |
| EK-LA210-TM | LA210 TECHNICAL MANUAL | EACH | \$126.00 | 3 | A | | EK-LP100-MM | LP100 LINE PRINTER SYSTEM MAN | EACH | \$42.00 | 3 | A | |
| EK-LA210-UG | LA210 USER GUIDE | EACH | REPLACED | 3 | A | EK-LA210-UP | EK-LP100-OP | LA100 (LETTERPRINTER) OPER GD | EACH | REPLACED | 3 | A | EK-LP1PC-UG |
| EK-LA210-UP | LA210 LETTERPRINTER USER PKG | EACH | \$63.00 | 3 | A | | EK-LP100-RC | LETTERPRINTER 100 OPER & PROG | EACH | \$5.00 | 3 | A | |
| EK-LA21X-UG | LA21X-SF/SH INSTALL & USERS G | EACH | \$21.00 | 3 | A | | EK-LP100-RM | LA100 (LETTERPRINTER) PROG RE | EACH | REPLACED | 3 | A | EK-LP1PC-UG |
| EK-LA2RA-IP | LA120-RA DECWRITER III IPB | EACH | \$42.00 | 3 | A | | EK-LP11S-OP | LP11/LS11/LA11 LINE PRINTER U | EACH | \$21.00 | 3 | A | |
| EK-LA2RA-UG | LA120-RA USER GUIDE | EACH | \$21.00 | 3 | A | | EK-LP1PC-UG | LA100 USER PACK | EACH | \$42.00 | 3 | A | |
| EK-LA34S-IP | LA34 DECWRITER IV IPB | EACH | \$21.00 | 3 | A | | EK-LP210-PS | LP210 POCKET SERVICE GUIDE | EACH | REPLACED | 3 | A | EK-LA210-PS |
| EK-LA34S-PS | DECWRITER IV POCKET SERVICE G | EACH | \$42.00 | 3 | A | | EK-LP210-RM | LP210 PROGRAMMER REF MANUAL | EACH | REPLACED | 3 | A | EK-LA210-RM |
| EK-LA34S-TM | DECWRITER IV TECHNICAL MANUAL | EACH | \$84.00 | 3 | A | | EK-LP210-UP | LP210 USER DOC PACKAGE | EACH | REPLACED | 3 | A | EK-LA120-UP |
| EK-LA356-J1 | LA35/36 DECWRITER MINI MAINT | EACH | \$5.00 | 3 | A | | EK-LP279-IN | LP27/LP29 INST GUIDE | EACH | \$20.00 | 3 | A | |
| EK-LA365-OP | LA35/36 DECWRITER II USERS MA | EACH | \$42.00 | 3 | A | | EK-LP279-IP | LP27/LP29 LINE PRINTER | EACH | \$80.00 | 3 | A | |
| EK-LA75B-IN | LA75 BAR CODE INSTALLATION | EACH | \$20.00 | 3 | A | | EK-LP279-OM | LP27/LP29 OWNERS MANUAL | EACH | \$40.00 | 3 | A | |
| EK-LA75C-IN | LA75 CARTRIDGE INSTALL. MAN. | EACH | \$21.00 | 3 | A | | EK-LP297-IP | LP27/LP29 LINE PRINTER IPB | EACH | \$80.00 | 3 | A | |
| EK-LA75P-RM | LA75P REFERENCE MANUAL | EACH | \$42.00 | 3 | A | | EK-LPA11-IN | LPA11-K LAB INSTALLATION & MA | EACH | \$42.00 | 3 | A | |
| EK-LA75X-UG | LA75X-SF INSTALL & USER GUIDE | EACH | \$21.00 | 3 | A | | EK-LPA11-UG | LPA11-K USERS GUIDE | EACH | \$21.00 | 3 | A | |
| EK-LCG01-IN | LCG01 COLOR PRINTER INST. GD. | EACH | \$21.00 | 3 | A | | EK-LPD11-MM | LPD11 INTERFACE MAINTENANCE M | EACH | \$42.00 | 3 | A | |
| EK-LCG01-UG | LCG01 COLOR PRINTER USER GD. | EACH | \$42.00 | 3 | A | | EK-LPD11-OP | LPD11 INTERFACE USERS MANUAL | EACH | \$21.00 | 3 | A | |
| EK-LCP01-TM | LCP01 COLOR PRINTING SYS T.M. | EACH | \$84.00 | 3 | A | | EK-LPR11-IN | LPR11 REMOTE PRINTER INSTALLA | EACH | \$21.00 | 3 | A | |
| EK-LCP01-UG | LCP01 COLOR PRINTING USER | EACH | \$42.00 | 3 | A | | EK-LPR11-TM | LPR11 REMOTE PRINTER SYS TECH | EACH | \$42.00 | 3 | A | |
| EK-LEP01-OM | RX50-D-4 DUAL FLEX DISK DRIVE | EACH | \$21.00 | 3 | A | | EK-LPR11-UG | LPR11 REMOTE PRINTER SYS USER | EACH | \$21.00 | 3 | A | |
| EK-LEP02-IP | RD51-D/R DISK DRIVE SUBSYSTEM | EACH | \$42.00 | 3 | A | | EK-LPS40-IN | PRINTSERVER 40 INSTALL. GUIDE | EACH | \$21.00 | 3 | A | |
| EK-LEP04-IP | RD52-D/R DISK DRIVE SUBSYSTEM | EACH | \$42.00 | 3 | A | | EK-LPS40-IP | LPS40 PRINTSERVER IPB | EACH | \$40.00 | 3 | A | |
| EK-LEP05-IP | TK50-D/R TAPE DRIVE SUBSYSTEM | EACH | \$42.00 | 3 | A | | EK-LPS40-OP | LPS40 OPERATORS GDE | EACH | \$40.00 | 3 | A | |



Prices Effective 02-January-89 to 30-June-89
 To Order—Call DECdirect™ TOLL-FREE 800-344-4825, 8:30 a.m. to 8:00 p.m. ET in Continental U.S.A.

DOCUMENTATION AND DIAGNOSTICS PRICE LIST

| PART NUMBER | DESCRIPTION | UNIT ORDER | UNIT PRICE | REP D L | REPLACEMENT PART NUMBER | PART NUMBER | DESCRIPTION | UNIT ORDER | UNIT PRICE | REP D L | REPLACEMENT PART NUMBER |
|-------------|-------------------------------|------------|------------|---------|-------------------------|--------------|-------------------------------|------------|------------|---------|-------------------------|
| EK-LPS40-RC | LPS40 REFERENCE CARD | EACH | \$5.00 | 3 A | | EK-MS78E-IN | MS780-EC/ED INSTALLATION PROC | EACH | REPLACED | 3 A | EK-780EH-IN |
| EK-LPS40-SV | LPS40 SERVICE GDE | EACH | \$120.00 | 3 A | | EK-MS78E-TD | MS780 MEMORY SYBSYSTEM TECHN | EACH | REPLACED | 3 A | EK-780EH-TD |
| EK-LPV11-OP | LPV11 PRINTER SYSTEM USER MAN | EACH | \$21.00 | 3 A | | EK-MS82B-UG | MS820-AA/AB MOS MEM USRS GDE | EACH | \$20.00 | 3 A | |
| EK-LQ2HL-RC | LQP02 HOT LINE TROUBLESHOOTIN | EACH | \$5.00 | 3 A | | EK-MSV1D-OP | MSV11-D/E USERS MANUAL | EACH | \$21.00 | 3 A | |
| EK-LQ3SF-UG | LQPX3-SF USERS GUIDE | EACH | \$21.00 | 3 A | | EK-MSV1J-UG | MSV11-J MOS MEMORY USER GUIDE | EACH | \$21.00 | 3 A | |
| EK-LQP01-PS | LQP01 PRINTER POCKET SERVICE | EACH | \$42.00 | 3 A | | EK-MSV1Q-UG | MSV11-Q MOS MEMORY USERS GUID | EACH | \$21.00 | 3 A | |
| EK-LQP02-PS | LQP02 PRINTER POCKET SERVICE | EACH | \$42.00 | 3 A | | EK-MSV1S-UG | MSV11-S MOS MEMORY USERS GD. | EACH | \$21.00 | 3 A | |
| EK-LQP02-RM | LQP02 PROGRAMMER REFERENCE MA | EACH | \$42.00 | 3 A | | EK-MSVOL-UG | MSVOL-L USER GUIDE | EACH | \$21.00 | 3 A | |
| EK-LQP03-PS | LQP03 POCKET SERVICE GUIDE | EACH | \$42.00 | 3 A | | EK-MSVOP-UG | MSV11-P USER GUIDE | EACH | \$21.00 | 3 A | |
| EK-LQP03-RM | LQP03 PROGRAMMER REF MANUAL | EACH | \$42.00 | 3 A | | EK-MULCOP-UG | MULTI-CPU USER GUIDE | EACH | \$21.00 | 3 A | |
| EK-LQP03-UG | LQP03 USERS GUIDE | EACH | \$21.00 | 3 A | | EK-MV630-IP | MICRO VAXII 630 QT IPB | EACH | \$20.00 | 3 A | |
| EK-LQP45-PS | LQP45 POCKET SERVICE GDE | EACH | \$40.00 | 3 A | | EK-MVDH6-IP | MICROVAX 2000 IPB | EACH | \$20.00 | 3 A | |
| EK-LQPX2-PS | LQPX2-SF POCKET SERVICE GUIDE | EACH | \$42.00 | 3 A | | EK-MVSVIP-IP | MVAX 2000 DISKLESS SYS IPB | EACH | \$40.00 | 3 A | |
| EK-LS120-IP | LS120 DECWRITER III IPB | EACH | \$42.00 | 3 A | | EK-MXV1B-UG | MXV11-B MULTI-FUNCTION OPTION | EACH | \$21.00 | 3 A | |
| EK-LS120-OP | LS120 DECWRITER III OPERATORS | EACH | \$21.00 | 3 A | | EK-MXVB2-UG | MXV11-B2 ROM SET USERS GUIDE | EACH | \$21.00 | 3 A | |
| EK-LS120-TM | LS120 DECWRITER III TECHNICAL | EACH | \$46.00 | 3 A | | EK-NETAA-UG | MVAX2000.VS2000.VAXMATE NETWK | EACH | REPLACED | 3 A | EK-NETAB-UG |
| EK-LS120-UG | LS120 DECWRITER III USERS GUI | EACH | \$21.00 | 3 A | | EK-NETAB-UG | MVAX2000.VS2000.VXMTTE NETWK | EACH | REPLACED | 3 A | EK-NETAC-UG |
| EK-LS11-TM | LSI-11 PDP-11/03 USERS MANUAL | EACH | \$42.00 | 3 A | | EK-NETAC-UG | MVAX2000.VS2000.VXMTTE NETWK | EACH | \$40.00 | 3 A | |
| EK-LS1F5-SV | LSI-11 SYS SERV MAN. 3 VOL. | EACH | \$42.00 | 3 A | | EK-NETWK-TM | INTRO TO NETWORK PERFORMANCE | EACH | \$120.00 | 3 A | |
| EK-LSP25-TM | LSP25 BAND PRINTER TECH MAN. | EACH | \$42.00 | 3 A | | EK-O63AB-IS | MICRO PDP11 H9642 TECH INFO | EACH | \$40.00 | 3 A | |
| EK-LVP16-OM | LVP16 OWNERS MANUAL | EACH | \$21.00 | 3 A | | EK-O67AB-PG | MICROSYSTEMS SITE PREP GD | EACH | \$21.00 | 3 A | |
| EK-LVP16-RC | LVP16 REFERENCE CARD | EACH | \$5.00 | 3 A | | EK-O74AA-SP | IVAX 630 SITE PREP GDE | EACH | \$40.00 | 3 A | |
| EK-LVP16-RM | LVP16 REFERENCE MANUAL | EACH | \$84.00 | 3 A | | EK-OC011-OP | CD11 CARD READER SYSTEM USERS | EACH | \$21.00 | 3 A | |
| EK-LW100-IN | LETTERWRITER 100 INSTALLATION | EACH | \$21.00 | 3 A | | EK-OCORP-SP | DIGITAL SITE PREPARATION GUID | EACH | \$42.00 | 3 A | |
| EK-LW100-OP | LA100 (LETTERWRITER) OPER GUI | EACH | \$42.00 | 3 A | | EK-OCR11-OP | CR11/CM11 CARD READERS USERS | EACH | \$21.00 | 3 A | |
| EK-LW100-UG | LETTERWRITER 100 USER DOCUMEN | EACH | \$42.00 | 3 A | | EK-ODF02-IP | DF02 MODEM UNIT ASSEMBLY IPB | EACH | \$21.00 | 3 A | |
| EK-LXY01-PS | LXY01/02 IMPACT LINE PRINTER | EACH | \$42.00 | 3 A | | EK-ODF02-PS | DF02 MODEM POCKET SERVICE GUI | EACH | \$42.00 | 3 A | |
| EK-LXY22-IN | LXY12/LXY22 IMPACT PRINTER/PL | EACH | \$21.00 | 3 A | | EK-ODF02-UG | DF02 USER GUIDE | EACH | \$21.00 | 3 A | |
| EK-LXY22-UG | LXY12/LXY22 IMPACT PRINTER/PL | EACH | \$21.00 | 3 A | | EK-ODF03-IP | DF03 MODEM UNIT ASSEMBLY IPB | EACH | \$21.00 | 3 A | |
| EK-M7552-IN | RRD50 Q-BUS CONTROLLER INST. | EACH | \$21.00 | 3 A | | EK-ODF03-TM | DF03 MODEM FAMILY TECH MANUAL | EACH | \$42.00 | 3 A | |
| EK-M8781-TM | KU116 TECHNICAL MANUAL | EACH | \$42.00 | 3 A | | EK-ODF03-UG | DF03 MODEM USERS GUIDE | EACH | \$42.00 | 3 A | |
| EK-M8203-TM | M8203 LINE UNIT TECHNICAL MAN | EACH | \$84.00 | 3 A | | EK-ODH11-TM | DH11 TECHNICAL MANUAL | EACH | \$126.00 | 3 A | |
| EK-M8207-TM | M8207 MICROPROCESSOR TECHNICA | EACH | \$42.00 | 3 A | | EK-ODH11-UG | DH11 USERS GUIDE | EACH | \$21.00 | 3 A | |
| EK-M9301-TM | M9301 BOOTSTRAP TECHNICAL MAN | EACH | \$84.00 | 3 A | | EK-ODL11-TM | DL11 ASYNCHRONOUS LINE INTERF | EACH | \$42.00 | 3 A | |
| EK-M9312-TM | M9312 TECHNICAL MANUAL (PDP-1 | EACH | \$42.00 | 3 A | | EK-ODQ11-MM | DQ11 NPR INTERFACE MANUAL (PD | EACH | \$84.00 | 3 A | |
| EK-MA780-TD | MA780 MULTIPOINT MEMORY TECHN | EACH | \$126.00 | 3 A | | EK-ODT07-TM | VAX-11 DT07 SWITCHED BUS TECH | EACH | \$84.00 | 3 A | |
| EK-MCA25-IN | MCA25 INSTALLATION PROCEDURE | EACH | \$21.00 | 3 A | | EK-ODV11-MM | DV11 MAINTENANCE MANUAL | EACH | \$84.00 | 3 A | |
| EK-MCV1D-RC | MCV11-D USER GUIDE REFER CARD | EACH | \$5.00 | 3 A | | EK-ODV11-OP | DV11 USERS MANUAL | EACH | \$21.00 | 3 A | |
| EK-MCV1D-UG | MCV11-D USERS GUIDE | EACH | \$21.00 | 3 A | | EK-ODY32-UG | VAX-11 DY32 USERS GUIDE | EACH | \$21.00 | 3 A | |
| EK-MIC11-OM | MICRO PDP11 SYS OWNERS MANUAL | EACH | \$21.00 | 3 A | | EK-ODZ32-TM | DZ32 TECHNICAL MANUAL | EACH | \$42.00 | 3 A | |
| EK-MIC11-SG | MICRO PDP-11 SYS MAINT GUIDE | EACH | \$42.00 | 3 A | | EK-OH754-IP | H754 REGULATOR IPB | EACH | \$21.00 | 3 A | |
| EK-MIC11-TM | MICRO PDP-11 SYSTEM TECH. MAN | EACH | \$42.00 | 3 A | | EK-OH766-IP | H766 POWER SUPPLY IPB | EACH | \$21.00 | 3 A | |
| EK-MICSV-IN | MICRO PDP11/SV TO MICRO 1123 | EACH | \$21.00 | 3 A | | EK-OH771-IP | H771 POWER SUPPLY IPB | EACH | \$21.00 | 3 A | |
| EK-MM780-TD | VAX-11/780 BUFFER, CACHE, SBI | EACH | \$84.00 | 3 A | | EK-OH960-UG | H960/H967 CABINETS USER GUIDE | EACH | \$21.00 | 3 A | |
| EK-MM785-TD | VAX-11/785 TRANSLATION BUFFER | EACH | \$84.00 | 3 A | | EK-OIVIS-PS | H960/H967 CABINETS USER GUIDE | EACH | \$40.00 | 3 A | |
| EK-MRV1D-UG | MRV11-D PROM MODULE USER GUID | EACH | \$21.00 | 3 A | | EK-OKL10-TM | KL10 BASED TECH MAN | EACH | \$32.00 | 3 A | |
| EK-MS11L-TM | MS11-L MOS MEMORY TECHNICAL M | EACH | \$42.00 | 3 A | | EK-OLA34-RG | LA34 DECWRITER IV REFERENCE G | EACH | \$20.00 | 3 A | |
| EK-MS11L-UG | MS11-L MOS MEMORY USERS GUIDE | EACH | \$21.00 | 3 A | | EK-OLA34-UG | DECWRITER IV KSR SERIES USER | EACH | \$42.00 | 3 A | |
| EK-MS11M-TM | MS11-M MOS MEMORY TECHNICAL M | EACH | \$42.00 | 3 A | | EK-OLA36-IP | LA36 DECWRITER II IPB | EACH | \$21.00 | 3 A | |
| EK-MS11M-UG | MS11-M MOS MEMORY USER GUIDE | EACH | \$21.00 | 3 A | | EK-OLA38-IP | LA38 DECWRITER IV IPB | EACH | \$21.00 | 3 A | |
| EK-MS11P-TM | MS11-P MOS MEMORY TECHNICAL M | EACH | \$42.00 | 3 A | | EK-OLA50-IP | LA50 PRINTER I P B | EACH | \$21.00 | 3 A | |
| EK-MS730-TD | VAX-11/730 MEMORY SYS TECH DE | EACH | \$84.00 | 3 A | | EK-OLA50-PS | LA50 POCKET SERVICE GUIDE | EACH | \$42.00 | 3 A | |
| EK-MS750-IN | MS750-C/D INSTALLATION GUIDE | EACH | \$21.00 | 3 A | | EK-OLA50-RM | LA50 PRINTER PROGRAMMER REFER | EACH | \$42.00 | 3 A | |
| EK-MS750-TD | VAX-11/750 MEMORY SYS TECHNIC | EACH | \$42.00 | 3 A | | EK-OLA50-TM | LA50 PRINTER TECHNICAL MANUAL | EACH | \$42.00 | 3 A | |
| EK-MS780-TD | MS780 MEMORY SYSTEM TECH DESC | EACH | \$42.00 | 3 A | | EK-OLA50-UG | INSTALLING & USING THE LA50 | EACH | \$21.00 | 3 A | |



Prices Effective 02-January-89 to 30-June-89
To Order—Call DECdirect™ TOLL-FREE 800-344-4825, 8:30 a.m. to 8:00 p.m. ET in Continental U.S.A.

DOCUMENTATION AND DIAGNOSTICS PRICE LIST

| PART NUMBER | DESCRIPTION | UNIT ORDER | UNIT PRICE | REP D | L | REPLACEMENT PART NUMBER | PART NUMBER | DESCRIPTION | UNIT ORDER | UNIT PRICE | REP D | L | REPLACEMENT PART NUMBER |
|-------------|-------------------------------|------------|------------|-------|---|-------------------------|-------------------------------|-------------------------------|------------|------------|-------|---|-------------------------|
| EK-OLA75-IP | LA75/LA75P IPB | EACH | \$21.00 | 3 | A | | EK-ORA81-SV | RA81 DISK DRIVE SERVICE MANUA | EACH | \$84.00 | 3 | A | |
| EK-OLA75-PS | LA75/LA75P POCKET SERVICE GD. | EACH | \$42.00 | 3 | A | | EK-ORA81-UG | RA81 DISK DRIVE USER GUIDE | EACH | \$21.00 | 3 | A | |
| EK-OLA75-RC | LA75 REF CARD | EACH | \$5.00 | 3 | A | | EK-ORA82-UG | RA82 USER AND INSTALLATION GD | EACH | \$40.00 | 3 | A | |
| EK-OLA75-RM | LA75 REFERENCE MANUAL | EACH | \$80.00 | 3 | A | | EK-ORA90-IP | RA90 ILLUSTRATED PARTS | EACH | \$40.00 | 3 | A | |
| EK-OLA75-UG | LA75 COMPANION PRNTR USER GD. | EACH | \$21.00 | 3 | A | | EK-ORA90-PS | RA90 POCKET SERVICE GUIDE | EACH | \$40.00 | 3 | A | |
| EK-OLCP5-IN | MICRO/PDP-11 UNPACKING & INST | EACH | \$21.00 | 3 | A | | EK-ORC25-IN | RC25 DISK SUBSYS INST GUIDE | EACH | \$21.00 | 3 | A | |
| EK-OLCP5-IP | MICRO/PDP-11 IPB | EACH | \$21.00 | 3 | A | | EK-ORC25-IP | RC25 DISK DRIVE IPB MANUAL | EACH | \$42.00 | 3 | A | |
| EK-OLCP5-OM | MICRO/PDP-11 OWNERS MANUAL | EACH | \$42.00 | 3 | A | | EK-ORC25-PS | RC25 POCKET SERVICE GUIDE | EACH | \$42.00 | 3 | A | |
| EK-OLCP5-PS | MICRO/PDP-11 SYS POCKET SERVI | EACH | REPLACED | 3 | A | EK-MIC11-SG | RC25 DISK SUBSYSTEM USER GUID | EACH | \$21.00 | 3 | A | | |
| EK-OLCP5-SP | MICRO/PDP-11 SITE PREP VERIFI | EACH | REPLACED | 3 | A | EK-067AB-PG | RD32 ILLUSTRATED PARTS | EACH | \$40.00 | 3 | A | | |
| EK-OLCP5-TM | MICRO/PDP-11 SYS TECHNICAL MA | EACH | \$84.00 | 3 | A | | EK-ORD32-TD | RD32 TECHNICAL DESCRIPTION | EACH | \$40.00 | 3 | A | |
| EK-OLG01-IN | LG01 600 LPM INST/OPERATORS | EACH | \$21.00 | 3 | A | | EK-ORK05-OP | RK05 DISK DRIVE USERS MANUAL | EACH | \$21.00 | 3 | A | |
| EK-OLG01-TM | LG01 TECHNICAL MANUAL | EACH | \$42.00 | 3 | A | | EK-ORK07-IP | RK07 IPB | EACH | \$21.00 | 3 | A | |
| EK-OLG01-UG | LG01 600 LPM TEXT PRINTERS UG | EACH | \$21.00 | 3 | A | | EK-ORL01-IP | RL01 DISK DRIVE IPB | EACH | \$21.00 | 3 | A | |
| EK-OLG02-IN | LG02 INSTALL/OWNERS MANUAL | EACH | \$21.00 | 3 | A | | EK-ORL02-IP | RL02 DISK DRIVE IPB | EACH | \$21.00 | 3 | A | |
| EK-OLG02-TM | LG02 6000 LPM TECH MANUAL | EACH | \$80.00 | 3 | A | | EK-ORL11-TD | RL11 CONTROLLER TECHNICAL DES | EACH | \$42.00 | 3 | A | |
| EK-OLG02-UG | LG02 USERS GUIDE | EACH | \$63.00 | 3 | A | | EK-ORM02-IP | RM02 ILLUSTRATED PARTS | EACH | \$20.00 | 3 | A | |
| EK-OLG31-DK | LG31 USERS DOCUMENTATION KIT | EACH | \$40.00 | 3 | A | | EK-ORM03-IP | RM03 DISK DRIVE IPB | EACH | \$21.00 | 3 | A | |
| EK-OLN03-IP | LN03 LASER PRINTER IPB | EACH | \$21.00 | 3 | A | | EK-ORM05-IP | RM05 DISK DRIVE IPB | EACH | \$21.00 | 3 | A | |
| EK-OLN03-PS | LN03 POCKET SERVICE GUIDE | EACH | \$42.00 | 3 | A | | EK-ORM05-SV | RM05 DISK DRIVE SERVICE MANUA | EACH | \$126.00 | 3 | A | |
| EK-OLN03-RC | LN03 OPERATOR FLIP CARD | EACH | \$5.00 | 3 | A | | EK-ORM05-UG | RM05 DISK SUBSYSTEM USERS GUI | EACH | \$42.00 | 3 | A | |
| EK-OLN03-RM | LN03 PROG. REF. MANUAL | EACH | \$84.00 | 3 | A | | EK-ORM80-IP | RM80 IPB | EACH | \$21.00 | 3 | A | |
| EK-OLN03-TM | LN03 TECH. MANUAL | EACH | \$84.00 | 3 | A | | EK-ORM80-PG | RM80 DISK DRIVE POCKET GUIDE | EACH | \$21.00 | 3 | A | |
| EK-OLN03-UG | LN03 USERS GUIDE | EACH | \$42.00 | 3 | A | | EK-ORM80-SV | RM80 DISK DRIVE SERVICE MANUA | EACH | \$84.00 | 3 | A | |
| EK-OLP11-TM | LP11/LA11 LINE PRINTER MANUAL | EACH | \$42.00 | 3 | A | | EK-ORM80-TD | RM80 DISK DRIVE TECH DESCRIPT | EACH | \$42.00 | 3 | A | |
| EK-OLP27-IN | LP27 INSTALLATION MANUAL | EACH | \$21.00 | 3 | A | | EK-ORM80-UG | RM80 DISK DRIVE USERS GUIDE | EACH | \$21.00 | 3 | A | |
| EK-OLP27-PS | LP27 POCKET SERVICE GUIDE | EACH | \$42.00 | 3 | A | | EK-ORP07-PS | RP07 POCKET SERVICE GUIDE | EACH | \$42.00 | 3 | A | |
| EK-OLP27-TM | LP27 LINE PRINTER TECHNICAL M | EACH | \$126.00 | 3 | A | | EK-ORV20-IN | RV20 INSTALLATION GDE | EACH | \$20.00 | 3 | A | |
| EK-OLP27-UG | LP27 LINE PRINTER USERS GUIDE | EACH | \$42.00 | 3 | A | | EK-ORV20-OM | RV20 OWNERS MANUAL | EACH | \$20.00 | 3 | A | |
| EK-OLP29-IP | LP29 ILLUSTRATED PARTS | EACH | \$80.00 | 3 | A | | EK-ORV20-SV | RV20 SERVICE MANUAL | EACH | \$80.00 | 3 | A | |
| EK-OLP29-MG | LP29 MAINTENANCE GDE | EACH | \$120.00 | 3 | A | | EK-ORX01-IP | RX01 FLOPPY DISK IPB | EACH | \$21.00 | 3 | A | |
| EK-OMJ11-MM | MJ11 MEMORY SYS MAINT MANUAL | EACH | \$84.00 | 3 | A | | EK-ORX01-MM | RX01/08/11 MAINTENANCE MANUAL | EACH | \$84.00 | 3 | A | |
| EK-OMK11-MC | MK11 MEMORY MAINTENANCE CARD | EACH | \$5.00 | 3 | A | | EK-ORX01-OP | RX8/RX11 RX01 FLOPPY DISK SYS | EACH | \$21.00 | 3 | A | |
| EK-OMK11-TM | MK11 MOS MEMORY TECHNICAL MAN | EACH | \$84.00 | 3 | A | | EK-ORX02-IP | RX02 FLOPPY DISK IPB | EACH | \$21.00 | 3 | A | |
| EK-OMK11-UG | MK11 MOS MEMORY USERS GUIDE | EACH | \$21.00 | 3 | A | | EK-ORX02-TM | RX02 FLOPPY DISK SYS TECHNICA | EACH | \$84.00 | 3 | A | |
| EK-OML11-TD | ML11 MOS MEMORY SYS MAINT ADV | EACH | \$42.00 | 3 | A | | EK-ORX02-UG | RX02 FLOPPY DISK SYSTEM USERS | EACH | \$21.00 | 3 | A | |
| EK-OQBEC-SM | BROADBAND ETHERNET CHANNEL SM | EACH | \$42.00 | 3 | A | | EK-ORX33-IP | RX33 IPB | EACH | \$20.00 | 3 | A | |
| EK-OQBET-OM | DECOM BROADBAND ETHERNET OWN. | EACH | \$21.00 | 3 | A | | EK-ORX50-IP | RX50 ILLUSTRATED PARTS | EACH | \$20.00 | 3 | A | |
| EK-OQBET-TM | DECOM BROADBAND ETHERNET TECH | EACH | \$84.00 | 3 | A | | EK-ORX50-IP | RX50 DUAL DISKETT DRIVE IPB | EACH | \$21.00 | 3 | A | |
| EK-OOR80-IP | R80 DISK DRIVE I P B | EACH | \$21.00 | 3 | A | | EK-OSB11-IP | SB11 MICROCOMPUTER IPB | EACH | \$21.00 | 3 | A | |
| EK-OOR80-PS | R80 DISK DRIVE POCKET SERVICE | EACH | \$42.00 | 3 | A | | EK-OTA78-SV | TA78 MAGNETIC TAPE DRIVE | EACH | \$126.00 | 3 | A | |
| EK-OOR80-SV | R80 DISK DRIVE SERVICE MANUAL | EACH | \$42.00 | 3 | A | | EK-OTA78-TD | TA78 MAG TAPE DRIVE TECH DESC | EACH | REPLACED | 3 | A | EK-OTA79-TM |
| EK-OOR80-TD | R80 DISK DRIVE TECHNICAL DESC | EACH | \$42.00 | 3 | A | | EK-OTA78-UG | TA78 MAG. TAPE DRIVE USER GD. | EACH | \$21.00 | 3 | A | |
| EK-OOR80-UG | R80 DISK DRIVE USER GUIDE | EACH | \$21.00 | 3 | A | | EK-OTA79-IM | TA79,TU78 INSTALLATION GDE | EACH | \$20.00 | 3 | A | |
| EK-OPIO5-UG | I/O SUBSYSTEM USERS GUIDE | EACH | \$63.00 | 3 | A | | EK-OTA79-IN | TA79 INSTALLATION MANUAL | EACH | REPLACED | 3 | A | EK-OTA79-IM |
| EK-ORA60-FG | RA60 SUBSYSTEM FAULT ISOLATIO | EACH | \$21.00 | 3 | A | | EK-OTA79-OM | TA79 OWNERS MANUAL | EACH | \$40.00 | 3 | A | |
| EK-ORA60-HB | RA60 SAFETY MANUAL | EACH | \$21.00 | 3 | A | | EK-OTA79-SV | TA79 SERVICE MANUAL | EACH | \$80.00 | 3 | A | |
| EK-ORA60-IP | RA60 DISK DRIVE IPB | EACH | \$21.00 | 3 | A | | EK-OTA79-TM | TA79,TA78,TU78,TECH MANUAL | EACH | \$120.00 | 3 | A | |
| EK-ORA60-SV | RA60 DISK DRIVE SERVICE MANUA | EACH | \$84.00 | 3 | A | | EK-OTE16-IP | TE16 DEC MAGTAPE IPB | EACH | \$21.00 | 3 | A | |
| EK-ORA60-UG | RA60 DISK DRIVE USERS GUIDE | EACH | \$21.00 | 3 | A | | EK-OTE16-PS | TE16 POCKET SERVICE GUIDE | EACH | \$42.00 | 3 | A | |
| EK-ORA70-PS | RA70 DSK DRV POCKET REF CARD | EACH | \$20.00 | 3 | A | | EK-OTE16-TM | TE16/TE10W/TE10N MAINTENANCE | EACH | \$126.00 | 3 | A | |
| EK-ORA80-IP | RA80/RUA80 DISK DRIVE IPB | EACH | \$21.00 | 3 | A | | EK-OTAWN-OP | TE16/TE10W/TE10N USERS MANUAL | EACH | \$21.00 | 3 | A | |
| EK-ORA80-SV | RA80 DISK DRIVE SERVICE MANUA | EACH | \$42.00 | 3 | A | | EK-OTK25-PS | TK25 TAPE DRIVE POCKET SERV.G | EACH | \$42.00 | 3 | A | |
| EK-ORA80-UG | RA80 DISK DRIVE USER GUIDE | EACH | \$21.00 | 3 | A | | EK-OTK25-UG | TK25 TAPE DRIVE SUBSYS USER G | EACH | \$21.00 | 3 | A | |
| EK-ORA81-IP | RA81 DISK DRIVE I P B | EACH | \$21.00 | 3 | A | | EK-OTK50-IP | TK50 IPB | EACH | \$21.00 | 3 | A | |



Prices Effective 02-January-89 to 30-June-89

To Order—Call DECdirect™ TOLL-FREE 800-344-4825, 8:30 a.m. to 8:00 p.m. ET in Continental U.S.A.

DOCUMENTATION AND DIAGNOSTICS PRICE LIST

| PART NUMBER | DESCRIPTION | UNIT ORDER | UNIT PRICE | REP D | L | REPLACEMENT PART NUMBER | PART NUMBER | DESCRIPTION | UNIT ORDER | UNIT PRICE | REP D | L | REPLACEMENT PART NUMBER |
|-------------|-------------------------------|------------|------------|-------|---|-------------------------|-------------|-------------------------------|------------|------------|-------|---|-------------------------|
| EK-OTK50-TM | TK50 TAPE DRIVE TECH. MANUAL | EACH | \$42.00 | 3 | A | | EK-PC3AA-OM | PRO 300 SERIES REAL TIME | EACH | \$21.00 | 3 | A | |
| EK-OTK50-UG | TK50 TAPE DR. SYS USER GUIDE | EACH | \$21.00 | 3 | A | | EK-PC405-MM | PC04/05 READER PUNCH MANUAL | EACH | \$42.00 | 3 | A | |
| EK-OTK70-OM | TK70 OWNERS MANUAL | EACH | \$20.00 | 3 | A | | EK-PCCOL-IN | RAINBOW COLOR/GRAPHICS INSTAL | EACH | \$21.00 | 3 | A | |
| EK-OTK70-RC | TK70 REFERENCE CARD | EACH | \$5.00 | 3 | A | | EK-PCEBO-IN | PRO 380 BIT MAP OPT INSTALL. | EACH | \$21.00 | 3 | A | |
| EK-OTK70-SM | TK70 SERVICE MANUAL | EACH | \$80.00 | 3 | A | | EK-PCEXB-IN | PRO 380 EXP. BOX INSTALL. GD. | EACH | \$21.00 | 3 | A | |
| EK-OTM02-IP | TM02 FORMATTER IPB | EACH | \$21.00 | 3 | A | | EK-PCEXC-IN | RAINBOW 100 EXTENDED COMMUNIC | EACH | \$21.00 | 3 | A | |
| EK-OTM03-IP | TM03 FORMATTER IPB | EACH | \$21.00 | 3 | A | | EK-PCL1B-IN | PCL11-1 SYSTEM OPTS POCKET GD | EACH | \$21.00 | 3 | A | |
| EK-OTM03-TM | TM03 MAGNETIC TAPE FORMATTER | EACH | \$126.00 | 3 | A | | EK-PCL1B-PS | PCL11-1 SYS OPTIONS POCKET GD | EACH | \$42.00 | 3 | A | |
| EK-OTM03-UG | TM03 MAGNETIC TAPE FORMATTER | EACH | \$21.00 | 3 | A | | EK-PCL1B-TM | PCL11-B TECHNICAL MANUAL | EACH | \$84.00 | 3 | A | |
| EK-OTM78-TM | TM78 MAGNETIC TAPE FORMATTER | EACH | \$126.00 | 3 | A | | EK-PCMDM-IN | PRO 380 MEMORY INSTALLATION | EACH | \$21.00 | 3 | A | |
| EK-OTM78-UG | TM-78 TAPE USERS GUIDE | EACH | \$21.00 | 3 | A | | EK-PCMXA-CN | RAINBOW 100 MEMORY ADAPT NOTE | EACH | \$21.00 | 3 | A | |
| EK-OTS11-PS | TS11 POCKET SERVICE GUIDE | EACH | \$42.00 | 3 | A | | EK-PCMXA-IN | RAINBOW 100 MEMORY INSTALL | EACH | \$21.00 | 3 | A | |
| EK-OTS11-TM | TS11 SUBSYSTEM TECHNICAL MANU | EACH | \$126.00 | 3 | A | | EK-PCMXE-IN | RAINBOW 100 MEMORY EXTENSION | EACH | \$14.00 | 3 | A | |
| EK-OTS11-UG | TS11 SUBSYSTEM USERS GUIDE | EACH | \$21.00 | 3 | A | | EK-PQSL-IN | PRO 350/380 INSTALLION GDE | EACH | \$21.00 | 3 | A | |
| EK-OTU10-IP | TU10 MAGTAPE IPB | EACH | \$21.00 | 3 | A | | EK-PCRTI-TM | PRO 300 REAL TIME TECH MANUAL | EACH | \$42.00 | 3 | A | |
| EK-OTU10-MM | TU10 DECMAGTAPE MAINTENANCE M | EACH | \$42.00 | 3 | A | | EK-PCWIN-IN | RAINBOW WINCHESTER DISK & INS | EACH | \$5.00 | 3 | A | |
| EK-OTU10-TM | TU10 MAG TAPE MASTER SYS MAN. | EACH | \$42.00 | 3 | A | | EK-PDP44-MC | PDP-11/44 MAINTENANCE CARD | EACH | \$5.00 | 3 | A | |
| EK-OTU58-IP | TU58 CARTRIDGE TAPE DIRVE IPT | EACH | \$21.00 | 3 | A | | EK-PDP84-IN | PDP-11/84 INSTALLATION MANUAL | EACH | \$21.00 | 3 | A | |
| EK-OTU58-PS | TU58 DECTAPE II POCKET SERVIC | EACH | \$42.00 | 3 | A | | EK-PDP84-TM | PDP-11/84 TECH MANUAL | EACH | REPLACED | 3 | A | EK-1184A-TM |
| EK-OTU58-TM | TU58 DECTAPE-11 TECHNICAL MAN | EACH | \$42.00 | 3 | A | | EK-PRISM-PS | PRISM POCKET GUIDE | EACH | \$42.00 | 3 | A | |
| EK-OTU58-UG | TU58 DECTAPE-11 USERS GUIDE | EACH | \$21.00 | 3 | A | | EK-PROEX-MA | PRO 300 HARD ADVISORY | EACH | \$42.00 | 3 | A | |
| EK-OTU77-IP | TU77 MAGNETIC TAPE TRANSPORT | EACH | \$21.00 | 3 | A | | EK-PS730-TD | H7202 B POWER SYS TECH DESCRI | EACH | \$42.00 | 3 | A | |
| EK-OTU77-PS | TU77 SUBSYSTEM POCKET SERVICE | EACH | \$42.00 | 3 | A | | EK-PS750-TD | VAX-11/750 H7104 POWER SYS TE | EACH | \$42.00 | 3 | A | |
| EK-OTU77-UG | TU77 MAGTAPE TRANSPORT USER G | EACH | \$42.00 | 3 | A | | EK-PS780-TD | VAX-11/780 POWER SYS TECHNICA | EACH | \$84.00 | 3 | A | |
| EK-OTU78-IP | TU78/TM78 MAG TAPE TRANSPORT | EACH | REPLACED | 3 | A | EK-TUA78-IP | EK-PT150-J1 | PDT-11/150 MINI MAINT GUIDE | EACH | \$5.00 | 3 | A | |
| EK-OTU78-PS | TU78 SUBSYSTEM POCKET SERVIC | EACH | \$42.00 | 3 | A | | EK-PT150-TM | PDT-11/150 TECHNICAL MANUAL | EACH | \$84.00 | 3 | A | |
| EK-OTU78-UG | TU78 MAGNETIC TAPE TRANSPORT | EACH | \$21.00 | 3 | A | | EK-R100E-IN | RAINBOW 100 B INSTALLATION GU | EACH | \$21.00 | 3 | A | |
| EK-OTU80-IP | TU80 IPB | EACH | \$21.00 | 3 | A | | EK-R100E-OM | RAINBOW 100+ OWNER MANUAL | EACH | \$42.00 | 3 | A | |
| EK-OTU80-PS | TU80 POCKET SERVICE GUIDE | EACH | \$42.00 | 3 | A | | EK-RA70A-IP | RA70 ILLUSTRATED PARTS BRKDN | EACH | \$20.00 | 3 | A | |
| EK-OTU80-SV | TU80 PATHFINDER USER GUIDE | EACH | \$84.00 | 3 | A | | EK-RB100-TM | RAINBOW TECH ADDENDUM PC100-A | EACH | \$84.00 | 3 | A | |
| EK-OTU80-TM | TU80 TAPE SUBSYS TECHNICAL MA | EACH | \$84.00 | 3 | A | | EK-RB730-TD | VAX-11/730 IDC TECHNICAL | EACH | \$84.00 | 3 | A | |
| EK-OTU80-UG | TU80 SUBSYSTEM USERS GUIDE | EACH | \$21.00 | 3 | A | | EK-RBMXE-IN | RAINBOW MEMORY BOARD INSTALL | EACH | \$21.00 | 3 | A | |
| EK-OTU81-IP | TU81 IPB | EACH | \$42.00 | 3 | A | | EK-RBWIN-IN | RAINBOW WINCHESTER DISK OPT I | EACH | \$21.00 | 3 | A | |
| EK-OTU81-PS | TU81 POCKET SERVICE GUIDE | EACH | \$42.00 | 3 | A | | EK-RBWIN-SV | RAINBOW DISK OPTION TEST MESS | EACH | \$42.00 | 3 | A | |
| EK-OVT52-IP | VT52 DECScope IPB | EACH | \$42.00 | 3 | A | | EK-RC25S-IN | RC25 DISK INSTALLATION GUIDE | EACH | \$21.00 | 3 | A | |
| EK-OVT52-MM | VT52 DECScope MAINTENANCE MAN | EACH | \$84.00 | 3 | A | | EK-RCD31-OM | VAXMATE EXP BOX INST & OWN.GD | EACH | \$21.00 | 3 | A | |
| EK-OVT5X-OP | DECScope USERS MANUAL | EACH | \$21.00 | 3 | A | | EK-RD31A-IP | RD31-A DISK DRIVE IPB MANUAL | EACH | \$42.00 | 3 | A | |
| EK-OVT78-RM | VT78 PROGRAMMERS REFERENCE MA | EACH | \$84.00 | 3 | A | | EK-RD50A-IP | RD50-A DISK DRIVE I P B | EACH | \$21.00 | 3 | A | |
| EK-OXXDP-MC | XXDP-DEC/X11 PROGRAMMING CAR | EACH | \$5.00 | 3 | A | | EK-RD51A-IP | RD51-A IPB | EACH | \$21.00 | 3 | A | |
| EK-P100E-IN | RAINBOW 100 A INSTALLATION GU | EACH | \$21.00 | 3 | A | | EK-RD52A-IP | RD52A DISK DR. IPB | EACH | \$20.00 | 3 | A | |
| EK-P100E-OM | RAINBOW OWNERS MANUAL | EACH | \$21.00 | 3 | A | | EK-RD52A-TD | RD52-A DISK DRIVE TECH DESC | EACH | \$42.00 | 3 | A | |
| EK-P100E-SV | RAINBOW USERS SERVICE GUIDE | EACH | \$42.00 | 3 | A | | EK-RD53A-IP | RD53A ILLUSTRATED PARTS | EACH | \$20.00 | 3 | A | |
| EK-P500B-SV | VAXMATE SERVICE GDE | EACH | \$80.00 | 3 | A | | EK-RD53A-TD | RD53-A FIXED DISK DRIVE TECH. | EACH | \$42.00 | 3 | A | |
| EK-PC100-PS | RAINBOW 100 POCKET SERVICE GU | EACH | \$42.00 | 3 | A | | EK-RD54A-IP | RD54A ILLUSTRATED PARTS | EACH | \$20.00 | 3 | A | |
| EK-PC100-TM | RAINBOW 100 TECHNICAL MANUAL | EACH | \$126.00 | 3 | A | | EK-RF300-UG | RF30 DSK DRIVE USERS GDE | EACH | \$20.00 | 3 | A | |
| EK-PC238-IP | PC238 DECMATE III SYS. IPB | EACH | \$42.00 | 3 | A | | EK-RFH40-IN | RF-H4000 ETHERNET INSTALLATIO | EACH | \$21.00 | 3 | A | |
| EK-PC300-V1 | PROFESSIONAL 300 SERIES VOL 1 | EACH | \$21.00 | 3 | A | | EK-RFVR2-TM | RF-VR201-A EMI MONITOR TECH M | EACH | \$42.00 | 3 | A | |
| EK-PC300-V2 | PROFESSIONAL 300 SERIES VOL 2 | EACH | \$21.00 | 3 | A | | EK-RH750-TD | RH750 MASSBUS ADAPTER TECHNIC | EACH | \$84.00 | 3 | A | |
| EK-PC350-OM | PC350 OWNER'S MANUAL | EACH | \$21.00 | 3 | A | | EK-RH780-TD | VAX-11/780 RH780 TECH DESCR M | EACH | \$84.00 | 3 | A | |
| EK-PC350-PS | PROFESSIONAL 300 SERIES SERVI | EACH | \$42.00 | 3 | A | | EK-RK05J-IP | RK05-J DISK DRIVE IPB | EACH | \$21.00 | 3 | A | |
| EK-PC350-TM | PROFESSIONAL 300 SERIES TECH | EACH | \$126.00 | 3 | A | | EK-RK05X-MM | RK05 EXERCISER MAINTENANCE MA | EACH | \$42.00 | 3 | A | |
| EK-PC380-OM | PRO 380 OWNERS MANUAL | EACH | \$21.00 | 3 | A | | EK-RK067-SV | RK06/RK07 DISK DRIVE SERVICE | EACH | \$42.00 | 3 | A | |
| EK-PC380-PS | PRO 380 POCKET SERVICE GUIDE | EACH | \$20.00 | 3 | A | | EK-RK067-TD | RK06/07 TECHNICAL DESCRIPTION | EACH | \$126.00 | 3 | A | |
| EK-PC380-UG | PRO 350-380 UPGRD INSTRUCTION | EACH | \$20.00 | 3 | A | | EK-RK067-UG | RK06/07 USERS MANUAL | EACH | \$63.00 | 3 | A | |
| EK-PC3AA-IN | PROFESSIONAL 300 SERIES INSTA | EACH | \$21.00 | 3 | A | | EK-RK11D-MM | RK11-D/E MOVING HEAD DISK MAN | EACH | \$42.00 | 3 | A | |



Prices Effective 02-January-89 to 30-June-89

To Order—Call DECdirect™ TOLL-FREE 800-344-4825, 8:30 a.m. to 8:00 p.m. ET in Continental U.S.A.

DOCUMENTATION AND DIAGNOSTICS PRICE LIST

| PART NUMBER | DESCRIPTION | UNIT ORDER | UNIT PRICE | REP D | L | REPLACEMENT PART NUMBER | PART NUMBER | DESCRIPTION | UNIT ORDER | UNIT PRICE | REP D | L | REPLACEMENT PART NUMBER |
|-------------|--------------------------------|------------|------------|-------|---|-------------------------|-------------|-------------------------------|------------|------------|-------|---|-------------------------|
| EK-RK5JF-MM | RK05/05J/05F MAINTENANCE MANU | EACH | \$42.00 | 3 | A | | EK-TPEIG-IN | UNSHIELDED TW PR INST GUIDE | EACH | \$20.00 | 3 | A | |
| EK-RK611-TM | RK611 TECHNICAL DESCRIPTION M | EACH | \$42.00 | 3 | A | | EK-TPEWC-IN | UNSHLD TW PR CHARACTERIZATION | EACH | \$20.00 | 3 | A | |
| EK-RL012-PG | RL01/02 POCKET SERVICE GUIDE | EACH | \$42.00 | 3 | A | | EK-TPR01-TM | AT&T TELEPRINTER 1000 RO DOCU | EACH | \$42.00 | 3 | A | |
| EK-RL012-UG | RL01/02 USERS GUIDE | EACH | \$42.00 | 3 | A | | EK-TS11A-IP | TS11-A MAGNETIC TAPE SYSTEM I | EACH | \$21.00 | 3 | A | |
| EK-RL121-TM | RL01/RL02 TECH MAN. VOL I. | EACH | \$84.00 | 3 | A | | EK-TS11C-IP | TS11-C MAGNETIC TAPE SUBSYSTE | EACH | \$21.00 | 3 | A | |
| EK-RL122-TM | RL01/RL02 TECH MAN. VOL II. | EACH | \$84.00 | 3 | A | | EK-TSU05-IN | TSU05 TAPE TRANSPORT SUBSYS I | EACH | \$21.00 | 3 | A | |
| EK-RLTER-PS | RL01/02 POCKET SERVICE GUIDE | EACH | \$42.00 | 3 | A | | EK-TSU05-UG | TSU05 TAPE TRANSPORT SUBSYSTE | EACH | \$42.00 | 3 | A | |
| EK-RLV11-TD | RLV11 CONTROLLER TECH DESC. M | EACH | \$84.00 | 3 | A | | EK-TSV05-IN | TSV05 TAPE TRANSPORT SUBSYSTE | EACH | \$21.00 | 3 | A | |
| EK-RLV12-TD | RLV12 TECHNICAL DESCRIPTION | EACH | \$42.00 | 3 | A | | EK-TSV05-PS | TSV05 TAPE TRANSPORT POCKET S | EACH | \$42.00 | 3 | A | |
| EK-RLV12-UG | RLV12 DISK CONTROLLER USERS G | EACH | \$21.00 | 3 | A | | EK-TSV05-TM | TSV05 TAPE TRANSPORT SUBSYS. | EACH | \$84.00 | 3 | A | |
| EK-RM023-SV | RM02/03 DISK SUBSYSTEM SERVIC | EACH | \$84.00 | 3 | A | | EK-TSV05-UG | TSV05 TAPE TRANSPORT SUBSYS U | EACH | \$42.00 | 3 | A | |
| EK-RM023-UG | RM02/03 USERS GUIDE MANUAL | EACH | \$21.00 | 3 | A | | EK-TUA78-IP | TU78/TM78,TA78/TS78 IPB | EACH | \$40.00 | 3 | A | |
| EK-RMADA-TD | RM MASSBUS ADAPTER TECH DESCR | EACH | \$42.00 | 3 | A | | EK-TUA79-IP | TA79 ILLUSTRATED PARTS | EACH | \$80.00 | 3 | A | |
| EK-RP056-IN | RP05/06 INSTALLATION MANUAL | EACH | \$21.00 | 3 | A | | EK-TUA81-SV | TU81/TA81 SERVICE MANUAL | EACH | \$63.00 | 3 | A | |
| EK-RP056-MM | RP05/06 MAINTENANCE MANUAL | EACH | \$84.00 | 3 | A | | EK-TUA81-TM | TU81/TA81 TECH MANUAL | EACH | \$63.00 | 3 | A | |
| EK-RP056-OP | RP05/06 USERS MANUAL | EACH | \$21.00 | 3 | A | | EK-TUA81-UG | TU81/TA81 USER GUIDE | EACH | \$42.00 | 3 | A | |
| EK-RQDX1-UG | RQDX1 CONTROLLER MODULE USERS | EACH | \$21.00 | 3 | A | | EK-TWU16-MM | TWU16 MAINTENANCE MANUAL | EACH | \$42.00 | 3 | A | |
| EK-RQDX2-UG | RQDX2 CONTROLLER USERS GUIDE | EACH | \$21.00 | 3 | A | | EK-TZK50-MC | TZK50 MAINTENANCE CARD | EACH | \$5.00 | 3 | A | |
| EK-RQDX3-UG | RQDX3 CONTROLLER USERS GUIDE | EACH | \$21.00 | 3 | A | | EK-TZK50-TM | TZK50 TECHNICAL MANUAL | EACH | \$80.00 | 3 | A | |
| EK-RQDXE-UG | RQDXE EXPANDER MODULE USER GD | EACH | \$21.00 | 3 | A | | EK-UDA50-SV | UDA50 SERVICE MANUAL | EACH | \$80.00 | 3 | A | |
| EK-RRD50-PS | RRD50 SUBSYS. POCKET SERV. GD | EACH | \$42.00 | 3 | A | | EK-UDA50-UG | UDA50 USER GUIDE | EACH | \$40.00 | 3 | A | |
| EK-RRD50-TD | RRD50 DIGITAL DISC TECH. DESC | EACH | \$42.00 | 3 | A | | EK-UDIPT-IP | UNIV. DATA INTFC INSTALL. GD. | EACH | \$21.00 | 3 | A | |
| EK-RRD50-UG | RRD50 DIGITAL DISK DRIVE U.G. | EACH | \$21.00 | 3 | A | | EK-UI750-TD | VAX-11/750 UNIBUS INTERFACE T | EACH | \$42.00 | 3 | A | |
| EK-RT620-IP | RTVAX SYSTEM IPB | EACH | \$20.00 | 3 | A | | EK-V241E-PS | VR241-A COLOR VIDEO MAINTENAN | EACH | \$42.00 | 3 | A | |
| EK-RUA81-IP | RUA81 SUBSYS IPB | EACH | \$21.00 | 3 | A | | EK-VAXAC-IN | VAX-11/780 SYSTEM ACOUSTIC | EACH | \$21.00 | 3 | A | |
| EK-RV20P-IP | RV20 ILLUSTRATED PARTS | EACH | \$20.00 | 3 | A | | EK-VAXCM-MG | VAXCLUSTER CONFIGURATION MAP | EACH | \$42.00 | 3 | A | |
| EK-RWP56-MM | RWP05/06 MAINTENANCE MANUAL | EACH | \$84.00 | 3 | A | | EK-VAXIA-IN | INSTAL'N APPLICA W PCSA SFTW | EACH | \$40.00 | 3 | A | |
| EK-RWP56-OP | RWP05/06 USERS MANUAL | EACH | \$21.00 | 3 | A | | EK-VAXRT-UG | VAX REALTIME USERS GUIDE | EACH | \$60.00 | 3 | A | |
| EK-RX012-PS | RX01/RX02 POCKET SERVICE GUIDE | EACH | \$42.00 | 3 | A | | EK-VAXST-MA | VAXSTA 3200 & 3500 MAINT ADVS | EACH | \$40.00 | 3 | A | |
| EK-RX102-RC | RX01/RX02 REFERENCE CARD | EACH | \$5.00 | 3 | A | | EK-VAXV1-HB | VAX MAINT HANDBOOK V1 COMPLET | EACH | \$42.00 | 3 | A | |
| EK-RX33T-TM | RX33T/RX33 TECH DESCRIPTION | EACH | \$40.00 | 3 | A | | EK-VAXV2-HB | VAX MAINT HANDBOOK V2 COMPLET | EACH | \$42.00 | 3 | A | |
| EK-RXV11-OP | RXV11 USER'S GUIDE | EACH | \$40.00 | 3 | A | | EK-VAXV3-HB | VAX MAINT HANDBOOK V3 COMPLET | EACH | \$42.00 | 3 | A | |
| EK-SA482-UG | SA482 USER GUIDE | EACH | \$21.00 | 3 | A | | EK-VENUS-IP | VAX 8600 SYSTEM IPB | EACH | \$42.00 | 3 | A | |
| EK-SA600-CG | SA600 STRG ARAY CONFIG GDE | EACH | \$40.00 | 3 | A | | EK-VK100-PS | VK100 POCKET SERVICE GUIDE | EACH | \$42.00 | 3 | A | |
| EK-SB100-IP | PC100 RAINBOW 100 SYSTEM UNIT | EACH | \$42.00 | 3 | A | | EK-VK100-RC | GIGI TERMINAL SET-UP REFERENC | EACH | \$5.00 | 3 | A | |
| EK-SB350-IP | PC-350 PROFESSIONAL 350 SYS U | EACH | \$42.00 | 3 | A | | EK-VK100-TM | VK100 TECHNICAL MANUAL | EACH | \$42.00 | 3 | A | |
| EK-SB380-IP | PRO 380 SYSTEM UNIT IPB | EACH | \$42.00 | 3 | A | | EK-VR150-IN | VR150 INSTALLATION MANUAL | EACH | \$20.00 | 3 | A | |
| EK-SBC01-UG | SBC-11/21 SINGLE-BOARD USER G | EACH | \$63.00 | 3 | A | | EK-VR150-IP | VR150 ILLUSTRATED PARTS | EACH | \$40.00 | 3 | A | |
| EK-SBC02-UG | SBC-11/21 PLUS COMPUTER USER' | EACH | \$63.00 | 3 | A | | EK-VR150-PS | VR150 MONOCHROME POCKET SERV | EACH | \$20.00 | 3 | A | |
| EK-SC008-UG | SC008 STAR COUPLER USERS GUID | EACH | \$21.00 | 3 | A | | EK-VR160-IN | VR160 OWNERS/INSTALLATION GDE | EACH | \$20.00 | 3 | A | |
| EK-SI730-IN | VAX-11/730 INSTALLATION GUIDE | EACH | \$42.00 | 3 | A | | EK-VR160-IP | VR160 ILLUSTRATED PARTS | EACH | \$40.00 | 3 | A | |
| EK-SI75F-IN | VAX-11/750 INSTALLATION GUIDE | EACH | \$42.00 | 3 | A | | EK-VR160-PS | VR160 POCKET SERVICE GUIDE | EACH | \$20.00 | 3 | A | |
| EK-SI785-IN | VAX 11785 INSTALLATION MANUAL | EACH | \$21.00 | 3 | A | | EK-VR201-IP | VR20/MONOCHROME MONITOR IPB | EACH | \$21.00 | 3 | A | |
| EK-SI78F-IN | VAX-11/780 INSTALLATION MAN. | EACH | \$42.00 | 3 | A | | EK-VR241-IN | VR241-A VIDEO MONITOR INSTALL | EACH | \$21.00 | 3 | A | |
| EK-T03L0-OP | PDP-11/T03-L SYSTEM MANUAL | EACH | \$21.00 | 3 | A | | EK-VR241-IP | VR241-A 13" COLOR MON. IPB | EACH | \$21.00 | 3 | A | |
| EK-T25QA-IN | M7605 Q-BUS KIT INSTALL GUIDE | EACH | \$21.00 | 3 | A | | EK-VR241-PS | VR241-A POCKET SERVICE GUIDE | EACH | \$42.00 | 3 | A | |
| EK-T25TD-IN | TK25 TAPE DRIVE INSTALL GUIDE | EACH | \$21.00 | 3 | A | | EK-VR260-IN | VR260 MONOCHROME MONITOR OWN. | EACH | \$21.00 | 3 | A | |
| EK-TA78U-IP | TA78 UPGRADE PROCEDURE | EACH | \$21.00 | 3 | A | | EK-VR260-IP | VR260 19" MONITOR IPB | EACH | \$21.00 | 3 | A | |
| EK-TA81M-MA | TA81 TAPE SUBSYST MAINT. ADVS | EACH | \$40.00 | 3 | A | | EK-VR260-MA | VR260 MAINTENANCE ADVISORY | EACH | \$20.00 | 3 | A | |
| EK-THNRP-UG | ETHERNET/IEEE 802.3 THN WIRE | EACH | \$20.00 | 3 | A | | EK-VR290-IN | VR290 INSTALLATION GDE | EACH | \$20.00 | 3 | A | |
| EK-TK25M-MA | TK25 TAPE DRIVE SUBSYSTEM MAI | EACH | \$42.00 | 3 | A | | EK-VR290-IP | VR290 IPB | EACH | \$40.00 | 3 | A | |
| EK-TK50Z-IP | TK50Z TAPE SYS ILLUSTR PARTS | EACH | \$40.00 | 3 | A | | EK-VR290-SV | VR290 ILLUSTRATED SERVICE | EACH | \$84.00 | 3 | A | |
| EK-TK70A-IP | TK70 ILLUSTRATED PARTS BRKDN | EACH | \$20.00 | 3 | A | | EK-VRTS1-MG | PRO 300 COLORSCREEN MAINT MAN | EACH | \$42.00 | 3 | A | |
| EK-TMB11-MM | TMB11/TS03 MAINTENANCE MANUAL | EACH | \$126.00 | 3 | A | | EK-VRTS1-OM | PRO 300 OWNERS GUIDE | EACH | \$20.00 | 3 | A | |
| EK-TMS11-PR | TMS11 MARKUP MANUAL & UPDATE | EACH | \$21.00 | 3 | A | | EK-VRTS1-PS | PRO 300 COLOR TOUCH SCREEN PS | EACH | \$42.00 | 3 | A | |



Prices Effective 02-January-89 to 30-June-89

To Order—Call DECdirect™ TOLL-FREE 800-344-4825, 8:30 a.m. to 8:00 p.m. ET in Continental U.S.A.

DOCUMENTATION AND DIAGNOSTICS PRICE LIST

| PART NUMBER | DESCRIPTION | UNIT ORDER | UNIT PRICE | REP D L | REPLACEMENT PART NUMBER | PART NUMBER | DESCRIPTION | UNIT ORDER | UNIT PRICE | REP D L | REPLACEMENT PART NUMBER |
|-------------|-------------------------------|------------|------------|---------|-------------------------|-------------|-------------------------------|------------|------------|---------|-------------------------|
| ER-LQP02-TM | LQP02 PRINTER TECHNICAL MANUA | EACH | \$16.00 | 3 | A | FB-LA120-RA | LA120-RA DOCUMENTATION KIT | EACH | \$575.00 | 3 | A |
| ER-LVP16-SV | LVP16 PLOTTER SERVICE MANUAL | EACH | \$42.00 | 3 | A | FB-LA180-00 | LA180 DOCUMENTS | EACH | \$572.00 | 3 | A |
| ER-ORM02-MP | RM02 PRINTSET | EACH | \$20.00 | 3 | A | FB-LA34-00 | LA34 DOCUMENTATION KIT | EACH | \$760.00 | 3 | A |
| ER-ORM02-TM | RM02 TECHNICAL MANUAL | EACH | \$40.00 | 3 | A | FB-LA36-00 | LA36 DOCUMENTS | EACH | \$465.00 | 3 | A |
| ER-ORM03-MP | RM03 DISK DRIVE MAINT MANUAL | EACH | \$42.00 | 3 | A | FB-LG31-00 | LG31 TECHNICAL DOC KIT | EACH | \$65.00* | 3 | A |
| ER-ORM03-TM | RM03 DISK DRIVE TECH MANUAL | EACH | \$42.00 | 3 | A | FB-LK201-00 | LK201 DOC | EACH | \$135.00 | 3 | A |
| | | | | | | FB-LPS40-00 | TECH DOC KIT | EACH | \$2,360.00 | 3 | A |
| | | | | | | FB-LPS40-UK | USERS DOC KIT -IN -OP -RC | EACH | \$52.00 | 3 | A |
| | | | | | | FB-M9312-00 | M9312 DOCUMENTS | EACH | \$688.00 | 3 | A |
| | | | | | | FB-MA780-00 | MA780 DOCUMENTATION | EACH | \$2,500.00 | 3 | A |
| | | | | | | FB-MICRO-11 | MICRO/PDP-11 HARDWARE DOC KIT | EACH | \$893.00 | 3 | A |
| | | | | | | FB-MS730-00 | MS730 DOCUMENTATION KIT | EACH | \$375.00 | 3 | A |
| | | | | | | FB-MS780-00 | MS780 DOCUMENTATION | EACH | \$1,565.00 | 3 | A |
| | | | | | | FB-MVII-00 | 630Q1 TECH DOCUMENTATION | EACH | \$1,960.00 | 3 | A |
| | | | | | | FB-MVII-01 | 630Q2-H, 630Q2-F TECH DOC | EACH | \$2,024.00 | 3 | A |
| | | | | | | FB-MVII-02 | 630Q3-H Q3-J Q4-J TECH DOC | EACH | \$2,122.00 | 3 | A |
| | | | | | | FB-MVII-03 | 630Q5-H 630Q6-B TECH DOC | EACH | \$1,360.00 | 3 | A |
| | | | | | | FB-PC100-00 | PC100 TECH & SV DOC | EACH | \$171.00 | 3 | A |
| | | | | | | FB-PC100-MP | PC100 PRINTSET | EACH | \$830.00 | 3 | A |
| | | | | | | FB-PC278-00 | PC278 TECH & SV DOC | EACH | \$194.00 | 3 | A |
| | | | | | | FB-PC278-MP | DECMATE II MAINT PRINTSET KIT | EACH | \$820.00 | 3 | A |
| | | | | | | FB-PC350-00 | PC350 TECH & SV DOC | EACH | \$80.00 | 3 | A |
| | | | | | | FB-PC350-MP | PC350 PRINT SET KIT | EACH | \$1,200.00 | 3 | A |
| | | | | | | FB-R80-00 | R80 TECH DOCUMENTATION KIT | EACH | \$1,104.00 | 3 | A |
| | | | | | | FB-RA60-00 | RA60 TECH DOCUMENTATION KIT | EACH | \$684.00 | 3 | A |
| | | | | | | FB-RA70-00 | RA70 DOCUMENTATION KIT | EACH | \$318.00 | 3 | A |
| | | | | | | FB-RA80-00 | RA80 DOCUMENTS | EACH | \$1,284.00 | 3 | A |
| | | | | | | FB-RA90-00 | RA90 TECHNICAL DOC KIT | EACH | \$335.00 | 3 | A |
| | | | | | | FB-RB730-00 | RB730 DOCUMENTATION KIT | EACH | \$242.00 | 3 | A |
| | | | | | | FB-RH780-00 | RH780 DOCUMENTATION KIT | EACH | \$805.00 | 3 | A |
| | | | | | | FB-RK07-00 | RK07 DOCUMENTS | EACH | \$1,150.00 | 3 | A |
| | | | | | | FB-RL01-00 | RL01 DOCUMENTATION KIT | EACH | \$580.00 | 3 | A |
| | | | | | | FB-RL02-00 | RL02 DOCUMENTATION KIT | EACH | \$580.00 | 3 | A |
| | | | | | | FB-RL11-00 | RL11 DOC. KIT | EACH | \$430.00 | 3 | A |
| | | | | | | FB-RLV12-00 | RLV12 DOCUMENTS | EACH | \$285.00 | 3 | A |
| | | | | | | FB-RM02-00 | RM02 DOC. KIT | EACH | \$578.00 | 3 | A |
| | | | | | | FB-RM03-00 | RM03 DOCUMENTS | EACH | \$578.00 | 3 | A |
| | | | | | | FB-RM05-00 | RM05 DOCUMENTS | EACH | \$2,075.00 | 3 | A |
| | | | | | | FB-RM80-00 | RM80 DOCUMENTS | EACH | \$150.00 | 3 | A |
| | | | | | | FB-RV20-00 | RV20 TECHNICAL DOCUMNT KIT | EACH | \$1,268.00 | 3 | A |
| | | | | | | FB-RX01-00 | RX01 DOCUMENTATION KIT | EACH | \$765.00 | 3 | A |
| | | | | | | FB-RX02-00 | RX02 DOCUMENTATION KIT | EACH | \$695.00 | 3 | A |
| | | | | | | FB-RX33-00 | RX33 TECH DOCUMENTATION KIT | EACH | \$117.00 | 3 | A |
| | | | | | | FB-RX50-00 | RX50 DOC KIT | EACH | \$235.00 | 3 | A |
| | | | | | | FB-RXV11-00 | RXV11 DOCUMENTS | EACH | \$1,390.00 | 3 | A |
| | | | | | | FB-TA78-00 | TA78 TECH DOCUMENTATION KIT | EACH | \$616.00 | 3 | A |
| | | | | | | FB-TA79-00 | TA79,TU79,TS78 TM78 DOC KIT | EACH | \$1,340.00 | 3 | A |
| | | | | | | FB-TE16-00 | TE16 DOCUMENTS | EACH | \$945.00 | 3 | A |
| | | | | | | FB-TK50-00 | TK50 TECHNICAL DOCUMENTATION | EACH | \$280.00 | 3 | A |
| | | | | | | FB-TK70-00 | TK70 TECH DOC KIT | EACH | \$320.00 | 3 | A |
| | | | | | | FB-TM03-00 | TM03 DOCUMENTS | EACH | \$1,200.00 | 3 | A |
| | | | | | | FB-TM78-00 | TM78 DOCUMENTS | EACH | \$145.00 | 3 | A |
| | | | | | | FB-TS11-00 | TS11 DOCUMENTS | EACH | \$1,550.00 | 3 | A |
| | | | | | | FB-TSV05-00 | TSV05 DOC | EACH | \$465.00 | 3 | A |
| | | | | | | FB-TU58-00 | TU58 DOC. KIT | EACH | \$375.00 | 3 | A |
| FB-00861-00 | 861 A,B,C,D,E DOCUMENTS | EACH | \$175.00 | 3 | A | | | | | | |
| FB-11/44-00 | 11/44 (KD11-Z) CPU/SYSTEM DOC | EACH | \$1,845.00 | 3 | A | | | | | | |
| FB-1134A-00 | 1134A (KD11-EA) CPU/SYSTEM DO | EACH | \$3,376.00 | 3 | A | | | | | | |
| FB-625NT-00 | MVAX 2000 TECH DOCUMENTION | EACH | \$648.00 | 3 | A | | | | | | |
| FB-650QX-00 | MVAX 3500/3600/3602 TECH DOC | EACH | \$1,104.00 | 3 | A | | | | | | |
| FB-BDV11-00 | BDV11 DOCUMENTS | EACH | \$205.00 | 3 | A | | | | | | |
| FB-CI780-00 | CI780 DOCUMENTATION KIT | EACH | \$2,520.00 | 3 | A | | | | | | |
| FB-DLV11-J | DLV11-J DOC | EACH | \$145.00 | 3 | A | | | | | | |
| FB-DMF32-00 | DMF32 DOCUMENTATION KIT | EACH | \$250.00 | 3 | A | | | | | | |
| FB-DR11-C | DR11 C DOCUMENTS | EACH | \$200.00 | 3 | A | | | | | | |
| FB-DR11-W | DR11-W DOC | EACH | \$280.00 | 3 | A | | | | | | |
| FB-DR750-00 | DR750 DOC | EACH | \$613.00 | 3 | A | | | | | | |
| FB-DR780-00 | DR780 DOCUMENTATION KIT | EACH | \$980.00 | 3 | A | | | | | | |
| FB-DTC03-00 | DECTALK DTC03 KIT | EACH | \$404.00 | 3 | A | | | | | | |
| FB-DW780-00 | DW780 DOCUMENTATION | EACH | \$1,260.00 | 3 | A | | | | | | |
| FB-DZ11-A | DZ11-A/B/E DOC | EACH | \$190.00 | 3 | A | | | | | | |
| FB-DZ11-C | DZ11-C/D/F | EACH | \$200.00 | 3 | A | | | | | | |
| FB-DZV11-00 | DZV11 DOCUMENTS | EACH | \$580.00 | 3 | A | | | | | | |
| FB-FP730-00 | FP730 DOCUMENTATION KIT | EACH | \$498.00 | 3 | A | | | | | | |
| FB-FP780-00 | FP780-A DOCUMENTATION | EACH | \$885.00 | 3 | A | | | | | | |
| FB-KA730-00 | KA730 DOCUMENTATION KIT | EACH | \$2,153.00 | 3 | A | | | | | | |
| FB-KA750-00 | VAX-11/750 (KA750) CPU/SYSTEM | EACH | \$1,750.00 | 3 | A | | | | | | |
| FB-KA780-00 | KA780 DOC. KIT | EACH | \$4,609.00 | 3 | A | | | | | | |
| FB-KA785-00 | VAX 11/785 CPU AND SYS | EACH | \$5,200.00 | 3 | A | | | | | | |
| FB-KC750-00 | KC750 DOCUMENTS | EACH | \$60.00 | 3 | A | | | | | | |
| FB-KC780-00 | KC780 DOCUMENTATION | EACH | \$885.00 | 3 | A | | | | | | |
| FB-KE44-A | KE44-A DOC | EACH | \$250.00 | 3 | A | | | | | | |
| FB-KL10-01 | KL10A/B MAINT. PRINTSET KIT | EACH | \$5,000.00 | 3 | A | | | | | | |
| FB-KL10-03 | KL10 -D MAINT PRINTSET KIT | EACH | \$8,000.00 | 3 | A | | | | | | |
| FB-KL10-04 | KL10-E MAINT PRINTSET KIT | EACH | \$8,000.00 | 3 | A | | | | | | |
| FB-KL10-05 | KL10-R MAINT PRINTSET KIT | EACH | \$5,000.00 | 3 | A | | | | | | |
| FB-KT24-00 | KT24 DOCUMENTATION KIT | EACH | REPLACED | 3 | A | MP-01029-00 | | | | | |
| FB-LA100-00 | LA100 DOC | EACH | \$825.00 | 3 | A | | | | | | |
| FB-LA12-00 | LA12 DOCUMENTATION KIT | EACH | \$750.00 | 3 | A | | | | | | |
| FB-LA120-00 | LA120 DOCUMENTS | EACH | \$825.00 | 3 | A | | | | | | |



Prices Effective 02-January-89 to 30-June-89
 To Order—Call DECdirect™ TOLL-FREE 800-344-4825, 8:30 a.m. to 8:00 p.m. ET in Continental U.S.A.

DOCUMENTATION AND DIAGNOSTICS PRICE LIST

| PART NUMBER | DESCRIPTION | UNIT ORDER | UNIT PRICE | REP D L | REPLACEMENT PART NUMBER | PART NUMBER | DESCRIPTION | UNIT ORDER | UNIT PRICE | REP D L | REPLACEMENT PART NUMBER |
|---|-------------------------------|------------|------------|---------|-------------------------|------------------------------------|-------------------------------|------------|------------|---------|-------------------------|
| FB-TU77-00 | TU77 DOCUMENTS | EACH | \$325.00 | 3 A | | MD-PDP11-2L | 2 YR RENEWAL FOR MD-PDP11-L | EACH | \$1,260.00 | 3 A | |
| FB-TU78-00 | TU78 DOCUMENTS | EACH | \$1,500.00 | 3 A | | MD-PDP11-2R | 2 YR RENEWAL FOR MD-PDP11 | EACH | \$2,363.00 | 3 A | |
| FB-TU80-00 | TU80 HARDWARE DOCUMENTATION | EACH | \$390.00 | 3 A | | MD-PDP11-D1 | PDP11 DOC ONLY LIB W 1 YR UPD | EACH | \$1,606.00 | 3 A | |
| FB-TU81-00 | TU81 DOC KIT | EACH | \$1,044.00 | 3 A | | MD-PDP11-D2 | PDP11 DOC ONLY LIB W 2YR UPDS | EACH | \$2,079.00 | 3 A | |
| FB-UDA50-00 | UDA50 DOCUMENTS | EACH | \$460.00 | 3 A | | MD-PDP11-DR | 1 YR RENEWAL FOR MD-PDP11-D | EACH | \$735.00 | 3 A | |
| FB-VAXBI-00 | VAX BI FAMILY TECH DOC KIT | EACH | \$128.00 | 3 A | | MD-PDP11-L1 | PDP11 DIAG LIST LIB W 1YR UPD | EACH | \$1,606.00 | 3 A | |
| FB-VAXBI-01 | VAX 8200/8300 TECH DOC KIT | EACH | \$2,190.00 | 3 A | | MD-PDP11-L2 | PDP11 DIAG LIST LIB W 2YR UPD | EACH | \$2,079.00 | 3 A | |
| FB-VAXBI-02 | VAX 8500/8530/8530 DOC KIT | EACH | \$3,232.00 | 3 A | | MD-PDP11-LR | 1 YR RENEWAL FOR MD-PDP11-L | EACH | \$735.00 | 3 A | |
| FB-VAXBI-03 | VAX 8700/8800 TECH DOC KIT | EACH | \$2,575.00 | 3 A | | MD-PDP11-R | 1 YR RENEWAL FOR MD-PDP11 | EACH | \$1,470.00 | 3 A | |
| FB-VAXBI-04 | VAX 8820/8830/8840 DOC KIT | EACH | \$4,096.00 | 3 A | | MD-PDP8-00 | PDP8 MAINT. DOC./DIAG. LIST. | EACH | \$2,100.00 | 3 A | |
| FB-VAXBI-05 | VAX 6200 TECHNICAL DOC KIT | EACH | \$848.00 | 3 A | | MD-QBUS-01 | QBUS DOC/LIST LIB W 1 YR UPDS | EACH | \$2,268.00 | 3 A | |
| FB-VR150-00 | VR150 DOCUMENTATION KIT | EACH | \$180.00 | 3 A | | MD-QBUS-2D | 2 YR UPD SVC FOR MD-QBUS-D | EACH | \$840.00 | 3 A | |
| FB-VR160-00 | VR160 DOCUMENTATION KIT | EACH | \$204.00 | 3 A | | MD-QBUS-2L | 2 YR UPD SVC FOR MD-QBUS-L | EACH | \$840.00 | 3 A | |
| FB-VR260-00 | VR260 DOC KIT | EACH | \$222.00 | 3 A | | MD-QBUS-2R | 2 YR RENEWAL FOR MD-QBUS | EACH | \$1,680.00 | 3 A | |
| FB-VR290-00 | VR290 DOC KIT | EACH | \$262.00 | 3 A | | MD-QBUS-D1 | QBUS DOC ONLY LIB W 1 YR UPDS | EACH | \$1,134.00 | 3 A | |
| FB-VS300-00 | VAXSTATION 3200/3500 TECH DOC | EACH | \$1,110.00 | 3 A | | MD-QBUS-DR | 1 YR RENEWAL FOR MD-QBUS-D | EACH | \$525.00 | 3 A | |
| FB-VT100-00 | VT100 DOCUMENTS | EACH | \$725.00 | 3 A | | MD-QBUS-L1 | QBUS DIAG LIST ONLY W 1YR UPD | EACH | \$1,134.00 | 3 A | |
| FB-VT101-00 | VT101 DOCUMENTS | EACH | \$820.00 | 3 A | | MD-QBUS-R | 1 YR RENEWAL FOR MD-QBUS | EACH | \$1,050.00 | 3 A | |
| FB-VT102-00 | VT102 DOCUMENTS | EACH | \$70.00 | 3 A | | MD-TRMNL-01 | TERMINALS DOC/DIAG LIB W 1YR | EACH | \$945.00 | 3 A | |
| FB-VT125-00 | VT125 DOCUMENTATION KIT | EACH | \$925.00 | 3 A | | MD-TRMNL-02 | TERMINALS DOC/DIAG LIB W 2YR | EACH | \$1,171.00 | 3 A | |
| FB-VT180-00 | VT180 DOCUMENTATION KIT | EACH | \$42.00 | 3 A | | MD-TRMNL-2R | 2 YR UPD RENEWAL FOR MD-TRMNL | EACH | \$590.00 | 3 A | |
| FB-VT220-00 | VT220 HARDWARE DOCUMENTATION | EACH | \$820.00 | 3 A | | MD-TRMNL-R | 1YR UPD RENEWAL FOR MD-TRMNL | EACH | \$369.00 | 3 A | |
| FB-VT220-UK | VT220 USER DOCUMENTATION KIT | EACH | \$96.00 | 3 A | | MD-VAX-01 | VAX DOC/DIAG LIB W 1 YR UPD | EACH | \$4,536.00 | 3 A | |
| FB-VT240-00 | VT240 HARDWARE DOCUMENTATION | EACH | \$880.00 | 3 A | | MD-VAX-02 | VAX DOC/DIAG LIB W 2 YR UPDS | EACH | \$5,575.00 | 3 A | |
| FB-VT240-UK | VT240 USER DOCUMENTATION KIT | EACH | \$160.00 | 3 A | | MD-VAX-2D | 2 YR RENEWAL FOR MD-VAX -D1 | EACH | \$1,575.00 | 3 A | |
| FB-VT241-00 | VT241 TECH DOCUMENTATION KIT | EACH | \$995.00 | 3 A | | MD-VAX-2L | 2 YR RENEWAL FOR MD-VAX -L1 | EACH | \$1,575.00 | 3 A | |
| FB-VT320-00 | VT320 TECH DOCUMENTATION KIT | EACH | \$525.00 | 3 A | | MD-VAX-2R | 2 YR RENEWAL FOR MD-VAX | EACH | \$3,045.00 | 3 A | |
| FB-VT330-00 | VT330 TECH DOCUMENTATION KIT | EACH | \$453.00 | 3 A | | MD-VAX-D1 | VAX DOC ONLY LIB W 1 YR UPDS | EACH | \$2,268.00 | 3 A | |
| FB-VT340-00 | VT340 TECH DOCUMENTATION | EACH | \$525.00 | 3 A | | MD-VAX-D2 | VAX DOC LIB ONLY W 2 YR UPDS | EACH | \$2,835.00 | 3 A | |
| FB-VT340-UK | VT340 USER DOCUMENTATION KIT | EACH | REPLACED | 3 A | EK-VT3XX-UP | MD-VAX-DR | 1 YR RENEWAL FOR MD-VAX -D | EACH | \$945.00 | 3 A | |
| MD CLASS Maintenance Documentation Service & DEC-O-LOG | | | | | | | | | | | |
| MD-16000-00 | SINGLE UPD FOR MD-LEVAX-00 | EACH | \$228.00 | 3 A | | MD-VAX-L1 | VAX DIAG LIST ONLY W 1 YR UPD | EACH | \$2,268.00 | 3 A | |
| MD-KI10-01 | KAIO/KI10 DOC/DIAG LIB W 1YR | EACH | \$4,725.00 | 3 A | | MD-VAX-L2 | 2AX DIAG LIST ONLY W 2YR UPDS | EACH | \$2,835.00 | 3 A | |
| MD-KL10-01 | KL10 DOC/DIAG LIB W 1YR UPDS | EACH | \$4,725.00 | 3 A | | MD-VAX-LR | 1 YR RENEWAL FOR MD-VAX -L | EACH | \$945.00 | 3 A | |
| MD-KL10-2R | 2 YR. UPD SVC FOR MD-KL10-00 | EACH | \$1,680.00 | 3 A | | MD-VAX-R | 1 YR RENEWAL FOR MD-VAX | EACH | \$1,890.00 | 3 A | |
| MD-KL10-R | 1 YR RENEWAL FOR MD-KL10 | EACH | \$1,050.00 | 3 A | | | | | | | |
| MD-KS10-01 | KS10 DOC/DIAG LIB W 1 YR UPDS | EACH | \$4,725.00 | 3 A | | MP CLASS Maintenance Prints | | | | | |
| MD-KS10-R | 1 YR RENEWAL FOR MD-KS10 | EACH | \$1,050.00 | 3 A | | MP-00004-00 | DR11-M PRINTSET | EACH | \$263.00 | 3 A | |
| MD-LEVAX-02 | LOEND VAX DOC/DIAG LIB W 2YR | EACH | \$3,874.00 | 3 A | | MP-00015-00 | KY11-LB PRINTSET | EACH | \$263.00 | 3 A | |
| MD-LEVAX-2R | 2 YR RENEWAL FOR MD-LEVAX | EACH | \$2,100.00 | 3 A | | MP-00024-00 | RXV11 PRINTSET | EACH | \$1,785.00 | 3 A | |
| MD-LEVAX-O1 | LOEND VAX DOC/DIA LIB W 1 YR | EACH | \$3,213.00 | 3 A | | MP-00035-00 | VT52 PRINTSET | EACH | \$525.00 | 3 A | |
| MD-LEVAX-R | 1 YR RENEWAL FOR MD-LEVAX | EACH | \$1,365.00 | 3 A | | MP-00036-00 | VT50 PRINTSET | EACH | \$525.00 | 3 A | |
| MD-MFDOL-01 | DECOLOG LIB W 1 YR UPD | EACH | \$415.00 | 3 A | | MP-00038-00 | FP11-C PRINTSET | EACH | \$1,050.00 | 3 A | |
| MD-MFDOL-02 | DECOLOG LIB W 2YR UPD SERVICE | EACH | \$332.00 | 3 A | | MP-00044-00 | 11/34 PRINTSET | EACH | \$2,415.00 | 3 A | |
| MD-MFDOL-2R | 2YR RENEWAL FOR MD-MFDOL | EACH | \$462.00 | 3 A | | MP-00048-00 | KW11-K PRINT SET | EACH | \$289.00 | 3 A | |
| MD-MFDOL-R | 1 YR UPD RENEWAL FOR MD-MFDOL | EACH | \$289.00 | 3 A | | MP-00049-00 | KD11-F PRINTSET | EACH | \$289.00 | 3 A | |
| MD-PCKIT-01 | PC'S MAINT DOC W 1 YR UPDS | EACH | \$368.00 | 3 A | | MP-00054-00 | DRV11 PRINTSET | EACH | \$131.00 | 3 A | |
| MD-PCKIT-R | 1 YR RENEWAL FOR MD-PCKIT | EACH | \$210.00 | 3 A | | MP-00055-00 | DLV11 PRINTSET | EACH | \$131.00 | 3 A | |
| MD-PDP11-01 | PDP11 DOC/DIAG LIB W 1 YR UPD | EACH | \$3,213.00 | 3 A | | MP-00067-00 | MSV11-B PRINTSET | EACH | \$131.00 | 3 A | |
| MD-PDP11-02 | PDP11 DOC/DIAG LIB W 2YR UPDS | EACH | \$4,016.00 | 3 A | | MP-00076-00 | DMC11 PRINTSET | EACH | \$1,050.00 | 3 A | |
| MD-PDP11-2D | 2 YR RENEWAL FOR MD-PDP11-D | EACH | \$1,260.00 | 3 A | | MP-00078-00 | TMB11 PRINTSET | EACH | \$814.00 | 3 A | |
| | | | | | | MP-00085-00 | H7440 PRINTSET | EACH | \$75.00 | 3 A | |



Prices Effective 02-January-89 to 30-June-89

To Order—Call DECdirect™ TOLL-FREE 800-344-4825, 8:30 a.m. to 8:00 p.m. ET in Continental U.S.A.

DOCUMENTATION AND DIAGNOSTICS PRICE LIST

| PART NUMBER | DESCRIPTION | UNIT ORDER | UNIT PRICE | REP D L | REPLACEMENT PART NUMBER | PART NUMBER | DESCRIPTION | UNIT ORDER | UNIT PRICE | REP D L | REPLACEMENT PART NUMBER |
|-------------|-------------------------|------------|------------|---------|-------------------------|-------------|-------------------------------|------------|------------|---------|-------------------------|
| MP-00086-00 | RP04/05/06 PRINTSET | EACH | \$1,575.00 | 3 A | | MP-00566-00 | MSV11-D PRINT SET | EACH | \$630.00 | 3 A | |
| MP-00098-00 | VT55 PRINTSET | EACH | \$614.00 | 3 A | | MP-00568-00 | 869-D & E PRINT | EACH | \$184.00 | 3 A | |
| MP-00105-00 | RK611 PRINTSET | EACH | \$1,050.00 | 3 A | | MP-00574-00 | KK11-A PRINTSET | EACH | \$525.00 | 3 A | |
| MP-00106-00 | DL11-W PRINTSET | EACH | REPLACED | 3 A | MP-00968-01 | MP-00576-00 | RK07 PRINTSET | EACH | \$1,313.00 | 3 A | |
| MP-00153-00 | RL11 PRINTSET | EACH | \$525.00 | 3 A | | MP-00577-00 | H9602-D PRINTSET | EACH | \$1,943.00 | 3 A | |
| MP-00160-00 | DRV11-B PRINTSET | EACH | \$200.00 | 3 A | | MP-00586-00 | DLV11-J PRINTSET | EACH | REPLACED | 3 A | MP-00989-01 |
| MP-00177-00 | 8A-0-1 PRINTSET | EACH | \$2,100.00 | 3 A | | MP-00587-00 | H7750 PRINT | EACH | \$184.00 | 3 A | |
| MP-00188-00 | FP11-AU PRINTSET | EACH | \$1,785.00 | 3 A | | MP-00617-00 | M9312 PRINTSET | EACH | \$646.00 | 3 A | |
| MP-00190-00 | 11/34-A PRINTSET | EACH | \$3,203.00 | 3 A | | MP-00626-00 | RX211 PRINTSET | EACH | \$226.00 | 3 A | |
| MP-00192-00 | KD11-EA PRINTSET | EACH | \$814.00 | 3 A | | MP-00628-00 | RXV21 PRINTSET | EACH | \$236.00 | 3 A | |
| MP-00208-00 | MRV11-VA PRINT | EACH | \$131.00 | 3 A | | MP-00629-00 | RX02 PRINTSET | EACH | \$719.00 | 3 A | |
| MP-00271-00 | H7441 MAINTENANCE PRINT | EACH | \$131.00 | 3 A | | MP-00633-00 | VT1C0 PRINTSET | EACH | \$761.00 | 3 A | |
| MP-00274-00 | IBV11-A PRINTSET | EACH | \$200.00 | 3 A | | MP-00642-00 | VT1C5 PRINT | EACH | \$840.00 | 3 A | |
| MP-00276-00 | DD11-K PRINT SET | EACH | \$200.00 | 3 A | | MP-00644-00 | TU77 PRINTSET | EACH | \$158.00 | 3 A | |
| MP-00296-00 | RX01 PRINTSET | EACH | \$814.00 | 3 A | | MP-00660-00 | H96C0 PRINT SET | EACH | \$1,313.00 | 3 A | |
| MP-00311-00 | BA11-K PRINTSET | EACH | \$683.00 | 3 A | | MP-00662-00 | 11V03-L PRINTSET | EACH | \$1,549.00 | 3 A | |
| MP-00318-00 | DT06-A PRINT | EACH | \$53.00 | 3 A | | MP-00663-00 | LA120 PRINTSET | EACH | \$866.00 | 3 A | |
| MP-00322-00 | LS120 PRINTSET | EACH | \$814.00 | 3 A | | MP-00672-00 | MS11-L PRINTSET | EACH | \$630.00 | 3 A | |
| MP-00333-00 | TE16 PRINTSET | EACH | \$1,050.00 | 3 A | | MP-00689-00 | H9602-H PRINT | EACH | \$462.00 | 3 A | |
| MP-00335-00 | H9602-C PRINTSET | EACH | \$79.00 | 3 A | | MP-00693-00 | DR11-W PRINTSET | EACH | \$347.00 | 3 A | |
| MP-00339-00 | KMC11 PRINTSET | EACH | \$1,103.00 | 3 A | | MP-00695-00 | LA34 PRINTSET | EACH | \$788.00 | 3 A | |
| MP-00347-00 | RL01 PRINTSET | EACH | \$446.00 | 3 A | | MP-00698-00 | RL02-AK PRINTSET | EACH | \$630.00 | 3 A | |
| MP-00349-00 | TM03 PRINTSET | EACH | \$1,391.00 | 3 A | | MP-00704-00 | KC7E0-B PRINT | EACH | \$200.00 | 3 A | |
| MP-00350-00 | RM03 PRINTSET | EACH | \$1,260.00 | 3 A | | MP-00706-00 | LS11 -ET PRINT | EACH | \$3,045.00 | 3 A | |
| MP-00356-00 | KPV11 PRINTSET | EACH | \$105.00 | 3 A | | MP-00730-00 | MXV11-A PRINT | EACH | \$273.00 | 3 A | |
| MP-00373-00 | LASXX-AJ PRINT | EACH | \$147.00 | 3 A | | MP-00731-00 | VT103 PRINT | EACH | \$1,050.00 | 3 A | |
| MP-00377-00 | H7111 PRINTSET | EACH | \$210.00 | 3 A | | MP-00734-00 | KDF11-A PRINTSET | EACH | \$173.00 | 3 A | |
| MP-00382-00 | RH11-B PRINTSET | EACH | \$551.00 | 3 A | | MP-00735-00 | KEF11-A PRINT | EACH | \$121.00 | 3 A | |
| MP-00407-00 | H7112 PRINT | EACH | \$168.00 | 3 A | | MP-00740-00 | PDP11/23 PRINTSET | EACH | \$1,575.00 | 3 A | |
| MP-00422-00 | LXY11 PRINT | EACH | \$105.00 | 3 A | | MP-00742-00 | MS11-M PRINTSET | EACH | \$509.00 | 3 A | |
| MP-00425-00 | H334 PRINT | EACH | \$121.00 | 3 A | | MP-00744-00 | KC780-E PRINT | EACH | \$131.00 | 3 A | |
| MP-00452-00 | ISB11 PRINT | EACH | \$751.00 | 3 A | | MP-00747-00 | TU58-C PRINTSET | EACH | \$362.00 | 3 A | |
| MP-00456-00 | RM02 PRINTSET | EACH | \$1,155.00 | 3 A | | MP-00748-00 | VT132 PRINT | EACH | \$630.00 | 3 A | |
| MP-00461-00 | DLV11-F PRINT | EACH | \$226.00 | 3 A | | MP-00754-00 | LA38-GA PRINTSET | EACH | \$893.00 | 3 A | |
| MP-00462-00 | DZV11 PRINTSET | EACH | \$656.00 | 3 A | | MP-00779-00 | H9642-B PRINTSET | EACH | \$173.00 | 3 A | |
| MP-00468-00 | VT78-WA PRINT SET | EACH | \$210.00 | 3 A | | MP-00782-00 | DZ11-X PRINT | EACH | \$1,050.00 | 3 A | |
| MP-00480-00 | H7100 PRINTSET | EACH | \$473.00 | 3 A | | MP-00790-00 | D542X PRINT SET | EACH | \$53.00 | 3 A | |
| MP-00487-00 | BA11-N PRINTSET | EACH | \$893.00 | 3 A | | MP-00809-00 | 11/44 SYS PRINTSET | EACH | \$2,205.00 | 3 A | |
| MP-00489-00 | BDV11-A PRINTSET | EACH | \$226.00 | 3 A | | MP-00810-00 | FP11-F PRINTSET | EACH | \$761.00 | 3 A | |
| MP-00495-00 | KD11-HA PRINTSET | EACH | \$173.00 | 3 A | | MP-00811-00 | KK11B PRINT | EACH | \$289.00 | 3 A | |
| MP-00496-00 | KA780 PRINTSET | EACH | \$3,780.00 | 3 A | | MP-00812-00 | KD11-Z PRINT | EACH | \$840.00 | 3 A | |
| MP-00497-00 | DW780 PRINTSET | EACH | \$1,256.00 | 3 A | | MP-00813-00 | KE44-A PRINTSET | EACH | \$263.00 | 3 A | |
| MP-00498-00 | MS780 PRINTSET | EACH | \$1,523.00 | 3 A | | MP-00823-00 | 1170 PRINTS CA,CB | EACH | \$3,308.00 | 3 A | |
| MP-00499-00 | RH780 PRINTSET | EACH | \$1,123.00 | 3 A | | MP-00826-00 | MA780-A MAINT PRINT | EACH | \$3,150.00 | 3 A | |
| MP-00523-00 | MK11-0 PRINTSET | EACH | \$2,993.00 | 3 A | | MP-00832-00 | BA11-A PRINTSET | EACH | \$893.00 | 3 A | |
| MP-00526-00 | RL11-AK PRINTSET | EACH | \$121.00 | 3 A | | MP-00835-00 | DR78J PRINTSET | EACH | \$1,238.00 | 3 A | |
| MP-00527-00 | RL01-AK PRINTSET | EACH | \$630.00 | 3 A | | MP-00837-00 | H7140 FAM PRNT (AA,AB,B,C,D'S | EACH | \$824.00 | 3 A | |
| MP-00534-00 | KC780 PRINTSET | EACH | \$825.00 | 3 A | | MP-00838-00 | 11/750 PRINTSET | EACH | \$1,088.00 | 3 A | |
| MP-00535-00 | KU780 PRINTSET | EACH | \$341.00 | 3 A | | MP-00840-00 | BA11-V PRINTSET | EACH | \$210.00 | 3 A | |
| MP-00539-00 | 11/780 PRINTSET | EACH | \$4,125.00 | 3 A | | MP-00848-00 | TS04-A-1 PRINT | EACH | \$1,433.00 | 3 A | |
| MP-00542-00 | H9281-BC PRINT | EACH | \$105.00 | 3 A | | MP-00849-00 | TS11-A PRINTSET | EACH | \$1,811.00 | 3 A | |
| MP-00550-00 | RK711-E PRINTSET | EACH | \$53.00 | 3 A | | MP-00856-00 | TS04-A PRINT | EACH | \$189.00 | 3 A | |
| MP-00553-00 | RL02 PRINTSET | EACH | \$473.00 | 3 A | | MP-00857-00 | M8723 PRINTSET | EACH | \$504.00 | 3 A | |
| MP-00556-00 | LAXX-RS PRINT | EACH | \$158.00 | 3 A | | MP-00858-00 | L0011 PRINTSET | EACH | \$341.00 | 3 A | |
| MP-00565-00 | FP780 PRINTSET | EACH | \$825.00 | 3 A | | MP-00859-00 | KDF11-TA PRINT | EACH | \$515.00 | 3 A | |



Prices Effective 02-January-89 to 30-June-89

To Order—Call DECdirect™ TOLL-FREE 800-344-4825, 8:30 a.m. to 8:00 p.m. ET in Continental U.S.A.

DOCUMENTATION AND DIAGNOSTICS PRICE LIST

| PART NUMBER | DESCRIPTION | UNIT ORDER | UNIT PRICE | REP D | L | REPLACEMENT PART NUMBER | PART NUMBER | DESCRIPTION | UNIT ORDER | UNIT PRICE | REP D | L | REPLACEMENT PART NUMBER |
|-------------|----------------------------|------------|------------|-------|---|-------------------------|-------------|----------------------------|------------|------------|-------|---|-------------------------|
| MP-00861-00 | LP14 PRINT | EACH | \$53.00 | 3 | A | | MP-01102-00 | VS11 PRINT SET | EACH | \$893.00 | 3 | A | |
| MP-00863-00 | VT100-X PRINT SET | EACH | \$368.00 | 3 | A | | MP-01111-00 | KMS11-BD MAINTENANCE PRINT | EACH | \$1,785.00 | 3 | A | |
| MP-00864-00 | LP25 PRINTSET | EACH | \$105.00 | 3 | A | | MP-01118-00 | KMC11-B MAINTENANCE PRINT | EACH | \$147.00 | 3 | A | |
| MP-00865-00 | 872 PRINTSET | EACH | \$273.00 | 3 | A | | MP-01121-00 | RT1XX-AC MAINT PRINT | EACH | \$158.00 | 3 | A | |
| MP-00866-00 | DRV11-J PRINT | EACH | \$236.00 | 3 | A | | MP-01157-00 | TSV05 PRINTSET | EACH | \$420.00 | 3 | A | |
| MP-00868-00 | TS11-C PRINTSET | EACH | \$1,664.00 | 3 | A | | MP-01173-00 | KMV11-A PRINT SET | EACH | \$819.00 | 3 | A | |
| MP-00871-00 | MRV11-C PRINT | EACH | \$121.00 | 3 | A | | MP-01186-00 | LP06 PRINT SET | EACH | \$2,048.00 | 3 | A | |
| MP-00885-00 | RL02-CK PRINT | EACH | \$604.00 | 3 | A | | MP-01194-00 | LP27 PRINT | EACH | \$352.00 | 3 | A | |
| MP-00890-00 | H7150 PRINT | EACH | \$252.00 | 3 | A | | MP-01194-01 | LP27 MAINTENANCE PRINTSET | EACH | \$375.00 | 3 | A | |
| MP-00893-00 | VK100 MAINTENANCE PRINT | EACH | \$362.00 | 3 | A | | MP-01196-00 | DRU11 MAINTENANCE PRINTS | EACH | \$263.00 | 3 | A | |
| MP-00894-00 | VT101 PRINT | EACH | REPLACED | 3 | A | MP-01066-00 | MP-01197-00 | LXY12 PRINT | EACH | \$452.00 | 3 | A | |
| MP-00897-00 | 11X44 PRINTSET | EACH | \$3,465.00 | 3 | A | | MP-01213-00 | KC750-H MAINTENANCE PRINT | EACH | \$553.00 | 3 | A | |
| MP-00901-00 | VT1XX-AC PRINT | EACH | \$158.00 | 3 | A | | MP-01224-00 | KBD01-A MAINTENANCE PRINT | EACH | \$698.00 | 3 | A | |
| MP-00905-00 | RL211-AK PRINT | EACH | \$53.00 | 3 | A | | MP-01226-00 | KBD01-B MAINTENANCE PRINT | EACH | \$735.00 | 3 | A | |
| MP-00911-00 | DMR11 PRINTSET | EACH | \$788.00 | 3 | A | | MP-01233-00 | BA11-S PRINTSET | EACH | \$735.00 | 3 | A | |
| MP-00919-00 | DPV11-D PRINTSET | EACH | REPLACED | 3 | A | MP-00992-00 | MP-01234-00 | 11/23-B PRINTSET | EACH | \$131.00 | 3 | A | |
| MP-00920-00 | DF03-AA MAINTENANCE PRINT | EACH | \$389.00 | 3 | A | | MP-01235-00 | 11T23-B PRINTSET | EACH | \$299.00 | 3 | A | |
| MP-00941-00 | DZ32 PRINTSET | EACH | \$672.00 | 3 | A | | MP-01236-00 | KDF11-B PRINTSET | EACH | \$226.00 | 3 | A | |
| MP-00942-00 | DMV11 MAINTENANCE PRINT | EACH | \$751.00 | 3 | A | | MP-01238-00 | MSV11-L MAINTENANCE PRINT | EACH | \$362.00 | 3 | A | |
| MP-00946-00 | H7224 MAINTENANCE PRINT | EACH | \$362.00 | 3 | A | | MP-01239-00 | MSV11-P PRINTSET | EACH | \$525.00 | 3 | A | |
| MP-00965-00 | DMF32 MAINTENANCE PRINT | EACH | \$158.00 | 3 | A | | MP-01258-00 | 11751 PRINTSET | EACH | \$982.00 | 3 | A | |
| MP-00968-01 | DL11-W PRINTSET | EACH | \$173.00 | 3 | A | | MP-01259-00 | H9602-M PRINT SET | EACH | \$2,258.00 | 3 | A | |
| MP-00970-01 | DZ11-M MAINTENANCE PRINT | EACH | \$147.00 | 3 | A | | MP-01262-00 | TWU78 PRINT SET | EACH | \$158.00 | 3 | A | |
| MP-00970-02 | DZ11-N MAINTENANCE PRINT | EACH | \$158.00 | 3 | A | | MP-01267-00 | CI780 PRINT SET | EACH | \$2,415.00 | 3 | A | |
| MP-00980-01 | DH11 PRINTSET | EACH | \$158.00 | 3 | A | | MP-01268-00 | KU750 PRINTSET | EACH | \$236.00 | 3 | A | |
| MP-00982-01 | DUP11 PRINTSET | EACH | \$168.00 | 3 | A | | MP-01269-00 | FP750 PRINTSET | EACH | \$488.00 | 3 | A | |
| MP-00983-01 | CK-DUP11 PRINT SET | EACH | \$263.00 | 3 | A | | MP-01270-00 | 11/730-Z PRINTSET | EACH | \$1,803.00 | 3 | A | |
| MP-00984-01 | DV11 PRINT | EACH | \$184.00 | 3 | A | | MP-01271-00 | DMF32 PRINTSET | EACH | REPLACED | 3 | A | MP-00965-00 |
| MP-00987-01 | DLVE1 PRINTSET | EACH | \$200.00 | 3 | A | | MP-01274-00 | DW750 MAINTENANCE PRINT | EACH | \$200.00 | 3 | A | |
| MP-00989-01 | DLV11-J PRINTSET | EACH | \$168.00 | 3 | A | | MP-01277-00 | PKG SYSTEM 1 | EACH | \$1,470.00 | 3 | A | |
| MP-00992-01 | DPV11 PRINTSET | EACH | \$147.00 | 3 | A | | MP-01278-00 | RB730 PRINTSET | EACH | \$263.00 | 3 | A | |
| MP-00997-01 | DMZ32 PRINT SET | EACH | \$2,625.00 | 3 | A | | MP-01282-00 | RLV12 PRINTSET | EACH | \$352.00 | 3 | A | |
| MP-01003-01 | DFM PRINT SET | EACH | \$315.00 | 3 | A | | MP-01283-00 | RLV22 MAINTENANCE PRINT | EACH | \$389.00 | 3 | A | |
| MP-01014-00 | TU58-E PRINT | EACH | \$415.00 | 3 | A | | MP-01285-00 | FPF11 MAINTENANCE PRINT | EACH | \$751.00 | 3 | A | |
| MP-01016-00 | 874 PRINTSET | EACH | \$263.00 | 3 | A | | MP-01291-00 | AXV11-C MAINTENANCE PRINT | EACH | \$121.00 | 3 | A | |
| MP-01018-00 | 11/24 PRINTSET | EACH | \$2,153.00 | 3 | A | | MP-01292-00 | ADV11-C MAINTENANCE PRINT | EACH | \$79.00 | 3 | A | |
| MP-01020-00 | H7104-C PRINTSET | EACH | \$672.00 | 3 | A | | MP-01293-00 | KWV11-C MAINTENANCE PRINT | EACH | \$95.00 | 3 | A | |
| MP-01021-00 | H7140-D MAINT PRINT | EACH | \$578.00 | 3 | A | | MP-01294-00 | AAV11-C MAINTENANCE PRINT | EACH | \$121.00 | 3 | A | |
| MP-01022-00 | 875 PRINTSET | EACH | \$436.00 | 3 | A | | MP-01309-00 | MCV11-D PRINTSET | EACH | \$273.00 | 3 | A | |
| MP-01024-00 | KA750 PRINTSET | EACH | \$1,248.00 | 3 | A | | MP-01317-00 | 11E23-B PRINTSET | EACH | \$289.00 | 3 | A | |
| MP-01028-00 | KDF11 (11/24) MAINT. PRINT | EACH | \$436.00 | 3 | A | | MP-01323-00 | KXT11 PRINTSET | EACH | \$378.00 | 3 | A | |
| MP-01029-00 | KT24 PRINTSET | EACH | \$263.00 | 3 | A | | MP-01328-00 | VT3CX MAINTENANCE PRINT | EACH | \$95.00 | 3 | A | |
| MP-01044-00 | TGU78 MAINTENANCE PRINT | EACH | \$252.00 | 3 | A | | MP-01331-00 | UD450 PRINT SET | EACH | \$499.00 | 3 | A | |
| MP-01045-00 | RH 750 PRINTSET | EACH | \$515.00 | 3 | A | | MP-01332-00 | RL02-FK PRINTSET | EACH | \$1,339.00 | 3 | A | |
| MP-01046-00 | LA120-RA PRINTSET | EACH | \$672.00 | 3 | A | | MP-01339-00 | 11V23-B PRINTSET | EACH | \$273.00 | 3 | A | |
| MP-01052-00 | VT1XX-C MAINTENANCE PRINT | EACH | \$378.00 | 3 | A | | MP-01349-00 | KDF11-C MAINTENANCE PRINT | EACH | \$362.00 | 3 | A | |
| MP-01053-00 | VT125 PRINTSET | EACH | \$1,103.00 | 3 | A | | MP-01357-00 | LA12 PRINTSET | EACH | \$887.00 | 3 | A | |
| MP-01061-00 | TU78 PRINTSET | EACH | \$1,706.00 | 3 | A | | MP-01359-00 | RA81 MAINTENANCE PRINT | EACH | \$751.00 | 3 | A | |
| MP-01063-00 | TU58-DA PRINT | EACH | \$121.00 | 3 | A | | MP-01363-00 | DR750 PRINTSET | EACH | \$767.00 | 3 | A | |
| MP-01064-00 | KBD01 MAINTENANCE PRINT | EACH | \$578.00 | 3 | A | | MP-01364-00 | FP730 PRINTSET | EACH | \$439.00 | 3 | A | |
| MP-01065-00 | DYT01 MAINTENANCE PRINT | EACH | \$499.00 | 3 | A | | MP-01365-00 | PKG SYSTEM 2 | EACH | \$399.00 | 3 | A | |
| MP-01066-00 | VT101 PRINTSET | EACH | \$840.00 | 3 | A | | MP-01366-00 | MS730 PRINTSET | EACH | \$404.00 | 3 | A | |
| MP-01068-00 | H7837 MAINTENANCE PRINT | EACH | \$147.00 | 3 | A | | MP-01369-00 | H4000 MAINTENANCE PRINT | EACH | \$200.00 | 3 | A | |
| MP-01075-00 | RM05 PRINTSET | EACH | \$2,520.00 | 3 | A | | MP-01370-00 | SC008 PRINT SET | EACH | \$378.00 | 3 | A | |
| MP-01096-00 | LA100 PRINT SET | EACH | \$998.00 | 3 | A | | MP-01372-00 | MS780-E PRINTSET | EACH | \$1,554.00 | 3 | A | |



Prices Effective 02-January-89 to 30-June-89

To Order—Call DECdirect™ TOLL-FREE 800-344-4825, 8:30 a.m. to 8:00 p.m. ET in Continental U.S.A.

DOCUMENTATION AND DIAGNOSTICS PRICE LIST

| PART NUMBER | DESCRIPTION | UNIT ORDER | UNIT PRICE | REP D | L | REPLACEMENT PART NUMBER | PART NUMBER | DESCRIPTION | UNIT ORDER | UNIT PRICE | REP D | L | REPLACEMENT PART NUMBER |
|-------------|----------------------------|------------|------------|-------|---|-------------------------|-------------|-------------------------------|------------|------------|-------|---|-------------------------|
| MP-01373-00 | 11780-F PRINTSET | EACH | \$735.00 | 3 | A | | MP-01633-01 | PC1XXA MAINTENANCE PRINTS | EACH | \$147.00 | 3 | A | |
| MP-01374-00 | MA780-J MAINTENANCE PRINTS | EACH | \$410.00 | 3 | A | | MP-01634-01 | LN01 PRINTSET | EACH | \$173.00 | 3 | A | |
| MP-01376-00 | H9652-M PRINT SET | EACH | \$53.00 | 3 | A | | MP-01636-01 | PC1XX-BB MAINTENANCE PRINTS | EACH | \$158.00 | 3 | A | |
| MP-01377-00 | 11750-F PRINTSET | EACH | \$499.00 | 3 | A | | MP-01643-01 | PC325-UG MAINTENANCE PRINTS | EACH | \$368.00 | 3 | A | |
| MP-01378-00 | DEUNA MAINTENANCE PRINTS | EACH | \$1,092.00 | 3 | A | | MP-01649-01 | 11A23 PRINT | EACH | \$1,208.00 | 3 | A | |
| MP-01379-00 | KC780-F PRINTSET | EACH | \$956.00 | 3 | A | | MP-01650-01 | 11C23 PRINT | EACH | \$1,050.00 | 3 | A | |
| MP-01380-00 | MA780-K MAINTENANCE PRINTS | EACH | \$173.00 | 3 | A | | MP-01651-01 | BA23-A PRINT SET | EACH | \$60.00 | 3 | A | |
| MP-01383-00 | RH780-F MAINTENANCE PRINTS | EACH | \$1,470.00 | 3 | A | | MP-01652-01 | SX-RA500 (MICRO/PDP11) PRINTS | EACH | \$1,024.00 | 3 | A | |
| MP-01384-00 | 782UP-5 MAINTENANCE PRINTS | EACH | \$184.00 | 3 | A | | MP-01656-01 | DELNI PRINTSET | EACH | \$250.00 | 3 | A | |
| MP-01385-00 | DECSA PRINT SET | EACH | \$3,019.00 | 3 | A | | MP-01657-00 | RCD50-AA MAINTENANCE PRINTS | EACH | \$509.00 | 3 | A | |
| MP-01386-00 | H9642-F | EACH | \$263.00 | 3 | A | | MP-01707-01 | LG01 PRINTSET | EACH | \$228.00 | 3 | A | |
| MP-01388-00 | RH750-F MAINTENANCE PRINTS | EACH | \$551.00 | 3 | A | | MP-01708-00 | KL10-R PRINT SET | EACH | \$1,103.00 | 3 | A | |
| MP-01389-00 | DR750-F MAINTENANCE PRINTS | EACH | \$971.00 | 3 | A | | MP-01713-00 | PCXX-AA PRINT SET | EACH | \$184.00 | 3 | A | |
| MP-01392-00 | VAX-11/730-A MAINT. PRINTS | EACH | \$1,244.00 | 3 | A | | MP-01714-01 | VAX 8600 PRINT SET | EACH | \$6,615.00 | 3 | A | |
| MP-01394-00 | PC350 PRINTSET | EACH | \$945.00 | 3 | A | | MP-01718-01 | RCD50-A MAINTENANCE PRINTS | EACH | \$473.00 | 3 | A | |
| MP-01395-00 | LK201-A-1 PRINTSET | EACH | \$158.00 | 3 | A | | MP-01719-01 | RCD51-AA MAINTENANCE PRINTS | EACH | \$483.00 | 3 | A | |
| MP-01398-00 | M8750 PRINTSET | EACH | \$462.00 | 3 | A | | MP-01722-01 | PC100-B PRINT SET | EACH | \$263.00 | 3 | A | |
| MP-01404-00 | L0016 PRINTSET | EACH | \$630.00 | 3 | A | | MP-01727-01 | RCD51-C MAINTENANCE PRINTS | EACH | \$399.00 | 3 | A | |
| MP-01406-00 | LP32 PRINT | EACH | \$173.00 | 3 | A | | MP-01731-01 | RQDX1 MAINTENANCE PRINTS | EACH | \$252.00 | 3 | A | |
| MP-01410-00 | VR201 PRINTSET | EACH | \$184.00 | 3 | A | | MP-01732-01 | VT220 MAINTENANCE PRINTS | EACH | \$824.00 | 3 | A | |
| MP-01414-00 | H7842-A PRINT SET | EACH | \$68.00 | 3 | A | | MP-01740-01 | 874-F | EACH | \$263.00 | 3 | A | |
| MP-01416-00 | RCD50 MAINTENANCE PRINT | EACH | \$121.00 | 3 | A | | MP-01743-00 | H9642-E MAINTENANCE PRINTS | EACH | \$394.00 | 3 | A | |
| MP-01418-00 | RCD50-A MAINTENANCE PRINT | EACH | \$289.00 | 3 | A | | MP-01744-00 | KA730-A MAINTENANCE PRINTS | EACH | \$908.00 | 3 | A | |
| MP-01419-00 | R80 PRINTSET | EACH | \$1,323.00 | 3 | A | | MP-01745-00 | 11730-C PRINTSET | EACH | \$1,801.00 | 3 | A | |
| MP-01420-00 | RA80 PRINT SET | EACH | \$1,365.00 | 3 | A | | MP-01747-00 | VAX-11/785 PRINT | EACH | \$1,769.00 | 3 | A | |
| MP-01421-00 | RA60 PRINT | EACH | \$772.00 | 3 | A | | MP-01748-00 | 11785 CONSOLE MAINT PRINT SET | EACH | \$562.00 | 3 | A | |
| MP-01422-00 | HSC50 PRINT SET | EACH | \$2,982.00 | 3 | A | | MP-01749-00 | 11785 CPU MAINT PRINT SET | EACH | \$4,279.00 | 3 | A | |
| MP-01424-00 | SA600-X (RA90) PRINTSET | EACH | \$418.00 | 3 | A | | MP-01754-00 | FP785 PRINT SET | EACH | \$1,260.00 | 3 | A | |
| MP-01426-00 | HSC70 PRINTSET | EACH | \$2,512.00 | 3 | A | | MP-01759-01 | MS780-H PRINTSET | EACH | \$960.00 | 3 | A | |
| MP-01427-00 | RA82 PRINTSET | EACH | \$1,950.00 | 3 | A | | MP-01761-01 | DSRVA/DEC SERVER 100 PRINT | EACH | \$315.00 | 3 | A | |
| MP-01428-01 | RA70 PRINTSET | EACH | \$358.00 | 3 | A | | MP-01762-01 | H7204-B PRINTSET | EACH | \$855.00 | 3 | A | |
| MP-01469-00 | MXV11-B MAINTENANCE PRINT | EACH | \$173.00 | 3 | A | | MP-01778-00 | H7231 PRINTSET | EACH | \$1,344.00 | 3 | A | |
| MP-01470-00 | VC201-A MAINTENANCE PRINT | EACH | \$299.00 | 3 | A | | MP-01786-01 | VAX 8200 PRINTSET | EACH | \$1,200.00 | 3 | A | |
| MP-01471-00 | VC241-A MAINTENANCE PRINT | EACH | \$131.00 | 3 | A | | MP-01787-01 | DELUA PRINT SET | EACH | \$158.00 | 3 | A | |
| MP-01473-00 | KEF11-C MAINTENANCE PRINT | EACH | \$53.00 | 3 | A | | MP-01788-01 | VAX 8700/8800 PRINTSET | EACH | \$3,000.00 | 3 | A | |
| MP-01477-00 | MS11-P PRINTSET | EACH | \$273.00 | 3 | A | | MP-01791-01 | VAX 8300 PRINTSET | EACH | \$1,380.00 | 3 | A | |
| MP-01482-00 | RX50-AA PRINTSET | EACH | \$289.00 | 3 | A | | MP-01793-00 | DHV11 PRINT SET | EACH | REPLACED | 3 | A | MP-01793-01 |
| MP-01491-00 | PC100 PRINTSET | EACH | \$200.00 | 3 | A | | MP-01793-01 | DHV11 PRINTSET | EACH | \$465.00 | 3 | A | |
| MP-01492-00 | PC 278 PRINTSET | EACH | \$441.00 | 3 | A | | MP-01794-00 | DHU11 PRINT SET | EACH | REPLACED | 3 | A | MP-01794-01 |
| MP-01504-00 | TSU05 PRINT SET | EACH | \$263.00 | 3 | A | | MP-01794-01 | DHU11 PRINTSET | EACH | \$263.00 | 3 | A | |
| MP-01551-00 | RT1XX-AF PRINT SET | EACH | \$79.00 | 3 | A | | MP-01795-00 | DZ011 PRINT SET | EACH | REPLACED | 3 | A | MP-01795-01 |
| MP-01556-00 | RT102-HA PRINT SET | EACH | \$53.00 | 3 | A | | MP-01795-01 | DZ011-M PRINTSET | EACH | \$440.00 | 3 | A | |
| MP-01561-01 | DT07 PRINT SET | EACH | \$2,783.00 | 3 | A | | MP-01807-01 | VT240 MAINTENANCE PRINTS | EACH | \$772.00 | 3 | A | |
| MP-01570-01 | PCL11 PRINT SET | EACH | \$788.00 | 3 | A | | MP-01811-01 | CK DEQNA PRINT SET | EACH | \$158.00 | 3 | A | |
| MP-01582-01 | DRV11-WA PRINT SET | EACH | \$100.00 | 3 | A | | MP-01820-01 | DTC01 PRINT SET | EACH | \$131.00 | 3 | A | |
| MP-01587-01 | LCP01 MAINTENANCE PRINTSET | EACH | \$558.00 | 3 | A | | MP-01827-01 | DSRVB PRINTSET | EACH | \$788.00 | 3 | A | |
| MP-01597-00 | VS240 PRINT | EACH | \$200.00 | 3 | A | | MP-01829-01 | VAX 8500 PRINTSET | EACH | \$3,815.00 | 3 | A | |
| MP-01598-00 | 877 PRINTSET | EACH | \$189.00 | 3 | A | | MP-01836-01 | CIBCA MAINTENANCE PRINTSET | EACH | \$1,085.00 | 3 | A | |
| MP-01602-00 | MRV11-D MAINTENANCE PRINTS | EACH | \$289.00 | 3 | A | | MP-01837-01 | VAX 8820/8830/8840 PRINTSET | EACH | \$2,000.00 | 3 | A | |
| MP-01603-01 | TU80 PRINTSET | EACH | \$263.00 | 3 | A | | MP-01848-01 | VAX 6200 MAINTENANCE PRINTSET | EACH | \$900.00 | 3 | A | |
| MP-01612-00 | RC25 PRINT SET | EACH | \$1,003.00 | 3 | A | | MP-01885-00 | DEQNA PRINT SET | EACH | REPLACED | 3 | A | MP-01885-01 |
| MP-01614-00 | TA78 PRINT SET | EACH | \$550.00 | 3 | A | | MP-01885-01 | DEQNA PRINTSET | EACH | \$850.00 | 3 | A | |
| MP-01616-00 | PC325 MAINTENANCE PRINTS | EACH | REPLACED | 3 | A | MP-01616-01 | MP-01890-01 | KDJ11 PRINT SET | EACH | \$184.00 | 3 | A | |
| MP-01616-01 | PC325 MAINTENANCE PRINTS | EACH | \$893.00 | 3 | A | | MP-01893-01 | VR241 PRINT SET | EACH | \$173.00 | 3 | A | |
| MP-01618-00 | TU81 PRINT SET | EACH | \$1,208.00 | 3 | A | | MP-01895-00 | DECNA PRINT SET | EACH | \$173.00 | 3 | A | |



Prices Effective 02-January-89 to 30-June-89

To Order—Call DECdirect™ TOLL-FREE 800-344-4825, 8:30 a.m. to 8:00 p.m. ET in Continental U.S.A.

DOCUMENTATION AND DIAGNOSTICS PRICE LIST

| PART NUMBER | DESCRIPTION | UNIT ORDER | UNIT PRICE | REP D | L | REPLACEMENT PART NUMBER | PART NUMBER | DESCRIPTION | UNIT ORDER | UNIT PRICE | REP D | L | REPLACEMENT PART NUMBER |
|-------------|-------------------------------|------------|------------|-------|---|-------------------------|------------------------------|----------------------------|------------|------------|-------|---|-------------------------|
| MP-01903-01 | C120-AA PRINTSET | EACH | \$2,639.00 | 3 | A | | MP-02509-01 | VT320 PRINTSET | EACH | \$468.00 | 3 | A | |
| MP-01922-01 | PC380 PRINT SET | EACH | \$788.00 | 3 | A | | MP-02511-01 | H7868 | EACH | \$171.00 | 3 | A | |
| MP-01929-00 | RD52-O PRINT SET | EACH | \$200.00 | 3 | A | | MP-02536-01 | PDP1184D PRINTSET | EACH | \$1,511.00 | 3 | A | |
| MP-01955-01 | PDP11/84E PRINTSET | EACH | \$1,250.00 | 3 | A | | MP-02538-01 | MVAX 3000 BA213 PRINTSET | EACH | \$375.00 | 3 | A | |
| MP-01962-00 | RD52-D PRINT SET | EACH | \$263.00 | 3 | A | | MP-02539-01 | MV 3000 CABINET PRINTSET | EACH | \$375.00 | 3 | A | |
| MP-01969-01 | KDJ11-B PRINT SET | EACH | \$263.00 | 3 | A | | MP-02544-01 | VR150 MAINTENANCE PRINTSET | EACH | \$165.00 | 3 | A | |
| MP-01970-01 | VC241-B PRINT SET | EACH | \$462.00 | 3 | A | | MP-02595-01 | VR160 MAINTENANCE PRINT | EACH | \$195.00 | 3 | A | |
| MP-01984-01 | NIA20-AA PRINTSET | EACH | \$2,080.00 | 3 | A | | MP-ADC8-00 | ADC8 PRINT | EACH | \$184.00 | 3 | A | |
| MP-02002-01 | VR241 PRNT W/LK201 & VS240 | EACH | \$1,103.00 | 3 | A | | MP-BA11-M | BA11-M PRINT SET | EACH | \$53.00 | 3 | A | |
| MP-02004-01 | VR260 MONITOR PRINT SET | EACH | \$263.00 | 3 | A | | MP-CR11-00 | CR11 PRINTSET | EACH | \$273.00 | 3 | A | |
| MP-02007-01 | LA210 PRINT SET | EACH | \$263.00 | 3 | A | | MP-CR8-E | CR8-E PRINT | EACH | \$121.00 | 3 | A | |
| MP-02011-01 | 11/84 PRINT SET | EACH | \$1,469.00 | 3 | A | | MP-DD11-C | DD11-C PRINTSET | EACH | \$273.00 | 3 | A | |
| MP-02015-01 | PDP11/84-PA,PB,PC,PD PRINTSET | EACH | \$1,399.00 | 3 | A | | MP-DD11-D | DD11-D PRINTSET | EACH | \$709.00 | 3 | A | |
| MP-02027-01 | TA81 PRINTSET | EACH | \$1,242.00 | 3 | A | | MP-DR11-C | DR11-C PRINTSET | EACH | \$184.00 | 3 | A | |
| MP-02028-01 | MICROVAX II BA23 RACK-MOUNT P | EACH | \$1,103.00 | 3 | A | | MP-DR11-K | DR11-K PRINTSET | EACH | \$147.00 | 3 | A | |
| MP-02054-01 | TK50 PRINT SET | EACH | \$263.00 | 3 | A | | MP-DUP11-00 | DUP11 PRINTSET | EACH | REPLACED | 3 | A | MP-00982-01 |
| MP-02055-01 | M7546 PRINT SET | EACH | \$473.00 | 3 | A | | MP-DV11-00 | DV11 PRINTSET | EACH | REPLACED | 3 | A | MP-00984-01 |
| MP-02060-00 | TU81E PLUS PRINTSET | EACH | REPLACED | 3 | A | MP-02060-01 | MP-H7102-00 | H7102 MAINTENANCE PRINTS | EACH | \$53.00 | 3 | A | |
| MP-02060-01 | TU81E PLUS PRINTSET | EACH | \$1,208.00 | 3 | A | | MP-H7103-00 | H7103 MAINTENANCE PRINTS | EACH | \$53.00 | 3 | A | |
| MP-02065-01 | MICROVAX II BA23 PEDESTAL PRI | EACH | \$1,103.00 | 3 | A | | MP-H720-00 | H720 PRINTSET | EACH | \$499.00 | 3 | A | |
| MP-02071-01 | MICROVAX II BA123 PEDESTAL PR | EACH | \$1,103.00 | 3 | A | | MP-H742-00 | H742 PRINT SET | EACH | \$50.00 | 3 | A | |
| MP-02083-01 | VCBO2 PRINTSET | EACH | \$513.00 | 3 | A | | MP-H9270-00 | H9270 PRINT | EACH | \$121.00 | 3 | A | |
| MP-02090-01 | DESTA PRINTSET | EACH | \$60.00 | 3 | A | | MP-KB11-C | KB11-C PRINTSET | EACH | \$2,126.00 | 3 | A | |
| MP-02198-01 | PDP11/84-AA,AB,BA,BB,CA,CB | EACH | \$1,433.00 | 3 | A | | MP-KG11-A | KG11-A PRINTSET | EACH | \$105.00 | 3 | A | |
| MP-02199-01 | PDP11X84-AA,AB,BA,BB,CA,CB | EACH | \$1,300.00 | 3 | A | | MP-LA180-00 | LA180 PRINTSET | EACH | \$383.00 | 3 | A | |
| MP-02208-01 | 11/83 PRINT SET | EACH | \$525.00 | 3 | A | | MP-LA36-00 | LA36 PRINTSET | EACH | \$399.00 | 3 | A | |
| MP-02219-01 | MV11 CABINET SYS. PRINT | EACH | \$499.00 | 3 | A | | MP-LC11-00 | LC11 PRINT | EACH | \$121.00 | 3 | A | |
| MP-02252-01 | PC500 PRINT SET | EACH | \$824.00 | 3 | A | | MP-LP05-00 | LP05 PRINTSET | EACH | \$105.00 | 3 | A | |
| MP-02259-00 | RQDX3 PRINT SET | EACH | REPLACED | 3 | A | MP-02259-01 | MP-LP11-00 | LP11 PRINTSET | EACH | \$252.00 | 3 | A | |
| MP-02259-01 | RQDX3 PRINTSET | EACH | \$585.00 | 3 | A | | MP-LS11-00 | LS11 PRINT | EACH | \$158.00 | 3 | A | |
| MP-02270-01 | DTC03-AA PRINT SET | EACH | \$420.00 | 3 | A | | MP-M7258-00 | M7258 PRINT | EACH | \$53.00 | 3 | A | |
| MP-02273-01 | LPS40 PRINTSET | EACH | \$2,790.00 | 3 | A | | MP-M7800-00 | M7800 PRINT | EACH | \$131.00 | 3 | A | |
| MP-02279-01 | RX33 PRINT SET | EACH | \$86.00 | 3 | A | | MP-M7940-00 | M7940 PRINT SET | EACH | \$53.00 | 3 | A | |
| MP-02289-01 | TA79,TU79,TS78,TM78 PRINT | EACH | \$1,395.00 | 3 | A | | MP-M9202-00 | M9202 PRINT | EACH | \$53.00 | 3 | A | |
| MP-02293-01 | RV20 MAINTENANCE PRINTSET | EACH | \$1,485.00 | 3 | A | | MP-M9302-00 | M9302 PRINTSET | EACH | \$53.00 | 3 | A | |
| MP-02294-01 | TK70 PRINTSET | EACH | \$300.00 | 3 | A | | MP-N0861-00 | 861 PRINTSET | EACH | \$147.00 | 3 | A | |
| MP-02358-01 | DEMPR PRINTSET | EACH | \$279.00 | 3 | A | | MP-N0861-D | 861-D MAINTENANCE PRINT | EACH | \$105.00 | 3 | A | |
| MP-02362-00 | VR290 PRINTSET | EACH | \$263.00 | 3 | A | | MP-N0866-D | 866-D PRINTSET | EACH | \$121.00 | 3 | A | |
| MP-02375-01 | RCD31 PRINT SET | EACH | \$252.00 | 3 | A | | MP-RH11-00 | RH11 PRINTSET | EACH | \$683.00 | 3 | A | |
| MP-02379-00 | DELQA PRINTSET | EACH | REPLACED | 3 | A | MP-02379-01 | MP-RH70-00 | RH70 PRINTSET | EACH | \$662.00 | 3 | A | |
| MP-02379-01 | DELQA PRINTSET | EACH | \$715.00 | 3 | A | | MP-RM03-C | RM03-C PRINT | EACH | \$105.00 | 3 | A | |
| MP-02380-00 | DHQ11 PRINTSET | EACH | \$450.00 | 3 | A | | MP-RPP11-00 | RPP11 PRINT | EACH | \$158.00 | 3 | A | |
| MP-02381-01 | CXA/CXB16 MAINTENANCE PRNTSET | EACH | \$100.00 | 3 | A | | MP-RX11-00 | RX11 PRINTSET | EACH | \$131.00 | 3 | A | |
| MP-02389-01 | H7848-B PRINT SET | EACH | \$153.00 | 3 | A | | MP-TU10-00 | TU10 PRINTSET | EACH | \$1,003.00 | 3 | A | |
| MP-02391-01 | RD32-F | EACH | \$270.00 | 3 | A | | MP-TU55-00 | TU55 PRINT | EACH | \$147.00 | 3 | A | |
| MP-02392-01 | RD53-F PRINT SET | EACH | \$333.00 | 3 | A | | | | | | | | |
| MP-02393-01 | RD54-F | EACH | \$270.00 | 3 | A | | | | | | | | |
| MP-02394-01 | TK50Z PRINT SET | EACH | \$810.00 | 3 | A | | | | | | | | |
| MP-02399-01 | DH625NT PRINT SET | EACH | \$558.00 | 3 | A | | | | | | | | |
| MP-02400-01 | VS450 PRINT SET | EACH | \$1,365.00 | 3 | A | | | | | | | | |
| MP-02411-01 | VT330 PRINTSET | EACH | \$486.00 | 3 | A | | | | | | | | |
| MP-02412-01 | VT340 PRINTSET | EACH | \$576.00 | 3 | A | | | | | | | | |
| MP-02414-01 | VS410 PRINTSET | EACH | \$462.00 | 3 | A | | | | | | | | |
| MP-02431-01 | DESVA PRINTSET | EACH | \$136.00 | 3 | A | | | | | | | | |
| MP-02458-01 | LP29 PRINTSET | EACH | \$666.00 | 3 | A | | | | | | | | |
| | | | | | | | QA CLASS and QL CLASS | | | | | | |
| | | | | | | | QA-VI5AA-H5 | REMS TK50 | EACH | \$510.00 | | U | B |
| | | | | | | | QA-VI5AA-H7 | REMS RX33 | EACH | \$510.00 | | U | B |
| | | | | | | | QA-VI5AA-HM | REMS 16MT9 | EACH | \$510.00 | | U | B |
| | | | | | | | QL-VI5A9-AA | REMS, LICENSE ONLY | EACH | \$3,000.00 | | U | B |



Prices Effective 02-January-89 to 30-June-89

To Order—Call DECdirect™ TOLL-FREE 800-344-4825, 8:30 a.m. to 8:00 p.m. ET in Continental U.S.A.

Part C
DECmailer Repair Services

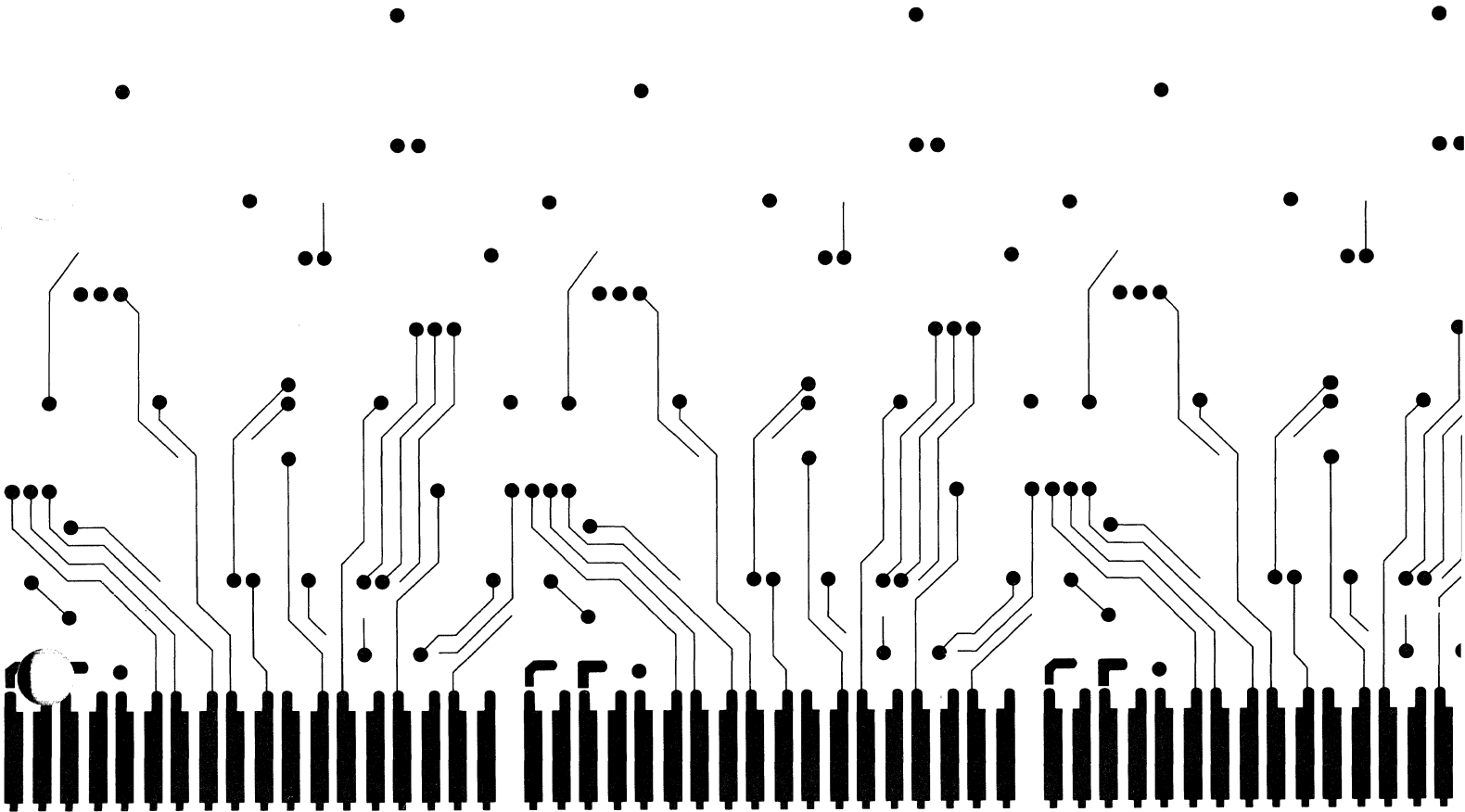

DECmailer PRICE LIST

| PART NUMBER | DESCRIPTION | LOWEST ACCEPTABLE | | | REPAIR PRICE | PART NUMBER | DESCRIPTION | LOWEST ACCEPTABLE | | | REPAIR PRICE |
|-------------|--|-------------------|-----|-----------|--------------|-------------|--|-------------------|-----|-----------|--------------|
| | | ETCH | REV | USED ON | | | | ETCH | REV | USED ON | |
| 00861-B | 120V,16A,PWR CONT,1-PHASE (874-C NEAREST | F1 | | TU16 | 147.00 | 0AD11-K | ANALOG DIGITAL 12BIT | E | | 11 FAMILY | 208.00 |
| 00861-C | 120V,24A,PWR CONT,1-PHASE (874-D NEAREST | F1 | | TU16 | 147.00 | 0AM11-K | EXPANDER PANEL (AD11-K) | B | | 11 FAMILY | 352.00 |
| 00861-E | 240V,24A,3-PHASE PWR CONT (881-B NEAREST | A | | KL10 | 365.00 | 0AR11-00 | 16 CH 10 BIT A/D CLOCK (M7809) | C | | 11 FAMILY | 338.00 |
| 00861-F | 120V,12A,1-PHASE PWR CONT (874-A NEAREST | F1 | | 11/70 | 131.00 | 0DD11-CK | USE 70-11528 | | | 11/04 | 00.00 |
| 00869-D | POWER CONTROL W/PWR SEQUENCING,4 SWITCHE | | | 11/780 | 383.00 | 0DD11-PK | USE 70-11523 | | | 11/04 | 00.00 |
| 00869-E | 869-D POWER CONTROL EXCEPT 240V 12A 3 PH | | | 11/780 | 383.00 | 0DF03-AA | REPLACED BY DF112-AA:WAS 300/1200BPS MOD | | | MODEMS | 299.00 |
| 00871-A | 120V,12A,PWR CONT,1-PHASE (874-A NEAREST | | | 11/03 | 100.00 | 0DF03-AC | REPLACED BY DF112-AA:WAS DF03-AA+M7177-Y | | | MODEMS | 380.00 |
| 00871-C | 120V,16A,PWR CONT,1-PHASE (874-C NEAREST | A | | 11/03 | 79.00 | 0DH11-AD | SEE DH11-M + CK-DH11-A* 7-B DIST P | | | 11 FAMILY | 646.00 |
| 00872-C | USE 874-C | | | | 00.00 | 0DKC8-AA | USE M8316 | | | PDP8A | 00.00 |
| 00872-D | 120V,24A,PWR CONT,1-PHASE,OBS (REPLACED | | | 11/34-34A | 294.00 | 0DL11-A | USE M7800-YA | | | 11/05 | 00.00 |
| 00874-A | 120V 12A FILTERED POWER CONT,6 SW OUTLET | | | 11/23-23B | 100.00 | 0DL11-B | USE M7800 | | | 11/05 | 00.00 |
| 00874-B | 220-240V 12A FILTERED PWR CONT,6 SW OUTL | | | 11/730 | 320.00 | 0DL11-C | USE M7800-YA | | | 11/05 | 00.00 |
| 00874-D | 120V 24A FILTERED POWER CONT,6 SW OUTLET | | | RL01 | 200.00 | 0DL11-D | USE M7800 | | | 11/05 | 00.00 |
| 00875-A | 120V 24A PC,POWER SEQUENCING,4 SWITCHED | | | 11/750 | 263.00 | 0DL11-W | USE M7856 | | | 11/04 | 00.00 |
| 00875-B | 875-A EXCEPT 240V 12A | | | 11/750 | 221.00 | 0DL11-WA | USE M7856 | | | 11/04 | 00.00 |
| 00876-A | 120V/208V 30A 3 PHASE PWR CONT,ISOLATED | | | VAX8600 | 600.00 | 0DR11-B | DIR MEM ACCESS DEVICE INTERFAC | | | 11 FAMILY | 383.00 |
| 00KC8-AA | USE 701064400 | | | PDP8A | 00.00 | 0DR11-C | USE M7860 | | | 11 FAMILY | 00.00 |
| 00KC8-EA | USE 54-09057 | | | PDP8E,M,F | 00.00 | 0DR11-W | USE M8716 | | | 11 FAMILY | 00.00 |
| 00KL8-A | USE M8319 | | | PDP8A | 00.00 | 0DZ11-A | 8-LINE DBL BUF ASYNC EIA 50-10 KBAUD W 1 | | | 11 FAMILY | 320.00 |
| 00KL8-FA | USE M8652 | | | PDP8E,M,F | 00.00 | 0DZ11-B | USE M7819 | | | 11 FAMILY | 00.00 |
| 00KL8-JA | USE M8655 | | | PDP8E,M,F | 00.00 | 0G050-00 | AMP READ | D | | TU10 | 77.00 |
| 00MDE-BD | EVENT DETECTOR & STATE ANALYZER MODULE F | | | MDE | 500.00 | 0G056-00 | USE G066 | D | | TU16 | 00.00 |
| 00MDE-BE | T11 EMULATOR MODULE FOR MDE (M8742) | | | MDE | 483.00 | 0G057-00 | PRE-AMP | | | TS FAMILY | 68.00 |
| 00MDE-BM | 32 KBYTE OF SIMULATOR MEMORY FOR MDE-BA | | | MDE | 465.00 | 0G060-00 | COMPRESSOR | D | | TU10 | 50.00 |
| 00MM8-AA | 8KX12 MEMORY | C | | MEMORIES | 180.00 | 0G060-YA | MODULE TU10 COMPRESSOR | D | | TU10 | 100.00 |
| 00MM8-AB | 16KX12 MEMORY | C | | MEMORIES | 200.00 | 0G066-00 | READ AMP 9-CH | C | | TU10 | 250.00 |
| 00MM8-EJ | 8K X 12 BIT 18 MIL MEMORY, 1,2 USEC (8/E | | | MEMORIES | 460.00 | 0G088-00 | DETECTOR, READ AMPFR PEAK | E | | RS FAMILY | 170.00 |
| 00MR8-EC | 256 X 12 BIT BRAID ROM, TD8-E HANDLER | | | MEMORIES | 1125.00 | 0G092-00 | TIMING AMP & LOGIC | | | RS FAMILY | 125.00 |
| 00MR8-FE | 4K CONTENT ALTERABLE PROM | | | MEMORIES | 800.00 | 0G104-00 | SENSE INHIBIT | D | | PDP8E,M,F | 105.00 |
| 00MS8-CB | 32K 12 BIT MOS RAM 4K CHIPS | B | | MEMORIES | 375.00 | 0G109-00 | CONTROL & DATA LOOPS FOR G109 & G109-YA | E | | 11/05 | 133.00 |
| 0A001-00 | 8 CHANNEL UDC BRD | C | | 11 FAMILY | 205.00 | 0G109-YA | M SELECT FF & DATA LOAD PULSE PINS | C | | 11/05 | 75.00 |
| 0A002-00 | UDC INPUT SIGNAL CONDITIONER | E | | 11 FAMILY | 110.00 | 0G110-00 | CONTROL AND DATA LOOPS | C | | 11/05 | 150.00 |
| 0A005-00 | RELAY 8 CH MULTIPLEXER FOR A001 | D | | 11 FAMILY | 305.00 | 0G111-00 | SENSE INHIBIT | C | A | PDP8E,M,F | 110.00 |
| 0A007-00 | 16 CH BIT MUX FOR A005 | B | | 11 FAMILY | 305.00 | 0G114-00 | 16K SENSE/INHIBIT G112 W 8881 & 380 | B | | 11/05 | 131.00 |
| 0A009-00 | USE AD11-K | C | | 11 FAMILY | 00.00 | 0G116-00 | SENSE/INH BIT MODULE | C | A | 11 FAMILY | 131.00 |
| 0A012-00 | USE ADV11-A | D | | 11/03 | 00.00 | 0G157-00 | TS04 READ/WRITE | | | TS FAMILY | 53.00 |
| 0A013-00 | USE MNCAD | | | LSI11 | 00.00 | 0G158-00 | REEL SERVO MODULE | F | | TS FAMILY | 84.00 |
| 0A014-00 | 8/16 BIT ANALOG/DIGITAL CONVERTER | D | | DPM | 780.00 | 0G159-00 | CAPSTAN SERVO | E | | TS FAMILY | 130.00 |
| 0A017-00 | NCV11-A,DUAL 4 INPUT MUX, S AND H 8-BIT | | | 11 FAMILY | 196.00 | 0G180-00 | LOW DENSITY | K | | RK05 | 80.00 |
| 0A020-00 | A/D 8 RELAY SWITCHED | D | F | DPM | 500.00 | 0G182-00 | R/W HEAD & DETECTION | J | | RS FAMILY | 70.00 |
| 0A150-00 | 8 CHAN FLYING CAP MUX,QUAD,CONN ON HANDL | A | | 11 FAMILY | 125.00 | 0G227-00 | DRIVE XY | C | | PDP8E,M,F | 105.00 |
| 0A156-00 | SOLID STATE MULTIPLEXER | B | | DPM | 300.00 | 0G231-00 | MEMORY DRIVER PDP-11 | CE | | 11/05 | 116.00 |
| 0A157-00 | DSY. CHN.,16 DIFF. LOW-LEVEL PROG. MUX,U | D | | DPM | 425.00 | 0G233-00 | 8K X-Y | C | A | PDP8E,M,F | 110.00 |
| 0A232-00 | ANALOG MULTIPLEXOR & EXPANDER | | | PDP8 FAM | 210.00 | 0G235-00 | 16K X-Y DRIVE | D | | 11/05 | 131.00 |
| 0A233-00 | 4 OUTPUT BUFFER AMPLIFIERS | C | | 11 FAMILY | 115.00 | 0G236-00 | 32K XY DRIVE | E | 1 | 11 FAMILY | 125.00 |
| 0A246-00 | USE MNCAG | | | LSI11 | 00.00 | 0G281-00 | DRUM X SELECT | B | | | 115.00 |
| 0A320-00 | GEN & DRIVE (VT40) | C | | VT FAMILY | 365.00 | 0G401-YA | HIGH SPEED MOS MEM MAT | C | | 11/45 | 277.00 |
| 0A613-00 | USE A615 | A | | | 00.00 | 0G649-00 | USE MM8-AA | | | MEMORIES | 00.00 |
| 0A614-00 | CONVERTER 12 BIT POLAR D/A | D | | 11 FAMILY | 115.00 | 0G650-00 | USE MM8-AB | | | MEMORIES | 00.00 |
| 0A615-00 | CONVERTOR, DIGITAL TO ANALOG | | | | 90.00 | 0G651-00 | USE MM11-C | | | 11 FAMILY | 00.00 |
| 0A631-00 | 4 CH 12-BIT ISOLATED DAC 20MA OR IPG + 1 | | | DPM | 460.00 | 0G652-00 | USE MM11-DP | | | MEMORIES | 00.00 |
| 0A633-00 | 4-10 BIT DAC'S | D | | 11 FAMILY | 150.00 | 0G653-00 | USE MMV11-A | | | MEMORIES | 00.00 |
| 0A638-00 | USE AA11-K | B | | 11 FAMILY | 00.00 | 0G848-00 | MOTOR CONTROL | M | | 11 FAMILY | 50.00 |
| 0A805-00 | 12-BIT A/D CONVERTER USED W A1004 OR A10 | B | | 11 FAMILY | 400.00 | 0G918-00 | PHOTOCELL AMP FOR PT04,5,REPLACEMENT FOR | D | | 11 FAMILY | 80.00 |
| 0AA11-K | 4 CHANNEL DAC | B | | 11 FAMILY | 164.00 | 0G933-00 | REEL, MTR AMPLIFIER | D | | PDP8E,M,F | 80.00 |



Prices Effective 02-January-89 to 30-June-89
When you need a part repaired, call 800-225-5385.

SPARES PRICE LIST C-2

0G938-00 — 0M306-00

DECmailer PRICE LIST

| PART NUMBER | DESCRIPTION | LOWEST ACCEPTABLE | | | REPAIR PRICE | PART NUMBER | DESCRIPTION | LOWEST ACCEPTABLE | | | REPAIR PRICE |
|-------------|---|-------------------|-----|------------|--------------|-------------|--|-------------------|-----|------------|--------------|
| | | ETCH | REV | USED ON | | | | ETCH | REV | USED ON | |
| 0G938-00 | RK05J HEAD POSITION SERVO | K | | RK05 | 80.00 | 0H773-A | USE 301486900 | | | 11 FAMILY | 00.00 |
| 0G938-YA | DEC PACK HEAD POSITION SERVO PREAM | E | A | RK05 | 70.00 | 0H775-D | BATTERY BACK-UP 11/70 | C | | 11/70 | 207.00 |
| 0H212-00 | 8K 12 BIT H211,MM8-EJ | C | | PDP8E,M,F | 250.00 | 0H777-00 | USE 000H777CA | | | | 00.00 |
| 0H213-00 | 4K 16 BIT STACK ON G645,3 WIRE | H | | 11/05 | 263.00 | 0H777-AA | USE H777CA | | | 11/04 | 00.00 |
| 0H214-00 | USE H215 | D | | 11/05 | 00.00 | 0H777-BA | USE H777-DA | | | 11/04 | 00.00 |
| 0H215-00 | 8K 18BIT PARITY MEMORY STACK | A | | 11/05 | 263.00 | 0H777-CA | H777-AA EXCEPT +5V 32A,120V | | | 11/04 | 280.00 |
| 0H217-B | MEMORY STK,16384 WORD 19B | E | | 10 FAMILY | 185.00 | 0H777-DA | H777-BA EXCEPT +5V 32A,120V | | | 11/04 | 280.00 |
| 0H217-C | MEMORY STK,16384 WORD 18B | E | C | 11/05 | 142.00 | 0H777-UA | 11/24 PS: +5V 32A,+15V 3A,-15V 3A,120V | | | 11 FAMILY | 720.00 |
| 0H217-D | MEMORY STK, 16384 WORD 16B | A | | 11/05 | 260.00 | 0H780-A | POWER SUPPLY 11V05 | A | | 11/03 | 210.00 |
| 0H219-A | USE 00MM8AA | B | | MEMORIES | 00.00 | 0H780-B | POWER SUPPLY | A | | 11/03 | 210.00 |
| 0H219-B | USE MM8AB | | | MEMORIES | 00.00 | 0H780-E | H780,11/03 SLAVE CONSOLE,120V LINE CORD | A | | 11/03 | 210.00 |
| 0H220-00 | 4K,12 BIT,22 MIL STACK ON G619,PS 300983 | A | | PDP8E,M,F | 360.00 | 0H780-H | H780-A W NO LINE CORD | A | | 11 FAMILY | 320.00 |
| 0H222-A | USE MM11-DP | | | MEMORIES | 00.00 | 0H781-00 | REGULATOR FOR PDO 5, 15 | E | | PDP FAMILY | 130.00 |
| 0H224-B | MEMORY STK 18B | B | | MEMORIES | 285.00 | 0H783-00 | VT61 SUPPLY: 120V/240V 50/60HZ | D | T | VT61-61T | 250.00 |
| 0H224-C | MEMORY STK 19B | B | | 11 FAMILY | 330.00 | 0H785-00 | BATTERY BACKUP REGULATOR | A | | 11/34-34A | 150.00 |
| 0H228-B | USE 000MM11YP | | | 11 FAMILY | 00.00 | 0H786-00 | BA11-NC,-ND, PS: +5V 22A,+12V 11A,120V/2 | A | 3 | 11/03 | 147.00 |
| 0H317-E | H317-E CABLE BOX ASSY | | A | 11/750 | 100.00 | 0K123-00 | NON-INVERTING GATE | A | | 11 FAMILY | 70.00 |
| 0H319-00 | 20 MA CURRENT LOOP RECEIVER (OPTICAL ISO | C | | 11 FAMILY | 70.00 | 0K198-00 | INVERTERS, EIGHT | B | | PDP FAMILY | 70.00 |
| 0H405-A | POWER INPUT BOX: 3PH 120V 16A,15FT CORD | | | VAX8500 | 450.00 | 0K579-00 | AC INPUT CONVERTER | C | | PDP FAMILY | 63.00 |
| 0H405-B | POWER INPUT BOX: 3PH DELTA 380-415V 11A, | | | VAX8500 | 450.00 | 0K614-00 | USE K616 | D | | K110 | 00.00 |
| 0H405-E | H405-A W/2 SW DEC PWR BUS OUT,1 UNSW IEC | | | VAX6200 | 550.00 | 0K615-00 | LIKE K614,EXCEPT 1 INPUT TO EACH CKTS IS | C | | KL10 | 90.00 |
| 0H405-F | H405-B W/2 SW DEC PWR BUS OUT,1 UNSW IEC | | | VAX6200 | 550.00 | 0K616-00 | ISOLATED AC OUTPUT | A | | PDP FAMILY | 83.00 |
| 0H603-00 | AMPLIFIER, CAPSTAN SERVO PWR | H | | TU10 | 80.00 | 0K652-00 | DRIVER D C | B | | KL10 | 70.00 |
| 0H604-00 | DECPACK HEAD POS. SERVO PWR AMP | H | | RK05 | 150.00 | 0KD11-A | USE 70-10230 | | | 11/35-40 | 00.00 |
| 0H606-00 | POWER BOARD (TU16) | D | A | TU16 | 236.00 | 0KD11-D | USE M7263 | | | 11/04 | 00.00 |
| 0H607-00 | TAPE MOTION BOARD | A | | TU16 | 257.00 | 0KD11-F | LSI11: M7264-AA (11/03 PROCESSOR W 8KB M | C | | 11/03 | 145.00 |
| 0H714-00 | LINE FILTER,250VAC,2 X 30 AMPS,CHOKE INP | D | | 11 FAMILY | 280.00 | 0KD11-H | USE M7264-YC | C | | 11/03 | 00.00 |
| 0H720-E | H720-A WITH POWER CONTROL & REMOTE/LOCAL | D | | 11 FAMILY | 500.00 | 0KD11-HA | USE M7270 | E | | LSI11 | 00.00 |
| 0H720-F | 240V H720-E | D | | 11/70 | 600.00 | 0KD11-L | KD11-F + KEV11 OR KEV11-A | C | | 11/03 | 193.00 |
| 0H721-00 | +5V +/-2% 20A,-15.5V+/-10% 3.5A,+10.5V+/- | A | | 11 FAMILY | 516.00 | 0KD11-N | KD11-H AND KEV11 OR KEV11-A | C | | 11/03 | 100.00 |
| 0H724-00 | POWER SUPPLY 8/E 60 CYCLE | A | | PDP8E,M,F | 250.00 | 0KD11-NA | KD11-HA + KEV11-A | E | | LSI11 | 126.00 |
| 0H725-00 | 15V 20A SUPPLY FOR K110,50/60 HZ RESONAN | A | | TU10 | 525.00 | 0KD11-Q | USE M7264-YB | E | | LSI11 | 00.00 |
| 0H730-A | POWER SUPPLY, TU10, 115V | F | | TU10 | 338.00 | 0KE11-B | USE M7840 | | | 11 FAMILY | 00.00 |
| 0H738-B | POWER SUPPLY | D | | 11 FAMILY | 224.00 | 0KW11-K | DUAL PROG CLK 1000,100,10,1,0.1KHZ,PHASE | C | | 11 FAMILY | 600.00 |
| 0H739-A | USE H758-A | A | | 11 FAMILY | 00.00 | 0KW11-P | USE M7228 | | | 11 FAMILY | 00.00 |
| 0H740-D | +5V20A,-15V5A,+15V1A,ACLO,DCLO,LINE FREQ | A | | 11 FAMILY | 218.00 | 0KY11-B | USE M828 | | | 11 FAMILY | 00.00 |
| 0H740-DA | POWER SUPPLY | E | FA | 11 FAMILY | 240.00 | 0KY11-D | USE 54-09701 | | | 11 FAMILY | 00.00 |
| 0H742-A | PS CHASSIS FOR 11/45,5 30VAC 6A EACH,+15 | A | | 11/45 | 380.00 | 0LA12-A | LA12-D + 300 BAUD ACOUSTIC COUPLER,300/1 | | | LA12 | 780.00 |
| 0H742-B | PS CHASSIS 11/45 230 VAC | A | | 11/45 | 400.00 | 0LA12-AB | LA12-A W/DIAL-THRU-KEYBRD MICROCODE & MO | | | LA12 | 650.00 |
| 0H744-00 | POWER REGULATOR | F | Z | 11 FAMILY | 280.00 | 0LA50-RA | USE 301985801 | | | LA50 | 00.00 |
| 0H745-00 | POWER REGULATOR | C | C | 11 FAMILY | 95.00 | 0LA50-RB | USE 301985802 | | | LA50 | 00.00 |
| 0H746-00 | MOS REGULATOR | F | | 11 FAMILY | 100.00 | 0LAXX-KV | USE M7735 | | | LA35 | 00.00 |
| 0H751-A | P.S. TU60 CASSETTE 60HZ | | | TU60 | 105.00 | 0LAXX-KY | USE M7736 | | | LA35 | 00.00 |
| 0H754-00 | + 20 VOLT REGULATOR | J | | 11 FAMILY | 110.00 | 0LK02-00 | KEYBOARD | E | | LA36 | 80.00 |
| 0H755-00 | POWER SUPPLY | A | | 11 FAMILY | 335.00 | 0LK03-A | 14 KEY NUMERIC PAD | | | LA36 | 70.00 |
| 0H758-A | H758 POWER SUPPLY | UA | | 11 FAMILY | 168.00 | 0LK05-B | USE 30-12538 | | | VT71-71T | 00.00 |
| 0H765-A | POW SUPPLY BA11-K 115V | O | | PDP FAMILY | 450.00 | 0LK09-E | USE 121608902 | | | VT173 | 00.00 |
| 0H766-A | USE H7660-C | E | | RA80 | 00.00 | 0M040-00 | M040 E | E | | PC FAMILY | 70.00 |
| 0H766-C | USE H7660-A | | | RA81 | 00.00 | 0M105-00 | ADDRESS SELECTOR | | | PDP FAMILY | 90.00 |
| 0H770-00 | +15V 10A REGULATOR FOR H742 | B | | KL10 | 130.00 | 0M111-00 | 16 INDEPENDENT INVERTERS | C | | PDP FAMILY | 70.00 |
| 0H771-A | POW SUPPLY RX01 (RX11) 60HZ | B | B | RX01 | 100.00 | 0M206-00 | SIX FLIP FLOPS | C | | PDP FAMILY | 70.00 |
| 0H771-D | RX01 SUP: +5V 5A,-5V 0.15A,+9.5V 1A,+26V | B | B | RX01 | 103.00 | 0M224-00 | DATA PATHS | B | | PDP FAMILY | 70.00 |
| 0H771-EA | REPACKAGED H771-A.NO AC INPUT,120V 60HZ, | | | | 150.00 | 0M234-00 | REGISTERS, KE11-A | B | | PDP FAMILY | 95.00 |
| 0H772-A | POWER SUPPLY,ICS,60HZ,OUT=5V,+21V,-21V | 1 | | 11 FAMILY | 333.00 | 0M304-00 | ONE SHOT DELAY | B | D | PDP FAMILY | 70.00 |
| 0H772-B | POWER SUPPLY,ICS,50HZ,OUT=5V,+21V,-21V | 1 | | 11 FAMILY | 338.00 | 0M306-00 | INTEGRATING ONE SHOT | B | | PDP FAMILY | 70.00 |



Prices Effective 02-January-89 to 30-June-89
When you need a part repaired, call 800-225-5385.

DECmailer PRICE LIST

| PART NUMBER | DESCRIPTION | LOWEST ACCEPTABLE | | REPAIR PRICE | PART NUMBER | DESCRIPTION | LOWEST ACCEPTABLE | | REPAIR PRICE | | |
|-------------|---|-------------------|-----|--------------|-------------|-------------|---|------|--------------|-----------|---------|
| | | ETCH | REV | | | | USED ON | ETCH | | REV | USED ON |
| OM307-00 | 2 INTEGRATING ONE SHOT | B | | PDP FAMILY | 70.00 | 0MB20-M | MEMORY 32K X 19 | | | MEMORIES | 463.00 |
| OM309-00 | POW SEQUENCE FILTER | B | | PDP FAMILY | 90.00 | 0MF20-M | ARRAY CARD | D | | MEMORIES | 450.00 |
| OM360-00 | VARIABLE DELAY | B | | PDP8 FAM | 160.00 | 0MG20-M | 1024KW 11-BIT MEMORY ARRAY (M8570-AA) [1 | | | MEMORIES | 1164.00 |
| OM405-00 | CRYSTAL CLOCK | A | | 11 FAMILY | 90.00 | 0MJ11-BM | USE MB20-M | | | MEMORIES | 00.00 |
| OM594-00 | CONVERTER, EIA LEVEL | B | | 11 FAMILY | 90.00 | 0ML11-AS | USE M7357-AA | B | | MEMORIES | 00.00 |
| OM596-00 | USE M5960 | C | | 11 FAMILY | 00.00 | 0MM11-CP | 8K CORE MEMORY | D | | MEMORIES | 338.00 |
| OM627-00 | POWER AMPLIFIER | A | | 11 FAMILY | 50.00 | 0MM11-DP | 16K CORE MEMORY | D | | MEMORIES | 360.00 |
| OM640-00 | MASTER / INTERFACE BUS DRIVER | C | | TU10 | 70.00 | 0MM11-YP | 32K 18BIT MEMORY ONE 1" BOARD | C | | MEMORIES | 338.00 |
| OM688-00 | UNIBUS POWER FAIL DRIVERS | B | | PDP FAMILY | 100.00 | 0MS10-BA | MS10 BA 64K X43 | B | | MEMORIES | 265.00 |
| OM710-00 | PUNCH CONTROL | F | | PDP FAMILY | 70.00 | 0MS11-AP | MEMORY 4K X 18 BIT | A | | MEMORIES | 365.00 |
| OM715-00 | READER CLOCK | F | | 11 FAMILY | 160.00 | 0MS11-BR | USE G401 | | | 11/45 | 00.00 |
| OM715-YA | READER CLOCK PMK01 (PR68) | B | | 11 FAMILY | 63.00 | 0MS11-BT | USE G401-YA | | | 11/45 | 00.00 |
| OM724-00 | BUSS & CONSOLE CONTROL | B | | 11 FAMILY | 145.00 | 0MS11-E | 4K 16 BIT MOS RAM (M7847-AA) | | | MEMORIES | 115.00 |
| OM725-00 | BUSS INTERFACE | B | | 11 FAMILY | 90.00 | 0MS11-EP | 4K 18 BIT MOS RAM MEM W PARITY | D | | MEMORIES | 96.00 |
| OM726-00 | I R DECODER | B | | 11 FAMILY | 135.00 | 0MS11-F | 8K 16 BIT MOS RAM (M7847-AC) | | | MEMORIES | 185.00 |
| OM727-00 | STATE CONTROL | B | | 11 FAMILY | 115.00 | 0MS11-FP | 8K 18 BIT MOS RAM MEM W PARITY | D | | MEMORIES | 139.00 |
| OM728-00 | TIMING & STATES | B | | 11 FAMILY | 120.00 | 0MS11-JP | 16K UNIBUS MOS MEM/PARITY | D | | MEMORIES | 177.00 |
| OM763-00 | BUFFER WRITE | C | | TU10 | 200.00 | 0MS11-KE | 16K 39BIT MOS MEM ARRAY FAST 4K CHIPS M7 | C | 1 | MEMORIES | 425.00 |
| OM765-00 | BUFFER, READ | B | | TU10 | 70.00 | 0MS11-LA | 64KBYTE MOS MEM W PARITY LOGIC (M7891-AA | | | MEMORIES | 365.00 |
| OM768-00 | TRANSMITTER, DELAY | E | | TU10 | 70.00 | 0MS11-LB | MS11-LB 64K 18 BIT MOS MEM W PARITY LOGI | B | | MEMORIES | 350.00 |
| OM769-00 | CONTROL, FUNCTION | H | | TU10 | 70.00 | 0MS11-LD | MS11-LD 128K 18 BIT MOS MEM W PARITY LOG | C | E | MEMORIES | 200.00 |
| OM783-00 | UNIBUS DRIVERS | B | | 11 FAMILY | 70.00 | 0MS11-MB | 256 KBYTES MOS ECC MEMORY(M8722-BA) | C | | MEMORIES | 250.00 |
| OM784-00 | UNIBUS RECEIVERS | A | | 11 FAMILY | 70.00 | 0MS11-PB | USE M8743-BA | | | MEMORIES | 00.00 |
| OM787-00 | 50-08774-E | B | | 11/70 | 70.00 | 0MS86-AA | USE L0226-BA | | | VAX8600 | 00.00 |
| OM792-00 | ROM DIODE MATRIX | E | | 11 FAMILY | 140.00 | 0MS86-BA | USE L0200-BA | | | VAX8600 | 00.00 |
| OM792-YA | MATRIX, ROM DIODE | E | | 11 FAMILY | 155.00 | 0MS86-CA | 16MB MEM MODULE,256K CHIP (L0225-AA) FOR | | | VAX8650 | 1500.00 |
| OM795-00 | WC & CMA | D | | 11 FAMILY | 25.00 | 0MS88-CA | 16MB MEMORY (L0115) W/2MB DAUGHTER BRDS | | | VAX8650 | 400.00 |
| OM820-00 | DATA PATH CONTROL | C | | 11 FAMILY | 95.00 | 0RA60-P | RA60 PACK,16-BIT WORDS FOR 11,VAX | | | RA60 | 225.00 |
| OM821-00 | REGISTER CONTROL | A | | 11 FAMILY | 130.00 | 0RD31-A | 20MB WINCHESTER HARD 5.25" DISK DRIVE,1.6 | | | RD FAMILY | 368.00 |
| OM822-00 | FLAG CONTROL | C | | 11 FAMILY | 50.00 | 0RD31-EA | PC500 20MB HARD DISK DRIVE | 1A | | PC500 | 330.00 |
| OM827-00 | CLOCK AND STATES, KE11-A | D | | 11 FAMILY | 120.00 | 0RD32-A | USE RD32-EA | | | RD FAMILY | 00.00 |
| OM833-00 | USE M833000 | C | | PDP8E,M,F | 00.00 | 0RD32-EA | 42MB WINCHESTER DISK DRIVE W/O SKID PLAT | | | RD FAMILY | 380.00 |
| OM837-00 | EXTENSION, MEMORY FINE SHARE | F | N | PDP8E,M,F | 100.00 | 0RD50-A | 5MB WINCHESTER HARD 5.25" DSK DRIVE,3.5" | | | RD FAMILY | 683.00 |
| OM840-00 | CONTROL, READ PUNCH | C | | PDP8E,M,F | 150.00 | 0RD51-A | 10MB WINCHESTER NON-R 5.25" DSK,3.5"H,RE | | | RD FAMILY | 683.00 |
| OM842-00 | CONTROL, PLOTTER XY8-E | K | | PDP8 FAM | 90.00 | 0RD52-A | 28/31MB 5.25" NON-REM WINI DISK,3.5"H,RE | | | RD FAMILY | 683.00 |
| OM847-00 | M18E BOOTSTRAP LEADER | E | | PDP8 FAM | 100.00 | 0RD53-A | 67/71MB 5.25" FULL HEIGHT FIXED WINCHEST | | | RD FAMILY | 683.00 |
| OM847-YP | USE M18-EP | E | | PDP8E,M,F | 00.00 | 0RD54-A | 159 MB FIXED DISK,5.25" FULL HIGH,38.3 M | | | RD FAMILY | 683.00 |
| OM848-00 | POWER FAIL & AUTO RESTART | E | | PDP8E,M,F | 160.00 | 0RP06-P | DISK PACK DATA 200 TPI | | | RP05/6 | 230.00 |
| OM851-00 | BUS RECEIVER-ADDRESS DECODER | E | | 11 FAMILY | 70.00 | 0RX01-CA | SINGLE ADD-ON FLOPPY DISK DRIVE,120V,60H | | | RX01 | 185.00 |
| OM852-00 | LARGER CACHE ADDRESS | | | MCA25 | 640.00 | 0RX33-00 | USE RX33-A | | | HSC50/70 | 00.00 |
| OM853-00 | LARGER CACHE EXTENSION | | | MCA25 | 473.00 | 0RX33-A | 1.2 MB FLOPPY DISK DRIVE,5.25" DBL-SIDED | | | HSC50/70 | 100.00 |
| OM854-00 | PHYSICAL MEMORY MODULE FOR LARGER CACHE | A | 1A | MCA25 | 590.00 | 0RX50-AA | DUAL 5.25" SINGLE SIDED FLOPPY DRIVE,96T | | | RX50 | 225.00 |
| OM855-00 | 2-WAY ASC PAGE TABLE ADDING MBOX CTRL03 | A | 1A | MCA25 | 895.00 | 0SHIP-00 | TRANSPORTATION CHARGES | | | | 0.00 |
| OM856-00 | IR,D RAM & CARRY,LARGER CACHE | A | 1A | MCA25 | 980.00 | 0TK25-00 | USE TK25-AA | | | TK25 | 00.00 |
| OM857-00 | M-BOX CONTROL FOR LARGER CACHE | A | 1A | MCA25 | 382.00 | 0TK25-AA | USE 302296902 | | | TK25 | 00.00 |
| OM860-00 | REAL TIME CLOCK CONTROL | H | | PDP8 FAM | 90.00 | 0TK50-AA | USE TK50-AX | | | TK50 | 00.00 |
| OM863-00 | 12 CHANNEL I/O | F | | PDP8 FAM | 100.00 | 0TK50-AX | TK50-AA PACKAGED | A | | TK50 | 550.00 |
| OM873-YA | BOOTSTRAP LOADER | C | | 11 FAMILY | 120.00 | 0TK70-AX | TK70-AA WITH NO CARTRIDGE, PACKAGED | | | TK70 | 650.00 |
| OM873-YB | RESTART LOADER/128 WORD ROM | C | | 11 FAMILY | 50.00 | 0TK70-EA | TK70 WITH NO SKID PLATE + CARTRIDGE | | | TK70 | 650.00 |
| OM890-00 | CONTROL, MOTION | F | | 11 FAMILY | 100.00 | 0TU58-AB | SINGLE TU58,SERIAL CONT,5 & 12VDC (TU58- | | | | 0.00 |
| OM891-00 | CRC & WRITE GATING | D | | TMD2 | 80.00 | 0TU58-XA | TU58 DR MECHANISM ONLY | | B | TU58 | 85.00 |
| OM892-00 | TU10 GAP TIMING & READ | E | | TU10 | 90.00 | 0TU58-XB | MODULE W SERIAL INTERFACE (54-13489) | F | | TU58 | 95.00 |
| OM895-00 | READ TIMING | | | MEMORIES | 381.00 | 0TU58-XC | MODULE W PARALLEL INTERFACE (54-13491) | | | TU58 | 100.00 |
| OM930-00 | BUSS TERMINATOR | | | 11/05 | 80.00 | 0TU80-CA | TU80,874-D,TU80K-AC,H9642,120V | | | TU80/81 | 4500.00 |
| OMA20-M | 16KX19 BIT MEM MOD SET | | | MEMORIES | 770.00 | 0W743-00 | INPUT MODULE | B | | 11 FAMILY | 90.00 |



Prices Effective 02-January-89 to 30-June-89
When you need a part repaired, call 800-225-5385.

DECmailer PRICE LIST

| PART NUMBER | DESCRIPTION | LOWEST ACCEPTABLE | | | REPAIR PRICE | PART NUMBER | DESCRIPTION | LOWEST ACCEPTABLE | | | REPAIR PRICE |
|-------------|--|-------------------|-----|------------|--------------|-------------|---|-------------------|-----|------------|--------------|
| | | ETCH | REV | USED ON | | | | ETCH | REV | USED ON | |
| 0W816-00 | UNIBUS GRANT RELAY | B | P | 11 FAMILY | 110.00 | DESNC-BA | LAN ENCRYPT DEV W/ETHERNT CONN,4 THINWIR | | | ETHERNET | 1050.00 |
| 0X022-00 | RAINBOW UNIBUS WINDOW SIMILAR TO DA11H | B | | 11/34-34A | 155.00 | DESNC-BB | LAN ENCRYPT DEV W/ETHERNT CONN,4 THINWIR | | | ETHERNET | 1050.00 |
| 0X025-00 | RAINBOW,IG FONT MEMORY ARRAY,HEX | B | | 11/34-34A | 365.00 | DESPR-AA | THINWIRE (10 BASE 2) TO ETHERNET (10 BAS | | | ETHERNET | 255.00 |
| 0X026-00 | RAINBOW OUTPUT HEX | C | | 11/34-34A | 275.00 | DESTA-AA | THINWIRE ETHERNET STATION ADAPTER | | | ETHERNET | 150.00 |
| 0X030-00 | RAINBOW,CDC DISK CONTROL,HEX | C | | 11/34-34A | 190.00 | DF100-DT | DESK TOP MODEM ENCLOSURE,PS,120V 60HZ | | | MODEMS | 135.00 |
| 0X032-00 | IG FONT MEMORY ARRAY | C | | 11/34-34A | 190.00 | DF100-RM | RACK FOR 12 MODEMS INCL 6A 120V POWER SU | | | MODEMS | 950.00 |
| 0X032-AA | USE X032 | | | 11/34-34A | 00.00 | DF104-AM | 150/2400 BPS,2-W/FDX,ACU TERM TO PROC MO | | | MODEMS | 175.00 |
| 0X032-AB | USE X032 | | | 11/34-34A | 00.00 | DF104-BM | 2400/150 BPS,2-W/FDX/ACU PROC-TO-TERM MO | | | MODEMS | 175.00 |
| 0X032-AC | USE X032 | | | 11/34-34A | 00.00 | DF112-AA | DF112-AM MODEM(300/1200BPS,2-W/FDX,ACU)I | | | MODEMS | 175.00 |
| 0X032-AD | USE X032 | | | 11/34-34A | 00.00 | DF112-AM | 300/1200BPS SYNC/ASYNCR 212A/V.22 MODEM W | | | MODEMS | 175.00 |
| 0Y034-00 | BELL MODEM DRIVER | A | | 11 FAMILY | 115.00 | DF124-AA | DF124-AM(2400/1200 BPS MODEM),DF100-DT(D | | | MODEMS | 260.00 |
| 0Y083-00 | SP MDD TIMING BOARD | H | | | 90.00 | DF124-AM | 2400/1200 BPS FDX SYNC/ASYNCR V.22BIS/212 | | | MODEMS | 206.00 |
| 0Y084-00 | SP MOD DEVICE SELECT | C | | | 70.00 | DF124-CM | USE 29-26381 | | | DF124 | 00.00 |
| A1004-00 | 8-CHAN RELAY MUX,2-WIRE,+/-10V OUTPUTS T | A | | 11 FAMILY | 150.00 | DF126-AA | DF126-AM MODEM(2400 BPS,HDX,201/V.26,ACU | | | MODEMS | 210.00 |
| A1005-00 | 8-CHAN RELAY MUX,3-WIRE,+/-10V OUTPUTS T | A | | 11 FAMILY | 150.00 | DF126-AM | 2400 BPS,HDX,201/V.26,W/ACU PROC-TO-PROC | | | MODEMS | 175.00 |
| A6001-00 | USE AAV11-A | | | 11/03 | 00.00 | DF127-AA | 4800BPS LEASED LINE MODEM(DF127-AM IN DF | | | MODEMS | 463.00 |
| A6002-00 | USE MNCAA | | | LSI11 | 00.00 | DF127-AM | USE 302138602 | | | MODEMS | 00.00 |
| A6005-00 | 2-CHANNEL D/A,10 BIT,+/-0.1%,4-20MA,DUAL | | | CMR01 | 250.00 | DF129-AA | 9600BPS US/CAN MODEM(DF129-AM IN DF100-D | | | MODEMS | 525.00 |
| A6006-00 | USE 30-18691 | | | 11/03 | 00.00 | DF129-AM | USE 302138702 | | | MODEMS | 00.00 |
| A6330-00 | 4 CHNL 10-BIT DAC (ICMDA-OA) | C | | 11 FAMILY | 305.00 | DF224-AA | USE 29-25042 | | | DF100 FAM | 00.00 |
| A8000-00 | USE 30-18693 | | | 11/03 | 00.00 | DFMZA-BA | USE 702099902 | | | ETHERNET | 00.00 |
| AAV11-A | D/A FOR 11/03 | D | | 11/03 | 179.00 | DFMZA-BB | USE 702099901 | | | ETHERNET | 00.00 |
| AAV11-C | USE 30-18691 | | | 11/03 | 00.00 | DHQ11-M | USE M3107 | | | 11 FAMILY | 00.00 |
| ADV11-A | A/D FOR 11/03 | E | | 11/03 | 179.00 | DHV11-A | USE DHV11-M | | | 11 FAMILY | 00.00 |
| ADV11-C | USE 30-18693 | | | 11/03 | 00.00 | DHV11-M | USE M3104 | | | 11 FAMILY | 00.00 |
| AXV11-C | USE 30-18689 | | | 11/03 | 00.00 | DLV11-00 | USE M7940 | B | | 11/03 | 00.00 |
| BDV11-AA | USE M8012-YA | C | | 11/03 | 00.00 | DLV11-E | USE M8017-AA | C | | LSI11 | 00.00 |
| BM873-YJ | BOOT STRAP LOADER | | | 11 FAMILY | 90.00 | DLV11-F | USE M8028 | C | | LSI11 | 00.00 |
| C5005-00 | DEC TALK III,ENGLISH TEXT TO USA/CANADA | | | DECTALK | 358.00 | DLV11-J | USE M8043 | C | | LSI11 | 00.00 |
| DCSAX-LA | M3100,ONE-LINE SYNC LINE CARD,EIA,DASH B | | | | 140.00 | DLV11-KA | SEE CK-DLVK1-H8 | A | | 11 FAMILY | 70.00 |
| DCSAX-LB | M3101,ONE-LINE SYNC LINE CARD,V.35,DASH | | | DECSA | 350.00 | DLV11-KB | SEE CK-DLVK1-H7 | A | | 11 FAMILY | 70.00 |
| DCSAX-LC | M3102,TWO-LINE ASYNC LINE CARD,EIA,DASH | C | | DECSA | 175.00 | DLVE1-M | USE M8017-AA | | | 11 FAMILY | 00.00 |
| DDV11-B | BACK PLANE ASSY | | | 11 FAMILY | 310.00 | DLVJ1-M | USE M8043 | | | LSI11 | 00.00 |
| DDV11-CF | USE 70-14256 | | | 11 FAMILY | 00.00 | DMV11-AA | USE M8053-MA | | | 11/03 | 00.00 |
| DDV11-CK | USE 70-14257 | | | 11 FAMILY | 00.00 | DMV11-AB | USE M8053-MA | | | 11/03 | 00.00 |
| DEBET-AA | DIGITAL ETHERNET BRIDGE TO ETHERNET, LOC | | | ETHERNET | 1500.00 | DMV11-AC | USE M8064-MA | | | 11/03 | 00.00 |
| DEBET-AB | DIGITAL ETHERNET BRIDGE TO ETHERNET, LOC | | | ETHERNET | 1500.00 | DRQ3B-AA | USE M7658-00 | | | MICROVAXII | 00.00 |
| DEBET-RA | DIGITAL ETHERNET BRIDGE TO ETHERNET,REMO | | | ETHERNET | 1680.00 | DRV11-00 | USE M7941 | | | 11/03 | 00.00 |
| DEBET-RC | ETHERNET FIBER OPTIC BRIDGE (REMOTE),1 B | | | ETHERNET | 1680.00 | DRV11-B | USE M7950 | | | 11/03 | 00.00 |
| DEBET-RD | ETHERNET FIBER OPTIC BRIDGE (REMOTE),1 B | | | ETHERNET | 1680.00 | DRV11-J | USE M8049 | C | | 11 FAMILY | 00.00 |
| DECNA-00 | NEWLY ADDED CRC PART | | | PC FAMILY | 125.00 | DRV11-P | USE M7948 | | | LSI11 | 00.00 |
| DECNA-K | USE 541598701 | | | DECNA | 00.00 | DRV1W-SA | USE M7651-PA | | | MICROVAXII | 00.00 |
| DECOM-AA | BROADBAND ETHERNET XCEIVER FOR DUAL CABL | | | | 1075.00 | DRV1W-SF | USE M7651-PA | | | MICROVAXII | 00.00 |
| DECOM-AB | DECOM-AA EXCEPT 240V (REQS DEBBK-A*) | | | | 1075.00 | DSRVA-A2 | DSRVA-AA WITHOUT COUNTRY KIT (FIELD SERV | | | DSRVA | 357.00 |
| DECOM-BA | BROADBAND ETHERNET XCEIVER FOR SINGLE-CA | | | ETHERNET | 1075.00 | DSRVA-AA | USE DSRVA-A2 | | | DSRVA | 00.00 |
| DECOM-BB | DECOM-BA EXCEPT 240V (REQUIRES DEBBK-A*) | | | ETHERNET | 1075.00 | DSRVA-AB | DECSERV 100,8-LINE TERM SRVR,REQS DSRVK- | | | DSRVA | 357.00 |
| DEFTR-AA | HEAD-END BROADBAND ETHERNET FREQ XLATOR | | | ETHERNET | 1075.00 | DSRVA-B2 | DECSERVER 200 RS232 F.S. SPARE W/O COUNT | | | ETHERNET | 425.00 |
| DEFTR-AB | HEAD-END BROADBAND ETHERNET FREQ XLATOR | | | ETHERNET | 1075.00 | DSRVB-AA | USE DSRVB-A2 | | | ETHERNET | 00.00 |
| DELNI-AA | ETHERNET COMM DEV FOR LOCAL AREA NETWRKS | | | ETHERNET | 314.00 | DSRVB-AB | DECSERVER 200 TERM SERVER FOR ETHERNET(L | | | ETHERNET | 425.00 |
| DELNI-AB | ETHERNET COMM DEVICE FOR LOCAL AREA NETW | | | ETHERNET | 314.00 | DSRVB-B2 | DECSERVER 200 DEC423 F.S SPARE W/O COUNT | | | ETHERNET | 425.00 |
| DELQA-SA | USE M7516-PA | | | VAX FAMILY | 00.00 | DSRVB-BA | USE DSRVB-B2 | | | ETHERNET | 00.00 |
| DELUA-M | USE M7521-AA | | | | 00.00 | DSRVB-BB | DECSERVER 200 TERM SERVER FOR ETHERNET(L | | | ETHERNET | 425.00 |
| DEMPR-AA | 8-PORT THINWIRE (10 BASE 2) ETHERNET REP | | | DEMPR | 650.00 | DSRVC-A2 | DECROUTER 200 W/O COUNTRY KIT,120V, | | | ETHERNET | 425.00 |
| DEMPR-AB | DEMPR-AA EXCEPT 240V | | | DEMPR | 650.00 | DSRVC-AB | DEC ROUTER 200,ASYNC,240V | | | ETHERNET | 425.00 |
| DEPCA-AA | USE 702425201 | | | DEPCA | 00.00 | DSRZA-BA | USE 702421602 | | | ETHERNET | 00.00 |



Prices Effective 02-January-89 to 30-June-89
When you need a part repaired, call 800-225-5385.

DECmailer PRICE LIST

| PART NUMBER | DESCRIPTION | LOWEST ACCEPTABLE | | | REPAIR PRICE | PART NUMBER | DESCRIPTION | LOWEST ACCEPTABLE | | | REPAIR PRICE |
|-------------|--|-------------------|-----|------------|--------------|-------------|--|-------------------|-----|------------|--------------|
| | | ETCH | REV | USED ON | | | | ETCH | REV | USED ON | |
| DSRZA-BB | USE 702421601 | | | ETHERNET | 00.00 | H7188-A | USE H7188-AB | | | VAX8600 | 00.00 |
| DTC03-AM | USE C5005-00 | | | DECTALK | 00.00 | H7188-AB | H7188-A ENM W/BUS ENCHANCEMENT FOR 800** | F | | VAX8600 | 750.00 |
| DTC11-B | TMS VOICE UNIT,SPKR PHONE W/EHANCD VOICE | | | DECTALK | 90.00 | H7189-A | +5V 55A,-5.2V 25A,-2V 15A,+12V 2A,-12V 2 | A1 | | VAX8500 | 1500.00 |
| DUV11-DA | USE M7951 | | | 11/03 | 00.00 | H7200-00 | 5V POWER MODULE: 5V 70A,300V 200W,CAN US | | | 11/24 | 148.00 |
| DYX02-00 | USE 54-14640 | | | 11 FAMILY | 00.00 | H7202-B | 11730 POW SUP: H7200,H7211,H7213,120V/24 | | | 11/730 | 582.00 |
| DZQ11-M | USE M3106 | | | MICROVAXII | 00.00 | H7202-KA | REPACKAGED H7202-B (H7200,H7211,H7213)12 | | | | 625.00 |
| DZS11-EA | USE M7190 | | | 11 FAMILY | 00.00 | H7202-KB | ORION PS: H7200,H7211,120V/240V 50/60HZ | | | | 499.00 |
| DZV11-B | USE M7957 | C | | 11/03 | 00.00 | H7203-A | BA11-XX PS: +5V 100A,300VDC,ACLO,DCLC,CL | 11 | | MEMORIES | 200.00 |
| DZV11-M | USE M7957 | | | 11/03 | 00.00 | H7204-BA | H7203,H7216-A,H7217,120V | | | 11 FAMILY | 500.00 |
| F1001-00 | MCL (MEMORY CONTROLLER LOGIC MODULE) FOR | 1D | 2A | VAX8500 | 1950.00 | H7204-CA | H7204-AA W/LOWER PROFILE ENCLOSURE,120V | | | 11 FAMILY | 615.00 |
| F1002-00 | SHIFTER LOGIC MODULE FOR NAUTILUS CPU,HE | 1A | X01 | VAX8500 | 3600.00 | H7206-A | POWER & LOGIC BOX,208/300VDC 2000W,14V 1 | | | VAX6200 | 500.00 |
| F1003-00 | ALU SLICE #1 MODULE FOR NAUTILUS CPU,HEX | 1A | X01 | VAX8500 | 3150.00 | H7211-00 | COMM OPT PS: +15V 2A,-15V 3A,+12V 2A,-12 | A | | 11/24 | 79.00 |
| F1004-00 | ALU SLICE #0 MODULE FOR NAUTILUS CPU,HE | 1A | X01 | VAX8500 | 3150.00 | H7213-00 | MEMORY & FAN REGULATOR: 5.1V 15A,12.3V 3 | A | | 11/730 | 131.00 |
| F1005-00 | ADDRESS DATA PATH MODULE FOR NAUTILUS CP | 1A | X05 | VAX8500 | 2500.00 | H7214-A | 600W,+5V 120A,13.5V 0.5A,30KHZ SWTCHER,1 | | | VAX6200 | 550.00 |
| F1006-00 | CACHE MODULE FOR NAUTILUS CPU,HEX W/ZIFF | 1D | X09 | VAX8500 | 1900.00 | H7215-A | 300VDC AND 14VDC IN,-5.2V 30A,-2V 12A,+1 | | | VAX6200 | 600.00 |
| F1007-00 | DECODER MODULE FOR NAUTILUS CPU,HEX W/ZI | 1A | X01 | VAX8500 | 1950.00 | H7216-00 | -5.3V 10A,+12.4V 2.0A SWITCHER FROM H720 | | | CI750/780 | 116.00 |
| F1008-00 | MICRO SEQUENCER LOGIC MOD FR NAUTILUS CP | 1A | X01 | VAX8500 | 3550.00 | H7231-N | VALUE ENGINEERED H7231-M (1 BOX INSTEAD | | | VAX6200 | 400.00 |
| F1009-00 | 16K WORD WRITE CONT STORE FR NAUTILUS CP | 1A | X00 | VAX8500 | 4000.00 | H7251-00 | 1250W 300VDC SUPPLY 120/240 INPUT | 1A | | VAX8200 | 204.00 |
| F1010-00 | CLOCK GENERATION & CONSOLE INTERFACE FOR | 1C | X04 | VAX8500 | 2200.00 | H7253-00 | 5V 20A,-5V 12A,-2V 4A,24V 2A FROM 300VDC | 1A | | VAX8200 | 197.00 |
| F1011-00 | NBI(NMI TO BI INTERFACE MODULE)HEX W/ZIF | 1C | 2A | VAX8500 | 2200.00 | | 5V 55A,15V 3.25A,-15V 4A,12V 3.75A,-12V | 1C | | VAX8200 | 309.00 |
| F1015-00 | DECODER F MODULE FOR NAUTILUS B | | | VAX8500 | 1950.00 | H7270-A | 120V PC500 PS: 5.1V 10.24A,12.1V 1.37A,2 | | | PC500 | 60.00 |
| FPF11-00 | USE M8188 | | | 11/23-23B | 00.00 | H7270-B | 240V PC500 PS: H7270-A EXCEPT 240V INPUT | | | PC500 | 60.00 |
| G8010-00 | -5.2V CONTROL KL10 | C | | KL10 | 105.00 | H7420-A | POW SUPPLY HI POW H742-A 115V | A | | 11 FAMILY | 204.00 |
| G8011-00 | -2V CONTROL KL10 | C | | KL10 | 90.00 | H7440-00 | POA1 H7440 | E | | 11/60 | 105.00 |
| G8014-00 | -5.2V DETECTOR 16 INPUTS | B | | KL10 | 70.00 | H7441-00 | USE H7441-YA | A | | 11 FAMILY | 00.00 |
| G8016-00 | REGULATOR FOR H763 | D | D | PDP8 FAM | 350.00 | H7441-YA | FCC 5V 32A REGULATOR FOR H7420,H765 | | | 11 FAMILY | 84.00 |
| G8018-00 | H774 REGULATOR | C | | PDP8 FAM | 130.00 | H7476-00 | USE 541424000 | | | TU/TA78 | 00.00 |
| G8019-00 | POWER DISTRIBUTION BOARD CONTROLL, DOUBL | F | | PDP8 FAM | 90.00 | H7660-C | USE H7660-C | | | RA81 | 00.00 |
| G9340-00 | TU10 BRAKE LOGIC | A | | TU10 | 70.00 | H7660-B | USE 00H7660D0 | | | RA81 | 00.00 |
| G9341-00 | TU10 BRAKE ACTUATOR | B | | TU10 | 105.00 | H7660-C | H7660-A IMPROVED FOR ALL RA- DISK DRIVES | | | RA82 | 800.00 |
| H3006-00 | 8-LINE RS232 DISTRIBUTION PANEL FOR DZ11 | | | | 200.00 | H7660-D | H7660-B IMPROVED FOR ALL RA- DISK DRIVES | | | RA82 | 800.00 |
| H4005-00 | 802.3/ETHERNET TRANSCEIVER | | | ETHERNET | 0.00 | H7750-AA | MK11-A BATT BACKUP W CHARGER FOR 3 H7850 | | | 11 FAMILY | 275.00 |
| H4005-AA | NEWLY ADDED CRC PART | | | ETHERNET | 150.00 | H7751-B | CMR POWER SUPPLY ASSEMBLY,12VDC BATTERY | | | CMR01 | 155.00 |
| H4005-AB | NEWLY ADDED CRC PART | | | ETHERNET | 150.00 | H7831-00 | USE 70-14979 | | | VT100 FAM | 00.00 |
| H7060-A | 100-240VAC IN,+5V 4A,+12V 3A,-12V 0.4A,3 | | A1 | VAX8500 | 550.00 | H7832-A | POWER SUPPLY VT62,VT68 115V WITH 50/60 H | C | | VT62 | 260.00 |
| H7061-A | INTERFACE LOGIC MODULE FOR NAUTILUS & SK | | A1 | VAX8500 | 450.00 | H7834-00 | H7834 PWR SUPPLY LA34 | | | LA34 | 100.00 |
| H7062-A | N BOX TRANSLATOR PROVIDES SIGNAL LEVEL,S | | A1 | VAX8500 | 150.00 | H7835-00 | VT103 SUPPLY:120V/240V 50/60HZ INPUT,+5V | A | A | VT100 FAM | 121.00 |
| H7100-A | 11780 500 WATT SUPPLY: 5V 100A,120VAC (H | | | 11/780 | 690.00 | H7837-00 | USE H7847-AA | | | LA100 | 00.00 |
| H7100-B | 11780 500-WATT SUPPLY: 5V 100A,240VAC (H | | | 11/780 | 690.00 | H7837-AA | USE H7847-AA | | | LA100 | 00.00 |
| H7104-C | 7016157-01: 7016157-00(2.5V 85A),H7103(+ | | | 11/750 | 400.00 | H7838-A | USE 701737400 | | | | 00.00 |
| H7104-D | 7016156-01: 7016156-00(+5V 135A),H7105(+ | | | 11/750 | 400.00 | H7842-A | USE H7842-D | | | PC FAMILY | 00.00 |
| H7110-00 | LA120 PS, 115/230VAC | | | LA120 | 105.00 | H7842-B | USE H7842-D | | | | 00.00 |
| H7130-C | KS10,LH RESEARCH POWER SUPPLY,UL APPROVE | | B | KS10 | 880.00 | H7842-D | SMALL SYS UNIT POW SUP:142 WATTS,+5V 11. | | | PC FAMILY | 79.00 |
| H7130-D | KS10,LH RESEARCH POWER SUPPLY,UL APPROVE | Y | | KS10 | 880.00 | H7844-00 | USE H7847-AA | | | LA100 | 00.00 |
| H7131-00 | POWER SUPPLY-MF20 120/240V NO LINE CORD | | | KL10 | 1746.00 | H7845-AA | USE H7845-BA | | | PC FAMILY | 00.00 |
| H7140-AA | H7140 W 120V LINE CORD,50/60HZ | | Z1 | 11 FAMILY | 695.00 | H7845-BA | 120V SMALL SYS PWR SUP: 85 WATT,+5V,+/-1 | | | PC FAMILY | 100.00 |
| H7140-AB | H7140 W 240V LINE CORD,50/60HZ | | | 11 FAMILY | 595.00 | H7846-00 | USE H784400 | | | LA100 | 00.00 |
| H7140-CA | H7140 EXCEPT +/-15V BATT,60HZ FANS,120V | | | 11 FAMILY | 900.00 | H7847-AA | 120/240V PS,OUTPUT 97W,5V,+/-12V,+/-24V | | | LA100 | 90.00 |
| H7140-DA | H7140 EXCEPT +12V/-15V BATT,120V LINE CO | | | 11 FAMILY | 1000.00 | H7848-BA | VS400 PWR SUPPLY,120V 104 WATT,+5.1V @13 | | | VAXSTATION | 305.00 |
| H7150-00 | LA120 PS: +24V 2.4A,-24V 2.8A,+5V 3A,+/- | | | LA120 | 105.00 | H7850-00 | BATTERY BACK-UP REG | A | 1 | 11 FAMILY | 168.00 |
| H7170-A | 120/208VAC 3 PHASE 300V 9.5A,+12/+15V 2A | | | VAX8600 | 600.00 | H7861-00 | BA11-SA,-SB PS: +5V 36A,+12V 5A,120V/240 | A | | 11 FAMILY | 241.00 |
| H7176-A | 120V 3-PHASE 2800 WATT 300V POWER SUPPLY | A1 | | VAX8500 | 850.00 | H7862-00 | USE H7862-C | | | PC FAMILY | 00.00 |
| H7180-A | FLOATING 5 OR 5.2V 200A SWITCHING REGULA | | | VAX8600 | 600.00 | H7862-B | USE H7862-C | | | PC FAMILY | 00.00 |
| H7186-A | +/-5V @ 85A SWITCHING REGULATOR FOR 4050 | | | VAX8600 | 600.00 | H7862-C | H7862 EXCEPT +5V 2-20A,+12V 0.6-8A (54-1 | | | PC FAMILY | 160.00 |
| H7187-A | +/-2.5V 100A SWITCHING REGULATOR FOR 405 | | | VAX8600 | 600.00 | H7864-A | USE 302174901 | | | VAXSTATION | 00.00 |



Prices Effective 02-January-89 to 30-June-89
When you need a part repaired, call 800-225-5385.

DECmailer PRICE LIST

| PART NUMBER | DESCRIPTION | LOWEST ACCEPTABLE | | | REPAIR PRICE | PART NUMBER | DESCRIPTION | LOWEST ACCEPTABLE | | | REPAIR PRICE |
|-------------|--|-------------------|-----|------------|--------------|-------------|--|-------------------|-----|------------|--------------|
| | | ETCH | REV | USED ON | | | | ETCH | REV | USED ON | |
| H7868-A | BA223 POWER SUPPLY: 5V 33A,12V 7A,-7V TO | | | | 275.00 | L0009-00 | CCI (CMI TO CIPA INTERFACE),4-LAYER HEX | | | | 488.00 |
| H9194-00 | BUS CONN 8/A 8+4 SLOTS | B | N | PDP8 FAM | 375.00 | L0010-00 | UBI (UNIBUS INTERFACE (VERSION 2)) | A | C | C1750/780 | 473.00 |
| H9273-A | LOGIC ASSY H9273 | | | 11/03 | 115.00 | L0011-00 | 16K MEMORY CONTROL,4-LAYER HEX 12 | 1 | 1 | 11/750 | 310.00 |
| H9275-A | FRAME,18 DUAL/9 QUAD Q-22 SLOTS,TERMINAT | | | 11 FAMILY | 250.00 | L0014-00 | CMI (BACKPLANE) PARALLEL INTERFACE (DR75 | | | 11/750 | 583.00 |
| H9278-A | Q22 BUS BACKPLANE,8 QUAD SLOTS | | | | 75.00 | L0016-00 | 64K MEMORY CONTROL,4-LAYER HEX 12 | | | 11/750 | 473.00 |
| H9400-AA | VAXBI 6-SLOT LOGIC CAGE BACKPLANE W/REMO | | | VAX6200 | 600.00 | L0022-00 | 256K MEM CONTROL FOR MS750,4-LAYER HEX 1 | | | VAX8500 | 675.00 |
| HSC5X-BA | KSDI INTERFACE KIT TO 4 SDI DISK DRIVES | D | D | HSC50/70 | 705.00 | L0072-00 | NI20 (KL10 TO NI ADAPTOR) | | | | 685.00 |
| HSC5X-CA | KSTI INTERFACE KIT TO 4 STI TAPE FORMATT | D | D | HSC50/70 | 705.00 | L0100-00 | USE L0118 | | B | HSC50/70 | 00.00 |
| IBV11-A | USE M7954 | C | | 11/03 | 00.00 | L0101-00 | IPB (CI CONTROL STORE & PACKET BUFFER),H | | | C1750/780 | 600.00 |
| IEQ11-A | USE M8634-00 | C | E | | 00.00 | L0102-00 | IDP (CI DATA PATH),HEX 12 | | | 11/780 | 520.00 |
| IEQ11-AA | USE M8634-00 | C | E | | 00.00 | L0104-00 | ISI (CI SBI INTERFACE FOR CI PORT),HEX 1 | | | C1750/780 | 483.00 |
| IEQ11-SA | USE M8634-PA | | | MICROVAXII | 00.00 | L0105-00 | HSC50 PIOC (F11 PROC & I/O CTL),HEX 12 | D | D | HSC50/70 | 546.00 |
| IEQ11-SF | USE M8634-PA | | | MICROVAXII | 00.00 | L0106-00 | USE L0106-AA | | | HSC50/70 | 00.00 |
| ISV11-A | SERIAL BUS INTERFACE M8080,M8084 | | | DPM | 507.00 | L0106-AA | 128KB DATA,128KB CONT,256KB PGM,HEX 12 = | C | | HSC50/70 | 462.00 |
| ISV11-B | ISV11-A W 2 SEPARATE MODULES (M8080,M808 | | | DPM | 700.00 | L0106-AH | USE L0106-AA | | | | 00.00 |
| KA620-AA | USE M7478-AA | | | MICROVAXII | 00.00 | L0107-00 | USE L0107-YA | | | HSC50/70 | 00.00 |
| KA620-BA | USE 00M7478AA | | | | 00.00 | L0107-YA | HSC50 KPLI(PLI PORT CONTROL),HEX 12 | C | C | HSC50/70 | 368.00 |
| KA630-AA | USE M7606-AA | | | MICROVAXII | 00.00 | L0108-YA | USE HSC5X-BA | | | HSC50/70 | 00.00 |
| KDF11-AA | M8186 DUAL-HEIGHT CPU W/KFT11-AA OPT (MM | | | 11/23-23B | 162.00 | L0108-YB | USE HSC5X-CA | | | HSC50/70 | 00.00 |
| KDF11-AB | USE 00KDF11AA | C | | | 00.00 | L0109-00 | HSC50 PILA(PACKET BUFFER BOARD),HEX 12 | E | | HSC50/70 | 221.00 |
| KDF11-AC | USE M8186-00 | A | | 11/23-23B | 00.00 | L0111-00 | J-11 I/O CONTROL PROCESSOR MODULE | D | | HSC50/70 | 446.00 |
| KDF11-BA | M8189(DCF11-AA,2 SLU,CLK),KTF11-AA(MMU), | | | 11/23-23B | 320.00 | L0115-00 | 8000 LOGIC MOTHERBRD W/DAUGHTRBRDS,8 44- | | | HSC50/70 | 400.00 |
| KDF11-BE | USE KDF11-BF | | | LSI11 | 00.00 | L0116-AA | 4MB MEMORY ARRAY CARD ILUS | | | HSC50/70 | 300.00 |
| KDF11-BF | USE KDF11-BH | | | LSI11 | 00.00 | L0116-AF | USE L0116-AA | | | HSC50/70 | 00.00 |
| KDF11-BH | USE KDF11-BJ | | | LSI11 | 00.00 | L0117-00 | USE L0117-AA | | | HSC50/70 | 00.00 |
| KDF11-BJ | KDF11-BF + KDF11-B3 BOOT ROM FOR TK50 | | | LSI11 | 320.00 | L0117-AA | STD2 MEM FOR HSC70: 521KB DATA,256KB CON | A | | HSC50/70 | 1208.00 |
| KDF11-CA | USE KDF11-CC | | | PC FAMILY | 00.00 | L0118-00 | 32 NODE CLUSTER LINK FOR CI/HSC DEVICES | | B1 | VAX FAMILY | 600.00 |
| KDF11-CB | USE 00KDF11-CC | | | PC350 | 00.00 | L0200-BA | 4MB MOS ARRAY,256K PARTS, = L0200-BC,-BF | | | VAX8600 | 1500.00 |
| KDF11-CC | KDF11-CA W/ROMS FOR IVIS | | | PC3XX FAM | 300.00 | L0201-00 | CSL (CONSOLE CONTROL),HEX 12 FOR KA86 | | D3 | VAX8600 | 1575.00 |
| KDJ11-AA | USE M8192-00 | | | LSI11/73 | 00.00 | L0202-00 | (SBS) SBI INTERFACE,HEX 12 FOR KA86 | | B1 | VAX8600 | 1500.00 |
| KDJ11-BC | USE M8190 | | | 11 FAMILY | 00.00 | L0203-00 | (SBA) SBIA ABUS INTERFACE,HEX 12 FOR KA8 | | B1 | VAX8600 | 1500.00 |
| KDJ11-CA | PC380 MOTHER BD,J11 CPU,512KB SYS RAM,6 | | | PC FAMILY | 1214.00 | L0204-00 | (MCD) MBOX DATA PATH,HEX 12 FOR KA86 | | D4 | VAX8600 | 3000.00 |
| KEF11-AA | FP11 MICROCODE CHIPS FOR KDF11 (NEEDS 21 | | | 11 FAMILY | 20.00 | L0205-00 | (MAP) MBOX ADDRESS PATH,HEX 12 FOR KA86 | | D3 | VAX8600 | 3000.00 |
| KMC11-A | USE M8204 | | | 11 FAMILY | 00.00 | L0206-00 | (IDP) IBOX DATA PATH,HEX 12 FOR KA86 | | F3 | VAX8600 | 3000.00 |
| KMC11-B | USE M8206 | | | 11 FAMILY | 00.00 | L0207-00 | (ICA) IBOX CONTROL A,HEX 12 FOR KA86 | | H3 | VAX8600 | 2000.00 |
| KMV1A-M | BASE KMV11(M7500) PROGRAMBLE COMM INTERF | B | | | 500.00 | L0208-00 | (IBD) IBOX INSTRUCTION BUFFER,HEX 12 FOR | | F5 | VAX8600 | 3500.00 |
| KPV11-A | USE M8016 | D | | 11 FAMILY | 00.00 | L0209-00 | (EDP) EBOX DATA PATH,HEX 12 FOR KA86 | | C2 | VAX8600 | 2500.00 |
| KPV11-B | USE M8016-YB | D | | 11 FAMILY | 00.00 | L0210-00 | (EBC) EBOX BUFFER,HEX 12 FOR KA86 | | C3 | VAX8600 | 1500.00 |
| KUV11-UH | USE M7264-YC | C | | LSI11 | 00.00 | L0211-00 | (EBD) EBOX CONTROL,HEX 12 FOR KA86 | | F | VAX8600 | 1250.00 |
| KWV11-A | 11/03 PROGRAM CLOCK | B | | 11/03 | 142.00 | L0212-00 | (FBA) FBOX FLOATING PT CNTRL + DATA PATH | | E7 | VAX8600 | 2000.00 |
| KWV11-C | USE 30-18690 | | | 11/03 | 00.00 | L0213-00 | (FBM) FBOX FLOATING PT MULTIPLIER,HEX 12 | | C5 | VAX8600 | 2000.00 |
| KXJ11-CA | USE M7616 | | | KXJ11 | 00.00 | L0214-00 | (ICB) IBOX CONTROL B,HEX 12 FOR KA86 | | F4 | VAX8600 | 1250.00 |
| KXT11-AA | USE M8063-BA | | | LSI11 | 00.00 | L0215-00 | CSA (CONTROL STORE ARRAY BOARD) FOR KA86 | | B2 | VAX8600 | 3000.00 |
| KXT11-AB | USE M7676 | | | LSI11 | 00.00 | L0216-00 | (CSB) CONTROL STORAGE ARRAY,HEX 12 FOR K | | B2 | VAX8600 | 3000.00 |
| KXT11-CA | USE M8377 | | | LSI11 | 00.00 | L0217-00 | (GLK) CLOCK, HEX 12 FOR KA86 | | C5 | VAX8600 | 1500.00 |
| L0001-00 | FLOATING POINT ACCELERATOR | D | A | 11/750 | 400.00 | L0218-00 | (FBOX) JUMPER MODULE,HEX 4 FOR KA86 | | | VAX8600 | 400.00 |
| L0002-00 | DPM (DATA PATH & MICRO SEQUENCER),4-LAYE | C | A | 11/750 | 326.00 | L0219-00 | (EBE) EBOX CONTROL,HEX 12 FOR KA86 | | B2 | VAX8600 | 1250.00 |
| L0003-00 | MEMORY INTERFACE | D | A | 11/750 | 473.00 | L0220-00 | (MCC) CACHE CONTROL,HEX 12 FOR KA86 | | K1 | VAX8600 | 3000.00 |
| L0003-YA | COST REDUCED MEMORY INTERFACE + CACHE | C | A | 11/750 | 540.00 | L0222-00 | (MTM)MEM ARRAY TERMINAL BOARD,4 LAYER HE | | | VAX8600 | 400.00 |
| L0004-00 | UNIBUS INTERFACE | D | A | 11/750 | 326.00 | L0223-00 | (FTM)F-BOX TERMINATOR BOARD,4-LAYER HEX | | | VAX8600 | 400.00 |
| L0006-00 | RDM (REMOTE DIAG MODULE),4-LAYER HEX 12 | A | | 11/750 | 326.00 | L0224-00 | (STM)SBI/A-BUS TERMINATOR BOARD,4-LAYER | | B4 | VAX8600 | 400.00 |
| L0006-YA | 11750 MAINTENANCE TOOL,4-LAYER HEX 12 | | | 11/750 | 326.00 | L0225-00 | MEMORY MOTHER BOARD W/NO DAUGHTER BOARDS | | | VAX8650 | 1500.00 |
| L0007-00 | MBA (MASSBUS ADAPTOR),4-LAYER HEX 12 | C | | 11/750 | 326.00 | L0226-BA | MS86 4MB,ECC MOS ARRAY,35MHZ,=L0226-BC,- | | | VAX8600 | 1500.00 |
| L0008-YA | (PCS)PATCHABLE CONTROL STORE FOR 11750,H | | | 11/750 | 672.00 | L0230-00 | MCC (M-BOX CACHE CONTROL) | | | VAX8600 | 5000.00 |
| L0008-YB | L0008-YA W 1K OF WCS,HEX 12 | | | 11/750 | 672.00 | L0231-00 | CLOCK FOR KA86 | | | VAX8600 | 3000.00 |



Prices Effective 02-January-89 to 30-June-89
When you need a part repaired, call 800-225-5385.

DECmailer PRICE LIST

| PART NUMBER | DESCRIPTION | LOWEST ACCEPTABLE | | | REPAIR PRICE | PART NUMBER | DESCRIPTION | LOWEST ACCEPTABLE | | | REPAIR PRICE |
|-------------|---|-------------------|-----|------------|--------------|-------------|--|-------------------|-----|------------|--------------|
| | | ETCH | REV | USED ON | | | | ETCH | REV | USED ON | |
| L0400-00 | CDP (CI750 DATA PATH MODULE),4-LAYER HEX | | | CI750/780 | 714.00 | M6010-00 | 32 BIT NONISO DC OUTPUT | C | | DPM | 260.00 |
| LA12X-DL | 4 KBYTE EXPANDABLE BUFFER | | | LA120 | 90.00 | M6011-00 | 16 BIT ONESAOT DC OUTPUT | | | DPM | 280.00 |
| LAV11-00 | USE M7949 | B | | LS111 | 00.00 | M6012-00 | 8 BIT ISO DC OUTPUT | B | | DPM | 195.00 |
| LK001-A | LA36 KEYBOARD WITHOUT NUMERIC KEYPAD | A | | LA36 | 85.00 | M6013-00 | 8BIT ISO AC OUTPUT | | | DPM | 300.00 |
| LK001-B | LA36 KEYBOARD WITH NUMERIC KEYPAD | A | | LA36 | 85.00 | M6014-00 | 4/78 DUAL 16-BIT COUNTER | | | DPM | 435.00 |
| LK201-A | USE LK201-AA | | | PC FAMILY | 00.00 | M6015-00 | DC RETENTATIVE ISOLATED DC OUTPUT,QUAD | | | DPM | 250.00 |
| LK201-AA | LK201-A W/USA KEYCAPS,BCC01,BN09A-1K USA | | | PC FAMILY | 130.00 | M6850-00 | 16 BIT FLIP-FLOP DC OUTPUT | E | | | 95.00 |
| LK201-B | USE 00LK201BA | | | PC FAMILY | 00.00 | M6870-00 | 16 BIT DC SING-SHOT OUTPUT | D | | 11 FAMILY | 121.00 |
| LK201-BA | LK201-B W WPS USA/CANADA KEYCAPS,BCC01,US | | | PC FAMILY | 130.00 | M7002-00 | TIMING, MEMORY & MEMORY | C | | VT FAMILY | 62.00 |
| LK201-EC | LK201-A W/APL KEYCAPS,BCC01,120V USA POW | | | PC FAMILY | 130.00 | M7004-00 | INTERFACE, HIGH SPEED VT05 | C | | VT FAMILY | 50.00 |
| LK201-EE | LK201-A UK/USA KEYCAPS,240V POWER CORD | | | PC FAMILY | 130.00 | M7013-00 | VECTOR GEN & CHAR GEN CONT | B | | VT FAMILY | 185.00 |
| LK201-NA | LK201-N WITH USA/UK BLOCK MODE KEYCAPS | | | PC FAMILY | 130.00 | M7014-00 | UNIBUS CONT & BOOTSTRAP-VT40 | B | | VT FAMILY | 115.00 |
| LK201-PA | LK201-P WITH WPS/BLOCK MODE,USA/UK KEYCA | | | PC FAMILY | 130.00 | M7014-YA | UNIBUS CONT & BOOTSTRAP FOR VT40 | B | | VT FAMILY | 260.00 |
| LK201-RE | LK201-A UK/USA KEYCAPS, NO PWR CORD | | | PC FAMILY | 130.00 | M7016-00 | PROGRAMMABLE REAL TIME CLOCK W3 SCHMIDTT | B | | 11 FAMILY | 90.00 |
| LK201-XB | LK201-A W/NS100 KEYCAPS,BCC01,USA PWR CO | | | PC FAMILY | 130.00 | M7024-00 | VT55 GRAPHIC CONTROL | B | | VT50 FAM | 234.00 |
| LK201-XC | LK201-A W/NS200 KEYCAPS,BCC01,USA PWR CO | | | PC FAMILY | 130.00 | M7025-00 | USE KW11-K | | | 11 FAMILY | 00.00 |
| LK250-AA | LK250 LOW PROFILE KEYBOARD,ENGLISH VERSI | | | PC500 | 70.00 | M7049-00 | READER DATA MODULE | D | | RT FAMILY | 210.00 |
| LPV11-00 | USE M802700 | B | | 11/03 | 00.00 | M7050-00 | CONTROL, READER | C | | 11 FAMILY | 52.00 |
| M3002-00 | CI20 MICROPROCESSOR,MULTIWIRE HEX | | | CI20 | 1142.00 | M7061-00 | USE 00M7061YA | E | | 11 FAMILY | 00.00 |
| M3100-00 | USE DCSAX-LA | | | DECSA | 00.00 | M7061-YA | VSV11-F,-H,-J,-K,SYNC GEN & CURSOR CONT, | E | | 11 FAMILY | 550.00 |
| M3102-00 | USE DCSAX-LC | | | DECSA | 00.00 | M7062-00 | IMAGE MEMORY (VSV11-MA),QUAD | F | | 11 FAMILY | 293.00 |
| M3103-00 | LP LINE UNIT FOR DECSA,DOUBLE 8.5 | | | DECSA | 175.00 | M7064-00 | IMAGE PROCESSOR VPV11-A | E | | 11 FAMILY | 338.00 |
| M3104-00 | DHV11-A (8-LINE ASYNC MUX,DMA CONTROL),Q | | | 11 FAMILY | 263.00 | M7071-00 | IMAGE MEM,RAMS & BUFFER LOGIC FOR VIDEO | E | | VT100 FAM | 170.00 |
| M3105-00 | DHU11-A (16-LINE ASYNC MUX,DMA CONTROL), | | | 11 FAMILY | 263.00 | M7075-00 | TRANSMITTER, SYNCHRONOUS | D | | 11 FAMILY | 70.00 |
| M3106-00 | DZQ11,4LN DBL BUF ASYNC MUX EIA 50-10KB, | | | DZQ11-M/AP | 158.00 | M7081-00 | PRINTER LOGIC AND POWER BOARD | D | | LA120 | 95.00 |
| M3106-PA | 4 LINE DBL BUFFER ASYNC MUX W/S-BOX HAND | | | VAX FAMILY | 150.00 | M7081-YB | M7081 W ROMS FOR LAS12, LA124 | E | A | LAS12 | 95.00 |
| M3107-00 | QBUS 8 LINE ASYNC MUX MODULE,DUAL | | | MICROVAX2 | 280.00 | M7090-00 | 11/44 CIM (CONSOLE INTERFACE),DOUBLE 8.5 | A | | 11/44 | 137.00 |
| M3108-00 | 2-LINE SYNCHRONOUS COMM DEVICE,SPEEDS TO | | | MICROVAX2 | 275.00 | M7091-00 | 4/78 KE44-A, CIS QUAD | A | | 11/44 | 194.00 |
| M3110-00 | PROTOCOL ASSIST #1 W SPECIAL CHAR CHECK | C | | DECSA | 242.00 | M7092-00 | 4/78 KE44-A, CIS HEX | B | | 11/44 | 320.00 |
| M3111-00 | PROTOCOL ASSIST #2 W SPECIAL CHAR CHECK | | | DECSA | 236.00 | M7093-00 | 4/78 FP11-F,FLOATING POINT HEX | B | | 11/44 | 275.00 |
| M3112-00 | CONSOLE BOOT TERMINATOR,HEX HEX | | | DECSA | 231.00 | M7094-00 | KD11-T DATA PATH | B | A | 11/44 | 275.00 |
| M3118-YA | QUAD ASYNC 16 LINE MODULE,INTEGRAL HANDL | | | VAX FAMILY | 375.00 | M7095-00 | KD11-Z,CONTROL MODULE,HEX | B | | 11/44 | 325.00 |
| M3118-YB | QUAD ASYNC 16 LINE,NO MODEM CONTROL,INTE | | | VAX FAMILY | 375.00 | M7096-00 | KD11-Z,(MFM) MULTIFUNCTION MODULES,HEX | B | | 11/44 | 290.00 |
| M3119-YA | 8 LINE ASYNC MUX,W/MODEM CNTRL,INTEGRAL | | | VAX FAMILY | 375.00 | M7097-00 | KK11-B,4K WORD CACHE,HEX | C | A | 11/44 | 325.00 |
| M3121-00 | DUAL INTEGRAL MODEM,Q-BUS,S-BOX,DF224 CO | | | MODEMS | 300.00 | M7098-00 | KD11-Z,UNIBUS INTERFACE,HEX | B | A | 11/44 | 275.00 |
| M4002-00 | USE 30-18690 | | | 11/03 | 00.00 | M7104-00 | DATA BUF & STATUS | B | | PDP8E,M,F | 130.00 |
| M4540-00 | M454 W MORE FREQ AVAILABLE | B | | 11 FAMILY | 80.00 | M7105-00 | MAJOR REGISTER | B | | PDP8E,M,F | 105.00 |
| M5010-00 | 32 BIT NON ISO DC SENSE MOD | B | | DPM | 200.00 | M7106-00 | RK8-E CONTROL | C | | PDP8E,M,F | 105.00 |
| M5011-00 | 16 BIT NON ISO DC INTER MOD | C | | DPM | 200.00 | M7122-00 | MICROCONTROLLER MODULE | F | | RT FAMILY | 180.00 |
| M5012-00 | 16 BIT ISO DC INPUT | B | | DPM | 200.00 | M7122-YA | DPM01 MICRO CONTROLLER QUAD | F | | VT100 FAM | 155.00 |
| M5012-YA | M5012 W TTL COMPATIBLE INPUTS | | | DPM | 220.00 | M7127-00 | FDC SERIAL BUS PORT | D | | 11 FAMILY | 130.00 |
| M5013-00 | 8 BIT AC INPUT MOD | | | DPM | 225.00 | M7128-00 | DRPM01 EIA/CURRENT WOP MUX FOR DECATAWAY | B | | VT100 FAM | 115.00 |
| M5014-00 | I/O DAISY CHAIN BUS,DUAL 16-BIT INPUT CO | | | DPM | 430.00 | M7133-00 | KDF11-UA CPU,LINE CLOCK,2 SER LNS,ETCH R | D | | 11/24 | 250.00 |
| M5016-00 | 16 BIT OUTPUT COUNTER | C | | DPM | 320.00 | M7133-YA | KDF11-UA CPU,LINE CLOCK,2 SER LNS,ETCH R | D | | 11/24 | 320.00 |
| M5031-00 | 16-BIT 55V ISOLATED CHANGE OF STATE INTE | B | | 11 FAMILY | 155.00 | M7134-00 | UNIBUS MAP (EXTENDED ADDRESS TO 22 BITS) | D | | 11/24 | 290.00 |
| M5800-00 | 2-WIRE DUPLEX MODEM,300/1200BPS,ORIGINAT | C | | MODEMS | 210.00 | M7135-00 | MICROVAX I DATAPATH W G FLOATING POINT (| A | | MICROVAX1 | 803.00 |
| M5864-00 | 18 INPUT & 2 OUTPUT OPTICAL COUPLED ISOL | B | | | 70.00 | M7135-YA | MICROVAX I DATAPATH W D FLOATING POINT (| A | D | MICROVAX1 | 715.00 |
| M5901-00 | 16 CH EIA TRANSCEIVER DJ11 DOU | B | | 11 FAMILY | 26.00 | M7136-00 | MEMORY CONTROL FOR KD32-A MICROVAX I (SE | A | | MICROVAX1 | 599.00 |
| M5902-00 | 16 CH FULL DUPLEX TTY TRANSC DJ1 | A | | 11 FAMILY | 105.00 | M7142-00 | STAND ALONE MODULE FOR CRT TERMINAL,ASCI | C | | VK100 | 200.00 |
| M5903-00 | MASSBUS TERMINAL TRANSCEIVER,DOUBLE 8.5 | H | A | MEMORIES | 74.00 | M7147-00 | MODEM CONTROL | A | W | 11 FAMILY | 232.00 |
| M5904-00 | MASSBUS CONTROL TRANSCEIVER,DOUBLE 8.5 | C | | 11 FAMILY | 90.00 | M7161-YA | USE M7485-YA | | | UDA50 | 00.00 |
| M5906-00 | 16 CH EIA CONV + PRIORITY BRD | B | | 11 FAMILY | 60.00 | M7162-00 | USE M7486 | | | UDA50 | 00.00 |
| M5922-00 | MASS BUS TRANSCEIVER, PORT A | D | | | 95.00 | M7164-00 | QDA PROCESSOR,QUAD | | | KDA50 | 683.00 |
| M5923-00 | MASS BUS TRANSCEIVER, PORT B | D | C | RM03 | 95.00 | M7165-00 | QDA SDI,QUAD | C | | KDA50 | 683.00 |
| M5960-00 | REPLACEMENT M596 | | | 11 FAMILY | 60.00 | M7168-00 | 4 PLANE COLOR BITMAP | | F | VAXSTATION | 1170.00 |



Prices Effective 02-January-89 to 30-June-89
When you need a part repaired, call 800-225-5385.

DECmailer PRICE LIST

| PART NUMBER | DESCRIPTION | LOWEST ACCEPTABLE | | | REPAIR PRICE | PART NUMBER | DESCRIPTION | LOWEST ACCEPTABLE | | | REPAIR PRICE |
|-------------|--|-------------------|-----|------------|--------------|-------------|--|-------------------|-----|------------|--------------|
| | | ETCH | REV | USED ON | | | | ETCH | REV | USED ON | |
| M7169-00 | Q22 BUS VIDEO CONTROLLER MODULE FOR VCB0 | | E | VAXSTATION | 2130.00 | M7278-00 | REG & BYTE CNT | C | FA | 11 FAMILY | 115.00 |
| M7181-00 | CMR HOST CONTROLLER FOR Q-BUS TO Q-BUS I | A | | LSH11 | 125.00 | M7279-00 | 1ST IN 1ST OUT BUFFER DH11,DJ11 DO | B | | 11 FAMILY | 80.00 |
| M7182-00 | CMR HOST CONTROLLER FOR Q-BUS MICRO CTL | | | LSH11 | 300.00 | M7280-00 | MULTIPLE UART CARD | D | | 11 FAMILY | 105.00 |
| M7190-00 | 8-LINE STATISTICAL COMM MUX (DZS11-EA),H | C | | 11 FAMILY | 403.00 | M7281-00 | RELAY DISTRIBUTE | D | | 11 FAMILY | 207.00 |
| M7194-00 | 2G-E02YA,DIFFERENTIAL SIGNAL CONDITIONIN | | | 11 FAMILY | 76.00 | M7282-00 | MODULE INPUT SCAN | D | | 11 FAMILY | 260.00 |
| M7195-FA | 128KB RAM,2 ASYNC EIA SLU,I/O,CLOCK,2 28 | C | | 11/23-23B | 195.00 | M7285-00 | DJ11 MUX CONTROL BOARD,HEX 8.5 | B | C | 11 FAMILY | 190.00 |
| M7196-00 | TSV05 CONTROLLER FOR Q/Q22 BUS,QUAD | D | | TS FAMILY | 535.00 | M7288-00 | DH11 LINE PARAMETERS CONTROL | B | | 11 FAMILY | 105.00 |
| M7199-00 | USE M7199-AA | | | VAX8500 | 00.00 | M7289-00 | DH11 RECV SCANNER | A | | 11 FAMILY | 75.00 |
| M7199-AA | 4MB ECC ARRAY 256K DRAMS = M7199-A*,4-LA | | | VAX8500 | 275.00 | M7291-00 | 16 POINT INPUT INTERRUPT CB11 | B | | 11 FAMILY | 115.00 |
| M7210-00 | KE11-A DATA CONTROL | A | | 11 FAMILY | 90.00 | M7294-00 | DATA BUFFER & CONT RH11 | C | A | 11 FAMILY | 300.00 |
| M7211-00 | KELL-A REGISTER CNTL | C | | 11 FAMILY | 70.00 | M7294-YA | DATA BUFFER + CONTROL | B | | 11 FAMILY | 315.00 |
| M7212-00 | ALINES, BUS REPEATER | C | | 11 FAMILY | 70.00 | M7295-00 | BUS CONTROL RH11 | B | | 11 FAMILY | 280.00 |
| M7213-00 | CARD, REPEATER MASTER | H | | 11 FAMILY | 70.00 | M7296-00 | CONTROL & STATUS REG | B | | | 100.00 |
| M7213-YA | BUS REPEATER CONTROL | H | P* | 11 FAMILY | 90.00 | M7297-00 | MASSBUS PARITY CONTROL,RH11,DOUBLE 8.5 | A | | | 90.00 |
| M7216-00 | CNTL, PRIORITY | B | | 11 FAMILY | 70.00 | M7357-AA | 256KB ARRAY,MOSTLY GOOD 16K CHIPS,4LAY H | A | | MEMORIES | 480.00 |
| M7218-00 | REQUESTS, BUS | A | | 11 FAMILY | 155.00 | M7361-00 | ML11 ASYNC CONTROL,HEX | E | | MEMORIES | 213.00 |
| M7219-00 | INTERFACE, KC11 BUS | D | | 11 FAMILY | 105.00 | M7362-00 | ML11 SYNC CONTROL,HEX | B | | MEMORIES | 168.00 |
| M7223-00 | SYNCHRONOUS CONTROL | C | | 11 FAMILY | 105.00 | M7363-00 | ML11 ARRAY DATA,4-LAYER HEX | B | | MEMORIES | 57.00 |
| M7226-00 | DN11 CONTROL,DOUBLE X 8.5 | B | | 11 FAMILY | 90.00 | M7390-00 | ASYNCHRONOUS TRANSCEIVER | D | | RT FAMILY | 105.00 |
| M7228-00 | KW11-P REAL TIME CLOCK | F | | 11 FAMILY | 95.00 | M7431-00 | PDP14/30 I/O CONTROL | C | | PDP FAMILY | 130.00 |
| M7229-00 | DR11-B INTERFACE FOR DA11-B | D | | 11 FAMILY | 115.00 | M7432-00 | 14/30 I/O MULTIPLEXER DRIVER | E | | PDP FAMILY | 115.00 |
| M7231-00 | DATA PATHS, KD11-A | C | | 11/35-40 | 180.00 | M7433-00 | MULTIPLEX DRIVERS | C | | PDP FAMILY | 140.00 |
| M7232-00 | U WORD,KD11-A,8.5 QUAD | B | | 11/35-40 | 145.00 | M7434-00 | INTFACE CONN | C | | PDP FAMILY | 90.00 |
| M7233-00 | KD11-A IR DECODE | B | | 11/35-40 | 163.00 | M7443-00 | VT14 VIDEO DISPLAY | C | | VT FAMILY | 135.00 |
| M7234-00 | KD11-A TIMING | D | | 11/35-40 | 188.00 | M7452-00 | UNIBUS TO 68000 FIBER OPTIC CONVERTER,QU | | | 11/730 | 189.00 |
| M7235-00 | KD11-A STATUS PROCESSOR | B | | 11/35-40 | 163.00 | M7454-00 | TU80 UNIBUS INTERFACE,QUAD(DILOG/DIGITAL | | | TU80/81 | 536.00 |
| M7236-00 | KT11-D MEMORY MANAGEMENT | A | | 11/35-40 | 188.00 | M7455-00 | TSU05 CONTROLLER FOR UNIBUS,HEX | | | TS FAMILY | 535.00 |
| M7238-00 | KE11-E EIS BRD | B | | 11/35-40 | 250.00 | M7458-AA | MSV11-RA: 1MB PMI/Q22 PARITY MEMORY W/CS | | | MEMORIES | 475.00 |
| M7239-00 | KE11-F FIS CONTROL | B | | 11/35-40 | 99.00 | M7459-00 | TRS,TERMINATOR & SILO,4-LAYER HEX 12 | | | 11/785 | 347.00 |
| M7247-00 | MODEM CONTROL MUX | A | | | 70.00 | M7460-00 | KA785,SBL,CPU SBI LOW BITS INTERFACE,4-L | | | 11/785 | 557.00 |
| M7248-00 | UNIBUS REPEATER | | | 11 FAMILY | 50.00 | M7461-00 | KA785,SBH,SBI (SYNCHRONOUS BACK PLANE IN | | | 11/785 | 625.00 |
| M7251-00 | XOR AND CRC BLOCK | D | | 11 FAMILY | 58.00 | M7462-00 | KA785,CAM,CACHE ADDRESS MATRIX,4-LAYER H | | | 11/785 | 819.00 |
| M7254-00 | RK11-D STATUS CONTROL | C | | 11 FAMILY | 106.00 | M7463-00 | KA785,CDM,CACHE DATA MATRIX,4-LAYER HEX | | | 11/785 | 908.00 |
| M7255-00 | RK11-D DISK CONTROL | F | | 11 FAMILY | 89.00 | M7464-00 | KA785,TBM,CPU TRANSLATION BUFFER MATRIX, | | | 11/785 | 746.00 |
| M7256-00 | RK11-D REGISTER | B | | 11 FAMILY | 89.00 | M7465-00 | KA785,IDP,CPU INSTRUCTION DATA PATH,4-LA | | | 11/785 | 509.00 |
| M7257-00 | RK11-D BUS CONTROL | B | | 11 FAMILY | 100.00 | M7466-00 | KA785,IRC,CPU INSTRUCTION DECODE & CLOCK | | | 11/785 | 473.00 |
| M7258-00 | LP11/LS11 INTERFACE,QUAD | D | H | 11 FAMILY | 105.00 | M7467-00 | KA785,DBP,CPU DATA PATH "B",4-LAYER HEX | | | 11/785 | 588.00 |
| M7259-00 | MODULE, PARITY CONTROL | C | | 11 FAMILY | 80.00 | M7468-00 | KA785,DEP,CPU DATA PATH E,4-LAYER HEX 12 | | | 11/785 | 473.00 |
| M7260-00 | DATA PATHS | B | | 11/05 | 158.00 | M7468-YA | DEP, DATAPATH MODULE,16-31 BITS FOR KA78 | | A1 | 11/785 | 473.00 |
| M7261-00 | CONTROL LOGIC E MICROPROGRAM | C | | 11/05 | 158.00 | M7469-00 | KA785,DDP,CPU DATA PATH D,4-LAYER HEX 12 | | | 11/785 | 604.00 |
| M7263-00 | KD11-D PROCESSOR MOD HEX | D | | 11/04 | 179.00 | M7469-YA | DDP, DATAPATH MODULE, 08-15 BITS FOR KA7 | | A1 | 11/785 | 829.00 |
| M7264-00 | USE KD11-F | | | LSH11 | 00.00 | M7470-00 | KA785,DCP,CPU DATA PATH C,4-LAYER HEX 12 | | | 11/785 | 473.00 |
| M7264-AB | USE KD11-F | | | LSH11 | 00.00 | M7470-YA | DCP, DATAPATH MODULE, 00-07 BITS FOR KA7 | | A1 | 11/785 | 605.00 |
| M7264-BB | LSH11 CPU MODULE | E | | LSH11 | 123.00 | M7471-00 | KA785,DAP,CPU DATA PATH A,4-LAYER HEX 12 | | | 11/785 | 431.00 |
| M7264-CB | USE KD11-F | | | 11/03 | 00.00 | M7471-YA | DAP, DATAPATH CONTROL MODULE FOR KA785 | | A1 | 11/785 | 624.00 |
| M7264-DB | USE KD11-F | | | 11/03 | 00.00 | M7472-00 | KA785,CEH (CONDITION CODES,EXCEPTIONS,HI | | | 11/785 | 431.00 |
| M7264-EB | USE KD11-F | C | | 11/03 | 00.00 | M7473-00 | KA785,ICL (INTERRUPT CONTROL,LOW BITS),4 | | | 11/785 | 520.00 |
| M7264-YA | USE M7264YC | C | | LSH11 | 00.00 | M7474-00 | KA785,CLK (CPU CLOCK)4-LAYER HEX 12 | | | 11/785 | 1040.00 |
| M7264-YB | LSI-11 CPU MODULE | E | 1 | LSH11 | 191.00 | M7475-00 | KA785,JCS,JOINT CONTROL STORE,4-LAYER HE | | | 11/785 | 1040.00 |
| M7264-YC | LST-11 CPU MODULE | E | | LSH11 | 131.00 | M7476-00 | KA785,USC,MICRO SEQUENCER CONTROL,4-LAYE | | | 11/785 | 509.00 |
| M7265-00 | USE M8265 | C | | 11/34-34A | 00.00 | M7477-00 | KA785,CIB,CPU CONSOLE INTERFACE,4-LAYER | | | 11/785 | 431.00 |
| M7268-00 | RK11-D ADAPTER | C | 1 | LSH11 | 51.00 | M7478-AA | RTVAX W/1MB,FP,INCL TIMR OF YEAR CLOCK,B | | | MICROVAX2 | 550.00 |
| M7269-00 | RKV11 CONTROL | C | 1 | LSH11 | 50.00 | M7478-AF | USE M7478-AA | | | MICROVAX2 | 00.00 |
| M7270-00 | KD11-HA, M7264-YA ON DOUBLE 8.5 | E | | LSH11 | 89.00 | M7483-00 | LOW SPEED SERIAL IMEINT | B | A | PDP FAMILY | 101.00 |
| M7277-00 | SCANNERS & NPR,DH11,HEX 8.5 | C | | 11 FAMILY | 105.00 | M7485-00 | USE M7485-YA | | | UDA50 | 00.00 |



Prices Effective 02-January-89 to 30-June-89
When you need a part repaired, call 800-225-5385.

DECmailer PRICE LIST

| PART NUMBER | DESCRIPTION | LOWEST ACCEPTABLE | | | REPAIR PRICE | PART NUMBER | DESCRIPTION | LOWEST ACCEPTABLE | | | REPAIR PRICE |
|-------------|--|-------------------|-----|------------|--------------|-------------|---|-------------------|-----|------------|--------------|
| | | ETCH | REV | USED ON | | | | ETCH | REV | USED ON | |
| M7485-YA | M7485 W/BLASTED ROMS,4-LAYER HEX | A | | UDA50 | 700.00 | M7656-00 | Q-BUS SINGLE BOARD COLOUR GRAPHICS CONTR | | | | 1000.00 |
| M7486-00 | UDA SI | A | | UDA50 | 700.00 | M7658-00 | 16 BIT PARALLEL I/O W/ DMA + BLOCK MODE | | | MICROVAX2 | 160.00 |
| M7487-00 | 2 LINE COMM FRONT END PROCESSOR (SYNC & | | | 11 FAMILY | 1300.00 | M7670-00 | TIMER, FORWARD B.O.T | C | | TU10 | 70.00 |
| M7500-00 | Q-COMMS CONTROLLER | | | 11 FAMILY | 394.00 | M7671-00 | MASTER/SLAVE BUS DRIVER FOR TU10 MASTERS | B | | TU10 | 100.00 |
| M7504-00 | Q-BUS TO ETHERNET ADAPTER,DUAL | B | | MICROVAX2 | 225.00 | M7672-00 | TU10 COMMAND BUFFERS | B | | TU10 | 150.00 |
| M7504-PA | M7504-YA W/S-BOX BULKHEAD HANDLE ASSY | | | MICROVAX2 | 350.00 | M7676-00 | DC310 (TINY 11) 2 SERIAL, 1 PARALLEL LINE | | | LSI11 | 131.00 |
| M7505-00 | CONDITIONING MODULE FOR BTR INTERFACE | | | ETHERNET | 280.00 | M7680-00 | RK05F,SECTOR CTR,INDEX & PHOTOAMP,DUAL 8 | B | | RK05 | 80.00 |
| M7506-AA | MSV11-MA 512KB 18BIT RAM,256K DIPS,-M750 | | | MEMORIES | 500.00 | M7681-00 | CYLINDER ADDRESS & TRACK DIFF,DUAL 8.5 (| B | | RK05 | 150.00 |
| M7506-BA | MSV11-MB 1MB RAM,256K DIPS,-M7506-BC,-BF | | | MEMORIES | 525.00 | M7684-00 | CONTROL SEQUENCER | D | | RM03 | 155.00 |
| M7513-00 | RD/RX DISK EXPANDER FOR RQDXX DISK CNTLR | | | | 200.00 | M7685-00 | USE M8685 | C | | RM02 | 00.00 |
| M7516-00 | Q-BUS TO ETHERNET ADAPTOR,DUAL | | | ETHERNET | 430.00 | M7685-YA | DATA SEQUENCER FOR RM02/3/5,HEX,CAN BE R | C | | RM03 | 79.00 |
| M7516-PA | M7516 WITH S-BOX HANDLE (Q-BUS TO ETHERN | | | VAX FAMILY | 270.00 | M7688-00 | USE M7686-YA | C | | RM03 | 00.00 |
| M7521-AA | DELUA-AA ETHERNET LSI UNIBUS ADAPTOR (= | | | DELUA | 375.00 | M7688-YA | RM02/3/5 CONTROL INTERFACE,HEX,CAN REPLA | C | | RM03 | 85.00 |
| M7522-00 | RX50 CONTROL FOR UNIBUS,QUAD | | | RX50 | 170.00 | M7700-00 | USE M768000 | J | | RK05 | 00.00 |
| M7540-00 | FP785,FNM,FLT PT FRACTION NORMALIZER,70- | | | 11/785 | 551.00 | M7701-00 | DEC PAK CONTROL & INTERLOCK | K | | RK05 | 80.00 |
| M7541-00 | FP785 FMH,FLT PT FRACTION MULTIPLR HI,70 | | D1 | 11/785 | 457.00 | M7702-00 | USE M768100 | B | | RK05 | 00.00 |
| M7542-00 | FP785,FML,FLT PT FRACTION MULTIPLIER LOW | | | 11/785 | 462.00 | M7705-00 | RK06 DRIVE CONTROL LOGIC | E | | RK06 | 105.00 |
| M7543-00 | FP785,FAD,FLOATING PT FRACTION ADDER | | | 11/785 | 509.00 | M7706-00 | RK06 INTERFACE + TIMING | A | C | RK06 | 105.00 |
| M7544-00 | FP785,FCT,FLOATING PT ACCELERATOR CONTRO | | | 11/785 | 578.00 | M7707-00 | RK06 SERVO CONTROL | C | | RK06 | 117.00 |
| M7546-00 | Q-BUS TAPE CONTROLLER,DBL 8.5 | | | TK50 | 310.00 | M7708-00 | RK06 TRACK POS DETECTOR/PLO | C | | RK06 | 168.00 |
| M7547-00 | UNIBUS TMSCP TAPE CONTROLLER,QUAD | | | TK50 | 395.00 | M7726-00 | RX01 TRACK LOGIC | B | | RX01 | 131.00 |
| M7551-AA | 1MB Q22 MEM,PAR,CSR,64K CHIPS,-M7551-AC, | | | MEMORIES | 394.00 | M7727-00 | RX01 R/W CONTROL | B | A | RX01 | 131.00 |
| M7551-BA | 2MB Q22 MEM,PAR,CSR,256K CHIPS,-M7551-BC | | | MEMORIES | 394.00 | M7728-YC | M7728 ETCH REV L AND LATER | D | | LA36 | 95.00 |
| M7551-CA | 4MB Q22 MEM,PAR,CSR,256K CHIPS,-M7551-CC | | | MEMORIES | 394.00 | M7729-00 | SERVO ANELOG BOARD RK06 | B | | RK06 | 162.00 |
| M7552-00 | QBUS CONTROL FOR RRD50 (M7552) | | | RRD50 | 340.00 | M7730-00 | RK06 DUCIL PORT LOGIC BOARD | C | | RK06 | 68.00 |
| M7554-00 | J11 CPU,15MHZ,512KB MEM,2 SERIAL LINES,L | | | 11 FAMILY | 207.00 | M7736-00 | MODULE LAXX-KY | B | | LA36 | 74.00 |
| M7555-00 | Q-BUS WINCHESTER AND FLOPPY DISK CONTROL | | | RD FAMILY | 310.00 | M7740-00 | Q22 TO LESI BUS ADAPTOR(REPLACES M8654JU | D | | RC25 | 150.00 |
| M7558-AA | MSV11-SA 2MB PARITY CSR MEM = M7558-AC,- | | | 11 FAMILY | 200.00 | M7741-00 | TIMING & REGISTERS | B | A | PDP FAMILY | 103.00 |
| M7559-00 | TQK70 TAPE CONTROLLER FOR TK70 | | | TK70 | 336.00 | M7744-00 | USE M7744-YC | C | | RX02 | 00.00 |
| M7602-00 | USE M7602-YA | A | | VAXSTATION | 00.00 | M7744-YC | M7744 WITH FCC COMPLIANCE,HEX | D | | RX02 | 125.00 |
| M7602-YA | QVSS(QBUS VIDEO SUB SYS MODULE)BIT MAP G | | | VAXSTATION | 263.00 | M7745-00 | USE M7745-YA | C | | RX02 | 00.00 |
| M7605-00 | USE 302297101 | | | TK25 | 00.00 | M7745-YA | M7745 WITH FCC COMPLIANCE,HEX | D | | RX02 | 125.00 |
| M7606-AA | MICROVAX II W/1MB,FP,INCL TIME OF YR CLO | | | MICROVAX2 | 1500.00 | M7751-00 | ENCODER - DECODER PLL | E | | RS FAMILY | 90.00 |
| M7606-AC | USE M7606-AA | | | MICROVAXII | 00.00 | M7753-00 | RS03 DATA BUFFER | C | | RS FAMILY | 70.00 |
| M7606-AF | USE M7606-AA | | | MICROVAXII | 00.00 | M7755-00 | RS03 STATUS CONTROL | K | | RS FAMILY | 70.00 |
| M7606-AH | USE M7606-AA | | | MICROVAXII | 00.00 | M7760-00 | TU60 CASSETTE LOGIC | E | | TU60 | 84.00 |
| M7607-AA | 1 MB MEMORY = M7607-AC,-AF,-AH,-AP,-AV, | | | MICROVAX2 | 221.00 | M7761-00 | TU60 CASSETTE SERVO & READ | D | | TU60 | 131.00 |
| M7608-AA | 2MB MEMORY = M7608-AC,-AF,-AH,-AP,-AS,-A | | | MICROVAX2 | 120.00 | M7762-00 | RL11 CONTROLLER | H | K | RL01 | 200.00 |
| M7608-AC | USE M7608-AA | | | MICROVAXII | 00.00 | M7773-00 | ASYNCHRONOUS LOGIC-RP04 | D | E | RP04 | 169.00 |
| M7608-AH | USE M7608-AA | | | MICROVAXII | 00.00 | M7774-00 | REGISTER LOGIC-RP04 | E | E | RP04 | 175.00 |
| M7608-BA | 4MB MEMORY = M7608-BC,-BF,-BH,-BP,-BS,-B | | | MICROVAX2 | 310.00 | M7776-00 | ERROR CORRECT LOGIC-RP0H | D | D | RP04 | 169.00 |
| M7608-BC | USE M7608-BA | | | MICROVAXII | 00.00 | M7786-00 | SEEK & SEARCH CNTL LOGIC | E | | RP05/6 | 168.00 |
| M7608-BP | USE M7608-BA | | | MICROVAXII | 00.00 | M7787-00 | INTERFACE CONTROL | C | | RP05/6 | 270.00 |
| M7609-AA | 8MB PARITY 36BIT RAM,256K ZIPS,-M7609-AC | | | MICROVAX2 | 415.00 | M7788-00 | RP05/6 MINIMUM DEVICE LEVEL INTERFACE TR | A | | RP05/6 | 78.00 |
| M7609-AF | USE 00M7609AA | | | MICROVAXII | 00.00 | M7789-00 | INTERFACE RECEIVER | A | | | 61.00 |
| M7609-AH | USE 00M7609AA | | | MICROVAXII | 00.00 | M7792-00 | DEUNA PORT MODULE(UNIBUS TO ETHERNET MIC | | | ETHERNET | 250.00 |
| M7609-AP | USE 00M7609AA | | | MICROVAXII | 00.00 | M7793-00 | DEUNA LINK MODULE(M7792 TO ETHERNET BUS | | | ETHERNET | 250.00 |
| M7609-AS | USE 00M7609AA | | | MICROVAXII | 00.00 | M7800-00 | ASYNCHRONOUS LINE INTERFACE | B | | 11/05 | 130.00 |
| M7609-AV | USE 00M7609AA | | | MICROVAXII | 00.00 | M7800-YA | M7800 WITHOUT EIA CHIPS | H | | 11/05 | 89.00 |
| M7616-00 | J11 CPU,512KB RAM,64KB PROM,Q22 PERIPHER | | | LSI11 | 550.00 | M7801-00 | DATA WORD CONTROL MC11 | | | | 306.00 |
| M7620-AA | CVAX 90NS CPU MOD,2 LEVEL 64KB CACHE,ECC | | | VAX FAMILY | 1020.00 | M7807-00 | EIA LEVEL CONVERT | D | W | 11 FAMILY | 105.00 |
| M7620-BA | M7620-AA W/MOD ROM CODE FOR SINGLE USER | | B1 | VAX FAMILY | 1015.00 | M7808-00 | USE M7147 | D | | 11 FAMILY | 00.00 |
| M7621-AA | 8MB 256K CHIP RAM ARRAY = M7621-AF,-AH, | | | VAX FAMILY | 300.00 | M7809-00 | USE AR11 | B | | 11 FAMILY | 00.00 |
| M7651-00 | DRV11-WA,DMA 18/22-BIT PARALLEL GEN PURP | | | 11 FAMILY | 130.00 | M7810-00 | PC11-INTERFACE | C | | 11 FAMILY | 80.00 |
| M7651-PA | DRV11-WA,DMA 18/22 BIT PAR GP INTFC,DUA | C | | MICROVAX2 | 300.00 | M7812-00 | DQ11-AA BUS SELECTOR CSR SHIFT REGISTER | E | | 11 FAMILY | 175.00 |

digital

Prices Effective 02-January-89 to 30-June-89
When you need a part repaired, call 800-225-5385.

SPARES PRICE LIST C-9

DECmailer PRICE LIST

| PART NUMBER | DESCRIPTION | LOWEST ACCEPTABLE | | | REPAIR PRICE | PART NUMBER | DESCRIPTION | LOWEST ACCEPTABLE | | | REPAIR PRICE |
|-------------|--|-------------------|-----|-----------|--------------|-------------|-------------------------------------|-------------------|-----|-----------|--------------|
| | | ETCH | REV | USED ON | | | | ETCH | REV | USED ON | |
| M7813-00 | DQ11-AA CHAR COUNT BUSS ADR SHIFT CONT | E | 3H | 11 FAMILY | 175.00 | M7847-ED | USE MS11-FP | | | MEMORIES | 00.00 |
| M7814-00 | 20MA DATA MUX | D | | 11 FAMILY | 158.00 | M7847-EE | USE MS11-H | | | MEMORIES | 00.00 |
| M7815-00 | DQ11-AA MODEM CONT (DQ11-BA) | A | | 11 FAMILY | 70.00 | M7847-EF | USE MS11-HP | | | MEMORIES | 00.00 |
| M7816-00 | DQ11-AB BUSS SELECTOR & CLOCK CHECK CHAR | F | | 11 FAMILY | 90.00 | M7847-EH | USE MS11-J | | | MEMORIES | 00.00 |
| M7817-00 | DQ11-AB CHAR DET & SEQ CONT (DQ11-BB) | E | | 11 FAMILY | 90.00 | M7847-EJ | USE MS11-JP | | | MEMORIES | 00.00 |
| M7818-00 | DQ11-AA HARDWIRE CHAR DET & NPR CONT | D | | 11 FAMILY | 70.00 | M7847-HJ | USE MS11-JP | | | MEMORIES | 00.00 |
| M7819-00 | DZ11-A 8-LINE DBL BUF ASYNC EIA 50 TO 96 | C | D | 11 FAMILY | 158.00 | M7847-JJ | USE MS11-JP | | | MEMORIES | 00.00 |
| M7821-00 | INTERRUPT CONTROL | A | B | 11 FAMILY | 68.00 | M7847-YA | USE MS11-E | | | MEMORIES | 00.00 |
| M7822-00 | DU11 QUAD 8.5 | E | | 11 FAMILY | 174.00 | M7847-YB | USE MS11-EP | | | MEMORIES | 00.00 |
| M7823-00 | WATCHD G TIMER KW11-W | B | | 11 FAMILY | 430.00 | M7847-YC | USE MS11-F | | | MEMORIES | 00.00 |
| M7826-00 | TRANSMITTER SERIAL LINE (RCVR) | C | | 11 FAMILY | 90.00 | M7847-YD | USE MS11-FP | | | MEMORIES | 00.00 |
| M7828-00 | REMOTE DT03 BUS SWITCH CONTROL DOUBLE 8. | | P | | 90.00 | M7847-YE | USE MS11-H | | | MEMORIES | 00.00 |
| M7833-00 | ASYNC MUX LINE CARD HEX (DV11-BB&BC | A | | 11 FAMILY | 175.00 | M7847-YF | USE MS11-HP | | | MEMORIES | 00.00 |
| M7836-00 | DV11 ALU & TRANSFER BUS | B | | 11 FAMILY | 175.00 | M7847-YH | USE MS11-J | | | MEMORIES | 00.00 |
| M7837-00 | DV11 UNIBUS DATA & NPR CONT | B | | 11 FAMILY | 185.00 | M7847-YJ | USE MS11-JP | | | MEMORIES | 00.00 |
| M7838-00 | DV11 ROM RAM & BRANCH | C | F | 11 FAMILY | 185.00 | M7850-00 | MEM PARITY BOARD FOR G651 | B | | 11/04 | 84.00 |
| M7839-00 | SYNC MUX LINE CARD | B | | 11 FAMILY | 185.00 | M7855-00 | UNIBUS EXERCISER PDP11 | B | | 11/60 | 1170.00 |
| M7840-00 | KE11-B | B | | 11 FAMILY | 110.00 | M7856-00 | DL11-W SLU/RTC OPT QUAD | D | | 11/04 | 100.00 |
| M7843-00 | DIGITAL I/O DR11-K | B | B | 11 FAMILY | 325.00 | M7859-00 | CONSOLE PROGRAMMER | C | | 11/04 | 100.00 |
| M7846-00 | RX01 UNIBUS INTERFACE,QUAD | B | | RX01 | 200.00 | M7860-00 | DR11-C INTERFACE | D | K | 11 FAMILY | 225.00 |
| M7847-AA | USE MS11-E | | | MEMORIES | 00.00 | M7864-00 | 2-WORD UNIBUS INPUT INTERFACE | C | | 11 FAMILY | 90.00 |
| M7847-AB | USE MS11-EP | | | MEMORIES | 00.00 | M7865-00 | 2-WORD OUTPUT INTERFACE | | | 11 FAMILY | 130.00 |
| M7847-AC | USE MS11-F | | | MEMORIES | 00.00 | M7867-00 | SYNC MODEM DUP11-DA | D | | 11 FAMILY | 160.00 |
| M7847-AD | USE MS11-FP | | | MEMORIES | 00.00 | M7871-00 | DIAGNOSTIC CONTROL STORE | C | | 11 FAMILY | 170.00 |
| M7847-AE | USE MS11-H | | | MEMORIES | 00.00 | M7872-00 | U WORD BOARD | D | | 11/60 | 335.00 |
| M7847-AF | USE MS11-HP | | | MEMORIES | 00.00 | M7873-00 | 11 DDO DATA PATH | F | | 11/60 | 236.00 |
| M7847-AH | USE MS11-J | | | MEMORIES | 00.00 | M7874-00 | CACHE KIT FOR 11PDO | C | | 11/60 | 142.00 |
| M7847-AJ | USE MS11-JP | | | MEMORIES | 00.00 | M7875-00 | CACHE/KT FOR 11 PDO | C | | 11/60 | 338.00 |
| M7847-BA | USE MS11-E | | | MEMORIES | 00.00 | M7876-00 | 11PDQ TIMING BOARD | F | | 11/60 | 137.00 |
| M7847-BB | USE MS11-EP | | | MEMORIES | 00.00 | M7877-00 | 11PDQ STATUS BOARD | C | | 11/60 | 200.00 |
| M7847-BC | USE MS11-F | | | MEMORIES | 00.00 | M7878-00 | FP11-E,EXPONENT,4-LAYER HEX | B | | 11/60 | 176.00 |
| M7847-BD | USE MS11-FP | | | MEMORIES | 00.00 | M7879-00 | FP11-E,EXPONENT,4-LAYER HEX | B | | 11/60 | 158.00 |
| M7847-BE | USE MS11-H | | | MEMORIES | 00.00 | M7880-00 | FP11-E FNJA(FLOATING POINT) | B | | 11/60 | 211.00 |
| M7847-BF | USE MS11-HP | | | MEMORIES | 00.00 | M7881-00 | LOW DATA PATH | C | | 11/60 | 188.00 |
| M7847-BH | USE MS11-J | | | MEMORIES | 00.00 | M7883-00 | 24 CHANNEL DATA MUX,HEX | | | | 650.00 |
| M7847-BJ | USE MS11-JP | | | MEMORIES | 00.00 | M7884-00 | UNIBUS INTERFACE CARD,ASYNC,HEX | | | | 325.00 |
| M7847-CA | USE MS11-E | | | MEMORIES | 00.00 | M7891-AA | USE MS11-LA | | | MEMORIES | 00.00 |
| M7847-CB | USE MS11-EP | | | MEMORIES | 00.00 | M7891-BA | USE MS11-LB | | | MEMORIES | 00.00 |
| M7847-CC | USE MS11-F | | | MEMORIES | 00.00 | M7891-DA | USE MS11-LD | | | MEMORIES | 00.00 |
| M7847-CD | USE MS11-FP | | | MEMORIES | 00.00 | M7891-DB | USE MS11-LD | | | MEMORIES | 00.00 |
| M7847-CE | USE MS11-H | | | MEMORIES | 00.00 | M7892-00 | CASSETTE INTERFACE PR | B | | 11 FAMILY | 105.00 |
| M7847-CF | USE MS11-HP | | | MEMORIES | 00.00 | M7893-YA | 48 CHANNEL OUTPUT DRS11 | | | | 490.00 |
| M7847-CH | USE MS11-J | | | MEMORIES | 00.00 | M7895-YA | 48 CHANNEL INPUT, DSS11 | | | | 600.00 |
| M7847-CJ | USE MS11-JP | | | MEMORIES | 00.00 | M7899-00 | DZ32 8-LINE ASYNC MUX MODEM CONTROL | E | | 11 FAMILY | 300.00 |
| M7847-DA | USE MS11-E | | | MEMORIES | 00.00 | M7900-00 | UNIBUS INTERFACE RK611 | 1 | C | RK06 | 120.00 |
| M7847-DB | USE MS11-EP | | | MEMORIES | 00.00 | M7901-00 | BOARD REGISTER RK611 | D | | RK06 | 120.00 |
| M7847-DC | USE MS11-F | | | MEMORIES | 00.00 | M7902-00 | CONTROL RK611 | C | | RK06 | 300.00 |
| M7847-DD | USE MS11-FP | | | MEMORIES | 00.00 | M7903-00 | BOARD DATA | D | | RK06 | 150.00 |
| M7847-DE | USE MS11-H | | | MEMORIES | 00.00 | M7904-00 | INTERFACE DRIVE RK611 | B | | RK06 | 150.00 |
| M7847-DF | USE MS11-HP | | | MEMORIES | 00.00 | M7906-00 | SERVO ANALOG | B | | RK07 | 128.00 |
| M7847-DH | USE MS11-J | | | MEMORIES | 00.00 | M7907-00 | SERVO CONTROL | A | | RK07 | 108.00 |
| M7847-DJ | USE MS11-JP | | | MEMORIES | 00.00 | M7908-00 | TRACK POSITIONING OSCILL | B | F | RK07 | 200.00 |
| M7847-EA | USE MS11-E | | | MEMORIES | 00.00 | M7911-00 | TMB11 TAPE CTRL | B | | 11 FAMILY | 95.00 |
| M7847-EB | USE MS11-EP | | | MEMORIES | 00.00 | M7912-00 | TMB-11 MODULE | C | | RK07 | 105.00 |
| M7847-EC | USE MS11-F | | | MEMORIES | 00.00 | M7915-00 | IEC11-B CONTROL | | | 11 FAMILY | 278.00 |



Prices Effective 02-January-89 to 30-June-89
When you need a part repaired, call 800-225-5385.

DECmailer PRICE LIST

| PART NUMBER | DESCRIPTION | LOWEST ACCEPTABLE | | | REPAIR PRICE | PART NUMBER | DESCRIPTION | LOWEST ACCEPTABLE | | | REPAIR PRICE |
|-------------|--|-------------------|-----|-----------|--------------|-------------|--|-------------------|-----|-----------|--------------|
| | | ETCH | REV | USED ON | | | | ETCH | REV | USED ON | |
| M7924-00 | MA11-F UNIBUS INTERFACE | D | | 11 FAMILY | 173.00 | M8003-00 | DIFFERENTIAL TRANSCEIVER PCL11-B (CSS) | | | 11 FAMILY | 918.00 |
| M7930-00 | LP11 INTERFACE | D | | 11 FAMILY | 150.00 | M8012-00 | USE M8012-YA | C | 3 | 11/03 | 00.00 |
| M7940-00 | SERIAL LINE 11V03 | B | B | 11/03 | 68.00 | M8012-YA | Q-BUS TERMINATOR,SPCE FOR BOOT & DIAG RO | D | | 11/03 | 95.00 |
| M7941-00 | 16 BIT PARALLEL LINE UNIT 11V03 | C | | 11/03 | 63.00 | M8016-00 | POWER FAIL,CLOCK MODULE | | | 11 FAMILY | 75.00 |
| M7942-00 | 4-K 16 BIT PROM 11V03 | D | | 11/03 | 74.00 | M8016-YB | M8016 W 120-OHM TERMINATION | | | 11 FAMILY | 200.00 |
| M7942-YA | USE MRV11VA | D | | VT71-71T | 00.00 | M8017-00 | USE DLV11-E | C | | LSI11 | 00.00 |
| M7942-YC | MRV11-VC, VT72 BOOTSTRAP | D | | 11/03 | 80.00 | M8017-AA | DLV11-E & DLV11-EC (ETCH REV D),REPLACES | | | LSI11 | 88.00 |
| M7944-00 | 4K 16BIT RAM 11V03 | B | A | 11/03 | 90.00 | M8018-00 | WRITEABLE CONTROL STORE RE,DOUBLE | B | | 11/03 | 263.00 |
| M7946-00 | RXV11 CONTROL,DOUBLE 8.5 | B | | 11/03 | 79.00 | M8020-00 | SERIAL SYNC INTERF,1 LINE PROG BIT STUFF | B | D | 11 FAMILY | 150.00 |
| M7949-00 | M7949 LA180 INTERFACE | C | | 11/03 | 74.00 | M8021-00 | LSI11 PROM/RAM BOARD | | | 11/03 | 79.00 |
| M7950-00 | DRV11-B,DMA 16-BIT PARALLEL GEN PURPOSE | C | | 11/03 | 100.00 | M8026-00 | NC11-A,DMA CONTROLLER QUAD | C | | 11 FAMILY | 123.00 |
| M7951-00 | DUV11-DA,SYNC INTERFACE,CHARACTER PROTOC | D | | 11/03 | 100.00 | M8027-00 | Q-BUS UNIVERSAL PRINTER INTERFACE DOUBLE | B | | 11/03 | 74.00 |
| M7952-00 | USE KVV11-A | B | | 11/03 | 00.00 | M8028-00 | DLV11-A,-C,ASYNC INTERFACE 20MA CURRENT | C | D | LSI11 | 79.00 |
| M7953-00 | USE MNCKW | | | LSI11 | 00.00 | M8029-00 | RXV21,Q-BUS RX02 INTERFACE,DOUBLE 8.5 | D | | RX02 | 105.00 |
| M7954-00 | INTERFACE LSI11 BUS TO INST. BUS | C | | 11/03 | 110.00 | M8030-00 | 16 BIT LATCH RELAY (ICMRL-OA) | D | | 11 FAMILY | 180.00 |
| M7955-00 | USE MSV11-CD | C | | MEMORIES | 00.00 | M8036-00 | Q-BUS CONTROL FOR MCV11-A, QUAD | B | | 11 FAMILY | 92.00 |
| M7955-AA | USE MSV11-CA | | | 11 FAMILY | 00.00 | M8040-00 | USE DRV11-C | | | 11 FAMILY | 00.00 |
| M7955-AB | USE MSV11-CB | | | MEMORIES | 00.00 | M8043-00 | DLV11-J,4-SERIAL LINE PERIPHEREL INTERFA | D | F | LSI11 | 99.00 |
| M7955-AC | USE MSV11-CC | | | MEMORIES | 00.00 | M8044-AA | USE MSV11-DA | | | MEMORIES | 00.00 |
| M7955-AD | USE MSV11-CD | | | MEMORIES | 00.00 | M8044-AB | USE MSV11-DA | | | MEMORIES | 00.00 |
| M7955-BA | USE MSV11-CA | | | MEMORIES | 00.00 | M8044-AC | USE MSV11-DA | | | MEMORIES | 00.00 |
| M7955-BB | USE MSV11-CB | | | MEMORIES | 00.00 | M8044-AD | USE MSV11-DA | | | MEMORIES | 00.00 |
| M7955-BC | USE MSV11-CC | | | MEMORIES | 00.00 | M8044-BA | USE MSV11-DB | | | MEMORIES | 00.00 |
| M7955-BD | USE MSV11-CD | | | MEMORIES | 00.00 | M8044-BB | USE MSV11-DB | | | MEMORIES | 00.00 |
| M7955-BE | USE MSV11-CA | | | MEMORIES | 00.00 | M8044-BC | USE MSV11-DB | | | MEMORIES | 00.00 |
| M7955-BF | USE MSV11-CB | | | MEMORIES | 00.00 | M8044-BD | USE MSV11-DB | | | MEMORIES | 00.00 |
| M7955-BH | USE MSV11-CC | | | MEMORIES | 00.00 | M8044-CA | USE MSV11-DC | | | MEMORIES | 00.00 |
| M7955-BJ | USE MSV11-CD | | | MEMORIES | 00.00 | M8044-CB | USE MSV11-DC | | | MEMORIES | 00.00 |
| M7955-YA | USE MSV11-CA | | | MEMORIES | 00.00 | M8044-CC | USE MSV11-DC | | | MEMORIES | 00.00 |
| M7955-YB | USE MSV11-CB | | | MEMORIES | 00.00 | M8044-CD | USE MSV11-DC | | | MEMORIES | 00.00 |
| M7955-YC | USE MSV11-CC | | | MEMORIES | 00.00 | M8044-CE | USE MSV11-DC | | | MEMORIES | 00.00 |
| M7955-YD | USE MSV11-CD | | | MEMORIES | 00.00 | M8044-CF | USE MSV11-DC | | | MEMORIES | 00.00 |
| M7955-YE | USE MSV11-CA | | | MEMORIES | 00.00 | M8044-DA | MSV11-DD 32K 16BIT MOS RAM 16K CHIPS M80 | | | MEMORIES | 120.00 |
| M7955-YF | USE MSV11-CB | | | MEMORIES | 00.00 | M8044-DB | USE MSV11-DD | | | MEMORIES | 00.00 |
| M7955-YH | USE MSV11-CC | | | MEMORIES | 00.00 | M8044-DC | USE MSV11-DD | | | MEMORIES | 00.00 |
| M7955-YJ | USE MSV11-CD | | | MEMORIES | 00.00 | M8044-DD | USE MSV11-DD | | | MEMORIES | 00.00 |
| M7957-00 | 4 LINE DBL BUF ASYNC MUX EIA 50-10K BAUD | C | B | 11/03 | 79.00 | M8044-DE | USE MSV11-DD | | | MEMORIES | 00.00 |
| M7958-00 | I/O CONTROL MODULE | D | | 11 FAMILY | 90.00 | M8044-DF | USE MSV11-DD | | | MEMORIES | 00.00 |
| M7959-00 | Q-BUS TO D-BUS CABLE I/O DAISY CHAIN BUS | | | 11 FAMILY | 245.00 | M8044-DH | USE MSV11-DD | | | MEMORIES | 00.00 |
| M7982-00 | UNIBUS TO SERIAL CONTROLLER | D | | 11 FAMILY | 125.00 | M8044-DK | USE MSV11-DD | | | MEMORIES | 00.00 |
| M7983-00 | 32KX16 CONTROLLER | D | 1 | 11 FAMILY | 168.00 | M8044-EA | 24K 16BIT MOS RAM,16K CHIPS = M8044-EB,- | | | MEMORIES | 120.00 |
| M7984-AB | USE MS11-KE | | | MEMORIES | 00.00 | M8044-EB | USE M8044-EA | | | MEMORIES | 00.00 |
| M7984-EA | USE MS11-KE | | | MEMORIES | 00.00 | M8044-EE | USE MSV11-DE | | | MEMORIES | 00.00 |
| M7984-EB | USE MS11-KE | | | MEMORIES | 00.00 | M8044-EF | USE MSV11-DE | | | MEMORIES | 00.00 |
| M7984-EC | USE MS11-KE | | | MEMORIES | 00.00 | M8044-EK | USE MSV11-DE | | | MEMORIES | 00.00 |
| M7984-ED | USE MS11-KE | | | MEMORIES | 00.00 | M8045-AA | MSV11-EA 4K 18BIT MOS RAM,4K CHIPS = M80 | | | MEMORIES | 250.00 |
| M7984-EE | MS11 K | | | 11 FAMILY | 220.00 | M8045-AB | USE MSV11-EA | | | MEMORIES | 00.00 |
| M7985-00 | IEC BUS INTERFACE, IEC11-A (CSS) | A | | 11 FAMILY | 473.00 | M8045-AC | USE MSV11-EA | | | MEMORIES | 00.00 |
| M7991-00 | PCL11-A,TXM (TRANSMITTER) INTERFACE HEX | A | | 11 FAMILY | 250.00 | M8045-AD | USE MSV11-EA | | | MEMORIES | 00.00 |
| M7992-00 | PCL11-A,TXM UNIBUS CONTROL HEX | B | | 11 FAMILY | 130.00 | M8045-BA | USE MSV11-EB | | | MEMORIES | 00.00 |
| M7993-00 | PCL11-A,TXM REGISTERS HEX | A | 1 | 11 FAMILY | 150.00 | M8045-BB | USE MSV11-EB | | | MEMORIES | 00.00 |
| M7994-00 | PCL11-A TDM BUS LOGIC + DRIVERS HEX | A | | 11 FAMILY | 150.00 | M8045-BC | USE MSV11-EB | | | MEMORIES | 00.00 |
| M7995-00 | PCL11-A,RCY (RECEIVER) REGISTERS HEX | A | | 11 FAMILY | 130.00 | M8045-BD | USE MSV11-EB | | | MEMORIES | 00.00 |
| M7996-00 | PCL11-A,RCV UNIBUS CONTROL HEX | | | 11 FAMILY | 293.00 | M8045-CA | MSV11-EC 16K 18BIT MOS RAM,16K CHIPS = M | | | MEMORIES | 185.00 |
| M7997-00 | PCL11-A,RCV INTERFACE HEX | A | | 11 FAMILY | 130.00 | M8045-CB | USE MSV11-EC | | | MEMORIES | 00.00 |

digital

Prices Effective 02-January-89 to 30-June-89
When you need a part repaired, call 800-225-5385.

SPARES PRICE LIST C-11

DECmailer PRICE LIST

| PART NUMBER | DESCRIPTION | LOWEST ACCEPTABLE | | | REPAIR PRICE | PART NUMBER | DESCRIPTION | LOWEST ACCEPTABLE | | | REPAIR PRICE | |
|-------------|--|-------------------|-----|-----------|--------------|-------------|---|-------------------|-----|-----------|--------------|-------|
| | | ETCH | REV | USED ON | | | | ETCH | REV | USED ON | | |
| M8045-CC | USE MSV11-EC | | | MEMORIES | 00.00 | M8108-YA | ROM BOARD | B | A | 11/45 | 128.00 | |
| M8045-CD | USE MSV11-EC | | | MEMORIES | 00.00 | M8109-00 | TIMING GENERATOR | C | | 11/45 | 234.00 | |
| M8045-DA | USE MSV11-ED | | | MEMORIES | 00.00 | M8110-00 | MOS/BIPOLAR MEMORY CONTROL | C | | 11/45 | 218.00 | |
| M8045-DB | USE MSV11-ED | | | MEMORIES | 00.00 | M8112-00 | F.P. ROM + ROM CONTROL | B | | 11/45 | 166.00 | |
| M8045-DC | USE MSV11-ED | | | MEMORIES | 00.00 | M8113-00 | FXP (FLOATING POINT EXPONENT DATA PATHS) | C | | 11/45 | 100.00 | |
| M8045-DD | USE MSV11-ED | | | MEMORIES | 00.00 | M8114-00 | FRACTION DATA PATH HIGH ORDER | B | | 11/45 | 163.00 | |
| M8045-DF | USE MSV11-ED | | | MEMORIES | 00.00 | M8115-00 | FRL (FRACTION LOW ORDER DATA PATH) 8.5 H | B | | 11/45 | 188.00 | |
| M8047-AA | ROMS, IS M8047-AB,-AC,-AD | D | A | 11 FAMILY | 105.00 | M8116-00 | SJB (SEGMENTATION JUMPER BOARD),8.5 HEX, | A | | 11/45 | 105.00 | |
| M8047-CA | MXV11-AC,16K RAM,IS M8047-CB,-CC,-CD,-CE | D | A | MEMORIES | 130.00 | M8119-00 | UNIBUS CONSOL CONTROL | A | R | 11/45 | 188.00 | |
| M8047-HA | MXV11-HA: 16KW RAM,2 ASYNC EIA SLU (8 BI | | | MEMORIES | 315.00 | M8120-00 | BIPOLAR MEM CONTROL | D | | 11/45 | 216.00 | |
| M8048-00 | MRV11-C UNIVERSAL-SOCKETS FOR 8 24-PIN R | C | | 11/03 | 84.00 | M8121-YA | USE MS11-AP | | | | MEMORIES | 00.00 |
| M8049-00 | DRV11-J,HI-DENSITY PARALLEL LINE UNIT | B | A | 11 FAMILY | 105.00 | M8123-00 | KB11-C,RAC (ROM & ADDRESS CONTROL),HEX,F | B | R | 11/70 | 168.00 | |
| M8050-00 | 16 BIT FLIP-FLOP RELAY | D | | 11 FAMILY | 180.00 | M8126-00 | FRACTION PROCESSOR HIGH ORDER | B | | 11/70 | 189.00 | |
| M8053-MA | M8053 W DDCMP CTL ROM (POINT TO POINT OR | | | 11/03 | 158.00 | M8127-00 | FRACTION PROCESSOR LOW ORDER | B | | 11/70 | 189.00 | |
| M8059-FA | MSV11-LF: -M8059-FC,-FF,-FH,-FJ,-FP (4-L | | | MEMORIES | 158.00 | M8128-00 | FRACTION PROCESSOR ROM CONTROL | B | | 11/70 | 168.00 | |
| M8059-FC | USE M8059-FA | | | MEMORIES | 00.00 | M8129-00 | FRACTION PROCESSOR EXPONENT PATH | B | | 11/70 | 163.00 | |
| M8059-FF | USE M8059-FA | | | | | M8130-00 | M8100 MODIFIED,DPA (DATA PATHS) 4-LAYER | A | | 11/70 | 137.00 | |
| M8059-FH | CSR 64K 18BIT MOS RAM,SINGLE VOLTAGE NEC | | | MEMORIES | 00.00 | M8131-00 | M8101 MODIFIED,GRA (GENERAL REGS & ALU C | B | | 11/70 | 137.00 | |
| M8059-FP | USE M8059-FA | | | MEMORIES | 184.00 | M8132-00 | M8102 MODIFIED,IRC (IR DECODE & COND COD | A | R | 11/70 | 137.00 | |
| M8059-KA | MSV11-LK: -M8059-KC,-KF,-KH,-KJ,-KP (4 L | | | MEMORIES | 00.00 | M8133-00 | M8103,MODIFIED,RAC (ROM & ROM CONT),4-LA | B | | 11/70 | 163.00 | |
| M8059-KC | USE M8059-KA | | | MEMORIES | 00.00 | M8134-00 | M8104 MODIFIED,PDR (PROC DATA & UNIBUS R | B | | 11/70 | 137.00 | |
| M8059-KF | USE M8059-KA | | | | | M8135-00 | M8105 MODIFIED: TMC (TRAP & MISC CONTROL) | 1 | 1 | 11/70 | 137.00 | |
| M8059-KH | USE M8059-KA | | | | | M8136-00 | M8106 MODIFIED: UBC (UNIBUS & CONSOLE CO | B | | 11/70 | 137.00 | |
| M8060-YA | M8060 WITH BDV11-BA PROMS | A | | LSI11 | 433.00 | M8137-00 | M8107 MODIFIED: SAP (SYSTEM ADDRESS PATH | A | | 11/70 | 131.00 | |
| M8061-00 | RL01/RL02 DISK CONTROL,22-BIT ADDRESS,QU | B | | RL01 | 170.00 | M8138-00 | M8108 MODIFIED: SSR (SEGMENTATION STATUS | A | | 11/70 | 163.00 | |
| M8063-AA | USE M8063-BA | | | LSI11 | 00.00 | M8138-YA | SSR (SEAGMENTATION STATUS REG) 4-LAYER H | A | | 11/70 | 131.00 | |
| M8063-BA | DC310 (TINY 11),2 SERIAL,1 PARALLEL LINE | | | LSI11 | 147.00 | M8139-00 | M8109 MODIFIED: TIG (TIMING GENERATOR) 4 | A | | 11/70 | 168.00 | |
| M8064-MA | M8064 W DDCMP PT TO PT OR MULTIDROP,INTE | | | LSI11 | 158.00 | M8140-00 | SEGMENT + CONSOLE CONT | A | | 11/70 | 131.00 | |
| M8067-KA | MSV11-PK: 256KB MOS MEM WITH PARITY CSR, | | | MEMORIES | 236.00 | M8141-00 | MAPPING BOX | A | | 11/70 | 137.00 | |
| M8067-KB | USE M8067-KA | | | MEMORIES | 00.00 | M8142-00 | CACHE CONTROL BRD | A | | 11/70 | 137.00 | |
| M8067-KD | USE M8067-KA | | | MEMORIES | 00.00 | M8143-00 | CACHE ADM (ADDRESS MEMORY BOARD) 4-LAYER | B | A | 11/70 | 163.00 | |
| M8067-KF | USE M8067-KA | | | MEMORIES | 00.00 | M8144-00 | CACHE DATA MEMORY | A | | 11/70 | 163.00 | |
| M8067-KH | USE M8067-KA | | | MEMORIES | 00.00 | M8145-00 | CACHE DATA PATH | A | | 11/70 | 163.00 | |
| M8067-LA | MSV11-PL: 512KB MOS MEM WITH PARITY CSR, | | | MEMORIES | 263.00 | M8147-00 | MEMORY CONTROL TIMING MCT | A | | MEMORIES | 137.00 | |
| M8067-LB | USE M8067-LA | | | MEMORIES | 00.00 | M8148-00 | USE M8147 | A | | MEMORIES | 00.00 | |
| M8067-LD | USE M8067-LA | | | MEMORIES | 00.00 | M8149-00 | MEM TRANSCEIVER CARD | B | | MEMORIES | 131.00 | |
| M8067-LE | USE M8067-LA | | | MEMORIES | 00.00 | M8150-00 | RH55 MASSBUS DATA PATH | B | | 11/70 | 200.00 | |
| M8067-LF | USE M8067-LA | | | MEMORIES | 00.00 | M8151-00 | RH55 CONTROL + STATUS | A | | 11/70 | 194.00 | |
| M8067-LH | USE M8067-LA | | | MEMORIES | 00.00 | M8152-00 | RH55 ADDRESS + WORD COUNT | A | | 11/70 | 131.00 | |
| M8067-LJ | USE M8067-LA | | | MEMORIES | 00.00 | M8153-00 | RH55 UNIBUS CONTROL | B | | 11/70 | 158.00 | |
| M8067-LP | USE M8067-LA | | | | 00.00 | M8158-00 | MK11 ADDRESS BUFFER 4 LAYER HEX | C | 1 | MEMORIES | 137.00 | |
| M8085-00 | DECDATAWAY SERIAL LINE INTERFACE (REPLAC | | | DPM | 300.00 | M8159-00 | USE 00M816400 | D | | MEMORIES | 00.00 | |
| M8090-00 | MASTER CONT FOR ICS11 | B | | 11 FAMILY | 90.00 | M8160-00 | 11/70 CONTROL A | D | 1 | MEMORIES | 142.00 | |
| M8094-00 | REMOTE MASTER CONTROL ICR11 | C | | 11 FAMILY | 102.00 | M8161-00 | 11/70 CONTROL B | B | 1 | MEMORIES | 131.00 | |
| M8096-00 | ICR11 REMOTE SLAVE CONTROL | B | | 11 FAMILY | 96.00 | M8164-00 | MK11,MKA11 DATA BUFFER,4 LAYER HEX,WILL | A | | MEMORIES | 131.00 | |
| M8098-00 | ICR11 REMOTE MODEM CONTROL | B | | 11 FAMILY | 195.00 | M8184-00 | DATA MEMORY | | | 11/70 | 868.00 | |
| M8100-00 | DATA PATH MODULE, 11/45, HEX X 8.5, 4 LA | A | | | 188.00 | M8185-00 | CACHE DATA PATH | | | 11/70 | 335.00 | |
| M8101-00 | GENERAL REGS + ALU. CONTROL | B | | 11/45 | 136.00 | M8186-00 | KDF11-A DUAL HEIGHT CPU,Q-BUS PDP11 (DCF | C | A | 11/23-23B | 150.00 | |
| M8102-00 | IR DECODE & COND CODES | B | | 11/45 | 105.00 | M8188-00 | FPF11 FLOATING POINT PROCESSOR QUAD | | | 11/23-23B | 289.00 | |
| M8103-00 | ROM & ROM CONTROL | B | | 11/45 | 292.00 | M8189-00 | USE KDF11-BA | | | 11/23-23B | 00.00 | |
| M8104-00 | PDR(PROCSSR DATA & UNIBUS REGISTRS),11/4 | C | | 11/45 | 126.00 | M8190-00 | USE M8190-AB | | | 11/730 | 00.00 | |
| M8105-00 | TRAP & MISC CONTROL | B | | 11/45 | 130.00 | M8190-AB | 15MHZ QUAD CPU MOD,DCJ11-AA.2 BOOT & DIA | | | 11/730 | 515.00 | |
| M8106-00 | UNIBUS AND CONSOLE CONTROL | B | A | 11/45 | 173.00 | M8190-AE | 18MHZ QUAD CPU MOD,DCJ11-AA.2 BOOT & DIA | | | 11/730 | 429.00 | |
| M8107-00 | SYS ADDRESS PATH | ABC | | 11/45 | 128.00 | M8191-00 | UNIBUS ADAPTOR FOR KDJ11-B W/MAP,PMI (KT | | | | 175.00 | |
| M8108-00 | SEG STATUS REG | A | | 11/45 | 108.00 | M8192-00 | USE M8192-YB | | | LSI11/73 | 00.00 | |

DECmailer PRICE LIST

| PART NUMBER | DESCRIPTION | LOWEST ACCEPTABLE | | | REPAIR PRICE | PART NUMBER | DESCRIPTION | LOWEST ACCEPTABLE | | | REPAIR PRICE |
|-------------|--|-------------------|-----|-----------|--------------|-------------|--|-------------------|-----|-----------|--------------|
| | | ETCH | REV | USED ON | | | | ETCH | REV | USED ON | |
| M8192-YB | DUAL HEIGHT CPU BRD (KDJ11-A),Q-BUS,DCJ1 | | | LSI11 | 525.00 | M8258-00 | MA780,MULTIPOINT PORT INTERFACE,HEX 12 | | | 11/780 | 533.00 |
| M8192-YC | DUAL HEIGHT CPU BRD (KDJ11-A),Q-BUS,DCJ1 | | | LSI11 | 680.00 | M8259-00 | MA780,MULTIPOINT PORT CONTROLLER,HEX 12 | | | 11/780 | 280.00 |
| M8200-YA | INTERPROCESSOR LINKUP | E | | 11 FAMILY | 190.00 | M8260-00 | MA780,MULTIPOINT ARRAY TIMING,HEX 12 | | | 11/780 | 280.00 |
| M8200-YB | INTERPROCESSOR LINKUP INT | C | | 11 FAMILY | 190.00 | M8261-00 | KS10 DATA PATH MEMORY | | | 11/780 | 212.00 |
| M8200-YC | INTERPROCESSOR LINKUP | E | | 11 FAMILY | 275.00 | M8265-00 | DATA PATH,HEX(KD11EA) | A | | 11/34-34A | 180.00 |
| M8201-00 | IPL SLU LO | C | | 11 FAMILY | 180.00 | M8266-00 | CONTROL,HEX(KD11EA) | A | | 11/34-34A | 180.00 |
| M8202-YA | IPL SLU HI [1 MB] | C | | 11 FAMILY | 166.00 | M8267-00 | HEX(FP11A) | A | | 11/34-34A | 230.00 |
| M8202-YB | IPL SLU HI [500 KB] | C | | 11 FAMILY | 155.00 | M8268-00 | CACHE HEX MODULE | D | | 11/34-34A | 158.00 |
| M8202-YC | IPL SLU HI [230.8 KB] | | | 11 FAMILY | 186.00 | M8270-00 | YSI SBI INTERFACE | B | | 11/780 | 252.00 |
| M8202-YD | IPL SLU HI [65 KB] | C | | 11 FAMILY | 173.00 | M8271-00 | YMD UNIBUS MAP AND DATA PATH | A | A | 11/780 | 252.00 |
| M8203-00 | DMP11 LINE UNIT,RS-449,INTEGRAL MODEM,HE | E | K | 11 FAMILY | 275.00 | M8272-00 | UNIBUS ADAPTER ADDRESS | B | | 11/780 | 305.00 |
| M8204-00 | IOP MICRO PROCESSOR | D | | 11 FAMILY | 250.00 | M8273-00 | UNIBUS ADAPTER CONTROL | A | | 11/780 | 231.00 |
| M8206-00 | MICROPROCESSOR,DMC11 CODE,4K RAM SPACE,4 | E | J | 11 FAMILY | 300.00 | M8274-00 | RH780 EXTENDED SILO (256X8) MASSBUS DATA | A | | 11/780 | 257.00 |
| M8207-RA | MICROPROCESSOR BASED SYNCHRONOUS COMMUNI | C | F | 11 FAMILY | 330.00 | M8275-00 | MSI MASSBUS ADAPTER SBI INTERFACE | A | | 11/780 | 252.00 |
| M8207-YA | MICROPROC W DDCMP 4K CONT ROM USED M8201 | C | | 11 FAMILY | 350.00 | M8276-00 | MIR MASSBUS INTERNAL REGISTERS | A | | 11/780 | 252.00 |
| M8208-00 | FIELD SERVICE SELF TEST ON VT103,DUAL 8. | | | VT100 FAM | 70.00 | M8277-00 | USE M8274 | C | | 11/780 | 00.00 |
| M8210-00 | MOS MEMORY ARRAY | B | | MEMORIES | 270.00 | M8278-00 | MCB MASSBUS ADAPTER CONTROL | B | | 11/780 | 252.00 |
| M8210-AA | USE M8210 | | | MEMORIES | 00.00 | M8285-00 | FLOATING POINT FRACTION NORMALIZER | A | | 11/780 | 252.00 |
| M8210-AB | USE M8210 | | | MEMORIES | 00.00 | M8286-00 | FLOATING POINT FRACTION MULTIPLIER | A | | 11/780 | 252.00 |
| M8210-AC | USE M8210 | | | MEMORIES | 00.00 | M8287-00 | FLOATING POINT FRACTION ADDER | A | | 11/780 | 252.00 |
| M8210-AD | USE M8210 | | | MEMORIES | 00.00 | M8288-00 | FLOATING POINT ACCELERATOR CONTROL | C | A | 11/780 | 158.00 |
| M8210-AE | USE M8210 | | | MEMORIES | 00.00 | M8289-00 | FP780,FCT,FLOATING PT ACCELERATOR CONTRO | A | | 11/780 | 252.00 |
| M8210-AF | USE M8210 | | | MEMORIES | 00.00 | M8290-00 | ORDER M8291 + 70-11217-25 | C | | 11 FAMILY | 105.00 |
| M8210-AK | USE M8210 | | | MEMORIES | 00.00 | M8291-00 | CR11 CM11 CONTROL | C | C* | 11 FAMILY | 130.00 |
| M8211-AB | USE M8211 | | | MEMORIES | 00.00 | M8293-00 | M7293 W NO 8838'S | B | | 11/35-40 | 100.00 |
| M8211-AC | USE M8211 | | | MEMORIES | 00.00 | M8300-00 | REGISTER, MAJOR | B | | PDP8E,M,F | 130.00 |
| M8212-00 | MDT MEMORY DATA PATH | B | D | 11/780 | 252.00 | M8310-00 | CONTROL, MAJOR REGISTER | F | | PDP8E,M,F | 105.00 |
| M8213-00 | MCN MEMORY CONTROLLER | B | | 11/780 | 252.00 | M8315-00 | CPU OMNIBUS 8E INSTRUCT | D | D | PDP8 FAM | 150.00 |
| M8214-00 | MEMORY SBI BOARD | B | | 11/780 | 305.00 | M8316-00 | 8A XTAL CLOCK OPT BRD #1 | C | R | PDP8 FAM | 150.00 |
| M8217-00 | UNIBUS TO LSI-11 BUS CONVERTER | C | | 11/780 | 231.00 | M8317-00 | USE M8317YB | D | | PDP8A | 00.00 |
| M8218-00 | SBL LOW BIT INTERFACE | B | | 11/780 | 252.00 | M8317-YA | M8317/ROM REMOVED OPT BRD #2 | | | PDP8 FAM | 115.00 |
| M8219-00 | SBH CPU HIGH BITS INTERFACE | B | | 11/780 | 252.00 | M8317-YB | M8317 ETCH REV E,SPLIT LUG JUMPERS TO DI | E | | PDP8 FAM | 125.00 |
| M8220-00 | CAM CPU CACHE ADAPTER MATRIX | B | | 11/780 | 347.00 | M8319-00 | MULTISERIAL LINE UNIT 8A | C | | PDP8 FAM | 140.00 |
| M8221-00 | CDM CPU CACHE DATA MATRIX | B | | 11/780 | 352.00 | M8320-00 | LOADS, BUS | B | | PDP8E,M,F | 105.00 |
| M8222-00 | TBM CPU TRANSLATION BUFFER MATRIX | B | | 11/780 | 252.00 | M8326-00 | INTERPROCESSOR BUFFER DB-E | E | | PDP8 FAM | 70.00 |
| M8223-00 | IRC CPU INSTRUCT DECODE&CLOCKS | B | | 11/780 | 252.00 | M8329-00 | USE M834200 | C | | PDP8E,M,F | 00.00 |
| M8224-00 | IDP CPU INTERUCTION DATA PATH | C | | 11/780 | 305.00 | M8330-00 | TIMING GEN FOR KK8-E W/STOP CLK INPUT,QU | C | | PDP8E,M,F | 175.00 |
| M8225-00 | KA780,DBP,CPU DATA PATH "B",4-LAYER HEX | B | | 11/780 | 252.00 | M8330-YB | USE M8330 | | | PDP8E,M,F | 00.00 |
| M8226-00 | KA780,DEP,CPU DATA PATH E,4-LAYER HEX 12 | C | | 11/780 | 252.00 | M8340-00 | DECODER AND STEPCOUNTER | E | | PDP8E,M,F | 100.00 |
| M8227-00 | KA780,DDP,CPU DATA PATH D,4-LAYER HEX 12 | B | A | 11/780 | 252.00 | M8341-00 | MULTIPLEXORS & TIMING GENERATO | D | | PDP8E,M,F | 100.00 |
| M8228-00 | KA780,DCP,CPU DATA PATH C,4-LAYER HEX 12 | B | A | 11/780 | 252.00 | M8350-00 | POSITIVE 10 BUS INTERFACE | B | | PDP8E,M,F | 80.00 |
| M8229-00 | DAP DATA PATH A | B | | 11/780 | 252.00 | M8357-00 | RX01/RX02 OMNIBUS INTERFACE FOR 8/E | B | | RX01 | 131.00 |
| M8230-00 | CPU CONDITION CODE | B | | 11/780 | 252.00 | M8365-00 | LC8-P CONTROL FOR LA180,QUAD | B | | PDP8E,M,F | 100.00 |
| M8231-00 | CPU TRAPS AND INTERRUPTS CONTROL | A | | 11/780 | 252.00 | M8366-00 | LQP8E CONTROL | C | B | PDP8E,M,F | 85.00 |
| M8232-00 | CLK CPU CLOCK | B | | 11/780 | 257.00 | M8373-00 | USE M8373-AA | | | MEMORIES | 00.00 |
| M8233-00 | WCS CPU WRITEABLE CONTROL STORE | B | | 11/780 | 305.00 | M8373-AA | 256K X 39BIT MOS MEM ARRAY=M8373-AC,-AF, | | | MEMORIES | 300.00 |
| M8234-00 | KA780-A,PCS,PROM CONTROL STORE,4-LAYER H | B | | 11/780 | 347.00 | M8373-AF | USE M8373-AA | | | MEMORIES | 00.00 |
| M8235-00 | MICRO SEQUENCER CONTROL | D | | 11/780 | 252.00 | M8373-AH | USE M8373-AA | | | MEMORIES | 00.00 |
| M8236-00 | CIB CONSOLE INTERFACE | A | | 11/780 | 305.00 | M8374-AA | 1M X 39BIT MOS MEM ARRAY,=M8374-AC,AF,AH | | | | 300.00 |
| M8237-00 | TERMINATOR SILO | A | | 11/780 | 210.00 | M8375-00 | MEMORY CONTROL,4-LAYER HEX 12 | C | C | 11/780 | 250.00 |
| M8238-00 | KU780-A 2K WCS (WRITEABLE CONTROL STORE) | | | 11/780 | 252.00 | M8376-00 | SBI INTERFACE,4-LAYER HEX 12 | D | E | 11/780 | 219.00 |
| M8254-00 | INTERPROCESSOR BUFFER QUAD | C | | 11 FAMILY | 168.00 | M8377-00 | T11 CPU,32KB RAM,32KB ROM,Q22 MULTI IOP | | | LSI11 | 215.00 |
| M8255-00 | UNIBUS SERIAL CONSOLE MICRO CONTROL QUAD | D | | 11 FAMILY | 163.00 | M8388-00 | RB730 IDC (INTEGRATED DISK CONTROLLER) H | | | 11/730 | 525.00 |
| M8255-01 | UNIBUS SERIAL EUROPEAN CONSOLE MICRO CON | D | | 11 FAMILY | 190.00 | M8389-00 | FPA (FLOATING POINT ACCELERATOR) | | | 11/730 | 893.00 |
| M8256-00 | RX211 UNIBUS RX02 INTERFACE QUAD | B | | RX02 | 125.00 | M8390-00 | DAP (DATA PATH) | | | 11/730 | 473.00 |

digital

Prices Effective 02-January-89 to 30-June-89
When you need a part repaired, call 800-225-5385.

SPARES PRICE LIST C-13

SPARES PRICE LIST C-14

M8391-00 — M8622-00

DECmailer PRICE LIST

| PART NUMBER | DESCRIPTION | LOWEST ACCEPTABLE | | | REPAIR PRICE | PART NUMBER | DESCRIPTION | LOWEST ACCEPTABLE | | | REPAIR PRICE |
|-------------|--|-------------------|-----|-----------|--------------|-------------|--|-------------------|-----|----------|--------------|
| | | ETCH | REV | USED ON | | | | ETCH | REV | USED ON | |
| M8391-00 | MCT (MEMORY CONTROLLER) HEX | B | | 11/730 | 534.00 | M8544-00 | MEMORY CONTROL | A | | KL10 | 260.00 |
| M8391-YA | MCT (MEMORY CONTROLLER W BATTERY BACKUP) | | | 11/730 | 534.00 | M8545-00 | APR BOARD | A | | KL10 | 210.00 |
| M8394-00 | WRITEABLE CONTROL STORE,HEX | | | 11/730 | 593.00 | M8548-00 | TIME MODULE | A | | KL10 | 365.00 |
| M8396-00 | DMF32 I/O MUX,HEX | D | C | 11/730 | 450.00 | M8550-00 | I/O BUS ADAPT DATA PATH-KI10 | C | | KL10 | 180.00 |
| M8398-00 | 24-LINE DMA ASYNC COMM MODULE,HEX | | | DMZ32 | 200.00 | M8551-00 | CTRL BRD FOR KL10 I/O ADAPTER | B | | KL10 | 180.00 |
| M8416-00 | CONTROL MODULE | C | | PDP8 FAM | 167.00 | M8552-00 | 10/11 DATA PATCH 4 | D | | KL10 | 130.00 |
| M8417-BA | USE MS8-CB | | | MEMORIES | 00.00 | M8553-00 | 10/11 BUS AND DATA CONTROL | F | | KL10 | 180.00 |
| M8433-00 | RL8A,RL01 CONT,4-LAYER HEX | B | B | PDP8 FAM | 273.00 | M8554-00 | 10/11 BUS + DATA CONTROL EXT | B | | KL10 | 200.00 |
| M8434-00 | 11/70 CHANNEL INTERFACE | A | | 11/70 | 282.00 | M8555-00 | E BUS INTERFACE KL10 | C | | KL10 | 180.00 |
| M8436-00 | USE M8436-BA | | | VT FAMILY | 00.00 | M8556-00 | MASSBUS DATA PATH,4 LAYER HEX 8.5 | E | | KL10 | 210.00 |
| M8436-BA | M8436 W 32K 12BIT MEMORY | F | A | VT FAMILY | 555.00 | M8557-00 | MASSBUS CONTROL 4 LAYER HEX | B | | KL10 | 260.00 |
| M8437-AA | M8437 W ROM SET "A" (23-629F1,23-630F1,2 | C | | VT FAMILY | 210.00 | M8558-00 | KI MEMORY BUS ADAPTER | C | | KL10 | 130.00 |
| M8439-00 | RL01/02 DISK CONTROL,QUAD (RL278) | | | RL02 | 200.00 | M8559-00 | CLOCK DISTRIBUTION | B | | KL10 | 415.00 |
| M8507-00 | CONTROL MODULE | H | | RT FAMILY | 130.00 | M8560-00 | DMA20 BRDL | C | | KL10 | 415.00 |
| M8510-00 | SHIFT MATRIX,4 LAYER HEX 8.5 | A | | KL10 | 210.00 | M8561-00 | MA20 CONTROL 4 | B | | KL10 | 210.00 |
| M8511-00 | CTRL ROM ADDR KL10 | E | | KL10 | 365.00 | M8562-00 | TIMING BOARD MA20 | B | | KL10 | 180.00 |
| M8512-00 | DATA PATH BOARD KL10 | A | | KL10 | 210.00 | M8563-00 | DMA20 BOARD 2 4 LAYER HEX | D | | KL10 | 130.00 |
| M8513-00 | CACHE CONTROL KL10 | D | | KL10 | 210.00 | M8565-00 | MB20 & MH10,TIMING,4-LAYER DOUBLE 8.5 | B | | KL10 | 130.00 |
| M8513-YA | MODULE CACHE CONTROL | D | | KL10 | 260.00 | M8566-00 | MB20 & MH10,CYCLE TIMING,4-LAYER DOUBLE | C | | KL10 | 90.00 |
| M8514-00 | KL10 CACHE BOARD | C | | KL10 | 278.00 | M8568-00 | MB20,MEMORY BUS INTERFACE & DIAGNOSTIC L | A | | KL10 | 130.00 |
| M8515-00 | KL10 CACHE BOARD | C | | KL10 | 365.00 | M8571-00 | LP20 MODULE | E | U | KL10 | 119.00 |
| M8516-00 | FCL/TTL TRANSLATOR KL10 | D | | KL10 | 68.00 | M8572-00 | MULTIPLE S-BUS TRANSLATOR, 4 LAYER HEX | A | | KL10 | 260.00 |
| M8517-00 | MEMORY BUFFER KL10 | C | | KL10 | 315.00 | M8574-00 | WRITE PATH | A | | KL10 | 401.00 |
| M8518-00 | PHYSICAL MEM ADDR MODULE | C | | KL10 | 315.00 | M8575-00 | SYMPTOME MF20 | A | | KL10 | 365.00 |
| M8518-YA | M8518 FOR KL10-PV | C | | KL10 | 365.00 | M8576-00 | MOS CONTROL | B | | KL10 | 300.00 |
| M8519-00 | INTERNAL MEM BUS TRANSLATOR | B | | KL10 | 180.00 | M8577-00 | ADDRESS + TIME MF20 | C | | KL10 | 466.00 |
| M8520-00 | PAGING BOARD KL10 | D | | KL10 | 365.00 | M8578-00 | UNIVERSAL Q-22 BUS EPROM (WILL REPLACE M | C | | MEMORIES | 80.00 |
| M8520-YA | M8520 FOR KL10-PV | B | | KL10 | 365.00 | M8579-AA | USE MF20-M | | | MEMORIES | 00.00 |
| M8521-00 | KL10 CACHE BOARD | B | | KL10 | 415.00 | M8580-00 | TRANSLATOR DUAL MF20 | A | | KL10 | 260.00 |
| M8522-00 | TR D RAM AND CARRY KL10 | C | | KL10 | 315.00 | M8586-00 | CONTROL MODULE (LP20) | D | | KL10 | 180.00 |
| M8523-00 | VIRTUAL MEMORY ADDRESS | C | | KL10 | 260.00 | M8587-00 | DATA PATH MODULE (LP20) | B | | KL10 | 365.00 |
| M8524-00 | SCAD PC13-17 PC FLAGS | B | | KL10 | 210.00 | M8589-00 | MG10 CYCLE TIME | B | | KL10 | 415.00 |
| M8525-00 | APR CONTROL REGISTER | C | | KL10 | 210.00 | M8590-00 | MG10 PRIORITY CONTROL | A | | KL10 | 105.00 |
| M8526-00 | CLOCK CTRL KL10 | B | | KL10 | 260.00 | M8591-00 | MG10 ADDRESS RECEIVER | B | | KL10 | 130.00 |
| M8526-YA | M8526 FOR KL10-PV | C | | KL10 | 260.00 | M8594-00 | DATA TRANSCEIVER MG10 | B | | KL10 | 105.00 |
| M8527-00 | E BOX CTRL LOGIC KL10 | D | | KL10 | 260.00 | M8595-00 | DX10 MEM BUS ADAPTER | C | | KL10 | 180.00 |
| M8528-00 | CONTROL RAM KL10 | B | | KL10 | 365.00 | M8596-00 | DX10 CHNL BUS INTERFACE | C | | KL10 | 180.00 |
| M8529-00 | M BOX CONTROL LOGIC KL10 | C | | KL10 | 210.00 | M8597-00 | DX10 CONTROL | C | C | KL10 | 260.00 |
| M8529-YA | TIME MODULE | C | | KL10 | 210.00 | M8598-00 | DX10 I/O INTERFACE | C | | KL10 | 180.00 |
| M8530-00 | E BOX MEMORY CONTROL KL10 | B | | KL10 | 315.00 | M8599-00 | DX10 CHNL BUS INTERFACE | F | | KL10 | 210.00 |
| M8531-00 | M BOX CONTROL 3 KL10 | B | | KL10 | 210.00 | M8601-00 | DX20, MICRO STORE, HEX | A | | KL10 | 610.00 |
| M8531-YA | MBOX CONTROL 3 | C | | KL10 | 161.00 | M8602-00 | DX20, MICRO CONTROLLER, HEX | | | KL10 | 519.00 |
| M8532-00 | USE M8532-YA | C | | KL10 | 00.00 | M8603-00 | DX20,MASSBUS INTERFACE DATA BOARD,QUAD | B | | KL10 | 464.00 |
| M8532-YA | M8532 FOR USE WITH NIA20 + CI20 | B | | KL10 | 210.00 | M8604-00 | DX20,MASSBUS INTERFACE CONTROL,HEX | | | KL10 | 463.00 |
| M8533-00 | CHANNEL CONTROL | D | | KL10 | 260.00 | M8605-00 | DX20, DATA PATH BUFFER STORAGE,HEX | B | | KL10 | 365.00 |
| M8534-00 | CHANNEL CONTROL WORD | B | | KL10 | 315.00 | M8606-00 | DATA PATH 4 MATTER DX20 | B | | KL10 | 514.00 |
| M8535-00 | CHANNEL RAM CTRL 4 | C | | KL10 | 210.00 | M8607-00 | IBM CHNL BUS INTF DX20 | B | | KL10 | 493.00 |
| M8536-00 | CHANNEL CTR LOGIC | D | | KL10 | 210.00 | M8612-00 | AN10, PRIORITY INTERRUPT CONTROL, QUAD | A | | KL10 | 280.00 |
| M8537-00 | M BOX CTRL 4 | C | | KL10 | 210.00 | M8614-00 | AN10, IMP TO HOST INTERFACE CONTROL HEX | | | KL10 | 300.00 |
| M8538-00 | METER (70-9418) KL10 | B | | KL10 | 365.00 | M8616-00 | KS10 CONSOLE | B | B | KS10 | 415.00 |
| M8539-00 | ARITHMETIC PROCESS REGISTER-KL10 | B | | KL10 | 260.00 | M8618-00 | MOS MEMORY CONTROL | B | | KS10 | 415.00 |
| M8540-00 | MODULE SHIFT MATRIX | A | | KL10 | 210.00 | M8619-00 | LIMITED UNIBUS ADAPTOR,MULTIWIRE HEX | B | B | KS10 | 196.00 |
| M8541-00 | CONTROL RAW ADDRESS | A | | KL10 | 365.00 | M8620-00 | KS10 DATA PATH EXECUTE | A | B | KS10 | 415.00 |
| M8542-00 | VMA BOARD | A | | KL10 | 315.00 | M8621-00 | KS10 DATA PATH MEMORY | A | B | KS10 | 525.00 |
| M8543-00 | E BOX CONTROL | A | | KL10 | 200.00 | M8622-00 | CRAM ADDRESS MULTIWIRE | A | B | KS10 | 415.00 |



Prices Effective 02-January-89 to 30-June-89
When you need a part repaired, call 800-225-5385.

DECmailer PRICE LIST

| PART NUMBER | DESCRIPTION | LOWEST ACCEPTABLE | | | REPAIR PRICE | PART NUMBER | DESCRIPTION | LOWEST ACCEPTABLE | | | REPAIR PRICE |
|-------------|--|-------------------|-----|------------|--------------|-------------|--|-------------------|-----|------------|--------------|
| | | ETCH | REV | USED ON | | | | ETCH | REV | USED ON | |
| M8623-00 | CONTROL RAM UNIT ASSY | A | B | KS10 | 525.00 | M8742-00 | T11 EMULTOR, 4-LAYER HEX | | | MDE | 120.00 |
| M8629-BA | USE MS10-BA | | | MEMORIES | 00.00 | M8743-AA | 512KB (256K X 22) ECC RAM,=M8743-AB,-AC, | | | DECSEA | 194.00 |
| M8631-AA | 4K 16BIT 2KX8 STATIC CMOS RAM W 96HR BAT | C | | LSI11 | 50.00 | M8743-BA | 1MB (512K X 22) ECC RAM,=M8743-BB,-BC,-B | | | MEMORIES | 280.00 |
| M8631-AF | USE M8631-AA | | | | 00.00 | M8743-BB | M8743-BA W MOSTEK PARTS | | | MEMORIES | 575.00 |
| M8631-CA | 16K 16BIT 2KX8 CMOS STATIC RAM W 96HR BA | B | A | MEMORIES | 485.00 | M8743-BC | USE M8743-BA | | | MEMORIES | 00.00 |
| M8631-CF | USE MCV11-DC | | | LSI11 | 00.00 | M8743-BF | USE M8743-BA | | | MEMORIES | 00.00 |
| M8631-CL | USE MCV11-DC | | | LSI11 | 00.00 | M8743-BH | USE M8743-BA | | | | 00.00 |
| M8634-00 | Q-BUS INTERFACE TO IEEE488/IEC625 GEN PU | C | E | | 175.00 | M8750-CA | 1MB(256K X 39) ECC MOS RAM ARRAY,64K PAR | | | MEMORIES | 210.00 |
| M8637-BA | USE 00M8637DA | | | MEMORIES | 00.00 | M8750-CB | USE M8750-CA | | | MEMORIES | 00.00 |
| M8637-BH | USE M8637-BA | | | MEMORIES | 00.00 | M8750-CC | USE M8750-CA | | | MEMORIES | 00.00 |
| M8637-CA | USE 00M8637EA | | | MEMORIES | 00.00 | M8750-CD | USE M8750-CA | | | MEMORIES | 00.00 |
| M8637-DA | MSV11-JD 1MB ECC RAM MEM,PMI/Q22 W/CSR,Q | | | MEMORIES | 595.00 | M8750-CH | USE M8750-CA | | | MEMORIES | 00.00 |
| M8637-EA | MSV11-JE 2MB ECC RAM MEM,PMI/Q22 W/CSR,Q | | | MEMORIES | 460.00 | M8750-CJ | USE M8750-CA | | | MEMORIES | 00.00 |
| M8637-EF | USE M8637-EA | | | | 00.00 | M8750-CP | USE M8750-CA | | | MEMORIES | 00.00 |
| M8639-00 | USE M8639-YA | | | MICROVAX I | 00.00 | M8901-00 | USE M8901YB | C | | TU16 | 00.00 |
| M8639-YA | Q-BUS CONTROL FOR RD51 OR RD52 + RX50 | | | RCROVAX1 | 578.00 | M8901-YB | TU16 DATA SYNCHRONIZER,QUAD 8.5,REPLACES | F | | TU16 | 95.00 |
| M8639-YB | Q-BUS CONTROL FOR RD51 OR RD52 + RX50,CA | | | RD FAMILY | 578.00 | M8901-YC | DATA SYNCHRONIZER-TM02 | E | | TM02 | 95.00 |
| M8640-00 | UNIBUS 8CH. MODEM CONT. QUAD | C | | 11 FAMILY | 260.00 | M8901-YD | TM03-AB DATA SYNCHRONIZER FOR 125 IPS DR | L | F | TM03 | 95.00 |
| M8648-00 | UNIBUS INTERFACE TO IEEE488/IEC625 GEN P | | A | | 325.00 | M8902-00 | TM02 TAPE CONTROL,PE,QUAD | F | | TM02 | 137.00 |
| M8650-00 | KL8/EA ASYNCH DATA CONTROL | B | | PDP8E,M,F | 100.00 | M8902-YA | TAPE CONT. PHASE ENCODE | D | | | 220.00 |
| M8652-00 | USE M8652-YB | | | PDP8E,M,F | 00.00 | M8903-00 | TAPE CONT COMMON MODE-TM02 | E | | TM02 | 100.00 |
| M8652-YB | DOUBLE BUFFERED | | | PDP8E,M,F | 150.00 | M8903-YA | TAPE CONT COMMON TM02 | D | | TM02 | 90.00 |
| M8655-00 | TERMINAL CONTRL KL8-JA | B | | PDP8E,M,F | 100.00 | M8904-00 | TAPE CONT NRZI (TM02) | B | | TM02 | 95.00 |
| M8656-00 | VT71 LK05 TO Q BUS INTERFACE | C | | VT71-71T | 105.00 | M8904-YA | TAPE CONTROL NRZI | D | | TM02 | 330.00 |
| M8657-00 | USE M8657YA | C | | | 00.00 | M8905-00 | MAINTENANCE REGISTER-TM02 | B | | TM02 | 74.00 |
| M8657-YA | VT71 CONTROL SECTION | C | | VT71-71T | 105.00 | M8905-YA | MAINTENANCE REGOSTER TM02 | C | | TM02 | 74.00 |
| M8658-00 | USE M8658YA | | | | 00.00 | M8905-YB | MAINTENANCE REGISTER-TM03 | D | | TM03 | 90.00 |
| M8658-YA | VT71 VIDEO | D | | VT71-71T | 155.00 | M8906-00 | 16-BIT FIDDLER (TM02) | 2 | B | TM02 | 74.00 |
| M8685-00 | DATA SEQUENCER,4-LAYER HEX,WILL REPLACE | | | RM80 | 158.00 | M8907-00 | CONN TERM | A | | TM02 | 116.00 |
| M8704-00 | 8-LINE SYNC LINE UNIT,NO CRC32(REPLACES | C | A | 11 FAMILY | 467.00 | M8908-00 | RECEIVER/TERM | A | | TM02 | 63.00 |
| M8711-00 | DMS11-D, 8-LINE SYNC LINE UNIT,4-LAYER H | B | | 11 FAMILY | 1500.00 | M8908-YA | TM03 MASSBUS INTERFACE,REPLACES M8908,HE | A | 1 | TM03 | 63.00 |
| M8711-YA | USE M8704 | B | | 11 FAMILY | 00.00 | M8909-00 | USE M8909-YA | C | | TM02 | 00.00 |
| M8716-00 | DR11-W,DMA INTERFACE,DR11-B IN HEX | E | E | 11 FAMILY | 170.00 | M8909-YA | TM02/3 MASSBUS INTERFACE,HEX (REPLACES M | D | | TM02 | 145.00 |
| M8719-00 | UNIBUS TO D-BUS CABLE I/O DAISY CHAIN BU | B | | 11 FAMILY | 115.00 | M8910-00 | LOGIC & WRITE BD (TU16) | E | | TU16 | 110.00 |
| M8721-YB | ISOLATED LOOP VERSION DT07 PORT MODULE,H | B | | 11 FAMILY | 380.00 | M8911-00 | SLAVE CLOCK MOTION DELAY (TU16) | E | | TU16 | 79.00 |
| M8721-YC | DT07 SWITCHED UNIBUS REPEATER,HEX SPC | C | | 11 FAMILY | 430.00 | M8911-YB | USE M893100 | E | F | PDP15/16 | 00.00 |
| M8721-YD | PORT TERMINATED DT07 PORT MODULE,HEX SPC | C | | 11 FAMILY | 318.00 | M8912-00 | SLAVE TEST FUNCT GEN (TU16) | B | | TU16 | 100.00 |
| M8722-BA | USE MS11-MB | | | MEMORIES | 00.00 | M8913-00 | DATA DRIVER | A | | TU10 | 70.00 |
| M8722-BB | USE MS11-MB | | | MEMORIES | 00.00 | M8913-YA | USE M9039 | A | | TM02 | 00.00 |
| M8722-BC | USE MS11-MB | | | MEMORIES | 00.00 | M8916-00 | LOGIC AND WRITE BOARD | C | B | TU16 | 137.00 |
| M8722-BD | USE MS11-MB | | | MEMORIES | 00.00 | M8920-00 | ADAPTOR TS03 | C | | TS FAMILY | 140.00 |
| M8722-BE | USE MS11-MB | | | MEMORIES | 00.00 | M8922-00 | PE CONTROL | | | TS FAMILY | 90.00 |
| M8722-BH | USE MS11-MB | | | MEMORIES | 00.00 | M8923-00 | READ CONTROL | | | 11 FAMILY | 70.00 |
| M8728-00 | USE M8728-AA | | | MEMORIES | 00.00 | M8924-00 | PE FORMAT | F | | TS FAMILY | 105.00 |
| M8728-AA | 64K X 39 MOS MEM ARRAY,=M8728-AB THRU -A | B | A | MEMORIES | 170.00 | M8926-00 | MODULE TU10-W INTERFACE | C | | TU10 | 200.00 |
| M8728-AC | USE M8728-AA | B | | MEMORIES | 00.00 | M8928-00 | USE M8928YA | | | TM03 | 00.00 |
| M8728-AH | USE M8728-AA | | | MEMORIES | 00.00 | M8928-YA | MTA BRD FOR TM02,TM03 ON TU45 | D | F | TM02 | 168.00 |
| M8728-AK | USE M8728-AA | | | | 00.00 | M8929-00 | TS04 WRITE CONTROL | | | 11 FAMILY | 90.00 |
| M8729-00 | ALTERNATE BUFFER DMA INTERFACE | | | 11 FAMILY | 156.00 | M8931-00 | SLAVE CLOCK AND MOTION DELAY | A | | PDP FAMILY | 70.00 |
| M8730-00 | KW11-C,CALENDER CLOCK QUAD X | C | | 11 FAMILY | 510.00 | M8932-00 | TAPE CONTROL P.E. | B | | TM03 | 95.00 |
| M8739-00 | KLESI-UA (LESI TO UNIBUS INTERFACE),QUAD | D | | RC25 | 150.00 | M8933-00 | MODULE TAPE CONTROL TM03 | A | | TM03 | 152.00 |
| M8740-00 | USE MDE-BM | | | MDE | 00.00 | M8934-00 | TAPE CONTROL, NRZ1 | | | TM03 | 110.00 |
| M8740-AA | USE MDE-BM | | | MDE | 00.00 | M8934-YA | TAPE CONTROL NRZI (75 IPS) | B | F | TM03 | 380.00 |
| M8740-AD | 32KB MOS RAM,INTEL 4K PARTS,HEX | | | MDE | 300.00 | M8937-00 | TM03,CONTROL & WRITE DRIVERS,DOUBLE 8.5 | C | | TM03 | 63.00 |
| M8741-00 | STATE ANALYZER,4-LAYER HEX | | | MDE | 130.00 | M8940-00 | MTA | E | | TU77 | 155.00 |



Prices Effective 02-January-89 to 30-June-89
When you need a part repaired, call 800-225-5385.

DECmailer PRICE LIST

| PART NUMBER | DESCRIPTION | LOWEST ACCEPTABLE | | | REPAIR PRICE | PART NUMBER | DESCRIPTION | LOWEST ACCEPTABLE | | | REPAIR PRICE |
|-------------|---|-------------------|-----|-----------|--------------|-------------|---|-------------------|-----|-------------|--------------|
| | | ETCH | REV | USED ON | | | | ETCH | REV | USED ON | |
| M8950-00 | TM78, READ CHANNEL | J | H | TM78 | 100.00 | MNCAG-00 | 4-CH DIFF SW GAIN (0.5,5,50,500)PREAMPS(| D | | LSI11 | 302.00 |
| M8951-00 | ERROR CORRECTION BOARD | | | TU,TA78 | 299.00 | MNCDO-00 | DIGITAL OUTPUT (M6003) (WAS DOV11-B) | | | LSI11 | 150.00 |
| M8952-00 | CRC + ACRC | B | | TM78 | 68.00 | MNCKW-00 | PROGRAMMABLE REAL-TIME CLOCK (M7953) (WA | E | | LSI11 | 222.00 |
| M8953-00 | READ PATH SEQUENCER | | | TU,TA78 | 310.00 | MRV11-AA | USE M794200 | D | | 11/03 | 00.00 |
| M8955-00 | TU PORT PO | | | TU,TA78 | 236.00 | MRV11-BA | USE M8021 | D | | 11/03 | 00.00 |
| M8956-00 | TM78, MASSBUS DATA PORT, QUAD | | | TM78 | 60.00 | MRV11-C | USE M8048 | C | | 11/03 | 00.00 |
| M8957-00 | TM78, MASSBUS CONTROL, QUAD | | | TM78 | 60.00 | MRV11-D | USE M8578 | | | MEMORIES | 00.00 |
| M8958-00 | TM78 TRANSLATOR | | | TM78 | 60.00 | MRV11-VA | BOOTSTRAP, M7942-YA | D | | VT71-71T | 90.00 |
| M8959-00 | WRITE MICROCONTROLLER | | | TU,TA78 | 315.00 | MS630-AA | USE M7607-AA | | | MICROVAXII | 00.00 |
| M8960-00 | TM78, MICRO COMPUTER, QUAD (8085 CHIP) | D | | TM78 | 152.00 | MS630-BA | USE M7608-AA | | | MICROVAXII | 00.00 |
| M8962-00 | TS04 MICROPROCESSOR, DOUBLE 8.5 | | | TS FAMILY | 90.00 | MS630-BB | USE M7608-BA | | | | 00.00 |
| M8963-00 | TS04 MICROSTACK, DOUBLE 8.5 CAPSTAN IN | | | TS FAMILY | 70.00 | MS630-CA | USE M7609-AA | | | MICROVAXII | 00.00 |
| M8964-00 | ROM BOARD | | | 11 FAMILY | 115.00 | MS650-AA | USE M7621-AA | | | VAX FAMILY | 00.00 |
| M8966-00 | TS04 I/O SILO, FRAME COUNTER | | | TS FAMILY | 90.00 | MS730-CA | USE M8750-CA | C | | 11/730 | 00.00 |
| M8967-00 | I/O CONTROL | | | TS FAMILY | 90.00 | MS750-AA | USE M8728-AA | C | | MEMORIES | 00.00 |
| M8968-00 | TS04, ROM EXTENSION BOARD, DOUBLE 8.5 | C | | TS FAMILY | 120.00 | MS750-CA | USE M8750-CA | C | | MEMORIES | 00.00 |
| M8970-00 | STI INTERFACE MICRO BOARD (QUAD) | | | TU,TA78 | 116.00 | MS780-D | MEMORY ARRAY | | | MEMORIES | 0.00 |
| M8971-00 | STI INTERFACE DRIVER BOARD (QUAD) | | | TU,TA78 | 116.00 | MS780-DA | USE M8210 | B | | MEMORIES | 00.00 |
| M8972-00 | TA78 MICROCOMPUTER, QUAD (8085 CHIP) | | | TU,TA78 | 84.00 | MS780-JD | USE M8374-AA | | | MEMORIES | 00.00 |
| M8973-00 | 8085 EXTENDED MEMORY, DOUBLE 8.5 | | | TU,TA78 | 116.00 | MSC11-CK | USE 5415488KA | | | PC FAMILY | 00.00 |
| M8985-00 | COMM INTERFACE, DUAL | | | | 100.00 | MSV11-B | USE M7944 | B | | 11/03 | 00.00 |
| M8988-00 | DCT11-AA MICROCONTROL, DUAL | | | 11 FAMILY | 220.00 | MSV11-CA | 4K MOS RAM (M7955-AA) | | | MEMORIES | 290.00 |
| M8989-00 | R-BUS CONTROL, DUAL | | | 11 FAMILY | 135.00 | MSV11-CB | 8K MOS RAM (M7955-AB) | | | MEMORIES | 290.00 |
| M8990-00 | CMR11 HOST CONT, UNIBUS INTFC, 4 SERIAL PO | B | | LSI11 | 227.00 | MSV11-CC | 12K MOS RAM (M7955-AC) | | | MEMORIES | 185.00 |
| M8991-00 | MICRO PROC CONT FOR CMR01, DRIVES R-BUS, R | A | B | LSI11 | 189.00 | MSV11-CD | 16K MOS RAM (M7955-AD) | C | 1 | MEMORIES | 138.00 |
| M8992-00 | USED W M8991, INCL 1 SERIAL PORT & DISPLA | | | LSI11 | 95.00 | MSV11-DA | USE MSV11-DD | C | | MEMORIES | 00.00 |
| M8993-00 | 16-BIT DIGITAL INPUT, OCI, 5V 2MA, DUAL 8.5 | | B | | 85.00 | MSV11-DB | 8K 16 BIT MOS RAM 8K CHIPS M8044-BA | C | | MEMORIES | 90.00 |
| M8994-00 | 16-BIT DIGITAL OUTPUT, HGM WETTED FORM A R | B | | LSI11 | 122.00 | MSV11-DC | 16 16 BIT MOS RAM, 16K CHIPS M8044-CA | B | | MEMORIES | 120.00 |
| M8995-00 | LIMITED DISTANCE MODEM FOR CMR01 | | | CMR01 | 100.00 | MSV11-DD | 32K 16 BIT MOS RAM, 16K CHIPS M8044-DA | D | B | MEMORIES | 120.00 |
| M9001-00 | TU16 CABLE CARD | | | TU16 | 70.00 | MSV11-DE | USE M8044-EA | | | MEMORIES | 00.00 |
| M9001-YA | M9001/8 LINES GROUND | C | | TU16 | 70.00 | MSV11-EA | USE M8045-AA | | | MEMORIES | 00.00 |
| M9001-YB | M9001 TERMINATED | C | F | TM03 | 63.00 | MSV11-EB | 8K 18 BIT MOS RAM, 4K CHIPS (M8045-BA) | | | MEMORIES | 115.00 |
| M9001-YC | M9001-YA TERMINATED | C | | TU16 | 70.00 | MSV11-EC | USE M8045-CA | | | MEMORIES | 00.00 |
| M9039-00 | TERMINATOR BRD TE16 CE M9001 S | | | TE16 | 158.00 | MSV11-JB | USE M8637-BA | | | MEMORIES | 00.00 |
| M9202-00 | CABLE UNIBUS JUMPER | | | 11 FAMILY | 80.00 | MSV11-JD | USE M8637-DA | | | MEMORIES | 00.00 |
| M9300-00 | UNIBUS B TERMINATOR | A | | 11 FAMILY | 70.00 | MSV11-JE | USE M8637-EA | | | MEMORIES | 00.00 |
| M9301-00 | USE 00M9301YA | F | | 11 FAMILY | 00.00 | MSV11-LF | USE M8059-FA | C | | MEMORIES | 00.00 |
| M9301-SA | M9301 W WESTERN ELECTRIC BOOTSTRAP | F | | 11 FAMILY | 105.00 | MSV11-LK | USE M8059-KA | C | | MEMORIES | 00.00 |
| M9301-SW | M9301-SF UPDATED W DA11 DECNET 2 BOOTSTR | E | | 11 FAMILY | 115.00 | MSV11-LA | 512KB Q-BUS DUAL PARITY BLOCK MODE 256KX | | | MEMORIES | 500.00 |
| M9301-YA | M9301 W OEM BOOTSTRAP | F | | 11/04 | 110.00 | MSV11-PK | USE M8067-KA | C | | MEMORIES | 00.00 |
| M9301-YB | M9301 W/END USER BOOTSTRAP | F | | 11/04 | 105.00 | MSV11-PL | USE M8067-LA | C | | MEMORIES | 00.00 |
| M9301-YC | BOOTSTRAP LOADER | F | | 11/04 | 105.00 | MSV11-QA | USE M7551-AA | | | MEMORIES | 00.00 |
| M9301-YF | M9301 W BOOT FOR PC11, RP02-6, RS03-4, RK05 | F | | 11/04 | 88.00 | MSV11-QB | USE M7551-BA | | | MEMORIES | 00.00 |
| M9301-YH | M9301 W 11/60 BOOTSTRAP | F | | 11/60 | 73.00 | MSV11-QC | USE M7551-CA | | | MEMORIES | 00.00 |
| M9301-YX | M9301 WITH RAINBOW BOOTSTRAP | H | | 11 FAMILY | 90.00 | MSV11-RA | USE M7458-AA | | | MEMORIES | 00.00 |
| M9302-00 | UNIBUS TERMINATOR | B | | 11 FAMILY | 70.00 | MXV11-AA | USE M8047-AA | D | | 11/23-23B | 00.00 |
| M9312-00 | BOOTSTRAP TERMINATOR W 5 EMPTY ROM SOCKE | C | | 11/24 | 100.00 | MXV11-AC | USE M8047-CA | D | | 11/23-23B | 00.00 |
| M9313-00 | UNIBUS EXERCIZER + TERMINATOR (UET), DOUB | A | | 11/750 | 100.00 | MXV11-BF | USE M7195-FA | | | 11/23-23B | 00.00 |
| M9400-YA | LSI REF. CABLE CONN | B | | LSI11 | 99.00 | MXV11-HA | USE M8047-HA | | | | |
| M9400-YC | LSI REF. CABLE CONN | B | | LSI11 | 50.00 | PC23X-DA | USE 541653701 | | | DECIMATEIII | 00.00 |
| MCV11-DA | USE M8631-AA | B | | MEMORIES | 00.00 | PC278-A | BA25-B, KK612-A, 120/240V | | | PC FAMILY | 900.00 |
| MCV11-DC | USE M8631-CA | B | | MEMORIES | 00.00 | PC27X-AH | USE PC27X-AN | | | PC FAMILY | 00.00 |
| MMV11-A | 4KX16 BIT MEMORY 11V05 | A | | MEMORIES | 395.00 | PC27X-AJ | 8/16 BIT XPU, 512KB (PC27X-AP + QWA50-A3 | | | PC FAMILY | 520.00 |
| MNCAA-00 | 4-CHANNEL 12-BIT D/A (A6002) (WAS AAV11- | E | | LSI11 | 207.00 | PC27X-AL | 16 BIT XPU, 512KB UPGRADE (REPLACES 256KB) | | | PC FAMILY | 390.00 |
| MNCAD-00 | 16-CHANNEL 12-BIT A/D (A013) (WAS ADV11- | D | | LSI11 | 293.00 | PC27X-AN | EK-DM4XP-IN, 70-22011-01, BL-DA82A-MV, 37-0 | | | PC FAMILY | 280.00 |



Prices Effective 02-January-89 to 30-June-89
When you need a part repaired, call 800-225-5385.

DECmailer PRICE LIST

| PART NUMBER | DESCRIPTION | LOWEST ACCEPTABLE | | | REPAIR PRICE | PART NUMBER | DESCRIPTION | LOWEST ACCEPTABLE | | | REPAIR PRICE |
|-------------|--|-------------------|-----|------------|--------------|-------------|---|--|-----|-----------|--------------|
| | | ETCH | REV | USED ON | | | | ETCH | REV | USED ON | |
| PCXXA-AA | CROSSOVER SWITCH FOR SERIAL PRNTR,2FEM/2 | | | PC FAMILY | 150.00 | VDP50-AA | VDP50-A2 + VDP5X-KA,USA/ENGLISH 120V | | | VDP50 | 500.00 |
| RCD31-E | RD31 CONTROLLER FOR PC500 | | 1A | PC500 | 100.00 | VDP50-RC | VDP50 BATTERY POWERED REMOTE CONTROL | | | VDP50 | 100.00 |
| REV11-A | USE M9400-YA | | | LS111 | 00.00 | VK170-CA | USE M7142 | | | VK100 | 00.00 |
| REV11-C | USE M9400-YC | | | LS111 | 00.00 | VR201-A | VR201 QTR-PAGE (24LX80C) MONITOR WITH WH | | | PC FAMILY | 150.00 |
| REV11-H | USE M9400-YH | | | LS111 | 00.00 | VR201-B | VR201 QTR-PAGE (24LX80C) MONITOR WITH GR | | | PC FAMILY | 150.00 |
| RLV12-00 | USE M8061 | | | RL01 | 00.00 | VR201-C | VR201 QTR-PAGE (24LX80C) MONITOR WITH AM | | | PC FAMILY | 150.00 |
| RQDX2-00 | USE M8639-YB | | | | 00.00 | VR241-A | 13" RGB COLOR MONITOR,120/240V | | | PC FAMILY | 340.00 |
| RQDX3-00 | USE M7555 | | | | 00.00 | VR260-AA | 19" MONO MONITOR,1024X864 PIXELS,USA ENG | | | VR260 | 1430.00 |
| RRD50-A2 | 600MB LASER READ-ONLY CD READER,100/120V | | | RRD50 | 435.00 | VR290-DA | VR290 FOR NORTH AMERICA(NORTH HEMISPHERE) | | | VR290 | 1150.00 |
| RRD50-A3 | 600MB LASER READ-ONLY CD READER,220/240V | | | RRD50 | 435.00 | VS10X-EA | USE 302003801 | | | 11/730 | 00.00 |
| RXV11-00 | USE M7946 | | B | 11/03 | 00.00 | VS240-A | USE VS240-BA | | | VT240 | 00.00 |
| RXV21-00 | USE M8029 | | C | 11/03 | 00.00 | VS240-BA | VT240 SYS BOX,OLD TCB,F/W 2.0,PS,120V | | | VT240 | 592.00 |
| ST101-00 | USE M7081-YB | | | LAS12 | 00.00 | VS240-CA | USE VS240-BA | | | VS240 | 00.00 |
| ST103-00 | USE 7015763-1 | | | LA120 | 00.00 | VSV21-AA | USE M7656 | | | VSV21 | 00.00 |
| ST105-00 | USE 7016799-1 | | | LA120 | 00.00 | VT1X3-MM | USE M8208 | | | VT100 FAM | 00.00 |
| ST106-00 | USE 54-13044 | | | LA120 | 00.00 | VT1XX-AB | USE 54-13097 | | | VT100 FAM | 00.00 |
| ST111-00 | USE 70-15388 | | | LA120 | 00.00 | VT1XX-EB | USE 54-14707 | | | VT100 FAM | 00.00 |
| T0003-00 | USE T1003 | | | KDB50 | 00.00 | VT220-A | USE VT220-A2 | | A | VT220 | 00.00 |
| T1001-00 | KA820-AA SCORPIO CPU MODULE,8" X 9.19(ZI | | 1B | D1 | VAX8200 | 5000.00 | VT220-A2 | USE VT220-D2 | | VT220 | 00.00 |
| T1001-YA | SARGAS VAXBI CPU MODULE,8" X 9.19",ZIFF | | D1 | | VAX8200 | 5000.00 | VT220-B | USE VT220-B2 | | VT220 | 00.00 |
| T1002-00 | BI-DISK-ADAPTER I (BDA) | | | KDB50 | 960.00 | VT220-B2 | USE VT220-E2 | | | VT220 | 00.00 |
| T1003-00 | BI-DISK-ADAPTER TO SDI | | | KDB50 | 940.00 | VT220-C | USE VT220-C2 | | A | VT220 | 00.00 |
| T1008-BA | MS820-AA: 2MB 39BIT ECC MOS RAM,256K CHI | | 1A | | VAX8200 | 2225.00 | VT220-C2 | USE 00V7220F2 | | VT220 | 00.00 |
| T1008-BC | USE T1008-BA | | 1A | | VAX8200 | 00.00 | VT220-D2 | ENHANCED VT220-A2 TEXT TERM,WHITE PHOS,R | | VT220 | 227.00 |
| T1008-BF | USE T1008-BA | | 1A | | VAX8200 | 00.00 | VT220-E2 | ENHANCED VT220-B2 TEXT TERM,GREEN PHOS,R | | VT220 | 227.00 |
| T1008-BH | USE T1008-BA | | 1A | | VAX8200 | 00.00 | VT220-F2 | ENHANCED VT220-C2 TEXT TERM,AMBER PHOS,R | | VT220 | 227.00 |
| T1008-BL | USE T1008-BA | | 1A | | VAX8200 | 00.00 | VT22K-AA | USA/CANADA KEYBOARD COUNTRY KIT: LK201-A | | PC FAMILY | 100.00 |
| T1008-BP | USE T1008-BA | | 1A | | VAX8200 | 00.00 | VT22X-AA | VT220 EXTERNAL INTEGRAL MODEM OPTION,120 | | VT220 | 90.00 |
| T1008-BR | USE T1008-BA | | 1A | | VAX8200 | 00.00 | W7000-00 | AUX POW SUPPLY-KL10 | | C | 90.00 |
| T1010-00 | BUA (BI UNIBUS ADAPTER) MODULE | | | VAX8200 | 2400.00 | W7410-00 | 16 BIT SS DC CONTACT SENSE | | | C | 121.00 |
| T1012-00 | BI COMBO MODULE,CONNECTS TO BI BACKPLANE | | 1E | DRB32 | 960.00 | W7430-00 | 16 BIT SS DC CONTACT INTRUPT | | | C | 115.00 |
| T1014-A | BI TO LESI ADAPTOR(KLESI-B)W/FS PKG (20- | | | VAX8200 | 1100.00 | 12-16089-00 | KEYBOARD,105 KEYS FOR LK09-R | | | | 300.00 |
| T1015-00 | PORT CONTROL, BI TO CLIP INTERFACE FOR C | | | VAX8200 | 530.00 | 12-16089-01 | KEYBOARD,123 KEYS FOR LK09-C | | | | 70.00 |
| T1017-00 | BI-BUS TO CI750 INTERFACE CONTROL MODULE | | A1 | VAX8200 | 500.00 | 12-16089-02 | KEYBOARD,123 KEYS FOR LK09-E | | | | 95.00 |
| T1018-00 | BI ADAPTOR DATA TRANSFER MODULE (BIA #2) | | | VAX8200 | 200.00 | 17-00276-05 | CABLE,RIBBON 40COND 30"LG | | | | 25.00 |
| T1019-AA | 4MB ECC MEM ARRAY,SURFACE MNT=T1019-AE,- | | 2B | VAX8200 | 2225.00 | 17-00951-02 | CABLE,COAX WIRE MESH | | | | 220.00 |
| T1020-00 | NAUTILUS MEM INTERCONNECT(NMI) INTF TO B | | | VAX8200 | 1150.00 | 20-25924-01 | MODULE,ELECTRONICS,FOR BARCODE READER | | | VT220 | 200.00 |
| T1022-00 | VAXBI BUS TO DRB BUS CONVERTER MODULE | | | DRB32 | 750.00 | 20-M7454-01 | MODULE,CONTROLLER TU80 TO PDP11 UNIBUS | | | TU80/81 | 600.00 |
| T1023-00 | DRB32 TO DR11-W BUS ADAPTER INTERCONN MO | | | DRB32 | 225.00 | 29-18510-00 | 30PCBA CLOCK | | | 29 CLASS | 167.00 |
| T1024-00 | DRB32 TO EXTEND DRB32 BUS ADAPTER MODULE | | | DRB32 | 525.00 | 29-19945-00 | 14PCBA AP-17/37, RIBBON CONTR | | | LP FAMILY | 400.00 |
| T1025-00 | CI FRONT END AND PACKET BUFFER FOR CIBCA | | | VAX8200 | 510.00 | 29-20669-00 | 14PCBA AV-18 HB PWR SUP REG | | | LP FAMILY | 400.00 |
| T1032-00 | USE T1034 | | | VAX8200 | 00.00 | 29-21102-00 | 14VFU 12 CHAN2470 | | | LP FAMILY | 414.00 |
| T1034-00 | NI ADAPTER BOARD W/TK50 CNTLR (IEEE 802, | | 3D | VAX8200 | 1617.00 | 29-21112-00 | 14PCBA LOGIC LP05 | | | LP FAMILY | 311.00 |
| T1040-AA | 16MB ECC MEMORY W/1MB RAMS = T1040-AC, - | | | VAX8200 | 985.00 | 29-21113-00 | 14PCBA SERVO LO05 | | W | LP FAMILY | 150.00 |
| T1043-00 | XMI TO BI ADAPTER (XBIB) | | | VAX8200 | 1200.00 | 29-21114-00 | 14PCBA HMMR DRVR | | | LP FAMILY | 133.00 |
| T1045-00 | PORT CONTROLLER,BI TO CILP INTERFACE FOR | | D1 | VAX FAMILY | 780.00 | 29-21115-00 | 14PCBA POWER REGULATOR | | | LP FAMILY | 189.00 |
| T1046-00 | CI FRONT END AND PACKET BUFFER, CILP TO | | E2 | VAX FAMILY | 650.00 | 29-21121-00 | 14VFU CKT CARD | | | LP FAMILY | 128.00 |
| T2011-00 | XMI CVAX PROCESSOR MODULE (XCP) (9.18 X | | | VAX6200 | 9950.00 | 29-21125-00 | 14MOTOR, PAPER FEED | | | LP FAMILY | 500.00 |
| T2012-00 | XMI TO BI ADAPTER (XBIA) (9.18 X 11) | | | VAX6200 | 1500.00 | 29-21222-00 | 14PCBA SELP TEST | | | LP FAMILY | 100.00 |
| T2014-BA | XMI32MB MEMORY (XMA) =T2014-BF,BH,BL,BP | | | VAX6200 | 6500.00 | 29-21237-00 | 29PCBA CURVE GENERATOR | | | RP04 | 70.00 |
| TQK50-00 | USE M7546 | | | | 00.00 | 29-21238-00 | 29PCBA SUMMING AMP | | | RP04 | 97.00 |
| TQK50-AA | USE M7546 | | | TK50 | 00.00 | 29-21239-00 | 29PCBA READ/WRITE SAFTY | | | RP04 | 61.00 |
| UDA50-A | USE 00M7485YA | | | UDA50 | 00.00 | 29-21240-00 | 29PCBA READ/WRITE DETCECT | | | RP04 | 76.00 |
| VC241-B | EXTENDED BIT MAP DAUGHTER BRD,COLOR&ENHA | | | PC FAMILY | 430.00 | 29-21243-00 | 29PCBA POWER CONTROL B | | | RP04 | 73.00 |
| VDP40-AA | SONY LDP1000A VIDEO DSK PLYR,UL APPROVED | | | PC3XX IVIS | 600.00 | 29-21244-00 | 29PCBA ACCESS CONTROL | | | RP04 | 57.00 |



Prices Effective 02-January-89 to 30-June-89
When you need a part repaired, call 800-225-5385.

DECmailer PRICE LIST

| PART NUMBER | DESCRIPTION | LOWEST ACCEPTABLE | | | REPAIR PRICE | PART NUMBER | DESCRIPTION | LOWEST ACCEPTABLE | | | REPAIR PRICE |
|-------------|--------------------------------|-------------------|-----|-----------|--------------|-------------|-----------------------------|-------------------|-----|-----------|--------------|
| | | ETCH | REV | USED ON | | | | ETCH | REV | USED ON | |
| 29-21245-00 | 29PCBA IND DET/SEC CLOCK B | | | RP04 | 65.00 | 29-22140-00 | 19PCBA -15V REGULATOR | | | | 231.00 |
| 29-21246-00 | 29PCBA FILE SAFETY | | | RP04 | 96.00 | 29-22161-00 | 19PCBA DYNAMIC BRAKE | | | RP05/6 | 167.00 |
| 29-21248-00 | 29PCBA TF SERVO CLOCK | | | RP04 | 128.00 | 29-22176-00 | 19PCBA VELOCITY SERVO | | | RP05/6 | 177.00 |
| 29-21249-00 | 29PCBA SERVO SELECT B | | | RP04 | 134.00 | 29-22215-00 | 19PCBA LAMP MATRIX | | | RP05/6 | 120.00 |
| 29-21251-00 | 29PCBA TACH | | | RP04 | 78.00 | 29-22225-00 | 19HEAD ASSY, AD 100MB | | | RP05/6 | 150.00 |
| 29-21253-00 | 29PCBA WRITE B | | | RP04 | 113.00 | 29-22226-00 | 19HEAD ASSY AU 100MB | | | RP05/6 | 150.00 |
| 29-21254-00 | 29PCBA MATRIX RP04 | | | RP04 | 265.00 | 29-22227-00 | 19HEAD ASSY, BD 100MB | | | RP05/6 | 150.00 |
| 29-21256-00 | 29PCBA READ/WRITE DATA | | | RP04 | 88.00 | 29-22228-00 | 19HEAD ASSY, BU 100MB | | | RP05/6 | 150.00 |
| 29-21264-00 | 29PCBA MDLI DRIVER | | | RP04 | 68.00 | 29-22233-00 | 19PCBA R/W MATRIX | | | RP05/6 | 109.00 |
| 29-21265-00 | 29PCBA MDLI FILE STATUS | | | RP04 | 63.00 | 29-22234-00 | 19PCBA POSITION SERVO | | | RP05/6 | 224.00 |
| 29-21266-00 | 29PCBA DISC SPEED SENSOR | | | RP04 | 110.00 | 29-22287-00 | 26PCBA DATA K1 | | | TU45 | 276.00 |
| 29-21270-00 | 29POWER DRIVE ASSY | | | RP04 | 199.00 | 29-22296-00 | 26PCBA TAPE CONTROL | E | | TU45 | 475.00 |
| 29-21272-00 | 29BLOWER ASSY60HZ | | | RP04 | 263.00 | 29-22299-00 | 26MOTOR, REEL DC | | | TU45 | 146.00 |
| 29-21277-00 | 29HEAD ASSY AV A | | | RP04 | 102.00 | 29-22303-00 | 26PCBA POWER SUPPLY G1 | | | TU45 | 290.00 |
| 29-21278-00 | 29HEAD ASSY AD A | | | RP04 | 57.00 | 29-22323-00 | 14POWER SUPPLY, REGULATED | | | LP FAMILY | 731.00 |
| 29-21279-00 | 29HEAD ASSY BU A | | | RP04 | 131.00 | 29-22353-00 | 14PWR SUP PAPER FEED | | | LP FAMILY | 1484.00 |
| 29-21280-00 | 29HEAD ASSY BD A | | | RP04 | 102.00 | 29-22415-00 | 14PCBA REGULATOR | | | LP FAMILY | 102.00 |
| 29-21281-00 | 29HEAD ASSY SERVO A | | | RP04 | 50.00 | 29-22416-00 | 14PCBA SERVO | | | LP FAMILY | 192.00 |
| 29-21382-00 | 29MOTOR ASSY, DRIVE 60HZ | | | RP04 | 399.00 | 29-22417-00 | 14PCBA LOGIC | | | LP FAMILY | 276.00 |
| 29-21383-00 | 29MOTOR ASSY DRIVE 50HZ | | | RP04 | 464.00 | 29-22466-00 | 27CARRIAGE ASSY | | B | LQP01 | 457.00 |
| 29-21387-00 | 29SEQUENCER AS 60 | | | RP04 | 1028.00 | 29-22483-00 | 27PCBA TRANSDUCER | | B | LQP01 | 88.00 |
| 29-21388-00 | 29SEQUENCER ASSY 50HZ | | | RP04 | 1127.00 | 29-22487-00 | 27PCBA LOGIC 1 | E | B | LQP01 | 78.00 |
| 29-21390-00 | 29SHAFT ASSY SPINDLE LOCK | | | RP04 | 1373.00 | 29-22488-00 | 27PCBA LOGIC 2 | E | B | LQP01 | 88.00 |
| 29-21405-00 | 29CARRIAGE SUBASY | | | RP04 | 1075.00 | 29-22489-00 | 27PCBA SERVO | E | B | LQP01 | 77.00 |
| 29-21413-00 | 29POWER SUPPLY | | | RP04 | 1074.00 | 29-22490-00 | 27PCBA, CARRIAGE PWR AMP | E | B | LQP01 | 86.00 |
| 29-21417-00 | 29BRACKET ASSY, EMA | | | RP04 | 426.00 | 29-22491-00 | 27PCBA PRINTWHEEL POWER A | | B | LQP01 | 79.00 |
| 29-21490-00 | 14POWER SUPPLY, HMR BNK | | | LP FAMILY | 908.00 | 29-22785-00 | 19KIT, MOTOR DRIVE 60HZ | | | RP05/6 | 567.00 |
| 29-22067-00 | 19PCBA INPUT | | | RP05/6 | 118.00 | 29-22786-00 | 19KIT, MOTOR DRIVE 50HZ | | | RP05/6 | 434.00 |
| 29-22068-00 | 19PCBA OUTPUT | | | RP05/6 | 173.00 | 29-22839-00 | 14PCBA REGULATOR | | | LP FAMILY | 109.00 |
| 29-22069-00 | 19PCBA PRECOMPENSATION | | | RP05/6 | 445.00 | 29-22844-00 | 14PCBA SERVO | | | LP FAMILY | 119.00 |
| 29-22070-00 | 19PCBA INDEX | | | RP05/6 | 181.00 | 29-22865-00 | 14PCBA CONTROL LOGIC | | | LP FAMILY | 134.00 |
| 29-22071-00 | 19PCBA VARIABLE FREQUENCY | | | RP05/6 | 216.00 | 29-22875-00 | 42PCBA HRVV RECEIVER | | | RM03 | 58.00 |
| 29-22072-00 | 19PCBA SEQUENCE | | | RP05/6 | 158.00 | 29-22877-00 | 42PCBA ASHV POWER SUPPLY | | | RM03 | 89.00 |
| 29-22073-00 | 19PCBA SERVO CONTROL | | | RP05/6 | 113.00 | 29-22878-00 | 42PCBA ASJV PWR SUPPLY | | | RM03 | 70.00 |
| 29-22074-00 | 19PCBA VELOCITY SERVO | | | RP05/6 | 244.00 | 29-22879-00 | 42PCBA 5SKV POWER SUPPLY | | | RM03 | 185.00 |
| 29-22075-00 | 19PCBA POSITION SERVO | | | RP05/6 | 310.00 | 29-22880-00 | 42PCBA HTVV TRANSMITTER | | | RM03 | 89.00 |
| 29-22076-00 | 19PCBA WRITE LOGIC | | | RP05/6 | 253.00 | 29-22881-00 | 42PCBA HFRV FINE SERVO | | | RM03 | 116.00 |
| 29-22077-00 | 19PCBA LINEAR AMP 1 | | | RP05/6 | 230.00 | 29-22882-00 | 42PCBA EKPV FAULT REGISTER | | | RM03 | 74.00 |
| 29-22078-00 | 19PCBA DETECTOR/SELECT 1 | | | RP05/6 | 211.00 | 29-22883-00 | 42PCBA FLPV SERVO CONTROL | | | RM03 | 58.00 |
| 29-22079-00 | 19PCBA DATA SAFETY/HEAD SELECT | | | RP05/6 | 134.00 | 29-22884-00 | 42PCBA | | | RM03 | 84.00 |
| 29-22084-00 | 19PCBA OPERATOR CONTROL | | | RP05/6 | 250.00 | 29-22885-00 | 42PCBA HLRV DATA LATCH | | | RM03 | 68.00 |
| 29-22088-00 | 19AMP ASSY, SERVO POWER | | | RP05/6 | 668.00 | 29-22886-00 | 42PCBA CLSV WRITE PLO | | | RM03 | 95.00 |
| 29-22099-00 | 19PCBA RD/WR MATRIX 1 | | | RP05/6 | 131.00 | 29-22887-00 | 42PCBA ELTV A-CONT/SECTOR | | | RM03 | 53.00 |
| 29-22100-00 | 19PCBA SERVO PREAMP | | | RP05/6 | 160.00 | 29-22888-00 | 42PCBA ELUV A-CONT 2 | | | RM03 | 74.00 |
| 29-22104-00 | 19HEAD ASSY, AD 200MB | | | RP05/6 | 88.00 | 29-22890-00 | 42PCBA FLWV DIFF GENERATORS | | | RM03 | 53.00 |
| 29-22105-00 | 19HEAD ASSY, AU 200MB | | | RP05/6 | 88.00 | 29-22891-00 | 42PCBA ELXV NRZ TO MFM | | | RM03 | 68.00 |
| 29-22106-00 | 19HEAD ASSY, BD 200MB | | | RP05/6 | 88.00 | 29-22892-00 | 42PCBA BLZV READ PLO | | | RM03 | 110.00 |
| 29-22107-00 | 19HEAD ASSY, BU 200MB | | | RP05/6 | 88.00 | 29-22894-00 | 42PCBA FZQN SERVO PREAMP | | | RM03 | 89.00 |
| 29-22108-00 | 19HEAD ASSY, A SERVO 200MB | | | RP05/6 | 88.00 | 29-22895-00 | 42HEAD AND ARM ASSY | | | RM03 | 88.00 |
| 29-22109-00 | 19WAY ASSY, CARRIAGE | | | RP05/6 | 326.00 | 29-22898-00 | 42PCBA NZJN HD SEL/RD AMP | | | RM03 | 74.00 |
| 29-22110-00 | 19T-BLOCK ASSY, CARRIAGE | | | RP05/6 | 300.00 | 29-22899-00 | 42PCBA EZKN WRITE DRIVER | | | RM03 | 58.00 |
| 29-22121-00 | 19SPINDLE ASSY | | | RP05/6 | 658.00 | 29-22900-00 | 42SPINDLE ASSY | | | RM03 | 378.00 |
| 29-22137-00 | 19PCBA +5V REGULATOR | | | RP05/6 | 272.00 | 29-22910-00 | 42CARRIAGE AND COIL ASSY | | | RM02 | 154.00 |
| 29-22138-00 | 19PCBA -5.2V REGULATOR | | | RP05/6 | 274.00 | 29-22913-00 | 42PCBA 5VTN SERVO POWER AMP | | | RM03 | 53.00 |
| 29-22139-00 | 19PCBA +15V REGULATOR | | | RP05/6 | 190.00 | 29-23021-00 | 14PCBA PVFU | W | | LP FAMILY | 108.00 |



Prices Effective 02-January-89 to 30-June-89
When you need a part repaired, call 800-225-5385.

DECmailer PRICE LIST

| PART NUMBER | DESCRIPTION | LOWEST ACCEPTABLE | | | REPAIR PRICE | PART NUMBER | DESCRIPTION | LOWEST ACCEPTABLE | | | REPAIR PRICE |
|-------------|----------------------------|-------------------|-----|-----------|--------------|-------------|------------------------------|-------------------|-----|---------|--------------|
| | | ETCH | REV | USED ON | | | | ETCH | REV | USED ON | |
| 29-23047-00 | USE 2924701 | | | LXV11 | 00.00 | 29-23517-00 | 44POWER SUPPLY | | | VST0 | 272.00 |
| 29-23091-00 | 26PCBA DATA K2 | | | TU45 | 433.00 | 29-23522-00 | 44PWR SUPL LO VOLT A5.9 | | | VST0 | 453.00 |
| 29-23092-00 | 26PCBA PE/NRZI WRITE 2 | | | TU45 | 216.00 | 29-23540-00 | 42PCBA, AZCN PWR AMP | | | RM05 | 126.00 |
| 29-23107-00 | 42HEAD AND ARM ASSY UPPER | | | RM02 | 105.00 | 29-23541-00 | 42PCBA, 5YEN CAP BRD | | | RM05 | 168.00 |
| 29-23108-00 | 42HEAD AND ARM ASSY, SERVO | | | RM02 | 110.00 | 29-23543-00 | 42PCBA, AYFN RELAY | | | RM05 | 105.00 |
| 29-23113-00 | 42PCBA LLRV DATA LATCH | | | RM03 | 252.00 | 29-23553-00 | 42PCBA, DMSV AN SERV | | | RM05 | 95.00 |
| 29-23117-00 | 42PCBA ASGV SPEED DETECT | | | RM03 | 74.00 | 29-23554-00 | 42PCBA, READ AMP | | | RM05 | 84.00 |
| 29-23119-00 | 42PCBA SZJV HD SEL/RD AMP | | | RM02 | 89.00 | 29-23555-00 | 42PCBA, WRITE DRIVER | | | RM05 | 89.00 |
| 29-23213-00 | 26PCBA INTERCONNECT F1 | | | TU77 | 120.00 | 29-23556-00 | 42PCBA, R/W CONT | | | RM05 | 53.00 |
| 29-23226-00 | 26PCBA WRITE | | | TU77 | 263.00 | 29-23557-00 | 42PCBA,DIFF/HEAD REG | | | RM05 | 95.00 |
| 29-23227-00 | 26PCBA DATA L | | | TU77 | 284.00 | 29-23558-00 | 42PCBA, ACESS CONT | | | RM05 | 53.00 |
| 29-23229-00 | USE 292377400 | | | TU77 | 00.00 | 29-23559-00 | 42SPINDLE ASSY | | | RM05 | 340.00 |
| 29-23230-00 | 26PCBA CAPSTAN SERVO | | | TU77 | 268.00 | 29-23566-00 | 42PCBA, REG 5V | | | RM05 | 53.00 |
| 29-23231-00 | 26PCBA REEL SERVO | | | TU77 | 446.00 | 29-23567-00 | 42PCBA, 4XFN MB | | | RM05 | 53.00 |
| 29-23232-00 | 26PCBA 9 TRK PREAMP | | | TU77 | 252.00 | 29-23568-00 | 42PCBA, BXGN SHS | | | RM05 | 100.00 |
| 29-23234-00 | 26MOTOR ASSY, CAPSTAN | | | TU77 | 1060.00 | 29-23574-00 | 42DRV MOTOR/PULLEY ASSY 60HZ | | | RM05 | 720.00 |
| 29-23236-00 | 26MOTOR ASSY, REEL | | | TU77 | 408.00 | 29-23579-00 | 42POWER SUPPLY,60HZ | | | RM05 | 1250.00 |
| 29-23249-00 | 26PRESSURE VALVE ASSY | | | TU77 | 90.00 | 29-23596-00 | 29HEAD DISK ASSY A | | | RP07 | 7000.00 |
| 29-23257-00 | 26COMPRESSOR | | | TU77 | 140.00 | 29-23605-00 | 29PCBA, 3 PHASE DET B9 | | | RP07 | 116.00 |
| 29-23328-00 | 29PCBA POWER REGULATOR B | E | | RP07 | 126.00 | 29-23656-00 | 42HEAD/ARM ASSY | | | RM05 | 88.00 |
| 29-23335-00 | 29MOTOR/BRAKE ASSY 60HZ A | | | RP07 | 233.00 | 29-23657-00 | 42HEAD/ARM ASSY | | | RM05 | 88.00 |
| 29-23340-00 | 29PCBA EMA DRV B9 | | | RP07 | 195.00 | 29-23658-00 | 42HEAD/ARM ASSY | | | RM05 | 88.00 |
| 29-23341-00 | 29PCBA B | | | RP07 | 226.00 | 29-23686-00 | 37PCBA,DA | | | RP20 | 492.00 |
| 29-23342-00 | 29PCBA ANALOG C B | | | RP07 | 383.00 | 29-23687-00 | 37PCBA, DC | | | RP20 | 498.00 |
| 29-23343-00 | 29PCBA B | | | RP07 | 326.00 | 29-23688-00 | 37PCBA, DD | | | RP20 | 1029.00 |
| 29-23344-00 | 29PCBA ANALOG A B | | | RP07 | 205.00 | 29-23689-00 | 37PCBA-DE | | | RP20 | 269.00 |
| 29-23345-00 | 29PCBA CMND/INDX/SCTR B | | | RP07 | 162.00 | 29-23692-00 | 37PCBA | | | RP20 | 340.00 |
| 29-23346-00 | 29PCBA, DEV CONT 2 B9 | | | RP07 | 389.00 | 29-23693-00 | 37PCBA | | | RP20 | 331.00 |
| 29-23347-00 | 29PCBA, DEV CONT 1 B9 | | | RP07 | 310.00 | 29-23694-00 | 37PCBA-DK | | | RP20 | 454.00 |
| 29-23348-00 | 29PCBA MASSBUS I/F B | | | RP07 | 121.00 | 29-23700-00 | 37PWR SUPPLY DC | | | RP20 | 344.00 |
| 29-23349-00 | 29PCBA, DATA ENCDR DECDR B | | | RP07 | 231.00 | 29-23701-00 | 37PCBA-DB | | | RP20 | 572.00 |
| 29-23350-00 | 29PCBA, I/F CONT B | | | RP07 | 163.00 | 29-23702-00 | 37POWER SUPPLY | | | RP20 | 150.00 |
| 29-23351-00 | 29PCBA SERDES/ECC | | | RP07 | 184.00 | 29-23703-00 | 37HEAD DISK ASSY | | | RP20 | 6016.00 |
| 29-23352-00 | 29PCBA,R/W SAFETY B | | | RP07 | 110.00 | 29-23759-00 | 54LOGIC BOARD (PCB) | | | VRV02 | 213.00 |
| 29-23353-00 | 29PCBA,R/W ANALOG B | | | RP07 | 195.00 | 29-23760-00 | 54POWER SUPPLY ASSY | | | VRV02 | 290.00 |
| 29-23394-00 | 14PCBA, RECTIFIER (UNIV) | | | LP FAMILY | 250.00 | 29-23761-00 | 5419" LP PHOSPHOR TUBE ASSY | | | VRV02 | 640.00 |
| 29-23395-00 | 14PCBA, HAMMER DRIVE | | | LP FAMILY | 252.00 | 29-23762-00 | 26READ PCBA (TU77/78) | | | | 420.00 |
| 29-23400-00 | 14PCBA, PROCESS LESS PROMS | | | LP FAMILY | 274.00 | 29-23763-00 | 26PCBA, WRITE | | | TU/TA78 | 350.00 |
| 29-23401-00 | 14PCBA, TIMING/STATUS | | | LP FAMILY | 122.00 | 29-23764-00 | 26PCBA,CONTROL M2 | | | TU/TA78 | 263.00 |
| 29-23402-00 | 14BOARD POWER | | | LP FAMILY | 220.00 | 29-23765-00 | 26PCBA, CAPSTAN SERVO | | | TU/TA78 | 290.00 |
| 29-23419-00 | 14PCBA INTERFACE (STD) | | | LP FAMILY | 126.00 | 29-23766-00 | 26PCBA, PREAMP | | | TU/TA78 | 147.00 |
| 29-23433-00 | 14PCBA INTERF LL W/VFU | | | LP FAMILY | 130.00 | 29-23768-00 | 26MOTOR ASSY, CAPSTAN | | | TU/TA78 | 660.00 |
| 29-23438-00 | 14PCBA, INTERFACE VFU | | | LP FAMILY | 170.00 | 29-23769-00 | 26PCBA,MIA | | | TU/TA78 | 457.00 |
| 29-23476-00 | 44MICRO PROC. | | | VST0 | 2009.00 | 29-23770-00 | 26PCBA,INTERCONNECT F1 | | | TU/TA78 | 79.00 |
| 29-23477-00 | 44PCBA INTERFACE | | | VST0 | 2009.00 | 29-23774-00 | 26PCBA, CNTL M2 | | | TU77 | 200.00 |
| 29-23478-00 | 44PCBA IPCU INTERFACE | | | VST0 | 1142.00 | 29-23888-00 | 42POW SUP ASSY 60-HZ | | | RM05 | 726.00 |
| 29-23479-00 | 44PCBA VECTOR GENERATOR | | | VST0 | 2009.00 | 29-23916-00 | 43SHUTTLE ASSY | | | | 1125.00 |
| 29-23480-00 | 4416 K RAM | | | VST0 | 3171.00 | 29-23920-00 | 43PCBA, PWR SUP. 600LPM | | | | 289.00 |
| 29-23501-00 | 44MONITOR DISP 15 MIL | | | VST0 | 5172.00 | 29-23921-00 | 43PNR SUP. ASSY | | | | 760.00 |
| 29-23503-00 | 44PCBA, DEFL AMPL A24 | | | VST0 | 418.00 | 29-24028-00 | 39MECHANISM ASSY | | | LQP02 | 400.00 |
| 29-23505-00 | 44PCBA, PHOSPHOR PROTECT | | | VST0 | 487.00 | 29-24029-00 | 39PCBA, INTERFACE | | | LQP02 | 165.00 |
| 29-23506-00 | 44PWR SUPL ASSY HI VOLT | | | VST0 | 530.00 | 29-24030-00 | 39DIGITAL BOARD | | | LQP02 | 140.00 |
| 29-23507-00 | 44HEATSINK SUB-ASSY +45V | | | VST0 | 422.00 | 29-24031-00 | 39PCBA, ANALOG | | | LQP02 | 140.00 |
| 29-23508-00 | 44HEATSINK SUB-ASSY -45V | | | VST0 | 422.00 | 29-24032-00 | 39PCBA, PWR SUPPLY | | | LQP02 | 150.00 |
| 29-23516-00 | 44LOGIC BOARD | | | VST0 | 605.00 | 29-24034-00 | 39PCBA, MOTHER | | | LQP02 | 115.00 |



Prices Effective 02-January-89 to 30-June-89
When you need a part repaired, call 800-225-5385.

DECmailer PRICE LIST

| PART NUMBER | DESCRIPTION | LOWEST ACCEPTABLE | | | REPAIR PRICE | PART NUMBER | DESCRIPTION | LOWEST ACCEPTABLE | | | REPAIR PRICE |
|-------------|-----------------------------------|-------------------|-----|-----------|--------------|-------------|--|-------------------|-----|------------|--------------|
| | | ETCH | REV | USED ON | | | | ETCH | REV | USED ON | |
| 29-24035-00 | 39CONTROL PANEL | | | LQP02 | 130.00 | 29-25088-00 | USE 29-25380 | | | LN03 | 00.00 |
| 29-24050-00 | 61DISK DRIVE, RX180 | | | VT FAMILY | 190.00 | 29-25089-00 | 91POWER SUPPLY 100V | | | LN03 | 175.00 |
| 29-24086-00 | 47MODULE | | | TS FAMILY | 500.00 | 29-25334-00 | 91CONTROLLER | | | LN03 | 740.00 |
| 29-24112-00 | 49R/W BOARD | | | PC FAMILY | 91.00 | 29-25339-00 | A2DEVICE PCB 1 | | | RD FAMILY | 250.00 |
| 29-24195-00 | N6 KIT, SERVICE HHT I 99 | | | TU/TA78 | 469.00 | 29-25345-00 | 51STI MODULE 77042148 | | | TU80/81 | 1378.00 |
| 29-24213-00 | 51KIT, MOTOR INSTALLATION | | | TU80/81 | 300.00 | 29-25380-00 | 91ENG. DRIVE BOARD | | | LN03 | 141.00 |
| 29-24215-00 | 51KIT, MAG HEAD INSTALLATION | | | TU80/81 | 450.00 | 29-25536-00 | 64VIDEO SUB ASSY 3119 | | | VR290 | 260.00 |
| 29-24220-00 | 51POWER SUPPLY 60 HZ | | | TU80/81 | 399.00 | 29-25538-00 | 64DEFLECTION BD 3119 | | | VR290 | 160.00 |
| 29-24221-00 | 51FORMATTER CONTROL, PWA | | | TU80/81 | 280.00 | 29-25539-00 | 64APP BOARD 3119 | | | VR290 | 216.00 |
| 29-24222-00 | 51R/W SERVO PWA | | | TU80/81 | 368.00 | 29-25540-00 | 64MAINS BOARD 3119 | | | VR290 | 160.00 |
| 29-24223-00 | 51 POWER AMP MODULE | | | TU80/81 | 131.00 | 29-25556-00 | A6HAMMER DRIVER PCB | | | LG01/02 | 441.00 |
| 29-24238-00 | 52CPU LA50, ROMS C | | | LA50 | 88.00 | 29-25569-00 | A6PARALLEL I/O PCB | | | LG01/02 | 252.00 |
| 29-24272-00 | 52HEAD (2) UNIT C | | | LA50 | 53.00 | 29-25573-00 | A6POWER AMP PCB | | | LG01/02 | 500.00 |
| 29-24329-00 | 14CCA,HMMR DRVR | | | LP FAMILY | 500.00 | 29-25797-00 | 51BUFFERED TMSCP MOD(TU81E) | | | TU80/81 | 1200.00 |
| 29-24330-00 | 14CCA,INTERFACE | | | LP FAMILY | 250.00 | 29-25918-00 | 52MECH ASSY C | | | LA75 | 125.00 |
| 29-24331-00 | 14CCA, PAP FEED | | | LP FAMILY | 300.00 | 29-25968-00 | 52LOGIC BOARD C | | | LA75 | 115.00 |
| 29-24551-00 | 53IOTC PWBA (LN01) | | | LN03 | 446.00 | 29-26070-00 | 91OPT HOUS UN ASSY (LN03C.R.) | | | LN03 | 315.00 |
| 29-24602-00 | 54 PWB ASSY CD4-AN2 | | | VR241 | 79.00 | 29-26096-00 | 91P.S. U. ASSY (LN03C.R.) | | | LN03 | 85.00 |
| 29-24603-00 | 54 PWB ASSY CD4-P2 | | | VR241 | 79.00 | 29-26098-00 | 91ENGINE DR BOARD (LN03C.R.) | | | LN03 | 254.00 |
| 29-24608-00 | USE 29-26101 | | | VR241 | 00.00 | 29-26101-00 | 54SB CRT YOKE ASSY | | | VR241 | 470.00 |
| 29-24614-00 | 54 DEFLECT. SUB ASSY | | | VR241 | 79.00 | 29-26103-00 | B1DEVICE PCB (RD54) | | | RD FAMILY | 300.00 |
| 29-24701-00 | 43PCBA, LOGIC B9 | | | TU80/81 | 250.00 | 29-26164-00 | BAMECH PRINTER GROUP 0 | | | LQP45 | 425.00 |
| 29-24704-00 | 51AMP, PWA READ | | | TU80/81 | 273.00 | 29-26171-00 | BAMAIN BOARD-AT131 | | | LQP45 | 242.00 |
| 29-24705-00 | 51SERVO MODULE (TU81/TA81) | | | TU80/81 | 194.00 | 29-26254-00 | 26WRITING PCBA | | | TU90 | 1011.00 |
| 29-24706-00 | 51PWA WRITE DRIVE | | | TU80/81 | 142.00 | 29-26255-00 | 26PREAMP PCB | | | TU79 | 320.00 |
| 29-24707-00 | 51PWA MSCP | | | TU80/81 | 273.00 | 29-26381-00 | 76MODEM MODULE TD24 | | | MODEMS | 170.00 |
| 29-24708-00 | 51PWA FORMATTER WR (TU81/TA81) | | | TU80/81 | 350.00 | 29-26617-00 | A6LG02 CONTROLLER (LG02) | | | LG01/02 | 701.00 |
| 29-24709-00 | 51PWA FORMATTER READ | | | TU80/81 | 400.00 | 29-80040-00 | 42CARD RCVR | | | 29 CLASS | 170.00 |
| 29-24712-00 | 58MODULE, POWER SUPPLY | | | DFMSA-AA | 160.00 | 29-80335-00 | 60I/F BOARD, Q BUS | | | | 650.00 |
| 29-24713-00 | 58MODULE CONTROLLER | | | DFMSA-AA | 325.00 | 29-80480-00 | 67 I MB MEMORY | | | 29 CLASS | 850.00 |
| 29-24752-00 | 51MAGNETIC HEAD | | | TU80/81 | 300.00 | 29-80488-00 | 67IDM 500/1/2 5 VOLT POW SUP | | | 29 CLASS | 750.00 |
| 29-24753-00 | 51POWER SUPPLY | | | TU80/81 | 450.00 | 29-80519-00 | 48DISK I/F RMOX | | | 29 CLASS | 840.00 |
| 29-24755-00 | 51OPERATOR PANEL | | | TU80/81 | 250.00 | 29-81226-00 | 495 1/4" 10MB WINCHESTER DRIVE M | | | | 450.00 |
| 29-24756-00 | 63CONTROLLER ASSEMBLY 3 | | | 11/730 | 434.00 | 29-81293-00 | 75 4190 CACHE 512K (OOSDCOXXX) | | | 29 CLASS | 1700.00 |
| 29-24757-00 | 63PUCK | | | 11/730 | 338.00 | 29-81915-00 | E2ICP 1622 W/512KD | | | | 1100.00 |
| 29-24782-00 | 64POWER SUPPLY 5107 | | | 11/730 | 104.00 | 29-90007-00 | AASERIAL BOARD | | | LQP45 | 172.00 |
| 29-24783-00 | 64VIDEO MODULE 5107 | | | 11/730 | 109.00 | 30-05523-03 | PDP-10 16K X 37 FABRITEK | | | PDP FAMILY | 7693.00 |
| 29-24784-00 | 64DEFLECTION MODUEE 5107 | | | 11/730 | 109.00 | 30-09356-00 | PUNCH, PAPER TAPE | | | 29 CLASS | 731.00 |
| 29-24797-00 | 66PROCESSOR MODULE | | | DMZ32 | 425.00 | 30-10133-00 | USE A877 | | | 30 CLASS | 00.00 |
| 29-24798-00 | 66EXPANSION MODULE | | | DMZ32 | 300.00 | 30-10326-00 | DISPLAY TV MODULE VT05 | | | VT FAMILY | 126.00 |
| 29-24799-00 | 66POWER SUPPLY ASSY | | | DMZ32 | 225.00 | 30-10759-00 | MAGNETIC FIELD PROBE HALL EFFE | | | 30 CLASS | 232.00 |
| 29-24806-00 | 02LOGIC MODULE 0 | | | LVP16 | 357.00 | 30-11070-00 | DISPLAY,ALPHANUMERICAL W/MEMRY | | | RT FAMILY | 641.00 |
| 29-24891-00 | 39POWER SUPPLY | | | LQP03 | 175.00 | 30-11843-00 | READER,BADGE (CARD) 22COLM. | | | RT FAMILY | 316.00 |
| 29-24893-00 | 39LOGIC MODULE | | | LQP03 | 175.00 | 30-12537-01 | DISPLAY MODULE WITH P4 PHOSPHOR | | | VT71-71T | 265.00 |
| 29-24926-00 | 49R/W BOARD | | | PC3XX FAM | 70.00 | 30-12538-00 | KEYBOARD,LK05, 112 KEYS,12 LEDS | | | VT71-71T | 168.00 |
| 29-24931-00 | 39PRINT WHEEL MOTOR ASSY 8 | | | LQP02 | 200.00 | 30-12538-01 | KEYBOARD FOR VT71 | | | VT71-71T | 162.00 |
| 29-24932-00 | 39CARRIAGE MOTOR | | | LQP02 | 90.00 | 30-13129-00 | CARD/BADGE READER | | | RT FAMILY | 675.00 |
| 29-24945-00 | 05IXO HAND HELD TERMINAL TC200 W/ | | | RA81 | 400.00 | 30-13129-02 | CARD/BADGE READER,115 VAC,60 HZ,RT805 | | | RT FAMILY | 675.00 |
| 29-24988-00 | USE 29-25334 | | | LN03 | 00.00 | 30-13129-03 | CARD/BADGE READER,230 VAC,50 HZ,RT805 | | | RT FAMILY | 675.00 |
| 29-24992-00 | 71MAIN PCB | | | LN03 | 260.00 | 30-13880-00 | READER,BADGE(CARD) 10COL M. | | | RT FAMILY | 190.00 |
| 29-25042-00 | 76MODEM | | | MODEMS | 175.00 | 30-14869-00 | POWER SUPPLY, 47-63HZ, OUT=-5V,+15V,-15V | | | 11 FAMILY | 305.00 |
| 29-25043-00 | 76PWR SUPPLY/CABLE | | | MODEMS | 60.00 | 30-15949-00 | MODEM,LOW SPEED ASYNC | | | 11/780 | 191.00 |
| 29-25070-00 | 91OPTICAL HOUSING | | | LN03 | 720.00 | 30-16080-04 | USE 701736300 | | A | VT100 FAM | 00.00 |
| 29-25071-00 | 91DEVELOPMENT UNIT | | | LN03 | 193.00 | 30-18689-00 | CONVERTER, A-D 12BIT, 16CHANNEL,12BIT,2CHA | | | 11/03 | 360.00 |
| 29-25072-00 | 91FUSING UNIT, 100V | | | LN03 | 180.00 | 30-18690-00 | MODULE,REAL TIME CLOCK DUAL HGT. | | | 11/03 | 242.00 |



Prices Effective 02-January-89 to 30-June-89
When you need a part repaired, call 800-225-5385.

DECmailer PRICE LIST

| PART NUMBER | DESCRIPTION | LOWEST ACCEPTABLE | | | REPAIR PRICE | PART NUMBER | DESCRIPTION | LOWEST ACCEPTABLE | | | REPAIR PRICE |
|-------------|--|-------------------|-----|------------|--------------|-------------|-----------------------------------|-------------------|-----|-----------|--------------|
| | | ETCH | REV | USED ON | | | | ETCH | REV | USED ON | |
| 30-18691-00 | CONVERTER,D-A,12BIT, 4CHANNEL | | | 11/03 | 310.00 | 54-10541-00 | MAIN KEYBOARD (LK01-R) | C | | VT220 | 105.00 |
| 30-18693-00 | CONVERTER,A-D,12BIT,16CHANNEL DUAL HGT. | | | 11/03 | 310.00 | 54-10736-00 | USE LK02 | E | | LA36 | 00.00 |
| 30-19203-00 | READER,BARCODE MODULE | | | RT FAMILY | 480.00 | 54-10805-00 | LA36 POWER BOARD | B | | LA36 | 79.00 |
| 30-19858-01 | PRINTER,R.O. LA50 | | | LA50 | 250.00 | 54-10817-00 | POWER MONITOR-RP04 | | | | 80.00 |
| 30-19858-02 | PRINTER,R.O. LA50-RB 220V | | | LA50 | 330.00 | 54-10864-00 | POWER DIST BRD (BA11K) | D | | 11 FAMILY | 90.00 |
| 30-20038-01 | MOUSE,HAND HELD 3 BUTTON 100PULSES PER I | | | 11/730 | 289.00 | 54-10886-00 | MON/POW SUPPLY (VT50-AA) | C | | VT50 FAM | 115.00 |
| 30-20198-01 | USE 702018401 | | | HSC50/70 | 00.00 | 54-10902-00 | PROC UART ROM (VT50AA) | B | | VT50 FAM | 173.00 |
| 30-20198-02 | P.S.SWITCHING REGULATOR 240V 50/60HZ | | | HSC50/70 | 650.00 | 54-10902-02 | PROC UART ROM (VT50-H) | B | | VT50 FAM | 88.00 |
| 30-20199-01 | USE 702003301 | | | HSC50/70 | 00.00 | 54-10906-00 | PROC DATA PATH (VT50-AA) | B | | VT50 FAM | 173.00 |
| 30-20199-02 | USE 702003302 | | | HSC50/70 | 00.00 | 54-10993-00 | USE 54-13089 | | | 11 FAMILY | 00.00 |
| 30-20418-04 | READER,BARCODER,NO WAND/PWR PACK | | | RT FAMILY | 220.00 | 54-11021-00 | LA180 POWER BRD | E | | LA180 | 110.00 |
| 30-20444-01 | USE 302174901 | | | | 00.00 | 54-11023-02 | LA180 LA120 LOGIC BOARD | F | | LA180 | 95.00 |
| 30-20746-01 | EXPANDER,OPTION,4 LINE F/DFM04/08 MULTIP | | | 30 CLASS | 285.00 | 54-11042-00 | POWER AMP RK06 | D | | RK06 | 120.00 |
| 30-20746-02 | EXPANDER,OPTION,8 LINE F/DFM04/08 MULTIP | | | 30 CLASS | 285.00 | 54-11060-00 | READ/WRITE RK06 | | | RK06 | 145.00 |
| 30-21386-02 | MODEM,MODULE,FULL DUPLEX 4800BPS | | | MODEMS | 475.00 | 54-11060-YA | READ WRITE MODULE | | | RK07 | 135.00 |
| 30-21386-03 | MODEM,SYNCHRONOUS 4800BPS SIGNAL RATE DF | | | MODEMS | 475.00 | 54-11086-00 | +15V REGULATOR (BA11-K) | D | A | RM03 | 60.00 |
| 30-21387-01 | MODEM,INTEGRAL 9.6BPS | | | MODEMS | 722.00 | 54-11086-YA | POWER LINE 115 V. REG | E | B | 11 FAMILY | 70.00 |
| 30-21387-02 | MODEM,MODULE FULL DUPLEX 9600BPS | | | MODEMS | 475.00 | 54-11170-00 | VT61 KEYBOARD | C | | VT61-61T | 113.00 |
| 30-21387-03 | MODEM,SYNCHRONOUS 9600BPS SIGNAL RATE DF | | | MODEMS | 475.00 | 54-11170-02 | KEYBOARD VT61 /VT50H | C | | VT50 FAM | 80.00 |
| 30-21749-01 | P.S. 5V 230W | | | VAXSTATION | 190.00 | 54-11170-04 | KEYBOARD VT61 /VT50H | C | | VT50 FAM | 100.00 |
| 30-22249-01 | READER,BAR CODE NO KEYPADS | | | RT FAMILY | 450.00 | 54-11170-06 | KEYBOARD VT61 /VT50H | C | | VT50 FAM | 114.00 |
| 30-22249-02 | READER,BAR CODE W/KEYPAD | | | RT FAMILY | 500.00 | 54-11170-08 | KEYBOARD VT61 /VT50H | C | | VT50 FAM | 55.00 |
| 30-22270-00 | NEWLY ADDED CRC PART | | | PC3XX IVIS | 111.00 | 54-11278-00 | VT 61 BOARD "A" | F | | VT61-61T | 105.00 |
| 30-22529-01 | CONVERTER F/BB ETHERNET SINGLE CABLE TRA | | | DECOM | 175.00 | 54-11278-01 | INPUT. OUTPUT FOR VT62 | H | | VT62 | 130.00 |
| 30-22563-01 | TRANCEIVER,DUAL CABLE BROADBAND ETHERNET | | | DECOM | 1075.00 | 54-11280-00 | VT 61 MEMORY BOARD | C | | VT61-61T | 145.00 |
| 30-22801-01 | USE H7845-BA | | | PC FAMILY | 00.00 | 54-11282-00 | VT 61 PROM BOARD | C | | VT61-61T | 148.00 |
| 30-22969-01 | SUBSYSTEM, TAPE,CARTRIDGE/CABNT,DRIVE,PS | | | TK25 | 800.00 | 54-11282-01 | PROM BOARD YT61 | C | | VT61-61T | 148.00 |
| 30-22969-02 | SUBSYSTEM,TAPE,CARTRIDGE W/ACCESSORY KIT | | | TK25 | 761.00 | 54-11284-00 | VT 61 BOARD "B" | E | A | VT61-61T | 200.00 |
| 30-22971-01 | CONTROLLER,TAPE CARTRIDGE SUBSYSTEM TO Q | | | TK25 | 325.00 | 54-11284-01 | MODULE VT61 B BOARD | E | A | VT62 | 200.00 |
| 30-23506-01 | P.S. 5.1V 9.7A SWITCHING | | | RA90 | 289.00 | 54-11284-02 | VIDEO PROCESS MODULE FOR VT62 | E | | VT62 | 210.00 |
| 30-23616-01 | P.S. 460W 2DC REGULATOR BDS,FAN SPEED C | | | VAX FAMILY | 457.00 | 54-11294-00 | CONSOLE MOD 11/70 | B | | 11/70 | 360.00 |
| 30-23959-01 | CONDITIONER,PWR LINE 120V 60HZ 1000VA CO | | | MICROVAX2 | 579.00 | 54-11398-00 | USE 701071800 | | | RX01 | 00.00 |
| 30-25269-01 | MODULE,ANALOG INPUT 16 CHANNEL 50KHZ | | | MICROVAX2 | 415.00 | 54-11444-00 | MONITOR BOARD | K | | VT61-61T | 130.00 |
| 30-25270-01 | MODULE,DUAL CHANNEL D-A | | | MICROVAX2 | 375.00 | 54-11444-01 | VT78 MONITOR | D | | VT FAMILY | 105.00 |
| 30-25646-01 | USE RCD31-E | 1A | | PC500 | 00.00 | 54-11450-00 | VT55 POWER BRD | K | | VT50 FAM | 185.00 |
| 30-27655-01 | PRINTHEAD,DOT MATRIX 7 WIRE | | | LA120 | 100.00 | 54-11522-00 | PILOT CONTROL | | | | 105.00 |
| 34-23566-01 | CONTAINERS,MODULE,CONDUCTIVE,DOUBLE WALL | | | | 35.00 | 54-11599-00 | USE 541159901 | C | | 11/04 | 00.00 |
| 34-24071-01 | CASE,MODULE DUAL WALL CONDUCTIVE PLA | | | VAX8600 | 25.00 | 54-11599-01 | T20V REG H777 NO FAT TEST | | | 11/34-34A | 100.00 |
| 54-08475-00 | POWER REG H720 PD11 54-9267 | | | 11 FAMILY | 158.00 | 54-11601-00 | MOS REGULATOR 15V | D | | 11 FAMILY | 150.00 |
| 54-08924-00 | POWER CONTROL TW10 | B | | TU10 | 135.00 | 54-11601-01 | MOS REGULATOR 15V | E | | 11 FAMILY | 210.00 |
| 54-08928-00 | REGULATOR, VOLTAGE | D | | TU10 | 80.00 | 54-11625-00 | MODULE H779 | | | | 215.00 |
| 54-09057-00 | FRONT PNL 8E | C | | PDP8E,M,F | 150.00 | 54-11725-00 | VT 61 SWITCH PANEL | B | | VT61-61T | 80.00 |
| 54-09057-01 | CONTROL PANEL FRONT 8/E | E | | PDP8E,M,F | 185.00 | 54-11736-00 | POWER BOARD LA180 | E | | LA180 | 85.00 |
| 54-09267-00 | BOARD, REG H720F | B | | 11 FAMILY | 168.00 | 54-11743-00 | USE 541174304 | B | | VT50 FAM | 00.00 |
| 54-09484-00 | 8 TO 20V REGULATOR | D | | RK05 | 105.00 | 54-11743-02 | ROM VART | A | | VT50 FAM | 90.00 |
| 54-09503-00 | (5 VOLT REGULATOR | F | 1 | RK05 | 105.00 | 54-11743-04 | ROM VART | A | | VT50 FAM | 173.00 |
| 54-09668-00 | FRONT PNL 8M | D | | PDP8E,M,F | 300.00 | 54-11745-00 | DATA PATH | 1 | 1 | VT50 FAM | 173.00 |
| 54-09684-00 | ASSY 11/45 CONSOLE | B | | 11/45 | 246.00 | 54-11776-00 | H780 POWER SUPPLY | 1 | 1 | 11/03 | 165.00 |
| 54-09701-00 | KY11-D CONSOLE | D | | 11 FAMILY | 295.00 | 54-11800-00 | USE 541180001 | D | | 11/04 | 00.00 |
| 54-09728-00 | BOARD REGULATOR | D | | PDP8E,M,F | 110.00 | 54-11800-01 | KY11-LB CONSOLE BRD SYSTEM TESTED | | | 11 FAMILY | 360.00 |
| 54-09730-00 | POWER CONTROL BD 11/45 | C | | 11/45 | 88.00 | 54-11844-00 | READ&WRITE BOARD | E | H | RL01 | 74.00 |
| 54-09766-00 | DISPLAY BUFFER & DRIVER | B | | 11/05 | 68.00 | 54-11848-00 | ETCH BRD 54-11848 | E | | 11 FAMILY | 55.00 |
| 54-10131-00 | CASSETTE POWER SUPPLY | B | | PDP8E,M,F | 70.00 | 54-11850-00 | D.C. SERVO AND POWER BOARD | C | | RL01 | 95.00 |
| 54-10199-00 | REGULATOR BRD | E | | 11 FAMILY | 163.00 | 54-12046-00 | VT52 PIN PRINTER INTERFACE MODULE | B | | VT50 FAM | 82.00 |
| 54-10451-00 | USE 541224200 | | | TU16 | 00.00 | 54-12166-00 | LA180 MODULE | C | | LA180 | 70.00 |

digital

Prices Effective 02-January-89 to 30-June-89
When you need a part repaired, call 800-225-5385.

SPARES PRICE LIST C-21

DECmailer PRICE LIST

| PART NUMBER | DESCRIPTION | LOWEST ACCEPTABLE | | | REPAIR PRICE | PART NUMBER | DESCRIPTION | LOWEST ACCEPTABLE | | | REPAIR PRICE |
|-------------|--|-------------------|-----|-----------|--------------|-------------|---|-------------------|-----|-----------|--------------|
| | | ETCH | REV | USED ON | | | | ETCH | REV | USED ON | |
| 54-12166-YA | LA180 MODULE | C | | LA180 | 70.00 | 54-13673-00 | USE H7150-00 | | | LA120 | 00.00 |
| 54-12175-00 | DRIVE LOGIC RL01 | D | D | RL01 | 116.00 | 54-13679-00 | USE 00DLV11KB | | | 11 FAMILY | 00.00 |
| 54-12233-00 | BACKPLANE BOARD | | | 11 FAMILY | 200.00 | 54-13747-00 | LA34 CONTROL BAORD | | | LA34 | 100.00 |
| 54-12242-00 | POWER SUPPLY TU16 | A | | TU16 | 142.00 | 54-13747-02 | USE 541374704 | | | 11 FAMILY | 00.00 |
| 54-12264-00 | USE H60700 | | | 11 FAMILY | 00.00 | 54-13747-04 | LOGIC BOARD | | | 11 FAMILY | 275.00 |
| 54-12441-00 | USE H7441 | | | TU/TA78 | 00.00 | 54-13764-00 | PLUS OR MINUS 15V POWER SUP. | | | 11/24 | 400.00 |
| 54-12530-00 | MASTER BOARD | | | 11 FAMILY | 300.00 | 54-13782-01 | EXPANDED MEMORY LA34 | | | LA34 | 120.00 |
| 54-12550-00 | MOTHER BOARD | A | | 11/780 | 131.00 | 54-13867-00 | USE H7211 | | | | 00.00 |
| 54-12554-00 | BIAS CONTROL | C | | 11/780 | 89.00 | 54-13935-00 | LQP SERIAL INTERFACE (DAUGHTER) | | | LQP01 | 100.00 |
| 54-12556-00 | +12V REGULATOR | B | | 11/780 | 79.00 | 54-13937-00 | LQP SERIAL INTERFACE (MOTHER) | | | LQP01 | 105.00 |
| 54-12560-00 | -5V REGULATOR | B | | 11/780 | 79.00 | 54-13939-00 | USE 701820401 | | | 11 FAMILY | 00.00 |
| 54-12610-00 | USE 541261001 | | | LS120 | 00.00 | 54-13951-00 | ADAPTOR BOARD | | | VT100 FAM | 225.00 |
| 54-12610-01 | LS120 LOGIC BOARD | A | | LA120 | 160.00 | 54-14012-00 | MICRO PROCESSOR | D | | RM80 | 263.00 |
| 54-12660-00 | CMOS-8 | C | | VT FAMILY | 250.00 | 54-14014-00 | SERVO CONTROL | | | RA80 | 341.00 |
| 54-12675-00 | BATTERY CHARGER | A | | 11/780 | 79.00 | 54-14025-00 | DRIVE LOGIC | B | F | RL02 | 105.00 |
| 54-12691-00 | CMO8-8 MEMORY | A | | VT FAMILY | 168.00 | 54-14131-00 | USE 7017362-1 | | | VT100 FAM | 00.00 |
| 54-12781-00 | SLAVE MODULE | H | | 11/70 | 139.00 | 54-14185-00 | VT101 TERMINAL CONTROL | F | | VT100 FAM | 150.00 |
| 54-12781-01 | UNIBUS SERIAL CONSOLE | C | | 11/70 | 97.00 | 54-14185-01 | VT102 TERMINAL CONTROL | F | | VT100 FAM | 150.00 |
| 54-12985-00 | LIGHTS SW | | | 11/03 | 90.00 | 54-14185-02 | VT131 TERMINAL CONTROL | F | | VT100 FAM | 150.00 |
| 54-12989-00 | ETCHED BACKPLANE MOTHER BOARD | | | 11 FAMILY | 350.00 | 54-14230-00 | VK100 LOGIC BOARD | D | | VK100 | 360.00 |
| 54-13009-00 | VT100 BASIC VIDEO CONTROLLER | E | | VT100 FAM | 100.00 | 54-14240-00 | H7476 REGULATOR | | | | 150.00 |
| 54-13009-01 | USE 541300904 | C | D | VT100 FAM | 00.00 | 54-14245-00 | USE 701737400 | | | | 00.00 |
| 54-13009-03 | VT100 BASIC VIDEO | E | | VT100 FAM | 120.00 | 54-14256-00 | LA100 LOGIC BOARD | | | LA100 | 150.00 |
| 54-13009-04 | VT100 BASIC VIDEO | | | VT100 FAM | 185.00 | 54-14256-01 | USE 541425600 | | | LA100 | 00.00 |
| 54-13016-00 | 869 PILOT CONTROL BOARD | | | 11 FAMILY | 140.00 | 54-14256-06 | LOGIC BOARD | J | AA | PC FAMILY | 85.00 |
| 54-13044-00 | USE H7110 | D | | LA120 | 00.00 | 54-14260-00 | STP FOUNDATION MODULE | A | | VT100 FAM | 63.00 |
| 54-13089-00 | A.C. CONTROL BOARD | | | 11 FAMILY | 75.00 | 54-14275-00 | VT125 PADDLE BOARD | | | VT100 FAM | 79.00 |
| 54-13097-00 | VT100 ADVANCED VIDEO | B | | VT100 FAM | 80.00 | 54-14277-00 | VT125 MONO BD. | E | E | VT100 FAM | 236.00 |
| 54-13097-01 | ADVANCE VIDEO LA120 | B | B | VT100 FAM | 100.00 | 54-14497-YA | DATA WAY INTERFACE | B | | 11 FAMILY | 290.00 |
| 54-13206-00 | 20 MA ADAPTER | | | VT100 FAM | 53.00 | 54-14610-00 | LA12 POWER SUPPLY | | | LA12 | 70.00 |
| 54-13265-00 | MOS BATTERY BACKUP | | | | 200.00 | 54-14630-00 | USE 541463002 | | | LA12 | 00.00 |
| 54-13269-00 | TIM PERIPHERAL MODULE | D | | 11 FAMILY | 105.00 | 54-14630-01 | USE 541463002 | | | LA12 | 00.00 |
| 54-13271-00 | TERMINAL INTELLIGENCE MODULE | D | | 11 FAMILY | 155.00 | 54-14630-02 | LA12 LOGIC BOARD | D | | LA12 | 90.00 |
| 54-13273-00 | FLOPPY CONTROLLER R-W | A | | 11 FAMILY | 173.00 | 54-14630-03 | USE 541463002 | | | LA12 | 00.00 |
| 54-13275-CC | MEMORY_32K | | | MEMORIES | 185.00 | 54-14636-00 | AZTEC CONTROLLER MODULE | C | | RC25 | 630.00 |
| 54-13275-CE | USE 5413275CA | | | 11 FAMILY | 00.00 | 54-14645-00 | AZTEC DRIVE CARD | F | | RC25 | 510.00 |
| 54-13343-00 | H7833 POWER SUPPLY | B | | 11 FAMILY | 140.00 | 54-14707-00 | VT1XX-EA/EB LOGIC BD (2A-E066A) | D | | VT100 FAM | 320.00 |
| 54-13374-00 | LA00 LOGIC BOARD | C | D | LA34 | 115.00 | 54-14823-00 | LA12 MODEM | | | LA12 | 125.00 |
| 54-13396-00 | PLUS 2.5V CONTROL BOARD | | | 11/750 | 58.00 | 54-14823-01 | 300/1200 MODEM | | | LA12 | 90.00 |
| 54-13404-00 | VT100 FULL KEYBOARD | | | VT100 FAM | 68.00 | 54-14827-00 | USE H3006 | | | | 00.00 |
| 54-13414-00 | PLUS & MINUS SVB BATTERY REG. | | | 11 FAMILY | 115.00 | 54-14923-00 | USE 70-18327 | | | RA80 | 00.00 |
| 54-13446-00 | USE LA12X-DL | | | LA120 | 00.00 | 54-14966-00 | NI TRANCEIVER MODULE | | | ETHERNET | 150.00 |
| 54-13446-01 | USE LA12X-DL | | | LA120 | 00.00 | 54-15058-00 | RX50 FLOPPY CONTROL(CAN DRIVE 2 RX50'S) | | | RX50 | 85.00 |
| 54-13489-00 | USE TU58-XB | | | TU58 | 00.00 | 54-15084-00 | USE 5415084FA | | | PC FAMILY | 00.00 |
| 54-13491-00 | USE TU58-XC | | | TU58 | 00.00 | 54-15084-FA | C.T. RAM 128 KB | D | | PC FAMILY | 80.00 |
| 54-13534-00 | DC SERVO + POWER SUPPLY (RL02) | B | | RL02 | 100.00 | 54-15101-00 | USE KDF11-CC | | | PC FAMILY | 00.00 |
| 54-13536-00 | RL02 READ/WRITE | B | | RL02 | 125.00 | 54-15134-00 | RD 50 CONTROL | C | | RD FAMILY | 200.00 |
| 54-13596-00 | READ/WRITE | | | RM80 | 131.00 | 54-15134-01 | RD52 CONTROL | | | RD FAMILY | 200.00 |
| 54-13599-00 | LOGIC INVERTER BD | C | | 11/750 | 285.00 | 54-15138-00 | CT100 VIDEO GENERATOR | C | C | PC FAMILY | 80.00 |
| 54-13601-00 | LOGIC INVERTER BD | C | | 11/750 | 115.00 | 54-15146-00 | CT100 COLOR BIT MAP | A | | PC FAMILY | 200.00 |
| 54-13603-00 | MEMORY INVERTER BD | B | | 11/750 | 330.00 | 54-15152-00 | USE 5415152AA | | | VT100 FAM | 00.00 |
| 54-13605-00 | BIAS AND INTERFACE BOARD FOR 11144 POWER | C | | 11/750 | 115.00 | 54-15152-AA | VT180 | | | VT100 FAM | 240.00 |
| 54-13607-00 | MEMORY REGULATOR BD | D | | 11/750 | 115.00 | 54-15160-00 | AZTEC DISK POWER SUPPLY | D | | RC25 | 320.00 |
| 54-13615-00 | H7140 MOTHER BOARD | E | | 11 FAMILY | 260.00 | 54-15215-00 | USE 541521501 | | | DECTALK | 00.00 |
| 54-13656-01 | VT61T MEMORY BOARD | A | | VT61-61T | 150.00 | 54-15215-01 | CONTROL FOR DTC11-A (USA/CANADA) | | | DECTALK | 233.00 |



Prices Effective 02-January-89 to 30-June-89
When you need a part repaired, call 800-225-5385.

DECmailer PRICE LIST

| PART NUMBER | DESCRIPTION | LOWEST ACCEPTABLE | | | REPAIR PRICE | PART NUMBER | DESCRIPTION | LOWEST ACCEPTABLE | | | REPAIR PRICE |
|-------------|-----------------------------------|-------------------|-----|------------|--------------|-------------|---|-------------------|-----|------------|--------------|
| | | ETCH | REV | USED ON | | | | ETCH | REV | USED ON | |
| 54-15247-00 | R81 MICRO PROCESSOR MODULE | B | D | RA81 | 683.00 | 54-16021-00 | PC278 GRAPHICS OPTION | | | PC FAMILY | 155.00 |
| 54-15249-00 | USE 701904601 | | | RA81 | 00.00 | 54-16042-01 | DFMSA POW SUP: +5.1V 1.2A, +/-12V 0.36A,1 | | | DFMSA-AA | 50.00 |
| 54-15253-00 | R81 READ/WRITE MODULE | B | B | RA81 | 404.00 | 54-16053-01 | ETHERNET FIBER OPTIC REPEATER | | | ETHERNET | 82.00 |
| 54-15264-00 | USE 541526401 | | | RA60 | 00.00 | 54-16188-01 | R82 SERVO CONTROL | | | RA82 | 990.00 |
| 54-15264-01 | POST AMP/DATA SEPARATOR MODULE | | | RA60 | 300.00 | 54-16190-01 | R82 HYBRID MODULE | | | RA82 | 1067.00 |
| 54-15266-01 | DRIVE LOGIC MODULE | C | | RA60 | 450.00 | 54-16192-01 | R82 READ/WRITE MODULE | | | RA82 | 650.00 |
| 54-15266-02 | USE 541526601 | | | RA60 | 00.00 | 54-16234-LA | PC300 RAM 512 KB | | | PC FAMILY | 538.00 |
| 54-15270-01 | I/O MODULE | D | | RA60 | 500.00 | 54-16239-01 | EBO MODULE 84 | | | PC3XX FAM | 645.00 |
| 54-15272-00 | USE 541527201 | | | RA60 | 00.00 | 54-16368-01 | FRONT PANEL TO 20 POSITION BARRIER STRIP | | | | 50.00 |
| 54-15272-01 | FRONT PANEL | | | RA60 | 100.00 | 54-16489-01 | DECIMATE ITT SYSTEM BD. | | | PC FAMILY | 200.00 |
| 54-15284-01 | RA80 MICROPROCESSOR | A | | RA80 | 257.00 | 54-16500-AA | USE 5416500BA | | | VAX8650 | 00.00 |
| 54-15426-00 | USE 70-19973 | | | PC278 | 00.00 | 54-16500-BA | LOW POWER 2MB SMU MEMORY ARRAY =54-16500 | | | | 850.00 |
| 54-15436-00 | DECIMATE II RX78 INTERFACE | | | DECIMATE | 150.00 | 54-16529-01 | OPTION CARD,8086 (XPU) EXTENDED PROCCSO | | | PC FAMILY | 140.00 |
| 54-15451-00 | PC278 APU | B | | DECIMATE | 110.00 | 54-16531-AA | Z80 W/512KB = 54-16531-AC,-AF OR -AH | | | DECIMATE | 175.00 |
| 54-15459-00 | USE 702077901 | | | PC FAMILY | 00.00 | 54-16533-01 | USE 5416533AA | | | PC FAMILY | 00.00 |
| 54-15478-00 | VS100 DISPLAY PROCESSOR | | | 11/730 | 709.00 | 54-16533-AA | Z80 W/256KB MEM = 54-16533-AC, -AF OR -A | | | PC FAMILY | 140.00 |
| 54-15480-00 | USE 541548001 | | | 11/730 | 00.00 | 54-16537-01 | MICRO MODEM OR PC238-A | | | DECIMATE | 115.00 |
| 54-15480-01 | BIT/BLT ACCELERATOR | | | | 341.00 | 54-16553-01 | DECIMATE III BIT MAPPED GRAPHICS DISPLAY | | | DECIMATE | 165.00 |
| 54-15482-00 | PC100 RX50 CONTROLLER | B | B | RX50 | 50.00 | 54-16572-01 | USE 541657202 | | | VAX8200 | 00.00 |
| 54-15488-KA | PC300 256KB MEMORY MODULE | | | PC FAMILY | 80.00 | 54-16572-02 | POLARIS CONTROL MODULE | | | VAX8200 | 250.00 |
| 54-15490-AA | PC100 MEMORY EXT. (64KB MEM/EXT.) | | | PC FAMILY | 53.00 | 54-16574-01 | CONTROL PANEL FOR SCORPIO SYSTEMS. | | | VAX6200 | 100.00 |
| 54-15490-BA | PC100 MEMORY EXT (192KB MEM/EXT.) | | | PC FAMILY | 50.00 | 54-16622-01 | 4 ASYNCHRONOUS SERIAL LINE MODULE FOR CT | | | PC3XX FAM | 110.00 |
| 54-15495-00 | USE 541549502 | | | VT240 | 00.00 | 54-16681-01 | IVIS BACKPACK CONNECTOR & MASTER SYNC GE | B2 | | PC3XX IVIS | 111.00 |
| 54-15495-01 | USE 541549502 | A | | VT240 | 00.00 | 54-16683-01 | CONTROLLER BOARD FOR IVIS,CTI INTERFACE, | B2 | | PC3XX IVIS | 128.00 |
| 54-15495-02 | VS240 MODULE | | | VT240 | 260.00 | 54-16802-AA | MS400-AA 2MB MEM,SURFACE MNT,256K PLCC D | 1D | A | VAXSTATION | 180.00 |
| 54-15539-01 | IEEE/2 DL/24 LINE INTERFACE | | | PC FAMILY | 148.00 | 54-16802-BA | MS400-BA 4MB MEM,SURFACE MNT,256K PLCC D | 1D | A | VAXSTATION | 350.00 |
| 54-15586-00 | NEWLY ADDED CRC PART | | | ETHERNET | 220.00 | 54-16804-01 | NTWK INTERFACE OPTIUON FOR VAXSTATION 20 | F | A | VAXSTATION | 290.00 |
| 54-15586-01 | REPEATER | | | DEREP-AA | 220.00 | 54-16847-01 | USE 541715801 | | | PC500 | 00.00 |
| 54-15624-01 | VR260 DEFLECTION BOARD | | | VR260 | 85.00 | 54-16853-AF | 2MB MEMORY W/HITACHI 256K RAMS | | 1B | PC500 | 160.00 |
| 54-15626-01 | VIDEO AMP BOARD | | | VR260 | 135.00 | 54-16881-01 | PCXX INTRICAL MODEN - WORKSTATION | | | PC500 | 190.00 |
| 54-15641-00 | PC300 SERIES CP/M OPTION MODULE | | | PC FAMILY | 83.00 | 54-16888-01 | VS2000 4-PLANE VIDEO OPTION | | | VAXSTATION | 700.00 |
| 54-15643-01 | VT240 MODEM | | | VT240 | 158.00 | 54-16903-01 | GRAPHIC BITMAP MODULE | | | VT330/340 | 255.00 |
| 54-15651-00 | USE 702062401 | | | VT220 | 00.00 | 54-16905-01 | MONOCHROME MONITOR POWER SUPPLY MODULE | | | VT330/340 | 45.00 |
| 54-15651-01 | USE 702062402 | | | VT220 | 00.00 | 54-16909-01 | MONOCHROME CPU MODULE | | | VT330/340 | 50.00 |
| 54-15653-00 | USE 702081402 | | | VT220 | 00.00 | 54-16943-01 | 1MB DYNAMIC RAM,128KB ROM LN03 OPTION BO | | | LN03 | 144.00 |
| 54-15653-01 | USE 702081401 | | | VT220 | 00.00 | 54-16961-01 | USE 702451601 | | | VT330/340 | 00.00 |
| 54-15653-02 | USE 702081402 | | | VT220 | 00.00 | 54-16965-01 | TERMINAL CNTRL MODULE | | | VT330/340 | 485.00 |
| 54-15662-00 | USE 702077901 | | | PC FAMILY | 00.00 | 54-17054-01 | DECIMATE III PLUS CPU BOARD | | | PC FAMILY | 250.00 |
| 54-15688-01 | RAINBOW COLOR GRAPHICS OPTION | | | PC FAMILY | 115.00 | 54-17056-01 | DECIMATE III WINCHESTER HARD DRIVE CONTRO | | | PC FAMILY | 150.00 |
| 54-15703-00 | PC100 COMMUNICATION OPTION | | | PC FAMILY | 80.00 | 54-17158-01 | CPU BOARD FOR VAXMATE | | | PC500 | 290.00 |
| 54-15961-AA | PC100B MEMORY EXT. AC,AF,AH,AJ | | | DECNA | 180.00 | 54-17187-01 | USE 541715801 | | | PC500 | 00.00 |
| 54-15987-01 | DECNA | | | DECNA | 166.00 | 54-17195-01 | LN03R CONTROL BOARD | | | LN03 | 495.00 |
| 54-15989-01 | MICRO SWITCH LOGIC BD. | | | DFMSA-AA | 150.00 | 54-17556-01 | RRD50 PC/XT CONTROLLER | | | RRD50 | 150.00 |
| 54-15991-00 | IVIS-CT DEVELOPMENT | | | PC3XX IVIS | 100.00 | 54-17639-01 | TK50 CSIC CONTROLLER | | | TK50 | 146.00 |
| 54-15991-01 | IVIS SYSTEM MODULE | | | PC3XX IVIS | 100.00 | 54-17655-01 | FRONT PANEL MODULE W/10 LEDS,SWITCH,POWE | | | | 50.00 |
| 54-15993-00 | IVIS-CT DEVELOPMENT | | | PC3XX IVIS | 103.00 | 54-17659-01 | 16BIT A/D W/PROGRAMMABLE GAIN/RS32 & IEE | | | | 1124.00 |
| 54-15993-01 | EXTERNAL IVIS ANALOG | | | PC3XX IVIS | 103.00 | 54-18172-01 | CLOCK ARBITER CARD FOR XMI | | | VAX6200 | 450.00 |
| 54-15993-02 | IVIS ANALOG | | | PC3XX IVIS | 110.00 | 57-00006-00 | USE KEF11-BB | | | 11/23-23B | 00.00 |
| 54-15995-00 | IVIS-CT DEVELOPMENT | | | PC3XX IVIS | 100.00 | 70-08329-00 | LOGIC DR11-B | | | 11 FAMILY | 90.00 |
| 54-15995-01 | EXTERNAL IVIS LOGIC | | | PC3XX IVIS | 100.00 | 70-08474-03 | NIXIE CABLE RT01-NC | | | RT FAMILY | 210.00 |
| 54-16006-00 | USE 541600601 | | | PC3XX IVIS | 00.00 | 70-08702-00 | LINEAR POSITIONER | | | RK05 | 463.00 |
| 54-16006-01 | IVIS EBO | | | PC3XX IVIS | 133.00 | 70-08871-00 | LOGIC KB11-A 11/45 | R | | 11/45 | 175.00 |
| 54-16008-01 | IVIS VIDEO GENERATOR | | | PC3XX IVIS | 143.00 | 70-09006-00 | PWR SUP & CONT 115V 60HZ RS03 & RS04 | | | RS FAMILY | 275.00 |
| 54-16010-00 | FOT/R | | | 11/730 | 160.00 | 70-09014-01 | TRANSPORT ASY DIE CAST (TU60) | | | TU60 | 400.00 |
| 54-16019-00 | PC100 RD51 CONTROLLER | | | PC FAMILY | 180.00 | 70-09062-00 | LOGIC DD11-B | | | 11 FAMILY | 90.00 |

digital

Prices Effective 02-January-89 to 30-June-89
When you need a part repaired, call 800-225-5385.

SPARES PRICE LIST C-23

DECmailer PRICE LIST

| PART NUMBER | DESCRIPTION | LOWEST ACCEPTABLE | | | REPAIR PRICE | PART NUMBER | DESCRIPTION | LOWEST ACCEPTABLE | | | REPAIR PRICE |
|-------------|--|-------------------|-----|-----------|--------------|-------------|--|-------------------|-----|-----------|--------------|
| | | ETCH | REV | USED ON | | | | ETCH | REV | USED ON | |
| 70-09179-00 | LOGIC DJ11-AA, DJ11-AB, DJ11-AC | | | 11 FAMILY | 90.00 | 70-14115-01 | USE 541261001 | | | LS120 | 00.00 |
| 70-09282-00 | POWER SUPPLY ASSY PLR | | | PDP8,M,F | 625.00 | 70-14226-00 | MK11 BACKPLANE ASSY | | | 11 FAMILY | 275.00 |
| 70-09295-02 | LOGIC-MF11-UP C | | | 11 FAMILY | 118.00 | 70-14251-00 | 70-14251 BATTERY BACKUP REGULATOR | 1 | | 11 FAMILY | 320.00 |
| 70-09397-00 | LOGIC RH11 | | | 11 FAMILY | 115.00 | 70-14257-00 | BACKPLANE ASSY DDV11-CK | | | | 70.00 |
| 70-09404-00 | USE 700940401 | B | | KL10 | 00.00 | 70-14411-00 | BDN-DATA (METRIC) | | | RK07 | 75.00 |
| 70-09404-01 | REGULATED HEAT SINK ASSY. -2.0V | D | D | KL10 | 446.00 | 70-14411-01 | RK07 DISK HEAD | | | RK07 | 75.00 |
| 70-09405-00 | USE 700940501 | B | | KL10 | 00.00 | 70-14411-02 | BDN-SERVO (METRIC) | | | RK07 | 75.00 |
| 70-09405-01 | REGULATED HEAT SINK ASSY. -5.2V | D | | KL10 | 460.00 | 70-14420-01 | INPUT BOXES | | | 11 FAMILY | 75.00 |
| 70-09605-00 | LOGIC TU16 | | | TU16 | 90.00 | 70-14420-02 | INPUT BOXES | | | 11 FAMILY | 50.00 |
| 70-09612-00 | LOGIC DB11-A | | | 11 FAMILY | 90.00 | 70-14533-01 | PRINTER MECH W/O HEAD | | | LA120 | 350.00 |
| 70-09623-00 | LOGIC-RP04 | | | RP04 | 115.00 | 70-14956-00 | UDA OPTION SUPPLY | | | 11/780 | 550.00 |
| 70-09636-00 | USE 701671100 | | | TS11 | 00.00 | 70-14956-01 | UBA OPTION SUPPLY 50HZ | | | 11/780 | 550.00 |
| 70-09644-01 | MOTOR ASSY. LOWER-TU16 | | | TU16 | 300.00 | 70-14957-00 | MEM OPTION SUPPORT | B | | 11/780 | 640.00 |
| 70-09644-02 | MOTOR ASSY. UPPER-TU16 | | | TU16 | 241.00 | 70-14957-01 | MEM OPTION SUPPLY 50HZ | B | | 11/780 | 640.00 |
| 70-09691-00 | MOTOR DC & ENCODER ASSY (LA36) | | | LA36 | 125.00 | 70-14979-00 | POWER SUPPLY ASSY | C | | VT100 FAM | 200.00 |
| 70-09811-01 | USE 701442001 | | | 11 FAMILY | 00.00 | 70-15085-00 | PRINT HEAD ASSY | | | LA120 | 85.00 |
| 70-09835-00 | MOTOR CAPSTAN ASSY-TU16 | | | TU16 | 370.00 | 70-15116-00 | SPINDLE ASSY | | | RL02 | 200.00 |
| 70-09883-00 | PRINT HEAD LA36 | | | LA36 | 135.00 | 70-15140-00 | X605 BACKPLANE ASSY | | | 11 FAMILY | 120.00 |
| 70-09885-05 | 9TRK NARROW RADIUS | | | TU16 | 225.00 | 70-15184-00 | BACKPLANE ASSY | | | | 90.00 |
| 70-09885-08 | 9TRK NARROW RADIUS | | | TU16 | 110.00 | 70-15273-00 | 20 MA-ADAPTER ASSY | | | VT100 FAM | 53.00 |
| 70-10068-00 | COPIER ASSY GEAR BOX WITH 115V 60HZ MOTO | A | | VT50 FAM | 257.00 | 70-15276-01 | KEYBOARD BEZEL | | | LA120 | 150.00 |
| 70-10068-01 | COPIER ASSY GEAR BOX WITH 230V 50HZ MOTO | A | | VT50 FAM | 257.00 | 70-15388-00 | SERVO MOTOR ASSY | | | LA120 | 115.00 |
| 70-10092-00 | DC MOTOR & ENCODER ASSEMBLY | | | LA180 | 125.00 | 70-15490-00 | LA00 PRINT HEAD ASSY | | | LA34 | 79.00 |
| 70-10230-00 | LOGIC 11/35 | M | | 11/35-40 | 130.00 | 70-15510-00 | USE TU58-XA | | | TU58 | 00.00 |
| 70-10329-00 | LOGIC ASSY CPU (KB11-B) | L | | 11/70 | 575.00 | 70-15514-00 | KEYBOARD/KECAP ASSY. | E | | LA34 | 85.00 |
| 70-10644-00 | KEYBOARD ASSY | B | D | PDP8 FAM | 130.00 | 70-15514-02 | LA34-JA KEYBOARD/KEYCAP ASSY. | | | LA34 | 100.00 |
| 70-10718-00 | BOARD POWER ASSY H771 | B | | RX01 | 80.00 | 70-15514-03 | USE 701551402 | | | LA34 | 00.00 |
| 70-11073-00 | +5V REG ASSY | E | | 11 FAMILY | 140.00 | 70-15637-00 | RL02 DATA HEAD "A" UP | | | 11 FAMILY | 84.00 |
| 70-11164-00 | BACKPLANE ASSY [DD11-DK] | | | 11 FAMILY | 115.00 | 70-15637-01 | RL02 DATA HEAD "A" DN | | | RL02 | 84.00 |
| 70-11523-00 | BACKPLANE ASSY DD11-PK | F | A | 11/04 | 95.00 | 70-15737-00 | USE 70-18960 | | | LA34 | 00.00 |
| 70-11528-00 | WIRE ASSY | | | 11/04 | 90.00 | 70-15763-00 | USE 701763001 | D | | LA120 | 00.00 |
| 70-11915-00 | CARRIAGE AND COIL ASSY (RK06) | | | RK06 | 240.00 | 70-15763-01 | USE 701763001 | A | | LA120 | 00.00 |
| 70-11915-01 | CARRIAGE, COIL ASSY | | | RK06 | 118.00 | 70-15764-00 | KEY PAD/KEY CAP ASSY | | | LA120 | 53.00 |
| 70-12114-00 | DISK MOTOR ASSY | | | 11 FAMILY | 100.00 | 70-15764-01 | KEYPAD ASSY GREY KEYCAPS | | | LA120 | 53.00 |
| 70-12117-00 | POSITIONER ASSY | | | 11 FAMILY | 225.00 | 70-15765-00 | KEYBOARD/KEYCAP ASSY | B | A | VT100 FAM | 68.00 |
| 70-12122-10 | USE BC21Z-10 | | | | 00.00 | 70-15765-02 | KEYBOARD/KEYCAP ASSY | | | VT100 FAM | 90.00 |
| 70-12306-00 | BACK PLANE ASSY DD11-DF | C | | 11 FAMILY | 210.00 | 70-15765-03 | KEYBOARD/KEYCAP ASSY | B | W | VT100 FAM | 80.00 |
| 70-12356-00 | ACOUSTIC COUPLER ASSY | | | LA36 | 54.00 | 70-15765-04 | KEYBD/KEYCAP ASSY 82KEY (VT132 EDITING T | | | VT100 FAM | 125.00 |
| 70-12413-00 | WIRED ASSY RK611 | | | RK06 | 115.00 | 70-15765-10 | KEYBOARD KEYCAP ASSY | | | VT100 FAM | 70.00 |
| 70-12445-00 | BACK PLANE ASSY DD11-CF | F | | 11 FAMILY | 90.00 | 70-15765-13 | KEYBOARD KEYCAP ASSY | | | VT100 FAM | 70.00 |
| 70-12524-00 | TRANSDUCER ASSY | | | RK06 | 125.00 | 70-15929-00 | USE 875-A | | | 11/750 | 00.00 |
| 70-12524-01 | TRANSDUCER ASSY | | | RK07 | 125.00 | 70-16059-00 | 20 MA OPTION (LA120) | A | | LA120 | 74.00 |
| 70-12909-00 | +5V REGULATOR ASSY | B | | 11/24 | 158.00 | 70-16156-01 | USE H7104-D | A | | 11/750 | 00.00 |
| 70-12912-00 | CAP BRD BRKT ASSY | D | | RK06 | 71.00 | 70-16157-01 | USE H7104-C | A | | 11/750 | 00.00 |
| 70-12953-00 | BACKPLANE ASSY | | | | 400.00 | 70-16225-00 | HEAD/DISK ASSEMBLY | A | | RA80 | 3800.00 |
| 70-13077-00 | FLEXIBLE DRIVE ASSY (60HZ) | | | RX01 | 185.00 | 70-16486-00 | BACKPLANE | | | 11 FAMILY | 262.00 |
| 70-13077-01 | FLEXIBLE DRIVE ASSY (50HZ) | | | RX01 | 185.00 | 70-16687-00 | VACUUM ASSY | | | TU16 | 250.00 |
| 70-13077-02 | FLEXIBLE DISK DRIVE | | | RX01 | 185.00 | 70-16711-00 | TRANS/CAP POWER SUPPLY ASSY | | | TS FAMILY | 741.00 |
| 70-13077-04 | USE 70-13077 | | | RX02 | 00.00 | 70-16723-02 | LOW VOLTAGE 60HZ | | | RL02 | 368.00 |
| 70-13077-06 | 60HZ DRIVE WITH BROWN HANDLE | | | RX01 | 185.00 | 70-16795-00 | USE 70-16225 | | | RA80 | 00.00 |
| 70-13398-00 | WIRED ASSY. | | | RM03 | 185.00 | 70-16799-00 | KEYPAD ASSY,LA120 R/O | C | | LA120 | 84.00 |
| 70-13574-00 | 9TRK HEAD PLATE ASSY | | | TS FAMILY | 750.00 | 70-16799-01 | KEYPAD ASSY LA120 R/O | C | | LA120 | 50.00 |
| 70-13585-01 | 9TRK HEAD PLATE ASSY | | | TE16 | 750.00 | 70-16975-00 | PERSONALITY BD & STIFFENER ASSY. | | | RM80 | 186.00 |
| 70-13625-00 | BACKPLANE ASSY (MEMORY) | A | | 11 FAMILY | 225.00 | 70-16976-00 | SERVO BOARD AND STIFFENER ASSY. | | | RM80 | 341.00 |
| 70-13628-00 | BACKPLANE ASSY (CPU) | | | 11 FAMILY | 365.00 | 70-17211-00 | BOARD AND PANEL ASSY | | | MODEMS | 180.00 |



Prices Effective 02-January-89 to 30-June-89
When you need a part repaired, call 800-225-5385.

DECmailer PRICE LIST

| PART NUMBER | DESCRIPTION | LOWEST ACCEPTABLE | | | REPAIR PRICE | PART NUMBER | DESCRIPTION | LOWEST ACCEPTABLE | | | REPAIR PRICE | |
|-------------|-----------------------------------|-------------------|-----|-----------|--------------|-------------|---|-------------------|-----|------------|--------------|--------|
| | | ETCH | REV | USED ON | | | | ETCH | REV | USED ON | | |
| 70-17298-00 | PANEL ASSY DF03-A TLI | | | MODEMS | 145.00 | 70-20184-01 | POWER SUPPLY ASSY, OPT 120V 60HZ | | 4A | HSC50/70 | 650.00 | |
| 70-17362-01 | MONITOR PC BD. ASSY./EMITTER FOL | | 3 | VT100 FAM | 110.00 | 70-20184-02 | POWER SUPPLY ASSY, OPT 240V 50HZ | | 4A | HSC50/70 | 650.00 | |
| 70-17374-00 | P.S. BD. + AC INPUT BOX ASSY. | | 3 | VT100 FAM | 74.00 | 70-20405-00 | T L I INSULATOR ASSY. | | | DECTALK | 50.00 | |
| 70-17397-00 | KEYBOARD KEYCAP ASSY | | | VK100 | 120.00 | 70-20524-00 | NEWLY ADDED CRC PART | | | HSC50/70 | 50.00 | |
| 70-17484-00 | USE 70-17397 | | | | 00.00 | 70-20579-01 | BACKPLANE ASSY (CPU) | | C1 | 11/785 | 625.00 | |
| 70-17630-01 | KEYBOARD/CAP ASSY | | | | 58.00 | 70-20579-02 | BACKPLANE ASSY CPU | | C1 | 11/785 | 625.00 | |
| 70-17630-03 | KEYBOARD CAP ASSY | | | | 58.00 | 70-20624-01 | PCB BEZEL ASSY | | A | VT220 | 100.00 | |
| 70-17740-01 | SPINDLE ASSY | | | RA60 | 825.00 | 70-20689-01 | MODULE ACCESS DOOR ASSY | | A | LA210 | 115.00 | |
| 70-17863-01 | USE 701786301 | | | LA100 | 00.00 | 70-20779-01 | RCD51-CA DISK CONTROLLER ASSY | | | PC FAMILY | 402.00 | |
| 70-17863-01 | KEYBOARD/KEYCAP ASSY KSR | | | LA100 | 70.00 | 70-20814-01 | USE 702081402 | | A | VT220 | 00.00 | |
| 70-17935-00 | KEYBOARD ASSY. | | A | RT FAMILY | 400.00 | 70-20814-02 | TERMINAL CONTROL BD. BEZEL ASSY. | | | VT220 | 125.00 | |
| 70-18327-00 | PERSONALITY BD. AND STIFFNER ASSY | | | RA80 | 221.00 | 70-20999-01 | STATISTICAL MULTIPLEXER UA 240V | | NU | DSRZA | 750.00 | |
| 70-18409-00 | USE 701965501 | | | LA100 | 00.00 | 70-20999-02 | STATISTICAL MULTIPLEXER UA 120V | | NU | DSRZA | 750.00 | |
| 70-18431-00 | USE 701843101 | | | LA12 | 00.00 | 70-21127-01 | BASE PLATE CHASSIS ASSY | | | RC25 | 3000.00 | |
| 70-18452-01 | POSITIONER ASSEMBLY | | | RA60 | 950.00 | 70-21148-01 | DEC TALK | | | DECTALK | 475.00 | |
| 70-18474-01 | POWER MODULE ASSEMBLY | | | RA60 | 560.00 | 70-21170-01 | HEAD/DISK ASSEMBLY (16 BIT) | | | RA82 | 3240.00 | |
| 70-18476-01 | CAPACITOR/RECTIFIER ASSEMBLY | | | RA60 | 230.00 | 70-21495-01 | CONNECTOR PLATE ASSY. | | | VAXSTATION | 90.00 | |
| 70-18491-01 | HEAD/DISK ASSEMBLY (16 BIT) | | | RA81 | 3183.00 | 70-21682-02 | A/C MAJOR BD ASSY | | | | 200.00 | |
| 70-18491-02 | HEAD/DISK ASSEMBLY (18 BIT) | | | RA81 | 3183.00 | 70-21936-02 | BASIC DISK DRIVE SUB-ASSY - INA 6-15-88 | | | RA70 | 1575.00 | |
| 70-18704-00 | PRINTER MECH ASSY. | | | LA12 | 270.00 | 70-21946-01 | HEAD/DISK ASSEMBLY (HDA) | | | RA70 | 4585.00 | |
| 70-18707-00 | USE 70-18960 | | | LA100 | 00.00 | 70-22026-01 | SLU INTERCONNECT ASSY. | | | PC3XX FAM | 100.00 | |
| 70-18759-00 | SUPPLY +5V MEMORY OPT | | | 11/780 | 640.00 | 70-22032-01 | ASSY FLAT PANEL KEYBOARD | | | | 198.00 | |
| 70-18759-01 | SUPPLY +5V MEMORY OPT | | | 11/780 | 640.00 | 70-22032-02 | ASSY FULL TRAVEL KEYBOARD | | | | 198.00 | |
| 70-18762-00 | POWER SUPPLY ASSY. | | | 11/24 | 300.00 | 70-22494-01 | MODULE ASSEMBLY | | | RA70 | 1125.00 | |
| 70-18960-00 | SERVO MOTOR/ENCODER ASSY. | | | LA100 | 70.00 | 70-22782-01 | USE DESTA-AA | | | ETHERNET | 00.00 | |
| 70-19045-01 | SERVO BD AND STIFF ASSEMBLY | | B | RA81 | 709.00 | 70-22942-01 | ELECTRONIC CONTROL MODULE | | | RA90 | 2299.00 | |
| 70-19046-01 | PERSONALITY BD AND STIFF ASSY | | B1 | RA81 | 404.00 | 70-22951-01 | HDA/CARRIER ASSY | | | RA90 | 13205.00 | |
| 70-19343-01 | POSEIDON CONCENTRATOR TERM. 120V | | | ETHERNET | 452.00 | 70-23297-01 | I/O BOARD ASSY | | 1J | PC500 | 220.00 | |
| 70-19343-02 | POSEIDON CONCENTRATOR TERM. 240V | | | ETHERNET | 452.00 | 70-23328-01 | POWER SUPPLY ASSY. | | | DECTALK | 350.00 | |
| 70-19479-01 | RT1XX-AF TACTILE KEYBOARD | | | RT FAMILY | 605.00 | 70-23361-01 | POWER SUPPLY/MONITOR ASSY | | A | 1 | VT220 | 125.00 |
| 70-19499-00 | USE 701949901 | | A | VT240 | 00.00 | 70-23363-01 | TCB ASSY | | A | 1 | VT220 | 150.00 |
| 70-19499-01 | CHASSIS ASSY | | A | VT240 | 120.00 | 70-24216-01 | MUXSERVER 100 240V LEFT PARENTHESIS | | NU | DSRZA | 1000.00 | |
| 70-19521-00 | BASE PLATE ASSY. | | | | 0.00 | 70-24216-02 | MUX SERVER 100 120V | | NU | ETHERNET | 1000.00 | |
| 70-19572-00 | FAN BRACKET ASSY | | | PC FAMILY | 60.00 | 70-24252-01 | DEPCA,MODULE,ASSY | | | DEPCA | 66.00 | |
| 70-19584-00 | MONITOR BOARD ASSY | | C | PC FAMILY | 75.00 | 70-24268-01 | KA410-A SYSTEM MODULE ASSY | | F | A | VAXSTATION | 700.00 |
| 70-19655-01 | PRINT HEAD ASSY LAMINATED | | | LA210 | 120.00 | 70-24268-02 | KA410-B SYSTEM MODULE ASSY | | | VAXSTATION | 700.00 | |
| 70-19729-00 | BACKPLANE ASSY MEMORY | | | | 400.00 | 70-24373-01 | CARD CAGE SYSTEM ASSY, 14 SLOT | | | VAX6200 | 2000.00 | |
| 70-19973-00 | CPU ASSY, DECMATE | | C | DECMATE | 160.00 | 70-24380-01 | CI UNIT ASSY | | A1 | VAX FAMILY | 562.00 | |
| 70-19974-00 | CPU ASSY, RAINBOW 100 | | E | PC FAMILY | 200.00 | 70-24516-01 | PS/MONITOR AND ARC PROTECTION ASSY | | | VT330/340 | 73.00 | |
| 70-19974-02 | CPU ASSY, RAINBOW 100B LANG CL1 | | | PC FAMILY | 275.00 | 70-24577-01 | MONITOR AND LOGIC W/ARC PROTECTION | | | VT320 | 55.00 | |
| 70-20033-01 | POWER SUPPLY ASSY (STD) 60HZ | | 4A | | 650.00 | 70-24577-02 | MONITOR AND LOGIC W/ARC PROTECTION | | | VT320 | 55.00 | |
| 70-20033-02 | STANDARD PWR SUPP ASSY 240V 50HZ | | | HSC50/70 | 650.00 | 74-08212-00 | ASSY, MOTOR & HUB | | | RS FAMILY | 458.00 | |
| 70-20033-03 | USE 702003301 | | | | 00.00 | EQ-01454-05 | LO118 FCO KIT | | B1 | VAX FAMILY | 600.00 | |
| 70-20033-04 | STANDARD POWER SUPPLY ASSY | | | HSC50/70 | 650.00 | | | | | | | |
| 70-20170-01 | MONITOR ASSY W/TOUCH SCREEN | | | PC3XX FAM | 790.00 | | | | | | | |

digital

Prices Effective 02-January-89 to 30-June-89
When you need a part repaired, call 800-225-5385.

SPARES PRICE LIST C-25

Part D
Factory Repair Services

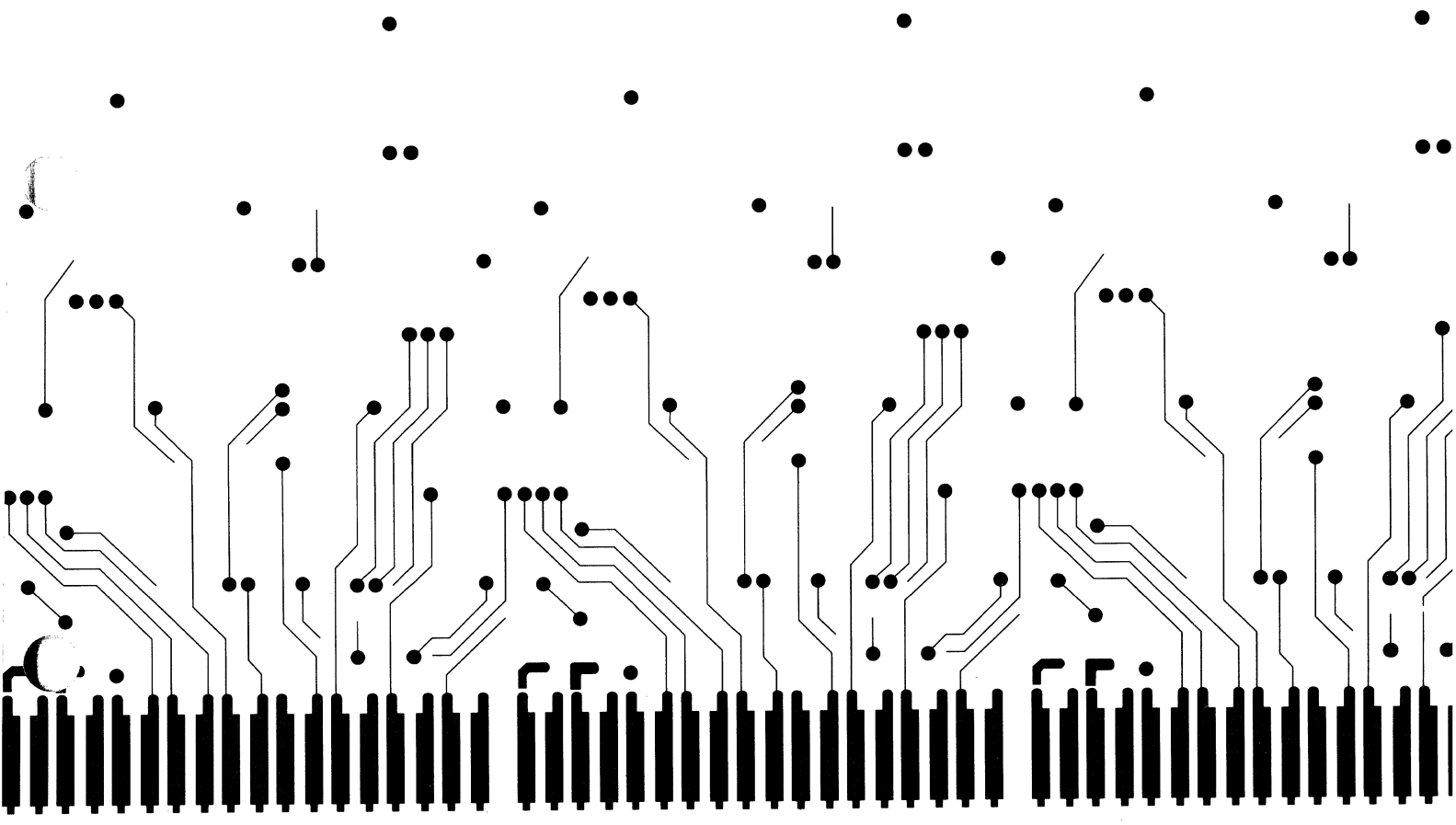

FACTORY REPAIR

| PART NUMBER | DESCRIPTION | LOWEST ACCEPTABLE | | | REPAIR PRICE | PART NUMBER | DESCRIPTION | LOWEST ACCEPTABLE | | | REPAIR PRICE |
|-------------|--|-------------------|-----|-----------|--------------|-------------|--|-------------------|-----|-----------|--------------|
| | | ETCH | REV | USED ON | | | | ETCH | REV | USED ON | |
| 00861-B | 120V,16A,PWR CONT,1-PHASE (874-C NEAREST | F1 | | TU16 | 140.00 | 0DH11-AD | SEE DH11-M + CK-DH11-A* 7-B DIST P | | | 11 FAMILY | 614.00 |
| 00861-C | 120V,24A,PWR CONT,1-PHASE (874-D NEAREST | F1 | | TU16 | 140.00 | 0DKC8-AA | USE M8316 | | | PDP8A | 00.00 |
| 00861-E | 240V,24A,3-PHASE PWR CONT (881-B NEAREST | A | | KL10 | 347.00 | 0DL11-A | USE M7800-YA | | | 11/05 | 00.00 |
| 00861-F | 120V,12A,1-PHASE PWR CONT (874-A NEAREST | F1 | | 11/70 | 124.00 | 0DL11-B | USE M7800 | | | 11/05 | 00.00 |
| 00869-E | 869-D POWER CONTROL EXCEPT 240V 12A 3 PH | | | 11/780 | 364.00 | 0DL11-C | USE M7800-YA | | | 11/05 | 00.00 |
| 00871-A | 120V,12A,PWR CONT,1-PHASE (874-A NEAREST | | | 11/03 | 95.00 | 0DL11-D | USE M7800 | | | 11/05 | 00.00 |
| 00871-C | 120V,16A,PWR CONT,1-PHASE (874-C NEAREST | A | | 11/03 | 75.00 | 0DL11-W | USE M7856 | | | 11/04 | 00.00 |
| 00872-C | USE 874-C | | | | 00.00 | 0DL11-WA | USE M7856 | | | 11/04 | 00.00 |
| 00872-D | 120V,24A,PWR CONT,1-PHASE,OBS (REPLACED | | | 11/34-34A | 279.00 | 0DR11-B | DIR MEM ACCESS DEVICE INTERFAC | | | 11 FAMILY | 364.00 |
| 00874-A | 120V 12A FILTERED POWER CONT,6 SW OUTLET | | | 11/23-23B | 95.00 | 0DR11-C | USE M7860 | | | 11 FAMILY | 00.00 |
| 00874-B | 220-240V 12A FILTERED PWR CONT,6 SW OUTL | | | 11/730 | 190.00 | 0DR11-W | USE M8716 | | | 11 FAMILY | 00.00 |
| 00875-B | 875-A EXCEPT 240V 12A | | | 11/750 | 210.00 | 0DZ11-A | 8-LINE DBL BUF ASYNC EIA 50-10 KBAUD W 1 | | | 11 FAMILY | 304.00 |
| 00876-A | 120V/208V 30A 3 PHASE PWR CONT,ISOLATED | | | VAX8600 | 570.00 | 0DZ11-B | USE M7819 | | | 11 FAMILY | 00.00 |
| 00881-A | USE 302437401 | | | | 00.00 | 0G050-00 | AMP READ | | | TU10 | 73.00 |
| 00KC8-AA | USE 701064400 | | | | 00.00 | 0G056-00 | USE G066 | D | | TU16 | 00.00 |
| 00KC8-EA | USE 54-09057 | | | PDP8E,M,F | 00.00 | 0G057-00 | PRE-AMP | | | TS FAMILY | 65.00 |
| 00KL8-A | USE M8319 | | | PDP8A | 00.00 | 0G060-00 | COMPRESSOR | D | | TU10 | 48.00 |
| 00KL8-FA | USE M8652 | | | PDP8E,M,F | 00.00 | 0G060-YA | MODULE TU10 COMPRESSOR | D | | TU10 | 95.00 |
| 00KL8-JA | USE M8655 | | | PDP8E,M,F | 00.00 | 0G088-00 | DETECTOR, READ AMPFR PEAK | E | | RS FAMILY | 162.00 |
| 00MDE-BD | EVENT DETECTOR & STATE ANALYZER MODULE F | | | MDE | 475.00 | 0G092-00 | TIMING AMP & LOGIC | | | RS FAMILY | 119.00 |
| 00MDE-BE | T11 EMULATOR MODULE FOR MDE (M8742) | | | MDE | 459.00 | 0G104-00 | SENSE INHIBIT | D | | PDP8E,M,F | 100.00 |
| 00MDE-BM | 32 KBYTE OF SIMULATOR MEMORY FOR MDE-BA | | | MDE | 442.00 | 0G109-00 | CONTROL & DATA LOOPS FOR G109 & G109-YA | E | | 11/05 | 126.00 |
| 00MM8-AA | 8KX12 MEMORY | C | | MEMORIES | 171.00 | 0G109-YA | M SELECT FF & DATA LOAD PULSE PINS | C | | 11/05 | 71.00 |
| 00MM8-EJ | 8K X 12 BIT 18 MIL MEMORY, 1,2 USEC (8/E | | | MEMORIES | 437.00 | 0G110-00 | CONTROL AND DATA LOOPS | C | | 11/05 | 143.00 |
| 00MR8-EC | 256 X 12 BIT BRAID ROM, TD8-E HANDLER | | | MEMORIES | 1069.00 | 0G157-00 | TS04 READ/WRITE | | | TS FAMILY | 50.00 |
| 00MS8-CB | 32K 12 BIT MOS RAM 4K CHIPS | B | | MEMORIES | 356.00 | 0G182-00 | R/W HEAD & DETECTION | J | | RS FAMILY | 67.00 |
| 0A001-00 | 8 CHANNEL UDC BRD | C | | 11 FAMILY | 195.00 | 0G227-00 | DRIVE XY | C | | PDP8E,M,F | 100.00 |
| 0A002-00 | UDC INPUT SIGNAL CONDITIONER | E | | 11 FAMILY | 105.00 | 0G231-00 | MEMORY DRIVER PDP-11 | CE | | 11/05 | 110.00 |
| 0A005-00 | RELAY 8 CH MULTIPLEXER FOR A001 | D | | 11 FAMILY | 290.00 | 0G235-00 | 16K X-Y DRIVE | D | | 11/05 | 124.00 |
| 0A007-00 | 16 CH BIT MUX FOR A005 | B | | 11 FAMILY | 290.00 | 0G281-00 | DRUM X SELECT | B | | | 109.00 |
| 0A009-00 | USE AD11-K | C | | 11 FAMILY | 00.00 | 0G401-YA | HIGH SPEED MOS MEM MAT | C | | 11/45 | 263.00 |
| 0A012-00 | USE ADV11-A | D | | 11/03 | 00.00 | 0G649-00 | USE MM8-AA | | | MEMORIES | 00.00 |
| 0A013-00 | USE MNCAD | | | LS11 | 00.00 | 0G650-00 | USE MM8-AB | | | MEMORIES | 00.00 |
| 0A014-00 | 8/16 BIT ANALOG/DIGITAL CONVERTER | D | | DPM | 741.00 | 0G651-00 | USE MM11-C | | | 11 FAMILY | 00.00 |
| 0A017-00 | NCV11-A,DUAL 4 INPUT MUX, S AND H 8-BIT | | | 11 FAMILY | 186.00 | 0G652-00 | USE MM11-DP | | | MEMORIES | 00.00 |
| 0A150-00 | 8 CHAN FLYING CAP MUX,QUAD,CONN ON HANDL | A | | 11 FAMILY | 119.00 | 0G653-00 | USE MMV11-A | | | MEMORIES | 00.00 |
| 0A156-00 | SOLID STATE MULTIPLEXER | B | | DPM | 285.00 | 0G848-00 | MOTOR CONTROL | M | | 11 FAMILY | 48.00 |
| 0A157-00 | DSY. CHN.,16 DIFF. LOW-LEVEL PROG. MUX,U | D | | DPM | 404.00 | 0G918-00 | PHOTOCELL AMP FOR PT04,5,REPLACEMENT FOR | D | | 11 FAMILY | 76.00 |
| 0A232-00 | ANALOG MULTIPLEXOR & EXPANDER | | | PDP8 FAM | 200.00 | 0G933-00 | REEL, MTR AMPLIFIER | D | | PDP8E,M,F | 76.00 |
| 0A233-00 | 4 OUTPUT BUFFER AMPLIFIERS | C | | 11 FAMILY | 109.00 | 0G938-YA | DEC PACK HEAD POSITION SERVO PREAM | E | A | RK05 | 67.00 |
| 0A246-00 | USE MNCAG | | | LS11 | 00.00 | 0H212-00 | 8K 12 BIT H211,MM8-EJ | C | | PDP8E,M,F | 238.00 |
| 0A320-00 | GEN & DRIVE (VT40) | C | | VT FAMILY | 347.00 | 0H213-00 | 4K 16 BIT STACK ON G645,3 WIRE | H | | 11/05 | 250.00 |
| 0A613-00 | USE A615 | A | | | 00.00 | 0H214-00 | USE H215 | D | | 11/05 | 00.00 |
| 0A614-00 | CONVERTER 12 BIT POLAR D/A | D | | 11 FAMILY | 109.00 | 0H217-B | MEMORY STK,16384 WORD 19B | E | | 10 FAMILY | 176.00 |
| 0A615-00 | CONVERTOR, DIGITAL TO ANALOG | | | | 86.00 | 0H217-C | MEMORY STK,16384 WORD 18B | E | C | 11/05 | 135.00 |
| 0A631-00 | 4 CH 12-BIT ISOLATED DAC 20MA OR IPG + 1 | | | DPM | 437.00 | 0H217-D | MEMORY STK, 16384 WORD 16B | A | | 11/05 | 247.00 |
| 0A633-00 | 4-10 BIT DAC'S | D | | 11 FAMILY | 143.00 | 0H219-A | USE 00MM8AA | B | | MEMORIES | 00.00 |
| 0A638-00 | USE AA11-K | B | | 11 FAMILY | 00.00 | 0H219-B | USE MM8AB | | | MEMORIES | 00.00 |
| 0A805-00 | 12-BIT A/D CONVERTER USED W A1004 OR A10 | B | | 11 FAMILY | 232.00 | 0H220-00 | 4K,12 BIT,22 MIL STACK ON G619,PS 300983 | A | | PDP8E,M,F | 342.00 |
| 0AA11-K | 4 CHANNEL DAC | B | | 11 FAMILY | 156.00 | 0H222-A | USE MM11-DP | | | MEMORIES | 00.00 |
| 0AD11-K | ANALOG DIGITAL 12BIT | E | | 11 FAMILY | 198.00 | 0H224-B | MEMORY STK 18B | B | | MEMORIES | 271.00 |
| 0AM11-K | EXPANDER PANEL (AD11-K) | B | | 11 FAMILY | 334.00 | 0H224-C | MEMORY STK 19B | B | | 11 FAMILY | 314.00 |
| 0AR11-00 | 16 CH 10 BIT A/D CLOCK (M7809) | C | | 11 FAMILY | 321.00 | 0H228-B | USE 000MM11YP | | | 11 FAMILY | 00.00 |
| 0DD11-CK | USE 70-11528 | | | 11/04 | 00.00 | 0H317-E | H317-E CABLE BOX ASSY | | A | 11/750 | 95.00 |
| 0DD11-PK | USE 70-11523 | | | 11/04 | 00.00 | 0H319-00 | 20 MA CURRENT LOOP RECEIVER (OPTICAL ISO | C | | 11 FAMILY | 67.00 |

digital

Prices Effective 02-January-89 to 30-June-89
When you need a part repaired, call 800-225-5385.

SPARES PRICE LIST D-1

SPARES PRICE LIST D-2

OH325-00 — OM783-00

FACTORY REPAIR

| PART NUMBER | DESCRIPTION | LOWEST ACCEPTABLE | | | REPAIR PRICE | PART NUMBER | DESCRIPTION | LOWEST ACCEPTABLE | | | REPAIR PRICE |
|-------------|---|-------------------|-----|------------|--------------|-------------|--|-------------------|-----|------------|--------------|
| | | ETCH | REV | USED ON | | | | ETCH | REV | USED ON | |
| OH325-00 | CONN. MODEM TEST | | | | 0.00 | OK614-00 | USE K616 | D | | KI10 | 00.00 |
| OH405-A | POWER INPUT BOX: 3PH 120V 16A,15FT CORD | | | VAX8500 | 428.00 | OK615-00 | LIKE K614,EXCEPT 1 INPUT TO EACH CKTS IS | C | | KL10 | 86.00 |
| OH405-B | POWER INPUT BOX: 3PH DELTA 380-415V 11A, | | | VAX8500 | 428.00 | OK616-00 | ISOLATED AC OUTPUT | A | | PDP FAMILY | 79.00 |
| OH405-E | H405-A W/2 SW DEC PWR BUS OUT,1 UNSW IEC | | | VAX6200 | 523.00 | OK652-00 | DRIVER D C | B | | KL10 | 67.00 |
| OH405-F | H405-B W/2 SW DEC PWR BUS OUT,1 UNSW IEC | | | VAX6200 | 523.00 | OKD11-A | USE 70-10230 | | | 11/35-40 | 00.00 |
| OH603-00 | AMPLIFIER, CAPSTAN SERVO PWR | H | | TU10 | 76.00 | OKD11-D | USE M7263 | | | 11/04 | 00.00 |
| OH604-00 | DECPACK HEAD POS. SERVO PWR AMP | H | | RK05 | 48.00 | OKD11-H | USE M7264-YC | C | | 11/03 | 00.00 |
| OH606-00 | POWER BOARD (TU16) | D | A | TU16 | 224.00 | OKD11-HA | USE M7270 | E | | LS111 | 00.00 |
| OH714-00 | LINE FILTER,250VAC,2 X 30 AMPS,CHOKE INP | | | | 266.00 | OKD11-L | KD11-F + KEV11 OR KEV11-A | C | | 11/03 | 183.00 |
| OH720-E | H720-A WITH POWER CONTROL & REMOTE/LOCAL | D | | 11 FAMILY | 475.00 | OKD11-N | KD11-H AND KEV11 OR KEV11-A | C | | 11/03 | 95.00 |
| OH720-F | 240V H720-E | D | | 11/70 | 523.00 | OKD11-NA | KD11-HA + KEV11-A | E | | LS111 | 120.00 |
| OH721-00 | +5V +/-2% 20A,-15.5V+/-10% 3.5A,+10.5V+/- | A | | 11 FAMILY | 490.00 | OKD11-Q | USE M7264-YB | E | | LS111 | 00.00 |
| OH724-00 | POWER SUPPLY 8/E 60 CYCLE | A | | PDP8E,M,F | 238.00 | OKE11-B | USE M7840 | | | 11 FAMILY | 00.00 |
| OH725-00 | 15V 20A SUPPLY FOR KI10,50/60 HZ RESONAN | A | | KL10 | 499.00 | OKW11-K | DUAL PROG CLK 1000,100,10,1,0.1KHZ,PHASE | C | | 11 FAMILY | 124.00 |
| OH730-A | POWER SUPPLY, TU10, 115V | F | | TU10 | 321.00 | OKW11-P | USE M7228 | | | 11 FAMILY | 00.00 |
| OH738-B | POWER SUPPLY | D | | 11 FAMILY | 213.00 | OKY11-B | USE M828 | | | 11 FAMILY | 00.00 |
| OH739-A | USE H758-A | A | | 11 FAMILY | 00.00 | OKY11-D | USE 54-09701 | | | 11 FAMILY | 00.00 |
| OH740-D | +5V20A,-15V5A,+15V1A,ACLO,DCLO,LINE FREQ | A | | 11 FAMILY | 207.00 | OLA12-A | LA12-D + 300 BAUD ACOUSTIC COUPLER,300/1 | | | LA12 | 741.00 |
| OH740-DA | POWER SUPPLY | E | FA | 11 FAMILY | 228.00 | OLA50-RA | USE 301985801 | | | LA50 | 00.00 |
| OH742-A | PS CHASSIS FOR 11/45,5 30VAC 6A EACH,+15 | A | | 11/45 | 361.00 | OLA50-RB | USE 301985802 | | | LA50 | 00.00 |
| OH742-B | PS CHASSIS 11/45 230 VAC | A | | 11/45 | 380.00 | OLAXX-KV | USE M7735 | | | LA35 | 00.00 |
| OH744-00 | POWER REGULATOR | F | Z | 11 FAMILY | 266.00 | OLAXX-KY | USE M7736 | | | LA35 | 00.00 |
| OH745-00 | POWER REGULATOR | C | C | 11 FAMILY | 90.00 | OLK03-A | 14 KEY NUMERIC PAD | | | LA36 | 67.00 |
| OH746-00 | MOS REGULATOR | F | | 11 FAMILY | 95.00 | OLK05-B | USE 30-12538 | | | VT71-71T | 00.00 |
| OH751-A | P.S. TU60 CASSETTE 60HZ | | | TU60 | 100.00 | OLK09-E | USE 121608902 | | | VT173 | 00.00 |
| OH755-00 | POWER SUPPLY | A | | 11 FAMILY | 318.00 | OM040-00 | M040 E | E | | PC FAMILY | 67.00 |
| OH758-A | H758 POWER SUPPLY | UA | | 11 FAMILY | 160.00 | OM105-00 | ADDRESS SELECTOR | | | | 86.00 |
| OH765-A | POW SUPPLY BA11-K 115V | O | | PDP FAMILY | 428.00 | OM111-00 | 16 INDEPENDENT INVERTERS | C | | PDP FAMILY | 67.00 |
| OH766-A | USE H7660-C | E | | RA80 | 00.00 | OM206-00 | SIX FLIP FLOPS | C | | PDP FAMILY | 67.00 |
| OH766-C | USE H7660-A | | | RA81 | 00.00 | OM224-00 | DATA PATHS | B | | PDP FAMILY | 67.00 |
| OH770-00 | +15V 10A REGULATOR FOR H742 | B | | KL10 | 124.00 | OM234-00 | REGISTERS, KE11-A | B | | PDP FAMILY | 90.00 |
| OH771-A | POW SUPPLY RX01 (RX11) 60HZ | B | B | RX01 | 95.00 | OM304-00 | ONE SHOT DELAY | B | D | PDP FAMILY | 67.00 |
| OH771-D | RX01 SUP: +5V 5A,-5V 0.15A,+9.5V 1A,+26V | | | RX01 | 98.00 | OM306-00 | INTEGRATING ONE SHOT | B | | PDP FAMILY | 67.00 |
| OH771-EA | REPACKAGED H771-A,NO AC INPUT,120V 60HZ, | | | | 143.00 | OM307-00 | 2 INTEGRATING ONE SHOT | B | | PDP FAMILY | 67.00 |
| OH772-A | POWER SUPPLY,ICS,60HZ,OUT=5V,+21V,-21V | 1 | | 11 FAMILY | 316.00 | OM309-00 | POW SEQUENCE FILTER | B | | PDP FAMILY | 86.00 |
| OH772-B | POWER SUPPLY,ICS,50HZ,OUT=5V,+21V,-21V | 1 | | 11 FAMILY | 321.00 | OM360-00 | VARIABLE DELAY | B | | PDP8 FAM | 152.00 |
| OH773-A | USE 301486900 | | | 11 FAMILY | 00.00 | OM405-00 | CRYSTAL CLOCK | A | | 11 FAMILY | 67.00 |
| OH775-D | BATTERY BACK-UP 11/70 | C | | 11/70 | 197.00 | OM594-00 | CONVERTER, EIA LEVEL | B | | 11 FAMILY | 86.00 |
| OH777-00 | USE 000H777CA | | | | 00.00 | OM596-00 | USE M5960 | C | | 11 FAMILY | 00.00 |
| OH777-AA | USE H777CA | | | 11/04 | 00.00 | OM627-00 | POWER AMPLIFIER | A | | 11 FAMILY | 48.00 |
| OH777-BA | USE H777-DA | | | 11/04 | 00.00 | OM640-00 | MASTER/ INTERFACE BUS DRIVER | C | | TU10 | 67.00 |
| OH777-CA | H777-AA EXCEPT +5V 32A,120V | | | 11/04 | 266.00 | OM688-00 | UNIBUS POWER FAIL DRIVERS | B | | PDP FAMILY | 95.00 |
| OH777-DA | H777-BA EXCEPT +5V 32A,120V | | | 11/04 | 266.00 | OM710-00 | PUNCH CONTROL | F | | PDP FAMILY | 67.00 |
| OH777-UA | 11/24 PS: +5V 32A,+15V 3A,-15V 3A,120V | | | 11 FAMILY | 684.00 | OM715-00 | READER CLOCK | F | | 11 FAMILY | 60.00 |
| OH780-A | POWER SUPPLY 11V05 | A | | 11/03 | 200.00 | OM715-YA | READER CLOCK PMK01 (PR68) | | | 11 FAMILY | 60.00 |
| OH780-B | POWER SUPPLY | A | | 11/03 | 200.00 | OM724-00 | BUSS & CONSOLE CONTROL | B | | 11 FAMILY | 138.00 |
| OH780-E | H780,11/03 SLAVE CONSOLE,120V LINE CORD | A | | 11/03 | 200.00 | OM725-00 | BUSS INTERFACE | B | | 11 FAMILY | 86.00 |
| OH780-H | H780-A W NO LINE CORD | | | 11 FAMILY | 304.00 | OM726-00 | I R DECODER | B | | 11 FAMILY | 128.00 |
| OH781-00 | REGULATOR FOR PDO 5, 15 | E | | PDP FAMILY | 124.00 | OM727-00 | STATE CONTROL | B | | 11 FAMILY | 109.00 |
| OH783-00 | VT61 SUPPLY: 120V/240V 50/60HZ | D | T | VT61-61T | 238.00 | OM728-00 | TIMING & STATES | B | | 11 FAMILY | 114.00 |
| OH785-00 | BATTERY BACKUP REGULATOR | A | | 11/34-34A | 143.00 | OM763-00 | BUFFER WRITE | C | | TU10 | 190.00 |
| OH786-00 | BA11-NC,-ND, PS: +5V 22A,+12V 11A,120V/2 | A | 3 | 11/03 | 140.00 | OM765-00 | BUFFER, READ | B | | TU10 | 67.00 |
| OK123-00 | NON-INVERTING GATE | A | | 11 FAMILY | 67.00 | OM768-00 | TRANSMITTER, DELAY | E | | TU10 | 67.00 |
| OK138-00 | INVERTERS, EIGHT | B | | PDP FAMILY | 67.00 | OM769-00 | CONTROL, FUNCTION | H | | TU10 | 67.00 |
| OK579-00 | AC INPUT CONVERTER | C | | PDP FAMILY | 60.00 | OM783-00 | UNIBUS DRIVERS | B | | 11 FAMILY | 67.00 |



Prices Effective 02-January-89 to 30-June-89
When you need a part repaired, call 800-225-5385.

FACTORY REPAIR

| PART NUMBER | DESCRIPTION | LOWEST ACCEPTABLE | | | REPAIR PRICE | PART NUMBER | DESCRIPTION | LOWEST ACCEPTABLE | | | REPAIR PRICE |
|-------------|--|-------------------|-----|-----------|--------------|-------------|--|-------------------|-----|-----------|--------------|
| | | ETCH | REV | USED ON | | | | ETCH | REV | USED ON | |
| 0M784-00 | UNIBUS RECEIVERS | A | | 11 FAMILY | 67.00 | 0RD31-A | 20MB WINCHESTER HARD 5.25" DISK DRIVE, 1.6 | | | RD FAMILY | 350.00 |
| 0M787-00 | 50-08774-E | B | | 11/70 | 67.00 | 0RD31-EA | PC500 20MB HARD DISK DRIVE | 1A | | PC500 | 314.00 |
| 0M792-00 | ROM DIODE MATRIX | E | | 11 FAMILY | 133.00 | 0RD32-A | USE RD32-EA | | | RD FAMILY | 00.00 |
| 0M792-YA | MATRIX, ROM DIODE | E | | 11 FAMILY | 147.00 | 0RD32-EA | 42MB WINCHESTER DISK DRIVE W/O SKID PLAT | | | RD FAMILY | 361.00 |
| 0M795-00 | WC & CMA | D | | 11 FAMILY | 24.00 | 0RD52-A | 28/31MB 5.25" NON-REM WINI DISK, 3.5"H, RE | | | RD FAMILY | 649.00 |
| 0M820-00 | DATA PATH CONTROL | C | | 11 FAMILY | 90.00 | 0RD53-A | 67/71MB 5.25" FULL HEIGHT FIXED WINCHEST | | | RD FAMILY | 649.00 |
| 0M821-00 | REGISTER CONTROL | A | | 11 FAMILY | 124.00 | 0RD54-A | 159 MB FIXED DISK, 5.25" FULL HIGH, 38.3 M | | | RD FAMILY | 649.00 |
| 0M822-00 | FLAG CONTROL | C | | 11 FAMILY | 48.00 | 0RP06-P | DISK PACK DATA 200 TPI | | | RP05/6 | 219.00 |
| 0M827-00 | CLOCK AND STATES, KE11-A | D | | 11 FAMILY | 114.00 | 0RX01-CA | SINGLE ADD-ON FLOPPY DISK DRIVE, 120V, 60H | | | RX01 | 176.00 |
| 0M833-00 | USE M833000 | | | PDP8E,M,F | 00.00 | 0RX33-00 | USE RX33-A | | | HSC50/70 | 00.00 |
| 0M837-00 | EXTENSION, MEMORY FINE SHARE | C | N | PDP8E,M,F | 95.00 | 0RX33-A | 1.2 MB FLOPPY DISK DRIVE, 5.25" DBL-SIDED | | | HSC50/70 | 95.00 |
| 0M840-00 | CONTROL, READ PUNCH | F | | PDP8E,M,F | 143.00 | 0SHIP-00 | TRANSPORTATION CHARGES | | | | 0.00 |
| 0M842-00 | CONTROL, PLOTTER XY8-E | K | | PDP8 FAM | 86.00 | 0TK25-00 | USE TK25-AA | | | TK25 | 00.00 |
| 0M847-00 | M18E BOOTSTRAP LEADER | E | | PDP8 FAM | 95.00 | 0TK25-AA | USE 302296902 | | | TK25 | 00.00 |
| 0M847-YP | USE M18-EP | | | PDP8E,M,F | 00.00 | 0TK50-AA | USE TK50-AX | | | TK50 | 00.00 |
| 0M848-00 | POWER FAIL & AUTO RESTART | E | | PDP8E,M,F | 152.00 | 0TK50-AX | TK50-AA PACKAGED | A | | TK50 | 523.00 |
| 0M851-00 | BUS RECEIVER-ADDRESS DECODER | E | | 11 FAMILY | 67.00 | 0TK70-AX | TK70-AA WITH NO CARTRIDGE, PACKAGED | | | TK70 | 618.00 |
| 0M852-00 | LARGER CACHE ADDRESS | | | MCA25 | 608.00 | 0TK70-EA | TK70 WITH NO SKID PLATE + CARTRIDGE | | | TK70 | 618.00 |
| 0M853-00 | LARGER CACHE EXTENSION | | | MCA25 | 449.00 | 0TU58-AB | SINGLE TU58, SERIAL CONT, 5 & 12VDC (TU58- | | | | 0.00 |
| 0M854-00 | PHYSICAL MEMORY, MODULE FOR LARGER CACHE | A | 1A | MCA25 | 561.00 | 0TU58-XA | TU58 DR MECHANISM ONLY | | B | TU58 | 81.00 |
| 0M855-00 | 2-WAY ASC PAGE TABLE ADDING MBOX CTRLR03 | A | 1A | MCA25 | 850.00 | 0TU58-XC | MODULE W PARALLEL INTERFACE (54-13491) | | | TU58 | 95.00 |
| 0M856-00 | IR, D RAM & CARRY, LARGER CACHE | A | 1A | MCA25 | 931.00 | 0TU80-CA | TU80, 874-D, TU80K-AC, H9642, 120V | | | TU80/81 | 4275.00 |
| 0M857-00 | M-BOX CONTROL FOR LARGER CACHE | A | 1A | MCA25 | 363.00 | 0W743-00 | INPUT MODULE | B | | 11 FAMILY | 86.00 |
| 0M860-00 | REAL TIME CLOCK CONTROL | H | | PDP8 FAM | 86.00 | 0W816-00 | UNIBUS GRANT RELAY | B | P | 11 FAMILY | 105.00 |
| 0M863-00 | 12 CHANNEL I/O | F | | PDP8 FAM | 95.00 | 0X022-00 | RAINBOW UNIBUS WINDOW SIMILAR TO DA11H | B | | 11/34-34A | 147.00 |
| 0M873-YA | BOOTSTRAP LEADER | C | | 11 FAMILY | 114.00 | 0X025-00 | RAINBOW, IG FONT MEMORY ARRAY, HEX | B | | 11/34-34A | 347.00 |
| 0M873-YB | RESTART LOADER/128 WORD ROM | C | | 11 FAMILY | 48.00 | 0X026-00 | RAINBOW OUTPUT HEX | C | | 11/34-34A | 261.00 |
| 0M890-00 | CONTROL, MOTION | F | | 11 FAMILY | 95.00 | 0X032-00 | IG FONT MEMORY ARRAY | C | | 11/34-34A | 181.00 |
| 0M891-00 | CRC & WRITE GATING | D | | TM02 | 76.00 | 0X032-AA | USE X032 | | | 11/34-34A | 00.00 |
| 0M892-00 | TU10 GAP TIMING & READ | E | | TU10 | 86.00 | 0X032-AB | USE X032 | | | 11/34-34A | 00.00 |
| 0M895-00 | READ TIMING | | | MEMORIES | 362.00 | 0X032-AC | USE X032 | | | 11/34-34A | 00.00 |
| 0M930-00 | BUSS TERMINATOR | | | 11/05 | 76.00 | 0X032-AD | USE X032 | | | 11/34-34A | 00.00 |
| 0MA20-M | 16KX19 BIT MEM MOD SET | | | MEMORIES | 732.00 | 0Y034-00 | BELL MODEM DRIVER | A | | 11 FAMILY | 109.00 |
| 0MB20-M | MEMORY 32K X 19 | | | MEMORIES | 440.00 | 0Y083-00 | SP MDD TIMING BOARD | H | | | 86.00 |
| 0MF20-M | ARRAY CARD | D | | MEMORIES | 428.00 | 0Y084-00 | SP MOD DEVICE SELECT | C | | | 67.00 |
| 0MG20-M | 1024KW 11-BIT MEMORY ARRAY (M8570-AA) [1 | | | MEMORIES | 1106.00 | A1004-00 | 8-CHAN RELAY MUX, 2-WIRE, +/-10V OUTPUTS T | A | | 11 FAMILY | 54.00 |
| 0MJ11-BM | USE MB20-M | | | MEMORIES | 00.00 | A1005-00 | 8-CHAN RELAY MUX, 3-WIRE, +/-10V OUTPUTS T | A | | 11 FAMILY | 54.00 |
| 0ML11-AS | USE M7357-AA | B | | MEMORIES | 00.00 | A6001-00 | USE AAV11-A | | | 11/03 | 00.00 |
| 0MM11-CP | 8K CORE MEMORY | D | | MEMORIES | 321.00 | A6002-00 | USE MNCAA | | | LSI11 | 00.00 |
| 0MS10-BA | MS10 BA 64K X43 | B | | MEMORIES | 252.00 | A6005-00 | 2-CHANNEL D/A, 10 BIT, +/-0.1%, 4-20MA, DUAL | | | CMR01 | 114.00 |
| 0MS11-BR | USE G401 | | | 11/45 | 00.00 | A6006-00 | USE 30-18691 | | | 11/03 | 00.00 |
| 0MS11-BT | USE G401-YA | | | 11/45 | 00.00 | A6330-00 | 4 CHNL 10-BIT DAC (ICMDA-OA) | C | | 11 FAMILY | 290.00 |
| 0MS11-E | 4K 16 BIT MOS RAM (M7847-AA) | | | MEMORIES | 109.00 | A8000-00 | USE 30-18693 | | | 11/03 | 00.00 |
| 0MS11-EP | 4K 18 BIT MOS RAM MEM W PARITY | D | | MEMORIES | 91.00 | AAV11-A | D/A FOR 11/03 | D | | 11/03 | 170.00 |
| 0MS11-F | 8K 16 BIT MOS RAM (M7847-AC) | | | MEMORIES | 176.00 | AAV11-C | USE 30-18691 | | | 11/03 | 00.00 |
| 0MS11-LA | 64KBYTE MOS MEM W PARITY LOGIC (M7891-AA) | | | MEMORIES | 347.00 | ADV11-A | A/D FOR 11/03 | E | | 11/03 | 170.00 |
| 0MS11-PB | USE M8743-BA | | | MEMORIES | 00.00 | ADV11-C | USE 30-18693 | | | 11/03 | 00.00 |
| 0MS86-AA | USE L0226-BA | | | VAX8600 | 00.00 | AXV11-C | USE 30-18689 | | | 11/03 | 00.00 |
| 0MS86-BA | USE L0200-BA | | | VAX8600 | 00.00 | BCC03-06 | USE 170028400 | | | | 00.00 |
| 0MS86-CA | 16MB MEM MODULE, 256K CHIP (L0225-AA) FOR | | | VAX8650 | 1425.00 | BDV11-AA | USE M8012-YA | C | | 11/03 | 00.00 |
| 0MS88-CA | 16MB MEMORY (L0115) W/2MB DAUGHTER BRDS | | | VAX8650 | 380.00 | BM873-YJ | BOOT STRAP LEADER | | | 11 FAMILY | 86.00 |
| 0RA60-P | RA60 PACK, 16-BIT WORDS FOR 11 VAX | | | RA60 | 214.00 | C5005-00 | DEC TALK III, ENGLISH TEXT TO USA/CANADA | | | DECTALK | 340.00 |
| 0RA81-AA | 16-BIT 456MB RACK MOUNT DISK DRIVE, SDI I | | | | 0.00 | DCSAX-LA | M3100, ONE-LINE SYNC LINE CARD, EIA, DASH B | | | | 133.00 |
| 0RC25-BA | RC25 MASTER, RACK MOUNT, RC25K-DC, 120V LN | | | RC25 | 0.00 | DCSAX-LB | M3101, ONE-LINE SYNC LINE CARD, V.35, DASH | | | DECSA | 333.00 |
| 0RC25-EA | RC25 SLAVE, ADD-ON, OPEN FRAME, RC25K-DC, CA | | | RC25 | 0.00 | DDV11-B | BACK PLANE ASSY | | | 11 FAMILY | 295.00 |

digital

Prices Effective 02-January-89 to 30-June-89
When you need a part repaired, call 800-225-5385.

SPARES PRICE LIST D-3

SPARES PRICE LIST D-4

DDV11-CF — H7140-CA

FACTORY REPAIR

| PART NUMBER | DESCRIPTION | LOWEST ACCEPTABLE | | | REPAIR PRICE | PART NUMBER | DESCRIPTION | LOWEST ACCEPTABLE | | | REPAIR PRICE | |
|-------------|---|-------------------|-----|------------|--------------|-------------|---|-------------------|-----|---------|--------------|--------|
| | | ETCH | REV | USED ON | | | | ETCH | REV | USED ON | | |
| DDV11-CF | USE 70-14256 | | | | | DLVE1-M | USE M8017-AA | | | | 11 FAMILY | 00.00 |
| DDV11-CK | USE 70-14257 | | | | | DLVJ1-M | USE M8043 | | | | LSI11 | 00.00 |
| DEBET-AA | DIGITAL ETHERNET BRIDGE TO ETHERNET, LOC | | | 11 FAMILY | 00.00 | DMV11-AA | USE M8053-MA | | | | 11/03 | 00.00 |
| DEBET-AB | DIGITAL ETHERNET BRIDGE TO ETHERNET, LOC | | | ETHERNET | 1425.00 | DMV11-AB | USE M8053-MA | | | | 11/03 | 00.00 |
| DEBET-RA | DIGITAL ETHERNET BRIDGE TO ETHERNET,REMO | | | ETHERNET | 1596.00 | DMV11-AC | USE M8064-MA | | | | 11/03 | 00.00 |
| DEBET-RC | ETHERNET FIBER OPTIC BRIDGE (REMOTE),1 B | | | ETHERNET | 1596.00 | DRQ3B-AA | USE M7658-00 | | | | MICROVAXII | 00.00 |
| DEBET-RD | ETHERNET FIBER OPTIC BRIDGE (REMOTE),1 B | | | ETHERNET | 1596.00 | DRV11-00 | USE M7941 | | | | 11/03 | 00.00 |
| DECNA-00 | NEWLY ADDED CRC PART | | | PC FAMILY | 119.00 | DRV11-B | USE M7950 | C | | | 11/03 | 00.00 |
| DECNA-K | USE 541598701 | | | DECNA | 00.00 | DRV11-J | USE M8049 | B | | | 11 FAMILY | 00.00 |
| DECOM-AA | BROADBAND ETHERNET XCEIVER FOR DUAL CABL | | | | 1021.00 | DRV11-P | USE M7948 | | | | LSI11 | 00.00 |
| DECOM-AB | DECOM-AA EXCEPT 240V (REQS DEBBK-A*) | | | | 1021.00 | DRV1W-SA | USE M7651-PA | | | | MICROVAXII | 00.00 |
| DECOM-BA | BROADBAND ETHERNET XCEIVER FOR SINGLE-CA | | | ETHERNET | 1021.00 | DRV1W-SF | USE M7651-PA | | | | MICROVAXII | 00.00 |
| DECOM-BB | DECOM-BA EXCEPT 240V (REQUIRES DEBBK-A*) | | | ETHERNET | 1021.00 | DSRVA-A2 | DSRVA-AA WITHOUT COUNTRY KIT (FIELD SERV | | | | DSRVA | 339.00 |
| DEFTR-AA | HEAD-END BROADBAND ETHERNET FREQ XLATOR | | | ETHERNET | 1021.00 | DSRVA-AA | USE DSRVA-A2 | | | | | 00.00 |
| DEFTR-AB | HEAD-END BROADBAND ETHERNET FREQ XLATOR | | | ETHERNET | 1021.00 | DSRVA-AB | DECSERV 100,8-LINE TERM SRVR,REQS DSRVK- | | | | DSRVA | 339.00 |
| DELNI-AA | ETHERNET COMM DEV FOR LOCAL AREA NETWORKS | | | ETHERNET | 298.00 | DSRVB-A2 | DECSERVER 200 RS232 F.S. SPARE W/O COUNT | | | | ETHERNET | 404.00 |
| DELNI-AB | ETHERNET COMM DEVICE FOR LOCAL AREA NETW | | | ETHERNET | 298.00 | DSRVB-AA | USE DSRVB-A2 | | | | ETHERNET | 00.00 |
| DELQA-SA | USE M7516-PA | | | VAX FAMILY | 00.00 | DSRVB-AB | DECSERVER 200 TERM SERVER FOR ETHERNET(L | | | | ETHERNET | 404.00 |
| DELUA-M | USE M7521-AA | | | | 00.00 | DSRVB-B2 | DECSERVER 200 DEC423 F.S SPARE W/O COUNT | | | | ETHERNET | 404.00 |
| DEMPR-AA | 8-PORT THINWIRE (10 BASE 2) ETHERNET REP | | | DEMPR | 618.00 | DSRVB-BA | USE DSRVB-B2 | | | | ETHERNET | 00.00 |
| DEMPR-AB | DEMPR-AA EXCEPT 240V | | | DEMPR | 618.00 | DSRVB-BB | DECSERVER 200 TERM SERVER FOR ETHERNET(L | | | | ETHERNET | 404.00 |
| DEPCA-AA | USE 702425201 | | | DEPCA | 00.00 | DSRVC-A2 | DECROUTER 200 W/O COUNTRY KIT,120V, | | | | ETHERNET | 404.00 |
| DEPCA-UG | NEWLY ADDED CRC PART | | | DEPCA | 71.00 | DSRVC-AB | DEC ROUTER 200,ASYNC,240V | | | | ETHERNET | 404.00 |
| DESNC-BA | LAN ENCRYPT DEV W/ETHERNT CONN,4 THINWIR | | | ETHERNET | 998.00 | DSRZA-BA | USE 702421602 | | | | ETHERNET | 00.00 |
| DESNC-BB | LAN ENCRYPT DEV W/ETHERNT CONN,4 THINWIR | | | ETHERNET | 998.00 | DSRZA-BB | USE 702421601 | | | | ETHERNET | 00.00 |
| DESPR-AA | THINWIRE (10 BASE 2) TO ETHERNET (10 BAS | | | ETHERNET | 242.00 | DTC03-AM | USE C5005-00 | | | | DECTALK | 00.00 |
| DESTA-AA | THINWIRE ETHERNET STATION ADAPTER | | | ETHERNET | 143.00 | DTC11-B | TMS VOICE UNIT,SPKR PHONE W/EHANCND VOICE | | | | DECTALK | 86.00 |
| DF100-DT | DESK TOP MODEM ENCLOSURE,PS,120V 60HZ | | | MODEMS | 128.00 | DUV11-DA | USE M7951 | | | | 11/03 | 00.00 |
| DF100-RM | RACK FOR 12 MODEMS INCL 6A 120V POWER SU | | | MODEMS | 903.00 | DYX02-00 | USE 54-14640 | | | | 11 FAMILY | 00.00 |
| DF104-AM | 150/2400 BPS,2-W/FDX,ACU TERM TO PROC MO | | | MODEMS | 166.00 | DZQ11-M | USE M3106 | | | | MICROVAXII | 00.00 |
| DF104-BM | 2400/150 BPS,2-W/FDX/ACU PROC-TO-TERM MO | | | MODEMS | 166.00 | DZS11-EA | USE M7190 | | | | 11 FAMILY | 00.00 |
| DF112-AA | DF112-AM MODEM(300/1200BPS,2-W/FDX,ACU) | | | MODEMS | 166.00 | DZV11-B | USE M7957 | C | | | 11/03 | 00.00 |
| DF112-AM | 300/1200BPS SYNC/ASYNC 212A/V,22 MODEM W | | | MODEMS | 166.00 | DZV11-M | USE M7957 | | | | 11/03 | 00.00 |
| DF124-AA | DF124-AM(2400/1200 BPS MODEM),DF100-DT(D | | | MODEMS | 247.00 | FPF11-00 | USE M8188 | | | | 11/23-23B | 00.00 |
| DF124-AM | 2400/1200 BPS FDX SYNC/ASYNC V.22BIS/212 | | | MODEMS | 196.00 | G8010-00 | -5.2V CONTROL KL10 | C | | | KL10 | 100.00 |
| DF124-CM | USE 29-26381 | | | DF124 | 00.00 | G8011-00 | -2V CONTROL KL10 | C | | | KL10 | 86.00 |
| DF126-AA | DF126-AM MODEM(2400 BPS,HDX,201/V,26,ACU | | | MODEMS | 200.00 | G8014-00 | -5.2V DETECTOR 16 INPUTS | B | | | KL10 | 67.00 |
| DF126-AM | 2400 BPS,HDX,201/V,26,W/ACU PROC-TO-PROC | | | MODEMS | 166.00 | G8016-00 | REGULATOR FOR H763 | D | D | | PDP8 FAM | 124.00 |
| DF127-AA | 4800BPS LEASED LINE MODEM(DF127-AM IN DF | | | MODEMS | 440.00 | G8019-00 | POWER DISTRIBUTION BOARD CONTROLL, DOUBL | F | | | PDP8 FAM | 86.00 |
| DF127-AM | USE 302138602 | | | MODEMS | 00.00 | G9340-00 | TU10 BRAKE LOGIC | A | | | TU10 | 67.00 |
| DF129-AA | 9600BPS US/CAN MODEM(DF129-AM IN DF100-D | | | MODEMS | 499.00 | G9341-00 | TU10 BRAKE ACTUATOR | B | | | TU10 | 100.00 |
| DF129-AM | USE 302138702 | | | MODEMS | 00.00 | H3006-00 | 8-LINE RS232 DISTRIBUTION PANEL FOR DZ11 | | | | | 190.00 |
| DF224-AA | USE 29-25042 | | | DF100 FAM | 00.00 | H4005-00 | 802.3/ETHERNET TRANSCIEVER | | | | ETHERNET | 0.00 |
| DF242-CA | 2400/1200/300 BPS DESKTOP SCHOLAR PLUS M | | | WARRANTY | 0.00 | H4005-AA | NEWLY ADDED CRC PART | | | | ETHERNET | 143.00 |
| DFMZA-BA | USE 702099902 | | | ETHERNET | 00.00 | H4005-AB | NEWLY ADDED CRC PART | | | | ETHERNET | 143.00 |
| DFMZA-BB | USE 702099901 | | | ETHERNET | 00.00 | H7060-A | 100-240VAC IN,+5V 4A,+12V 3A,-12V 0.4A,3 | A1 | | | VAX8500 | 523.00 |
| DHQ11-M | USE M3107 | | | 11 FAMILY | 00.00 | H7061-A | INTERFACE LOGIC MODULE FOR NAUTILUS & SK | A1 | | | VAX8500 | 428.00 |
| DHV11-A | USE DHV11-M | | | 11 FAMILY | 00.00 | H7062-A | N BOX TRANSLATOR PROVIDES SIGNAL LEVEL,S | A1 | | | VAX8500 | 143.00 |
| DHV11-M | USE M3104 | | | 11 FAMILY | 00.00 | H7100-B | 11780 500-WATT SUPPLY: 5V 100A,240VAC (H | B | | | 11/780 | 656.00 |
| DLV11-00 | USE M7940 | B | | 11/03 | 00.00 | H7110-00 | LA120 PS, 115/230VAC | | | | LA120 | 100.00 |
| DLV11-E | USE M8017-AA | C | | LSI11 | 00.00 | H7130-C | KS10,LH RESEARCH POWER SUPPLY,UL APPROVE | | B | | KS10 | 836.00 |
| DLV11-F | USE M8028 | C | | LSI11 | 00.00 | H7130-D | KS10,LH RESEARCH POWER SUPPLY,UL APPROVE | Y | | | KS10 | 836.00 |
| DLV11-J | USE M8043 | C | | LSI11 | 00.00 | H7140-AA | H7140 W 120V LINE CORD,50/60HZ | | Z1 | | 11 FAMILY | 660.00 |
| DLV11-KA | SEE CK-DLVK1-H8 | A | | 11 FAMILY | 67.00 | H7140-AB | H7140 W 240V LINE CORD,50/60HZ | | | | 11 FAMILY | 565.00 |
| DLV11-KB | SEE CK-DLVK1-H7 | A | | 11 FAMILY | 67.00 | H7140-CA | H7140 EXCEPT +/-15V BATT,60HZ FANS,120V | | | | 11 FAMILY | 855.00 |



Prices Effective 02-January-89 to 30-June-89
When you need a part repaired, call 800-225-5385.

FACTORY REPAIR

| PART NUMBER | DESCRIPTION | LOWEST ACCEPTABLE | | | REPAIR PRICE | PART NUMBER | DESCRIPTION | LOWEST ACCEPTABLE | | | REPAIR PRICE |
|-------------|--|-------------------|-----|------------|--------------|-------------|--|-------------------|-----|------------|--------------|
| | | ETCH | REV | USED ON | | | | ETCH | REV | USED ON | |
| H7140-DA | H7140 EXCEPT +12V/-15V BATT,120V LINE CO | | | 11 FAMILY | 950.00 | H7861-00 | BA11-SA,-SB PS: +5V 36A,+12V 5A,120V/240 | A | | 11 FAMILY | 229.00 |
| H7150-00 | LA120 PS: +24V 2.4A,-24V 2.8A,+5V 3A,+/- | | | LA120 | 100.00 | H7862-00 | USE H7862-C | | | PC FAMILY | 00.00 |
| H7170-A | 120/208VAC 3 PHASE 300V 9.5A,+12/+15V 2A | | | VAX8600 | 570.00 | H7862-B | USE H7862-C | | | PC FAMILY | 00.00 |
| H7176-A | 120V 3-PHASE 2800 WATT 300V POWER SUPPLY | | A1 | VAX8500 | 808.00 | H7862-C | H7862 EXCEPT +5V 2-20A,+12V 0.6-8A (54-1 | | | PC FAMILY | 152.00 |
| H7180-A | FLOATING 5 OR 5.2V 200A SWITCHING REGULA | | | VAX8600 | 570.00 | H7864-00 | USE 302174901 | | | | 00.00 |
| H7186-A | +/-5V @ 85A SWITCHING REGULATOR FOR 4050 | | | VAX8600 | 570.00 | H7864-A | USE 302174901 | | | VAXSTATION | 00.00 |
| H7187-A | +/-2.5V 100A SWITCHING REGULATOR FOR 405 | | | VAX8600 | 570.00 | H7868-A | BA223 POWER SUPPLY: 5V 33A,12V 7A,-7V TO | | | | 261.00 |
| H7188-A | USE H7188-AB | | | VAX8600 | 00.00 | H9194-00 | BUS CONN 8/A 8+4 SLOTS | B | N | PDP8 FAM | 356.00 |
| H7188-AB | H7188-A ENM W/BUS ENCHANCEMENT FOR 800** | | F | VAX8600 | 713.00 | H9273-A | LOGIC ASSY H9273 | | | 11/03 | 109.00 |
| H7189-A | +5V 55A,-5.2V 25A,-2V 15A,+12V 2A,-12V 2 | | A1 | VAX8500 | 1425.00 | H9275-A | FRAME,18 DUAL/9 QUAD Q-22 SLOTS,TERMINAT | | | 11 FAMILY | 238.00 |
| H7200-00 | 5V POWER MODULE: 5V 70A,300V 200W,CAN US | | | 11/24 | 141.00 | H9278-A | Q22 BUS BACKPLANE,8 QUAD SLOTS | | | | 71.00 |
| H7202-B | 11730 POW SUP: H7200,H7211,H7213,120V/24 | | | 11/730 | 553.00 | H9400-AA | VAXBI 6-SLOT LOGIC CAGE BACKPLANE W/REMO | | | VAX6200 | 570.00 |
| H7202-KA | REPACKAGED H7202-B (H7200,H7211,H7213)12 | | | | 594.00 | IBV11-A | USE M7954 | | | 11/03 | 00.00 |
| H7202-KB | ORION PS: H7200,H7211,120V/240V 50/60HZ | | | | 474.00 | IEQ11-A | USE M8634-00 | | | | 00.00 |
| H7203-A | BA11-XX PS: +5V 100A,300VDC,ACLO,DCLC,CL | | 1I | MEMORIES | 190.00 | IEQ11-AA | USE M8634-00 | | | | 00.00 |
| H7204-BA | H7203 H7216-A,H7217,120V | | | 11 FAMILY | 475.00 | IEQ11-AB | USE M8634-00 | | | | 00.00 |
| H7204-CA | H7204-AA W/LOWER PROFILE ENCLOSURE,120V | | | 11 FAMILY | 584.00 | IEQ11-SA | USE M8634-PA | | | MICROVAXII | 00.00 |
| H7206-A | POWER & LOGIC BOX,208/300VDC 2000W,14V 1 | | | VAX6200 | 475.00 | IEQ11-SF | USE M8634-PA | | | MICROVAXII | 00.00 |
| H7211-00 | COMM OPT PS: +15V 2A,-15V 3A,+12V 2A,-12 | | A | 11/24 | 75.00 | IEU11-A | USE M8648 | | | | 00.00 |
| H7213-00 | MEMORY & FAN REGULATOR: 5.1V 15A,12.3V 3 | | A | 11/730 | 124.00 | ISV11-A | SERIAL BUS INTERFACE M8080,M8084 | | | DPM | 482.00 |
| H7214-A | 600W,+5V 120A,13.5V 0.5A,30KHZ SWTCHER,1 | | | VAX6200 | 523.00 | ISV11-B | ISV11-A W 2 SEPARATE MODULES (M8080,M808 | | | DPM | 665.00 |
| H7215-A | 300VDC AND 14VDC IN,-5.2V 30A,-2V 12A,+1 | | | VAX6200 | 570.00 | KA620-AA | USE M7478-AA | | | MICROVAXII | 00.00 |
| H7216-00 | -5.3V 10A,+12.4V 2.0A SWTCHER FROM H720 | | | C1750/780 | 110.00 | KA620-BA | USE 00M7478AA | | | | 00.00 |
| H7231-B | H7230-A + H7240-A,120V/240V | | | | 879.00 | KA630-AA | USE M7606-AA | | | MICROVAXII | 00.00 |
| H7231-N | VALUE ENGINEERED H7231-M (1 BOX INSTEAD | | | VAX6200 | 380.00 | KDF11-AB | USE 00KDF11AA | | | | 00.00 |
| H7250-00 | 1250W 300VDC SUPPLY,120/240 INPUT | | 1A | VAX8200 | 194.00 | KDF11-AC | USE M8186-00 | A | | 11/23-23B | 00.00 |
| H7251-00 | 5V 20A,-5V 12A,-2V 4A,24V 2A FROM 300VDC | | 1A | VAX8200 | 187.00 | KDF11-BE | USE KDF11-BF | | | LSI11 | 00.00 |
| H7253-00 | 5V 55A,15V 3.25A,-15V 4A,12V 3.75A,-12V | | 1C | VAX8200 | 294.00 | KDF11-BF | USE KDF11-BH | | | LSI11 | 00.00 |
| H7270-A | 120V PC500 PS: 5.1V 10.24A,12.1V 1.37A,2 | | | PC500 | 57.00 | KDF11-BH | USE KDF11-BJ | | | LSI11 | 00.00 |
| H7270-B | 240V PC500 PS: H7270-A EXCEPT 240V INPUT | | | PC500 | 57.00 | KDF11-BJ | KDF11-BF + KDF11-B3 BOOT ROM FOR TK50 | | | LSI11 | 304.00 |
| H7420-A | POW SUPPLY HI POW H742-A 115V | | A | 11 FAMILY | 194.00 | KDF11-CA | USE KDF11-CC | | | PC FAMILY | 00.00 |
| H7441-00 | USE H7441-YA | | A | 11 FAMILY | 00.00 | KDF11-CB | USE 00KDF11CC | | | PC350 | 00.00 |
| H7441-YA | FCC 5V 32A REGULATOR FOR H7420,H765 | | | 11 FAMILY | 80.00 | KDJ11-AA | USE M8192-00 | | | LSI11/73 | 00.00 |
| H7476-00 | USE 541424000 | | | TU/TA78 | 00.00 | KDJ11-AB | USE M8192-YB | | | | 00.00 |
| H7660-A | USE H7660-C | | | RA81 | 00.00 | KDJ11-AC | USE M8192-YC | | | | 00.00 |
| H7660-B | USE 00H7660D0 | | | RA81 | 00.00 | KDJ11-BB | USE M8190-AB | | | 11/730 | 00.00 |
| H7660-C | H7660-A IMPROVED FOR ALL RA- DISK DRIVES | | | RA82 | 760.00 | KDJ11-BC | USE M8190 | | | 11 FAMILY | 00.00 |
| H7660-D | H7660-B IMPROVED FOR ALL RA- DISK DRIVES | | | RA82 | 760.00 | KDJ11-BF | USE M8190-AE | | | | 00.00 |
| H7650-AA | MK11-A BATT BACKUP W CHARGER FOR 3 H7850 | | | 11 FAMILY | 261.00 | KDJ11-KA | UPGRADE KDJ11-AA TO KDJ11-AB | | | LSI11 | 0.00 |
| H7751-B | CMR POWER SUPPLY ASSEMBLY,12VDC BATTERY | | | CMR01 | 147.00 | KEF11-AA | FP11 MICROCODE CHIPS FOR KDF11 (NEEDS 21 | | | 11 FAMILY | 19.00 |
| H7831-00 | USE 70-14979 | | | VT100 FAM | 00.00 | KMC11-A | USE M8204 | | | 11 FAMILY | 00.00 |
| H7835-00 | VT103 SUPPLY:120V/240V 50/60HZ INPUT,+5V | | A | VT100 FAM | 115.00 | KMC11-B | USE M8206 | | | 11 FAMILY | 00.00 |
| H7837-00 | USE H7847-AA | | | LA100 | 00.00 | KMV1A-M | BASE KMV11(M7500) PROGRAMBLE COMM INTERF | | | | 475.00 |
| H7837-AA | USE H7847-AA | | | LA100 | 00.00 | KPV11-A | USE M8016 | B | | 11 FAMILY | 00.00 |
| H7838-A | USE 701737400 | | | | 00.00 | KPV11-B | USE M8016-YB | D | | 11 FAMILY | 00.00 |
| H7842-A | USE H7842-D | | | PC FAMILY | 00.00 | KUV11-UH | USE M7264-YC | | | LSI11 | 00.00 |
| H7842-B | USE H7842-D | | | | 00.00 | KWV11-C | USE 30-18690 | C | | 11/03 | 00.00 |
| H7842-D | SMALL SYS UNIT POW SUP:142 WATTS,+5V 11. | | | PC FAMILY | 75.00 | KXJ11-CA | USE M7616 | | | KXJ11 | 00.00 |
| H7844-00 | USE H7847-AA | | | LA100 | 00.00 | KXT11-AA | USE M8063-BA | | | LSI11 | 00.00 |
| H7845-AA | USE H7845-BA | | | PC FAMILY | 00.00 | KXT11-AB | USE M7676 | | | LSI11 | 00.00 |
| H7845-BA | 120V SMALL SYS PWR SUP: 85 WATT,+5V,+/-1 | | | PC FAMILY | 95.00 | KXT11-CA | USE M8377 | | | LSI11 | 00.00 |
| H7846-00 | USE H784400 | | | LA100 | 00.00 | L0003-YA | COST REDUCED MEMORY INTERFACE + CACHE | | | 11/750 | 513.00 |
| H7847-AA | 120/240V PS,OUTPUT 97W,5V,+/-12V,+/-24V | | | LA100 | 86.00 | L0006-YA | 11750 MAINTENANCE TOOL,4-LAYER HEX 12 | | | 11/750 | 310.00 |
| H7848-BA | VS400 PWR SUPPLY,120V 104 WATT,+5.1V @13 | | | VAXSTATION | 290.00 | L0009-00 | CCI (CMI TO CIPA INTERFACE),4-LAYER HEX | | | C1750/780 | 464.00 |
| H7850-00 | BATTERY BACK-UP REG | | A | 11 FAMILY | 160.00 | L0014-00 | CMI (BACKPLANE) PARALLEL INTERFACE (DR75 | | | 11/750 | 554.00 |



Prices Effective 02-January-89 to 30-June-89
When you need a part repaired, call 800-225-5385.

FACTORY REPAIR

| PART NUMBER | DESCRIPTION | LOWEST ACCEPTABLE | | | REPAIR PRICE | PART NUMBER | DESCRIPTION | LOWEST ACCEPTABLE | | | REPAIR PRICE |
|-------------|--|-------------------|-----|------------|--------------|-------------|--|-------------------|-----|-----------|--------------|
| | | ETCH | REV | USED ON | | | | ETCH | REV | USED ON | |
| L0022-00 | 256K MEM CONTROL FOR MS750,4-LAYER HEX 1 | | | VAX8500 | 641.00 | M5012-YA | M5012 W TTL COMPATIBLE INPUTS | | | DPM | 209.00 |
| L0072-00 | NI20 (KL10 TO NI ADAPTOR) | | | | 651.00 | M5013-00 | 8 BIT AC INPUT MOD | | | DPM | 214.00 |
| L0100-00 | USE L0118 | B | | HSC50/70 | 00.00 | M5014-00 | I/O DAISY CHAIN BUS,DUAL 16-BIT INPUT CO | | | DPM | 409.00 |
| L0101-00 | IPB (CI CONTROL STORE & PACKET BUFFER),H | | | C1750/780 | 570.00 | M5016-00 | 16 BIT OUTPUT COUNTER | C | | DPM | 304.00 |
| L0102-00 | IDP (CI DATA PATH),HEX 12 | | | 11/780 | 494.00 | M5031-00 | 16-BIT 55V ISOLATED CHANGE OF STATE INTE | B | | 11 FAMILY | 147.00 |
| L0104-00 | ISI (CI SBI INTERFACE FOR CI PORT),HEX 1 | | | C1750/780 | 459.00 | M5864-00 | 18 INPUT & 2 OUTPUT OPTICAL COUPLED ISOL | B | | | 67.00 |
| L0106-00 | USE L0106-AA | | | HSC50/70 | 00.00 | M5901-00 | 16 CH EIA TRANSCEIVER DJ11 DOU | B | | 11 FAMILY | 25.00 |
| L0106-AA | 128KB DATA,128KB CONT,256KB PGM,HEX 12 = | C | | HSC50/70 | 439.00 | M5906-00 | 16 CH EIA CONV + PRIORITY BRD | B | | 11 FAMILY | 57.00 |
| L0106-AH | USE L0106-AA | | | | 00.00 | M5922-00 | MASS BUS TRANSCEIVER, PORT A | D | | | 90.00 |
| L0107-00 | USE L0107-YA | | | HSC50/70 | 00.00 | M5923-00 | MASS BUS TRANSCEIVER, PORT B | D | C | RM03 | 90.00 |
| L0108-YA | USE HSC5X-BA | | | HSC50/70 | 00.00 | M5960-00 | REPLACEMENT M596 | | | 11 FAMILY | 57.00 |
| L0108-YB | USE HSC5X-CA | | | HSC50/70 | 00.00 | M6010-00 | 32 BIT NONISO DC OUTPUT | C | | DPM | 247.00 |
| L0115-00 | 8000 LOGIC MOTHERBRD W/DAUGHTRBRDS,8 44- | | | HSC50/70 | 380.00 | M6011-00 | 16 BIT ONESAOT DC OUTPUT | | | DPM | 266.00 |
| L0116-AA | 4MB MEMORY ARRAY CARD ILUS | | | HSC50/70 | 285.00 | M6012-00 | 8 BIT ISO DC OUTPUT | B | | DPM | 185.00 |
| L0116-AF | USE L0116-AA | | | HSC50/70 | 00.00 | M6013-00 | 8BIT ISO AC OUTPUT | | | DPM | 285.00 |
| L0117-00 | USE L0117-AA | | | HSC50/70 | 00.00 | M6014-00 | 4/78 DUAL 16-BIT COUNTER | | | DPM | 413.00 |
| L0117-AA | STD2 MEM FOR HSC70: 521KB DATA,256KB CON | A | | HSC50/70 | 1148.00 | M6015-00 | DC RETENTATIVE ISOLATED DC OUTPUT,QUAD | | | DPM | 238.00 |
| L0118-00 | 32 NODE CLUSTER LINK FOR CI/HSC DEVICES | | B1 | VAX FAMILY | 570.00 | M6850-00 | 16 BIT FLIP-FLOP DC OUTPUT | E | | | 90.00 |
| L0200-BA | 4MB MOS ARRAY,256K PARTS. = L0200-BC-BF | | | VAX8600 | 1425.00 | M6870-00 | 16 BIT DC SING-SHOT OUTPUT | D | | 11 FAMILY | 115.00 |
| L0225-00 | MEMORY MOTHER BOARD W/NO DAUGHTER BOARDS | | | VAX8650 | 1425.00 | M7002-00 | TIMING, MEMORY & MEMORY | C | | VT FAMILY | 59.00 |
| L0226-BA | MS86 4MB,ECC MOS ARRAY,35MHZ,=L0226-BC- | | | VAX8600 | 1425.00 | M7004-00 | INTERFACE, HIGH SPEED VT05 | C | | VT FAMILY | 48.00 |
| L0400-00 | CDP (CI750 DATA PATH MODULE),4-LAYER HEX | | | C1750/780 | 678.00 | M7013-00 | VECTOR GEN & CHAR GEN CONT | B | | VT FAMILY | 176.00 |
| LA12X-DL | 4 KBYTE EXPANDABLE BUFFER | B | | LA120 | 86.00 | M7014-00 | UNIBUS CONT & BOOTSTRAP-VT40 | B | | VT FAMILY | 109.00 |
| LAV11-AA | USE M7949 | C | | LSI11 | 00.00 | M7014-YA | UNIBUS CONT & BOOTSTRAP FOR VT40 | B | | VT FAMILY | 247.00 |
| LK001-A | LA36 KEYBOARD WITHOUT NUMERIC KEYPAD | A | | LA36 | 81.00 | M7016-00 | PROGRAMMABLE REAL TIME CLOCK W3 SCHMIDT | B | | 11 FAMILY | 86.00 |
| LK201-A | USE LK201-AA | | | PC FAMILY | 00.00 | M7024-00 | VT55 GRAPHIC CONTROL | B | | VT50 FAM | 222.00 |
| LK201-B | USE 00LK201BA | | | PC FAMILY | 00.00 | M7025-00 | USE KW11-K | | | 11 FAMILY | 00.00 |
| LK201-EC | LK201-A W/APL KEYCAPS,BCC01,120V USA POW | | | PC FAMILY | 124.00 | M7049-00 | READER DATA MODULE | D | | RT FAMILY | 200.00 |
| LK201-EE | LK201-A UK/JSA KEYCAPS,240V POWER CORD | | | PC FAMILY | 124.00 | M7050-00 | CONTROL, READER | E | | 11 FAMILY | 49.00 |
| LK201-NA | LK201-N WITH USA/UK BLOCK MODE KEYCAPS | | | PC FAMILY | 124.00 | M7061-00 | USE 00M7061YA | C | | 11 FAMILY | 00.00 |
| LK201-PA | LK201-P WITH WPS/BLOCK MODE,USA/UK KEYCA | | | PC FAMILY | 124.00 | M7061-YA | VSV11-F,-H,-J,-K,SYNC GEN & CURSOR CONT, | E | | 11 FAMILY | 299.00 |
| LK201-RE | LK201-A UK/JSA KEYCAPS, NO PWR CORD | | | PC FAMILY | 124.00 | M7062-00 | IMAGE MEMORY (VSV11-MA),QUAD | F | | 11 FAMILY | 278.00 |
| LK201-XB | LK201-A W/NS100 KEYCAPS,BCC01,USA PWR CO | | | PC FAMILY | 124.00 | M7064-00 | IMAGE PROCESSOR VPV11-A | E | | 11 FAMILY | 321.00 |
| LK201-XC | LK201-A W/NS200 KEYCAPS,BCC01,USA PWR CO | | | PC FAMILY | 124.00 | M7071-00 | IMAGE MEM,RAMS & BUFFER LOGIC FOR VIDEO | E | | VT100 FAM | 162.00 |
| LK250-AA | LK250 LOW PROFILE KEYBOARD,ENGLISH VERSI | | | PC500 | 67.00 | M7075-00 | TRANSMITTER, SYNCHRONOUS | D | | 11 FAMILY | 67.00 |
| LPV11-00 | USE M802700 | B | | 11/03 | 00.00 | M7084-00 | HIGH SPEED UNIBUS REPEATER | | | | 0.00 |
| M3002-00 | CI20 MICROPROCESSOR,MULTIWIRE HEX | | | CI20 | 1085.00 | M7090-00 | 11/44 CIM (CONSOLE INTERFACE),DOUBLE 8.5 | A | | 11/44 | 130.00 |
| M3100-00 | USE DCSAX-LA | | | DECSA | 00.00 | M7091-00 | 4/78 KE44-A, CIS,QUAD | A | | 11/44 | 184.00 |
| M3102-00 | USE DCSAX-LC | | | DECSA | 00.00 | M7092-00 | 4/78 KE44-A, CIS HEX | B | | 11/44 | 304.00 |
| M3103-00 | LP LINE UNIT FOR DECSA,DOUBLE 8.5 | | | DECSA | 166.00 | M7093-00 | 4/78 FP11-F,FLOATING POINT HEX | B | | 11/44 | 261.00 |
| M3104-00 | DHV11-A (8-LINE ASYNC MUX,DMA CONTROL),Q | | | 11 FAMILY | 250.00 | M7105-00 | MAJOR REGISTER | B | | PDP8E,M,F | 100.00 |
| M3106-00 | DZQ11,4LN DBL BUF ASYNC MUX EIA 50-10KB, | | | DZQ11-M/AP | 150.00 | M7106-00 | RK8-E CONTROL | C | | PDP8E,M,F | 100.00 |
| M3106-PA | 4 LINE DBL BUFFER ASYNC MUX W/S-BOX HAND | | | VAX FAMILY | 143.00 | M7122-00 | MICROCONTROLLER MODULE | F | | RT FAMILY | 171.00 |
| M3107-00 | QBUS 8 LINE ASYNC MUX MODULE,DUAL | | | MICROVAX2 | 266.00 | M7122-YA | DPM01 MICRO CONTROLLER QUAD | F | | VT100 FAM | 147.00 |
| M3108-00 | 2-LINE SYNCHRONOUS COMM DEVICE,SPEEDS TO | | | MICROVAX2 | 261.00 | M7127-00 | FDC SERIAL BUS PORT | D | | 11 FAMILY | 124.00 |
| M3112-00 | CONSOLE BOOT TERMINATOR,HEX HEX | | | DECSA | 219.00 | M7128-00 | DRPM01 EIA/CURRENT WOP MUX FOR DECATAWAY | B | | VT100 FAM | 109.00 |
| M3118-YA | QUAD ASYNC 16 LINE MODULE,INTEGRAL HANDL | | | VAX FAMILY | 356.00 | M7133-00 | KDF11-UA CPU,LINE CLOCK,2 SER LNS,ETCH R | D | | 11/24 | 238.00 |
| M3118-YB | QUAD ASYNC 16 LINE,NO MODEM CONTROL,INTE | | | VAX FAMILY | 356.00 | M7134-00 | UNIBUS MAP (EXTENDED ADDRESS TO 22 BITS) | | | 11/24 | 105.00 |
| M3119-YA | 8 LINE ASYNC MUX,W/MODEM CNTRL,INTEGRAL | | | VAX FAMILY | 356.00 | M7142-00 | STAND ALONE MODULE FOR CRT TERMINAL,ASCI | C | | VK100 | 190.00 |
| M3121-00 | DUAL INTEGRAL MODEM,Q-BUS,S-BOX,DF224 CO | | | MODEMS | 285.00 | M7147-00 | MODEM CONTROL | A | W | 11 FAMILY | 220.00 |
| M4002-00 | USE 30-18690 | | | 11/03 | 00.00 | M7161-YA | USE M7485-YA | | | UDA50 | 00.00 |
| M4540-00 | M454 W MORE FREQ AVAILABLE | B | | 11 FAMILY | 76.00 | M7162-00 | USE M7486 | | | UDA50 | 00.00 |
| M5010-00 | 32 BIT NON ISO DC SENSE MOD | B | | DPM | 190.00 | M7181-00 | CMR HOST CONTROLLER FOR Q-BUS TO Q-BUS I | A | | LSI11 | 58.00 |
| M5011-00 | 16 BIT NON ISO DC INTER MOD | C | | DPM | 190.00 | M7182-00 | CMR HOST CONTROLLER FOR Q-BUS MICRO CTL | | | LSI11 | 126.00 |
| M5012-00 | 16 BIT ISO DC INPUT | B | | DPM | 190.00 | M7190-00 | 8-LINE STATISTICAL COMM MUX (DZS11-EA),H | C | | 11 FAMILY | 383.00 |

FACTORY REPAIR

| PART NUMBER | DESCRIPTION | LOWEST ACCEPTABLE | | | REPAIR PRICE | PART NUMBER | DESCRIPTION | LOWEST ACCEPTABLE | | | REPAIR PRICE |
|-------------|---|-------------------|-----|------------|--------------|--------------|---|-------------------|-----|------------|--------------|
| | | ETCH | REV | USED ON | | | | ETCH | REV | USED ON | |
| M7194-00 | 2G-E02YA,DIFFERENTIAL SIGNAL CONDITIONING | | | 11 FAMILY | 72.00 | M7432-00 | 14/30 I/O MULTIPLEXER DRIVER | E | | 11 FAMILY | 109.00 |
| M7195-FA | 128KB RAM,2 ASYNC EIA SLU,I/O,CLOCK,2 28 | C | | 11/23-23B | 185.00 | M7434-00 | INTFACE CONN | C | | PDP FAMILY | 86.00 |
| M7196-00 | TSV05 CONTROLLER FOR Q/Q22 BUS,QUAD | D | | TS FAMILY | 508.00 | M7443-00 | VT14 VIDEO DISPLAY | C | | VT FAMILY | 128.00 |
| M7199-00 | USE M7199-AA | | | VAX8500 | 00.00 | M7452-00 | UNIBUS TO 68000 FIBER OPTIC CONVERTER,QU | | | 11/730 | 180.00 |
| M7199-AA | 4MB ECC ARRAY 256K DRAMS = M7199-A*,4-LA | | | VAX8500 | 261.00 | M7454-00 | TU80 UNIBUS INTERFACE,QUAD(DILOG)/DIGITAL | | | TU80/81 | 509.00 |
| M7210-00 | KE11-A DATA CONTROL | A | | 11 FAMILY | 86.00 | M7455-00 | TSU05 CONTROLLER FOR UNIBUS,HEX | | | TS FAMILY | 508.00 |
| M7211-00 | KELL-A REGISTER CNTL | C | | 11 FAMILY | 67.00 | M7458-AA | MSV11-RA: 1MB PMI/Q22 PARITY MEMORY W/CS | | | MEMORIES | 451.00 |
| M7212-00 | ALINES, BUS REPEATER | C | | 11 FAMILY | 67.00 | M7459-00 | TRS,TERMINATOR & SILO 4-LAYER HEX 12 | | | 11/785 | 330.00 |
| M7213-00 | CARD, REPEATER MASTER | H | | 11 FAMILY | 67.00 | M7461-00 | KA785 SBH,SBI (SYNCHRONOUS BACK PLANE IN | | | 11/785 | 594.00 |
| M7213-YA | BUS REPEATER CONTROL | H | P* | 11 FAMILY | 86.00 | M7465-00 | KA785,IDP,CPU INSTRUCTION DATA PATH,4-LA | | | 11/785 | 484.00 |
| M7216-00 | CNTL, PRIORITY | B | | 11 FAMILY | 67.00 | M7466-00 | KA785 IRC,CPU INSTRUCTION DECODE & CLOCK | | | 11/785 | 449.00 |
| M7218-00 | REQUESTS, BUS | A | | 11 FAMILY | 147.00 | M7473-00 | KA785 ICL (INTERRUPT CONTROL,LOW BITS),4 | | | 11/785 | 494.00 |
| M7223-00 | SYNCHRONOUS CONTROL | C | | 11 FAMILY | 100.00 | M7474-00 | KA785 CLK (CPU CLOCK)4-LAYER HEX 12 | | | 11/785 | 988.00 |
| M7226-00 | DN11 CONTROL,DOUBLE X 8.5 | B | | 11 FAMILY | 86.00 | M7475-00 | KA785,JCS,JOINT CONTROL STORE,4-LAYER HE | | | 11/785 | 988.00 |
| M7228-00 | KW11-P REAL TIME CLOCK | F | | 11 FAMILY | 90.00 | M7476-00 | KA785,USC,MICRO SEQUENCER CONTROL,4-LAYE | | | 11/785 | 484.00 |
| M7229-00 | DR11-B INTERFACE FOR DA11-B | D | | 11 FAMILY | 109.00 | M7478-AA | RTVAX W/1MB,FP,INCL TIMR OF YEAR CLOCK,B | | | MICROVAX2 | 523.00 |
| M7231-00 | DATA PATHS, KD11-A | B | | 11/35-40 | 171.00 | USE M7478-AA | | | | MICROVAX2 | 00.00 |
| M7238-00 | KE11-E EIS BRD | B | | 11/35-40 | 238.00 | M7483-00 | LOW SPEED SERIAL IMEINT | B | A | PDP FAMILY | 96.00 |
| M7239-00 | KE11-F FIS CONTROL | B | | 11/35-40 | 94.00 | M7485-00 | USE M7485-YA | | | UDA50 | 00.00 |
| M7247-00 | MODEM CONTROL MUX | A | | | 67.00 | M7487-00 | 2 LINE COMM FRONT END PROCESSOR (SYNC & | | | 11 FAMILY | 1235.00 |
| M7248-00 | UNIBUS REPEATER | | | 11 FAMILY | 48.00 | M7500-00 | Q-COMMS CONTROLLER | B | | 11 FAMILY | 374.00 |
| M7251-00 | XOR AND CRC BLOCK | D | | 11 FAMILY | 55.00 | M7504-00 | Q-BUS TO ETHERNET ADAPTER,DUAL | | | MICROVAX2 | 214.00 |
| M7254-00 | RK11-D STATUS CONTROL | C | | 11 FAMILY | 101.00 | M7504-PA | M7504-YA W/S-BOX BULKHEAD HANDLE ASSY | | | MICROVAX2 | 333.00 |
| M7258-00 | LP11/LS11 INTERFACE,QUAD | D | | 11 FAMILY | 100.00 | M7505-00 | CONDITIONING MODULE FOR BTR INTERFACE | | | ETHERNET | 266.00 |
| M7259-00 | MODULE, PARITY CONTROL | C | H | 11 FAMILY | 76.00 | M7506-AA | MSV11-MA 512KB 18BIT RAM,256K DIPS,=M750 | | | MEMORIES | 475.00 |
| M7260-00 | DATA PATHS | B | | 11/05 | 150.00 | M7506-BA | MSV11-MB 1MB RAM,256K DIPS,=M7506-BC,-BF | | | MEMORIES | 499.00 |
| M7261-00 | CONTROL LOGIC E MICROPROGRAM | C | | 11/05 | 150.00 | M7513-00 | RD/RX DISK EXPANDER FOR RQDX DISK CNTLR | | | | 59.00 |
| M7264-00 | USE KD11-F | | | LSI11 | 00.00 | M7516-00 | Q-BUS TO ETHERNET ADAPTER,DUAL | | | ETHERNET | 409.00 |
| M7264-AB | USE KD11-F | | | LSI11 | 00.00 | M7516-PA | M7516 WITH S-BOX HANDLE (Q-BUS TO ETHERN | | | VAX FAMILY | 257.00 |
| M7264-BB | LSI11 CPU MODULE | E | | LSI11 | 117.00 | M7522-00 | RX50 CONTROL FOR UNIBUS,QUAD | | | RX50 | 162.00 |
| M7264-CB | USE KD11-F | | | 11/03 | 00.00 | M7540-00 | FP785,FNM,FLT PT FRACTION NORMALIZER,70- | | | 11/785 | 523.00 |
| M7264-DB | USE KD11-F | | | 11/03 | 00.00 | M7542-00 | FP785,FML,FLT PT FRACTION MULTIPLIER LOW | | | 11/785 | 439.00 |
| M7264-YA | USE M7264YC | C | | LSI11 | 00.00 | M7543-00 | FP785,FAD,FLOATING PT FRACTION ADDER | | | 11/785 | 484.00 |
| M7264-YB | LSI-11 CPU MODULE | E | 1 | LSI11 | 181.00 | M7547-00 | UNIBUS TMSCP TAPE CONTROLLER,QUAD | | | TK50 | 375.00 |
| M7265-00 | USE M8265 | C | | 11/34-34A | 00.00 | M7551-AA | 1MB Q22 MEM,PAR,CSR,84K CHIPS,=M7551-AC, | | | MEMORIES | 374.00 |
| M7268-00 | RK11-D ADAPTER | C | 1 | LSI11 | 48.00 | M7551-BA | 2MB Q22 MEM,PAR,CSR,256K CHIPS,=M7551-BC | | | MEMORIES | 374.00 |
| M7269-00 | RKV11 CONTROL | C | 1 | LSI11 | 48.00 | M7551-CA | 4MB Q22 MEM,PAR,CSR,256K CHIPS,=M7551-CC | | | MEMORIES | 374.00 |
| M7277-00 | SCANNERS & NPR,DH11,HEX 8.5 | C | | 11 FAMILY | 100.00 | M7552-00 | QBUS CONTROL FOR RRD50 (M7552) | | | RRD50 | 323.00 |
| M7278-00 | REG & BYTE CNT | C | FA | 11 FAMILY | 109.00 | M7554-00 | J11 CPU,15MHZ,512KB MEM,2 SERIAL LINES,L | | | 11 FAMILY | 197.00 |
| M7279-00 | 1ST IN 1ST OUT BUFFER DH11,DJ11 DO | B | | 11 FAMILY | 76.00 | M7558-AA | MSV11-SA 2MB PARITY CSR MEM = M7558-AC,- | | | 11 FAMILY | 190.00 |
| M7280-00 | MULTIPLE UART CARD | D | | 11 FAMILY | 100.00 | M7559-00 | TQK70 TAPE CONTROLLER FOR TK70 | | | TK70 | 319.00 |
| M7281-00 | RELAY DISTRIBUTE | D | | 11 FAMILY | 197.00 | M7602-00 | USE M7602-YA | A | | VAXSTATION | 00.00 |
| M7282-00 | MODULE INPUT SCAN | D | | 11 FAMILY | 247.00 | M7602-YA | QVSS(QBUS VIDEO SUB SYS MODULE)BIT MAP G | | | VAXSTATION | 250.00 |
| M7285-00 | DJ11 MUX CONTROL BOARD,HEX 8.5 | B | C | 11 FAMILY | 181.00 | M7605-00 | USE 302297101 | | | TK25 | 00.00 |
| M7288-00 | DH11 LINE PARAMETERS CONTROL | B | | 11 FAMILY | 100.00 | M7606-AC | USE M7606-AA | | | MICROVAXII | 00.00 |
| M7291-00 | 16 POINT INPUT INTERRUPT CB11 | B | | 11 FAMILY | 109.00 | M7606-AF | USE M7606-AA | | | MICROVAXII | 00.00 |
| M7294-YA | DATA BUFFER + CONTROL | B | | 11 FAMILY | 299.00 | M7606-AH | USE M7606-AA | | | MICROVAXII | 00.00 |
| M7296-00 | CONTROL & STATUS REG | B | | | 95.00 | M7607-AA | 1 MB MEMORY = M7607-AC,-AF,-AH,-AP,-AV, | | | MICROVAX2 | 210.00 |
| M7297-00 | MASSBUS PARITY CONTROL,RH11,DOUBLE 8.5 | A | | | 86.00 | M7608-AA | 2MB MEMORY = M7608-AC,-AF,-AH,-AP,-AS,-A | | | MICROVAX2 | 114.00 |
| M7379-AA | 256KB ARRAY,MOSTLY GOOD 16K CHIPS,4LAY H | B | | MEMORIES | 456.00 | M7608-AC | USE M7608-AA | | | MICROVAXII | 00.00 |
| M7361-00 | ML11 ASYNC CONTROL,HEX | E | | MEMORIES | 202.00 | M7608-AH | USE M7608-AA | | | MICROVAXII | 00.00 |
| M7362-00 | ML11 SYNC CONTROL,HEX | B | | MEMORIES | 160.00 | M7608-BA | 4MB MEMORY = M7608-BC,-BF,-BH,-BP,-BS,-B | | | MICROVAX2 | 295.00 |
| M7363-00 | ML11 ARRAY DATA,4-LAYER HEX | B | | MEMORIES | 54.00 | M7608-BC | USE M7608-BA | | | MICROVAXII | 00.00 |
| M7390-00 | ASYNCHRONOUS TRANSCIEVER | D | | RT FAMILY | 100.00 | M7608-BP | USE M7608-BA | | | MICROVAXII | 00.00 |
| M7431-00 | PDP14/30 I/O CONTROL | C | | PDP FAMILY | 124.00 | M7609-AA | 8MB PARITY 36BIT RAM,256K ZIPS,=M7609-AC | | | MICROVAX2 | 394.00 |

digital

Prices Effective 02-January-89 to 30-June-89
When you need a part repaired, call 800-225-5385.

SPARES PRICE LIST D-7

SPARES PRICE LIST D-8

M7609-AF — M7847-YF

FACTORY REPAIR

| PART NUMBER | DESCRIPTION | LOWEST ACCEPTABLE | | USED ON | REPAIR PRICE | PART NUMBER | DESCRIPTION | LOWEST ACCEPTABLE | | USED ON | REPAIR PRICE |
|-------------|--|-------------------|-----|------------|--------------|-------------|------------------------------------|-------------------|-----|-----------|--------------|
| | | ETCH | REV | | | | | ETCH | REV | | |
| M7609-AF | USE 00M7609AA | | | MICROVAXII | 00.00 | M7833-00 | ASYN MUX LINE CARD HEX (DV11-BB&BC | A | | 11 FAMILY | 166.00 |
| M7609-AH | USE 00M7609AA | | | MICROVAXII | 00.00 | M7836-00 | DV11 ALU & TRANSFER BUS | B | | 11 FAMILY | 166.00 |
| M7609-AP | USE 00M7609AA | | | MICROVAXII | 00.00 | M7837-00 | DV11 UNIBUS DATA & NPR CONT | B | | 11 FAMILY | 176.00 |
| M7609-AS | USE 00M7609AA | | | MICROVAXII | 00.00 | M7838-00 | DV11 ROM RAM & BRANCH | C | F | 11 FAMILY | 176.00 |
| M7609-AV | USE 00M7609AA | | | MICROVAXII | 00.00 | M7839-00 | SYNC MUX LINE CARD | B | | 11 FAMILY | 176.00 |
| M7616-00 | J11 CPU,512KB RAM,64KB PROM,Q22 PERIPHER | | | LSI11 | 523.00 | M7840-00 | KE11-B | B | | 11 FAMILY | 105.00 |
| M7620-AA | CVAX 90NS CPU MOD.2 LEVEL 64KB CACHE,ECC | | | VAX FAMILY | 969.00 | M7843-00 | DIGITAL I/O DR11-K | B | B | 11 FAMILY | 143.00 |
| M7620-BA | M7620-AA W/MOD ROM CODE FOR SINGLE USER | | B1 | VAX FAMILY | 964.00 | M7847-AA | USE MS11-E | | | MEMORIES | 00.00 |
| M7621-AA | 8MB 256K CHIP RAM ARRAY = M7621-AF, -AH, | | | VAX FAMILY | 285.00 | M7847-AB | USE MS11-EP | | | MEMORIES | 00.00 |
| M7651-00 | DRV11-WA,DMA 18/22-BIT PARALLEL GEN PURP | | | 11 FAMILY | 124.00 | M7847-AC | USE MS11-F | | | MEMORIES | 00.00 |
| M7651-PA | DRV11-WA,DMA 18/22 BIT PAR GP INTFCE,DUA | | | MICROVAX2 | 285.00 | M7847-AD | USE MS11-FP | | | MEMORIES | 00.00 |
| M7656-00 | Q-BUS SINGLE BOARD COLOUR GRAPHICS CONTR | | | | 950.00 | M7847-AE | USE MS11-H | | | MEMORIES | 00.00 |
| M7658-00 | 16 BIT PARALLEL I/O W/ DMA + BLOCK MODE | | | MICROVAX2 | 152.00 | M7847-AF | USE MS11-HP | | | MEMORIES | 00.00 |
| M7670-00 | TIMER, FORWARD B.O.T. | | | TU10 | 67.00 | M7847-AH | USE MS11-J | | | MEMORIES | 00.00 |
| M7671-00 | MASTER/S�AVE BUS DRIVER FOR TU10 MASTERS | | | TU10 | 95.00 | M7847-AJ | USE MS11-JP | | | MEMORIES | 00.00 |
| M7672-00 | TU10 COMMAND BUFFERS | | | TU10 | 143.00 | M7847-BA | USE MS11-E | | | MEMORIES | 00.00 |
| M7676-00 | DC310 (TINY 11),2 SERIAL,1 PARALLEL LINE | | | LSI11 | 124.00 | M7847-BB | USE MS11-EP | | | MEMORIES | 00.00 |
| M7685-00 | USE M8685 | | | RM02 | 00.00 | M7847-BC | USE MS11-F | | | MEMORIES | 00.00 |
| M7685-YA | DATA SEQUENCER FOR RM02/3/5,HEX,CAN BE R | | | RM03 | 75.00 | M7847-BD | USE MS11-FP | | | MEMORIES | 00.00 |
| M7686-00 | USE M7686-YA | | | RM03 | 00.00 | M7847-BE | USE MS11-H | | | MEMORIES | 00.00 |
| M7700-00 | USE M768000 | | | RK05 | 00.00 | M7847-BF | USE MS11-HP | | | MEMORIES | 00.00 |
| M7701-00 | DEC PAK CONTROL & INTERLOCK | | | RK05 | 76.00 | M7847-BH | USE MS11-J | | | MEMORIES | 00.00 |
| M7702-00 | USE M768100 | | | RK05 | 00.00 | M7847-BJ | USE MS11-JP | | | MEMORIES | 00.00 |
| M7707-00 | RK06 SERVO CONTROL | | | RK06 | 111.00 | M7847-CA | USE MS11-E | | | MEMORIES | 00.00 |
| M7708-00 | RK06 TRACK POS DETECTOR/PLO | | | RK06 | 160.00 | M7847-CB | USE MS11-EP | | | MEMORIES | 00.00 |
| M7728-YC | M7728 ETCH REV L AND LATER | | | LA36 | 90.00 | M7847-CC | USE MS11-F | | | MEMORIES | 00.00 |
| M7729-00 | SERNO ANELOG BOARD RK06 | | | RK06 | 154.00 | M7847-CD | USE MS11-FP | | | MEMORIES | 00.00 |
| M7730-00 | RK06 DUCIL PORT LOGIC BOARD | | | RK06 | 65.00 | M7847-CE | USE MS11-H | | | MEMORIES | 00.00 |
| M7736-00 | MODULE LAXX-KY | | | LA36 | 70.00 | M7847-CF | USE MS11-HP | | | MEMORIES | 00.00 |
| M7740-00 | Q22 TO LESI BUS ADAPTOR(REPLACES M8654)U | | | RC25 | 143.00 | M7847-CH | USE MS11-J | | | MEMORIES | 00.00 |
| M7744-00 | USE M7744-YC | | | RX02 | 00.00 | M7847-CJ | USE MS11-JP | | | MEMORIES | 00.00 |
| M7745-00 | USE M7745-YA | | | RX02 | 00.00 | M7847-DA | USE MS11-E | | | MEMORIES | 00.00 |
| M7751-00 | ENCODER - DECODER PLL | | | RS FAMILY | 86.00 | M7847-DB | USE MS11-EP | | | MEMORIES | 00.00 |
| M7753-00 | RS03 DATA BUFFER | | | RS FAMILY | 67.00 | M7847-DC | USE MS11-F | | | MEMORIES | 00.00 |
| M7755-00 | RS03 STATUS CONTROL | | | RS FAMILY | 67.00 | M7847-DD | USE MS11-FP | | | MEMORIES | 00.00 |
| M7760-00 | TU60 CASSETTE LOGIC | | | TU60 | 80.00 | M7847-DE | USE MS11-H | | | MEMORIES | 00.00 |
| M7761-00 | TU60 CASSETTE SERVO & READ | | | TU60 | 124.00 | M7847-DF | USE MS11-HP | | | MEMORIES | 00.00 |
| M7788-00 | RP05/6 MINIMUM DEVICE LEVEL INTERFACE TR | | | RP05/6 | 74.00 | M7847-DH | USE MS11-J | | | MEMORIES | 00.00 |
| M7789-00 | INTERFACE RECEIVER | | | | 58.00 | M7847-DJ | USE MS11-JP | | | MEMORIES | 00.00 |
| M7800-YA | M7800 WITHOUT EIA CHIPS | | | 11/05 | 85.00 | M7847-EA | USE MS11-E | | | MEMORIES | 00.00 |
| M7801-00 | DATA WORD CONTROL MC11 | | | | 291.00 | M7847-EB | USE MS11-EP | | | MEMORIES | 00.00 |
| M7807-00 | EIA LEVEL CONVERT | | | 11 FAMILY | 100.00 | M7847-EC | USE MS11-F | | | MEMORIES | 00.00 |
| M7808-00 | USE M7147 | | | 11 FAMILY | 00.00 | M7847-ED | USE MS11-FP | | | MEMORIES | 00.00 |
| M7809-00 | USE AR11 | | | 11 FAMILY | 00.00 | M7847-EE | USE MS11-H | | | MEMORIES | 00.00 |
| M7812-00 | DQ11-AA BUS SELECTOR CSR SHIFT REGISTER | | | 11 FAMILY | 166.00 | M7847-EF | USE MS11-HP | | | MEMORIES | 00.00 |
| M7813-00 | DQ11-AA CHAR COUNT BUSS ADR SHIFT CONT | | | 11 FAMILY | 166.00 | M7847-EH | USE MS11-J | | | MEMORIES | 00.00 |
| M7815-00 | DQ11-AA MODEM CONT (DQ11-BA) | | | 11 FAMILY | 67.00 | M7847-EJ | USE MS11-JP | | | MEMORIES | 00.00 |
| M7816-00 | DQ11-AB BUSS SELECTOR & CLOCK CHECK CHAR | | | 11 FAMILY | 86.00 | M7847-HJ | USE MS11-JP | | | MEMORIES | 00.00 |
| M7817-00 | DQ11-AB CHAR DET & SEQ CONT (DQ11-BB) | | | 11 FAMILY | 86.00 | M7847-JJ | USE MS11-JP | | | MEMORIES | 00.00 |
| M7818-00 | DQ11-AA HARDWIRE CHAR DET & NPR CONT | | | 11 FAMILY | 67.00 | M7847-YA | USE MS11-E | | | MEMORIES | 00.00 |
| M7821-00 | INTERRUPT CONTROL | | | 11 FAMILY | 65.00 | M7847-YB | USE MS11-EP | | | MEMORIES | 00.00 |
| M7822-00 | DU11 QUAD 8.5 | | | 11 FAMILY | 165.00 | M7847-YC | USE MS11-F | | | MEMORIES | 00.00 |
| M7823-00 | WATCHD G TIMER KW11-W | | | 11 FAMILY | 333.00 | M7847-YD | USE MS11-FP | | | MEMORIES | 00.00 |
| M7826-00 | TRANSMITTER SERIAL LINE (RCVR) | | | 11 FAMILY | 86.00 | M7847-YE | USE MS11-H | | | MEMORIES | 00.00 |
| M7828-00 | REMOTE DT03 BUS SWITCH CONTROL,DOUBLE 8. | | | 11 FAMILY | 86.00 | M7847-YF | USE MS11-HP | | | MEMORIES | 00.00 |



Prices Effective 02-January-89 to 30-June-89
When you need a part repaired, call 800-225-5385.

FACTORY REPAIR

| PART NUMBER | DESCRIPTION | LOWEST ACCEPTABLE | | | REPAIR PRICE | PART NUMBER | DESCRIPTION | LOWEST ACCEPTABLE | | | REPAIR PRICE |
|-------------|--|-------------------|-----|-----------|--------------|-------------|--|-------------------|-----|-----------|--------------|
| | | ETCH | REV | USED ON | | | | ETCH | REV | USED ON | |
| M7847-YH | USE MS11-J | | | MEMORIES | 00.00 | M7955-YE | USE MSV11-CA | | | MEMORIES | 00.00 |
| M7847-YJ | USE MS11-JP | | | MEMORIES | 00.00 | M7955-YF | USE MSV11-CB | | | MEMORIES | 00.00 |
| M7850-00 | MEM PARITY BOARD FOR G651 | | | | | M7955-YH | USE MSV11-CC | | | MEMORIES | 00.00 |
| M7855-00 | UNIBUS EXERCISER PDP11 | B | | 11/04 | 80.00 | M7955-YJ | USE MSV11-CD | | | MEMORIES | 00.00 |
| M7859-00 | CONSOLE PROGRAMMER | B | | 11/60 | 1112.00 | M7957-00 | 4 LINE DBL BUF ASYNC MUX EIA 50-10K BAUD | C | B | 11/03 | 75.00 |
| | | C | | 11/04 | 95.00 | | | | | | |
| M7864-00 | 2-WORD UNIBUS INPUT INTERFACE | C | | 11 FAMILY | 86.00 | M7958-00 | I/O CONTROL MODULE | D | | 11 FAMILY | 86.00 |
| M7865-00 | 2-WORD OUTPUT INTERFACE | | | 11 FAMILY | 124.00 | M7959-00 | Q-BUS TO D-BUS CABLE I/O DAISY CHAIN BUS | | | 11 FAMILY | 233.00 |
| M7867-00 | SYNC MODEM DUP11-DA | D | | 11 FAMILY | 152.00 | M7984-AB | USE MS11-KE | | | MEMORIES | 00.00 |
| M7872-00 | U WORD BOARD | D | | 11/60 | 318.00 | M7984-EA | USE MS11-KE | | | MEMORIES | 00.00 |
| M7873-00 | 11 DDO DATA PATH | F | | 11/60 | 224.00 | M7984-EB | USE MS11-KE | | | MEMORIES | 00.00 |
| | | | | | | | | | | | |
| M7876-00 | 11PDQ TIMING BOARD | F | | 11/60 | 130.00 | M7984-EC | USE MS11-KE | | | MEMORIES | 00.00 |
| M7877-00 | 11PDQ STATUS BOARD | C | | 11/60 | 190.00 | M7984-ED | USE MS11-KE | | | MEMORIES | 00.00 |
| M7883-00 | 24 CHANNEL DATA MUX,HEX | | | | 618.00 | M7984-EE | MS11 K | | | 11 FAMILY | 209.00 |
| M7884-00 | UNIBUS INTERFACE CARD,ASYNC,HEX | | | | 309.00 | M7985-00 | IEC BUS INTERFACE, IEC11-A (CSS) | A | | 11 FAMILY | 449.00 |
| M7891-AA | USE MS11-LA | | | MEMORIES | 00.00 | M7991-00 | PCL11-A,TXM (TRANSMITTER) INTERFACE HEX | A | | 11 FAMILY | 86.00 |
| | | | | | | | | | | | |
| M7891-BA | USE MS11-LB | | | MEMORIES | 00.00 | M7992-00 | PCL11-A,TXM UNIBUS CONTROL HEX | B | | 11 FAMILY | 124.00 |
| M7891-DA | USE MS11-LD | | | MEMORIES | 00.00 | M7993-00 | PCL11-A,TXM REGISTERS HEX | A | 1 | 11 FAMILY | 143.00 |
| M7891-DB | USE MS11-LD | | | MEMORIES | 00.00 | M7994-00 | PCL11-A TDM BUS LOGIC + DRIVERS HEX | A | | 11 FAMILY | 143.00 |
| M7892-00 | CASSETTE INTERFACE PR | B | | 11 FAMILY | 100.00 | M7995-00 | PCL11-A,RCV (RECEIVER) REGISTERS HEX | A | | 11 FAMILY | 124.00 |
| M7893-YA | 48 CHANNEL OUTPUT DRS11 | | | | 466.00 | M7996-00 | PCL11-A,RCV UNIBUS CONTROL HEX | | | 11 FAMILY | 278.00 |
| | | | | | | | | | | | |
| M7895-YA | 48 CHANNEL INPUT, DSS11 | | | | 570.00 | M7997-00 | PCL11-A,RCV INTERFACE HEX | A | | 11 FAMILY | 124.00 |
| M7899-00 | DZ32 8-LINE ASYNC MUX MODEM CONTROL | E | | 11 FAMILY | 285.00 | M8003-00 | DIFFERENTIAL TRANSCEIVER PCL11-B (CSS) | | | 11 FAMILY | 872.00 |
| M7901-00 | BOARD REGISTER RK611 | D | | RK06 | 114.00 | M8012-00 | USE M8012-YA | C | 3 | 11/03 | 00.00 |
| M7902-00 | CONTROL RK611 | C | | RK06 | 114.00 | M8012-YA | Q-BUS TERMINATOR,SPCE FOR BOOT & DIAG RO | D | | 11/03 | 90.00 |
| M7911-00 | TMB11 TAPE CTRL | B | | 11 FAMILY | 90.00 | M8016-00 | POWER FAIL,CLOCK MODULE | | | 11 FAMILY | 71.00 |
| | | | | | | | | | | | |
| M7912-00 | TMB-11 MODULE | C | | RK07 | 100.00 | M8016-YB | M8016 W 120-OHM TERMINATION | | | 11 FAMILY | 190.00 |
| M7915-00 | IEC11-B CONTROL | | | 11 FAMILY | 264.00 | M8017-00 | USE DLV11-E | C | | LSI11 | 00.00 |
| M7924-00 | MA11-F UNIBUS INTERFACE | D | | 11 FAMILY | 164.00 | M8017-AA | DLV11-E & DLV11-EC (ETCH REV D),REPLACES | | | LSI11 | 84.00 |
| M7930-00 | LP11 INTERFACE | D | | 11 FAMILY | 143.00 | M8018-00 | WRITEABLE CONTROL STORE RE,DOUBLE | B | | 11/03 | 250.00 |
| M7942-00 | 4-K 16 BIT PROM 11V03 | D | | 11/03 | 70.00 | M8020-00 | SERIAL SYNC INTERF,1 LINE PROG BIT STUFF | B | D | 11 FAMILY | 143.00 |
| | | | | | | | | | | | |
| M7942-YA | USE MRV11VA | D | | VT71-71T | 00.00 | M8026-00 | NC11-A,DMA CONTROLLER QUAD | C | | 11 FAMILY | 117.00 |
| M7942-YC | MRV11-VC, VT72 BOOTSTRAP | D | | 11/03 | 76.00 | M8027-00 | Q-BUS UNIVERSAL PRINTER INTERFACE DOUBLE | B | | 11/03 | 70.00 |
| M7946-00 | RXV11 CONTROL,DOUBLE 8.5 | B | | 11/03 | 75.00 | M8028-00 | DLV11-A,-C,ASYNC INTERFACE 20MA CURRENT | C | D | LSI11 | 75.00 |
| M7949-00 | M7949 LA180 INTERFACE | C | | 11/03 | 70.00 | M8029-00 | RXV21,Q-BUS RX02 INTERFACE,DOUBLE 8.5 | D | | RX02 | 100.00 |
| M7951-00 | DUV11-DA,SYNC INTERFACE,CHARACTER PROTOC | D | | 11/03 | 95.00 | M8030-00 | 16 BIT LATCH RELAY (ICMRL-OA) | D | | 11 FAMILY | 171.00 |
| | | | | | | | | | | | |
| M7952-00 | USE KVV11-A | B | | 11/03 | 00.00 | M8036-00 | Q-BUS CONTROL FOR MCV11-A, QUAD | B | | 11 FAMILY | 87.00 |
| M7953-00 | USE MNCKW | | | LSI11 | 00.00 | M8040-00 | USE DRV11-C | | | 11 FAMILY | 00.00 |
| M7954-00 | INTERFACE LSI11 BUS TO INST. BUS | C | | 11/03 | 105.00 | M8044-AA | USE MSV11-DA | | | MEMORIES | 00.00 |
| M7955-00 | USE MSV11-CD | C | | MEMORIES | 00.00 | M8044-AB | USE MSV11-DA | | | MEMORIES | 00.00 |
| M7955-AA | USE MSV11-CA | | | 11 FAMILY | 00.00 | M8044-AC | USE MSV11-DA | | | MEMORIES | 00.00 |
| | | | | | | | | | | | |
| M7955-AB | USE MSV11-CB | | | MEMORIES | 00.00 | M8044-AD | USE MSV11-DA | | | MEMORIES | 00.00 |
| M7955-AC | USE MSV11-CC | | | MEMORIES | 00.00 | M8044-BA | USE MSV11-DB | | | MEMORIES | 00.00 |
| M7955-AD | USE MSV11-CD | | | MEMORIES | 00.00 | M8044-BB | USE MSV11-DB | | | MEMORIES | 00.00 |
| M7955-BA | USE MSV11-CA | | | MEMORIES | 00.00 | M8044-BC | USE MSV11-DB | | | MEMORIES | 00.00 |
| M7955-BB | USE MSV11-CB | | | MEMORIES | 00.00 | M8044-BD | USE MSV11-DB | | | MEMORIES | 00.00 |
| | | | | | | | | | | | |
| M7955-BC | USE MSV11-CC | | | MEMORIES | 00.00 | M8044-CA | USE MSV11-DC | | | MEMORIES | 00.00 |
| M7955-BD | USE MSV11-CD | | | MEMORIES | 00.00 | M8044-CB | USE MSV11-DC | | | MEMORIES | 00.00 |
| M7955-BE | USE MSV11-CA | | | MEMORIES | 00.00 | M8044-CC | USE MSV11-DC | | | MEMORIES | 00.00 |
| M7955-BF | USE MSV11-CB | | | MEMORIES | 00.00 | M8044-CD | USE MSV11-DC | | | MEMORIES | 00.00 |
| M7955-BH | USE MSV11-CC | | | MEMORIES | 00.00 | M8044-CE | USE MSV11-DC | | | MEMORIES | 00.00 |
| | | | | | | | | | | | |
| M7955-BJ | USE MSV11-CD | | | MEMORIES | 00.00 | M8044-CF | USE MSV11-DC | | | MEMORIES | 00.00 |
| M7955-YA | USE MSV11-CA | | | MEMORIES | 00.00 | M8044-DA | MSV11-DD 32K 16BIT MOS RAM 16K CHIPS M80 | | | MEMORIES | 114.00 |
| M7955-YB | USE MSV11-CB | | | MEMORIES | 00.00 | M8044-DB | USE MSV11-DD | | | MEMORIES | 00.00 |
| M7955-YC | USE MSV11-CC | | | MEMORIES | 00.00 | M8044-DC | USE MSV11-DD | | | MEMORIES | 00.00 |
| M7955-YD | USE MSV11-CD | | | MEMORIES | 00.00 | M8044-DD | USE MSV11-DD | | | MEMORIES | 00.00 |

digital

Prices Effective 02-January-89 to 30-June-89
When you need a part repaired, call 800-225-5385.

SPARES PRICE LIST D-9

SPARES PRICE LIST D-10

M8044-DE — M8258-10

FACTORY REPAIR

| PART NUMBER | DESCRIPTION | LOWEST ACCEPTABLE | | | REPAIR PRICE | PART NUMBER | DESCRIPTION | LOWEST ACCEPTABLE | | | REPAIR PRICE |
|-------------|--|-------------------|-----|-----------|--------------|-------------|---|-------------------|-----|-----------|--------------|
| | | ETCH | REV | USED ON | | | | ETCH | REV | USED ON | |
| M8044-DE | USE MSV11-DD | | | MEMORIES | 00.00 | M8067-LH | USE M8067-LA | | | MEMORIES | 00.00 |
| M8044-DF | USE MSV11-DD | | | MEMORIES | 00.00 | M8067-LJ | USE M8067-LA | | | MEMORIES | 00.00 |
| M8044-DH | USE MSV11-DD | | | MEMORIES | 00.00 | M8067-LP | USE M8067-LA | | | MEMORIES | 00.00 |
| M8044-DK | USE MSV11-DD | | | MEMORIES | 00.00 | M8085-00 | DECADATAWAY SERIAL LINE INTERFACE (REPLAC | | | DPM | 285.00 |
| M8044-EA | 24K 16BIT MOS RAM,16K CHIPS = M8044-EB,- | | | MEMORIES | 114.00 | M8090-00 | MASTER CONT FOR ICS11 | B | | 11 FAMILY | 86.00 |
| M8044-EB | USE M8044-EA | | | MEMORIES | 00.00 | M8094-00 | REMOTE MASTER CONTROL ICR11 | C | | 11 FAMILY | 97.00 |
| M8044-EE | USE MSV11-DE | | | MEMORIES | 00.00 | M8096-00 | ICR11 REMOTE SLAVE CONTROL | B | | 11 FAMILY | 91.00 |
| M8044-EF | USE MSV11-DE | | | MEMORIES | 00.00 | M8098-00 | ICR11 REMOTE MODEM CONTROL | B | | 11 FAMILY | 185.00 |
| M8044-EK | USE MSV11-DE | | | MEMORIES | 00.00 | M8100-00 | DATA PATH MODULE, 11/45, HEX X 8.5, 4 LA | A | | 11/45 | 179.00 |
| M8045-AA | MSV11-EA 4K 18BIT MOS RAM,4K CHIPS = M80 | | | MEMORIES | 238.00 | M8102-00 | IR DECODE & COND CODES | B | | 11/45 | 100.00 |
| M8045-AB | USE MSV11-EA | | | MEMORIES | 00.00 | M8103-00 | ROM & ROM CONTROL | B | | 11/45 | 277.00 |
| M8045-AC | USE MSV11-EA | | | MEMORIES | 00.00 | M8104-00 | PDR(PROCSSR DATA & UNIBUS REGISTR),11/4 | C | | 11/45 | 120.00 |
| M8045-AD | USE MSV11-EA | | | MEMORIES | 00.00 | M8105-00 | TRAP & MISC CONTROL | B | | 11/45 | 124.00 |
| M8045-BA | USE MSV11-EB | | | MEMORIES | 00.00 | M8106-00 | UNIBUS AND CONSOLE CONTROL | B | A | 11/45 | 164.00 |
| M8045-BB | USE MSV11-EB | | | MEMORIES | 00.00 | M8107-00 | SYS ADDRESS PATH | ABC | | 11/45 | 122.00 |
| M8045-BC | USE MSV11-EB | | | MEMORIES | 00.00 | M8109-00 | TIMING GENERATOR | C | | 11/45 | 222.00 |
| M8045-BD | USE MSV11-EB | | | MEMORIES | 00.00 | M8110-00 | MOS/BIPOLAR MEMORY CONTROL | C | | 11/45 | 207.00 |
| M8045-CA | MSV11-EC 16K 18BIT MOS RAM,16K CHIPS = M | | | MEMORIES | 176.00 | M8112-00 | F.P. ROM + ROM CONTROL | B | | 11/45 | 158.00 |
| M8045-CB | USE MSV11-EC | | | MEMORIES | 00.00 | M8113-00 | FXP (FLOATING POINT EXPONENT DATA PATHS) | C | | 11/45 | 95.00 |
| M8045-CC | USE MSV11-EC | | | MEMORIES | 00.00 | M8114-00 | FRACTION DATA PATH HIGH ORDER | B | | 11/45 | 155.00 |
| M8045-CD | USE MSV11-EC | | | MEMORIES | 00.00 | M8116-00 | SJB (SEGMENTATION JUMPER BOARD),8.5 HEX, | A | | 11/45 | 100.00 |
| M8045-DA | USE MSV11-ED | | | MEMORIES | 00.00 | M8119-00 | UNIBUS CONSOL CONTROL | A | R | 11/45 | 179.00 |
| M8045-DB | USE MSV11-ED | | | MEMORIES | 00.00 | M8120-00 | BIPOLAR MEM CONTROL | D | | 11/45 | 205.00 |
| M8045-DC | USE MSV11-ED | | | MEMORIES | 00.00 | M8121-YA | USE MS11-AP | | | MEMORIES | 00.00 |
| M8045-DD | USE MSV11-ED | | | MEMORIES | 00.00 | M8147-00 | MEMORY CONTROL TIMING MCT | A | | MEMORIES | 130.00 |
| M8045-DF | USE MSV11-ED | | | MEMORIES | 00.00 | M8148-00 | USE M8147 | A | | MEMORIES | 00.00 |
| M8047-AA | ROMS, IS M8047-AB,-AC,-AD | D | A | 11 FAMILY | 100.00 | M8159-00 | USE 00M816400 | D | | MEMORIES | 00.00 |
| M8047-CA | MXV11-AC,16K RAM,IS M8047-CB,-CC,-CD,-CE | D | A | MEMORIES | 124.00 | M8184-00 | DATA MEMORY | | | 11/70 | 825.00 |
| M8048-00 | MRV11-C UNIVERSAL:SOCKETS FOR 8 24-PIN R | C | | 11/03 | 80.00 | M8185-00 | CACHE DATA PATH | | | 11/70 | 318.00 |
| M8049-00 | DRV11-J,HI-DENSITY PARALLEL LINE UNIT | B | A | 11 FAMILY | 100.00 | M8188-00 | FPF11 FLOATING POINT PROCESSOR QUAD | | | 11/23-23B | 275.00 |
| M8050-00 | 16 BIT FLIP-FLOP RELAY | D | | 11 FAMILY | 171.00 | M8190-00 | USE M8190-AB | | | 11/730 | 00.00 |
| M8059-00 | MSV11-L | | | MEMORIES | 0.00 | M8191-00 | UNIBUS ADAPTOR FOR KDJ11-B W/MAP,PMI (KT | | | | 166.00 |
| M8059-FA | MSV11-LF: =M8059-FC,-FF,-FH,-FJ,-FP (4-L | | | MEMORIES | 150.00 | M8192-00 | USE M8192-YB | | | LSI11/73 | 00.00 |
| M8059-FC | USE M8059-FA | | | MEMORIES | 00.00 | M8200-YC | INTERPROCESSOR LINKUP | E | | 11 FAMILY | 261.00 |
| M8059-FF | USE M8059-FA | | | MEMORIES | 00.00 | M8202-YB | IPL SLU HI [500 KB] | C | | 11 FAMILY | 147.00 |
| M8059-FH | CSR 64K 18BIT MOS RAM,SINGLE VOLTAGE NEC | | | MEMORIES | 00.00 | M8202-YC | IPL SLU HI [230.8 KB] | | | 11 FAMILY | 177.00 |
| M8059-FP | USE M8059-FA | | | MEMORIES | 00.00 | M8202-YD | IPL SLU HI [65 KB] | C | | 11 FAMILY | 164.00 |
| M8059-KA | MSV11-LK: =M8059-KC,-KF,-KH,-KJ,-KP (4 L | | | MEMORIES | 175.00 | M8206-00 | MICROPROCESSOR,DMC11 CODE,4K RAM SPACE,4 | E | J | 11 FAMILY | 285.00 |
| M8059-KC | USE M8059-KA | | | MEMORIES | 00.00 | M8207-YA | MICROPROC W DDCMP 4K CONT ROM USED M8201 | C | | 11 FAMILY | 333.00 |
| M8059-KF | USE M8059-KA | | | MEMORIES | 00.00 | M8208-00 | FIELD SERVICE SELF TEST ON VT103,DUAL 8. | | | VT100 FAM | 67.00 |
| M8059-KH | USE M8059-KA | | | MEMORIES | 00.00 | M8210-AA | USE M8210 | | | MEMORIES | 00.00 |
| M8060-YA | M8060 WITH BDV11-BA PROMS | A | | LSI11 | 411.00 | M8210-AB | USE M8210 | | | MEMORIES | 00.00 |
| M8063-AA | USE M8063-BA | | | LSI11 | 00.00 | M8210-AC | USE M8210 | | | MEMORIES | 00.00 |
| M8063-BA | DC310 (TINY 11),2 SERIAL,1 PARALLEL LINE | | | LSI11 | 140.00 | M8210-AD | USE M8210 | | | MEMORIES | 00.00 |
| M8064-MA | M8064 W DDCMP PT TO PT OR MULTIDROP,INTE | | | LSI11 | 150.00 | M8210-AE | USE M8210 | | | MEMORIES | 00.00 |
| M8067-KA | MSV11-PK: 256KB MOS MEM WITH PARITY CSR, | | | MEMORIES | 224.00 | M8210-AF | USE M8210 | | | MEMORIES | 00.00 |
| M8067-KB | USE M8067-KA | | | MEMORIES | 00.00 | M8210-AK | USE M8210 | | | MEMORIES | 00.00 |
| M8067-KD | USE M8067-KA | | | MEMORIES | 00.00 | M8211-AB | USE M8211 | | | MEMORIES | 00.00 |
| M8067-KF | USE M8067-KA | | | MEMORIES | 00.00 | M8211-AC | USE M8211 | | | MEMORIES | 00.00 |
| M8067-KH | USE M8067-KA | | | MEMORIES | 00.00 | M8233-00 | WCS CPU WRITEABLE CONTROL STORE | B | | 11/780 | 290.00 |
| M8067-LA | MSV11-PL: 512KB MOS MEM WITH PARITY CSR, | | | MEMORIES | 250.00 | M8237-00 | TERMINATOR SILO | A | | 11/780 | 200.00 |
| M8067-LB | USE M8067-LA | | | MEMORIES | 00.00 | M8254-00 | INTERPROCESSOR BUFFER QUAD | C | | 11 FAMILY | 160.00 |
| M8067-LD | USE M8067-LA | | | MEMORIES | 00.00 | M8255-01 | UNIBUS SERIAL EUROPEAN CONSOLE MICRO CON | B | | 11 FAMILY | 181.00 |
| M8067-LE | USE M8067-LA | | | MEMORIES | 00.00 | M8256-00 | RX211 UNIBUS RX02 INTERFACE QUAD | D | | RX02 | 119.00 |
| M8067-LF | USE M8067-LA | | | MEMORIES | 00.00 | M8258-00 | MA780,MULTIPOINT PORT INTERFACE,HEX 12 | B | | 11/780 | 506.00 |



Prices Effective 02-January-89 to 30-June-89
When you need a part repaired, call 800-225-5385.

FACTORY REPAIR

| PART NUMBER | DESCRIPTION | LOWEST ACCEPTABLE | | | REPAIR PRICE | PART NUMBER | DESCRIPTION | LOWEST ACCEPTABLE | | | REPAIR PRICE |
|-------------|--|-------------------|-----|-----------|--------------|-------------|--|-------------------|-----|----------|--------------|
| | | ETCH | REV | USED ON | | | | ETCH | REV | USED ON | |
| M8259-00 | MA780,MULTIPOINT PORT CONTROLLER,HEX 12 | | | 11/780 | 266.00 | M8525-00 | APR CONTROL REGISTER | C | | KL10 | 200.00 |
| M8260-00 | MA780,MULTIPOINT ARRAY TIMING,HEX 12 | | | 11/780 | 266.00 | M8526-00 | CLOCK CTRL KL10 | B | | KL10 | 247.00 |
| M8261-00 | KS10 DATA PATH MEMORY | | | 11/780 | 201.00 | M8526-YA | M8526 FOR KL10-PV | C | | KL10 | 247.00 |
| M8274-00 | RH780 EXTENDED SILO (256X8) MASSBUS DATA | | | 11/780 | 244.00 | M8527-00 | E BOX CTRL LOGIC KL10 | D | | KL10 | 247.00 |
| M8290-00 | ORDER M8291 + 70-11217-25 | C | | 11 FAMILY | 100.00 | M8528-00 | CONTROL RAM KL10 | B | | KL10 | 347.00 |
| M8291-00 | CR11 CM11 CONTROL | C | C* | 11 FAMILY | 124.00 | M8529-00 | M BOX CONTROL LOGIC KL10 | C | | KL10 | 200.00 |
| M8293-00 | M7293 W NO 8838'S | B | | 11/35-40 | 95.00 | M8529-YA | TIME MODULE | C | | KL10 | 200.00 |
| M8300-00 | REGISTER, MAJOR | B | | PDP8E,M,F | 124.00 | M8530-00 | E BOX MEMORY CONTROL KL10 | B | | KL10 | 299.00 |
| M8310-00 | CONTROL, MAJOR REGISTER | F | | PDP8E,M,F | 100.00 | M8531-00 | M BOX CONTROL 3 KL10 | B | | KL10 | 200.00 |
| M8316-00 | 8A XTAL CLOCK OPT BRD #1 | C | R | PDP8 FAM | 143.00 | M8531-YA | MBOX CONTROL 3 | C | | KL10 | 153.00 |
| M8317-00 | USE M8317YB | D | | PDP8A | 00.00 | M8532-00 | USE M8532-YA | C | | KL10 | 00.00 |
| M8317-YA | M8317/ROM REMOVED OPT BRD #2 | | | PDP8 FAM | 109.00 | M8532-YA | M8532 FOR USE WITH NIA20 + CI20 | B | | KL10 | 200.00 |
| M8319-00 | MULTISERIAL LINE UNIT 8A | C | | PDP8 FAM | 133.00 | M8533-00 | CHANNEL CONTROL | D | | KL10 | 247.00 |
| M8320-00 | LOADS, BUS | B | | PDP8E,M,F | 100.00 | M8534-00 | CHANNEL CONTROL WORD | B | | KL10 | 299.00 |
| M8326-00 | INTERPROCESSOR BUFFER DB-E | E | | PDP8 FAM | 67.00 | M8535-00 | CHANNEL RAM CTRL 4 | C | | KL10 | 200.00 |
| M8329-00 | USE M834200 | C | | PDP8E,M,F | 00.00 | M8536-00 | CHANNEL CTR LOGIC | D | | KL10 | 200.00 |
| M8330-YB | USE M8330 | | | PDP8E,M,F | 00.00 | M8537-00 | M BOX CTRL 4 | C | | KL10 | 200.00 |
| M8340-00 | DECODER AND STEPCOUNTER | E | | PDP8E,M,F | 95.00 | M8538-00 | METER (70-9418) KL10 | B | | KL10 | 347.00 |
| M8341-00 | MULTIPLEXORS & TIMING GENERATO | D | | PDP8E,M,F | 95.00 | M8539-00 | ARITHMETIC PROCESS REGISTER-KL10 | B | | KL10 | 247.00 |
| M8357-00 | RX01/RX02 OMNIBUS INTERFACE FOR 8/E | B | | RX01 | 124.00 | M8540-00 | MODULE SHIFT MATRIX | A | | KL10 | 200.00 |
| M8365-00 | LC8-P CONTROL FOR LA180,QUAD | B | | PDP8E,M,F | 95.00 | M8542-00 | VMA BOARD | A | | KL10 | 299.00 |
| M8366-00 | LQP8E CONTROL | C | B | PDP8E,M,F | 81.00 | M8543-00 | E BOX CONTROL | A | | KL10 | 124.00 |
| M8373-00 | USE M8373-AA | | | MEMORIES | 00.00 | M8544-00 | MEMORY CONTROL | A | | KL10 | 247.00 |
| M8373-AA | 256K X 39BIT MOS MEM ARRAY=M8373-AC,-AF, | | | MEMORIES | 285.00 | M8545-00 | APR BOARD | A | | KL10 | 200.00 |
| M8373-AF | USE M8373-AA | | | MEMORIES | 00.00 | M8550-00 | I/O BUS ADAPT DATA PATH-KI10 | C | | KL10 | 171.00 |
| M8373-AH | USE M8373-AA | | | MEMORIES | 00.00 | M8551-00 | CTRL BRD FOR KL10 I/O ADAPTER | B | | KL10 | 171.00 |
| M8374-AA | 1M X 39BIT MOS MEM ARRAY,=M8374-AC,AF,AH | | | | 285.00 | M8552-00 | 10/11 DATA PATCH 4 | D | | KL10 | 124.00 |
| M8377-00 | T11 CPU,32KB RAM,32KB ROM,Q22 MULTI IOP | | | LSI11 | 204.00 | M8553-00 | 10/11 BUS AND DATA CONTROL | F | | KL10 | 171.00 |
| M8391-YA | MCT (MEMORY CONTROLLER W BATTERY BACKUP) | | | 11/730 | 507.00 | M8554-00 | 10/11 BUS + DATA CONTROL EXT | B | | KL10 | 100.00 |
| M8398-00 | 24-LINE DMA ASYNC COMM MODULE,HEX | | | DMZ32 | 190.00 | M8555-00 | E BUS INTERFACE KL10 | C | | KL10 | 171.00 |
| M8416-00 | CONTROL MODULE | C | | PDP8 FAM | 159.00 | M8556-00 | MASSBUS DATA PATH,4 LAYER HEX 8.5 | E | | KL10 | 200.00 |
| M8417-BA | USE MS8-CB | | | MEMORIES | 00.00 | M8557-00 | MASSBUS CONTROL,4 LAYER HEX | B | | KL10 | 247.00 |
| M8431-YA | DR01-CL CONTROL BRD | | | DTR01 | 0.00 | M8558-00 | KI MEMORY BUS ADAPTER | C | | KL10 | 124.00 |
| M8434-00 | 11/70 CHANNEL INTERFACE | A | | 11/70 | 268.00 | M8559-00 | CLOCK DISTRIBUTION | B | | KL10 | 394.00 |
| M8436-00 | USE M8436-BA | | | VT FAMILY | 00.00 | M8560-00 | DMA20 BRDL | C | | KL10 | 394.00 |
| M8437-AA | M8437 W ROM SET "A" (23-629F1,23-630F1,2 | C | | VT FAMILY | 200.00 | M8561-00 | MA20 CONTROL 4 | B | | KL10 | 200.00 |
| M8439-00 | RL01/02 DISK CONTROL,QUAD (RL278) | | | RL02 | 190.00 | M8562-00 | TIMING BOARD MA20 | B | | KL10 | 171.00 |
| M8440-00 | GENERAL PURPOSE MASSBUS INTERFACE CONTRO | E | C | DTR01 | 760.00 | M8563-00 | DMA20 BOARD 2 4 LAYER HEX | D | | KL10 | 124.00 |
| M8507-00 | CONTROL MODULE | H | | RT FAMILY | 124.00 | M8565-00 | MB20 & MH10,TIMING,4-LAYER DOUBLE 8.5 | B | | KL10 | 124.00 |
| M8510-00 | SHIFT MATRIX,4 LAYER HEX 8.5 | A | | KL10 | 200.00 | M8566-00 | MB20 & MH10,CYCLE TIMING,4-LAYER DOUBLE | C | | KL10 | 86.00 |
| M8511-00 | CTRL ROM ADDR KL10 | E | | KL10 | 347.00 | M8568-00 | MB20,MEMORY BUS INTERFACE & DIAGNOSTIC L | A | | KL10 | 124.00 |
| M8513-00 | CACHE CONTROL KL10 | D | | KL10 | 200.00 | M8571-00 | LP20 MODULE | E | U | KL10 | 113.00 |
| M8513-YA | MODULE CACHE CONTROL | D | | KL10 | 247.00 | M8572-00 | MULTIPLE S-BUS TRANSLATOR, 4 LAYER HEX | A | | KL10 | 247.00 |
| M8515-00 | KL10 CACHE BOARD | C | | KL10 | 347.00 | M8574-00 | WRITE PATH | A | | KL10 | 381.00 |
| M8516-00 | FCL/TTL TRANSLATOR KL10 | D | | KL10 | 65.00 | M8575-00 | SYMPTOME MF20 | A | | KL10 | 347.00 |
| M8517-00 | MEMORY BUFFER KL10 | C | | KL10 | 299.00 | M8576-00 | MOS CONTROL | B | | KL10 | 285.00 |
| M8518-00 | PHYSICAL MEM ADDR MODULE | C | | KL10 | 299.00 | M8577-00 | ADDRESS + TIME MF20 | C | | KL10 | 443.00 |
| M8518-YA | M8518 FOR KL10-PV | C | | KL10 | 347.00 | M8578-00 | UNIVERSAL Q-22 BUS EPROM (WILL REPLACE M | C | | MEMORIES | 76.00 |
| M8519-00 | INTERNAL MEM BUS TRANSLATOR | B | | KL10 | 171.00 | M8579-AA | USE MF20-M | | | MEMORIES | 00.00 |
| M8520-00 | PAGING BOARD KL10 | D | | KL10 | 347.00 | M8580-00 | TRANSLATOR DUAL MF20 | A | | KL10 | 247.00 |
| M8520-YA | M8520 FOR KL10-PV | B | | KL10 | 347.00 | M8586-00 | CONTROL MODULE [LP20] | D | | KL10 | 171.00 |
| M8521-00 | KL10 CACHE BOARD | B | | KL10 | 394.00 | M8587-00 | DATA PATH MODULE [LP20] | B | | KL10 | 347.00 |
| M8522-00 | TR D RAM AND CARRY KL10 | C | | KL10 | 299.00 | M8589-00 | MG10 CYCLE TIME | B | | KL10 | 394.00 |
| M8523-00 | VIRTUAL MEMORY ADDRESS | C | | KL10 | 247.00 | M8590-00 | MG10 PRIORITY CONTROL | A | | KL10 | 100.00 |
| M8524-00 | SCAD PC13-17 PC FLAGS | B | | KL10 | 200.00 | M8591-00 | MG10 ADDRESS RECEIVER | B | | KL10 | 124.00 |

digital

Prices Effective 02-January-89 to 30-June-89
When you need a part repaired, call 800-225-5385.

SPARES PRICE LIST D-11

SPARES PRICE LIST D-12

M8594-00 — M8928-YA

FACTORY REPAIR

| PART NUMBER | DESCRIPTION | LOWEST ACCEPTABLE | | | REPAIR PRICE | PART NUMBER | DESCRIPTION | LOWEST ACCEPTABLE | | | REPAIR PRICE |
|-------------|--|-------------------|-----|------------|--------------|-------------|--|-------------------|-----|-----------|--------------|
| | | ETCH | REV | USED ON | | | | ETCH | REV | USED ON | |
| M8594-00 | DATA TRANSCEIVER MG10 | B | | KL10 | 100.00 | M8722-BA | USE MS11-MB | | | MEMORIES | 00.00 |
| M8595-00 | DX10 MEM BUS ADAPTER | C | | KL10 | 171.00 | M8722-BB | USE MS11-MB | | | MEMORIES | 00.00 |
| M8596-00 | DX10 CHNL BUS INTERFACE | C | | KL10 | 171.00 | M8722-BC | USE MS11-MB | | | MEMORIES | 00.00 |
| M8597-00 | DX10 CONTROL | C | C | KL10 | 247.00 | M8722-BD | USE MS11-MB | | | MEMORIES | 00.00 |
| M8598-00 | DX10 I/O INTERFACE | C | | KL10 | 171.00 | M8722-BE | USE MS11-MB | | | MEMORIES | 00.00 |
| M8599-00 | DX10 CHNL BUS INTERFACE | F | | KL10 | 200.00 | M8722-BH | USE MS11-MB | | | MEMORIES | 00.00 |
| M8601-00 | DX20, MICRO STORE, HEX | A | | KL10 | 580.00 | M8728-00 | USE M8728-AA | | | MEMORIES | 00.00 |
| M8602-00 | DX20, MICRO CONTROLLER, HEX | | | KL10 | 493.00 | M8728-AC | USE M8728-AA | B | | MEMORIES | 00.00 |
| M8603-00 | DX20,MASSBUS INTERFACE DATA BOARD,QUAD | B | | KL10 | 441.00 | M8728-AH | USE M8728-AA | | | MEMORIES | 00.00 |
| M8604-00 | DX20,MASSBUS INTERFACE CONTROL,HEX | | | KL10 | 440.00 | M8728-AK | USE M8728-AA | | | MEMORIES | 00.00 |
| M8605-00 | DX20, DATA PATH BUFFER STORAGE,HEX | B | | KL10 | 347.00 | M8729-00 | ALTERNATE BUFFER DMA INTERFACE | | | 11 FAMILY | 148.00 |
| M8606-00 | DATA PATH 4 MATTER DX20 | B | | KL10 | 488.00 | M8730-00 | KW11-C,CALENDER CLOCK QUAD X | C | | 11 FAMILY | 485.00 |
| M8607-00 | IBM CHNL BUS INTF DX20 | B | | KL10 | 468.00 | M8739-00 | KLESI-UA (LESI TO UNIBUS INTERFACE),QUAD | D | | RC25 | 143.00 |
| M8612-00 | AN10, PRIORITY INTERRUPT CONTROL, QUAD | A | | KL10 | 266.00 | M8740-00 | USE MDE-BM | | | MDE | 00.00 |
| M8614-00 | AN10, IMP TO HOST INTERFACE CONTROL HEX | | | KL10 | 285.00 | M8740-AA | USE MDE-BM | | | MDE | 00.00 |
| M8616-00 | KS10 CONSOLE | B | B | KS10 | 394.00 | M8740-AD | 32KB MOS RAM,INTEL 4K PARTS,HEX | | | MDE | 147.00 |
| M8618-00 | MOS MEMORY CONTROL | B | | KS10 | 394.00 | M8741-00 | STATE ANALYZER,4-LAYER HEX | | | MDE | 124.00 |
| M8619-00 | LIMITED UNIBUS ADAPTOR,MULTIWIRE HEX | B | B | KS10 | 186.00 | M8742-00 | T11 EMULTOR, 4-LAYER HEX | | | MDE | 114.00 |
| M8620-00 | KS10 DATA PATH EXECUTE | A | B | KS10 | 394.00 | M8743-AA | 512KB (256K X 22) ECC RAM,=M8743-AB,-AC, | | | DECSA | 184.00 |
| M8621-00 | KS10 DATA PATH MEMORY | A | B | KS10 | 499.00 | M8743-BA | 1MB (512K X 22) ECC RAM,=M8743-BB,-BC,-B | | | MEMORIES | 266.00 |
| M8622-00 | CRAM ADDRESS MULTIWIRED | A | B | KS10 | 394.00 | M8743-BB | M8743-BA W MOSTEK PARTS | | | MEMORIES | 546.00 |
| M8623-00 | CONTROL RAM UNIT ASSY | A | B | KS10 | 499.00 | M8743-BC | USE M8743-BA | | | MEMORIES | 00.00 |
| M8629-BA | USE MS10-BA | | | MEMORIES | 00.00 | M8743-BF | USE M8743-BA | | | MEMORIES | 00.00 |
| M8631-AA | 4K 16BIT 2KX8 STATIC CMOS RAM W 96HR BAT | C | | LSI11 | 48.00 | M8743-BH | USE M8743-BA | | | MEMORIES | 00.00 |
| M8631-AF | USE M8631-AA | | | | 00.00 | M8750-CB | USE M8750-CA | | | MEMORIES | 00.00 |
| M8631-CA | 16K 16BIT 2KX8 CMOS STATIC RAM W 96HR BA | B | A | MEMORIES | 461.00 | M8750-CC | USE M8750-CA | | | MEMORIES | 00.00 |
| M8631-CF | USE MCV11-DC | | | LSI11 | 00.00 | M8750-CD | USE M8750-CA | | | MEMORIES | 00.00 |
| M8631-CL | USE MCV11-DC | | | LSI11 | 00.00 | M8750-CH | USE M8750-CA | | | MEMORIES | 00.00 |
| M8634-00 | Q-BUS INTERFACE TO IEEE488/IEC625 GEN PU | C | E | | 166.00 | M8750-CJ | USE M8750-CA | | | MEMORIES | 00.00 |
| M8637-BA | USE 00M8637DA | | | MEMORIES | 00.00 | M8750-CP | USE M8750-CA | | | MEMORIES | 00.00 |
| M8637-BH | USE M8637-BA | | | MEMORIES | 00.00 | M8901-00 | USE M8901YB | C | | TU16 | 00.00 |
| M8637-CA | USE 00M8637EA | | | MEMORIES | 00.00 | M8901-YC | DATA SYNCHRONIZER-TM02 | F | | TM02 | 90.00 |
| M8637-CF | USE M8637-CA | | | | 00.00 | M8902-00 | TM02 TAPE CONTROL,PE,QUAD | | | TM02 | 130.00 |
| M8637-DA | MSV11-JD 1MB ECC RAM MEM,PMI/Q22 W/CSR,Q | | | MEMORIES | 565.00 | M8902-YA | TAPE CONT. PHASE ENCODE | D | | | 209.00 |
| M8637-EA | MSV11-JE 2MB ECC RAM MEM,PMI/Q22 W/CSR,Q | | | MEMORIES | 1078.00 | M8903-00 | TAPE CONT COMMON MODE-TM02 | E | | TM02 | 95.00 |
| M8637-EF | USE M8637-EA | | | | 00.00 | M8903-YA | TAPE CONT COMMON TM02 | D | | TM02 | 86.00 |
| M8639-00 | USE M8639-YA | | | MICROVAX I | 00.00 | M8904-00 | TAPE CONT NRZI (TM02) | B | | TM02 | 90.00 |
| M8639-YB | Q-BUS CONTROL FOR RD51 OR RD52 + RX50,CA | | | RD FAMILY | 549.00 | M8904-YA | TAPE CONTROL NRZI | D | | TM02 | 314.00 |
| M8640-00 | UNIBUS 8CH. MODEM CONT, QUAD | C | | 11 FAMILY | 247.00 | M8905-00 | MAINTENANCE REGISTER-TM02 | B | | TM02 | 70.00 |
| M8648-00 | UNIBUS INTERFACE TO IEEE488/IEC625 GEN P | | A | | 309.00 | M8905-YA | MAINTENANCE REGOSTER TM02 | C | | TM02 | 70.00 |
| M8650-00 | KL8/EA ASYNCH DATA CONTROL | B | | PDP8E,M,F | 95.00 | M8905-YB | MAINTENANCE REGISTER-TM03 | D | | TM03 | 86.00 |
| M8652-00 | USE M8652-YB | | | PDP8E,M,F | 00.00 | M8907-00 | CONN TERM | A | | TM02 | 110.00 |
| M8652-YB | DOUBLE BUFFERED | | | PDP8E,M,F | 143.00 | M8908-00 | RECEIVER/TERM | A | | TM02 | 60.00 |
| M8656-00 | VT71 LK05 TO Q BUS INTERFACE | C | | VT71-71T | 100.00 | M8908-YA | TM03 MASSBUS INTERFACE,REPLACES M8908,HE | A | 1 | TM03 | 60.00 |
| M8657-00 | USE M8657YA | C | | | 00.00 | M8909-00 | USE M8909-YA | C | | TM02 | 00.00 |
| M8657-YA | VT71 CONTROL SECTION | C | | VT71-71T | 100.00 | M8911-00 | SLAVE CLOCK MOTION DELAY (TU16) | E | | TU16 | 75.00 |
| M8658-00 | USE M8658YA | | | | 00.00 | M8911-YB | USE M893100 | E | F | PDP15/16 | 00.00 |
| M8658-YA | VT71 VIDEO | D | | VT71-71T | 147.00 | M8912-00 | SLAVE TEST FUNCT GEN (TU16) | B | | TU16 | 95.00 |
| M8704-00 | 8-LINE SYNC LINE UNIT,NO CRC32(REPLACES | C | A | 11 FAMILY | 444.00 | M8913-00 | DATA DRIVER | A | | TU10 | 67.00 |
| M8711-00 | DMS11-D, 8-LINE SYNC LINE UNIT,4-LAYER H | B | | 11 FAMILY | 390.00 | M8913-YA | USE M9039 | A | | TM02 | 00.00 |
| M8711-YA | USE M8704 | B | | 11 FAMILY | 00.00 | M8920-00 | ADAPTOR TS03 | C | | TS FAMILY | 133.00 |
| M8719-00 | UNIBUS TO D-BUS CABLE I/O DAISY CHAIN BU | B | | 11 FAMILY | 109.00 | M8922-00 | PE CONTROL | | | TS FAMILY | 86.00 |
| M8721-YB | ISOLATED LOOP VERSION DT07 PORT MODULE,H | C | | 11 FAMILY | 361.00 | M8923-00 | READ CONTROL | | | 11 FAMILY | 67.00 |
| M8721-YC | DT07 SWITCHED UNIBUS REPEATER,HEX SPC | C | | 11 FAMILY | 299.00 | M8928-00 | USE M8928YA | | | TM03 | 00.00 |
| M8721-YD | PORT TERMINATED DT07 PORT MODULE,HEX SPC | C | | 11 FAMILY | 302.00 | M8928-YA | MTA BRD FOR TM02,TM03 ON TU45 | D | F | TM02 | 160.00 |



Prices Effective 02-January-89 to 30-June-89
When you need a part repaired, call 800-225-5385.

FACTORY REPAIR

| PART NUMBER | DESCRIPTION | LOWEST ACCEPTABLE | | | REPAIR PRICE | PART NUMBER | DESCRIPTION | LOWEST ACCEPTABLE | | | REPAIR PRICE |
|-------------|---|-------------------|-----|------------|--------------|-------------|--|-------------------|-----|------------|--------------|
| | | ETCH | REV | USED ON | | | | ETCH | REV | USED ON | |
| M8929-00 | TS04 WRITE CONTROL | | | 11 FAMILY | 86.00 | MRV11-D | USE M8578 | | | MEMORIES | 00.00 |
| M8931-00 | SLAVE CLOCK AND MOTION DELAY | A | | PDP FAMILY | 67.00 | MRV11-VA | BOOTSTRAP,M7942-YA | D | | VT71-71T | 86.00 |
| M8934-YA | TAPE CONTROL NRZI (75 IPS) | B | F | TM03 | 361.00 | MS630-AA | USE M7607-AA | | | MICROVAXII | 00.00 |
| M8937-00 | TM03 CONTROL & WRITE DRIVERS,DOUBLE 8.5 | C | | TM03 | 60.00 | MS630-BA | USE M7608-AA | | | MICROVAXII | 00.00 |
| M8951-00 | ERROR CORRECTION BOARD | | | TU/TA78 | 284.00 | MS630-BB | USE M7608-BA | | | | 00.00 |
| M8955-00 | TU PORT PO | | | TU/TA78 | 224.00 | MS630-CA | USE M7609-AA | | | MICROVAXII | 00.00 |
| M8958-00 | TM78 TRANSLATOR | | | TM78 | 57.00 | MS650-AA | USE M7621-AA | | | VAX FAMILY | 00.00 |
| M8959-00 | WRITE MICROCONTROLLER | | | TU/TA78 | 299.00 | MS730-CA | USE M8750-CA | C | | 11/730 | 00.00 |
| M8962-00 | TS04 MICROPROCESSOR,DOUBLE 8.5 | | | TS FAMILY | 86.00 | MS750-AA | USE M8728-AA | C | | MEMORIES | 00.00 |
| M8963-00 | TS04 MICROSTACK,DOUBLE 8.5 CAPSTAN IN | | | TS FAMILY | 67.00 | MS750-CA | USE M8750-CA | C | | MEMORIES | 00.00 |
| M8966-00 | TS04 I/O SILO,FRAME COUNTER | | | TS FAMILY | 86.00 | MS780-D | MEMORY ARRAY | | | MEMORIES | 0.00 |
| M8967-00 | I/O CONTROL | | | TS FAMILY | 86.00 | MS780-DA | USE M8210 | B | | MEMORIES | 00.00 |
| M8970-00 | STI INTERFACE MICRO BOARD (QUAD) | | | TU/TA78 | 110.00 | MS780-JD | USE M8374-AA | | | MEMORIES | 00.00 |
| M8971-00 | STI INTERFACE DRIVER BOARD (QUAD) | | | TU/TA78 | 110.00 | MSC11-CK | USE 5415488KA | | | PC FAMILY | 00.00 |
| M8972-00 | TA78 MICROCOMPUTER,QUAD (8085 CHIP) | | | TU/TA78 | 80.00 | MSV11-B | USE M7944 | B | | 11/03 | 00.00 |
| M8973-00 | 8085 EXTENDED MEMORY,DOUBLE 8.5 | | | TU/TA78 | 110.00 | MSV11-CA | 4K MOS RAM (M7955-AA) | | | MEMORIES | 276.00 |
| M8985-00 | COMM INTERFACE,DUAL | | | | 95.00 | MSV11-CB | 8K MOS RAM (M7955-AB) | | | MEMORIES | 276.00 |
| M8988-00 | DCT11-AA MICROCONTROL,DUAL | | | 11 FAMILY | 209.00 | MSV11-CC | 12K MOS RAM (M7955-AC) | | | MEMORIES | 176.00 |
| M8989-00 | R-BUS CONTROL,DUAL | | | 11 FAMILY | 128.00 | MSV11-DA | USE MSV11-DD | C | | MEMORIES | 00.00 |
| M8990-00 | CMR11 HOST CONT,UNIBUS INTFC,4 SERIAL PO | B | | LS11 | 216.00 | MSV11-DB | 8K 16 BIT MOS RAM 8K CHIPS M8044-BA | C | | MEMORIES | 86.00 |
| M8991-00 | MICRO PROC CONT FOR CMR01,DRIVES R-BUS,R | A | B | LS11 | 180.00 | MSV11-DE | USE M8044-EA | | | MEMORIES | 00.00 |
| M8992-00 | USED W M8991,INCL 1 SERIAL PORT & DISPLA | | | LS11 | 90.00 | MSV11-EA | USE M8045-AA | | | MEMORIES | 00.00 |
| M8993-00 | 16-BIT DIGITAL INPUT,OCI,5V 2MA,DUAL 8.5 | | B | | 81.00 | MSV11-EB | 8K 18 BIT MOS RAM, 4K CHIPS (M8045-BA) | | | MEMORIES | 109.00 |
| M8994-00 | 16-BIT DIGITAL OUTPUT,HG WETTED FORM A R | B | | LS11 | 116.00 | MSV11-EC | USE M8045-CA | | | MEMORIES | 00.00 |
| M8995-00 | LIMITED DISTANCE MODEM FOR CMR01 | | | CMR01 | 95.00 | MSV11-JB | USE M8637-BA | | | MEMORIES | 00.00 |
| M9001-00 | TU16 CABLE CARD | | | TU16 | 67.00 | MSV11-JD | USE M8637-DA | | | MEMORIES | 00.00 |
| M9001-YA | M9001/8 LINES GROUND | C | | TU16 | 67.00 | MSV11-JE | USE M8637-EA | | | MEMORIES | 00.00 |
| M9001-YB | M9001 TERMINATED | C | F | TM03 | 60.00 | MSV11-LF | USE M8059-FA | C | | MEMORIES | 00.00 |
| M9001-YC | M9001-YA TERMINATED | C | | TU16 | 67.00 | MSV11-LK | USE M8059-KA | C | | MEMORIES | 00.00 |
| M9039-00 | TERMINATOR BRD TE16 CE M9001 S | | | TE16 | 150.00 | MSV11-MA | 512KB Q-BUS DUAL PARITY BLOCK MODE 256KX | | | MEMORIES | 475.00 |
| M9202-00 | CABLE UNIBUS JUMPER | | | 11 FAMILY | 76.00 | MSV11-PK | USE M8067-KA | C | | MEMORIES | 00.00 |
| M9300-00 | UNIBUS B TERMINATOR | A | | 11 FAMILY | 67.00 | MSV11-PL | USE M8067-LA | C | | MEMORIES | 00.00 |
| M9301-00 | USE 00M9301YA | F | | 11 FAMILY | 00.00 | MSV11-QA | USE M7551-AA | | | MEMORIES | 00.00 |
| M9301-SA | M9301 W WESTERN ELECTRIC BOOTSTRAP | F | | 11 FAMILY | 100.00 | MSV11-QB | USE M7551-BA | | | MEMORIES | 00.00 |
| M9301-SW | M9301-SF UPDATED W DA11 DECNET 2 BOOTSTR | E | | 11 FAMILY | 109.00 | MSV11-QC | USE M7551-CA | | | MEMORIES | 00.00 |
| M9301-YA | M9301 W OEM BOOTSTRAP | F | | 11/04 | 105.00 | MSV11-RA | USE M7458-AA | D | | MEMORIES | 00.00 |
| M9301-YB | M9301 W/END USER BOOTSTRAP | F | | 11/04 | 100.00 | MXV11-AA | USE M8047-AA | D | | 11/23-23B | 00.00 |
| M9301-YC | BOOTSTRAP LOADER | F | | 11/04 | 100.00 | MXV11-AC | USE M8047-CA | | | 11/23-23B | 00.00 |
| M9301-YD | M9301 W BOOT FOR PC11,RP02-6,RS03-4,RK05 | F | | 11/04 | 84.00 | MXV11-BF | USE M7195-FA | | | 11/23-23B | 00.00 |
| M9301-YH | M9301 W 11/60 BOOTSTRAP | F | | 11/60 | 69.00 | MXV11-HA | USE M8047-HA | | | | 00.00 |
| M9302-00 | UNIBUS TERMINATOR | B | | 11 FAMILY | 67.00 | PC23X-DA | USE 541653701 | | | DECMATEIII | 00.00 |
| M9313-00 | UNIBUS EXERCIZER + TERMINATOR (UET),DOUB | A | | 11/750 | 95.00 | PC278-A | BA25-B,KK612-A,120/240V | | | PC FAMILY | 855.00 |
| M9400-YA | LSI REF. CABLE CONN | B | | LS11 | 94.00 | PC27X-AH | USE PC27X-AN | | | PC FAMILY | 00.00 |
| M9400-YC | LSI REF. CABLE CONN | B | | LS11 | 48.00 | PC27X-AJ | 8/16 BIT XPU,512KB (PC27X-AP + QWA50-A3 | | | PC FAMILY | 494.00 |
| MCV11-DA | USE M8631-AA | B | | MEMORIES | 00.00 | PC27X-AL | 16 BIT XPU,512KB UPGRADE(REPLACES 256KB) | | | PC FAMILY | 371.00 |
| MCV11-DC | USE M8631-CA | B | | MEMORIES | 00.00 | PC27X-AN | EK-DM4XP-IN,70-22011-01,BL-DA82A-MV,37-0 | | | PC FAMILY | 266.00 |
| MMV11-A | 4KX16 BIT MEMORY 11V05 | A | | MEMORIES | 375.00 | PCXXA-AA | CROSSOVER SWITCH FOR SERIAL PRNTR,2FEM/2 | | | PC FAMILY | 143.00 |
| MNCAA-00 | 4-CHANNEL 12-BIT D/A (A6002) (WAS AAV11- | E | | LS11 | 197.00 | RCD31-E | RD31 CONTROLLER FOR PC500 | 1A | | PC500 | 95.00 |
| MNCAD-00 | 16-CHANNEL 12-BIT A/D (A013) (WAS ADV11- | D | | LS11 | 278.00 | RCD31-EA | USE RCD31-FA | | | NRW | 00.00 |
| MNCAG-00 | 4-CH DIFF SW GAIN (0.5,5.0,50,500)PREAMPS(- | D | | LS11 | 287.00 | REV11-A | USE M9400-YA | | | LS11 | 00.00 |
| MNCDO-00 | DIGITAL OUTPUT (M6003) (WAS DOV11-B) | | | LS11 | 143.00 | REV11-C | USE M9400-YC | | | LS11 | 00.00 |
| MNCKW-00 | PROGRAMMABLE REAL-TIME CLOCK (M7953) (WA | E | | LS11 | 211.00 | REV11-H | USE M9400-YH | | | LS11 | 00.00 |
| MRV11-AA | USE M794200 | D | | 11/03 | 00.00 | RLV12-00 | USE M8061 | | | RL01 | 00.00 |
| MRV11-BA | USE M8021 | D | | 11/03 | 00.00 | RQDX2-00 | USE M8639-YB | | | | 00.00 |
| MRV11-C | USE M8048 | C | | 11/03 | 00.00 | RQDX3-00 | USE M7555 | | | | 00.00 |

digital

Prices Effective 02-January-89 to 30-June-89
When you need a part repaired, call 800-225-5385.

SPARES PRICE LIST D-13

FACTORY REPAIR

| PART NUMBER | DESCRIPTION | LOWEST ACCEPTABLE | | | REPAIR PRICE | PART NUMBER | DESCRIPTION | LOWEST ACCEPTABLE | | | REPAIR PRICE |
|-------------|--|-------------------|-----|------------|--------------|-------------|--|-------------------|-----------|---------|--------------|
| | | ETCH | REV | USED ON | | | | ETCH | REV | USED ON | |
| RRD50-A2 | 600MB LASER READ-ONLY CD READER,100/120V | | | RRD50 | 413.00 | VT220-C | USE VT220-C2 | A | VT220 | 00.00 | |
| RRD50-A3 | 600MB LASER READ-ONLY CD READER,220/240V | | | RRD50 | 413.00 | VT220-C2 | USE 00VT220F2 | | VT220 | 00.00 | |
| RXV11-00 | USE M7946 | B | | 11/03 | 00.00 | VT220-D2 | ENHANCED VT220-A2,TEXT TERM,WHITE PHOS,R | | VT220 | 178.00 | |
| RXV21-00 | USE M8029 | C | | 11/03 | 00.00 | VT220-E2 | ENHANCED VT220-B2 TEXT TERM,GREEN PHOS,R | | VT220 | 178.00 | |
| ST101-00 | USE M7081-YB | | | LAS12 | 00.00 | VT220-F2 | ENHANCED VT220-C2 TEXT TERM,AMBER PHOS,R | | VT220 | 178.00 | |
| ST103-00 | USE 7015763-1 | | | LA120 | 00.00 | VT22K-AA | USA/CANADA KEYBOARD COUNTRY KIT: LK201-A | | PC FAMILY | 95.00 | |
| ST105-00 | USE 7016799-1 | | | LA120 | 00.00 | VT22X-AA | VT220 EXTERNAL INTEGRAL MODEM OPTION,120 | | VT220 | 86.00 | |
| ST106-00 | USE 54-13044 | | | LA120 | 00.00 | W7000-00 | AUX POW SUPPLY-KL10 | C | KL10 | 86.00 | |
| ST111-00 | USE 70-15388 | | | LA120 | 00.00 | W7410-00 | 16 BIT SS DC CONTACT SENSE | C | 11 FAMILY | 115.00 | |
| T0003-00 | USE T1003 | | | KDB50 | 00.00 | W7430-00 | 16 BIT SS DC CONTACT INTERRUPT | C | 11 FAMILY | 109.00 | |
| T1008-BA | MS820-AA: 2MB 39BIT ECC MOS RAM,256K CHI | 1A | | VAX8200 | 2114.00 | 12-16089-00 | KEYBOARD,105 KEYS FOR LK09-R | | | 285.00 | |
| T1008-BC | USE T1008-BA | 1A | | VAX8200 | 00.00 | 12-16089-01 | KEYBOARD,123 KEYS FOR LK09-C | | VT FAMILY | 67.00 | |
| T1008-BF | USE T1008-BA | 1A | | VAX8200 | 00.00 | 12-16089-02 | KEYBOARD,123 KEYS FOR LK09-E | | VT FAMILY | 90.00 | |
| T1008-BH | USE T1008-BA | 1A | | VAX8200 | 00.00 | 17-00276-05 | CABLE,RIBBON 40COND 30*LG | | | 0.00 | |
| T1008-BL | USE T1008-BA | 1A | | VAX8200 | 00.00 | 17-00951-02 | CABLE,COAX WIRE MESH | | | 0.00 | |
| T1008-BP | USE T1008-BA | 1A | | VAX8200 | 00.00 | 20-25924-01 | MODULE ELECTRONICS FOR BARCODE READER | | VT220 | 190.00 | |
| T1008-BR | USE T1008-BA | 1A | | VAX8200 | 00.00 | 20-M7454-01 | MODULE,CONTROLLER TU80 TO PDP11 UNIBUS | | TU80/81 | 570.00 | |
| T1012-00 | BI COMBO MODULE,CONNECTS TO BI BACKPLANE | 1E | | DRB32 | 912.00 | 29-18510-00 | 30PCBA CLOCK | | 29 CLASS | 159.00 | |
| T1014-A | BI TO LESI ADAPTOR(KLESI-BIW/FS PKG (20- | | | VAX8200 | 1045.00 | 29-19945-00 | 14PCBA AP-17/37, RIBBON CONTR | | LP FAMILY | 380.00 | |
| T1015-00 | PORT CONTROL, BI TO CLIP INTERFACE FOR C | | | VAX8200 | 504.00 | 29-20669-00 | 14PCBA AV-18 HB PWR SUP REG | | LP FAMILY | 380.00 | |
| T1018-00 | BI ADAPTOR DATA TRANSFER MODULE (BIA #2) | | | VAX8200 | 190.00 | 29-21102-00 | 14VFU 12 CHAN2470 | | LP FAMILY | 393.00 | |
| T1019-AA | 4MB ECC MEM ARRAY,SURFACE MNT=T1019-AE,- | | | VAX8200 | 2114.00 | 29-21112-00 | 14PCBA LOGIC LP05 | | LP FAMILY | 295.00 | |
| T1025-00 | CI FRONT END AND PACKET BUFFER FOR CIBCA | | | VAX8200 | 485.00 | 29-21113-00 | 14PCBA SERVO L005 | W | LP FAMILY | 143.00 | |
| T1032-00 | USE T1034 | | | VAX8200 | 00.00 | 29-21114-00 | 14PCBA HMMR DRVR | | LP FAMILY | 126.00 | |
| T1034-00 | NI ADAPTER BOARD W/TK50 CNTLR (IEEE 802. | 3D | | VAX8200 | 1536.00 | 29-21115-00 | 14PCBA POWER REGULATOR | | LP FAMILY | 180.00 | |
| T1040-AA | 16MB ECC MEMORY W/1MB RAMS = T1040-AC, - | | | VAX8200 | 936.00 | 29-21121-00 | 14VFU CKT CARD | | LP FAMILY | 122.00 | |
| T1043-00 | XMI TO BI ADAPTER (XBIB) | | | VAX6200 | 1140.00 | 29-21125-00 | 14MOTOR, PAPER FEED | | LP FAMILY | 190.00 | |
| T1045-00 | PORT CONTROLLER,BI TO CILP INTERFACE FOR | D1 | | VAX FAMILY | 741.00 | 29-21222-00 | 14PCBA SELP TEST | | LP FAMILY | 95.00 | |
| T1046-00 | CI FRONT END AND PACKET BUFFER, CILP TO | E2 | | VAX FAMILY | 618.00 | 29-21237-00 | 29PCBA CURVE GENERATOR | | RP04 | 67.00 | |
| T2011-00 | XMI CVAX PROCESSOR MODULE (XCP) (9.18 X | | | VAX6200 | 9453.00 | 29-21238-00 | 29PCBA SUMMING AMP | | RP04 | 92.00 | |
| T2012-00 | XMI TO BI ADAPTER (XBIA) (9.18 X 11) | | | VAX6200 | 1425.00 | 29-21239-00 | 29PCBA READ/WRITE SAFTY | | RP04 | 58.00 | |
| T2014-BA | XMI32MB MEMORY (XMA) =T2014-BF,BH,BL,BP | | | VAX6200 | 6175.00 | 29-21240-00 | 29PCBA READ/WRITE DETCECT | | RP04 | 72.00 | |
| TQK50-00 | USE M7546 | | | TK50 | 00.00 | 29-21243-00 | 29PCBA POWER CONTROL B | | RP04 | 69.00 | |
| TQK50-AA | USE M7546 | | | TK50 | 00.00 | 29-21244-00 | 29PCBA ACCESS CONTROL | | RP04 | 54.00 | |
| UDA50-A | USE 00M7485YA | | | UDA50 | 00.00 | 29-21245-00 | 29PCBA IND DET/SEC CLOCK B | | RP04 | 62.00 | |
| VC241-B | EXTENDED BIT MAP DAUGHTER BRD,COLOR&ENHA | | | PC FAMILY | 409.00 | 29-21246-00 | 29PCBA FILE SAFETY | | RP04 | 91.00 | |
| VDP40-AA | SONY LDP1000A VIDEO DSK PLYR,UL APPROVED | | | PC3XX IVIS | 570.00 | 29-21248-00 | 29PCBA TF SERVO CLOCK | | RP04 | 122.00 | |
| VDP50-AA | VDP50-A2 + VDP5X-KA,USA/ENGLISH 120V | | | VDP50 | 475.00 | 29-21249-00 | 29PCBA SERVO SELECT B | | RP04 | 127.00 | |
| VDP50-RC | VDP50 BATTERY POWERED REMOTE CONTROL | | | VDP50 | 95.00 | 29-21251-00 | 29PCBA TACH | | RP04 | 74.00 | |
| VK170-CA | USE M7142 | | | VK100 | 00.00 | 29-21253-00 | 29PCBA WRITE B | | RP04 | 107.00 | |
| VR241-A | 13" RGB COLOR MONITOR,120/240V | | | PC FAMILY | 323.00 | 29-21254-00 | 29PCBA MATRIX RP04 | | RP04 | 252.00 | |
| VR260-AA | 19" MONO MONITOR,1024X864 PIXELS,USA ENG | | | VR260 | 1359.00 | 29-21256-00 | 29PCBA READ/WRITE DATA | | RP04 | 84.00 | |
| VR290-DA | VR290 FOR NORTH AMERICA(NORTH HEMISPHERE | | | VR290 | 1093.00 | 29-21264-00 | 29PCBA MDLI DRIVER | | RP04 | 65.00 | |
| VS10X-EA | USE 302003801 | | | 11/730 | 00.00 | 29-21265-00 | 29PCBA MDLI FILE STATUS | | RP04 | 60.00 | |
| VS240-A | USE VS240-BA | | | VT240 | 00.00 | 29-21266-00 | 29PCBA DISC SPEED SENSOR | | RP04 | 105.00 | |
| VS240-BA | VT240 SYS BOX,OLD TCB,F/W 2.0,PS,120V | | | VT240 | 562.00 | 29-21270-00 | 29POWER DRIVE ASSY | | RP04 | 189.00 | |
| VS240-CA | USE VS240-BA | | | VS240 | 00.00 | 29-21272-00 | 29BLOWER ASSY60HZ | | RP04 | 250.00 | |
| VSV21-AA | USE M7656 | | | VSV21 | 00.00 | 29-21277-00 | 29HEAD ASSY AV A | | RP04 | 97.00 | |
| VT1X3-MM | USE M8208 | | | VT100 FAM | 00.00 | 29-21278-00 | 29HEAD ASSY AD A | | RP04 | 54.00 | |
| VT1XX-AB | USE 54-13097 | | | VT100 FAM | 00.00 | 29-21279-00 | 29HEAD ASSY BU A | | RP04 | 124.00 | |
| VT1XX-EB | USE 54-14707 | | | VT100 FAM | 00.00 | 29-21280-00 | 29HEAD ASSY BD A | | RP04 | 97.00 | |
| VT220-A | USE VT220-A2 | A | | VT220 | 00.00 | 29-21281-00 | 29HEAD ASSY SERVO A | | RP04 | 48.00 | |
| VT220-A2 | USE VT220-D2 | | | VT220 | 00.00 | 29-21382-00 | 29MOTOR ASSY, DRIVE 60HZ | | RP04 | 379.00 | |
| VT220-B | USE VT220-B2 | A | | VT220 | 00.00 | 29-21383-00 | 29MOTOR ASSY DRIVE 50HZ | | RP04 | 441.00 | |
| VT220-B2 | USE VT220-E2 | | | VT220 | 00.00 | 29-21387-00 | 29SEQUENCER AS 60 | | RP04 | 977.00 | |

FACTORY REPAIR

| PART NUMBER | DESCRIPTION | LOWEST ACCEPTABLE | | REPAIR PRICE | PART NUMBER | DESCRIPTION | LOWEST ACCEPTABLE | | REPAIR PRICE |
|-------------|--------------------------------|-------------------|-----|--------------|-------------|-----------------------------|-------------------|------|--------------|
| | | ETCH | REV | | | | USED ON | ETCH | |
| 29-21388-00 | 29SEQUENCER ASSY 50HZ | | | 1071.00 | 29-22483-00 | 27PCBA TRANSDUCER | | B | 84.00 |
| 29-21390-00 | 29SHAFT ASSY SPINDLE LOCK | | | 1304.00 | 29-22487-00 | 27PCBA LOGIC 1 | E | B | 74.00 |
| 29-21405-00 | 29CARRIAGE SUBASY | | | 1021.00 | 29-22488-00 | 27PCBA LOGIC 2 | E | B | 84.00 |
| 29-21413-00 | 29POWER SUPPLY | | | 1020.00 | 29-22489-00 | 27PCBA SERVO | E | B | 73.00 |
| 29-21417-00 | 29BRACKET ASSY, EMA | | | 405.00 | 29-22490-00 | 27PCBA, CARRIAGE PWR AMP | E | B | 82.00 |
| 29-21490-00 | 14POWER SUPPLY, HMR BNK | | | 863.00 | 29-22491-00 | 27PCBA PRINTWHEEL POWER A | E | B | 75.00 |
| 29-22067-00 | 19PCBA INPUT | | | 112.00 | 29-22785-00 | 19KIT, MOTOR DRIVE 60HZ | | | 539.00 |
| 29-22068-00 | 19PCBA OUTPUT | | | 164.00 | 29-22786-00 | 19KIT, MOTOR DRIVE 50HZ | | | 412.00 |
| 29-22069-00 | 19PCBA PRECOMPENSATION | | | 423.00 | 29-22839-00 | 14PCBA REGULATOR | | | 104.00 |
| 29-22070-00 | 19PCBA INDEX | | | 172.00 | 29-22844-00 | 14PCBA SERVO | | | 113.00 |
| 29-22071-00 | 19PCBA VARIABLE FREQUENCY | | | 205.00 | 29-22865-00 | 14PCBA CONTROL LOGIC | | | 127.00 |
| 29-22072-00 | 19PCBA SEQUENCE | | | 150.00 | 29-22875-00 | 42PCBA HRVV RECEIVER | | | 55.00 |
| 29-22073-00 | 19PCBA SERVO CONTROL | | | 107.00 | 29-22877-00 | 42PCBA ASHV POWER SUPPLY | | | 85.00 |
| 29-22074-00 | 19PCBA VELOCITY SERVO | | | 232.00 | 29-22878-00 | 42PCBA ASJV PWR SUPPLY | | | 67.00 |
| 29-22075-00 | 19PCBA POSITION SERVO | | | 295.00 | 29-22879-00 | 42PCBA SSKV POWER SUPPLY | | | 176.00 |
| 29-22076-00 | 19PCBA WRITE LOGIC | | | 240.00 | 29-22880-00 | 42PCBA HTVV TRANSMITTER | | | 85.00 |
| 29-22077-00 | 19PCBA LINEAR AMP 1 | | | 219.00 | 29-22881-00 | 42PCBA HFRV FINE SERVO | | | 110.00 |
| 29-22078-00 | 19PCBA DETECTOR/SELECT 1 | | | 200.00 | 29-22882-00 | 42PCBA EKPV FAULT REGISTER | | | 70.00 |
| 29-22079-00 | 19PCBA DATA SAFETY/HEAD SELECT | | | 127.00 | 29-22883-00 | 42PCBA FLPV SERVO CONTROL | | | 55.00 |
| 29-22084-00 | 19PCBA OPERATOR CONTROL | | | 238.00 | 29-22884-00 | 42PCBA | | | 80.00 |
| 29-22088-00 | 19AMP ASSY, SERVO POWER | | | 635.00 | 29-22885-00 | 42PCBA HLRV DATA LATCH | | | 65.00 |
| 29-22099-00 | 19PCBA RD/WR MATRIX 1 | | | 124.00 | 29-22886-00 | 42PCBA CLSV FINE SERVO | | | 90.00 |
| 29-22100-00 | 19PCBA SERVO PREAMP | | | 152.00 | 29-22887-00 | 42PCBA ELTV A-CONT/SECTOR | | | 50.00 |
| 29-22104-00 | 19HEAD ASSY, AD 200MB | | | 84.00 | 29-22888-00 | 42PCBA ELUV A-CONT 2 | | | 70.00 |
| 29-22105-00 | 19HEAD ASSY, AU 200MB | | | 84.00 | 29-22890-00 | 42PCBA FLWV DIFF GENERATORS | | | 50.00 |
| 29-22106-00 | 19HEAD ASSY, BD 200MB | | | 84.00 | 29-22891-00 | 42PCBA ELXV NRZ TO MFM | | | 65.00 |
| 29-22107-00 | 19HEAD ASSY, BU 200MB | | | 84.00 | 29-22892-00 | 42PCBA BLZV READ PLO | | | 105.00 |
| 29-22108-00 | 19HEAD ASSY, A SERVO 200MB | | | 84.00 | 29-22894-00 | 42PCBA FZQN SERVO PREAMP | | | 85.00 |
| 29-22109-00 | 19WAY ASSY, CARRIAGE | | | 310.00 | 29-22895-00 | 42HEAD AND ARM ASSY | | | 84.00 |
| 29-22110-00 | 19T-BLOCK ASSY, CARRIAGE | | | 285.00 | 29-22898-00 | 42PCBA NZJN HD SEL/RD AMP | | | 70.00 |
| 29-22116-00 | 19MOTOR, LINER | | | 0.00 | 29-22899-00 | 42PCBA EZKN WRITE DRIVER | | | 55.00 |
| 29-22121-00 | 19SPINDLE ASSY | | | 625.00 | 29-22900-00 | 42SPINDLE ASSY | | | 359.00 |
| 29-22137-00 | 19PCBA +5V REGULATOR | | | 258.00 | 29-22910-00 | 42CARRIAGE AND COIL ASSY | | | 146.00 |
| 29-22138-00 | 19PCBA -5.2V REGULATOR | | | 260.00 | 29-22913-00 | 42PCBA SVTN SERVO POWER AMP | | | 50.00 |
| 29-22139-00 | 19PCBA +15V REGULATOR | | | 181.00 | 29-23021-00 | 14PCBA PVFU | W | | 103.00 |
| 29-22140-00 | 19PCBA -15V REGULATOR | | | 219.00 | 29-23047-00 | USE 2924701 | | | 00.00 |
| 29-22161-00 | 19PCBA DYNAMIC BRAKE | | | 159.00 | 29-23091-00 | 26PCBA DATA K2 | | | 411.00 |
| 29-22176-00 | 19PCBA VELOCITY SERVO | | | 168.00 | 29-23092-00 | 26PCBA PE/NRZI WRITE 2 | | | 205.00 |
| 29-22215-00 | 19PCBA LAMP MATRIX | | | 114.00 | 29-23107-00 | 42HEAD AND ARM ASSY UPPER | | | 100.00 |
| 29-22225-00 | 19HEAD ASSY, AD 100MB | | | 76.00 | 29-23108-00 | 42HEAD AND ARM ASSY, SERVO | | | 105.00 |
| 29-22226-00 | 19HEAD ASSY AU 100MB | | | 76.00 | 29-23113-00 | 42PCBA LLRV DATA LATCH | | | 239.00 |
| 29-22227-00 | 19HEAD ASSY, BD 100MB | | | 76.00 | 29-23117-00 | 42PCBA ASGV SPEED DETECT | | | 70.00 |
| 29-22228-00 | 19HEAD ASSY, BU 100MB | | | 76.00 | 29-23119-00 | 42PCBA SZJV HD SEL/RD AMP | | | 85.00 |
| 29-22233-00 | 19PCBA R/W MATRIX | | | 104.00 | 29-23213-00 | 26PCBA INTERCONNECT F1 | | | 114.00 |
| 29-22234-00 | 19PCBA POSITION SERVO | | | 213.00 | 29-23226-00 | 26PCBA WRITE | | | 250.00 |
| 29-22287-00 | 26PCBA DATA K1 | | | 262.00 | 29-23227-00 | 26PCBA DATA L | | | 270.00 |
| 29-22296-00 | 26PCBA TAPE CONTROL | E | | 451.00 | 29-23229-00 | USE 292377400 | | | 00.00 |
| 29-22299-00 | 26MOTOR, REEL DC | | | 139.00 | 29-23230-00 | 26PCBA CAPSTAN SERVO | | | 255.00 |
| 29-22303-00 | 26PCBA, POWER SUPPLY G1 | | | 276.00 | 29-23231-00 | 26PCBA REEL SERVO | | | 424.00 |
| 29-22323-00 | 14POWER SUPPLY, REGULATED | | | 694.00 | 29-23232-00 | 26PCBA 9 TRK PREAMP | | | 239.00 |
| 29-22353-00 | 14PWR SUP PAPER FEED | | | 1410.00 | 29-23234-00 | 26MOTOR ASSY, CAPSTAN | | | 1007.00 |
| 29-22415-00 | 14PCBA REGULATOR | | | 97.00 | 29-23236-00 | 26MOTOR ASSY, REEL | | | 388.00 |
| 29-22416-00 | 14PCBA SERVO | | | 182.00 | 29-23249-00 | 26PRESSURE VALVE ASSY | | | 86.00 |
| 29-22417-00 | 14PCBA LOGIC | | | 262.00 | 29-23257-00 | 26COMPRESSOR | | | 133.00 |
| 29-22466-00 | 27CARRIAGE ASSY | B | | 434.00 | 29-23328-00 | 29PCBA POWER REGULATOR B | E | | 120.00 |



Prices Effective 02-January-89 to 30-June-89
When you need a part repaired, call 800-225-5385.

SPARES PRICE LIST D-16

29-23335-00 — 29-24603-00

FACTORY REPAIR

| PART NUMBER | DESCRIPTION | LOWEST ACCEPTABLE | | | REPAIR PRICE | PART NUMBER | DESCRIPTION | LOWEST ACCEPTABLE | | | REPAIR PRICE |
|-------------|------------------------------|-------------------|-----|-----------|--------------|-------------|-----------------------------|-------------------|-----|-----------|--------------|
| | | ETCH | REV | USED ON | | | | ETCH | REV | USED ON | |
| 29-23335-00 | 29MOTOR/BRAKE ASSY 60HZ A | | | RP07 | 221.00 | 29-23657-00 | 42HEAD/ARM ASSY | | | RM05 | 84.00 |
| 29-23340-00 | 29PCBA EMA DRV B9 | | | RP07 | 185.00 | 29-23658-00 | 42HEAD/ARM ASSY | | | RM05 | 84.00 |
| 29-23341-00 | 29PCBA B | | | RP07 | 215.00 | 29-23686-00 | 37PCBA, DA | | | RP20 | 467.00 |
| 29-23342-00 | 29PCBA ANALOG C B | | | RP07 | 364.00 | 29-23687-00 | 37PCBA, DC | | | RP20 | 473.00 |
| 29-23343-00 | 29PCBA B | | | RP07 | 310.00 | 29-23688-00 | 37PCBA, DD | | | RP20 | 978.00 |
| 29-23344-00 | 29PCBA ANALOG A B | | | RP07 | 195.00 | 29-23689-00 | 37PCBA-DE | | | RP20 | 256.00 |
| 29-23345-00 | 29PCBA CMND/INDX/SCTR B | | | RP07 | 154.00 | 29-23692-00 | 37PCBA | | | RP20 | 323.00 |
| 29-23346-00 | 29PCBA, DEV CONT 2 B9 | | | RP07 | 370.00 | 29-23693-00 | 37PCBA | | | RP20 | 314.00 |
| 29-23347-00 | 29PCBA, DEV CONT 1 B9 | | | RP07 | 295.00 | 29-23694-00 | 37PCBA-DK | | | RP20 | 431.00 |
| 29-23348-00 | 29PCBA MASSBUS I/F B | | | RP07 | 115.00 | 29-23700-00 | 37PWR SUPPLY DC | | | RP20 | 327.00 |
| 29-23349-00 | 29PCBA, DATA ENCDR DECDR B | | | RP07 | 219.00 | 29-23701-00 | 37PCBA-DB | | | RP20 | 543.00 |
| 29-23350-00 | 29PCBA, I/F CONT B | | | RP07 | 155.00 | 29-23702-00 | 37POWER SUPPLY | | | RP20 | 143.00 |
| 29-23351-00 | 29PCBA SERDES/ECC | | | RP07 | 175.00 | 29-23703-00 | 37HEAD DISK ASSY | | | RP20 | 5715.00 |
| 29-23352-00 | 29PCBA,R/W SAFETY B | | | RP07 | 105.00 | 29-23759-00 | 54LOGIC BOARD (PCB) | | | VRV02 | 202.00 |
| 29-23353-00 | 29PCBA,R/W ANALOG B | | | RP07 | 185.00 | 29-23760-00 | 54POWER SUPPLY ASSY | | | VRV02 | 276.00 |
| 29-23394-00 | 14PCBA, RECTIFIER (UNIV) | | | LP FAMILY | 238.00 | 29-23761-00 | 5419" LP PHOSPHOR TUBE ASSY | | | VRV02 | 608.00 |
| 29-23395-00 | 14PCBA, HAMMER DRIVE | | | LP FAMILY | 239.00 | 29-23762-00 | 26READ PCBA (TU77/78) | | | TU/TA78 | 399.00 |
| 29-23400-00 | 14PCBA, PROCESS LESS PROMS | | | LP FAMILY | 260.00 | 29-23763-00 | 26PCBA, WRITE | | | TU/TA78 | 333.00 |
| 29-23401-00 | 14PCBA, TIMING/STATUS | | | LP FAMILY | 116.00 | 29-23764-00 | 26PCBA,CONTROL M2 | | | TU/TA78 | 250.00 |
| 29-23402-00 | 14BOARD POWER | | | LP FAMILY | 209.00 | 29-23765-00 | 26PCBA, CAPSTAN SERVO | | | TU/TA78 | 276.00 |
| 29-23419-00 | 14PCBA INTERFACE (STD) | | | LP FAMILY | 120.00 | 29-23766-00 | 26PCBA, PREAMP | | | TU/TA78 | 140.00 |
| 29-23433-00 | 14PCBA INTERF LL W/VFU | | | LP FAMILY | 124.00 | 29-23768-00 | 26MOTOR ASSY, CAPSTAN | | | TU/TA78 | 627.00 |
| 29-23438-00 | 14PCBA, INTERFACE VFU | | | LP FAMILY | 162.00 | 29-23769-00 | 26PCBA,MIA | | | TU/TA78 | 434.00 |
| 29-23476-00 | 44MICRO PROC. | | | VS70 | 1909.00 | 29-23770-00 | 26PCBA,INTERCONNECT F1 | | | TU/TA78 | 75.00 |
| 29-23477-00 | 44PCBA INTERFACE | | | VS70 | 1909.00 | 29-23774-00 | 26PCBA, CNTL M2 | | | TU77 | 190.00 |
| 29-23478-00 | 44PCBA IPCU INTERFACE | | | VS70 | 1085.00 | 29-23888-00 | 42POW SUP ASSY 60-HZ | | | RM05 | 690.00 |
| 29-23479-00 | 44PCBA VECTOR GENERATOR | | | VS70 | 1909.00 | 29-23916-00 | 43SHUTTLE ASSY | | | | 1069.00 |
| 29-23480-00 | 4416 K RAM | | | VS70 | 3012.00 | 29-23920-00 | 43PCBA, PWR SUP. 600LPM | | | | 275.00 |
| 29-23501-00 | 44MONITOR DISP 15 MIL | | | VS70 | 4913.00 | 29-23921-00 | 43PNR SUP. ASSY | | | | 722.00 |
| 29-23503-00 | 44PCBA, DEFL AMPL A24 | | | VS70 | 397.00 | 29-24028-00 | 39MECHANISM ASSY | | | LQP02 | 380.00 |
| 29-23505-00 | 44PCBA, PHOSPHOR PROTECT | | | VS70 | 463.00 | 29-24029-00 | 39PCBA, INTERFACE | | | LQP02 | 157.00 |
| 29-23506-00 | 44PWR SUPL ASSY HI VOLT | | | VS70 | 504.00 | 29-24030-00 | 39DIGITAL BOARD | | | LQP02 | 133.00 |
| 29-23507-00 | 44HEATSINK SUB-ASSY +45V | | | VS70 | 401.00 | 29-24031-00 | 39PCBA, ANALOG | | | LQP02 | 133.00 |
| 29-23508-00 | 44HEATSINK SUB-ASSY -45V | | | VS70 | 143.00 | 29-24032-00 | 39PCBA, PWR SUPPLY | | | LQP02 | 143.00 |
| 29-23516-00 | 44LOGIC BOARD | | | VS70 | 575.00 | 29-24034-00 | 39PCBA, MOTHER | | | LQP02 | 109.00 |
| 29-23517-00 | 44POWER SUPPLY | | | VS70 | 258.00 | 29-24035-00 | 39CONTROL PANEL | | | LQP02 | 124.00 |
| 29-23522-00 | 44PWR SUPL LO VOLT A5,9 | | | VS70 | 430.00 | 29-24050-00 | 61DISK DRIVE, RX180 | | | VT FAMILY | 181.00 |
| 29-23540-00 | 42PCBA, AZCN PWR AMP | | | RM05 | 120.00 | 29-24086-00 | 47MODULE | | | TS FAMILY | 475.00 |
| 29-23541-00 | 42PCBA, 5YEN CAP BRD | | | RM05 | 160.00 | 29-24112-00 | 49R/W BOARD | | | PC FAMILY | 86.00 |
| 29-23543-00 | 42PCBA, AYFN RELAY | | | RM05 | 100.00 | 29-24195-00 | N6 KIT, SERVICE HHT I 99 | | | TU/TA78 | 446.00 |
| 29-23553-00 | 42PCBA, DMSV AN SERV | | | RM05 | 90.00 | 29-24213-00 | 51KIT,MOTOR INSTALLATION | | | TU80/81 | 285.00 |
| 29-23554-00 | 42PCBA, READ AMP | | | RM05 | 80.00 | 29-24215-00 | 51KIT,MAG HEAD INSTALLATION | | | TU80/81 | 428.00 |
| 29-23555-00 | 42PCBA, WRITE DRIVER | | | RM05 | 85.00 | 29-24220-00 | 51POWER SUPPLY 60 HZ | | | TU80/81 | 379.00 |
| 29-23556-00 | 42PCBA, R/W CONT | | | RM05 | 50.00 | 29-24221-00 | 51FORMATTER CONTROL, PWA | | | TU80/81 | 152.00 |
| 29-23557-00 | 42PCBA,DIFF/HEAD REG | | | RM05 | 90.00 | 29-24222-00 | 51R/W SERVO PWA | | | TU80/81 | 350.00 |
| 29-23558-00 | 42PCBA, ACCESS CONT | | | RM05 | 50.00 | 29-24223-00 | 51 POWER AMP MODULE | | | TU80/81 | 124.00 |
| 29-23559-00 | 42SPINDLE ASSY | | | RM05 | 323.00 | 29-24238-00 | 52CPU LA50, ROMS C | | | LA50 | 84.00 |
| 29-23566-00 | 42PCBA, REG 5V | | | RM05 | 50.00 | 29-24272-00 | 52HEAD (2) UNIT C | | | LA50 | 50.00 |
| 29-23567-00 | 42PCBA, 4XFN MB | | | RM05 | 50.00 | 29-24325-00 | 14CCA PROCESSOR PROM | | | | 0.00 |
| 29-23568-00 | 42PCBA, BXGN SHS | | | RM05 | 95.00 | 29-24329-00 | 14CCA,HMMR DRVR | | | LP FAMILY | 475.00 |
| 29-23574-00 | 42DRV MOTOR/PULLEY ASSY 60HZ | | | RM05 | 684.00 | 29-24330-00 | 14CCA,INTERFACE | | | LP FAMILY | 238.00 |
| 29-23579-00 | 42POWER SUPPLY,60HZ | | | RM05 | 1188.00 | 29-24331-00 | 14CCA, PAP FEED | | | LP FAMILY | 285.00 |
| 29-23596-00 | 29HEAD DISK ASSY A | | | RP07 | 6650.00 | 29-24551-00 | 53IOTC PWBA (LN01) | | | LN03 | 424.00 |
| 29-23605-00 | 29PCBA, 3 PHASE DET B9 | | | RP07 | 110.00 | 29-24602-00 | 54 PWB ASSY CD4-AN2 | | | VR241 | 75.00 |
| 29-23656-00 | 42HEAD/ARM ASSY | | | RM05 | 84.00 | 29-24603-00 | 54 PWB ASSY CD4-P2 | | | VR241 | 75.00 |



Prices Effective 02-January-89 to 30-June-89
When you need a part repaired, call 800-225-5385.

FACTORY REPAIR

| PART NUMBER | DESCRIPTION | LOWEST ACCEPTABLE | | | REPAIR PRICE | PART NUMBER | DESCRIPTION | LOWEST ACCEPTABLE | | | REPAIR PRICE |
|-------------|-----------------------------------|-------------------|-----|-----------|--------------|-------------|--|-------------------|-----|------------|--------------|
| | | ETCH | REV | USED ON | | | | ETCH | REV | USED ON | |
| 29-24608-00 | USE 29-26101 | | | VR241 | 00.00 | 29-26098-00 | 91ENGINE DR BOARD (LN03C.R.) | | | LN03 | 241.00 |
| 29-24614-00 | 54 DEFLECT. SUB ASSY | | | VR241 | 75.00 | 29-26101-00 | 54SB CRT YOKE ASSY | | | VR241 | 447.00 |
| 29-24701-00 | 43PCBA, LOGIC B9 | | | TU80/81 | 238.00 | 29-26103-00 | B1DEVICE PCB (RD54) | | | RD FAMILY | 285.00 |
| 29-24704-00 | 51AMP. PWA READ | | | TU80/81 | 259.00 | 29-26164-00 | BAMECH PRINTER GROUP 0 | | | LQP45 | 404.00 |
| 29-24705-00 | 51SERVO MODULE (TU81/TA81) | | | TU80/81 | 184.00 | 29-26171-00 | BAMAIN BOARD-AT131 | | | LQP45 | 230.00 |
| 29-24706-00 | 51PWA WRITE DRIVE | | | TU80/81 | 135.00 | 29-26254-00 | 26WRITING PCBA | | | TU90 | 960.00 |
| 29-24707-00 | 51PWA MSCP | | | TU80/81 | 259.00 | 29-26255-00 | 26PREAMP PCB | | | TU79 | 304.00 |
| 29-24708-00 | 51PWA FORMATTER WR (TU81/TA81) | | | TU80/81 | 333.00 | 29-26381-00 | 76MODEM MODULE TD24 | | | MODEMS | 162.00 |
| 29-24709-00 | 51PWA FORMATTER READ | | | TU80/81 | 380.00 | 29-26617-00 | A6LG02 CONTROLLER (LG02) | | | LG01/02 | 666.00 |
| 29-24712-00 | 58MODULE, POWER SUPPLY | | | DFMSA-AA | 152.00 | 29-80040-00 | 42CARD RCVR | | | 29 CLASS | 162.00 |
| 29-24713-00 | 58MODULE CONTROLLER | | | DFMSA-AA | 309.00 | 29-80335-00 | 60I/F BOARD, Q BUS | | | | 618.00 |
| 29-24752-00 | 51MAGNETIC HEAD | | | TU80/81 | 285.00 | 29-80480-00 | 67 I MB MEMORY | | | 29 CLASS | 808.00 |
| 29-24753-00 | 51POWER SUPPLY | | | TU80/81 | 259.00 | 29-80488-00 | 67IDM 500/1/2 5 VOLT POW SUP | | | 29 CLASS | 713.00 |
| 29-24755-00 | 51OPERATOR PANEL | | | TU80/81 | 238.00 | 29-80519-00 | 48DISK I/F RMOX | | | 29 CLASS | 798.00 |
| 29-24756-00 | 63CONTROLLER ASSEMBLY 3 | | | 11/730 | 412.00 | 29-81226-00 | 495 1/4" 10MB WINCHESTER DRIVE M | | | | 428.00 |
| 29-24757-00 | 63PUCK | | | 11/730 | 321.00 | 29-81293-00 | 75 4190 CACHE 512K (OOSDCOXXX) | | | 29 CLASS | 1615.00 |
| 29-24782-00 | 64POWER SUPPLY 5107 | | | 11/730 | 99.00 | 29-81915-00 | E2ICP 1622 W/512KD | | | | 1045.00 |
| 29-24783-00 | 64VIDEO MODULE 5107 | | | 11/730 | 104.00 | 29-90007-00 | AASERIAL BOARD | | | LQP45 | 163.00 |
| 29-24784-00 | 64DEFLECTION MODULE 5107 | | | 11/730 | 104.00 | 30-05523-03 | PDP-10 16K X 37 FABRITEK | | | PDP FAMILY | 7308.00 |
| 29-24797-00 | 66PROCESSOR MODULE | | | DMZ32 | 404.00 | 30-09356-00 | PUNCH, PAPER TAPE | | | 29 CLASS | 694.00 |
| 29-24798-00 | 66EXPANSION MODULE | | | DMZ32 | 285.00 | 30-10133-00 | USE A877 | | | 30 CLASS | 00.00 |
| 29-24799-00 | 66POWER SUPPLY ASSY | | | DMZ32 | 214.00 | 30-10326-00 | DISPLAY TV MODULE VT05 | | | VT FAMILY | 120.00 |
| 29-24806-00 | 02LOGIC MODULE 0 | | | LVP16 | 339.00 | 30-10759-00 | MAGNETIC FIELD PROBE HALL EFFE | | | 30 CLASS | 220.00 |
| 29-24891-00 | 39POWER SUPPLY | | | LQP03 | 166.00 | 30-11070-00 | DISPLAY,ALPHANUMERICAL W/MEMRY | | | RT FAMILY | 609.00 |
| 29-24893-00 | 39LOGIC MODULE | | | LQPO3 | 166.00 | 30-11843-00 | READER,BADGE (CARD) 22COLM. | | | RT FAMILY | 300.00 |
| 29-24926-00 | 49R/W BOARD | | | PC3XX FAM | 67.00 | 30-12537-01 | DISPLAY MODULE WITH P4 PHOSPHOR | | | VT71-71T | 252.00 |
| 29-24931-00 | 39PRINT WHEEL MOTOR ASSY 8 | | | LQP02 | 190.00 | 30-12538-00 | KEYBOARD,LK05, 112 KEYS,12 LEDS | | | VT71-71T | 160.00 |
| 29-24932-00 | 39CARRIAGE MOTOR | | | LQP02 | 86.00 | 30-12538-01 | KEYBOARD FOR VT71 | | | VT71-71T | 154.00 |
| 29-24945-00 | 05IXO HAND HELD TERMINAL TC200 W/ | | | RA81 | 380.00 | 30-13129-00 | CARD/BADGE READER | | | RT FAMILY | 641.00 |
| 29-24988-00 | USE 29-25334 | | | LN03 | 00.00 | 30-13129-02 | CARD/BADGE READER,115 VAC,60 HZ-RT805 | | | RT FAMILY | 456.00 |
| 29-24992-00 | 71MAIN PCB | | | | 247.00 | 30-13129-03 | CARD/BADGE READER,230 VAC,50 HZ,RT805 | | | RT FAMILY | 641.00 |
| 29-25042-00 | 76MODEM | | | MODEMS | 166.00 | 30-13880-00 | READER,BADGE(CARD) 10COL M. | | | RT FAMILY | 181.00 |
| 29-25043-00 | 76PWR SUPPLY/CABLE | | | MODEMS | 57.00 | 30-14869-00 | POWER SUPPLY, 47-63HZ, OUT-5V,+15V,-15V | | | 11 FAMILY | 290.00 |
| 29-25070-00 | 91OPTICAL HOUSING | | | LN03 | 684.00 | 30-15949-00 | MODEM,LOW SPEED ASYNC | | | 11/780 | 181.00 |
| 29-25071-00 | 91DEVELOPMENT UNIT | | | LN03 | 183.00 | 30-16080-04 | USE 701736300 | | | VT100 FAM | 00.00 |
| 29-25072-00 | 91FUSING UNIT, 100V | | | LN03 | 171.00 | 30-18689-00 | CONVERTER,A-D 12BIT,16CHANNEL/12BIT,2CHA | | | 11/03 | 342.00 |
| 29-25088-00 | USE 29-25380 | | | LN03 | 00.00 | 30-18690-00 | MODULE,REAL TIME CLOCK DUAL HGT. | | | 11/03 | 230.00 |
| 29-25089-00 | 91POWER SUPPLY 100V | | | LN03 | 166.00 | 30-18691-00 | CONVERTER,D-A,12BIT, 4CHANNEL | | | 11/03 | 295.00 |
| 29-25334-00 | 91CONTROLLER | | | LN03 | 703.00 | 30-18693-00 | CONVERTER,A-D,12BIT,16CHANNEL DUAL HGT. | | | 11/03 | 295.00 |
| 29-25339-00 | A2DEVICE PCB 1 | | | RD FAMILY | 238.00 | 30-19203-00 | READER,BARCDE MODULE | | | RT FAMILY | 456.00 |
| 29-25345-00 | 51STI MODULE 77042148 | | | TU80/81 | 1309.00 | 30-19475-01 | TRACTOR,BIDIRECTIONAL,FORMS LQPX2-AA | | | LQP02 | 0.00 |
| 29-25380-00 | 91ENG. DRIVE BOARD | | | LN03 | 134.00 | 30-19858-02 | PRINTER,R.O. LA50-RB 220V | | | LA50 | 314.00 |
| 29-25536-00 | 64VIDEO SUB ASSY 3119 | | | VR290 | 247.00 | 30-20038-01 | MOUSE,HAND HELD 3 BUTTON 100PULSES PER I | | | 11/730 | 275.00 |
| 29-25538-00 | 64DEFLECTION BD 3119 | | | VR290 | 152.00 | 30-20198-01 | USE 702018401 | | | HSC50/70 | 00.00 |
| 29-25539-00 | 64APP BOARD 3119 | | | VR290 | 205.00 | 30-20198-02 | P.S.SWITCHING REGULATOR 240V 50/60HZ | | | HSC50/70 | 618.00 |
| 29-25540-00 | 64MAINS BOARD 3119 | | | VR290 | 152.00 | 30-20199-01 | USE 702003301 | | | HSC50/70 | 00.00 |
| 29-25556-00 | A6HAMMER DRIVER PCB | | | LG01/02 | 419.00 | 30-20199-02 | USE 702003302 | | | HSC50/70 | 00.00 |
| 29-25569-00 | A6PARALLEL I/O PCB | | | LG01/02 | 239.00 | 30-20418-03 | REA,BARCODE,EIA,120V,39/11 | | | | 0.00 |
| 29-25573-00 | A6POWER AMP PCB | | | LG01/02 | 475.00 | 30-20418-04 | READER,BARCORDER,NO WAND/PWR PACK | | | RT FAMILY | 209.00 |
| 29-25797-00 | 51BUFFERED TMSCP MOD(TU81E) | | | TU80/81 | 855.00 | 30-20444-01 | USE 302174901 | | | | 00.00 |
| 29-25916-00 | 52PRINTHEAD C | | | WARRANTY | 0.00 | 30-20746-01 | EXPANDER,OPTION,4 LINE F/DFM04/08 MULTIP | | | 30 CLASS | 271.00 |
| 29-25918-00 | 52MECH ASSY C | | | LA75 | 119.00 | 30-20746-02 | EXPANDER,OPTION,8 LINE F/DFM04/08 MULTIP | | | 30 CLASS | 271.00 |
| 29-25968-00 | 52LOGIC BOARD C | | | LA75 | 109.00 | 30-21386-02 | MODEM,MODULE,FULL DUPLEX 4800BPS | | | MODEMS | 366.00 |
| 29-26070-00 | 91OPT HOUS UN ASSY (LN03C.R.) | | | LN03 | 299.00 | 30-21386-03 | MODEM,SYNCHRONOUS 4800BPS SIGNAL RATE DF | | | MODEMS | 366.00 |
| 29-26096-00 | 91P.S. U. ASSY (LN03C.R.) | | | LN03 | 81.00 | 30-21387-01 | MODEM,INTEGRAL 9.6BPS | | | MODEMS | 686.00 |



Prices Effective 02-January-89 to 30-June-89
When you need a part repaired, call 800-225-5385.

FACTORY REPAIR

| PART NUMBER | DESCRIPTION | LOWEST ACCEPTABLE | | | REPAIR PRICE | PART NUMBER | DESCRIPTION | LOWEST ACCEPTABLE | | | REPAIR PRICE |
|-------------|--|-------------------|-----|------------|--------------|-------------|--|-------------------|-----|-----------|--------------|
| | | ETCH | REV | USED ON | | | | ETCH | REV | USED ON | |
| 30-21387-02 | MODEM,MODULE FULL DUPLEX 9600BPS | | | MODEMS | 366.00 | 54-11599-00 | USE 541159901 | C | | 11/04 | 00.00 |
| 30-21387-03 | MODEM,SYNCHRONOUS 9600BPS SIGNAL RATE DF | | | MODEMS | 366.00 | 54-11599-01 | TZ0V REG H777 NO FAT TEST | | | 11/34-34A | 95.00 |
| 30-21749-01 | P.S. 5V 230W | | | VAXSTATION | 181.00 | 54-11601-01 | MOS REGULATOR 15V | E | | 11 FAMILY | 48.00 |
| 30-22249-01 | READER,BAR CODE NO KEYPADS | | | RT FAMILY | 428.00 | 54-11625-00 | MODULE H779 | | | | 204.00 |
| 30-22249-02 | READER,BAR CODE W/KEYPAD | | | RT FAMILY | 475.00 | 54-11725-00 | VT 61 SWITCH PANEL | B | | VT61-61T | 76.00 |
| 30-22270-00 | NEWLY ADDED CRC PART | | | PC3XX IVIS | 105.00 | 54-11743-00 | USE 541174304 | B | | VT50 FAM | 00.00 |
| 30-22529-01 | CONVERTER F/BB ETHERNET SINGLE CABLE TRA | | | DECOM | 166.00 | 54-11743-02 | ROM VART | A | | VT50 FAM | 86.00 |
| 30-22563-01 | TRANCEIVER,DUAL CABLE BROADBAND ETHERNET | | | DECOM | 1021.00 | 54-11800-00 | USE 541180001 | D | | 11/04 | 00.00 |
| 30-22801-01 | USE H7845-BA | | | PC FAMILY | 00.00 | 54-11800-01 | KY11-LB CONSOLE BRD SYSTEM TESTED | | | 11 FAMILY | 86.00 |
| 30-22969-01 | SUBSYSTEM, TAPE,CARTRIDGE/CABNT,DRIVE,PS | | | TK25 | 760.00 | 54-11844-00 | READ&WRITE BOARD | E | H | RL01 | 70.00 |
| 30-22969-02 | SUBSYSTEM,TAPE,CARTRIDGE W/ACCESSORY KIT | | | | 723.00 | 54-11848-00 | ETCH BRD 54-11848 | E | | 11 FAMILY | 52.00 |
| 30-22971-01 | CONTROLLER,TAPE CARTRIDGE SUBSYSTEM TO Q | | | TK25 | 309.00 | 54-11850-00 | D.C. SERVO AND POWER BOARD | C | | RL01 | 90.00 |
| 30-23506-01 | P.S. 5.1V 9.7A SWITCHING | | | RA90 | 275.00 | 54-12046-00 | VT52 PIN PRINTER INTERFACE MODULE | B | | VT50 FAM | 78.00 |
| 30-23616-01 | P.S. 460W 2DC REGULATOR BDS,FAN SPEED C | | | | 434.00 | 54-12233-00 | BACKPLANE BOARD | | | 11 FAMILY | 190.00 |
| 30-23959-01 | CONDITIONER,PWR LINE 120V 60HZ 1000VA CO | | | VAX FAMILY | 550.00 | 54-12264-00 | USE H60700 | | | 11 FAMILY | 00.00 |
| 30-25269-01 | MODULE,ANALOG INPUT 16 CHANNEL 50KHZ | | | MICROVAX2 | 394.00 | 54-12441-00 | USE H7441 | | | TU/TA78 | 00.00 |
| 30-25270-01 | MODULE,DUAL CHANNEL D-A | | | MICROVAX2 | 356.00 | 54-12530-00 | MASTER BOARD | | | 11 FAMILY | 285.00 |
| 30-25646-01 | USE RCD31-E | | 1A | PC500 | 00.00 | 54-12550-00 | MOTHER BOARD | A | | 11/780 | 124.00 |
| 30-27655-01 | PRINTHEAD,DOT MATRIX 7 WIRE | | | LA120 | 95.00 | 54-12554-00 | BIAS CONTROL | C | | 11/780 | 85.00 |
| 34-23566-01 | CONTAINERS,MODULE,CONDUCTIVE,DOUBLE WALL | | | | 33.00 | 54-12556-00 | +12V REGULATOR | B | | 11/780 | 75.00 |
| 34-24071-01 | CASE,MODULE DUAL WALL CONDUCTIVE PLA | | | VAX8600 | 24.00 | 54-12560-00 | -5V REGULATOR | B | | 11/780 | 75.00 |
| 54-08475-00 | POWER REG H720 PD11 54-9267 | B | | 11 FAMILY | 150.00 | 54-12610-00 | USE 541261001 | | | LS120 | 00.00 |
| 54-08924-00 | POWER CONTROL TW10 | E | | TU10 | 128.00 | 54-12675-00 | BATTERY CHARGER | A | | 11/780 | 75.00 |
| 54-08928-00 | REGULATOR, VOLTAGE | D | | TU10 | 76.00 | 54-12781-00 | SLAVE MODULE | H | | 11/70 | 132.00 |
| 54-09057-00 | FRONT PNL 8E | C | | PDP8E,M,F | 143.00 | 54-12781-01 | UNIBUS SERIAL CONSOLE | C | | 11/70 | 92.00 |
| 54-09057-01 | CONTROL PANEL FRONT 8/E | E | | PDP8E,M,F | 176.00 | 54-12985-00 | LIGHTS SW | | | 11/03 | 86.00 |
| 54-09267-00 | BOARD, REG H720F | B | | 11 FAMILY | 160.00 | 54-12989-00 | ETCHED BACKPLANE MOTHER BOARD | | | 11 FAMILY | 333.00 |
| 54-09484-00 | 8 TO 20V REGULATOR | D | | RK05 | 100.00 | 54-13009-01 | USE 541300904 | C | D | VT100 FAM | 00.00 |
| 54-09503-00 | (5 VOLT REGULATOR | F | 1 | RK05 | 100.00 | 54-13009-04 | VT100 BASIC VIDEO | | | VT100 FAM | 176.00 |
| 54-09668-00 | FRONT PNL 8M | D | | PDP8E,M,F | 190.00 | 54-13016-00 | 869 PILOT CONTROL BOARD | | | 11 FAMILY | 133.00 |
| 54-09684-00 | ASSY 11/45 CONSOLE | B | | 11/45 | 234.00 | 54-13044-00 | USE H7110 | D | | LA120 | 00.00 |
| 54-09701-00 | KY11-D CONSOLE | D | | 11 FAMILY | 285.00 | 54-13089-00 | A.C. CONTROL BOARD | | | 11 FAMILY | 21.00 |
| 54-09730-00 | POWER CONTROL BD 11/45 | C | | 11/45 | 84.00 | 54-13097-00 | VT100 ADVANCED VIDEO | B | | VT100 FAM | 76.00 |
| 54-09766-00 | DISPLAY BUFFER & DRIVER | B | | 11/05 | 65.00 | 54-13097-01 | ADVANCE VIDEO LA120 | B | B | VT100 FAM | 95.00 |
| 54-10131-00 | CASSETTE POWER SUPPLY | B | | PDP8E,M,F | 67.00 | 54-13206-00 | 20 MA ADAPTER | | | VT100 FAM | 50.00 |
| 54-10199-00 | REGULATOR BRD | E | | 11 FAMILY | 155.00 | 54-13265-00 | MOS BATTERY BACKUP | | | | 190.00 |
| 54-10451-00 | USE 541224200 | | | TU16 | 00.00 | 54-13275-CC | MEMORY 32K | | | MEMORIES | 176.00 |
| 54-10736-00 | USE LK02 | E | | LA36 | 00.00 | 54-13275-CE | USE 5413275CA | | | 11 FAMILY | 00.00 |
| 54-10817-00 | POWER MONITOR-RP04 | | | | 76.00 | 54-13343-00 | H7833 POWER SUPPLY | B | | 11 FAMILY | 133.00 |
| 54-10864-00 | POWER DIST BRD (BA11K) | D | | 11 FAMILY | 86.00 | 54-13396-00 | PLUS 2.5V CONTROL BOARD | | | 11/750 | 55.00 |
| 54-10902-00 | PROC UART ROM (VT50AA) | B | | VT50 FAM | 164.00 | 54-13404-00 | VT100 FULL KEYBOARD | | | VT100 FAM | 65.00 |
| 54-10902-02 | PROC UART ROM (VT50-H) | B | | VT50 FAM | 84.00 | 54-13414-00 | PLUS & MINUS 5VB BATTERY REG. | | | 11 FAMILY | 109.00 |
| 54-10906-00 | PROC DATA PATH (VT50-AA) | B | | VT50 FAM | 164.00 | 54-13446-00 | USE LA12X-DL | | | LA120 | 00.00 |
| 54-10993-00 | USE 54-13089 | | | 11 FAMILY | 00.00 | 54-13446-01 | USE LA12X-DL | | | LA120 | 00.00 |
| 54-11021-00 | LA180 POWER BRD | E | | LA180 | 105.00 | 54-13489-00 | USE TU58-XB | | | TU58 | 00.00 |
| 54-11060-00 | READ/WRITE RK06 | | | RK06 | 138.00 | 54-13491-00 | USE TU58-XC | | | TU58 | 00.00 |
| 54-11060-YA | READ WRITE MODULE | | | RK07 | 128.00 | 54-13599-00 | LOGIC INVERTER BD | C | | 11/750 | 109.00 |
| 54-11086-YA | POWER LINE 115 V. REG | E | B | 11 FAMILY | 67.00 | 54-13601-00 | LOGIC INVERTER BD | C | | 11/750 | 109.00 |
| 54-11170-00 | VT61 KEYBOARD | C | | VT61-61T | 107.00 | 54-13603-00 | MEMORY INVERTER BD | B | | 11/750 | 143.00 |
| 54-11170-02 | KEYBOARD VT61/VT50H | C | | VT50 FAM | 76.00 | 54-13605-00 | BIAS AND INTERFACE BOARD FOR 11144 POWER | C | | 11/750 | 109.00 |
| 54-11170-06 | KEYBOARD VT61/VT50H | C | | VT50 FAM | 108.00 | 54-13607-00 | MEMORY REGULATOR BD | D | | 11/750 | 109.00 |
| 54-11294-00 | CONSOLE MOD 11/70 | B | | 11/70 | 342.00 | 54-13615-00 | H7140 MOTHER BOARD | E | | 11 FAMILY | 86.00 |
| 54-11398-00 | USE 701071800 | | | RX01 | 00.00 | 54-13656-01 | VT61T MEMORY BOARD | A | | VT61-61T | 143.00 |
| 54-11450-00 | VT55 POWER BRD | K | | VT50 FAM | 176.00 | 54-13673-00 | USE H7150-00 | | | LA120 | 00.00 |
| 54-11522-00 | PILOT CONTROL | | | | 100.00 | 54-13679-00 | USE 00DLV11KB | | | 11 FAMILY | 00.00 |



Prices Effective 02-January-89 to 30-June-89
When you need a part repaired, call 800-225-5385.

FACTORY REPAIR

| PART NUMBER | DESCRIPTION | LOWEST ACCEPTABLE | | USED ON | REPAIR PRICE | PART NUMBER | DESCRIPTION | LOWEST ACCEPTABLE | | USED ON | REPAIR PRICE |
|-------------|-----------------------------------|-------------------|-----|-----------|--------------|-------------|--|-------------------|-----|------------|--------------|
| | | ETCH | REV | | | | | ETCH | REV | | |
| 54-13747-00 | LA34 CONTROL BAORD | | | LA34 | 95.00 | 54-15495-01 | USE 541549502 | A | | VT240 | 00.00 |
| 54-13747-02 | USE 541374704 | | | 11 FAMILY | 00.00 | 54-15495-02 | VS240 MODULE | | | VT240 | 247.00 |
| 54-13747-04 | LOGIC BOARD | | | 11 FAMILY | 261.00 | 54-15539-01 | IEEE/2 DL/24 LINE INTERFACE | | | PC FAMILY | 141.00 |
| 54-13764-00 | PLUS OR MINUS 15V POWER SUP | | | 11/24 | 143.00 | 54-15586-00 | NEWLY ADDED CRC PART | | | ETHERNET | 209.00 |
| 54-13782-01 | EXPANDED MEMORY LA34 | | | LA34 | 114.00 | 54-15586-01 | REPEATER | | | DEREP-AA | 209.00 |
| 54-13867-00 | USE H7211 | | | | 00.00 | 54-15624-01 | VR260 DEFLECTION BOARD | | | VR260 | 81.00 |
| 54-13935-00 | LQP SERIAL INTERFACE (DAUGHTER) | | | LQP01 | 95.00 | 54-15626-01 | VIDEO AMP BOARD | | | VR260 | 128.00 |
| 54-13937-00 | LQP SERIAL INTERFACE (MOTHER) | | | LQP01 | 100.00 | 54-15641-00 | PC300 SERIES CP/M OPTION MODULE | | | PC FAMILY | 79.00 |
| 54-13939-00 | USE 701820401 | | | 11 FAMILY | 00.00 | 54-15643-01 | VT240 MODEM | | | VT240 | 150.00 |
| 54-13951-00 | ADAPTOR BOARD | | | VT100 FAM | 214.00 | 54-15651-00 | USE 702062401 | | | VT220 | 00.00 |
| 54-14014-00 | SERVO CONTROL | | | RA80 | 324.00 | 54-15651-01 | USE 702062401 | | | VT220 | 00.00 |
| 54-14131-00 | USE 7017362-1 | | | VT100 FAM | 00.00 | 54-15653-00 | USE 702081402 | | | VT220 | 00.00 |
| 54-14240-00 | H7476 REGULATOR | | | | 143.00 | 54-15653-01 | USE 702081401 | | | VT220 | 00.00 |
| 54-14245-00 | USE 701737400 | | | | 00.00 | 54-15653-02 | USE 702081402 | | | VT220 | 00.00 |
| 54-14256-01 | USE 541425600 | | | LA100 | 00.00 | 54-15662-00 | USE 702077901 | | | PC FAMILY | 00.00 |
| 54-14256-06 | LOGIC BOARD | J | AA | PC FAMILY | 81.00 | 54-15688-01 | RAINBOW COLOR GRAPHICS OPTION | | | PC FAMILY | 109.00 |
| 54-14260-00 | STP FOUNDATION MODULE | A | | VT100 FAM | 60.00 | 54-15703-00 | PC100 COMMUNICATION OPTION | | | PC FAMILY | 76.00 |
| 54-14275-00 | VT125 PADDLE BOARD | | | VT100 FAM | 75.00 | 54-15961-AA | PC100B MEMORY EXT. AC,AF,AH,AJ | | | | 171.00 |
| 54-14277-00 | VT125 MONO BD. | E | E | VT100 FAM | 224.00 | 54-15987-01 | DECNA | | | DECNA | 158.00 |
| 54-14497-YA | DATA WAY INTERFACE | B | | 11 FAMILY | 276.00 | 54-15989-01 | MICRO SWITCH LOGIC BD. | | | DFMSA-AA | 143.00 |
| 54-14610-00 | LA12 POWER SUPPLY | | | LA12 | 67.00 | 54-15991-00 | IVIS-CT DEVELOPMENT | | | PC3XX IVIS | 95.00 |
| 54-14630-00 | USE 541463002 | | | LA12 | 00.00 | 54-15991-01 | IVIS SYSTEM MODULE | | | PC3XX IVIS | 95.00 |
| 54-14630-01 | USE 541463002 | | | LA12 | 00.00 | 54-15993-00 | IVIS-CT DEVELOPMENT | | | PC3XX IVIS | 98.00 |
| 54-14630-02 | LA12 LOGIC BOARD | D | | LA12 | 86.00 | 54-15993-01 | EXTERNAL IVIS ANALOG | | | PC3XX IVIS | 98.00 |
| 54-14630-03 | USE 541463002 | | | LA12 | 00.00 | 54-15993-02 | IVIS ANALOG | | | PC3XX IVIS | 105.00 |
| 54-14636-00 | AZTEC CONTROLLER MODULE | C | | RC25 | 599.00 | 54-15995-00 | IVIS-CT DEVELOPMENT | | | PC3XX IVIS | 95.00 |
| 54-14645-00 | AZTEC DRIVE CARD | F | | RC25 | 485.00 | 54-15995-01 | EXTERNAL IVIS LOGIC | | | PC3XX IVIS | 95.00 |
| 54-14671-00 | USE 70-20266 | | | RC25 | 00.00 | 54-16006-00 | USE 541600601 | | | PC3XX IVIS | 00.00 |
| 54-14707-00 | VT1XX-EA/EB LOGIC BD (2A-E066A) | D | | VT100 FAM | 304.00 | 54-16006-01 | IVIS EBO | | | PC3XX IVIS | 126.00 |
| 54-14823-00 | LA12 MODEM | | | LA12 | 119.00 | 54-16008-01 | IVIS VIDEO GENERATOR | | | PC3XX IVIS | 136.00 |
| 54-14823-01 | 300/1200 MODEM | | | LA12 | 86.00 | 54-16010-00 | FOT/R | | | 11/730 | 75.00 |
| 54-14827-00 | USE H3006 | | | | 00.00 | 54-16021-00 | PC278 GRAPHICS OPTION | | | PC FAMILY | 147.00 |
| 54-14923-00 | USE 70-18327 | | | RA80 | 00.00 | 54-16042-01 | DFMSA POW SUP: +5.1V 1.2A,+/-12V 0.36A,1 | | | DFMSA-AA | 48.00 |
| 54-14966-00 | NI TRANCEIVER MODULE | | | ETHERNET | 143.00 | 54-16053-01 | ETHERNET FIBER OPTIC REPEATER | | | ETHERNET | 78.00 |
| 54-15084-00 | USE 5415084FA | | | PC FAMILY | 00.00 | 54-16234-LA | PC300 RAM 512 KB | | | PC FAMILY | 511.00 |
| 54-15101-00 | USE KDF11-CC | | | PC FAMILY | 00.00 | 54-16368-01 | FRONT PANEL TO 20 POSITION BARRIER STRIP | | | | 48.00 |
| 54-15152-00 | USE 5415152AA | | | VT100 FAM | 00.00 | 54-16500-AA | USE 5416500BA | | | VAX8650 | 00.00 |
| 54-15152-AA | VT180 | | | VT100 FAM | 228.00 | 54-16500-BA | LOW POWER 2MB SMU MEMORY ARRAY =54-16500 | | | | 808.00 |
| 54-15215-00 | USE 541521501 | | | DECTALK | 00.00 | 54-16529-01 | OPTION CARD,8086 (XPU) EXTENDED PROCESSO | | | PC FAMILY | 133.00 |
| 54-15215-01 | CONTROL FOR DTC11-A (USA/CANADA) | | | DECTALK | 221.00 | 54-16531-AA | Z80 W/512KB = 54-16531-AC,-AF OR -AH | | | DECMATE | 166.00 |
| 54-15249-00 | USE 701904601 | | | RA81 | 00.00 | 54-16533-01 | USE 5416533AA | | | PC FAMILY | 00.00 |
| 54-15264-00 | USE 541526401 | | | RA60 | 00.00 | 54-16533-AA | Z80 W/256KB MEM = 54-16533-AC, -AF OR -A | | | PC FAMILY | 133.00 |
| 54-15266-02 | USE 541526601 | | | RA60 | 00.00 | 54-16537-01 | MICRO MODEM OR PC238-A | | | DECMATE | 109.00 |
| 54-15272-00 | USE 541527201 | | | RA60 | 00.00 | 54-16553-01 | DECMATE III BIT MAPPED GRAPHICS DISPLAY | | | DECMATE | 157.00 |
| 54-15426-00 | USE 70-19973 | | | PC278 | 00.00 | 54-16572-01 | USE 541657202 | | | VAX8200 | 00.00 |
| 54-15436-00 | DECMATE II RX78 INTERFACE | | | DECMATE | 143.00 | 54-16572-02 | POLARIS CONTROL MODULE | | | VAX8200 | 238.00 |
| 54-15459-00 | USE 702077901 | | | PC FAMILY | 00.00 | 54-16574-01 | CONTROL PANEL FOR SCORPIO SYSTEMS. | | | VAX6200 | 95.00 |
| 54-15478-00 | VS100 DISPLAY PROCESSOR | | | 11/730 | 674.00 | 54-16622-01 | 4 ASYNCHRONOUS SERIAL LINE MODULE FOR CT | | | PC3XX FAM | 105.00 |
| 54-15480-00 | USE 541548001 | | | 11/730 | 00.00 | 54-16681-01 | IVIS BACKPACK CONNECTOR & MASTER SYNC GE | | | PC3XX IVIS | 105.00 |
| 54-15480-01 | BIT/BLT ACCELERATOR | | | | 324.00 | 54-16683-01 | CONTROLLER BOARD FOR IVIS,CTI INTERFACE, | | | PC3XX IVIS | 122.00 |
| 54-15482-00 | PC100 RX50 CONTROLLER | B | B | RX50 | 48.00 | 54-16802-AA | MS400-AA 2MB MEM,SURFACE MNT,256K PLCC D | 1D | A | VAXSTATION | 171.00 |
| 54-15488-KA | PC300 256KB MEMORY MODULE | | | PC FAMILY | 76.00 | 54-16802-BA | MS400-BA 4MB MEM,SURFACE MNT,256K PLCC D | 1D | A | VAXSTATION | 333.00 |
| 54-15490-AA | PC100 MEMORY EXT. (64KB MEM/EXT.) | | | PC FAMILY | 50.00 | 54-16804-01 | NTWK INTERFACE OPTIUON FOR VAXSTATION 20 | F | A | VAXSTATION | 133.00 |
| 54-15490-BA | PC100 MEMORY EXT (192KB MEM/EXT.) | | | PC FAMILY | 48.00 | 54-16847-01 | USE 541715801 | | | PC500 | 00.00 |
| 54-15495-00 | USE 541549502 | | | VT240 | 00.00 | 54-16853-AF | 2MB MEMORY W/HITACHI 256K RAMS | | | PC500 | 152.00 |



Prices Effective 02-January-89 to 30-June-89
When you need a part repaired, call 800-225-5385.

SPARES PRICE LIST D-20

54-16881-01 — 70-16687-00

FACTORY REPAIR

| PART NUMBER | DESCRIPTION | LOWEST ACCEPTABLE | | REPAIR PRICE | PART NUMBER | DESCRIPTION | LOWEST ACCEPTABLE | | REPAIR PRICE |
|-------------|--|-------------------|-----------|--------------|-------------|--|-------------------|----------------|--------------|
| | | ETCH | REV | | | | USED ON | ETCH | |
| 54-16881-01 | PCXX INTRICAL MODEN - WORKSTATION | | | 181.00 | 70-12114-00 | DISK MOTOR ASSY | | | 95.00 |
| 54-16888-01 | VS2000 4-PLANE VIDEO OPTION | | | 665.00 | 70-12117-00 | POSITIONER ASSY | | | 214.00 |
| 54-16903-01 | GRAPHIC BITMAP MODULE | | | 242.00 | 70-12122-10 | USE BC21Z-10 | | | 00.00 |
| 54-16905-01 | MONOCHROME MONITOR POWER SUPPLY MODULE | | | 43.00 | 70-12306-00 | BACK PLANE ASSY DD11-DF | C | | 200.00 |
| 54-16909-01 | MONOCHROME CPU MODULE | | | 48.00 | 70-12356-00 | ACOUSTIC COUPLER ASSY | | 11 FAMILY LA36 | 51.00 |
| 54-16943-01 | 1MB DYNAMIC RAM,128KB ROM LN03 OPTION BO | | | 137.00 | 70-12413-00 | WIRED ASSY RK611 | | RK06 | 109.00 |
| 54-16961-01 | USE 702451601 | | | 00.00 | 70-12445-00 | BACK PLANE ASSY DD11-CF | F | 11 FAMILY | 86.00 |
| 54-16965-01 | TERMINAL CNTRL MODULE | | | 461.00 | 70-12909-00 | +5V REGULATOR ASSY | B | 11/24 | 150.00 |
| 54-17054-01 | DECMATE III PLUS CPU BOARD | | | 95.00 | 70-12953-00 | BACKPLANE ASSY | | | 90.00 |
| 54-17056-01 | DECMATE III WINCHESTER HARD DRIVE CONTRO | | | 57.00 | 70-13077-02 | FLEXIBLE DISK DRIVE | | RX01 | 176.00 |
| 54-17158-01 | CPU BOARD FOR VAXMATE | | | 276.00 | 70-13077-04 | USE 70-13077 | | RX02 | 00.00 |
| 54-17187-01 | USE 541715801 | | | 00.00 | 70-13398-00 | WIRED ASSY | | RM03 | 176.00 |
| 54-17195-01 | LN03R CONTROL BOARD | | | 470.00 | 70-13574-00 | 9TRK HEAD PLATE ASSY | | TS FAMILY | 713.00 |
| 54-17521-01 | 10/10 ETHERNET BRIDGE | | | 0.00 | 70-13585-01 | 9TRK HEAD PLATE ASSY | | TE16 | 713.00 |
| 54-17556-01 | RRD50 PC/XT CONTROLLER | | | 143.00 | 70-13625-00 | BACKPLANE ASSY (MEMORY) | A | 11 FAMILY | 214.00 |
| 54-17639-01 | TK50 CSIC CONTROLLER | | TK50 | 139.00 | 70-13628-00 | BACKPLANE ASSY (CPU) | | 11 FAMILY | 347.00 |
| 54-17655-01 | FRONT PANEL MODULE W/10 LEDS,SWITCH,POWE | | | 48.00 | 70-14115-01 | USE 541261001 | | LS120 | 00.00 |
| 54-17659-01 | 16BIT A/D W/PROGRAMMABLE GAIN/RS32 & IEE | | | 1068.00 | 70-14226-00 | MK11 BACKPLANE ASSY | | 11 FAMILY | 261.00 |
| 54-18172-01 | CLOCK ARBITER CARD FOR XMI | | VAX6200 | 428.00 | 70-14251-00 | 70-14251 BATTERY BACKUP REGULATOR | 1 | 11 FAMILY | 133.00 |
| 57-00006-00 | USE KEF11-BB | | 11/23-23B | 00.00 | 70-14257-00 | BACKPLANE ASSY DDV11-CK | | | 67.00 |
| 70-08329-00 | LOGIC DR11-B | | 11 FAMILY | 86.00 | 70-14411-00 | BDN-DATA (METRIC) | | RK07 | 71.00 |
| 70-08474-03 | NIXIE CABLE RT01-NC | | RT FAMILY | 200.00 | 70-14411-01 | RK07 DISK HEAD | | RK07 | 71.00 |
| 70-08871-00 | LOGIC KB11-A 11/45 | R | 11/45 | 166.00 | 70-14411-02 | BDN-SERVO (METRIC) | | RK07 | 71.00 |
| 70-09006-00 | PWR SUP & CONT 115V 60HZ RS03 & RS04 | | RS FAMILY | 261.00 | 70-14420-01 | INPUT BOXES | | 11 FAMILY | 71.00 |
| 70-09062-00 | LOGIC DD11-B | | 11 FAMILY | 86.00 | 70-14420-02 | INPUT BOXES | | 11 FAMILY | 48.00 |
| 70-09179-00 | LOGIC DJ11-AA, DJ11-AB, DJ11-AC | | 11 FAMILY | 86.00 | 70-14533-01 | PRINTER MECH W/O HEAD | | LA120 | 333.00 |
| 70-09282-00 | POWER SUPPLY ASSY PLR | | PDP8E,M,F | 594.00 | 70-14653-00 | KEYBOARD ASSY | | VT100 FAM | 0.00 |
| 70-09295-02 | LOGIC-MF11-UP C | | 11 FAMILY | 112.00 | 70-14956-01 | UBA OPTION SUPPLY 50HZ | | 11/780 | 523.00 |
| 70-09397-00 | LOGIC RH11 | | 11 FAMILY | 109.00 | 70-14957-00 | MEM OPTION SUPPORT | B | 11/780 | 608.00 |
| 70-09404-00 | USE 700940401 | B | KL10 | 00.00 | 70-14957-01 | MEM OPTION SUPPLY 50HZ | B | 11/780 | 608.00 |
| 70-09404-01 | REGULATED HEAT SINK ASSY. -2.0V | D | KL10 | 424.00 | 70-15140-00 | X605 BACKPLANE ASSY | | 11 FAMILY | 114.00 |
| 70-09405-00 | USE 700940501 | B | KL10 | 00.00 | 70-15184-00 | BACKPLANE ASSY | | | 86.00 |
| 70-09405-01 | REGULATED HEAT SINK ASSY. -5.2V | D | KL10 | 437.00 | 70-15273-00 | 20 MA-ADAPTER ASSY | | VT100 FAM | 50.00 |
| 70-09605-00 | LOGIC TU16 | | TU16 | 86.00 | 70-15276-01 | KEYBOARD BEZEL | | LA120 | 143.00 |
| 70-09612-00 | LOGIC DB11-A | | 11 FAMILY | 86.00 | 70-15490-00 | LA00 PRINT HEAD ASSY | | LA34 | 75.00 |
| 70-09623-00 | LOGIC-RP04 | | RP04 | 109.00 | 70-15510-00 | USE TU58-XA | | TU58 | 00.00 |
| 70-09636-00 | USE 701671100 | | TS11 | 00.00 | 70-15514-00 | KEYBOARD/KEYCAP ASSY. | E | LA34 | 81.00 |
| 70-09644-01 | MOTOR ASSY. LOWER-TU16 | | TU16 | 285.00 | 70-15514-02 | LA34-JA KEYBOARD/KEYCAP ASSY. | | LA34 | 95.00 |
| 70-09644-02 | MOTOR ASSY. UPPER-TU16 | | TU16 | 229.00 | 70-15514-03 | USE 701551402 | | LA34 | 00.00 |
| 70-09811-01 | USE 701442001 | | 11 FAMILY | 00.00 | 70-15637-00 | RL02 DATA HEAD "A"UP | | 11 FAMILY | 80.00 |
| 70-09835-00 | MOTOR CAPSTAN ASSY-TU16 | | TU16 | 352.00 | 70-15637-01 | RL02 DATA HEAD "A" DN | | RL02 | 80.00 |
| 70-09883-00 | PRINT HEAD LA36 | | LA36 | 128.00 | 70-15737-00 | USE 70-18960 | | LA34 | 00.00 |
| 70-09885-05 | 9TRK NARROW RADIUS | | TU16 | 214.00 | 70-15763-01 | USE 701763001 | A | LA120 | 00.00 |
| 70-09885-08 | 9TRK NARROW RADIUS | | TU16 | 105.00 | 70-15764-00 | KEY PAD/KEY CAP ASSY | | LA120 | 50.00 |
| 70-10068-00 | COPIER ASSY GEAR BOX WITH 115V 60HZ MOTO | A | VT50 FAM | 244.00 | 70-15764-01 | KEYPAD ASSY GREY KEYCAPS | | LA120 | 50.00 |
| 70-10068-01 | COPIER ASSY GEAR BOX WITH 230V 50HZ MOTO | A | VT50 FAM | 244.00 | 70-15765-02 | KEYBOARD/KEYCAP ASSY | | VT100 FAM | 86.00 |
| 70-10230-00 | LOGIC 11/35 | M | 11/35-40 | 124.00 | 70-15765-04 | KEYBD/KEYCAP ASSY 82KEY (VT132 EDITING T | | VT100 FAM | 119.00 |
| 70-10329-00 | LOGIC ASSY CPU (KB11-B) | L | 11/70 | 546.00 | 70-15765-13 | KEYBOARD KEYCAP ASSY | | VT100 FAM | 67.00 |
| 70-10644-00 | KEYBOARD ASSY | B | PDP8 FAM | 124.00 | 70-15929-00 | USE 875-A | | 11/750 | 00.00 |
| 70-11073-00 | +5V REG ASSY | E | 11 FAMILY | 133.00 | 70-16059-00 | 20 MA OPTION (LA120) | A | LA120 | 70.00 |
| 70-11164-00 | BACKPLANE ASSY [DD11-DK] | | 11 FAMILY | 109.00 | 70-16156-01 | USE H7104-D | A | 11/750 | 00.00 |
| 70-11523-00 | BACKPLANE ASSY DD11-PK | F | 11/04 | 90.00 | 70-16157-01 | USE H7104-C | A | 11/750 | 00.00 |
| 70-11528-00 | WIRE ASSY | | 11/04 | 86.00 | 70-16225-00 | HEAD/DISK ASSEMBLY | A | RA80 | 3610.00 |
| 70-11915-00 | CARRIAGE AND COIL ASSY (RK06) | | RK06 | 228.00 | 70-16486-00 | BACKPLANE | | 11 FAMILY | 249.00 |
| 70-11915-01 | CARRIAGE, COIL ASSY | | RK06 | 112.00 | 70-16687-00 | VACUUM ASSY | | TU16 | 238.00 |



Prices Effective 02-January-89 to 30-June-89
When you need a part repaired, call 800-225-5385.

FACTORY REPAIR

| PART NUMBER | DESCRIPTION | LOWEST ACCEPTABLE | | | REPAIR PRICE | PART NUMBER | DESCRIPTION | LOWEST ACCEPTABLE | | | REPAIR PRICE | |
|-------------|----------------------------------|-------------------|-----|-----------|--------------|-------------|---|-------------------|-----|------------|--------------|--------|
| | | ETCH | REV | USED ON | | | | ETCH | REV | USED ON | | |
| 70-16711-00 | TRANS/CAP POWER SUPPLY ASSY | | | TS FAMILY | 704.00 | 70-20033-04 | STANDARD POWER SUPPLY ASSY | | | HSC50/70 | 618.00 | |
| 70-16723-03 | HIGH VOLTAGE 50HZ | | | | 0.00 | 70-20170-01 | MONITOR ASSY W/TOUCH SCREEN | | | PC3XX FAM | 751.00 | |
| 70-16795-00 | USE 70-16225 | | | RA80 | 00.00 | 70-20184-02 | POWER SUPPLY ASSY,OPT 240V 50HZ | | 4A | HSC50/70 | 618.00 | |
| 70-16799-00 | KEYPAD ASSY,LA120 R/O | | | LA120 | 80.00 | 70-20405-00 | T L I INSULATOR ASSY. | | | DECTALK | 48.00 | |
| 70-16799-01 | KEYPAD ASSY LA120 R/O | | | LA120 | 48.00 | 70-20524-00 | NEWLY ADDED CRC PART | | | HSC50/70 | 48.00 | |
| 70-16975-00 | PERSONALITY BD & STIFFENER ASSY. | | | RM80 | 177.00 | 70-20579-01 | BACKPLANE ASSY (CPU) | | C1 | 11/785 | 594.00 | |
| 70-17211-00 | BOARD AND PANEL ASSY | | | MODEMS | 171.00 | 70-20579-02 | BACKPLANE ASSY CPU | | C1 | 11/785 | 594.00 | |
| 70-17362-01 | MONITOR PC BD. ASSY./EMITTER FOL | | 3 | VT100 FAM | 105.00 | 70-20779-01 | RCD51-CA DISK CONTROLLER ASSY | | | PC FAMILY | 382.00 | |
| 70-17374-00 | P.S. BD. + AC INPUT BOX ASSY. | | 3 | VT100 FAM | 70.00 | 70-20814-01 | USE 702081402 | | A | VT220 | 00.00 | |
| 70-17397-00 | KEYBOARD KEYCAP ASSY | | | VK100 | 114.00 | 70-20999-01 | STATISTICAL MULTIPLEXER UA 240V | | NU | DSRZA | 713.00 | |
| 70-17484-00 | USE 70-17397 | | | | 00.00 | 70-20999-02 | STATISTICAL MULTIPLEXER UA 120V | | NU | DSRZA | 713.00 | |
| 70-17630-01 | KEYBOARD/CAP ASSY | | | | 55.00 | 70-21127-01 | BASE PLATE CHASSIS ASSY | | | RC25 | 2850.00 | |
| 70-17630-03 | KEYBOARD CAP ASSY | | | | 55.00 | 70-21148-01 | DEC TALK | | | DECTALK | 451.00 | |
| 70-17740-01 | SPINDLE ASSY | | | RA60 | 784.00 | 70-21170-01 | HEAD/DISK ASSEMBLY (16 BIT) | | | RA82 | 3078.00 | |
| 70-17863-00 | USE 701786301 | | | LA100 | 00.00 | 70-21495-01 | CONNECTOR PLATE ASSY. | | | VAXSTATION | 40.00 | |
| 70-17863-01 | KEYBOARD/KEYCAP ASSY KSR | | | LA100 | 67.00 | 70-21682-02 | A/C MAJOR BD ASSY | | | | 190.00 | |
| 70-17935-00 | KEYBOARD ASSY. | | A | RT FAMILY | 214.00 | 70-21936-02 | BASIC DISK DRIVE SUB-ASSY - INA 6-15-88 | | | RA70 | 1496.00 | |
| 70-18409-00 | USE 701965501 | | | LA100 | 00.00 | 70-21946-01 | HEAD/DISK ASSEMBLY (HDA) | | | RA70 | 4356.00 | |
| 70-18431-00 | USE 701843101 | | | LA12 | 00.00 | 70-22026-01 | SLU INTERCONNECT ASSY. | | | PC3XX FAM | 95.00 | |
| 70-18452-01 | POSITIONER ASSEMBLY | | | RA60 | 903.00 | 70-22032-01 | ASSY FLAT PANEL KEYBOARD | | | | 188.00 | |
| 70-18476-01 | CAPACITOR/RECTIFIER ASSEMBLY | | | RA60 | 219.00 | 70-22032-02 | ASSY FULL TRAVEL KEYBOARD | | | | 188.00 | |
| 70-18477-01 | TRANSFORMER ASSEMBLY | | | RA60 | 0.00 | 70-22494-01 | MODULE ASSEMBLY | | | RA70 | 1069.00 | |
| 70-18491-01 | HEAD/DISK ASSEMBLY (16 BIT) | | | RA81 | 3024.00 | 70-22782-01 | USE DESTA-AA | | | ETHERNET | 00.00 | |
| 70-18491-02 | HEAD/DISK ASSEMBLY (18 BIT) | | | RA81 | 3024.00 | 70-22942-01 | ELECTRONIC CONTROL MODULE | | | RA90 | 2184.00 | |
| 70-18707-00 | USE 70-18960 | | | LA100 | 00.00 | 70-22951-01 | HDA/CARRIER ASSY | | | RA90 | 12545.00 | |
| 70-18762-00 | POWER SUPPLY ASSY. | | | 11/24 | 141.00 | 70-23297-01 | I/O BOARD ASSY | | 1J | PC500 | 209.00 | |
| 70-18960-00 | SERVO MOTOR/ENCODER ASSY. | | | LA100 | 67.00 | 70-23328-01 | POWER SUPPLY ASSY. | | | DECTALK | 333.00 | |
| 70-19343-01 | POSEIDON CONCENTRATOR TERM. 120V | | | ETHERNET | 429.00 | 70-24216-01 | MUXSERVER 100 240V LEFT PARENTHESIS | | NU | DSRZA | 950.00 | |
| 70-19343-02 | POSEIDON CONCENTRATOR TERM. 240V | | | ETHERNET | 429.00 | 70-24216-02 | MUX SERVER 100 120V | | NU | ETHERNET | 950.00 | |
| 70-19479-01 | RT1XX-AF TACTILE KEYBOARD | | | RT FAMILY | 575.00 | 70-24252-01 | DEPCA,MODULE,ASSY | | | DEPCA | 63.00 | |
| 70-19499-00 | USE 701949901 | | A | VT240 | 00.00 | 70-24268-01 | KA410-A SYSTEM MODULE ASSY | | F | A | VAXSTATION | 665.00 |
| 70-19521-00 | BASE PLATE ASSY. | | | | 0.00 | 70-24268-02 | KA410-B SYSTEM MODULE ASSY | | | VAXSTATION | 665.00 | |
| 70-19572-00 | FAN BRACKET ASSY | | | PC FAMILY | 57.00 | 70-24373-01 | CARD CAGE SYSTEM ASSY, 14 SLOT | | | VAX6200 | 1900.00 | |
| 70-19584-00 | MONITOR BOARD ASSY | | C | PC FAMILY | 71.00 | 70-24380-01 | CI UNIT ASSY | | A1 | VAX FAMILY | 534.00 | |
| 70-19655-01 | PRINT HEAD ASSY LAMINATED | | C | LA210 | 114.00 | 70-24516-01 | PS/MONITOR AND ARC PROTECTION ASSY | | | VT330/340 | 69.00 | |
| 70-19729-00 | BACKPLANE ASSY MEMORY | | | | 380.00 | 70-24577-01 | MONITOR AND LOGIC W/ARC PROTECTION | | | VT320 | 52.00 | |
| 70-19964-00 | FILTER CONN. BOARD ASSY. | | | | 0.00 | 70-24577-02 | MONITOR AND LOGIC W/ARC PROTECTION | | | VT320 | 52.00 | |
| 70-20033-01 | POWER SUPPLY ASSY (STD) 60HZ | | 4A | | 618.00 | 74-08212-00 | ASSY, MOTOR & HUB | | | RS FAMILY | 435.00 | |
| 70-20033-02 | STANDARD PWR SUPP ASSY 240V 50HZ | | | HSC50/70 | 618.00 | EQ-01454-05 | LO118 FCO KIT | | B1 | VAX FAMILY | 570.00 | |
| 70-20033-03 | USE 702003301 | | | | 00.00 | | | | | | | |



Prices Effective 02-January-89 to 30-June-89
When you need a part repaired, call 800-225-5385.

SPARES PRICE LIST D-21



FACTORY REPAIR SAME BOARD RETURN

| PART NUMBER | DESCRIPTION | LOWEST ACCEPTABLE | | | REPAIR PRICE | PART NUMBER | DESCRIPTION | LOWEST ACCEPTABLE | | | REPAIR PRICE |
|-------------|--|-------------------|-----|------------|--------------|-------------|--|-------------------|-----|-----------|--------------|
| | | ETCH | REV | USED ON | | | | ETCH | REV | USED ON | |
| 00861-D | 120V,24A,3-PHASE PWR CONT (881-A NEAREST | F | A | KL10 | 394.00 | G8018-00 | H774 REGULATOR | C | | PDP8 FAM | 124.00 |
| 00869-D | POWER CONTROL W/PWR SEQUENCING,4 SWITCHE | | | 11/780 | 364.00 | H7100-A | 11780 500 WATT SUPPLY: 5V 100A,120VAC (H | | | 11/780 | 656.00 |
| 00874-D | 120V 24A FILTERED POWER CONT,6 SW OUTLET | | | RL01 | 190.00 | H7104-C | 7016157-01: 7016157-00(2.5V 85A),H7103(+ | | | 11/750 | 380.00 |
| 00875-A | 120V 24A PC,POWER SEQUENCING,4 SWITCHED | | | 11/750 | 250.00 | H7104-D | 7016156-01: 7016156-00(+5V 135A),H7105(+ | | | 11/750 | 380.00 |
| 00MM8-AB | 16KX12 MEMORY | C | | MEMORIES | 190.00 | H7131-00 | POWER SUPPLY-MF20 120/240V NO LINE CORD | | | KL10 | 1659.00 |
| 00MR8-FE | 4K CONTENT ALTERABLE PROM | | | MEMORIES | 760.00 | H7832-A | POWER SUPPLY VT62,VT68 115V WITH 50/60 H | C | | VT62 | 247.00 |
| 0A020-00 | A/D 8 RELAY SWITCHED | C | | DPM | 475.00 | H7834-00 | H7834 PWR SUPPLY LA34 | | | LA34 | 95.00 |
| 0DF03-AA | REPLACED BY DF112-AA:WAS 300/1200BPS MOD | | | MODEMS | 284.00 | HSC5X-BA | KSDI INTERFACE KIT TO 4 SDI DISK DRIVES | D | C | HSC50/70 | 670.00 |
| 0DF03-AC | REPLACED BY DF112-AA:WAS DF03-AA+M7177-Y | | | MODEMS | 361.00 | HSC5X-CA | KSTI INTERFACE KIT TO 4 STI TAPE FORMATT | D | D | HSC50/70 | 670.00 |
| 0G066-00 | READ AMP 9-CH | C | | TU10 | 238.00 | KDF11-AA | M8186 DUAL-HEIGHT CPU W/KFT11-AA OPT (MM | C | | 11/23-23B | 154.00 |
| 0G111-00 | SENSE INHIBIT | C | A | PDP8E,M,F | 105.00 | KDF11-BA | M8189(DCF11-AA,2 SLU,CLK),KTF11-AA(MMU), | | | 11/23-23B | 304.00 |
| 0G114-00 | 16K SENSE/INHIBIT G112 W 8881 & 380 | B | | 11/05 | 124.00 | KDF11-CC | KDF11-CA W/ROMS FOR IVIS | | | PC3XX FAM | 177.00 |
| 0G116-00 | SENSE/INH BIT MODULE | C | A | 11 FAMILY | 124.00 | KDJ11-CA | PC380 MOTHER BD,J11 CPU,512KB SYS RAM,6 | | | PC FAMILY | 1153.00 |
| 0G158-00 | REEL SERVO MODULE | F | | TS FAMILY | 80.00 | KWV11-A | 11/03 PROGRAM CLOCK | | | 11/03 | 135.00 |
| 0G159-00 | CAPSTAN SERVO | E | | TS FAMILY | 124.00 | L0001-00 | FLOATING POINT ACCELERATOR | D | | 11/750 | 380.00 |
| 0G233-00 | 8K X-Y | C | A | PDP8E,M,F | 105.00 | L0002-00 | DPM (DATA PATH & MICRO SEQUENCER),4-LAYE | C | A | 11/750 | 310.00 |
| 0G236-00 | 32K XY DRIVE | E | | 11 FAMILY | 119.00 | L0003-00 | MEMORY INTERFACE | C | A | 11/750 | 449.00 |
| 0G401-00 | HIGH SPEED MOS MEM MATRIX | | | 11/45 | 244.00 | L0004-00 | UNIBUS INTERFACE | D | A | 11/750 | 310.00 |
| 0H215-00 | 8K 18BIT PARITY MEMORY STACK | A | | 11/05 | 250.00 | L0006-00 | RDM (REMOTE DIAG MODULE),4-LAYER HEX 12 | A | | 11/750 | 310.00 |
| 0H607-00 | TAPE MOTION BOARD | A | | TU16 | 244.00 | L0007-00 | MBA (MASSBUS ADAPTOR),4-LAYER HEX 12 | C | | 11/750 | 310.00 |
| 0K564-00 | DC INPUT CONVERTER | | | PDP FAMILY | 124.00 | L0008-YA | (PCS)PATCHABLE CONTROL STORE FOR 11750,H | B | | 11/750 | 638.00 |
| 0KD11-F | LSI11: M7264-AA (11/03 PROCESSOR W 8KB M | C | | 11/03 | 138.00 | L0008-YB | L0008-YA W 1K OF WCS,HEX 12 | | | 11/750 | 638.00 |
| 0LA12-AB | LA12-A W/DIAL-THRU-KEYBRD MICROCODE & MO | | | LA12 | 618.00 | L0010-00 | UBI (UNIBUS INTERFACE (VERSION 2)) | A | C | 11/750 | 449.00 |
| 0LK02-00 | KEYBOARD | E | | LA36 | 76.00 | L0011-00 | 16K MEMORY CONTROL,4-LAYER HEX 12 | | | 11/750 | 295.00 |
| 0MM11-DP | 16K CORE MEMORY | | | MEMORIES | 342.00 | L0016-00 | 64K MEMORY CONTROL,4-LAYER HEX 12 | | | 11/750 | 449.00 |
| 0MM11-YP | 32K 18BIT MEMORY ONE 1" BOARD | C | | MEMORIES | 321.00 | L0105-00 | HSC50 PIOC (F11 PROC & I/O CTL),HEX 12 | D | D | HSC50/70 | 519.00 |
| 0MS11-AP | MEMORY 4K X 18 BIT | | | MEMORIES | 347.00 | L0107-YA | HSC50 KPLI(PLI PORT CONTROL),HEX 12 | C | C | HSC50/70 | 350.00 |
| 0MS11-FP | 8K 18 BIT MOS RAM MEM W PARITY | | | MEMORIES | 132.00 | L0109-00 | HSC50 PILA(PACKET BUFFER BOARD),HEX 12 | E | 2 | HSC50/70 | 210.00 |
| 0MS11-JP | 16K UNIBUS MOS MEM/PARITY | | | MEMORIES | 168.00 | L0111-00 | J-11 I/O CONTROL PROCESSOR MODULE | D | | HSC50/70 | 424.00 |
| 0MS11-KE | 16K 39BIT MOS MEM ARRAY FAST 4K CHIPS M7 | | | MEMORIES | 404.00 | L0201-00 | CSL (CONSOLE CONTROL),HEX 12 FOR KA86 | | | VAX8600 | 1496.00 |
| 0MS11-LB | MS11-LB 64K 18 BIT MOS MEM W PARITY LOGI | B | | MEMORIES | 333.00 | L0202-00 | (SBS) SBIA SBI INTERFACE,HEX 12 FOR KA86 | | | VAX8600 | 1425.00 |
| 0MS11-LD | MS11-LD 128K 18 BIT MOS MEM W PARITY LOG | C | E | MEMORIES | 190.00 | L0203-00 | (SBA) SBIA ABUS INTERFACE,HEX 12 FOR KA8 | | | VAX8600 | 1425.00 |
| 0MS11-MB | 256 KBYTES MOS ECC MEMORY(M8722-BA) | C | | MEMORIES | 238.00 | L0204-00 | (MCD) MBOX DATA PATH,HEX 12 FOR KA86 | | | VAX8600 | 2850.00 |
| 0RD50-A | 5MB WINCHESTER HARD 5.25" DSK DRIVE,3.5" | | | RD FAMILY | 649.00 | L0205-00 | (MAP) MBOX ADDRESS PATH,HEX 12 FOR KA86 | | | VAX8600 | 2850.00 |
| 0RD51-A | 10MB WINCHESTER NON-R 5.25" DSK,3.5"H,RE | | | RD FAMILY | 649.00 | L0206-00 | (IDP) IBOX DATA PATH,HEX 12 FOR KA86 | | | VAX8600 | 2850.00 |
| 0RX50-AA | DUAL 5.25" SINGLE SIDED FLOPPY DRIVE,96T | | | RX50 | 214.00 | L0207-00 | (ICA) IBOX CONTROL A,HEX 12 FOR KA86 | | | VAX8600 | 1900.00 |
| 0TU58-XB | MODULE W SERIAL INTERFACE (54-13489) | F | | TU58 | 90.00 | L0208-00 | (IBD) IBOX INSTRUCTION BUFFER,HEX 12 FOR | | | VAX8600 | 3325.00 |
| 0X020-00 | RAINBOW DATA PATH HEX | | | 11/34-34A | 147.00 | L0209-00 | (EDP) EBOX DATA PATH,HEX 12 FOR KA86 | | | VAX8600 | 2375.00 |
| 0X021-00 | RAINBOW CD ROM CONTROL HEX | | | 11/34-34A | 176.00 | L0210-00 | (EBC) EBOX BUFFER,HEX 12 FOR KA86 | | | VAX8600 | 1425.00 |
| 0X027-00 | RAINBOW INPUT HEX | | | 11/34-34A | 285.00 | L0211-00 | (EBD) EBOX CONTROL,HEX 12 FOR KA86 | | | VAX8600 | 1188.00 |
| 0X030-00 | RAINBOW,CDC DISK CONTROL,HEX | | | 11/34-34A | 181.00 | L0212-00 | (FBA) FBOX FLOATING PT CNTRL + DATA PATH | | | VAX8600 | 1900.00 |
| 0Y202-00 | DIP-E AND VCD INTERFACE | C | | | 147.00 | L0213-00 | (FBM) FBOX FLOATING PT MULTIPLIER,HEX 12 | | | VAX8600 | 1900.00 |
| 0CSAX-LC | M3102,TWO-LINE ASYNC LINE CARD,EIA DASH | C | | DECSA | 166.00 | L0214-00 | (ICB) IBOX CONTROL B,HEX 12 FOR KA86 | | | VAX8600 | 1188.00 |
| F1001-00 | MCL (MEMORY CONTROLLER LOGIC MODULE) FOR | 1D | 4F | VAX8500 | 1853.00 | L0215-00 | CSA (CONTROL STORE ARRAY BOARD) FOR KA86 | | | VAX8600 | 2850.00 |
| F1002-00 | SHIFTER LOGIC MODULE FOR NAUTILUS CPU,HE | 1A | 1A | VAX8500 | 3420.00 | L0216-00 | (CSB) CONTROL STORAGE ARRAY,HEX 12 FOR K | | | VAX8600 | 2850.00 |
| F1003-00 | ALU SLICE #1 MODULE FOR NAUTILUS CPU,HEX | 1A | 1A | VAX8500 | 2993.00 | L0217-00 | (CLK) CLOCK, HEX 12 FOR KA86 | | | VAX8600 | 1425.00 |
| F1004-00 | ALU SLICE #0 MODULE FOR NAUTILUS CPU,HE | 1A | 1A | VAX8500 | 2993.00 | L0218-00 | (FBOX) JUMPER MODULE,HEX 4 FOR KA86 | | | VAX8600 | 380.00 |
| F1005-00 | ADDRESS DATA PATH MODULE FOR NAUTILUS CP | 1A | 1B | VAX8500 | 2375.00 | L0219-00 | (EBE) EBOX CONTROL,HEX 12 FOR KA86 | | | VAX8600 | 1188.00 |
| F1006-00 | CACHE MODULE FOR NAUTILUS CPU,HEX W/ZIFF | 1D | 2A | VAX8500 | 1805.00 | L0220-00 | (MCC) CACHE CONTROL,HEX 12 FOR KA86 | | | VAX8600 | 2850.00 |
| F1007-00 | DECODER MODULE FOR NAUTILUS CPU,HEX W/ZI | 1A | X01 | VAX8500 | 1853.00 | L0222-00 | (MTM)MEM ARRAY TERMINAL BOARD,4 LAYER HE | K1 | | VAX8600 | 380.00 |
| F1008-00 | MICRO SEQUENCER LOGIC MOD FR NAUTILUS CP | 1A | X01 | VAX8500 | 3373.00 | L0223-00 | (FTM)F-BOX TERMINATOR BOARD,4-LAYER HEX | | | VAX8600 | 380.00 |
| F1009-00 | 16K WORD WRITE CONT STORE FR NAUTILUS CP | 1A | X00 | VAX8500 | 3800.00 | L0224-00 | (STM)SBI/A-BUS TERMINATOR BOARD,4-LAYER | | | VAX8600 | 380.00 |
| F1010-00 | CLOCK GENERATION & CONSOLE INTERFACE FOR | 1C | X04 | VAX8500 | 2090.00 | L0230-00 | MCC (M-BOX CACHE CONTROL) | | | VAX8600 | 4750.00 |
| F1011-00 | NB(NMI TO BI INTERFACE MODULE)HEX W/ZIF | 1C | 3A | VAX8500 | 2090.00 | L0231-00 | CLOCK FOR KA86 | | | VAX8600 | 2850.00 |
| F1015-00 | DECODER F MODULE FOR NAUTILUS B | | | VAX8500 | 1853.00 | LK001-B | LA36 KEYBOARD WITH NUMERIC KEYPAD | | | LA36 | 81.00 |



Prices Effective 02-January-89 to 30-June-89
When you need a part repaired, call 800-225-5385.

FACTORY REPAIR SAME BOARD RETURN

| PART NUMBER | DESCRIPTION | LOWEST ACCEPTABLE | | | REPAIR PRICE | PART NUMBER | DESCRIPTION | LOWEST ACCEPTABLE | | | REPAIR PRICE |
|-------------|--|-------------------|-----|------------|--------------|-------------|--|-------------------|-----|------------|--------------|
| | | ETCH | REV | USED ON | | | | ETCH | REV | USED ON | |
| LK201-AA | LK201-A W/USA KEYCAPS,BCC01,BN09A-1K USA | | | PC FAMILY | 71.00 | M7471-YA | DAP, DATAPATH CONTROL MODULE FOR KA785 | | | 11/785 | 593.00 |
| LK201-BA | LK201-B W WPS USA/CANADA KEYCAPS,BCC01,USA | | | PC FAMILY | 57.00 | M7472-00 | KA785,CEH (CONDITION CODES,EXCEPTIONS,HI | | | 11/785 | 409.00 |
| M3105-00 | DHU11-A (16-LINE ASYNC MUX,DMA CONTROL), | | | 11 FAMILY | 250.00 | M7477-00 | KA785,CIB,CPU CONSOLE INTERFACE,4-LAYER | | | 11/785 | 409.00 |
| M3110-00 | PROTOCOL ASSIST #1 W SPECIAL CHAR CHECK | C | 1E | DECSA | 230.00 | M7485-YA | M7485 W/BLASTED ROMS,4-LAYER HEX | A | | UDA50 | 665.00 |
| M3111-00 | PROTOCOL ASSIST #2 W SPECIAL CHAR CHECK | | | DECSA | 224.00 | M7486-00 | UDA SI | A | | UDA50 | 665.00 |
| M5800-00 | 2-WIRE DUPLEX MODEM,300/1200BPS,ORIGINAT | | | MODEMS | 200.00 | M7521-AA | DELUA-AA ETHERNET LSI UNIBUS ADAPTOR (= | | | DELUA | 356.00 |
| M5902-00 | 16 CH FULL DUPLEX TTY TRANSC DJ1 | | | 11 FAMILY | 100.00 | M7541-00 | FP785 FMH,FLT PT FRACTION MULTIPLR HI,70 | D1 | | 11/785 | 434.00 |
| M5903-00 | MASSBUS TERMINAL TRANSCEIVER,DOUBLE 8.5 | H | A | MEMORIES | 70.00 | M7544-00 | FP785,FCT,FLOATING PT ACCELERATOR CONTRO | D1 | | 11/785 | 549.00 |
| M5904-00 | MASSBUS CONTROL TRANSCEIVER,DOUBLE 8.5 | | | 11 FAMILY | 86.00 | M7546-00 | Q-BUS TAPE CONTROLLER,DBL 8.5 | | | TK50 | 295.00 |
| M7081-00 | PRINTER LOGIC AND POWER BOARD | D | 1 | LA120 | 90.00 | M7555-00 | Q-BUS WINCHESTER AND FLOPPY DISK CONTROL | | | RD FAMILY | 295.00 |
| M7081-YB | M7081 W ROMS FOR LAS12, LA124 | E | A | LAS12 | 90.00 | M7606-AA | MICROVAX II W/1MB,FP,INCL TIME OF YR CLO | | | MICROVAX2 | 1425.00 |
| M7094-00 | KD11-T DATA PATH | B | A | 11/44 | 261.00 | M7541-00 | SEE M7606-AA | N | N | MICROVAX2 | 1425.00 |
| M7095-00 | KD11-Z,CONTROL MODULE,HEX | B | | 11/44 | 309.00 | M7680-00 | RK05F SECTOR CTR,INDEX & PHOTOAMP,DUAL 8 | B | | RK05 | 76.00 |
| M7096-00 | KD11-Z,(MFM) MULTIFUNCTION MODULES,HEX | B | | 11/44 | 276.00 | M7681-00 | Q-CYLINDER ADDRESS & TRACK DIFF,DUAL 8.5 (| B | | RK05 | 76.00 |
| M7097-00 | KK11-B,4K WORD CACHE,HEX | C | A | 11/44 | 309.00 | M7684-00 | CONTROL SEQUENCER | D | M | RM03 | 147.00 |
| M7098-00 | KD11-Z,UNIBUS INTERFACE,HEX | B | A | 11/44 | 261.00 | M7686-YA | RM02/3/5 CONTROL INTERFACE,HEX,CAN REPLA | C | K | RM03 | 81.00 |
| M7104-00 | DATA BUF & STATUS | | | PDP8E,M,F | 124.00 | M7705-00 | RK06 DRIVE CONTROL LOGIC | E | A | RK06 | 100.00 |
| M7114-00 | VT30-H VIDEO TV SYNC GEN. MEM. CONT. OUT | | | VT30 | 1000.00 | M7706-00 | RK06 INTERFACE + TIMING | C | | RK06 | 100.00 |
| M7133-YA | KDF11-UA CPU,LINE CLOCK,2 SER LNS,ETCH R | | | 11/24 | 304.00 | M7726-00 | RX01 CONTROLLER | B | | RX01 | 124.00 |
| M7135-00 | MICROVAX I DATAPATH W G FLOATING POINT (| A | D | MICROVAX1 | 763.00 | M7727-00 | RX01 R/W CONTROL | B | A | RX01 | 124.00 |
| M7135-YA | MICROVAX I DATAPATH W D FLOATING POINT (| A | D | MICROVAX1 | 679.00 | M7741-00 | TIMING & REGISTERS | B | A | PDP FAMILY | 98.00 |
| M7136-00 | MEMORY CONTROL FOR KD32-A MICROVAX I (SE | A | A | MICROVAX1 | 569.00 | M7744-YC | M7744 WITH FCC COMPLIANCE,HEX | D | A | RX02 | 119.00 |
| M7164-00 | QDA PROCESSOR,QUAD | | | KDA50 | 649.00 | M7745-YA | M7745 WITH FCC COMPLIANCE,HEX | D | | RX02 | 119.00 |
| M7165-00 | QDA SDI,QUAD | C | | KDA50 | 649.00 | M7762-00 | RL11 CONTROLLER | H | K | RL01 | 190.00 |
| M7168-00 | 4 PLANE COLOR BITMAP | | F | VAXSTATION | 1112.00 | M7773-00 | ASYNCHRONOUS LOGIC-RP04 | D | E | RP04 | 161.00 |
| M7169-00 | Q22 BUS VIDEO CONTROLLER MODULE FOR VCB0 | | E | VAXSTATION | 2024.00 | M7774-00 | REGISTER LOGIC-RP04 | E | E | RP04 | 166.00 |
| M7219-00 | INTERFACE, KC11 BUS | D | | 11 FAMILY | 100.00 | M7776-00 | ERROR CORRECT LOGIC-RP0H | D | D | RP04 | 161.00 |
| M7232-00 | U WORD,KD11-A,8.5 QUAD | | | 11/35-40 | 138.00 | M7785-00 | SEEK & SEARCH CNTL LOGIC | | | RP05/6 | 160.00 |
| M7233-00 | KD11-A IR DECODE | B | | 11/35-40 | 155.00 | M7787-00 | INTERFACE CONTROL | | | RP05/6 | 257.00 |
| M7234-00 | KD11-A TIMING | D | | 11/35-40 | 179.00 | M7792-00 | DEUNA PORT MODULE(UNIBUS TO ETHERNET MIC | | | ETHERNET | 238.00 |
| M7235-00 | KD11-A STATUS PROCESSOR | | | 11/35-40 | 155.00 | M7793-00 | DEUNA LINK MODULE(M7792 TO ETHERNET BUS | | | ETHERNET | 238.00 |
| M7236-00 | KT11-D MEMORY MANAGEMENT | | | 11/35-40 | 179.00 | M7800-00 | ASYNCHRONOUS LINE INTERFACE | B | | 11/05 | 124.00 |
| M7255-00 | RK11-D DISK CONTROL | | | 11 FAMILY | 85.00 | M7810-00 | PC11-INTERFACE | C | | 11 FAMILY | 76.00 |
| M7256-00 | RK11-D REGISTER | | | 11 FAMILY | 85.00 | M7814-00 | 20MA DATA MUX | D | | 11 FAMILY | 150.00 |
| M7257-00 | RK11-D BUS CONTROL | | | 11 FAMILY | 95.00 | M7819-00 | DZ11-A 8-LINE DBL BUF ASYNC EIA 50 TO 96 | C | D | 11 FAMILY | 150.00 |
| M7263-00 | KD11-D PROCESSOR MOD HEX | D | | 11/04 | 170.00 | M7846-00 | RX01 UNIBUS INTERFACE,QUAD | | | RX01 | 105.00 |
| M7264-EB | USE KD11-F | | | 11/03 | 00.00 | M7856-00 | DL11-W SLU/RTC OPT QUAD | D | | 11/04 | 95.00 |
| M7264-YC | LST-11 CPU MODULE | | | LSH11 | 124.00 | M7860-00 | DR11-C INTERFACE | | K | 11 FAMILY | 100.00 |
| M7270-00 | KD11-HA, M7264-YA ON DOUBLE 8.5 | E | | LSH11 | 85.00 | M7871-00 | DIAGNOSTIC CONTROL STORE | | | 11 FAMILY | 162.00 |
| M7289-00 | DH11 REC V SCANNER | | | 11 FAMILY | 71.00 | M7874-00 | CACHE KIT FOR 11PDO | | | 11/60 | 135.00 |
| M7294-00 | DATA BUFFER & CONT RH11 | C | A | 11 FAMILY | 111.00 | M7875-00 | CACHE/KT FOR 11 PDO | | | 11/60 | 321.00 |
| M7295-00 | BUS CONTROL RH11 | | | 11 FAMILY | 95.00 | M7878-00 | FP11-E,EXPONENT,4-LAYER HEX | | | 11/60 | 167.00 |
| M7433-00 | MULTIPLEX DRIVERS | | | PDP FAMILY | 133.00 | M7879-00 | FP11-E,EXPONENT,4-LAYER HEX | | | 11/60 | 150.00 |
| M7460-00 | KA785,SBL,CPU SBI LOW BITS INTERFACE,4-L | | | 11/785 | 529.00 | M7880-00 | FP11E FNUA(FLOATING POINT) | | | 11/60 | 200.00 |
| M7462-00 | KA785,CAM,CACHE ADDRESS MATRIX,4-LAYER H | | | 11/785 | 778.00 | M7881-00 | LOW DATA PATH | | | 11/60 | 179.00 |
| M7463-00 | KA785,CDM,CACHE DATA MATRIX,4-LAYER HEX | | | 11/785 | 863.00 | M7900-00 | UNIBUS INTERFACE RK611 | | C | RK06 | 114.00 |
| M7464-00 | KA785,TBM,CPU TRANSLATION BUFFER MATRIX, | | | 11/785 | 709.00 | M7903-00 | BOARD DATA | | | RK06 | 143.00 |
| M7467-00 | KA785,DBP,CPU DATA PATH "B",4-LAYER HEX | | | 11/785 | 559.00 | M7904-00 | INTERFACE DRIVE RK611 | | | RK06 | 143.00 |
| M7468-00 | KA785,DEP,CPU DATA PATH E,4-LAYER HEX 12 | | | 11/785 | 449.00 | M7906-00 | SERVO ANALOG | | | RK07 | 122.00 |
| M7468-YA | DEP, DATAPATH MODULE,16-31 BITS FOR KA78 | | | 11/785 | 449.00 | M7907-00 | SERVO CONTROL | | | RK07 | 103.00 |
| M7469-00 | KA785,DDP,CPU DATA PATH D,4-LAYER HEX 12 | | | 11/785 | 574.00 | M7908-00 | TRACK POSITIONING OSCILL | | | RK07 | 124.00 |
| M7469-YA | DDP, DATAPATH MODULE, 08-15 BITS FOR KA7 | | | 11/785 | 788.00 | M7940-00 | SERIAL LINE 11V03 | B | B | 11/03 | 65.00 |
| M7470-00 | KA785,DCP,CPU DATA PATH C,4-LAYER HEX 12 | | | 11/785 | 449.00 | M7941-00 | 16 BIT PARALLEL LINE UNIT 11V03 | C | | 11/03 | 60.00 |
| M7470-YA | DCP, DATAPATH MODULE, 00-07 BITS FOR KA7 | | | 11/785 | 575.00 | M7944-00 | 4K 16BIT RAM 11V03 | B | A | 11/03 | 86.00 |
| M7471-00 | KA785,DAP,CPU DATA PATH A,4-LAYER HEX 12 | | | 11/785 | 409.00 | M7950-00 | DRV11-B,DMA 16-BIT PARALLEL GEN PURPOSE | | | 11/03 | 95.00 |



Prices Effective 02-January-89 to 30-June-89
When you need a part repaired, call 800-225-5385.

SPARES PRICE LIST D-24

M7982-00 — M8639-YA

FACTORY REPAIR SAME BOARD RETURN

| PART NUMBER | DESCRIPTION | LOWEST ACCEPTABLE | | | REPAIR PRICE | PART NUMBER | DESCRIPTION | LOWEST ACCEPTABLE | | | REPAIR PRICE |
|-------------|--|-------------------|-----|-----------|--------------|-------------|---|-------------------|-----|-----------|--------------|
| | | ETCH | REV | USED ON | | | | ETCH | REV | USED ON | |
| M7982-00 | UNIBUS TO SERIAL CONTROLLER | | | 11 FAMILY | 119.00 | M8218-00 | SBL LOW BIT INTERFACE | B | A | 11/780 | 239.00 |
| M7983-00 | 32KX16 CONTROLLER | | | 11 FAMILY | 160.00 | M8219-00 | SBH CPU HIGH BITS INTERFACE | B | A | 11/780 | 239.00 |
| M8013-00 | BLV11 CONTROL MODULE | C | F | RL01 | 162.00 | M8222-00 | TBM CPU TRANSLATION BUFFER MATRIX | B | A | 11/780 | 239.00 |
| M8014-00 | RLV11 CONTROL MODULE | B | B | RL01 | 149.00 | M8223-00 | IRC CPU INSTRUCT DECODE&CLOCKS | B | A | 11/780 | 239.00 |
| M8021-00 | LSH11 PROM/RAM BOARD | | | 11/03 | 75.00 | M8224-00 | IDP CPU INTERUCTION DATA PATH | C | | 11/780 | 290.00 |
| M8043-00 | DLV11-J,4-SERIAL LINE PERIPHEREL INTERFA | D | F | LSI11 | 94.00 | M8225-00 | KA780,DBP,CPU DATA PATH "B",4-LAYER HEX | B | A | 11/780 | 239.00 |
| M8047-HA | MXV11-HA: 16KW RAM,2 ASYNC EIA SLU (8 BI | | | MEMORIES | 299.00 | M8226-00 | KA780,DEP,CPU DATA PATH E,4-LAYER HEX 12 | C | A | 11/780 | 239.00 |
| M8053-MA | M8053 W DDCMP CTL ROM (POINT TO POINT OR | | | 11/03 | 150.00 | M8227-00 | KA780,DDP,CPU DATA PATH D,4-LAYER HEX 12 | B | A | 11/780 | 239.00 |
| M8061-00 | RL01/RL02 DISK CONTROL,22-BIT ADDRESS,QU | B | | RL01 | 162.00 | M8228-00 | KA780,DCP,CPU DATA PATH C,4-LAYER HEX 12 | B | A | 11/780 | 239.00 |
| M8101-00 | GENERAL REGS + ALU. CONTROL | | | 11/45 | 129.00 | M8229-00 | DAP DATA PATH A | B | A | 11/780 | 239.00 |
| M8108-00 | SEG STATUS REG | | | 11/45 | 103.00 | M8230-00 | CPU CONDITION CODE | B | A | 11/780 | 239.00 |
| M8108-YA | ROM BOARD | | | 11/45 | 122.00 | M8231-00 | CPU TRAPS AND INTERRUPTS CONTROL | A | A | 11/780 | 239.00 |
| M8115-00 | FRL (FRACTION LOW ORDER DATA PATH) 8.5 H | | | 11/45 | 179.00 | M8232-00 | CLK CPU CLOCK | B | A | 11/780 | 244.00 |
| M8123-00 | KB11-C,RAC (ROM & ADDRESS CONTROL),HEX,F | | | 11/70 | 160.00 | M8234-00 | KA780-A,PCS,PROM CONTROL STORE,4-LAYER H | B | A | 11/780 | 330.00 |
| M8126-00 | FRACTION PROCESSOR HIGH ORDER | | | 11/70 | 180.00 | M8235-00 | MICRO SEQUENCER CONTROL | | | 11/780 | 239.00 |
| M8127-00 | FRACTION PROCESSOR LOW ORDER | | | 11/70 | 180.00 | M8236-00 | CIB CONSOLE INTERFACE | A | A | 11/780 | 290.00 |
| M8128-00 | FRACTION PROCESSOR ROM CONTROL | | | 11/70 | 160.00 | M8238-00 | KU780-A 2K WCS (WRITEABLE CONTROL STORE) | | | 11/780 | 239.00 |
| M8129-00 | FRACTION PROCESSOR EXPONENT PATH | | | 11/70 | 155.00 | M8255-00 | UNIBUS SERIAL CONSOLE MICRO CONTROL QUAD | | | 11 FAMILY | 155.00 |
| M8131-00 | M8101 MODIFIED,GRA (GENERAL REGS & ALU C | | | 11/70 | 130.00 | M8265-00 | DATA PATH,HEX(KD11EA) | A | | 11/34-34A | 171.00 |
| M8132-00 | M8102 MODIFIED,IRC (IR DECODE & COND COD | | | 11/70 | 130.00 | M8266-00 | CONTROL,HEX(KD11EA) | A | | 11/34-34A | 171.00 |
| M8133-00 | M8103,MODIFIED,RAC (ROM & ROM CONT),4-LA | | | 11/70 | 155.00 | M8267-00 | HEX(FP11A) | | | 11/34-34A | 219.00 |
| M8134-00 | M8104 MODIFIED,PDR (PROC DATA & UNIBUS R | | | 11/70 | 130.00 | M8268-00 | CACHE HEX MODULE | | | 11/34-34A | 150.00 |
| M8135-00 | M8105 MODIFIED; TMC (TRAP & MSC CONTROL) | | | 11/70 | 130.00 | M8270-00 | YSI SBI INTERFACE | B | A | 11/780 | 239.00 |
| M8136-00 | M8106 MODIFIED; UBC (UNIBUS & CONSOLE CO | | | 11/70 | 130.00 | M8271-00 | YMD UNIBUS MAP AND DATA PATH | A | A | 11/780 | 239.00 |
| M8137-00 | M8107 MODIFIED; SAP (SYSTEM ADDRESS PATH | | | 11/70 | 124.00 | M8273-00 | UNIBUS ADAPTER CONTROL | | | 11/780 | 219.00 |
| M8138-00 | M8108 MODIFIED; SSR (SEGMENTATION STATUS | | | 11/70 | 155.00 | M8275-00 | MSI MASSBUS ADAPTER SBI INTERFACE | A | B | 11/780 | 239.00 |
| M8138-YA | SSR (SEAGMENTATION STATUS REG) 4-LAYER H | | | 11/70 | 124.00 | M8276-00 | MIR MASSBUS INTERNAL REGISTERS | A | B | 11/780 | 239.00 |
| M8139-00 | M8109 MODIFIED; TIG (TIMING GENERATOR) 4 | | | 11/70 | 160.00 | M8277-00 | USE M8274 | C | | 11/780 | 00.00 |
| M8140-00 | SEGMENT + CONSOLE CONT | | | 11/70 | 124.00 | M8278-00 | MCB MASSBUS ADAPTER CONTROL | B | A | 11/780 | 239.00 |
| M8141-00 | MAPPING BOX | A | | 11/70 | 130.00 | M8285-00 | FOATING POINT FRACTION NORMALIZER | A | A | 11/780 | 239.00 |
| M8142-00 | CACHE CONTROL BRD | B | | 11/70 | 130.00 | M8286-00 | FLOATING POINT FRACTION MULTIPLIER | A | B | 11/780 | 239.00 |
| M8143-00 | CACHE ADM (ADDRESS MEMORY BOARD) 4-LAYER | B | A | 11/70 | 155.00 | M8287-00 | FLOATING POINT FRACTION ADDER | A | | 11/780 | 239.00 |
| M8145-00 | CACHE DATA PATH | B | | 11/70 | 155.00 | M8288-00 | FLOATING POINT ACCELERATOR CONTROL | C | A | 11/780 | 150.00 |
| M8149-00 | MEM TRANSCEIVER CARD | | | MEMORIES | 124.00 | M8289-00 | FP780,FCT,FLOATING PT ACCELERATOR CONTROL | A | | 11/780 | 239.00 |
| M8150-00 | RH55 MASSBUS DATA PATH | | | 11/70 | 190.00 | M8315-00 | CPU OMNIBUS 8E INSTRUCT | | | PDP8 FAM | 143.00 |
| M8151-00 | RH55 CONTROL + STATUS | A | | 11/70 | 184.00 | M8317-YB | M8317 ETCH REV E,SPLIT LUG JUMPERS TO DI | | | PDP8 FAM | 119.00 |
| M8152-00 | RH55 ADDRESS + WORD COUNT | A | | 11/70 | 124.00 | M8330-00 | TIMING GEN FOR KK8-E W/STOP CLK INPUT,QU | | | PDP8E,M,F | 166.00 |
| M8153-00 | RH55 UNIBUS CONTROL | B | | 11/70 | 150.00 | M8350-00 | POSITIVE 10 BUS INTERFACE | | | PDP8E,M,F | 76.00 |
| M8158-00 | MK11 ADDRESS BUFFER 4 LAYER HEX | C | | MEMORIES | 130.00 | M8375-00 | MEMORY CONTROL,4-LAYER HEX 12 | C | C | 11/780 | 238.00 |
| M8161-00 | 11/70 CONTROL B | B | | MEMORIES | 124.00 | M8376-00 | SBI INTERFACE,4-LAYER HEX 12 | D | E | 11/780 | 208.00 |
| M8164-00 | MK11,MKA11 DATA BUFFER,4 LAYER HEX,WILL | A | | MEMORIES | 95.00 | M8388-00 | RB730 IDC (INTEGRATED DISK CONTROLLER) H | B | | 11/730 | 499.00 |
| M8186-00 | KDF11-A DUAL HEIGHT CPU,Q-BUS PDP11 (DCF | C | A | 11/23-23B | 143.00 | M8389-00 | FPA (FLOATING POINT ACCELERATOR) | | | 11/730 | 848.00 |
| M8189-00 | USE KDF11-BA | C | | 11/23-23B | 00.00 | M8390-00 | DAP (DATA PATH) | B | | 11/730 | 449.00 |
| M8190-AB | 15MHZ QUAD CPU MOD,DCJ11-AA,2 BOOT & DIA | | | 11/730 | 489.00 | M8391-00 | MCT (MEMORY CONTROLLER) HEX | B | E2 | 11/730 | 507.00 |
| M8190-AE | 18MHZ QUAD CPU MOD,DCJ11-AA,2 BOOT & DIA | | | 11/730 | 408.00 | M8394-00 | WRITEABLE CONTROL STORE,HEX | B | | 11/730 | 563.00 |
| M8192-YB | DUAL HEIGHT CPU BRD (KDJ11-A),Q-BUS,DCJ1 | | | LSI11 | 499.00 | M8396-00 | DMF32 I/O MUX,HEX | D | C | 11/730 | 428.00 |
| M8192-YC | DUAL HEIGHT CPU BRD (KDJ11-A),Q-BUS,DCJ1 | | | LSI11 | 646.00 | M8411-00 | DATA PATH 8A FPP | | | PDP8 FAM | 200.00 |
| M8203-00 | DMP11 LINE UNIT,RS-449,INTEGRAL MODEM,HE | E | K1 | 11 FAMILY | 261.00 | M8433-00 | RL8A,RL01 CONT,4-LAYER HEX | | | PDP8 FAM | 259.00 |
| M8204-00 | IOP MICRO PROCESSOR | | | 11 FAMILY | 238.00 | M8436-BA | M8436 W 32K 12BIT MEMORY | F | A | VT FAMILY | 527.00 |
| M8207-RA | MICROPROCESSOR BASED SYNCHRONOUS COMMUNI | C | F | 11 FAMILY | 314.00 | M8512-00 | DATA PATH BOARD KL10 | | | KL10 | 200.00 |
| M8210-00 | MOS MEMORY ARRAY | B | | MEMORIES | 257.00 | M8514-00 | KL10 CACHE BOARD | | | KL10 | 264.00 |
| M8212-00 | MDT MEMORY DATA PATH | B | D | 11/780 | 239.00 | M8541-00 | CONTROL RAW ADDRESS | | | KL10 | 347.00 |
| M8213-00 | MCN MEMORY CONTROLLER | B | | 11/780 | 239.00 | M8548-00 | TIME MODULE | | | KL10 | 347.00 |
| M8214-00 | MEMORY SBI BOARD | | | 11/780 | 290.00 | M8634-PA | Q-BUS INTERFACE TO IEEE488/IEC625 BUS W/ | | | MICROVAX2 | 530.00 |
| M8217-00 | UNIBUS TO LSI-11 BUS CONVERTER | | | 11/780 | 219.00 | M8639-YA | Q-BUS CONTROL FOR RD51 OR RD52 + RX50 | | | MICROVAX1 | 549.00 |



Prices Effective 02-January-89 to 30-June-89
When you need a part repaired, call 800-225-5385.

FACTORY REPAIR SAME BOARD RETURN

| PART NUMBER | DESCRIPTION | LOWEST ACCEPTABLE | | | REPAIR PRICE | PART NUMBER | DESCRIPTION | LOWEST ACCEPTABLE | | | REPAIR PRICE |
|-------------|---|-------------------|-----|-----------|--------------|-------------|---|-------------------|-----|-----------|--------------|
| | | ETCH | REV | USED ON | | | | ETCH | REV | USED ON | |
| M8655-00 | TERMINAL CONTRL KL8-JA | | | PDP8E,M,F | 95.00 | 54-11170-04 | KEYBOARD VT61/VT50H | | | VT50 FAM | 95.00 |
| M8685-00 | DATA SEQUENCER,4-LAYER HEX,WILL REPLACE | | | RM80 | 150.00 | 54-11170-08 | KEYBOARD VT61/VT50H | | | VT50 FAM | 52.00 |
| M8707-00 | 8-LINE ISOCRONOUS MUX,THROTTLE CTL_HEX | | | 11 FAMILY | 1910.00 | 54-11278-00 | VT 61 BOARD "A" | | A | VT61-61T | 100.00 |
| M8708-00 | DIFF TRANSCEIVER,MIL STD 188-114_HEX(RE | | | 11 FAMILY | 1894.00 | 54-11278-01 | INPUT_OUTPUT FOR VT62 | H | A | VT62 | 124.00 |
| M8716-00 | DR11-W,DMA INTERFACE,DR11-B IN HEX | E | E | 11 FAMILY | 162.00 | 54-11280-00 | VT 61 MEMORY BOARD | | | VT61-61T | 138.00 |
| M8728-AA | 64K X 39 MOS MEM ARRAY,=M8728-AB THRU -A | B | A | MEMORIES | 162.00 | 54-11282-00 | VT 61 PROM BOARD | | | VT61-61T | 141.00 |
| M8750-CA | 1MB(256K X 39) ECC MOS RAM ARRAY,64K PAR | | | MEMORIES | 200.00 | 54-11282-01 | PROM BOARD YT61 | | | VT61-61T | 141.00 |
| M8901-YB | TU16 DATA SYNCHRONIZER,QUAD 8.5,REPLACES | | | TU16 | 90.00 | 54-11284-00 | VT 61 BOARD "B" | | | VT61-61T | 190.00 |
| M8901-YD | TM03-AB DATA SYNCHRONIZER FOR 125 IPS DR | | | TM03 | 90.00 | 54-11284-01 | MODULE VT61 B BOARD | | | VT62 | 190.00 |
| M8906-00 | 16-BIT FIDDLER (TM02) | | | TM02 | 70.00 | 54-11284-02 | VIDEO PROCESS MODULE FOR VT62 | | | VT62 | 200.00 |
| M8909-YA | TM02/3 MASSBUS INTERFACE,HEX (REPLACES M | D | | TM02 | 138.00 | 54-11444-00 | MONITOR BOARD | K | E | VT61-61T | 124.00 |
| M8910-00 | LOGIC & WRITE BD (TU16) | | | TU16 | 105.00 | 54-11444-01 | VT78 MONITOR | | | VT FAMILY | 100.00 |
| M8916-00 | LOGIC AND WRITE BOARD | C | B | TU16 | 130.00 | 54-11601-00 | MOS REGULATOR 15V | | | 11 FAMILY | 86.00 |
| M8924-00 | PE FORMAT | | | TS FAMILY | 100.00 | 54-11743-04 | ROM VART | A | | VT50 FAM | 164.00 |
| M8926-00 | MODULE TU10-W INTERFACE | | | TU10 | 190.00 | 54-11745-00 | DATA PATH | A | | VT50 FAM | 164.00 |
| M8932-00 | TAPE CONTROL P.E. | | | TM03 | 90.00 | 54-11776-00 | H780 POWER SUPPLY | | | 11/03 | 157.00 |
| M8933-00 | MODULE TAPE CONTROL TM03 | | | TM03 | 144.00 | 54-12166-00 | LA180 MODULE | | | LA180 | 67.00 |
| M8934-00 | TAPE CONTROL, NRZ1 | | | TM03 | 105.00 | 54-12166-YA | LA180 MODULE | C | H | LA180 | 67.00 |
| M8935-00 | RS422 PARALLEL LINE UNIT FOR KMC11 | | | | 399.00 | 54-12175-00 | DRIVE LOGIC RL01 | | | RL01 | 110.00 |
| M8940-00 | MTA | | | TU77 | 147.00 | 54-12242-00 | POWER SUPPLY TU16 | A | | TU16 | 135.00 |
| M8950-00 | TM78, READ CHANNEL | | | TM78 | 95.00 | 54-12610-01 | LS120 LOGIC BOARD | A | D | LA120 | 152.00 |
| M8952-00 | CRC + ACRC | | | TM78 | 65.00 | 54-12660-00 | CMOS-8 | | | VT FAMILY | 238.00 |
| M8953-00 | READ PATH SEQUENCER | | | TU/TA78 | 295.00 | 54-12691-00 | CM08-8 MEMORY | A | B | VT FAMILY | 160.00 |
| M8956-00 | TM78,MASSBUS DATA PORT,QUAD | | | TM78 | 57.00 | 54-13009-00 | VT100 BASIC VIDEO CONTROLLER | E | 1 | VT100 FAM | 95.00 |
| M8957-00 | TM78,MASSBUS CONTROL,QUAD | | | TM78 | 57.00 | 54-13009-03 | VT100 BASIC VIDEO | E | | VT100 FAM | 114.00 |
| M8960-00 | TM78,MICRO COMPUTER,QUAD (8085 CHIP) | | | TM78 | 144.00 | 54-13269-00 | TIM PERIPHERAL MODULE | D | | 11 FAMILY | 100.00 |
| M8964-00 | ROM BOARD | | | 11 FAMILY | 109.00 | 54-13271-00 | TERMINAL INTELLIGENCE MODULE | D | | 11 FAMILY | 147.00 |
| M8968-00 | TS04,ROM EXTENSION BOARD, DOUBLE 8.5 | | | TS FAMILY | 114.00 | 54-13273-00 | FLOPPY CONTROLLER R-W | E | | 11 FAMILY | 164.00 |
| M9301-YX | M9301 WITH RAINBOW BOOTSTRAP | | | 11 FAMILY | 86.00 | 54-13374-00 | LA00 LOGIC BOARD | C | D | LA34 | 109.00 |
| M9312-00 | BOOTSTRAP TERMINATOR W 5 EMPTY ROM SOCKE | | | 11/24 | 95.00 | 54-13534-00 | DC SERVO + POWER SUPPLY (RL02) | | | RL02 | 95.00 |
| MSV11-CD | 16K MOS RAM (M7955-AD) | | | MEMORIES | 131.00 | 54-13536-00 | RL02 READ/WRITE | | | RL02 | 119.00 |
| MSV11-DC | 16 16 BIT MOS RAM,16K CHIPS M8044-CA | | | MEMORIES | 114.00 | 54-13596-00 | READ/WRITE | | | RM80 | 124.00 |
| MSV11-DD | 32K 16 BIT MOS RAM,16K CHIPS M8044-DA | D | B | MEMORIES | 114.00 | 54-14012-00 | MICRO PROCESSOR | | | RM80 | 250.00 |
| MSV11-ED | 32K 18 BIT MOS RAM,16K CHIPS M8045-DA | H | C | MEMORIES | 87.00 | 54-14025-00 | DRIVE LOGIC | B | F | RL02 | 100.00 |
| T1001-00 | KA820-AA SCORPIO CPU MODULE,8" X 9.19(ZI) | 1B | D1 | VAX8200 | 4750.00 | 54-14185-00 | VT101 TERMINAL CONTROL | F | | VT100 FAM | 143.00 |
| T1001-YA | SARGAS VAXBI CPU MODULE,8" X 9.19",ZIFF | | | VAX8200 | 4750.00 | 54-14185-01 | VT102 TERMINAL CONTROL | F | | VT100 FAM | 143.00 |
| T1002-00 | BI-DISK-ADAPTER I (BDA) | | | KDB50 | 912.00 | 54-14185-02 | VT131 TERMINAL CONTROL | F | | VT100 FAM | 143.00 |
| T1003-00 | BI-DISK-ADAPTER TO SDI | | | KDB50 | 893.00 | 54-14230-00 | VK100 LOGIC BOARD | | | VK100 | 342.00 |
| T1010-00 | BUA (BI UNIBUS ADAPTER) MODULE | | | VAX8200 | 2280.00 | 54-14256-00 | LA100 LOGIC BOARD | F | | LA100 | 91.00 |
| T1017-00 | BI-BUS TO CI750 INTERFACE CONTROL MODULE | | | VAX8200 | 475.00 | 54-15058-00 | RX50 FLOPPY CONTROL(CAN DRIVE 2 RX50'S) | | | RX50 | 81.00 |
| T1020-00 | NAUTILUS MEM INTERCONNECT(NMI) INTF TO B | | 2B | VAX8200 | 1093.00 | 54-15084-FA | C.T. RAM 128 KB | | | PC FAMILY | 48.00 |
| T1022-00 | VAXBI BUS TO DRB BUS CONVERTER MODULE | | | DRB32 | 713.00 | 54-15134-00 | RD 50 CONTROL | | | RD FAMILY | 190.00 |
| T1023-00 | DRB32 TO DR11-W BUS ADAPTER INTERCONN MO | | | DRB32 | 214.00 | 54-15134-01 | RD52 CONTROL | | | RD FAMILY | 190.00 |
| T1024-00 | DRB32 TO EXTEND DRB32 BUS ADAPTER MODULE | | | DRB32 | 499.00 | 54-15138-00 | CT100 VIDEO GENERATOR | C | C | PC FAMILY | 76.00 |
| VR201-A | VR201 QTR-PAGE (24LX80C) MONITOR WITH WH | | | PC FAMILY | 86.00 | 54-15146-00 | CT100 COLOR BIT MAP | A | C | PC FAMILY | 90.00 |
| VR201-B | VR201 QTR-PAGE (24LX80C) MONITOR WITH GR | | | PC FAMILY | 84.00 | 54-15160-00 | AZTEC DISK POWER SUPPLY | D | 4B | RC25 | 114.00 |
| VR201-C | VR201 QTR-PAGE (24LX80C) MONITOR WITH AM | | | PC FAMILY | 84.00 | 54-15247-00 | R81 MICRO PROCESSOR MODULE | B | D | RA81 | 649.00 |
| 2K-E0EAA-00 | MODULE | | | VT30 | 1000.00 | 54-15253-00 | R81 READ/WRITE MODULE | B | B | RA81 | 384.00 |
| 30-19858-01 | PRINTER,R.O. LA50 | | | LA50 | 238.00 | 54-15264-01 | POST AMP/DATA SEPARATOR MODULE | C1 | E1 | RA60 | 285.00 |
| 54-09728-00 | BOARD REGULATOR | D | | PDP8E,M,F | 105.00 | 54-15266-01 | DRIVE LOGIC MODULE | C | | RA60 | 428.00 |
| 54-10541-00 | MAIN KEYBOARD (LK01-R) | C | A | VT220 | 100.00 | 54-15270-01 | I/O MODULE | D | | RA60 | 475.00 |
| 54-10805-00 | LA36 POWER BOARD | B | | LA36 | 75.00 | 54-15272-01 | FRONT PANEL | | | RA60 | 95.00 |
| 54-10886-00 | MON/POW SUPPLY (VT50-AA | C | | VT50 FAM | 109.00 | 54-15284-01 | RA80 MICROPROCESSOR | | | RA80 | 244.00 |
| 54-11042-00 | POWER AMP RK06 | | | RK06 | 114.00 | 54-15451-00 | PC278 APU | B | A | DECMATE | 105.00 |
| 54-11086-00 | +15V REGULATOR (BA11-K) | D | A | RM03 | 57.00 | 54-16019-00 | PC100 RD51 CONTROLLER | | | PC FAMILY | 171.00 |



Prices Effective 02-January-89 to 30-June-89
When you need a part repaired, call 800-225-5385.

FACTORY REPAIR SAME BOARD RETURN

| PART NUMBER | DESCRIPTION | LOWEST ACCEPTABLE | | | REPAIR PRICE | PART NUMBER | DESCRIPTION | LOWEST ACCEPTABLE | | | REPAIR PRICE |
|-------------|----------------------------------|-------------------|-----|-----------|--------------|-------------|-----------------------------------|-------------------|-----|-----------|--------------|
| | | ETCH | REV | USED ON | | | | ETCH | REV | USED ON | |
| 54-16188-01 | R82 SERVO CONTROL | | | RA82 | 941.00 | 70-16723-02 | LOW VOLTAGE 60HZ | | | RL02 | 350.00 |
| 54-16190-01 | R82 HYBRID MODULE | | | RA82 | 1014.00 | 70-16976-00 | SERVO BOARD AND STIFFENER ASSY. | | | RM80 | 324.00 |
| 54-16192-01 | R82 READ/WRITE MODULE | | | RA82 | 618.00 | 70-17298-00 | PANEL ASSY DF03-A TLI | | | MODEMS | 138.00 |
| 54-16239-01 | EBO MODULE 84 | | | PC3XX FAM | 613.00 | 70-18327-00 | PERSONALITY BD. AND STIFFNER ASSY | | | RA80 | 210.00 |
| 54-16489-01 | DECMATE ITT SYSTEM BD. | 2D | 2A | PC FAMILY | 190.00 | 70-18474-01 | POWER MODULE ASSEMBLY | | D | RA60 | 532.00 |
| 70-08702-00 | LINEAR POSITIONER | | | RK05 | 440.00 | 70-18704-00 | PRINTER MECH ASSY. | | | LA12 | 100.00 |
| 70-09014-01 | TRANSPORT ASY DIE CAST (TU60) | | | TU60 | 143.00 | 70-18759-00 | SUPPLY +5V MEMORY OPT | | | 11/780 | 608.00 |
| 70-09691-00 | MOTOR DC & ENCODER ASSY (LA36) | | | LA36 | 119.00 | 70-18759-01 | SUPPLY +5V MEMORY OPT | | | 11/780 | 608.00 |
| 70-10092-00 | DC MOTOR & ENCODER ASSEMBLY | | | LA180 | 119.00 | 70-19045-01 | SERVO BD AND STIFF ASSEMBLY | | B | RA81 | 674.00 |
| 70-10718-00 | BOARD POWER ASSY H771 | | | RX01 | 76.00 | 70-19046-01 | PERSONALITY BD AND STIFF ASSY | | B1 | RA81 | 384.00 |
| 70-12912-00 | CAP BRD BRKT ASSY | | | RK06 | 67.00 | 70-19499-01 | CHASSIS ASSY | | A | VT240 | 114.00 |
| 70-13077-00 | FLEXIBLE DRIVE ASSY (60HZ) | | | RX01 | 176.00 | 70-19973-00 | CPU ASSY, DECMATE | | C | DECMATE | 152.00 |
| 70-13077-01 | FLEXIBLE DRIVE ASSY (50HZ) | | | RX01 | 176.00 | 70-19974-00 | CPU ASSY, RAINBOW 100 | | E | PC FAMILY | 190.00 |
| 70-13077-06 | 60HZ DRIVE WITH BROWN HANDLE | | | RX01 | 176.00 | 70-19974-02 | CPU ASSY, RAINBOW 100B LANG CL1 | | | PC FAMILY | 261.00 |
| 70-14653-11 | USE 701576511 | | | VT100 FAM | 00.00 | 70-20184-01 | POWER SUPPLY ASSY, OPT 120V 60HZ | | | HSC50/70 | 618.00 |
| 70-14956-00 | UDA OPTION SUPPLY | | | 11/780 | 523.00 | 70-20624-01 | PCB BEZEL ASSY | | A | VT220 | 95.00 |
| 70-14979-00 | POWER SUPPLY ASSY | | C | VT100 FAM | 95.00 | 70-20689-01 | MODULE ACCESS DOOR ASSY | | | LA210 | 109.00 |
| 70-15116-00 | SPINDLE ASSY | | | RL02 | 190.00 | 70-20814-02 | TERMINAL CONTROLL BD. BEZEL ASSY. | | | VT220 | 119.00 |
| 70-15388-00 | SERVO MOTOR ASSY | | | LA120 | 109.00 | 70-23361-01 | POWER SUPPLY/MONITOR ASSY | | A | VT220 | 31.00 |
| 70-15763-00 | USE 701763001 | | D | LA120 | 00.00 | 70-23363-01 | TCB ASSY | | A | VT220 | 46.00 |
| 70-15765-00 | KEYBOARD/KEYCAP ASSY | | B | VT100 FAM | 65.00 | | | | | | |
| 70-15765-03 | KEYBOARD/KEYCAP ASSY | | | VT100 FAM | 76.00 | | | | | | |
| 70-15765-09 | VT100 KEYBOARD FOR PRIVATE BRAND | | A | VT100 FAM | 67.00 | | | | | | |
| 70-15765-10 | KEYBOARD KEYCAP ASSY | | | VT100 FAM | 67.00 | | | | | | |
| 70-15765-11 | KEYBOARD KEYCAP ASSY. | | | VT100 FAM | 67.00 | | | | | | |



Prices Effective 02-January-89 to 30-June-89
When you need a part repaired, call 800-225-5385.

Part E
Purchase Policies/Terms and Conditions

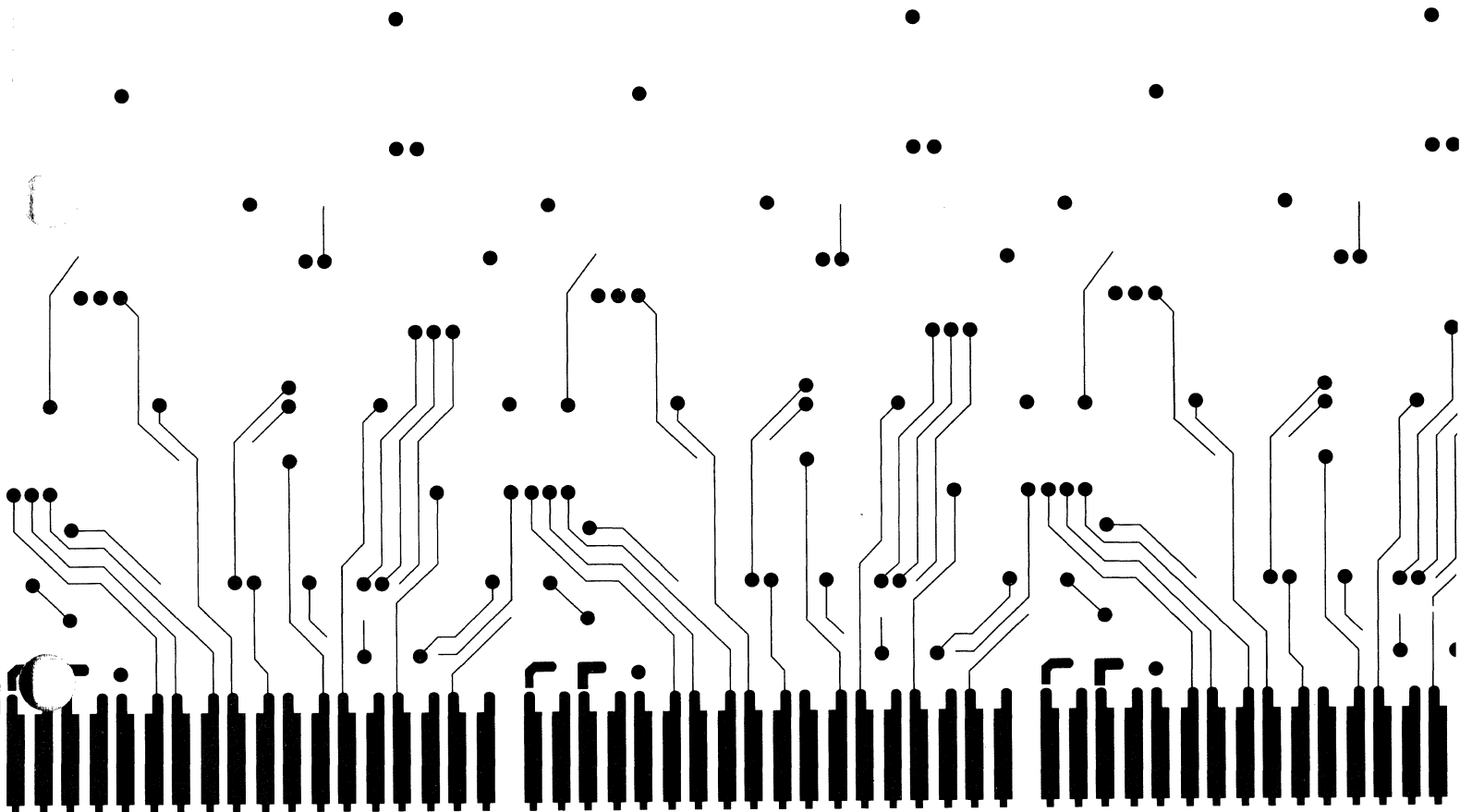

Digital Equipment Corporation U.S. Standard Terms and Conditions

The following are the Terms and Conditions under which Digital Equipment Corporation ("DIGITAL") sells and licenses Products, Services, and Distributed Software in the United States of America.

1. Definitions

1.1 "Equipment" refers to computer systems (excluding software), related hardware, accessories, and spare parts listed in the Price List. Equipment may be manufactured using refurbished components or may have been used internally for ongoing reliability testing. Spare parts may be refurbished.

1.2 "Software" refers to software products (including databases), listed in the Price List, supplied with Equipment, or otherwise supplied or developed by DIGITAL including packaged application software and software supplied in connection with Services. The term "Software" applies to all parts of Software, and to new releases, updates, and modifications of Software, but does not include Distributed Software.

1.3 "Distributed Software" refers to third-party software products, including databases, licensed directly to Purchaser by a third party and identified as such.

1.4 "Documentation" refers to manuals, handbooks, maintenance libraries, and other publications listed in the Price List or supplied with Software or Equipment listed in Price List or supplied in connection with Services. The term "Documentation" does not include Software Product Descriptions, Service Descriptions, Software, or Distributed Software.

1.5 "Services" refers to DIGITAL standard software services, equipment services and educational services, for which there is a Service Description, but does not refer to custom services.

1.6 "Products" refers to Equipment, Software, and Documentation or other products furnished under these Terms and Conditions, but not to Services or to Distributed Software. For Software, other licensed Products and Distributed Software, the term "purchase" means "license" and the term "Purchaser" means "Licensee."

1.7 "Price List" refers to the DIGITAL published price list: i) applicable to the Products or Services that are the subject of a particular order, and ii) that is current when the order is accepted.

1.8 "Software Product Descriptions" ("SPDs") refers to documents of this name and any addenda thereto which provide Software specifications, warranty, and license information for Software described therein.

1.9 "Service Descriptions" refers to documents of this name which provide information regarding DIGITAL's and Purchaser's obligations for Services provided under these Terms and Conditions.

2. Orders, Prices and Fees

Prices and fees for Products, Distributed Software, and Services will be as specified in an authorized DIGITAL quotation that is current at the time an order is accepted, or in the absence of a quotation, shall be DIGITAL's standard prices and fees specified in the Price List. Fees for and services included with Software licensed under a Periodic Payment License ("PPL") may be changed by DIGITAL upon ninety (90) days' written notice.

3. Taxes

Prices and fees are exclusive of and Purchaser is responsible for all applicable taxes on the sale, license, or use of Products and Distributed Software or on the provision of Services, except for taxes based on DIGITAL's net income.

4. Delivery

Products and Distributed Software will be delivered F.O.B. DIGITAL's plants. Purchaser will be responsible for constructed transportation charges, and for insurance at rates in effect at the time an order is accepted. Purchaser may elect to provide its own insurance by providing specific written notice to DIGITAL.

5. Security Interest

DIGITAL reserves a purchase-money security interest in each Product delivered and, in the case of authorized resellers, in any proceeds of the Product including accounts receivable. Purchaser agrees to sign upon request, any document necessary to perfect DIGITAL's security interest.

6. Payment

Payment for Products and Distributed Software is due thirty (30) days from the date of delivery, provided Purchaser maintains credit arrangements satisfactory to DIGITAL. Payment for Services and of fees for which no "delivery" of Products is involved is due upon receipt of invoice.

7. Cancellation and Rescheduling Charges

Cancellation or rescheduling by Purchaser of an order for Products or Distributed Software thirty (30) days or less prior to the acknowledged delivery date will be subject to a charge to Purchaser of five percent (5%) of the list price of the Products or Distributed Software to a maximum of ten thousand dollars (\$10,000). Rescheduling of an order is subject to acceptance by DIGITAL.

Cancellation charges for regularly scheduled courses conducted at a DIGITAL facility are fifty percent (50%) of the course price if cancelled fourteen (14) days or less prior to the scheduled start date. Cancellation charges may also be incurred as specified in the applicable Service Description in the event of Purchaser's cancellation of Services furnished under agreement.

8. Installation

Products or Distributed Software will be installed by DIGITAL at Purchaser's facility in the United States if the price includes installation or if Purchaser separately purchases installation services. Availability of installation is specified in the Price List. Installation shall be deemed complete upon the successful execution of DIGITAL's diagnostic programs. Purchaser is responsible for preparation of a safe and suitable site in accordance with DIGITAL's site specifications. Additional installation charges may be imposed if DIGITAL is prevented from installing the Products for more than thirty (30) days after delivery.

9. Warranty

9.1 Equipment

Equipment is warranted by DIGITAL to Purchaser against defects in workmanship and material during the applicable warranty period.

9.1.1 The warranty period for Equipment is specified in the Price List. The period begins on the date installation is completed, or upon delivery if the Equipment is not installed by DIGITAL.

9.1.2 Warranty service will be provided in the United States at either Purchaser's facility or a DIGITAL repair facility, as specified in the Price List.

9.2 Software

DIGITAL warrants to Purchaser that Software designated as warranted in the SPD or the Price List will conform to the SPD applicable to the Software at the time an order is accepted. The term of the warranty and the manner in which DIGITAL will remedy any nonconformance is specified in the SPD or the Price List. All other Software is provided "as is." DIGITAL does not warrant that the execution of Software shall be uninterrupted or error free.

9.3 Distributed Software and Documentation

DIGITAL does not warrant the form or content of Distributed Software or Documentation, both of which DIGITAL provides "as is." Certain Distributed Software is warranted by the third party.

9.4 Limitation of Warranty

The warranties provided in Subparagraphs 9.1 and 9.2 are limited warranties and do not apply to:

- a) any Products, other than Equipment or Software, which may be sold or licensed by DIGITAL. The above are sold or licensed "as is," or are warranted directly to Purchaser by a third party, or
- b) conditions resulting from improper use of the Equipment or Software or operation of the Equipment outside the specified environmental conditions, or
- c) conditions resulting from causes external to the Equipment after delivery, or
- d) conditions resulting from modifications to Equipment or Software other than modifications made by DIGITAL.

9.5 Service Warranty

DIGITAL warrants that Services will be provided in a workmanlike manner in accordance with the Service Description applicable at the time of order.

9.6 Remedies

Purchaser's remedies for DIGITAL's obligations under Paragraph 9 are as set forth in Paragraph 15.

9.7 Disclaimer of Warranties

THE ABOVE WARRANTIES ARE THE EXCLUSIVE WARRANTIES, AND NO OTHER WARRANTY, EXPRESS OR IMPLIED, SHALL APPLY. DIGITAL SPECIFICALLY DISCLAIMS THE IMPLIED WARRANTIES OF MERCHANTABILITY AND FITNESS FOR A PARTICULAR PURPOSE.

10. Patents and Copyrights

10.1 Defense and Indemnification

DIGITAL shall defend, at its expense, any claim (including any suit) brought against Purchaser alleging that any Equipment, Software or Documentation furnished hereunder infringe a United States patent, copyright, or mask work right, and shall pay all costs and damages finally awarded, provided that Purchaser gives DIGITAL prompt written notice of such claim, and information, reasonable assistance and sole authority to defend or settle the claim. In the defense or settlement of the claim, DIGITAL may obtain for Purchaser the right to continue using the Equipment, Software or Documentation replace or modify the Equipment, Software or Documentation so they become non-infringing, or, if such remedies are not reasonably available, grant Purchaser a credit for the Equipment, Software or Documentation as depreciated and accept their return. DIGITAL shall not have any liability if the alleged infringement is based upon the use, license or sale of the Equipment, Software or Documentation in combination with other products (including software) not furnished by DIGITAL. DIGITAL DISCLAIMS ALL OTHER LIABILITY FOR VIOLATION, MISAPPROPRIATION OR INFRINGEMENT OF INTELLECTUAL PROPERTY RIGHTS, AND FURTHER DISCLAIMS ANY LIABILITY FOR INCIDENTAL OR CONSEQUENTIAL DAMAGES.

10.2 Patent License

For Equipment which has a UNIBUS or Q-BUS interconnection bus, DIGITAL grants to Purchaser a non-transferable license under U.S. Patent 3,815,099, effective on DIGITAL's acceptance of Purchaser's order for the Equipment, to manufacture, but not to have manufactured, up to ten (10) Devices (as defined below) for connection to the Equipment through the bus, and to use or, to the extent that Purchaser is authorized by DIGITAL to resell the Equipment under a written agreement and any applicable addendum thereto, to sell a system containing the Equipment and the manufactured Devices. The term "Device" means a memory or peripheral unit adapted to be directly connected to the bus, or an interface for a memory or peripheral unit enabling it to be connected in such a way that the connected memory or peripheral unit is covered by one or more claims of U.S. Patent 3,815,099.

11. SOFTWARE LICENSE

Purchaser receives no right to use any Software except by the grant of a Software license by DIGITAL. A Software license identifies the Software and the processor or equipment configuration on which the Software may be executed and may identify additional license terms.

11.1 Grant of Software License

On DIGITAL's acceptance of Purchaser's order for a Software license DIGITAL grants Purchaser a Software license as provided below. For Software supplied by DIGITAL with Equipment or in connection with Services (except the Software indicated in Paragraph 13) or for Packaged Applications Software, Purchaser's order for Equipment or Services or the Packaged Application Software shall constitute the order for a Software License.

Purchaser's license shall continue unless terminated as provided herein.

These Terms and Conditions govern the license granted by DIGITAL to Purchaser and Purchaser's obligations thereunder. DIGITAL grants no Software licenses whatsoever, either explicitly or implicitly, except by acceptance of an order for a Software license. Storage media which Purchaser receives from DIGITAL may contain certain Software for which DIGITAL has not accepted an order from Purchaser for a Software license. If Purchaser desires to license this Software, Purchaser must obtain the appropriate Software licenses from DIGITAL. Technical means may be incorporated in Software to prevent Purchaser's access to unlicensed Software.

11.2 Standard License Terms

11.2.1 Software Execution

Purchaser may execute the Software on the Licensed Processor, and may load, copy or transmit the Software, in whole or in part, only as necessary for execution on the Licensed Processor, except that: i) Purchaser may execute the Software (except diagnostic Software) on another single processor or equipment configuration on a temporary basis during a malfunction which prevents execution of the Software on the Licensed Processor, and may load, transmit, or copy the Software as necessary for such temporary execution; and, ii) Purchaser may make archival copies of the Software as provided in the Copyright Law of the United States.

The term "Licensed Processor" shall mean a processor or equipment configuration of the type specified in the license: i) the serial number of which is specified in the DIGITAL license certificate furnished by DIGITAL or in the Software license order acknowledged by DIGITAL, or, if none is so specified, ii) on which the Software is first executed pursuant to the license grant.

11.2.2 Modification and Merger

Purchaser may i) modify the Software (in machine readable form only), or ii) merge modified Software or unmodified Software into other software, to form adaptations intended solely for execution by Purchaser on the Licensed Processor. Any part of the Software included in such adaptations will continue to be subject to these Terms and Conditions and of the applicable Software license.

11.2.3 Access to Software

Purchaser may make the Software available to its employees and agents to the extent needed to exercise its license hereunder. Purchaser may also make the Software available to eligible related parties (as defined in a Shared Access Agreement) which have executed a Shared Access Agreement agreeing to be bound by all the terms of Purchaser's license, and to their employees and agents in accordance with the terms of the Shared Access Agreement. Purchaser shall not make the Software available in any form to any parties except those identified in this Subparagraph 11.2.

To the extent that the Software contains any confidential or trade secret information, the Software and the information it contains are licensed to Purchaser pursuant to a confidential relationship. Purchaser expressly acknowledges this confidential relationship and agrees to keep the Software and information in confidence as provided herein.

11.2.4 Personal, Nonexclusive Licenses

Purchaser's license is personal and non-exclusive, and may not be transferred without DIGITAL's express consent, except as provided in DIGITAL's Software License Transfer Policy stated in the Price List in effect at the time of transfer.

11.2.5 Record Keeping

Purchaser shall keep complete and accurate records a) uniquely identifying the Software and the Licensed Processors (through retention of the DIGITAL issued license certificate or otherwise) and b) indicating where the Software is located. Within thirty (30) days after receiving a request from DIGITAL, Purchaser shall provide copies of the applicable records to DIGITAL, and if DIGITAL reasonably believes that the Software has been made available to any third party or executed (except as permitted by these Terms and Conditions) on any other processor or equipment configuration during the term of the license, Purchaser shall provide an explanation.

Purchaser agrees to reproduce DIGITAL's copyright and all other legal notices, including but not limited to other proprietary notices and notices mandated by governmental entities, on all complete or partial copies, adaptations, or transmissions of the Software.

11.2.6 License Limitation, Reverse Engineering

DIGITAL transfers no title to or ownership of any Software to Purchaser or any third party. Except as explicitly set forth in these Terms and Conditions, Purchaser shall not execute, use, copy, or modify the Software or take any action inconsistent with DIGITAL's intellectual property rights in the Software. Purchaser shall not decompile or reverse assemble the Software, or analyze or otherwise examine it for reverse engineering the Software or for reverse engineering any hardware or firmware implementation of the Software.

11.3 Additional License Terms

If Purchaser orders certain Software licenses, additional or modified terms may apply as indicated or referenced as follows:

11.3.1 Software License Order Without Media

If Purchaser's order specifies a Software license for which no corresponding media order is required by DIGITAL, then on DIGITAL's acceptance of the order, DIGITAL will grant to Purchaser the additional right to load, copy, or transmit a version of the Software already licensed to Purchaser and in Purchaser's possession for execution only on the Licensed Processor specified in Purchaser's order.

11.3.2 Sources

Additional terms apply to all Software license orders for source code Software. Purchaser must execute an appropriate source license agreement to obtain a license for source code Software.

11.3.3 New Versions

Applicable license terms and fees, if any, for new versions of the Software are specified in the Price List.

11.3.4 PPL

Software orders specifying a PPL license require payment of initial fees and ongoing periodic fees. Purchaser may terminate a PPL license effective at the end of any payment period on ninety (90) days prior written notice to DIGITAL.

11.3.5 Terms in Price List or SPD

For certain licenses additional or modified terms may apply as indicated and/or referenced in the Price List, the applicable SPD or Service Description.

11.4 License Termination

DIGITAL may terminate any licenses granted and any Software orders placed hereunder if Purchaser neglects or fails to perform or observe any of its obligations to DIGITAL under these Terms and Conditions, and such condition is not remedied within ten (10) days after written notice has been given to Purchaser.

Termination, whether by DIGITAL or Purchaser, shall apply to all versions of the Software licensed for execution on the Licensed Processor.

Before any termination by Purchaser becomes effective, and in the event of any termination by DIGITAL, Purchaser shall i) return to DIGITAL any license certificate furnished by DIGITAL, ii) destroy all copies of all versions of the Software in Purchaser's possession, iii) remove all portions of all versions of the Software from any adaptations made by Purchaser and destroy such portions, and iv) certify in writing that all copies, including all those included in Purchaser's adaptations, have been destroyed in accordance with DIGITAL's standard Destruction of Software certification.

11.5 Distributed Software

Distributed Software is licensed in accordance with the terms and conditions of the third-party license agreement accompanying the Distributed Software. Purchaser shall not load, execute, modify, copy, disclose, transfer, or otherwise use the Distributed Software except as provided in the applicable third party license agreement.

12. Reservation of Property Rights

12.1 The purchase or license of DIGITAL Products does not convey any right to combine or connect DIGITAL Products, protocols, or system architectures with products other than Authorized Products where DIGITAL has one or more patents covering such combination or connection. Authorized Products are: 1) products covered by an express license between DIGITAL and Purchaser, 2) products distributed directly or indirectly by DIGITAL, or 3) products distributed directly or indirectly by any Licensee of DIGITAL whose license includes the right to resell or sublicense such products.

12.2 Except as expressly set forth in these Terms and Conditions, DIGITAL grants no right, title, or interest in its intellectual property rights to Purchaser.

13. Maintenance Material

Diagnostic Software, Documentation, equipment or other material used by DIGITAL in the performance of installation, warranty, or Services may be furnished with Products or stored at Purchaser's facility. DIGITAL grants no title or license to such material, and it remains the exclusive property of DIGITAL. Purchaser agrees to properly secure such material and not to use it in any manner or make it available to third parties without DIGITAL's prior consent.

14. Export

Purchaser hereby acknowledges that it will not export any DIGITAL Products, Distributed Software or technical data (e.g., any technical information relating to Products or Distributed Software, written or otherwise), or any product incorporating Products, Distributed Software, or DIGITAL technical data, without first obtaining required U.S. Government export licenses. Purchaser further acknowledges that it is knowledgeable about U.S. Government export licensing requirements or that it will become so prior to engaging, directly or indirectly, in any export transaction involving Products, Distributed Software, or DIGITAL technical data.

15. Remedies and Limitations

15.1 DIGITAL's entire liability and Purchaser's remedies are set forth in this Paragraph 15, except as provided in Subparagraph 10.1. These remedies are Purchaser's exclusive remedies and are in lieu of any other remedy at law or in equity.

15.2 In all situations involving performance or nonperformance of Equipment and Software furnished hereunder, Purchaser's remedy is 1) repair or replacement by DIGITAL (at DIGITAL's option) of defective Equipment if notified by Purchaser of the defect within the warranty period, or 2) remedy, by DIGITAL in the manner specified in the SPD, of a nonconformance of Software to the applicable SPD during the stated warranty period. If DIGITAL fails to perform its warranty or service responsibilities, or if Purchaser has any other claim related Products or Services purchased or licensed from DIGITAL, Purchaser shall be entitled to recover only direct damages and only up to the limits set forth in Subparagraph 15.3.

15.3 DIGITAL'S LIABILITY TO PURCHASER FOR ANY CAUSE WHATSOEVER SHALL BE LIMITED TO THE GREATER OF ONE MILLION DOLLARS (\$1,000,000.00) OR THE PURCHASE PRICE PAID TO DIGITAL FOR THE PRODUCTS AND SERVICES THAT ARE THE SUBJECT OF PURCHASER'S CLAIM. THIS LIMITATION WILL APPLY REGARDLESS OF THE FORM OF ACTION, WHETHER CONTRACT OR TORT, INCLUDING WITHOUT LIMITATION NEGLIGENCE. THE FOREGOING LIMITATION DOES NOT APPLY TO DAMAGES RESULTING FROM PERSONAL INJURY CAUSED BY DIGITAL'S NEGLIGENCE.

15.4 IN NO EVENT WILL DIGITAL BE LIABLE FOR ANY DAMAGES RESULTING FROM LOSS OF DATA OR USE, LOST PROFITS OR ANY INCIDENTAL OR CONSEQUENTIAL DAMAGES.

15.5 Any action against DIGITAL must be brought within eighteen (18) months after the cause of action arises.

16. General Provisions

DIGITAL Products are manufactured for standard commercial uses and are not intended to be sold or licensed for use in critical safety systems in nuclear facilities. DIGITAL may require additional contractual safeguards for other nuclear, mass transportation, and aviation applications.

DIGITAL is not responsible for delay or failure to perform its obligations due to causes beyond its reasonable control. Installation, warranty, and Services to be performed at Purchaser's facility may not be performed if DIGITAL reasonably believes conditions at the Purchaser's facility represent a safety or health hazard to any DIGITAL employee.

Neither party may assign or transfer any of the rights, duties and obligations listed above without the written consent of the other party.

Service Descriptions, SPD's, and the provisions in the Price List applicable to Products, Services or Distributed Software that are the subject of Purchaser's order shall be considered part of these Terms and Conditions and are provided to Purchaser, or if not provided, are available to Purchaser on request. DIGITAL's acceptance of Purchaser's order will form an agreement subject only to these Terms and Conditions. These Terms and Conditions will supersede any previous communications, representations, or agreements by either party whether verbal or written including any terms and conditions on Purchaser's order. Any modification to these Terms and Conditions must be in writing and signed by authorized representatives of DIGITAL and Purchaser. This agreement is governed by and construed under the laws of Massachusetts.

4/1/87

Diagnostic Software License Policy

It is DIGITAL's policy to control the use of and access to proprietary diagnostic software. Provisions, allowing DIGITAL's customers the right to use certain diagnostics, are explained in this policy.

1. Definition of Diagnostics

Diagnostics are computer programs that recognize, identify and locate faults in equipment and indicate a need for repairs.

2. Digital's Property Rights Notices

The following notice is included in DIGITAL's Standard Terms and Conditions of sale and service.

"Diagnostic Software, Documentation, equipment or other material used by DIGITAL in the performance of installation, warranty, or Services may be furnished with Products or stored at Purchaser's facility. DIGITAL grants no title or license to such material, and it remains the exclusive property of DIGITAL. Purchaser agrees to properly secure such material and not to use it in any manner or make it available to third parties without DIGITAL's prior consent."

3. Source Code

Source Code for DIGITAL's proprietary diagnostic software, whether in human or machine-readable form, is not sold, licensed or otherwise distributed without prior approval of the Corporate Vice President—Field Service.

4. Object Code (Binary)

Object code, in binary form, for DIGITAL's proprietary diagnostic software is available for sale or license, as applicable, under DIGITAL's Standard Terms and Conditions of sale and service. Certain limitations apply to DIGITAL's licensed trade secret diagnostic software (see following section).

5. Licensed (Trade Secret) Diagnostics (e.g., VAX-11 Family, VAXBI Family, DECsystem-10/20, MicroVAX)

Licensed diagnostics are trade secrets of Digital Equipment Corporation and are made available solely for Licensee's use in maintaining the specified computer system. They always remain the exclusive property of DIGITAL. They are made available only to owners, lessees and end-users of corresponding DIGITAL computer systems and only under a license to use the diagnostics on the single identified computer system.

Licensed diagnostics which are left on customer's site for use by DIGITAL Field Service Personnel may not be used or copied by the customer unless the customer has been appropriately licensed by DIGITAL.

Upon completion or termination of DIGITAL's on-site service obligations (e.g., Installation, Warranty, or Service Agreement), the diagnostic software will be physically removed from the customer's site by DIGITAL personnel. Diagnostics for which the customer has purchased a license will not be removed.

In order to control the distribution and maintain the security of its trade secret diagnostic software, it is DIGITAL's policy only to license such diagnostic software to owners, lessees or end-users who have physical control of the system on which the diagnostics are installed and who respect the proprietary and confidential nature of the diagnostics and do not misuse them. DIGITAL does not license its trade secret diagnostic software to brokers for resale or to independent maintenance suppliers for use on their customer's systems. However, DIGITAL's licensee may permit its employees and agents to use the diagnostic software on the licensee's behalf on the designated computer system.

5A. CPU Model Licensing—VAX-11 Models (700 Series), VAX 8600, VAX 8650, 8650, MicroVAX, DECsystem 10/20.

VAX diagnostic software is not interchangeable among the various VAX-11 CPU models because of significant differences in each of the CPU's hardware and dedicated diagnostics (VAX-11/780 diagnostic software will not function on a VAX-11/750 or VAX-11/730 CPU). Consequently, VAX-11 diagnostic licenses are not interchangeable among the various VAX-11 CPU models.

An end-user intending to maintain various VAX-11 CPU models, using VAX-11 diagnostic software, must purchase the appropriate "C" license for each initial CPU model. "DZ" licenses must be purchased for each additional VAX-11 CPU of the same model.

DIGITAL's diagnostic software licenses are issued to the customer division, subsidiary, or organization specified on the license invoice, license certificate or other license document. Each subsidiary or division would be eligible to purchase "License Only" (DZ) licenses to copy software provided under a Primary license (C) previously purchased by the subsidiary or division.

When the customer is a Federal, State or Local government, the license is issued to the government user activity (e.g., Base, Facility, University, Department) specified on the license invoice, license certificate or other license document. In all instances, each license permits installation and use of the diagnostic software only on a single CPU as identified by its individual CPU serial number.

5B. CPU (Model Licensing)—VAXBI Models (8000 Series), VAX 8200/8300, 8500/8800 and MicroVAX 3000 Series.

An end-user intending to maintain various VAXBI CPU models, using VAXBI diagnostic software, must purchase a "UZ" license for each CPU. In addition, a customer must purchase the appropriate "HW" media/documentation kit for the initial CPU.

5C. Dual Processor Licensing

Dual processors are functionally a single CPU which require a single license. The appropriate diagnostic license is determined by the basic model diagnostic support required. A VAX-11/782 System is comprised of two VAX-11/780 CPU's and therefore requires a single VAX-11/780 Diagnostic License. Two CPU's operating in parallel (one being a "hot backup") require two licenses.

5D. Cluster Licensing

Since many of the diagnostic programs for each CPU model are functionally different and operate under unique diagnostic supervisors, each CPU within a "CLUSTER" must be individually licensed—there are no provisions for "CLUSTER LICENSING" of multiple model types within a cluster.

5E. Sublicensing and License Transfer

A sublicense contains the same rights and responsibilities as a direct license from DIGITAL. In accordance with the terms of its DIGITAL OEM Agreement, an OEM who purchases computer systems and appropriate diagnostic licenses may sublicense the diagnostic software to its end-user. The OEM cannot sublicense the diagnostic software to a customer to which the OEM has not sold a corresponding hardware system. The OEM must always obtain a signed sublicense agreement from its customer for the sublicense to be valid.

A license transfer is a mechanism DIGITAL has created to permit a licensee to transfer diagnostic software to another user as part of a system sale or transfer. DIGITAL must approve the transaction before the diagnostic software is transferred. The new customer/licensee must sign a DIGITAL license agreement and be registered by DIGITAL for the diagnostic software to be transferred.

5F. Licensed Diagnostics Subscription Update Service

New products are released regularly and existing diagnostics may be enhanced at any time. In order to ensure license holders a means of keeping their diagnostic software current with their systems hardware/software, DIGITAL provides an annual Diagnostic Subscription Update Service for purchase. The service provides selected media updates as new "releases" become available. There is a separate service for each corresponding CPU model license.

6. Copyrighted Diagnostics (e.g., PDP-8 AND PDP-11)

Diagnostic software for certain hardware systems (e.g., PDP-8 and PDP-11) is protected by copyright and does not require the purchase of a single-use, end-user license. The U.S. copyright laws prohibit the customer from making copies of copyrighted software programs except for archival purposes.

It is DIGITAL's intention in making these diagnostics available to its customers that they may be used on a single system at a time and not be reproduced. Accordingly, customers may not make copies for use on multiple systems or for further distribution without express reproduction authorization from DIGITAL (see Reproduction Agreement). This diagnostic software may be provided by DIGITAL directly to customers with their systems or may be purchased separately under DIGITAL's Standard Terms and Conditions of sale and service.

6A. Reproduction of Copyrighted Documentation and Copyrighted Diagnostics

Where an End-User or OEM has a legitimate need to reproduce Copyrighted DIGITAL hardware/software documentation or Copyrighted diagnostic software, a Reproduction Agreement is available for purchase from DIGITAL.

7. Personal Computer

Diagnostic software for personal computers (e.g., Professional 300 Series) is included in the Country Kit for the personal computer. This software is distributed directly to customers with the personal computer system under the Terms of DIGITAL's personal computer Software Product License. This personal computer single-use end-user license permits the customer to transfer the software (including the diagnostics) with the personal computer to another party provided the customer properly notifies DIGITAL.

The customer accepts the license terms when the seal on the box of software is broken (this is DIGITAL's standard practice for personal computer software).

8. Ordering and Other Information

To order refer to the Diagnostics Section of this catalog.

NOTE: For a complete description of each diagnostic product and information on how to order, refer to the specific Software Product Description (SPD).

All VAX micro and macro diagnostics are provided in single kit from for each CPU model.

9. Warranty

Diagnostic software is provided "AS IS" without any warranty of any kind, either expressed or implied. DIGITAL does not warrant that the execution of diagnostic software shall be uninterrupted or error-free.

Self Maintenance Services Warranty and Installation Availability

1. SPARES are warranted against defects in workmanship and material for a period of ninety (90) days from the date of delivery. SPARES are customer installable. For return instructions contact your Customer Services administrator at the location where you placed your order.
2. DECMAILER and FACTORY REPAIR repairs are warranted against defects in workmanship and material for a period of ninety (90) days after date of shipment by DIGITAL.
3. DIAGNOSTIC software is provided "as is" without any warranty of any kind, either expressed or implied. DIAGNOSTIC software is customer installable.
4. DOCUMENTATION is provided "as is" without any warranty of form or content.
5. ENVIRONMENTAL PRODUCTS are warranted against defects in workmanship and material for a period of one (1) year from the date installation is completed, or upon delivery if the equipment is not installed by DIGITAL. The level of warranty service is equivalent to DECservice. ENVIRONMENTAL PRODUCTS will be installed by DIGITAL at no charge when installed at time of initial installation of DIGITAL-installed systems. Add-on installation charges will be specified in the U.S. or Country Price List.
6. Products are sold solely for the remedial maintenance of DIGITAL hardware systems and options. DIGITAL reserves the right to refuse or cancel orders intended for any other purpose.

Policy for Reproduction of Digital Copyrighted Publications

Where an end-user or OEM has a legitimate need to reproduce copyrighted DIGITAL hardware documentation, or copyrighted diagnostics which do not require a software license, a reproduction agreement is available for purchase from DIGITAL. These reasons include:

- translation to a foreign language;
- incorporation or adaptation into a unique customer format;
- only limited portions of the publication are to be reproduced;
- urgent need DIGITAL cannot fulfill.

Reproduction Agreements are available to end-users and OEMs for the sole purpose of supporting products owned or distributed by the end-user or OEM.

The rights granted will not include the right to copy restricted documentation, licensed software, or micro form products.

The requester will determine the quantity needed of the particular publication(s) (minimum quantity 20). DIGITAL, in turn, grants a license to copy the publication(s). The requestor may, within a one year period, reproduce the documentation, in whole or in part, up to the specified quantity. The terms and conditions of this agreement can be found in the back of this price book.

The royalty fee paid to DIGITAL is twenty-five percent of the list price of the publication multiplied by the quantity to be reproduced.

EXAMPLE:

$$\begin{aligned} & \$10.00 \text{ (Manual List Price)} \times 100 \text{ (Qty)} \\ & \quad = \$1000.00 \text{ (Total List Price)} \end{aligned}$$

$$\begin{aligned} & \$1000.00 \text{ (Total List Price)} \times 25\% \\ & \quad = \$250.00 \text{ (Net Price)} \end{aligned}$$

NOTE: You must purchase the initial copy of any manual/tape that you are planning to reproduce.

No other discounts or pricing adjustments apply.

Submit request in writing to:

Self-Maintenance Administration
 Digital Equipment Corporation
 Continental Boulevard, MK01-2/M38
 Merrimack, NH 03054

Reproduction Policy for Digital's Copyrighted Publications

Policy

Customers who require an alternative method of providing hardware manuals, diagnostic documentation and copy-righted diagnostics are eligible to purchase authorization to locally reproduce the items. The rights granted will not include the right to copy restricted documentation, software media, micro form products.

Terms and Conditions

Digital Equipment Corporation (Digital) and Purchaser agree that the terms and conditions of the Agreement shall be effective only upon execution by both parties; shall govern the reproduction of copyrighted material (Documentation); and shall only apply to a single purchase order as described in Paragraph 5, Ordering Procedures, below. Reproduction of Documentation may only be made during the one (1) year term commencing on the Effective Date hereof.

1. Purchaser

Purchaser for the purposes of the Agreement is a single business entity (excluding subsidiaries, corporate parent and affiliated subsidiaries) at a single buying location.

2. Documentation

The right to copy is limited to hardcopy manuals, software manuals and engineering drawings (with the purchase of aperture cards, contact positives, 11"x 17" negatives or mylar washoffs), and PDP-11 Diagnostics. The rights granted do not include the right to copy restricted Documentation (i.e., "Company Confidential," "Digital Use Only," etc.) software media or micro form. Purchaser, as an OEM of Digital, may transfer copies of the Documentation in the ordinary course of

such business, to its customers. Otherwise, such right to copy is limited to use by and distribution to employees of the Purchaser and no rights are granted to reproduce Documentation for sale to any other party.

3. Prices

Prices shall be based upon the list price as specified in the applicable Price List prevailing at the time Digital accepts an order or on an authorized quotation in force at the time Digital accepts the applicable order. Prices for the right to copy Documentation shall be equal to twenty five percent (25%) of such list prices. Prices for the Documentation to be copied shall be equal to such list prices. Prices for PDP-11 Diagnostics shall be fixed price (non-based on media and number of copies requested).

4. Ordering Procedures

The Purchaser shall attach to the executed Agreement a purchase order specifying the Documentation to be copied by part number and title; the maximum quantity to be copied, the list price of each Documentation and the net price to be paid. Such purchase order shall also specify any Documentation to be purchased by part number, title, list price and net price. The minimum number of copies per Documentation shall not be less than twenty (20). No credit shall be made for unused Documentation or rights to copy.

5. Payment

Net 30 (thirty) days from date of invoice from Digital. Payment shall be based upon the Documentation and number of copies ordered.

6. Delivery

Any deliveries requested shall be FOB origin. Digital reserves the right to make partial deliveries.

7. Taxes

Prices are exclusive of, and purchaser is responsible for, all sales, use and like taxes.

8. Copyright Legends

On the first page of each reproduced copy of the Documentation, the purchaser shall include a Digital copyright notice as follows: "Copyright © (year) Digital Equipment Corporation Reproduced under Agreement Number (the number of this Agreement) granted by Digital Equipment Corporation."

NOTE: The year in the above notice is the year appearing in the copyright reservation notice in the Documentation to be copied.

9. Assignment

Either party may terminate the Agreement or any orders by notice sent registered mail if the other party (a) assigns this Agreement or any of its rights or (b) neglects or fails to substantially perform or observe any of its obligations, unless the cause for termination is remedied within thirty (30) days. Notwithstanding the above, any obligations which attached prior to such termination shall survive any such termination.

10. Audits

The Purchaser shall keep accurate records of the number of copies made for each publication under the Agreement and upon request by Digital shall furnish a copy of the records certified by an authorized representative of the Purchaser.

11. Warranty

Each delivered copy of Documentation ordered shall be suitable for reproduction on conventional reproduction equipment. EXCEPT FOR THE EXPRESS WARRANTIES STATED HEREIN, DIGITAL DISCLAIMS ALL WARRANTIES ON COPYRIGHTED MATERIAL FURNISHED, INCLUDING, WITHOUT LIMITATION, ALL IMPLIED WARRANTIES OF MERCHANTABILITY AND FITNESS; and the stated express warranties are in lieu of all obligations or liabilities on the part of digital arising out of or in connection with the use of performance of the Documentation or any copies thereof.

12. Patent/Copyrighted Infringement

Digital will defend, at its own expense, any claim brought against Purchaser alleging the Documentation manufac-

tured by Digital and furnished infringe a United States patent or copyright, and will pay all costs and damages finally awarded, provided that Digital is given prompt written notice of the claim and is given information, reasonable assistance, and sole authority to defend or settle the claim. Digital will obtain for Purchaser the right to continue using the Documentation so that they become noninfringing or, if these remedies are not reasonably available, grant Purchaser a credit for the Documentation and accept their return. Digital will have no other liability for patent and copyright infringement.

13. Limitation of Liability

PURCHASER'S RIGHT TO RECOVER DAMAGES TO PROPERTY CAUSED BY DIGITAL'S FAULT OR NEGLIGENCE WILL BE LIMITED TO ONE (1) MILLION DOLLARS. DIGITAL WILL NOT BE LIABLE IN ANY EVENT FOR ANY DAMAGES RESULTING FROM LOSS OF

DATA, PROFITS, USE OF PRODUCTS OR FOR ANY INCIDENTAL OR CONSEQUENTIAL DAMAGES, EVEN IF ADVISED OF THE POSSIBILITY OF SUCH DAMAGE. This limitation of Digital's liability will apply regardless of the form of action, whether in contract, patent/copyrighted infringement or tort including negligence. Any action against Digital must be brought within eighteen (18) months after the cause of action accrues.

The agreement constitutes the entire Agreement between the parties with respect to the subject matter and supersedes all prior proposals, negotiations and communications, oral or written, between the parties with respect to the subject matter, and no deviation from these terms and conditions shall be binding unless in writing and signed by the party against whom the same is sought to be enforced.

DECmailer Service Provisions

1. Availability

DECmailer Service is available throughout the United States for the provision of replacement/repaired DIGITAL modules, sub-assemblies, or spare parts (hereinafter "Parts") to OWNER END USERS and DIGITAL AUTHORIZED RESELLERS of DIGITAL equipment.

2. Term

DECmailer Service shall be effective when the application is signed by both parties and a signed copy with a DECmailer number is returned to the Customer. Except as provided in Section 3.3 below. Service may be terminated by either party upon thirty (30) days prior written notice.

3. Eligible Parts

3.1 Parts listed in the then current DECmailer price list are eligible for return under DECmailer Service.

3.2 Parts in need of repair due to improper treatment or use are not eligible for return. Improper treatment includes, but is not limited to, lifted, burnt etches, or delamination due to Non-DIGITAL repair or modification; delamination due to excessive heat; or missing parts. Parts which have been defaced by removing serial numbers, etch levels, or key components are not eligible for return.

3.3 If parts are returned which are subsequently deemed ineligible or unrepairable by DIGITAL's repair source, DIGITAL may immediately terminate

Customer's DECmailer Agreement. Additionally, DIGITAL may demand return of any replacement Part(s) or bill Customer for full Maynard List Price (MLP) value of the replacement Part(s), and will return the ineligible part(s) to Customer upon receipt of payment or the replacement Part(s).

3.4 Proof of Purchase or ownership of equipment, including serial numbers may be required.

4. Responsibilities of Digital

4.1 DIGITAL will use best efforts to at its option, repair or replace eligible Parts within five (5) working days of their receipt and acceptance at DIGITAL's receiving dock. Shipment to Customer will be F.O.B. DIGITAL shipping point.

4.2 Repaired and/or replacement Parts will be at the current revision level as specified in the then current price list. Parts may be refurbished. In the event newly installed Field Engineering Change Orders (FCOs) cause an incompatibility or other interference within the customer's system, Customer accepts responsibility for such incompatibility or interference.

4.3 DIGITAL assumes all risk of loss or damage to parts in transit to Customer. Return of Parts to Customer shall be made by a second-day delivery carrier chosen by DIGITAL.

5. Responsibilities of Customer

5.1 Customer shall properly package and prepay transportation costs of Parts sent to DIGITAL. All packages must reference Customer's DECmailer account number. Packages without the appropriate DECmailer account number may be subject to delay in receipt and acceptance.

5.2 Customer assumes all risk of loss or damage to Parts in transit to DIGITAL.

5.3 Customer shall issue DIGITAL a funding authorization (Purchase Order) for a period of at least one (1) year.

6. Charges

6.1 Charges for DECmailer Service shall be as indicated in the then current DECmailer price list.

6.2 Customer has the option of (A) an open account with monthly invoicing or (B) invoicing per line item. DECmailer Service is subject to Customer's maintaining funding authorization satisfactory to DIGITAL. Otherwise, terms are cash in advance.

6.3 Payment is due thirty (30) days from the date of invoice. DIGITAL reserves the right to withhold shipment and service of any orders if Customer is in default of its payment obligations.

6.4 Charges are exclusive of and Customer is responsible for all sales, use and like taxes.

7. Warranty

7.1 All repairs are warranted against defects in workmanship and material for a period of ninety (90) days after date of shipment by DIGITAL.

7.2 THE ABOVE WARRANTIES ARE THE EXCLUSIVE WARRANTIES AND NO OTHER WARRANTY, EXPRESS OR IMPLIED, SHALL APPLY. DIGITAL SPECIFICALLY DISCLAIMS THE IMPLIED WARRANTIES OF MERCHANTABILITY AND FITNESS FOR A PARTICULAR PURPOSE.

8. Remedies and Limitations

8.1 DIGITAL's entire liability and Customer's remedies are set forth in this Section 8. These remedies are Customer's exclusive remedies and are in lieu of any other remedy at law or in equity.

8.2 In all situations involving performance or nonperformance of Parts furnished hereunder, Customer's remedy is repair or replacement by DIGITAL (at DIGITAL's option) of defective Parts if notified by Customer of the defect within the warranty period. (Should a repair be eligible for warranty service, please call the Customer Returns Center for a Warranty Return authorization number [RA #]). If DIGITAL determines that a Part is not defective within the terms of the warranty, Customer shall pay DIGITAL all costs of handling and transportation. If DIGITAL fails to perform its warranty of service responsibilities or if Customer has any other claim related to Parts or Services purchased from DIGITAL, Customer shall be entitled to recover only direct damages and only up to the limits set forth in Section 8.3.

8.3 DIGITAL'S LIABILITY TO CUSTOMER FOR ANY CAUSE WHATSOEVER SHALL BE LIMITED TO THE GREATER OF ONE MILLION DOLLARS (\$1,000,000.00) OR THE PURCHASE PRICE PAID TO DIGITAL FOR THE PARTS OR SERVICES THAT ARE THE SUBJECT OF CUSTOMER'S CLAIM. THIS LIMITATION WILL APPLY REGARDLESS OF THE FORM OF ACTION, WHETHER CONTRACT OR TORT INCLUDING, WITHOUT LIMITATION, NEGLIGENCE. THE FOREGOING LIMITATION DOES NOT APPLY TO DAMAGES RESULTING FROM PERSONAL INJURY CAUSED BY DIGITAL'S NEGLIGENCE.

8.4 IN NO EVENT WILL DIGITAL BE LIABLE FOR ANY DAMAGES RESULTING FROM LOSS OF DATA OR USE, LOST PROFITS OR ANY INCIDENTAL OR CONSEQUENTIAL DAMAGES.

8.5 Any action against DIGITAL must be brought within eighteen (18) months after the cause of action arises.

9. Certificate of Compliance

DIGITAL certifies that workmanship standards or materials used in the repair/replacement of Parts processed under this Agreement substantially comply with DIGITAL published specifications.

10. General

10.1 The provisions of this DECmailer Service Agreement supersede all previous DECmailer Service Agreement provisions.

10.2 The provisions of this Agreement are declared to be severable.

10.3 The provisions of this Agreement shall solely apply. Additional provisions will only be applicable if DIGITAL agrees in writing. Neither party may assign this Agreement unless mutually agreed.

10.4 This Agreement is governed by the laws of the Commonwealth of Massachusetts or the state of billing address.

10.5 Regardless of any disclosure made by Customer to DIGITAL of an ultimate destination of the repaired/replaced Part, Customer will not export, either directly or indirectly, any repaired/replaced Part of equipment incorporating any repaired/replaced Part without first obtaining a license from the United States Government, as required.

**To All Recipients of the Self-Maintenance Services Price Book:
Please Read This Important Announcement**

The U.S. price list is published periodically as a reference guide for use by Digital Equipment Corporation personnel and Digital's customers. Prices are accurate as of the date printed on the cover.

The information in this document is subject to change without advance notice and should not be construed as a commitment by Digital Equipment Corporation.

Digital assumes no responsibility for any errors that may appear in this price list.

For verification of the current prices and to obtain quote information, contact your local sales representative.

Copyright © 1988, Digital Equipment Corporation, All Rights Reserved.
Printed in U.S.A.

digital™

All this in one book:

- **Spare Parts**
- **Repair Services**
- **Diagnostics**
- **Documentation**
- **Tools and Test Equipment**
- **Field Change Orders**
- **Preventive Maintenance**
- **Training**

Printed in U.S.A. EJ 32877 79/88 12 43 16.0 BUO Copyright © 1988 Digital Equipment Corporation All Rights Reserved