

8 1 3 0

**CONTROL DATA<sup>®</sup> 8130**  
**REMOTE TERMINAL**  
**USER'S MANUAL**

*Any comments concerning this manual should be addressed to:*

**CONTROL DATA CORPORATION**

*Publication Department*

**2200 BERKSHIRE LANE NORTH  
MINNEAPOLIS, MINNESOTA 55427**

# CONTENTS

INTRODUCTION . . . . .	1
GENERAL DESCRIPTION . . . . .	1
8130 Stored Program Processor (SPP) . . . . .	2
8130 Terminal Control Panel (TCP) . . . . .	2
8197 Data Set Controller (DSC) . . . . .	2
8130 Card Reader . . . . .	2
8130 Line Printer . . . . .	4
The 8130 Terminal Program (TERP-I) . . . . .	4
INPUT FILES . . . . .	5
Magnetic Tape Files . . . . .	5
Punched Card Files . . . . .	5
OUTPUT FILES . . . . .	6
Magnetic Tape Files . . . . .	6
Line Printer Files . . . . .	6
General . . . . .	6
Record Structure . . . . .	6
Vertical Format Control . . . . .	7
Standard Output Format . . . . .	7
Other Output Format . . . . .	7
Punched Card Files . . . . .	7
OPERATING CHARACTERISTICS AND DATA FLOW . . . . .	8
General . . . . .	8
Data Transmission (On-Line) Mode . . . . .	8
Buffered vs. Serial Operation . . . . .	9
Data Compression/Expansion . . . . .	9
Local Medium Conversion (Off-Line) Mode . . . . .	10
Error Protection . . . . .	10
CONTROL CARDS AND JOB DECK STRUCTURE . . . . .	11
General . . . . .	11
Job Descriptor Card . . . . .	13
End-of-Job Card . . . . .	14
8130 SYSTEM OPERATING PROCEDURES . . . . .	15
Terminal Control Panel (TCP) . . . . .	15
TERP-I Program Loading . . . . .	15
Putting the 8130 On-Line with the Central Data Processing System . . . . .	16
Data Transmission from the 8130 System . . . . .	16
Local Medium Conversion Mode . . . . .	16
End-of-Job Procedures . . . . .	17
Error Conditions and Their Disposition . . . . .	17
APPENDICES	
A. Record Structure and Exchange Logic for 8130 System Interface with a Dominant Computer Site . . . . .	A-1
B. 8130 System Internal BCD Codes . . . . .	B-1
C. 8130 System External BCD Codes . . . . .	C-1
D. Bose-Chadhuri Cyclic Code Generation Techniques . . . . .	D-1
INDEX . . . . .	I-1

## ILLUSTRATIONS

Figure 1. 8130 Remote Terminal System . . . . .	v
Figure 2. CONTROL DATA 8130 System in Support of a Central Data Processing System . . . . .	3
Figure 3. Job Deck Structure for 8130 System . . . . .	12
Figure 4. 8130 System Terminal Control Panel (TCP) . . . . .	15
Table 1. 8130 System Error Codes, Their Interpretation and Disposition . . . . .	18

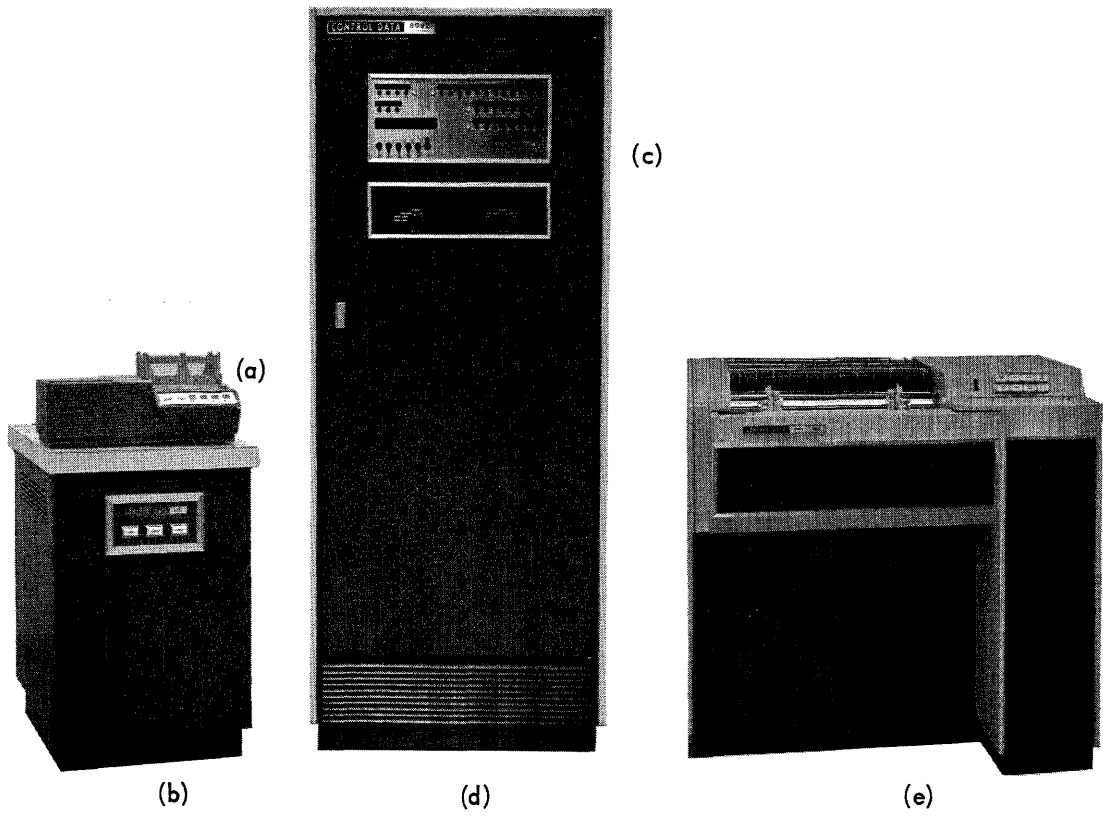

299/1

Figure 1. 8130 Remote Terminal System

# 8130 REMOTE TERMINAL SYSTEM

## INTRODUCTION

The CONTROL DATA® 8130 Remote Terminal System (Figure 1) is a satellite system designed to operate as a remote (subordinate) site to a central (dominant) data processing system. It functions as a medium-volume input/output (I/O) terminal to the central data processing system. When used for data transmission, the 8130 System operates at the convenience (and under the supervision) of the dominant site. When not engaged in data transmission, the 8130 System is used for isolated local processing operations, such as data medium conversion.

The 8130 System utilizes a Stored Program Processor (SPP) as the controlling unit at the site, and communicates with the central data processing system over standard voice bandwidth telephone circuits. The complete 8130 System includes a Terminal Program (TERP-I) to support the processor. It can be installed and operated in any area where reliable, medium-speed, low-cost data transmission is required. A TERP-I option permits the use of the 8130 System as an isolated sub-system for local processing operations whenever its on-line service to the dominant computer site is not required.

## GENERAL DESCRIPTION

The CONTROL DATA 8130 Remote Terminal System is a complete hardware/software package which functions as a satellite to a central (dominant) data processing system (such as a Control Data 3000-Series Computer System). It is also used to perform local on-site processing operations. The 8130 System is connected with the dominant system via a voice bandwidth telephone circuit and associated modulation/demodulation equipment (modems).

A basic 8130 System consists of the following functional units:

<u>Unit</u>	<u>Figure 1 Reference</u>
1. 8130 Stored Program Processor (SPP)	(d)
2. 8130 Terminal Control Panel (TCP)	(c)
3. 8197 Data Set Controller (DSC)	(b)
4. 8130 Card Reader	(a)
5. 8130 Line Printer	(e)

The terminal may also include optional equipment such as one magnetic tape unit or one card punch. Figure 2 shows a basic 8130 System with optional equipment and associated controllers in support of a central data processing system.

The 8130 System, operating almost exclusively under program control, provides a low-cost, efficient, easy-to-operate, remote data collection and transmission system. It is used to assemble data for transmission and to receive data for printout. A representative installation might include several 8130 Systems connected via a communication network (using two-or four-wire, leased or switched voice band lines) to a central data processing system. In such a network, each terminal is able to communicate, through the central data processing system, with any other terminal in the network. When not used by the central data processing system, each 8130 System is available for local on-site operations, such as transfer of data from punched cards to printer off-line.

### **8130 Stored Program Processor (SPP)**

The SPP is the central processing unit of the 8130 System. It has local supervisory control over all data transfers between the terminal and the central data processing system. It also serves as the interface between on-site equipment (i.e., the 8130 Card Reader and the 8130 Line Printer). The 4096-word SPP memory, acting as a buffer, is basic to all data transfers. The SPP (under control of TERP-I) is also responsible for interpreting all control functions governing the relationship of the (subordinate) 8130 System and the (dominant) central data processing system.

### **8130 Terminal Control Panel (TCP)**

The TCP, installed in the SPP, provides operator interface and visual-audible indications of system status under control of TERP-I. The mode and peripheral selection mechanisms on the panel are not operable when using TERP-I; system parameters are entered via control cards.\*

### **8197 Data Set Controller (DSC)**

The DSC interfaces the SPP to a standard DATA-PHONE® Data Set 201A (2000 bits per second) or 201B (2400 bits per second) connected to a full-or half-duplex voice-grade circuit. Its major function is serial/parallel data conversion.

### **8130 Card Reader**

The 8130 Card Reader transfers data, under control of TERP-I, from 80-column punched cards to the 4096-word SPP memory. Cards can be read with Hollerith-to-internal BCD translation by the card reader controller, or as column binary images. In addition to data transfers, the card reader is used to enter TERP-I control parameters for local on-site processing functions. The 8130 Card Reader reads cards at the rate of 100 cards per minute (approximately 130 characters per second for Hollerith cards or 260 characters per second for binary cards).

\* See Control Cards and Job Deck Structure, page 11.

DATA-PHONE® is a registered trademark of Bell System.

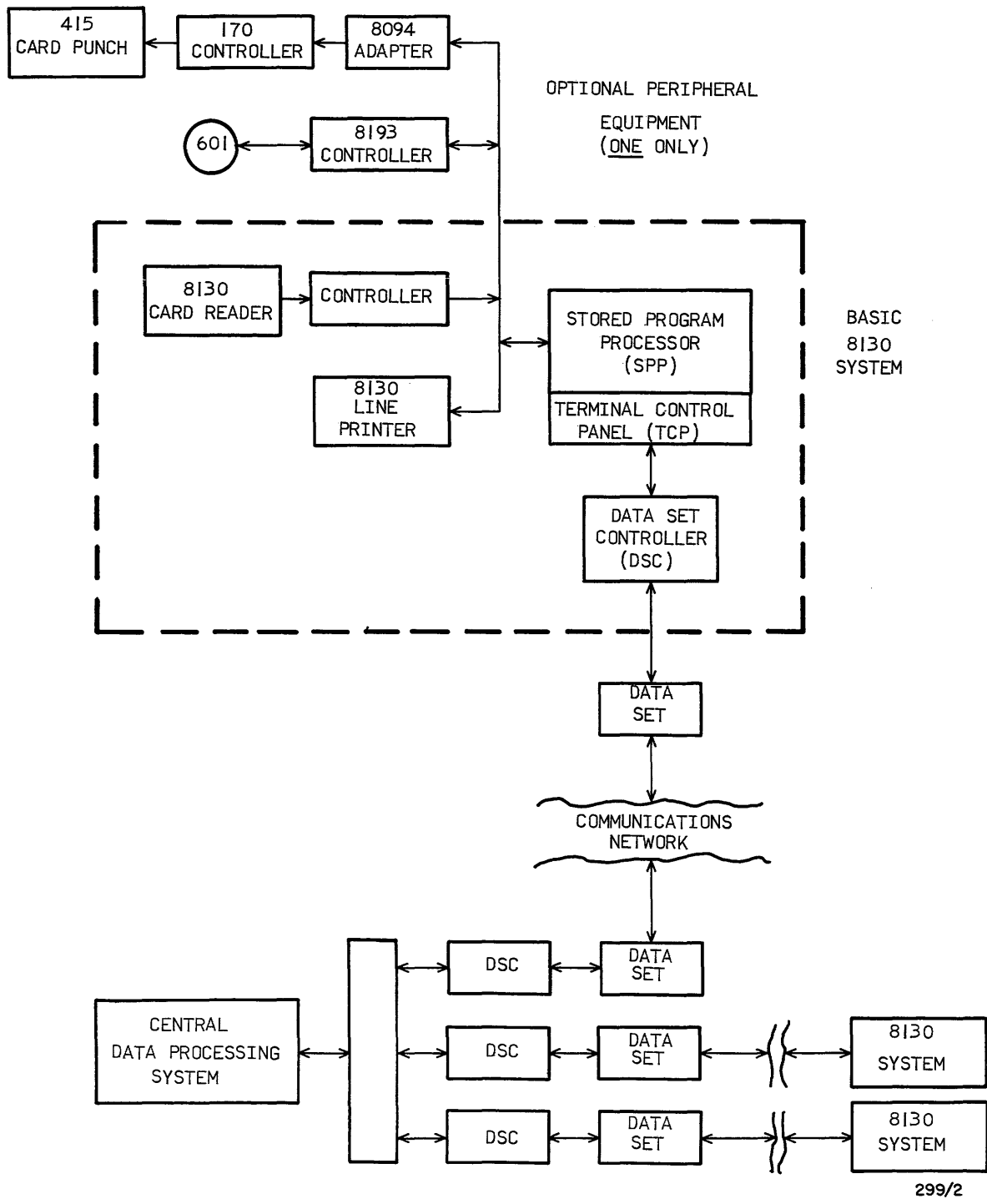

Figure 2. CONTROL DATA 8130 System in Support of a Central Data Processing System



## 8130 Line Printer

The 8130 Line Printer transfers data, under control of TERP-I, from the SPP to hard copy at the rate of 300 lines per minute. A maximum of 120 characters may be emitted on each line. Line spacing and page ejection functions are provided by a standard printer carriage control tape.

## The 8130 Terminal Program (TERP-I)

TERP-I is the control program in the SPP which provides complete communication and operator control for the 8130 System for both transmission involving the central data processing system and local on-site processing between peripheral equipment. Drivers are provided as part of the 8130 package to service 8130 System peripheral equipment. Using appropriate combinations of these peripherals, TERP-I is able to perform operations such as the following:

1. Local card to magnetic tape\*
2. Local card to printer
3. Local magnetic tape\* to printer

The specific control card parameters and procedures for performing these operations are described in this manual.

Data transmitted by the 8130 System (via TERP-I) to the central data processing system may in turn be converted to a variety of external media, limited only by the peripheral equipment available to the central data processing system and options provided by the communication package residing in its memory.

TERP-I is a cyclic job-oriented software package designed to operate the 8130 System in each of the following two modes:

1. Data Transmission (On-Line) Mode
2. Local Medium Conversion (Off-Line) Mode

Prior to execution under either mode, TERP-I performs an initialization process to determine functional characteristics for the job. Following job processing, TERP-I reverts to an idle, or between-job state, awaiting introduction of another set of job parameters.

---

\* One magnetic tape unit is available as optional 8130 System equipment.

## INPUT FILES

Standard TERP-I input subprograms provide the ability to process magnetic tape or punched card files.

### Magnetic Tape Files

A magnetic tape file is that collection of physical tape records between input tape position at start of job and the next end-of-file record in a forward direction.

Records in a magnetic tape file can have odd or even parity and can be variable in length. Maximum permissible record length is 1018 characters. Recording density can be 200 or 556 characters per inch. A given file can contain a mixture of odd and even parity records but must be of uniform density.

Under one option, by sensing for two adjacent end-of-file marks, TERP-I can process multi-file tapes as well as single-file tapes. Multi-reel files can be processed if an end-of-file record terminates each reel. Trailer labels can be processed as a one-record file if they are followed by an additional end-of-file record.

### Punched Card Files

A punched card file is a collection of 80-column cards, preceded by a Job Descriptor Control Card\* and followed by an End-of-Job Control Card.\* The Job Descriptor is transmitted to the dominant site. These control cards supply job parameters to TERP-I and signal end-of-file status. They are not carried over to the output medium (if in Local Medium Conversion Mode), or to the central data processing system (if in Data Transmission Mode). TERP-I assembles one card image per data record. Cards can be read in standard input format, with Hollerith-to-internal BCD translation by the card reader controller, or in optional input format (i.e., as column binary images with no translation).

If standard input format is elected, all cards (except those designated by  $\frac{7}{9}$  or  $\frac{8}{9}$  punches in column 1) are translated to internal BCD.\*\* Each column results in one character located in the six low-order (right-most) bit positions of an eight-bit SPP word (byte).

Cards identified by  $\frac{7}{9}$  or  $\frac{8}{9}$  punches, when read under the standard input format option, as well as all cards read under the optional input format, are transmitted in column binary format. Under this format, each column results in two transmission bytes. Rows 12 through 3 make up the first byte, and rows 4 through 9 make up the second byte, as follows:

Bit	7	6	5	4	3	2	1	0
Byte 1	0	0	12	11	0	1	2	3
Byte 2	0	0	4	5	6	7	8	9

\*See Control Cards and Job Deck Structure, page 11 for control card formats.

\*\*See Appendix B for internal BCD codes.

## OUTPUT FILES

An output file results from the processing of an input file. The formats of output files are dependent upon input and output media. Standard TERP-I output subprograms provide the ability to process output files on the following media:

1. Magnetic Tapes
2. Line Printer
3. Punched Cards

### Magnetic Tape Files

A magnetic tape file resulting from tape input is usually an exact record-by-record copy of the input file (including the End-of-File record). If a non-recoverable tape error occurs, operator intervention is required which will ultimately affect the output file. Magnetic tape reels of unequal length can also affect the output file in that detection of the physical end-of-tape (reflective spot) during output causes the writing of an End-of-File record. The balance of the output file is then continued on another tape.

Recording parity (odd or even) is set or determined on a record-by-record basis, giving the ability to write variable parity files. Characters to be transferred to magnetic tape must occupy the low-order (right-most) bit positions of a single SPP transmission byte.

Records being transferred to magnetic tape for subsequent printing must be edited to conform to Line Printer output specifications. Binary or BCD records transferred to magnetic tape for subsequent punching must be edited according to the Card Punch specifications.

### Line Printer Files

General. Input files to be printed can contain either binary or BCD records. Binary records are treated as BCD, and the resultant printer output may or may not be intelligible. Printing is done with or without carriage control. The SPP controls the line printer, which has a buffered input to assemble all the characters in one line of copy for simultaneous printing.

Record Structure. TERP-I accepts blocked (multiple) or unblocked (single) data-records for line printer output. Each record to be printed is formatted as a successive string of internal BCD\* characters, forming a line image for printing. Records which are in external BCD\*\* code must be converted to internal BCD code prior to being sent to the printer. For convenience, TERP-I provides code conversion services.

---

\*See Appendix B for internal BCD codes.

\*\*See Appendix C for external BCD codes.

Each record to be printed (blocked or unblocked) must not exceed 120 characters. Records, if blocked, must be separated by a record mark character (i.e., an internal BCD character of value 728 – an 0,2,8 punch if a card record is to be processed). The first character of each record may (optionally) be printed or serve as a non-printing control character for vertical format skipping, as described in the following paragraphs. Internal records prepared for printing must be arranged in successive words of SPP memory such that each character to be printed occupies the low-order (right-most) bit positions of an SPP transmission byte (word).

Vertical Format Control. Vertical format skipping is available in one of the following two modes:

1. Standard Output Format
2. Other Output Format

Standard Output Format. If standard output format is elected, line spacing and page ejection are determined by channel 1 of the printer carriage control tape. Skipping occurs following the printing of each line. Use of the standard tape results in single spacing with automatic ejection at end-of-page.

Other Output Format. If other output format is elected, the first character of each print line is not printed, but is interpreted as a carriage control character according to the following convention:

<u>Character</u>	<u>Octal Code</u>	<u>Action</u>
0	00	Double space, print and single space.
1	01	Eject page, print and single space.
+	20	Print and suppress spacing.
Other	Other	Print and single space.

PRINT tapes produced by programs written in Control Data FORTRAN systems can be printed by the 8130 System.

### **Punched Card Files**

TERP-I accepts data records containing one or more punch images, which are of fixed-length and contain no inter-image separators or start of image identifiers. The

records must be pre-formatted as follows:

Byte	7	6	5	4	3	2	1	0	Row
	Col. No.								
1 --	0	0	1	2	3	4	5	6	-- 9
2 --	0	0	7	8	9	10	11	12	-- 9
3 --	0	0	13	14	15	16	17	18	-- 9
4 --	0	0	19	20	21	22	23	24	-- 9
5 --	0	0	25	26	27	28	29	30	-- 9
6 --	0	0	31	32	33	34	35	36	-- 9
7 --	0	0	37	38	39	40	41	42	-- 9
8 --	0	0	43	44	45	46	47	48	-- 9
9 --	0	0	49	50	51	52	53	54	-- 9
10 --	0	0	55	56	57	58	59	60	-- 9
11 --	0	0	61	62	63	64	65	66	-- 9
12 --	0	0	67	68	69	70	71	72	-- 9
13 --	0	0	73	74	75	76	77	78	-- 9
14 --	0	0	79	80	not used				-- 9
15 --	0	0	1	2	3	4	5	6	-- 8
-----									
167 --	0	0	73	74	75	76	77	78	-- 12
168 --	0	0	79	80	not used				-- 12

A "1" in any position results in a punch.

Each image represents one punched card.

## OPERATING CHARACTERISTICS AND DATA FLOW

### General

A principal capability provided by the 8130 System (through TERP-I) is point-to-point data transmission. At the convenience (and under the direction) of the (dominant) central data processing system, the 8130 System collects and disseminates information and relieves the central data processing system of I/O processing functions. When not operating as a satellite, the 8130 System is available for local (off-line) data processing functions. When performing local medium conversion, TERP-I ignores transmissions received via the communications channel to the dominant site. Inter-terminal communication between operators may be performed, however, by using the channel in voice mode.

### Data Transmission (On-Line) Mode

When operating in the Data Transmission (On-Line) Mode, TERP-I transfers data between 8130 System peripheral equipment and the central data processing system via the SPP memory and information paths (data links) connecting the 8130 System and

the central data processing system. Data being sent from the 8130 System is transferred by the SPP to the DSC in parallel, one eight-bit word at a time. There it is dis-assembled and transmitted one bit at a time in serial mode through the data link to the central processing site.

Data being received by the 8130 System is received a bit at a time (serially) by the DSC, assembled into eight-bit words, and transmitted in parallel to the SPP. The transmission rate is 250 eight-bit words per second (utilizing the Data Set 201A), or 300 eight-bit words per second (utilizing the Data Set 201B).

Buffered vs. Serial Operation. Data flow is in one direction during the course of a job. However, if all data records in a given job contain 506 or fewer bytes within a data field (record), TERP-I automatically allocates two alternate data areas and is capable of overlapping data transmission with conventional input (or data reception with conventional output). Buffered operation is effective only if the other terminal is able to operate in the same manner. If any data record contains a data field of more than 506 bytes, the operations are performed serially.

Data Compression/Expansion. Data being collected by the 8130 System may (optionally) be represented in compressed format prior to transmission to the dominant site. Conversely, data being received by the 8130 System from the dominant site may arrive in compressed format, requiring reconstruction prior to transmission to output peripheral equipment. TERP-I supplies data compression/expansion services. Compressed data is information which may be contained in seven or fewer bit positions in a single eight-bit byte (i.e., six-bit internal BCD information). Data compression is extremely useful in expressing repeated characters utilizing a minimum amount of memory space and data transmission time.

Each record of data (compressed or expanded) is contained in a series of eight-bit bytes, preceded by a control field called a preamble. The preamble is utilized to transmit information such as end-of-file, odd or even parity, or identification of initial data record. Control information denoting possible compression within ensuing data records is transmitted in the initial fields of data records.\*

A data record is expressed in compressed format as follows:

Byte	7	6	5	4	3	2	1	0
n	1	x	x	x	x	x	x	x
n + 1	0	c	c	c	c	c	c	c

Bit position 7 of byte "n" contains the digit "1", denoting data compression. The string of "c" bit positions contain a seven-digit binary count of the total number of times data pattern "xxxxxx" (seven-character code) is to repeat. A digit "0" in bit position 7 of byte "n" denotes no data compression. TERP-I is thus able to process intermixed compressed and non-compressed data.

\*See Appendix A for detailed 8130 System record structures.

A string of five consecutive asterisk characters (\*\*\*\*\*), for example, to be transmitted to the 8130 site from the central data processing system for printing, would appear as follows if sent in compressed format:

Byte	7	6	5	4	3	2	1	0
n	1	0	1	0	1	1	0	0
n + 1	0	0	0	0	0	1	0	1

The following illustrates the same data expressed in expanded format:

Byte	7	6	5	4	3	2	1	0
n	0	0	1	0	1	1	0	0
n + 1	0	0	1	0	1	1	0	0
n + 2	0	0	1	0	1	1	0	0
n + 3	0	0	1	0	1	1	0	0
(n+c-1) n + 4	0	0	1	0	1	1	0	0

### Local Medium Conversion (Off-Line) Mode

Whenever the 8130 System is not required to service the central data processing system, it is available for local job processing involving data medium conversion. In response to operator action\*, TERP-I reads the standard input device (card reader) seeking a job descriptor (control card) at the start of a job deck. When a job descriptor card is sensed, its parameters determine the task to be performed and the equipment to be utilized. The data transfer then proceeds.

Local medium conversions are strictly serial since both input and output peripheral equipment are connected to the same processor data channel. Data compression options are not required (or available) for local medium conversion. Maximum input record length in this mode is 1018 characters (or frames, if input is from magnetic tape).

### Error Protection

An extremely important characteristic of the 8130 System is its ability to reliably detect record transformations within the inter-terminal data channel (transmission errors). The parity term developed and transmitted with each record is based upon a Bose-Chadhuri cyclic code\*\* having a Hamming distance of 6. Protection afforded by

\* See 8130 System Operating Procedures, Page 15.

\*\* See Appendix A for description of Bose-Chadhuri Cyclic code; Appendix D for implementation techniques.

the parity term is as follows:

1. One through 5-bit transformations occurring anywhere within a record are always detected.
2. More than 5-bit transformations occurring within 27 contiguous bits of the record are always detected.
3. If more than 5-bit transformations occur within the record but not within 27 contiguous bits, the odds of detecting the transformation are better than 67 million to 1.

## CONTROL CARDS AND JOB DECK STRUCTURE

### General

Control cards introduced through the standard input medium (card reader) are used for the definition of jobs under the following modes of operation:

1. Local Medium Conversion (Off-Line) Mode
2. Data Transmission (On-Line) Mode – when the 8130 System is the collecting source (transmitting site) for data to be sent to the dominant computer site.

Control cards are not required by the 8130 System when operating in Data Transmission Mode and data is being transmitted to the 8130 System by the central data processing system. In such cases, parameters are sent via control records formed and transmitted by the central data processing system.

Operations involving the collection of data or local on-site 8130 System operation when in Local Medium Conversion Mode require the preparation of the following control cards:

1. Job Descriptor Card
2. End-of-Job Card

The Job Descriptor card is applicable only when the 8130 System is serving as data source in a transmission operation, or when performing local medium conversion. When the source of the input data is via the 8130 Card Reader, the Job Descriptor Card must precede the data, as shown in Figure 3; an End-of-Job card must then follow the data. When data input is from devices other than the card reader (such as magnetic tape), the End-of-Job card is not used.

The following is a detailed description of the format of each of the control cards.



## Job Descriptor Card

The format of the Job Descriptor Card is as follows:

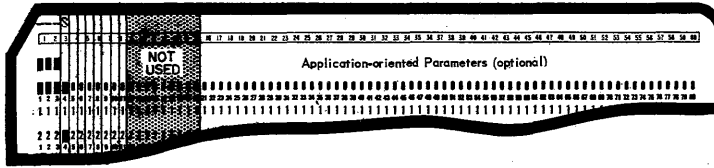

<u>COLUMNS</u>	<u>CONTENTS</u>								
1 - 3	<table border="0"> <tr> <td>11</td> <td>11</td> <td>11</td> <td></td> </tr> <tr> <td>0</td> <td>0</td> <td>0</td> <td> - punches, as shown above.</td> </tr> </table>	11	11	11		0	0	0	- punches, as shown above.
11	11	11							
0	0	0	- punches, as shown above.						
4	"S" (as shown above) identifying the type of card.								
5	"0" if the data input source is the 8130 Card Reader. Any other punch assigns the input source as magnetic tape.								
6	"0" if the data is to be read in standard (Hollerith) input format. Any other punch denotes that the data is to be read in optional (column binary) format.								
7(1)	"0" if the data output medium is the 8130 Line Printer. Any other punch denotes that the output medium is to be other than the printer.*								
8(1)	"0" if standard output vertical format control is desired (skip on channel 1 of the standard printer carriage control tape). Any other punch selects "Other" output vertical format control (used for printing output tapes from standard FORTRAN executions).**								
9(2)	"0" if buffered record transmission is desired (and the record size is no larger than 506 bytes). Any other punch results in serial data transmission (where records are larger than 506 bytes).								

Notes: (1) Interpreted only when the job is local medium conversion.

(2) Interpreted only when the job is data transmission.

\*Currently implemented for magnetic tape (optional peripheral equipment).

\*\*See Page 7 for descriptions of Standard and Other Output Formats.

## 8130 SYSTEM OPERATING PROCEDURES

### Terminal Control Panel (TCP)

The Terminal Control Panel (TCP) – Figure 4 – , installed in the SPP, simplifies operator functions encountered with the 8130 System. It allows the operator to indicate to the SPP the desired mode of operation, and provides visual and audible indications of system status, under control of TERP-I.

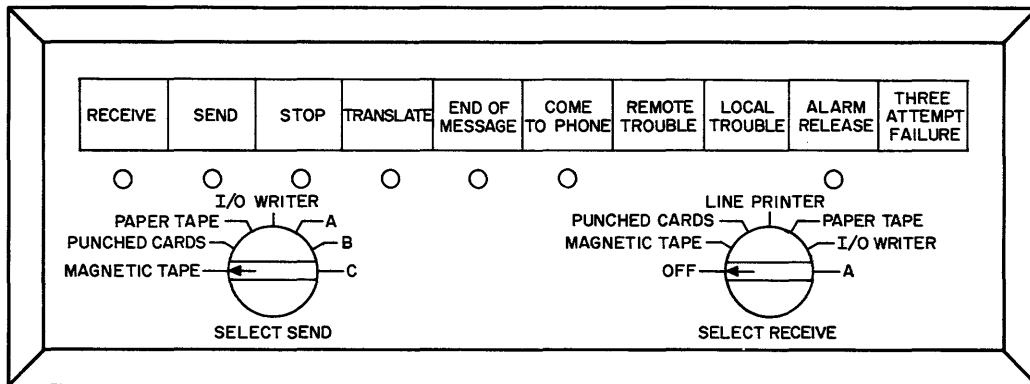

299/4

Figure 4. 8130 System Terminal Control Panel (TCP)

The TCP and the RUN, LOAD, and MASTER CLEAR switches of the SPP, coupled with the P-register for the display of error codes, provide a complete control facility for the entire 8130 System and its associated peripheral equipments.

### TERP-I Program Loading

1. Turn on all equipment.
2. Place TERP-I program deck in the 8130 Card Reader; ready the reader by registering the first card.
3. MASTER CLEAR.
4. LOAD and RUN. The TERP-I program deck is read and stored in SPP memory.

## End-of-Job Procedures

Normal End-of-Job is signalled by lighting the END OF MESSAGE and ALARM RELEASE indicators on the TCP, and sounding the audible alarm. Simultaneous lighting of the LOCAL TROUBLE indicator means abnormal End-of-Job.

If performing transmission or reception, MASTER CLEAR and RUN to return On Line state.

If performing local conversion, another job can be processed by returning to Procedure (2), under "Local Medium Conversion Mode".

## Error Conditions and Their Disposition

An 8130 System condition which necessitates a processing or data exchange pause is signalled by lighting the LOCAL TROUBLE and ALARM RELEASE indicators and sounding the audible alarm. Under such conditions, the following steps should be taken:

1. Press ALARM RELEASE on the TCP to silence the audible alarm.
2. Put the BXR/BER Switch on the SPP console in the lower position. An error diagnostic code is then displayed in the P-register display on the SPP console. Table 1 lists Error Codes, their interpretation, and disposition.

After interpretation of the error condition, the following steps should be taken (as appropriate):

3. To TERMINATE the Job:
  - a. Press END OF MESSAGE on the TCP.
  - b. Depress (momentarily) the Manual Interrupt Switch on the SPP console.
4. To RESUME the Job:  
(assuming the problem has been corrected)
  - a. Press ALARM RELEASE.
  - b. Depress (momentarily) the Manual Interrupt Switch on the SPP console.

# APPENDIX A

## RECORD STRUCTURE AND EXCHANGE LOGIC FOR 8130 SYSTEM INTERFACE WITH A DOMINANT COMPUTER SITE

### INTRODUCTION

This section contains information pertinent to the implementation of exchange logic at a central (dominant) data processing system to enable the exchange of information to and/or from an 8130 Remote Terminal System.

The method outlined is designed primarily for the type of transmission involving the movement of a number of related data records (e.g., a print job) from one terminal to the other without any intervening movement of data in the opposite direction.

The record structure and exchange logic is independent of any character set and can be used to transmit pure binary data.

Information in more detail is available in the following documents, from which material in this appendix is abstracted:

1. Smith, R. J. and Herrick, D. R. "A Proposed Record Structure and Record Exchange Logic for Interfacing a Job-Oriented Remote Terminal." Control Data Corporation Technical Memorandum IDP-1. Feb. 1, 1966.
2. "A Record Structure and Exchange Logic for Interfacing an 8-Bit Job-Oriented Terminal." Control Data Corporation IDP Technical Paper. April 18, 1966.

### RECORD STRUCTURE

For all practical purposes information flows through a telephone channel as a stream of binary digits (bits). Terminal devices which act as the interface between the telephone channel and a computer input/output channel accumulate a byte of digits and pass them in a single parallel transfer to the computer (or accept them in a single parallel transfer and serialize them into the telephone channel one at a time).

All format descriptions are presented in terms of bytes of binary digits as they would appear at the interface between an 8-bit 8130 Remote Terminal System and a central data processing system.

- b<sub>4</sub> Unable to proceed
- b<sub>3</sub> End of Job
- b<sub>2</sub> Unassigned
- b<sub>1</sub> Unassigned
- b<sub>0</sub> Unassigned

Data Records. Data Records are composed of a Preamble, followed by the Data Field. A Preamble as 8-bit bytes has the following format:

Byte	7	6	5	4	3	2	1	0
0	d	d	d	d	d	d	d	d
1	0	0	0	0	s	s	s	s
2	s	s	s	s	s	s	s	s

The second field, denoted by “ssssssssssss”, is a 12-digit binary value specifying the number of bytes comprising both the Preamble and the Data Field. The high-order digit is s<sub>3</sub>, byte 1.

The first field, denoted by “ddddddd” in byte 0, provides supplementary descriptive information regarding the data. The digit positions have the following significance:

- d<sub>7</sub> End of File
- d<sub>6</sub> Data Parity; 0 = even, 1 = odd
- d<sub>5</sub> Initial data record
- d<sub>4</sub> Unassigned
- d<sub>3</sub> Unassigned
- d<sub>2</sub> Unassigned
- d<sub>1</sub> Unassigned
- d<sub>0</sub> Unassigned

A Data Field follows the Preamble, and may not exceed 1018 eight-bit bytes. This is primarily due to the fact that this is the maximum length of a data field that can be protected by transmission error-detection methods which are employed. The performance capability of a given terminal may dictate a shorter data field.

Since the parity term is really a number resulting from arithmetic computation, significance is important. Byte<sub>0</sub>, digit 7 is most significant. Byte<sub>0</sub>, digit 6 is next most significant, etc. Significance goes from left to right within a byte and downward by byte.

The following are permissible transmission formats:

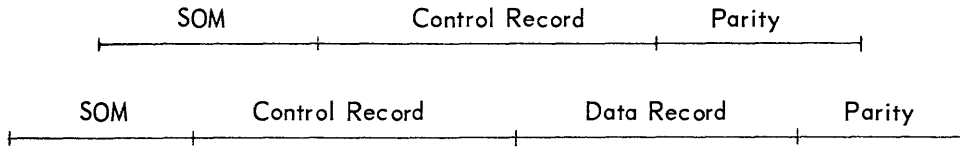

### Example of Error-Free Exchange

The following example illustrates a dominant terminal (D) soliciting data from a subordinate terminal (S). The illustration typifies exchange of control information and provides a point of departure for subsequent discussion. Since data transmission is to the dominant site, only control field "b" is relevant.

<u>Originator</u>	<u>Field b</u>	<u>Comment</u>
	7 0	
D	10 0 00000	Invitation to transmit data record
S	00 0 00000	No data response
D	10 0 00000	Invitation to transmit data record
S	11 0 00000	b <sub>7</sub> = request to send <u>next</u> data record b <sub>6</sub> = invited data record follows this control record b <sub>5</sub> = sequence no. of data record which follows
D	11 0 00000	Acknowledge of data record <u>and</u> invitation to send next data record
S	11 1 00000	b <sub>7</sub> = request to send <u>next</u> data record b <sub>6</sub> = invited data record follows b <sub>5</sub> = sequence no. of data record
D	11 1 00000	Acknowledge of data record, <u>and</u> invitation to send next data record.
S	11 0 00000	Request to send <u>next</u> data record, invited data record follows, sequence no. 0
D	11 0 00000	Acknowledge of data record <u>and</u> invitation to send next data record
	:	
	:	
	etc.	

Other more likely problems are:

- |  |   |
|--|---|
| 1. Unable to Proceed   | The terminal transmitting data cannot obtain data from its source, or the terminal receiving data cannot transfer data to its sink. |
| 2. Missing Transmission, Wrong Transmission Size, or Incorrect Parity. | Transmitting and receiving terminal interface hardware loses byte synchronization.  |

### Recovery Measures

General. The basic mechanism for recovery is re-transmission. Re-transmission may take place in response to a re-transmission request, or as the result of the passage of an interval of time without response to a previous transmission.

Responsibilities Unique to the Dominant Terminal. Once a job sequence has started, the dominant terminal is responsible for sustaining inter-terminal communication regardless of whether it is transmitting data or receiving data. In order to fulfill this responsibility, the dominant terminal must be prepared to re-transmit as a function of elapsed time.

Consider the following examples:

#### - EXAMPLE 1 -

<u>Originator</u>	<u>Transmission Description</u>	<u>Comment</u>
D	Control - Data <sub>1</sub> <div style="display: inline-block; vertical-align: middle; margin-left: 10px;"> <math>\left. \begin{array}{c} \\ \\ \\ \end{array} \right\} \Delta t</math> </div>	SOM Mutilated. Transmission discarded by S as noise. Since S saw no legitimate transmission it does not reply.
D	Control - Data <sub>1</sub>	After $\Delta t$ record is retransmitted.
S	Normal Reply <div style="display: inline-block; vertical-align: middle; margin-left: 10px;"> <math>\begin{array}{c} \cdot \\ \cdot \\ \cdot \\ \text{etc.} \end{array}</math> </div>	

- EXAMPLE 2 -

D	Control + Data <sub>1</sub>	
S	Normal Reply	SOM mutilated. Transmission discarded by D as noise. It appears to D that S did not reply.
		
D	Control + Data <sub>1</sub>	After Δt record is retransmitted.
S	Normal Reply	
	.	
	.	
	.	
	etc.	

- EXAMPLE 3 -

S	Control + Data <sub>1</sub>	
D	Normal Reply	SOM mutilated. Transmission discarded by S as noise.
		
D	Normal Reply	After Δt record is retransmitted.
S	Control + Data <sub>0</sub>	
	.	
	.	
	.	
	etc.	

It should be noted that all errors illustrated in the foregoing examples ultimately result in the same problem (missing transmission) and are taken care of by a single recovery measure (dominant terminal re-transmission as a function of elapsed time).

If after n re-transmission attempts no response is received, it is indicative of either transmission failure or subordinate terminal collapse and the dominant terminal should produce a diagnostic.

Responsibilities Unique to the Subordinate Terminal. If the subordinate terminal is on-line, it must respond to every recognized transmission from the dominant terminal. In addition, once a job sequence has started, the subordinate terminal must stay alive to give dominant terminal elapsed-time re-transmission logic a chance to operate. The operator is notified if no transmission is received within a reasonable time.



Common Responsibilities. Both terminals share several common responsibilities. Among them are:

1. An extra transmission must be discarded.
2. Bytes not preceded by SOM must be discarded.
3. Size errors must be planned for. If more or fewer bytes are received than anticipated, the entire transmission should be ignored and a retransmission requested. Terminals which accept bytes via interface hardware that assembles blocks in core must not fall into the trap of defining a buffer area on the basis of size and expect it to reliably terminate.
4. Both terminals must generate parity for transmitted records and regenerate parity over received records (it is a property of systematic cyclic codes that regenerated parity, if correct, will be all zeros). In event of incorrect parity, the detecting terminal should request re-transmission as soon as possible to avoid waste of channel time while waiting for time-out logic to operate.
5. If either terminal is unable to proceed, it must so inform the other.

#### Control Information in Detail

##### Field "a"

This field controls data transmission from the dominant site.

Digits 6 and 7

##### When Transmitted by D

- 7    1 = Request permission to transmit another data record.  
      0 = Do not desire to transmit another data record
- 6    1 = Previously invited data record follows  
      0 = No data record follows

##### When Transmitted by S

- 7    1 = Invitation to transmit another data record  
      0 = Do not send another data record
- 6    1 = I acknowledge satisfactory receipt of a data record  
      0 = I do not acknowledge receipt of a data record

Digit 5 supplements 6, identifying the particular data record transmitted or acknowledged. The initial data record of a job sequence is numbered 0. Record number toggles between 1 and 0 for subsequent data records.

Digit 4 indicates that the first terminal which transmits it is unable to continue the job sequence.

Digit 3 indicates normal end of job.

Digit 2 unassigned.

Digit 1 unassigned.

Digit 0 unassigned.

Field "b"

This field controls data transmission to the dominant site. If one interchanges D and S in the explanation of digits 7 and 6 above, all digits have exactly the same meaning.

**Exchange Procedures in Detail**

The general rules in exchange procedures are as follows:

1. The subordinate terminal (8130 System) always responds to a recognized transmission from the dominant terminal (central data processing site).
2. The dominant terminal must repeat its last transmission if the subordinate terminal does not respond within the specified interval of time. At least five (5) repeats must be attempted.
3. Once a job-sequence has started, the dominant terminal must respond to each subordinate terminal transmission except the last one.

**Starting a Job.** Two possible techniques can be used for starting a job:

**Polling and Dead Start.**

1. Polling. The dominant terminal periodically polls the subordinate terminal by transmitting control records of the following form:

<u>Field a</u>	<u>Field b</u>
7        0	7        0
00 0 00000	10 0 00000

Invitation to transmit data to the dominant site

The subordinate terminal responds to each transmission by transmitting the following control record:

<u>Field a</u>	<u>Field b</u>
7            0	7            0
10 0 00000	00 0 00000

Invitation to transmit data      No business response  
from the dominant site. This digit is optional. If present, it means S is prepared to accept data in the next transmission from D. Field a could be returned all zeros in which case D would set the digit when he desired to transmit and wait for it to be returned by S.

A sample start sequence is as follows:

<u>Originator</u>	<u>Field a</u>	<u>Field b</u>	<u>Comment</u>
D	00 0 00000	10 0 00000	Invite to transmit to D
S	10 0 00000	00 0 00000	No business reply + Invite to transmit to S.
D	11 0 00000	10 0 00000	D accepts the invitation issued by S, transmits the initial data record, and requests permission to send the next. D is capable of alternating data exchange and continues inviting S to transmit data.
S	11 0 00000	00 0 00000	S, who is not capable of alternating exchange, declines the invitation to transmit, acknowledges the first data record, and invites another.
S	11 0 00000	00 0 00000	

Alternatively, the transmission could have been started by the subordinate site (S) as follows:

D	00 000000	10 0 00000	Invite to transmit to D
S	10 0 00000	00 0 00000	No business reply + Invite to transmit to S.
D	00 0 00000	10 0 00000	Invite to transmit to D
S	000 0 00000	11 0 00000	S accepts D's invitation, sends the initial data record, and requests permission to send the next. Note that S who is incapable of alternating data exchange, has dropped his invitation to transmit.
D	10 0 00000	11 0 00000	D, unaware that S is incapable of alternating exchange, requests permission to transmit to S, acknowledges the initial data record, and invites another.
S	00 0 00000 . . . etc.	11 1 00000	S denies D's transmit request, sends the invited data record, and requests permission to send another.

2. Dead Start. Both terminals essentially lie dormant. When either of them wishes to transmit data, it requests permission to send from the other by transmitting a control record. This type of operation might be relevant if the dialed network is being used for inter-terminal communication.

A Sample dead start starting sequence is as follows:

<u>Originator</u>	<u>Field a</u>	<u>Field b</u>	<u>Comment</u>
S	00 0 00000	10 0 00000	S requests permission to send
D	00 0 00000	10 0 00000	D returns invitation to transmit
S	00 0 00000	11 0 00000	S sends first data record and requests permission to send another.
D	00 0 00000 . . . etc.	11 0 00000	D acknowledges first record and invites transmission of another.

- or -

D	10 0 00000	10 0 00000	D requests permission to send and invites S to transmit.
S	10 0 00000	00 0 00000	S invites D to transmit and declines D's invitation.
D	11 0 00000	10 0 00000	D sends first data record and requests permission to send another. D also continues to invite transmission by S.
S	11 0 00000	00 0 00000	S acknowledges D's data, invites D to transmit another record and declines D's invitation to transmit.
	.		
	.		
	.		
	etc.		

### Sustaining a Job In Progress

Assuming no problems, a job is sustained simply by replying to each send-terminal transmission with a control record containing control information duplicating that received.

### Terminating a Job Normally

#### 1. Data Being Transmitted by Dominant Terminal

<u>Originator</u>	<u>Field a</u>	<u>Comment</u>
D	11 0 00000	
S	11 0 00000	
D	00 0 01000	D drops request to send next record, shows no accompanying data, and indicates end of job.
S	00 0 01000	Acknowledges end of job.

DONE!

The end of job indicator can also accompany the last data record as shown below:

2. Data being Transmitted by Subordinate Terminal

<u>Originator</u>	<u>Field b</u>	<u>Comment</u>
S	11 0 00000	
D	11 0 00000	
S	01 1 01000	Transmits final data record, indicates end of job, and drops request to send another data record.
D	01 1 01000	Acknowledges final data record and end of job.
S	00 0 00000	Fulfills general rule 1.

Requesting Re-transmission. Either terminal can request re-transmission from the other by repeating its own last transmission. The only time re-transmission is requested is upon detection of incorrect parity or wrong size. Dominant terminal elapsed-time re-transmission logic takes care of other cases.

Pause. Need may arise to hold data transmission in abeyance temporarily. This is accomplished as illustrated by the following examples:

1. Data Being Transmitted by Dominant Terminal.

<u>Originator</u>	<u>Field a</u>	<u>Comment</u>
.		
.		
.		
D	11 0 00000	
S	11 0 00000	
*D	00 0 00000	No business, but still alive
*S	10 0 00000	Invitation for D to transmit
D	11 1 00000	D resumes data transmission

---

\*These exchanges can go on indefinitely.

- OR -

.  
. .  
D 11 0 00000  
S 01 0 00000 S drops invitation to transmit next record and  
acknowledges last record.  
\*D 10 0 00000 D requests permission to send  
\*S 00 0 00000 Permission denied  
D 10 0 00000  
S 10 0 00000 S invites data transmission  
D 11 1 00000 D resumes data transmission

2. Data Being Transmitted by Subordinate Terminal.

<u>Originator</u>	<u>Field b</u>	<u>Comment</u>
.		
.		
S	11 0 00000	
D	01 0 00000	D drops invitation to transmit and acknowledges last data record
*S	10 0 00000	S requests permission to send
*D	00 0 00000	Permission denied
S	10 0 00000	
D	10 0 00000	D invites data transmission
S	11 1 00000	S resumes data transmission

\*These exchanges can go on indefinitely.

- OR -

.  
.  
.  
S 11 0 00000  
D 11 0 00000  
\*S 00 0 00000 No business, but still alive  
\*D 10 0 00000 D invites next transmission  
S 00 0 00000  
D 10 0 00000  
S 11 1 00000 S resumes data transmission

Abnormal Termination. Either terminal may find itself unable to proceed and may truncate the job in exactly the way shown for normal termination except that the Unable to Proceed digit is set and acknowledged via End of Job.

## MISCELLANEOUS

Purposefully, no attempt has been made to define end of job other than in the context of its effect on transmission exchange.

The question of what it means must be decided within the framework of dominant and subordinate site processing abilities.

## TRANSMISSION ERROR DETECTION

### Terminology

Code Word. A Code Word is a group of related binary digits used to convey information.

(n,k) Code. (n,k) is simply an annotation describing the information digit content of a code word with respect to the total number of digits in the code word.

n = total number of digits

k = number of information digits

---

\*These changes can go on indefinitely.



Hamming Distance. The Hamming Distance between two code words is equal to the number of digits in which they differ.

Example:

Code Word A = 1 1 1 1 1 1 1

Code Word B = 1 1 0 0 0 1 1

The Hamming Distance between A and B is 3.

### A Point of View

Usually when one thinks of code words, one thinks in terms of small units of information. For example, the 6-digit code words comprising the external BCD code, or the 5-digit code words comprising the Baudot code, or the 8-digit code words comprising the ASCII code, etc. One can, however, assume a macroscopic point of view and look upon a record comprised of many small code words as a code word itself.

### Choosing a Code for Transmission

For several reasons it is advantageous to send a large number, perhaps many thousand, binary digits in a single transmission when moving information over a telephone channel.

Now suppose that one thought of each transmission as a single code word of fixed-length  $n$ . There are, then,  $2^n$  possible unique code words that can be transmitted, each of which will differ from some other code word in only 1 digit (Hamming distance of 1). If all of the digits represent information (i.e.,  $n = k$ ) it is completely impossible to detect any errors since a code word transformed by even one error will become another legitimate code word.

If, however, one parity digit is added to each code word to make the total number of binary 1's transmitted always odd, the minimum Hamming distance between any two code words becomes 2 and a single error occurring during transmission can be detected. (A single error will result in an even number of 1's which is illegitimate by definition).

In general, if one can somehow ensure that the smallest Hamming distance between any two code words is  $d$ , then it is always possible to detect  $d-1$  errors.

One of the objectives in choosing a code is to provide the greatest possible Hamming distance between code words. Another way of stating this is: given information

words of length  $k$ , one would like to operate mechanistically over the information to produce code words of length  $n$  which are as distant from each other as possible. In the latter case described above  $n-k = 1$ . As  $n-k$  is made larger the distance between code words can be increased.

A second objective in choosing a code is to keep the value of

$$\frac{k}{n}$$

which is a measure of transmission efficiency, near 1 without sacrificing distance.

A third objective is to choose a code which protects against known error characteristics of a telephone channel. While Hamming distance is a good measure of a codes ability to detect independent errors, it tells one little about a code's susceptibility to burst errors, a common phenomenon on telephone channels.

A fourth objective is to provide for a variable  $k$ , such that when  $k$  decreases  $n$  decreases correspondingly without jeopardizing the error detection capability of the code.

Finally, one must choose a code where the mechanistic operation necessary to convert an information word into a code word is a realistic undertaking on a finite machine.

### The Bose-Chadhuri Cyclic Code

In deference to space and time no attempt will be made to describe cyclic codes. (The interested reader is referred to the excellent material in CONTROL DATA TECHNICAL REPORT 54). A Bose-Chadhuri cyclic code has been chosen for use in detecting transmission errors because it satisfies the criteria for a good transmission code as well as or better than any other readily available. In applying the code, an entire transmission excluding the SOM byte is treated as an information word. The particular code used has the following characteristics

$n$	=	32767
$k$	=	32736
$n-k$	=	31
Hamming Distance	=	6
$k/n$	≅	.999
Generator Polynomial	=	30614012257g

#### 1. Error Detection Properties

All cyclic codes have the following error detection properties:

##### Independent Errors

If the Hamming distance of the code is  $d$ , it will always detect  $d-1$  independent errors.

### Burst Errors

If the error burst length is  $\leq n-k$ , the probability of undetected error,  $P(u)$ , is

$$P(u) = 0$$

If the error burst length is  $= n-k + 1$ , the probability of undetected error is

$$P(u) = \frac{1}{2^{n-k-1}}$$

If the error burst length is  $< n-k + 1$ , the probability of undetected error is

$$P(u) = \frac{1}{2^{n-k}}$$

### Special Error Cases

An even number of errors will always be detected.

## 2. Transmission Efficiency

A given code operates most efficiently at its natural length; that is, when the maximum permissible number of information digits is transmitted. If fewer information digits are transmitted the number of parity digits remains constant and the error protection ability of the code is unchanged. When fewer information digits than the theoretical maximum are transmitted the code is said to be shortened.

### Example

When operated at its natural length the (32767, 32736) code has a transmission efficiency of

$$E = \frac{32736}{32767} \cong .999$$

If the code is shortened to (8031, 8000) efficiency drops to

$$E = \frac{8000}{8031} \cong .996$$

Error detection ability remains unchanged.

**APPENDIX B**  
**8130 SYSTEM INTERNAL BCD CODES**

OCTAL CODE	PRINTER SYMBOL	HOLLERITH	OCTAL CODE	PRINTER SYMBOL	HOLLERITH
00	0	0	40	-	11
01	1	1	41	J	11 1
02	2	2	42	K	11 2
03	3	3	43	L	11 3
04	4	4	44	M	11 4
05	5	5	45	N	11 5
06	6	6	46	O	11 6
07	7	7	47	P	11 7
10	8	8	50	Q	11 8
11	9	9	51	R	11 9
12	:	2 8	52	∨	11 0
13	=	3 8	53	\$	11 3 8
14	≠	4 8	54	*	11 4 8
15	≦	5 8	55	↑	11 5 8
16	%	6 8	56	↓	11 6 8
17	□	7 8	57	>	11 7 8
20	+	12	60	blank	unpunched
21	A	12 1	61	/	0 1
22	B	12 2	62	S	0 2
23	C	12 3	63	T	0 3
24	D	12 4	64	U	0 4
25	E	12 5	65	V	0 5
26	F	12 6	66	W	0 6
27	G	12 7	67	X	0 7
30	H	12 8	70	Y	0 8
31	I	12 9	71	Z	0 9
32	<	12 0	72	⌋	0 2 8
33	.	12 3 8	73	,	0 3 8
34	)	12 4 8	74	(	0 4 8
35	≧	12 5 8	75	→	0 5 8
36	┘	12 6 8	76	≡	0 6 8
37	;	12 7 8	77	^	0 7 8

**APPENDIX C**  
**8130 SYSTEM EXTERNAL BCD CODES**  
**(IN CODE SEQUENCE)**

BCD CODE	CHARACTER	HOLLERITH CODE	BCD CODE	CHARACTER	HOLLERITH CODE
00	- illegal -		40	-	11
01	1	1	41	J	11 1
02	2	2	42	K	11 2
03	3	3	43	L	11 3
04	4	4	44	M	11 4
05	5	5	45	N	11 5
06	6	6	46	O	11 6
07	7	7	47	P	11 7
10	8	8	50	Q	11 8
11	9	9	51	R	11 9
12	0	0	52	%	11 0
13	=	3 8	53	\$	11 3 8
14	≠	4 8	54	*	11 4 8
15	≤	5 8	55	↑	11 5 8
16	:	6 8	56	↓	11 6 8
17	□	7 8	57	>	11 7 8
20	blank	unpunched	60	+	12
21	/	0 1	61	A	12 1
22	S	0 2	62	B	12 2
23	T	0 3	63	C	12 3
24	U	0 4	64	D	12 4
25	V	0 5	65	E	12 5
26	W	0 6	66	F	12 6
27	X	0 7	67	G	12 7
30	Y	0 8	70	H	12 8
31	Z	0 9	71	I	12 9
32	∩	0 2 8	72	<	12 0
33	'	0 3 8	73	.	12 3 8
34	(	0 4 8	74	)	12 4 8
35	→	0 5 8	75	≥	12 5 8
36	≡	0 6 8	76	?	12 6 8
37	~	0 7 8	77	;	12 7 8

**8130 SYSTEM EXTERNAL BCD CODES  
(IN CHARACTER SEQUENCE)**

CHARACTER	OCTAL CODE	CHARACTER	OCTAL CODE
Blank	20	L	43
0	12	M	44
1	01	N	45
2	02	O	46
3	03	P	47
4	04	Q	50
5	05	R	51
6	06	S	22
7	07	T	23
8	10	U	24
9	11	V	25
.	73	W	26
-	40	X	27
+	60	Y	30
=	13	Z	31
≠	14	(	34
/	21	)	74
~	37	,	33
%	52	?	76
\$	53	;	77
*	54	:	16
A	61	:	00
B	62	□	32
C	63	→	35
D	64	≡	36
E	65	↑	55
F	66	↓	56
G	67	>	57
H	70	<	72
I	71	≧	75
J	41	≦	15
K	42	□	17

# APPENDIX D

## BOSE-CHADHURI CYCLIC CODE GENERATION TECHNIQUES

### GENERAL

This appendix describes recommended methods for the implementation of Bose-Chadhuri Cyclic Code generation and verification in a dominant computer system, conversant with an 8130 Remote Terminal System (through TERP-I). As stated elsewhere in the text,\* Bose-Chadhuri offers the best protection for this kind of environment in comparison with other possible code generation techniques.

### Introduction

In applying the Bose-Chadhuri Cyclic Code, an entire transmission, excluding the SOM (Start of Message) byte, is treated as one continuous stream of bits independent of word size. A parity term (remainder) is developed by division modulo 2 (exclusive OR) of the Bose-Chadhuri Generator Polynomial ( $G(X) = 30614012257_8$ ) into the data stream. The receiving terminal is thus able, through application of similar techniques, to verify (and thus virtually guarantee) the integrity of the transmission.

### Implementation Technique – 3000 Series Computer Systems

General Method for Generation. Assume the organization of a message as a string of 8-bit bytes, arranged as follows in a sequence of 24-bit words:

	22221111	11111100	00000000
	32109876	54321098	76543210
base	D1	D2	D3
base + 1	D4	D5	D6
base + 2	D7	D8	D9
base + 3	D10	D11	R1
base + 4	R2	R3	R4

D1, D2, D3, D4, D5, D6, D7, D8, D9, D10, and D11 represent the data bytes. R1, R2,

\* See "Error Protection", Page 10

R3, and R4 represent the remainder or parity term. Steps in generation of the parity term are as follows:

1. Initialize byte positions R1, R2, R3, and R4 to zero.
2. Set up  $G(X) = 30614012257_8$  as a constant, occupying two successive memory locations left-justified as (61430024,53600000).
3. Load the A/Q registers with bytes D1, D2, D3, D4, D5, and D6.
4. Examine the leftmost bit position of the A-register. If "0", proceed to step 6 without further action. If "1", proceed to step 5.
5. Perform an exclusive OR between A/Q and G(X). The result is in A/Q.
6. Shift the A/Q registers left one bit position and repeat step 4 until all data bits have been acted upon by step 4.

NOTE: After each 8th left shift of the A/Q registers, the next byte of the message should be introduced into the low-order bit positions of the Q-register.

After  $8n$  shifts (where "n" represents the number of bytes in the transmission) the leftmost 31 bits in the A-register represent the remainder and are appended to the data as the parity term (occupying bytes R1, R2, R3, and R4).

Steps 2 through 6 can be used for verification as well as generation if byte positions R1, R2, R3, and R4 are cleared to zero prior to generation, as shown by step 1.

General Method for Verification. Verification is accomplished utilizing the same procedure as in step 2 through 6 of the generation. Since the remainder was included as part of the transmission, the result of the last division should result in the A/Q registers being equal to zero. Any non-zero remainder denotes a transmission error.



### Example of Generation and Verification

Assume that a message, consisting of a single 8-bit byte, is to be transmitted, and that a pseudo  $G(X)$  exists – for illustrative purposes – as the binary pattern (1101). The message to be transmitted is (10110110). On division, a three-bit remainder will be generated, so that prior to the generation, three “0” bits must be appended to the data.

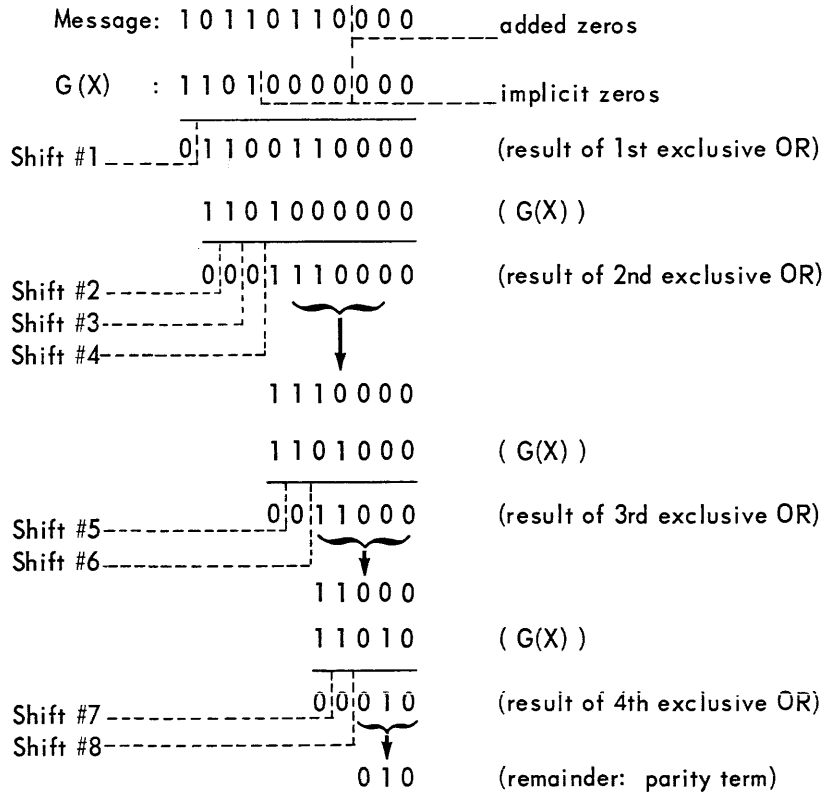

Message (with parity) transmitted:

1	0	1	1	0	1	1	0	0	1	0
message								parity term		

Message (with parity) received:

1 0 1 1 0 1 1 0 0 1 0

G(X): 1 1 0 1 0 0 0 0 0 0 0 ..... implicit zeros

Shift #1 ----- 0 1 1 0 0 1 1 0 0 1 0 (result of 1st exclusive OR)  
 1 1 0 1 0 0 0 0 0 0 (G(X))

Shift #2 ----- 0 0 0 1 1 1 0 0 1 0 (result of 2nd exclusive OR)

Shift #3 -----  
 Shift #4 -----  
 1 1 1 0 0 1 0  
 1 1 0 1 0 0 0 (G(X))

Shift #5 ----- 0 0 1 1 0 1 0 (result of 3rd exclusive OR)

Shift #6 -----  
 1 1 0 1 0  
 1 1 0 1 0 (G(X))

Shift #7 ----- 0 0 0 0 0  
 Shift #8 -----  
 0 0 0 (remainder: signifying error-free transmission)

**Implementation Technique – 8092 Series and other 8-bit Word Computer Systems**

General Method for Generation. Assume the organization of a message as a string of 8-bit bytes, arranged as follows in a sequence of 8-bit words:

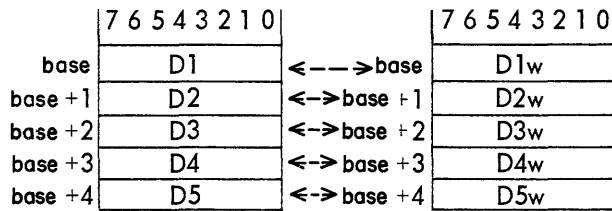

Data Message

Working Table

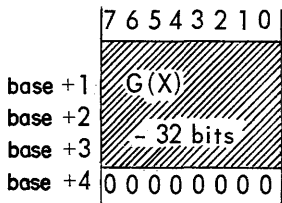

Pattern 1

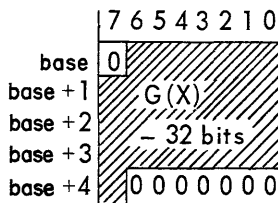

Pattern 2

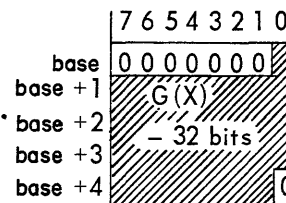

Pattern 8

The array  $Dnw$  ( $1 \leq n \leq 5$ ) represents a working table which is operated upon in conjunction with the eight Pattern  $m$  ( $1 \leq m \leq 8$ ) tables. The Pattern  $m$  tables represent the circular block shifts of the block containing  $G(X)$  – where  $G(X) = 30614012257_8$ . In Pattern 1, for example,  $G(X)$  is represented in the first four words as follows:

	7 6 5 4 3 2 1 0
base	1 1 0 0 0 1 1 0
base + 1	0 0 1 1 0 0 0 0
base + 2	0 0 0 1 0 1 0 0
base + 3	1 0 1 0 1 1 1 1
base + 4	0 0 0 0 0 0 0 0

The entire pattern is right-shifted one position for each succeeding table, as indicated previously.

The method of processing is as follows:

1. Test bit 7 of  $D1w$ . If it is "1", perform five (5) exclusive OR operations with corresponding words in the Working Table and Pattern 1. If bit 7 is zero, proceed to step 2.
2. Test bit 6 of  $D1w$ . If it is "1", perform five (5) exclusive OR operations with corresponding words in the Working Table and Pattern 2. If bit 6 is zero, proceed to step 3.
- .
- .
- .
- .
8. Test bit 0 of  $D1w$ . If it is "1", perform five (5) exclusive OR operations with corresponding words in the Working Table and Pattern 8. If bit 0 is zero, proceed to step 9.
9. Update the Working Table by discarding  $D1w$  and moving every word up one position. Place the next data word in  $D5w$ .
10. After the last data word has been encoded, update the Working Table again. The remainder (parity term) is then represented in the Working Table as  $R(X) = D1w, D2w, D3w, D4w$ .

The verification technique is essentially the same process.

Summary. In general, techniques for generation and validity checking can be accomplished in computer systems with a word size of 12 bits in much the same manner as outlined in the preceding section. Techniques similar to that shown for 3000 Series Computer Systems (with 24-bit words) can be used to implement the logic for computer systems with larger word sizes.

## INDEX

Abnormal Termination . . . . .	A-16
Bose-Chadhuri Cyclic Code . . . . .	A-18
Generation Techniques . . . . .	D-1
Buffered Operation . . . . .	9
Card Reader . . . . .	2
Code Word, definition of . . . . .	A-16
CONTROL CARDS AND JOB DECK STRUCTURE . . . . .	11
Control Information, details of . . . . .	A-9
Control Records . . . . .	A-4, A-5
Criteria for Selection of a Transmission Code . . . . .	A-17
Data Compression/Expansion . . . . .	9
Data Records . . . . .	9, A-3
Data Field . . . . .	A-3
Preamble . . . . .	9, A-3
Data Transmission (On-Line) Mode . . . . .	8
Data Set Controller (DSC) . . . . .	2
End-of-Job Card . . . . .	14
Exchange Logic . . . . .	A-4
Exchange Procedures, detailed . . . . .	A-10
Error Protection Features . . . . .	10
External BCD Codes . . . . .	C-1, C-2
Hamming Distance . . . . .	10, A-17
INPUT FILES . . . . .	5
Magnetic Tape Files . . . . .	5
Punched Card Files . . . . .	5
Internal BCD Codes . . . . .	B-1
Job Descriptor Card . . . . .	13
Line Printer . . . . .	4
Line Printer Files . . . . .	6
General . . . . .	6
Other Output Format . . . . .	7
Record Structure . . . . .	6
Standard Output Format . . . . .	7
Vertical Format Control . . . . .	7
Local Medium Conversion (Off-Line) Mode . . . . .	10
Logic, Exchange . . . . .	A-4
Magnetic Tape Files	
Input Files . . . . .	5
Output Files . . . . .	6
OPERATING CHARACTERISTICS AND DATA FLOW . . . . .	8
General . . . . .	8
OPERATING PROCEDURES . . . . .	15
Data Transmission from the 8130 System . . . . .	16
End-of-Job Procedures . . . . .	17
Error Conditions and Their Disposition . . . . .	17, 18
Local Medium Conversion Mode . . . . .	16
Putting the 8130 On-Line with the	
Central Data Processing System . . . . .	16
TERP-I Program Loading . . . . .	15

## INDEX (Cont'd)

OUTPUT FILES .....	6
Line Printer Files .....	6
Magnetic Tape Files .....	6
Punched Card Files .....	7
Pause .....	A-14
Punched Card Files	
Input Files .....	5
Output Files .....	7
Record Structure .....	A-1
Compressed Data .....	9
Control Records .....	A-2
Data Records .....	A-2
Expanded Data .....	10
Line Printer Files .....	6
Magnetic Tape Files .....	5,6
Punched Card Files .....	7
Recovery Measures .....	18, A-7
Serial Operation .....	9
Starting a Job .....	A-10
Dead Start Techniques .....	A-12
Polling Techniques .....	A-10
Stored Program Processor (SPP) .....	2
Terminal Control Panel (TCP) .....	2, 15
Terminal Program (TERP-I) .....	4
TERP-I Program, General Description of .....	4
TERP-I Program Loading .....	15
Transmission Errors, Description of .....	18, A-6
Transmission Formats .....	A-4

## CITED REFERENCES

1. Smith, R. J. and Herrick, D. R. "A proposed Record Structure and Record Exchange Logic for Interfacing a Job-Oriented Remote Terminal." Control Data Corporation Technical Memorandum IDP-1. February 1, 1966.
2. "A Record Structure and Exchange Logic for Interfacing an 8-bit Job-Oriented Terminal." Control Data Corporation IDP Technical Paper. April 18, 1966.

## 8130 SYSTEM DOCUMENTS

368 105 00 SPP – Input/Output Specifications  
368 106 00A SPP – Reference Manual  
368 107 00A SPP Programming/Reference Manual  
368 278 00 Card Reader and Card Reader Controller – Reference Manual  
368 280 00 8130 Remote Terminal Reference Manual  
368 283 00 8197 Data Set Controller (DSC) Reference Manual