

---

# CONTROL DATA® 6000 SERIES COMPUTER SYSTEMS

---

## HARDWARE REFERENCE MANUAL

New features, as well as changes, deletions, and additions to information in this manual, are indicated by bars in the margins or by a dot near the page number if the entire page is affected. A bar by the page number indicates pagination rather than content has changed.

<b>REVISION RECORD</b>	
<b>REVISION</b>	<b>DESCRIPTION</b>
	This manual obsoletes the 6600 Computer System Reference Manual, Pub. No. 60045000.
A (4-5-66)	Publication Change Order CA13186. Addition and deletion of information for technical accuracy. Title changed to 6400/6600 Computer Systems Reference Manual. This edition obsoletes all previous editions.
B (9-1-66)	Publication Change Order 14568. Pages 3-13, B-4, B-9, B-12, B-13, B-14, B-15, B-16, D-5 and Index-2 revised.
C (10-27-66)	Publication Change Order 15036. Page D-6 revised.
D (2-21-67)	Publication Change Order 15866. Addition of 6500 information; title changed to 6400/6500/6600 Computer Systems Reference Manual. The following pages revised: cover and title page, iv, v, frontispiece, 1-1, 1-2, 1-3, 1-4, 1-5, 1-7, 1-8, 3-1, 3-2, 3-6, 3-7, 3-12, 3-16, 3-20, 3-51, 4-1, 4-13, 4-24, 4-25, 4-29, 4-30, 4-36, 5-1, 6-1, 6-4, Appendix A title page, A-1, A-2, A-3, A-4, A-5, A-6, B-2, B-3, B-5, B-6, B-7, B-8, C-1, D-1, D-2, D-3, D-4, D-6, and Comment Sheet.
E (5-16-67)	Field Change Order 15829. Changes included in Publications Change Order 19635.
F (5-16-67)	Publications Change Order 19635. Deletion of ECS information, addition of COMPASS mnemonics, miscellaneous additions and corrections. The following pages revised: Title Page and Record of Revisions, iii, iv, v, 1-3, 1-8, 3-9, 3-11, 3-23, 3-46, 3-47, 4-7, 4-10, 4-25, 4-26, 4-29, 4-30, 4-31, 4-37, 4-38, 4-39, 6-2, 6-4, A-3, A-4, B-6, Appendix D Title Page, D-1 through D-6, Index-1, and Index-2.
G (9-26-68)	Manual revised; includes Engineering Change Order 20617, publication change only. Pages 3-8, 3-13, and 4-8 revised.
H (2-21-69)	Manual revised; includes Engineering Change Order 21720, publication change only. Pages iii, v, 3-3, 3-4, 3-5, 3-6, 3-7, 3-34, 3-35, 3-42, 3-43, D-2, D-4 and D-5 revised.
J (11-17-69)	Manual revised; includes Engineering Change Order 23887, publication change only. Pages iv, 1-8, and 6-1 revised. Page E-1 and Appendix E (Title page) added.
K (8-4-70)	Manual revised; includes Engineering Change Order 25288, publications change only. The following pages revised: Covers, iv, v, Frontispiece, 1-1 through 1-6, 1-8, 2-1 through 2-3, 3-1 through 3-9, 3-21, 3-22, 3-23, 3-25, 3-26, 3-27, 3-39, 3-41, 3-42, 3-46, 3-47, 3-49, 4-1, 4-2, 4-5, 4-10, 4-24, 4-25, 4-29, 4-31, 4-33, 4-34, 5-1, 6-1, 6-3, 6-4, A-1, A-2, A-3, A-4, B-1, B-6 through B-13, Appendix D, divider, D-1, D-2, D-3, D-5, and E-1. The following pages added: 1-9, 1-10, Appendix F.
L (1-10-71)	Manual revised; includes Engineering Change Order 26843, publications change only. Pages revised: inside front cover, 1-3, 3-13, 3-18, B-6 and B-8.
M (6-20-71)	Manual revised; includes Engineering Change Order 28208 covering 6000 Station and 6200 System. Publications change only. Pages revised: Cover, Title Page, Record of Revision, iii, iv, v, Frontispiece, 1-1 through 1-11, 2-1, 3-1, 3-2, 3-6, 3-7, 3-9, 3-39 through 3-42, 4-1, 4-24,
Publication No. 60100000	

REVISION LETTERS I, O, Q AND X ARE NOT USED

Address comments concerning this manual to:

Control Data Corporation  
Publications and Graphics Division  
4201 North Lexington Avenue  
St. Paul, Minnesota 55112

© 1966, 1967, 1968, 1969, 1970, 1971, 1972, 1973, 1974, 1975, 1976, 1978  
by Control Data Corporation

Printed in the United States of America

or use Comment Sheet in the back of this manual.

## REVISION RECORD (CONT'D)

REVISION	DESCRIPTION
M (6-20-71)	4-25, A-1, A-2, A-3, B-2 through B-8, B-14, E-1, F-2, Index-1, Index-2, Comment Sheet, Back Cover. (Revision authorized by Engineering Change Order 26925 but changes made according to Engineering Change Order 28208.)
N (3-10-72)	Manual revised; includes Engineering Change Order 26379. Pages iv, 3-15, 3-36, 3-37, 3-41, 3-42, 3-43, 4-27, 6-3, B-6, B-14, Appendix C (divider), C-1, C-2, F-6, F-7, and Index 1 are revised. Page F-8 is deleted.
P (9-8-72)	Manual revised; includes Engineering Change Order 32489. Inside front cover, and pages 3-6, 3-13, 3-22, 3-23, 4-10, 4-35, B-6, B-7, B-8, Index 1 and Index 2 are revised. Inside back cover and appendix D are deleted. (Revision authorized by Engineering Change Order 28208 but changes made under revision M.)
R (1-15-73)	Engineering Change Order 30817; publication change only. Changes have been covered under revision N.
S (1-15-73)	Manual revised; includes Engineering Change Order 30638. Page 3-41 is revised.
T (1-15-73)	Engineering Change Order 30866; no effect to this manual.
U (1-15-73)	Manual revised; includes Engineering Change Order 31029. Page 3-41 is revised.
V (1-15-73)	Engineering Change Order 32489; publication change only. Changes have been made under revision P.
W (1-15-73)	Manual revised; includes Engineering Change Order 33032. Page 3-41 is revised.
Y (3-14-74)	Manual revised; includes Engineering Change Order 33696. Pages 3-21, 3-25, 4-7, 4-10, 4-29, 4-30, 4-31, 4-32, and F2 are revised.
Z (7-2-74)	Manual revised; includes Engineering Change Order 35100. Page 6-3 is revised.
AA (7-2-74)	Manual revised; includes Engineering Change Order 35196. Page 4-31 is revised.
AB (9-9-74)	Manual revised; includes Engineering Change Order 35579. Page 6-3 is revised.
AC (10-24-74)	Manual revised; includes Field Change Order 34717. Pages iv, 4-25, 4-26, 4-27, 6-3, 6-4, and F-7 are revised.
AD (12-3-74)	Manual revised; includes Engineering Change Order 35678. Pages iii, v, 3-16, 3-17, 3-21, 3-40, 3-41, 4-8, and 4-9 are revised. Pages 4-9.0 and 4-9.1 are revised.
AE (2-7-75)	Manual revised; includes Engineering Change Order 36046. Page 3-46 is revised.
AF (8-14-75)	Manual revised; includes Engineering Change Order 36469. Pages 3-16 and 3-35 are revised.
AG (10-23-75)	Manual revised; includes Engineering Change Order 36700. Front Cover, Title Page, iv, 3-27, and Appendix D (divider) are revised. Page D-1 is added.
AH (3-4-76)	Manual revised; includes Engineering Change Order 36994. Page B-13 is revised.
AJ (2-15-78)	Manual revised; includes Engineering Change Order 37836. Page 4-7 is revised.
Publication No. 60100000	

## REVISION RECORD (CONT'D)

REVISION	DESCRIPTION
AK (2-15-78)	Manual revised; includes Engineering Change Order 38414. Pages iii, 2-2, 2-3, 2-4, 3-3, 3-12, and 3-13 are revised.
AL (8-29-78)	Manual revised; includes Engineering Change Order 39088. Pages 3-31, 3-33, 3-41, and 4-7 are revised.
RECEIVED	
05 MAR 1979	
DAVID E. LEE	

Publication No.  
60100000

# CONTENTS

<p><b>1. SYSTEMS DESCRIPTION</b></p> <p>Introduction 1-1</p> <p>Systems Characteristics Summary 1-2</p> <p style="padding-left: 20px;">6000 Station 1-2</p> <p style="padding-left: 20px;">6200 Computer 1-3</p> <p style="padding-left: 20px;">6400 Computer 1-4</p> <p style="padding-left: 20px;">6500 Computer 1-5</p> <p style="padding-left: 20px;">6600 Computer 1-6</p> <p style="padding-left: 20px;">6700 Computer 1-7</p> <p style="padding-left: 20px;">6416 Augmented I/O Buffer and Control 1-8</p> <p style="padding-left: 20px;">Unified Central Processor 1-9</p> <p style="padding-left: 20px;">10 Functional Unit Central Processor 1-9</p> <p style="padding-left: 20px;">Peripheral and Control Processor 1-9</p> <p style="padding-left: 20px;">Central Memory 1-10</p> <p>System Options 1-11</p> <p><b>2. CENTRAL MEMORY</b></p> <p>Organization 2-1</p> <p>Address Format 2-1</p> <p>Central Memory Access 2-1</p> <p>Memory Protection 2-3</p> <p><b>3. CENTRAL PROCESSOR</b></p> <p>Organization 3-1</p> <p>Central Processor Programming 3-4</p> <p style="padding-left: 20px;">Functional Units 3-5</p> <p style="padding-left: 20px;">Instruction Formats 3-5</p> <p style="padding-left: 20px;">Operating Registers 3-6</p> <p style="padding-left: 20px;">Exchange Jump 3-9</p> <p style="padding-left: 20px;">Exit Mode 3-11</p> <p style="padding-left: 20px;">Floating Point Arithmetic 3-15</p> <p style="padding-left: 20px;">Fixed Point Arithmetic 3-21</p>	<p>Description of Central Processor Instructions 3-22</p> <p style="padding-left: 20px;">Program Stop and No Operation 3-23</p> <p style="padding-left: 20px;">Increment 3-24</p> <p style="padding-left: 20px;">Fixed Point Arithmetic 3-28</p> <p style="padding-left: 20px;">Logical 3-29</p> <p style="padding-left: 20px;">Shift 3-32</p> <p style="padding-left: 20px;">Floating Point Arithmetic 3-37</p> <p style="padding-left: 20px;">Branch 3-43</p> <p style="padding-left: 20px;">Extended Core Storage Communication 3-46</p> <p><b>4. PERIPHERAL AND CONTROL PROCESSORS</b></p> <p>Organization 4-1</p> <p>Peripheral Processor Programming 4-6</p> <p style="padding-left: 20px;">Instruction Formats 4-6</p> <p style="padding-left: 20px;">Address Modes 4-6</p> <p style="padding-left: 20px;">Registers 4-8</p> <p style="padding-left: 20px;">Description of Peripheral Processor Instructions 4-9.1</p> <p style="padding-left: 40px;">No Operation 4-10</p> <p style="padding-left: 40px;">Data Transmission 4-11</p> <p style="padding-left: 40px;">Arithmetic 4-13</p> <p style="padding-left: 40px;">Shift 4-16</p> <p style="padding-left: 40px;">Logical 4-16</p> <p style="padding-left: 40px;">Replace 4-19</p> <p style="padding-left: 40px;">Branch 4-22</p> <p style="padding-left: 40px;">Central Processor and Central Memory 4-24</p> <p style="padding-left: 40px;">Input/Output 4-27</p> <p style="padding-left: 20px;">Access to Central Memory 4-32</p> <p style="padding-left: 20px;">Input and Output 4-35</p> <p style="padding-left: 20px;">Real-Time Clock 4-39</p>
--	--

<b>5. SYSTEM INTERRUPT</b>		<b>Dead Start</b>	<b>6-1</b>
Introduction	5-1	Load Mode	6-1
Hardware Provisions for Interrupt	5-1	Sweep Mode	6-2
Exchange Jump	5-1	Dump Mode	6-2
Channel and Equipment Status	5-1	Console	6-4
Exit Mode	5-2	Program/Constant Mode	6-4
		Keyboard Input	6-4
<b>6. MANUAL CONTROL</b>		Display	6-4
Introduction	6-1		
Appendix A	Augmented I/O Buffer and Control (6416)		
Appendix B	Instruction Execution Times		
Appendix C	Floating Point Arithmetic Operation Tables		
Appendix D	Increment Adder		
Appendix E	6415-7, 6415-8, and 6415-9 Computer Systems		
Appendix F	Central Exchange Jump (CEJ) and Monitor Exchange Jump (MEJ)		
	Central Memory Access Priority (CMAP)		

## FIGURES

1-1 Block Diagram of 6000 Station	1-2 3-3 Exchange Jump Package	3-9
1-2 Block Diagram of 6200 System	1-3 3-4 Detecting and Handling Central Processor Stops	3-14
1-3 Block Diagram of 6400 System	1-4	
1-4 Block Diagram of 6500 System	1-5 4-1 Flow Chart: 6000 Systems	4-1
1-5 Block Diagram of 6600 System	1-6 4-2 Peripheral and Control Processors	4-5
1-6 Block Diagram of 6700 System	1-7 4-3 Slot Block Diagram	4-9
1-7 Block Diagram of 6416 Unit	1-8 6-1 Dead Start Panel	6-3
2-1 Memory Map	2-3 6-2 Display Console	6-5
3-1 Central Processor Instruction Formats	3-6 6-3 Sample Display	6-6
3-2 Central Processor Operating Registers	3-7	

## TABLES

3-1 Central Processor Differences	3-1 3-7 Central Processor Instruction Designators	3-22
3-2 Functional Units	3-5	
3-3 Exit Mode: Address Out of Bounds	3-13	
3-4 Range of Permissible Exponents	3-16	
3-5 Indefinite Forms	3-17	
3-6 Overflow and Underflow Conditions	3-20	
	4-1	
	4-2	
	4-8	
	4-10	

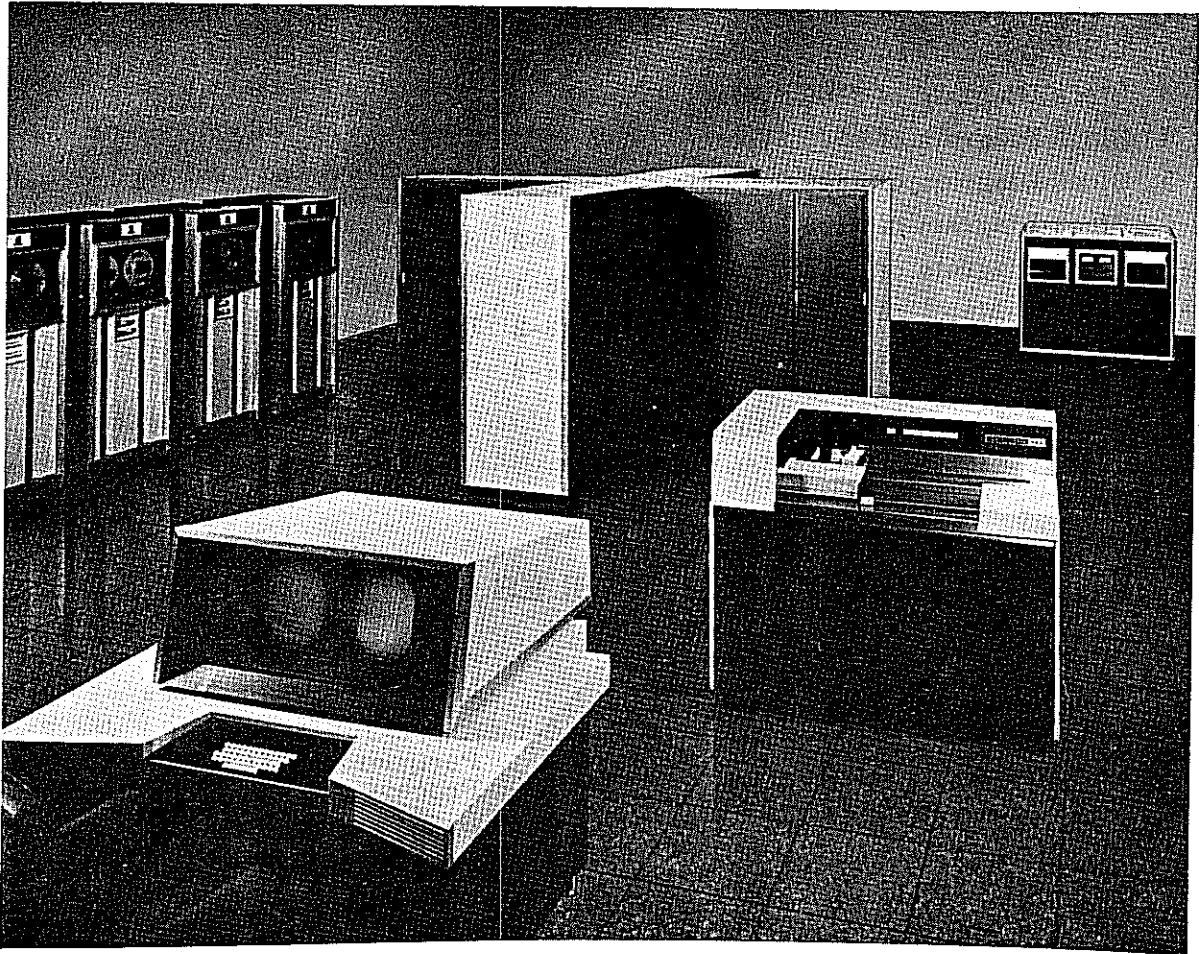

1610

## A CONTROL DATA 6000 SERIES COMPUTER SYSTEM

Display console (foreground) - includes a keyboard for manual input and operator control and two 10-inch display tubes for display of problem status and operator directives.

Main frame (center) - contains 10 Peripheral and Control Processors, Central Processor, Central Memory, some I/O synchronizers. The main frame in this photo is that of the 6600 Computer System; the main frames for the other 6000 series systems differ in physical appearance depending on options included in the systems.

CONTROL DATA 607 Magnetic Tape Transport (left front) - 1/2-inch magnetic tape units for supplementary storage; binary or BCD data handled at 200, 556, or 800 bpi.

CONTROL DATA 626 Magnetic Tape Transport (left rear) - 1-inch magnetic tape units for supplementary storage; binary data handled at 800 bpi.

CONTROL DATA 405 Card Reader (right front) - reads binary or BCD cards at 1200 card per minute rate.

Disk file (right rear) - supplementary mass storage device; holds 500 million bits of information.



# 1. SYSTEM DESCRIPTION

## INTRODUCTION

The CONTROL DATA® 6000 Series Computer systems consist of a main frame and a variable assortment of peripheral equipment. A complete system requires input and output peripheral equipment such as card readers, magnetic tape units, mass storage units (disk or drum), printer units and in most systems a console. Extended Core Storage (ECS) can be included in some systems to augment rapid access memory.

The main frame contains the Peripheral and Control Processors (PPU's) and the data channels which provide access to and from peripheral equipment. The Central Core Memory (CM) and Central Processor or Processors (CPU's) are also on the main frame. Optional couplers or controllers are included in some system main frames.

This manual gives descriptions and programming information for the main frame. Descriptions and programming information for the peripheral equipment (and their controllers) is covered in separate manuals which are provided for each equipment type.

## SYSTEM CHARACTERISTICS SUMMARY

### 6000 Station

- Basic Unified Arithmetic Central Processor
- 7, 8, 9, or 10 Peripheral and Control Processors
- Central Memory of 32K or 65K 60-bit words
- 9, 10, 11, or 12 Input/Output Data Channels (dependent on number of Peripheral and Control Processors)
- Interface for one 7600 Computer System PPU Channel

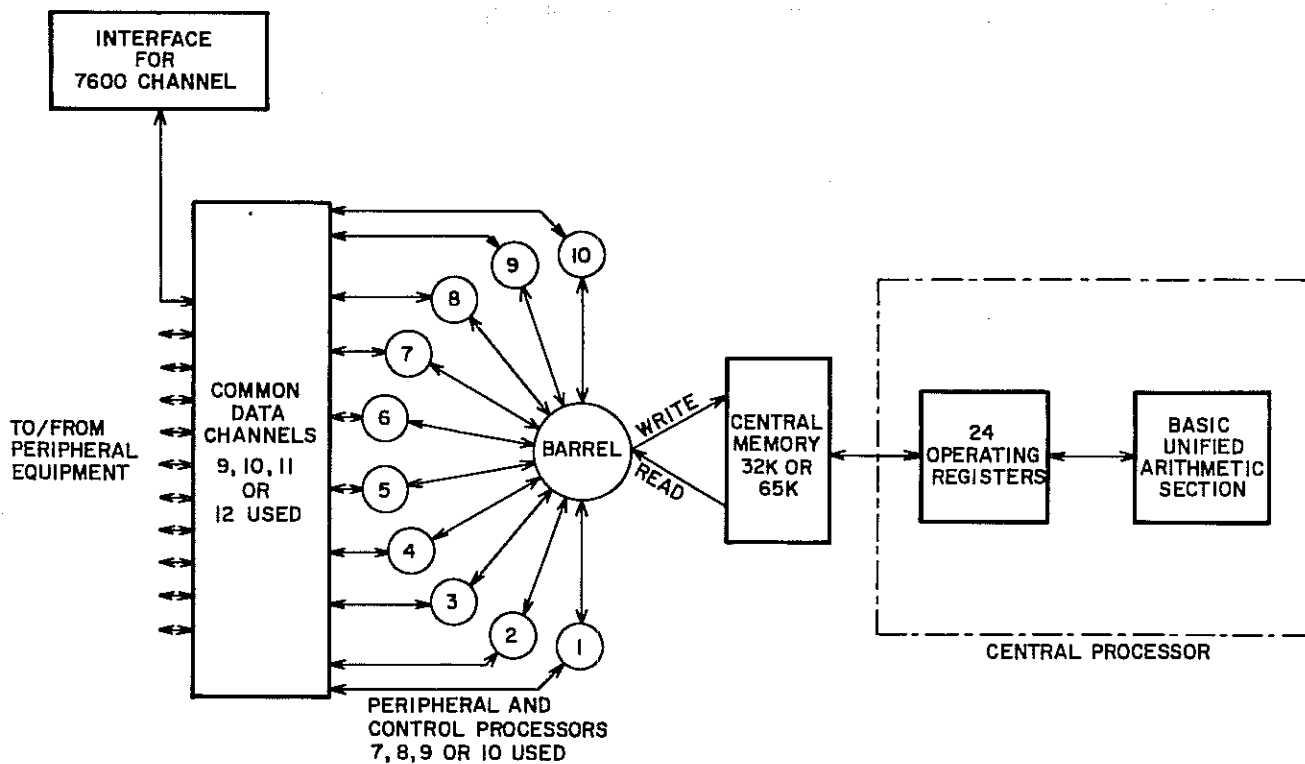

Figure 1-1. Block Diagram of 6000 Station

## 6200 Computer

- Basic Unified Arithmetic Central Processor
- 7, 8, 9, or 10 Peripheral and Control Processors
- Central Memory of 32K or 65K of 60-bit words
- 9, 10, 11, or 12 Input/Output Data Channels (dependent on the number of Peripheral and Control Processors)

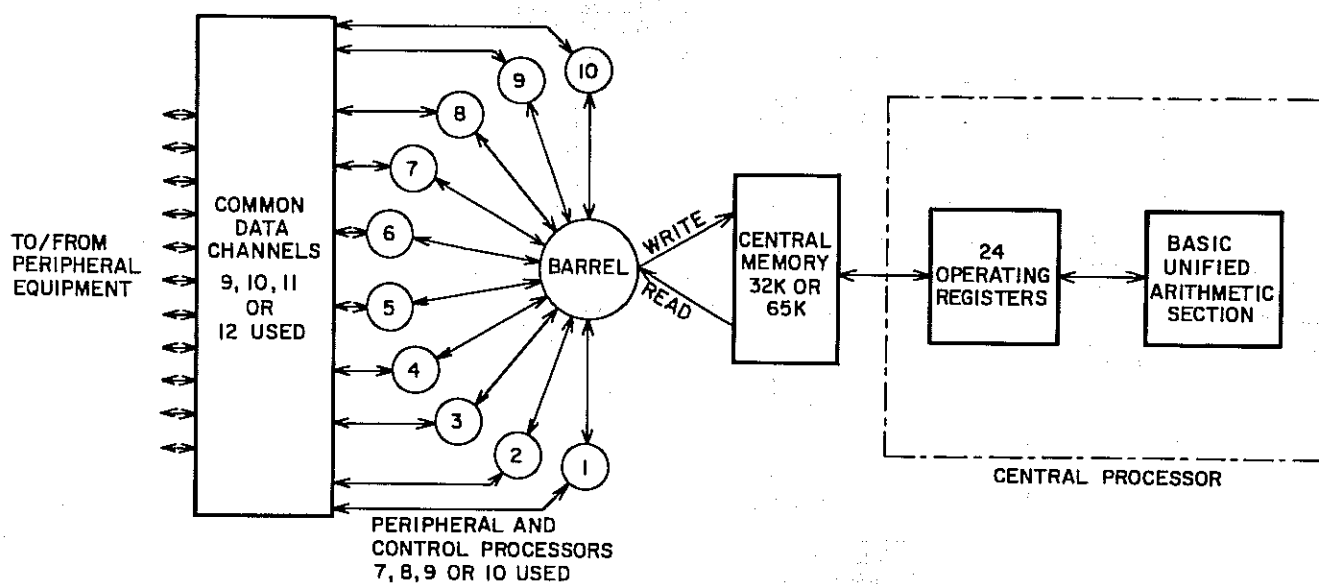

Figure 1-2. Block Diagram of 6200 System

## 6400 Computer

- Unified Arithmetic Central Processor
- 7, 8, 9, or 10 Peripheral and Control Processors
- Central Memory of 32K, 65K, or 131K 60-bit words
- 9, 10, 11, or 12 Input/Output Data Channels (dependent on the number of Peripheral Processors)
- Interface Coupler for Extended Core Storage

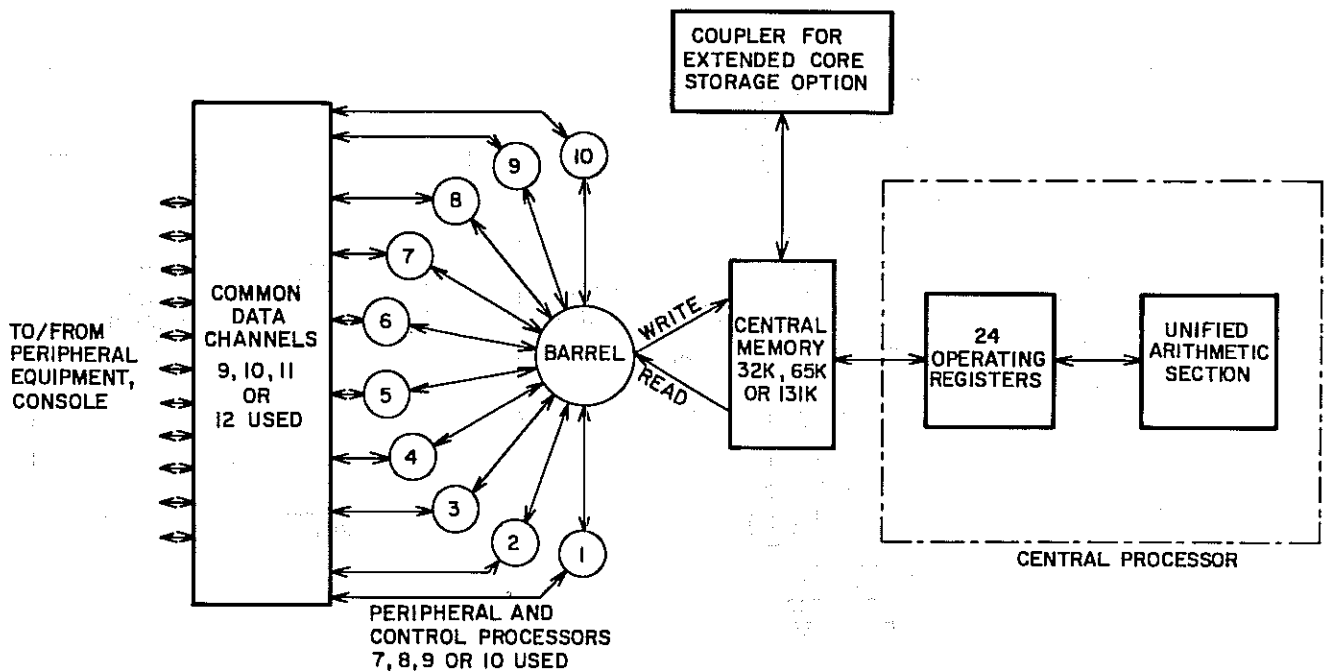

Figure 1-3. Block Diagram of 6400 System

## 6500 Computer

- Two Unified Arithmetic Central Processors
- 10 Peripheral and Control Processors
- Central memory of 65K or 131K 60-bit words
- 12 Input/Output Data Channels
- Interface Coupler for Extended Core Storage

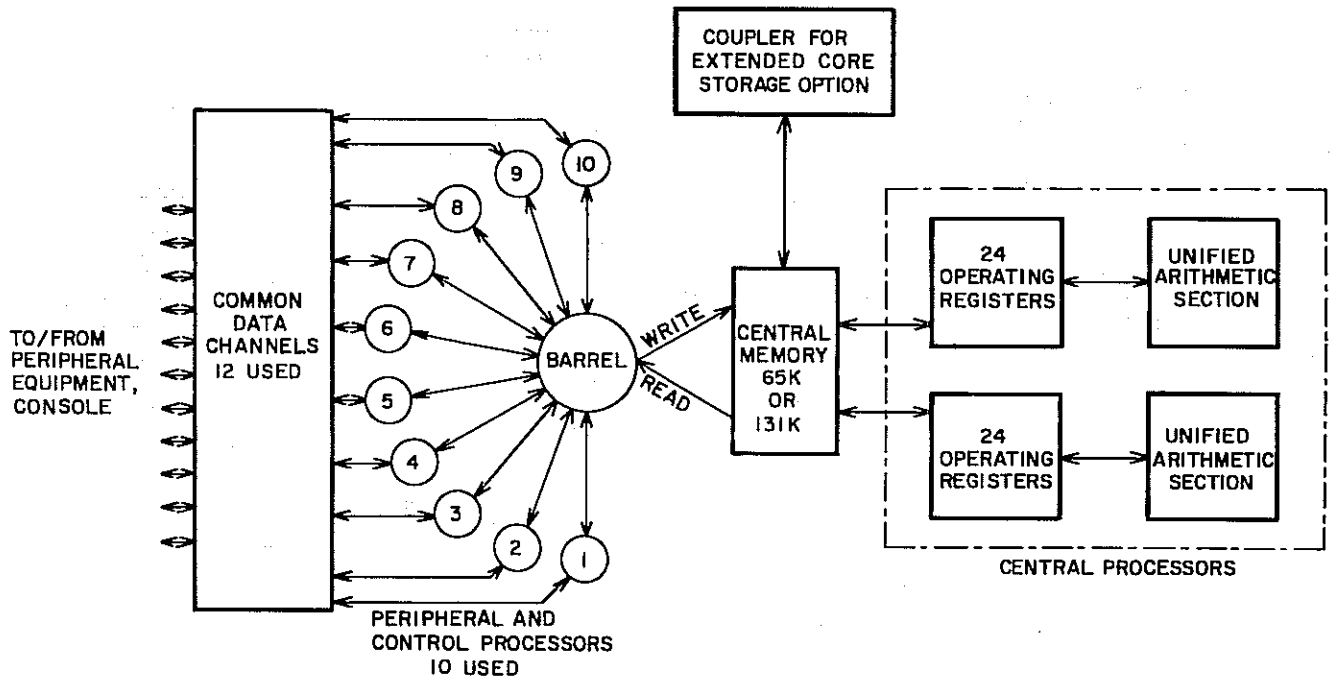

Figure 1-4. Block Diagram of 6500 System

## 6600 Computer

- 10 functional Unit Type Central Processor
- 10 Peripheral and Control Processors
- Central Memory of 32K, 65K, or 131K 60-bit words
- 12 Input/Output Data Channels
- Interface Coupler for Extended Core Storage

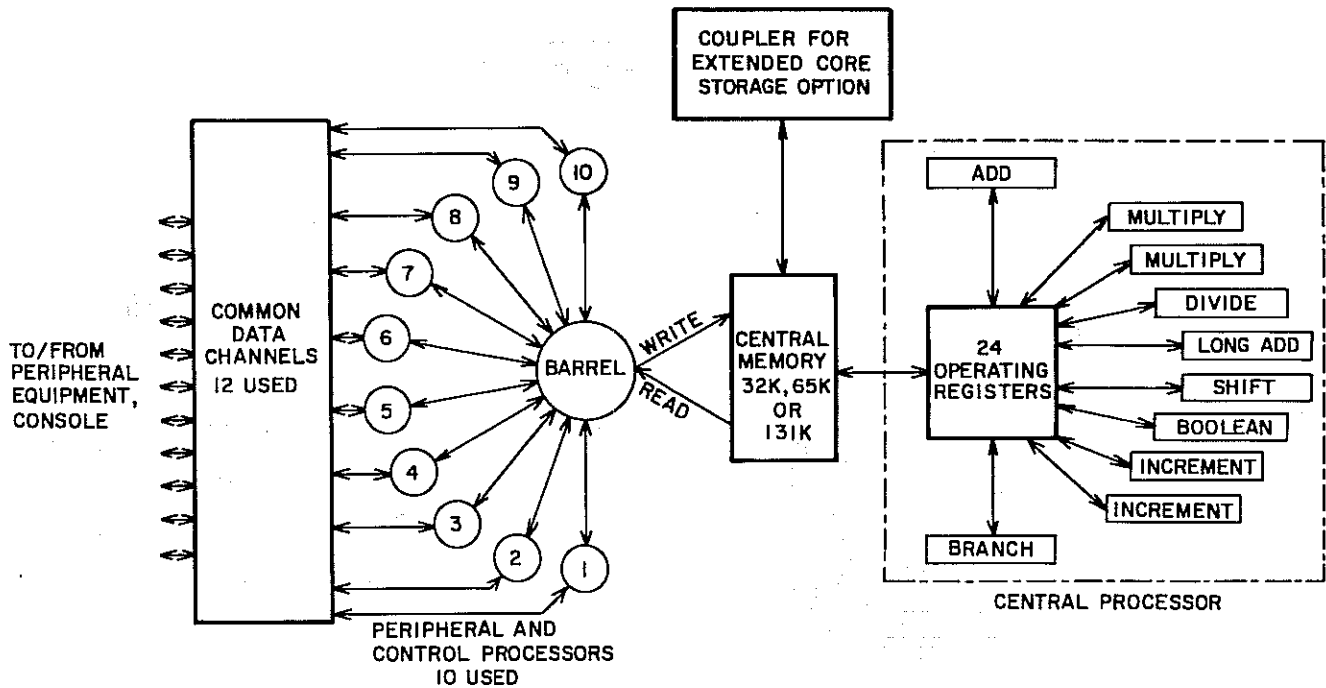

Figure 1-5. Block Diagram of 6600 System

## 6700 Computer

- 10 functional Unit Type Central Processor
- Secondary Unified Arithmetic Central Processor
- 10 Peripheral and Control Processors
- Central Memory of 65K or 131K 60-bit words
- Central Exchange Jump/Monitor Exchange Jump (CEJ/MEJ) Capability
- 12 Input/Output Data Channels
- Interface Coupler for Extended Core Storage

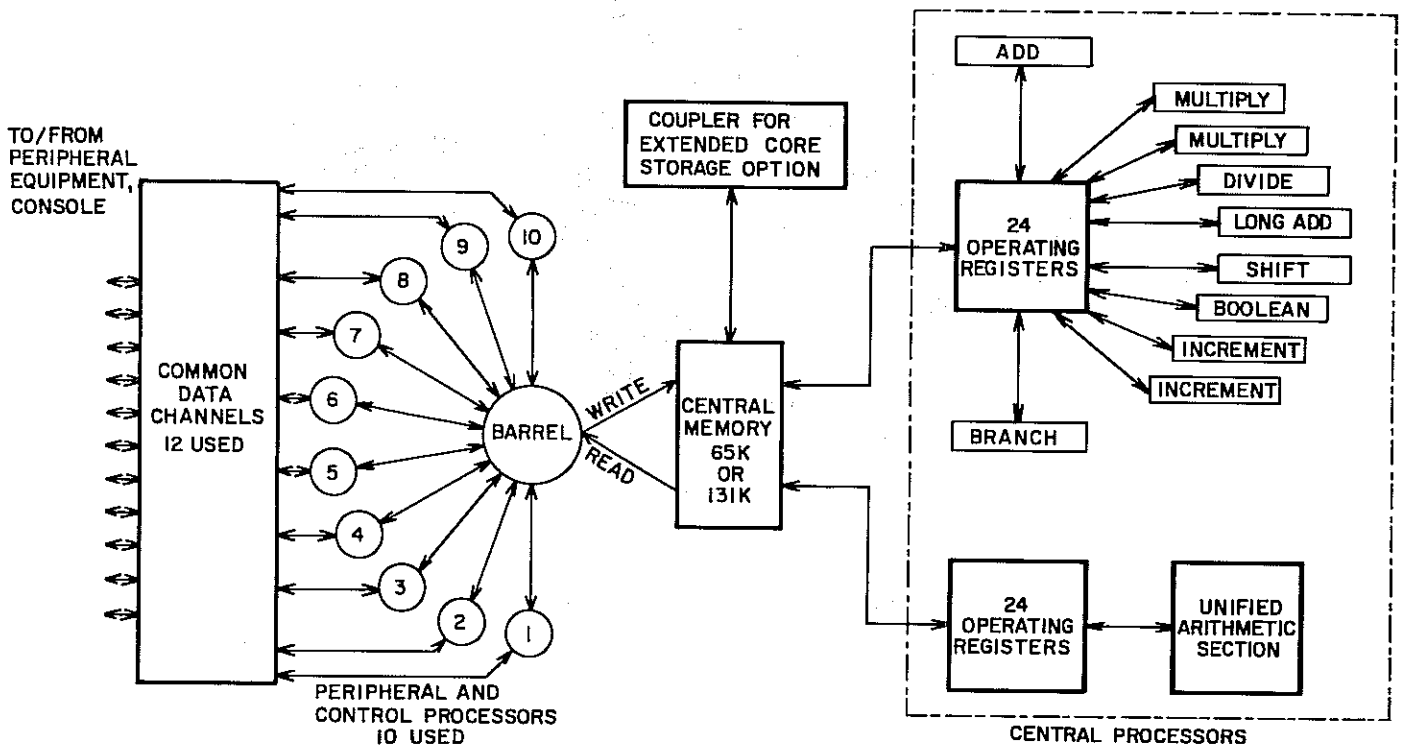

Figure 1-6. Block Diagram of 6700 System

## 6416 Augmented I/O Buffer and Control

- 10 Peripheral and Control Processors
- Central Memory of 16K 60-bit words
- 12 Input/Output Data Channels

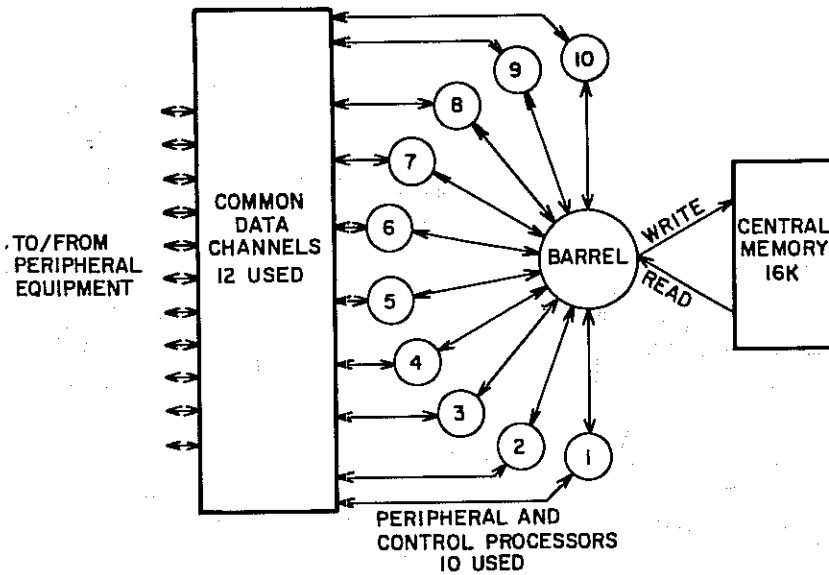

Figure 1-7. Block Diagram of 6416 Unit



## **Unified Central Processor**

- 60-bit word length
- Computation in Floating Point and Fixed Point, Single and Double Precision
- 24 operating registers per Central Processor
- Memory transfer rate of up to one word each 100 nsec
- 60-bit instruction Buffer register

### **NOTE**

For programming purposes the basic and the regular unified processors differ only in their speed of operation.

## **10 Functional Unit Central Processor**

- 60-bit word length
- Computation in Floating Point and Fixed Point, Single and Double Precision
- 24 operating registers per Central Processor
- Independent arithmetic functional units for concurrent operations
- Memory transfer rate of up to one word each 100 nsec
- Instruction stack which holds up to 27 instructions for simplified access

## **Peripheral and Control Processor**

- 12-bit word length
- Computation in Fixed Point arithmetic
- Time-shared access to Central Memory
- Internal memory of 4,096 12-bit words

## Central Memory

- Capacities of 16,384, or 32,768, or 49,152, or 65,536, or 98,304, or 131,072 60-bit words
- Independent bank construction, to allow separate overlapped access to each 4K bank (called phasing)
- Transfer rate of up to one word each 100 nsec in phased operation

## SYSTEMS OPTIONS

Various options can be added to increase the capabilities of a system or to upgrade one system to another higher configuration. The list of options shown here is not necessarily complete, since new options are continually being introduced.

- Addition of Central Exchange Jump/Monitor Exchange Jump Capability. (STD Option 10103 for 6400 and 6500 Systems or STD Option 10104 for 6600 Systems.) This is standard on 6700 Systems. See appendix F.
- Central Memory increase to 131K (STD Option 10105 for 6600 Systems)
- Central Memory increase to 65K (STD Option 10112 for 6400 Systems)
- Conversion of 6400 to 6500 System (STD Option 10117)
- Central Memory increase to 131K (STD Option 10119 for 6400 or 6500 Systems)
- Central Memory increase to 65K (STD Option 10161 for 6600 Systems)
- Addition of Central Memory Access Priority capability (STD Option 10169 for 6400, 6500, 6600 Systems)
- Addition of 10 Peripheral and Control Processors and 12 Data Channels (STD Option 10173 for 6400, 6500, 6600, 6700)
- Addition of Secondary Central Processor (STD Option 10174 for 6600 Systems)
- Central Memory Increment of 16K (STD Option 10177 for 6000 stations, 6200, 6400 Systems)
- Central Memory Increment of 32K (STD Option 10178 for 6400 Systems)
- Central Memory Increment of 16K (STD Option 10179 for 6600 Systems)
- Central Memory Increment of 32K (STD Option 10180 for 6600, 6700 Systems)
- Addition of one Peripheral and Control Processor to systems with less than 10 (STD Option 10201) See appendix E.
- Conversion of 6200 to 6400 or of 6000 to 6400 system (STD Option 10225)
- Addition of Extended Core storage (standard product; see ECS Reference Manual)

Section 1: Introduction

The first part of the document discusses the importance of maintaining accurate records and the role of the committee in overseeing the process. It highlights the need for transparency and accountability in all financial transactions.

The committee has reviewed the financial statements and found them to be in compliance with the relevant regulations. However, there are several areas that require further attention and clarification.

One of the main concerns is the lack of detailed documentation for certain expenses. The committee requests that you provide a more thorough breakdown of these costs.

The second part of the document addresses the budgetary constraints and the need for cost-effective solutions.

It is noted that the current budget is insufficient to cover all necessary operational costs.

The committee has identified several areas where savings can be realized without compromising the quality of services. These include streamlining administrative processes and reducing unnecessary expenditures.

The committee also emphasizes the importance of regular communication and reporting to ensure that all stakeholders are kept informed of the financial situation.

In conclusion, the committee is committed to ensuring the financial integrity of the organization. We urge you to take the necessary steps to address the identified issues and provide a comprehensive report by the next meeting.

Thank you for your cooperation and attention to this matter.

Sincerely,  
[Signature]

For further information, please contact the committee secretary at [contact information].

Respectfully,  
[Signature]

## 2. CENTRAL MEMORY ORGANIZATION

Central Memory is organized into 32K, 49K, 65K, 98K, or 131K words (60-bit) in banks of 4096 words each. The banks are logically independent, and consecutive addresses go to different banks. Banks may be phased into operation at minor cycle\* intervals, resulting in the high Central Memory operating speed. The Central Memory address and data control mechanisms permit a word to move to or from Central Memory every minor cycle.

### ADDRESS FORMAT

The location of each word in Central Memory is identified by an assigned number (address), which consists of 18 bits. Address formats are shown below for 8-bank (32K), 12-bank (49K), 16-bank (65K), 24-bank (98K), and 32-bank (131K) systems. Within the address format, the bank portion specifies one of 8, 16, or 32 banks; the 12-bit address defines one of 4096 separate locations within the specified bank.

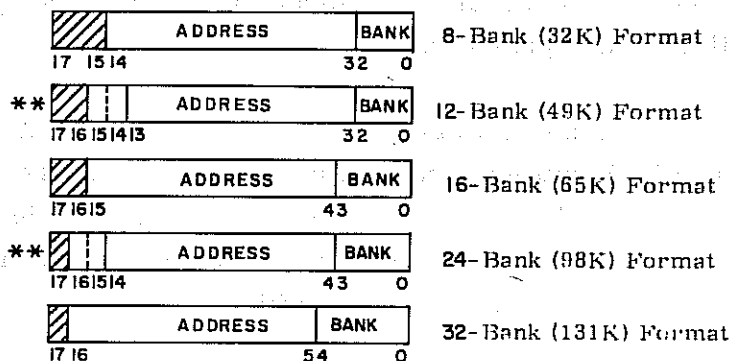

Addresses written or compiled in the conventional manner reference consecutive banks and hence make most efficient use of the bank phasing feature.

### CENTRAL MEMORY ACCESS

References to Central Memory from all areas of the system (Central Processor and Peripheral and Control Processors) and Extended Core Storage go to a common address clearing house (called a stunt box in the 6600/6700) and are sent from there to all banks in Central Memory. The stunt box accepts addresses from the various sources under a priority system and at a maximum rate of one address every minor cycle.

\*Minor cycle - 100 nsec.

\*\*One bit of bank portion is supplied by address bit  $2^{15}$  or  $2^{14}$  (49K) or  $2^{16} + 2^{15}$ , (98K), depending on the Section/Chassis configuration selected.

An address is sent to all banks, and the correct bank, if free (the bank ignores the address if it is busy processing a previous address), accepts the address and indicates this to the stunt box. The associated data word is then sent to or stored from a central data distributor. The stunt box issues addresses at a maximum rate of one every minor cycle.

The stunt box saves, in a hopper mechanism, each address that it sends to Central Memory and then reissues it (and again saves it) under priority control in the event it is not accepted because of bank conflict. The address issue-save process repeats until the address is accepted, at which time the address is dropped from the hopper and the read or store data word is distributed. A fixed time lapse from address-issue to the memory-accept synchronizes the action taken.

The hopper (i. e., a previously unaccepted address) has highest priority in issuing addresses to Central Memory. The Central Processor and Peripheral and Control Processors (all 10 share a common path to the stunt box) follow in that order. In the 6700, the 6400 type Central Processor is handled as if it were a Peripheral and Control Processor (i. e., third priority).

A data distributor which is common to all processors handles all data words to and from Central Memory (the Peripheral and Control Processors share one read path and one write path to the distributor). A series of buffer registers in the distributor provides temporary storage for words to be written into storage when the addresses are not immediately accepted because of bank conflict.

Each group of four banks communicates with the distributor on separate 60-bit read and write paths, but only one word moves on the data paths at one time. However, words can move at minor cycle intervals between the distributor and Central Memory or distributor and address-sender.

Data words and addresses are correlated by control information (tags) entered in the stunt box with the address. The tags define the address sender, origin/destination of data, and whether the address is a Read, Write, or Exchange Jump address.

The first Central Memory Write after a dead start on a 6600 with more than 10 PPU, may not be valid due to Master Clear not clearing the PPU B Write Distributor. The Write operation after dead start could OR data with the data left in the Write Distributor

at dead start time. The system can control this problem by rewriting the first word written to Central Memory by PPU B. All Central Memory Writes thereafter will be valid.

The first Central Memory Write after a dead start may not be valid due to Master Clear not clearing the PPU A Write Distributor on a 6400. The Write operation after a dead start could OR data with the data left in the Write Distributor at dead start time. The system can control this problem by rewriting the first word written to Central Memory. All Central Memory Writes thereafter will be valid.

## MEMORY PROTECTION

All Central Processor references to Central Memory for new instructions, or to read and store data, are made relative to the Reference Address. The Reference Address defines the lower limit of a Central Memory program. Changes to the Reference Address permit easy relocation of programs in Central Memory.

During an Exchange Jump, an 18-bit Reference Address and an 18-bit Field Length (parts of the Exchange Jump package) are loaded into their respective registers to define the Central Memory limits of the program initiated by the Exchange Jump.

The relationship between absolute memory address, relative memory address, Reference Address (RA), and Field Length (FL) is indicated in Figure 2-1.

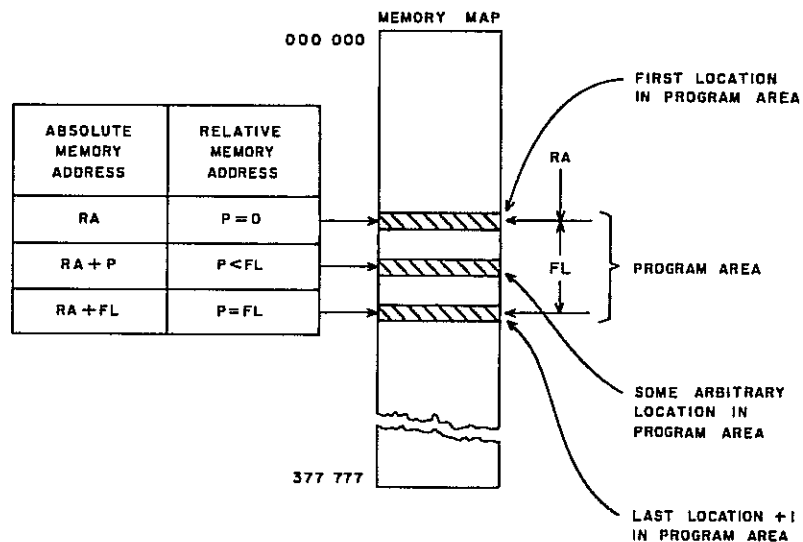

Figure 2-1. Memory Map

The following relationships must be true if the program is to operate within its bounds:

$$\begin{aligned} RA \leq (RA + P) < (RA + FL) \text{ (Absolute Memory Addresses), or} \\ 0 \leq P < FL \text{ (Relative Memory Addresses)} \end{aligned}$$

#### NOTE

- 1) FL is the number of 60-bit words comprising the program. It is not an address.
- 2) To avoid possible "artificial" range faults, instructions should not be stored near the upper limit address of the Field Length. For example, using absolute address  $[(RA + FL) - 1]$  for an instruction produces a range fault when the (look-ahead) Read Next Instruction occurs to  $(RA + FL)$ . Data should always be stored in addresses near or approaching absolute location  $(RA + FL)$ , rather than instructions.

An optional exit condition (EM in the Exchange Jump package) allows the Central Processor to stop on a memory reference outside the limits expressed above.

System Dump Routines performed at dead start time may contain invalid register data, because Master Clear changes the CPU registers before they are exchanged into Central Memory.

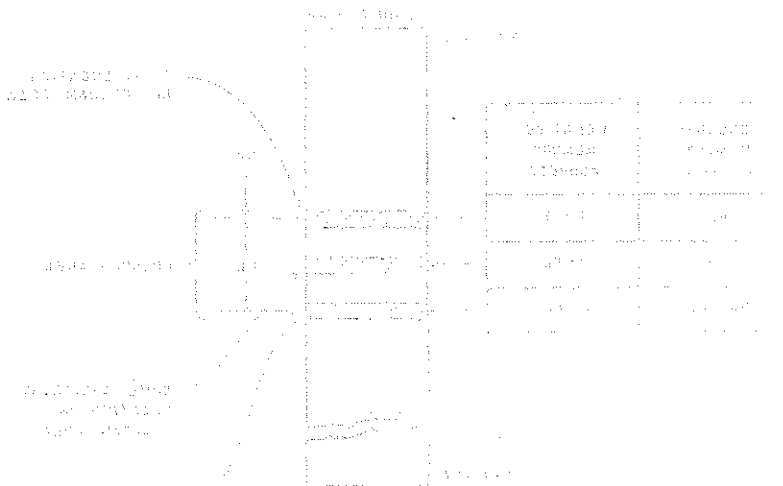



# 3. CENTRAL PROCESSOR

## ORGANIZATION

The Central Processor is an extremely high-speed arithmetic processor which communicates only with Central Memory. It consists (functionally) of an arithmetic unit and a control unit. The arithmetic unit contains all logic necessary to execute the arithmetic, manipulative and logical operations. The control unit directs the arithmetic operations and provides the interface between the arithmetic unit and Central Memory. It also performs instruction retrieving, address preparation, memory protection, and data retrieving and storing.

The Central Processor is isolated from the Peripheral and Control Processors and is thus free to carry on high-speed computation unencumbered by input/output requirements.

The organization of the unified arithmetic Central Processor differs from the 10 functional unit type Central Processors. The differences are tabulated in Table 3-1.

TABLE 3-1. CENTRAL PROCESSOR DIFFERENCES

System	Instruction Registers	Arithmetic Section
Unified Arithmetic Central Processors	Instruction Buffer Register: holds one 60-bit instruction word.	Executes instructions in serial order. Requires no reservation control.
10 Functional Unit Type Central Processor	Instruction Stack: holds eight 60-bit instruction words.	Ten functional (arithmetic & logical) units operate concurrently on unrelated instructions. Require reservation control.

With the exception of differences noted in the above table, the unified arithmetic Central Processor operation is identical to the operation of the 10 Functional Unit Central Processors. Each of the two 6500 Central Processors operate exactly alike.

Programs for the Central Processor are held in Central Memory. A program begins with an Exchange Jump instruction from a Peripheral and Control Processor. This instruction specifies a segment of Central Memory for the central program, specifies the mode of exit (normal or error) of the program, and sets initial quantities in the X, B, and A registers.

High speed in the Central Processor depends first on minimizing memory references. Twenty-four registers are provided to lower the Central Memory requirements for arithmetic operands and results. These 24 are divided into:

- 8 address registers of 18 bits in length
- 8 increment registers of 18 bits in length
- 8 operand registers of 60 bits in length

Eight 60-bit registers are provided to hold instructions (6600/6700), thereby limiting the number of memory reads for repetitive instructions, especially in inner loops. Multiple banks of Central Memory are provided to minimize memory reference time. References to different banks of memory may be handled without waiting.

In the 6600/6700 Computer System operational speed is maximized by providing 10 arithmetic (functional) units and reservation control. Unrelated instructions are executed simultaneously, providing no conflicts exist in the arithmetic units.

The systems with unified arithmetic sections, execute instructions serially, with little concurrency.

Programs are written for the Central Processor in a conventional manner, specifying a sequence of arithmetic and control operations to be executed. Each instruction in a program is brought up in its turn from one of the instruction registers. These registers are filled from Central Memory in a manner sufficient to keep a reasonable flow of instructions available.

A branch to another area of the program voids the old instructions in the registers and brings in new instructions. When a new instruction is brought up, a test is made to determine which of the 10 arithmetic units is needed, if it is busy, or if reservation conflict is possible. If the unit is free and no conflict is present, the entire instruction is given to the specified arithmetic unit for further action. Another instruction may then be brought up and issued.

The original sequence of the program is established at the time each instruction is issued. Only those operations which depend on previous results prevent the issuing of instructions, and then only if the steps are incomplete. The reservation control keeps a running account of the address, increment, and operand registers and of the arithmetic units in order to preserve the original sequence.

On occasion, a program may use an Increment Store instruction to modify the contents of a memory location holding a subsequent instruction. In the 6600/6700, this modification must occur before the instruction is read from Central Memory into the stack, for once in the stack the instruction can not be so modified. To avoid this potential problem, modification of any subsequent instruction words should be restricted to relative locations  $\geq (P) + 8$ . This rule applies equally to both in-stack loops and to other programs where, under certain conflict conditions, the Central Processor of the 6600/6700 may continue reading instruction words from Central Memory while delaying execution of a previously issued Increment Store instruction. In sequential processors, 6400/6500 and 6700 second CPU storing in P+1 from some parcel other than the first, causes the same problem as storing in stack for parallel processors.

Nearly all Central Memory references for information or instructions are made on an implicit or secondary basis. Instructions are retrieved from memory only if the instruction registers are nearly empty (or when ordered by a branch). Information is brought to or from the operand registers only when appropriate address registers are referenced during the course of a program. Such references are also accounted for in the reservation control.

All Central Processor references to Central Memory are made relative to the lower boundary address assigned by a Peripheral and Control Processor. A Central Processor program may therefore be relocated in Central Memory by modifying the boundaries only. Any attempt by the Central Processor to reference memory outside of its boundaries causes an immediate exit which can be readily examined by a Peripheral and Control Processor and displayed for the operator.

The Exchange Jump instruction starts a central program. This instruction starts a sequence of Central Memory references which exchanges 16 words in memory with the contents of the address, increment, and operand registers of the Central Processor. Also exchanged are the program address, the Central Memory and Extended Core Storage boundaries, and choice of program exit. This instruction may be executed by any Peripheral and Control Processor and acts as an interrupt to an active central program as well as a start from an inactive state. The Exchange Jump is used by the operating system to switch between two central programs, leaving the first program in a usable state for later re-entry.

## **CENTRAL PROCESSOR PROGRAMMING**

Central Processor program instructions are stored in Central Memory. A 60-bit memory location may hold 60 data bits, four 15-bit instructions, two 30-bit instructions or a combination of 15 or 30-bit instructions. Figure 3-1 shows all instruction combinations in a 60-bit word and the two instruction word formats.

The Central Processor reads 60-bit words from Central Memory and stores them in an instruction stack which is capable of holding up to eight 60-bit words.

Each instruction in turn is sent to a series of instruction registers for interpretation and testing and is then issued to one of 10 functional units for execution. The functional units obtain the instruction operands from and store results in the 24 operating registers. The reservation control records active operating registers and functional units to avoid conflicts and insure that the original instructions do not get out of order.

## Functional Units

The 10 functional units in the 6600/6700 system handle the requirements of the various instructions. The Multiply and Increment units are duplexed, and an instruction is sent to the second unit if the first is busy. The general function of each unit is listed in Table 3-2.

TABLE 3-2. FUNCTIONAL UNITS

Unit	General Function
Branch	Handles all jumps or branches from the program.
Boolean	Handles the basic logical operations of transfer, logical product, logical sum, and logical difference.
Shift	Handles operations basic to shifting. This includes left (circular) and right (end-off sign extension) shifting, and Normalize, Pack, and Unpack floating point operations. The unit also provides a mask generator.
Add	Performs floating point addition and subtraction on floating point numbers or their rounded representation.
Long add	Performs one's complement addition and subtraction of 60-bit fixed point numbers.
Multiply	Performs floating point multiplication on floating point numbers or their rounded representation.
Divide	Performs floating point division of floating point quantities or their rounded representation. Also sums the number of "1's" in a 60-bit word.
Increment	Performs one's complement addition and subtraction of 18-bit numbers.

## Instruction Formats

Groups of bits in an instruction are identified by the letters f, m, i, j, k, and K (Figure 3-1). All letters represent octal digits except K, which is an 18-bit constant. The f and m digits are the operation code and identify the type of instruction. In a few instructions the i designator becomes a part of the operation code.

In most 15-bit instructions the i, j, and k digits each specify one of eight operating registers where operands are found and where the result of the operation is to be stored. In other 15-bit instructions, the j and k digits provide a 6-bit shift count.

In 30-bit instructions the f and j digits each specify one of eight operating registers where one operand is found and where the result is to be stored, and K is taken directly as an 18-bit second operand.

**NOTE**

Figure 3-1 shows all the proper instruction combinations. 30-bit instructions must be confined to a single 60-bit instruction word.

If the upper 15 bits of a 30-bit instruction were entered into the lower 15 bit positions on a 6600 or 6700 CPU-0, the lower 15 bits for the instruction would be taken from the upper 15 bit positions of the same 60-bit instruction word. On other 6000 systems, the instruction would be executed as an Error Exit with no error flag bit being set.

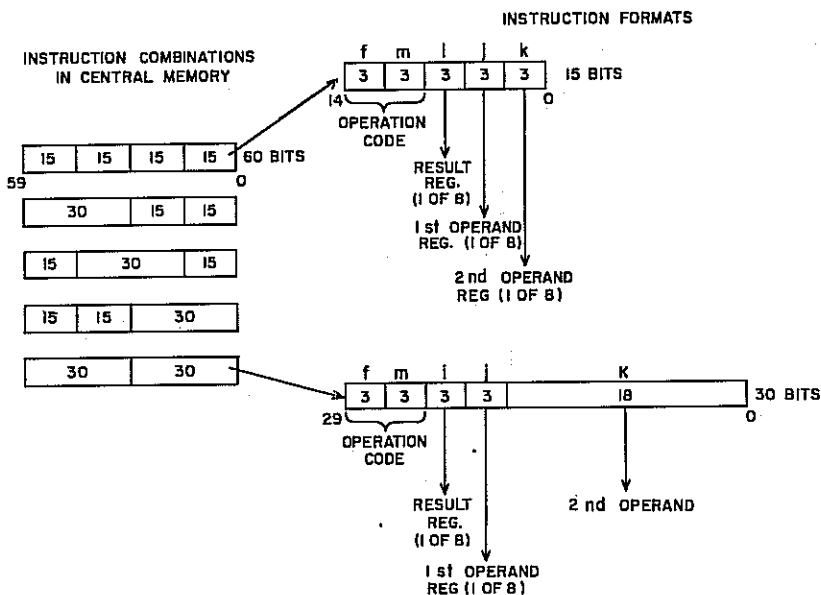

Figure 3-1. Central Processor Instruction Formats

### Operating Registers

In order to provide a compact symbolic language, the 24 operating registers are identified by letters and numbers:

- A = address register (A0, A1 . . . A7)
- B = increment register (B0, B1 . . . B7)
- X = operand register (X0, X1 . . . X7)

The operand registers hold operands and results for servicing the arithmetic section. Five registers (X1 - X5) hold read operands from Central Memory, and two registers (X6 - X7) hold results to be sent to Central Memory (Figure 3-2). Operands and results transfer between memory and these registers as a result of placing a quantity into a corresponding address register (A1 - A7).

Placing a quantity into an address register A1 - A5 produces an immediate memory reference to that address and reads the operand into the corresponding operand register X1 - X5. Similarly, placing a quantity into address register A6 or A7 stores the word in the corresponding X6 or X7 operand register in the new address.

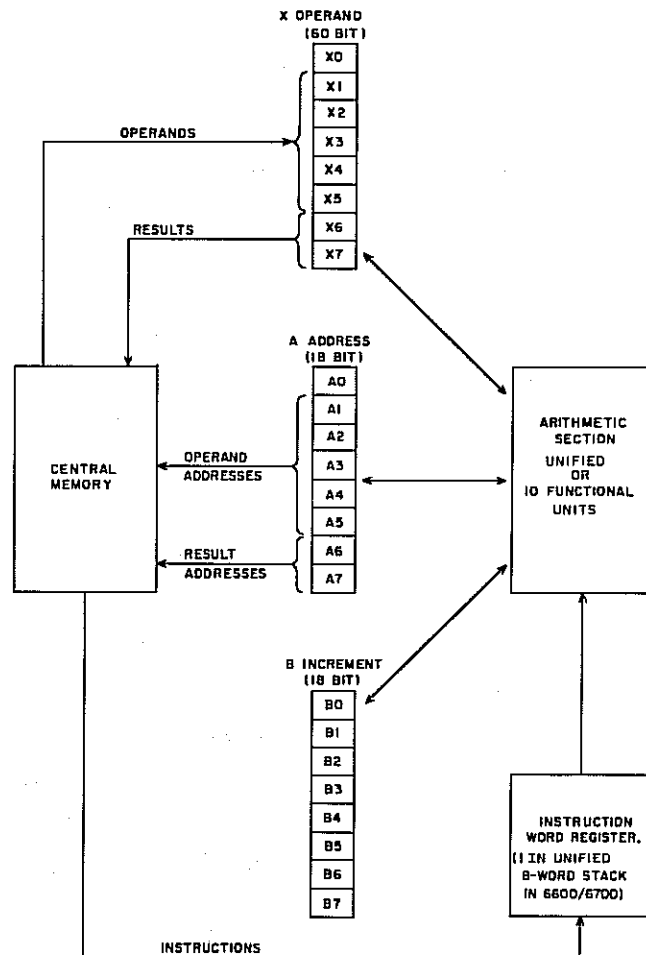

Figure 3-2. Central Processor Operating Registers

The increment instructions place a result in address register  $A_i$  (where "i" = 0-7) in three ways:

- By adding an 18-bit signed constant  $K$  to the contents of any A, B, or X register.
- By adding the content of any B register to any A, B, or X register.
- By subtracting the content of any B register from any A register or any other B register.

The A0 and X0 registers are independent and have no connection with Central Memory. They may be used for scratch pad or intermediate results. Note the special use of A0 and X0 when executing Extended Core Storage communication instructions.

The B registers have no connection with Central Memory. The B0 register is fixed to provide a constant zero (18-bit) which is useful for various tests against zero, providing an unconditional jump modifier, etc. In general, the B registers offer means for program indexing. For example, B4 may store the number of times a program loop has been traversed, thereby providing a terminal condition for a program exit.

An Exchange Jump instruction from a Peripheral and Control Processor enters initial values in the operating registers to start Central Processor operation. Subsequent address modification instructions executed in the increment functional units provide the addresses required to retrieve and store data.

#### Program Address

An 18-bit P register serves as a program address counter and holds the address for each program step. P is advanced to the next program step in the following ways:

- 1) P is advanced by one when all instructions in a 60-bit word have been extracted and sent to the instruction registers.
- 2) P is set to the address specified by a Go To . . . (branch) instruction. If the instruction is a Return Jump,  $(P) + 1$  is stored before the branch to allow a return to the sequence after the branch.
- 3) P is set to the address specified in the Exchange Jump package.

All branch instructions to a new program start the program with the instruction located in the highest order position of the 60-bit word.



## Exchange Jump

A Peripheral and Control Processor Exchange Jump instruction starts or interrupts the Central Processor and provides Central Memory with the first address (which is the address in the Peripheral and Control Processor A register) of a 16-word package in Central Memory. The Exchange Jump package (Figure 3-3) provides the following information on a program to be executed:

- 1) Program address (P)
- 2) Reference Address for Central Memory ( $RA_{CM}$ )
- 3) Field length of program for Central Memory ( $FL_{CM}$ )
- 4) Reference Address for Extended Core Storage ( $RA_{ECS}$ )
- 5) Field length of program for Extended Core Storage ( $FL_{ECS}$ )\*
- 6) Program exit mode (EM)
- 7) Initial contents of the eight A registers
- 8) Initial contents of the eight X registers
- 9) Initial contents of B registers B1 - B7 (B0 is fixed at 0)
- 10) Monitor Exchange (MA); Optional Instruction

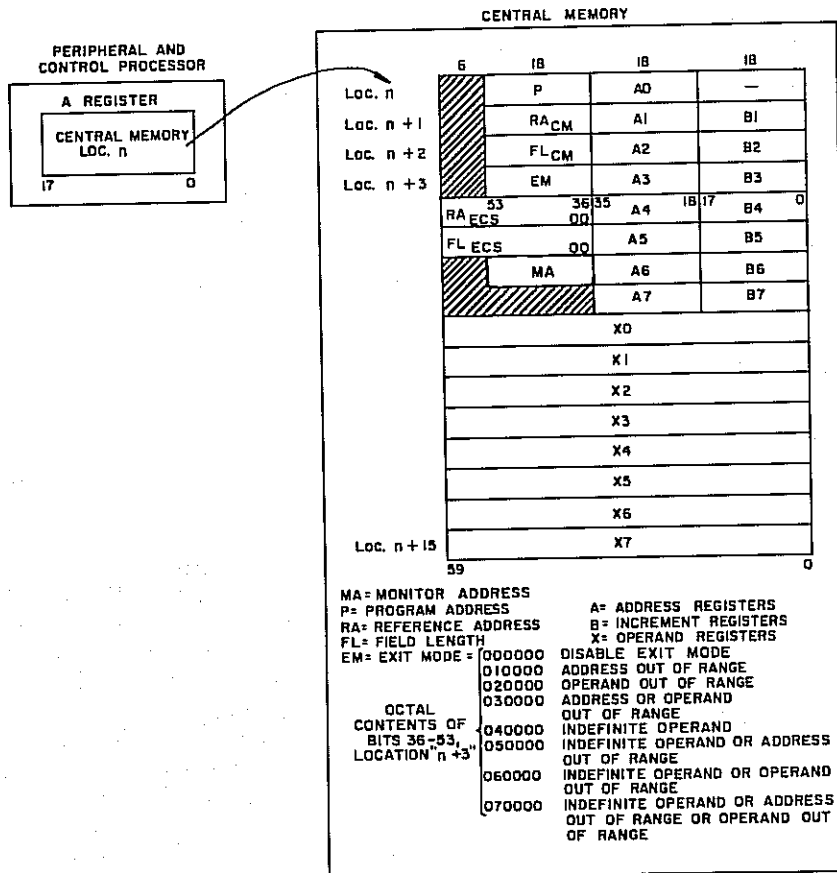

Figure 3-3. Exchange Jump Package

\*In the unified arithmetic systems the upper three bits of  $RA(ECS)$  are not transferred to the  $RA(ECS)$  register.

The Central Processor enters the information about a new program into the appropriate registers and stores the corresponding and current information from the interrupted program at the same 16 locations in Central Memory. Hence, the controlling information for two programs is exchanged. A later Exchange Jump may return an interrupted program to the Central Processor for completion. The normal relation of the A and X registers (described earlier) is not active during the Exchange Jump so that the new entries in A are not reflected into changes in X.

### PROGRAMMING NOTE

When an Exchange Jump interrupts the Central Processor, several steps occur to insure leaving the interrupted program in a usable state for re-entry:

- 1) Issue of instructions halts after issuing all instructions from the current instruction word in the instruction stack.
- 2) The Program Address register, P, is set to the address of the next instruction word to be executed.
- 3) The issued instructions are executed, and then
- 4) The parameters for the two programs are exchanged.

A subsequent Exchange Jump can then re-enter the interrupted program at the point it was interrupted, with no loss of program continuity.

To preserve the integrity of an "in-stack" loop (in the event of an Exchange Jump), it is illegal to modify the contents of any memory address which holds an executable instruction (or instruction word) contained within the loop.

#### EXAMPLE:

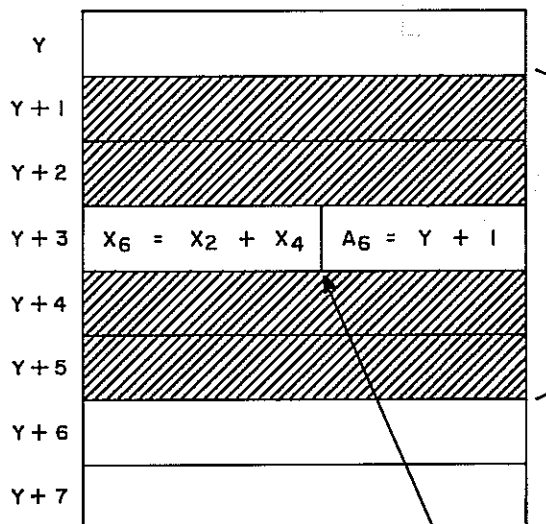

These instruction words in stack (from memory locations [Y + 1] through [Y + 5]) constitute a loop.

After executing the lower instruction at [Y + 3], the contents of memory location [Y + 1] differ from the contents of [Y + 1] in the stack. If the Exchange Jump comes in as indicated, subsequent reentry will call up the modified loop from memory, rather than the stack loop in its original un-modified form.

Assume Exchange Jump comes in at this point

All Central Processor references to Central Memory for new instructions, or to fetch and store data, are made relative to the Reference Address. This allows easy relocation of a program in Central Memory. The Reference Address or beginning address and the Field Length define the Central Memory limits of the program. An Exit Selection allows the Central Processor to stop on a memory reference outside these limits.

The Program Address register P defines the location of a program step within the limits prescribed. Each reference to memory to fetch instructions is made to the address specified by P + RA. Hence program relocation is conveniently handled through a single change to RA.

A P = 0 condition specifies address zero and hence RA. This address is reserved for recording program exit (error) conditions and should not, therefore, be used to store data or instructions of a program.

## Exit Mode

The Exit mode feature allows the programmer to select Exit or Stop conditions for the Central Processor. Exit selections are loaded into bits 36-53 of memory location "n+3" of the Exchange Jump package (Figure 3-3). When the Exchange Jump occurs to that package, the exit selections are stored in the Central Processor and the exit occurs as soon as the selected condition is sensed. The Exit conditions, as stored in bits 36-53 of address "n+3" in the Exchange Jump package, are shown below in octal format:

EM	=	000000	Disable Exit mode - no Exit selections made.
	=	010000	Address out of range -
			a) an attempt to reference either Central Memory or Extended Core Storage outside established limits, or
			b) the word count, [ (Bj) + K ], in an Extended Core Storage Communication instruction is negative.

(For details on action when an address is out of range, refer to the Increment and Extended Core Storage instruction descriptions.)

	=	020000	Operand out of range - floating point arithmetic unit received an infinite operand (see Range Definitions under Floating Point Arithmetic following).
--	---	--------	---

- = 030000 Address or operand out of range
- = 040000 Indefinite operand - floating point arithmetic unit (Add, Multiply, or Divide) attempted to use an indefinite operand (see Range Definitions, page 3-17).
- = 050000 Indefinite operand or address out of range
- = 060000 Indefinite operand or operand out of range
- = 070000 Indefinite operand or operand or address out of range

Typically, the Reference Address (RA) for any program is left cleared to all zeros. When an error exit is taken, the Central Processor records at RA the exit condition (upper 2 octal digits only) and the Program Address at exit time (refer to the format below).

**NOTE**

The Exit condition(s) recorded at RA comprises all the Exit conditions detected since the last Exchange Jump, regardless of whether they were selected. Thus, combinations of error Exit conditions (03, 05, 06 or 07) can appear at RA:

- a) When at least one Exit condition was selected and the selected condition plus another condition occurred since the last Exchange Jump, or
- b) When more than one Exit condition was selected and each occurred in the same minor cycle.

The contents of RA are then read up, interpreted as a Stop instruction, and the Central Processor stops.

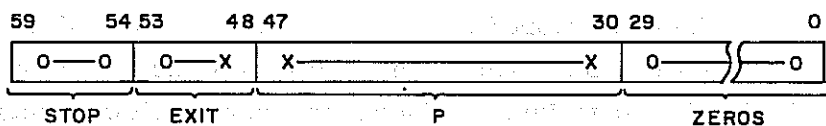

P = (P) + 1; AT TIME OF ERROR EXIT.

For error stops, (P) + 1 gives only an approximate location of the error since the Central Processor may have issued other instructions to the functional units (one of which may have been a branch) before the exit was sensed.

An exchange can interrupt an Error Exit condition from Parcel 3 in a 6400 and cause the Error Exit condition to be lost due to P advancing before the Error Exit condition is sensed. When the exchange package is exchanged back in, P will have been advanced beyond the Error Exit condition, causing the Error Exit to be lost.

On an Address Out of Range, hardware action differs from that outlined above. In some cases, a stop occurs when an address is out of bounds even though an Exit mode stop is not selected for this condition. Table 3-3 summarizes hardware action for operations which may reference addresses that are out of bounds.

TABLE 3-3. EXIT MODE: ADDRESS OUT OF BOUNDS

HARDWARE ACTION		
OPERATION	EXIT MODE SELECTED	EXIT MODE NOT SELECTED
RNI to an address that is out-of bounds (occurs when an instr. is located in absolute address (RA + FL) - 1).	<ol style="list-style-type: none"> <li>1. Detect error condition</li> <li>2. Clear P</li> <li>3. Write EM and (P) + 1 into RA</li> <li>4. Stop by reading (RA)</li> </ol> <p>Note: If FL = 0 on a 6400/6500 the first RNI will be out of range and the CPU will hang up.</p>	<ol style="list-style-type: none"> <li>1. Detect error condition</li> <li>2. Stop by reading (AAZ)*</li> <li>3. Nothing stored in RA</li> <li>4. (P) = out of range P or (P) + 1</li> </ol>
Branch to an address that is out-of-bounds.	<ol style="list-style-type: none"> <li>1. Detect error condition</li> <li>2. Clear P</li> <li>3. Write EM and execution address + 1 in RA</li> </ol> <p>Note: On a 6400/6500 Write EM and jump address in RA.</p> <ol style="list-style-type: none"> <li>4. Stop by reading (RA)</li> </ol>	<ol style="list-style-type: none"> <li>1. Detect error condition</li> <li>2. Stop by reading (AAZ)</li> <li>3. Nothing stored in RA</li> <li>4. (P) = execution address or (P) + 1</li> </ol> <p>Note: On a 6400/6500 (P) = out of range P.</p>
Read Operand	<ol style="list-style-type: none"> <li>1. Detect error condition</li> <li>2. Clear P</li> <li>3. Write EM and (P) + 1 into RA</li> <li>4. Stop by reading (RA)</li> <li>5. (X<sub>1</sub>) = (AAZ)</li> </ol>	<ol style="list-style-type: none"> <li>1. Detect error condition</li> <li>2. Read (AAZ) into X<sub>1</sub>. A<sub>1</sub> = Increment Result</li> </ol>
Write Operand	<ol style="list-style-type: none"> <li>1. Detect error condition</li> <li>2. Clear P</li> <li>3. Write EM and (P) + 1 into RA</li> <li>4. Stop by reading (RA)</li> </ol>	<ol style="list-style-type: none"> <li>1. Detect error condition</li> <li>2. Read (AAZ), but (X<sub>1</sub>) not stored; (X<sub>1</sub>) unchanged. A<sub>1</sub> = Increment Result</li> <li>3. Continue program</li> </ol>

Action After Exit Mode or Normal Stop

Typically, a Peripheral and Control Processor periodically searches for an unchanging Central Processor Program Address register (any value) to determine if the Central Processor has stopped. Once it has been determined that the Central Processor has stopped, the examining Peripheral and Control Processor can transfer control to an error routine to determine the nature of the condition causing the Stop. Figure 3-4 illustrates sample steps for processing Central Processor stops (either Exit mode or normal).

\* AAZ = Absolute Address Zero

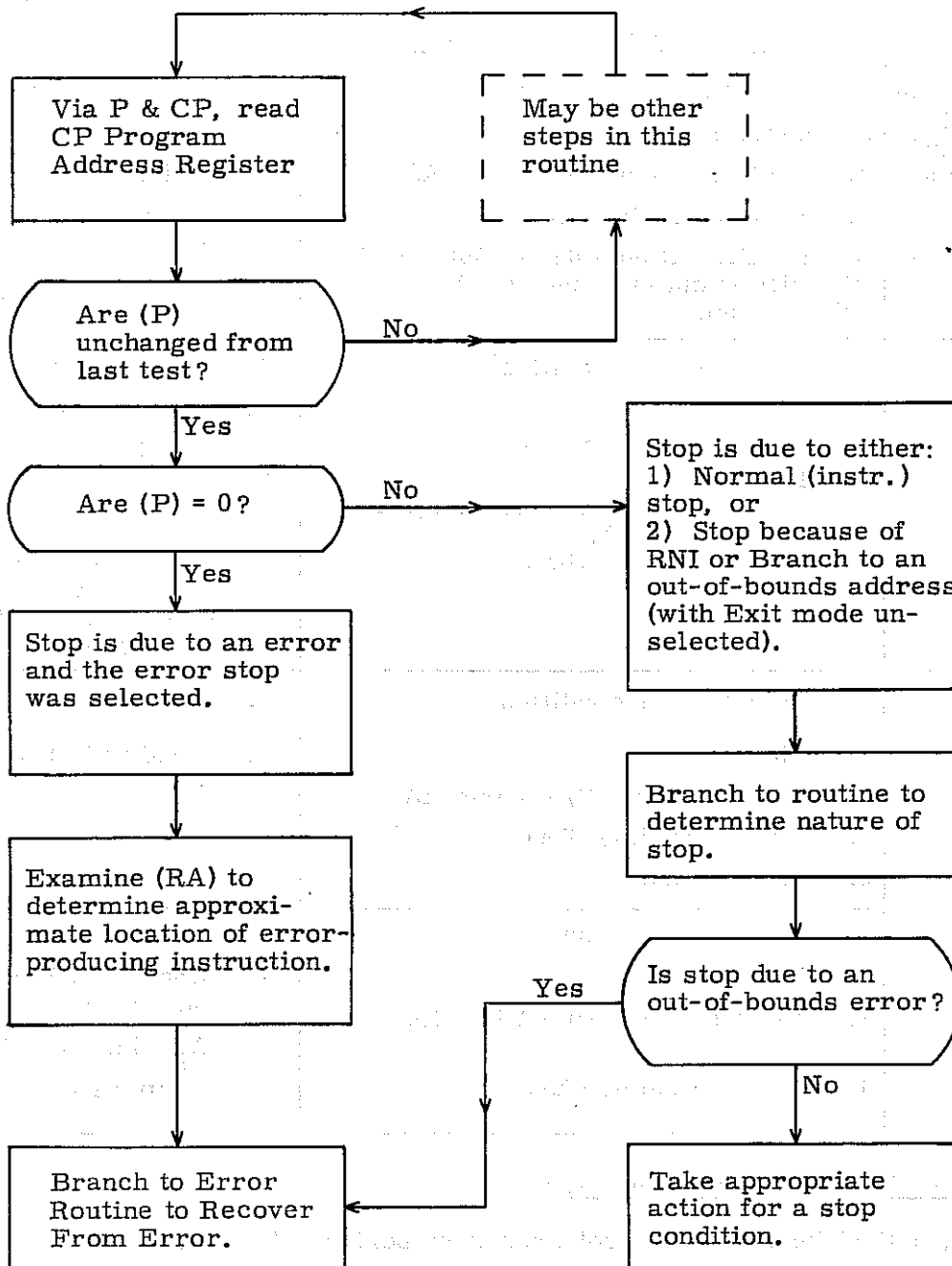

Figure 3-4. Detecting and Handling Central Processor Stops

## Floating Point Arithmetic

### Format

Floating point arithmetic takes advantage of the ability to express a number with the general expression  $kB^n$ , where:

k = coefficient

B = base number

n = exponent, or power to which the base number is raised

The base number is constant (2) for binary-coded quantities and is not included in the general format. The 60-bit floating-point format is shown below. The binary point is considered to be to the right of the coefficient, thereby providing a 48-bit integer coefficient, the equivalent of about 14 decimal digits. The sign of the coefficient is carried in the highest order bit of the packed word. Negative numbers are represented in one's complement notation.

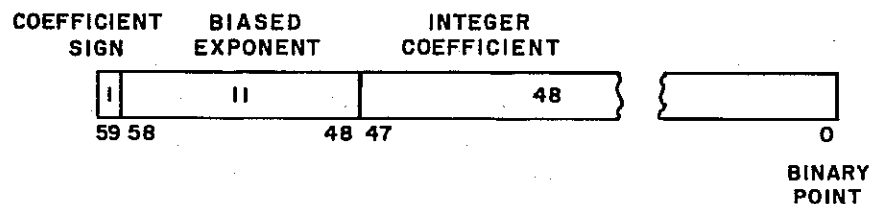

The 11-bit exponent carries a bias of  $2^{10}$  ( $2000_8$ ) when packed in the floating point word (biased exponent sometimes referred to as characteristic). The bias is removed when the word is unpacked for computation and restored when a word is packed into floating format. Table 3-4 lists (in decimal and octal notation) the complete range of permissible exponents and the octal form of the corresponding positive and negative floating point words.

Thus, a number with an exponent of  $342_8$  would appear as  $2342_8$ ; a number with an exponent of  $-160_8$  would appear as  $1617_8$ . Exponent arithmetic is done in one's complement notation. Floating point numbers can be compared for equality and threshold.

TABLE 3-4. RANGE OF PERMISSIBLE EXPONENTS

EXPONENT (n)		PACKED FORM OF KXB <sup>n</sup> (OCTAL)*		UNPACKED FORM OF n (OCTAL)*
DECIMAL	OCTAL	POSITIVE COEFFICIENT	NEGATIVE COEFFICIENT	CONTENTS of Bj= (UNBIASED-SIGN EXTENDED)
+ 1023	+ 1777	3777X....X	4000X....X	Bj=001777
+ 1022	+ 1776	3776X....X	4001X....X	Bj=001776
.	.	.	.	.
.	.	.	.	.
.	.	.	.	.
.	.	.	.	.
+ 1	+ 1	2001X....X	5776X....X	Bj=000001
+ 0	+ 0	2000X....X	5777X....X	Bj=000000
- 0	- 0	1777X....X	6000X....X	Bj=777777
- 1	- 1	1776X....X	6001X....X	Bj=777776
.	.	.	.	.
.	.	.	.	.
.	.	.	.	.
.	.	.	.	.
- 1023	- 1777	0000X....X	7777X....X	Bj=776000

Normalizing and Rounding

Normalizing a floating point quantity shifts the coefficient left until the most significant bit is in bit 47. Sign bits are entered in the low-order bits of the coefficient as it is normalized. Each shift decreases the exponent by one. Two normalized input operands cannot be used during an integer multiply operation; they will be treated like floating point operands and will cause the storage of positive underflow results. To insure that floating point operands are not mistaken for integer multiply operands, floating point quantities used as operands should be normalized.

A round bit is added (optionally) to the coefficient during an arithmetic process and has the effect of increasing the absolute value of the operand or result by one-half the value of the least significant bit. Normalizing and rounding are not automatic during pack or unpack operations so that operands and results may not be normalized.

Single and Double Precision

The floating point arithmetic instructions generate double-precision results. Use of unrounded operations allows separate recovery of upper and lower half results with proper exponents; only upper half results can be obtained with rounded operations.

\* See pages 3-35 and 3-36 for Central Processor Instructions to pack and unpack floating point quantities.



Double length registers appear as follows:

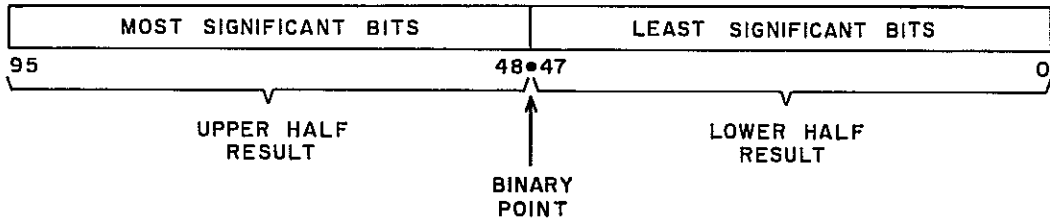

Range Definitions

A result with an exponent so large that it exceeds the upper limit of octal 3777 (overflow case) is treated as an infinite quantity. A coefficient of all zeros and an exponent of octal 3777 or 4000 is packed for this case. An optional exit is provided when an attempt is made to use an infinite operand in the floating arithmetic units since its use may propagate an indefinite result as shown in Table 3-5. No error exit occurs when an infinite or indefinite result is generated in a functional unit.

TABLE 3-5. INDEFINITE FORMS

$\infty - \infty$	= INDEFINITE	$\infty + N = \infty$
$\infty + \infty$	= INDEFINITE	$\infty + N = \infty$
$\infty \cdot 0$	= INDEFINITE	$\infty - N = \infty$
$0 \div 0$	= INDEFINITE	$N + 0 = \infty$
INDEFINITE +, -, $\div$ , $\cdot$ (X)	= INDEFINITE	$0 + \infty = 0$
$\infty + \infty$	= $\infty$	$0 \cdot 0 = 0$
$\infty \cdot \infty$	= $\infty$	$0 \div N = 0$
$\infty \div 0$	= $\infty$	$N \div \infty = 0$

WHERE:  $\infty$  = INFINITY, N = INTEGER,  
X =  $\infty$ , N OR 0.

A result the exponent of which is less than the lower limit of octal 0000 (underflow case) is treated as a zero quantity. This quantity is packed with a zero exponent and zero coefficient. No exit is provided for underflow. A partial underflow result with an exponent of octal 0000 and a coefficient which is not zero is a non-zero quantity and is packed with a zero exponent and the non-zero coefficient. A precaution must be taken to normalize when using partial underflow results as operands in subsequent floating point multiply operations. This will prevent these operands from being interpreted as integer operands resulting in an integer multiply operation.

Use of either infinity or zero as operands may produce an indefinite result. An exponent of octal 1777 and a zero coefficient are packed in this case, and an optional exit provided. Note that zero, infinite, and indefinite results are generated or regenerated in floating arithmetic operations only. The branch instructions test for infinite or indefinite quantities.

In all floating arithmetic operations, an attempt to normalize an indefinite quantity returns the original quantity, e. g., if the number 17770237... were to be normalized, the result would be the same as the original number. Exit mode can be made to occur on detecting an indefinite quantity even though the Shift Unit is used.

Exit mode tests for infinite and indefinite operands are made only in the Floating Add, Multiply, and Divide Units. The 12 most significant bits of each operand are tested for these special forms.

In the Multiply and Divide Units (but not in the Floating Add Unit) there is a special test for zero operands as determined by the 12 most significant bits.

Thus the special operand forms (in octal) are:

3777X...X	(+ $\infty$ )	} infinite operands
4000X...X	(- $\infty$ )	
1777X...X	(+IND)	} indefinite operands
6000X...X	(-IND)	
0000X...X	(+0)	} zero operands for Multiply and Divide units only
7777X...X	(-0)	

Whenever infinite, indefinite, or zero results are generated in accordance with the rules given in Table 3-5 and Appendix C, only the following octal words can occur as results:

37770...0	= + $\infty$	(result)
40000...0	= - $\infty$	(result)
17770...0	= +IND	(result)
00000...0	= +0	(result)

Note that in these cases the 48 least significant bits of the result are zeros. Indefinite and zero results generated in accordance with Table 3-5 and Appendix C are always positive, but the sign of infinite results is determined by the usual algebraic sign convention. For example:

$(+0)/(-0)$	$= +\text{IND}$	$= 17770\dots 0$
$(+N)*(-0)$	$= +0$	$= 00000\dots 0$
$(-\infty)/(-0)$	$= +\infty$	$= 37770\dots 0$
$(+\infty)/(-0)$	$= -\infty$	$= 40000\dots 0$

There is no special treatment of zero operands in the Floating Add unit. Zero coefficients and the forms  $0000X\dots X$  and  $7777X\dots X$  are not specially detected, and unstandardized zero results can be produced. (See description of 30 instruction, page 3-37.)

#### Overflow and Underflow

Exponents lying outside the range  $-1777_8$  to  $+1777_8$  cannot be generated during execution of a floating point arithmetic instruction or during execution of a Normalize instruction. An attempt to generate an exponent greater than  $+1777_8$  yields an infinite result (overflow case). An attempt to generate an exponent less than  $-1777_8$  yields a zero result (underflow case). All cases of overflow and underflow are listed in Table 3-6.

#### Converting Integers to Floating Format

Conversion of integers to floating point format makes use of the Shift Unit and the zero constant in increment register B0. The B0 quantity provides for generation of exponent bias in this case. For example, the instructions:

- Sum of  $B_j$  and  $B_k$  to  $X_i$  (where  $i = 2, j = 3, k = 4$ )
- Pack  $X_i$  from  $X_k$  and  $B_j$  (where  $i = 2, j = 0, k = 2$ )

form an 18-bit signed integer in operand register X2 as a result of the addition of the contents of increment registers B3 and B4. The integer coefficient with its sign, plus the octal 2000 exponent is then packed into the floating format shown earlier. The coefficient is not normalized; normalizing may be accomplished with a Normalize instruction.

TABLE 3-6. OVERFLOW AND UNDERFLOW CONDITIONS

OVERFLOW		
INSTRUCTIONS	OVERFLOW CONDITION	RESULT
Normalize (24, 25)	None	---
Upper Sum (30, 31, 34, 35)	None (see Note 1)	---
Lower Sum (32, 33)	None	---
Upper Product (40, 41)	$*n_1 + n_2 + 60_8 \geq 2000_8$ $n_1 + n_2 \geq 2000_8$ $n_1 - n_2 - 57_8 \geq 2000_8$	$X_i = 3777\ 0\dots 0_8$ or $4000\ 0\dots 0_8$ (True Sign)
Lower Product (42)		
Quotient (44, 45)		
UNDERFLOW		
INSTRUCTIONS	UNDERFLOW CONDITION	RESULT
Normalize (24 only)	Initial coefficient = $\pm 0$	$X_i = 0000\ 0\dots 0_8$ , $(B_j) = 60_8$
Normalize (24, 25)	$\text{Final Exponent} \leq -2000_8$	$X_i = 0000\ 0\dots 0_8$ , $(B_j)$ are correct. (See Note 2.)
Upper Sum (30, 31, 34, 35)		
Lower Sum (32, 33)	$\text{Final Exponent} \leq -2000_8$	$X_i = 0000\ 0\dots 0_8$
Upper Product (40, 41)	$n_1 + n_2 + 57_8 \leq -2000_8$ $n_1 + n_2 - 1 \leq -2000_8$ $n_1 - n_2 - 60_8 \leq -2000_8$	$X_i = 0000\ 0\dots 0_8$
Lower Product (42)		
Quotient (44, 45)		

\* $n_1$  and  $n_2$  are the initial exponents.

Note 1. Overflow of Upper Sum: Overflow cannot occur unless one operand is infinite. In this case the result is as indicated. If a one-place Right Shift occurs when the larger operand exponent is equal to  $+1776_8$ , a correct result with exponent  $+1777_8$  is generated.

Note 2. Underflow of Exponent During Normalization: The final  $(B_j)$  are the same as if underflow had not occurred. In particular, if the initial coefficient is zero,  $(B_j)$  are equal to  $60_8$ .

## Fixed Point Arithmetic

Fixed point addition and subtraction of 60-bit numbers are handled in the Long Add Unit (6600/6700). Negative numbers are represented in one's complement notation, and overflows are ignored. The sign bit is in the high-order bit position (bit 59) and the binary point is at the right of the low-order bit position (bit 0).

The Increment Units provide an 18-bit fixed point add and subtract facility. Negative numbers are represented in one's complement notation and overflows are ignored. The sign bit is in the high-order bit position (bit 17), and the binary point is at the right of the low-order bit position (bit 0). The Increment Units allow program indexing through the full range of Central Memory addresses.

Fixed point integer addition and subtraction are possible in the Floating Add Unit providing the exponents of both operands are zero and no overflow occurs. The unit performs the one's complement addition (or subtraction) in the upper half of a 98-bit accumulator. If overflow occurs, the unit shifts the result one place right and adds one to the exponent, thereby producing a floating point quantity. Thus, care must be used in performing fixed point arithmetic in the Floating Add Unit.

Integer multiplication is handled as a subset of the unrounded Floating Multiply (42) instruction. The integer multiply requires that both of the 47-bit integer operands have zero exponents (0000 + 7777) and one or both operands are not normalized. The result is 48 bits with sign extension. Both operands normalized will cause positive underflow results to be reported. If the result exceeds 48 bits, overflow will not be detected. (See 40 instruction description for detection of overflow.)

An integer divide takes several steps and makes use of the Divide and Shift Units. For example, an integer quotient  $X1 = X2/X3$  is produced by the following steps:

<u>Instructions</u>	<u>Remarks</u>
1) Pack X2 from X2 and B0	Pack X2
2) Pack X3 from X3 and B0	Pack X3
3) Normalize X3 in X0 and B0	Normalize X3 (divisor)
4) Floating quotient of X2 and X0 to X1	Divide
5) Unpack X1 to X1 and B7	Unpack quotient
6) Shift X1 nominally left B7 places	Shift to integer position

The divide requires that:

- 1) both integer ( $2^{47}$  maximum) operands be in floating format
- and 2) the divisor be shifted 48 places left
- or 3) The quotient be shifted 48 places right
- or 4) any combination of  $n$  left-shifts of the divisor and  $48-n$  right shifts of the quotient be accomplished.

The Normalize X3 instruction shifts the divisor  $n$  places left ( $n \geq 0$ ), providing divisor exponent of  $-n$ . The quotient exponent then is:  $0 - (-n) - 48 = n - 48 \leq 0$ .

After unpacking and shifting nominally left, the negative (or zero) value in B7 shifts the quotient  $48 - n$  places right, producing an integer quotient in X1. A remainder may be obtained by an integer multiply of X1 and X3 and subtracting the result from X2.

## Description of Central Processor Instructions

Instruction grouping follows a somewhat pedagogical approach (i. e., simple to complex) and does not necessarily relate instructions to the functional units (6600/6700 system) which execute them. Central Processor instructions as related to functional units are tabulated in Appendix B, Instruction Execution Times.

### NOTE

The codes which are not defined here are considered illegal. The results obtained from an illegal code are not specified and cannot be guaranteed.

TABLE 3-7. CENTRAL PROCESSOR INSTRUCTION DESIGNATORS

Designator	Use
A	Specifies one of eight 18-bit address registers.
B	Specifies one of eight 18-bit index registers; B0 is fixed and equal to zero.
fm	A 6-bit instruction code.
i	A 3-bit code specifying one of eight designated registers (e. g., Ai).
j	A 3-bit code specifying one of eight designated registers (e. g., Bj).
jk	A 6-bit constant, indicating the number of shifts to be taken.
k	A 3-bit code specifying one of eight designated registers (e. g., Bk).
K	An 18-bit constant, used as an operand or as a branch destination (address).
X	Specifies one of eight 60-bit operand registers.

Preceding the description of each instruction is the octal code, mnemonic code and address field, the instruction name and length. Mnemonic codes and address field mnemonics are from COMPASS.

**EXAMPLE:**

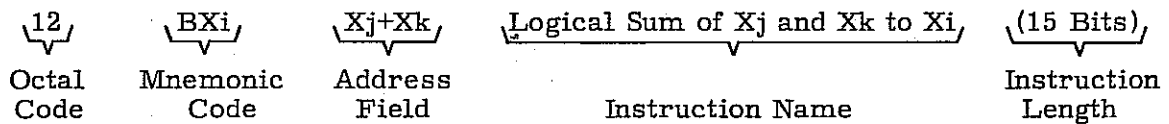

Instruction formats are also given; parallel lines within a format indicate these bits are not used in the operation.

**Program Stop and No Operation**

**00**      **PS**                                      **Program Stop**                                      **(30 Bits)**

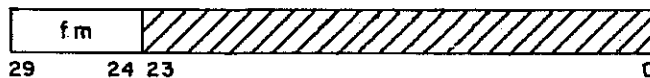

This instruction stops the Central Processor at the current step in the program. An exchange Jump is necessary to restart the Central Processor.

**46**      **NO**                                      **No operation (Pass)**                                      **(15 Bits)**

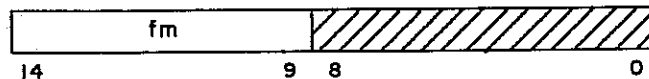

This instruction is a "do-nothing" instruction that is typically used to pad the program between certain program steps.

EXAMPLE:

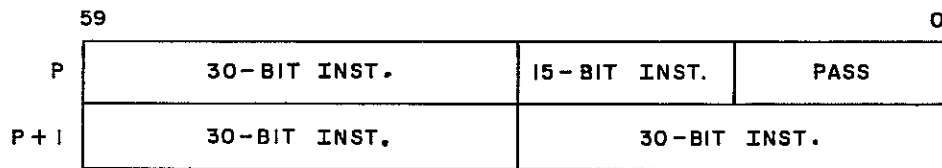

In this example, a Pass instruction is used to pad the remainder of the word at P. Since the next instruction is 30 bits, it cannot fit in P and must be placed in P + 1.

Increment

<b>50</b>	<b>SAi</b>	<b><math>A_j + K</math></b>	<b>Set Ai to <math>A_j + K</math></b>	<b>(30 Bits)</b>
<b>51</b>	<b>SAi</b>	<b><math>B_j + K</math></b>	<b>Set Ai to <math>B_j + K</math></b>	<b>(30 Bits)</b>
<b>52</b>	<b>SAi</b>	<b><math>X_j + K</math></b>	<b>Set Ai to <math>X_j + K</math></b>	<b>(30 Bits)</b>

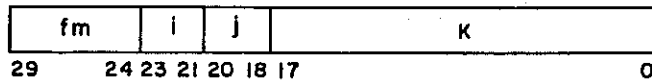

<b>53</b>	<b>SAi</b>	<b><math>X_j + B_k</math></b>	<b>Set Ai to <math>X_j + B_k</math></b>	<b>(15 Bits)</b>
<b>54</b>	<b>SAi</b>	<b><math>A_j + B_k</math></b>	<b>Set Ai to <math>A_j + B_k</math></b>	<b>(15 Bits)</b>
<b>55</b>	<b>SAi</b>	<b><math>A_j - B_k</math></b>	<b>Set Ai to <math>A_j - B_k</math></b>	<b>(15 Bits)</b>
<b>56</b>	<b>SAi</b>	<b><math>B_j + B_k</math></b>	<b>Set Ai to <math>B_j + B_k</math></b>	<b>(15 Bits)</b>
<b>57</b>	<b>SAi</b>	<b><math>B_j - B_k</math></b>	<b>Set Ai to <math>B_j - B_k</math></b>	<b>(15 Bits)</b>

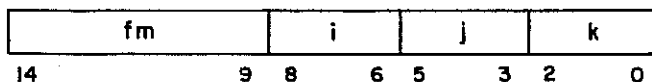



These instructions perform one's complement addition and subtraction of 18-bit operands and store an 18-bit result in address register *i*. Overflow, in itself, is ignored, but an address range fault may result from overflow in this set of instructions.

Operands are obtained from address (*A*), increment (*B*), and operand (*X*) registers as well as the instruction itself (*K* = 18-bit signed constant). Operands obtained from an *X<sub>j</sub>* operand register are the truncated lower 18 bits of the 60-bit word.

Note that an immediate memory reference is performed to the address specified by the final content of address registers *A1* - *A7*. The operand read from memory address specified by *A1* - *A5* is sent to the corresponding operand register *X1* - *X5*. When *A6* or *A7* is referenced, the operand from the corresponding *X6* or *X7* operand register is stored at the address specified by *A6* or *A7*.

#### NOTE

If, in this category of instructions, the result placed in address register *A<sub>i</sub>* is an address out of range, the following occurs: (Note that this action is independent of an Exit selection on Address Out of Range.)

If *i* = 1-5: Operand register *X<sub>i</sub>* is loaded with the contents of absolute address zero and the contents of memory location (*A<sub>i</sub>*) are unchanged.

If *i* = 6 or 7: Operand register *X<sub>i</sub>* retains its original contents and the contents of memory location (*A<sub>i</sub>*) are unchanged.

#### EXAMPLE:

50	$SA_i = A_j + K \quad i = 4$ $SA_4 = A_6 + K \quad j = 6$ $SA_4 = 032100_8 + 234567_8$ $SA_4 = 266667_8$	<u>Initial Quantities:</u> $K = 234567_8$ $A_4 = 321110_8$ $A_6 = 032100_8$ $X_4 = 00 \dots 00_8$ Storage location 266667 = 7 ... 75342104600 <sub>8</sub> <u>Final Quantities:</u> $A_4 = 266667_8$ $A_6 = 032100_8$ $X_4 = 7 \dots 75342104600_8$
----	---	--

60	<i>SBi</i>	$A_j + K$	Set Bi to $A_j + K$	(30 Bits)
61	<i>SBi</i>	$B_j + K$	Set Bi to $B_j + K$	(30 Bits)
62	<i>SBi</i>	$X_j + K$	Set Bi to $X_j + K$	(30 Bits)

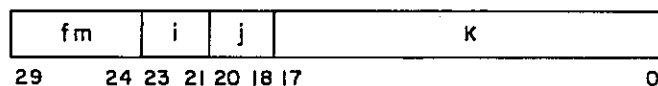

63	<i>SBi</i>	$X_j + B_k$	Set Bi to $X_j + B_k$	(15 Bits)
64	<i>SBi</i>	$A_j + B_k$	Set Bi to $A_j + B_k$	(15 Bits)
65	<i>SBi</i>	$A_j - B_k$	Set Bi to $A_j - B_k$	(15 Bits)
66	<i>SBi</i>	$B_j + B_k$	Set Bi to $B_j + B_k$	(15 Bits)
67	<i>SBi</i>	$B_j - B_k$	Set Bi to $B_j - B_k$	(15 Bits)

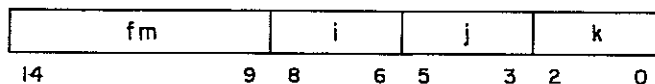

These instructions perform one's complement addition and subtraction of 18-bit operands and store an 18-bit result in increment register Bi. An overflow condition is ignored.

Operands are obtained from address (A), increment (B), and operand (X) registers as well as the instruction itself (K = 18-bit signed constant). Operands obtained from an Xj operand register are the truncated lower 18 bits of the 60-bit word.

70	<i>SXi</i>	$A_j + K$	Set Xi to $A_j + K$	(30 Bits)
71	<i>SXi</i>	$B_j + K$	Set Xi to $B_j + K$	(30 Bits)
72	<i>SXi</i>	$X_j + K$	Set Xi to $X_j + K$	(30 Bits)

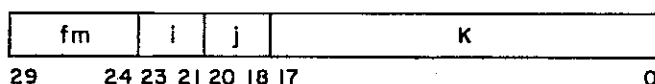

73	SXi	$X_j + B_k$	Set Xi to $X_j + B_k$	(15 Bits)
74	SXi	$A_j + B_k$	Set Xi to $A_j + B_k$	(15 Bits)
75	SXi	$A_j - B_k$	Set Xi to $A_j - B_k$	(15 Bits)
76	SXi	$B_j + B_k$	Set Xi to $B_j + B_k$	(15 Bits)
77	SXi	$B_j - B_k$	Set Xi to $B_j - B_k$	(15 Bits)

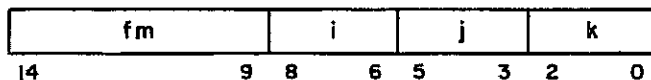

These instructions perform one's complement addition and subtraction of 18-bit operands and store an 18-bit result into the lower 18 bits of operand register Xi. The sign of the result is extended to the upper 42 bits of operand register Xi. An overflow condition is ignored.

Operands are obtained from address (A), increment (B), and operand (X) registers as well as the instruction itself (K = 18-bit signed constant). Operands obtained from an Xj operand register are the truncated lower 18 bits of the 60-bit word.

**EXAMPLE:**

				<u>Initial Quantities:</u>
73	SXi	$X_j + B_k$	$i = 2$	$X_2 = 0 \dots 0745321402_8$
	SX <sub>2</sub>	$X_3 + B_1$	$j = 3, k = 1$	$X_3 = 0 \dots 0652224310_8$
	SX <sub>2</sub>	$= 0 \dots 0652224310_8 + 511245_8$	$B_1 =$	$511245_8$
	SX <sub>2</sub>	$= 7 \dots 7777735555_8$		
				<u>Final Quantities:</u>
				$X_2 = 7 \dots 7777735555_8$
				$X_3 = 0 \dots 0652224310_8$
				$B_1 = 511245_8$

**NOTE**

See Appendix D for further information.

Fixed Point Arithmetic

36 **IXi**  **$X_j + X_k$**  *Integer sum of  $X_j$  and  $X_k$  to  $X_i$*  (15 Bits)

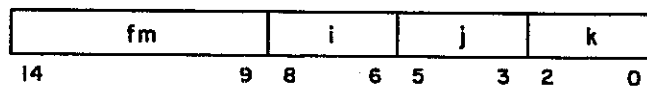

This instruction forms a 60-bit one's complement sum of the quantities from operand registers  $X_j$  and  $X_k$  and stores the result in operand register  $X_i$ . An overflow condition is ignored.

37 **IXi**  **$X_j - X_k$**  *Integer difference of  $X_j$  and  $X_k$  to  $X_i$*  (15 Bits)

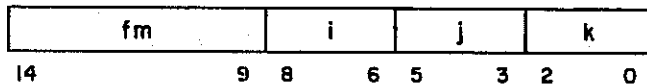

This instruction forms the 60-bit one's complement difference of the quantities from operand registers  $X_j$  (minuend) and  $X_k$  (subtrahend) and stores the result in operand register  $X_i$ . An overflow condition is ignored.

47 **CXi**  **$X_k$**  *Count the number of "1's" in  $X_k$  to  $X_i$*  (15 Bits)

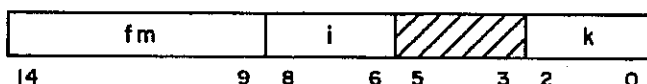

This instruction counts the number of "1's" in operand register  $X_k$  and stores the count in the lower order 6 bits of operand register  $X_i$ . Bits 6 through 59 are cleared to zero.

**EXAMPLE:**

47 CXi Xk i = 4  
 CX<sub>4</sub> X<sub>1</sub> k = 1  
 CX<sub>4</sub> = 11<sub>8</sub>

Initial Quantities:

X<sub>1</sub> = 0 ... 0543321<sub>8</sub>  
 X<sub>4</sub> = 23420 ... 0005547<sub>8</sub>

Final Quantities:

X<sub>1</sub> = 0 ... 0543321<sub>8</sub>  
 X<sub>4</sub> = 0 ... 0000011<sub>8</sub>

**Logical**

**10** BXi Xj Transmit Xj to Xi (15 Bits)

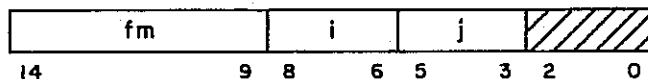

This instruction transfers a 60-bit word from operand register Xj to operand register Xi.

**11** BXi Xj \* Xk Logical Product of Xj and Xk to Xi (15 Bits)

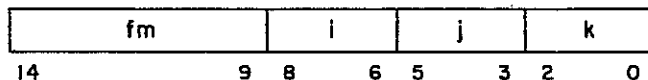

This instruction forms the logical product (AND function) of 60-bit words from operand registers Xj and Xk and places the product in operand register Xi. Bits of register Xi are set to "1" when the corresponding bits of the Xj and Xk registers are "1" as in the following example:

Xj = 0101  
 Xk = 1100  
 Xi = 0100

12      **BXi**       $X_j + X_k$       *Logical sum of  $X_j$  and  $X_k$  to  $X_i$*       (15 Bits)

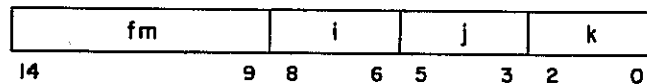

This instruction forms the logical sum (inclusive OR) of 60-bit words from operand registers  $X_j$  and  $X_k$  and places the sum in operand register  $X_i$ . Bits of register  $X_i$  are set to "1" if the corresponding bit of the  $X_j$  or  $X_k$  register is a "1" as in the following example:

$X_j = 0101$   
 $X_k = \underline{1100}$   
 $X_i = 1101$

13      **BXi**       $X_j - X_k$       *Logical difference of  $X_j$  and  $X_k$  to  $X_i$*       (15 Bits)

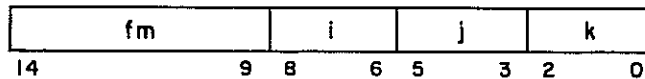

This instruction forms the logical difference (exclusive OR) of 60-bit words from operand registers  $X_j$  and  $X_k$  and places the difference in operand register  $X_i$ . Bits of register  $X_i$  are set to "1" if the corresponding bits in the  $X_j$  and  $X_k$  registers are unlike as in the following example:

$X_j = 0101$   
 $X_k = \underline{1100}$   
 $X_i = 1001$

14      **BXi**       $\neg X_k$       *Transmit the complement of  $X_k$  to  $X_i$*       (15 Bits)

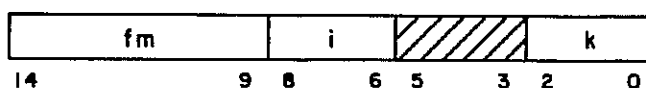

This instruction extracts the 60-bit word from operand register Xk, complements it, and transmits this complemented quantity to operand register Xi.

15      **BXi**       $\neg Xk \cdot Xj$       *Logical product of Xj and complement of Xk to Xi*      (15 Bits)

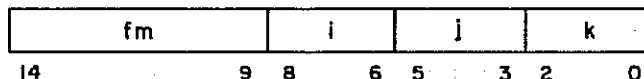

This instruction forms the logical product (AND function) of the 60-bit quantity from operand register Xj and the complement of the 60-bit quantity from operand register Xk, and places the result in operand register Xi. Thus, bits of Xi are set to "1" when the corresponding bits of the Xj register and the complement of the Xk register are "1" as in the following example:

Xj = 0101  
 Complemented Xk = 0011  
 Xi = 0001

16      **BXi**       $\neg Xk + Xj$       *Logical sum of Xj and complement of Xk to Xi*      (15 Bits)

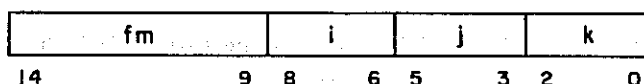

This instruction forms the logical sum (inclusive OR) of the 60-bit quantity from operand register Xj and the complement of the 60-bit word from operand register Xk, and places the result in operand register Xi. Thus, bits of Xi are set to "1" if the corresponding bit of the Xj register or complement of the Xk register is a "1" as in the following example:

Xj = 0101  
 Complemented Xk = 0011  
 Xi = 0111

17 **BXi**  $-Xk - Xj$  *Logical difference of Xj and complement of Xk to Xi (15 Bits)*

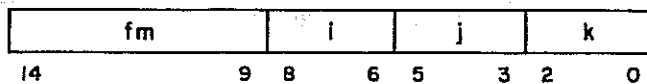

This instruction forms the logical difference (exclusive OR) of the quantity from operand register Xj and the complement of the 60-bit word from operand register Xk, and places the result in operand register Xi. Thus, bits of Xi are set to "1" if the corresponding bits of register Xj and the complement of register Xk are unlike as in the following example:

Xj = 0101  
 Complemented Xk = 0011  
 Xi = 0110

Shift  
 20 **LXi**  $jk$  *Left shift Xi, jk places* (15 Bits)



This instruction shifts the 60-bit word in operand register Xi left circular jk places. Bits shifted off the left end of operand register Xi replace those from the right end.

The 6-bit shift count jk allows a complete circular shift of register Xi.

21 **AXi**  $jk$  *Arithmetic right shift Xi, jk places* (15 Bits)

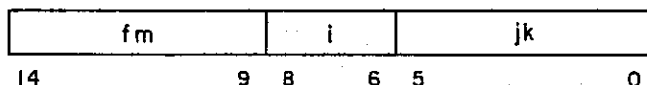



This instruction shifts the 60-bit word in operand register  $X_i$  right  $jk$  places. The right-most bits of  $X_i$  are discarded and the sign bit is extended.

22       $LX_i$        $B_j$     $X_k$       *Left shift  $X_k$  nominally  $B_j$  places to  $X_i$*       (15 Bits)

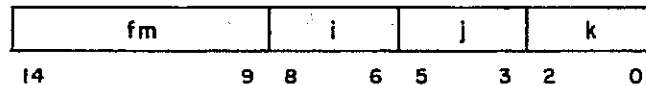

This instruction shifts the 60-bit quantity from operand register  $X_k$  the number of places specified by the quantity in increment register  $B_j$  and places the result in operand register  $X_i$ .

- 1) If  $B_j$  is positive (i. e., bit 17 of  $B_j = 0$ ), the quantity from  $X_k$  is shifted left-circular. (The low order six bits of  $B_j$  specify the shift count.)
- 2) If  $B_j$  is negative (i. e., bit 17 of  $B_j = 1$ ), the quantity from  $X_k$  is shifted right (end off with sign extension). (The one's complement of the low order eleven bits of  $B_j$  specify the shift count.) If any of bits  $2^6-2^{10}$ , after complementing, are "1's", the shift is not performed and the result register  $X_i$  is cleared to all zeros.

23       $AX_i$        $B_j$     $X_k$       *Arithmetic right shift  $X_k$  nominally  $B_j$  places to  $X_i$*       (15 Bits)

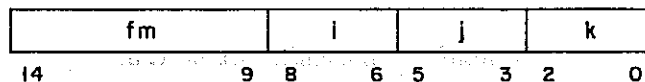

This instruction shifts the 60-bit quantity from operand register  $X_k$  the number of places specified by the quantity in increment register  $B_j$  and places the result in operand register  $X_i$ .

- 1) If  $B_j$  is positive (i. e., bit 17 of  $B_j = 0$ ), the quantity from register  $X_k$  is

shifted right (end-off with sign extension). (The low order eleven bits of  $B_j$  specify the shift count.) If any of bits  $2^6 - 2^{10}$  are "1's", the shift is not performed and the result register  $X_i$  is cleared to all zeros.

- 2) If  $B_j$  is negative (i. e., bit 17 of  $B_j = 1$ ), the quantity from register  $X_k$  is shifted left circular. (The complement of the lower order six bits of  $B_j$  specify the shift count.)

24       $NX_i$        $B_j$        $X_k$       *Normalize  $X_k$  in  $X_i$  and  $B_j$*       (15 Bits)

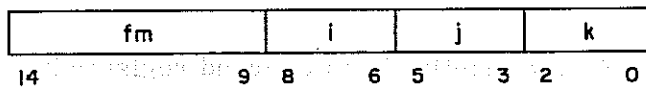

This instruction normalizes the floating point quantity from operand register  $X_k$  and places it in operand register  $X_i$ . The number of left shifts necessary to normalize the quantity is entered in increment register  $B_j$ . A Normalize operation may cause underflow which will clear  $X_i$  to all zeros regardless of the original sign of  $X_k$ . Normalizing either a plus or minus zero coefficient sets the shift count ( $B_j$ ) to  $48_{10}$  and clears  $X_i$  to all zeros.

If  $X_k$  contains an infinite quantity ( $3777X...X$  or  $4000X...X$ ) or an indefinite quantity ( $1777X...X$  or  $6000X...X$ ), no shift takes place. The contents of  $X_k$  are copied into  $X_i$  and  $B_j$  is set equal to zero. Optional error exits do occur.

25       $ZX_i$        $B_j$        $X_k$       *Round and normalize  $X_k$  in  $X_i$  and  $B_j$*       (15 Bits)

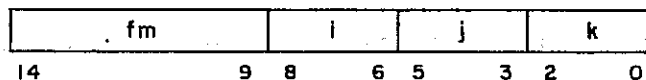

This instruction performs the same operation as instruction 24 except that the quantity

from operand register  $X_k$  is rounded before it is normalized. Rounding is accomplished by placing a "1" round bit immediately to the right of the least significant coefficient bit. Normalizing a zero coefficient places the round bit in bit 47 and reduces the exponent by 48. Note that the same rules apply for underflow.

If  $X_k$  contains an infinite quantity (3777X...X or 4000X...X) or an indefinite quantity (1777X...X or 6000X...X), no shift takes place. The contents of  $X_k$  are copied into  $X_i$  and  $B_j$  is set equal to zero. Optional error exits do occur.

26       $UX_i$        $B_j$        $X_k$       *Unpack  $X_k$  to  $X_i$  and  $B_j$*       (15 Bits)

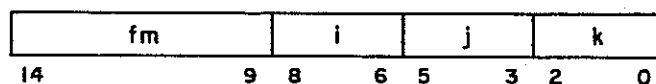

This instruction unpacks the floating point quantity from operand register  $X_k$  and sends the 48-bit coefficient to operand register  $X_i$  and the 11-bit exponent to increment register  $B_j$ . The exponent bias is removed during Unpack so that the quantity in  $B_j$  is the one's complement representation of the true exponent.

The exponent and coefficient are sent to the low-order bits of the respective registers as shown below:

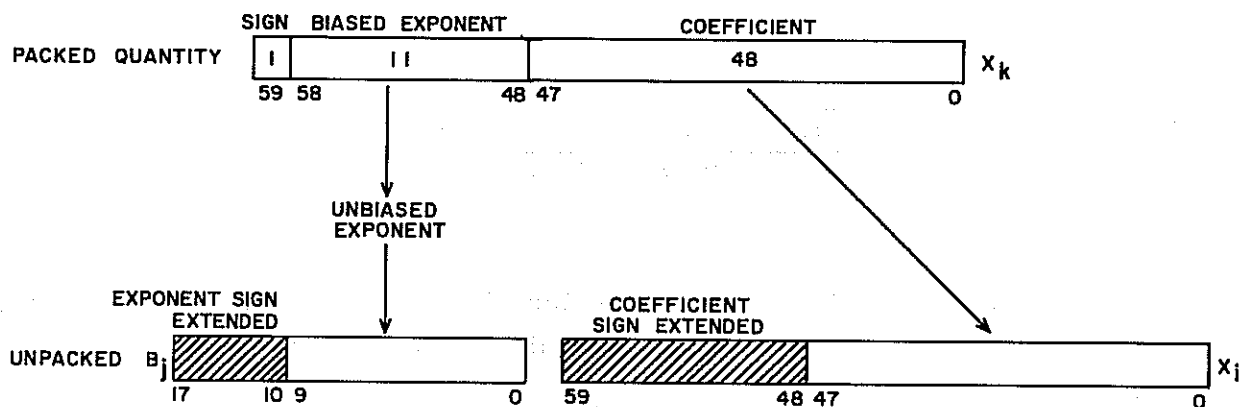

27      *PXi*      *Bj* *Xk*      *Pack Xi from Xk and Bj*      (15 Bits)

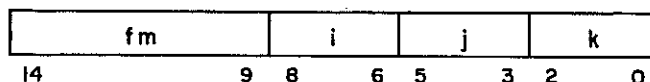

This instruction packs a floating point number in operand register *Xi*. The coefficient of the number is obtained from operand register *Xk* and the exponent from increment register *Bj*. Bias is added to the exponent during the Pack operation. The instruction does not normalize the coefficient.

Exponent and coefficient are obtained from the proper low-order bits of the respective registers and packed as shown in the illustration for the Unpack (26) instruction. Thus, bits 48 to 58 of *Xk* and bits 11 to 17 of *Bj* are ignored. There is no test for overflow or underflow.

Note that if *Xk* is positive, the packed exponent occupying positions 48 to 58 of *Xi* is obtained from bits 0 to 10 of *Bj* by complementing bit 10; if *Xk* is negative, bit 10 is not complemented but bits 0 to 9 are.

43      *MXi*      *jk*      *Form mask in Xi, jk bits*      (15 Bits)

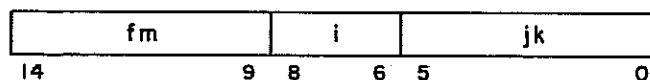

This instruction forms a mask in operand register *Xi*. The 6-bit quantity *jk* defines the number of "1's" in the mask as counted from the highest order bit in *Xi*.

The contents of operand register *Xi* = 0 when *jk* = 0.

## Floating Point Arithmetic

**30**      *FXi*       $X_j + X_k$       *Floating sum of  $X_j$  and  $X_k$  to  $X_i$*       (15 Bits)

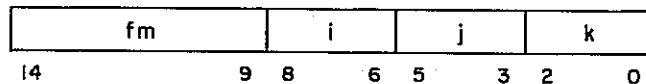

This instruction forms the sum of the floating point quantities from operand registers  $X_j$  and  $X_k$  and packs the result in operand register  $X_i$ . The packed result is the upper half of a double precision sum.

At the start both arguments are unpacked, and the coefficient of the argument with the smaller exponent is entered into the upper half of a 96-bit accumulator. The coefficient is shifted right by the difference of the exponents. The other coefficient is then added into the upper half of the accumulator. If overflow occurs, the sum is right-shifted one place and the exponent of the result increased by one. The upper half of the accumulator holds the coefficient of the sum, which is not necessarily in normalized form. The exponent and upper coefficient are then repacked in operand register  $X_i$ .

If both exponents are zero\* and no overflow occurs, the instruction effects an ordinary integer addition. For treatment of special operands and/or indefinite forms, refer to Table 3-5 and Appendix C.

**31**      *FXi*       $X_j - X_k$       *Floating difference  $X_j$  and  $X_k$  to  $X_i$*       (15 Bits)

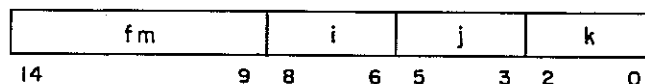

This instruction forms the difference of the floating point quantities from operand registers  $X_j$  and  $X_k$  and packs the result in operand register  $X_i$ . Alignment and overflow operations are similar to the Floating Sum (30) instruction, and the difference is not necessarily normalized. The packed result is the upper half of a double precision difference.

An ordinary integer subtraction is performed when the exponents are zero. For treatment of special operands and/or indefinite forms, refer to Table 3-5 and Appendix C.

\*A zero exponent is  $2000_8$ .

32      *DXi*       $X_j + X_k$       *Floating DP sum of  $X_j$  and  $X_k$  to  $X_i$*       (15 Bits)

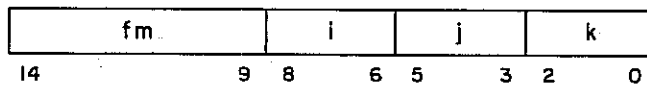

This instruction forms the sum of two floating point numbers as in the Floating Sum (30) instruction, but packs the lower half of the double precision sum with an exponent 48 less than the upper sum. For treatment of special operands and/or indefinite forms, refer to Table 3-5 and Appendix C.

33      *DXi*       $X_j - X_k$       *Floating DP difference of  $X_j$  and  $X_k$  to  $X_i$*       (15 Bits)

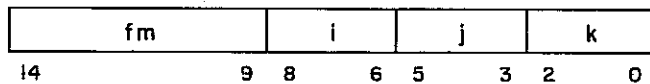

This instruction forms the difference of two floating point numbers as in the Floating Difference (31) instruction, but packs the lower half of the double precision difference with an exponent of 48 less than the upper sum. For treatment of special operands and/or indefinite forms, refer to Table 3-5 and Appendix C.

34      *RXi*       $X_j + X_k$       *Round floating sum of  $X_j$  and  $X_k$  to  $X_i$*       (15 Bits)

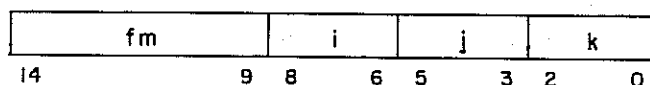

This instruction forms the round sum of the floating point quantities from operand registers  $X_j$  and  $X_k$  and packs the upper sum of the double precision result in operand register  $X_i$ . The sum is formed in the same manner as the Floating Sum instruction but the

operands are rounded before the addition, as shown below, to produce a round sum.

- 1) A round bit is attached at the right end of both operands if:
  - a) both operands are normalized, or
  - b) the operands have unlike signs.
- 2) A round bit is attached at the right end of the operand with the larger exponent for all other cases. In the event that the operands have equal exponents, a round bit is attached to the coefficient for only one of the operands.

For treatment of special operands and/or indefinite forms, refer to Table 3-5 and Appendix C.

**.35       $RXi$        $Xj - Xk$       *Round floating difference of  $Xj$  and  $Xk$  to  $Xi$*       (15 Bits)**

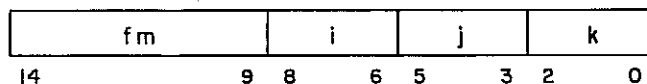

This instruction forms the round difference of the floating point quantities from operand registers  $Xj$  and  $Xk$  and packs the upper difference of the double precision result in operand register  $Xi$ . The difference is formed in the same manner as the Floating Difference (31) instruction but the operands are rounded before the subtraction, as shown below, to produce a round difference.

- 1) A round bit is attached at the right end of both operands if:
  - a) both operands are normalized, or
  - b) the operands have like signs.
- 2) A round bit is attached at the right end of the operand with the larger exponent for all other cases. In the event that the operands have equal exponents, a round bit is attached to the coefficient for only one of the operands.

For treatment of special operands and/or indefinite forms, refer to Table 3-5 and Appendix C.

40      *FXi*       $X_j * X_k$       *Floating product of Xj and Xk to Xi*      (15 Bits)

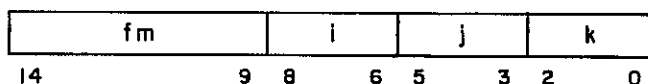

This instruction multiplies two floating point quantities obtained from operand registers Xj (multiplier) and Xk (multiplicand) and packs the upper product result in operand register Xi.

The two 48-bit coefficients are multiplied together to form a 96-bit product. The upper 48 bits of the product (bits 48-95) are then packed together with the resulting exponent. Note that when using unnormalized quantities, the entire result could lie in the lower-order 48 bits of the product; hence, this result would be lost when packing occurs.

The result is a normalized quantity only when both operands are normalized; the exponent in this case is the sum of the exponents plus 47 (or 48). The result is unnormalized when either or both operands are unnormalized; the exponent in this case is the sum of the exponents plus 48. For treatment of special operands and/or indefinite forms, refer to Table 3-5 and Appendix C.

This instruction is not meant for integer multiplication, however it can be used to detect overflow resulting from operands too large for integer multiplication. Any non-zero resultant from an attempted integer multiply indicates overflow.

41      *RXi*       $X_j * X_k$       *Round floating product of Xj and Xk to Xi*      (15 Bits)

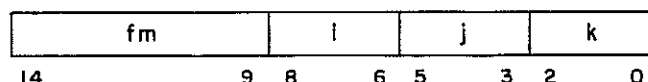

This instruction multiplies the floating point number from operand register Xk (multiplicand), by the floating point number from operand register Xj. The upper product result is packed in operand register Xi. (No lower product available.) The multiply operation is identical to that of instruction 40 with the following exception:



Before the left shift of the final product and during the merge operation to form the final product, a "1" bit is added to bit  $2^{46}$ . The following rounded result is the net effect of this action:

- for products  $> 2^{95}$ , round is by one-fourth
- for all other products, round is by one-half
- when one or both operands are unnormalized, round is by one-fourth.

The result is a normalized quantity only when both operands are normalized; the exponent in this case is the sum of the exponents plus 47 (or 48).

The result is unnormalized when either or both operands are unnormalized; the exponent in this case is the sum of the exponents plus 48. For treatment of special operands and/or indefinite forms, refer to Table 3-5 and Appendix C.

42      *DXi*       $X_j \cdot X_k$       *Floating DP product of  $X_j$  and  $X_k$  to  $X_i$*       (15 Bits)



This instruction multiplies two floating point quantities obtained from operand registers  $X_j$  and  $X_k$  and packs the lower product in operand register  $X_i$ . The two 48-bit coefficients are multiplied together to form a 96-bit product. The lower-order 48 bits of this product (bits 47-00) are then packed together with the resulting exponent. The result is not necessarily a normalized quantity. The exponent of this result is 48 less than the exponent resulting from a 40 instruction using the same operands. For treatment of special operands and/or indefinite forms, refer to Table 3-5 and Appendix C.

#### Integer Multiply

The 42 code performs short word integer multiplication of 47-bit operands if the upper 12 bits (exponents) of both operands are  $\pm$  sign extended and the operands are not normalized. The 48 bit result is entered into  $X_i$  with sign extension. To ensure a resultant integer of 48 bits or less, the sum of the non-sign bits in the two operands should not exceed 48 bits. Normalized operands will cause positive underflow results to be reported. To detect overflow, see the 40 instruction description. See Appendix C for a tabulation of operations.

44 **FXi**  **$X_j / X_k$**  **Floating divide  $X_j$  by  $X_k$  to  $X_i$**  (15 Bits)

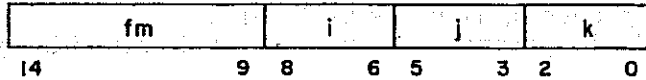

This instruction divides two normalized floating point quantities obtained from operand registers  $X_j$  (dividend) and  $X_k$  (divisor) and packs the quotient in operand register  $X_i$ .

The exponent of the result in a no-overflow case is the difference of the dividend and divisor exponents minus 48.

A one-bit overflow is compensated for by adjusting the exponent and right shifting the quotient one place. In this case the exponent is the difference of the dividend and divisor exponents minus 47.

The result is a normalized quantity when both the dividend and the divisor are normalized. A divide fault occurs when the coefficient of the dividend is two or more times as large as the coefficient of the divisor. This forces an indefinite result (17770...0). To avoid this, normalize both operands before executing this instruction. For treatment of special operands and/or indefinite forms, refer to Table 3-5 and Appendix C.

45 **RXi**  **$X_j / X_k$**  **Round floating divide  $X_j$  by  $X_k$  to  $X_i$**  (15 Bits)

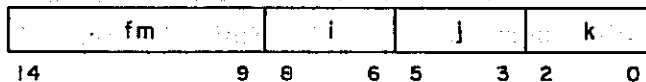

This instruction divides the floating quantity from operand register  $X_j$  (dividend) by the floating point quantity from operand register  $X_k$  (divisor) and packs the round quotient in operand register  $X_i$ . Rounding is accomplished by adding one-third during the division process. In effect, the quantity "2525...2525<sub>8</sub>" resides immediately to the right of the dividend binary point prior to starting the divide operation. On the first iteration, a "1" is added to the least significant bit of the dividend. After each iteration (subtraction of divisor from partial dividend) a two-place left shift occurs and a "1" is again added to the least significant bit of the partial dividend. Thus, successive iterations gradually bring in the one-third round "quantity" (25...25<sub>8</sub>).

The result exponent in a no-overflow case is the difference of the dividend and divisor exponents minus 48.

A one-bit overflow is compensated for by adjusting the exponent and right shifting the quotient one place; in this case the exponent is the difference of the dividend and divisor exponents minus 47.

The result is a normalized quantity when both the dividend and the divisor are normalized. A divide fault occurs when the coefficient of the dividend is two or more times as large as the coefficient of the divisor. This forces an indefinite result (17770...0). To avoid this, normalize both operands before executing this instruction. For treatment of special operands and/or indefinite forms, refer to Table 3-5 and Appendix C.

### Branch

**010 RJ K Return jump to K (30 Bits)**

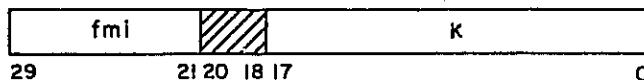

The instruction stores an 04 unconditional jump and the current address plus one  $[P + 1]$  in the upper half of address K, then branches to  $K + 1$  for the next instruction. Note that this instruction is always out of the instruction stack, thus voiding the stack.

The octal word at K after the instruction appears as follows:

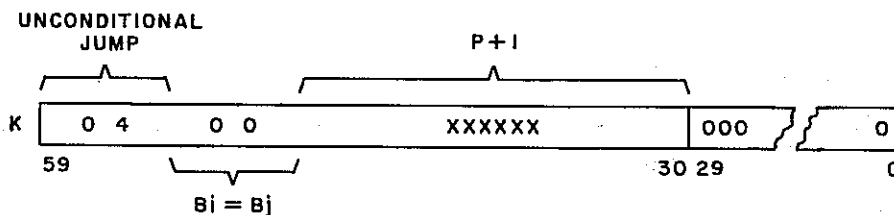

A jump to address K at the end of the branch routine returns the program to the original sequence.

02      *JP*       $B_i + K$       *Jump to  $B_i + K$*       (30 Bits)

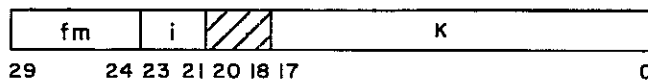

This instruction adds the contents of increment register  $B_i$  to  $K$  and branches to the address specified by the sum. The branch address is  $K$  when  $i = 0$ . Addition is performed modulo  $2^{18}-1$ .

Note that this instruction is always out of the instruction stack, thus voiding the stack. For an unindexed, unconditional jump, the 04 instruction with  $i = j = 0$  is a better choice. Thus, if this instruction is contained in a tight loop, the instruction at  $K$  can be obtained from the stack, if possible.

030	<i>ZR</i>	$X_j$	$K$	<i>Jump to <math>K</math> if <math>X_j = 0</math></i>	(30 Bits)
031	<i>NZ</i>	$X_j$	$K$	<i>Jump to <math>K</math> if <math>X_j \neq 0</math></i>	(30 Bits)
032	<i>PL</i>	$X_j$	$K$	<i>Jump to <math>K</math> if <math>X_j = \text{plus (positive)}</math></i>	(30 Bits)
033	<i>NG</i>	$X_j$	$K$	<i>Jump to <math>K</math> if <math>X_j = \text{negative}</math></i>	(30 Bits)
034	<i>IR</i>	$X_j$	$K$	<i>Jump to <math>K</math> if <math>X_j</math> is in range</i>	(30 Bits)
035	<i>OR</i>	$X_j$	$K$	<i>Jump to <math>K</math> if <math>X_j</math> is out of range</i>	(30 Bits)
036	<i>DF</i>	$X_j$	$K$	<i>Jump to <math>K</math> if <math>X_j</math> is definite</i>	(30 Bits)
037	<i>ID</i>	$X_j$	$K$	<i>Jump to <math>K</math> if <math>X_j</math> is indefinite</i>	(30 Bits)

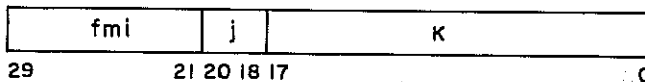

These instructions branch to  $K$  when the 60-bit word in operand register  $X_j$  meets the condition specified by the  $i$  digit. The instruction allows zero, sign, and indefinite forms tests for fixed or floating point words.

The following applies to tests made in this instruction group:

- a) The 030 (ZR) and 031 (NZ) operations test the full 60-bit word in Xj. The words 000...000 and 777...777 are treated as zero. All other words are non-zero.
- b) The 032 (PL) and 033 (NG) operations examine only the sign bit ( $2^{59}$ ) of Xj. If the sign bit is zero, the word is positive; if the sign bit is one, the word is negative. Thus, the sign test is valid for fixed point words or for coefficients in floating point words.
- c) The 034 (IR) and 035 (OR) operations examine the upper-order 12 bits of Xj. Both plus and minus infinity are detected:  
 3777XX...XX and 4000XX...XX are out of range; all other words are in range.
- d) The 036 (DF) and 037 (ID) operations examine the upper-order 12 bits of Xj. Both plus and minus indefinite forms are detected:  
 1777XX...XX and 6000XX...XX are indefinite; all other words are definite.

04	<i><b>EQ</b></i>	<i><b>Bi Bj K</b></i>	<i><b>Jump to K if Bi = Bj</b></i>	<i><b>(30 Bits)</b></i>
05	<i><b>NE</b></i>	<i><b>Bi Bj K</b></i>	<i><b>Jump to K if Bi ≠ Bj</b></i>	<i><b>(30 Bits)</b></i>
06	<i><b>GE</b></i>	<i><b>Bi Bj K</b></i>	<i><b>Jump to K if Bi ≥ Bj</b></i>	<i><b>(30 Bits)</b></i>
07	<i><b>LT</b></i>	<i><b>Bi Bj K</b></i>	<i><b>Jump to K if Bi &lt; Bj</b></i>	<i><b>(30 Bits)</b></i>

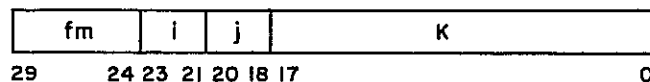

These instructions test an 18-bit word from register Bi against an 18-bit word from register Bj (both words signed quantities) for the condition specified and branch to address K on a successful test. All tests against zero (all zeros) can be made by setting Bj = B0.

The following rules apply in the tests made by these instructions:

- a) Positive zero is recognized as unequal to negative zero, and
- b) Positive zero is recognized as greater than negative zero, and
- c) A positive number is recognized as greater than a negative number.

Note that the 06 and 07 instructions first perform a sign test on  $B_i$  and  $B_j$  and the Branch/No Branch determination is based on the above rules. If  $B_i$  and  $B_j$  are of the same sign, a subtract test is performed (in the Increment Unit) and the sign of the result ( $B_i - B_j$ ) determines whether a Branch is made.

### Extended Core Storage Communication

This category of instructions provides the ability to communicate with Extended Core Storage (ECS). This section briefly describes Extended Core Storage itself, and a full description of the instructions is to be found in the Extended Core Storage Reference Manual.

These instructions must be located in the upper order position of the instruction word. If the instructions are used in a system that does not have ECS they will do a return jump.

**011 RE  $B_j + K$  Read Extended Core Storage (30 Bits)**

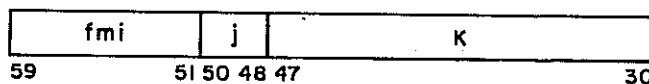

This instruction initiates a Read operation to transfer  $[(B_j) + K]$  60-bit words from Extended Core Storage to Central Memory. The initial Extended Core Storage address is  $[(X0) + RA_{ECS}]$ ; the initial Central Memory address is  $[(A0) + RA_{CM}]$ .

012

WE

$Bj + K$

Write Extended Core Storage

(30 Bits)

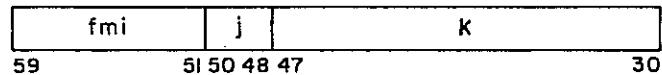

This instruction initiates a Write operation to transfer  $[(Bj) + K]$  60-bit words from Central Memory to Extended Core Storage. The initial Central Memory address is  $[(A0) + RA_{CM}]$ ; the initial Extended Core Storage address is  $[(X0) + RA_{ECS}]$ .





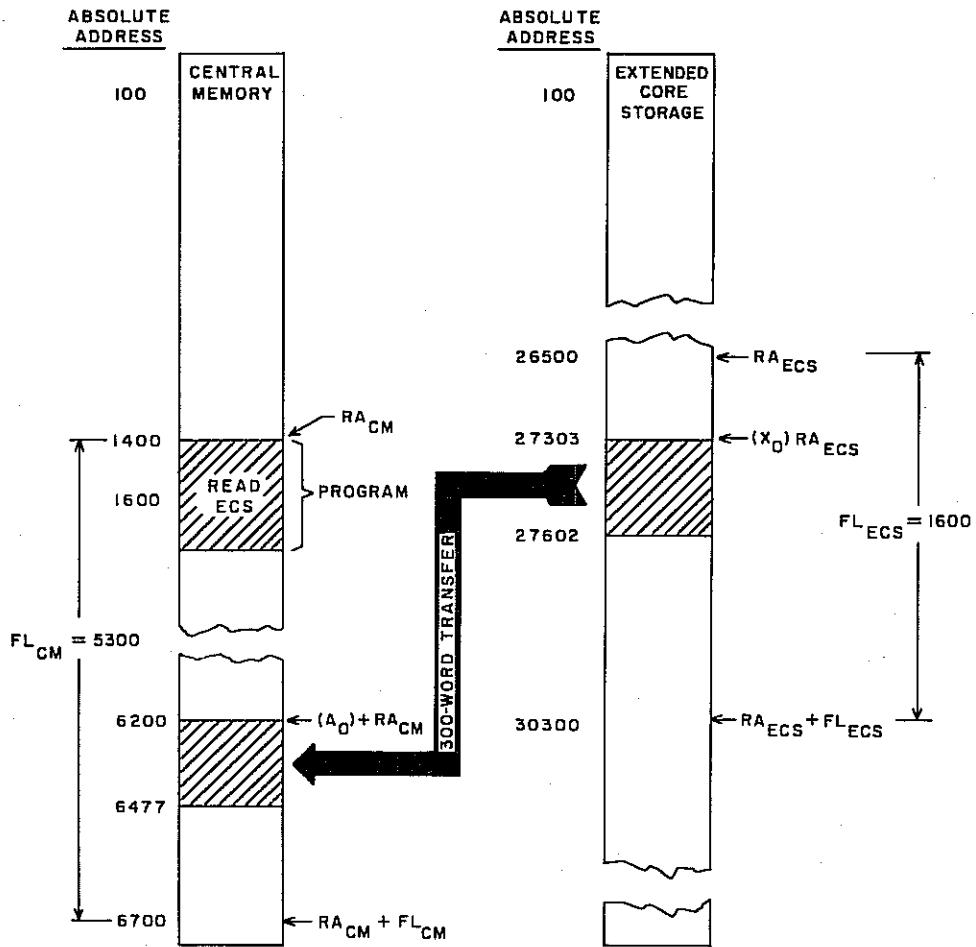

Figure 3-5. Memory Map (Read ECS Example)

Address Range Faults: Four address range fault conditions can arise when executing the Extended Core Storage Communication instructions:

- Word count fault
- Central Memory address out of range
- Extended Core Storage address out of range
- Last 60-bit word (word 7) in  $FL_{ECS}$  is referenced

a) Word Count

If, in forming the word count  $[(B_j) + K]$ , the result is negative, an address range fault occurs. If the Address Out of Range bit is set in the Exit Mode register, an error stop occurs; if this bit is clear, the Central Processor passes to the next instruction word at  $(P)+1$  with no data transfer.

b) Central Memory Address

Central Memory address out of range is checked by comparing  $FL_{CM}$  with the sum  $[(A_0) + (B_j) + K]$ .  $FL_{CM}$  must be greater than this sum or an address range fault occurs. If the Address Out of Range bit is set in the Exit Mode register, an error stop occurs; if this bit is clear, the Central Processor passes to the next instruction word at  $(P)+1$  with no data transfer.

c) Extended Core Storage Address

Extended Core Storage address out of range is checked by comparing  $FL_{ECS}$  with the sum  $[(X_0) + (B_j) + K]$ . In the comparison,  $FL_{ECS}$  is a 24-bit quantity with 36 upper-order bits of sign extended;  $X_0$  holds the 24-bit address quantity with 36 zeros occupying the upper-order bit positions. The result of this subtraction should always be negative; if positive, an address range fault occurs. If the Address Out of Range bit is set in the Exit Mode register, an error stop occurs; if this bit is clear, the Central Processor passes to the next instruction word at  $(P)+1$  with no data transfer.

d) Word 7 reference in  $FL_{ECS}$

If, after formation of the ECS address, the address format specifies a reference to word 7 in relative address  $FL_{ECS}$ , an address range fault occurs. If the Address Out of Range bit is set in the Exit Mode register, an error stop occurs; if this bit is clear, the Central Processor passes to the next instruction word at  $(P) + 1$  with no data transfer.

Note that address range checks are made on the entire block of both Extended Core Storage and Central Memory addresses before the transfer (Read or Write) is begun. If any address in the block to be transferred is out of range, either in Central Memory or Extended Core Storage, no data is transferred, regardless of whether or not the Address Out of Range bit is set in the Exit Mode register.

Error Action: An error exit is an exit to the lower-order 30 bits of the instruction word containing the ECS Read or Write instruction. These 30 bits should always hold a jump to an error routine.

Three error conditions cause an error exit:

- 1) Parity error(s) when reading ECS. If a parity error is detected, the entire block of data is transferred before the exit is taken.
- 2) The ECS bank from/to which data is to be transferred is not available because the bank is in Maintenance mode, or the bank has lost power. If either of these conditions exists on an attempted Read or Write, an immediate error exit is taken.
- 3) An attempt to reference a nonexistent address. On an attempted Write operation, no data transfer occurs and an immediate error exit is taken. If the attempted operation is a Read, and addresses are in range, zeros are transferred to Central Memory. This is a convenient high-speed method of clearing blocks of Central Memory.

Exchange Jump During ECS Communication: If an Exchange Jump occurs while an Extended Core Storage transfer is in progress, the exchange waits until completion of a record. Action is then as follows:

- a) If the record just completed is the last record of the block transfer, and the transfer was error-free, the Central Processor exits to (P)+1. The Exchange Jump then takes place.
- b) If the record just completed is the last record of the block transfer, and an error condition exists, the Central Processor exits to the lower instruction, executes it, and the Exchange Jump is performed.
- c) If the record just completed does not complete the block transfer, the Exchange Jump occurs, and (P) are stored in the Exchange Jump package. A return Exchange Jump to this program begins execution with the ECS Read or Write instruction and restarts the transfer. Note the transfer does not resume at the point it was truncated; rather, the entire transfer must be repeated.

The first part of the document discusses the importance of maintaining accurate records of all transactions. It emphasizes that every entry should be supported by a valid receipt or invoice. This ensures transparency and allows for easy verification of the data. The second part covers the process of reconciling bank statements with the company's ledger. It highlights the need to identify and explain any discrepancies between the two records. The third part addresses the handling of cash transactions, including the use of petty cash funds and the proper documentation of cash receipts and payments. The final part of the document provides a summary of the key points and offers some practical tips for ensuring the accuracy and integrity of the accounting records.

In conclusion, the document stresses that a robust accounting system is essential for the success of any business. It provides a clear framework for how to manage financial records effectively. By following the guidelines outlined in this document, businesses can ensure that their financial data is accurate, reliable, and easy to understand. This not only helps in making informed decisions but also in maintaining compliance with relevant regulations. The document is intended to serve as a valuable resource for anyone responsible for the financial health of an organization.

# 4. PERIPHERAL AND CONTROL PROCESSORS.

## ORGANIZATION

The Peripheral and Control Processors are identical and operate independently and simultaneously as stored-program computers. Thus up to ten programs may be running at one time. A combination of processors can be involved in one problem, the solution of which may require a variety of I/O tasks plus use of Central Memory and Central Processor(s). Figure 4-1 shows data flow between I/O devices, the processors, and Central Memory.

The Peripheral and Control Processors act as system control computers and I/O processors. This permits the Central Processor to continue high-speed computations while the Peripheral and Control Processors do the slower I/O and supervisory operations.

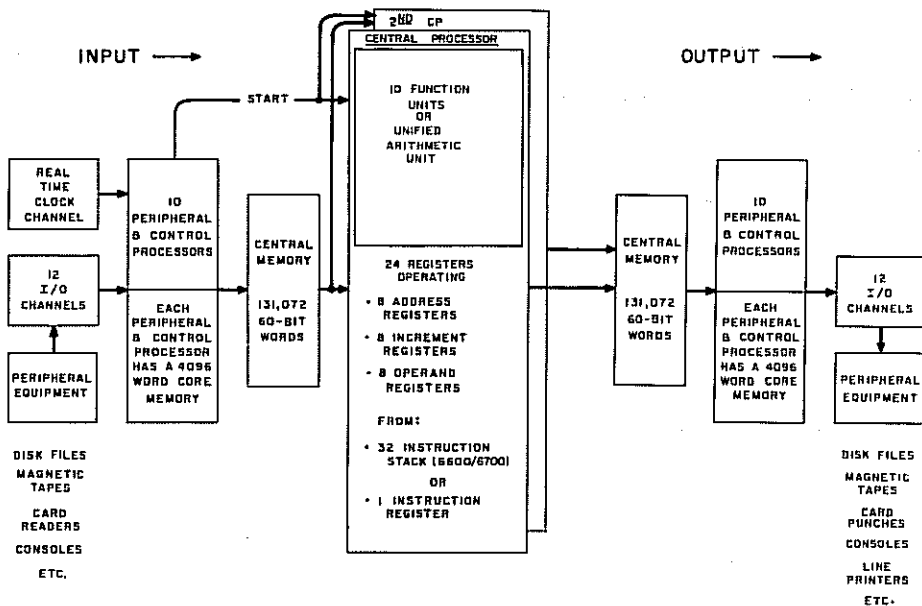

Figure 4-1. Flow Chart: 6000 Systems

Each processor has a 12-bit, 4096 word random-access memory (not a part of Central Memory) with a cycle time of 1000 ns (major cycle). Execution time of processor instructions is based on memory cycle time. A minor cycle is 1/10 of a major cycle and is another basic time interval.

All processors communicate with external equipment and each other on 12 independent, bidirectional I/O channels. All channels are 12-bit (plus control) and each may be connected to one or more external devices. Only one external equipment can communicate on one channel at one time, but all 12 channels can be active at one time. Data is transferred into or out of the system in 12-bit words; each channel has a single register which holds the data word being transferred in or out. Each channel operates at a maximum rate of one word per major cycle.

Data flows between a processor memory and the external device in blocks of words (a block may be as small as one word). A single word may be transferred between an external device and the A register of a processor.

The I/O instructions direct all activity with external equipment. These instructions determine the status of and select an equipment on any channel and transfer data to or from the selected device. Two channel conditions are made available to all processors as an aid to orderly use of channels.

- Each channel has an active/inactive flag to signal that it has been selected for use and is busy with an external device.
- Each channel has a full/empty flag to signal that a word (function or data) is available in the register associated with the channel.

Either state of both flags can be sensed. In general, an I/O operation involves the following steps:

- 1) Determine channel inactive
- 2) Determine equipment ready
- 3) Select equipment
- 4) Activate channel
- 5) Input/Output data
- 6) Disconnect channel

One processor may communicate with another over a channel which is selected as output by one and input by the other. A common channel can be reserved for inter-processor communication and order preserved by determining equipment and channel status.

A real-time clock reading is available on a channel which is separate from the twelve I/O channels. The clock period is 4096 major cycles. The clock starts with power on and runs continuously and cannot be preset or altered. The clock may be used to determine program running time or other functions such as time-of-day, as required.

Each processor exchanges data with Central Memory in blocks of  $n$  words. Five successive 12-bit processor words are assembled into a 60-bit word and sent to Central Memory. Conversely, a 60-bit Central Memory word is disassembled into five 12-bit words and sent to successive locations in a processor memory. Separate assembly (write) and disassembly (read) paths to Central Memory are shared by all ten processors. Up to four processors may be writing in Central Memory while another four are simultaneously reading from Central Memory.

The processors generally do not solve complex arithmetic and logical problems; usually they perform I/O operations for running Central Processor programs and organize problem data (operands, addresses, constants, length of program, relative starting address, exit mode), and store it in Central Memory. Then, an Exchange Jump instruction starts (or interrupts) the Central Processor and provides it with the starting address of a problem on file in Central Memory. At the next convenient breakpoint, the Central Processor exchanges the contents of its A, B, and X registers, program address, relative starting address, length of program, Exit mode and Extended Core Storage parameters with the same information for the new program. A later Exchange Jump may return to complete the interrupted program.

Programs for the ten processors are written in the conventional manner and are executed in a multiplexing arrangement which uses the principle of time-sharing. Thus, the ten programs operate from separate memories, but all share a common facility for add/subtract, I/O, data transfer to/from Central Memory, and other necessary instruction control facilities. The multiplex consists of a 10-position barrel, which stores information (in parallel) about the current instruction in each of 10 programs, and a common instruction control device, or slot (Figure 4-2). The 10 program steps move

around the barrel in series, and each step is presented in turn to the slot. A portion of or all of the instruction steps are performed in one pass through the slot, and the altered instruction (or next instruction in a program) is reentered in the barrel for the next excursion. One or more trips around the barrel complete execution of an instruction. Thus, up to 10 programs are in operation at one time, and each program is acted upon once every 1000 ns.

One cycle of the multiplex is 1000 ns, with 900 ns consumed in the barrel and 100 ns (minor cycle) in the slot. Instructions in the barrel are interpreted at critical time intervals so that information is available in the slot at the time the instruction is ready to enter the slot. Hence, a reference to memory for data is determined ahead of time so that the data word is available in the slot when the instruction arrives. Similarly, instructions are interpreted before they reach the slot so that control paths in the slot are established when the instruction arrives.

The slot contains two adders as part of the instruction control. One adder is 12 bits, and the other is 18 bits. Both adders treat all quantities as one's complement.

For I/O instructions or communication with Central Memory, one pass through the slot transfers one 12-bit word to or from a peripheral memory. Thus, block transfer of data requires a number of trips around the barrel.

The barrel network holds four quantities which pertain to the current instruction in each of the programs. The quantities are held in registers which require a total of 51 bits. (The barrel can be considered as a 51 x 10 shifting matrix which is closed by the slot.) The barrel registers are referred to implicitly in the instruction steps and are discussed under Registers, page 4-8.



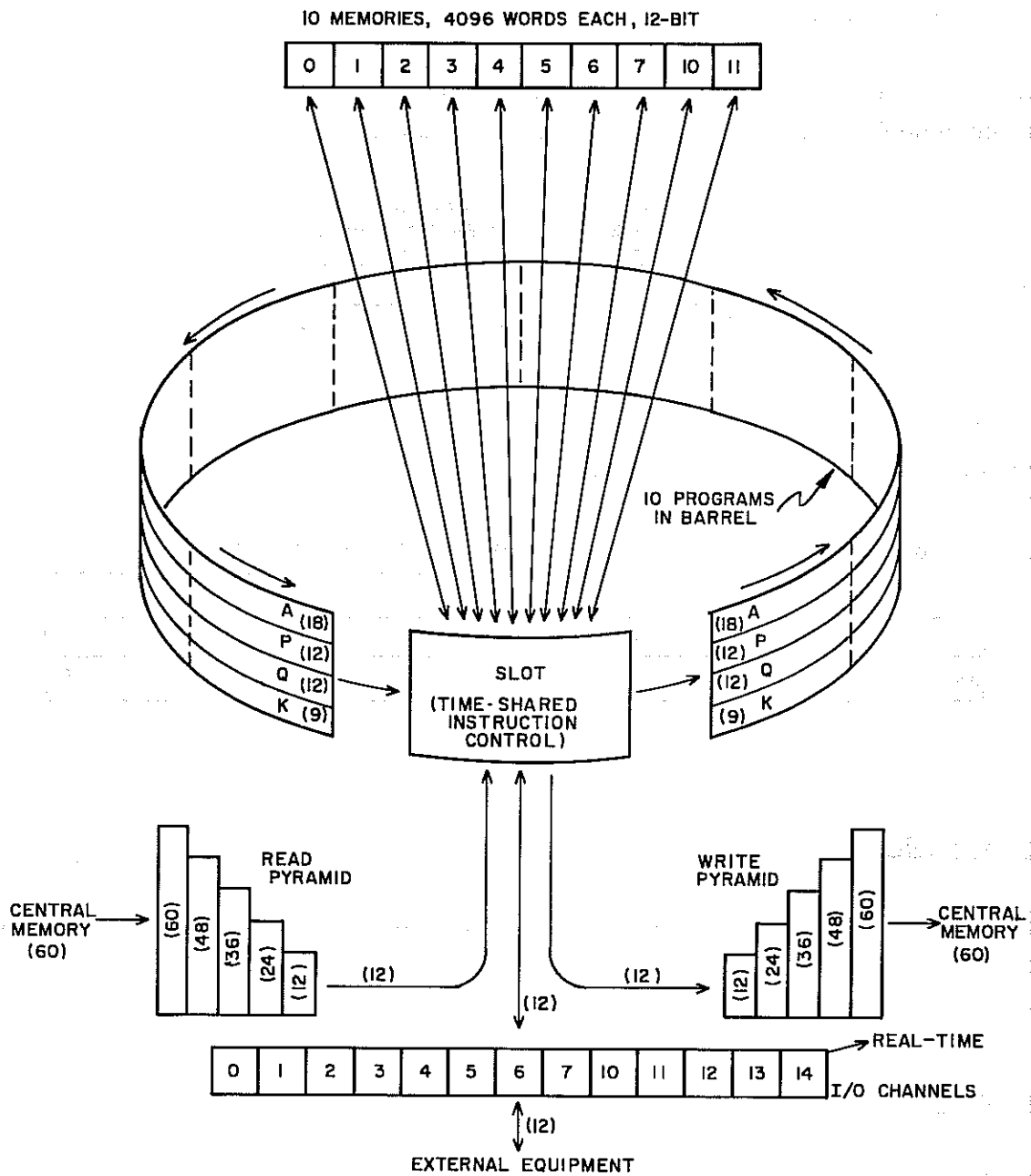
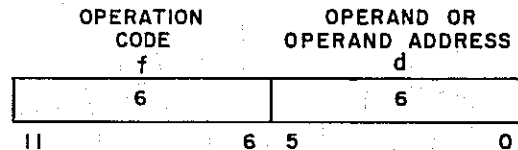

Figure 4-2. Peripheral and Control Processors

## PERIPHERAL PROCESSOR PROGRAMMING

### Instruction Formats

An instruction may have a 12-bit or a 24-bit format. The 12-bit format has a 6-bit operation code  $f$  and a 6-bit operand or operand address  $d$ .



The 24-bit format uses the 12-bit quantity  $m$ , which is the contents of the next program address ( $P + 1$ ), with  $d$  to form an 18-bit operand or operand address.

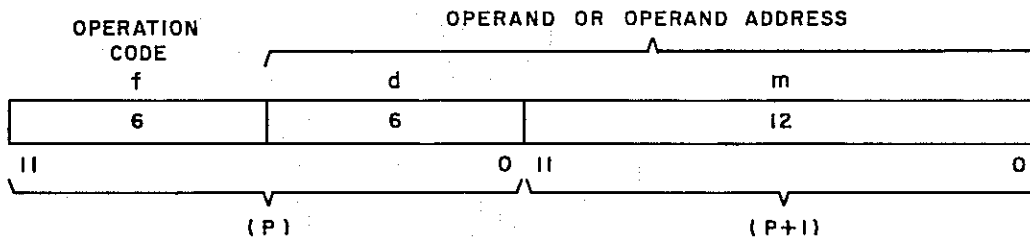

### Address Modes

Program indexing is accomplished and operands manipulated in several modes. The two instruction formats provide for 6-bit or 18-bit operands and 6-bit, 12-bit or 18-bit addresses.

#### No Address

In this mode  $d$  or  $dm$  is taken directly as an operand. This mode eliminates the need for storing many constants in storage. The  $d$  quantity is considered as a 12-bit number the upper six bits of which are zero. The  $dm$  quantity has  $d$  as the upper six bits and  $m$  as the lower 12 bits.

### Direct Address

In this mode,  $d$  or  $m + (d)$  is used as the address of the operand. The  $d$  quantity specifies one of the first 64 addresses in memory ( $0000-0077_g$ ). The  $m + (d)$  quantity generates a 12-bit address for referencing all possible peripheral memory locations ( $0000-7777_g$ ). (Note that the addition of  $m + (d)$  is on 12 bits. Overflow is not recognized although end-around carry does occur.) If  $d \neq 0$ , the content of address  $d$  is added to  $m$  to produce an operand address (indexed addressing). If  $d = 0$ ,  $m$  is taken as the operand address, (if  $m = 7777_g$ , the address is 0). Address  $7777_g$  is only accessible if  $(d) = 7777_g$  and  $m = 7777_g$ .

#### EXAMPLE: Address Modes

Given :  $d = 25$   
 $m = 100$   
contents of location  $25 = 0150$   
contents of location  $150 = 7776$   
contents of location  $250 = 1234$

Then :

MODE	INSTRUCTION	A REGISTER
No Address	LDN $d$	000025
	LDC $dm$	250100
Direct Address	LDD $(d)$	000150
	LDM $(m + (d))$	001234
Indirect Address	LDI $((d))$	007776

### Indirect Address

In this mode,  $d$  specifies an address the content of which is the address of the desired operand. Thus,  $d$  specifies the operand address indirectly. Indirect addressing and indexed addressing require an additional memory reference over direct addressing. Address  $7777_g$  is only accessible if  $((d)) = 7777_g$  and  $m = 7777_g$ . The Description of Instructions section, page 4-9, uses the expression  $(d)$  to define the contents of memory location  $d$ . An expression with double parentheses  $((d))$  refers to indirect addressing. The expression  $(m + (d))$  refers to direct addressing when  $d = 0$  and to indexed direct addressing when  $d \neq 0$ . Table 4-1 summarizes the addressing modes used for the various Peripheral and Control Processor instructions.

TABLE 4-1. ADDRESSING MODES FOR PERIPHERAL AND CONTROL PROCESSOR INSTRUCTIONS

INSTRUCTION TYPE	ADDRESSING MODE		
	DIRECT	INDIRECT	NO ADDRESS
Load	30, 50	40	14, 20
Add	31, 51	41	16, 21
Subtract	32, 52	42	17
Logical Difference	33, 53	43	11, 23
Store	34, 54	44	
Replace Add	35, 55	45	
Replace Add One	36, 56	46	
Replace Subtract One	37, 57	47	
Long Jump	01		
Return Jump	02		
Unconditional Jump			03
Zero Jump			04
Non-Zero Jump			05
Positive Jump			06
Minus Jump			07
Shift			10
Logical Product			12, 22
Selective Clear			13
Load Complement			15

## REGISTERS

The four registers in the barrel are A, P, Q, and K. Each plays an important part in the execution of processor instructions.

### A Register (18 bits)

The Arithmetic or A register is an adder. Quantities are treated as positive and over flows are not recognized, although an end-around carry does occur. No sign extension is provided for 6-bit or 12-bit quantities which are entered in the low order bits. However, the unused high-order bits are cleared to

zero. Zero is represented by all zeros. The A register holds an 18-bit Central Memory address during several instructions. The A adder is used to execute add, subtract, selective clear, logical product, and logical difference instructions. Parts of the A adder are also used to enter a word into the shift network and gate the result back to the barrel. The quantity of A in the barrel is always complemented when it enters the slot. When no operation on A is called for, (A) is complemented, enters the A adder, is added to zero, and the result is recomplemented at the output. The Add gate is always enabled except when Selective Clear, Logical Product, or Shift gates are enabled (see Figure 4-3).

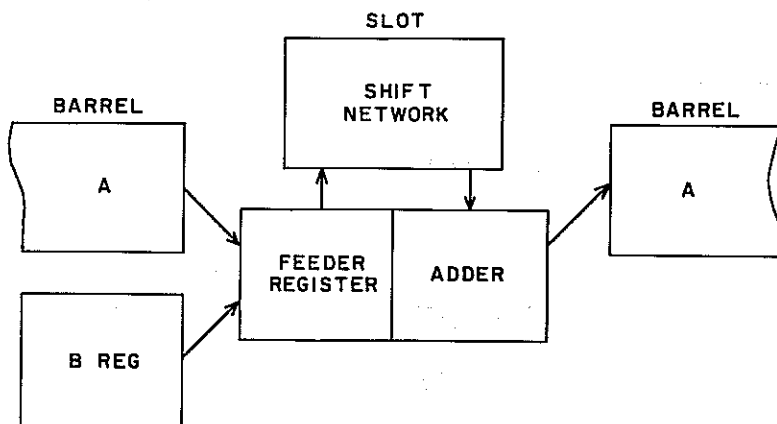

Figure 4-3. Slot Block Diagram.

**Add:**

For an add instruction, (A) is complemented and entered into the A input register. The second operand is also complemented and entered into the B input register. The two quantities in the input registers, taken as positive, are added and the sum is recomplemented as it is gated out of the adder to the barrel.

**Subtract:**

For subtract instructions, the minuend, (A) is complemented as it enters the adder. The subtrahend is entered into B without being complemented and the two quantities are added as in an add instruction.

**Selective Clear:**

For selective clear, the complement of A and the true value of d are entered into the adder and both the selective and the logical product gates are enabled.

**Logical Product:**

For logical product instructions, both A and d (or dm) are complemented before entering the adder and both the logical product and the selective gates are enabled.

**Logical Difference:**

For logical difference instructions, the complement of A and the true value of the second operand enter the adder and only the selective gate is enabled.

GENERATE	SATISFY	
1	0	1+0
1	0	0+1
<u>GENERATE</u>	<u>SATISFY</u>	<u>ENABLE</u>
<u>SATISFY = GENERATE OR ENABLE</u>		

**P Register (12 bits)**

The Program Address register or P register holds the address of the current instruction. At the beginning of each instruction, the contents of P are advanced by one to provide the address of the next instruction in the program. If a jump is called for, the jump address is entered in P.

**Q Register (12 bits)**

The Q register holds the lower six bits of a 12-bit instruction word, or, when the six bits specify an address, Q holds the 12-bit word which is read from that address. Q is an adder which may add +1 or -1 to its content.

### K Register (9 bits)

The K register holds the upper six bits (operation code) of an instruction and a 3-bit trip count designator. The trip count is a sequencing scheme to lend control to the sequential execution of an instruction.

There are other registers which provide indirect or transient control during execution of instructions. These include registers associated with the I/O channels, the registers in the read and write pyramids which assemble successive 12-bit words into 60-bit words or vice versa, and registers which hold the storage address and the word at that address for each peripheral memory.

## **Description of Peripheral Processor Instructions**

This section describes the Peripheral and Control Processor instructions. Table 4-2 lists designators used throughout the section.

TABLE 4-2. PERIPHERAL AND CONTROL PROCESSOR INSTRUCTION DESIGNATORS

Designator	Use
A	The A register.
d	A 6-bit operand or operand address.
f	A 6-bit instruction code.
m	A 12-bit quantity used with d to form an 18-bit operand or operand address.
P	The Program Address register.
Q	The Q register.
( )	Contents of a register or location
( ( ) )	Refers to indirect addressing.

Preceding the description of each instruction is the octal code, mnemonic code and address field, the instruction name and instruction length. Mnemonic codes and address field mnemonics are from COMPASS, a Peripheral and Control Processor Assembly language.

EXAMPLE:

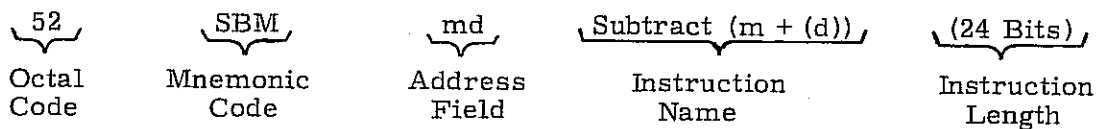

Instruction formats are also given; hashed lines within a format indicate these bits are not used in the operation.

No Operation

00	PSN	Pass	(12 Bits)
24	PSN	Pass	(12 Bits)
25	PSN	Pass	(12 Bits)

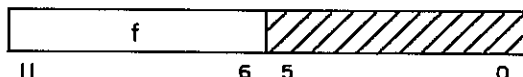

These instructions specify that no operation be performed. They provide a means of padding out a program.



Data Transmission

**14**      ***LDN***      *d*      ***Load d***      **(12 Bits)**

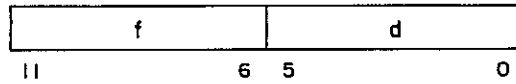

This instruction clears the A register and loads d. The upper 12 bits of A are zero.

**15**      ***LCN***      *d*      ***Load Complement d***      **(12 Bits)**

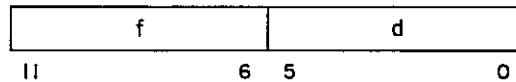

This instruction clears the A register and loads the complement of d. The upper 12 bits of A are set to one.

**30**      ***LDD***      *d*      ***Load (d)***      **(12 Bits)**

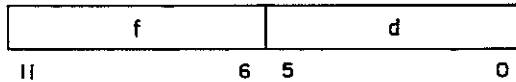

This instruction clears the A register and loads the contents of location d. The upper six bits of A are zero.

**34**      ***STD***      *d*      ***Store (d)***      **(12 Bits)**

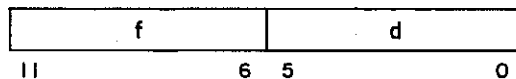

This instruction stores the lower 12 bits of A in location d.

40      *LDI*      *d*      *Load ((d))*      (12 Bits)

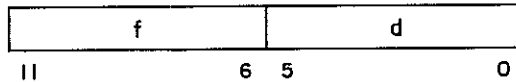

This instruction clears the A register and loads a 12-bit quantity that is obtained by indirect addressing. The upper six bits of A are zero. Location d is read out of memory, and the word obtained is used as the operand address.

44      *STI*      *d*      *Store ((d))*      (12 Bits)

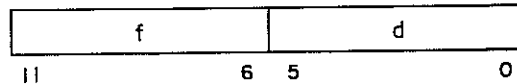

This instruction stores the lower 12 bits of A in the location specified by the contents of location d.

20      *LDC*      *dm*      *Load dm*      (24 Bits)

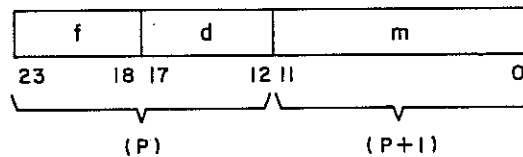

This instruction clears the A register and loads an 18-bit quantity consisting of d as the higher six bits and m as the lower 12 bits. The contents of the location following the present program address are read out to provide m.

50

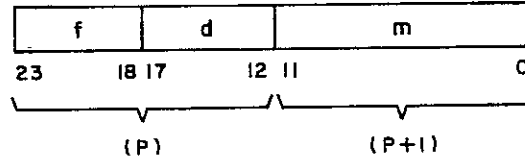
**LDM***m d***Load ( $m + (d)$ )****(24 Bits)**

This instruction clears the A register and loads a 12-bit quantity. The upper six bits of A are zero. The 12-bit operand is obtained by indexed direct addressing. The quantity "m", read out of memory location  $P + 1$  serves as the base operand address to which (d) is added. If  $d = 0$ , the operand address is simply m, but if  $d \neq 0$ , then  $m + (d)$  is the operand address. Thus location d may be used for an index quantity to modify operand addresses.

54

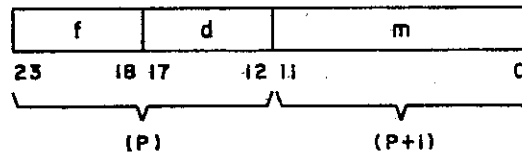
**STM***m d***Store ( $m + (d)$ )****(24 Bits)**

This instruction stores the lower 12 bits of A in the location determined by indexed addressing (see instruction 50).

### Arithmetic

16

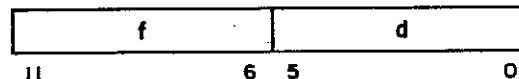
**ADN***d***Add d****(12 Bits)**

This instruction adds d (treated as a 6-bit positive quantity) to the content of the A register.

17      **SBN**      *d*      **Subtract *d***      (12 Bits)

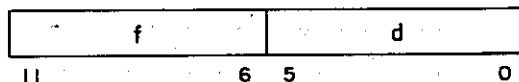

This instruction subtracts *d* (treated as a 6-bit positive quantity) from the content of the A register.

31      **ADD**      *d*      **Add(*d*)**      (12 Bits)



This instruction adds to the A register the contents of location *d* (treated as a 12-bit positive quantity).

32      **SBD**      *d*      **Subtract(*d*)**      (12 Bits)

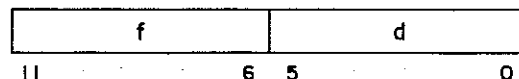

This instruction subtracts from the A register the contents of location *d* (treated as a 12-bit positive quantity).

41      **ADI**      *d*      **Add(*(d)*)**      (12 Bits)

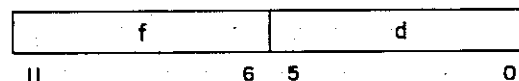

This instruction adds to the content of A a 12-bit operand (treated as a positive quantity) obtained by indirect addressing. Location *d* is read out of memory, and the word obtained is used as the operand address.

42

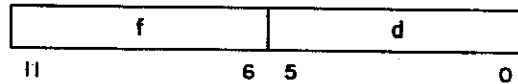
**SBI***d***Subtract ((d))****(12 Bits)**

This instruction subtracts from the A register a 12-bit operand (treated as a positive quantity) obtained by indirect addressing. Location *d* is read out of memory, and the word obtained is used as the operand address.

21

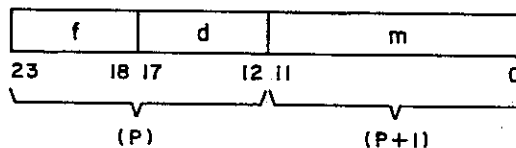
**ADC***dm***Add dm****(24 Bits)**

This instruction adds to the A register the 18-bit quantity consisting of *d* as the higher six bits and *m* as the lower 12 bits. The contents of the location following the present program address are read out to provide *m*.

51

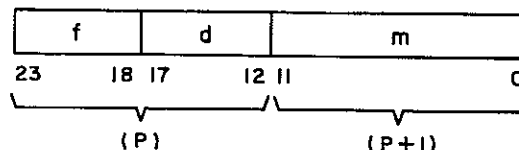
**ADM***m d***Add (m + (d))****(24 Bits)**

This instruction adds to the content of A a 12-bit operand (treated as a positive quantity) obtained by indexed direct addressing (see instruction 50).

52

**SBM**

*m d*

**Subtract (*m + (d)*)**

**(24 Bits)**

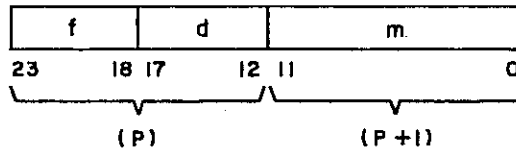

This instruction subtracts from the A register a 12-bit operand (treated as a positive quantity) obtained by indexed direct addressing (see instruction 50).

**Shift**

10

**SHN**

*d*

**Shift *d***

**(12 Bits)**

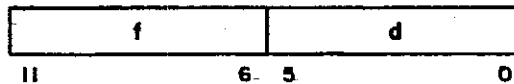

This instruction shifts the contents of A right or left *d* places. If *d* is positive (00-37) the shift is left circular; if *d* is negative (40-77) A is shifted right (end off with no sign extension). Thus, *d* = 06 requires a left shift of six places. A right shift of six places results when *d* = 71.

**Logical**

11

**LMN**

*d*

**Logical difference *d***

**(12 Bits)**

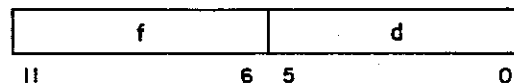

This instruction forms in A the bit-by-bit logical difference of *d* and the lower six bits of A. This is equivalent to complementing individual bits of A that correspond to bits of *d* that are one. The upper 12 bits of A are not altered.

12      *LPN*      *d*      *Logical product d*      (12 Bits)

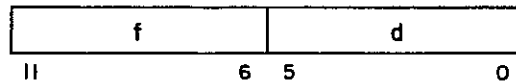

This instruction forms the bit-by-bit logical product of *d* and the lower six bits of the A register, and leaves this quantity in the lower 6 bits of A. The upper 12 bits of A are zero.

13      *SCN*      *d*      *Selective clear d*      (12 Bits)

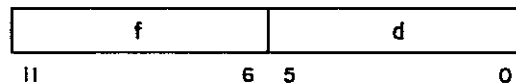

This instruction clears any of the lower six bits of the A register where there are corresponding bits of *d* that are one. The upper 12 bits of A are not altered.

33      *LMD*      *d*      *Logical difference (d)*      (12 Bits)

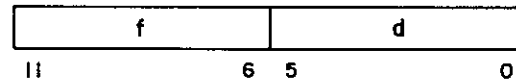

This instruction forms in A the bit-by-bit logical difference of the lower 12 bits of A and the contents of location *d*. This is equivalent to complementing individual bits of A which correspond to bits of (*d*) that are one. The upper six bits of A are not altered.

43      *LMI*      *d*      *Logical difference ((d))*      (12 Bits)



This instruction forms in A the bit-by-bit logical difference of the lower 12 bits of A and the 12-bit operand obtained by indirect addressing. Location d is read out of memory, and the word obtained is used as the operand address. The upper six bits of A are not altered.

22      *LPC*      *dm*      *Logical product dm*      (24 Bits)

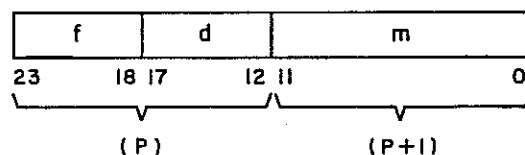

This instruction forms in the A register the bit-by-bit logical product of the contents of A and the 18-bit quantity dm. The upper six bits of this quantity consist of d and the lower 12 bits are the content of the location following the present program address.

23      *LMC*      *dm*      *Logical difference dm*      (24 Bits)

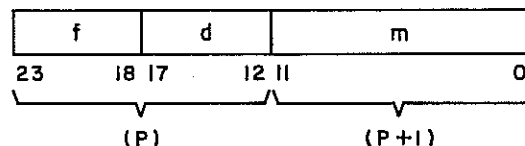

This instruction forms in A the bit-by-bit logical difference of the contents of A and the 18-bit quantity dm. This is equivalent to complementing individual bits of A which correspond to bits of dm that are one. The upper six bits of the quantity consist of d, and the lower 12 bits are the content of the location following the present program address.

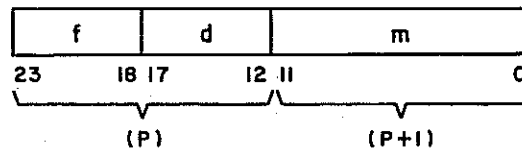

53

*LMM**m d**Logical difference (m + (d))**(24 Bits)*

This instruction forms in A the bit-by-bit logical difference of the lower 12-bits of A and a 12-bit operand obtained by indexed direct addressing. The upper six bits of A are not altered.

Replace

35

*RAD**d**Replace add (d)**(12 Bits)*

This instruction adds the quantity in location d to the contents of A and stores the lower 12 bits of the result at location d. The resultant sum is left in A at the end of the operation and the original contents of A are destroyed.

36

*AOD**d**Replace add one (d)**(12 Bits)*

The quantity in location d is replaced by its original value plus one. The resultant sum is left in A at the end of the operation, and the original contents of A are destroyed.

37      *SOD*      *d*      *Replace subtract one (d)*      (12 Bits)

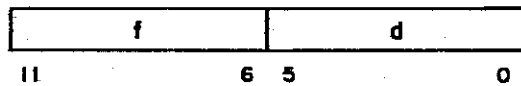

The quantity in location *d* is replaced by its original value minus one. The resultant difference is left in *A* at the end of the operation, and the original contents of *A* are destroyed.

45      *RAI*      *d*      *Replace add ((d))*      (12 Bits)

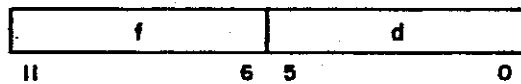

The operand which is obtained from the location specified by the contents of location *d*, is added to the contents of *A*, and the lower 12 bits of the sum replace the original operand. The resultant sum is also left in *A* at the end of the operation.

46      *AOI*      *d*      *Replace add one ((d))*      (12 Bits)



The operand, which is obtained from the location specified by the contents of location *d*, is replaced by its original value plus one. The resultant sum is also left in *A* at the end of the operation, and the original contents of *A* are destroyed.

47

SOI

*d**Replace subtract one ((d))*

(12 Bits)

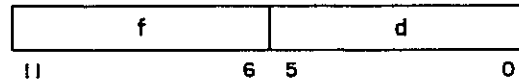

The operand, which is obtained from the location specified by the contents of location *d*, is replaced by its original value minus one. The resultant difference is also left in A at the end of the operation, and the original contents of A are destroyed.

55

RAM

*m d**Replace add (m + (d))*

(24 Bits)

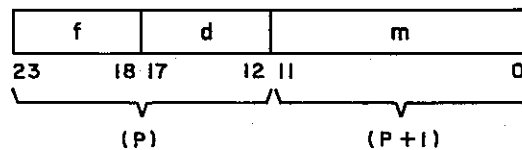

The operand, which is obtained from the location determined by indexed direct addressing, is added to the contents of A, and the lower 12 bits of the sum replace the original operand in memory. The resultant sum is also left in A at the end of the operation, and the original contents of A are destroyed.

56

AOM

*m d**Replace add one (m + (d))*

(24 Bits)

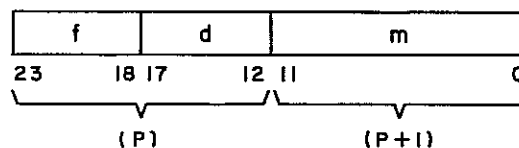

The operand, which is obtained from the location determined by indexed direct addressing, is replaced by its original value plus one (see instruction 50, page 4-13 for explanation of addressing). The resultant sum is also left in A at the end of the operation, and the original contents of A are destroyed.

57      **SOM**      *m d*      *Replace subtract one (m + (d))*      (24 Bits)

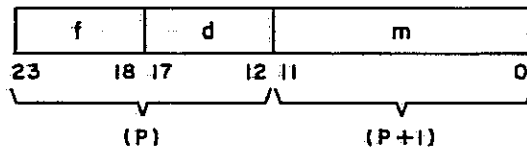

The operand, which is obtained from the location determined by indexed direct addressing, is replaced by its original value minus one (see instruction 50, page 4-13 for explanation of addressing). The resultant difference is also left in A at the end of the operation, and the original contents of A are destroyed.

**Branch**

03      **UJN**      *d*      *Unconditional jump d*      (12 Bits)

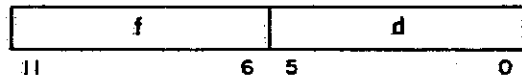

This instruction provides an unconditional jump to any instruction up to 31 steps forward or backward from the current program address. The value of d is added to the current program address. If d is positive (01 - 37), then 0001 (+1) - 0037 (+31) is added and the jump is forward. If d is negative (40 - 76) then 7740 (-31) - 7776 (-1) is added and the jump is backward. The program stops (a Dead Start is necessary to restart the machine) when d = 00 or 77.

04      **ZJN**      *d*      *Zero jump d*      (12 Bits)

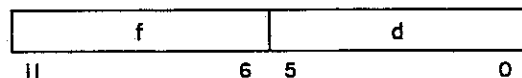

This instruction provides a conditional jump to any instruction up to 31 steps forward or backward from the current program address. If the content of the A register is zero, the jump is taken. If the content of A is non-zero, the next instruction is executed. Negative zero (777777) is treated as non-zero. For interpretation of d see instruction 03.

**05**      **NJN**      *d*      **Nonzero jump *d***      **(12 Bits)**

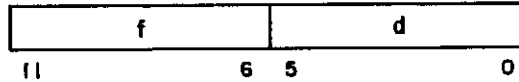

This instruction provides a conditional jump to any instruction up to 31 steps forward or backward from the current program address. If the content of the A register is nonzero, the jump is taken. If A is zero, the next instruction is executed. Negative zero (777777) is treated as nonzero. For interpretation of *d* see instruction 03.

**06**      **PJN**      *d*      **Plus jump *d***      **(12 Bits)**



This instruction provides a conditional jump to any instruction up to 31 steps forward or backward from the current program address. If the content of the A register is positive, the jump is taken. If A is negative, the next instruction is executed. Positive zero is treated as a positive quantity; negative zero is treated as a negative quantity. For interpretation of *d* see instruction 03.

**07**      **MJN**      *d*      **Minus jump *d***      **(12 Bits)**

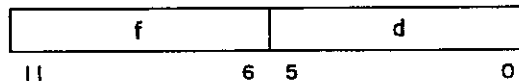

This instruction provides a conditional jump to any instruction up to 31 steps forward or backward from the current program address. If the content of the A register is negative, the jump is taken. If A is positive, the next instruction is executed. Positive zero is treated as a positive quantity; negative zero is treated as a negative quantity. For interpretation of *d* see instruction 03.

01 **LJM** *md* **Long jump to  $m + (d)$**  (24 Bits)

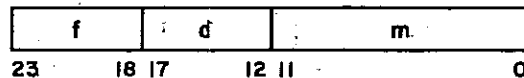

This instruction jumps to the sequence beginning at the address given by  $m + (d)$ . If  $d = 0$ , then  $m$  is not modified.

02 **RJM** *md* **Return jump to  $m + (d)$**  (24 Bits)

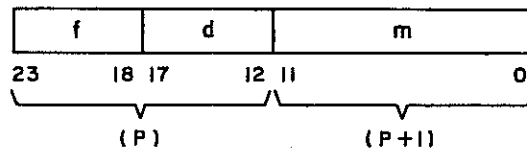

This instruction jumps to the sequence beginning at the address given by  $m + (d)$ . If  $d = 0$  then  $m$  is not modified. The current program address ( $P$ ) plus two is stored at the jump address. The new program commences at the jump address plus one. This program should end with a long jump to, or normal sequencing into, the jump address minus one, which should in turn contain a long jump, 0100. The latter returns the original program address plus two to the  $P$  register.

### Central Processor and Central Memory

260 **EXN** **Exchange jump** (12 Bits)

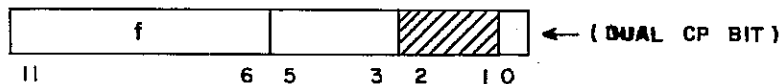

This instruction transmits an 18-bit (absolute) address (only 17 bits are used) from the  $A$  register to the Central Processor with a signal which tells the Central Processor to perform an Exchange Jump, with the address in  $A$  as the starting location of a file of 16 words containing information about the Central Processor program to be executed. The 18-bit initial address must be entered in  $A$  before this instruction is executed. The Central Processor replaces the file with similar information from the interrupted Central Processor program. The Peripheral Processor is not interrupted.

In systems with dual Central Processors, the lowest order bit of the instruction format specifies which Central Processor the Exchange Jump will interrupt. In other 6000 systems, this bit is not interpreted.

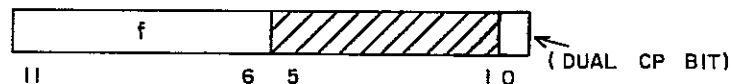

This instruction transfers the content of the Central Processor Program Address register, P, to the Peripheral Processor A register; this allows the Peripheral Processor to determine whether the Central Processor is running. In a system with dual Central Processors, the lowest order bit of the instruction format specifies which Central Processor P register is to be examined. In other 6000 systems, this bit is not interpreted. The largest value that (P) may be is 17 bits. The remaining bit (bit 17) will appear set to this instruction when an ECS transfer is in progress. However, bit 17 is not set in P.

60

CRD

*d*Central read from (A) to *d*

(12 Bits)

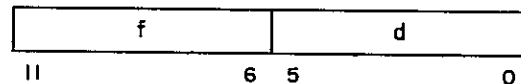

This instruction transfers a 60-bit word from Central Memory to five consecutive locations in the processor memory. The 18-bit address of the Central Memory location must be loaded into A prior to executing this instruction. (Note that this is an absolute address.) The 60-bit word is disassembled into five 12-bit words beginning at the left. Location *d* receives the first 12-bit word. The remaining 12-bit words go to succeeding locations. This instruction will not interrupt an ECS transfer unless bit 17 of the A register is set (Access priority) or Constant Mode is switch selected on the deadstart panel.

61

CRM

*m d*Central read (*d*) words from (A) to *m*

(24 Bits)

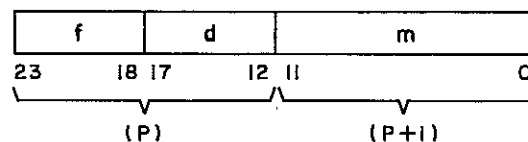

This instruction reads a block of 60-bit words from Central Memory. The content of location *d* gives the block length. The 18-bit address of the first central word must be loaded into A prior to executing this instruction. (Note that this is an absolute address.) During the execution of the instruction, (P) goes to processor address 0 and P holds *m*. Also, (*d*) goes to the Q register where it is reduced by one as each central word is processed. The original content of P is restored at the end of the instruction.

Each central word is disassembled into five 12-bit words beginning with the high-order 12 bits. The first word is stored at processor memory location  $m$ . The content of  $P$  (which is holding  $m$ ) is advanced by one to provide the next address in the processor memory as each 12-bit word is stored. If  $P$  overflows, operation continues as  $P$  is advanced from  $7777_8$  to  $0000_8$ . These locations will be written into as if they were consecutive.

The content of  $A$  is advanced by one to provide the next Central Memory address after each 60-bit word is disassembled and stored. Also, the contents of the  $Q$  register are reduced by one. The block transfer is complete when  $Q = 0$ . The block of Central Memory locations goes from address  $(A)$  to address  $(A) + (d) - 1$ . The block of processor memory locations goes from address  $m$  to  $m + 5(d) - 1$ . This instruction will not interrupt an ECS transfer unless bit 17 of the  $A$  register is set (Access priority) or Constant Mode is switch selected on the deadstart panel.

**62**      **CWD**       $d$       **Central write to (A) from  $d$**       **(12 Bits)**

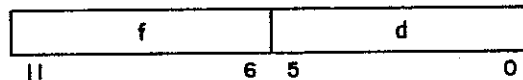

This instruction assembles five successive 12-bit words into a 60-bit word and stores the word in Central Memory. The 18-bit address word designating the Central Memory location must be in  $A$  prior to execution of the instruction. (Note that this is an absolute address.)

Location  $d$  holds the first word to be read out of the processor memory. This word appears as the higher order 12 bits of the 60-bit word to be stored in Central Memory. The remaining words are taken from successive addresses. This instruction will not interrupt an ECS transfer unless bit 17 of the  $A$  register is set (Access priority) or Constant Mode is switch selected on the deadstart panel.



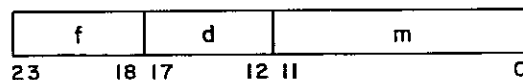

This instruction assembles a block of 60-bit words and writes them in Central Memory. The content of location *d* gives the number of 60-bit words. The content of the A register gives the beginning Central Memory address. (Note that this is an absolute address.) During the execution of this instruction (P) goes to processor address 0 and P holds *m*. Also, (*d*) goes to the Q register, where it is reduced by one as each central word is assembled. The original content of P is restored at the end of the instruction.

The content of P (the *m* portion of the instruction) gives the address of the first word to be read out of the processor memory. This word appears as the higher order 12 bits of the first 60-bit word to be stored in Central Memory.

The content of P is advanced by one to provide the next address in the processor memory as each 12-bit word is read. If P overflows, operation continues as P is advanced from  $7777_8$  to  $0000_8$ . These locations will be read from as if they were consecutive.

The content of A is advanced by one to provide the next Central Memory address after each 60-bit word is assembled. Also, Q is reduced by one. The block transfer is complete when  $Q = 0$ . This instruction will not interrupt an ECS transfer unless bit 17 of the A register is set (Access priority) or Constant Mode is switch selected on the deadstart panel.



## Input/Output

In systems with additional 10 PPU's, the channels are in a remote cabinet, so delays in channel status sensing result. A PPU does not recognize a status change made by any of the four PPU's immediately preceding it in the barrel until the next major cycle (barrel trip). Therefore, for normal I/O, the Monitor PPU must assign only one PPU to a channel or group of channels during a given time period. Two PPU's can be assigned to the same channel for PPU to PPU communication, one for input, the other for output. The PPU's should communicate over a double rank channel ( $24_8$  through  $33_8$ ) to ensure the maximum possible transfer rate.

Note that the channel sensing instructions (64, 65, 66, 67) are valid for a PPU only when that PPU is sensing a channel assigned to it by the Monitor PPU. PPU hang-ups or functioning a channel by more than one PPU at the same time can result when PPU's sense channels not assigned to them.

64      *AJM*      *m d*      *Jump to m if channel d active*      (24 Bits)

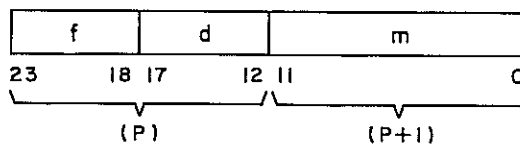

This instruction provides a conditional jump to a new program sequence beginning at an address given by the contents of *m*. The jump is taken if the channel specified by *d* is active. The current program sequence continues if the channel is inactive.

65

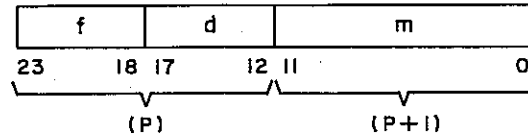
*IJM**m d**Jump to m if channel d inactive**(24 Bits)*

This instruction provides a conditional jump to a new program sequence beginning at an address given by *m*. The jump is taken if the channel specified by *d* is inactive. The current program sequence continues if the channel is active.

66

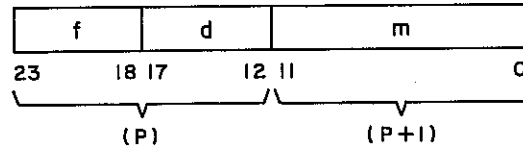
*FJM**m d**Jump to m if channel d full**(24 Bits)*

This instruction provides a conditional jump to a new program sequence beginning at an address given by *m*. The jump is taken if the channel designated by *d* is full. The present program sequence continues if the channel is empty.

An input channel is full when the input equipment has placed a word on the channel and that word has not yet been sampled by a processor. The channel is empty when a word has been accepted. An output channel is full when a processor places a word on the channel. The channel is empty when the output equipment has sampled the word.

67

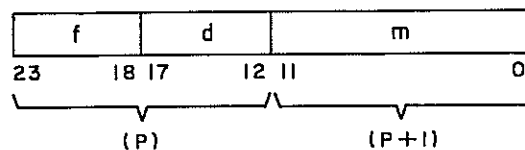
*EJM**m d**Jump to m if channel d empty**(24 Bits)*

This instruction provides a conditional jump to a new program sequence beginning at an address specified by *m*. The jump is taken if the channel specified by *d* is empty. The current program sequence continues if the channel is full. (See instruction 66 for explanation of full and empty.)

70

IAM

*d**Input to A from channel d*

(12 Bits)

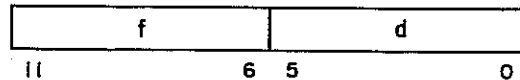

This instruction transfers a word from input channel *d* to the lower 12 bits of the A register. The upper 6 bits of the A register are cleared to zeros.

## NOTE

This instruction will hang up the Peripheral Processor if executed when the channel is inactive unless bit 5 is set. With bit 5 set, an inactive channel will cause an exit.

71

IAM

*m d**Input (A) words to m from channel d*

(24 Bits)

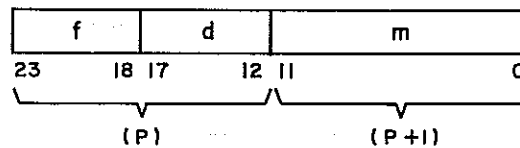

This instruction transfers a block of 12-bit words from input channel *d* to the processor memory. The content of A gives the block length. The first word goes to the processor address specified by *m*. The content of A is reduced by one as each word is read. The input operation is complete when  $A = 0$  or the data channel becomes inactive. If the operation is terminated by the channel becoming inactive, the next location in the processor memory is set to all zeroes. However, the word count is not affected by this empty word. Therefore, the contents of the A register gives the block length minus the number of real data words actually read in.

During this instruction address 0000 temporarily holds P, while *m* is held in the P register. The content of P advances by one to give the address for the next word as each word is stored.

## NOTE

If this instruction is executed when the data channel is inactive, no input operation is accomplished and the program continues at  $P + 2$ . However, the location specified by *m* is set to all zeroes.

72            **OAN**            *d*                    **Output from A on channel d**                    (12 Bits)

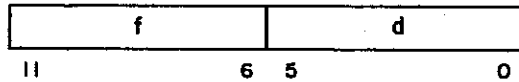

This instruction transfers a word from A (lower 12 bits) to output channel d.

**NOTE**

This instruction will hang up the Peripheral Processor if executed when the channel is inactive unless bit 5 is set. With bit 5 set, an inactive channel will cause an exit.

73            **OAM**            *m d*                    **Output (A) words from m on channel d**                    (24 Bits)

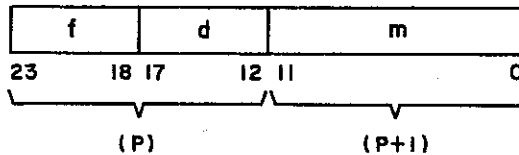

This instruction transfers a block of words from the processor memory to channel d. The first word comes from the address specified by m. The content of A specifies the number of words to be sent out. The content of A is reduced by one as each word is read out. The output operation is complete when A = 0 or the channel becomes inactive.

During this instruction address 0000 temporarily holds P, while m is held in the P register. The content of P advances by one to give the address of the next word as each word is taken from memory.

**NOTE**

If this instruction is executed when the data channel is inactive, no output operation is accomplished and the program continues at P + 2.

74

ACN

*d**Activate channel d*

(12 Bits)

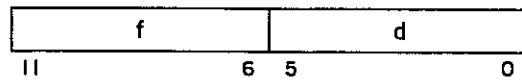

This instruction activates the channel specified by *d*. Activating a channel (must precede a 70 - 73 instruction) alerts and prepares the I/O equipment for the exchange of data.

## NOTE

Activating an already active channel causes the Peripheral Processor to hang up unless bit 5 is set. With bit 5 set, an active channel causes an exit.

75

DCN

*d**Disconnect channel d*

(12 Bits)

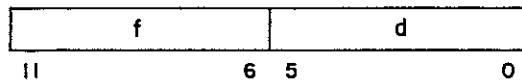

This instruction deactivates the channel specified by *d*. As a result, the I/O equipment stops and the buffer terminates.

## NOTE

- 1) Do not deactivate an already inactive channel or the Peripheral Processor will hang up unless bit 5 is set. With bit 5 set an inactive channel will cause an exit.
- 2) If an output instruction is followed by a disconnect instruction without first establishing that the information has been accepted by the input device (check for channel empty) the last word transmitted may be lost.
- 3) Do not deactivate a channel before putting a useful program in the associated processor. Processors other than 0 are hung up on an Input instruction (71). Deactivating a channel after Dead Start causes an exit to the address specified by the contents of location 0000 plus 1 and execution of that program. If the channel is deactivated without a valid program in that processor, the processor will execute whatever program was left in memory; it could, therefore, run wild.

76      *FAN*      *d*      *Function (A) on channel d*      (12 Bits)

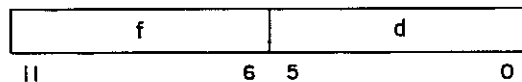

The external function code in the lower 12 bits of A is sent out on channel d.

NOTE

Do not execute this instruction when the channel is Active or the Peripheral Processor will hang up unless bit 5 is set. With bit 5 set, an active channel causes an exit.

77      *FNC*      *m d*      *Function m on channel d*      (24 Bits)



The external function code specified by m is sent out on channel d. With bit 17 set, an active channel will cause the Peripheral Processor to exit.

## Access to Central Memory

The Peripheral and Control Processors have access to all Central Memory storage locations. Four of the instructions (60, 61, 62, 63 - described previously) transfer one word or a block of words from a peripheral memory to Central Memory or vice versa. Data from an external equipment is read into a peripheral memory and, with separate instructions, transferred from there to Central Memory where it may be used by the Central Processor. Conversely, data is transferred from Central Memory to a peripheral memory and then transferred by separate instructions to external equipment. Note that all addresses sent to Central Memory from Peripheral and Control Processors are absolute addresses, rather than relative addresses.

### Read Central Memory

The 60 and 61 instructions read one word or a block of 60-bit Central Memory words. The Central Memory words are delivered to a five stage read pyramid where they are disassembled into five 12-bit words, beginning with the high-order word. Successive



stages of the pyramid contain 60, 48, 36, 24 and 12 bits. The upper 12 bits of the word are removed and sent to a peripheral memory as the word is transferred through each stage. Thus, a 60-bit word is disassembled into five 12-bit words.

Words move through the pyramid when the stage ahead is clear. One pass through the slot determines that the next stage is clear, sends 12 bits of the word to a peripheral memory, and moves the word ahead to the cleared stage. The pyramid is a part of the slot and may be time shared by up to four processors. Thus four Central Memory words may be in the pyramid at one time in varying stages of disassembly. With a full pyramid, Read instructions from other processors are partially executed (house-keeping) and circulated unchanged in the barrel until the number of pyramid users drop below four. Waiting processors are serviced in the order in which they appear at the slot. \* Other instruction control provides address incrementing and keeps the word count.

The Central Memory starting address must be entered in A before a Read instruction is executed. A Load dm (20) instruction may be used for this. For a one word transfer, the d portion of the Read (60) instruction specifies the following:

d = peripheral address (0000-0077<sub>g</sub>) of first 12-bit word; remaining words go to d + 1, d + 2, etc.

For a block transfer, d and m of the read (61) instruction specify the following:

(d) = number of Central Memory words to be transferred; reduced by one for each word transferred.

m = peripheral starting address; increased by one to provide locations for successive words. (A) is increased by one to locate consecutive Central Memory words.

#### Write Central Memory

The 62 and 63 instructions assemble 12-bit peripheral words into 60-bit words and write them in Central Memory. Peripheral words are assembled in a write pyramid and delivered from there to Central Memory. As in Read Central Memory, the pyramid is a part of the slot and is time-shared by up to four processors. Write pyramid action is similar to Read pyramid action except for the assembly.

---

\*Refer to Central Memory Access Priority (Appendix F) for exceptions.

The starting address in Central Memory is entered in A before the Write instruction is executed. For a one word transfer, the d portion of the Write (62) instruction specifies the following:

d = peripheral address (0000-0077<sub>8</sub>) of first 12-bit word; remaining words are taken from d + 1, d + 2, etc.

For block transfer, d and m of the Write (63) instruction specify the following:

(d) = number of Central Memory words to be transferred; reduced by one for each word transferred.

m = peripheral starting address; increased by one to locate each successive peripheral word. (A) is increased by one to provide consecutive Central Memory locations.

#### Access to the Central Processor

The Peripheral and Control Processors use two instructions to communicate with the Central Processor. One instruction starts a program running in the Central Processor and the other instruction monitors the progress of the program.

#### Exchange Jump

The 260 instruction (described previously) starts a program running in the Central Processor or interrupts a current program and starts a new program running. In either case, the Central Processor is directed to a Central Memory file of 16 words which stores information about the new program to be executed (see Exchange Jump section). The 18-bit starting address of this file must be entered in A before the Exchange Jump instruction is executed. The Central Processor replaces the file with similar but current information from the interrupted program. A later Exchange Jump instruction referencing this file returns the interrupted program to the Central Processor for completion. This exchange feature permits the Peripheral Processor to time-share the Central Processor.

### Read Program Address

The 27 instruction (described previously) transfers the content of the Central Processor P register into a peripheral A register. The peripheral program tests the A register content to determine the condition of the Central Processor. If  $A \neq 0$ , the Central Processor is running a program, may have come to a normal (instruction) stop, or may have stopped due to an out-of-bounds error (unselected). (Refer to Exit Mode section, page 3-11.) If  $A = 0$ , the Central Processor has stopped due to a selected Exit mode error; the reference address for the Central Processor program is then examined to determine which error condition exists. A Stop instruction ( $00_8$ ) in the upper six bits of the reference address signals a stop; the next lower six bits define the nature of the exit (see Exchange Jump section, page 3-9).

## **Input and Output**

There are 12 instructions to direct activity on the I/O channels. These instructions select a unit of external equipment and transfer data to or from the equipment. The instructions also determine whether a channel or external equipment is available and ready to transfer data. The preparatory steps insure that the data transfer is carried out in an orderly fashion.

Each external equipment has a set of external function codes which are used by the processors to establish modes of operation and to start or stop data transfer. Also, the devices are capable of detecting certain errors (e. g., parity error) and provide an indication of these errors to the controlling processor. The external error conditions can be read into a processor for interpretation and further action. Details of mode selection and error flags in external devices such as card readers and magnetic tape systems are presented in the appropriate 6000 Series Peripheral Equipment Reference manuals.

### Data Channels

Each channel has a 12-bit bi-directional data register and two control flags which indicate:

- The channel is active or inactive
- The channel register is full or empty

The 64 and 65 instructions determine the state of the channel, and the 66 and 67 instructions determine the state of the register. The flags provide housekeeping information for the processors so that channels can be monitored and processed in an orderly way. The flags also provide control for the I/O operation.

Word Rate: Each processor is serviced by the slot once every major cycle. This sets the maximum word rate on a channel at one word each 1000 ns, a 1 megacycle word rate. Up to 10 processors can be communicating with I/O equipment over separate channels at this rate since each processor is regularly serviced at major cycle intervals.

Channel Active/Inactive Flag: A channel is made active by a Function (76, 77) instruction or an Activate Channel (74) instruction.

The Function instruction selects a mode of operation in the external equipment. The instruction places a 12-bit function word in the channel register and activates the channel. The external equipment accepts the function word, and its response to the processor clears the register and drops the channel active flag. The latter action produces the channel inactive flag.

The activate channel instruction prepares a channel for data transfer. Subsequent input or output instructions transfer the data. A disconnect channel instruction after data transfer is complete returns the channel to the inactive state.

Register Full/Empty Flag: A register is full when it contains a function or data word for an external equipment or contains a word received from an external equipment. The register is empty when it is cleared. The flags are turned on or off as the register changes state.

On data output, the processor places a word in the Channel register and sets the full flag. The external device accepts the word, clears the register, and sets the empty flag. The empty flag and channel active flag signal the processor to send another word to the register to repeat the sequence.

On input, the external device places a word in the register and sets the full flag. The processor stores the word, clears the register, and sets the empty flag. The empty flag and channel active flag signal the external device to deliver another word.

## Data Input

Several instructions are necessary to transfer data from external equipment into a processor. The instructions prepare the channel and equipment for the transfer and then start the transfer. Some external equipment, when once started, send a series of words (record) spaced at equal time intervals and then stops automatically between records. Magnetic tape equipment is an example of this type of transfer. The processor can read all or a part of the record and then disconnect the channel to end the operation. The latter step makes the channel inactive. Other equipment, such as the display console, can send one word (or character) and then stop. The input instructions allow the input transfer to vary from one word to the capacity of the processor.

An input transfer may be accomplished in the following way:

- 1) Determine if the channel is inactive. A Jump to m on channel d Inactive (65) instruction does this. Here, m can be a function instruction to select Read mode or determine the status of the equipment.
- 2) Determine if the equipment is ready. A Function m on Channel d (77) instruction followed by an Activate channel d (74) followed by an Input to A from Channel d (70) instruction loads A with the status response of the desired equipment. Here, m is a status request code, and the status response in A can be tested to determine the course of action.
- 3) Disconnect Channel d (75); this avoids hanging up the processor.
- 4) Select Read mode in the equipment. A Function m on Channel d (77) instruction or Function (A) on Channel d (76) instruction will send a code word to the desired device to prepare it for data transfer.
- 5) Enter the number of words to be transferred in A. A Load d (14) or Load (d) (30) instruction will accomplish this.
- 6) Activate the channel. An Activate Channel d (74) instruction sets the channel active flag and prepares for the impending data transfer.
- 7) Start input data transfer. An Input (A) Words to m on Channel d (71) instruction or an Input to A from Channel d (70) instruction starts data transfer. The 71 instruction transfers one word or up to the capacity of the processor memory. The 70 instruction transfers one word only.

- 8) Disconnect the channel. A Disconnect Channel d (75) instruction makes the channel inactive and stops the flow of input information.

The design of some external equipment requires timing considerations in issuing function, activate, and input instructions. The timing consideration may be based on motion in the equipment, i. e., the equipment must attain a given speed before sending data (e. g., magnetic tape). In general, timing considerations can be resolved by issuing the necessary instructions without an intervening time gap. The external equipment literature lists timing considerations to be taken into account.

#### Data Output

The data output operation is similar to data input in that the channel and equipment must be ready before the data transfer is started by an output instruction.

An output transfer may be accomplished in the following way:

- 1) Determine if the channel is inactive. A Jump to m on Channel d Inactive (65) instruction does this. Here, m can be a function instruction to select Write mode or determine the status of the equipment.
- 2) Determine if the equipment is ready. A Function m on Channel d (77) followed by an Activate channel d (74) followed by an Input to A from Channel d (70) instruction loads A with the status response of the desired equipment. Here, m is a status request code, and the status response in A can be tested to determine the course of action.
- 3) Disconnect Channel d (75); this avoids hanging up the processor.
- 4) Select Write mode in the equipment. A Function m on Channel d (77) instruction or Function (A) on Channel d (76) instruction will send a code word to the desired device to prepare it for data transfer.
- 5) Enter the number of words to be transferred in A. A Load d (14) or Load d (30) instruction will accomplish this.
- 6) Activate the channel. An Activate Channel d (74) instruction signals an active channel and prepares for the impending data transfer.
- 7) Start data transfer. An Output (A) Words from m on Channel d (73) instruction or an Output from A on Channel d (72) instruction starts data transfer. The

73 instruction can transfer one or more words while the 72 instruction transfers only one word.

- 8) Test for channel empty. A Jump to m if Channel d Full (66) instruction where m = current address, provides this test. The instruction exits to itself until the channel is empty. When the channel is empty, the processor goes on to the next instruction which generally disconnects the channel. The instruction acts to idle the program briefly to insure successful transfer of the last output word to the recording device.
- 9) Disconnect the channel. A Disconnect Channel d (75) instruction makes the channel inactive. Data flow in this case terminates automatically when the correct number of words is sent out.

Instruction timing considerations, as in a data input operation, are a function of the external device.

## **Real-Time Clock**

The real-time clock runs continuously; its period is 4096 cycles (4.096 ms). The clock may be sampled by any Peripheral and Control Processor with an Input to A (70) instruction from channel 14<sub>g</sub>. The clock is advanced by the storage sequence control and cannot be cleared or preset.





# 5. SYSTEM INTERRUPT

## INTRODUCTION

Essentially, detecting and handling interruptible conditions involves both hardware and software. This section describes hardware provisions for detecting and handling interrupt. The salient features of an operating system for implementing interrupt handling are described in the operating system reference manual.

## HARDWARE PROVISIONS FOR INTERRUPT

### Exchange Jump

Within a Peripheral Processor, execution of an Exchange Jump instruction initiates hardware action in the Central Processor to interrupt the current Central Processor program and substitute a program, the parameters of which are defined in the Exchange Jump package. Note that the Exchange Jump is also used to start the Central Processor from a Stop condition. (Refer to the Exchange Jump section).

### Channel and Equipment Status

Within the Peripheral Processors, hardware flags indicate the state of various conditions in the data channels, e. g., Full/Empty, and Active/Inactive. External equipments are capable of detecting certain errors (e. g., parity error) and hold status information reflecting their operating conditions (e. g., Ready, End of File, etc.) Channel and equipment status information may be examined by instructions in the Peripheral Processors. The Input/Output section describes these instructions. For detailed status information on external devices such as magnetic tape units and card readers, refer to literature associated with these devices.

---

## Exit Mode

Central Processor hardware provides for three types of error halt conditions (Exit mode):

- Address out of range (i. e. , out of bounds)
- Operand out of range (i. e. , exponent overflow)
- Indefinite result

Detecting the occurrence of one or more of these conditions is accomplished by the hardware and causes an error halt. Note that halting on any of these conditions is selectable; selection is performed by setting appropriate flags in the Exit mode portion of the Exchange Jump package. (Refer to Exit Mode, page 3-11.)

# 6. MANUAL CONTROL

## INTRODUCTION

Manual control operation is provided through 1) the dead start panel and 2) the console keyboard. The Dead Start circuit is a means of manually entering a 12-word program (normally a load routine) to start operation. The console keyboard provides for the manual entry of data or instructions under program control.

## DEAD START

The dead start panel\* (Figure 6-1) contains a 12 x 12 matrix of toggle switches, a MODE switch to select SWEEP, LOAD, or DUMP, a DEAD START switch, and a CEJ/MEJ and a PPU-A switch. \*\* The panel also contains memory margin switches which are used for maintenance checks. The three modes of operation (Load, Sweep, Dump) selectable via the dead start panel are described below.

### Load Mode

To initially load programs and data into the computer system, the MODE switch is placed in the LOAD position. The matrix of toggle switches is set to a 12-word (or less) program (switch up = "1", switch down = "0"). The program set in the switch matrix is normally a load routine used to load a larger program from an input device such as a disk file or magnetic tape unit.

The DEAD START switch is turned on momentarily, then off. Turning on the DEAD START switch initiates the following operations:

- 1) Assigns processors 0-11<sub>g</sub> to corresponding data channels.
- 2) Sends a Master Clear to all I/O channels. A Master Clear removes all equipment selections except the dead start panel, and sets all channels to the Active and Empty condition (ready for input).

---

\*See Appendix E for Dead Start operation in 64XX-7, 64XX-8, and 64XX-9 Systems.  
\*\*CEJ/MEJ and PPU-A switches are for 6700 only or those systems which have the applicable Standard Options.

- 3) Sets all processors to the Input (71) instruction.
- 4) Clears the P register and sets the A register to  $10000_8$  in all processors.
- 5) Transmits a zero word followed by the 12 words from the toggle switches into memory locations  $0000 - 0014_8$  of peripheral processor 0, and then disconnects data channel 0 causing word  $0015_8$  of peripheral processor 0 to be zeroed and causing peripheral processor 0 to start execution with the instruction at location 0001.

After the switch matrix program is read from the dead start panel, the panel is automatically disconnected. Processor 0 reads location 0000, adds one to its content, and begins executing the program at address 0001. The other processors are still set to the Input (71) instruction and may receive data from processor 0 via their assigned channels.

## Sweep Mode

Placing the MODE switch in the SWEEP position and momentarily turning on the DEAD START switch results in the following:

- 1) Sets all processors to instruction 50X.
- 2) Clears all processor P registers to zero.

The translation of the 50X instruction in each processor causes each processor to sweep through its memory, reading and restoring the contents of each location, without executing instructions. Sweep mode is a maintenance tool useful in checking the operation of memory logic.

## Dump Mode

Placing the MODE switch in the DUMP position and momentarily turning on the DEAD START switch initiates the following operations:

- 1) Assigns processors  $0-11_8$  to corresponding data channels.
- 2) Sends a Master Clear to all I/O channels except channel 0.
- 3) Holds channel 0 to Active and Empty.
- 4) Sets all processors to the Output (73) instruction.
- 5) Clears the P register and sets the A register to  $10000_8$  in all processors.

NOTE

The CEJ/MEJ switch is for E model or system with the installed CEJ/MEJ option. Appendix F describes the option.

CEJ/MEJ is disabled when the key switch is turned fully clockwise and the system is deadstarted. CEJ/MEJ is enabled when the key switch is turned fully counter-clockwise and the system is deadstarted.

The FFU-A switch is for systems with 20 FFU's, it determines whether the internal FFU chassis is numbered 0-11 or 20-31.

\* NOTE: For 6000-A/B/C with CMAP option the switch is horizontal with Constant Mode to the left and Program Mode to the right.

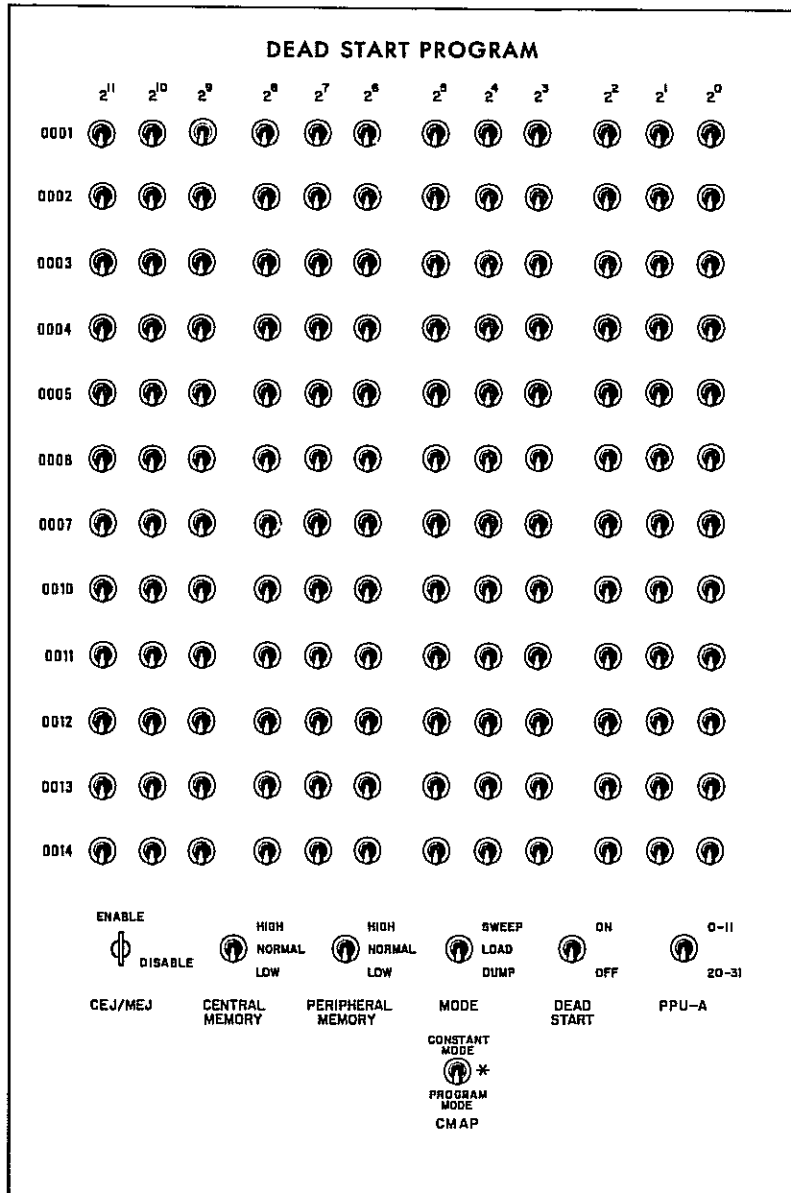

Figure 6-1. Dead Start Panel

Each of the processors senses the Active and Empty condition of its assigned channel and outputs the content of its memory address zero. Each of the I/O channels is then set to Full (except channel 0), and the processors wait for an Empty signal. Each processor advances its P register by one and reduces the content of its A register by one (to  $7776_8$ ). At this point, the processors waiting for an Empty signal are hung up and cannot proceed.

Channel 0 (assigned to processor 0) is held to Empty by the DUMP position. Processor 0, therefore, proceeds through the 73 instruction until the contents of A are reduced to one. Processor 0 has now dumped its entire memory content on channel 0 (although no I/O device was selected to receive it). Execution then starts with the instruction at the location specified by the contents of location 0000 plus one; it is now free to execute a dump program which must have been previously stored in its memory (location 0000 must have been previously set to the starting address minus one).

## PROGRAM/CONSTANT MODE

Placing the CMAP switch in the Program Mode position provides program selectable priority for each peripheral processor. Placing it in the Constant Mode position assigns priority status to all peripheral processors by which any one can interrupt an ECS transfer.

## CONSOLE

The display console (Figure 6-2) consists of two cathode ray tube displays and a keyboard for manual entry of data. A typical System may have several display consoles for controlling independent programs simultaneously.

### Keyboard Input

The console may be selected for input to allow manual entry of data or instructions to the computer. The first part of an operating system program may select keyboard input to allow the programmer to manually select a routine from the operating system. Data entered via the keyboard may be displayed on one of the display tubes if desired. Assembly and display of keyboard entries is done by a routine in the operating system.

### Display

The console may be selected to display (Figure 6-3) in either the Character or Dot mode. In the Character mode, two alphanumeric characters may be displayed for each 12-bit

word sent from a processor. Character sizes are:

- Small - 64 characters/line
- Medium - 32 characters/line
- Large - 16 characters/line

In Dot mode, a pattern of dots (graph, figures, etc.) may be displayed. Each dot is located by two 12-bit words: a vertical coordinate and a horizontal coordinate.

A display program must repeat a display periodically in order to maintain persistence on the display tube.



1371

Figure 6-2. Display Console

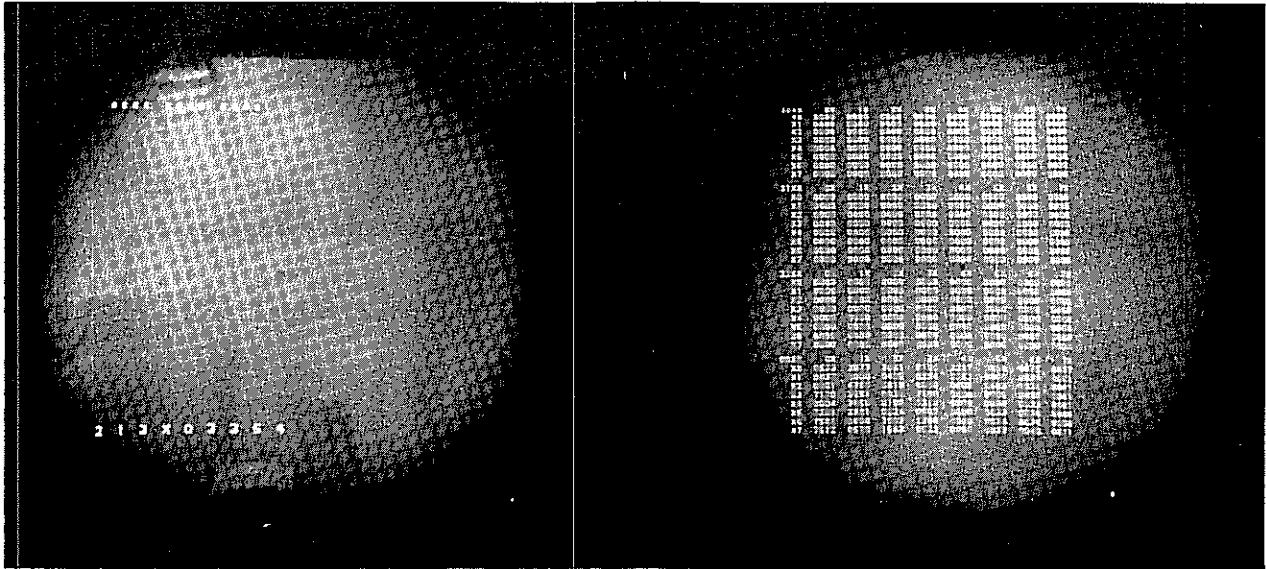

Figure 6-3. Sample Display

1596



Appendix A

**AUGMENTED I/O BUFFER AND CONTROL  
(6416)**



## CONTROL DATA 6416

### AUGMENTED I/O BUFFER AND CONTROL

The CONTROL DATA 6416 Augmented I/O Buffer and Control unit is a large-scale, solid state device for communication with the Central Processor of 6000 series Computer Systems.

### DESCRIPTION

The 6416 is comprised of ten Peripheral and Control Processors and a Central Memory. A summary of characteristics for the 6416 is tabulated below.

#### PERIPHERAL AND CONTROL PROCESSORS

- 10 identical processors
  - Each processor has a 4096 word magnetic core memory (12-bit)
  - Random access, coincident current
  - Major cycle = 1000 ns; Minor cycle = 100 ns
- 12 input/output channels
  - All channels common to all processors
  - Maximum transfer rate per channel - one word/major cycle
  - All channels may be active simultaneously
  - All channels 12-bit bidirectional
- Real-time clock (period = 4096 major cycles)
- Instructions
  - Logical
  - Branch
  - Add/Subtract
  - Input/Output
  - Central Memory Access
  - Extended Core Storage Access
- Average instruction execution time = two major cycles
- Indirect addressing
- Indexed addressing

## CENTRAL MEMORY

- 16,384 words (60-bit)
- Memory organized into four logically independent banks of 4096 words with corresponding multiphasing of banks
- Random-access, coincident-current, magnetic core
- One major cycle for read-write
- Maximum memory reference rate to all banks; four addresses/major cycle
- Maximum rate of data flow to/from memory; four words/major cycle

The 6416 has no Central Processor however, it is a computer capable of operating alone.

## SYSTEMS CONFIGURATIONS

The 6416, in typical systems configurations, provides a system expansion. For installations with multiple on-line users, the 6416 provides additional data channels to accommodate additional external equipment. The ten Peripheral and Control Processors, each capable of independently executing programs, and the 16,384 word 60-bit Central Memory significantly increase the multiprogramming and batch job processing capabilities of the 6000 series Computer Systems.

A typical configuration diagrammed in Figure A-1 illustrates the orientation of a 6416 with a 6400, 6600, or 6700 Computer System. The 6416 is attached to the main computer system via one of the Peripheral Processor Data Channels.

The 6682/6683 Satellite Coupler accepts and relays control signals and data to provide smooth information flow throughout the system.

In this configuration, the 6416 may be thought of as a batching terminal, where batch jobs may enter the system, be assembled, and placed in the 16K distributive memory. Access to the main computer Central Processor for job execution is then under operating system control.

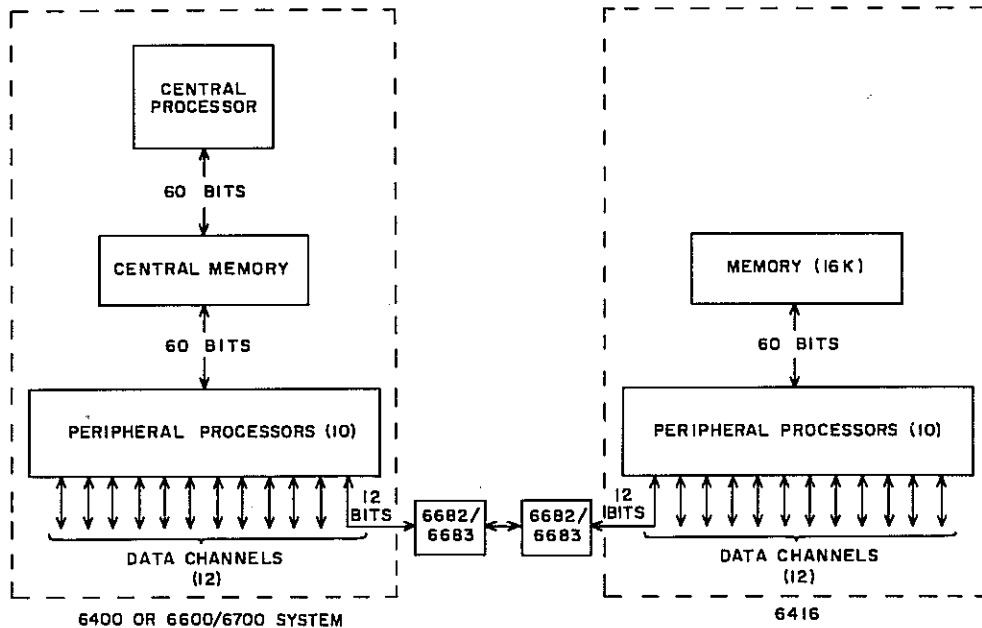

Figure A-1. Typical Configuration: 6416 with 6400 or 6600/6700 System

Another possible systems configuration (Figure A-2) incorporates Extended Core Storage between the 6400 or 6600/6700 Central Memory and the 6416 16K memory. This configuration implies a hierarchy of memories as follows:

- 1) Extended Core Storage as a system Central Memory
- 2) Main frame Central Memory as a system Central Processor memory
- 3) 6416 16K memory as a distributive memory

#### 6416 INSTRUCTIONS

Within the 6416, Peripheral Processor instructions are identical to those of the 6000 series systems with two exceptions. These are the Read Extended Core Coupler Status instruction (27, RCS) and the Extended Core Transfer instruction (26, ECT). The instructions are described in the ECS Reference Manual.

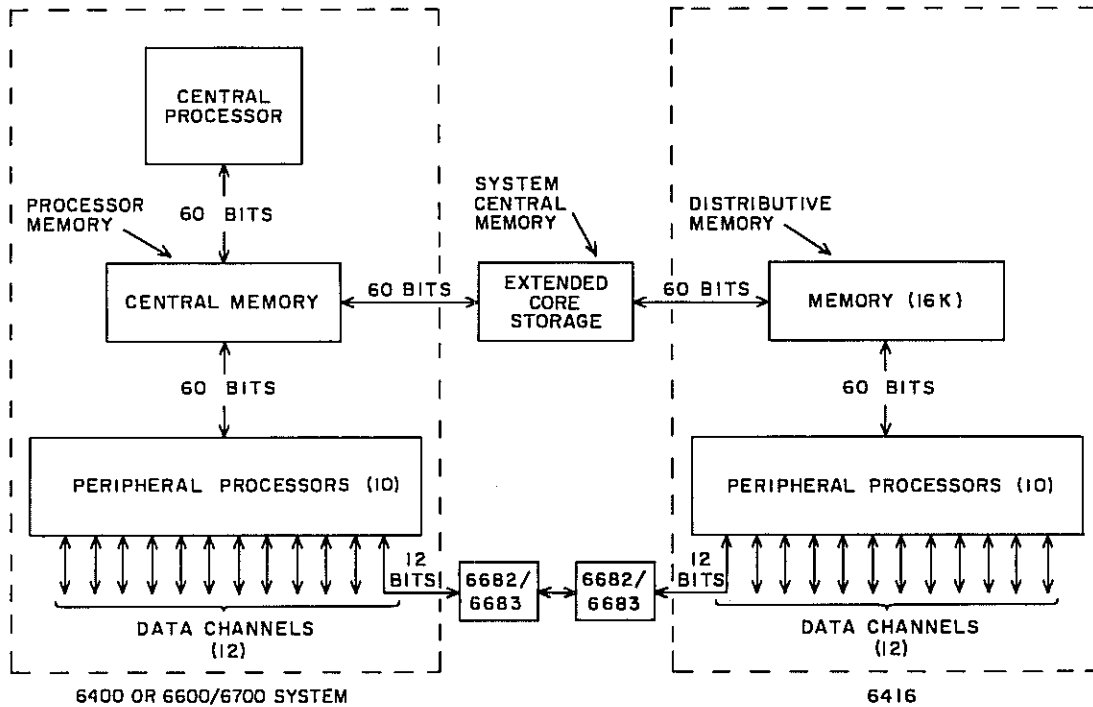
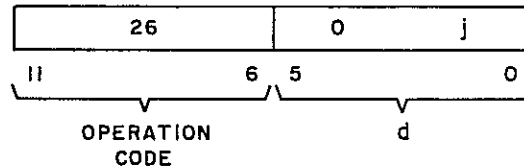

Figure A-2. Typical Configuration with Extended Core Storage

Within the Extended Core Coupler, status bit 17 is dynamic; bits 16 and 15 are cleared each time an Extended Core Storage transfer is initiated.

26 ECT d Extended Core Transfer (12 bits)



Execution of the Extended Core Transfer instruction initiates memory operations by transmitting an 18-bit address, "n", from the Peripheral Processor A register to the 6416 16K memory. Address "n" holds a word, the format of which is as follows:

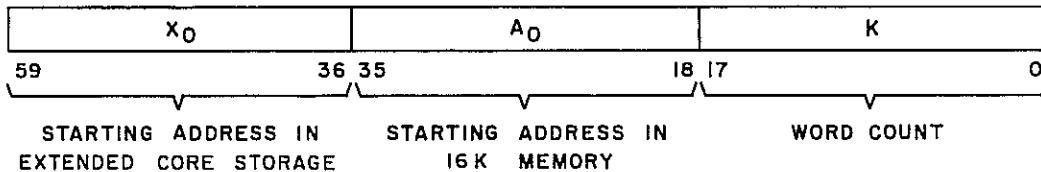

The "d" portion of this instruction specifies the storage operation to be performed:

- If "j" = 0, Read "K" words from Extended Core Storage into 16K memory.
- If "j" = 1, Write "K" words from 16K memory into Extended Core Storage.

NOTE

If this instruction is executed without Extended Core Storage in the system configuration, it acts as a Pass (Do-Nothing) instruction.

Note that addresses contained in the word at address "n" are absolute addresses. Operating systems may require relocation (adding RA to an address) and Field Length testing, e.g., is "address+RA"  $\geq$  FL? (The Exchange Jump package contains RA and FL values for Central Memory and for Extended Core Storage.) The 6416 has no hardware for automatic relocation and Field Length testing; it is therefore incumbent upon the program to perform these functions whenever required by an operating system.

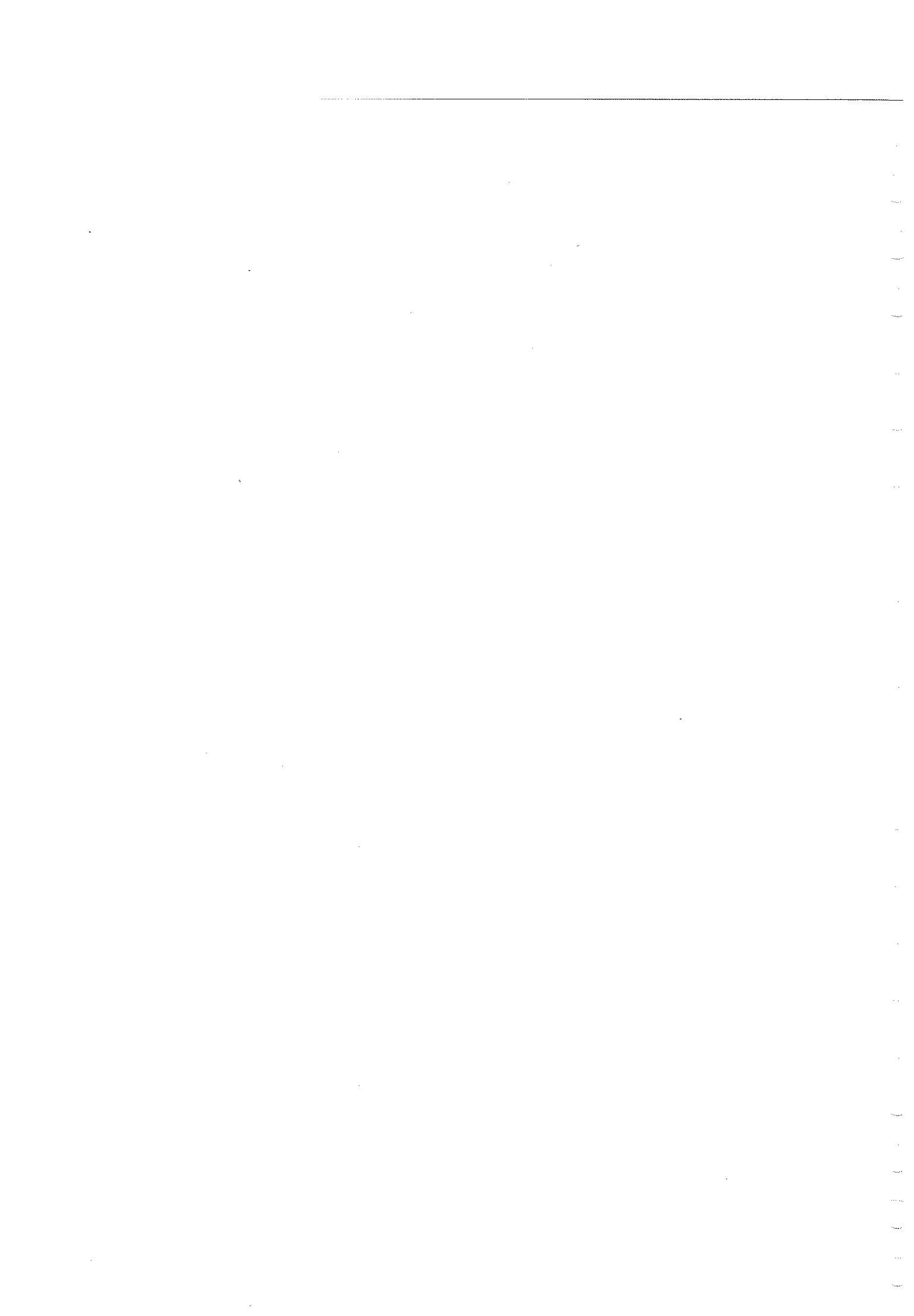



**Appendix B**

**INSTRUCTION EXECUTION TIMES**



## INSTRUCTION EXECUTION TIMES

The execution times for Central and Peripheral and Control Processor instructions are given in the following paragraphs. Factors which influence instruction execution time and hence program running time are also given.

### CENTRAL PROCESSOR (6600/6700 SYSTEM)

The execution time of Central Processor instructions is given in minor cycles, and instructions are grouped under the functional unit (6600/6700) which executes the instruction. Time is counted from the time the unit has both input operands to when the instruction result is available in the specified result register. Central Memory access time is not considered in those increment instructions which result in memory references to read operands or store results.

The following paragraphs give some general statements about Central Processor instruction execution and summarize the statements into a list which may be used as a guide to efficient use of the Central Processor functional units.

Central Processor programs are written in the conventional manner and are stored in Central Memory under direction of a Peripheral and Control Processor. After an Exchange Jump start by a Peripheral and Control Processor program, Central Processor instructions are sent automatically, and in the original sequence, to the instruction stack, which holds up to 32 instructions.

Instructions are read from the stack one at a time and issued to the functional units for execution. A scoreboard reservation system in Central Processor control keeps a current log of which units are busy (reserved) and which operating registers are reserved for results of computation in functional units.

Each unit executes several instructions, but only one at a time. Some branch instructions require two units, but the second unit receives its direction from the branch unit.

The instruction issue rate may vary from a theoretical maximum rate of one instruction every minor cycle (sustained issuing at this rate may not be possible because of unit and Central Memory conflict) and resulting parallel operation of many units to a slow issue rate and serial operation of units. The latter results when successive operations depend on results of previous steps. Thus, program running time can be decreased by efficient use of the many units. Instructions which are not dependent on previous steps may be arranged or nested in areas of the program where they may be executed during operation time of other units. Effectively, this eliminates dead spots in the program and steps up the instruction issue rate.

The following steps summarize instruction issuing and execution:

- 1) An instruction is issued to a functional unit when
  - the specified functional unit is not reserved
  - the specified result register is not reserved for a previous result.
- 2) Instructions are issued to functional units at minor cycle intervals when no reservation conflicts (see above) are present.
- 3) Instruction execution starts in a functional unit when both operands are available (execution is delayed when an operand(s) is a result of a previous step which is not complete.
- 4) No delay occurs between the end of a first unit and the start of a second unit which is waiting for the results of the first.
- 5) No instructions are issued after a Branch instruction until the Branch instruction has been executed. The Branch Unit uses
  - an Increment Unit to form the go to  $k + B_i$  and go to  $k$  if  $B_i . . .$  instructions, or
  - the Long Add unit to perform the go to  $k$  if  $X_j . . .$  instructions in the execution of a Branch instruction. The time spent in the Long Add or Increment Units is part of the total branch time.
- 6) Read Central Memory access time is computed from the end of Increment Unit time to the time operand is available in X operand register. Minimum time is 500 ns, assuming no Central Memory bank conflict.

#### CENTRAL PROCESSOR (UNIFIED ARITHMETIC SYSTEMS)

Central Processors with unified Arithmetic units, rather than separate functional units, execute instructions in sequence.

All execution times for instructions listed in Table B-1 include readying the next instruction for execution. For the Return Jump instruction and the Jump instructions (in which the jump condition is met), Table B-1 lists times which include obtaining the new instruction word from storage and readying it for execution. Times listed, then, are complete times except for possible additional time due to hardware limitations or memory bank conflicts. Factors which may add to the stated times in Table B-1 are summarized below:

- 1) Reading the next instruction word of a program from Central Memory (termed an RNI - Read Next Instruction) is in part concurrent with instruction execution. The RNI is initiated between execution of the first and second instructions of the instruction word being processed. Initiating the RNI operation requires 2 minor cycles; the remainder of the RNI time is in time parallel with the execution of the remaining instructions in the instruction word. (Refer to Figure B-1.)

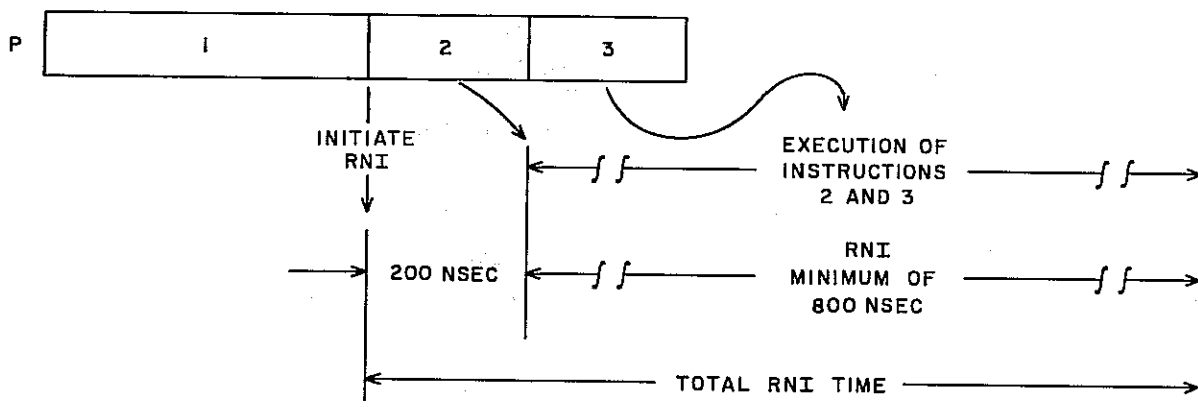

Figure B-1. RNI Timing Example

In the example diagrammed in Figure B-1, execution of instruction 2 is delayed 2 minor cycles until RNI initiation is complete.

In calculating execution times for a program, add 2 minor cycles to each instruction word in a program to cover the RNI initiation time. Exceptions to

this rule are the Return Jump and the Jump instructions (in which the jump condition is met) when these occupy the upper position of the instruction word. Since the stated times for these instructions in Table B-1 include the time required to read up the new instruction word at the jump address, no additional time is required.

Example: (for 6400)

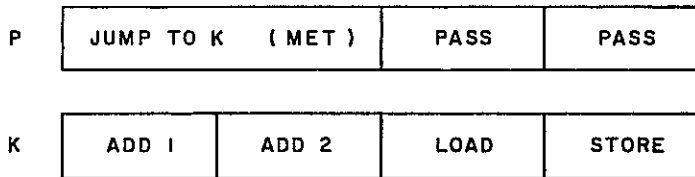

<u>Instruction</u>	<u>Time Required</u>
Jump	13 Minor Cycles
Add 1	5 Minor Cycles
RNI Initiation	2 Minor Cycles
Add 2	5 Minor Cycles
Load	12 Minor Cycles
Store	10 Minor Cycles
<hr/>	
Total Time Required =	47 Minor Cycles

- 2) After RNI has been initiated (between the first and second instructions of the instruction word), a minimum of 8 minor cycles elapse before the next instruction word is available for execution. If the total time required by instructions in the lower order positions of the word is less than 8 minor cycles, allow a minimum of 8 minor cycles, regardless of the execution times stated in Table B-1.

Example:

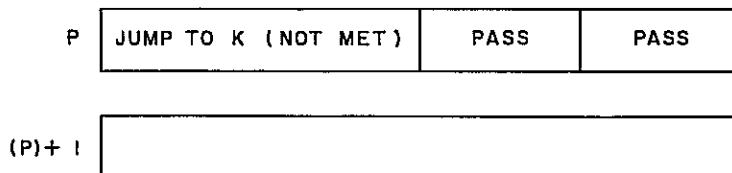

<u>Instruction</u>	<u>Time Required</u>
Jump (not met)	5 Minor Cycles
RNI Initiation	2 Minor Cycles
Pass = 3 } Pass = 3 } 6, but RNI Minimum =	8 Minor Cycles
<hr/>	
Minimum time before instruction word at P + 1 is available for execution =	15 Minor Cycles

- 3) The Return Jump instruction, all Jump instructions in which the jump condition is met, and Load/Store Memory instructions always require additional time when located in the second instruction position of an instruction word. This additional time is caused by hardware limitations and is not due to memory bank conflicts.

<u>Instruction</u>	<u>Additional Time Required If Used As Second Instruction in Word</u>
a) Jumps (02 - 07) in which the jump condition is met	1 Minor Cycle
b) Return Jump (010)	2 Minor Cycles
c) Load/Store (5X instructions with $i \neq 0$ )	2 Minor Cycles

- 4) An additional 3 minor cycles due to bank conflict are required if the second instruction of a word references the memory bank in which (P)+1 is located.
- 5) A Store (not Load) as the first instruction of a word can cause a bank conflict with (P)+1. If this occurs, 3 minor cycles are added to the execution time.

Summary of guidelines for efficient coding in the unified arithmetic Central Processors:

- Always attempt to place Jump instructions in the upper parcel of the instruction word. In most cases, this avoids both the additional time for RNI (2 minor cycles) and the possibility of a memory bank conflict with (P) + 1.
- Where possible, place Load/Store instructions in the lower order two parcels to avoid lengthening execution times as outlined above.

## CENTRAL PROCESSOR INSTRUCTION EXECUTION TIMES

Central Processor instruction execution times are tabulated in Table B-1 (6500 times are the same for each Central Processor). Instructions are tabulated according to the functional units in which they are executed; this functional unit designation, of course, does not apply to the unified arithmetic systems. Instruction execution times are listed in minor cycles.

TABLE B-1. INSTRUCTION EXECUTION TIMES: CENTRAL PROCESSOR

Octal Code	BRANCH UNIT	6000 6200	6400 6500	6600 & 6700 CPU-0	6700 CPU-1
00	STOP	-	-	-	-
010	RETURN JUMP to K	24	21	13	21
011	READ EXTENDED CORE STORAGE	**	**	**	**
012	WRITE EXTENDED CORE STORAGE	**	**	**	**
02	GO TO K + Bi †	16	13	14	15
030	GO TO K if Xj = zero	16	13	9*	15
031	GO TO K if Xj ≠ zero	16	13	9*	15
032	GO TO K if Xj = positive	16	13	9*	15
033	GO TO K if Xj = negative	16	13	9*	15
034	GO TO K if Xj is in range	16	13	9*	15
035	GO TO K if Xj is out of range	16	*** 13	9*	*** 15
036	GO TO K if Xj is definite	16	13	9*	15
037	GO TO K if Xj is indefinite	16	13	9*	15
04	GO TO K if Bi = Bj †	16	13	8*	15
05	GO TO K if Bi ≠ Bj †	16	13	8*	15
06	GO TO K if Bi > Bj †	16	13	8*	15
07	GO TO K if Bi < Bj †	16	13	8*	15

† GO TO K + Bi and GO TO K if Bi  
- - - tests made in Increment Unit

†† GO TO K if Xj - - - tests made in  
Long Add Unit

\*Add 6 minor cycles to branch time for a branch to an instruction which is out of the stack (no memory conflict considered); add 2 minor cycles to branch time for a no branch condition in the stack. Add 5 minor cycles to branch time for a no branch condition out of the stack.

\*\*Execution times for extended Core Storage operations are dependent upon several factors; refer to Extended Core Storage Reference Manual for timing information.

\*\*\*Jumps in which the jump condition is not met require 5 minor cycles.



TABLE B-1. (Cont'd)

Octal Code	BOOLEAN UNIT	6000 6200	6400 6500	6600 & 6700 CPU-0	6700 CPU-1
10	TRANSMIT Xj to Xi	8	5	3	5
11	LOGICAL PRODUCT of Xj and Xk to Xi	8	5	3	5
12	LOGICAL SUM of Xj and Xk to Xi	8	5	3	5
13	LOGICAL DIFFERENCE of Xj and Xk to Xi	8	5	3	5
14	TRANSMIT Xk COMP to Xi*	8	5	3	5
15	LOGICAL PRODUCT of Xj and Xk COMP. to Xi	8	5	3	5
16	LOGICAL SUM of Xj and Xk COMP. to Xi	8	5	3	5
17	LOGICAL DIFFERENCE of Xj and Xk COMP. to Xi	8	5	3	5
Octal Code	SHIFT UNIT				
20	SHIFT Xi LEFT jk places	9	6	3	6
21	SHIFT Xi RIGHT jk places	9	6	3	6
22	SHIFT Xk NOMINALLY LEFT Bj places to Xi	9	6	3	6
23	SHIFT Xk NOMINALLY RIGHT Bj places to Xi	9	6	3	6
24	NORMALIZE Xk in Xi and Bj	10	7	4	7
25	ROUND AND NORMALIZE Xk in Xi and Bj	10	7	4	7
26	UNPACK Xk to Xi and Bj	10	7	3	7
27	PACK Xi from Xk and Bj	10	7	3	7
43	FORM jk MASK in Xi	9	6	3	6
Octal Code	ADD UNIT				
30	FLOATING SUM of Xj and Xk to Xi	14	11	4	11
31	FLOATING DIFFERENCE of Xj and Xk to Xi	14	11	4	11
32	FLOATING DP SUM of Xj and Xk to Xi*	14	11	4	11
33	FLOATING DP DIFFERENCE of Xj and Xk to Xi	14	11	4	11
34	ROUND FLOATING SUM of Xj and Xk to Xi	14	11	4	11
35	ROUND FLOATING DIFFERENCE of Xj and Xk to Xi	14	11	4	11
Octal Code	LONG ADD UNIT				
36	INTEGER SUM of Xj and Xk to Xi	9	6	3	6
37	INTEGER DIFFERENCE of Xj and Xk to Xi	9	6	3	6
Octal Code	MULTIPLY UNIT**				
40	FLOATING PRODUCT of Xj and Xk to Xi	60	57	10	57
41	ROUND FLOATING PRODUCT of Xj and Xk to Xi	60	57	10	57
42	FLOATING DP PRODUCT of Xj and Xk to Xi	60	57	10	57

\*Comp. = Complement; DP = Double Precision

\*\*Duplexed units - instruction goes to free unit

TABLE B-1. (Cont'd)

Octal Code	DIVIDE UNIT	6000 6200	6400 6500	6600 & 6700 CPU-0	6700 CPU-1
44	FLOATING DIVIDE Xj by Xk to Xi	60	57	29	57
45	ROUND FLOATING DIVIDE Xj by Xk to Xi	60	57	29	57
47	SUM of 1's in Xk to Xi	71	68	8	68
46	PASS	6	3	1	3
Octal Code	INCREMENT UNIT*				
50	SUM of Aj and K to Ai	**	**	3***	†
51	SUM of Bj and K to Ai	**	**	3	†
52	SUM of Xj and K to Ai	**	**	3	†
53	SUM of Xj and Bk to Ai	**	**	3	†
54	SUM of Aj and Bk to Ai	**	**	3	†
55	DIFFERENCE of Aj and Bk to Ai	**	**	3	†
56	SUM of Bj and Bk to Ai	**	**	3	†
57	DIFFERENCE of Bj and Bk to Ai	**	**	3	†
60	SUM of Aj and K to Bi	8	5	3	5
61	SUM of Bj and K to Bi	8	5	3	5
62	SUM of Xj and K to Bi	8	5	3	5
63	SUM of Xj and Bk to Bi	8	5	3	5
64	SUM of Aj and Bk to Bi	8	5	3	5
65	DIFFERENCE of Aj and Bk to Bi	8	5	3	5
66	SUM of Bj and Bk to Bi	8	5	3	5
67	DIFFERENCE of Bj and Bk to Bi	8	5	3	5
70	SUM of Aj and K to Xi	9	6	3	6
71	SUM of Bj and K to Xi	9	6	3	6
72	SUM of Xj and K to Xi	9	6	3	6
73	SUM of Xj and Bk to Xi	9	6	3	6
74	SUM of Aj and Bk to Xi	9	6	3	6
75	DIFFERENCE of Aj and Bk to Xi	9	6	3	6
76	SUM of Bj and Bk to Xi	9	6	3	6
77	DIFFERENCE of Bj and Bk to Xi	9	6	3	6

\*Duplexed units - instruction goes to free unit

\*\*When: i = 0 the execution time is 6 minor cycles 6400/6500; 9 minor cycles 6000/6200

i = 1-5 the execution times is 12 minor cycles 6400/6500; 15 on 6000/6200

i = 6 or 7 the execution time is 10 minor cycles 6400/6500; 13 on 6000/6200, 13 on 6000/6200, 12 on 6700 CPU-1

\*\*\*50-57: "A" register reserved for 3 minor cycles.

When "i" = 1-5 then Xi register reserved for 8 minor cycles.

When "i" = 6-7 then Xi register reserved for 9 minor cycles.

† When: i = 0 the execution time is 6 minor cycles  
i = 1-5 the execution time is 14 minor cycles  
i = 6 or 7 the execution time is 12 minor cycles

## 6600/6700 CENTRAL PROCESSOR TIMING NOTES

1. The times given in Table B-1 are computational times - the time needed after the execution start until the result is computed and ready to be stored into the result register.
2. The functional units are not freed until one minor cycle after the result has been stored into the result register.
3. A result register value may be used as an operand to another instruction as soon as the result has been stored into the register (same minor cycle). This result register will not be freed to be used as a result register of another instruction until one cycle after the result has been stored into that register (no trunk priority considered).
4. An instruction is issued to a functional unit if:
  - a) The word containing the instruction is in the stack and the U registers,
  - b) The functional unit(s) needed are free, and
  - c) The result register(s) needed are free (note Table B-2 and B-3).

If these three conditions are not met, a first order conflict exists and all further instruction issues are held until they are satisfied. Each issued 15-bit instruction requires one minor cycle before the next instruction is available for issue. Each issued 30-bit instruction requires two minor cycles before the next instruction is available for issue.

5. Execution within a functional unit does not start until the operands are available (note Table B-3). The two operands required are fetched from the registers at the same time (one operand is not loaded while the unit waits for a second operand).
6. In instructions 02-07, where more than one functional unit is used, the instruction is not issued until both functional units involved are free.
7. Times given for instructions 01-07 and 50-57 do not consider any memory conflict conditions.

8. In instructions 50-57, if  $i = 1, 2 \dots 5$  (load from memory instructions), the  $X_i$  register value is not available until 8 minor cycles after the start of the instruction execution (assuming no memory conflicts). When two load instructions begin execution one minor cycle apart, one extra minor cycle is required for execution of the later instruction. Therefore, the second executed instruction would require 9 cycles for the load, 5 cycles for the Increment Unit, and 4 cycles for the A register.
9. In instructions 50-57, if  $i = 6$  or  $7$  (store to memory instructions), the  $X_i$  register is not available for a result register until 10 minor cycles after the instruction begins execution (assuming no memory conflicts).
10. When executing sequential instructions, the minimum time is one word of instructions every 8 cycles for instructions out of stack and every 4 cycles for instructions in stack. The time of issue of the last parcel of an instruction word to the time of issue of the first parcel of the next instruction word, while executing sequential instructions out of stack is 4 cycles, and 1 cycle for those in stack. If the last instruction in an instruction word is a 30-bit instruction, a minimum of 5 cycles (out of stack) and 2 cycles (in stack) are required from the time of issue to a functional unit of this instruction to the time of issue at the first instruction in the next word. An instruction word is parcelled as illustrated below.

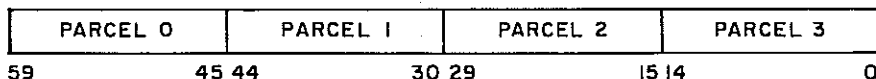

11. When a branch out of the stack is taken, 15 minor cycles are normally required for a 03ijk instruction and 14 minor cycles are normally required for other branch instructions (considering no memory conflict). The latter timing is from the start of branch instruction execution to the point when the instruction at the branch address is ready for issue to a functional unit.
12. Nine cycles are required for 03ijk instructions when the branch is taken within the stack. The next sequential word is recognized as within the stack.

13. Eight cycles are required for 04ijk to 07ijk instructions when the branch is taken within the stack. The next sequential word is recognized as within the stack.
14. Eleven cycles are required for 03ijk instructions when the branch is not taken (time from branch execution to issue of next instruction) if in the stack or if falling through to the same word. Out of the stack fall-through to the next word takes 14 cycles.
15. Ten cycles are required for 04ijk to 07ijk instructions when the branch is not taken (time from branch execution to issue of next instruction) if in the stack or if falling through to the same word. Out of the stack fall-through to the next word takes 13 cycles.
16. The B0 register is handled as any other Bi register for timing purposes (i. e., B0 will hold up execution of an instruction if it is a result register of a previous noncompleted instruction, etc.).
17. Neither Increment Unit may be involved in a load operation if a store operation is to be issued, and neither Increment Unit may be involved in a store operation if a load operation or a store operation is to be issued. The sequential loading of instruction words does not affect the load/store conditions of the Increment Units. Increments of A0 are considered neither loads nor stores.
18. The operand registers are available to more than one functional unit in the same minor cycles if the units are in different groups.

<u>Group 1</u>	<u>Group 2</u>	<u>Group 3</u>
Boolean	Shift	Increment 1
Divide	Floating Add	Increment 2
Multiply 1	Long Add	
Multiply 2		

19. The time needed for a functional unit to operate on indefinite, out-of-range, or zero values is the same as for normal, in-range values (i. e., no gain or loss in execution time due to a unit recognizing an indefinite operand and setting an indefinite result).

20. An Index Jump instruction (02) will always destroy the stack. If an unconditional jump back in the stack is desired, a 0400K instruction may be used (to save memory access time for instructions).
21. A Return Jump instruction (01) will always destroy the stack.
22. After a result has been computed by a functional unit, the result register is checked to see if it is still needed as an operand register for a previously issued instruction. This is done so that a result will not overlay an operand to a previously issued instruction.
23. In cases of bank conflict, unaccepted addresses get a chance at access every three minor cycles. If the address can then be accessed, the memory operation proceeds. If the bank is still busy, the address circulates in the hopper, while access is permitted for any other source requesting access.

TABLE B-2. FUNCTIONAL UNIT DATA TRUNK ASSIGNMENTS AND PRIORITY

FUNCTIONAL UNIT	RESULT (i)		OPERAND (j)		OPERAND (k)	
	Trunk	Priority	Trunk	Priority	Trunk	Priority
<u>Group 1: Shift</u>	3 (X)	} * 1	1	2	2	2
	4 (B)					
Add	3	2	1	1	2	1
Long Add	3	3	1	3	2	3
<u>Group 2: Boolean</u>	7	1	5	4	6	4
Divide	7	2	5	1	6	1
Multiply 1	7	3	5	2	6	2
Multiply 2	7	4	5	3	6	3
<u>Group 3: Increment 1</u>	10	1	8	1	9	1
Increment 2	10	2	8	2	9	2

\*The Shift Unit is sometimes required to store two results at one time: one into an X register and one into a B register.

TABLE B-3. 6600/6700 REGISTER RESERVATION CONTROL

INSTRUCTION	XBA RESULT REGISTER (ISSUE)	Q OPERAND REGISTER (EXECUTION)
Branch Unit 02ijk 03ijk 04ijk	-	Bi & Bj Xi & Xj Bi & Bj
Boolean Unit 10ijk - 17ijk	Xi	Xj & Xk
Shift Unit 20, 21 ijk 22, 23, 27, 43ijk 24, 25, 26ijk	Xi Xi Xi & Bj	Xi & Bj Bj & Xk Bj & Xk
Add Unit (Floating) 30ijk - 35ijk	Xi	Xj & Xk
Long Add (Integer) 36ijk - 37ijk	Xi	Xj & Xk
Multiply (2 Units) 40ijk - 42ijk	Xi	Xj & Xk
Divide Unit 44ijk - 47ijk	Xi	Xj & Xk
Increment (2 Units) 50ijk 51ijk 52ijk 53ijk 54ijk & 55ijk 56ijk & 57ijk 60ijk 61ijk 62ijk 63ijk 64ijk & 65ijk 66ijk & 67ijk 70ijk 71ijk 72ijk 73ijk 74ijk & 75ijk 76ijk & 77ijk	Ai & Xi * Ai & Xi * Ai & Xi * Ai & Xi * Ai & Xi * Ai & Xi * Bi Bi Bi Bi Bi Bi Bi Bi Bi Bi Xi Xi Xi Xi Xi Xi	Aj & Bk ** Bj & Bk ** Xj & Bk ** Xj & Bk Aj & Bk Bj & Bk Aj & Bk ** Bj & Bk ** Xj & Bk ** Xj & Bk Aj & Bk Bj & Bk Aj & Bk ** Bj & Bk ** Xj & Bk ** Xj & Bk Aj & Bk Bj & Bk

\* The Xi register is considered only when i = 1, 2...7.

\*\* k here refers to the high order 3 bits of 18-bit address field.

## PERIPHERAL AND CONTROL PROCESSOR

The execution time of Peripheral and Control Processor instructions is influenced by the following factors:

- Number of memory references - indirect addressing and indexed addressing require an extra memory reference. Instructions in 24-bit format require an extra reference to read m.
- Number of words to be transferred - in I/O instructions and in references to Central Memory the execution times vary with the number of words to be transferred. The maximum theoretical rate of flow is one word/major cycle. I/O word rates depend upon the speed of external equipments which are normally much slower than the computer.
- References to Central Memory may be delayed if there is conflict with Central Processor memory requests.
- Following an Exchange Jump instruction, no memory references (nor other Exchange Jump instructions) may be made until the Central Processor has completed the Exchange Jump.

TABLE B-4. PERIPHERAL AND CONTROL PROCESSOR  
INSTRUCTION EXECUTION TIMES

OCTAL CODE	NAME	TIME* (MAJOR CYCLES)
00	Pass	1
01	Long jump to m + (d)	2-3
02	Return jump to m + (d)	3-4
03	Unconditional jump d	1
04	Zero jump d	1
05	Nonzero jump d	1
06	Plus jump d	1
07	Minus jump d	1
10	Shift d	1
11	Logical difference d	1
12	Logical product d	1
13	Selective clear d	1
14	Load d	1

\*Note that the shorter time is taken in certain instructions when d = 0.



TABLE B-4. (Cont'd)

OCTAL CODE	NAME	TIME* (MAJOR CYCLES)
15	Load complement d	1
16	Add d	1
17	Subtract d	1
20	Load dm	2
21	Add dm	2
22	Logical product dm	2
23	Logical difference dm	2
24	Pass	1
25	Pass	1
260	Exchange jump	1**
27	Read program address	1
30	Load (d)	2
31	Add (d)	2
32	Subtract (d)	2
33	Logical difference (d)	2
34	Store (d)	2
35	Replace add (d)	3
36	Replace add one (d)	3
37	Replace subtract one (d)	3
40	Load ((d))	3
41	Add ((d))	3
42	Subtract ((d))	3
43	Logical difference ((d))	3
44	Store ((d))	3
45	Replace add ((d))	4
46	Replace add one ((d))	4
47	Replace subtract one ((d))	4
50	Load (m + ((d))	3-4
51	Add (m + (d))	3-4
52	Subtract (m + (d))	3-4
53	Logical difference (m + (d))	3-4
54	Store (m + (d))	3-4

\*Note that the shorter time is taken in certain instructions when  $d = 0$ .

\*\*Though the execution time for this instruction in the Peripheral and Control Processor is only 1 major cycle, a minimum of 2 major cycles is required to complete the Exchange operation in Central Memory. Thus, Central Memory honors no requests for access for a minimum of 2 major cycles during an Exchange Jump.

TABLE B-4. (Cont'd)

OCTAL CODE	NAME	TIME* (MAJOR CYCLES)
55	Replace add (m + (d))	4-5
56	Replace add one (m + (d))	4-5
57	Replace subtract one (m + (d))	4-5
60	Central read from (A) to d	min. 6
61	Central read (d) words from (A) to m	5 plus 5/word
62	Central write to (A) from d	min. 6
63	Central write (d) words to (A) from m	5 plus 5/word
64	Jump to m if channel d active	2
65	Jump to m if channel d inactive	2
66	Jump to m if channel d full	2
67	Jump to m if channel d empty	2
70	Input to A from channel d	2
71	Input (A) words to m from channel d	4 plus 1/word
72	Output from A on channel d	2
73	Output (A) words from m on channel d	4 plus 1/word
74	Activate channel d	2
75	Disconnect channel d	2
76	Function (A) on channel d	2
77	Function m on channel d	2

\*Note that the shorter time is taken in certain instructions when d = 0.

Appendix C

**OPERATION TABLES FLOATING  
POINT ARITHMETIC**



## FLOATING POINT ARITHMETIC OPERATION TABLES

The following is a tabulation of operations (Add, Subtract, Multiply, Integer Multiply, Divide) using various combinations of operands to supplement Table 3-5 (page 3-17). The key to operands and results used in the table is as follows:

KEY:

OPERANDS		RESULTS	
+0	= 0000 X...X	0	= 0000 0...0
-0	= 7777 X...X	IND	= 1777 0...0
+∞	= 3777 X...X	+∞	= 3777 0...0
-∞	= 4000 X...X	-∞	= 4000 0...0
+IND	= 1777 X...X	▽	= Any result except 0, IND, or ±∞.
-IND	= 6000 X...X		
W	= Any word except ±∞, ±IND		
N	= Any word except ±∞, ±IND, or ±0		

### ADD

$$X_i = X_j + X_k$$

(Instructions 30, 32, 34)

		X <sub>k</sub>			
		W	+∞	-∞	±IND
X <sub>j</sub>	W	-	+∞	-∞	IND
	+∞		+∞	IND	IND
	-∞		IND	-∞	IND
	±IND				IND

### SUBTRACT

$$X_i = X_j - X_k$$

(Instructions 31, 33, 35)

		X <sub>k</sub>			
		W	+∞	-∞	±IND
X <sub>j</sub>	W	-	-∞	+∞	IND
	+∞		+∞	IND	IND
	-∞		-∞	-∞	IND
	±IND		IND	IND	IND

MULTIPLY

$$X_i = X_j * X_k$$

(Instructions 40, 41, 42)

		X <sub>k</sub>						
		+N	-N	+0	-0	+∞	-∞	±IND
X <sub>j</sub>	+N	▽	▽	0	0	+∞	-∞	IND
	-N		▽	0	0	-∞	+∞	IND
	+0			Reserved for Integer Multiply		IND	IND	IND
	-0			Reserved for Integer Multiply		IND	IND	IND
	+∞			Reserved for Integer Multiply		+∞	-∞	IND
	-∞			Reserved for Integer Multiply			+∞	IND
	±IND			Reserved for Integer Multiply				IND

DIVIDE

$$X_i = X_j / X_k$$

(Instructions 44, 45)

		X <sub>k</sub>						
		+N	-N	+0	-0	+∞	-∞	±IND
X <sub>j</sub>	+N	-	-	+∞	-∞	0	0	IND
	-N	-	-	-∞	+∞	0	0	IND
	+0	0	0	IND	IND	0	0	IND
	-0	0	0	IND	IND	0	0	IND
	+∞	+∞	-∞	+∞	-∞	IND	IND	IND
	-∞	-∞	+∞	-∞	+∞	IND	IND	IND
	±IND	IND	IND	IND	IND	IND	IND	IND

KEY FOR INTEGER MULTIPLY:

OPERANDS	RESULTS
0=0000 0 ... 0	+0=0000 0 ... 0
-0=7777 7 ... 7	-0=7777 7 ... 7
+INT=0000 X ... X	+INT=0000 X ... X
-INT=7777 X ... X	-INT=7777 X ... X

INTEGER MULTIPLY  
 $X_i = X_j * X_k$  (Instruction 42)

X <sub>j</sub>	X <sub>k</sub>			
	+INT	-INT	+0	-0
+INT	+INT	-INT	+0	-0
-INT	-INT	+INT	-0	+0
+0	+0	-0	+0	-0
-0	-0	+0	-0	+0

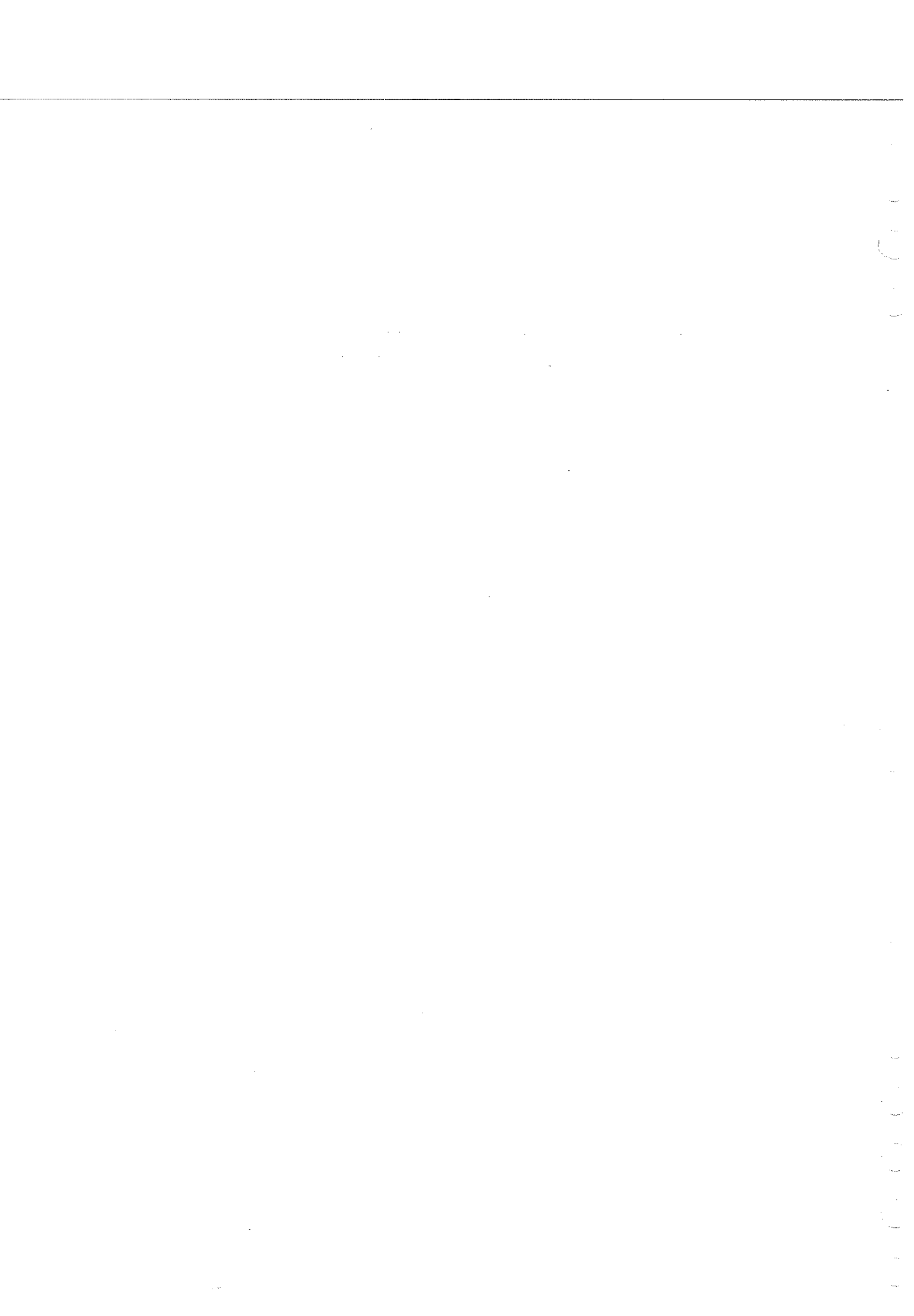



**Appendix D**

**INCREMENT ADDER**



## INCREMENT ADDER

The increment adder is a one's complement subtractive adder. Obtaining negative zero as a result is possible only by adding negative zero to negative zero or subtracting positive zero from negative zero.

Examples:

$$\begin{aligned} \text{A) } & 76 \text{ SXi } B_j + B_k \text{ Sets } X_7 = 0^+ \\ & i = 7 \quad j = 0 \quad k = 0 \end{aligned}$$

$$\begin{aligned} \text{B) } & 76 \text{ SXi } B_j + B_k \text{ Sets } X_7 = 0^- \\ & i = 7 \quad j = 1 \quad k = 2 \\ & B_1 = 777777_8 \quad B_2 = 777777_8 \end{aligned}$$

$$\begin{aligned} \text{C) } & 77 \text{ SXi } B_j - B_k \text{ Sets } X_7 = 0^+ \\ & i = 7 \quad j = 0 \quad k = 0 \end{aligned}$$

$$\begin{aligned} \text{D) } & 77 \text{ SXi } B_j - B_k \text{ Sets } X_7 = 0^- \\ & i = 7 \quad j = 1 \quad k = 0 \\ & B_1 = 777777_8 \end{aligned}$$



Appendix E

**CONTROL DATA 6415-7, 6415-8 AND 6415-9  
CENTRAL COMPUTER SYSTEMS**



CONTROL DATA 64XX-7, 64XX-8 and 64XX-9

DESCRIPTION

The Control Data® 64XX-7, 64XX-8, and 64XX-9\* are special versions of the 6400 Computer System with the following system configurations:

- 64XX-9 - Central Computer with ECS Coupler, nine PPU's, and eleven data channels.
- 64XX-8 - Central Computer with ECS Coupler, eight PPU's, and ten data channels.
- 64XX-7 - Central Computer with ECS Coupler, seven PPU's, and nine data channels.

The PPU's and Data Channels removed for each system described above are illustrated by Table E-1.

TABLE E-1. REMOVED PPU'S AND DATA CHANNELS

SYSTEM	PPU'S REMOVED	DATA CHANNELS REMOVED
64XX-7	5    6    7	5            6            7
64XX-8	6    7	6            7
64XX-9	7	7

DATA CHANNEL STATUS

The Data Channels removed remain INACTIVE and EMPTY, and cannot be activated.

PERIPHERAL PROCESSING UNIT STATUS

The PPU's removed are referenced normally on Dead Start but exit from a 712 instruction during the first trip, when the INACTIVE condition is sensed on the corresponding Data Channel. The program address 0001<sub>8</sub> is then sent to the removed PPU's memory, and all sevens are "read". The PPU then attempts to function Channel 77.

\*These computers are available with memory sizes of 32K, 49K, 65K, 98K and 131K.





APPENDIX F

CENTRAL EXCHANGE JUMP (CEJ) AND MONITOR EXCHANGE JUMP (MEJ)

CENTRAL MEMORY ACCESS PRIORITY (CMAP)



## CENTRAL EXCHANGE JUMP (CEJ) AND MONITOR EXCHANGE JUMP (MEJ)

In CONTROL DATA 6000 Series Computer Systems, system functions are normally handled by the Monitor located in a Peripheral and Control Processor. The Computer Systems are equipped with certain hardware capabilities to effectively implement Monitor activities in the Central Processor. Since the Central Processor can reference Extended Core Storage directly for service routines, programs and data, a Central Processor Monitor program to handle these and other functions is faster and more efficient than a Monitor residing in a Peripheral and Control Processor.

The hardware elements which provide the essential capabilities for implementing a Central Processor Monitor are described in the ensuing paragraphs.

### MONITOR ADDRESS REGISTER

Contained in the Exchange Jump package (bits 36-53 of location "n+6") is an 18-bit Monitor Address. Just as other Central Processor operational registers are loaded during an Exchange operation, so is the Monitor Address register loaded with the 18-bit Monitor Address. This Monitor Address is the starting address of the Exchange package for an ensuing Central Exchange Jump instruction (except when the Monitor Flag bit is set; refer to the instruction description).

### MONITOR FLAG BIT

The Central Processor has, in the Central Memory control section of the system, a Monitor Flag bit. A Master Clear (Dead Start) clears the Monitor Flag bit. Any action thereafter on this bit is via the Monitor Exchange or the Central Exchange Jump instructions. (There is no instruction with which to sample the status of this bit directly and/or independently of these instructions.) The operation of this Monitor Flag bit is described under the instruction descriptions.

## MONITOR AND CENTRAL EXCHANGE JUMP INSTRUCTIONS

These instructions are enabled or disabled by the maintenance panel CEJ/MEJ key switch. The instructions are for Central Processor monitor implementation:

Two instructions exist for Central Processor monitor implementation:

one executable by the Peripheral Processors; the other executable by the Central Processor. These instructions are as detailed below.

### Peripheral Processors

261      MXN      Monitor Exchange Jump      (12 bits)

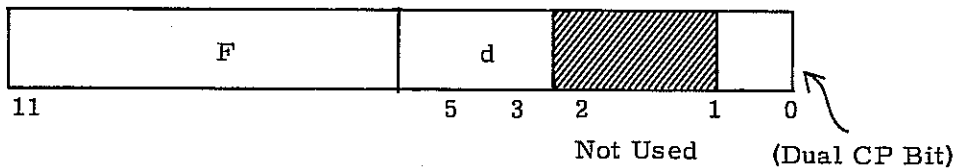

This instruction, typically used to initiate Central Processor Monitor activity, is a conditional exchange jump to the Central Processor. If the Monitor Flag bit is clear, this instruction sets the flag and initiates the exchange. If the Monitor Flag bit is set, this instruction acts as a Pass instruction. The starting address for this exchange is the 18-bit address held in the Peripheral Processor A register. (The Peripheral Processor program must have loaded A with an appropriate address prior to executing this instruction.) Note that this starting address is an absolute address. In the 6500 and 6700 this instruction is either 2610 (CPU-0) or 2611 (CPU-1).

### Central Processor

013      XJ      jK      Central Exchange Jump      (60 bits)

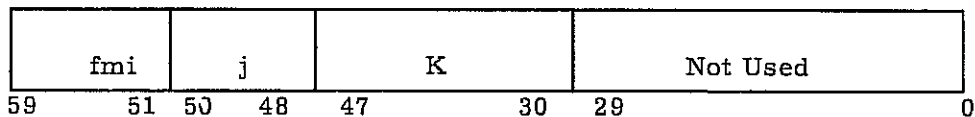

This instruction unconditionally exchange jumps the Central Processor, regardless of the state of the Monitor Flag bit. Instruction action differs, however, depending on whether the Monitor Flag bit is set or clear. Operation is as follows:

- a) Monitor Flag bit clear. The starting address for the exchange is taken from the 18-bit Monitor Address register. Note that this starting address is an absolute address. During the exchange, the Monitor Flag bit is set.

- b) Monitor Flag bit set. The starting address for the exchange is the 18-bit result formed by adding K to the contents of register Bj. Note that this starting address is an absolute address. During the exchange, the Monitor Flag bit is cleared.

Table 1 summarizes the operational differences between the normal Exchange Jump instruction (260) and the Monitor and Central Exchange Jumps (261 and 013).

TABLE 1-1. EXCHANGE INSTRUCTION DIFFERENCES

INSTRUCTION	CONDITIONAL/ UNCONDITIONAL	OPERATIONAL DIFFERENCES	
		Effect on Monitor Flag Bit	Location of Starting Address for Exchange
260 (Normal Peripheral Processor Exchange Jump)	Unconditional	No effect on Flag	Peripheral Processor A Register
261 (Peripheral Processor Monitor Exchange Jump)	Conditional (occurs only if Monitor Flag bit is clear; Passes if Flag is set)	Sets Flag	Peripheral Processor A Register
013 (Central Exchange Jump) with Monitor Flag Bit clear	Unconditional	Sets Flag	Central Processor Monitor Address Register
013 (Central Exchange Jump) with Monitor Flag Bit set	Unconditional	Clears Flag	Address formed by $K+(B_j)$

## PROGRAMMING NOTES

- 1) The Exchange package is precisely as described under Access to Central Memory in Section 4, with the single exception that bits 36-53 of location "n+6" hold a Monitor Address. Note that any exchange (260, 261, or 013) to that package will load the contents of location "n+6" into the Monitor Address register (other operational registers are similarly loaded). Thus, any ensuing 013 instruction using the contents of the Monitor Address register as a starting address uses those contents as loaded.
- 2) The Exchange packages for entering the Central Processor Monitor should usually have the Reference Address (RA) equal to 000000 and the Field Length (FL) equal to Central Memory size.
- 3) Since the Monitor Flag bit cannot directly sampled, a program cannot directly determine its state; hence, success in performing a Peripheral Processor Monitor Exchange cannot readily be predicted. Further, program control always is given to the next instruction, whether or not the Exchange is honored. A method of determining whether the Monitor Exchange occurred is as follows:
  - a) Set B0 (bits 0-17 of location "n") in the Exchange package to 7777
  - b) Initiate the Monitor Exchange (261)
  - c) Read B0 from the Exchange package in Central Memory. If the Monitor Exchange was honored, B0 in the Exchange package will equal 000000. If the instruction passed, this location still holds 7777.
- 4) Different Exchange packages should be used for Central Processor exchanges and Peripheral Processor exchanges. This aids software determination of which of two jumps (Central or Monitor Exchange Jumps) was executed when both were initiated at approximately the same time.
- 5) Simultaneous Exchange requests are resolved in favor of the Central Processor.
- 6) If either a 260 or 261 instruction is waiting to be honored when the Central Processor issues an 013 K instruction, the 013 instruction is not executed and the Peripheral Processor Exchange occurs. When control is returned to the exchanged program (the interrupted program containing the 013jK instruction), the 013jK instruction is re-issued and executed.

- 7) The state of the Monitor Flag bit has no effect on the operation of the normal PP Exchange Jump (260); nor has this instruction any effect on the Flag.

#### ADDITIONAL PROGRAMMING NOTES FOR 6500 AND 6700

1. When one CPU is in monitor mode, a Monitor Exchange Jump to either CPU will be aborted. Since the exchange was never started, the instruction is in effect a pass.
2. When one CPU is in Monitor mode, a Central Exchange Jump from the second CPU will hang until the first CPU's monitor flag is cleared.
3. If a regular exchange jump (2600) is executed with MEJ/CEJ instructions it is possible to cause both Monitor Flags to set. This condition could cause both CPU's to hang on CEJ instructions.
4. An ECS Transfer In Progress will block a Central Exchange Jump from either CPU.
5. A Monitor Exchange Jump to a CPU that has an ECS Transfer In Progress is allowed. A Monitor Exchange Jump to the other CPU, however, will be aborted until the first CPU has completed the ECS transfer.

Items 4 and 5 above are consistent with the dual access concept of the 6500/6700 coupler, i. e., if one CPU is executing an ECS instruction, the other CPU is blocked when doing any type of memory reference until the ECS transfer is complete. A normal exchange jump to a CPU doing an ECS transfer will terminate the ECS transfer and execute the exchange jump. A normal exchange jump to the other CPU will be withheld until the ECS transfer is finished in the first CPU.

## CENTRAL MEMORY ACCESS PRIORITY (CMAP)

### DESCRIPTION

CMAP is included in the E mod 6000 computer system and is optional on other 6000 systems. It modifies the PPU-Central Memory interface to provide the following:

1. A PPU may be designated a Priority PPU by setting bit  $2^{17}$  of its A register.
2. Priority PPU's have preference over other PPU's in the execution of Central Read and Central Write instructions when ECS is inactive.
3. Only Priority PPU's can interrupt ECS transfers to or from Central Memory.
4. All non-priority PPU's have equal priority for entry to the read or write pyramid.

#### Priority Central Reads

CMAP allows a Priority PPU to place a reservation for  $C^5$  (read pyramid input register from Central Memory) and Central Busy. When  $C^5$  is empty and Central Busy sets (indicating acceptance of the Priority Read) the reservation clears. The reservation prevents non-priority PPU's from setting Central Busy, so that the Priority Read is serviced within a few major cycles.

#### Priority Central Writes

CMAP allows a Priority PPU to place a reservation for  $D^1$  (input from PPU) in the write pyramid. When  $D^1$  is available, the reservation clears. The reservation prevents non-priority PPU's from writing in  $D^1$  or setting Central Busy, so that the Priority Write is serviced within a few major cycles.

#### CMAP Effect on ECS

Without CMAP, any PPU requesting Central Memory interrupts an ECS transfer in progress. Since one PPU request is honored for every ECS record, when several PPU Central Memory requests occur during an ECS transfer they can reduce the transfer rate significantly (75 per cent reduction for 500K ECS, 50 per cent reduction for 250K ECS, 125K ECS not affected).

With CMAP, however, non-priority reads and writes are prevented from entering the read and write pyramids during ECS transfers. Non-priority writes which are already in the write pyramid are not serviced until the ECS transfer terminates,



or until a Priority PPU issues a write. A non-priority read or write in the ECS coupler is serviced after the current ECS record is transferred.

#### CMAP Effect on Non-priority Central Reads

Without CMAP, a One Word Read (60) instruction which follows a Block Read (61) instruction can be delayed while the Block Read PPU waits for Central Memory. Also, a PPU which has partially completed a Block Read has a greater chance of having a Central Request honored than has a PPU which has just translated a Central Read instruction.

CMAP changes these two cases. The 12-bit word in  $C^1$  of the read pyramid is loaded unconditionally into the proper PPU memory at the PPU's slot time. In the case of a Block Read, a Flag bit in K sets if the read is not complete. The Flag bit causes the Block Read instruction to continue at the next iteration. Thus, One Single Word Reads flow through the read pyramid unhampered by Block Reads awaiting clearance from Central Memory. Furthermore, since Block Reads no longer tie up the read pyramid, all non-priority PPU's have an equal chance of having their Central Requests honored.

#### Access Priority

Two types of access priority are provided. Placing the Central Memory Access Priority (CMAP) switch in the Program Mode position, one or more peripheral processors may be assigned a priority status by setting bit  $2^{17}$  of its A register. This enables the selected peripheral processors to have preference over other peripheral processors in gaining access to central memory. It also makes it possible for a peripheral processor to interrupt an ECS transfer, which is not otherwise possible. Priority should be assigned to no more than three peripheral processors for operations when ECS is inactive because the value of priorities would thereby be defeated. For operations when ECS is active, priority usage should be limited, because even one interruption of an ECS transfer degrades the transfer rate significantly.

Placing the CMAP switch in the Constant Mode position forces  $2^{17}$  set for all peripheral processors. This makes it possible for any peripheral processor to interrupt an ECS transfer, however, there is no preferential priority among the peripheral processors.



# INDEX

- A register,
  - Central Processor, 3-6, 3-7
  - Peripheral Processor, 4-8
- Absolute memory address, 2-3
- Access to the Central Processor, 4-34
- Address, Peripheral and Control Processors, 4-4
- Address,
  - absolute, 2-3
  - Central Memory, 2-1
  - modes, 4-6
  - program, 3-8
  - relative, 2-3
  - reference, 2-2
- Arithmetic,
  - fixed point, 3-21
  - floating point, 3-15
  - non-standard floating point, C-1
- Arithmetic unit, 3-1
- Augmented Input/Output Buffer and Control, A-1
  - systems configuration, A-2, A-3
  - instructions, A-4
- B register, Central Processor, 3-6
- Barrel, 4-4
  - registers, 4-8
- Banks, Central Memory, 2-1
- Block transfer, 4-2, 4-29, 4-30, 4-32, 4-33, 4-34
- Branch instructions, 3-43
- CEJ/MEJ CMAP, F-6
- Central Exchange Jump, F-1
- Central Memory, 2-1
  - access, 2-1, 4-32, F-6
  - address format, 2-1
  - bank conflict, 2-2
  - characteristics,
    - map, 2-3
  - organization, 2-1
  - protection, 2-2
  - read, 4-32
  - write, 4-33
- Central Processor, 3-1
  - Differences, 3-1
  - Exchange Jump, 3-9
  - Exit mode, 3-11
  - fixed point arithmetic, 3-21
  - floating point arithmetic, 3-15
  - functional units, 3-5
  - instruction descriptions, 3-22
  - instruction execution times, B-1
  - instruction formats, 3-5
  - operating registers, 3-6
  - organization, 3-1
  - programming, 3-4
  - timing notes, B-9
- Clock, see Real-Time Clock
- CMAP, F-6
- Coefficient, 3-15, 3-16, 3-35
- Concurrency, 3-2
- Conflict, Bank, 2-2
- Console, see Display Console
- Control unit, 3-1
  - output, 4-30
  - word rate, 4-36
- Dead start panel, 6-1
- Display Console, 6-4
  - character mode, 6-4
  - dot mode, 6-5
  - sample display, photograph, 6-6
- Dot mode, 6-4
- Double precision, 3-16
- Exchange Jump, 2-3, 3-4, 3-9, 3-51, 4-34, 5-1
  - instruction, 4-24, F-2
  - package, 3-9
- Exit mode, 3-11, 5-2
- Exponent, 3-15, 3-16, 3-35
- Extended Core Storage, instructions, 3-46
- Field Length, 2-3, 3-9, 3-49, 3-50
- Fixed point arithmetic, 3-21
  - instructions, 3-28
- Flags, 4-2, 4-36, F-1
- Floating point arithmetic, 3-15
  - converting integers to floating format, 3-19
  - instructions, 3-37
  - operation tables, C-1
  - overflow and underflow conditions, 3-19, 3-20
- Functional units, Central Processor, 3-5
- Hopper, 2-2
- Illegal Codes, 3-22
- Indefinite forms, 3-17, 3-18, 3-19
  - see also Floating Point Arithmetic,
    - operation tables, C-1
- Input/Output, 4-2, 4-27
  - channels, 4-2
    - see also Data Channels
  - data flow, 4-1
  - data input, 4-37
  - data output, 4-38
- Interrupt, 5-1
  - hardware provisions, 5-1
- Instructions, Central Processor, 3-22
  - Branch, 3-43
  - Exchange Jump, F-2
  - execution, 3-3
  - execution times, B-1
  - Extended Core Storage, 3-46
  - fixed point arithmetic, 3-28
  - floating point, 3-37
  - formats, 3-5
  - Increment, 3-24
  - Logical, 3-29
  - Mask, 3-36
  - No Operation, 3-23
  - Normalize, 3-34, 3-16
  - Pack, 3-36
  - Program Stop, 3-23
  - Round and Normalize, 3-34
  - Shift, 3-32
  - Unpack, 3-35
- Instructions, Peripheral and Control Processors, 4-1
  - Arithmetic, 4-13
  - Branch, 4-22
  - Central Processor and Central Memory, 4-24,
  - Data Transmission, 4-11
  - execution times, B-1
  - formats, 4-6
  - input/output, 4-27

Logical, 4-16  
 Monitor Exchange Jump, F-2  
 No Operation, 4-10  
 Replace, 4-19  
 Shift, 4-16  
 Instruction execution times, B-1  
   Central Processor table, B-6  
   Peripheral and Control Processor table, B-14  
 Interprocessor communication, 4-3  
  
 Jump, see Branch  
  
 K register, Peripheral and Control Processor, 4-9  
 Keyboard input, 6-4  
  
 Manual control, 6-1  
 Mass memory, see Extended Core Storage  
 Mnemonics,  
   Compass, 3-23  
   Peripheral Processor, 4-10  
   Central Processor, 3-23  
 Mode,  
   Dump, 6-2  
   Exit, 3-11  
   Load, 6-1  
   Monitor, F-5  
   Sweep, 6-2  
 Modes, address (Peripheral Processor), 4-6  
 Monitor Address Register, F-1  
 Monitor Exchange Jump, F-1  
  
 Normalizing, 3-16, 3-34  
  
 Operands,  
   examples of, 3-25  
   indefinite, 3-16  
   infinite, 3-16  
 Output, 4-38  
  
 P register,  
   Central Processor, 3-8  
   Peripheral and Control Processor, 4-9  
 Peripheral and Control Processors, 4-1  
   access to Central Memory, 4-32  
   adders, 4-4  
   address modes, 4-6  
   barrel, 4-4  
   characteristics, 1-2  
   input/output, 4-35  
   input/output (I/O) channels, 4-2  
   instruction descriptions, 4-9  
   instruction formats, 4-6  
   organization, 4-1  
   programming, 4-6  
   real-time clock, 4-3, 4-39  
   registers, 4-8  
   slot, 4-4  
 Priority  
 Program Address register,  
   Central Processor, 3-8  
   Peripheral and Control Processor, 4-9  
 Programs, Central Processor, 3-3  
   Bounds, 2-3, 3-13  
 Pyramid,  
   read, 4-5, 4-32  
   write, 4-5, 4-33  
  
 Q register, Peripheral and Control Processor, 4-9  
  
 Range definitions, 3-17  
 Range faults, 2-3  
 Real-time clock, 4-3, 4-39  
 Reference address, 2-2  
 Registers, Central Processor  
   address (A), 3-2, 3-6, 3-7, 3-9  
   increment (B), 3-2, 3-6, 3-7, 3-9  
   operand (X), 3-2, 3-6, 3-7, 3-9  
   Program Address (P), 3-8  
 Registers, Peripheral and Control Processors, 4-8  
   arithmetic (A), 4-8  
   K register, 4-9  
   Program Address (P), 4-9  
   Q register, 4-9  
 Relative memory address, 2-3  
 Reservation Conflict, 3-3  
 Reservation Control, 3-3  
   Register, B-13  
 Rounding, 3-16  
  
 Single precision, 3-16  
 Slot, 4-4  
 Stack, Instruction, 3-4, 3-10  
 Status channel and equipment, 5-1  
 Stops, Central Processor,  
   flow chart, 3-14  
   illegal packing, 3-6  
 Stunt box, 2-1  
  
 Tags, 2-2  
  
 Unified Arithmetic Section, 3-2  
  
 X register, Central Processor, 3-6, 3-7

# COMMENT SHEET

MANUAL TITLE CDC 6000 Series Computer Systems

Hardware Reference Manual

PUBLICATION NO. 60100000 REVISION AL

**FROM:** NAME: \_\_\_\_\_  
BUSINESS \_\_\_\_\_  
ADDRESS: \_\_\_\_\_

## COMMENTS:

This form is not intended to be used as an order blank. Your evaluation of this manual will be welcomed by Control Data Corporation. Any errors, suggested additions or deletions, or general comments may be made below. Please include page number references and fill in publication revision level as shown by the last entry on the Revision Record page at the front of the manual. Customer engineers are urged to use the TAR.

CUT ALONG LINE

PRINTED IN U.S.A.

AA3419 REV. 6/78

NO POSTAGE STAMP NECESSARY IF MAILED IN U. S. A.

FOLD ON DOTTED LINES AND STAPLE

STAPLE

STAPLE

THREE THIRTIETHS

THREE THIRTIETHS

THREE THIRTIETHS

THREE THIRTIETHS

THREE THIRTIETHS

THREE THIRTIETHS

THREE THIRTIETHS

THREE THIRTIETHS

THREE THIRTIETHS

FOLD

FIRST CLASS  
PERMIT NO. 8241

MINNEAPOLIS, MINN.

**BUSINESS REPLY MAIL**

NO POSTAGE STAMP NECESSARY IF MAILED IN U.S.A.

POSTAGE WILL BE PAID BY  
**CONTROL DATA CORPORATION**  
Publications and Graphics Division  
ARH219  
4201 North Lexington Avenue  
Saint Paul, Minnesota 55112

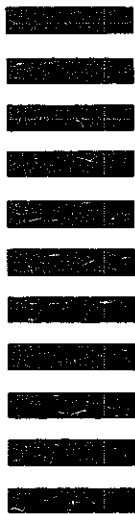

CUT ALONG LINE

FOLD