

25550
HOST
COMMUNICATION
PROCESSOR

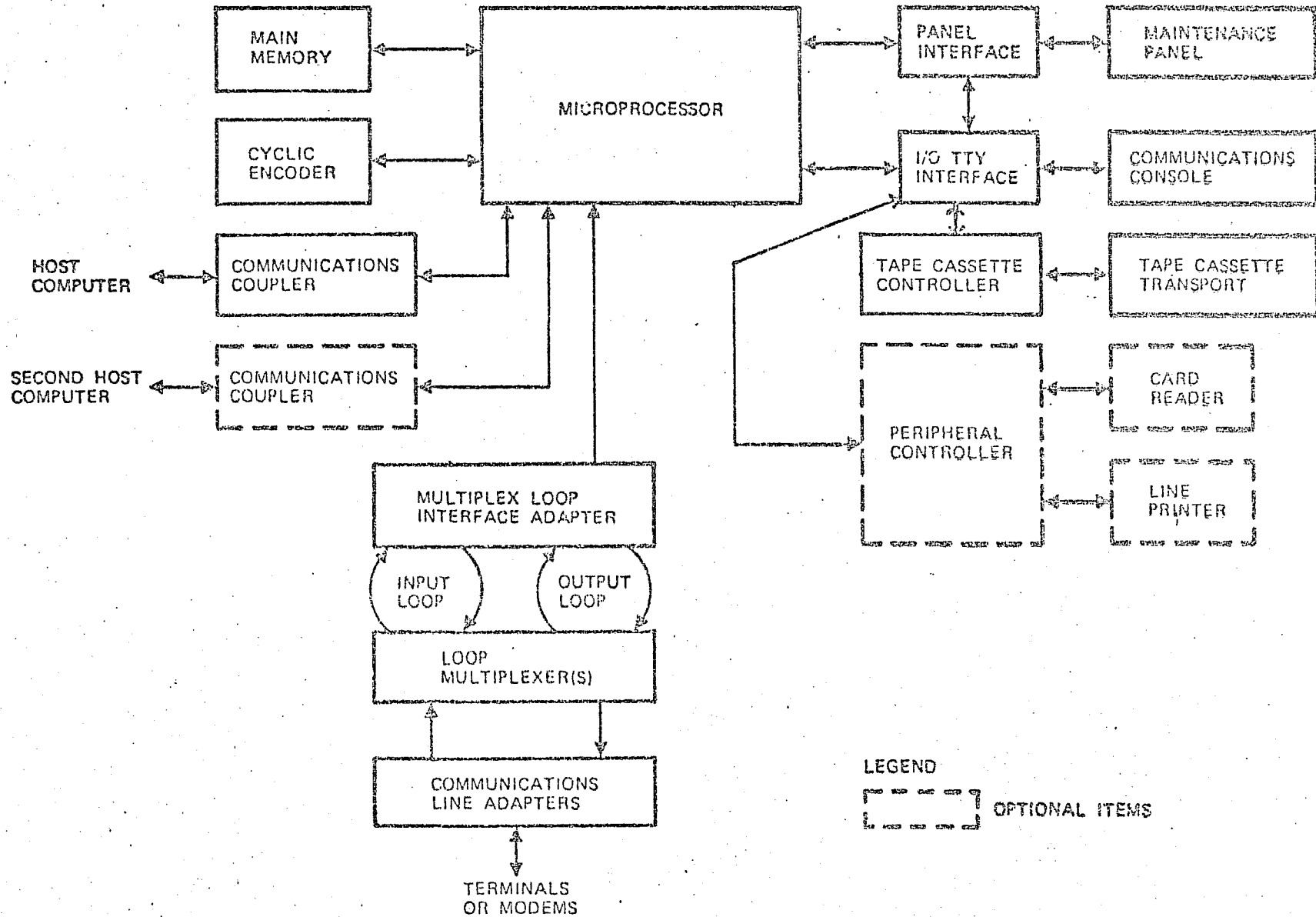

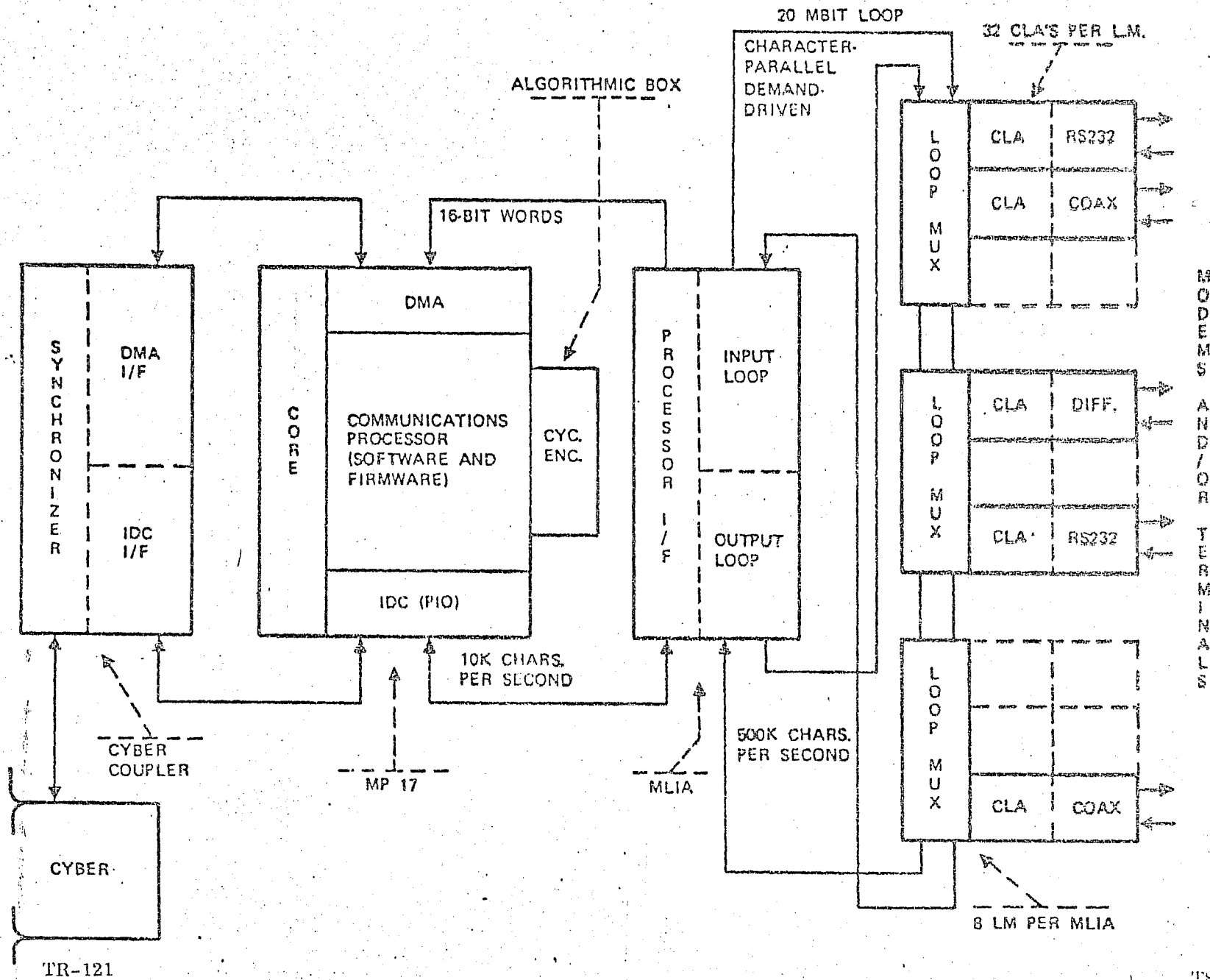



CYBER Coupler Registers

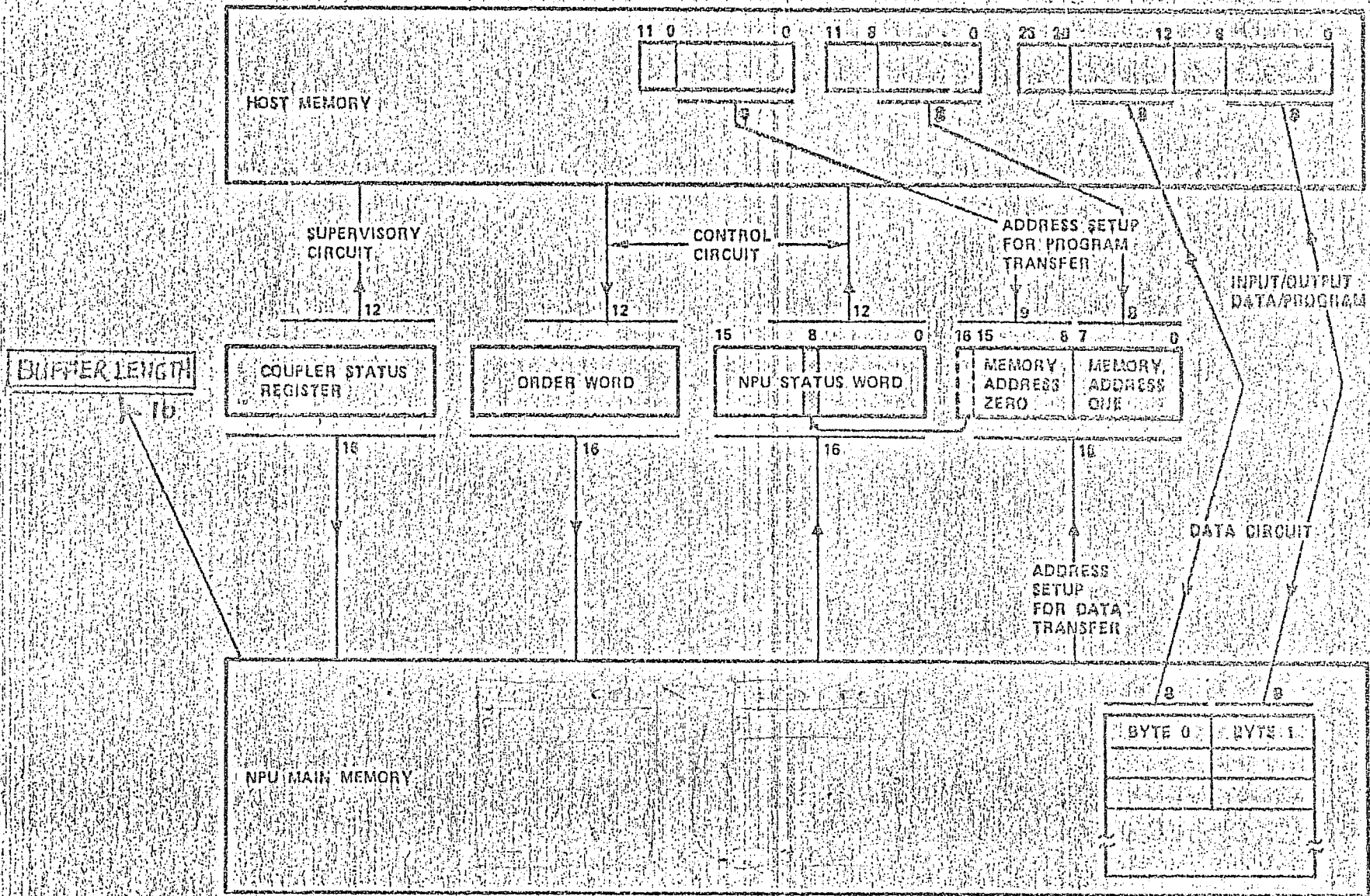

I/O PROGRAMMING FORMATS

COMMUNICATIONS COUPLER PPU FUNCTION CODES

	11	10	9	8	7	6	5	4	3	2	1	0	
Equip Code (=7)	1	0	0	0	0				X	X	X	X	Clear Coupler
	0	1	0	0					X	X	X	X	Clear CP
	0	0	1	0					X	X	X	X	Stop CP
	0	0	0	1					X	X	X	X	Start CP
	X	X	X	X					0	0	0	0	Input Memory Address Zero*
	X	X	X	X					0	0	0	1	Input Memory Address One*
	X	X	X	X					0	0	1	0	
	X	X	X	X					0	0	1	1	Input Data
	X	X	X	X					0	1	0	0	Input CP Status
	X	X	X	X					0	1	0	1	Input Coupler Status
	X	X	X	X					0	1	1	0	Input Order Word*
	X	X	X	X					0	1	1	1	Input Program
	X	X	X	X					1	0	0	0	Output Memory Address Zero (upper byte)
	X	X	X	X					1	0	0	1	Output Memory Address One (lower byte)
	X	X	X	X					1	0	1	0	
	X	X	X	X					1	0	1	1	
	X	X	X	X					1	1	0	0	Output Data
	X	X	X	X					1	1	0	1	Output Program
	X	X	X	X					1	1	1	0	Output Order Word
	X	X	X	X					1	1	1	1	

*Hardware Maintenance feature

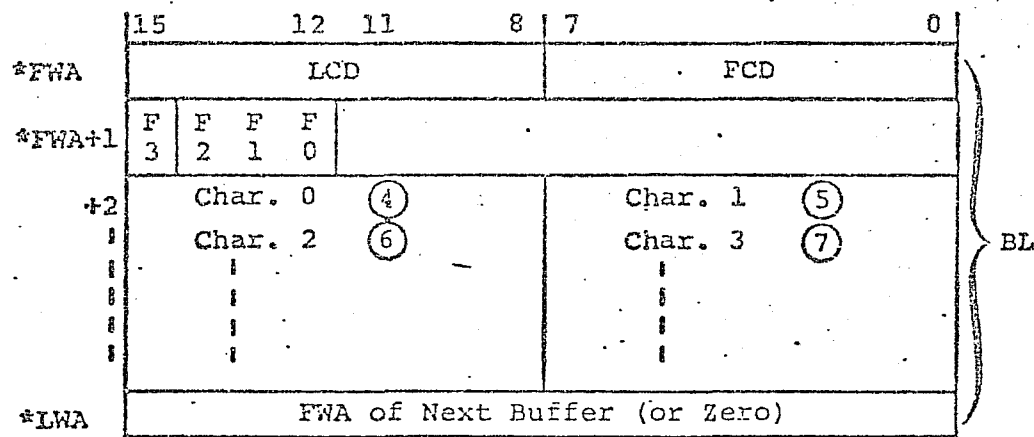

- FWA = First Word Address of Buffer (must be multiple of BL)
- LWA = Last Word Address of Buffer (LWA = FWA + (BL-1))
- LCD = Last Character Displacement (relative to FWA)
- FCD = First Character Displacement (relative to FWA)
- F3 = Last Buffer Flag
- F2-F0 = Last Character Flag (place succeeding character in next buffer(s))
- BL = Buffer Length (words) $BL=2^N$, $2 \leq N$ (integer) ≤ 7
- CD = Character Displacement ($4 \leq CD \leq 253$)
- *Control words placed in core before data I/O

NOTE: $LCD \geq FCD$. If $LCD < FCD$, buffer is skipped and operation points to the next buffer chain.

15	14	13	12	11	10	9	8	7	6	5	4	3	2	1	0																																																																																																									
0	0	0	0	0	1	E	E	E																																																																																																																
Equipment Address														Not Used																																																																																																										
First Coupler = 1100 ('C') (Standard)																																																																																																																								
Second Coupler = 1101 ('D') (Optional)																																																																																																																								
Sample (Read)																																																																																																																								
Set (Write)																																																																																																																								
<table border="1"> <tr> <td>0 0 0</td> <td>0 0</td> <td>Input Memory Address Zero*</td> </tr> <tr> <td>0 0 1</td> <td>0 0</td> <td>Input Memory Address</td> </tr> <tr> <td>0 1 0</td> <td>0 0</td> <td></td> </tr> <tr> <td>0 1 1</td> <td>0 0</td> <td>Input First/Present Character Displacement</td> </tr> <tr> <td>1 0 0</td> <td>0 0</td> <td>Input CP Status*</td> </tr> <tr> <td>1 0 1</td> <td>0 0</td> <td>Input Coupler Status</td> </tr> <tr> <td>1 1 0</td> <td>0 0</td> <td>Input Order Word</td> </tr> <tr> <td>1 1 1</td> <td>0 0</td> <td>Input IO*</td> </tr> <tr> <td colspan="3"> </td> </tr> <tr> <td>0 0 0</td> <td>0 1</td> <td>Input Last Word From Data Channel*</td> </tr> <tr> <td>0 0 1</td> <td>0 1</td> <td>Input FDMAR0/FDMAR1*</td> </tr> <tr> <td>0 1 0</td> <td>0 1</td> <td>Input FDMAR0/Flag Mux*</td> </tr> <tr> <td>0 1 1</td> <td>0 1</td> <td>Input FDMAR1/Flag Mux/Flag Register*</td> </tr> <tr> <td>1 0 0</td> <td>0 1</td> <td></td> </tr> <tr> <td>1 0 1</td> <td>0 1</td> <td>Input Switch Status</td> </tr> <tr> <td>1 1 0</td> <td>0 1</td> <td></td> </tr> <tr> <td>1 1 1</td> <td>0 1</td> <td>Input Character*</td> </tr> <tr> <td colspan="3"> </td> </tr> <tr> <td>0 0 0</td> <td>1 0</td> <td>Output Memory Address Zero*</td> </tr> <tr> <td>0 0 1</td> <td>1 0</td> <td></td> </tr> <tr> <td>0 1 0</td> <td>1 0</td> <td></td> </tr> <tr> <td>0 1 1</td> <td>1 0</td> <td>Output FCD, PCD, LCD*</td> </tr> <tr> <td>1 0 0</td> <td>1 0</td> <td>Output CP Status</td> </tr> <tr> <td>1 0 1</td> <td>1 0</td> <td>Output Buffer Length</td> </tr> <tr> <td>1 1 0</td> <td>1 0</td> <td>Output Order Word*</td> </tr> <tr> <td>1 1 1</td> <td>1 0</td> <td></td> </tr> <tr> <td colspan="3"> </td> </tr> <tr> <td>0 0 0</td> <td>1 1</td> <td>Clear Coupler</td> </tr> <tr> <td>0 0 1</td> <td>1 1</td> <td>Terminate Transfer</td> </tr> <tr> <td>0 1 0</td> <td>1 1</td> <td></td> </tr> <tr> <td>0 1 1</td> <td>1 1</td> <td></td> </tr> <tr> <td>1 0 0</td> <td>1 1</td> <td>Output Test*</td> </tr> <tr> <td>1 0 1</td> <td>1 1</td> <td>Input Test*</td> </tr> <tr> <td>1 1 0</td> <td>1 1</td> <td>Output Memory Address</td> </tr> <tr> <td>1 1 1</td> <td>1 1</td> <td>Output Character*</td> </tr> </table>																0 0 0	0 0	Input Memory Address Zero*	0 0 1	0 0	Input Memory Address	0 1 0	0 0		0 1 1	0 0	Input First/Present Character Displacement	1 0 0	0 0	Input CP Status*	1 0 1	0 0	Input Coupler Status	1 1 0	0 0	Input Order Word	1 1 1	0 0	Input IO*				0 0 0	0 1	Input Last Word From Data Channel*	0 0 1	0 1	Input FDMAR0/FDMAR1*	0 1 0	0 1	Input FDMAR0/Flag Mux*	0 1 1	0 1	Input FDMAR1/Flag Mux/Flag Register*	1 0 0	0 1		1 0 1	0 1	Input Switch Status	1 1 0	0 1		1 1 1	0 1	Input Character*				0 0 0	1 0	Output Memory Address Zero*	0 0 1	1 0		0 1 0	1 0		0 1 1	1 0	Output FCD, PCD, LCD*	1 0 0	1 0	Output CP Status	1 0 1	1 0	Output Buffer Length	1 1 0	1 0	Output Order Word*	1 1 1	1 0					0 0 0	1 1	Clear Coupler	0 0 1	1 1	Terminate Transfer	0 1 0	1 1		0 1 1	1 1		1 0 0	1 1	Output Test*	1 0 1	1 1	Input Test*	1 1 0	1 1	Output Memory Address	1 1 1	1 1	Output Character*
0 0 0	0 0	Input Memory Address Zero*																																																																																																																						
0 0 1	0 0	Input Memory Address																																																																																																																						
0 1 0	0 0																																																																																																																							
0 1 1	0 0	Input First/Present Character Displacement																																																																																																																						
1 0 0	0 0	Input CP Status*																																																																																																																						
1 0 1	0 0	Input Coupler Status																																																																																																																						
1 1 0	0 0	Input Order Word																																																																																																																						
1 1 1	0 0	Input IO*																																																																																																																						
0 0 0	0 1	Input Last Word From Data Channel*																																																																																																																						
0 0 1	0 1	Input FDMAR0/FDMAR1*																																																																																																																						
0 1 0	0 1	Input FDMAR0/Flag Mux*																																																																																																																						
0 1 1	0 1	Input FDMAR1/Flag Mux/Flag Register*																																																																																																																						
1 0 0	0 1																																																																																																																							
1 0 1	0 1	Input Switch Status																																																																																																																						
1 1 0	0 1																																																																																																																							
1 1 1	0 1	Input Character*																																																																																																																						
0 0 0	1 0	Output Memory Address Zero*																																																																																																																						
0 0 1	1 0																																																																																																																							
0 1 0	1 0																																																																																																																							
0 1 1	1 0	Output FCD, PCD, LCD*																																																																																																																						
1 0 0	1 0	Output CP Status																																																																																																																						
1 0 1	1 0	Output Buffer Length																																																																																																																						
1 1 0	1 0	Output Order Word*																																																																																																																						
1 1 1	1 0																																																																																																																							
0 0 0	1 1	Clear Coupler																																																																																																																						
0 0 1	1 1	Terminate Transfer																																																																																																																						
0 1 0	1 1																																																																																																																							
0 1 1	1 1																																																																																																																							
1 0 0	1 1	Output Test*																																																																																																																						
1 0 1	1 1	Input Test*																																																																																																																						
1 1 0	1 1	Output Memory Address																																																																																																																						
1 1 1	1 1	Output Character*																																																																																																																						

*Hardware maintenance feature

COMMUNICATIONS COUPLER STATUS FORMAT

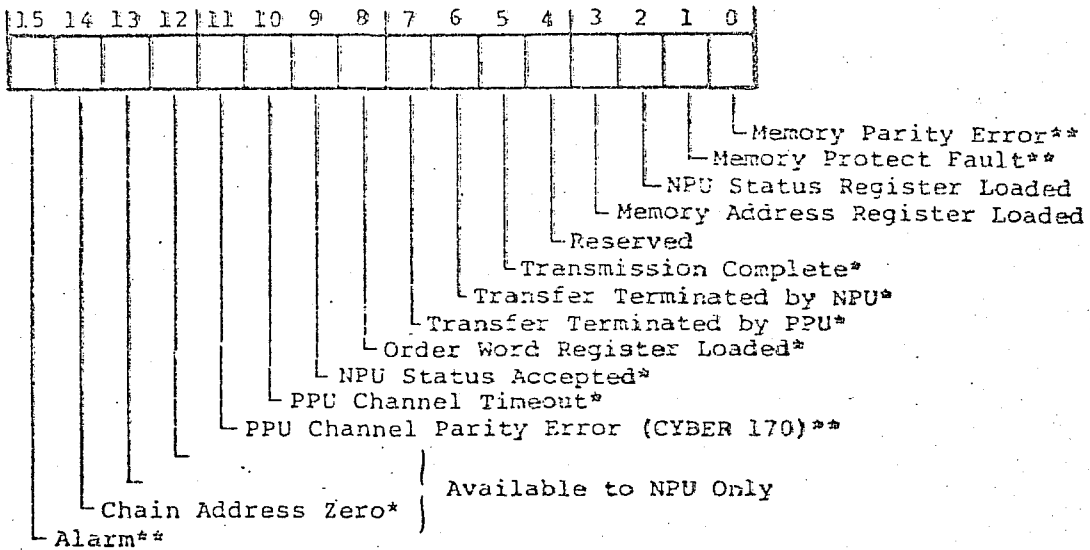

**Alarm Condition (all alarms generate NPU Interrupt)
 *NPU Interrupt Condition

NOTE: All non-alarm interrupt conditions except OWRL are cleared by input coupler status command, clear coupler function, and clear coupler command. OWRL interrupt condition is cleared by input OW command, clear coupler function and command, and Master Clear. Alarm interrupt conditions are cleared only by clear coupler functions and commands and Master Clear.

COMMUNICATIONS COUPLER INPUT SWITCH STATUS FORMAT

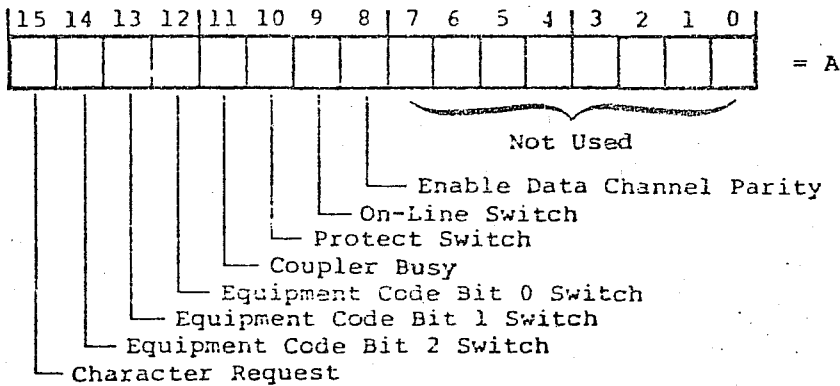

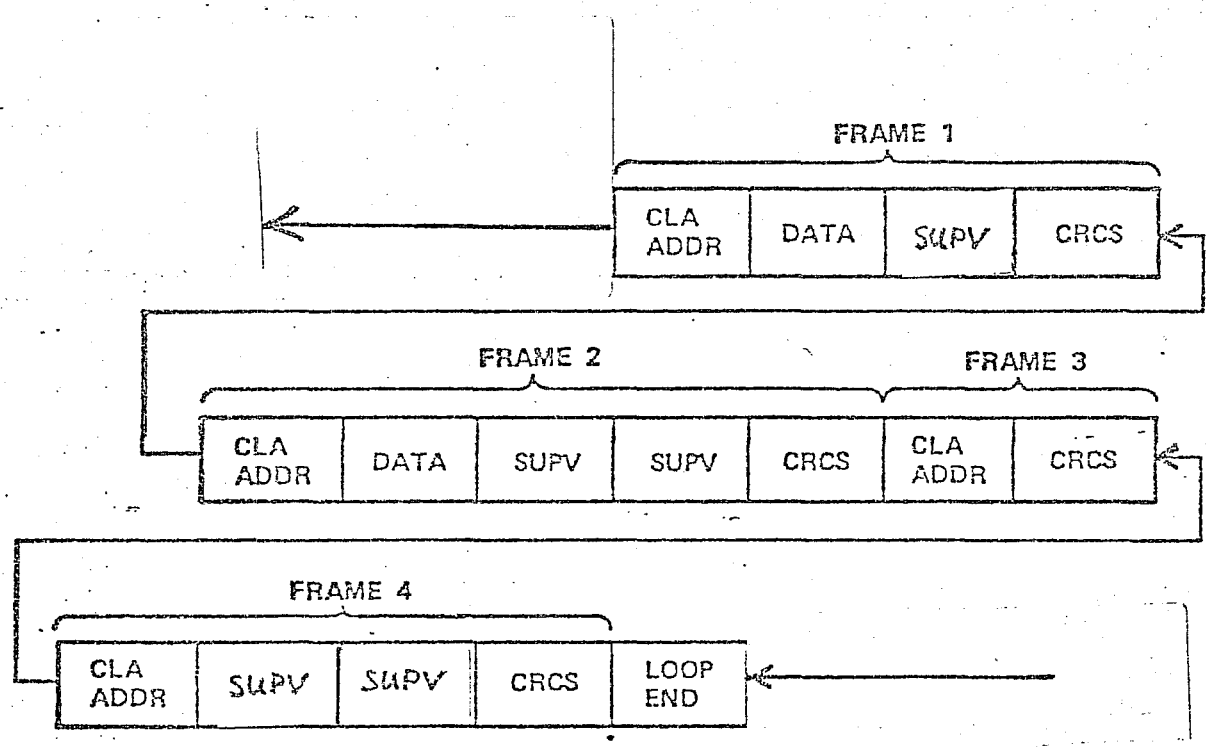
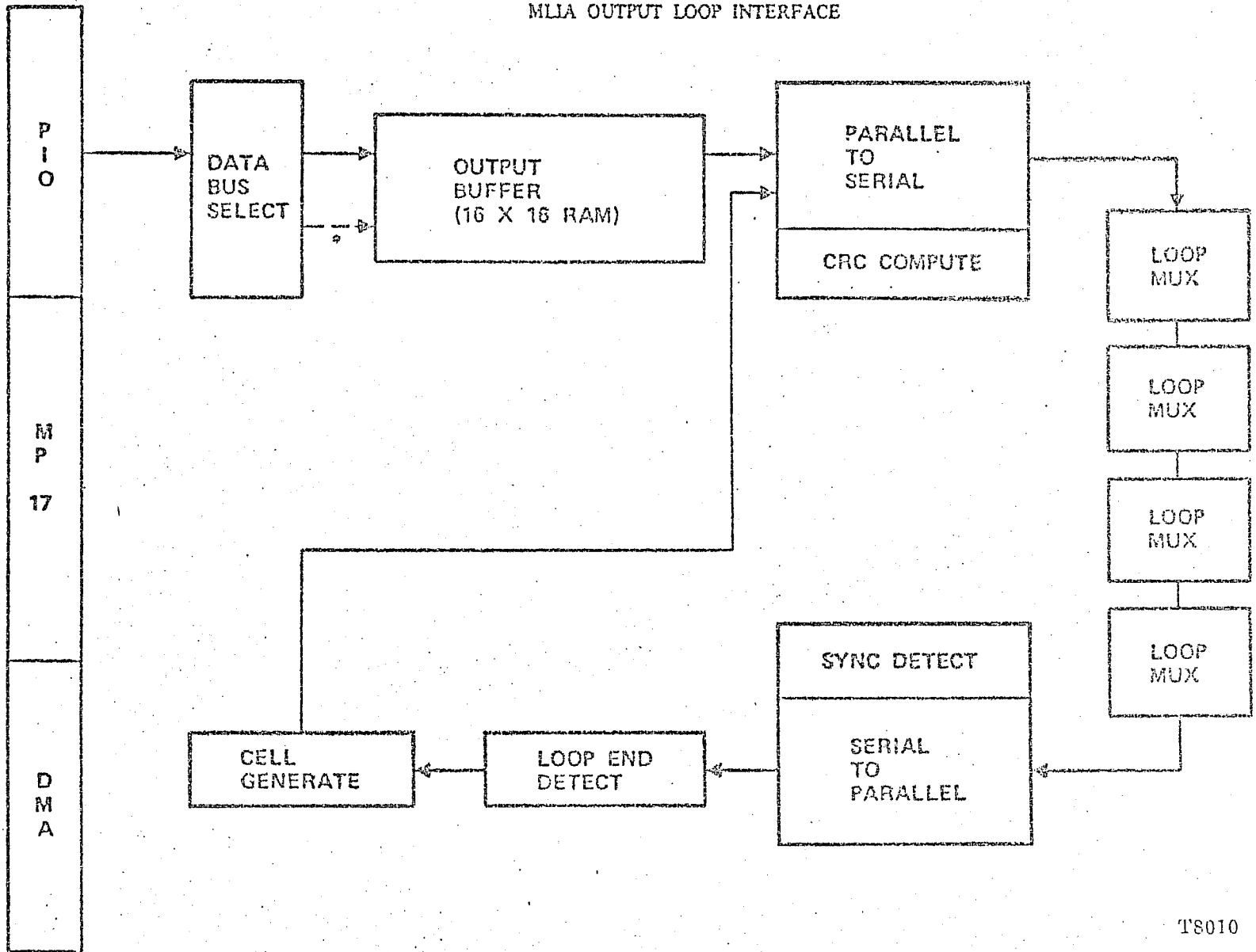
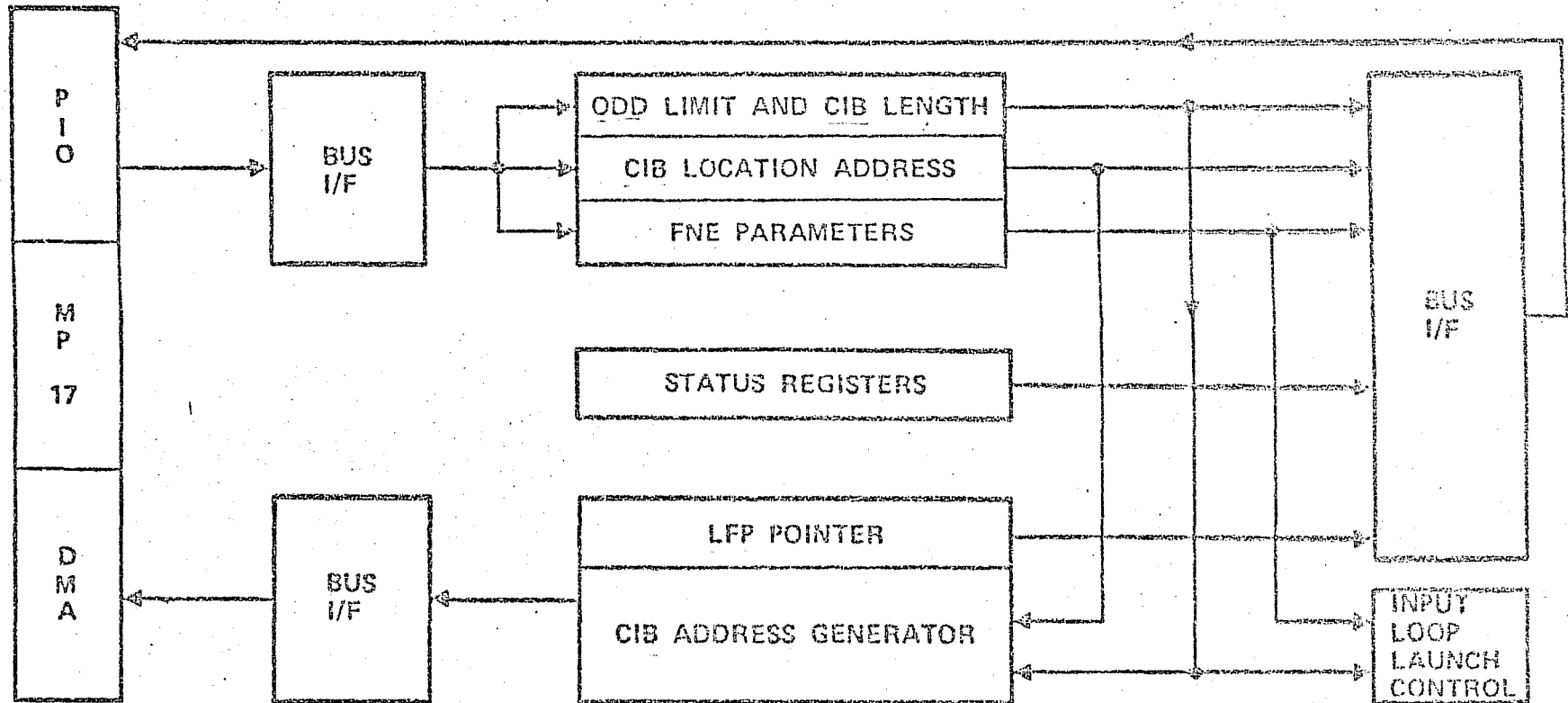

Figure Loop Batch and Line Frame Structure

MLIA OUTPUT LOOP INTERFACE



MLIA PROCESSOR INTERFACE



ODD = OUTPUT DATA DEMAND
 CIB = CIRCULAR INPUT BUFFER
 FNE = NO. OF EMPTY & NULLS IN LOOP BATCH
 LFP = LAST FRAME POSITION

TO INPUT CELL GENERATE

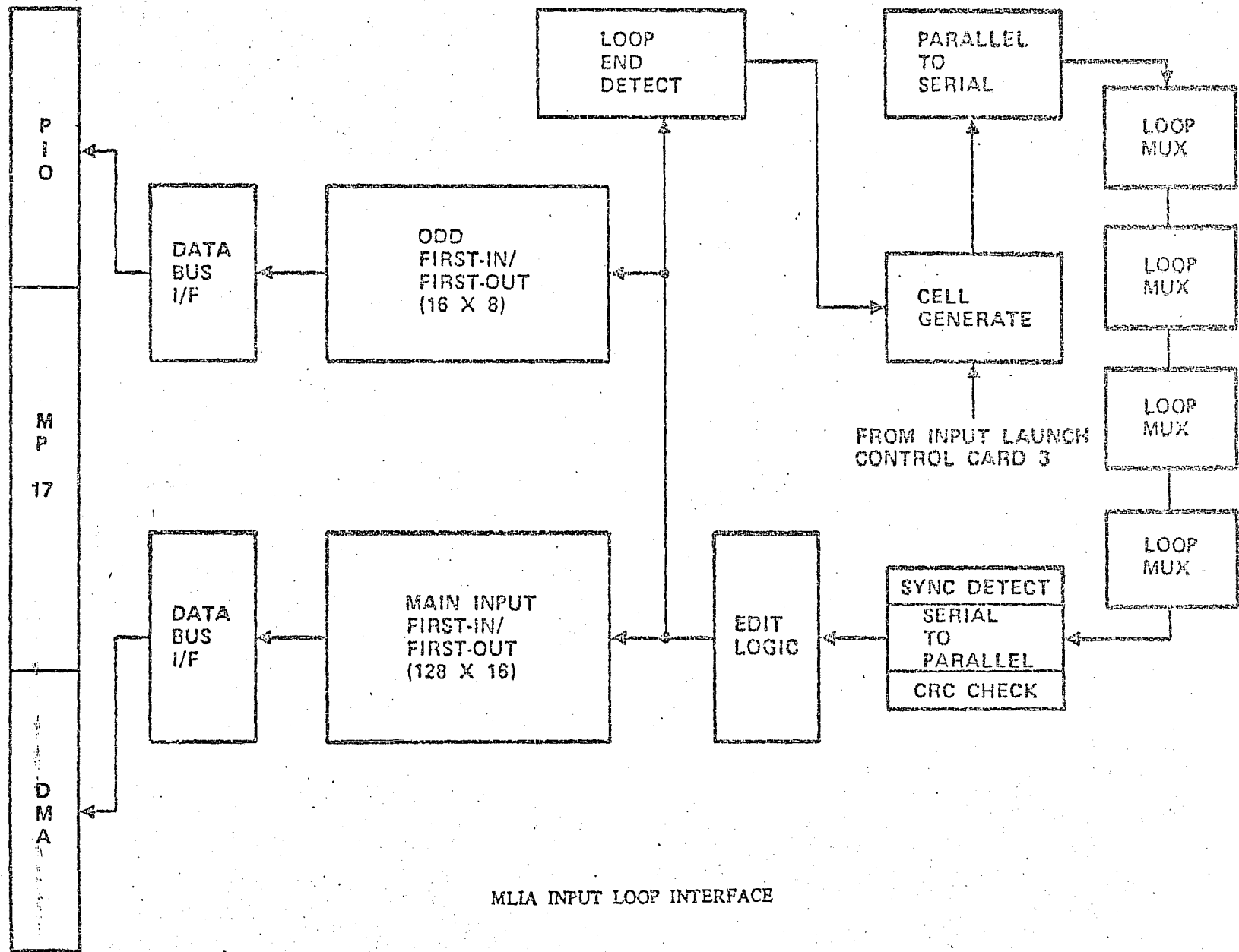

MLIA INPUT LOOP INTERFACE

MLIA

A-REGISTER FORMATS

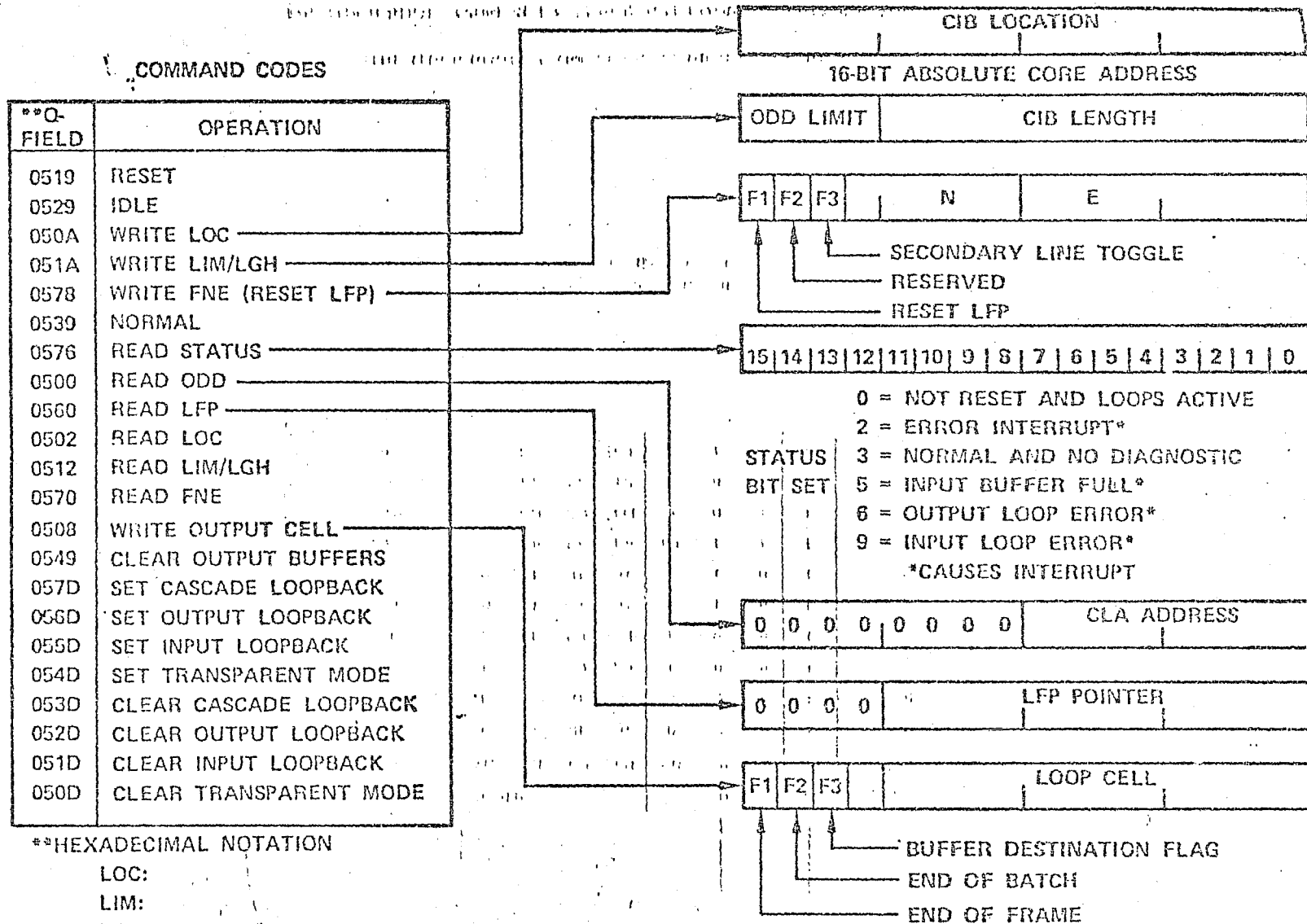

2-43

Figure 5-5. MLIA Commands

TYPE	FORMAT NUMBER	M	ID			INFORMATION								CELL DESIGNATION
		B0	B1	B2	B3	B4	B5	B6	B7	B8	B9	B10	B11	
LOOP MANAGEMENT FORMAT	0	1	0	0	0	0	0	0	0	0	0	0	0	EMPTY
	0	1	0	0	0	1	0	1	0	1	0	1	0	NULL
	1	1	0	0	1	F3	F2	1	1	1	0	0	0	LOOP END
	1	1	0	0	1	F3	F2	0	0	0	1	1	1	LOOP END RESTART
RESERVED FORMATS	2	1	0	1	0	R	R	R	R	R	R	R	R	UNDEFINED
	3	1	0	1	1	R	R	R	R	R	R	R	R	UNDEFINED
LOOP USAGE FORMATS	6/7 E-F	1	1	1	F1	A1	A2	A3	A4	A5	A6	A7	A8	CLA ADDRESS
	4 C	1	1	0	0	D1	D2	D3	D4	D5	D6	D7	D8	DATA
	5 D	1	1	0	1	S1	S2	S3	S4	S5	S6	S7	S8	SUPERVISION
	6	1	1	1	0	C1	C2	C3	C4	C5	C6	C7	C8	CRCS

INPUT LOOP CODING

- F1 = 0 NO OUTPUT DATA DEMAND
- F1 = 1 OUTPUT DATA DEMAND
- F2 = X UNDEFINED
- F3 = 0 PRIMARY DECODES LOOP END; SECONDARY IGNORES LOOP END
- F3 = 1 PRIMARY IGNORES LOOP END; SECONDARY DECODES LOOP END

OUTPUT LOOP CODING

- F1 = 1
- F2 = X UNDEFINED
- F3 = X UNDEFINED

CODING ON BOTH LOOPS

- A1 TO A8 = BINARY CODE OF CLA ADDRESS; A1 IS MOST SIGNIFICANT BIT
- D = DATA
- 0 = CYCLIC REDUNDANCY CHECK CHARACTER (CRCS), C1 IS MOST SIGNIFICANT BIT
- R = X RESERVED AND UNDEFINED

Figure 5-3. Format of Loop Cells

ASYNCHRONOUS LINE ADAPTER

(CRC) character. On the input loop, the address cell also carries the output-data-demand (ODD).

Other cells within the frame may contain data and/or supervision (status or commands). All cells are passed unmodified between the multiplex loop and the CLA, except the check character which is removed from the output loop and added to the input loop by the loop multiplexer.

LINE FRAME FORMATS

The ACLA uses the following general line frame format on the input loop:

E C D D

ACLA ADDR	INPUT DATA	STATUS WORD 1	STATUS WORD 2	CRC CHAR
-----------	------------	---------------	---------------	----------

The ACLA address cell is always present. It may contain an output data demand. The data cell appears next (if present) and contains input data. Two supervision cells follow (if present) and contain status word 1 and status word 2. If any status is to be reported, both status words always appear. The CRC character is added by the loop multiplexer.

The following general line frame format is required by the ACLA on the output loop:

E C D D D D

ACLA ADDRESS	OUTPUT DATA	COMMAND WORD 1	COMMAND WORD 2	COMMAND WORD 3	COMMAND WORD 4	CRC CHARACTER
--------------	-------------	----------------	----------------	----------------	----------------	---------------

The ACLA address cell is always present. Either the data cell or command words may appear next. The data cell (if present) contains output data. One to four supervision cells (if present) contain command words 1, 2, 3 & 4. Allowable combinations of command words are: none; 1; 1 and 2; 1, 2 and 3; or 1, 2, 3 and 4. The CRC character is removed by the loop multiplexer.

CELL AND WORD FORMATS

ADDRESSING CELL

Each ACLA is set to a different 8-bit binary address. Thus, when data, input-supervision, or output-data-demand are presented to the loop multiplexer from the ACLA, the first operation of the ACLA is to present its particular address.

Data or output supervision presented to the ACLA from the LM is preceded by an address. The ACLA compares this address with the internally pre-set address. If the two agree, the ACLA accepts the data or supervision. The addressing code format is shown in table 2-2.

In table 2-2, bit position IF3 is the output-data-demand bit in the address code. When the address is presented to the LM from the ACLA, the bit is a

TABLE 2-2. ADDRESSING CELL FORMAT

11	10	9	8	7	6	5	4	3	2	1	0	Processor Word Bit Position
B0	B1	B2	B3	B4	B5	B6	B7	B8	B9	B10	B11	Loop Cell Bit Position
X	OF1	OF2	OF3	IO1	IO2	IO3	IO4	IO5	IO6	IO7	IO8	LM to ACLA Interface
X	IF1	IF2	IF3	II1	II2	II3	II4	II5	II6	II7	II8	ACLA to LM Interface
1	1	1	0/1	A1	A2	A3	A4	A5	A6	A7	A8	Bit Definition

F+E

ODD

logic one if an ODD is present and is a logic zero if no ODD is present. This bit must be a logic one in an output loop address cell (OF3).

Address position A1 is the most significant bit and A8 is the least significant bit in the binary coded address.

DATA CELL

The data cell transfers information into or out of the ACLA via the loop multiplexer. The data cell format is presented in table 2-3. Bit D1 is always the first bit received from or transmitted to the modem by the ACLA.

SUPERVISION CELLS

The supervision cell on output gives information to the ACLA in the form of commands. On input it gives information to the processor in the form of status words from the ACLA.

STATUS WORDS

Most status changes, error conditions, or a supervision-report command causes status to be reported, and two words are sent to the processor. The status word 1 and status word 2 formats are shown in tables 2-4 and 2-5, respectively. In both tables a logic one indicates that the associated modem signal or status condition is active (on), and a logic zero indicates not active (off).

TABLE 2-3. DATA CELL FORMAT

11	10	9	8	7	6	5	4	3	2	1	0	Processor Word Bit Position
B0	B1	B2	B3	B4	B5	B6	B7	B8	B9	B10	B11	Loop Cell Bit Position
X	OF1	OF2	OF3	IO1	IO2	IO3	IO4	IO5	IO6	IO7	IO8	LM to ACLA Interface
X	IF1	IF2	IF3	II1	II2	II3	II4	II5	II6	II7	II8	ACLA to LM Interface
1	1	0	0	D8	D7	D6	D5	D4	D3	D2	D1	8- or 9-bit char
1	1	0	0	0	D7	D6	D5	D4	D3	D2	D1	7-bit character
1	1	0	0	0	0	D6	D5	D4	D3	D2	D1	6-bit character
1	1	0	0	0	0	0	D5	D4	D3	D2	D1	5-bit character

TABLE 2-4. STATUS WORD 1 FORMAT

11	10	9	8	7	6	5	4	3	2	1	0	Processor Word Bit Position
B0	B1	B2	B3	B4	B5	B6	B7	B8	B9	B10	B11	Loop Cell Bit Position
X	IF1	IF2	IF3	II1	II2	II3	II4	II5	II6	II7	II8	ACLA to LM Interface
1	1	0	1	CTS	DSR	DCD	RI	SDCD		ILE	OLE	Bit Definition

Bit Definitions

CTS = Clear-to-send. This status bit indicates the state of the modem signal clear-to-send.

When active, it indicates the modem is ready to accept data from the ACLA. It must be active to enable data output from the CLA. If this signal

changes from a logic one to a logic zero during character output, the current character is completed and the transmit-data line is set to marking. A change of state of this signal causes status to be reported.

DSR = Data-set-ready. This status bit indicates the state of the modem signal data-set-ready. When active, it indicates that power is applied to the modem and that it is connected to the communications line. Any change of state of this signal causes status to be reported.

DCD/RLSD = Data-carrier-detector. This status bit indicates the state of the modem signal receive-line-signal-detector (RLSD). When active, it indicates that a carrier signal is being received by the modem. Any change of state of this signal causes status to be reported.

RI = Ring-indicator. This status bit is set and status reported each time the modem signal ring-indicator goes from an on state to the off state. This indicates that the modem is receiving an incoming call from a remote station. The

status bit is reset when the status words are sent to the processor.

SDCD/SRLSD = Secondary-data-carrier-detect. Indicates state of modem signal secondary-receive-line-signal-detector (secondary-receive-data on some modems). On modems equipped with a reverse channel receiver, supervisory information can be received from a remote station while the ACLA is transmitting data to the station over a half-duplex, 2-wire circuit. Any change of state of this signal causes status to be reported.

ILE = Input-loop-error. When set to a one, the bit indicates that the LM has detected a loop error while the ACLA was using the input loop. This status is reset when the status words are sent to the processor.

OLE = Output-loop-error. When set to a one, the bit indicates that the LM has detected a loop error while the ACLA was using the output loop. This status is reset when the status words are sent to the processor.

TABLE 2-5. STATUS WORD 2 FORMAT

11	10	9	8	7	6	5	4	3	2	1	0	Processor Word Bit Position
B0	B1	B2	B3	B4	B5	B6	B7	B8	B9	B10	B11	Loop Cell Bit Position
X	IF1	IF2	IF3	II1	II2	II3	II4	II5	II6	II7	II8	ACLA to LM Interface
1	1	0	1	PES	DTO	FES						Bit Definition

Bit Definitions

PES = Parity-error-status. This status is generated when the ACLA has been instructed to check for even or odd character parity and a character is received with incorrect character parity. The status

always appears in the same line frame as the character. This status is reset when the next character with correct parity is received.

DTO = Data-transfer-overflow. This status is generated by the ACLA when it has a data char-

acter that is ready for transfer to the LM before the LM has picked up the previously assembled character. The previously assembled character is lost. This status is reset when the status words are sent to the processor.

FES = Framing-error-status. This status is posted by the ACLA when a character is received from the modem without the presence of a stop bit. The status always appears in the same line frame as the character. This status is not reset until another character with proper stop bit is received.

NOTE

FES can be set independently of the state of the ION (input-on) command. The character received that caused FES is always transferred. See Programming Notes for use of FES in break detection.

COMMAND WORDS

The command cells are instruction commands from the processor in the

form of command words 1, 2, 3 and 4-- these must be received in sequence. For example, words 1 and 2 must be received before word 3, and word 2 must always be preceded by command word 1. However, command word 1 can be received as a single word command. Formats for command word 1 and command word 2 are shown in tables 2-6 and 2-7. A logic one, in the position indicated, activates the associated signal, while a logic zero deactivates the signal. The commands operate independently of each other.

Each time a command is given to the ACLA, each bit (IO1-IO8) must be set to the condition desired on the associated function. Failure to do this will result in the condition being cleared or set to a different condition. Each time a command is given, the ACLA monitors each bit and takes the action dictated.

NOTE

When IO1 thru IO8 in command words 1 and 2 are all set to logic zero, the ACLA is cleared to a known state which disables any input (output-data-demand, status, or data) from the ACLA to HCP.

TABLE 2-6. COMMAND WORD 1 FORMAT

11	10	9	8	7	6	5	4	3	2	1	0	Processor Word Bit Position
B0	B1	B2	B3	B4	B5	B6	B7	B8	B9	B10	B11	Loop Cell Bit Position
X	OF1	OF2	OF3	IO1	IO2	IO3	IO4	IO5	IO6	IO7	IO8	LM to ACLA Interface
1	1	0	1	RTS	SRTS	OM	LM	DTR	TB	ION	OON	Bit Definition

Bit Definitions

RTS = Request-to-send. A logic one activates the request-to-send line to the modem and a logic zero in this position deactivates RTS.

SRTS = Secondary request-to-send. A logic one activates the secondary-request-to-send line to the modem (referred

to as secondary-send-data on some modems). On modems equipped with a reverse channel transmitter, supervisory information can be sent to a remote station while the ACLA is receiving data from the station over a half-duplex, 2-wire circuit. Typical uses include circuit assurance, error control, and interrupt

(break). A logic zero deactivates SRTS.

OM = Originate mode/auxiliary. A logic one in this position causes the ACLA to notify the modem equipment that it is in the originate mode. A logic zero indicates answer mode. This line is an auxiliary signal line and may be used for other functions as designated by system design.

LM = Local mode/auxiliary. A logic one in this position causes the ACLA to notify the modem (when equipped) to loop back the analog signal on the modem. A logic zero disables the loopback. This line is an auxiliary signal line and may be used for other functions as designated by system design.

DTR = Data-terminal-ready. A logic one in this location causes the ACLA to notify the modem

that the system is ready to communicate with the modem. A logic zero causes a not-ready signal to be reported.

TB = Terminal-busy. A logic one causes the ACLA to notify the modem to busy-out-the-line. A logic zero disables this function.

ION = Input-on. When this bit is a logic zero, the input section of the ACLA will not receive data characters nor transfer data to the LM. A logic one causes normal input operation.

OON = Output-on. A logic one causes the output section of the ACLA to report output-data-demand initially when command is received if clear-to-send is active, and enables the output to report output-data-demand whenever the output buffer is empty. A logic zero inhibits reporting of output-data-demand.

TABLE 2-7. COMMAND WORD 2 FORMAT

11	10	9	8	7	6	5	4	3	2	1	0	Processor Word Bit Position
B0	B1	B2	B3	B4	B5	B6	B7	B8	B9	B10	B11	Loop Cell Bit Position
X	OF1	OF2	OF3	IO1	IO2	IO3	IO4	IO5	IO6	IO7	IO8	LM to ACLA Interface
1	1	0	1	Break	ISR	ISON	DLM	RSR1	RSR2	TSR1	TSR2	Bit Definition

Bit Definitions

BREAK = Break-mode. A logic one in this position causes the ACLA to place the transmit-data line in a spacing condition (zero state). A logic zero inhibits the break operation and returns the line to marking condition (one state).

ISR = Input-supervision-report. A logic one in this position causes the ACLA to report the status of the RS-232 interface lines and any other ACLA status that may be active once each time the command is received. The ISR command is

honored only when the ACLA has previously received a logic one in the ISON position. This is a momentary nonstored command. (If ISR = 1 and ISON = 1 appear in the same line frame, status is reported.)

ISON = Input-supervision-on. When a logic one is placed in this bit position, the ACLA monitors the modem interface and reports input supervision. A logic zero inhibits monitoring and reporting. Status is not reported automatically when this command bit is first received by the ACLA.

The ACLA must receive either an ISR command or status change to report input supervision.

DLM = Data-line-monitor. A logic one in this position causes the ACLA to monitor the receive-data line that is in a break condition for one character time after reception of the command. This command is used to allow the processor to determine the length of a break condition on data input. This is a momentary, nonstored command.

RSR1, = Receive-speed-range 1 and 2.
RSR2 This code causes the ACLA to select a reference frequency from the loop multiplexer to provide a range of baud rates

selectable by bits IO1-IO4 in command word 4. See table 2-8.

TSR1, = Transmit-speed-range 1 and 2.
TSR2 This code causes the ACLA to select a reference frequency from the loop multiplexer to provide a range of transmit baud rates selectable by bits IO5-IO8 in command word 4. Table 2-8 shows the code and related reference frequencies.

In table 2-8, the special frequency is provided by an optional 115.2 kHz oscillator attached to the LM backplane. This special frequency can be used to accommodate a baud rate that is not available from the range of transmit baud rates shown in table 2-9.

TABLE 2-8. CODE BITS AND REFERENCE FREQUENCIES

RF No.	Code				Reference Frequency	Baud Rate
	IO5	IO6	IO7	IO8		
A	0	0	0	0	9.6 kHz	45 to 100
B	1	0	1	0	19.2 kHz	100 to 600
C	0	1	0	1	153.6 kHz	600 to 9600
D	1	1	1	1	Special	Special

TABLE 2-9. COMMON BAUD RATES AND COMMAND CODES

Baud Rate	Speed - Command Word 4								Range - Command Word 2					
	Input				Output				RF No.	Input		Output		
	I1	I2	I3	I4	I5	I6	I7	I8		I5	I6	I7	I8	
9600	1	1	1	1	1	1	1	1	C	0	1	0	1	
7200 (Special)	1	1	1	1	1	1	1	1	D	1	1	1	1	
4800	0	1	1	1	0	1	1	1	C	0	1	0	1	
3600 (Special)	0	1	1	1	0	1	1	1	D	1	1	1	1	
2400	0	0	1	1	0	0	1	1	C	0	1	0	1	
1800 (Special)	0	0	1	1	0	0	1	1	D	1	1	1	1	
1600	0	1	0	1	0	1	0	1	C	0	1	0	1	
1200	0	0	0	1	0	0	0	1	C	0	1	0	1	
1050	1	1	1	0	1	1	1	0	C	0	1	0	1	
800	0	0	1	0	0	0	1	0	C	0	1	0	1	
600	0	1	1	1	0	1	1	1	B	1	0	1	0	
300	0	0	1	1	0	0	1	1	B	1	0	1	0	
150	0	0	0	1	0	0	0	1	B	1	0	1	0	
133.3	1	1	1	0	1	1	1	0	B	1	0	1	0	
120	0	1	1	0	0	1	1	0	B	1	0	1	0	
110	1	0	1	0	1	0	1	0	B	1	0	1	0	
100	0	0	1	0	0	0	1	0	B	1	0	1	0	
75	0	0	0	0	0	0	0	0	B	1	0	1	0	
66.67	1	1	1	0	1	1	1	0	A	0	0	0	0	
50.0	0	0	1	0	0	0	1	0	A	0	0	0	0	

COMMAND WORD 3. The format for this command word is shown in table 2-10.

TABLE 2-10. COMMAND WORD 3 FORMAT

11	10	9	8	7	6	5	4	3	2	1	0	Processor Word Bit Position
B0	B1	B2	B3	B4	B5	B6	B7	B8	B9	B10	B11	Loop Cell Bit Position
X	OF1	OF2	OF3	IO1	IO2	IO3	IO4	IO5	IO6	IO7	IO8	IM to ACLA Interface
1	1	0	1	PSET	PI	CO1	CO2	SB		ECHO	LIT	Bit Definition

10 11

Bit Definitions

PSET = Parity-set. When this bit is a logic one, concurrent with PI set to a logic zero, the ACLA generates and checks for even parity. A logic zero concurrent with PI set to a logic zero causes the ACLA to generate and check for odd character parity.

PI = Parity-inhibit. A logic zero in this position causes the ACLA to check character parity on input and generate character parity on output. A logic one causes the ACLA to ignore parity.

NOTE

When parity is selected (PI=0), the ACLA does not transfer the received parity bit to the loop multiplexer in the data cell. A logic zero occupies the parity bit position within the character.

CO1, CO2 = Code 1 and Code 2 bits form a code so that each combination corresponds to a character length of either 5, 6, 7 or 8 bits. The checking and generation of character parity adds one information bit to the character and therefore must be considered when selecting the unit code. Table 2-11

shows these code bits in relation to parity-inhibit bit.

SB = Stop-bit. A logic one in this bit causes the output logic to generate two stop bits (1.5 stop bits on 5 data bits) on output and a logic zero causes one stop bit to be generated.

ECHO = Echoplex mode. A logic one in this position causes the ACLA to return all data received from the modem on the receive-data line back to the modem on the send-data line while maintaining normal data processing in the input logic. A logic zero inhibits echoplex operation.

LIT = Loop-internal-test. A logic one in this position causes the ACLA to go into an echoplex mode. Data and modem control signals from the output section are routed (looped back) to the input section. Refer to Programming Notes for additional information on this mode of operation. A logic zero disables echoplex mode.

COMMAND WORD 4. This command word format is shown in table 2-12.

TABLE 2-11. CODE AND PARITY INHIBIT BITS

PI	CO1	CO2	Code Level (No Parity)	PI	CO1	CO2	Code Level (Including Parity)
1	0	0	5	0	0	0	6
1	1	0	6	0	1	0	7
1	0	1	7	0	0	1	8
1	1	1	8	0	1	1	9

TABLE 2-12. COMMAND WORD 4 FORMAT

11	10	9	8	7	6	5	4	3	2	1	0	Processor Word Bit Position
B0	B1	B2	B3	B4	B5	B6	B7	B8	B9	B10	B11	Loop Cell Bit Position
X	OF1	OF2	OF3	IO1	IO2	IO3	IO4	IO5	IO6	IO7	IO8	LM to ACLA Interface
1	1	0	1	F/1	F/2	F/4	F/8	F/1	F/2	F/4	F/8	Bit Definition
Format				Receive				Transmit				

Command word 4 is used in conjunction with bits IO5, IO6, IO7 and IO8 of command word 2 to set the baud rate for the input and output sections. The input and output baud rates may differ. To determine the proper code for the baud rate, select the range from command word 2 in which the desired rate is contained and the desired baud rate from command word 4 as shown in table 2-9.

Complement
 $0101_2 = 1010_2 = 10_{10}$
 Add one to
 the result = $1011_2 = 11_{10}$
 Then, the
 baud rate = $\frac{19.2 \times 10^3}{11 \times 16} = 109.1$ baud

NOTE

BAUD RATE DETERMINATION. The baud rate can be determined from an algorithm using the appropriate bits (4 bits on input or 4 bits on output) from command word 4 in conjunction with the range selected from command word 2. Proceed as follows to find the baud rate:

The ACLA must be able to receive data that might have up to 40 percent distortion, that is, 40 percent of a bit per character. The result found above is valid for a 110 baud communications line, having .82 percent tolerance of the nominal value of 110 baud.

1. Complement each bit of the two 4-bit fields of command word 4. Convert each result to a base ten number using IO4 as the most significant bit for the input field and IO8 as the most significant bit for the output field. Add one to each result.
2. Multiply the above result by 16_{10} .
3. Divide this product into the reference frequency selected from table 2-9.

PROGRAMMING NOTES

The following notes provide additional information on the operation of the ACLA and are intended to assist the programmer. Typical input and output operations are presented.

EXAMPLE:

Given:

from command IO4 IO3 IO2 IO1
 word 4 - 0 1 0 1

from command IO5 IO6
 word 2 - 1 0 (19.2kHz)

ACLA INITIALIZATION

Before the ACLA is used following a power-up situation (either power up of a system in which the ACLA is already installed, or installation of the ACLA in an operating system), it should be cleared. Clearing the ACLA in this situation requires that the program:

SYNCHRONOUS LINE ADAPTER

SUPERVISION CELLS

The supervision cell on output gives information to the SCLA in the form of commands. On input this cell gives information to the processor in the form of status words from the SCLA.

status to be reported, and both words are sent to the processor. The Status Word 1 and Status Word 2 formats are shown in tables 2-4 and 2-5, respectively. In both tables a logic one indicates that the associated modem signal or status condition is active (on), and a logic zero indicates not active (off).

STATUS WORDS

Most status changes, error conditions, or a status request command cause

TABLE 2-4. STATUS WORD 1 FORMAT

11	10	9	8	7	6	5	4	3	2	1	0	Processor Word Bit Position
B0	B1	B2	B3	B4	B5	B6	B7	B8	B9	B10	B11	Loop Cell Bit Position
X	IF1	IF2	IF3	II1	II2	II3	II4	II5	II6	II7	II8	SCLA to LM Interface
1	1	0	1	CTS	DSR	DCD	RI	QM*	SQD*	ILE	OLE	Bit Definition

*2560-1 only. A logic 0 appears in these positions for 2560-2 and 2560-3.

Bit Definition

CTS = Clear-to-send. This status bit indicates the state of the modem signal clear-to-send. When active, it indicates the modem is ready to accept data from the SCLA. It must be active to enable data output from the CLA. If this signal changes from a logic one to a logic zero during character output, the current character is completed and the transmit-data line is set to marking. A change of state of this signal does not cause status to be reported.

DSR = Data-set-ready. This status bit indicates the state of the modem signal data-set-ready. When active, it indicates that power is applied to the modem and that it is connected to the communications line. Any change of state of this signal causes status to be reported.

DCD = Data-carrier-detect. This status bit indicates the state of the modem receive-line-signal-detector signal. When active, it indicates that a carrier signal is being received by the modem. Any change of state of this signal causes status to be reported. (For the 2560-2 SCLA connected to an AT&T 303 Wideband Data Station, this status is called AGC Lock.)

RI = Ring-indicator. This status bit is set and status reported each time the modem ring-indicator signal goes from an on state to the off state. This indicates that the modem is receiving an incoming call from a remote station. The status bit is reset when the status words are sent to the processor.

QM = Quality-monitor. This status bit indicates the state of the quality-monitor modem

signal. When off or zero, it indicates that the adaptive equalizer in the modem receiver is reset or retraining itself automatically due to poor error performance. Any data received has a "high" probability of error. When on or one, the automatic equalizer is in its normal trained mode and received data should have a "low" probability of error. Any change of state of this signal causes status to be reported.

SQD = Signal-quality-detector. This status bit indicates the state of the modem signal signal-quality-detector. It functions similarly to DCD but provides a fast responding indication of the

presence (one) or absence (zero) of data carrier signal from the remote station. Any change of state of this signal causes status to be reported.

ILE = Input-loop-error. When set to a one, the bit indicates that the LM has detected a loop error while the SCLA was using the input loop. This status is reset when the status words are sent to the processor.

OLE = Output-loop-error. When set to a one, the bit indicates that the LM has detected a loop error while the SCLA was using the output loop. This status is reset when the status words are sent to the processor.

TABLE 2-5. STATUS WORD 2 FORMAT

11	10	9	8	7	6	5	4	3	2	1	0	Processor Word Bit Position
B0	B1	B2	B3	B4	B5	B6	B7	B8	B9	B10	B11	Loop Cell Bit Position
X	IF1	IF2	IF3	II1	II2	II3	II4	II5	II6	II7	II8	SCLA to LM Interface
1	1	0	1	PES	DTO	0	NCNA	0	0	0	0	Bit Definition

Bit Definition

PES = Parity-error-status. This status is generated when the SCLA has been instructed to check for even or odd character parity and a character is received with incorrect character parity. The status always appears in the same line frame as the character. This status is reset when the status words are sent to the processor.

DTO = Data-transfer-overflow. This status is generated by the SCLA when it has a data character that is ready for transfer to the LM before the LM has picked up the previously

assembled character. The previously assembled character is lost. This status is reset when the status words are sent to the processor.

NCNA = Next-character-not-available. This status indicates that while the SCLA was in the process of transmitting, the next character was not received from the LM in time to maintain continuous character output. Thus character frame synchronization was lost. The output section must be enabled (output-on active) for this status to occur. The status sets only once and does not repeat until the NCNA condition is alleviated (by

receiving a character to output) and then can recur. The status is reset when the status words are transferred to the processor.

COMMAND WORDS

The command cells are instruction commands from the processor in the

form of command word 1, command word 2, and command word 3. Formats for command word 1 and command word 2 are shown in tables 2-6 and 2-7. A logic one, in the position indicated, activates the associated signal, while a logic zero deactivates the signal. The commands operate independent of each other.

TABLE 2-6. COMMAND WORD 1 FORMAT

11	10	9	8	7	6	5	4	3	2	1	0	Processor Word Bit Position
B0	B1	B2	B3	B4	B5	B6	B7	B8	B9	B10	B11	Loop Cell Bit Position
X	OF1	OF2	OF3	IO1	IO2	IO3	IO4	IO5	IO6	IO7	IO8	LM to SCLA Interface
1	1	0	1	RTS	RSYN	0	NSYN LT*	DTR	0	ION	OON	Bit Definition

*2560-1 only. This bit position is used for LT for the 2560-2 and 2560-3.

BIT DEFINITIONS

RTS = Request-to-send. A logic one activates the request-to-send line to the modem while a logic zero in this position deactivates RTS.

RSYN = Resynchronize. When the input of the SCLA is activated, a logic one causes the SCLA to drop input synchronization and search for a new synchronization sequence. (This is a momentary, nonstored command. This bit position should normally be a logic zero.)

NSYN = New-sync. A logic one in this location tells the SCLA to notify the modem via the new-sync interface signal that another message is coming contiguous to the present message and the modem should drop and reestablish bit synchronization. This command should normally be on for one msec or more, depending on modem type (2560-1 only).

LT = Local-test. A logic one in this position causes the SCLA to notify the modem to route

back transmit data to the SCLA input (2560-2 and 2560-3 only).

DTR = Data-terminal-ready. A logic one in this location causes the SCLA to notify the modem that the system is ready to communicate with the modem.

ION = Input-on. When this bit is a logic zero, the input section of the SCLA drops out of synchronization and does not receive data characters or transfer data to the LM. A logic one causes the normal acquisition of synchronization and transfer of data.

OON = Output-on. A logic one causes the output section of the SCLA to report output-data-demand initially when the command is received if clear-to-send is active, and enables the output to report output-data-demand whenever the output buffer is empty. A logic zero inhibits reporting of output-data-demand.

TABLE 2-7. COMMAND WORD 2 FORMAT

11	10	9	8	7	6	5	4	3	2	1	0	Processor Word Bit Position
B0	B1	B2	B3	B4	B5	B6	B7	B8	B9	B10	B11	Loop Cell Bit Position
X	OF1	OF2	OF3	IO1	IO2	IO3	IO4	IO5	IO6	IO7	IO8	LM to SCLA Interface
1	1	0	1	0	ISR	ISON	LIT	PSET	PI	CO1	CO2	Bit Definition

BIT DEFINITIONS

ISR = Input-supervision-report. A logic one in this position causes the SCLA to report the status of the modem interface lines and any other SCLA status that may be active once each time the command is received. The ISR command is honored only when the SCLA has previously received a logic one in the ISON position. (If ISR = 1 and ISON = 1 appear in the same line frame, status is reported).

ISON = Input-supervision-on. When a logic one is placed in this bit position, the SCLA monitors the modem interface and reports status. A logic zero inhibits monitoring and reporting. Status is not reported automatically when this command bit is first received by the SCLA. The SCLA must receive either an ISR command or status change to report status.

LIT = Loop-internal-test. A logic one in this position causes the SCLA to go into an echo-test mode. Data and modem control signals from the output section are routed (looped back) to the input section. The SCLA also switches to an internal clock (2.4 kHz) supplied by the LM. Refer to Programming Notes for additional information on this mode of operation. A logic zero disables echo-test mode.

PSET = Parity-set. When this bit is a logic one, concurrent with PI set to a logic zero, the SCLA generates and checks for even parity. A logic zero concurrent with PI set to a logic zero causes the SCLA to generate and check for odd parity.

PI = Parity-inhibit. A logic zero in this position causes the SCLA to check character parity on input and generate character parity on output. A logic one causes SCLA to ignore parity.

CO1, CO2 Code 1 and Code 2 bits form a code so that each combination corresponds to a character length of either 5, 6, 7, or 8 bits. The checking and generation of character parity adds one information bit to the character and therefore must be considered when selecting the unit code level. Table 2-8 shows these code bits in relation to the parity-inhibit bit.

TABLE 2-8. CODE BITS

PI	CO1	CO2	Code Level (No Parity)	PI	CO1	CO2	Code Level (Including Parity)
1	0	0	5	0	0	0	6
1	1	0	6	0	1	0	7
1	0	1	7	0	0	1	8
1	1	1	8	0	1	1	9

Command Word 3 contains the synchronization character. This command is stored and is used for obtaining synchronization. When the SCLA is attempting to acquire character frame synchronization, a 5- to 8-bit se-

quence (depending on code length) is compared against this stored command at each bit time. The format for this synchronization character command is shown in table 2-9. Bit D1 is the first bit received from the modem.

TABLE 2-9. COMMAND WORD 3 FORMAT

11	10	9	8	7	6	5	4	3	2	1	0	Processor Word Bit Position
B0	B1	B2	B3	B4	B5	B6	B7	B8	B9	B10	B11	Loop Cell Bit Position
X	OF1	OF2	OF3	IO1	IO2	IO3	IO4	IO5	IO6	IO7	IO8	Loop MUX to SCLA Interface
1	1	0	1	D8	D7	D6	D5	D4	D3	D2	D1	8- or 9-bit Character
1	1	0	1	0	D7	D6	D5	D4	D3	D2	D1	7-bit Character
1	1	0	1	0	0	D6	D5	D4	D3	D2	D1	6-bit Character
1	1	0	1	0	0	0	D5	D4	D3	D2	D1	5-bit Character

While the SCLA is attempting to synchronize, no characters are transferred to the LM. After synchronization is achieved, the SCLA transfers all characters to the LM until the SCLA is directed to resynchronize via command from the processor.

Each time a command is given to the SCLA, each bit in each command word must be set to the condition desired for the associated function. Failure to do this will result in the condition being cleared or set to a different condition. Each time a command

is given to the SCLA, the SCLA reads each bit and takes the action dictated.

Whenever the SCLA receives command words, it assumes they are received in order. For example, to change command word 2, both words 1 and 2 must be sent to the SCLA in the same line frame. Changing command word 3 requires sending all three command words.

To bring the SCLA to an idle (cleared) state, set all bits in command words 1 and 2 to logic zero.

TABLE

(162) = FWA

NFCCSE - LAST COMMAND SENT TO CLA

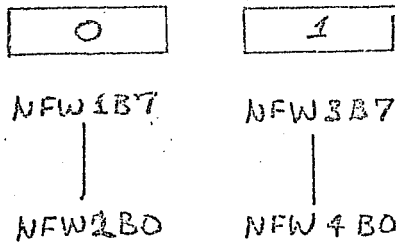

SYNCHRONOUS CLA

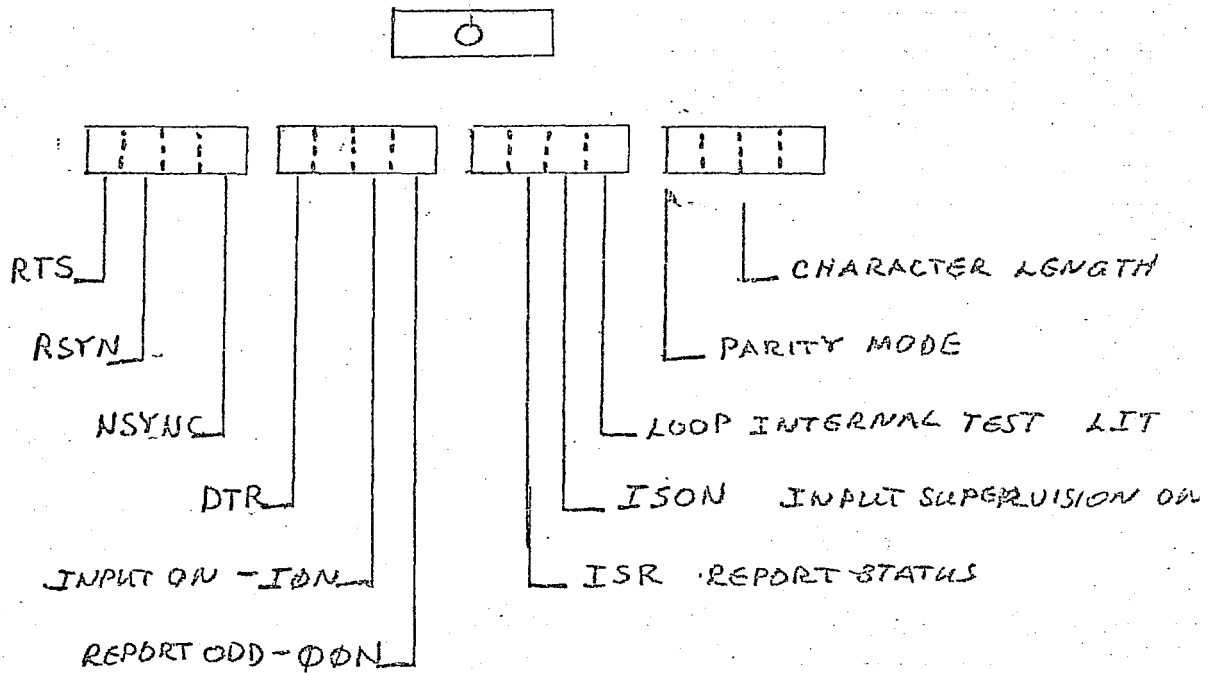

CHARACTER LENGTH 0=5 1=7 2=6 3=8

PARITY MODE 0 = ~~ENABLED~~ PARITY ODD
 1 = NO PARITY
 2 = EVEN PARITY

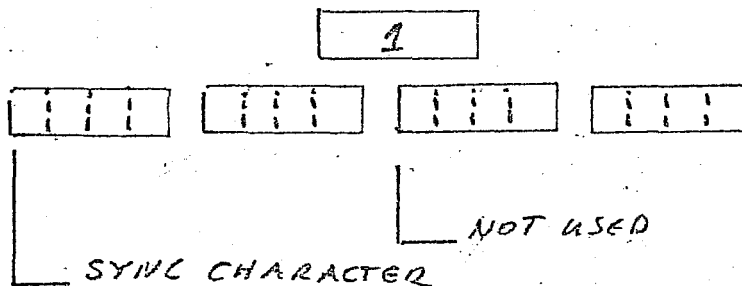

0

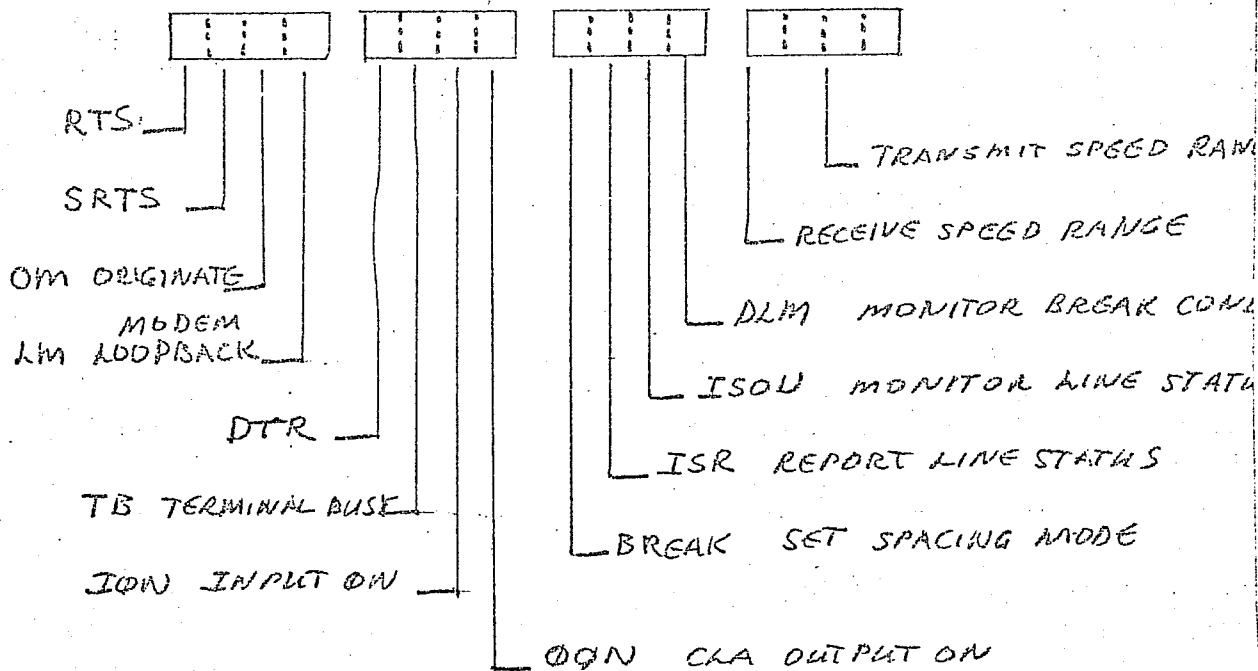

SPEED RANGE 0 = 45-100
 1 = 600-9600
 2 = 100-600

1

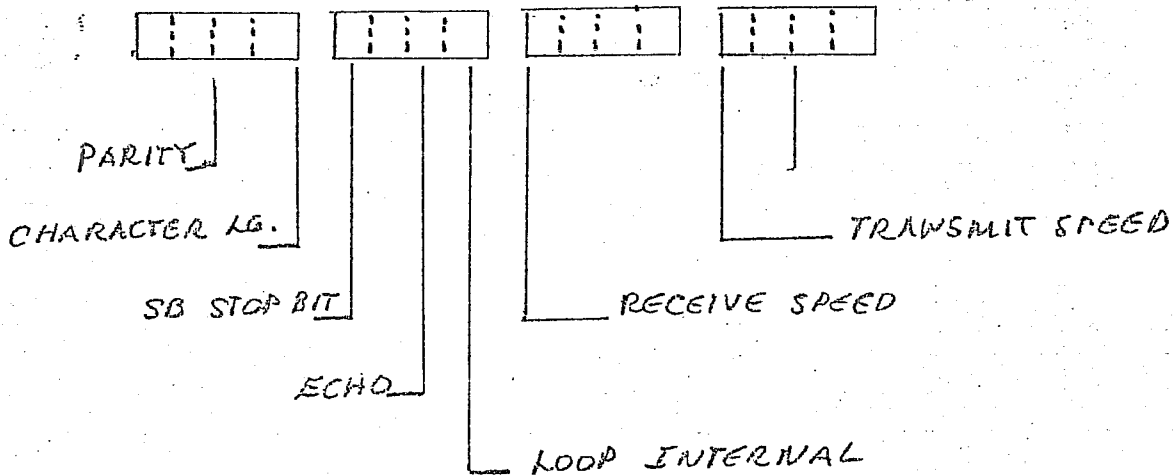

PARITY 0 = ODD PARITY
 1 = NO PARITY
 2 = EVEN PARITY

CHARACTER LENGTH 0 = 5 BITS
 1 = 7 BITS
 2 = 6 BITS 3 = 8 BITS

MLASTAT

(163) = FWA

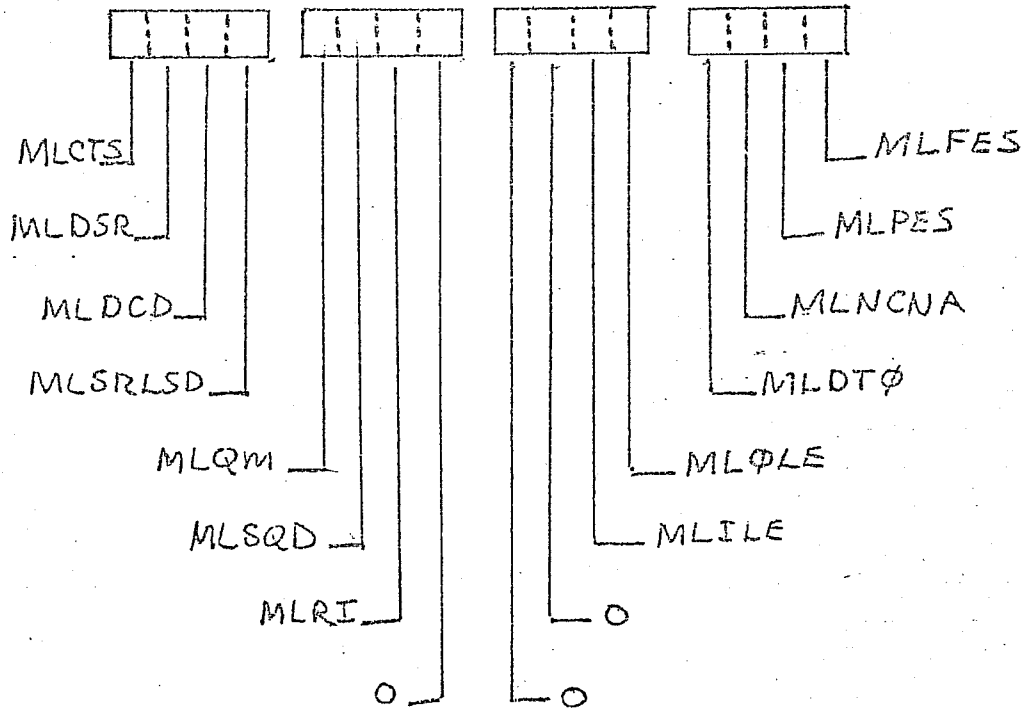

MLCTS - CLEAR TO SEND

MLDSR - DATA SET READY

MLDCD - DATA CARRIER DETECTED

MLSRLSD - SECONDARY RECEIVE LINE SIG

MLQm - QUALITY MONITOR

MLSQD - SIGNAL QUALITY DETECT

MLRI - RING INDICATOR

MLILE - INPUT LOOP ERROR

MLOLE - OUTPUT LOOP ERROR

MLDTφ - DATA TRANSFER OVERRUN

MLNcNA - NEXT CHARACTER NOT AVAILABLE

MLPES - PARITY ERROR

MLFES - FRAMING ERROR

TABLE 1-2. HCP FUNCTIONAL FEATURES

Main Memory	
Capacity:	32,768 words (expandable to 256k words)
Word length:	18 bits (16 Data, 1 Parity, 1 Protect)
Read-access time:	330 or 280 nanoseconds
Memory addressing modes:	8
Memory word and region protection	
Memory parity detection	
Direct memory access (4 users)	
External CPU Access	
Automatic interlaced refresh	
Micromemory	
Capacity:	3,072 Instruction (2,048 read/write; 1,024 read only)
Instruction length:	32 bits - 2 per word
Read-access time:	168 nanoseconds
Interrupts	
Macrointerrupts:	16
Microinterrupts:	16
Registers:	15
Files	
File 1:	256 words
File 2:	32 words
} 16 Bits each	

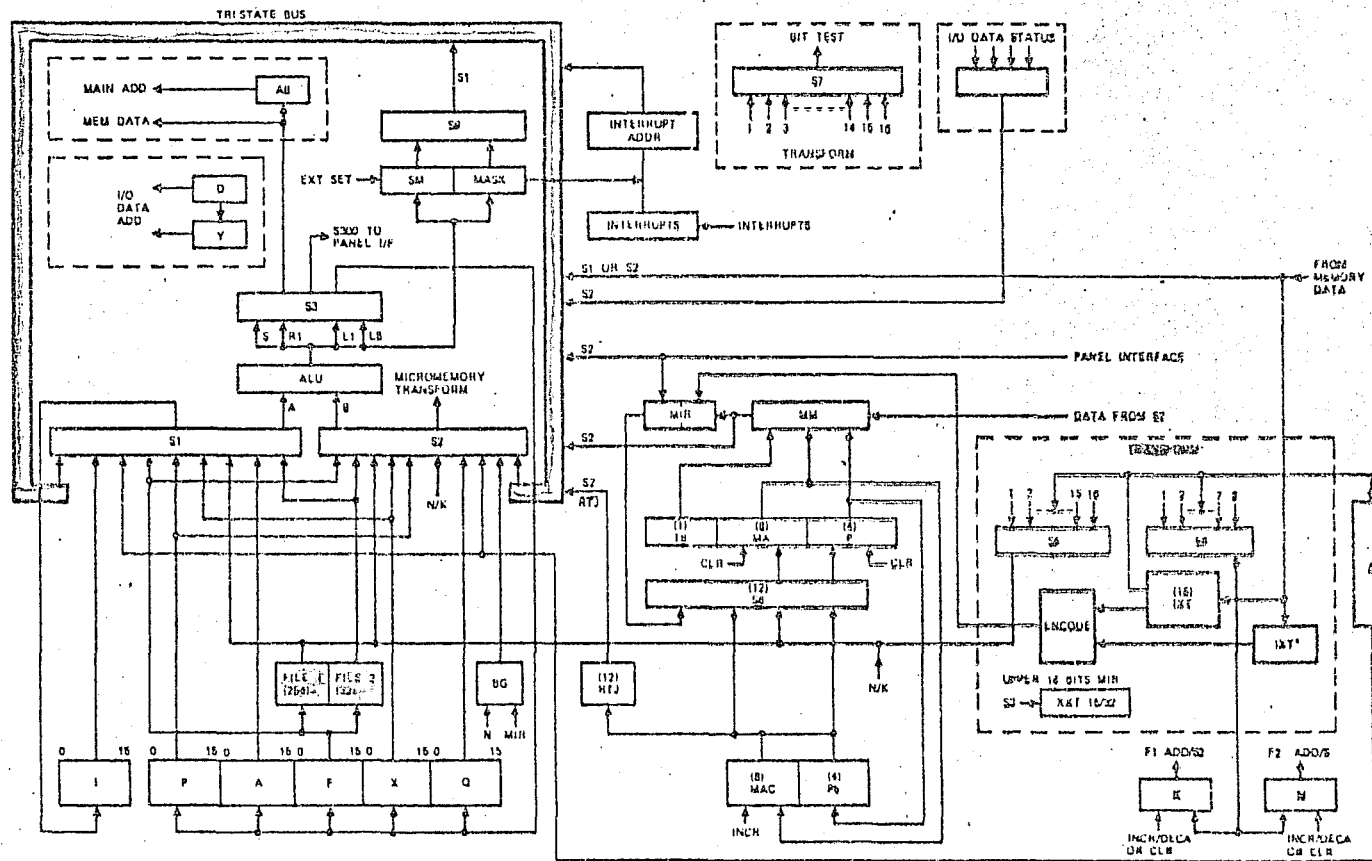

Detailed Microprocessor Block Diagram

TR-24

T8010

STATUS MODE BIT ASSIGNMENTS

Bit	Function
SM100	Not used (double precision)
SM101	One's Complement Arithmetic
SM102	Enable Bit Generator Input from N Register
SM103	Not used (split adder)
SM104	Macro Breakpoint Occurred (use with INT31/)
SM105	1700 Protect Fault Occurred
SM106	Enable Macro Interrupt System
SM107	Not used (enable decimal arithmetic)
SM108	Main Memory Parity Error Occurred
SM109	Enable Micromemory Halt
SM110	Overflow
SM111	Enable File 1 (Read/Write)
SM112	Not used (enable binary overflow)
SM113	Not used (enable R/W MM via transform)
SM114	Delay Enabling Macro Interrupts
SM115	MLIA Busy
SM200	Enable ADT Mode
SM201	Strobe or Read Data from M05 Device
SM202	Write Data to AQ Device
SM203	Terminate I/O Transfer
SM204	Enable Autoload
SM205	Enable MUX Subsystem Priority 3 Interrupt
SM206	Not used
SM207	Enable page selection with transform
SM208	Not used
SM209	Enable the unprotected instruction followed by a Protected Instruction Check
SM210	Write Data to Panel Device
SM211	Read Data to Panel Device
SM212	Write Data to FCR Register
SM213	Enable 1700 Enhanced Transform
SM214	Enable Console Control
SM215	Enable Macro Instruction Run

T8010

TR-29

INTERRUPT BIT ASSIGNMENTS

1B010

Bit	Function
I100	MLIA
I101	Communications Console (TTY or CRT)
I102	MLIA
I103	(unassigned)
I104	2571/2570 Line Printer Controller
I105	(unassigned)
I106	(unassigned)
I107	Tape Cassette Controller
I108	Real Time Clock
I109	(unassigned)
I110	(unassigned)
I111	2571-2572 Card Reader Controller
I112	1700 Emulator
I113	1700 Emulator
I114	1700 Emulator
I115	1700 Emulator
I200	Power Fail/Memory Parity
I201	Communications Console (TTY or CRT)
I202	Multiplex Subsystem Priority 3 (source is SM205)
I204	2571/2570 Line Printer Controller
I205	CYBER Coupler 2 (2558-1)
I206	CYBER Coupler
I207	Tape Cassette Controller
I208	Real Time Clock
I209	1732/608-609 Mag Tape Controller (QSE)
I210	1740-1742 Line Printer Controller (QSE)
I211	2571-2572 Card Reader Controller
I212	MLIA
I213	MLIA
I214	(unassigned)
I215	Macro Breakpoint

MICRO
INTERRUPTS

MACRO
INTERRUPTS

1R-30

I202 MLIA ERROR

MICRO INSTRUCTION FORMAT

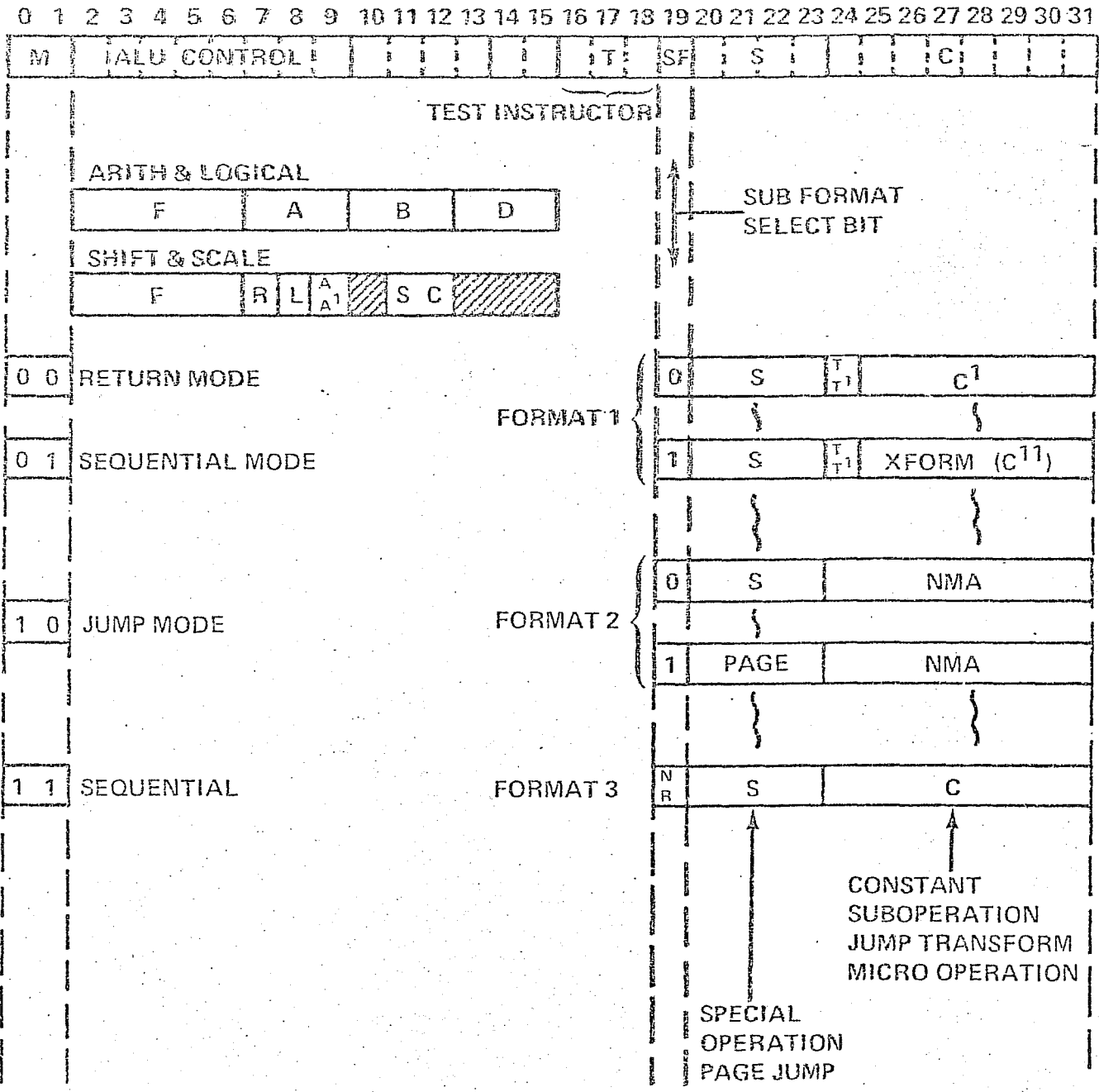

MICRO INSTRUCTION FORMAT

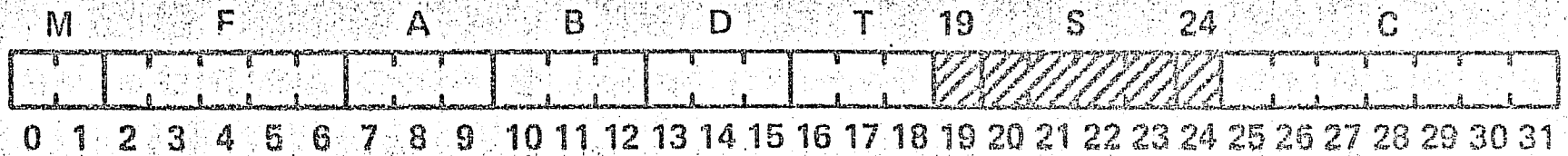

S MODIFIES A-B-D
19 MODIFIES C
24 MODIFIES T

MICRO-CODE SUBROUTINES TO EMULATE LDA MACRO INSTRUCTION

T	P/MA	MICRO-MEM	LOCATION	F	A	B	D	S	C	MT	COMMENT	
DECODE NEXT INSTRUCTION												
0	058	6C79	0000	B	INI	SUB	P	MEM	P		INCR. TO NEXT INST., P = P + 1	
1	058	D8D8	B307	G	RNI			READ	N=F2IREG	INTU	READ NEXT INST.	
0	059	4AF7	2830	B	+	B		INTA	F	U	PROCESS ACTIVE INTERRUPT	
1	059	58D8	302C	C	XNI			PAGE0	GITMAKXT	U	TRANSFORM ON NEXT INST.	
											⋮	
LOAD A REGISTER F = C												
0	098	6C79	2300	G	+LDA	SUB	P	MEM	P	READ	U	READ (EA), P + 1 TO P
0	099	9FDD	4058		+	A	MEM		A		J	(EA) TO A, GO TO RNI



0000	BEGIN
0100	INTERRUPT TRAPS
0140	JUMP TABLE
0150	ADDRESS TABLE
0170	1ST LEVEL INTERRUPT HANDLERS BASE SYSTEM ROUTINES OPS MONITOR
0970	PASCAL GLOBAL VARIABLES (GLOBL)
21CE	BASE SYSTEM ROUTINES (INCLUDING DEBUG AIDS)
4A2E	MUX SUBSYSTEM SOFTWARE
54C9	HIP
7B5D	TIP SUBROUTINES
6C58	ONLINE DIAGNOSTICS
6651	TIP SUBROUTINES
67C3	MODE 4 TIP
7589	TELETYPE TIP
8937	SERVICE MODULE
8EAE	BASE SYSTEM ROUTINES
90F5	
9F0E	MUX SUBSYSTEM FIRMWARE IMAGE BASE SYSTEM INITIALIZATION
0FFF	

ASSEMBLY
LANGUAGE
PROGRAMS

DUFFER
SPACE

TABLE 4-4. PIPRINT ADDRESS AREA FORMAT

\$150	0	BYWLCB	WORKLIST CONTROL BLOCK	} BASE
	1	JSWLADDR	WL ENTRY BY LEVELNO	
	2	BITCB	INTERNAL PROCESSING TCB	
	3	BIBUFF	INTERNAL PROCESSING BLOCK	
	4	JKMASK	INTERRUPT MASKS	
	5	JKTMASK	PBAMASK SAVE AREA	
	6	CBTMTBL	TIMAL TABLE	
	7	JACT	PD CONTROLLER TABLE	
	8	BECTLBK	BUFFER CONTROL BLOCK	
	9	BEBSA	BUFFER STAMP AREA	
	A	CLBFSPACE	BFR SPACE IN NO. SMALL BFRS	
	B	BKPIKT	POI TABLE	
	C	JLUERRSTAT	UPLINE ERR-STAT ROUTING	
	D	JLUSVM	UPLINE SERVICE MSG ROUTING	
	E	JLDSVM	DOWNLINE SERVICE MSG ROUTING	
	F	0		
160	10	NAPORT	PORT TABLE	} MUX SUBSYSTEM
	11	BQCIB	CIRCULAR INPUT BUFFER	
	12	NECCST	CLA CMD STATUS TABLE	
	13	MLSTABLE	CLA CURRENT STATUS TABLE	
	14	0		
	15	CGLCBS	LINE CONTROL BLOCKS	} LINES - TIPS
	16	CHSUBLCB	SUB LCBS	
	17	BJTIPTYPT	TIP TYPE TABLE	
	18	NJTECT	TERMINAL CHARACTERISTICS TABLE	} DEBUG AIDS
	19	0		
	1A	JFISNPTBLE	SNAPSHOT CORE TABLE	
	1B	JFWRAP	WRAP-SNAP TABLE	
	1C	J1STRT	START ADDR FOR PBDUMP	
	1D	J1QUICKPTR	BFR PTR FOR PBQUICKIO	
	1E	ONPINTAB	INIT SEQ COMPT AND ERROR TAB	

MONITOR
OPS
PROGRAM SCAN SEQUENCE

1. PRIORITY PROGRAMS

- A. PBINTPROC - INTERNAL PROCESSING
WORKLIST - BOINWL
- B. PTSTART -- COUPLER HOST INTERFACE PROCESSING
WORKLIST - BOCOWL
- C. PTTYP - TTY TERMINAL INTERFACE PROCESSING
WORKLIST - BOTIWL
- D. PTMODAT - MODE A TERMINAL INTERFACE PROCESSING
WORKLIST - BOMAWL
- E. PBTIMAL - TIMING SERVICES
WORKLIST - BOTIWL

2. NON PRIORITY PROGRAMS

- A. PBCONSOLE - CONSOLE INTERFACE PROCESSING
WORKLIST - BOCHWL
- B. PBCONTINUE - RETURN CONTROL TO TIPS AT OPS LEVEL
WORKLIST - BOCWAQ
- C. PBTIPDBG - DEBUG ROUTINE
WORKLIST - BOTYWD
- D. PBMLIAOPS - MLI A PROCESSOR
WORKLIST - BOMLWL
- E. PNSMWL - SERVICE MODULE PROCESSOR
WORKLIST - BOSMWL

LEVEL 8 PROCEDURE

PBTIMER

I205

REAL TIME CLOCK INTERRUPT INITIATED

CAUSE: REAL TIME CLOCK COUNT EQUALS CLOCK LIMIT
EVERY 30MS OR LESS

CALLS: PMT200M EVERY 200MS TO CHECK FOR CHARACTER
TIMEOUT

PRLSPLT EVERY 500MS TO ENTER WORKLIST ENTRY
IN OPS PROGRAM PBTIMAL TO CHECK
WAIT TIMER FIELDS FOR TIPS

LEVEL 6 PROCEDURE

PTINTPROC

I206

PRIMARY CYBER COUPLER INTERRUPT

LEVEL 5 PROCEDURE

PTINTPROC

I205

SECONDARY CYBER COUPLER INTERRUPT

CAUSE: NORMAL

1. CHANNEL ADDRESS ZERO
2. CHANNEL ACTIVE 3 SECONDS
3. NPW STATUS ACCEPTED
4. ORDER WORD LOADED
5. TRANSFER TERMINATED BY PPU
6. TRANSFER COMPLETE

ERROR

1. PPU CHANNEL PARITY ERROR
2. MEMORY PROTECT ERROR
3. MEMORY PARITY ERROR

LEVEL 3 PROCEDURE

PMWOLP

I203

STATUS MODE S205 INTERRUPT

CAUSE: INITIATED BY MICRO CODE SEQUENCE N2P3INTA.
WHICH SETS SM205 IN STATUS MODE REGISTER. THE
MICRO SEQUENCE IS CALLED BY OPS LEVEL PROGRAMS
WISHING TO PASS CONTROL TO MUX DRIVER.

CALLED BY: PBLCBTMSCN - TIMING SERVICE FOR TIPS TO RETN
TO MUX LEVEL AFTER WAIT TIME 1
EXPIRED

PMEDRV - MUX COMMAND DRIVER TO TERMINAY
INPUT OR OUTPUT

PMT200M - MUX SUBSYSTEM 200MS TIMER TO
RETURN TO MUX LEVEL AFTER WAIT
CONDITION AND CHARACTER TIMED

PMT1SEC - MUX SUBSYSTEM 1 SEC TIMER TO
RETURN TO MUX LEVEL AFTER EVEN
TIMEOUT OR ODD TIMEOUT

PTWAIT - RETURN TO MUX LEVEL AFTER WAIT
EVENT HAS OCCURRED

LEVEL 2 PROCEDURE

PMMLEH

I202

MLIA ERROR INTERRUPT

- CAUSE:
1. ODD LIMIT REACHED
 2. MLIA INPUT BUFFER FULL
 3. OUTPUT LOOP ERROR
 4. INPUT LOOP ERROR

LEVEL 1 PROCEDURE

PBTTYINT

I201 CONSOLE TTY INTERRUPT

- CAUSE:
1. MANUAL INTERRUPT FROM CONSOLE
 2. END OF OPERATION
 3. DATA INPUT

LEVEL 0 PROCEDURE

PBLN00

I200 POWER FAIL / PARITY INTERRUPT

- CAUSE:
1. MEMORY PARITY ERROR
 2. MEMORY PROTECT FAULT
 3. POWER FAILURE

CALLS: PBBREA - BREAKPOINT PROCESSOR CALLED IF PROTECT FAULT TO CHECK FOR BREAKPOINT CONDITION

BCB BUFFER CONTROL BLOCKS

(158) = FWA

(free buffer chain)

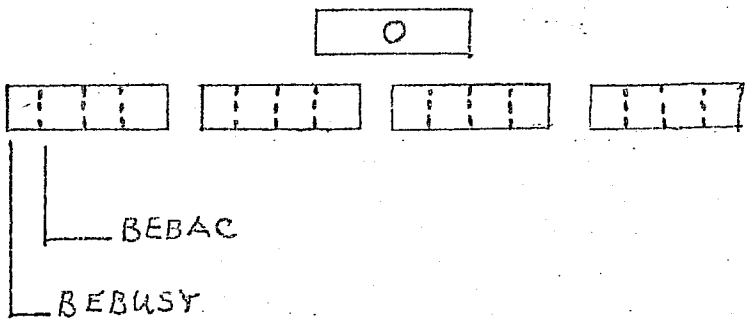
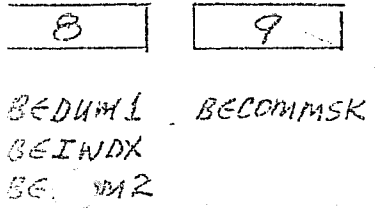
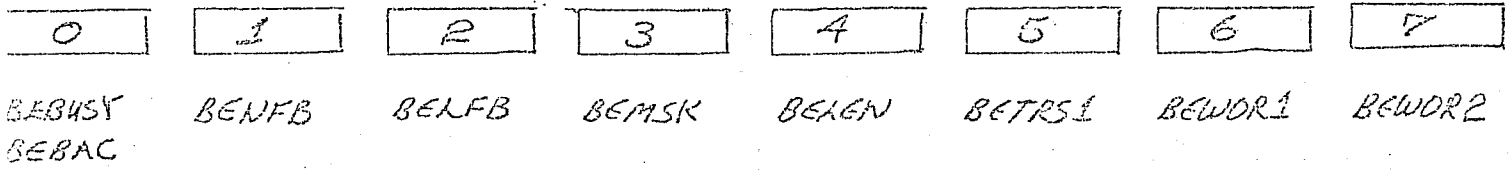

BEBUSY - INTERLOCK FLAG

BEBAC - BUFFERS AVAILABLE COUNT

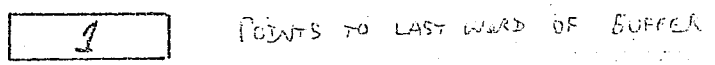

BENFB - NEXT FREE BUFFER

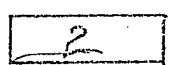

BELFB - LAST FREE BUFFER IN CHAIN

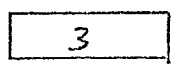

BEMSK - MASK FOR CHAIN ERROR CHECKING

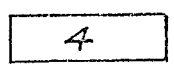

BELEN - LENGTH OF BUFFERS IN THIS POOL

5

BETRS1 - LOWER THRESHOLD FOR THIS BUFFER TYPE

6

~~BEWDR1~~
BEWDR1 - INITIAL VALUE OF FIRST WORD OF BUFFER
8/KCD, 8/FCD

7

BEWDR2 - INITIAL VALUE OF SECOND WORD OF BUFFER

8

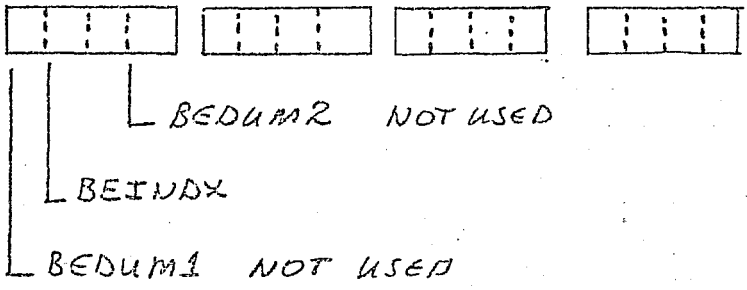

BEINDX - BUFFER SIZE

0 = BOS0	0D	CHARACTERS
1 = BOS1	1D	CHARACTERS
2 = BOS2	3D	CHARACTERS
3 = BOS3	7D	CHARACTERS

9

BECOMMSK - SETWORD

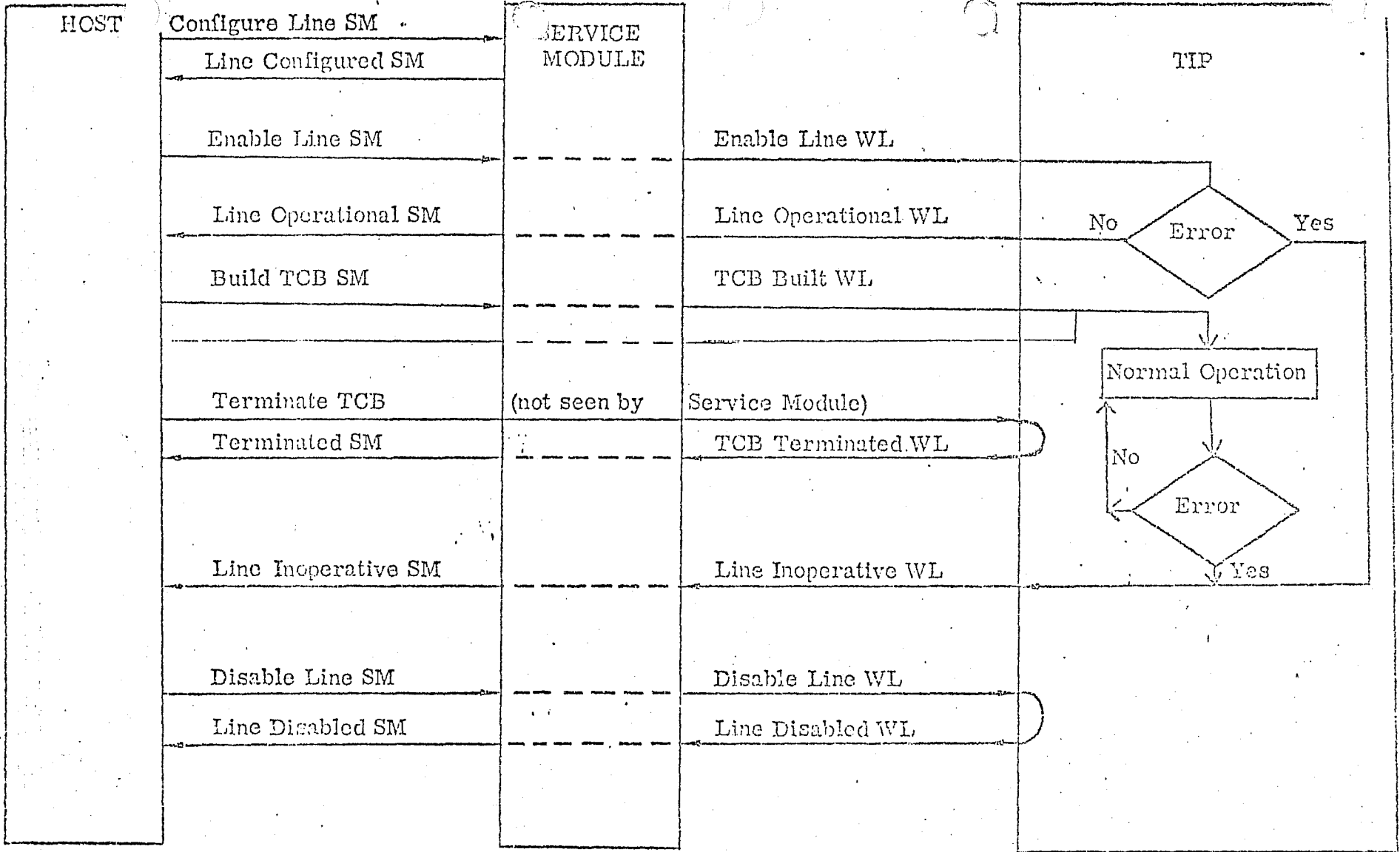

SM = Service Message
 WL = Worklist

4-79

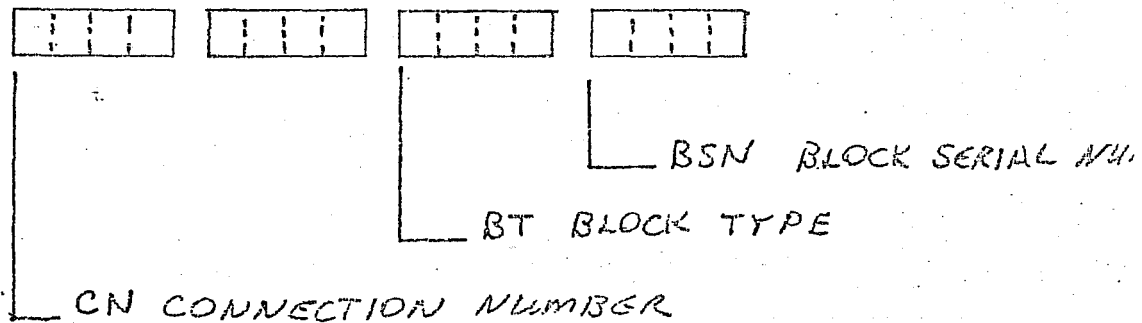
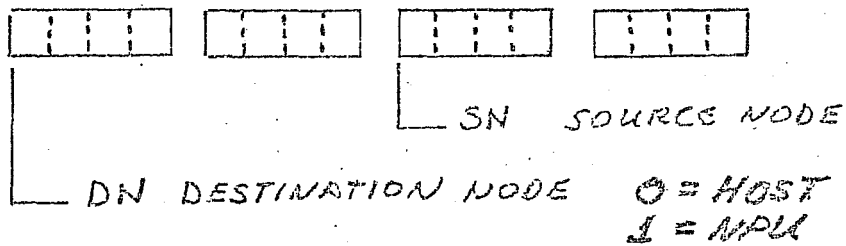
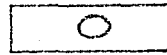
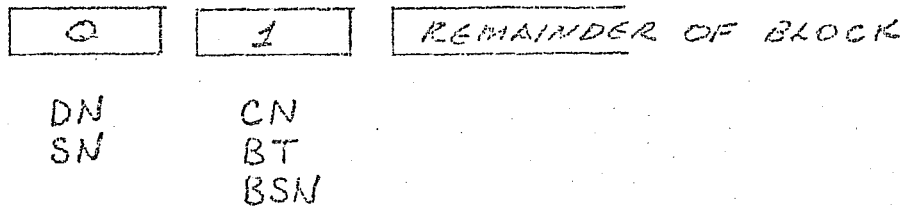

BT - BLOCK TYPE

7 TERMINATE

- 1 = BACK BLOCK WITH SAME CONNECTION AND BSN HAS BEEN PROCESSED
- 2 = BLK BLOCK WITH PORTION BUT NOT END
- 3 = MSG BLOCK WITH END OF DATA
- 4 = CMD COMMAND
- 5 = BREAK DISCONTINUITY IN DATA OR DIR
- 6 = RESET RESET DATA AFTER BREAK



DN	CN
SN	BT=1
	BSN

DATA BLOCK TYPE BLOCK OR MSG TYPE 2+



DN	CN	BFC
SN	BT=2+3	DATA
	BSN	

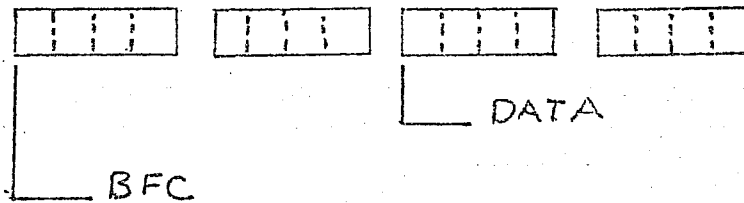
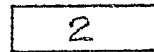

BFC - BLOCK FORMAT CODE EQUAL ZERO FOR ALL TYPES EXCEPT FOR MODE 4 TIP DOWNLINE

MODE-4
 0 = CLEAR WRITE
 1 = RESET WRITE
 2 = WRITE

DATA - DATA BLOCK = 2047 BYTES OF DATA
 MSG BLOCK = 2043 OR LESS BYTES OF DATA

BREAK TYPE BLOCK -5-

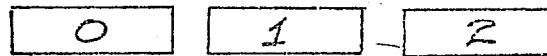

DN	CN	RB
SN	BT=5	
	BSN	

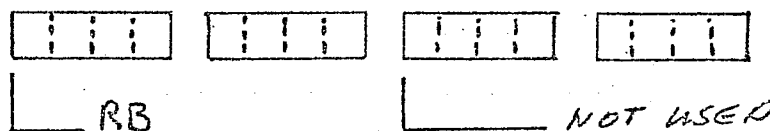
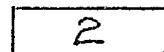

RB - REASON FOR BREAK. EQUAL ZERO FOR ALL EXCEPT MODE 4 TIP

MODE-4 BREAK RB

50
L

- 1 = VMNORESP NO RESPONSE FROM TERMINAL
- 2 = VMBDRESP BAD RESPONSE FROM TERMINAL
- 3 = VMERRESP ERROR RESPONSE FROM TERMINAL
- 4 = VMPRINTFAIL PRINTER FAILURE
- 5 = VMBATCHINT BATCH-INTERRUPT

RESET TYPE BLOCK -6-

0	1
---	---

DN	CN
SN	BT=6
	BSN=0

TERMINATE TYPE BLOCK -7-

0	1
---	---

DN	CN
SN	BT=7
	BSN=0

COMMAND TYPE BLOCK -T-

3
4

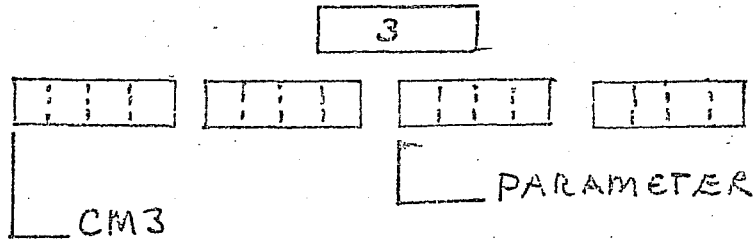
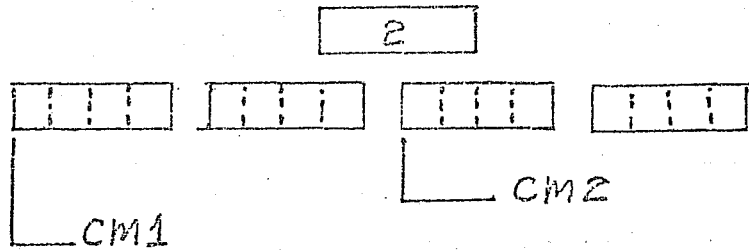
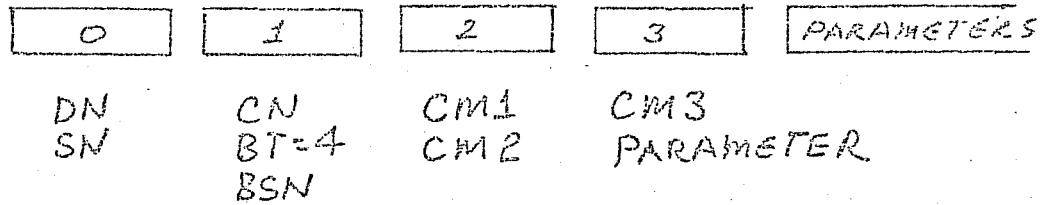

<u>CM1</u>	<u>CM2</u>	<u>CM3</u>	
1	0	0	CONFIGURE LINE MESSAGE
0	1	0	CONFIGURE LINE RESPONSE
1	0	1	CONFIGURE TERMINAL MESSAGE
0	1	1	CONFIGURE TERMINAL RESPONSE
2	0	0	ENABLE LINE MESSAGE
0	3	0	LINE OPERATIONAL
0	3	1	LINE INOPERATIVE
1	MD IB		MODE SET MD=0 INTERACTIVE TT =1 TAPE TT IB=0 INTERACTIVE MODE IB=1 BATCH MODE
3	SW		SET SCREEN WIDTH SW=WIDTH MODE
2			START POLL
0	4	0	REPORT TO CE ERROR FILE
0	4	1	NPU STATISTICS
0	4	2	LINE STATISTICS

COMMAND BLOCK CODES

(40) 3
1

<u>CM1</u>	<u>CM2</u>	<u>CM3</u>	
3	0	0	PLACE LINE OUT OF SERVICE
3	1	0	PLACE LINE IN SERVICE
3	2	0	START CMA INTERNAL LOOPBACK TEST
3	2	1	START MODEM LOOPBACK TEST
3	2	2	START EXTERNAL LOOPBACK
3	3	0	TERMINATE TEST

TERMINAL DEFINITION

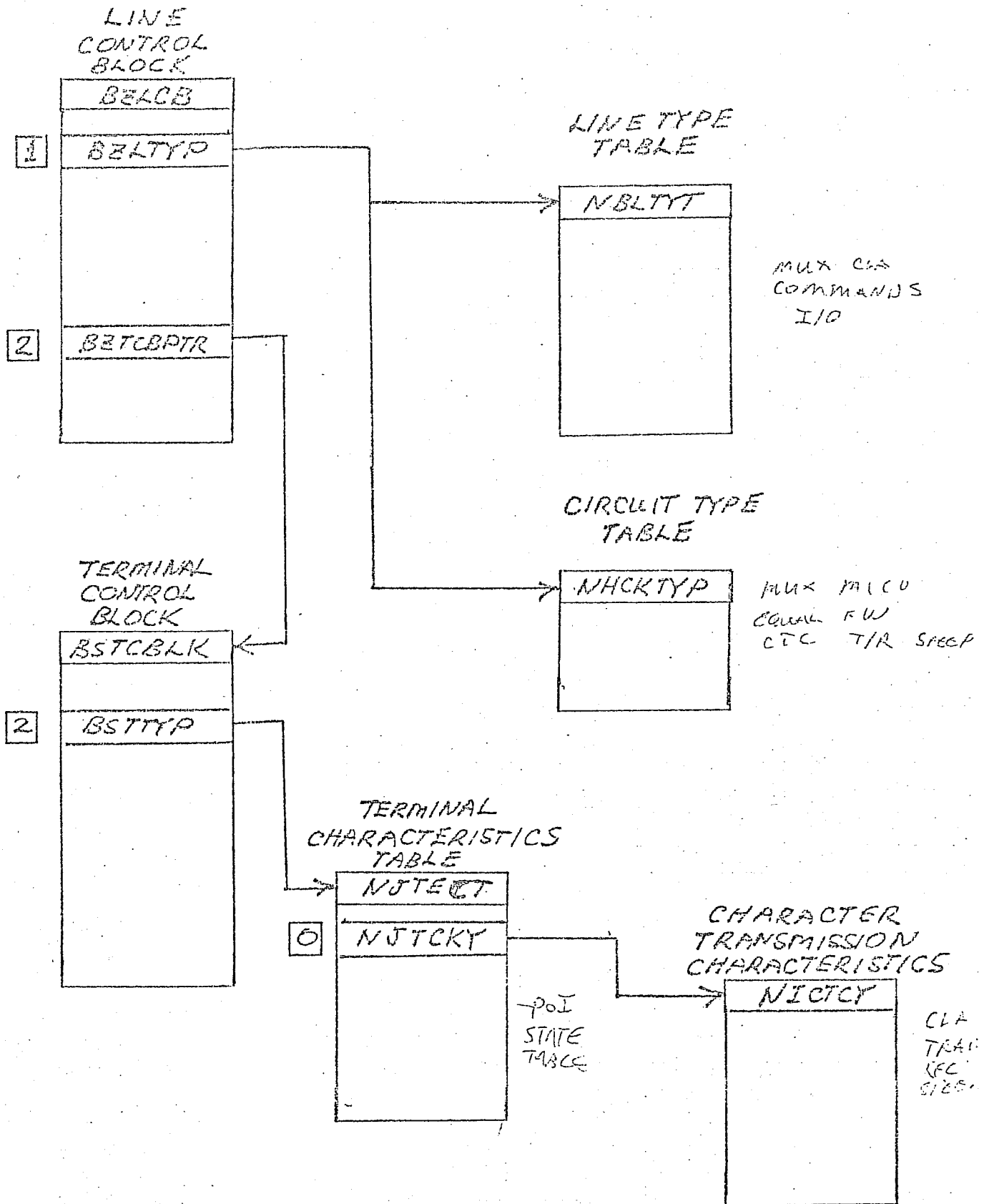

TERMINAL LINE CONTROL DEVICES
 —LCB—

10
1

0	1	2	3	4	5	6	7
BELINO	BETAPEX BELTYP BEDUMZ BETIPTYP BELTIMER	BESTATE BETTYP BECNFST BETTYPE	BZWSSTAT	BZWAITMSK	BZERROR	BZRTADDR	BZLNSTA

8	9	A	B	C	D	E	F
BZWCOUNT BZPDMO	BZBRACUM	BZRSAVE	BZRSVAVG	BZIFBA	BZITBA	BZOTBA	BZNPORG BZLOSPSWD BZLOS BZDIAG BZABORT BZNDME BZMDCL

10	11	12	13	14	15	16
BZRLKSWT BZBLKREC	BZCHASENT BZCHASREC	BZCHASREC BZCHAREC	BZTCBPTR BZTCBPTR	BZLBTOMIX	<u>MODE 4</u> BZCURTCB <u>TTY</u> BZTYRET	<u>MODE 4</u> BZDISABLED BZENABLED BZAUTOREC BZMASK BZMAD1 BZDELAYLINE BZTDISABLED BZMAXRSTRY <u>TTY</u> BZTYCNT BZTYRSN

0

BZLINO

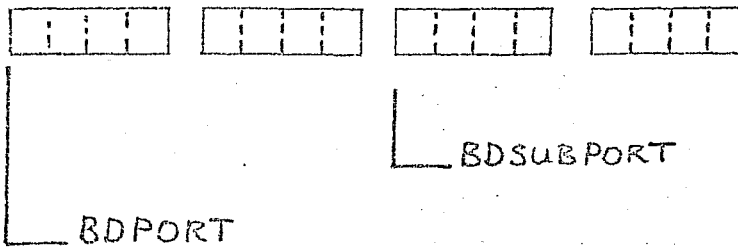

BDPOR = CLA ADDRESS PORT NUMBER LIVE NUMBER

BDSUBPOR = SUBPORT NUMBER

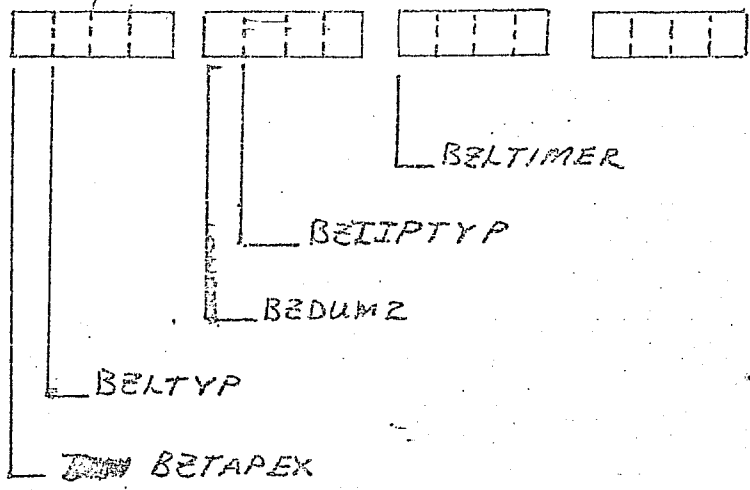

BETAPEX - T1MAL APPENDAGE EXISTS NO REF FOR SETTING

BELTYP - LINE TYPE

1 = NOL1	2560-1	DIAL UP	HALF DUPX	CONST. CARR.
2 = NOL2	2560	DEDICATED	FULL DUPX	CONST. CARR.
3 = NOL3	2560	DEDICATED	FULL DUPX	CONST. CARR.
4 = NOL4	2561	DIAL UP	FULL DUPX	CONST. CARR.
5 = NOL5	2561	DEDICATED	FULL DUPX	CONST. CARR.
6 = NOLDIAG	FOR ON LINE DIAGNOSTIC			

BEDUM2 - NOT USED

BELTIPTYP - TIP TYPE

1 = NOTTY	TTY TIP
2 = NDMODE4	MODE4 TIP
6 = NOLDIP	ON LINE DIAGNOSTIC

BELTIMER - GENERAL PURPOSE TIMER USED IN P1WAIT AMOUNT OF 1/2 SEC INTERVALS TO WAIT FOR EVENT TO OCCUR

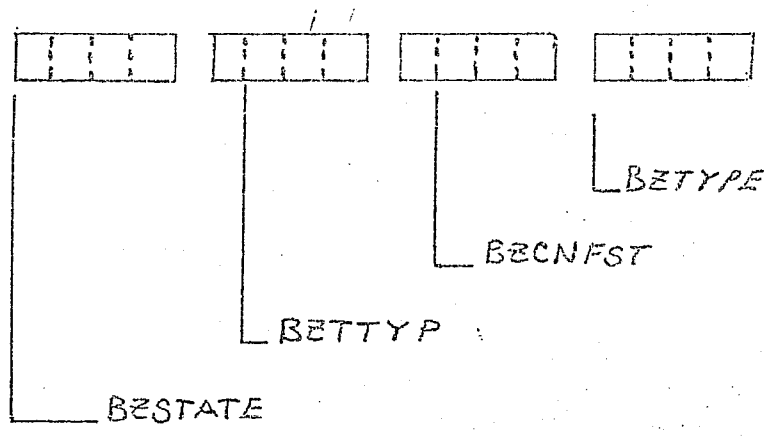

BZSTATE - CONFIGURED TERMINAL TYPE FROM MPU AFTER AUTO RECOGNITION

- 1 = NOT1TTY TTY 110 BAUD
- 2 = NOT2TTY 150 BAUD
- 3 = NOT3TTY 300 BAUD
- 4 = NOT4TTY TTY AUTO RECOGNITION
- 5 = NOT5MBA MODE 4A BCD 200 ULT
- 6 = NOT6MD4 MODE 4A ASCII 734
- 7 = NOT7MD4 MODE 4C 711-714
- 8 = NOT8MD4 MODE 4 AUTO RECOGNITION
- 9 = NOT9TTY TTY 600 BAUD
- A = NOTATTY 1200 BAUD
- F = NOTDIAG DIAG

BETTYP -

SET FROM CONFIGURE LINE COMMAND FROM HOST
SAME FORM AS BZSTATE

BECNFST - CURRENT STATE OF CONFIGURATION

- 0 = C7VOID CONTROL BLOCK VOID
- 1 = C7DISABLED LINE CONFIGURED BUT NOT ENABLED
- 2 = C7ENREQ ENABLE REQUESTED TO TIP
- 3 = C7OPER LINE OPERATIONAL BUT NO TCB
- 4 = C7TERCONF TERMINAL CONFIGURED
- 5 = C7DADSO

6 = C7 INOP LINE INOPERATIVE AND NO TIP

7 = C7 DCREQ DISCONNECT REQUESTED TO TIP

BETYPE - TYPE OF LCB MODE 4 OR TTY OR DIAGNOSTIC

0 = BESTD TTY OR MODE 4 OR DIAGNOSTIC

6 = MLIA

7 = CONSOLE

8 = COUPLER

TABLE 3-3. TERMINAL TYPE CODES

Term Type Code	TIP Type	Char. Transmission Characteristics Key	General Description	Specific Terminals Supported
1	TTY	1	10 cps, 110 baud	Teletype M33, M35, and M38 CDC 713-10
2	TTY	2	15 cps, 150 baud	Teletype M37 CDC 713-10
3	TTY	3	30 cps, 300 baud	CDC 713-10
4	TTY	1-3	Automatic recognition of above line speeds	Any teletype compatible terminals specified above
5	MD4	4	Mode 4A BCD	214, 217 (200 UT), 731-12, 732-12, 734-1
6	MD4	4	Mode 4A ASCII	217, 731-12, 732-12, 734-1
7	MD4	4	Mode 4C	711-10, 714-10/20
8	MD4	4	Automatic recognition of above by repeated poll of Controllers 70, 71, and 72	Any Mode 4 terminals specified above, after address strapping which implies terminal type from controller address

BZWSTAT

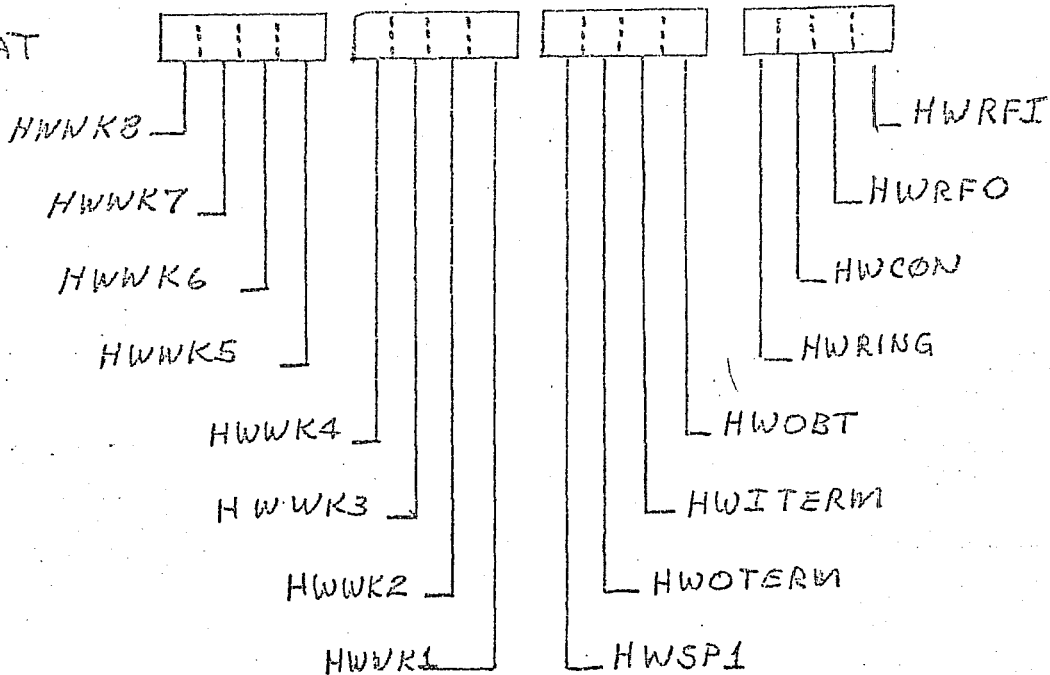

BZWSTAT - LINES CURRENT EVENT WAIT STATUS

HWWK8	MODE 4 -	TTY - GHBREAK	ESC / CNTL2 ENCOUNTERED
✓ HWWK7	MODE 4 - VM4 EOF	TTY - GHDLMLF	WAIT FOR EOF IN READ LINE FEED ENCOUNTERED
HWWK6	MODE 4 - VM4 ERR	TTY - GHDLMCR	WAIT FOR LINE ERROR CARRIAGE RETURN ENCOUNTERED
HWWK5	MODE 4 - VM4 RES	TTY - GHBLKSE	WAIT FOR RES+ACK+ERR DATA BLOCK SIZE EXHAUSTED
HWWK4	MODE 4 - VM4 RE3	TTY - GHRCFRS	WAIT FOR READ E3 CODE FIRST INPUT CHARACTER RECEIVED
HWWK3	MODE 4 - VM4 RE2	TTY - GHAD30	WAIT FOR READ E2 CODE AUTO BAUD AT 30 CPS
HWWK2	MODE 4 - VM4 RE1	TTY - GHAD15	WAIT FOR READ E1 CODE AUTO BAUD AT 15 CPS
	DIAGNOSTIC - HWSTAT		CAA STATUS RETURNED

HWWR1 TTY - GADIO AUTO BAUD AT 10 CPS
MODEM - VME-SOH WAIT FOR SOH

HWSP1

HWOTERM - OUTPUT TERMINATED

HWITERM - INPUT TERMINATED

HWOBTF - OUTPUT BUFFER TRANSMITTED

HWRING - RING INDICATOR

HWCON - CARRIER ON

HWRF0 - READY FOR OUTPUT

HWRFI - READY FOR INPUT

BZWAITMASK - EVENT TIP IS WAITING TO OCCUR, SET BEFORE CALLING PTWAIT. SAME FORMAT AS BZWSTAT-WORD 3 LCB. WHEN EVENT HAPPENS CONTROL IS RETURNED BACK TO TIP

Line Type Code	CLA Type	Modem Type	Circuit Type	Transmission Facility	Controlled Carrier
1	2560-1	RS232-201A Comp.	Switched	Half Duplex	Yes
2	2560-1	RS232-201B Comp.	Dedicated	Full Duplex	Yes
3	2560-1	RS232-201B Comp.	Dedicated	Full Duplex	No
4	2561-1	RS232-103E/113 Comp.	Switched	Full Duplex	No
5	2561-1	RS232-103 Comp.	Dedicated	Full Duplex	No

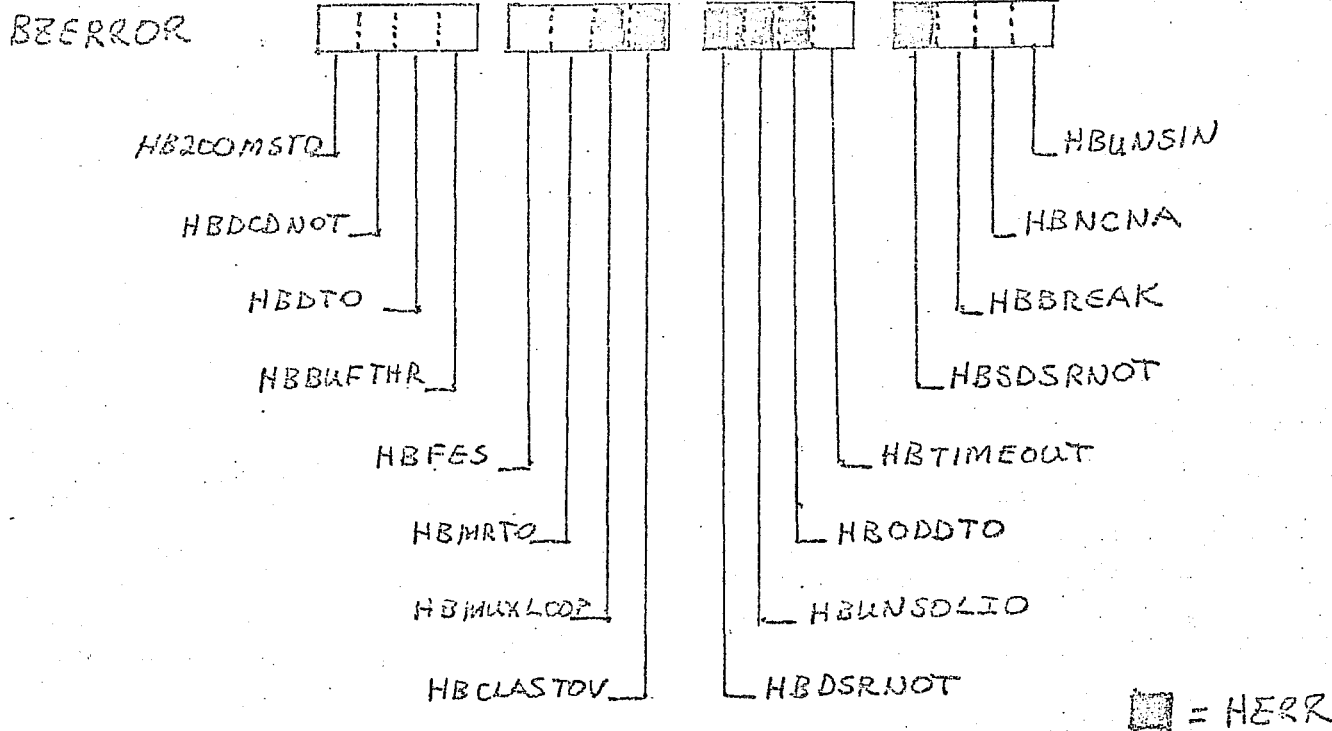

BZERROR - LINE LOGICAL STATUS DETECTED BY MUX DRIVER DURING PTWAIT TIME

HB200MSTO - 200 MS TIMEOUT

HBDCDNOT - DATA CARRIER DROPPED

HB D TO - DATA TRANSFER OVERRUN OUTPUT CHAR SENT BEFORE LAST CHAR TRANSMITTED

HB B U F T H R - BUFFER THRESHOLD REACHED

H B F E S - FRAMING ERROR STATUS TTY CHAR WITHOUT STOP BIT

H B M R T O - MODEM RESPONSE TIMEOUT

H B M U X L O O P - MUX LOOP ERROR

H B C L A S T O V - CLA STATUS OVERFLOW, EXCESS OF 128 HARDERR OCCURRED IN .5 SEC.

HARDERROR = HB M U X L O O P + H B D S R N O T + H B U N S O L I O + H B O D D T O + H B S D S R N O T

H B D S R N O T - DSR + CTS NOT READY DEDICATED LINE

H B U N S O L I O - UNSOLICITED I/O (ODD + NENA)

5

HBODDTO - ODD TIMEOUT

HBTIMEOUT - WAIT TIMEOUT

HBDSRNOT - DSR NOT READY DIAL UP LINE

HBBREAK - BREAK CHARACTER RECEIVED

HBNCNA - NEXT CHARACTER NOT AVAILABLE

HBUNSIN - UNSOLICITED INPUT DATA IN CIB

6

BERETADDR - RETURN ADDRESS IN TIP TO RETURN TO WHEN
EVENT SET IN BZWAITMASK OCCURS IN
BZSTAT

BELINSTA

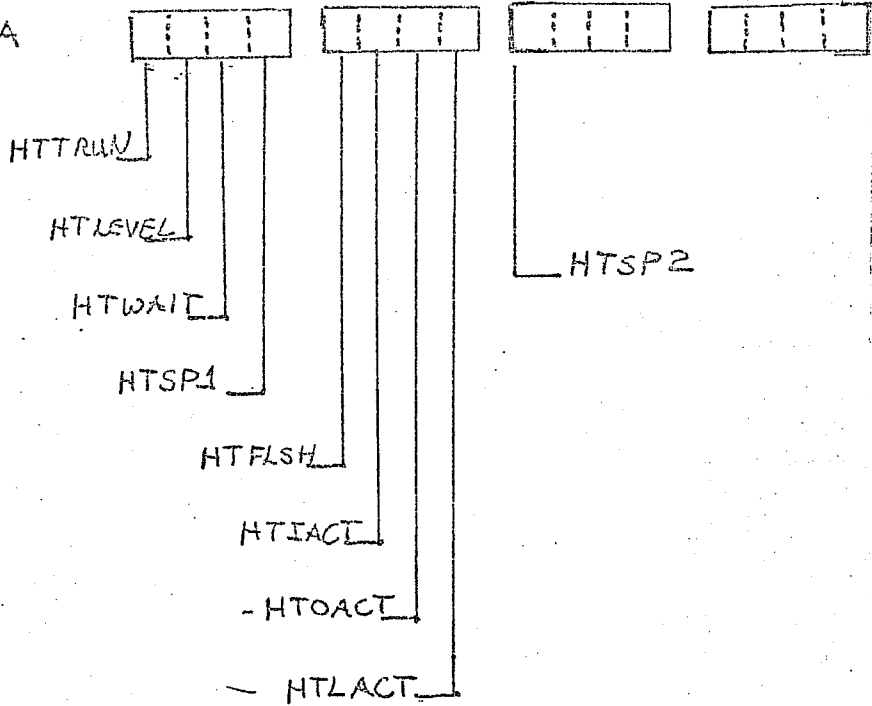

^{WAIT}
HTTRUN - TIMER ACTIVE WAITING ON BUS

HTLEVEL - LEVEL 1 = MUX 0 = DPS WHICH CALLED PTWAIT

HTWAIT - WAIT OUTSTANDING

HTSP1 - NOT USED

HTFLSH - FLUSH

HTIACT - INPUT ACTIVE

HTOACT - OUTPUT ACTIVE

HTLACT - LINE ACTIVE

HTSP2 - NOT USED

8

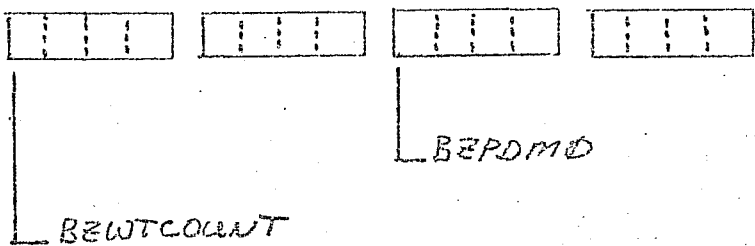

BEWTCOUNT - WAIT COUNT FOR CONTINUE W/L ENTRY

BEPDMO - CLA HARDERR STATUS COUNT, USED TO DETERMINE BERROR. HBCASTOV. 128 ERRORS IN .5 SEC DURING PTWAIT SEQUENCE.

SET EQUAL TO ZERO EVERY .5 SEC WHEN PBLCBTMSOV IS CALLED

9

BZERACUM - ACCUMULATED BERROR DURING PTWAIT SEQUENCE. SAME FORMAT AS BERROR LCB WORD-5

A

BZ1SAVE - SAVE R1 REGISTER AT TIME OF PTWAIT CALL

B

BZ2SAVE - SAVE R2 REGISTER AT TIME OF PTWAIT CALL

C

BZIFBA - BUFFER ADDRESS RECEIVED WHEN INPUT BEGAN

D

BZITBA - BUFFER ADDRESS RECEIVED WHEN INPUT ENDED

E

BZOTBA - BUFFER ADDRESS RECEIVED WHEN OUTPUT ENDED

F

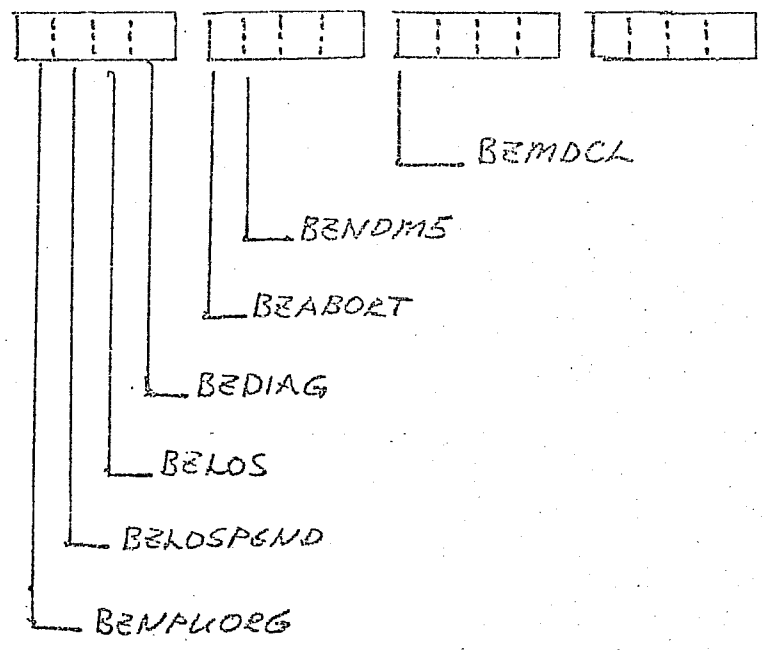

BENPUORG - NPU REQUESTED DISABLE LINE

BEKOSPEND - DISABLE LINE BY HOST PENDING

BELOS - LINE OUT OF SERVICE

BEDIAG - DIAGNOSTIC IN PROGRESS

BEABORT - TERMINATE DIAGNOSTIC

BENDMS - NOT USED

BEMDCL - MODEM CLASS USED WITH DIAGNOSTICS

10

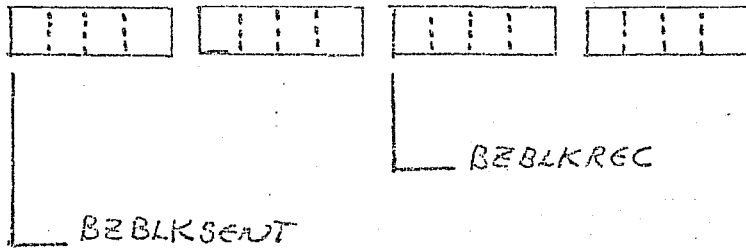

BZBLKSENT - BLOCKS SENT

BZBLKREC - BLOCKS RECEIVED

11

BECHRSENT - CHARACTERS SENT

12

BECHRREC - CHARACTERS RECEIVED

13

BETCBPTR - FIRST TCB TERMINAL CONTROL BLOCK ATTACHED TO THIS LCB

14

BZLBTOMUX - LAST BUFFER GIVEN TO MUX DRIVER TO OUTPUT

15

MODE 4 LINE

2

BECURTCB - CURRENT TCB TERMINAL CONTROL BUFFER
BEING SERVICED

15

TTY LINE

BZTYRET - RETURN ADDRESS FROM SUB CALL

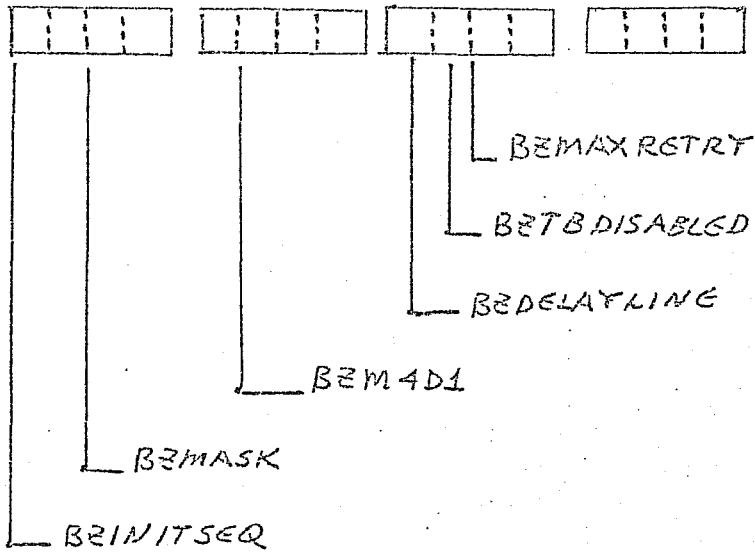

BRINITSEQ - LINE INITIALIZATION SEQUENCE

0 = BEDISABLED LINE DISABLED

1 = BEENABLED ENABLE LINE

2 = BEAUTOREC AUTO RECOGNITION

BEMASK - AUTO RECOGNITION MASK

BEMAD1 -

BEDELAYLINE - DELAY LINE SERVICE NEGATIVE EVENT TASK SENT BY TIP, SERVICE NEXT LINE

BETBDISABLED - DISABLE LINE RECEIVED

BEMAXRETRY - MAX RETRY FOR TIP TASK

16

TTY LINE

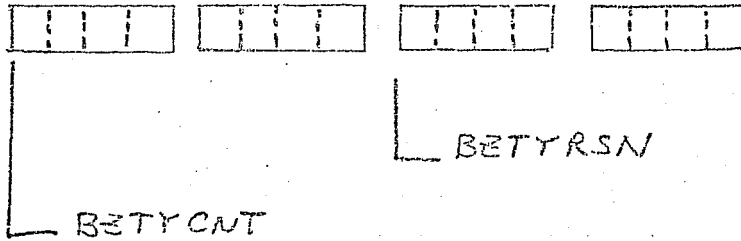

BETYCNT - MAX NUMBER OF RETRIES

BETYRSN - REASON TO BRING LINE DOWN

0 = INOP

1 = TCB

2 = DIS

LINE TYPE TABLE NBLTYT

0	1	2	3	4	5	6	7
NBSP1 NBAUSMOD NBCARR NBCIRTY NBMODCL NBCTYP	NBSP2	NBSP3	NBSP4	NB3TIME NB3SEND NB3SEQT	NB4TIME NB4SEND NB4SEQT	NB5TIME NB5SEND NB5SEQT	NB6TIME NB6SEND NB6SEQT

BELTYP 1
1-6

8	9	A	B
NB8TIME NB8SEND NB8SEQT	NB9TIME NB9SEND NB9SEQT	NBA8TIME NBA8SEND NBA8SEQT	NBA9TIME NBA9SEND NBA9SEQT

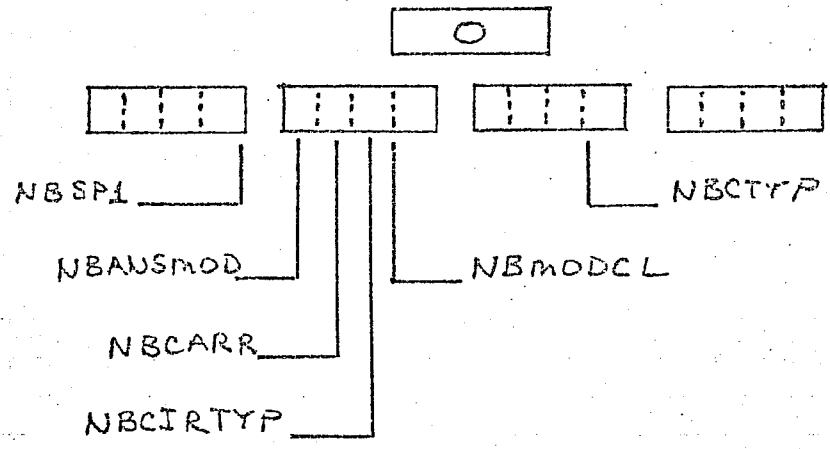

- NBSP1 - - NOT USED
- NBAUSMOD - ANSWER MODE 0=AUTO 1=DEDICATED
- NBCARR - CARRIER 0=CONSTANT 1=CONTROLLED
- NBCIRTYTYP - CIRCUIT TYPE 0=2WIRE 1=4WIRE
- NBMODCL - MODEM CLASS
- NBCTYP - CLA TYPE 0=2560 (SYNC) 1=2561 (ASYNC)

1 - 3

NBSP2
NBSP3 - NOT USED
NBSP4

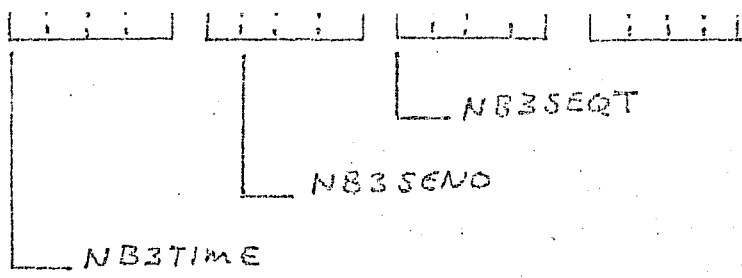

- NB3TIME - TIMER FOR NCTIME IN MUX LCB IN MUX DRIVER NRTURN
- NB3SEND - NUMBER OF CLA OUTPUT CELLS NEEDED FOR NRTURN
- NB3SEQT - MUX MODEM COMMAND SEQUENCE KEY FOR NRTURN

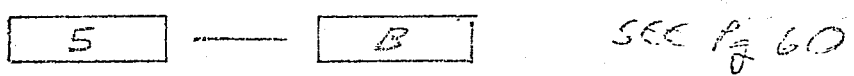

SAME FORMAT AS WORD 4

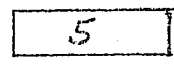

- NB4TIME - NKINIL TIMER FOR NCTIME IN MUX LCB
- NB4SEND - NKINIL NUMBER OF CLA OUTPUT CELL NEEDED
- NB4SEQT - NKINIL MUX MODEM SEQ COMMAND KEY

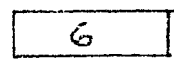

- NB5TIME - NKENBL TIMER
- NB5SEND - NKENBL CLA OUTPUT CELL COUNT
- NB5SEQT - NKENBL MUX MODEM SEQ COMMAND KEY

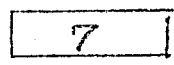

- NB6TIME - NKINPT TIMER
- NB6SEND - NKINPT CLA OUTPUT CELL COUNT
- NB6SEQT - NKINPT MUX COMMAND SEQ KEY



- NB8TIME - NKOUTPUT - NKQUOUT TIMER
- NB8SEND - NKOUTPUT - NKQUOUT CLA OUTPUT CELL COUNT
- NB8SEQT - NKOUTPUT - NKQUOUT MUX COMMAND SEQ KEY

9

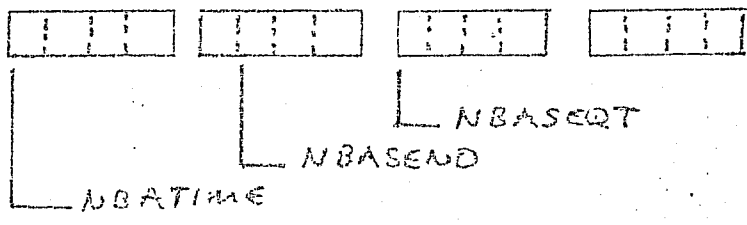

- NBETIME - NKENDIN TIMER FOR NCTIME IN MUX LCB
- NBASEND - NKENDIN CLA OUTPUT CELL COUNT
- NBASEQT - NKENDIN MUX COMMAND SEQ KEY

A

- NBBTIME - NKENDOUT TIMER FOR NCTIME IN MUX LCB
- NBBSEND - NKENDOUT CLA OUTPUT CELL COUNT
- NBBSEQT - NKENDOUT MUX COMMAND SEQ KEY

B

- NBCTIME - NKDISL TIMER FOR NCTIME IN MUX LCB
- NBBSEND - NKDISL CLA OUTPUT CELL COUNT
- NBBSEQT - NKDISL MUX COMMAND SEQ KEY

MODEM COMMAND SEQUENCE

76A

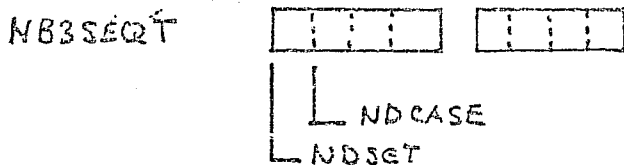

NDSET - SET CONDITION SPECIFIED BY NDCASE IF SET
CLEAR CONDITION SPECIFIED BY NDCASE IF ZERO

NDCASE - CIA COMMAND BIT TO CHANGE IN PROCEDURE PMPRAS

- 1 = RTS REQUEST TO SEND
- 2 = SRTS SECONDARY REQUEST TO SEND
- 3 = OM ORIGINATE MODE
- 4 = LM MODEM LOOPBACK
- 5 = DTR DATA TERMINAL READY
- 6 = TB TERMINAL BUSY
- 7 = ION INPUT ON
- 8 = OON OUTPUT ON
- 9 = BREAK BREAK MODE
- A = ISR INPUT SUPERVISION REPORT
- B = ISON INPUT SUPERVISION ON
- C = DLM DATA LINE MONITOR CHECK END OF BREAK
- D = PARITY SET ODD PARITY WHEN ON
- E = PARITY ENABLE
- F = ECHO SET ECHO MODE
- 10 = LBT INTERNAL LOOP BACK
- 11 = RSYN RESYNCHRONIZE INPUT
- 12 = HALF DUPLEX IF INPUT AFTER OUTPUT CLEAR ION
~~INTERNAL LOOP BACK~~

765

MODEM COMMAND
SEQUENCE TABLE
1434

INDEX	02	\overline{RTS}	
	03	RSTN	
	04	IF ION AFTER OON THEN \overline{ION}	
	05	\overline{ODN}	
	08	\overline{DTR}	
	09	\overline{RTS}	
	0C	ISR	INITIALIZE LINE
	0D	ISON	
	10	RTS	
	11	ISR	
	12	DTR	
	16	RTS	
	17	OON	
	18	\overline{ION}	
	1C	DTR	
	1D	RTS	
	20	\overline{ODN}	
	21	\overline{RTS}	
	24	RSTN	
	25	IF ION AFTER \overline{ODN} THEN ION	
	28	\overline{ODN}	
	2C	\overline{DTR}	
	30	RTS	
	31	ISR	
	34	DTR	38 \overline{ISON} CWA MOD
	35	ISAN	

DATA FROM LINE TYPE TABLE AND MODEM COMMAND SEQUENCE TABLE

7

LINE-TYPE	2	4	5
INITIALIZE LINE CMD	ISR ISON	ISON	ISR ISON
EXIT INITIALIZE CMD STATUS TBL	ISON <u>ISR</u> RSYN	ISON	ISON <u>ISR</u> DLM
ENABLE LINE CMD	DTR ISR ISON	RTS DTR ISON	RTS DTR ISR ISON
EXIT ENABLE CMD STATUS TBL	DTR ISON <u>ISR</u> RSYN	RTS DTR ISON <u>ISR</u> DLM	RTS DTR ISON <u>ISR</u> DLM
TERMINATE INPUT CMD	<u>ION</u>	<u>ION</u>	<u>ION</u>
TERMINATE OUTPUT CMD	<u>QON</u>	<u>QON</u>	<u>QON</u>
DISABLE LINE CMD	ISON <u>DTR</u> <u>RTS</u>	ISON <u>DTR</u> <u>RTS</u>	ISON <u>DTR</u> <u>RTS</u>
CLEAR LINE CMD	<u>ISON</u> <u>DTR</u> <u>RTS</u>	<u>ISON</u> <u>DTR</u> <u>RTS</u>	<u>ISON</u> <u>DTR</u> <u>RTS</u>

TCB

0	1	2	3	4	5	6	7
BSCHAIN	BSACBP	BSTPN BSTTYP BSBATCH BSHDQUED	BSOBLKL BSSPI	BSQPTR	BSLDEKY BSXMOD BSOPMOD BSPART BSTCBSIZ BSQPTYP	BSRQPTR	BSRQOPTR
8	9	A	B	C	D	E	F
BSBTPROC BSBSNDWU BSBSNUP BST&TERM BSACPOHT BSACPIN BSRQOVF	BSDN BSCN	<u>MODE4</u> BSBLKSEUT <u>TTY</u> BSTYOFRS	<u>MODE4</u> BSBLK REC <u>TTY</u> BSTYRTA	<u>MODE4</u> BSRETRANS <u>TTY</u> BSTYRGL BSTYOP BSTYXON BSTYLF BSTYIST	<u>MODE4</u> BSRECERR	<u>MODE4</u> BSBREAK	<u>MODE4</u> BSCLUSADD BSTERMAJ
10	11	12	13	14	15	16	17
<u>MODE4</u>	<u>MODE4</u>	<u>MODE4</u>	<u>MODE4</u>	<u>MODE4</u>	<u>MODE4</u>	<u>MODE4</u>	<u>MODE4</u>
BSM4D4 BSERRCNT BSEXITSK	BSRDECODE BSERR2 BSTOGREC BSEXT2	BSWRECODE BSAUTOREC BSM4D5 BSEXT3	BSBLANK BSSCRESAV	BSBLVOTRK BSPFECODE BSTASK BSWRE3Q BSWAITCRD BSTOGKNDW BSTOGSTAT BSTOGWAS BSTOGLOST BSTOGDET BSTOGCORR	BSCLSPTR	BSM4POLL POLL	POLL
18	19	1A	1B	1C	1D		
<u>MODE4</u>	<u>MODE4</u>	<u>MODE4</u>	<u>MODE4</u>	<u>MODE4</u>	<u>MODE4</u>		

0

BSCHAIN - CHAIN POINTER TO NEXT TCB ON LINE
OR ZERO IF END OF CHAIN

1

BSLCBP - POINTER TO FWA LCB LINE CONTROL BUFFER
WHICH IS ASSOCIATED WITH THIS TCB

2

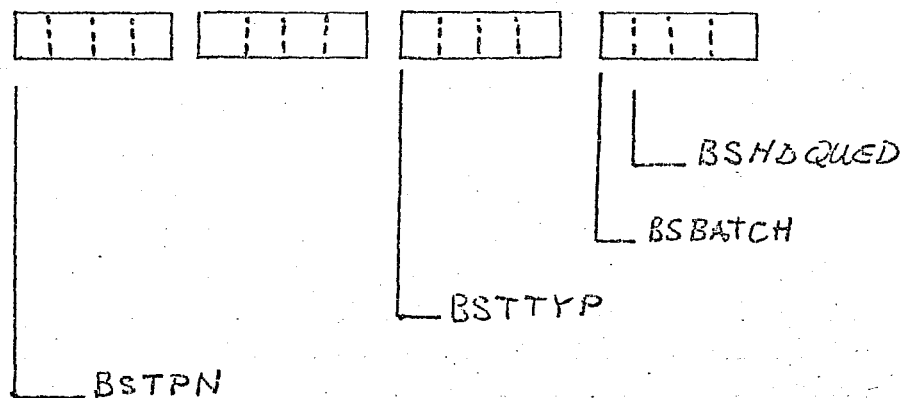

BSTPN - TERMINAL POSITION NUMBER NOT USED

BSTTY - TERMINAL TYPE AS DETERMINED IN CONFIGURE TERMINAL
COMMAND. SAME FORMAT AS BSTTYP IN LINE CONTROL
BUFFER LCB

BSBATCH - TERMINAL IN BATCH MODE

BSHDQUED - HOST DOWN MESSAGE QUEUED FOR THIS TERMINAL

3

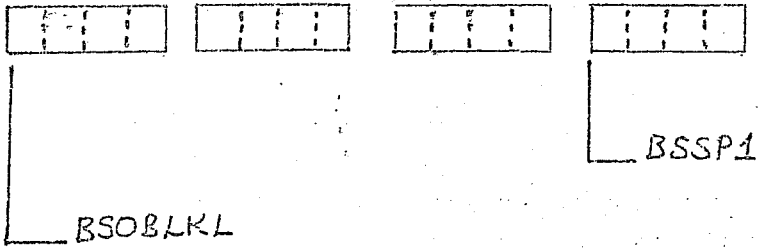

BSOBLKL - OUTPUT BLOCK SIZE IN CHARACTERS

BSSP1 -

4

BSQPTR - OUTPUT QUEUE POINTER

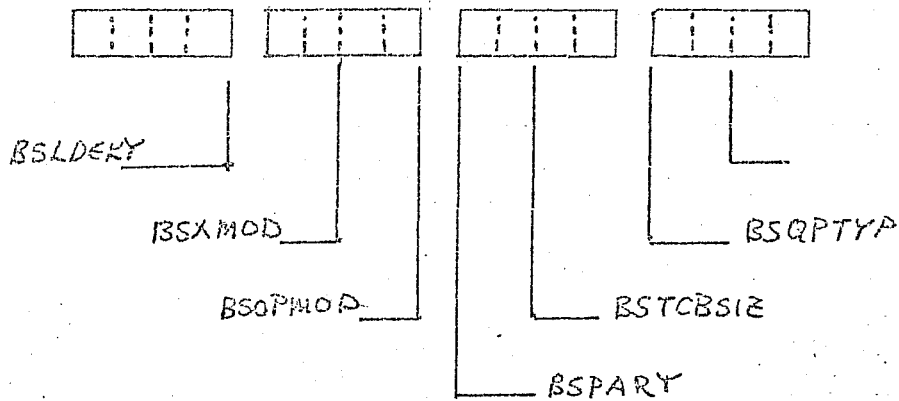

BSLDEKY - LINE DELAY NOT USED

BSXMOD - TRANSMISSION MODE

- 0 - NOFDX FULL DUPLEX
- 1 - NOHDX HALF DUPLEX
- 2 - NOEPX
- 3 - NOSPX

BSOPMOD - TELETYPE OPERATING MODE

- 0 - NOKEY
- 1 - NOTAPE
- 2 - NOTTT
- 3 - NOEEZ

BSPARY - PARITY TYPE

- 00 - ~~00~~ ODD PARITY
- 01 - NO PARITY
- 10 - EVEN PARITY

BSTCBSIZ - BUFFER SIZE OF THIS TCB

- 1 = 1D TTY - BOS1
- 2 = 3D MODEM - BOS2

BSQPTYP - TYPE OF QUEUE POINTER IN THIS TCB

- 0 = BQRCBLOCK QUEUE CONTROL BLOCK
- 1 = BQRNEXTSEG NEXT SEGMENT TO GET
- 2 = BQRDATLIST DATA LIST QUEUE

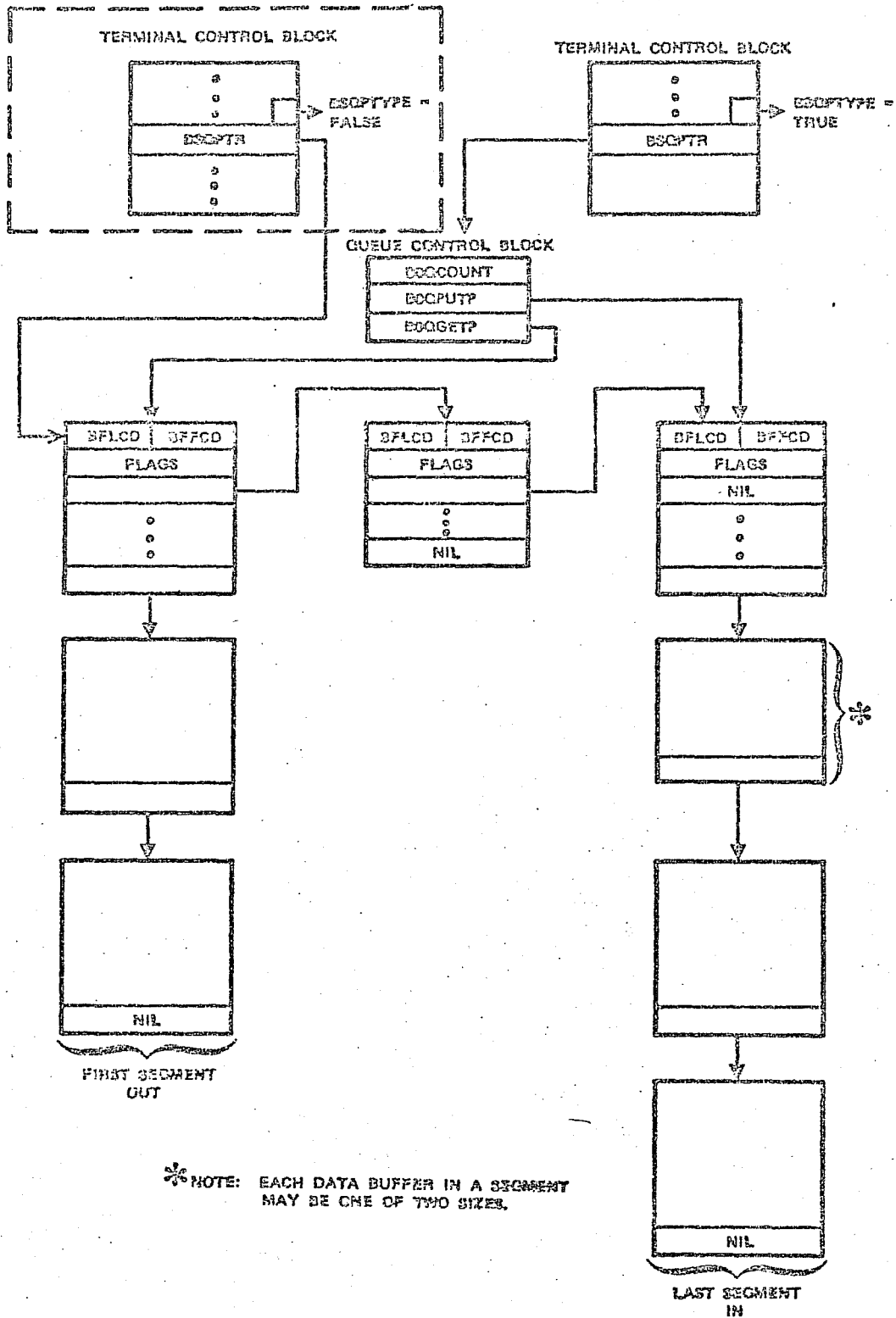

Figure 4-7. Structure of a Queue

6

BSRQPTR - SOURCE RETENTION QUEUE PTR
INPUT DATA FOR HOST FROM TERMINAL

7

BSRQOPTR - SOURCE RETENTION OVERFLOW POINTER

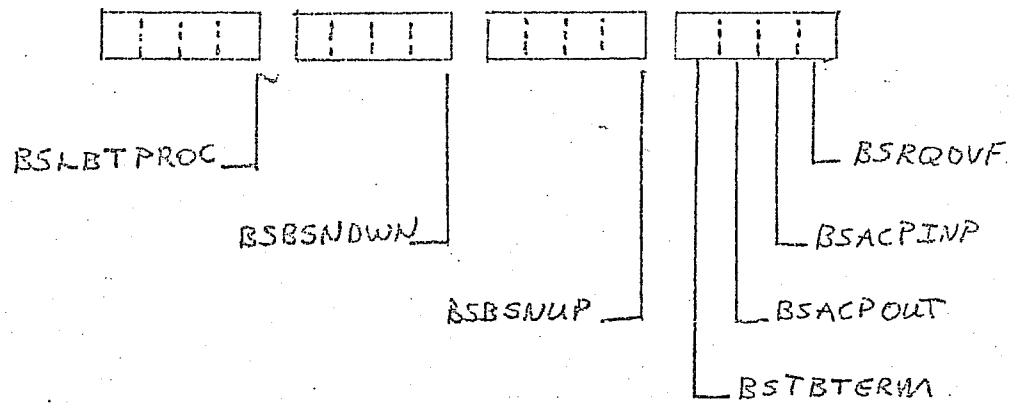

BSLBTPROC - LAST BLOCK TYPE PROCESSED BY TIP

0 = HTSYM INTERNAL SERVICE MESSAGE

1 = HTBACK BACK ACKNOWLEDGEMENT

2 = HTBLK DATA BLOCK FIRST BLOCK UP TO LAST

3 = HTMSG SHORT DATA BLOCK OR END OF HTBLK

4 = HTCMD COMMAND TYPE BLOCK

5 = HTBREAK BREAK

6 = ~~HTRESET~~ HTRESET RESET BREAK

BSBSNDWN - LAST BLOCK SERIAL NUMBER PROCESSED BY TIP

BSBSNUP - NEXT BLOCK SERIAL NUMBER TO SEND TO HOST

BSTBTERMA - LOGICAL CONNECTION TO BE TERMINATED

BSACPOUT - ACCEPT OUTPUT

BSACP IN. - ACCEPT INPUT

BSRQOVF - SOURCE RETENTION QUEUE CURRENTLY OVERFLOWED

9

857

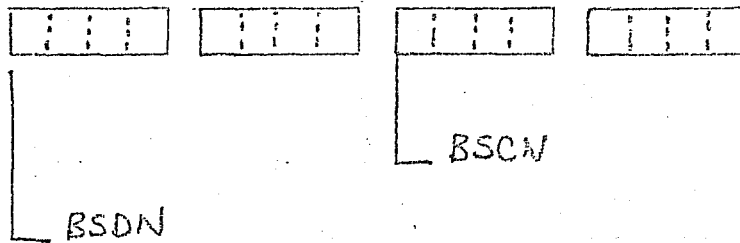

BSDN - BLOCK DESTINATION NODE

BSCN - BLOCK CONNECTION NUMBER

A MODE4 TIP

BSBLKSENT - BLOCKS SENT

A TTY TIP

BSTYQFRS - FIRST OUTPUT BUFFER

B MODE4 TIP

BSBLKREC - BLOCKS RECEIVED

B TTY TIP

BSTYRTA - RETURN ADDRESS SAVE AREA

C MODE4 TIP

BSRETRANS - BLOCKS RETRANSMITTED

C TTY TIP

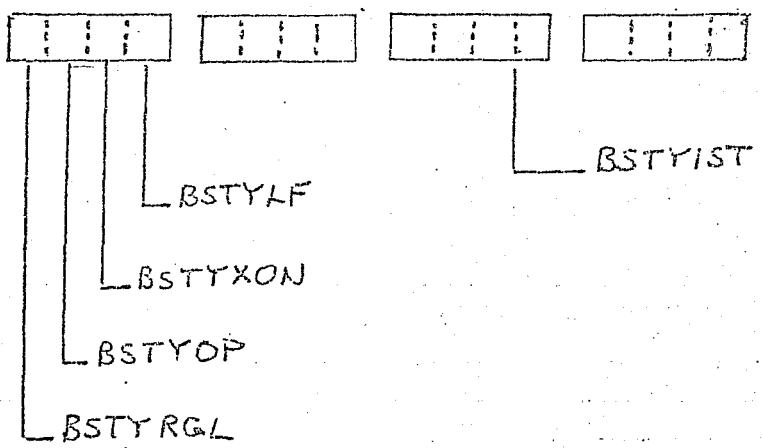

BSTYRGL - REGULATION IS ON

BSTYOP - DELIVER OUTPUT

BSTYXON - SEND XON TO TERMINAL

BSTYLEF - SUPPRESS 1 LFI ON OTPT

BSTYIST - INPUT STATE

2 = KEYBOARD

4 = CLEARSTATE

6 = PAPERTAPE

8 = BRKSTAT

12 = QIFCD

BSRGCERR - BLOCKS NOT ACCEPTED DUE TO ERRORS

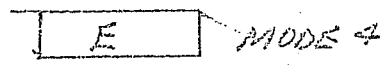

BSBREAK - UPLINE BREAKS DUE TO ERROR OF INCORRECT RESPONSE FROM TERMINAL

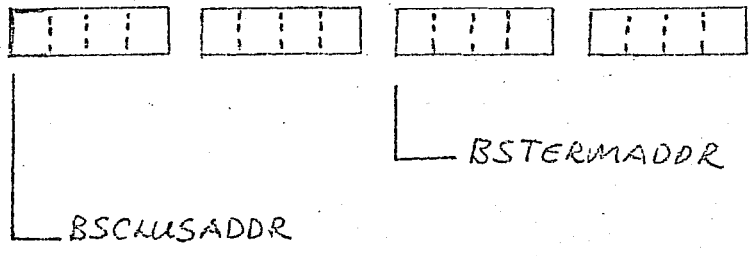

BSCLUSADDR - CLUSTER ADDRESS STATION

BSTERMADDR - TERMINAL ADDRESS DEVICE

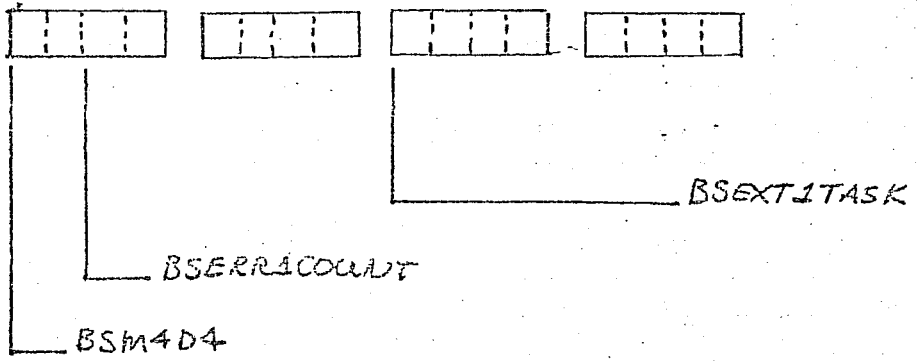
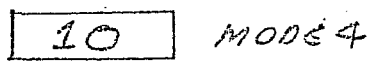

BSM4D4 -

BSERRICOUNT - NO RESPONSE COUNT FROM TERMINAL FOR TASK IN BSTASK WORD 14 TCB

BSEXTITASK - NEXT TASK TO PERFORM WHEN CORRECT RESPONSE RECEIVED FROM TERMINAL, SAME FORMAT BSTASK WD-

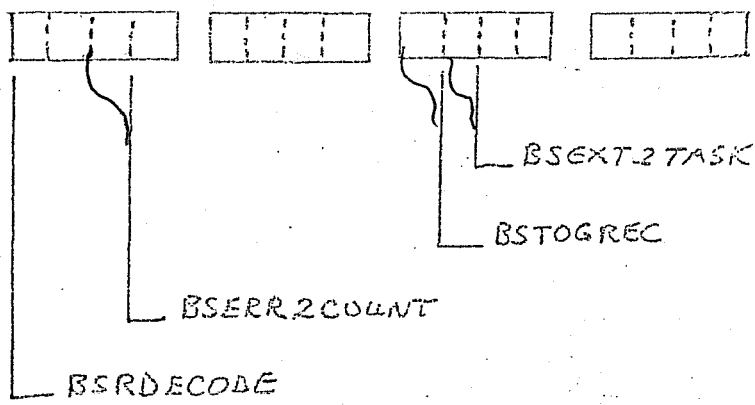

BSRDECODE - LAST E-CODE RECEIVED FROM TERMINAL

0 = E1 1 = E2 2 = E3 3 = E4

BSERR2COUNT - BAD ERROR-REJECT RESPONSE FROM TERMINAL COUNT, FOR TASK IN BSTASK WORD 14

BSTOGREC - LAST ADDRESS TOGGLE BIT RECEIVED

BSEXT2TASK - NEXT TASK TO PERFORM AFTER REJECT RECEIVED FOR RESPONSE FROM TERMINAL FOR TASK IN BSTASK WORD 14. SAME FORMAT AS BSTASK MAY BE NEGATIVE NUMBER

12 MODE 4

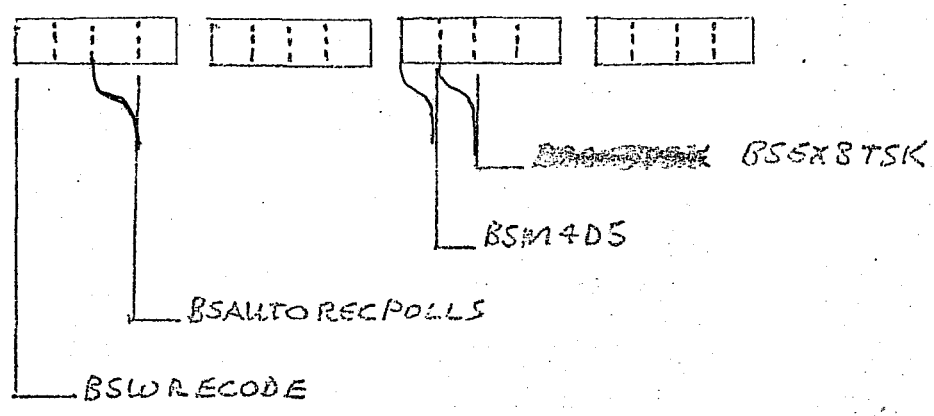

BSWRECODE - LAST E-CODE TRANSMITTED

BSAUTORECPOLLS - AUTO RECOGNITION POLL COUNT

BSM4DS -

BSEXT3TASK - NEXT TASK TO PERFORM AFTER NO RESPONSE FROM TERMINAL. SAME FORMAT AS BSTASK WITH TCB. MAY BE NEG

13

MODE 1

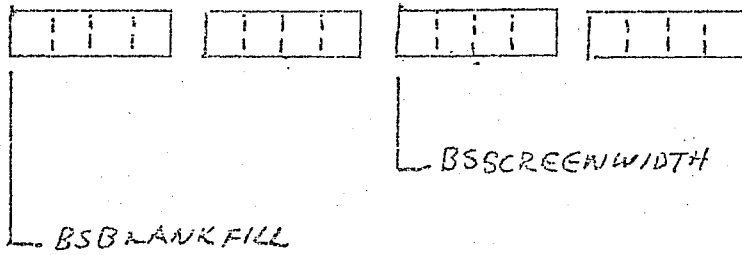

BSBANKFILL - NUMBER OF BLANKFILL CHARACTERS + 1

BSSCREENWIDTH - SCREENWIDTH IN CHARACTERS

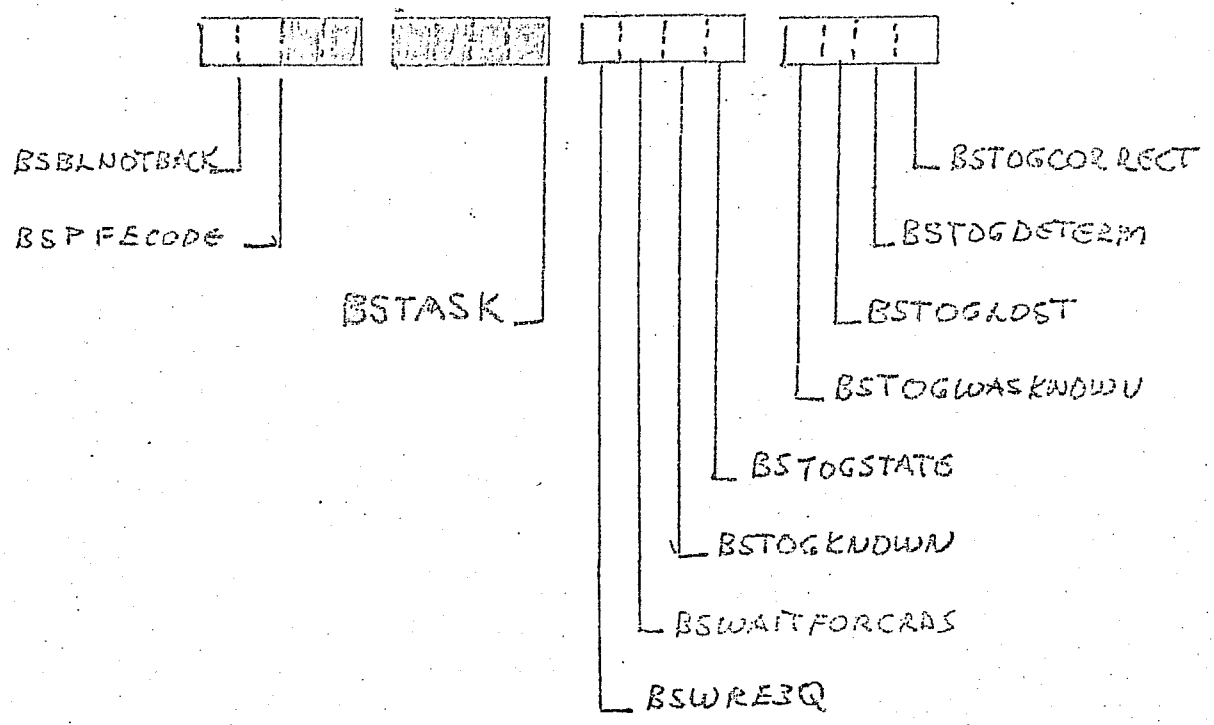

BSBLNOTBACK - BLOCKS NOT BACKED

BSPFECDDE - ESCAPE TO POLL E-CODE

BSTASK - CURRENT TASK TO PERFORM FOR THIS TERMINAL

- 0 = VTZERO FIRST TASK NEW TCB
- 1 = VTRSER RESET ERROR COUNTERS
- 2 = VTCHORQ CHECK OUTPUT QUEUE
- 3 = VTPSPR ISSUE POLL FOR PRINTER STATUS
- 4 = VTPSND NO RESPONSE FROM PRINTER
- 5 = VTPSRE READ RESPONSE FROM PRINTER POLL
- 6 = VTPSE3 READ E3 RESPONSE FROM PRINTER POLL
- 7 = VTWRPL WRITE OR POLL CARDS
- 8 = VTWRIT ISSUE WRITE MSG
- 9 = VTWRBD BAD RESPONSE ON WRITE
- A = VTWRER ERROR RECEIVED ON ~~READ~~ WRITE
- B = VTWRNO TOGGLE CANNOT BE OBTAINED
- C = VTWRAK ACK RECEIVED ON WRITE

E = VTPCRE	READ RECEIVED ON POLL FOR CARDS
F = VTPDSP	ISSUE POLL FOR DISPLAY
10 = VTPDRE	READ RECEIVED ON POLL DISPLAY
11 = VTDDRJ	REJECT RECEIVED ON POLL DISPLAY
12 = VTWNOR	NO RESPONSE ON WRITE
13 = VTPECD	POLL FOR E-CODE
14 = VTPERE	READ RECEIVED ON POLL FOR E CODE
15 = VTPEND	NO RESPONSE ON POLL FOR E CODE
16 = VTPEBD	BAD RESPONSE ON POLL FOR E CODE
17 = VTPEER	ERROR RESPONSE ON POLL E CODE
18 = VTPERS	REJECT RESPONSE ON POLL E CODE
19 = VTPTDG	POLL FOR TOGGLE
1A = VTPTNO	NO RESPONSE ON POLL FOR TOGGLE
1B = VTRBD	BAD RESPONSE ON POLL FOR TOGGLE
1C = VTPTDT	DATA RESPONSE ON POLL FOR TOG
1D = VTARPL	AUTO RECOGNITION POLL SENT
1E = VTAREC	AUTO RECOGNITION PERFORMED
1F = VTARNO	AUTO RECOGNITION FAILED

BSWRE3Q - WRITE E-3 QUEUED

BSWAITFORCARDS - WAITTING FOR CARDS

BSTOGKNOWN - ADDRESS TOGGLE IS KNOWN

BSTOGSTATE - EXPECTED ADDRESS TOGGLE BIT

BSTOGWASKNOWN - TOGGLE BIT WAS KNOWN

BSTOGLAST - LAST TOGGLE WAS INCORRECT

BSTOGDETERM - DETERMINE TOGGLE

BSTOCCORRECT - LAST TOGGLE CORRECT

15

MODE 4

126

BSCLSPTR - CLUSTER TCB. POINTER TO FIRST TCB IN MULTISTATION TCB LINE

16

1D

MODE 4

BSM4POLL - OUTPUT BUFFER WITH POLL FOR THIS TERMINAL

16

LCD | FCD

17

EOF

18

SYNC | SYNC

19

SYNC | SYNC

1A

SOH | STATION ADDRESS
01

1B

TERMINAL ADDRESS | POLL
05

1C

ETX | MPC
03

1D

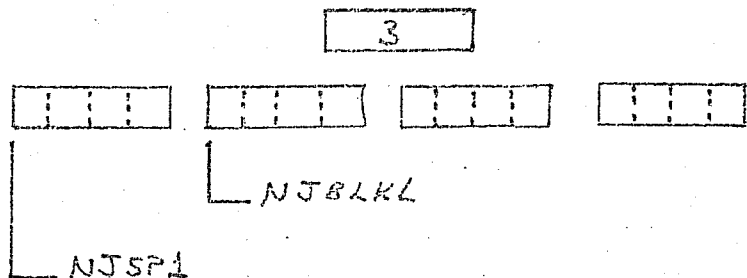

NJSP1 - NOT USED

NJBLKL - INPUT STATE COUNTER 2 DCC2-INTCC2

4

NJCXL - CODE XATE TABLE ADDRESS

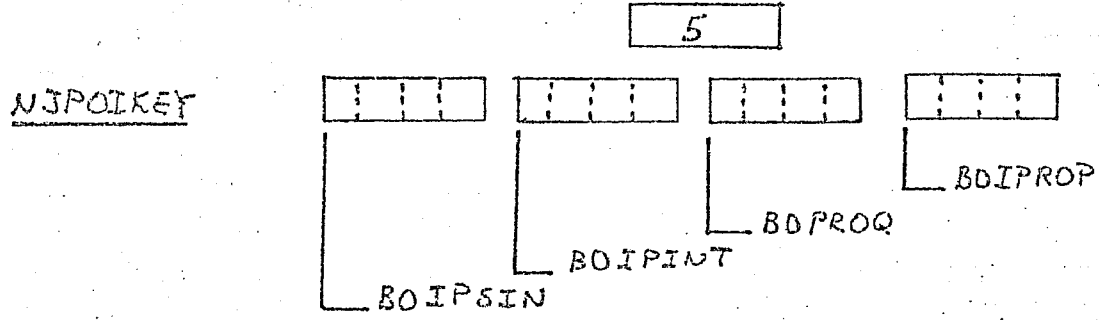

BOIP SIN - POI POST INPUT KEY

BOIP INT - POI INTERNAL INPUT KEY

BOIP ROQ - POI INTERNAL OUTPUT KEY

BOIPROP - POI PRE OUTPUT KEY

6

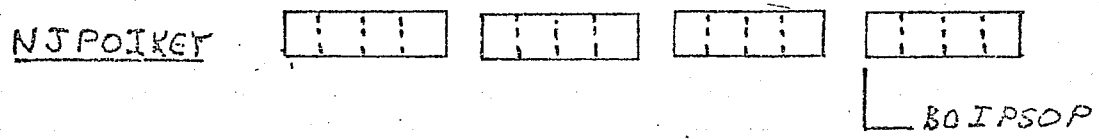

BOIP SOP - POI POST OUTPUT KEY

7

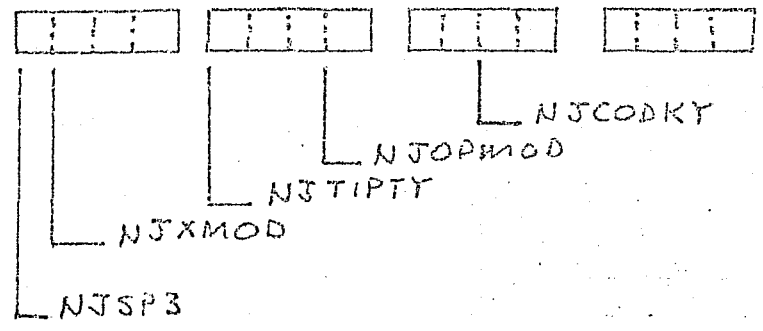

NJSP3 - NOT USED

NJXMOD - TRANSMISSION MODE
 0 = NOFDX
 1 = NOHDX
 2 = NOEPX
 3 = NO SPX

NJTIPTY - TIP TYPE 2 = TTY 4 = MODE 4

NJOPMOD - OPERATING MODE
 0 = NOKEY
 1 = NOTAPE
 2 = NOTTT
 3 = NOEEZ

NJCODKY - CODE SET KEY

8

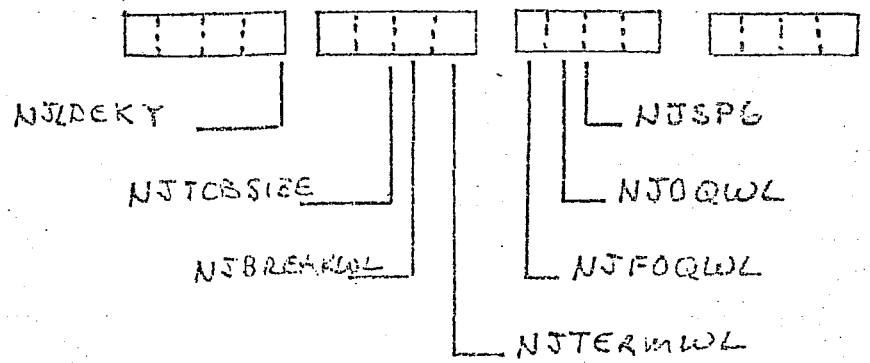

NJDEKY - LINE DELAY KEY

NJTCBSIZE - TCB BUFFER SIZE

NJBREAKWL - BUILD W/L FOR TIP FOR BREAK COMMAND

NJTERMWL - BUILD W/L FOR TIP FOR TERMINATE COMMAND

NJFOQWL - BUILD W/L FOR TIP FOR FIRST OUTPUT QUEUE

NJOQWL - BUILD W/L FOR TIP FOR ANY OUTPUT QUEUED

NJSP6 - NOT USED

9

NJTCCBSUB - ADDRESS OF TCB BUILD SUBROUTINE

A - B

NJWD10 - NOT USED

NJWD11 - NOT USED

POI KEY

<u>BIPOI</u> ↓	<u>BIKEY</u> →	1	2	3	4	5
BIIPSIN →		PT4PSIUP	PTYPINT			
BIIPINT →		PB21POI	PB22POI	PB23POI	PB24POI	PB25POI
BIPROQ →		PB31POI	PB32POI	PB33POI		
BIPROP →		PT4PROUT	PTYPREOUT			
BIIPSOP →		PT4PSOUT	PTYPOUT			

BIKEY FROM TERMINAL CHR. TABLE

<u>BIPOI</u> →	<u>BIIPSIN</u>	<u>BIIPINT</u>	<u>BIPROQ</u>	<u>BIPROP</u>	<u>BIIPSOP</u>
<u>BSTYP</u> TERMINAL TYPE ↓					
CONSOLE →		3	1		
COUPLER →		1	1		
BMD4-BMD4 MODE 4 →	1	2	3	1	1
TTY-ATTY TTY →	2	2	3	2	2

BIIPSIN - POST INPUT

BIIPINT - INTERNAL INPUT

BIPROQ - INTERNAL OUTPUT

BIPROP - PRE OUTPUT

BIIPSOP - POST OUTPUT

TTY

PTYPINT - Post Input

Does statistics on input data block and then forewords it to the host

PTYPREOUT - Pre Output

Output from host is removed from the Q

PTYPOUT - Post Output

Statistics, send back, release buffers

MD4

PT4PSINP - Post input

Statistics, upline block handler

PT4PROUT - Pre output

Does nothing

PT4PSOUT - Post output

Statistics

Both + S.M

PB22P0I - Internal in

Set EOT flag in last non empty buffer change TCB

PB33P0I - Internal out

Down line block handler

HIP

PB21P0I - Internal in

PNROUTE, generate WL if serv MSG, change TCB

PB31P0I - Internal out

Queue back to output TCB, generate WL if necessary

CHARACTER TRANSMISSION CHARACTERISTICS

NICTCY

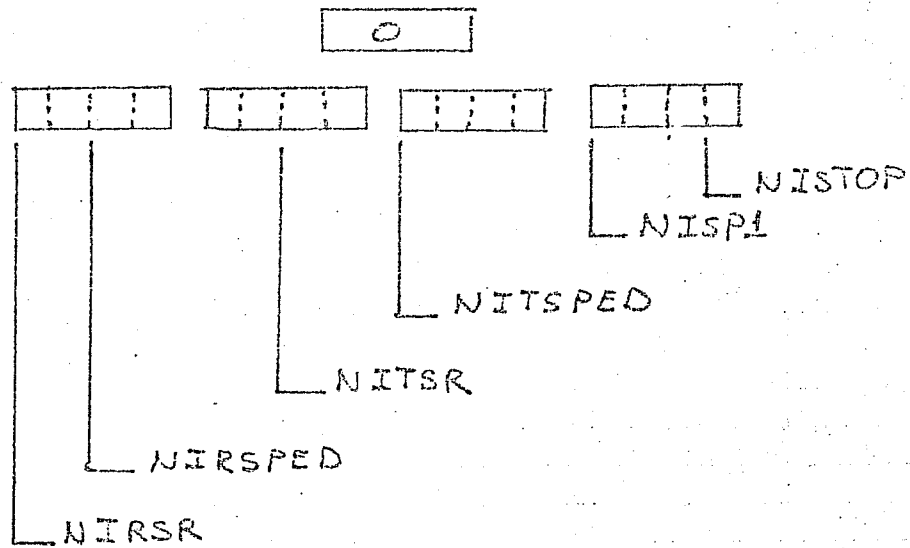

NIWDI

NIRSPEED - CIA RECEIVE SPEED RANGE

NITSR - CIA RECEIVE SPEED

NITSPED - CIA TRANSMIT SPEED RANGE

NISPL - NOT USED

NISTOP - CIA STOP BITS 0 = 1-STOP BIT 1 = 2-STOP BITS

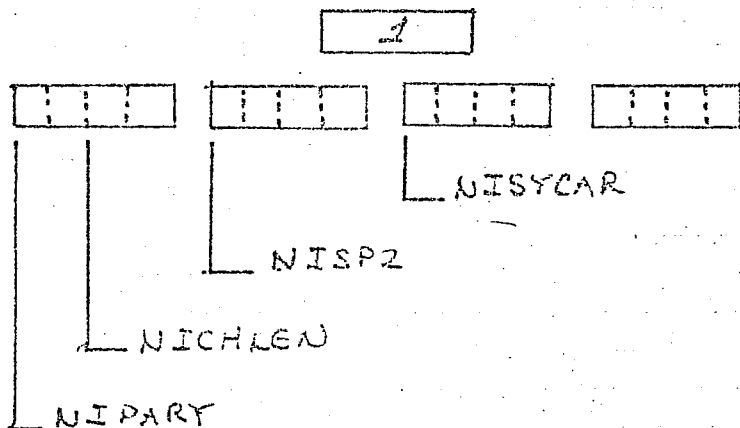

NIWDI

NIPARY - CIA PARITY MODE

NICHLEN - CIA CHARACTER LENGTH

NISYP2 - NOT USED

NISYCAR - CIA SYNC CHARACTER

BELSTOMUX

BSQPTR

NCOBP

MUX
PORT
TABLE
LINE-1

NALCBP

MUX
LCB
LINE-1

NCIBP

LCB
LINE-1

BZCURTCB

TCB
STATION
60
LINE-1

BSRQPTR

BSLCBP

BSCHAIN

TCB
STATION
61
LINE-1

BSRQPTR

BSQPTR

BSLCBP

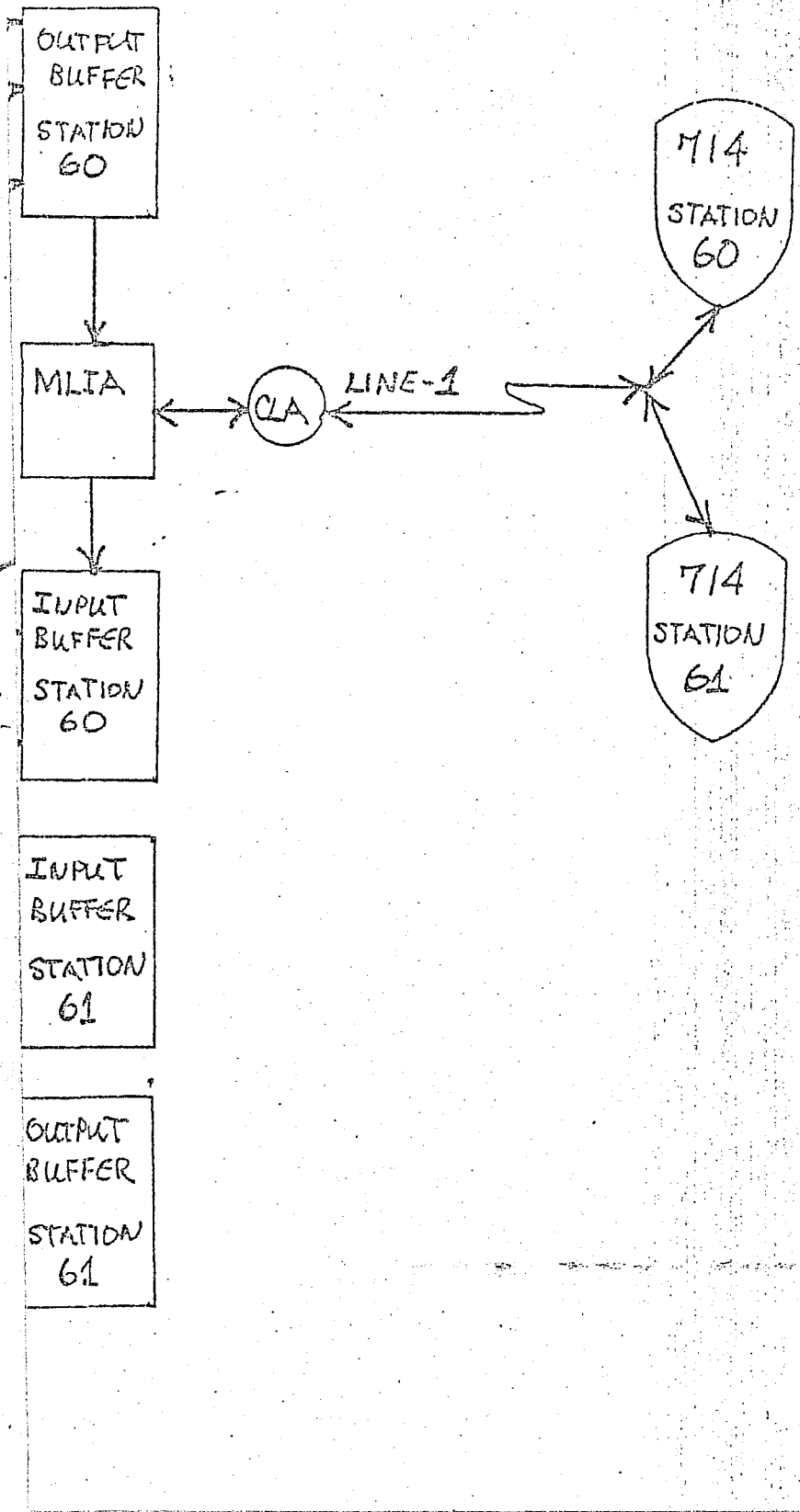

MUX PORT TABLE

FWA = (160)

196D

0 1

NAION NALCBP
 NAOON
 NAISON
 NALCBUP
 NALTYP
 NASPILL

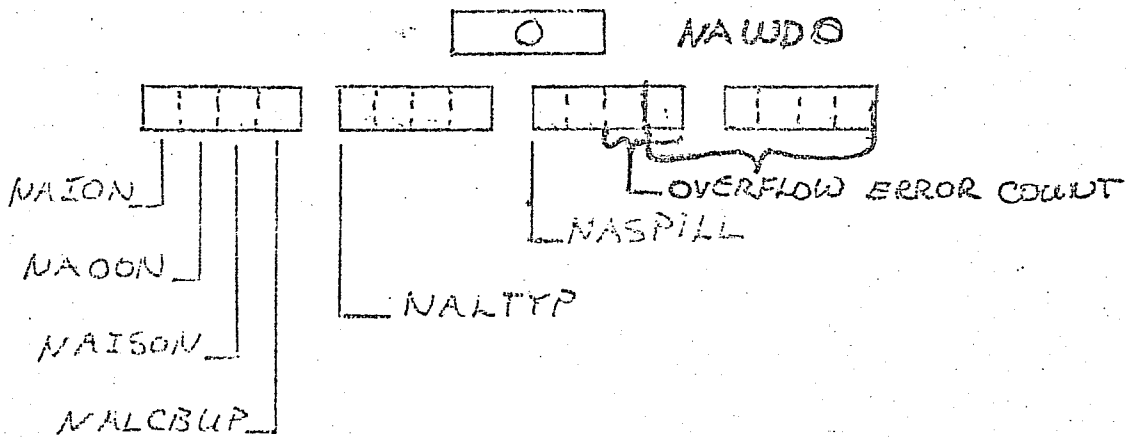

NAION - INPUT ON

NAOON - OUTPUT ON

NAISON - INPUT STATUS SUPERVISION ON

NALCBUP - LCB ASSIGNED

NALTYP - LINE TYPE SEE LCB BRTYP

NASPILL - CMA STATUS ERROR COUNTER USED TO SET OVERFLOW STATUS

1 NAWDI

NALCBP - ~~POINT~~ POINTER (MUX LCB)

F1-27
LFF ← DISPLACEMENT LAST ENTRY CIB

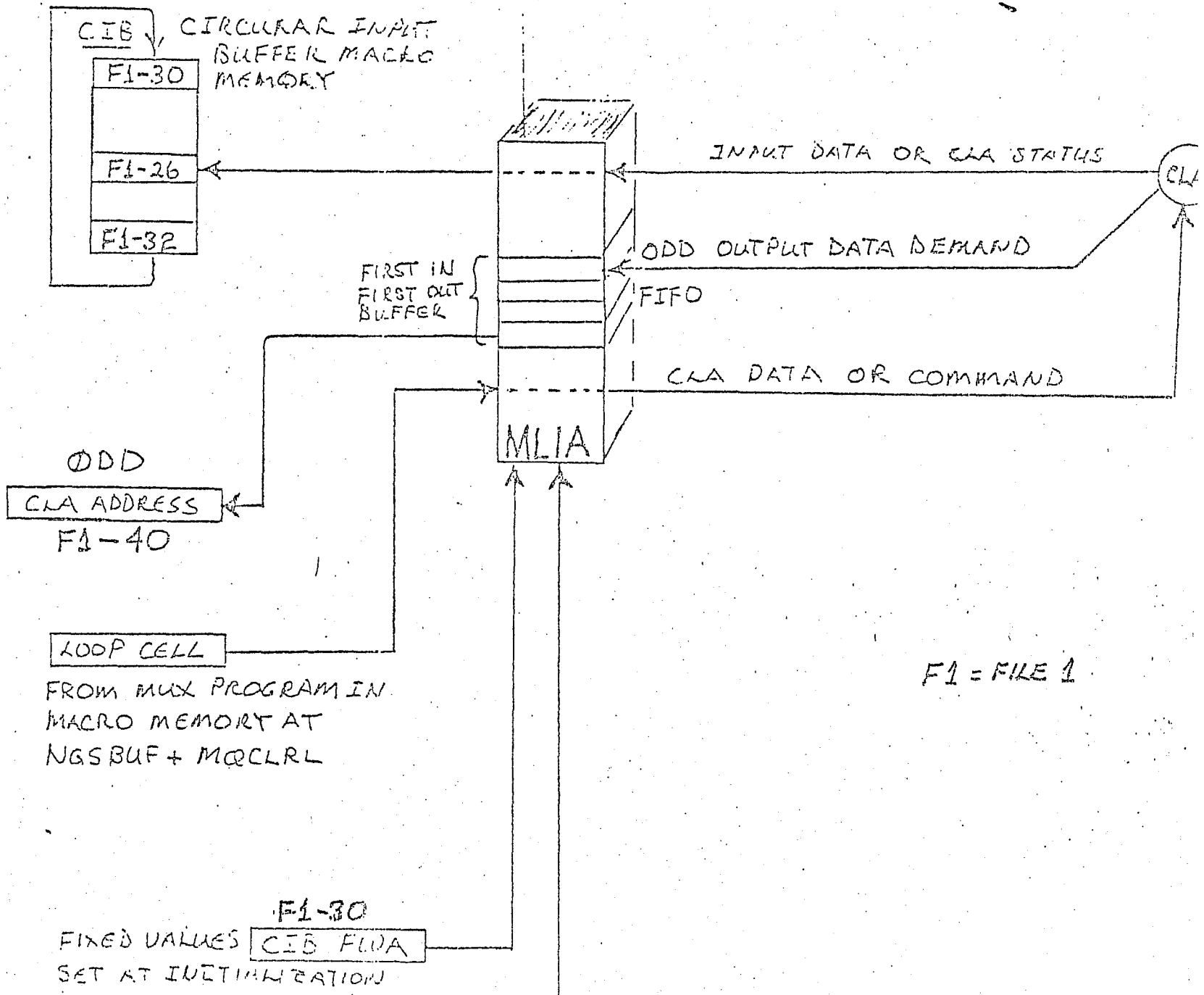

MUX

NCLCB

LINE CONTROL BLOCKS

~~DATA~~

0	1	2	3	4	5	6	7
NCEOBL	NCENDX	NCOBP	NCRINCH	NCCNTL	NCISPTA	NCIBP	NCDM
NCNXCDA	NCCARR		NCCAREC	NCCNTL			NETTY
NCUPCHA	NCSP1		NCNOXL				NCSP6
NCBPREQ	NCTIME		NCRPRT				NCCRC
NCOMPRD	NCQBACD		NCIDBS				
NCINOUT			NCSP2				
NCODDIN			NCINPRO				
NCODBS			NCSP4				
NCOCHR			NCSP5				
			NCISTA				
8	9	A	B	C	D	E	F
NCSCHR	NCCRC5	NCRER1	NCRER2	NCCXLTA	NCSCBA		
NCIBFCD		NCCNT2	NCBLKL				

MUX PORT TABLE ENTRY NALCBP HAS POINTER
TO NCLCB FOR EACH LINE THAT IS ENABLED

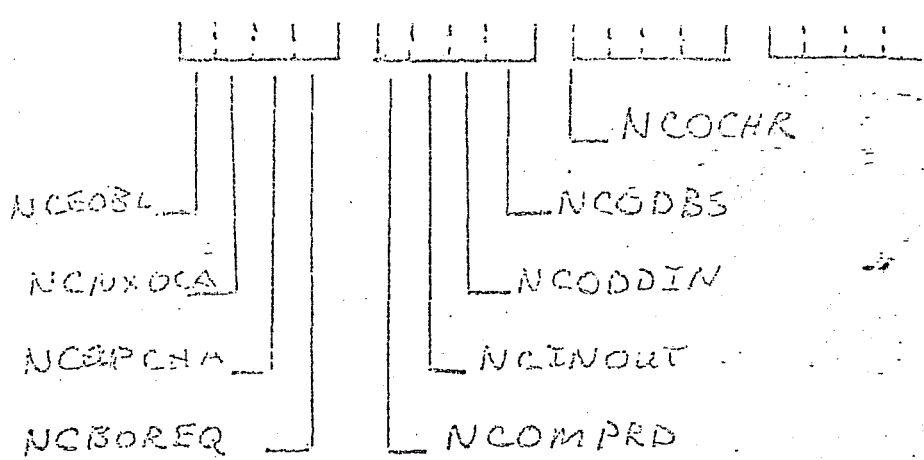

- NCEOBL - END OF BLOCK FLAG
- NCOODCA - NEXT OUTPUT CHARACTER AVAILABLE
- NCEPCHA - SUPPRESS BUFFER CHAINING
- NCBOREQ - BUFFER CHAINING REQUIRED
- NCOMPRD - OUTPUT MSG IN PROGRESS
- NCOINOUT - INPUT AFTER OUTPUT FLAG
- NCOODIN - ODD RECEIVED FLAG
- NCOODBS - OUTPUT DATA BUFFER SIZE
0 = SMALL 1 = LARGE
- NCOCHR - NEXT OUTPUT CHARACTER

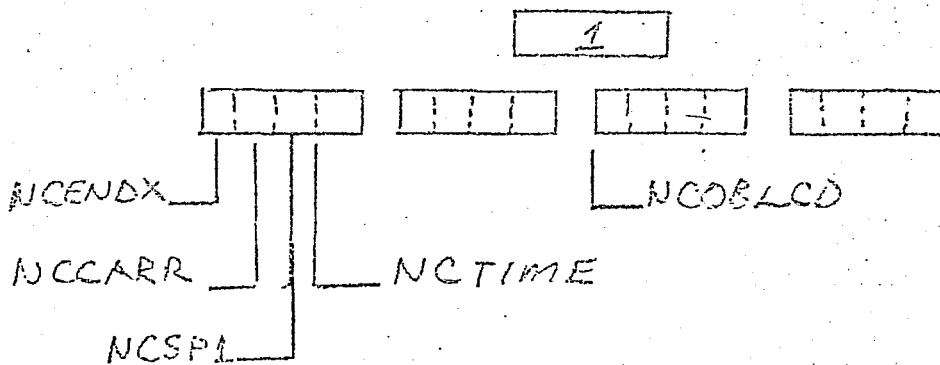

- NCENDX - END OF TRANSMISSION
- NCCARR - CARRIER
- NCTIME - TIMER
- NCOBLCD - LCD OF OUTPUT BUFFER
- NCSP1 - SPARE

NCOBP - OUTPUT BUFFER POINTER

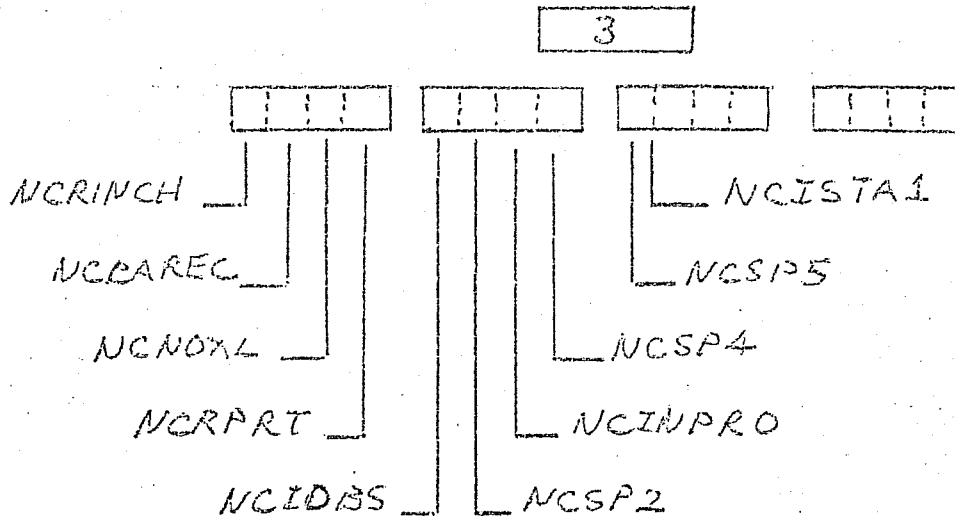

NCRINCH - INPUT CHARACTER IN RIGHT BYTE 8 BITS

NCCAREC - CHARACTER RECEIVED FLAG

NCNOXL - CODE TRANSLATE ACTIVE

NCRPRT - REMOVE PARITY BIT

NCIDBS - INPUT DATA BUFFER SIZE

0 = SMALL 1 = LARGE

NCSP2 - NOT USED

NCINPRO - INPUT MSG IN PROGRESS

NCSPA - NOT USED

NCSP5 - NOT USED

NCISTA1 - INDEX TO INPUT STATES POINTERS

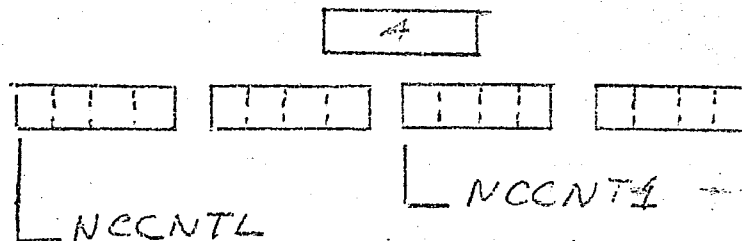

NCCNTL - CHARACTER COUNT LIMIT GET FROM TERMINAL CHARACTERISTICS TABLE VALUE NJCNT1

NCCNT1 - CURRENT CHARACTER 1 COUNT FROM INTCCI OR DCCI COMMAND IN STATES TABLE

5

NCISPTA - ADDRESS OF INPUT STATES POINTER TABLE

6

NCIBP - INPUT DATA BUFFER POINTER

7

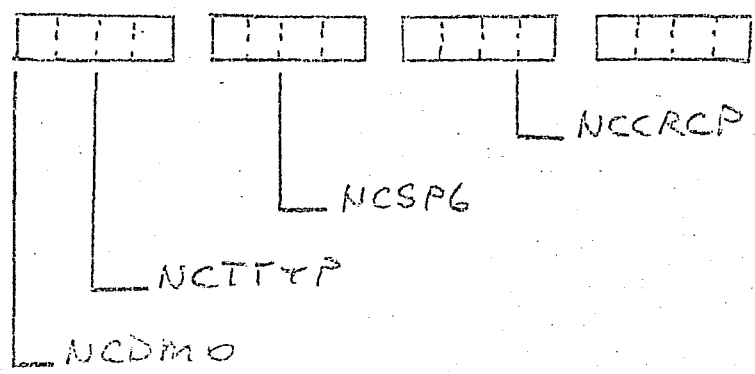

NCDMO - NOT USED

NCTTYP - TERMINAL TYPE SAME AS B2STATE OF LCB B2TYP

NCSP6 - NOT USED

NCCRCP - CRC POLYNOMIAL

8

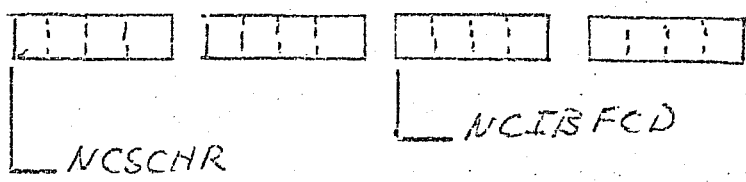

NCSCHR - SPECIAL CHARACTER

NCIBFCD - FCD OF INPUT BUFFER

9

NCCRCS - CRC ADDRESS

A

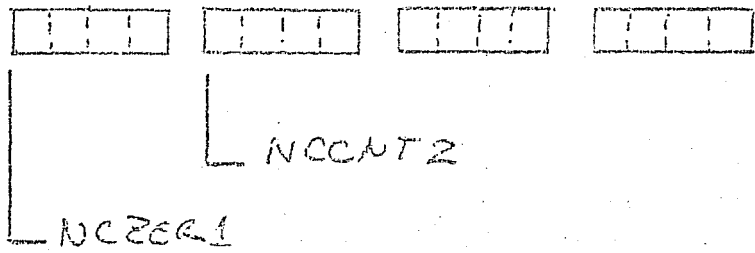

NCZER1 - NOT USED ZERO

NCCNT2 - CHARACTER COUNTER - 2 SET FROM INTCC2 OR PCC2 COMMAND IN STATES TABLE

B

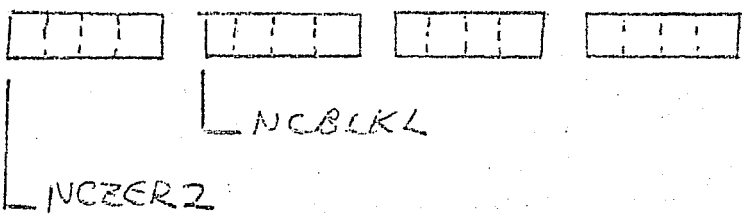

NCZER2 - NOT USED ZERO

NCBKLL - MAX BLOCK LENGTH SET FROM LINK CHARACTER TABLE NJBKLL USED TO INITIALIZE NCCNT1 WORD A

C

NCCXLT - CODE TRANSLATE TABLE ADDRESS

D

NCSCBA - FIRST BUFFER OF BLOCK ADDRESS

TO MLIA

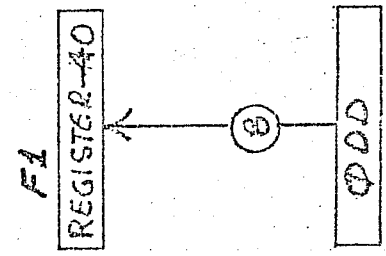
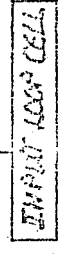
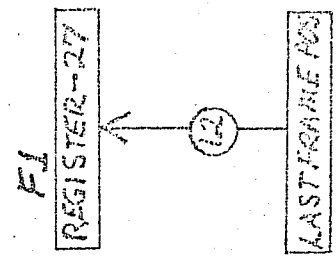
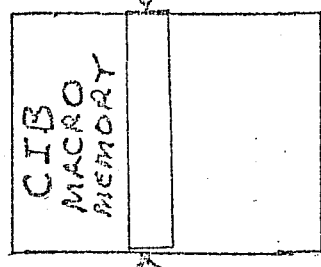
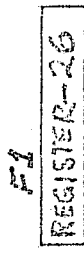
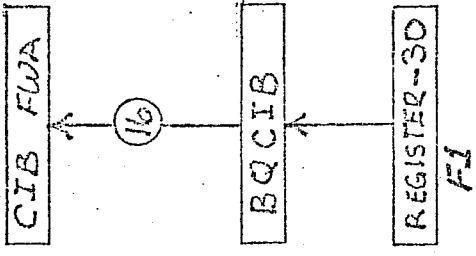
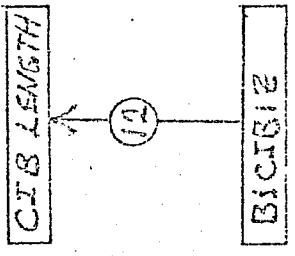
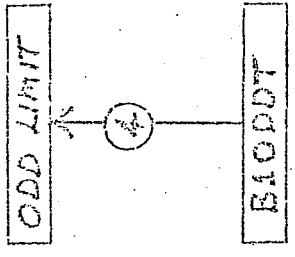
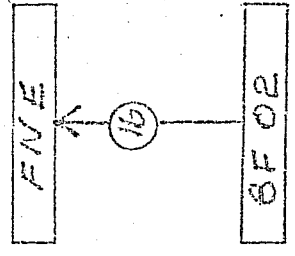
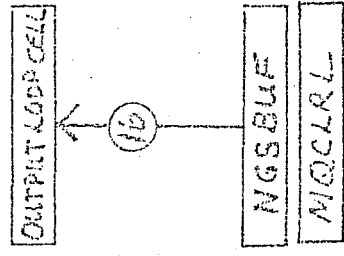

3

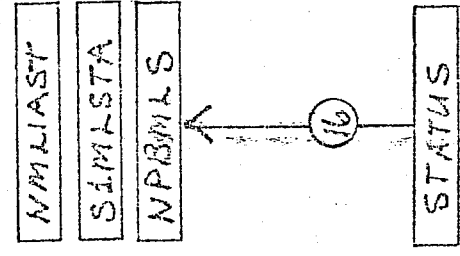

FROM MLIA

INPUT LOOP CELL

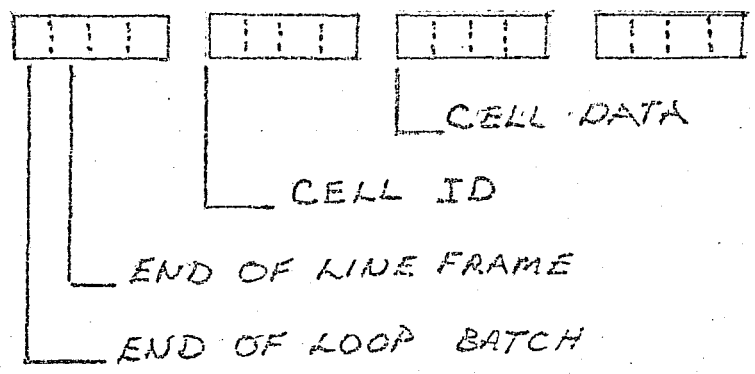

CELL ID

- C - INPUT DATA RECEIVED FROM TERMINAL
- D - CLA STATUS WORD
- E - CLA ADDRESS

DD INPUT

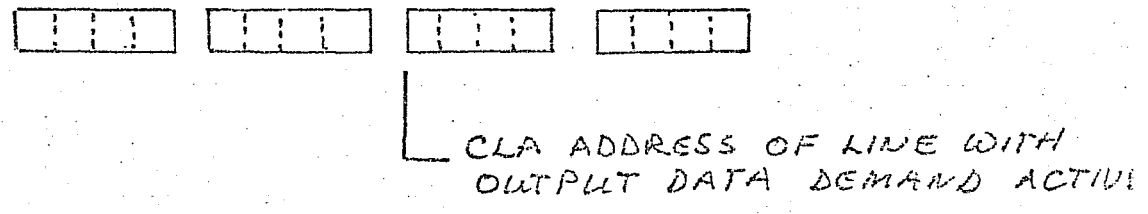

LFP INPUT

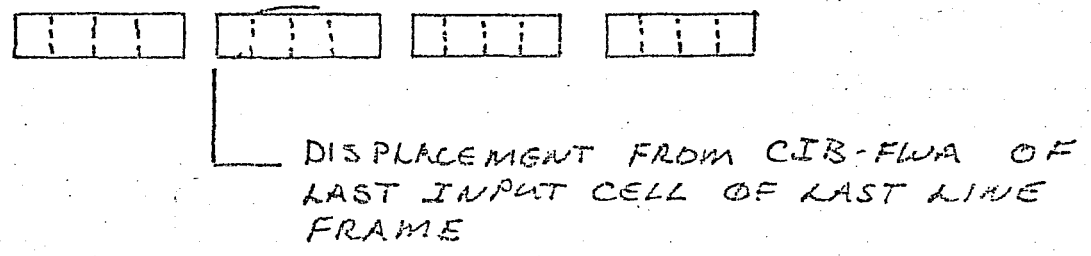

MLIA STATUS

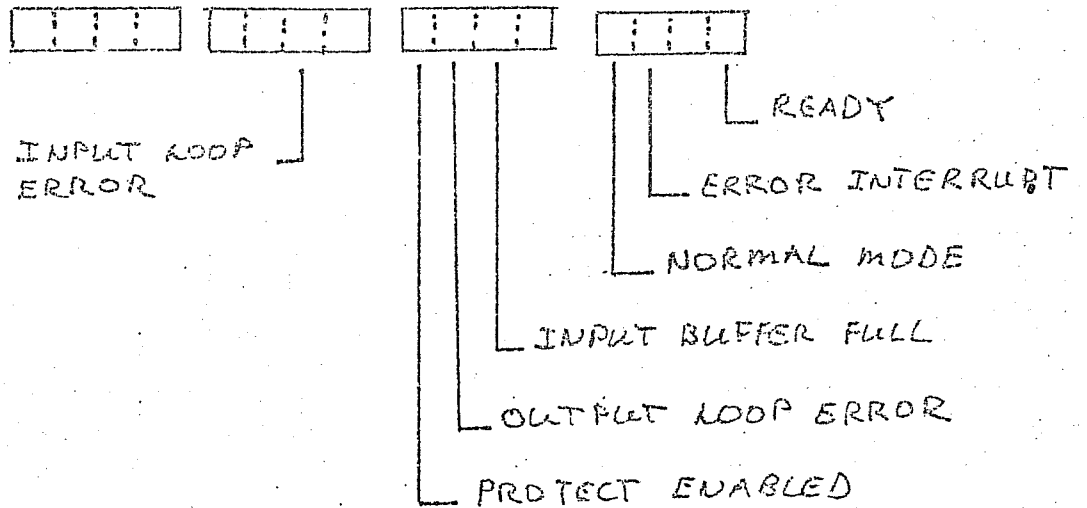

READY — MLIA CARD PLUGGED IN AND HAS POWER APPLIED
INPUT AND OUTPUT LOOPS ACTIVE

ERROR INTERRUPT — INPUT BUFFER FULL + OUTPUT LOOP ERROR
+ INPUT LOOP ERROR

PROTECT ENABLED — MLIA ALLOWED TO WRITE OR READ
PROTECTED AREA IN MEMORY

INPUT BUFFER FULL — INPUT FIFO OR ODD FIFO
ARE FULL

NORMAL MODE — NOT IN DIAGNOSTIC MODE

STATE PROCESS INSTRUCTIONS

OPCODE [HEX]	DESCRIPTION
00	/NOP
01	/SETINP
	/RSTINP
02	/RPLC
03	/BLDWL
04	/TIBWL
05	/CRSEQ
06	/DCC1, /DCC2
07	/INTCC1, /INTCC2
08	/STATE
09	/STBLC
0A	/CHARLS
0B	/STATLS
0C	/CHARNE
0D	/SPCHEQ
0E	/RESYNC
0F	/SETTRAN, /RSTRAN
10	/INTCRC

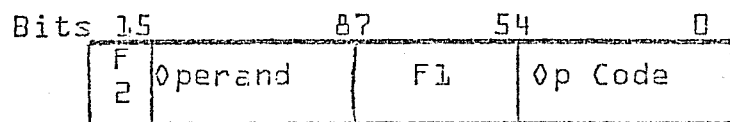

/EXIT
 /STOREXIT
 /CRCSTOREXIT
 /CRCEXIT

Entry Point	F1 Value	Entry Point Function
1	001	Discard character
2	010	Store character
3	011	Accumulate CRC and store character*
4	100	Accumulate CRC and discard character
5	101	Undefined
6	110	Undefined
7	111	Undefined

Exit when F1 not equal to 0 except for Skip instruction

OP CODE	F2 = 0	F2 = 1
01	Reset msg in process flag	Set msg in process
04		Repoint input buffer, Store LCD
05	Compare 8 bits	Compare 7 bits
06	Decrement counter 1	Decrement counter 2
07	Initialize counter 1	Initialize counter 2
08	Execute F1	Ignore F1
0F	Set Xlate mode	Resets Xlate mode
10	Reset checksum to 0	Reset checksum to 1

HOST COUPLER

TCB

0 1 2 3 4 5 6 7

WORD 0-9 SEE MODE4 TERMINAL TCB 978
BSCCB = SUB LINE CONTROL BLOCK NUMBER - 3

8 9 A B C D E F

BSCBSENT BSCBRECV BSCHSENT BSCHRECV BSCBUFRQ BSCP

10 11 12 13 14 15 16 17

BSCPINPAT BSCPVPTR BSCPDOWN BSCPOUTPUT BSBUFFOT BSCPSTAT BSCPDATA BSCP

18 19

BSCPBUFAV BSCPIDLT
BSCPBESTA

A

BSCBSENT - BLOCKS TRANSMITTED TO HOST

B

BSCBRECV - BLOCKS RECEIVED FROM HOST

C

BSCHSENT - CHARACTERS SENT TO HOST

D

BSCHRECV - CHARACTERS RECEIVED FROM HOST

E

BSCBUFRQ - REQUEST FOR ADDITIONAL BUFFERS FOR
MSG FROM HOST

F

BSCPFLAGS - COUPLER FLAGWORD

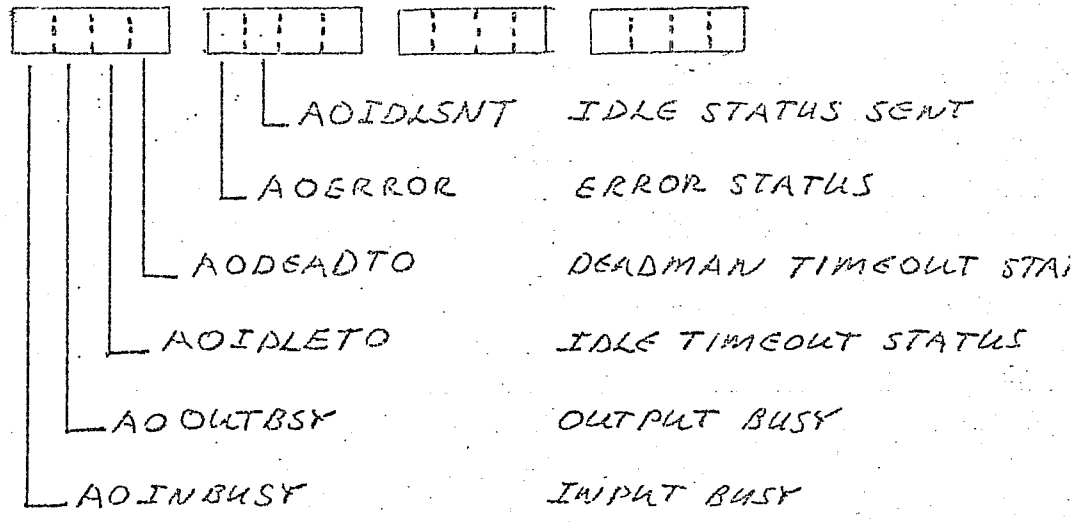

10

BSCPINPUT - INPUT BUFFER TO HOST WAITING TO BE SENT

11

BSCPVPTR - NEXT FREE BUFFER

12

BSCPCONN - COUPLER CONNECT CODE

13

BSCPOUTPUT - LAST BUFFER RECEIVED FROM HOST

14

BSBUFOT - MAR BUFFER ADDRESS STORAGE. FIRST BUFFER ADDRESS SENT TO COUPLER COULD BE INPUT OR OUTPUT

BSCPSTATUS - COUPLER STATUS

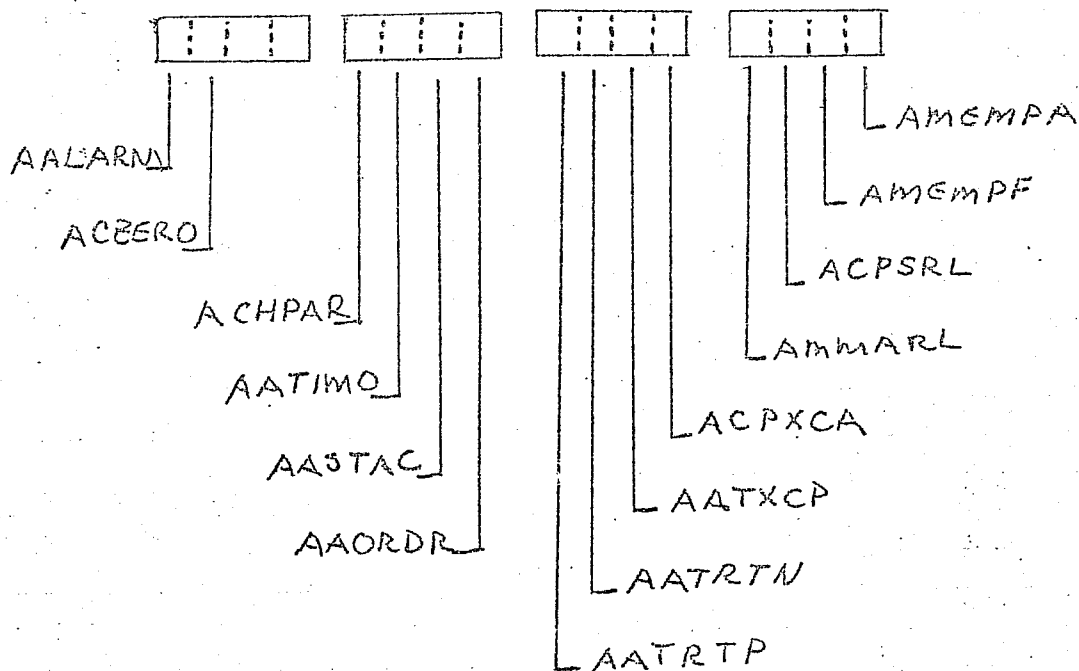

AALARM - POSITIVE TRANSITION OF ANY OTHER BIT OCCURED

ACEERO - CHAIN ADDRESS ZERO

ACHPAR - CYBER 170 PARITY ERROR

AATIMO - HARDWARE TIMEOUT CHANNEL-ACTIVE 3 SEC

AASTAC - HOST READ NPU STATUS

AAORDR - HOST HAS LOADED ORDER WORD

AATRTP - HOST SET CHANNEL INACTIVE DURING TRANSFER

AATRTP - NPU TERMINATED TRANSFER

AATXCP - HOST COMPLETED TRANSFER

ACPXCA - POWER FAILURE

AMMARL - MAR MEMORY ADDRESS JUST LOADED

ACPSRL - NPU STATUS REGISTER LOADED

AMEMPF - MEMORY PROTECT FAULT

AMEMPA - MEMORY PARITY ERROR

115

BSCPDATA - STORAGE FOR ORDER WORD / INPUT DATA
SET BY HOST TO INDICATE IT HAS OUTPUT FOR
NPM 1=BACK, 2=BLK, 3=MSG, 4=CMD, 5=BREAK, 6=RESET, 7=TER

17

BSCPCMD

BSCPCMD - LAST COUPLER COMMAND

- 10 = ~~DATA~~ ACPIMA INPUT MEMORY ADDRESS
- 30 = ACPIFC INPUT FCD / PCD
- 40 = ACPINS INPUT NPM STATUS
- * — 50 = ACPICS INPUT COUPLER STATUS
- * — 60 = ACPLOW INPUT ORDER WORD
- 70 = ACPID INPUT I/O
- 04 = ACPILW INPUT LAST WORD FROM DATA CHANNEL
- 14 = ACPIFD INPUT FDMARD / FDMARI
- 24 = ACPILC INPUT LAST CHARACTER FROM DMA UPPER
- 34 = ACPIFL INPUT FDMAI / FLAG REGISTER
- * — 54 = ACPISS INPUT SWITCH STATUS
- 74 = ACPICH INPUT CHARACTER
- 08 = ACPOMZ OUTPUT MEMORY ADDRESS ZERO
- 38 = ACPDFP OUTPUT FCD / PCD / LCD
- * — 48 = ACPONS OUTPUT NPM STATUS
- * — 58 = ACPOBL OUTPUT BUFFER LENGTH
- 68 = ACPDOW OUTPUT ORDER WORD
- * — 0C = ACPCLR CLEAR COUPLER
- 1C = ACPTRM TERMINATE TRANSFER
- 4C = ACPOTS OUTPUT TEST
- 5C = ACPITS INPUT TEST
- * — 6C = ACPOMA OUTPUT MEMORY ADDRESS
- 7C = ACPOCH OUTPUT CHARACTER

* = FUNCTIONS USED BY CCP

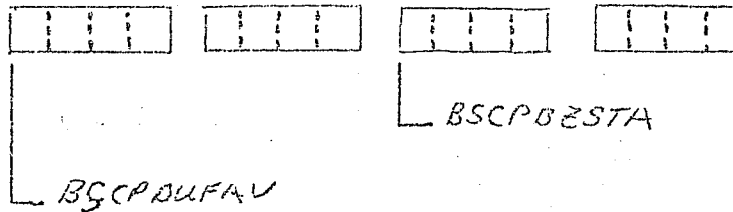

BSCPBUFAV - NUMBER OF ALLOCATED BUFFERS

BSCPBESTA - TEMP STORAGE FOR BSTATE

- 1 = AOPT1 WAIT FOR ACZERO + AATIMD + AATRTP + AATXCL THEN GO TO STATE AOPT2 ON INPUT FROM HO
1. CHAIN ADDRESS ZERO
 2. HARDWARE TIMEOUT
 3. TRANSFER TERMINATED BY PPU
 4. TRANSFER COMPLETE
- 2 = AOPT2 COMPLETE INPUT TRANSMISSION FROM HOST
- 3 = AOPT3 INITIALIZE OUTPUT TRANSACTION
- 4 = AOPT4 WAIT FOR ACZERO + AATIMD + AATRTP + AATXCL THEN GO TO STATE AOPT5 ON OUTPUT TO HOST
- 5 = AOPT5 COMPLETE OUTPUT TO HOST TRANSMISSION

BSCPIDLT - IDLE TIME COUNTER

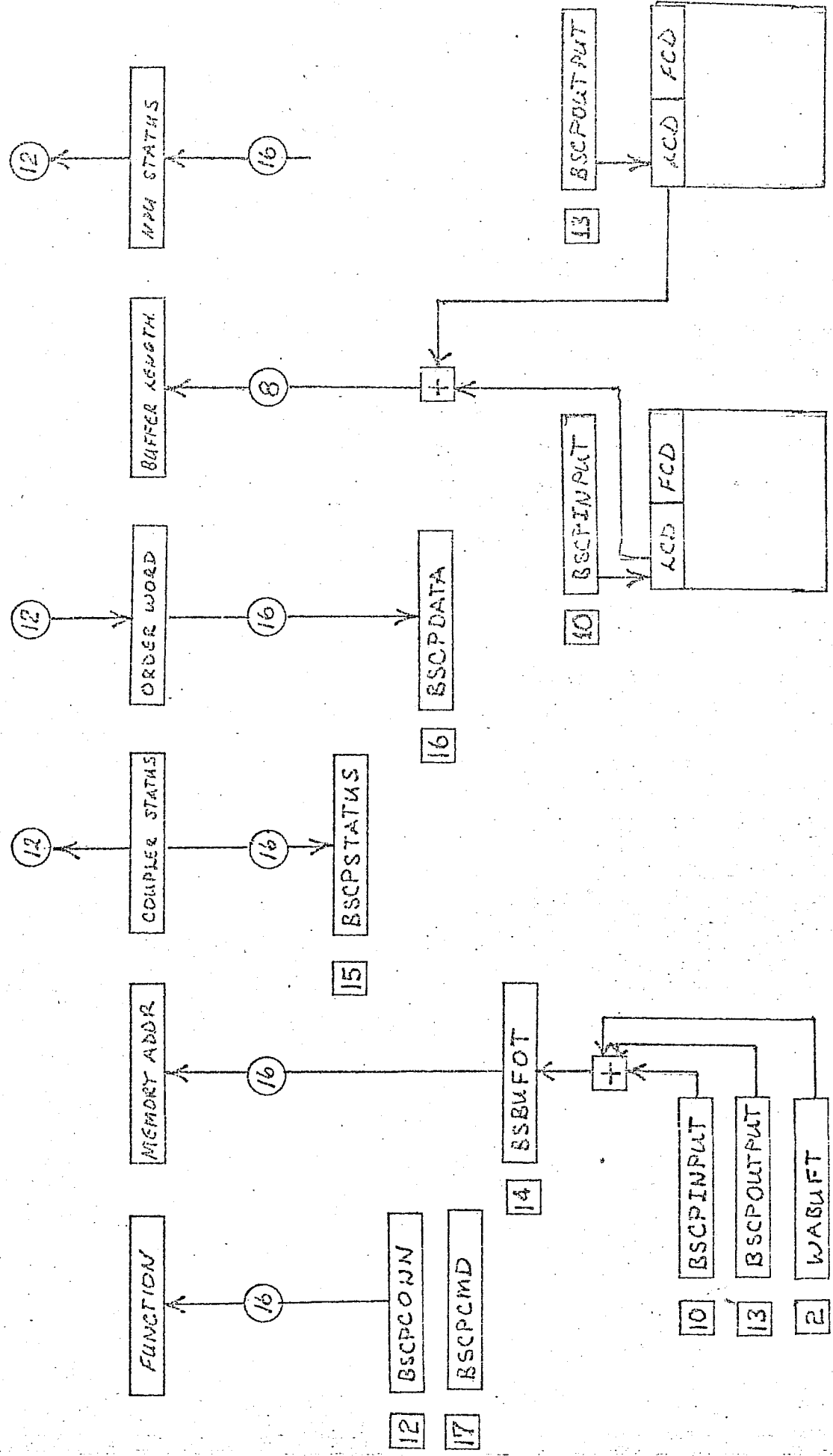

NPU STATUS

AIDLE	1	IDLE STATUS
AAREADY	4	READY TO ACCEPT OUTPUT FROM HOST
AANREADY	7	NOT READY TO ACCEPT OUTPUT FROM HOST
AINPAV	11	INPUT AVAILABLE TO HOST NOT BLK OR MSG
AINPSB	13	INPUT AVAILABLE TO HOST SMALL BLK OR MSG
AINPLB	14	INPUT AVAILABLE TO HOST LARGE BLK

NPU FUNCTIONS USED BY CCP 1.0

ACPCLR	0C	CLEAR COUPLER
ACPONS	4B	OUTPUT NPU STATUS
ACPICS	50	INPUT COUPLER STATUS
ACPQBL	58	OUTPUT BUFFER LENGTH
ACPQDW	60	INPUT ORDER WORD
ACPQMA	6C	OUTPUT MEMORY ADDRESS

HOST ORDER WORD

HTBACK	1	BACK BLOCK ACKNOWLEDGEMENT
HTBLK	2	DATA BLOCK
HTMSG	3	MSG OR SMALL DATA
HTCMD	4	COMMAND
HTBREAK	5	BREAK
HTRESET	6	RESET BREAK
HTTERM	7	TERMINATE

~~HTTERM~~

TABLE 3-5. COUPLER STATUS REGISTER

Bit Number	Flag Name	Set Condition	Interrupt Alarm*	Reset** Condition
0	Memory Parity	NPU memory parity error	A	1
1	Memory Protect Fault	NPU memory protect fault	A	1
2	NPU Status Word Loaded	NPU writes status word	-	2
3	Memory Address Register Loaded	Host or NPU writes memory address one	-	3
4	External Cab. Alarm	Power failure	I	4
5	Transmission Complete	Host completes any input or output operation	I	4
6	Transfer Terminated by NPU	NPU terminates transfer (not used)	I	4
7	Transfer Terminated by Host	Host sets channel inactive during data I/O	I	4
8	Orderword Register Loaded	Host writes orderword	I	5
9	NPU Status Read	Host reads NPU status word	-	4
10	Timeout	Coupler selected and active 3+ seconds in host data I/O operation	I	1
11	CYBER 170 Channel	Enable parity switch on and data channel 12-bit word (plus parity) not odd	A	6
12-13	Not Used			
14	Chain Address Zero	Coupler finds zero in last word of NPU buffer	-	4
15	Alarm	Positive transition of any flag causing alarm	A	4

NOTES:

*Raising associated flag causes alarm (A), interrupt (I) or neither alarm or interrupt (-).

**All flags are reset (cleared) by Master Clear. All except bit 2 are reset when NPU or host clears the coupler. Other reset conditions are as follows:

1. Reset when coupler status register is cleared.
2. Reset when host reads NPU status word.
3. Reset on first direct memory access (DMA).
4. Reset when NPU reads coupler status register.
5. Reset when NPU reads orderword.
6. Reset when NPU reads coupler status register or by enable parity switch positive transition.

WORK LIST CONTROL BLOCK

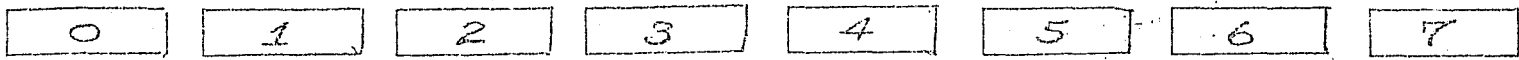

BYCNT BYPUT BYGET BYFEINC BYEXPRI - BYOVLY BYNPPT BYPRADR
 BYINC



BYCNT - ENTRY COUNT

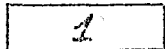

BYPUT - PUT LOCATION FOR NEXT ENTRY

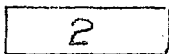

BYGET - GET LOCATION FOR NEXT ENTRY

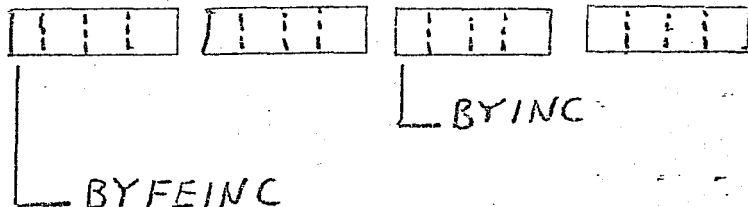

BYFEINC - FIRST ENTRY DISPLACEMENT IN BUFFER

BYINC - LENGTH OF ENTRY

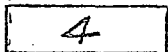

BYEXPRI - MONITOR CONTROL 0 = SCAN WORK LIST

1 = INHIBIT SCAN

2 = RETURN TO PROG

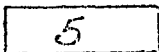

BYOVLY - OVERLAY INDEX

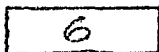

BYNPPT - LINK TO NEXT WORK LIST CONTROL BLOCK TO SCAN

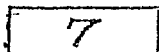

BYPRADDR - ENTRY POINT FOR ROUTINE

PROGRAMS WITH WORK LIST IN THE ORDER
THEY APPEAR IN THE WLCB

- 1. PBCONS - CONSOLE - 9EA
- 2. PNSMWL - SERVICE MODULE - 9F2
- 3. PBMWIAOPS - MLI HANDLER - 9FA
- 4. PBTIMA - TIMING SERVICES - A02
- 5. PB2IPO - INTERNAL PROCESSOR - A0A
- 6. PTTYP - TTY TIP - A12
- 7. PTMOD4T - MODE 4 TIP - A1A
- 8. PBTIPD - TIP DEBUG - A22
- 9. PBCONTINUE - CONTINUE WORKLIST - A2A
- 10. PTSTAR - COUPLER HIP - A32
- 11. - TTY CONSOLE DRUR PRIORITY - A3A
- 12. - TTY CONSOLE DRUR NON PRIORITY - A42
- 13. PMWOLP - MUX EVENT - A4A
- 14. - HIP DATA LIST QUEUE - A52
- 15. PMT200M - CRITICAL 200MS TIMING - A5A
- 16. - DUMMY - A62

TIP - HIP - KIP

0 = ACONTINUE	CONTINUE WORK CODE	
20 = AOTIMEOUT	TIMER EXPIRED	
21 = AOQUEUEOUT	OUTPUT IN QUEUE	
22 = AOSMEN	ENABLE LINE FROM SERVICE MODULE	
23 = AOSMDA	DISABLE LINE FROM SERVICE MODULE	
24 = AOSMTCB	TCB IS BUILT FROM SERVICE MODULE	
25 = AOBREAK	DOWN LINE BREAK RECEIVED	
26 = AOTERM	DOWN LINE TERMINATE RECEIVED	
27 = COSMSGR	SERVICE MESSAGE RECEIVED TO SM	
28 = COTCBREL	RELEASE TCB TO SERVICE MODULE	
29 = COSMDISP	DISPATCH SERVICE MESSAGE TO SM	
2A = COLINOP	LINE OPERATIONAL TO SERVICE MODULE	
2B = COLININOP	LINE INOPERATIVE	"
2C = COLNDA	LINE DISABLED	"
2D = CODLYTCB	DELAYED TCB BUILD	"
2E = COHSTDN	HOST DOWN FROM HIP	"
2F = COHSTUP	HOST UP FROM HIP	"
30 = COCHDM	CONTINUE HOST DOWN MSG	"
31 = COCHUM	CONTINUE HOST UP MSG	"
32 = AOBRON	TURN ON BREAK TO PMT200M	
33 = AOBROFF	TURN OFF BREAK TO PMT200M	
31 = AOWK1	WORK CODE 1	
32 = AOWK2	WORK CODE 2	
33 = AOWK3	WORK CODE 3	
34 = AOWK4	WORK CODE 4	

SERVICE MODULE

WORK LIST ENTRY PWSMWT

9F2

BOSMWT

0 1

CMDATA CMKIND
CMWKCODE CMPOINT
CMTIPWC

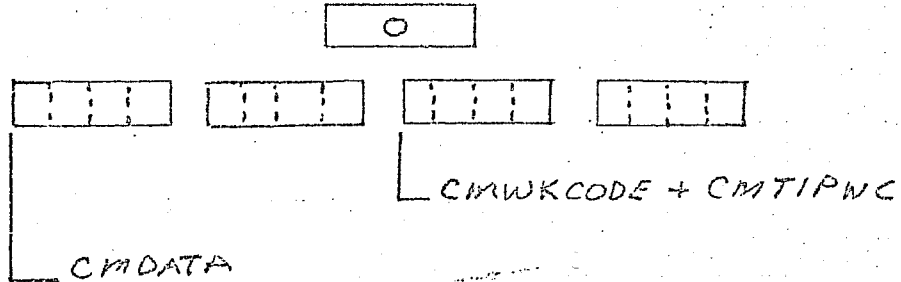

CMDATA - LINE ERROR CODE OR CONFIGURE TERMINAL TYPE

CMWKCODE - EVENT WORK CODE
CMTIPWC

1

TWO FORMS

CMKIND - LINE NUMBER

CMPOINT - BUFFER POINTER WORK CODES (COSMSGR...COCH)

SERVICE MODULE
DOWN LINE WORKLIST COMMAND

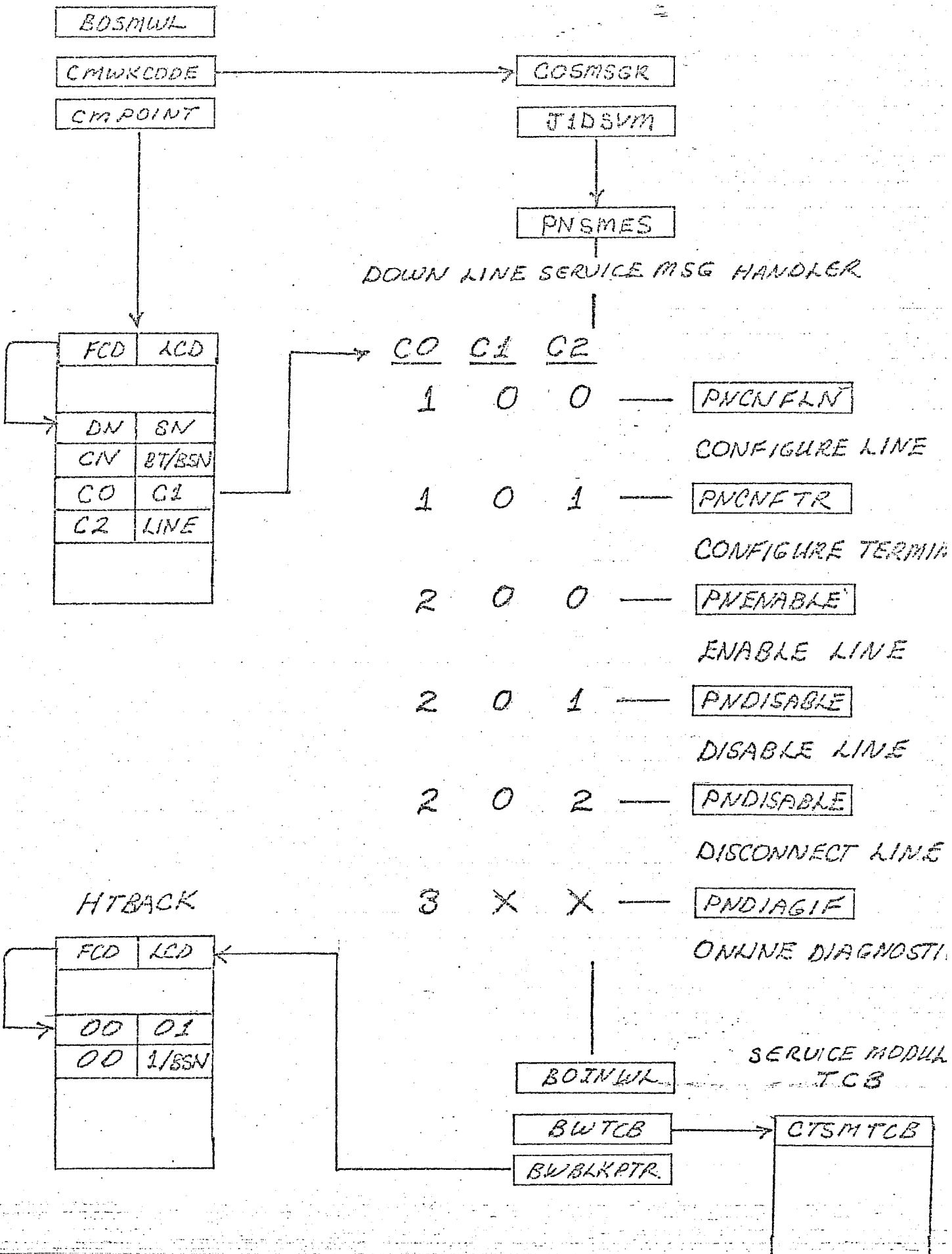

WORK LIST ENTRY - PBCONS

BOCHWL

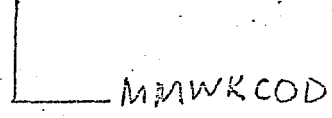
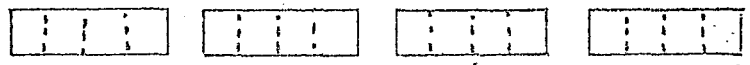

MMWKCOD

MMWKCOD - EVENT WORK CODE

INTERNAL PROCESSOR

WORK LIST ENTRY

PB2IPO

ADA

1967

BO-INWL

0

1

BWTCB BWBLKPTR

0

BWTCB - TCB POINTER

1

BWBLKPTR - DATA BLOCK POINTER

PBINTPROC

INTERNAL PROCESSING WORK LIST

127

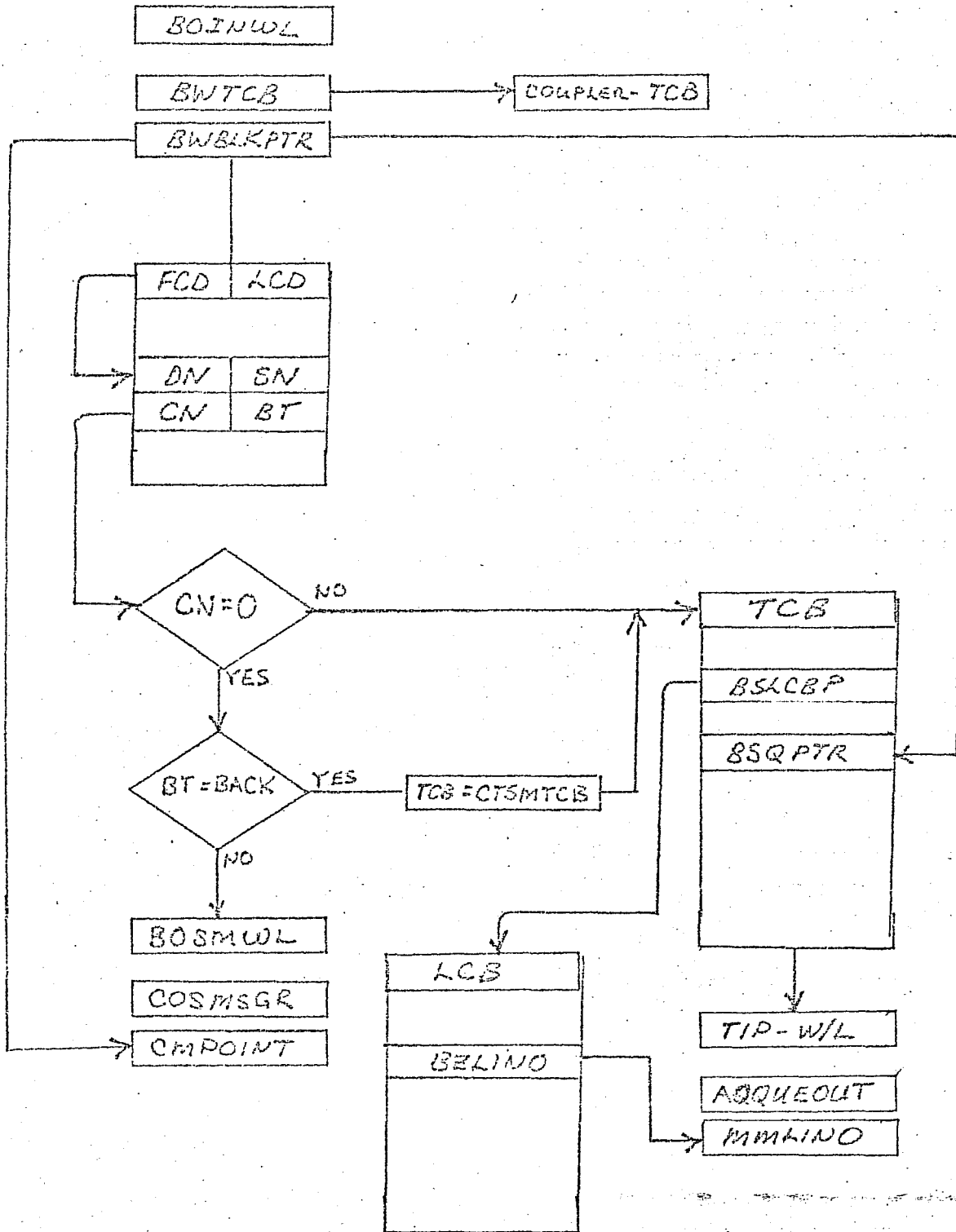

TTY TIP

WORK LIST ENTRY PTTYP

BOTYWT

0

1

2

MMWKCOD

MMLINO

MMIBP

0

MMWKCOD - EVENT WORK CODE

1

MMLINO - LINE NUMBER

2

MMIBP - TCB OR DATA BUFFER POINTER

EVENT WORK CODES

21 = A0QUEOQT OUTPUT QUEUED FOR LINE

22 = A0SMEN ENABLE LINE

23 = A0SMDA DISABLE LINE

24 = A0SMTCB TCB BUILT

25 = A0BREAK DOWN LINE BREAK

26 = A0TERM DOWN LINE TERMINATE

MODE 4 TIP

LOOK LIST ENTRY

PTMOD&T

AIAO
12

BOM4WL

MMWKCOD MMLIND MMIBP

MMWKCOD - EVENT WORK CODE

MMLIND - LINE NUMBER

MMIBP - TCB POINTER WHEN NEEDED OR DATA BUFFER

EVENT WORK CODES

- 21 - AOQUEOUT - OUTPUT QUEUED FROM PWDLBH
- 22 - AOSMEN - ENABLE LINE FROM SERVICE MODULE
- 23 - AOSMDA - DISABLE LINE FROM SERVICE MODULE
- 24 - AOSMTCB - TCB BUILT FROM SERVICE MODULE

WORK LIST ENTRY PT600P

BOCWKQ [0] [1] [2] [3]

MMWTCOUNT MMLIND MMRETADR MMWTERR
MMSPI
MMBAV
MMWKCOD

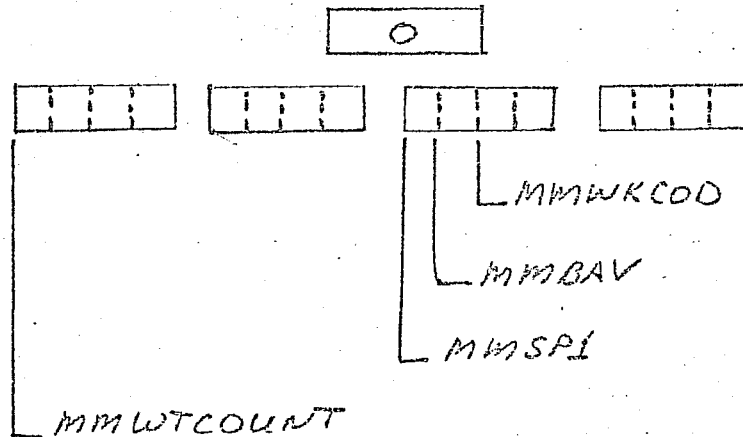

MMWTCOUNT - WAIT COUNT

MMSPI - NOT USED

MMBAV - BUFFER ADDRESS VALID FLAG

MMWKCOD - EVENT WORK CODE

[1]

MMLIND - LINE NUMBER

[2]

MMRETADR - RETURN ADDRESS

[3]

MMWTERR - ERROR FLAGS AT WAIT RETURN TIME
SEE LCB WORD 5 BERROR SAME
FORMAT

WORK LIST ENTRY PTSTAR

B0C0WL [0] [1] [2]

ACPEVENT ACPBLIND ACPBOBUF

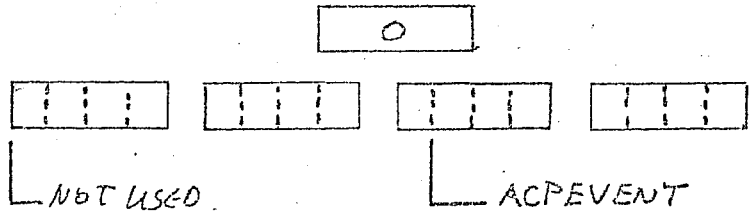

ACPEVENT - EVENT WORK CODE

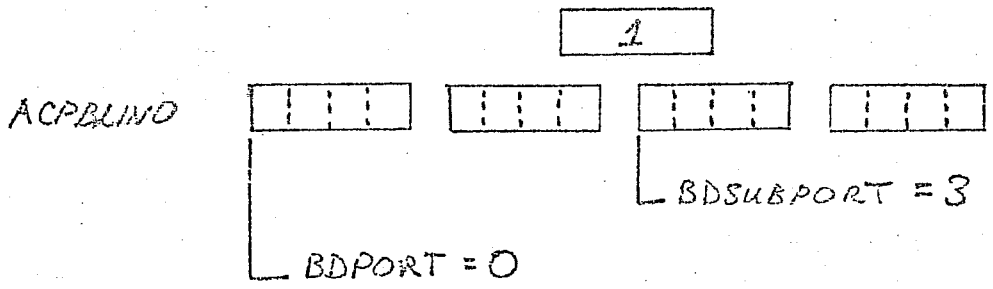

[2]

ACPBOBUF - BUFFER POINTER NOT USED

BWOLENTRY

SOFTWARE PRIORITY WORK LIST ENTRY TABLE

JSWLAD = FWA PRIORITY-1 WORK LIST ENTRY (A7C)=98

EACH ENTRY 6 WORDS LONG AND CONTAINS
LAST WORK LIST ENTRY THAT PRIORITY
PROGRAM WAS PUTTING OR GETTING FROM
A WORK LIST

SOFTWARE PRIORITY

- 1 = MEMPARITY, PROTECT, POWER FAIL PROGRAM
- 2 = MUX LOOP ERROR PROGRAM
- MUX2 3 = MUX SUBSYSTEM PROGRAMS
- 5 = COUPLER NO-2 (2558-1)
- 6 = CONSOLE
- CPL 7 = COUPLER NO-1
- 8 = TAPE CASSETTE
- RTC 9 = REAL TIME CLOCK
- 13 = OUTPUT DATA DEMAND RECEIVED MLIA
- 14 = INPUT LINE FRAME RECEIVED MLIA
- OPS 17 = OPS LEVEL PROGRAMS

PBTIMAL (CBITWATBL)

CDTOPGMS 0 1 2

CBTIMER CBINTVAL CBADDR

CBTIMER - TIME REMAINING 1= EXPIRED

CBINTVAL - TIME INTERVAL TO INITIALISE CBTIMER

CBADDR - PROGRAM ENTRY ADDRESS WHEN TIMER EXPIRES

		<u>TIME SEC</u>
0 - COLCBTMS CN	PBACBTMSCN	.5
1 - COADJUST	PBADJUST	.5
2 - COTUP	PBTUP	2.5
3 - COTIMEOFDAY	PBTIMODAY	1.0
4 - COTISEC	PMTISEC	1.0
5 - COPSTAT	PMPSTAT	60.0
6 - COIDTMP	PBIOTMP	.5
7 - COCECNT	PNCECNT	10.0

EVERY .5 SEC WORK LIST ENTRY ENTERED INTO PBTIMAL WORKLIST BY LEVEL B PROCEDURE PBTIMER WHICH IS CALLED BY REAL TIME CLOCK INTERRUPT

PBLCBTMSCN

1301

RUNS EVERY .5 SEC CHECKS ACTIVE CONTROL BLOCK TABLE FOR PTHWAIT TIME EXPIRED. CALLED FROM PBTIMAL USING CBRTMTBL ENTRY 0

ENTRY

CELCBACT - POINTER TO LIST OF ACTIVE LCB

LCBLST - ACTIVE LCB LIST

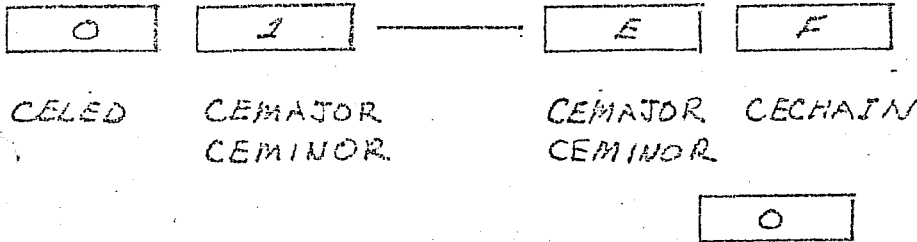

CELED - LAST ENTRY DISPLACEMENT

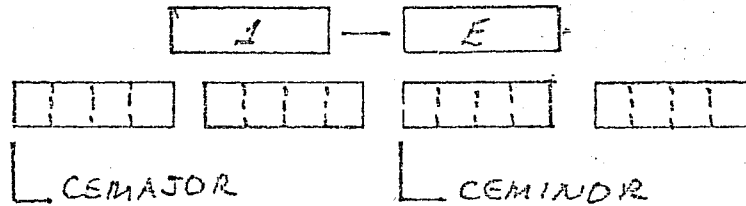

CEMAJOR - INDEX INTO LCB ARRAY

CEMINOR - INDEX INTO TDM LCB ARRAY

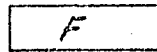

CECHAIN - LINK TO NEXT BUFFER IN LCBLST

SETS DATA IN LCB

BEPDMO = 0

CLA ERROR COUNT

BELTIMER = BELTIMER - 1

WAIT TIME COUNTER

IF BELTIMER = 0

BELINSTA.HTWAIT = FALSE
 BELINSTA.HTTRUN = FALSE
 BEERAC = BEERAC + BEERROR
 BEERROR = 0
 BEWAITMASK = 0
 BERETADDR = 0

WAIT ACTIVE
 WAIT TIMER RUNNING
 ACCUMULATED CLA ERRORS
 CLA ERRORS IN LAST .5 SEC
 WAIT EVENT
 RETURN ADDRESS

PBLCBTMSCN

EXIT

BEWINSTA.HTLEVEL = HLOPS EXIT TO SRET

BEWINSTA.HTLEVEL = HLMUX ENTER W/L MMEWLQ

MMWTERP = BERROR
MMIBAV = FALST
MMWICOUNT = BEWTCOUNT
MMWRCD = ACONTINUE
MMRETADR = BERETADR

P1 = SOFTWARE LEVEL CONTROL IS TO BE RETURNED TO

P2 = EVENT OR EVENTS TO WAIT FOR

P3 = TIME TO WAIT * .5 SECONDS

SETS DATA IN LCB

BELWTCOUNT = BELWTCOUNT + 1 - WAIT COUNT

BELTIMER = P3 - WAIT TIME

BELWSTA.HTTRUN = TRUE - WAIT TIMER RUNNING

BELWSTA.HTWAIT = TRUE - WAIT ACTIVE

BELWSTA.HTLEVEL = P1 - SOFTWARE LEVEL HROPS+HA

BELWAITMASK = P2 - WAIT EVENT CODE

BEL1SAVE = R1 - R1 SAVE

BEL2SAVE = R2 - R2 SAVE

BELRETADDR = RETURN ADDRESS

EXIT

P1 = HROPS - RETURN SRETOPS TO MONITOR

P1 = HLMUX - RETURN SRETMUX TO PMWOLF

WORKST ENTERED

P3 = -1 WL = BOTZOO MMWKCOD = AODRON

MMKIND = BDRIND

MMWTCOUNT = BELWTCOUNT

P2 = BELWSTAT - EVENT ALREADY OCCURRED

WL = BDCWLD MMBAV = FALSE

MMWTCOUNT = BELWTCOUNT

MMKIND = BDRIND

MMWKCOD = AODCONTINUE

MMRETADR = BELRETADR

00	80	NULL	NO-OP
01	81	SOH	START OF HEADING
02	82	STX	START OF TEXT
03	83	ETX	END OF TEXT
04	84	EOT	END OF TRANSMISSION
05	85	ENQ	ENQUIRY
06	86	ACK	ACKNOWLEDGE
07	87	BEL	ALERT
08	88	BS←	BACKSPACE
09	89	HT	HORIZONTAL TAB
0A	8A	LF↓	LINE FEED ADVANCE CURSOR ONE LINE DOWN
0B	8B	VT	VERTICAL TAB
0C	8C	FF	FORM FEED
0D	8D	RETURN	RESET CURSOR TO BEGINNING OF LINE
0E	8E	INVERSE	START INVERSE VIDEO
0F	8F	END INVERSE	END INVERSE VIDEO
10	90	DLE	DATA LINK ESCAPE
11	91	DC1	DEVICE CONTROL 1
12	92	DC2	DEVICE CONTROL 2
13	93	DC3	DEVICE CONTROL 3
14	94	DC4	DEVICE CONTROL 4
15	95	SKIP→	ADVANCE CURSOR ONE CHAR
16	96	LINE CLEAR	ENTER SPACE TO END OF LINE
17	97	EBT	END OF TRANSMISSION BLOCK
18	98	CLEAR	ENTER SPACE IN ENTIRE DISPLAY
19	99	RESET	RESET CURSOR TO FIRST CHAR IN DISPLAY
1A	9A	CURSOR↑	MOVE CURSOR UP ONE LINE
1B	9B	ESC	ESCAPE
1C	9C	FS	FILE SEPARATOR
1D	9D	GS	GROUP SEPARATOR
1E	9E	RS	RECORD SEPARATOR
1F	9F	US	UNIT SEPARATOR

20	A0	SPACE
21	A1	!
22	A2	"
23	A3	#
24	A4	\$
25	A5	%
26	A6	&
27	A7	'
28	A8	(
29	A9)
2A	AA	*
2B	AB	+
2C	AC	,
2D	AD	-
2E	AE	.
2F	AF	/
30	B0	0
31	B1	1
32	B2	2
33	B3	3
34	B4	4
35	B5	5
36	B6	6
37	B7	7
38	B8	8
39	B9	9
3A	BA	:
3B	BB	;
3C	BC	<
3D	BD	=
3E	BE	>
3F	BF	?
40	C0	@
41	C1	A
42	C2	B
43	C3	C
44	C4	D
45	C5	E
46	C6	F
47	C7	G
48	C8	H
49	C9	I

4A	CA	J
4B	CB	K
4C	CC	L
4D	CD	M
4E	CE	N
4F	CF	O
50	DO	P
51	D1	Q
52	D2	R
53	D3	S
54	D4	T
55	D5	U
56	D6	V
57	D7	W
58	D8	X
59	D9	Y
5A	DA	Z
5B	DB	[
5C	DC	\
5D	DD]
5E	DE	^
5F	DF	_
60	EO	`
61	E1	a
62	E2	b
63	E3	c
64	E4	d
65	E5	e
66	E6	f
67	E7	g
68	E8	h
69	E9	i
6A	EA	j
6B	EB	k
6C	EC	l
6D	ED	m
6E	EE	n
6F	EF	o
70	FO	p
71	F1	q
72	F2	r
73	F3	s

74	F4
75	F5
76	F6
77	F7
78	F8
79	F9
7A	FA
7B	FB
7C	FC
7D	FD
7E	FE
7F	FF

20 - A0
 21 A1
 22 A2
 23 A3
 24 A4
 25 A5
 26 A6
 27 A7
 28 A8
 29 A9
 2A AA
 2B AB
 2C AC
 2D AD
 2E AE
 2F AF
 30 B0
 31 B1
 32 B2
 33 B3
 34 B4
 35 B5
 36 B6
 37 B7
 38 B8
 39 B9
 3A BA
 3B BB
 3C BC
 3D BD
 3E BE
 3F BF
 40 C0
 41 C1
 42 C2
 43 C3
 44 C4
 45 C5
 46 C6
 47 C7
 48 C8
 49 C9
 4A CA
 4B CB
 4C CC
 4D CD
 4E CE
 4F CF
 50 D0
 51 D1
 52 D2
 53 D3
 54 D4
 55 D5

-
 J
 K
 L
 M
 N
 O
 P
 Q
 R
 V
 \$
 *
 ↑
 ↓
 v
 +
 A
 B
 C
 D
 E
 F
 G
 H
 I
 <
 .
)
 z
 ESCAPE
 ;
 1
 2
 3
 4
 5
 6
 7
 8
 9
 O
 =
 #
 <=
 %
 [
 SPACE
 /
 S
 T
 U
 V

56 D6
 57 D7
 58 D8
 59 D9
 5A DA
 5B DB
 5C DC
 5D DD
 5E DE
 5F DF

 9B ESCAPE
 01 SOH
 83 EOT

 70 SITE ADDRESS
 E0 STATION ADDRESS

 98 REJECT
 93 READ

 86 ACK

W
 X
 Y
 Z
 [
 \
]
 ^

20	A0	SPACE
21	A1	!
22	A2	"
23	A3	#
24	A4	\$
25	A5	%
26	A6	&
27	A7	'
28	A8	(
29	A9)
2A	AA	*
2B	AB	+
2C	AC	,
2D	AD	-
2E	AE	.
2F	AF	/
30	BO	0
31	B1	1
32	B2	2
33	B3	3
34	B4	4
35	B5	5
36	B6	6
37	B7	7
38	B8	8
39	B9	9
3A	BA	:
3B	BB	;
3C	BC	<
3D	BD	=
3E	BE	>
3F	BF	?
40	CO	@
41	C1	A
42	C2	B
43	C3	C
44	C4	D
45	C5	E
46	C6	F
47	C7	G
48	C8	H
49	C9	I
4A	CA	J
4B	CB	K
4C	CC	L
4D	CD	M
4E	CE	N
4F	CF	O
50	DD	P
51	D2	Q

53	D3	S
54	D4	T
55	D5	U
56	D6	V
57	D7	W
58	D8	X
59	D9	Y
5A	DA	Z
5B	DB	[
5C	DC	\
5D	DD]
5E	DE	^
5F	DF	_

61	E1	a
62	E2	b
63	E3	c
64	E4	d
65	E5	e
66	E6	f
67	E7	g
68	E8	h
69	E9	i
6A	EA	j
6B	EB	k
6C	EC	l
6D	ED	m
6E	EE	n
6F	EF	o
70	FO	p
71	F1	q
72	F2	r
73	F3	s
74	F4	t
75	F5	u
76	F6	v
77	F7	w
78	F8	x
79	F9	y
7A	FA	z
7B	FB	{
7C	FC	
7D	FD	}
7E	FE	~
7F	FF	▯

9B ESCAPE

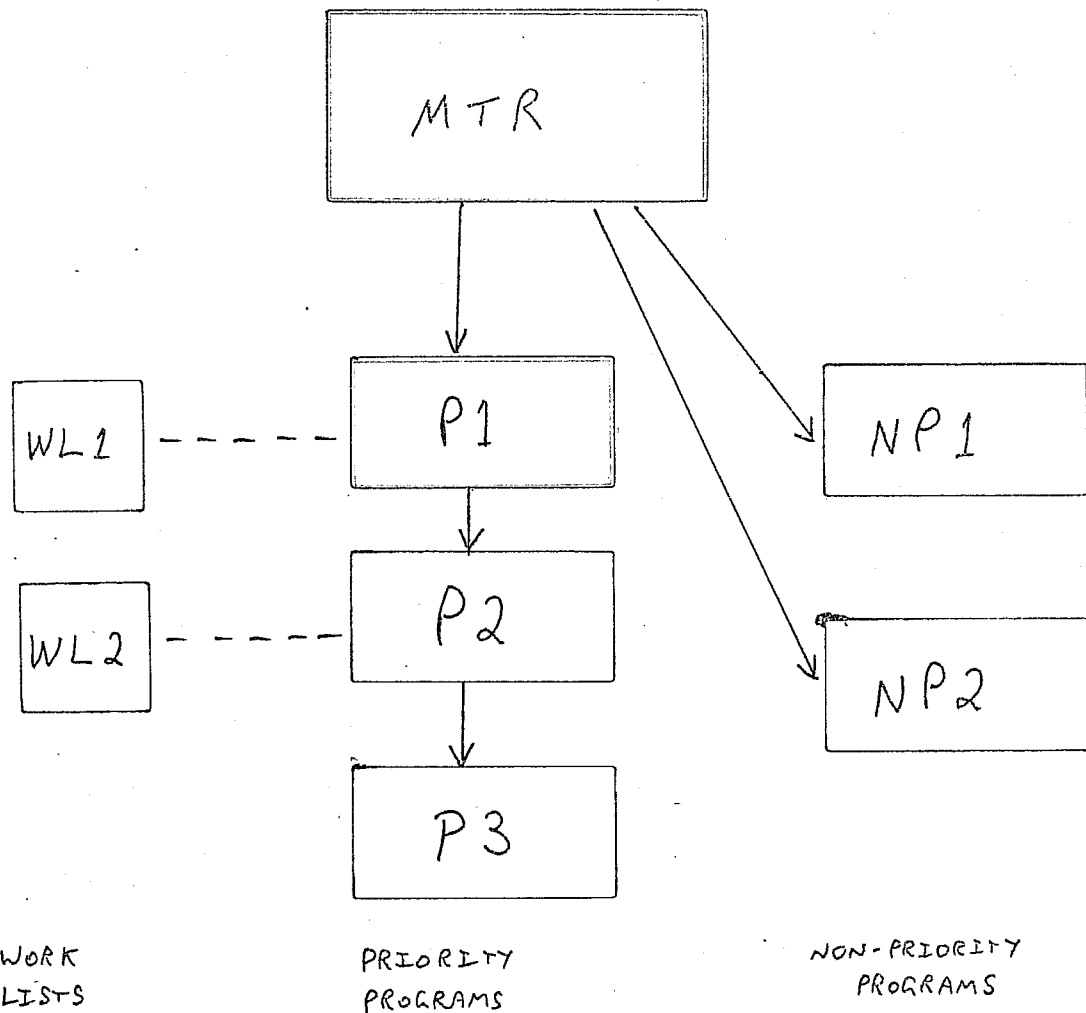

MONITOR LOOP EXECUTES EACH PRIORITY PROGRAM THEN EXECUTES ONE NON-PRIORITY PROGRAM. NEXT LOOP EXECUTES EACH PRIORITY PROGRAM THEN NEXT NON-PRIORITY PROGRAM.

EACH PROGRAM MAY REQUIRE SERVICE BY OTHER ROUTINES — IF SO IT PUTS AN ENTRY INTO THE OTHER ROUTINE'S WORKLIST AND THAT REQUEST IS EXECUTED NEXT TIME THAT PROGRAM IS ENTERED.

GENERAL OVERVIEW

INPUT FROM TERMINAL.

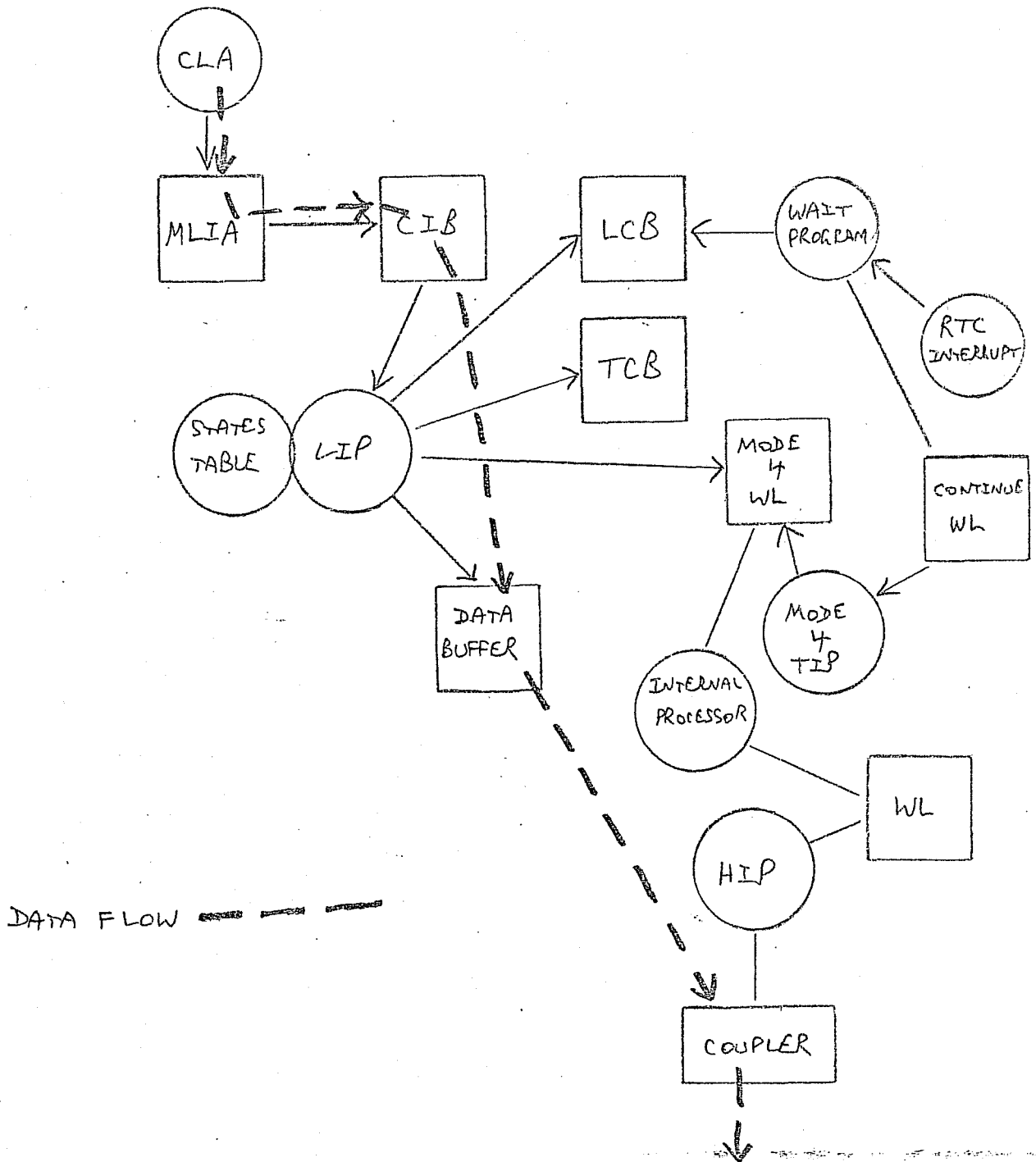

OUTPUT FROM HOST

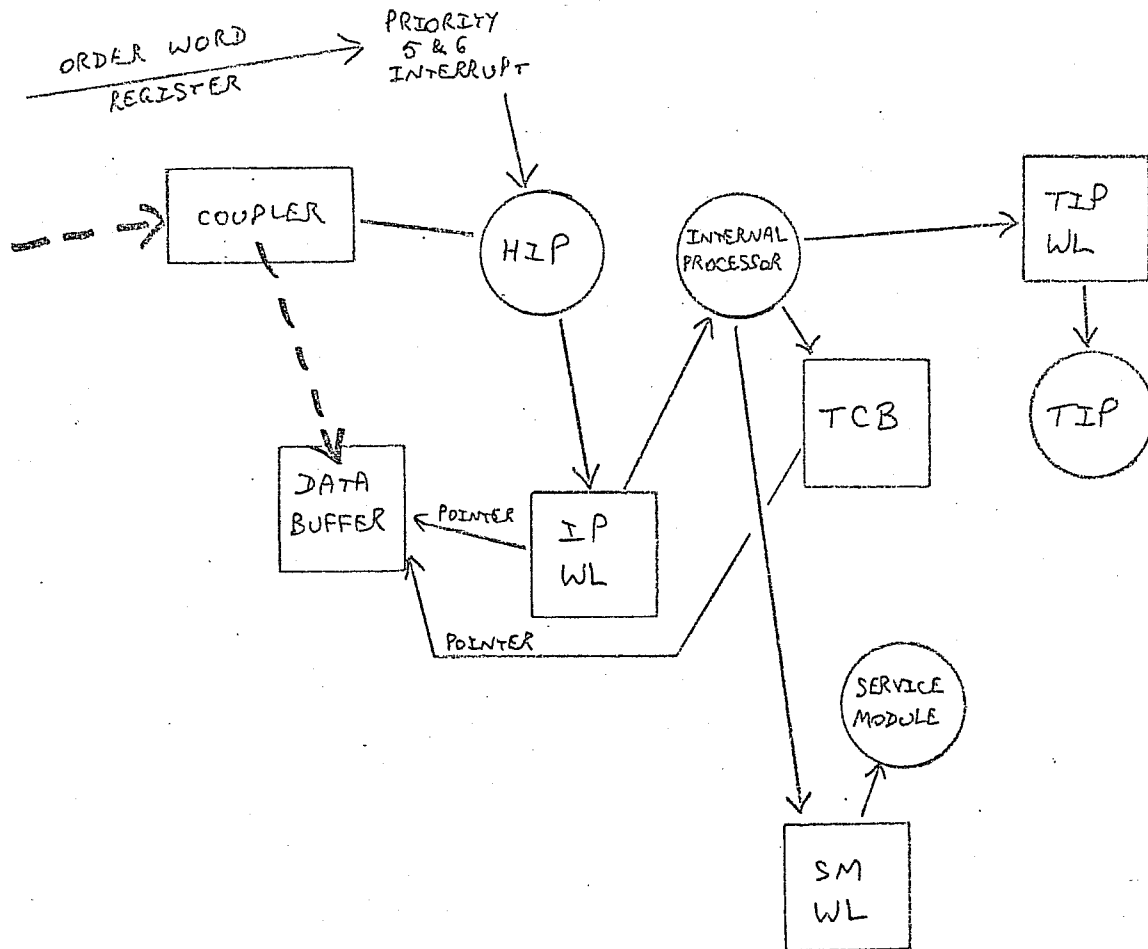

ANY DATA BUFFERS WITH CONNECTION NUMBERS OF ZERO ARE FOR SERVICE MODULE (I.E. COMMANDS FOR 2550 ITSELF RATHER THAN FOR A TERMINAL).

OUTPUT FROM HOST

- CYBER FUNCTIONS COUPLER WITH 'DATA READY'.
- INTERRUPT TO HIP - WHICH SETS UP BUFFER.
- HIP SETS COUPLER STATUS 'READY'.
- CYBER TRANSFERS DATA VIA COUPLER.
- INTERRUPT TO HIP ON END OF DATA.
- HIP SETS ENTRY IN INTERNAL PROCESSOR WL.
- IP EXAMINES BUFFER AND DETERMINES TIP TYPE, VIA CONNECTION NUMBER.
- IP SETS RELEVANT TIP (OR SERVICE MODULE) WORKLIST ENTRY.
- TIP OR SM PROCESSES DATA BUFFER WHEN ACTIVATED BY WL ENTRY.

COUPLER - NPU COMMUNICATION

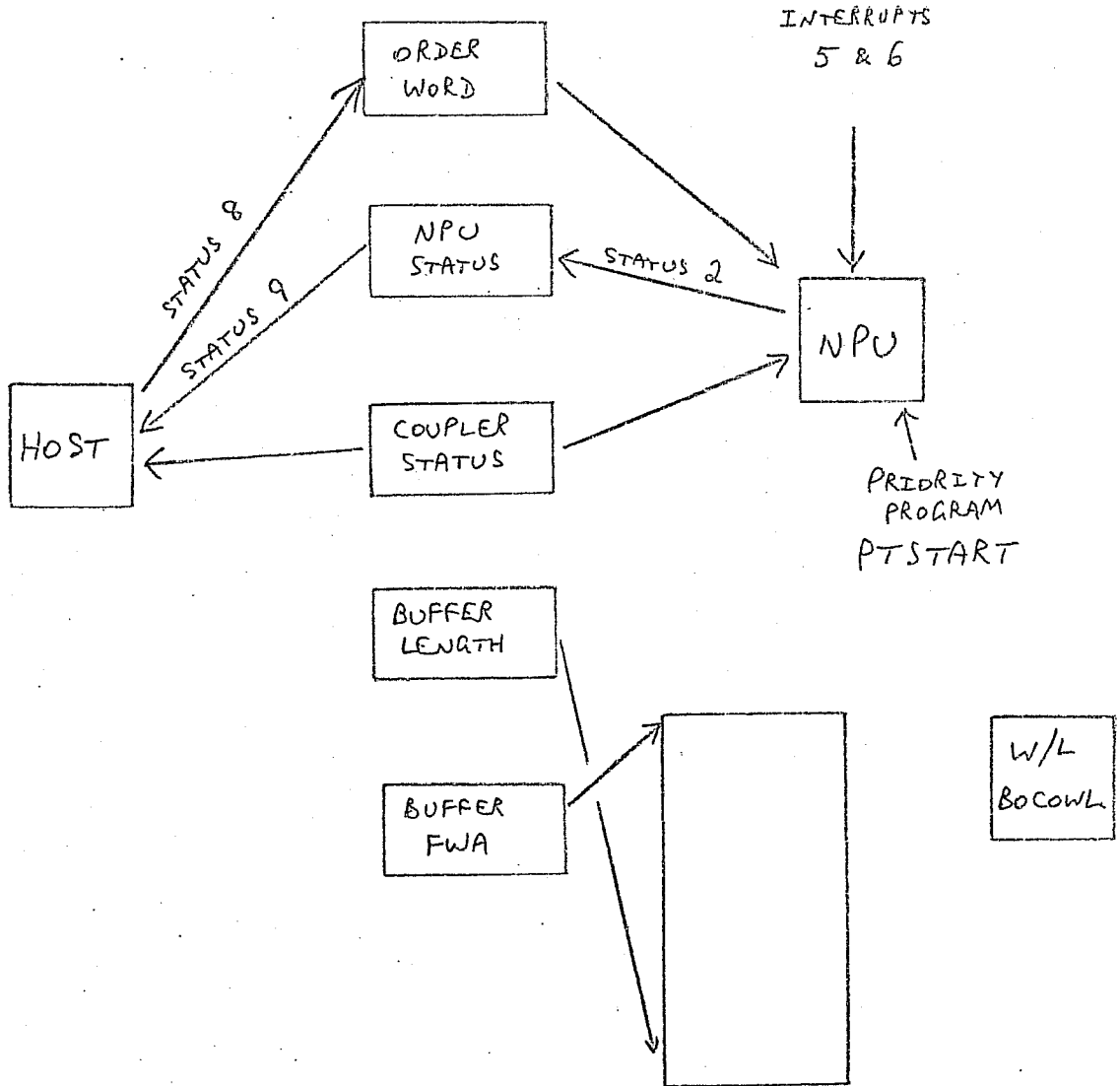

BREAKPOINT

WORD 16B POINTS TO TABLE USED FOR
WRAP-AROUND-SNAP (WRAPSNAP TABLE).

TABLE IS 9 WORDS

1	FWA DUMP BUFFER
2	FWA DUMP BUFFER
3	LWA DUMP BUFFER
4-5	AREA TO DUMP
6-7	"
8-9	"

ELEMENTS OF A PASCAL PROGRAM

- LABEL Declaration
- CONST Definition
- TYPE Definition
- VAR Declaration

LABEL Declaration

CONST Definition

TYPE Definition

VAR Declaration

VALUE Declaration

Procedure & Function Declaration

Statement Part

- VALUE Declaration
- Procedure & Function Declarations
- Statement Part

LABEL

10,20,30;

CONST

K1 = 1;

K10 = 10;

MAXCNT = 10000;

TYPE

T1 = PACKED ARRAY[1..10] OF CHAR;

T2 = 0..15;

VAR

A : INTEGER;

B : T1;

C : RECORD

F1 : T2;

F2 : CHAR;

F3 : ARRAY[0..5] OF INTEGER;

END;

VALUE

A = 100;

B = {'ABCDEFGH IJ'};

PROCEDURE TEST(X, Y : INTEGER;

VAR Z : INTEGER);

BEGIN

Z := X + Y;

END;

BEGIN

Statement list

END.

ARRAYSVAR

AREA : ARRAY[1..5,1..10] OF INTEGER;

I : INTEGER;

BEGIN

I := AREA[2,7] + 10;

AREA[2*I-9,3] := 32000;

END;

RECORDSVAR

INREC : RECORD

FLD1 : INTEGER;

FLD2 : D..20;

FLD3 : RECORD

XRAY : -10..10;

POSTVE : BOOLEAN;

IND : CHAR;

END;

FLD4 : CHAR;

END;

BEGIN

INREC.FLD2 := 19;

INREC.FLD3.IND := 'W';

END;

RECORD VARIANTSTYPE

T1 = RECORD

F1 : CHAR;

F2 : INTEGER;

CASE F3 : INTEGER OF

0 : {CNTX : INTEGER;

AREAX : ARRAY{1..5} OF CHAR};

1 : {FLAG1 : BOOLEAN};

2 : {B2 : -10..10};

3 : {TABLE : ARRAY{1..10,1..10} OF INTEGER};

END;

VAR

A : T1;

B : T1;

BEGIN

A.CNTX := 10;

B.FLAG1 := TRUE;

END;

SETS

TYPE

T1 = {E1, E2, E3, E4, E5, E6, E7, E8, E9,
E10, E11, E12, E13, E14, E15, E16};

T2 = SET OF T1;

T3 = 0..15;

VAR

SET1 : T2;

SET2 : T2;

SET3 : SET OF T3;

BEGIN

SET1 := SET1 ^ SET2;

SET1 := SET1 V {E1, E5, E8};

IF E1 IN SET1

THEN SET2 := SET1;

SET3 := {5, 9, 12, 14};

END;

BIT FIELDS -

PCKDWD : PACKED RECORD

F1 : 0..15;

F2 : BOOLEAN;

F3 : 0..255;

F4 : {A,B,C,D,E}

END;

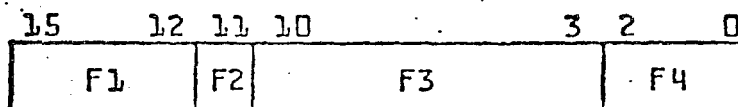

DYNAMIC VARIABLES

TYPE

```

PTR = ↑ LNKLST;
LNKLST = RECORD
    LNKPTR : PTR;
    A : INTEGER
END;

```

VAR

```

PTRV1 : PTR;
PTRV2 : PTR;
I : INTEGER;

```

BEGIN

```

PTRV2 := NIL;
FOR I := 1 TO 10 DO
    BEGIN
        NEW{PTRV1};
        PTRV1↑.LNKPTR := PTRV2;
        PTRV1↑.A := 0;
        PTRV2 := PTRV1;
    END;

```

END;

OPERATORSArithmetic

+ addition
- subtraction
* multiplication
div division
mod modulus

Relational {arithmetic}

= equal
≠ not equal
< less than
≤ less than or equal
> greater than
≥ greater than or equal

Boolean

¬ not
∨ or
∧ and

Set

∪ union
∩ intersection
- difference

Relational {set}

= equal
≠ not equal
⊆ set inclusion
⊇ set inclusion
in membership

STATEMENTS

Assignment statement	I := J + 1;
Procedure statement	PROC1; PROC2{X,Y,Z};
Compound statement	BEGIN I := J; PROC1 END;
IF statement	IF I = J THEN PROC1 ELSE PROC2{A,B,C};
CASE statement	CASE NODE OF 1 : BRNCH := 1; 2 : BRNCH := 2; 3 : BRNCH := 3 END;
REPEAT statement	REPEAT I := J + 1; PROC1 UNTIL I > 10;
WHILE statement	WHILE I ≤ 10 DO BEGIN I := J + 1; PROC1 END;
FOR statement	FOR I := 1 TO 10 DO BEGIN J := I * 100; PROC1; K := J - 3 END;

GOTO Statement

```

PROCEDURE A;
  LABEL 10;
  PROCEDURE B;
    BEGIN
      GOTO 10;
    10: GOTO EXIT10;
    END
  BEGIN
    10: Statement;
  END

```

WITH Statement

```

WITH LCB{A} DO
  BEGIN
    F1:=2;
    F2:=FALSE
  END
  equivalent to
  LCB{A}.FA:=2;
  LCB{A}.F2:=FALSE;

```

EMPTY Statement

```

GO TO 10;
10:;

```