

Burroughs B 6500

Data Communications Processor

REFERENCE MANUAL



Burroughs
B 6500
DATA COMMUNICATIONS PROCESSOR
REFERENCE MANUAL



Burroughs Corporation
Detroit, Michigan 48232

\$5.00

COPYRIGHT© 1970 BURROUGHS CORPORATION

The information contained herein is subject to change without notice. Revisions may be issued to advise of such changes and/or additions.

Correspondence regarding this document should be forwarded using the Remarks Form at the back of the manual, or may be addressed directly to Systems Documentation, Sales Technical Services, Burroughs Corporation, 6071 Second Avenue, Detroit, Michigan 48232.

TABLE OF CONTENTS

SECTION	TITLE	PAGE
	INTRODUCTION	xix
1	DATA COMMUNICATIONS SYSTEM CONFIGURATION	1-1
	General	1-1
	Data Communications Processor (DCP)	1-1
	Adapter Cluster	1-1
	Line Adapters	1-3
	Operation	1-3
	Data Communications Cabinet	1-5
	Cluster Cable	1-5
	Cluster Exchange.	1-5
	Data Communications Processor Optional Local Memory.	1-6
2	DATA COMMUNICATIONS PROCESSOR.	2-1
	General	2-1
	Nomenclature.	2-1
	Bit Numbering.	2-1
	Designation of Fields.	2-3
	Designation of Single Bits	2-3
	Byte Designation	2-4
	Half-word Designation.	2-4
	Adapter Cluster Interface Registers	2-5
	Adapter Address Register (AA).	2-5
	Adapter Control Register (AC).	2-5
	Adapter Information Register (AI).	2-5
	General Purpose Registers	2-5
	D Register	2-5
	Y Register	2-6
	X Register	2-6
	Comparison Register (CF).	2-6

TABLE OF CONTENTS (cont)

SECTION	TITLE	PAGE
2 (cont)	Memory Address Registers.	2-8
	Memory Address Registers (MA-2, MA-1 and MA-0).	2-8
	Instruction Address Registers.	2-9
	B 6500 Address Register (BA)	2-9
	Full Word Registers	2-10
	Instruction Register (IR).	2-10
	Word Register (W).	2-10
	Cluster Mask Register	2-11
	Memories.	2-11
	Scratchpad Memory (SM)	2-11
	Reserved Locations.	2-11
	Local Memory (LM).	2-12
	Basic Half-word and Byte Organization	2-12
	D Bus.	2-12
	E Bus.	2-13
	Full Word Transfer	2-13
	Arithmetic, Logical, and Translation Section	2-13
	Functions.	2-13
	A Bus.	2-15
	B Bus.	2-15
	C Bus.	2-15
	Instruction Format.	2-15
	Instruction Half-word.	2-15
	Op Field	2-16
	A Field.	2-17
	B Field.	2-17
	Literal	2-18
	B:C Branch Address (Groups 0 and 1)	2-18
	B:C Local Memory Address	2-19

TABLE OF CONTENTS (cont)

SECTION	TITLE	PAGE
2 (cont)	B Address	2-19
	Register Address	2-19
	Scratchpad Memory Address (Group 2, 3 and 4).	2-20
	Word Register Byte Address	2-22
	Indirect Address (Groups 2, 3 and 4)	2-23
	Special Indirect Address	2-23
	B Address Used As Destination Address.	2-24
	C Field.	2-24
	Literal	2-24
	C Address	2-24
	Register Address	2-24
	Scratchpad Memory Address.	2-24
	Word Register Byte Address	2-24
	Indirect Address	2-25
	Fetch Cycle	2-25
	Instruction Fetch.	2-25
	Instruction Address.	2-25
	Fetch From Local Memory, Normal Sequence	2-26
	Fetch From Local Memory, After Branch	2-26
	Fetch From B 6500 Memory	2-26
	Actions Related To The Fetch Cycle	2-27
	Parity Check.	2-27
	Tag Check	2-27
	L Instruction Passed Over	2-27
	Transfer Of R Instruction	2-28
	Instruction Address Count Up.	2-28
	Fault Interrupts.	2-28

TABLE OF CONTENTS (cont)

SECTION	TITLE	PAGE
2 (cont)	Priority Among Faults	2-30
	Fault Instruction Execution	2-31
	Attention Needed Timer.	2-31
	Scan Bus	2-32
	Scan-Out Information Word	2-32
	Ready And Scan Access Obtained.	2-33
	Not Ready	2-33
	Invalid Scan Orders	2-33
	Initialize [000]	2-33
	Set Attention Needed [100]	2-34
	Halt [010]	2-34
3	INSTRUCTIONS.	3-1
	General.	3-1
	Unit Time	3-1
	Indirect Address.	3-1
	Main Memory Access.	3-1
	Adapter Write Timing Specification	3-1
	Undefined Operation Codes	3-2
	Undefined Addresses	3-2
	Invalid Instructions	3-3
	Instruction Format.	3-3
	Group 0 Instructions	3-3
	Idle.	3-3
	Adapter Write	3-4
	Adapter Interrogate	3-4
	Stop/Branch On Breakpoint	3-6
	Shift MA Right.	3-7
	Set System Interrupt.	3-8
	Set Cluster Mask Register	3-9
	Read Cluster Mask Register.	3-10
	Group 1 Instructions	3-10

TABLE OF CONTENTS (cont)

SECTION	TITLE	PAGE
3 (cont)	Adapter Read When Attention Needed.	3-10
	Adapter Read If Needed.	3-12
	Decrement Y, Branch if Y Is Zero.	3-12
	Decrement Y, Branch if Y Is Non-Zero.	3-13
	Branch If System Attention Needed	3-14
	Branch.	3-14
	Branch Relative With X.	3-15
	Branch Relative Indirect.	3-16
	Group 2 Instructions	3-17
	Move Half-word.	3-17
	Local Memory Read, Indirect Address	3-17
	Scratchpad Memory Read.	3-18
	Local Memory Read, Direct Address	3-19
	Local Memory Write, Indirect Address.	3-19
	Scratchpad Memory Write	3-20
	Local Memory Write, Direct Address.	3-20
	Main Memory Read.	3-21
	Main Memory Write Unconditional	3-22
	Main Memory Write-Read Unconditional.	3-22
	Main Memory Protected Write	3-23
	Main Memory Write-Read Protected.	3-24
	Group 3 Instructions	3-25
	Half-word Add	3-25
	Half-word Add, Literal In B	3-26
	Half-word Subtract.	3-26
	Half-word Subtract, Literal In B.	3-27
	Translate	3-27
	Parity.	3-28
	Group 4 Instructions	3-29
	Add	3-29
	Add, Literal in B	3-30

TABLE OF CONTENTS (cont)

SECTION	TITLE	PAGE
3 (cont)	Add, Literal In C	3-30
	Subtract	3-31
	Subtract, Literal In B	3-31
	Subtract, Literal In C	3-32
	Logical AND.	3-32
	Logical AND, Literal In B.	3-33
	Logical AND, Literal In C.	3-34
	Logical AND-OR MA, Literal In C.	3-34
	Logical OR	3-35
	Logical OR, Literal In B	3-36
	Logical OR, Literal In C	3-36
	Logical Exclusive OR	3-37
	Logical Exclusive OR, Literal In B	3-38
	Logical Exclusive OR, Literal In C	3-38
4	DCP DISPLAY PANEL AND MAINTENANCE AIDS	4-1
	General	4-1
	Display Panel.	4-1
	Display Mode	4-1
	Operating Mode	4-1
	Instruction Display	4-1
	Data Display.	4-3
	Tag Display	4-3
	Control Display	4-3
	OFF-LINE/ON-LINE Switch	4-4
	BIT SET Button.	4-5
	BIT RESET Button.	4-5
	CM REGISTER Button.	4-5
	CLEAR Button.	4-5
	HOLD P-L/OFF/STOP ON FAULT Switch	4-5
	STOP IMMED/STOP ON FETCH Switch	4-5

TABLE OF CONTENTS (cont)

SECTION	TITLE	PAGE
4 (cont)	Breakpoint Control	4-6
	STOP/OFF/BRANCH Switch	4-6
	PULSE Switch	4-7
	DISPLAY TYPE Switch	4-7
	P-R Position	4-7
	REG Position	4-7
	SM-L Position	4-7
	SM-R Position	4-7
	DISPLAY ADDRESS Switch	4-7
5	ADAPTER CLUSTERS	5-1
	General	5-1
	Character Codes And Message Formats	5-1
	Adapter Cluster Control Of The DCP	5-1
	Temporary Storage Capability Of The Adapter Cluster	5-3
	Organization Of The Adapter Cluster	5-3
	Cluster Interface	5-4
	Control Signals From DCP To Adapter Cluster	5-4
	Designate (DES)	5-4
	Cluster Write (CWR)	5-4
	Clear (CLR)	5-4
	Control Signals From Adapter Clusters to DCP	5-5
	Cluster Attention Needed (CAN)	5-5
	Access Granted (ACG)	5-5
	Hold (HLD)	5-5
	Information Signals	5-5
	Adapter Address (AAO-AA3)	5-5
	Adapter Control (ACO-AC4)	5-5
	Adapter Information (AIO - AI8)	5-5
	Registers	5-6

TABLE OF CONTENTS (cont)

SECTION	TITLE	PAGE
5 (cont)	Access Confirm Register (AC)	5-6
	Cluster Interface Register (CIR)	5-6
	CIR State (CS)	5-6
	Adapter Address (AD)	5-8
	Cluster Control (CC)	5-8
	Data or Control (DC)	5-8
	CIR Priority	5-8
	Crosspoint Register (XP)	5-8
	Buffers Associative Register (BAR)	5-9
	Character One (C1)	5-9
	Character Two (C2)	5-9
	Bit Timer (BT)	5-9
	Type (TY)	5-11
	State Counter (SC) and State Counter Auxiliary (SA)	5-13
	BAR Command (BC)	5-14
	Out of Service	5-14
	Look for CE	5-14
	Receive Ready	5-14
	Initiate Receive Mode	5-14
	Transmit Ready	5-15
	Initiate Transmit Mode	5-15
	Finish Transmit	5-15
	Break Transmit	5-15
	BAR Interrupt (BI)	5-15
	Idle	5-15
	Idle Buffer	5-15
	Three Seconds Not Ready (Receive)	5-17
	Break	5-17
	Disconnect	5-17
	CF-Off	5-17

TABLE OF CONTENTS (cont)

SECTION	TITLE	PAGE
5 (cont)	CC←Off.	5-18
	Byte Request Back Up.	5-18
	Three Second Not Ready (Transmit).	5-18
	CB←Off.	5-18
	Ring Indicator.	5-18
	Data Present.	5-18
	Byte Request.	5-18
	Receive Status.	5-18
	Input Character Time Out (ICTO).	5-18
	Stop Bit Error.	5-18
	Buffer Overflow	5-19
	30 Second Runaway	5-19
	Break Complete.	5-19
	Three Seconds No Sync	5-19
	Sync Fill	5-19
	SB←On	5-19
	Program Error	5-19
	ACR←On.	5-19
	COS + DLO←Off	5-19
	COS←On.	5-19
	PWI←Off	5-19
	VR Enable	5-20
	Buffer Empty.	5-20
	RDY←Off	5-20
	Control Timer (CT)	5-20
	Program Timer (PT)	5-20
	Input Register (IR)	5-21
	Output Register (OR).	5-21
	Read/Write Timer Register	5-21

TABLE OF CONTENTS (cont)

SECTION	TITLE	PAGE
5 (cont)	Scan Counter	5-21
	Real Time Counter	5-21
	Maintenance Register (MR).	5-21
	Cluster Memory.	5-21
	Control Functions	5-23
	Read/Write Control Section	5-23
	Adapter Switching Matrix	5-23
	Data And Instruction Formats.	5-23
	Data Formats	5-23
	Instruction Codes	5-25
	Write Instructions	5-25
	Interrogate Instructions	5-26
	Interrupt Instructions	5-27
	Data Present.	5-27
	BC/BI	5-27
	Byte Request.	5-28
	PT.	5-28
	Character Synchronization	5-28
	Serialization And Deserialization Of Data	5-28
	Character Formats On Communication Lines.	5-29
	Serial-By-Bit Character Formats.	5-29
	Start-Stop Six Unit Character	5-29
	Start-Stop 7.5 Unit Character	5-29
	Start-Stop Nine Unit Character.	5-29
	Start-Stop Ten Unit Character	5-29
	Start-Stop 11 Unit Character.	5-30
	Sync Pattern Nine-Bit Character	5-30
	Sync Pattern Eight-Bit Pattern.	5-30
	Sync Pattern Seven-Bit Character.	5-30
	Parallel-By-Bit Character Formats.	5-31
	Dialing Digit Bits (Output)	5-31

TABLE OF CONTENTS (cont)

SECTION	TITLE	PAGE
5 (cont)	Touch Tone Character 4 Bits (Input)	5-31
6	CLUSTER DISPLAY PANEL AND MAINTENANCE AIDS.	6-1
	General.	6-1
	Operation.	6-1
	Switches and Indicators.	6-1
	Switches AA7F Through AA4F.	6-1
	Switch-Indicators AA3F Through AAOF	6-1
	Switch-Indicators AC4F Through ACOF	6-1
	Switch-Indicators AI8F Through AIOF	6-2
	Master Clear Switch	6-2
	Bit Reset Switch.	6-2
	Action Switch	6-2
	NEUTRAL.	6-2
	RUN.	6-2
	STEP	6-2
	Operation Switch.	6-2
	INTERROGATE.	6-2
	WRITE.	6-2
	CAN.	6-2
	EXCHANGE	6-3
	LOCAL.	6-3
	Count Enable Switch	6-3
7	ADAPTERS.	7-1
	General.	7-1
	Modem Connect Adapters	7-1
	Direct Connect Adapters.	7-2
	Automatic Calling Unit Adapter	7-2
	Touch-Tone Adapter	7-3
	Audio Response Adapter	7-4

TABLE OF CONTENTS (cont)

SECTION	TITLE	PAGE
APPENDIX A -	TRANSLATION CHART EBCDIC TO USASCII	A-1
APPENDIX B -	TRANSLATION CHART EBCDIC TO BCL	B-1
APPENDIX C -	TRANSLATION CHART USASCII TO EBCDIC	C-1
APPENDIX D -	TRANSLATION CHART BCL TO EBCDIC	D-1
APPENDIX E -	INSTRUCTION LIST.	E-1
APPENDIX F -	INSTRUCTION DESCRIPTION CHART	F-1
APPENDIX G -	OPERAND SELECTION CHARTS.	G-1
APPENDIX H -	INSTRUCTION MATRIX CHART.	H-1
APPENDIX I -	CARRY FLIP-FLOP CHART	I-1
INDEX.		one

LIST OF ILLUSTRATIONS

FIGURE	TITLE	PAGE
1-1	B 6500 System Configuration Including Data Communications	1-2
1-2	B 6500 Data Communications Cabinet Type A.	1-4
2-1	DCP Block Diagram.	2-2
2-2	Basic Word Structure	2-3
2-3	Field Designation.	2-3
2-4	Byte Designation	2-4
2-5	Half-word Designation.	2-4
2-6	Matrix Representation.	2-12
2-7	B 6500 DCP Register Organization	2-14
2-8	Instruction Half-word Format	2-15
2-9	B:C Branch Address Format.	2-18
2-10	LM Direct Address Format	2-19
2-11	Register Address Formats	2-19
2-12	Scratchpad Word Selection.	2-21
2-13	Half-word and Byte Selection	2-21
2-14	Word Register Byte Addressing.	2-22
2-15	Indirect Address Format.	2-23
2-16	Instruction Word Address Format.	2-25
2-17	Fault Code in the Instruction Register	2-29
2-18	DCP Address/Function Code Format	2-32
4-1	DCP Display Panel.	4-2
5-1	Adapter Cluster Block Diagram.	5-2
5-2	Adapter Cluster Interface.	5-7
5-3	Buffers Associative Register (BAR)	5-10
5-4	Clock Generation Within The Cluster For Asynchronous Operation	5-22
5-5	EBCDIC Coded Data (Character).	5-24
5-6	USASCII Coded Data (Character)	5-24
5-7	BCL Coded Data (Character)	5-24

LIST OF ILLUSTRATIONS (cont)

FIGURE	TITLE	PAGE
5-8	BAUDOT Coded Data (Character)	5-24
5-9	PTT CODE/6 Coded Data (Character)	5-25
5-10	XS-3 Coded Data (Character)	5-25
5-11	Burroughs Numeric Coded Data (Character).	5-25
5-12	Six Unit Character.	5-29
5-13	7.5 Unit Character.	5-29
5-14	Nine Unit Character	5-29
5-15	Ten Unit Character.	5-30
5-16	11 Unit Character	5-30
5-17	Nine-bit Character Sync Pattern	5-30
5-18	Eight-bit Character Sync Pattern.	5-30
5-19	Seven-bit Character Sync Pattern.	5-31
6-1	Cluster Display Panel	6-3
7-1	Voice Response Unit Address Format.	7-4

LIST OF TABLES

TABLE	TITLE	PAGE
2-1	CF Flip-flop Designations	2-6
2-2	CF1 and CF0 Conditional Results	2-8
2-3	Hardware Half-word Functions.	2-12
2-4	Instruction Groups.	2-16
2-5	Group 4 A Field Addressing.	2-17
2-6	Fault Codes	2-30
3-1	Exceptions to Undefined Operation Codes	3-2
3-2	MA Concatenations	3-8
4-1	Register Display Selection.	4-8
5-1	CIR Current Status.	5-6

LIST OF TABLES (cont)

TABLE	TITLE	PAGE
5-2	Type Field Designations.	5-11
5-3	Touch-tone Attended Light Control.	5-12
5-4	Synchronous Specifications	5-12
5-5	Sync Editing	5-12
5-6	Asynchronous Specifications.	5-13
5-7	BAR Commands	5-14
5-8	BAR Interrupts	5-16
5-9	PT Time Periods.	5-20
5-10	Write Codes And Formats.	5-26
5-11	Interrogate Codes And Formats.	5-27
5-12	Interrupt Codes And Formats.	5-28

INTRODUCTION

The Burroughs Data Communications Processor (DCP) is the heart of the data communications network. Four of these processors may be connected to each I/O Multiplexor; with each processor able to communicate with up to 256 remote lines. The DCP is programmable and contains the necessary registers and circuits to carry on such communications functions as polling, identification of control codes and delimiters, and all other line-checking functions, independently of the main processor. The modular design of the data communications network allows each line to be adapted to serve virtually any data communications device. The programmable nature of the DCP also allows generalized adapters to be used so that any remote device by a given data set may be handled over one line.

Because the Burroughs B 6500 system is designed for continuous multiprocessing and time sharing, it readily accommodates applications and procedures requiring data communications; real-time operations, remote computing, remote inquiry, and on-line programing merely become additions to the multiprocessing mix.

This manual provides a hardware description of the Data Communications Processor, the Adapter Clusters and the Line Adapters that are used to configure a data communications network.

The software used with the DCP is covered in separate manuals which include:

Burroughs B 6500 Data Communications Functional Description.

Burroughs B 6500 Data Communications Network Definition
Language Reference Manual.

Burroughs B 6500 Data Communications Message Control System
Reference Manual.

SECTION 1

B 6500

DATA COMMUNICATIONS SYSTEM CONFIGURATION

GENERAL

The B 6500 Data Communications System consists of a combination of the following units:

- a. Data Communications Processor.
- b. Adapter Clusters.
- c. Line Adapters.

DATA COMMUNICATIONS PROCESSOR (DCP).

The Data Communications Processor (DCP) is a small special purpose computer that contains sufficient registers and logic to perform all basic functions associated with the sending and receiving of data. Up to four DCP's can be connected to an I/O Multiplexor, with each DCP capable of accommodating from one to 256 communications lines (figure 1-1). On a two-multiplexor system, this provides a B 6500 with the ability to service 2048 communications lines.

The DCP's gain access to main memory through the word interfaces on the I/O multiplexor. All the DCP's on a single multiplexor share that multiplexor's memory bus with the multiplexor. Only the multiplexor or one DCP can use this memory bus at a time, but this use is interleaved automatically to prevent any one of these devices from obtaining exclusive use of the memory bus.

ADAPTER CLUSTER.

The Adapter Cluster services a heterogeneous group of line adapters. Up to 16 Adapter Clusters can be connected to one Data Communications Processor. The same Adapter Cluster can be connected to two Data Communications Processors when it is desirable to have exchange facilities between the clusters and the DCP's.

As stated previously, the B 6500 Data Communications System can accommodate up to 2048 communications lines; however, when servicing this number of lines, the Adapter Cluster cannot be connected to

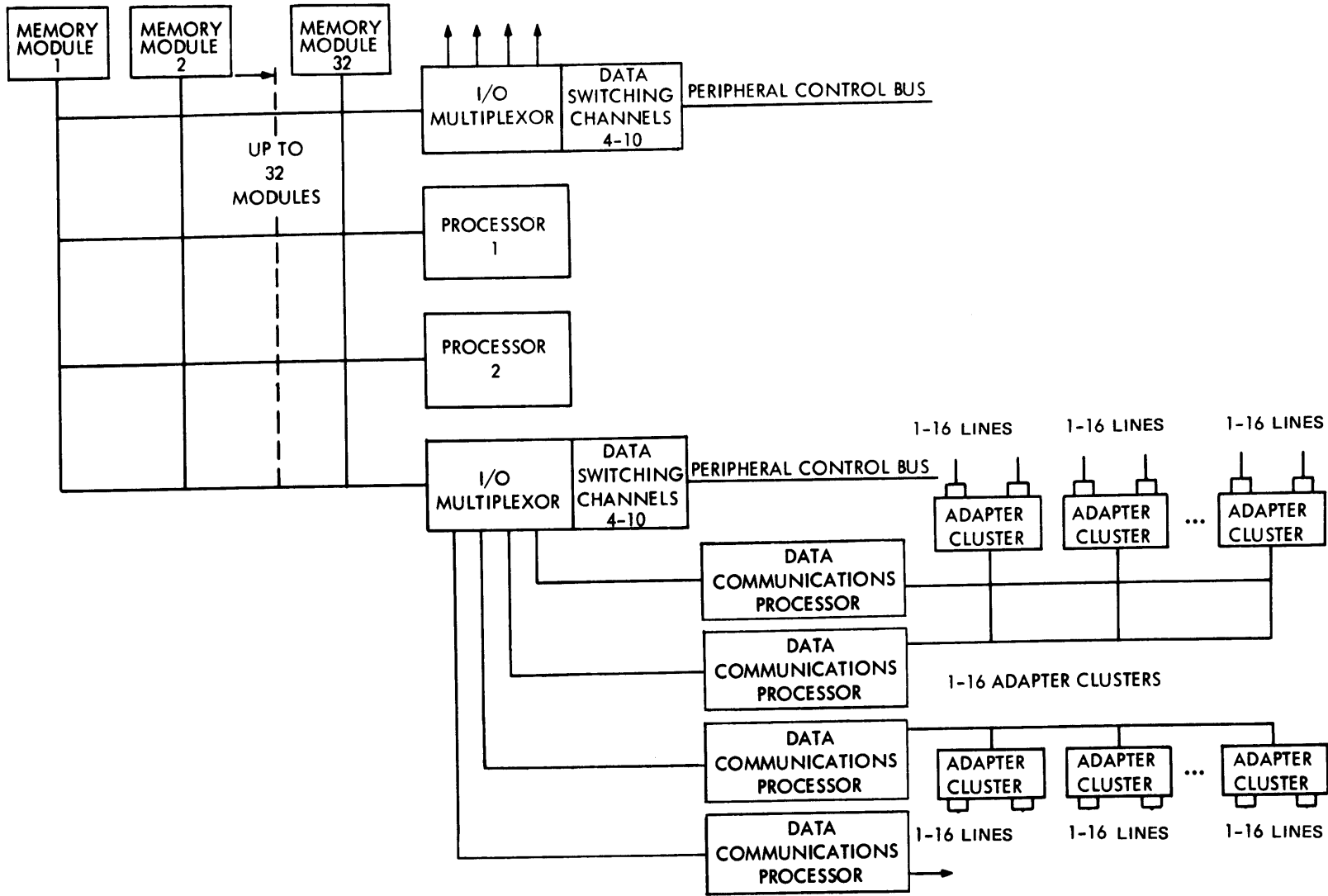

Figure 1-1. B 6500 System Configuration Including Data Communications

two DCP's.

LINE ADAPTERS.

Up to 16 line adapters can be placed in each Adapter Cluster. Each communications line requires one line adapter; some lines or terminals may require two, i.e., full duplex terminals.

Line adapters are available to interface to the following data sets (using the RS 232 interface), line types, or terminals:

WE 103A, 103F 108

WE 202G, 202D

WE 201A3, 201B

WE 801 A and C Series

WE 403E3/403D5

Direct connection to WE teletypes, Models 28, 33, 35, and 37

Direct connection to Burroughs units

The 16 line adapters are connected into the backplane of their associated Adapter Cluster.

OPERATION.

The DCP executes instructions residing in its optional local memory or in B 6500 main memory (MM). These instructions monitor the Adapter Clusters and the B 6500 Processors for required attention. They cause data, control requests, and information to be passed to and from both main memory and the Adapter Clusters.

These instructions are also used to set up to control information to tell the cluster what is to be done; i.e., write data, accept data, answer an incoming call, etc. This technique allows the DCP to handle the different line control disciplines, speeds, and character formats while requiring only a limited number of general adapter types. These different adapter types are primarily for the different electrical interfaces.

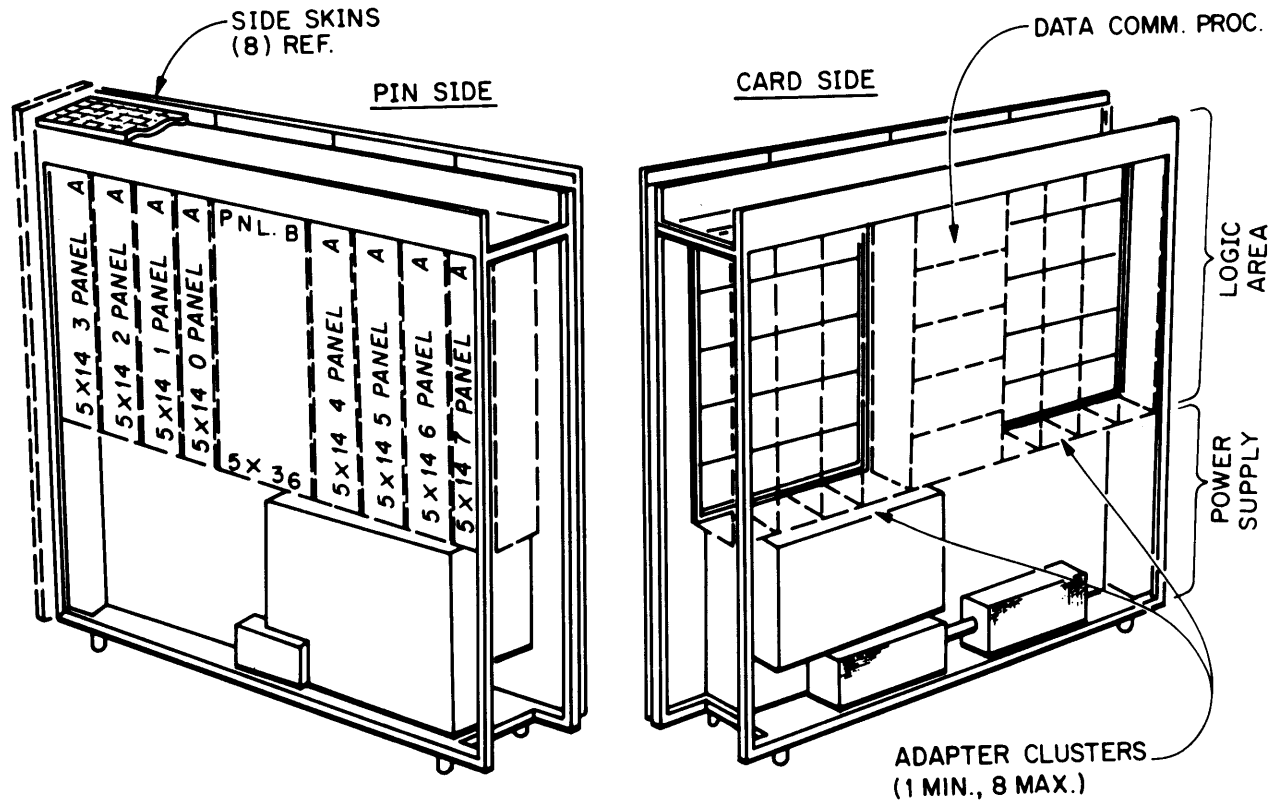

Figure 1-2. B 6500 Data Communications Cabinet Type A

DATA COMMUNICATIONS CABINET.

One Data Communications Processor and eight Adapter Clusters (each with 16 line adapters) can be installed in a Data Communications Cabinet (see figure 1-2).

When up to eight Adapter Clusters are connected to one Data Communications Processor, they must be in the same cabinet as the Data Communications Processor. If more than eight (up to 16) Adapter Clusters are connected to the same DCP, the additional ones must be in an adjoining cabinet.

If an Adapter Cluster is connected to two Data Communications Processors, the DCP's must be in adjoining cabinets with interconnection provided via the required control cable.

CLUSTER CABLE.

If four or fewer Adapter Clusters are connected to a Data Communications Processor, they can be connected individually with separate cables.

If more than four Adapter Clusters are connected to a Data Communications Processor, the Adapter Clusters must be placed in adjacent groups of four. Each group of four is connected to the Data Communications Processor by one special interconnecting cable (five connectors on each cable).

NOTE

The DCP has provisions
for four (4) cables.

CLUSTER EXCHANGE.

The Cluster Exchange connects each Adapter Cluster to the two Data Communications Processors. The circuitry of the Cluster Exchange is included in the Adapter Cluster, but the crosspoint control for the exchange is within the DCP's.

NOTE

The Adapter Cluster has provision for two (2) cables (one each to connect to a DCP).

DATA COMMUNICATIONS PROCESSOR OPTIONAL LOCAL MEMORY.

The Data Communications Processor can utilize an optional local memory (LM). The optional local memory is intended for instruction and control information storage. Its use permits higher system performance, i.e., larger throughput and faster response.

SECTION 2
B 6500
DATA COMMUNICATIONS PROCESSOR

GENERAL.

The Data Communications Processor (DCP) is an auxiliary processor which controls the Adapter Cluster for answering and terminating calls, observing formal line procedures, polling repetitiously, and handling all the line discipline message formatting for the information received and transmitted on many communication lines.

A DCP has access to the B 6500 main memory along with the other main frame units, such as the B 6500 Processor and the B 6500 Peripheral Control Multiplexor. Main memory allocation for the DCP is controlled by the interaction of the B 6500 Master Control Program and the DCP programs. The interaction also allows blocks of information to be exchanged.

The DCP code may reside in B 6500 main memory or in optional local memory. The use of the local memory reduces instruction fetch time and correspondingly increases the DCP throughput .

The DCP contains a small array of intercommunicating registers, a simple arithmetic-logical unit, an eight-word scratchpad memory, and possibly an optional local memory. It is designed to be micro-programed. The instruction repertoire consists largely of two and three-address instructions, operating on eight-bit bytes and executed in a single clock time. The byte organization fits into a basic half-word (three-byte) structure which permits efficient half-word transfers within the DCP along with byte transfers. Figure 2-1 is a block diagram of the Data Communications Processor.

NOMENCLATURE.

BIT NUMBERING.

The bits in a 52-bit word are numbered 0 through 51 from right to left (figure 2-2). Bit 0 is the least significant bit. Bit 47 is

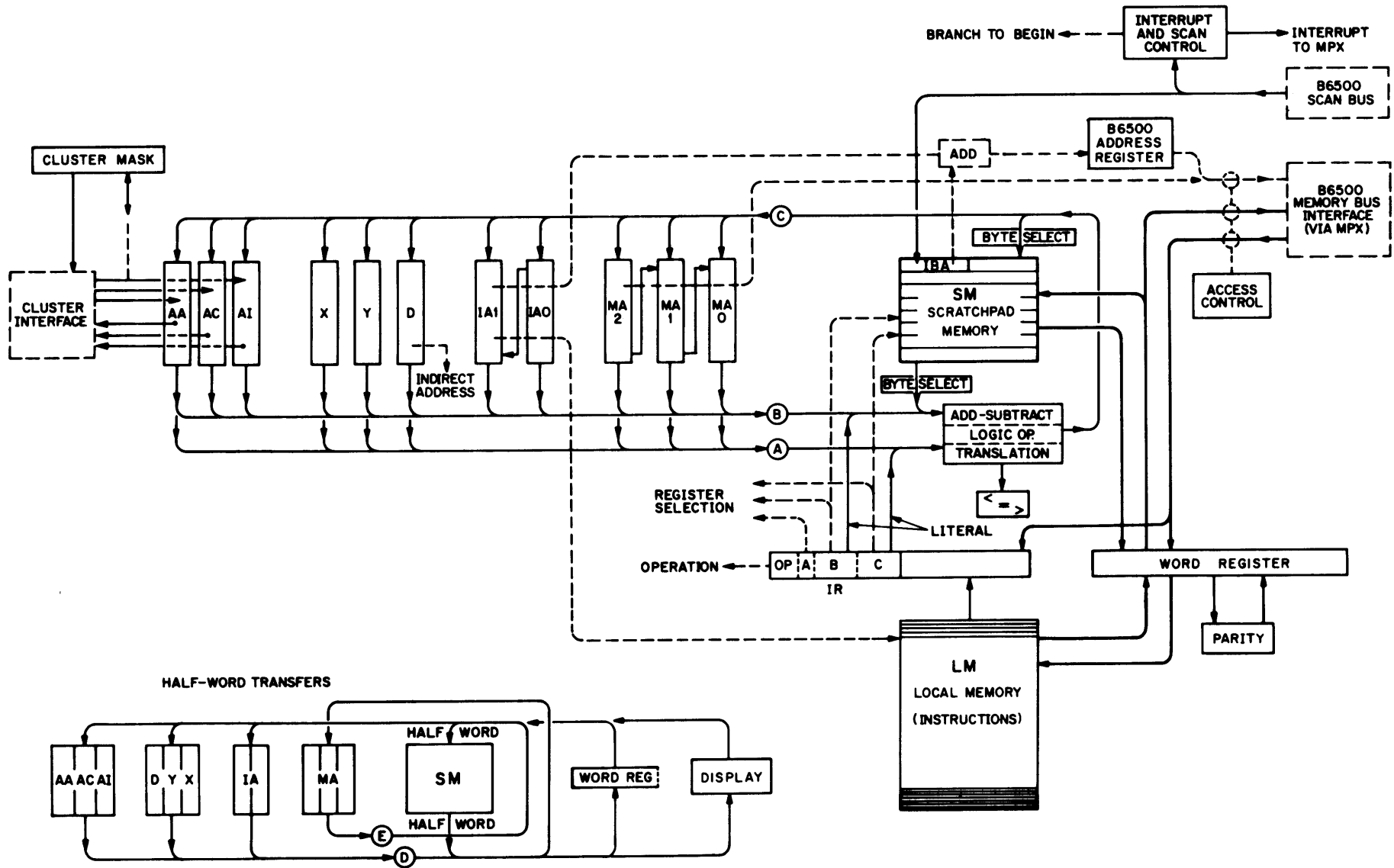

Figure 2-1. DCP Block Diagram

the most significant bit of the information part of the word. Bits 48, 49 and 50 are tag bits. Bit 51 is a parity bit (odd parity).

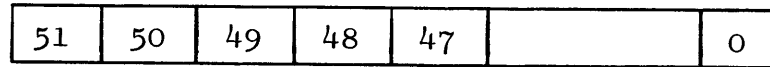

Figure 2-2. Basic Word Structure

In general, the bits of an n-bit register or byte are numbered 0 through n-1; bit 0 is the least significant bit, and bit n-1 is the most significant bit.

DESIGNATION OF FIELDS.

A particular field in a register R is identified by using the nomenclature R [m:n], where m donotes the starting bit position of a field extending n bits to the right. R may also be the OP field of a register or a register column (figure 2-3).

Example:

AC [4:2] identifies a two-bit field in the AC register consisting of bits 4 and 3.

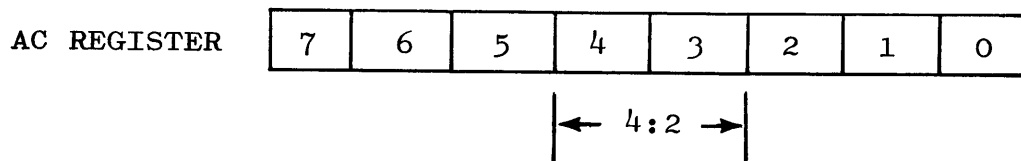

Figure 2-3. Field Designation

DESIGNATION OF SINGLE BITS.

A particular bit in a register R is identified by using the nomenclature R_n, where n donotes the desired bit. R may also be a field within a register such as the OP field or a register column such as the A register column.

Example:

AC₄ identifies bit 4 in the AC register.

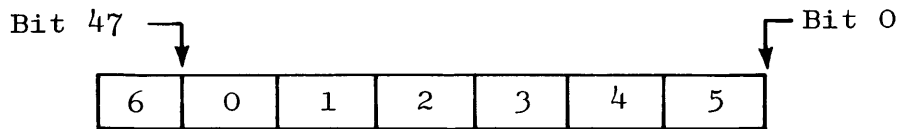

Figure 2-4. Byte Designation

BYTE DESIGNATION.

The 48-bit information part of the 52-bit word is divided into six, 8-bit bytes. The byte designations are 0 through 5 from left to right. The designation matches the normal sequence of serial-by-character input or output; high-order character first, or left to right across a line. If each byte contained a digit or a number, the high-order digit would be in byte 0 and the low-order digit would be in byte 5. This is illustrated in figure 2-4; note that the tag field, if present, is designated as byte 6 although it contains only four bits. The nomenclature is r-b, where r is a word or register and b is a byte number.

Example:

W-2 identifies byte 2 of the W register.

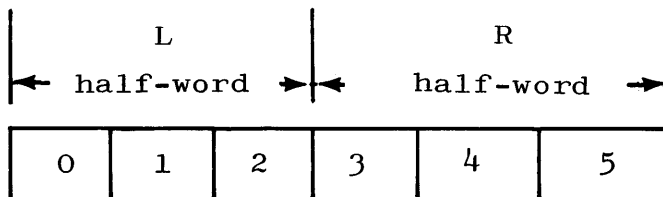

Figure 2-5. Half-word Designation

HALF-WORD DESIGNATION.

The left half-word, consisting of bytes 0, 1 and 2 is referred to as half-word L. The right half-word, consisting of bytes 3, 4 and 5 is referred to as half-word R. The nomenclature is r-h, where r is a word or register and h is the half-word designator, L or R (figure 2-5).

Example:

W-L identifies bytes 0, 1 and 2 of the W register.

ADAPTER CLUSTER INTERFACE REGISTERS.

All information, data, or control signals transferred between the Adapter Cluster and the DCP passes through these registers.

ADAPTER ADDRESS REGISTER (AA).

This eight-bit register has designations AA [7:8] and A [23:8]. The AA register contains an adapter designation. An adapter is actively designated only during the execution of an Adapter Read, Adapter Write, or Adapter Interrogate instruction. When the Adapter Cluster is used, AA [7:4] contains the cluster number and AA [3:4] contains the adapter number within the cluster.

ADAPTER CONTROL REGISTER (AC).

This eight-bit register has designations AC [7:8] or A [15:8]. The AC register contains bits which typically describe the information on the adapter interface. For example, a particular code in the AC register may signify that the AI register contains a data byte, whereas other codes may identify the AI register contents as control information of various types. Only five bits, AC [4:5], are defined for the Adapter Cluster.

ADAPTER INFORMATION REGISTER (AI).

This eight-bit plus separate parity bit (I21) has designations AI [7:8], or A [7:8] plus I21. AI is the primary information register for the adapter interface. It can contain data or control information.

GENERAL PURPOSE REGISTERS.

D REGISTER.

This eight-bit register has designations D [7:8] or G [23:8]. The D register is an indirect address register that can address other registers or local memory bytes. Otherwise, its use is unrestricted as a general purpose register.

Y REGISTER.

This eight-bit register has designations Y [7:8] or G [15:8]. The Y register contains an indirect source address when one is called for, but it is not used as an address register. When an indirect source address is used, the contents of the Y register are copied in the Instruction register. Otherwise, its use is unrestricted as a general purpose register.

X REGISTER.

This eight-bit register has designations X [7:8] or G [7:8]. The X register is referenced in the Branch Relative instruction. Otherwise, its use is unrestricted as a general purpose register.

COMPARISON REGISTER (CF).

This eight-bit register has designations I [23:8]; compare bits CF1 and CF0, or I [17:2]. The CF register contains eight special control flip-flops. The register is addressable, but in general, the flip-flops should not be programmatically controlled because it inhibits their extraordinary inputs.

Table 2-1

CF Flip-Flop Designations

Bit Position	Flip-Flop Designation	Special Function
0	I16 (CF0)	Carry flip-flop. Controlled by the carry/borrow signal from the arithmetic unit (when it is used). Cleared when a branch occurs or by a Shift MA.
1	I17 (CF1)	Zero-result flip-flop. Controlled by the result = zero signal from

Table 2-1 (cont)

CF Flip-Flop Designations

Bit Position	Flip-Flop Designation	Special Function
1	I17 (CF1) (cont)	the arithmetic unit (when it is used). Cleared when a branch occurs or by a Shift MA.
2	I18	Internal Carry flip-flop. Used in place of I16 (CFO) during the IA + IBA addition preceding a MM fetch and also during a Half-word Add or Subtract. Otherwise zero.
3	I19	Fault Control flip-flop. Set when the special fault instruction is executed. If I19 = 1, the fault interrupt action is modified.
4	I20	IA Counted flip-flop. Set when the address is counted up normally; otherwise cleared when the instruction is completed.
5	I21	AI parity bit. Controlled by the AI8 signal from the cluster interface and by the Parity instruction.
6	I22	MM interlock flip-flop. Must be zero. (If a MM access is separately buffered, I22 = 1 defeats the "wait" which occurs when the MA or W register is addressed before the access is completed).

Table 2-1 (cont)

CF Flip-Flop Designations

Bit Position	Flip-Flop Designation	Special Function
7	I23	Main System Attention Needed flip-flop. Set by the scan-out of Set Attention Needed. Cleared when it causes a branch in the instructions which explicitly test it.

The CF1 and CF0 flip-flops are set by the result of arithmetic and logical instructions to denote the conditions listed in table 2-2 which control the conditional branches.

Table 2-2

CF1 and CF0 Conditional Results

CF1	CF0	Compare Condition	Other Significance
0	0	>	Cleared state
0	1	<	Carry or borrow
1	0	=	Zero result
1	1		Carry and zero result (unlikely)

MEMORY ADDRESS REGISTERS.

MEMORY ADDRESS REGISTERS (MA-2, MA-1, and MA-0).

The three, 8-bit registers have designations MA-2 [7:8], MA-1 [7:8], MA-0 [7:8]; or M [23:24]. These registers are used for addressing B 6500 main memory and the DCP local memory. The 20-bit B 6500 main memory address excludes MA-2 [7:4]; the maximum 14-bit DCP local memory excludes MA-2 and MA-1 [7:2].

The MA registers are always used in half-word transfers and may be used in full-word transfer operations. The MA registers receive a half-word selected from a variety of sources (on the D bus), and simultaneously becomes the source of a half-word that is sent to one of several destinations (on the E bus). The MA-2, MA-1 and MA-0 registers are used implicitly in the Half-word Add and Subtract instructions.

These registers may be concatenated in various ways by the Shift Right MA instructions in which their contents are shifted right. The MA registers may also be used individually as general purpose registers.

INSTRUCTION ADDRESS REGISTERS.

The two, 8-bit registers have designations IA-1 [7:8] and IA-0 [7:8]; or I [15:16]. The concatenated IA registers hold the instruction address to address the DCP local memory directly or provide the relative part of an address for the B 6500 main memory. The most significant bit, IA-1 [7:1] or I15, selects the proper memory for this address:

- a. I15 = 0 IA has a relative address for the B 6500 main memory.
- b. I15 = 1 IA has a direct address for the DCP local memory.

The least significant bit, IA-0 [0:1] or I00, selects one of the two half-word instructions in a full instruction word.

The IA registers are counted up automatically as each instruction is loaded. They are loaded by the branch instructions, and may also be addressed like the other registers. If an IA is addressed as a designation, a new instruction fetch occurs after the current instruction is completed.

B 6500 ADDRESS REGISTER (BA).

This 20-bit register has a designation BA [19:20]. The B 6500 address register contains the actual instruction address for the

instruction words in B 6500 main memory. The actual address is the sum of the relative address in the IA register and the instruction base address. The B 6500 address register is not addressable. When a B 6500 memory access is required, the register is loaded either from the MA register, or indirectly from the IA registers.

FULL WORD REGISTERS.

INSTRUCTION REGISTER (IR).

This 52-bit register has designations IR [51:52] or P [51:52]; P-L denotes P [47:24] and P-R denotes P [23:24]. The Instruction register holds a full instruction word containing two, 24-bit instruction words. It is loaded from either the DCP local memory or the B 6500 main memory. The tag field, P [51:4], must have a correct odd parity bit in P [51:1] and P [50:3] must contain a six.

P-L is the active half of the IR in that instructions are executed only from P-L. The second instruction is transferred from P-R to P-L for execution.

WORD REGISTER (W).

This 52-bit register has a W [51:52] designation; W-L denotes W [47:24] and W-R denotes W [23:24]. It is a data buffer used for transferring full words to or from the scratchpad memory, the DCP local memory, and the B 6500 main memory. The parity bit in W [51:1] is automatically generated and checked.

The W register is divided into six individually-addressable, eight-bit registers plus a four-bit tag register. W-L and W-R may also be addressed as separate half-word register columns.

NOTE

The contents of the other registers (except P) can be transferred to the Word register and they can be loaded from it.

CLUSTER MASK REGISTER.

This register contains 16 independent flip-flops, one for each of the 16 possible Adapter Clusters. Each flip-flop in this register gates the corresponding cluster attention needed signal when it is on. If a Cluster Mask flip-flop is off, the DCP does not detect a cluster attention needed signal from that Adapter Cluster. In systems where an Adapter Cluster is connected to two DCP's, the corresponding Cluster Mask flip-flops in each DCP should be loaded so that only one DCP responds to a cluster attention needed signal.

This register is loaded with the Set Cluster Mask instruction.

MEMORIES.

SCRATCHPAD MEMORY (SM).

The scratchpad memory is an integrated circuit memory which contains eight, 52-bit words. Information can be read out or stored in full words, 24-bit half-words, or individual eight-bit bytes. Read and write are independent and can occur simultaneously in different locations. Read-out is non-destructive.

Read access time is 40 nanoseconds. Write access time is 50 nanoseconds including clock pulse. Access times do not include the address decoding time.

NOTE

The information in SM is
lost if power goes down.

SM is used for fast-access, temporary, data storage. The SM locations are like flip-flop registers except that the same location cannot be used both as a source and a destination when the result is a complementary function of the source operand. If the same byte is improperly addressed both as a source and destination, an invalid operator fault interrupt occurs.

RESERVED LOCATIONS. Table 2-3 defines the half-words that are used in hardware functions. The number within the parenthesis and following SM is the word address.

Table 2-3
Hardware Half-word Functions

Half-word	Use
SM (0)-L	Instruction base address
SM (0)-R	Fault interrupt, Branch on Breakpoint, Initialize
SM (1)-R	Fault interrupt

LOCAL MEMORY (LM).

Local memory is a 52-bit word memory used for instruction or data storage. Its use optimizes instruction fetch time and data fetch time. It is available in 4096 word modules which require the space of an Adapter Cluster in the DCP cabinet. One DCP may have as many as four of these memory modules. The cycle time for this memory is 650 nanoseconds.

BASIC HALF-WORD AND BYTE ORGANIZATION.

The data registers and scratchpad memory half-words are organized in a matrix that is illustrated in figure 2-6.

	A	G	I	M	SM-L	SM-R	W-L	W-R	
ROWS	2	AA	D	CF	MA-2	0	3	0	3
	1	AC	Y	IA-1	MA-1	1	4	1	4
	0	AI	X	IA-0	MA-0	2	5	2	5

Figure 2-6. Matrix Representation

The registers are interconnected along the rows by busses. The principal busses are two half-word busses named the D bus and the E bus. Each bus consists of three, 8-bit sections; one section for each row.

D BUS.

The D bus is a multiple source bus with three destinations. Any of the register columns or SM half-words can be chosen as its source. It is not necessary to select all of the registers in the column;

if there is no source for a section of the bus, the section carries zeros.

The destination of the D bus may be the MA register column, the W-L column, or the B bus.

E BUS.

The E bus has three sources and many destinations. The source depends upon the instruction being executed. The information on the E bus can come from the MA register column, the W-L column or the C bus.

Any of the register columns or SM half-words can be chosen as the destination of the E bus. However, not all registers in a column need be selected; if no destination is specified for a section of the E bus, no information is stored.

FULL WORD TRANSFER.

Full word transfers between the W register and a selected SM word location are made possible by separate busses which are used in addition to the D and E busses. The separate busses interconnect the R half-words including the tag field.

ARITHMETIC, LOGICAL, AND TRANSLATION SECTION.

FUNCTIONS.

The DCP performs the following arithmetic, logical, and translation functions on 8-bit bytes:

- a. Add.
- b. Subtract.
- c. Logical AND.
- d. Logical OR.
- e. Exclusive OR.
- f. Parity
- g. Translations (EBCDIC to USASCII or BCL, and USASCII or BCL to EBCDIC).

C = BUS IDENTIFICATION

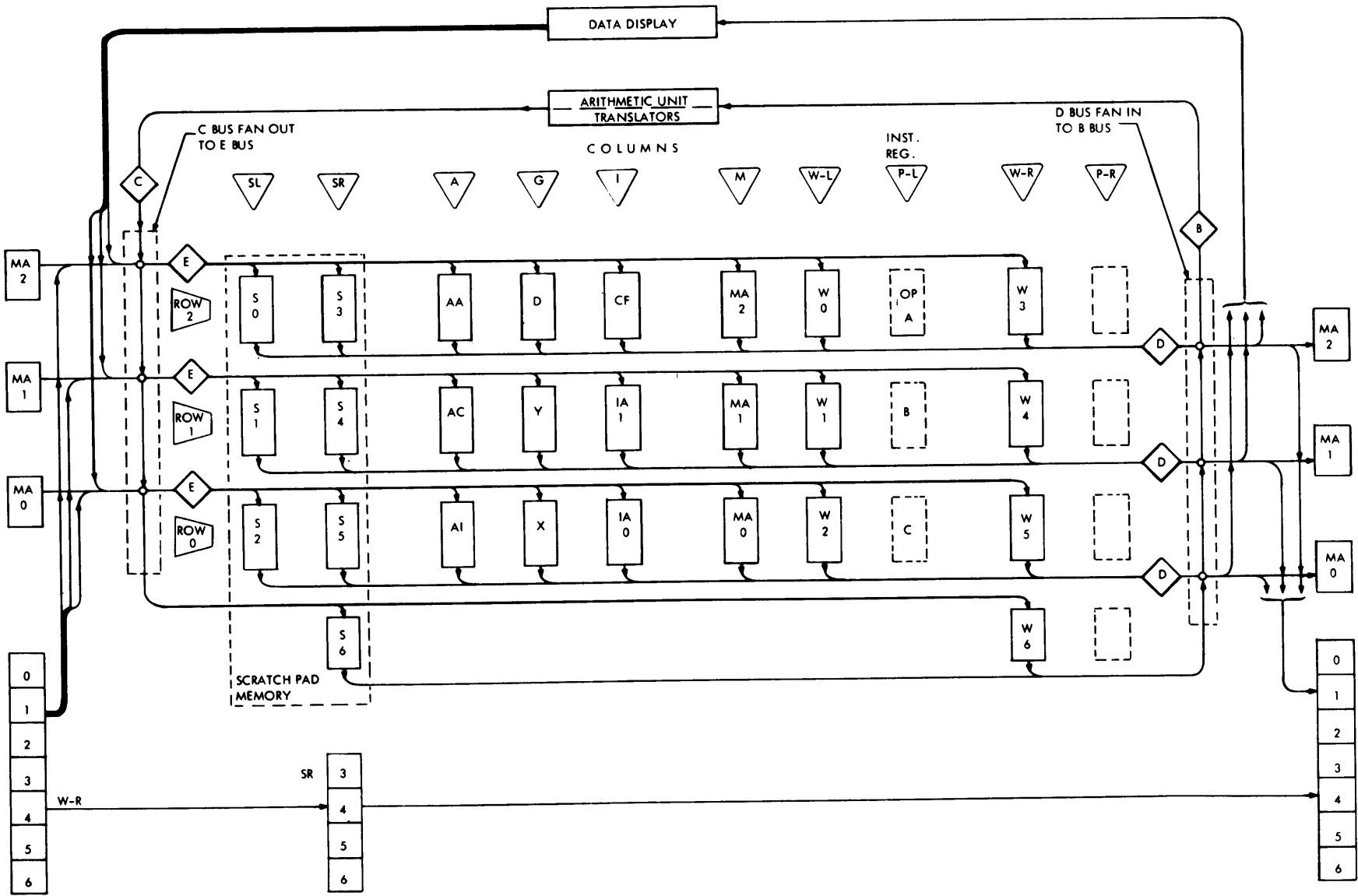

Figure 2-7. B 6500 DCP Register Organization.

The section containing the functional circuitry appears as a block with two input busses and one output bus. Each bus has an eight-bit (one byte) capacity. The input busses are named the A bus and the B bus. The output bus is named the C bus (figure 2-7).

A BUS.

The A bus is a multiple source bus. One of seven registers can be selected as the source: AA, D, Y, MA-2, MA-1, X, and MA-0. If a register is not selected, the A bus carries zeros.

B BUS.

The B bus is the logical OR of the three sections of the D bus. For normal byte operations, only one register should be selected as the source of the D bus.

C BUS.

For byte operations, the C bus becomes the source for each section of the E bus. The other sources of the E bus are gated off. For normal byte operations, only one register should be selected as the destination of the E bus.

INSTRUCTION FORMAT.

The 52-bit, full-word instruction is loaded into the Instruction register on a fetch cycle. The instruction word contains two, 24-bit instructions, must have odd parity, and contain a tag field of $IR [50:3] = 6$. If these conditions are not met, the instruction word is detected as invalid and the instructions in it are not executed.

INSTRUCTION HALF-WORD.

The 24-bit instruction half-word is divided into four fields as follows:

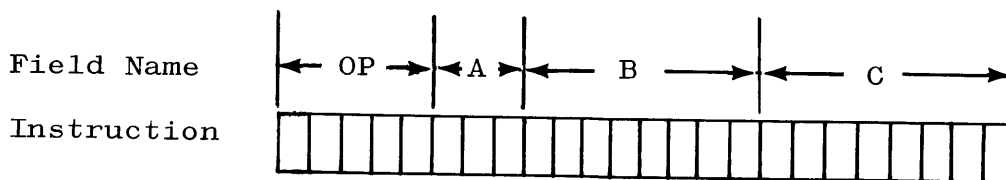

Figure 2-8. Instruction Half-Word Format

The OP field contains the basic instruction code.

The A field may be an extension of the OP field, or it may contain a register address.

The B field typically contains the address of the source. It may also contain a literal.

The C field typically contains the address of a destination. It may also contain a literal.

OP FIELD.

The OP field contains the basic instruction code. The actual instructions are chosen in a pattern that allows the instructions to be divided readily into five groups. The manner in which the other fields of an instruction are interpreted depends on the group the instruction is in (table 2-4).

Table 2-4
Instruction Groups

Group	Op Codes	Description
0	0 0 0 - -	Various instructions that do not contain addresses (exception: branch address in Breakpoint).
1	0 0 1 - -	Instructions in which the B:C fields contain only a branch address.
2	0 1 0 - -	Instructions which move half-words and load or unload the Word register.
3	0 1 1 - -	One-operand byte conversion instructions and special half-word instructions.
4	1 - - - -	Two-operand arithmetic and logical byte instructions.

A FIELD.

For instructions not in Group 4, the A field is an extension of the OP field. Typically the A field specifies variants of the basic instruction. For the instruction in Group 4, the A field contains a register address as shown in table 2-5.

Table 2-5
Group 4 A Field Addressing

A field			Instruction is not "literal in C field"	Instruction is "literal in C field"
			Register selected as source	Register selected as destination
A2	A1	AO		
0	0	0	None (data = zeros)	None (no data stored)
0	0	1	AA	Indirect (The B field selects both the source and the destination)
0	1	0	X	X
0	1	1	Y	Y
1	0	0	D	D
1	0	1	MA0	MA0
1	1	0	MA1	MA1
1	1	1	MA2	MA2

B FIELD.

The B field can contain any of the following items:

- a. Literal.
- b. B:C branch address.
- c. B:C local memory address.
- d. Register address.
- e. Scratchpad memory address.
- f. Word register byte address.
- g. Indirect address designation.

LITERAL. The B field contains a literal in most group 0 instructions and in the group 3 and 4 instructions that specify a literal in the B field. The function or use of the literal depends on the instruction.

B:C BRANCH ADDRESS (GROUPS 0 AND 1). The B field is concatenated with the C field and together they contain a branch instruction address.

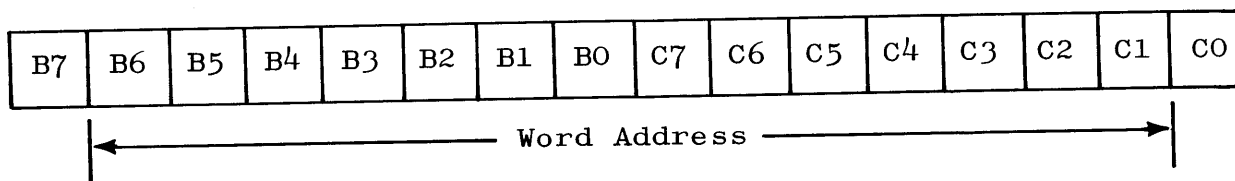

Figure 2-9. B:C Branch Address Format

B [7:1] contains the instruction source bit as shown below:

B7 = 0 Branch to MM
 = 1 Branch to LM

C [0:1] controls the half-word selection as follows:

C0 = 0 Branch to half-word-L
 = 1 Branch to half-word-R

The B field is transferred to the IA-1 register and the C field is transferred to the IA-0 register. When the branch is taken, a new instruction fetch cycle is initiated (see fetch cycle).

Applicable Instructions:

BKP	DBYZ	GOTO
ARWN	DBYN	GOX
ARIN	BRAN	GOI

B:C LOCAL MEMORY ADDRESS. In the "local memory direct address" instructions in group 2, the B field is concatenated with the C field and together they contain a local memory data address.

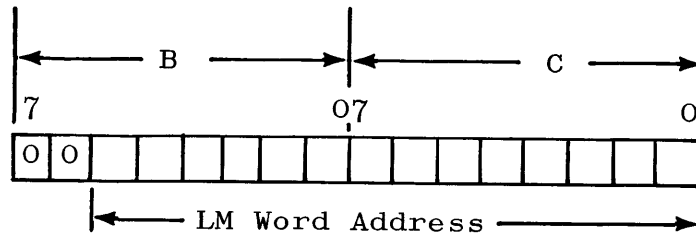

Figure 2-10. LM Direct Address Format

B [7:2] should contain 00. When used, the direct LM address in the B:C field is transferred to the MA1:MA0 registers.

Applicable instructions:

LMRD LMWD

B ADDRESS. The B field by itself contains an address in group 2 instructions (except the "local memory direct address" instructions) and in group 3 and 4 instructions that do not specify a literal in the B field. The B address is usually the address of a source.

The source data bits are all zeros if the B address does not select a location.

Register Address.

The methods used for obtaining a byte operand or a half-word operand when given an eight-bit address are defined below: The following descriptions all refer to the B field.

A register address is identified by B [7:2] = 0. B [5:3] contains a register column address and B [2:3] contains row selection bits (figure 2-11).

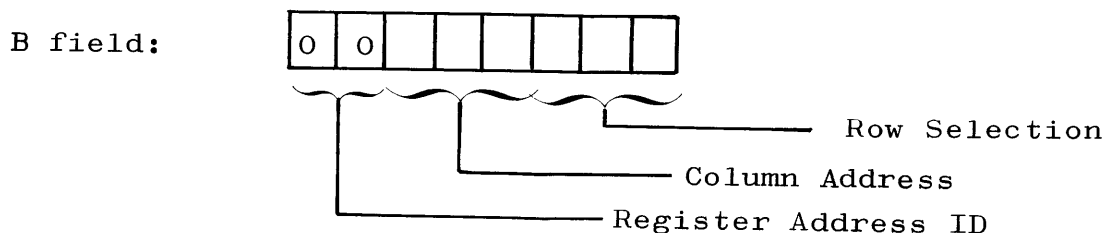

Figure 2-11. Register Address Formats

B [5:3]	B2 = 1	B1 = 1	B0 = 1
000	none*	none*	none*
001	AA	AC	AI
010	D	Y	X
011	MA-2	MA-1	MA-0
100	CF	IA-1	IA-0
101	W-0	W-1	W-2
110	W-3	W-4	W-5
111	reserved	reserved	reserved

* If source then zeros

Figure 2-11 (cont). Register Address Formats

The row select bits are specified independently. One, two, or three registers in the same column can be selected simultaneously. All registers in a column are selected if B [2:3] = 111. If a row select bit is 0, the data bits from that row are all zeros. No register is selected if B [2:3] = 000.

NOTE

In the Half-word Add and Half-word Subtract instructions, B [2:3] should contain 000; the rows are internally selected in order.

For the byte instructions in groups 3 and 4, only one register would normally be selected. If more than one register is selected in a register column, the data in the corresponding positions in the different rows is logically ORed.

Scratchpad Memory Address (Groups 2, 3 and 4).

B [7:2] = 10 identifies a scratchpad memory address. B [5:3] contains a scratchpad word address and B [2:3] contains a half-word selection bit or a byte designation.

B field:

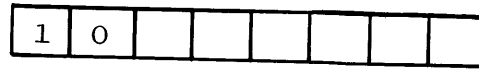

Half-word Selection

SP Word Address

SP Memory ID

Code			Scratchpad Memory Word
B5	B4	B3	
0	0	0	0
0	0	1	1
0	1	0	2
0	1	1	3
1	0	0	4
1	0	1	5
1	1	0	6
1	1	1	7

Figure 2-12. Scratchpad Word Selection

Code			Group 2 Half-word Selected	Group 3 Half-word Selected	Group 3 or Group 4 Byte Selected
B2	B1	B0			
0	0	0	L	L	None
0	0	1	L	X	0
0	1	0	L	X	1
0	1	1	L	X	2
1	0	0	R	R	3
1	0	1	R	X	4
1	1	0	R	X	5
1	1	1	R	X	6 (Tag field)

X = Improper Code

Figure 2-13. Half-word and Byte Selection

In group 2 instructions, B [2:1] contains the half-word selection bit and the B [1:2] bits are not significant. B [2:1] should be zero in the instructions that address a scratchpad full word.

In the Half-word Add and Half-word Subtract instructions in group 3, B [1:2] should contain 00. In the other group 3 instructions, B [2:3] contains a byte designation as in group 4 instructions.

NOTE

If B designates both a source and a destination, the result of the instruction must not depend on the source.

Word Register Byte Address.

In group 4 instructions and in the Translate and Parity instructions in group 3, the B address can address the bytes in the Word register as if it were a scratchpad memory word. This mode of addressing augments the addressing of the Word register as two columns, and it is the only way to address the Word register tag field. A Word register byte address is identified by B [7:2] = 11, and B [5:3] must contain 111. B [2:3] contains the single byte designation.

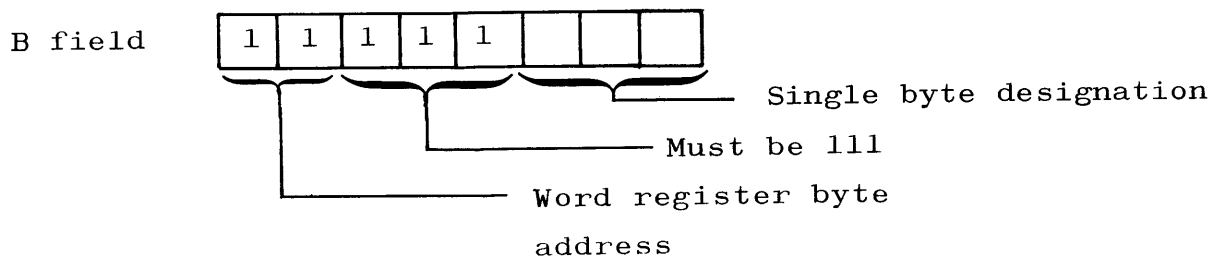

Code			Word Register Byte Selected
B2	B1	B0	
0	0	0	None
0	0	1	1
0	1	0	2
0	1	1	3
1	0	0	4
1	0	1	5
1	1	0	6
1	1	1	7

Figure 2-14. Word Register Byte Addressing

NOTE

Although not disabled, Word register byte addressing should not be used for instructions in group 2 or for other instructions in group 3.

Applicable instructions:

MOVE	MMWP	ADD	LANC
LMRI	MWRP	ADDB	LOAM
SMRD	HAD	ADDC	LOR
LMWI	HADB	SUB	LORB
SMWD	HSB	SUBB	LORC
MMR	HSBB	SUBC	LEO
MMVW	TRAN	LAN	LEOB
MMWR	PARY	LANB	LEOC

Indirect Address (Groups 2, 3, and 4).

B [7:2] = 01 specifies an indirect address.

The contents of the Y register are used as the B address. B [5:6] must be 000000.

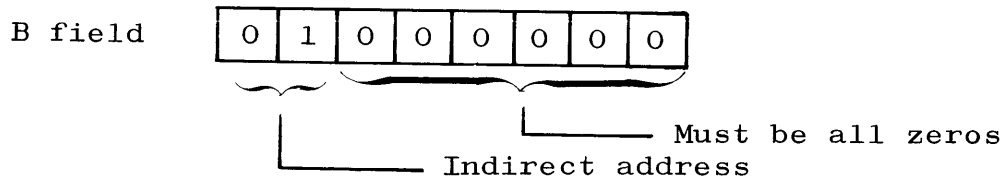

Figure 2-15. Indirect Address Format

The address format in the Y register is the same as the address format in the B field, except that Y [7:2] must not be 01.

An indirect address designation in the B address increases the execution time of an instruction by one unit.

Special Indirect Address.

In the Shift MA and Set B 6500 Interrupt instructions in group 0, the B field normally contains a literal with B [7:2] = 00. If B [7:2] = 01 in these instructions, the contents of the Y register are used as the B field literal. The indirect literal designation increases the instruction execution time by one unit.

B Address Used As Destination Address.

In group 4 instructions that specify a literal in the C field and in which the A field contains 001, the B address is used as a destination address as well as a source address. The same location is addressed both as a source and as a destination.

C FIELD.

The C field can contain the same items as the B field.

LITERAL. The C field contains a literal in most group 0 instructions and in the group 4 instructions that specify a literal in the C field. The function or use of the literal code depends on the instruction.

C ADDRESS. The C field by itself contains an address in group 2 instructions (except the local memory direct address instructions), the group 3 instructions, and the group 4 instructions that do not specify a literal in the C field. The C address is always the address of a destination.

If the C address does not select a location, information is not stored.

Register Address.

A register address is identified by $C [7:2] = 00$. Only the registers designated by a row select bit = 1 receive information in the addressed register column. See Register Address on page 2-19.

Scratchpad Memory Address.

A scratchpad memory address is identified by $C [7:2] = 10$. The use of the other bits is the same as Scratchpad Memory Address on page 2-20.

Word Register Byte Address.

A Word register byte address is identified by $C [7:2] = 11$, and $C [5:3]$ must contain 111. The use of the other bits is the same as the Word Register Byte Address on page 2-22.

Indirect Address.

An indirect address is identified by $C [7:2] = 01$. If $C [7:2] = 01$, the contents of the D register are used as the C address. $C [5:6]$ must be 000000.

The address format in the D register is the same as the address format in the C field, except that $D [7:2]$ must not be 01. An indirect address designation in the C address does not increase the instruction execution time.

FETCH CYCLE.

INSTRUCTION FETCH.

The fetch cycle loads a full instruction word into the Instruction register, either from local memory or from B 6500 memory. The instruction words are addressed by the IA registers.

A full instruction word contains two separate half-word instructions. In a normal sequence, the half-word L instruction is executed first, followed by the half-word R instruction. In this case, the fetch time for the second instruction is zero.

INSTRUCTION ADDRESS.

If $IA-1 [7:1] = 1$, $IA-1 [6:7]$ and $IA-0 [7:7]$ concatenated contain the address of a full instruction word in local memory, $IA-0 [0:1]$ selects the half-word instruction in the full instruction word; 0 specifies half-word L, 1 specifies half-word R.

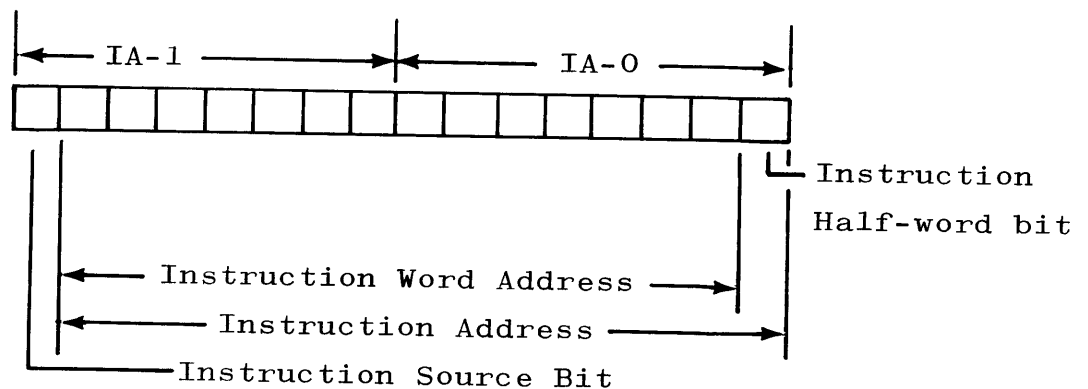

Figure 2-16. Instruction Word Address Format

If IA-1 [7:1] = 0, IA-1 [6:7] and IA-0 [7:7] concatenated contain a relative address for an instruction word in B 6500 memory. The base address, called the "instruction base address" or IBA, is presumed to be always present in half-word L of scratchpad memory word 0. IA-0 [0:1] selects the half-word instruction in the full instruction word.

The instruction address in IA-1 [6:7] and IA-0 [7:8] (including IA-0 [0:1]) is counted up one by the same clock pulse that starts the execution of an instruction. There is no count-up into IA-1 [7:1]. See fault interrupts for address overflow.

FETCH FROM LOCAL MEMORY, NORMAL SEQUENCE.

Fetch time: 1 unit

Using the address in the IA registers, the instruction word in local memory is read out and loaded into the Instruction register. The first instruction is executed immediately along with a simultaneous parity check. See fault interrupts for parity error action.

FETCH FROM LOCAL MEMORY AFTER BRANCH.

Fetch time for instruction-L: 2 units

Fetch time for instruction-R: 3 units

This operation is the same as for normal sequence, except that execution of instruction-R is delayed by 1 unit.

FETCH FROM B 6500 MEMORY.

Fetch time for instruction-L: 3 units +
B 6500 memory read access time.

Fetch time for instruction-R: 4 units +
B 6500 memory read access time.

Probable B 6500 memory read access time via the Multiplexor, if no DCP data access is in process:

Minimum: 5 units (Multiplexor clock)
Typical: 8 units

When B 6500 access control is free, the relative address in the IA registers is added to IBA in Scratchpad Memory word 0, and the sum is transferred to the B 6500 address register. A B 6500 memory read request is set with program execution inhibited in the DCP until the instruction word is obtained. When the instruction word is received, it is transferred directly to the Instruction register and is executed. The instruction word is parity checked immediately after the fetch. Execution of instruction-R is delayed by 1 unit. See fault interrupts for parity error or for fetch error.

The address addition is performed in three steps:

IBA (Scratchpad Memory)

IA-0 [7:8] + (Word 0 byte 2)	Address Section 0
IA-1 [6:7] + (Word 0 byte 1) + internal carry	Address Section 1
zero + (Word 0 byte 0) + internal carry	Address Section 2

CF0 and CF1 are not affected by the above address addition.

ACTIONS RELATED TO THE FETCH CYCLE.

PARITY CHECK. Immediately after a fetch cycle, the new instruction word is checked for odd parity. If there is a parity error, the execution of the L instruction is inhibited and a fault interrupt occurs.

TAG CHECK. Immediately after a fetch cycle, the tag field, IR [50:3], is checked for the code 110. If the tag field does not contain 110, the execution of the L instruction is inhibited and a fault interrupt occurs.

L INSTRUCTION PASSED OVER. If IA0 [0:1] = 1 when a new instruction word is loaded in the Instruction register, the L instruction is skipped over as if it were a no operation order. Only the R instruction in the word is executed.

TRANSFER OF R INSTRUCTION. The R instruction is executed after the L instruction unless a branch occurs in the L instruction. The R instruction is always transferred to the L half of the Instruction register before it is executed. The transfer is simultaneous with the completion of the L instruction, so fetch time is zero. The transfer is not a fetch cycle.

If the L instruction in a word is not executed, there is a fetch time of one unit for the R instruction.

INSTRUCTION ADDRESS COUNT UP. The instruction word address and the instruction half-word selection bit together comprise an instruction address for the half-word instructions. The instruction address is counted up by one each time that an instruction to be executed is transferred into the L half of the Instruction register. Thus the instruction address always designates the instruction to be executed next.

The Execute flip-flop and the I20 flip-flop are set when the instruction address is counted up. These flip-flops are cleared when an instruction is completed unless the next instruction is transferred into P-L at the same time. The I20 bit is significant after a fault interrupt.

The instruction source selection bit is subject to count-up along with the instruction address. If the instruction address is counted from all ones to all zeros, the instruction source selection bit is completed. There is no detection of this action in the hardware.

If a branch is taken, or if an instruction addresses the IA-1 or IA-0 register as a destination, the automatic count-up of the instruction address is inhibited and a fetch cycle is ordered.

FAULT INTERRUPTS.

A fault condition, such as a memory parity error, holds up the execution of a current instruction and inhibits the normal fetch of the next instruction. The fault condition creates a special Branch on Breakpoint instruction and inserts it in the Instruction register.

The unconditional branch condition is set and the special instruction is executed normally. A fault condition creates the following code in the Instruction register:

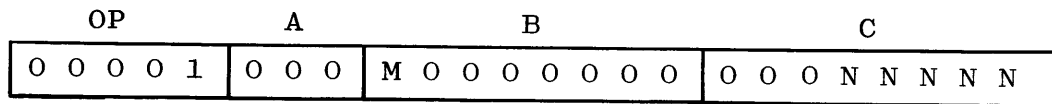

Figure 2-17. Fault Code in the Instruction Register

M is normally set equal to the I15 bit (LM-MM bit). Thus the branch address is for the memory which contains the program that was interrupted.

N N N N N: Characterizes the fault condition. (See fault codes.)

The state of the Execute flip-flop at the time of the fault condition is shown by the I20 bit. The I20 bit indicates whether or not the instruction address has been counted up.

I20 = 0: Fault condition occurred between instructions. The IA registers contain the address of the next instruction to be fetched.

I20 = 1: Fault condition interrupted the execution of an instruction. The IA registers contain the address of the next instruction to be fetched, but the current instruction was not completed.

The definitive fault branch addresses are created only if I19 = 0. If a fault condition occurs when I19 = 1, then any normal fault branch address is replaced by the "out of control" branch address for main memory. If a fault condition occurs when I19 = 1 and I15 = 0, which indicates that a fault-handling program is already running from main memory, then the Run flip-flop is cleared and DCP operation stops.

Exception: The scan-out Initialize is exempt from control by the I19 bit.

The I19-bit is set when a fault occurs. The I19-bit must be cleared programmatically.

Table 2-6
Fault Codes

		Branch Address						Description
I20	I19	39	28	27	26	25	24	
E	0	0	0	0	0	0	0	Initialize from scan-out
1	0	M	0	0	0	0	1	LM data address invalid
E	0	M	0	0	0	1	0	LM data word (W) parity error
E	0	M	0	0	0	1	1	Adapter cluster error
E	0	M	0	0	1	0	0	MM protected write denied
E	0	M	0	0	1	0	1	MM data address invalid
E	0	M	0	0	1	1	0	MM data word (W) parity error
E	0	M	0	0	1	1	1	MM memory-detected error on data access
E	0	1	0	1	0	0	0	LM inst. tag error, invalid op.
O	0	1	0	1	0	0	1	LM inst. address invalid
E	0	1	0	1	0	1	0	LM inst. (P) parity error
E	0	M	0	1	0	1	1	Unexpected time-out
E	0	0	0	1	1	0	0	MM inst. tag error, invalid op.
O	0	0	0	1	1	0	1	MM instruction address invalid
E	0	0	0	1	1	1	0	MM inst. (P) parity error
E	0	0	0	1	1	1	1	MM memory detected error on fetch
E	1	0	1	0	0	0	0	Fault following a fault: out of control

E = state of Execute flip-flop at time of fault condition.

M = I15 bit (LM-MM bit).

PRIORITY AMONG FAULTS.

If two fault conditions occur simultaneously, one of them takes precedence with the following priority:

- a. A scan-out Initialize or Halt displaces any fault condition.
- b. An execution fault takes precedence over a fetch fault.
- c. An invalid memory address fault precludes other memory access faults.
- d. A memory parity error fault takes precedence over code-produced faults.
- e. A MM memory-detected error fault takes precedence over both a parity error fault and a code-produced fault.

Execution faults from different instructions cannot occur at the same time.

FAULT INSTRUCTION EXECUTION.

When the special Branch on Breakpoint (Fault) instruction is executed, the following actions take place simultaneously:

- a. The contents of the MA registers are stored in SM word 0-R half.
 - 1) Exception: For the out of control fault, the contents of the MA registers are stored in SM word 1-R half.
- b. The contents of the I register column are transferred to the MA registers.
- c. The branch address in the B:C fields is transferred to the IA registers.
- d. The I19 is set to 1.

Following the branch a fetch cycle is ordered as usual.

ATTENTION NEEDED TIMER.

The attention needed timer is used to warn the DCP of unserviced CAN's and SAN's. This timer can time-out thus causing the unexpected time-out for two reasons:

- a. After a CAN has occurred and there have been no adapter reads for 500 microseconds the attention needed timer will time-out.
- b. A SAN condition exists continually for 0.5 milliseconds.

SCAN BUS.

The B 6500 processor has ultimate control over the Data Communications Processor (DCP) by means of the scan bus. Three different scan-out orders can be sent to the DCP: Initialize, Set Attention Needed, and Halt. The DCP does not accept scan-in orders.

The address/function code format for the DCP's is shown in figure 2-18.

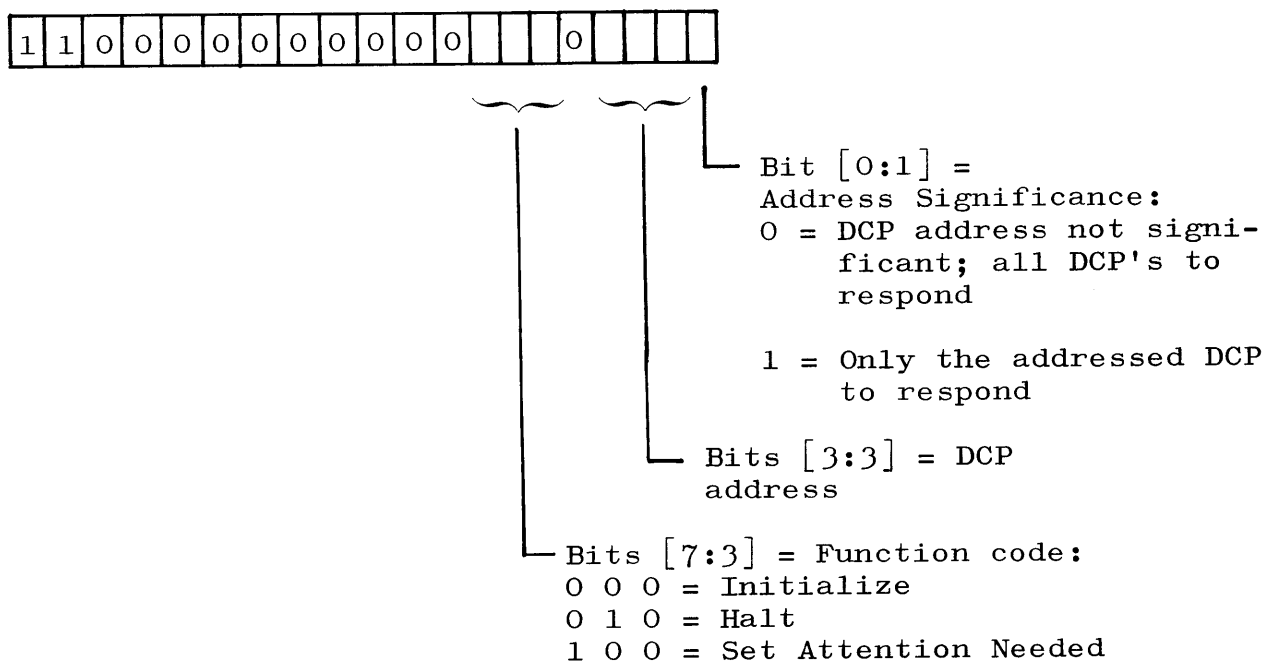

Figure 2-18. DCP Address/Function Code format

SCAN-OUT INFORMATION WORD.

The scan-out information word is used only in the Initialize order. This 48-bit word has the following format:

- Bits [47:28] = all zeros
- Bits [19:20] = Instruction base address

READY AND SCAN ACCESS OBTAINED.

Normally, the DCP returns a ready signal on the scan bus when the DCP is addressed by any scan order. The ready signal allows the main system processor to maintain the scan order in anticipation of a scan access obtained signal. The scan access obtained signal is sent by the DCP when it performs the scan-out operation as directed or when it detects an invalid scan order.

NOT READY.

The following conditions prevent the DCP from sending the ready signal when it is addressed by a scan order:

- a. OFF-LINE/ON-LINE switch in the OFF-LINE position.
- b. HOLD P-L/STOP ON FAULT switch in the HOLD P-L POSITION.
- c. STOP IMMEDIATE/STOP ON FETCH switch in the STOP IMMEDIATE position.
- d. Run flip-flop off in the Set Attention Needed scan-out.

The absence of the ready signal on the scan bus is detected by a time-out in the main system processor, which then ends the scan order. The DCP is identified as being not present in the system, or at least not available.

INVALID SCAN ORDERS.

The DCP does not act on scan-out orders in which there is an address/function code parity error or an information parity error. A scan-out function code other than the specified codes is also unacceptable. Any of these conditions causes the DCP to send a scan transmission error signal.

The DCP responds to a scan-in order by sending a scan transmission error signal and an all-zeros information word with a parity error.

INITIALIZE [000].

When recognized by the DCP, an Initialize scan-out turns on the Run

flip-flop and creates a fault interrupt. This fault interrupt takes precedence over any other fault interrupts. The 20-bit instruction base address in the scan-out information word is stored in the L half-word of SM word 0. The interrupt branch address is an all-zero for main memory. The special stop conditions that might otherwise prevent the fault actions are inhibited. The first instruction word is fetched from the main memory location that is addressed by the instruction base address.

SET ATTENTION NEEDED [100].

When recognized by a DCP and when the Run flip-flop is on, a Set Attention Needed scan-out sets the main system attention needed flip-flop. There is no interference with the other DCP operations. This scan-out does not cause a fault interrupt.

The DCP does not respond to a Set Attention Needed scan-out when the Run flip-flop is off. The absence of the ready signal must be recognized by the main system processor.

NOTE

The Run flip-flop controls the response so that the main system processor can determine if a DCP is running. The main system processor can find out if a DCP is available in the system by sending a scan-out Halt.

HALT [010].

When recognized by a DCP, a scan-out Halt creates a fault interrupt and stops DCP operations (before the fault actions occur) by turning off the Run and Execute flip-flops.

SECTION 3 INSTRUCTIONS

GENERAL.

UNIT TIME.

One unit of time in the DCP is one clock period (200 nanoseconds).

A specified instruction execution time is the minimum number of units required for actual instruction execution before the instruction is released. Most instructions are released simultaneously with the completion of the operations that they order. The following instructions begin operations which may be completed independently after the instruction is released:

- a. Main memory access instructions
- b. Adapter write instructions

A specified instruction execution time does not include the additional time that is required in the following cases:

INDIRECT ADDRESS.

An indirect address designation in the B field increases the specified execution time by one unit. The added time is masked if a main memory access is in process and the actual B address designates the W or MA registers.

MAIN MEMORY ACCESS.

An instruction that addresses the W or MA registers is held up if a main memory access cycle is in progress. The access was ordered by a prior instruction which was released.

ADAPTER WRITE TIMING SPECIFICATION.

Any instruction is held up if the preceding instruction was an Adapter Write instruction (released) and the adapter write operation has not been completed.

UNDEFINED OPERATION CODES.

Operators containing undefined operation codes are not released; they act like the Idle instruction. The following codes are exceptions to the above rule:

Table 3-1
Exceptions to Undefined Operation Codes

Operation Code	Interpreted As	Instruction
01000 100	01000 000	Move half-word
01001 000	01000 000	Move half-word
01001 01n	01000 000	Move half-word
01100 001	01100 000	Half-word Add
01100 01n	01100 000	Half-word Add
01100 101	01100 100	Half-word Subtract
01100 11n	01100 100	Half-word Subtract
01101 001	01101 000	Half-word Add, literal in the B field
01101 01n	01101 000	Half-word Add, literal in the B field
01101 101	01101 100	Half-word Subtract, literal in the B field
01101 11n	01101 100	Half-word Subtract, literal in the B field
01111 01n	11001 nnn	Exclusive OR
01111 1nn	11001 nnn	Exclusive OR

"n" denotes 0 or 1

UNDEFINED ADDRESSES.

Unless an address is specifically detected as invalid, an address which does not designate an existing location does not interfere

with the instruction execution. If no source is addressed, read-out information is all zeros. If no destination is addressed, no information is stored.

INVALID INSTRUCTIONS.

The following instruction errors are detected and create an invalid fault interrupt:

Instructions which address the same location in scratchpad memory as both a source and a destination.

Exceptions: Logical OR instructions
Logical AND instructions

INSTRUCTION FORMAT.

The following format is used in this section:

INSTRUCTION

MNEMONIC [OP CODE] [A FIELD] UNIT TIME, GROUP.

Example:

SET CLUSTER MASK REGISTER.

MSKW [00011] [000] 1 unit, Group 0.

GROUP 0 INSTRUCTIONS.

IDLE.

IDLE [00000] [000] Indefinite, Group 0.

A FIELD:

Specified above.

B FIELD:

Not significant.

C FIELD:

Not significant.

This instruction is the DCP idle state. It is held until the DCP receives a scan-out Initialize order from the B 6500 processor.

A system master clear signal establishes the all-zero state which sets up the Idle instruction.

ADAPTER WRITE.

AWI [00010] [0VV] 2 units (if no wait), Group 0.

A FIELD:

- 000 => Present contents of AC and AI are used.
- 001 => Present contents of AC used, AI←C then used.
- 010 => Present contents of AI used, AC←B then used.
- 011 => AC←B, AI←C then used.

NOTE

Present contents of AA are always used. AC⁴ must be 0 for a write.

B FIELD:

Described above when applicable.

C FIELD:

Described above when applicable.

The AC and AI registers may be loaded with the literals in the B and C fields as specified above. If a register is not loaded with a literal, its present contents are used.

The information in the AC and AI registers and the adapter address in AA [3:4] is sent to the designated cluster. The cluster is ordered to take the information, even if it pre-empts an attention needed condition, and is expected to return either an output accepted or a wait signal. The output accepted signal, signifying that the cluster has accepted the information, causes the program to continue in sequence. The wait signal causes the DCP to wait for the output accepted signal. If neither the output accepted nor the wait signal is present before the second clock, a fault interrupt occurs. The AA, AC and AI registers are not changed. The CF0 and CF1 flip-flops are not affected.

ADAPTER INTERROGATE.

AWRR [00010] [1VV] 3 to 18 units (if no wait), Group 0.

A FIELD:

- 100 => Present contents of AC and AI are used.
- 101 => Present contents of AC used, AI←C then used.
- 110 => Present contents of AI used, AC←B then used.
- 111 => AC←B, AI←C then used.

B FIELD:

Described above when applicable.

C FIELD:

Described above when applicable.

NOTE

Present contents of AA
always used. AC⁴ must
be 1 for an interrogate.

The operation is an Adapter Write combined with a special Adapter Read. The information in the Adapter Write is normally some sort of query and is answered by the read-in information given in response.

The control information in the AC and AI registers and the Adapter Address in AA [3:4] is sent to the designated cluster. The cluster is ordered to take the information, even if it pre-empts an attention needed condition, and is expected to return either an output accepted or a wait signal. The output accepted signal, signifying that the cluster has accepted the information, clears the AC and AI registers and changes the DCP order to a fixed-address Adapter Read. When the cluster responds with the demanded information, the information is set into the AC and AI registers, and the program continues in sequence. The wait signal causes the DCP to wait for the output accepted signal. If neither the output accepted nor the wait signal is present before the second clock, a fault interrupt is caused. If the wait signal goes away before the responsive read signal occurs, a fault interrupt is also caused. The CFO and CF1 flip-flops are not affected.

STOP/BRANCH ON BREAKPOINT.

BKP [00001] 1 unit (if control switch OFF, else 2 units), Group 0.

A FIELD:

Contains the breakpoint code.

B FIELD:

Contains a B:C branch address (see B:C branch address).

C FIELD:

Contains a B:C branch address (see B:C branch address).

The bits in the A field are compared with the settings of the BREAKPOINT toggle switches on the display panel. If there is correspondence in all three bit positions, the position of the STOP/BRANCH ON BREAKPOINT control switch determines the resulting action.

If the STOP ON BREAKPOINT/BRANCH ON BREAKPOINT control switch is in the center-OFF position, the instruction is released as a no-op and the program continues in sequence.

If the STOP ON BREAKPOINT/BRANCH ON BREAKPOINT switch is in a control position, the settings of the BREAKPOINT code switches on the display panel are compared with the bits in the A field. If the switch settings correspond with the A field bits in all three positions, a breakpoint match exists.

NOTE

The BREAKPOINT code switches have three positions: 1, OFF, and 0. If a switch is in the center-OFF position, a match with the corresponding A field bit is assured.

If there is a breakpoint match and the control switch is in the STOP ON BREAKPOINT position, the program execution is immediately stopped.

If there is a breakpoint match and the control switch is in the BRANCH ON BREAKPOINT position, a subroutine entry occurs: simultaneously, the contents of the MA registers are stored in the R half-word of the SM word 0, the contents of the IA register column are transferred to the MA registers, and the branch address in the B:C fields is transferred to the IA registers. The instruction is released. The CF1 and CF0 flip-flops are cleared.

If there is no breakpoint match, the instruction is released and the program continues in sequence.

SHIFT MA RIGHT.

SHFT [00011] [100] 1+B [2:3] units, Group 0.

A FIELD:

Specified above.

B FIELD:

B [7:2] \neq 01 \Rightarrow B [2:3] specifies the number of shifts desired minus one.

B [7:2] = 01 \Rightarrow indirect literal; contents of Y register used in place of B field.

C FIELD:

C [7:2] should be zero (not used).

C [5:3] = MA register interconnection control.

C5 = 1 \Rightarrow Byte circulate (end around on single byte).

C4 = 1 \Rightarrow Shift end around (on selected registers).

C3 = 1 \Rightarrow Concatenate (make connection between MA2, MA1 or MA0).

C [2:3] = Row select code for MA register column.

C2 = 1 \Rightarrow Select MA2

C1 = 1 \Rightarrow Select MA1

C0 = 1 \Rightarrow Select MA0

NOTE

C3 = 1 indicates that two or more of the shifting registers are concatenated.

The MA registers are first selected by C [2:3] and are interconnected as specified by C [5:3]. These selected registers are shifted right one bit position; this shift is repeated the number of times specified above by the B field or Y register if selected.

If by selecting combinations of C5, C4 and C3, more than one bit of information seems to be going to a single bit position, these input bits are ORed. Also, if no connection to the most significant bit position of a shifting register is designated, a zero is shifted in. The CF0 and CF1 flip-flops are cleared.

Below is a table of the different register concatenations. Byte circulate is not shown.

Table 3-2
MA Concatenations

Bit Configuration						Shift
C5	C4	C3	C2	C1	C0	
0	0	1	0	1	1	MA1:MA0 (":" denotes MA1 [0:1] => MA0 [7:1])
0	0	1	1	0	1	MA2:MA0 (MA1 bypassed)
0	0	1	1	1	0	MA2:MA1
0	0	1	1	1	1	MA2:MA1:MA0
0	1	1	0	1	1	MA1:MA0; MA0 [0:1] => MA1 [7:1]
0	1	1	1	0	1	MA2:MA0; MA0 [0:1] => MA2 [7:1]
0	1	1	1	1	0	MA2:MA1; MA1 [0:1] => MA2 [7:1]
0	1	1	1	1	1	MA2:MA1:MA0; MA0 [0:1] => MA2 [7:1]
0	1	0	0	1	1	MA1, MA0; MA0 [0:1] => MA1 [7:1]
0	1	0	1	0	1	MA2, MA0; MA0 [0:1] => MA2 [7:1]
0	1	0	1	1	0	MA2, MA1; MA1 [0:1] => MA2 [7:1]
0	1	0	1	1	1	MA2, MA1, MA0; MA0 [0:1] => MA2 [7:1]

SET SYSTEM INTERRUPT.

HEYU [00011] [101] 5 units, Group 0.

A FIELD:

Specified above.

B FIELD:

[00000011] Specifies a repeat count to hold the interrupt.

B [7:2] = 01 => 7 indirect literal; Y is used in place of the B field.

C FIELD:

[00000000] (reserved).

This instruction sends an interrupt signal on a special control lead to the peripheral control multiplexor. The repeat number in the B field holds the interrupt signal long enough for the multiplexor to recognize it (five units). Then the DCP continues in sequence.

SET CLUSTER MASK REGISTER.

MSKW [00011] [000] 1 unit, Group 0.

A FIELD:

Specified above.

B FIELD:

Not significant.

C FIELD:

Not significant.

This instruction places the AC register contents into the left byte of the CM Register, CM [15:8], and the AI register contents into the right byte of the CM register, CM [7:8]. The parity bit is not used. The CF0 and CF1 flip-flops are not affected.

A one bit in a position of the Cluster Mask register causes the DCP cluster interface control logic to recognize a cluster attention

needed signal from the corresponding Adapter Cluster. A zero bit prevents the recognition so the DCP will not respond to a cluster attention needed signal. The state of the Cluster Mask register affects the Adapter Read instructions indirectly, but does not affect the Adapter Write or Adapter Interrogate instructions.

READ CLUSTER MASK REGISTER.

MSKR [00011] [001] 1 unit, Group 0.

A FIELD:

Specified above.

B FIELD:

Not significant.

C FIELD:

Not significant.

This instruction places the contents of the left byte of the CM register, CM [15:8], into the AC register and the contents of the right byte of the CM register, CM [7:8], into the AI register. The parity bit (I21) is cleared. AA is set to 0. The CFO and CF1 flip-flops are not affected.

GROUP 1 INSTRUCTIONS.

ADAPTER READ WHEN ATTENTION NEEDED.

ARWN [00100] [000] 2 to indefinite, Group 1.

A FIELD:

Specified above.

B FIELD:

Contains a B:C branch address (see B:C branch address).

C FIELD:

Contains a B:C branch address (see B:C branch address).

NOTE

AA [7:2] designates the cluster group which may be read first.

When a cluster attention needed (CAN) condition occurs, the cluster exchange control section finds the cluster which is calling for attention. Then the AA, AC, and AI registers are set from the selected cluster interface signals and the program continues in sequence. The CFO and CF1 flip-flops are not affected.

If only a system attention needed (SAN) condition occurs (no CAN), the contents of the B and C fields are transferred to the IA registers and a branch is taken. The SAN flip-flop is reset and the CFO and CF1 flip-flops are cleared.

If there is neither a CAN nor SAN condition, the instruction is held indefinitely. When they occur simultaneously, the CAN is serviced first.

NOTE

AA [7:2] designates one of four cluster cables or cluster groups. When a cluster attention needed condition occurs in a cluster group other than the one being designated, the cluster exchange control section sets AA [7:2] to designate a group with attention needed. Independently, a cluster which needs attention within that group has been found by counting up a separate two-bit register. This register retains the number of one cluster which last had an attention needed condition in the group. The initial contents of AA [5:2] are not used in seeking the cluster.

ADAPTER READ IF NEEDED.

ARIN [00100] [001] 1 to 3 units, Group 1.

A FIELD:

Specified above.

B FIELD:

Contains a B:C branch address (see B:C branch address).

C FIELD:

Contains a B:C branch address (see B:C branch address).

NOTE

AA [7:2] designates the cluster
group which may be read first.

If a cluster attention needed (CAN) condition exists, the cluster exchange control section identifies a cluster which is calling for attention. The AA, AC, and AI registers are set from the selected cluster interface signals, and a branch to the address in the B and C fields is taken. The CFO and CF1 flip-flops are cleared.

If there is no CAN condition, the program continues in sequence. The CFO and CF1 flip-flops are not affected.

The program loop timer is reset by this instruction.

DECREMENT Y, BRANCH IF Y IS ZERO.

DBYZ [00100] [010] 1 unit, Group 1.

A FIELD:

Specified above.

B FIELD:

Contains a B:C branch address (see B:C branch address).

C FIELD:

Contains a B:C branch address (see B:C branch address).

If Y is zero, the branch address in the B:C field is transferred to the IA registers and the program continues. If Y is non-zero the program continues in sequence.

After the test, the Y register contents are always decremented by one if they are not already zero.

If the branch occurs, the CFO and CF1 flip-flops are cleared.

DECREMENT Y, BRANCH IF Y IS NON-ZERO.

DBYN [00100] [011] 1 unit, Group 1.

A FIELD:

Specified above.

B FIELD:

Contains a B:C branch address (see B:C branch address).

C FIELD:

Contains a B:C branch address (see B:C branch address).

If Y is non-zero, the branch address in the B:C field is transferred to the IA registers and the program continues. If Y is zero, the program continues in sequence. After the test, the Y register contents are always decremented by one if it is not already zero.

If the branch occurs, the CFO and CF1 flip-flops are cleared.

BRANCH IF SYSTEM ATTENTION NEEDED.

BRAN [00100] [100] 1 unit, Group 1.

A FIELD:

Specified above.

B FIELD:

Contains a B:C branch address (see B:C branch address).

C FIELD:

Contains a B:C branch address (see B:C branch address).

If the System Attention Needed (SAN) flip-flop is on, the instruction address in the B and C fields are transferred to the IA registers and the branch is taken. The SAN flip-flop is reset and the CFO and CF1 flip-flops are cleared.

If the SAN flip-flop is off, the program continues in sequence and CFO and CF1 are not affected.

BRANCH.

GOTO [00101] 1 unit, Group 1.

A FIELD:

A2	A1	A0	BRANCH CONDITION	RESULT SUBTRACTION
0	0	0	No branch	N/A
0	0	1	CF1=0 and CFO=0	A>B
0	1	0	CFO=1	A<B
0	1	1	CF1=0	A≠B
1	0	0	CF1=1	A=B
1	0	1	CFO=0	A≥B
1	1	0	CF1=1 or CFO=1	A≤B
1	1	1	Unconditional branch	N/A

B FIELD:

Contains a B:C branch address (see B:C branch address).

C FIELD:

Contains a B:C branch address (see B:C branch address).

The contents of the A field cause the compare flip-flops to be checked as above. If the specified compare condition is satisfied, the branch is effected by transferring the contents of the B and C fields to the IA registers. If the compare condition is not satisfied, program control continues in sequence. CFO and CF1 are cleared if the branch occurs.

BRANCH RELATIVE WITH X.

GOX [00110] 1, 2 or 3 units, Group 1.

A FIELD:

A2	A1	A0	BRANCH CONDITION	SUBTRACTION RESULTS
0	0	0	No branch	N/A
0	0	1	CF1=0 and CFO=0	A>B
0	1	0	CFO=1	A<B
0	1	1	CF1=0	A≠B
1	0	0	CF1=1	A=B
1	0	1	CFO=0	A≥B
1	1	0	CF1=1 or CFO=1	A≤B
1	1	1	Unconditional branch	N/A

B FIELD:

Contains a B:C branch address (see B:C branch address).

C FIELD:

Contains a B:C branch address (see B:C branch address).

The contents of the A field cause the compare flip-flops to be checked as above. If the specified compare condition is satisfied, the branch is effected by transferring the sum of the X register and the B and C fields to the IA registers. If the compare condition is not satisfied, program control continues in sequence. If

the branch occurs, CFO and CF1 are cleared.

The above address addition does not disturb CFO or CF1.

BRANCH RELATIVE INDIRECT.

GOI [00111] 1, 2 or 3 units, Group 1.

A FIELD:

A2	A1	A0	BRANCH CONDITION	SUBTRACTION RESULT
0	0	0	No Branch	N/A
0	0	1	CF1=0 and CFO=0	A>B
0	1	0	CFO=1	A<B
0	1	1	CF1=0	A≠B
1	0	0	CF1=1	A=B
1	0	1	CFO=0	A <u>></u> B
1	1	0	CF1=1 or CFO=1	A <u><</u> B
1	1	1	Unconditional Branch	N/A

B FIELD:

Contains a B:C branch address (see B:C branch address).

C FIELD:

Contains a B:C branch address (see B:C branch address).

NOTE

The Y Register contains a byte address (see 8-bit address).

The contents of the A field cause the compare flip-flops to be checked as above. If the specified compare condition is satisfied, the branch is effected by transferring the sum of the contents of the Y register byte address and the B and C fields to the IA registers. If the compare condition is not satisfied, program control continues in sequence. If the branch occurs, CFO and CF1 are cleared.

The above address addition does not disturb CFO or CF1.

GROUP 2 INSTRUCTIONS.

MOVE HALF-WORD.

MOVE [01000] [000] 1 unit, Group 2.

A FIELD:

Specified above.

B FIELD:

Contains a half-word source address (see 8-bit address).

C FIELD:

Contains a half-word destination address (see 8-bit address).

NOTE

The C field should not address the MA registers as a destination because the MA registers are implicitly addressed as the destination.

The information specified by the B field is transferred to the MA register. If the B field contains zeros, then zeros are transferred to the MA registers. If the B field addresses the MA registers, the contents of the MA registers are retained.

Simultaneously, the contents of the MA registers are transferred to the destination addressed by the C field. If the C field is all zeros no information is transferred.

LOCAL MEMORY READ, INDIRECT ADDRESS.

LMRI [01001] [001] 3 units (if no system wait), Group 2.

A FIELD:

Specified above.

B FIELD:

Contains a half-word source address (see 8-bit address).

C FIELD:

Contains a half-word destination address (see 8-bit address).

This instruction initiates a Move Half-word instruction to create an address for local memory. Then this address is stored in MA-1. MA-0 is used to obtain an entire word (including tag) from local memory which is stored in the W register. Parity is checked.

If memory access is not obtained within eight clock times, an invalid address fault interrupt is created.

NOTE

MA-1 [7:2] = 00.
MA [11:12] contains local
memory address.

SCRATCHPAD MEMORY READ.

SMRD [01000] [010] 1 unit (if no system wait), Group 2.

A FIELD:

Specified above.

B FIELD:

Contains a half-word source scratchpad memory address or register address.

C FIELD:

Contains a half-word destination address (see 8-bit address).

The B field may select either the L half-word of scratchpad memory or a register column half-word. If scratchpad memory L half-word is selected, the related full word is transferred to the W register. When a register column is selected, it is transferred to W-L and W-R will receive zeros. If B is zero, the W register will receive all zeros. Parity is not checked.

Simultaneously, the contents of the MA registers are sent to the half-word selected by the C field. If C is zero there is no information transfer.

NOTE

If C selects W-R, MA is
ORed with the information
selected by the B field.

LOCAL MEMORY READ, DIRECT ADDRESS.

LMRD [01000] [011] 3 units (if no system wait), Group 2.

A FIELD:

Specified above.

B FIELD:

B [7:2] = 00.

B [5:6]; C [7:8] contain a local memory source address right justified.

C FIELD:

Specified above.

The B and C fields are transferred to the MA-1 and MA-0 registers, and simultaneously, the MA-1 and MA-0 registers are transferred temporarily to the B and C fields of the Instruction register. The LM read cycle occurs after the address transfer. The read-out information is loaded into the W register, MA-1 and MA-0 are restored from the B and C fields, and the W register parity check control is set. If there is a parity error, a data parity error fault interrupt is created before the next instruction is executed.

If memory access is not obtained within eight clock times, an invalid address fault interrupt is created. The LM word address is in the MA1 and MA0 registers.

The B:C address selects a full word in local memory which is read into the W register. Parity is checked.

LOCAL MEMORY WRITE, INDIRECT ADDRESS.

LMWI [01000] [101] 3 units (if no system wait), Group 2.

A FIELD:

Specified above.

B FIELD:

Contains a half-word source address (see 8-bit address).

C FIELD:

Contains a half-word destination address (see 8-bit address).

This instruction initiates a Move Half-word instruction to create an address for local memory. MA [23:10] = 0 and MA [11:10] contain the local memory address. Then the full word (including tag) in the W register is stored into the location selected by the MA register. Odd parity is generated.

SCRATCHPAD MEMORY WRITE.

SMWD [01000] [110] 1 unit (if no system wait), Group 2.

A FIELD:

Specified above.

B FIELD:

Contains a half-word source address (see 8-bit address).

C FIELD:

Contains a scratchpad memory address or register address half-word destination.

The information selected by the B field is transferred to the MA registers. Zeros are transferred to the MA registers if B is zero. If the C field addresses scratchpad memory, that word of scratchpad memory is loaded from the W register. Parity is not generated.

If C selects a register column (half-word) the contents of W-L are transferred to the selected registers column. W-R is not transferred. If C is zero, there is no information transfer.

LOCAL MEMORY WRITE, DIRECT ADDRESS.

LMWD [01000] [111] 3 units (if no system wait), Group 2.

A FIELD:

Specified above.

B FIELD:

B [7:2] = 00.

B [5:6]; C [7:8] contain a local memory destination address right justified.

C FIELD:

Specified above.

Using the above B and C addresses, the full word (with tag) is transferred from the W register to local memory. Odd parity is generated.

MAIN MEMORY READ.

MMR [01001] [001] 1 unit, Group 2.

A FIELD:

Specified above.

B FIELD:

Contains a half-word source address (see 8-bit address).

C FIELD:

Contains a half-word destination address (see 8-bit address).

This instruction initiates a Move Half-word instruction to create the main memory address in the MA registers. A main memory access is requested after transferring the address to the B 6500 Memory Address register. When the access is granted the addressed information in main memory is loaded into the W register. This access of main memory occurs independently of other DCP operations so that the DCP may continue to execute code.

NOTE

Execution of any instruction
accessing main memory or the

W register will be delayed un-
til this instruction is completed.

MAIN MEMORY WRITE UNCONDITIONAL.

MMWU [01001] [100] 1 unit, Group 2.

A FIELD:

Specified above.

B FIELD:

Contains a half-word source address (see 8-bit address).

C FIELD:

Contains a half-word destination address (see 8-bit address).

This instruction initiates a Move Half-word instruction to create a main memory address in the MA registers. A main memory write is requested after transferring MA [19:20] to the B 6500 Memory Address register and generates odd parity for the word in the W register. When the access is granted, the information in the W register is unconditionally (no check of protect bit for word currently in main memory) written into the addressed main memory location.

This write continues independently of other DCP operations so that the DCP may continue to execute code.

NOTE

Execution of any instruction
accessing main memory or the
W register will be delayed
until this instruction is
completed.

MAIN MEMORY WRITE-READ UNCONDITIONAL.

MMWR [01001] [101] 1 unit, Group 2.

A FIELD:

Specified above.

B FIELD:

Contains a half-word source address (see 8-bit address).

C FIELD:

Contains a half-word destination address (see 8-bit address).

This instruction initiates a Move Half-word instruction to create a main memory address in the MA registers. A main memory write is requested after transferring MA [19:20] to the B 6500 Memory Address register and generating odd parity for the word in the W register. When the access is granted the information in the W register is unconditionally (no check of protect bit for word currently in main memory) written into the addressed main memory location. After the write, the previous contents of the addressed main memory location are loaded into the W register.

This write-read continues independently of other DCP operations so that the DCP may continue to execute code.

NOTE

Execution of any instruction accessing main memory or the W register will be delayed until this instruction is completed.

MAIN MEMORY PROTECTED WRITE.

MMWP [01001] [110] 1 unit, Group 2.

A FIELD:

Specified Above.

B FIELD:

Contains a half-word source address (see 8-bit address).

C FIELD:

Contains a half-word destination address (see 8-bit address).

This instruction initiates a Move Half-word instruction to create a main memory address in the MA registers. A main memory write is requested after transferring MA [19:20] to the B 6500 Memory Address register and generating odd parity for the word in the W register. When the access is granted, the information in the W register is written into the addressed main memory location only if the protect bit of the word currently in that location is zero (not protected). If the protect bit is one a fault interrupt will occur (see fault interrupt).

This write continues independently of other DCP operations so that the DCP may continue to execute code.

NOTE

Execution of any instruction accessing main memory or the W register will be delayed until this instruction is completed.

MAIN MEMORY WRITE-READ PROTECTED.

MWRP [01001] [111] 1 unit, Group 2.

A FIELD:

Specified above.

B FIELD:

Contains a half-word source address (see 8-bit address).

C FIELD:

Contains a half-word destination address (see 8-bit address).

This instruction initiates a Move Half-word instruction to create a main memory address in the MA registers. A main memory write is requested after transferring MA [19:20] to the B 6500 Memory Address register and generates odd parity for the word in the W register. When the access is granted the information in the W register is written into the addressed main memory location only

if the protect bit of the word currently in that location is zero (not protected). If the protect bit is one, a fault interrupt will occur (see Fault Interrupt). Whether the protect bit is on or not the previous contents of the addressed main memory location will be loaded into the W register. This Write Read continues independently of other DCP operations so that the DCP may continue to execute code.

NOTE

Execution of any instruction accessing main memory or the W register will be delayed until this instruction is completed.

GROUP 3 INSTRUCTIONS.

HALF-WORD ADD.

HAD [01100] [000] 3 units, Group 3.

A FIELD:

Specified above.

B FIELD:

Contains a half-word operand address (see 8-bit address).

C FIELD:

Contains a half-word destination address (see 8-bit address).

The half-word selected by the B field address is added to the contents of the MA registers with the sum stored in the half-word designated by the C field address.

The result of the half-word addition controls the CFO and CF1 flip-flops:

Carry:	set CFO	Sum zero:	set CF1
No Carry:	clear CFO	Sum non-zero:	clear CF1

HALF-WORD ADD, LITERAL IN B.

HADB [01101] [000] 3 units, Group 3.

A FIELD:

Specified above.

B FIELD:

Contains a literal operand.

C FIELD:

Contains a half-word destination address (see 8-bit address).

The literal in the B field is added to the contents of the MA registers and the sum is stored in the half-word designated by the C field address.

The result of the half-word addition controls the CFO and CF1 flip-flops:

Carry:	set CFO	Sum zero:	set CF1
No Carry:	clear CFO	Sum non-zero:	clear CF1

HALF-WORD SUBTRACT.

HSB [01100] [100] 3 units, Group 3.

A FIELD:

Specified above.

B FIELD:

Contains a half-word operand address (see 8-bit address).

C FIELD:

Contains a half-word destination address (see 8-bit address).

The half-word selected by the B field address is subtracted from the contents of the MA registers, and the remainder is stored in the half-word designated by the C field address.

The result of the half-word subtraction controls the CFO and CF1 flip-flops:

Borrow:	set CFO	Remainder zero:	set CF1
No borrow:	clear CFO	Remainder non-zero:	clear CF1

HALF-WORD SUBTRACT, LITERAL IN B.

HSBB [01101] [100] 3 units, Group 3.

A FIELD:

Specified above.

B FIELD:

Contains a literal operand.

C FIELD:

Contains a half-word destination address (see 8-bit address).

The literal in the B field is subtracted from the contents of the MA register half-word and the remainder is stored in the half-word designated by the C field.

The result of the half-word subtraction controls the CFO and CF1 flip-flops:

Borrow:	set CFO	Remainder zero:	set CF1
No borrow:	clear CFO	Remainder non-zero:	clear CF1

TRANSLATE.

TRAN [01110] 2 units, Group 3.

A FIELD:

A2	A1	A0	Translation
0	0	0	EBCDIC to USASCII
0	0	1	EBCDIC to BCL (Burroughs Common Language)
0	1	0	(reserved)
0	1	1	(reserved)
1	0	0	USASCII to EBCDIC
1	0	1	BCL to EBCDIC
1	1	0	(reserved)
1	1	1	(reserved)

B FIELD:

Contains a byte operand address (see 8-bit address).

C FIELD:

Contains a byte destination address (see 8-bit address).

The byte addressed by the B field is routed into the translator specified by the A field with the output byte from the translator sent to the destination specified by the C field.

The translation is always a one-to-one conversion. Addition or deletion of characters must be handled by the program. Other code translations, such as EBCDIC - Baudot, must be performed by a program.

NOTE

The hardware implementation of the translate feature is optional. See Appendix B for more detail.

PARITY.

PARY [01111] [OOV] 1 unit, Group 3.

A FIELD:

A=000 => check or generate even parity.

A=001 => check or generate odd parity.

B FIELD:

Contains a byte operand address (see 8-bit address).

C FIELD:

Contains a byte destination address (see 8-bit address).

The source operand addressed by the B field is transferred to the destination specified by the C field. The bits of the source operand (including the 9th bit of AI (parity bit) if AI is the selected source) and the AO bit are exclusively ORed together. The CF1 flip-flop is controlled by the outcome of the Exclusive OR:

Even number of one-bits, result zero: set CF1 (good parity).

Odd number of one-bits, result one: Clear CF1 (parity error).

The CFO flip-flop is always cleared.

If the AI register is selected as the destination, the 9th bit of AI (I21) is also controlled by the result of the Exclusive OR:

Odd number of one-bits, result one: set I21.

Even number of one-bits, result zero: clear I21.

NOTE

If the AI register is both
the source and the destination,
it is assumed that AI [8:1] = 0 initially.

GROUP 4 INSTRUCTIONS.

ADD.

ADD [11101] 1 unit, Group 4.

A FIELD:

Contains an A field operand address (see A field address).

B FIELD:

Contains a byte operand address (see 8-bit address).

C FIELD:

Contains a byte destination address (see 8-bit address).

The operands addressed by the A and B fields and the carry bit CF0 are added with the sum transferred to the destination specified by the C field. The operation is commutative.

The output carry signal controls the CF0 flip-flop, and the sum controls the CF1 flip-flop:

Carry:	set CF0	Sum zero:	set CF1
No carry:	clear CF0	Sum non-zero:	clear CF1

ADD, LITERAL IN B.

ADDB [11110] 1 unit, Group 4.

A FIELD:

Contains an A field operand address (see A field address).

B FIELD:

Contains a literal operand.

C FIELD:

Contains a byte destination address (see 8-bit address).

The operand addressed by the A field, the literal in the B field, and the carry bit in CF0 are added with the sum transferred to the destination specified by the C field. Otherwise, the operation is the same as ADD.

ADD, LITERAL IN C.

ADDC [11111] 1 unit, Group 4.

A FIELD:

Contains an A field destination address (see A field address).

B FIELD:

Contains a byte operand address (see 8-bit address).

C FIELD:

Contains literal operand.

The operand addressed by the B field, the literal in the C field, and the carry bit in CFO are added with the sum transferred to the register specified by the A field. Otherwise, the operation is the same as ADD.

SUBTRACT.

SUB [10000] 1 unit, Group 4.

A FIELD:

Contains an A field operand address (see A field address).

B FIELD:

Contains a byte operand address (see 8-bit address).

C FIELD:

Contains a byte destination address (see 8-bit address).

The subtrahend addressed by the B field and the borrow bit in CFO are subtracted from the minuend addressed by the A field with the remainder transferred to the destination specified by the C field. The operation is not commutative.

The output borrow signal controls the CFO flip-flop, and the remainder controls the CF1 flip-flop:

Borrow:	Set CFO	Remainder zero:	Set CF1
No borrow:	Clear CFO	Remainder non-zero:	Clear CF1

CF1 = And CFO = 0....A>B

CFO = 1.....A<B

CF1 = 0.....A≠B

CF1 = 0.....A=B

CFO = 0.....A≥B

CF1 = 1 OR CFO = 1...A≤B

SUBTRACT, LITERAL IN B.

SUBB [11000] 1 unit, Group 4.

A FIELD:

Contains an A field destination address (see A field address).

B FIELD:

Contains a literal operand.

C FIELD:

Contains a byte operand address (see 8-bit address).

The literal in the B field and the borrow bit in CF0 are subtracted from the minuend addressed by the A field with the remainder transferred to the destination specified by the C field. Otherwise, the operation is the same as SUB.

SUBTRACT, LITERAL IN C.

SUBC [11100] 1 unit, Group 4.

A FIELD:

Contains an A field destination address (see A field address).

B FIELD:

Contains a byte operand address (see 8-bit address).

C FIELD:

Contains a literal operand.

The subtrahend addressed by the B field and the borrow bit in CF0 are subtracted from the literal in the C field with the remainder transferred to the destination specified by the A field. Otherwise, the operation is the same as SUB.

LOGICAL AND.

LAN [10101] 1 unit, Group 4.

A FIELD:

Contains an A field operand address (see A field address).

B FIELD:

Contains a byte operand address (see 8-bit address).

C FIELD:

Contains a byte destination address (see 8-bit address).

The corresponding bits of the operands addressed by the A and B fields are logically ANDed together individually with the result transferred to the destination specified by the C field. The AND function has the following relationship:

Operands		Result
(A) [n:1]	(B) [n:1]	(C) [n:1]
0	0	0
0	1	0
1	0	0
1	1	1

There is no interaction between different bit positions. The operation is commutative.

The CF0 flip-flop is cleared, but the result controls the CF1 flip-flop:

All result bits zero: set CF1
Not all result bits zero: clear CF1

LOGICAL AND, LITERAL IN B.

LANB [10110] 1 unit, Group 4.

A FIELD:

Contains an A field source address (see A field address).

B FIELD:

Contains a literal operand.

C FIELD:

Contains a byte operand address (see 8-bit address).

The bits of the operand addressed by the A field and the corresponding bits of the literal operand in the B field are logically ANDed

together with the result transferred to the destination specified by the C field. Otherwise, the operation is the same as LAN.

LOGICAL AND, LITERAL IN C.

LANC [10111] 1 Unit, Group 4.

A FIELD:

Contains an A field destination address (see A field address).

B FIELD:

Contains a byte operand address (see 8-bit address).

C FIELD:

Contains a literal operand.

The bits of the operand addressed by the B field and the corresponding bits of the literal operand in the C field are logically ANDed with the result transferred to the register specified by the A field. Otherwise, the operation is the same as LAN.

LOGICAL AND-OR MA, LITERAL IN C.

LAOM [10100] 1 unit, Group 4.

A FIELD:

Contains an A field destination address (see A field address).

B FIELD:

Contains a byte operand address (see 8-bit address).

C FIELD:

Contains a literal operand.

The bits of the operand addressed by the B field are logically ANDed individually with the corresponding bits of the literal in the C field in the same manner as in LANC. This AND result is ORed with the contents of the MA byte register which is in the same row as the destination (A field). The combined result is transferred to the destination specified by the A field.

NOTE

If the destination is an MA register, the result is ORed into the selected MA register without losing any one bits. This function facilitates packing information into the MA registers.

LOGICAL OR.

LOR [10001] 1 unit, Group 4.

A FIELD:

Contains an A field operand address (see A field address).

B FIELD:

Contains a byte address operand (see 8-bit address).

C FIELD:

Contains a byte destination address (see 8-bit address).

The corresponding bits of the operands addressed by the A and B fields are logically ORed together individually with the result transferred to the destination specified by the C field. The OR function has the following relationship:

Operands		Result
(A) [N:1]	(B) [n:1]	(C) [n:1]
0	0	0
0	1	1
1	0	1
1	1	1

There is no interaction between different bit positions. The operation is commutative.

The CFO flip-flop is cleared, but the result controls the CF1 flip-flop:

All result bits zero: set CF1
Not all result bits zero: clear CF1

NOTE

When only one operand is
addressed, the operator
is in effect a "move
byte" operator.

LOGICAL OR, LITERAL IN B.

LORB [10010] 1 unit, Group 4.

A FIELD:

Contains an A field Operand address (see A field address).

B FIELD:

Contains a literal operand.

C FIELD:

Contains a byte destination address (see 8-bit address).

The bits of the operand addressed by the A field and the corresponding bits of the literal in the B field are logically ORed with the result transferred to the destination specified by the C field. Otherwise, the operation is the same as LOR.

When the A field is empty, the operator is in effect a "load byte" operator.

LOGICAL OR, LITERAL IN C.

LORC [10011] 1 unit, Group 4.

A FIELD:

Contains an A field destination address (see A field address).

B FIELD:

Contains a byte operand address (see 8-bit address).

C FIELD:

Contains a literal operand.

The bits of the operand addressed by the B field and the corresponding bits of the literal in the C field are logically ORed with the result transferred to the register specified by the A field. Otherwise, the operation is the same as LOR.

LOGICAL EXCLUSIVE OR.

LEO [11001] 1 unit, Group 4.

A FIELD:

Contains an A field operand address (see A field address).

B FIELD:

Contains a byte operand address (see 8-bit address).

C FIELD:

Contains a byte destination address (see 8-bit address).

The corresponding bits of the operands addressed by the A and B fields are logically exclusively ORed together individually with the result transferred to the destination specified by the C field. The Exclusive OR function has the following relationship:

Operands		Result
(A) [n:1]	(B) [n:1]	(C) [n:1]
0	0	0
0	1	1
1	0	1
1	1	0

There is no interaction between different bit positions. The operation is commutative.

The CFO flip-flop is cleared, but the result controls the CF1 flip-flop:

All result bits zero: set CF1
 Not all result bits zero: clear CF1

Exclusive OR may be used for generating longitudinal check characters and negating individual bits.

LOGICAL EXCLUSIVE OR, LITERAL IN B.

LEOB [11010] 1 unit, Group 4.

A FIELD:

Contains an A field operand address (see A field address).

B FIELD:

Contains a literal operand.

C FIELD:

Contains a byte destination address (see 8-bit address).

The bits of the operand addressed by the A field and the corresponding bits of the literal in the B field are logically exclusively ORed with the result transferred to the destination specified by the C field. Otherwise, the operation is the same as LEO.

LOGICAL EXCLUSIVE OR, LITERAL IN C.

LEOC [11011] 1 unit, Group 4.

A FIELD:

Contains an A field destination address (see A field address).

B FIELD:

Contains a byte operand address (see 8-bit address).

C FIELD:

Contains a literal operand.

The bits of the operand addressed by the B field and the corresponding bits of the literal in the C field are logically exclusively ORed with the result transferred to the register specified by the A field. Otherwise, the operation is the same as LEO.

SECTION 4

DCP DISPLAY PANEL AND MAINTENANCE AIDS

GENERAL.

DISPLAY PANEL (figure 4-1).

The DCP display panel is mounted in the same cabinet as the DCP. The display panel and DCP are interconnected with six cables. The DCP display panel has various switches and pushbutton indicators which are shared for flip-flop display.

DISPLAY MODE.

The DCP is in a display mode when the RUN flip-flop is off. In the display mode, the Display Select rotary switches select the registers or SM half-words which are displayed. The bits in a selected register or SM half-word can be manually set or reset.

OPERATING MODE.

The DCP is operating when the Run flip-flop is on. In the operating mode, the Display Select switches are not effective and bits cannot be manually set or reset.

INSTRUCTION DISPLAY.

In the display mode, the L half-word of the Instruction register (P-L) is normally connected to the 24-bit instruction display. A P-L flip-flop can be set or reset by pressing the corresponding pushbutton while holding down the BIT SET or BIT RESET button.

Exception: If the Display Type switch is in the P-R position, the R half-word of the Instruction register (P-R) is displayed in place of the L half-word. The P-R flip-flops cannot be manually set or reset.

In the operating mode, the R half-word of the Instruction register (P-R) is connected to the instruction display. The displayed information may be misleading if the instruction being executed is held for a long time; for example, an Adapter Read When Attention Needed.

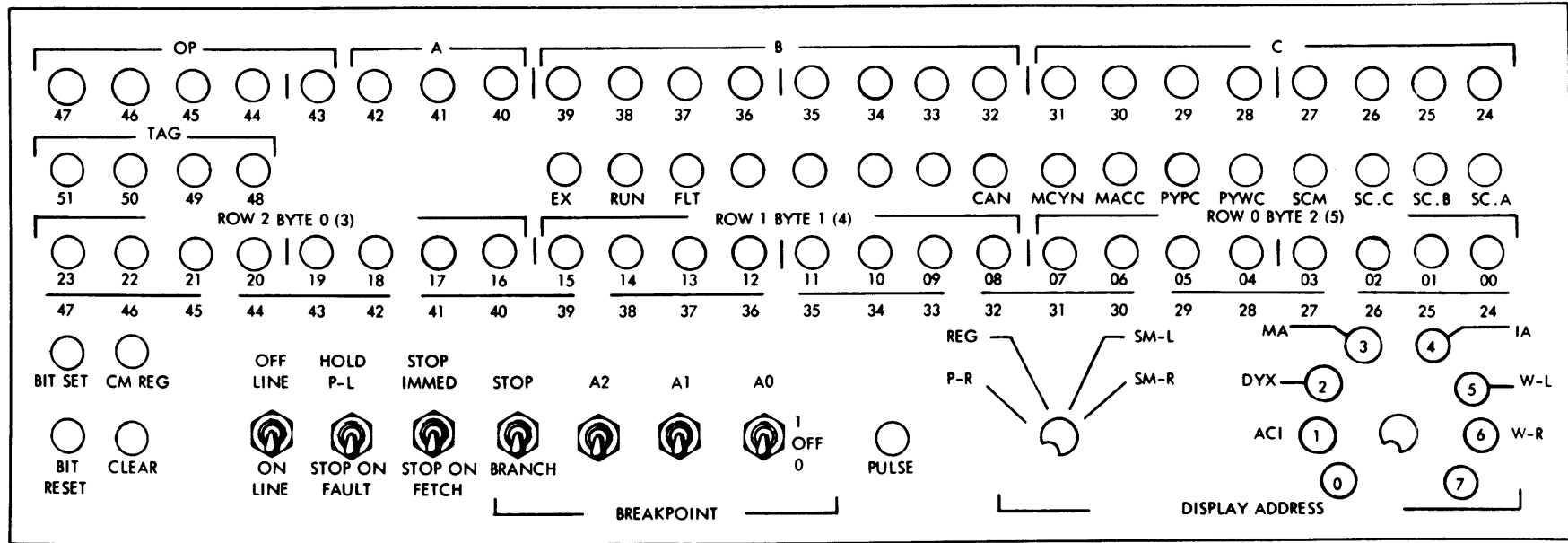

Figure 4-1. DCP Display Panel

DATA DISPLAY.

In the display mode, the register column or SM half-word which is designated by the Display Select rotary switches is connected to the 24-bit data display. A bit in the selected register or SM half-word can be manually set or reset by pressing the corresponding pushbutton while holding down the BIT SET or BIT RESET button.

Exception: If the Display Type switch is in the P-R position, nothing is connected to the data display.

In the operating mode, the D bus is connected to the data display and the pushbuttons are disabled.

TAG DISPLAY.

In the display mode, the tag field of a full word is connected to the four-bit tag display when an R half-word is selected. The bits can be manually set or reset.

Exception: If the Display Type switch is in the P-R position, the tag field of the Instruction register is displayed but the flip-flops cannot be manually set or reset.

CONTROL DISPLAY.

The state of some of the significant control flip-flops is shown by 12 control display indicators. The Execute flip-flop (EX) is the only flip-flop that can be manually set or reset (display mode only). The other pushbuttons are not connected.

EX Execute flip-flop. When on, signifies that the L half-word of the Instruction register contains an instruction to be executed.

RUN Run flip-flop. When on, orders DCP operation.

FLT Fault flip-flop. Set by a fault condition and, when on, orders fault action.

- CAN Cluster attention needed. Set by any selected cluster attention needed signal; cleared when there is no cluster attention needed signal.
- MCYN Main Memory Cycle Needed flip-flop. Set when any main memory access is needed.
- MACC Main Memory Access flip-flop. Set when any main memory is active.
- PYPC Parity P Register Check flip-flop. Set when the P register is loaded.
- PYWC Parity W Register Check flip-flop. Set when the W register is loaded from a local memory access.
- SCM Local Memory Sequence Control flip-flop. When on, selects the address in the MA registers for a local memory data access.
- SC.C Sequence Count "C" flip-flop, ORed. Indicates the C bit of either of two sequence counters, of which only one can be non-zero at a time.
- SC.B Sequence Count "B" flip-flop, ORed. Indicates the B bit of any of three sequence counters, of which only one can be non-zero at a time.
- SC.A Sequence Count "A" flip-flop, ORed. Indicates the A bit of any of three sequence counters, of which only one can be non-zero at a time.

OFF-LINE/ON-LINE SWITCH.

When the switch is in the OFF LINE position, the DCP appears not ready to any scan-out order from the main system. The other DCP operations are not affected. Main memory access requests are not inhibited, and the DCP can set the DCP Attention Needed flip-flop in the multiplexor.

When the switch is in the ON LINE position, the DCP operates normally with the main system. For completely normal on-line operation, all control switches must be off.

BIT SET BUTTON.

When the BIT SET button is held down, the indicator pushbuttons are enabled to act in the display mode as bit set buttons.

BIT RESET BUTTON

When the BIT RESET button is held down, the indicator pushbuttons are enabled to act in the display mode as bit reset buttons.

CM REGISTER BUTTON.

When depressed, the CM REG button transfers control of the 16 flip-flop Cluster Mask register to the BIT SET and BIT RESET buttons.

CLEAR BUTTON.

When depressed, the CLEAR button clears all flip-flops in the DCP. (The scratchpad memory is not cleared).

HOLD P-L/OFF/STOP ON FAULT SWITCH.

When the switch is in the HOLD P-L position, the instruction in the L half of the Instruction register is held indefinitely. After the Execute flip-flop is set, it is not reset. (Exception: a stop condition in Stop on Breakpoint.) Fetch cycles and IA count-up are inhibited. A fault condition is ignored.

When the switch is in the STOP ON FAULT position, the RUN flip-flop is cleared if a fault condition occurs. After a stop, the Execute (EX) and Fault (FLT) flip-flops are on, and P-L contains the special fault instruction.

STOP IMMED/OFF/STOP ON FETCH SWITCH.

When the switch is in the STOP IMMED position, the RUN flip-flop is cleared by every clock pulse, and the DCP operates in a single pulse mode.

Exceptions: The RUN flip-flop is not cleared during the following operations:

- a. Cluster intercommunication in process.
- b. LM data access in process.
- c. Branch Relative addition in process.
- d. Fetch cycle in process.

When the switch is in the STOP ON FETCH position, the RUN flip-flop is cleared whenever the next instruction in sequence is loaded in the L half of the Instruction register. After a stop, the Execute (EX) flip-flop is on and the new instruction is ready for execution.

BREAKPOINT CONTROL.

STOP/OFF/BRANCH SWITCH.

When the switch is in the STOP on BREAKPOINT position, the RUN flip-flop and the Execute flip-flop (EX) are cleared by the execution of a breakpoint instruction in which the A field matches the setting of the breakpoint code switches. The next fetch is inhibited and the Breakpoint instruction is left in the Instruction register.

When the switch is in the BRANCH on BREAKPOINT position, the following "enter subroutine" actions take place after the execution of a Breakpoint instruction in which the A field matches the setting of the breakpoint code switches:

- a. The contents of the MA registers are stored in the R half-word of SM word 0.
- b. The next instruction address in the IA registers is transferred to the MA registers.
- c. The branch address in the B:C fields is transferred to the IA registers.

If the branch condition is not satisfied, the next instruction in sequence is fetched.

A2, A1, A0; 1/OFF/O CODE SWITCHES.

When a switch is in the 1 position, the corresponding bit of the A field of a Breakpoint instruction must be a one to establish coincidence. When a switch is in the 0 position, the corresponding bit of the A field must be a zero to establish coincidence. When a switch is in the OFF position, coincidence with the corresponding bit of the A field is assured. Coincidence in all three positions allows breakpoint action to take place as directed by the Breakpoint Control switch.

PULSE SWITCH.

When the PULSE button is pressed, a single pulse which sets the RUN flip-flop is emitted.

DISPLAY TYPE SWITCH.

The four position DISPLAY TYPE rotary switch selects the type of information which is displayed in the display mode.

P-R POSITION.

The R half of the Instruction register (instead of the L half) is connected to the instruction display. The instruction tag field is connected to the tag display. The data display is vacant.

REG POSITION.

The register column which is designated by the DISPLAY ADDRESS switch is connected to the data display.

SM-L POSITION.

The L half of the SM word which is designated by the DISPLAY ADDRESS switch is connected to the data display.

SM-R POSITION.

The R half of the SM word which is designated by the DISPLAY ADDRESS switch is connected to the data display. The tag field of the word is connected to the TAG display.

DISPLAY ADDRESS SWITCH.

The eight-position DISPLAY ADDRESS switch designates the particular register column or SM word which is displayed in the display

mode. When the DISPLAY TYPE switch specifies SM-L or SM-R, the DISPLAY ADDRESS switch positions 0-7 give the SM word address. The DISPLAY ADDRESS switch positions select register columns as follows when the DISPLAY TYPE switch specifies REG.

Table 4-1
Register Display Selection

Position	Registers displayed
0	None
1	AA, AC, AI
2	D, Y, X
3	MA2, MA1, MA0
4	CF, IA1, IA0
5	W-L (bytes 0, 1, 2)
6	W-R (bytes 3, 4, 5, 6)
7	None

SECTION 5
ADAPTER CLUSTERS

GENERAL.

The Adapter Cluster provides interface between the Data Communications Processor and the Data Communications lines. Each adapter Cluster services a maximum of 16 lines operating simultaneously with speed ranges from 45.5 to 9600 bits per second.

The basic functions of the Adapter Cluster are:

- a. Line termination which includes scanning, clocking, and temporary storage.
- b. Character disassembly and assembly.
- c. Synchronization; both attainment and maintenance.
- d. Timer operation to maintain line discipline.
- e. Some character recognition logic (mainly synchronization characters for the various line disciplines).
- f. Provide the ability to exchange information with one DCP or two DCP's.

The Adapter Cluster block diagram is shown in figure 5-1.

CHARACTER CODES AND MESSAGE FORMATS.

The Adapter Cluster functions in a manner that makes it transparent to most character codes and all message formats. The Adapter Cluster recognizes only the SYN character in order to attain and retain synchronization when operating in the synchronous mode.

ADAPTER CLUSTER CONTROL OF THE DCP.

The Adapter Cluster is dependent upon the Data Communications Processor to provide control signals for all adapters operating within a cluster. Once an adapter operation is initiated by a DCP program, the adapter begins and continues to operate under control of the

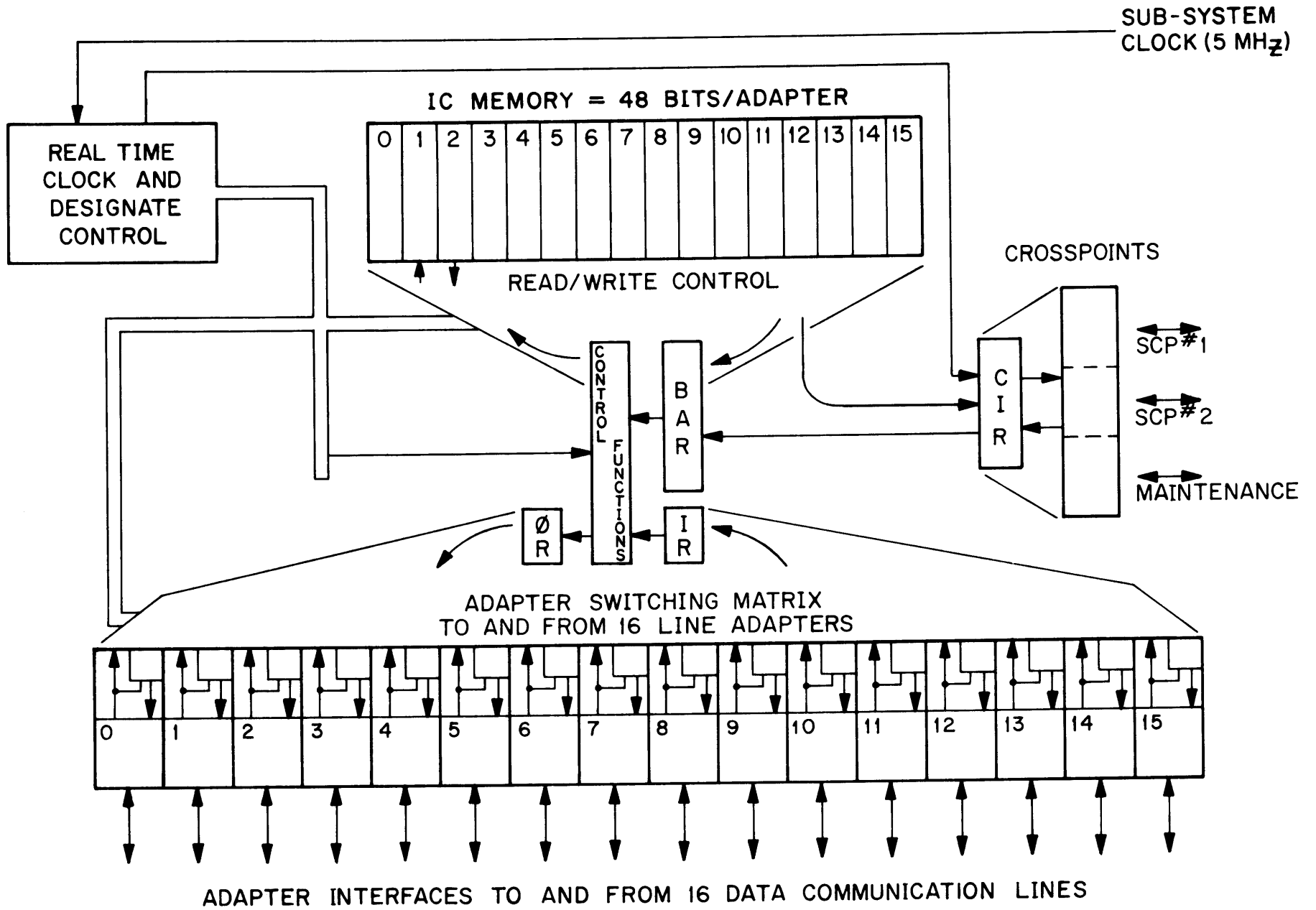

Figure 5-1. Adapter Cluster Block Diagram

Adapter Cluster until additional control is required from the DCP, in which case an interrupt is sent to the DCP.

Some of the adapter control requirements are:

- a. Ring Indicator was sensed.
- b. Data transfer requirement.
- c. Abandon Call and Retry.
- d. Loss of Carrier occurred.
- e. Buffer overflow.
- f. Time out has occurred.
- g. Break condition was sensed.
- h. Data Set went Not Ready.

TEMPORARY STORAGE CAPABILITY OF THE ADAPTER CLUSTER.

The Adapter Cluster provides a two-character minimum storage for each adapter or data line that it services.

The Adapter Cluster also provides for temporary storage of control status information for each adapter.

The Adapter Cluster provides each of the 16 adapters with a 56-bit word for temporary storage of data and control status information.

ORGANIZATION OF THE ADAPTER CLUSTER.

The Adapter Cluster is subdivided into control sections. These sections are associated with individual data lines (adapters) or all data lines (adapters).

Sections associated with individual data lines (unique to one line) are:

- a. Integrated circuit memory words.
- b. Adapters.

Sections associated with all data lines (time-shared by all lines) are:

- a. Cluster interface.

- b. Registers.
- c. Clock and Adapter Designate control.
- d. Bar-Field sensing and control logic.
- e. Read/Write control.
- f. Adapter Switching Matrix.

CLUSTER INTERFACE.

This interface is time-shared by all of the adapters in the Adapter Cluster. It interfaces both control and data information between the Adapter Cluster and either the DCP or the Cluster Display (figure 5-2).

These control signals are described as follows:

NOTE

Signals that apply to the DCP also apply to the Cluster Display.

CONTROL SIGNALS FROM DCP TO ADAPTER CLUSTER.

DESIGNATE (DES). When on, the Designate signal indicates that the DCP is executing an Adapter Read, an Adapter Write, or an Adapter Interrogate for the Adapter Cluster addressed by AA [7:4] of the DCP.

NOTE

There is a separate DES signal for each Adapter Cluster.

CLUSTER WRITE (CWR). When on, the Cluster Write signal indicates that the DCP is executing an Adapter Write or the write phase of the Adapter Interrogate. The Cluster Write signal is significant only when the Designate signal is on also.

CLEAR (CLR). When on, the Clear signal orders the Adapter Cluster to clear all of its control flip-flops and go to an initialized idle state. The Clear signal is independent of the other signals and may occur at any time.

CONTROL SIGNALS FROM THE ADAPTER CLUSTERS TO DCP.

CLUSTER ATTENTION NEEDED (CAN). When on, the Cluster Attention Needed signal indicates that an Adapter Cluster is requesting an Adapter Read operation, which will cause the CAN to go off.

ACCESS GRANTED (ACG). The Access Granted signal is on for one clock period to signify that a designated Adapter Cluster is either accepting output information from the DCP or is releasing information to the DCP.

HOLD (HLD). When on, the Hold signal causes the DCP to retain its Adapter Write or Adapter Interrogate in anticipation of the ACG signal coming on. If neither the HLD or ACG signal comes on during the execution of the above instructions, a fault interrupt occurs in the DCP signifying "adapter not present".

INFORMATION SIGNALS.

The information signals are transmitted in either direction in a half-duplex mode. When a CWR is on, information travels from the DCP to the designated Adapter Cluster. When CWR is off, information travels from the designated Adapter Cluster to the DCP. There is a one clock period turn-around time.

ADAPTER ADDRESS (AA0, AA1, AA2, AA3). The Adapter Address signals carry the adapter address between AA [3:4] in the DCP and the Adapter Cluster.

ADAPTER CONTROL (AC0, AC1, AC2, AC3, AC4). The Adapter Control signals carry control codes specifying the Adapter Cluster operations between AC [4:5] in the DCP and the designated Adapter Cluster.

ADAPTER INFORMATION (AI0, AI1, AI2, AI3, AI4, AI5, AI6, AI7, AI8). The Adapter Information signals carry data on control information depending on the setting of Adapter Control between AI [8:9] in the DCP and the Adapter Cluster. AI8 is used to carry the parity bit if the information is data.

REGISTERS.

ACCESS CONFIRM REGISTER (AC).

This six-bit register contains a four-bit adapter address, an occupied bit, and a program timer interrupt bit. This register addresses the adapter for which the DCP or Cluster Display has just serviced a CAN. The occupied bit is on until BAR clears the interrupt bit in the related cluster memory word. The program timer interrupt bit is used to differentiate the program timer interrupt from all the other interrupts.

CLUSTER INTERFACE REGISTER (CIR).

The Cluster Interface register is connected to the DCP and the Cluster Display via the Cluster Interface. The CIR register provides for information (control or data) transfer between the Cluster Memory and the DCP or Cluster Display.

This 20-bit register is divided into four fields (figure 5-2) which are:

CIR STATE (CS). This two-bit field is sensed and controlled by the Adapter Cluster and Cluster Interface (table 5-1).

Table 5-1
CIR Current Status

CS1	CS0	CIR State
0	0	Not occupied.
0	1	Occupied with information for the DCP or for the Cluster Display.
1	0	Occupied with information for the Adapter Cluster (BAR).
1	1	Master Clear occurred.

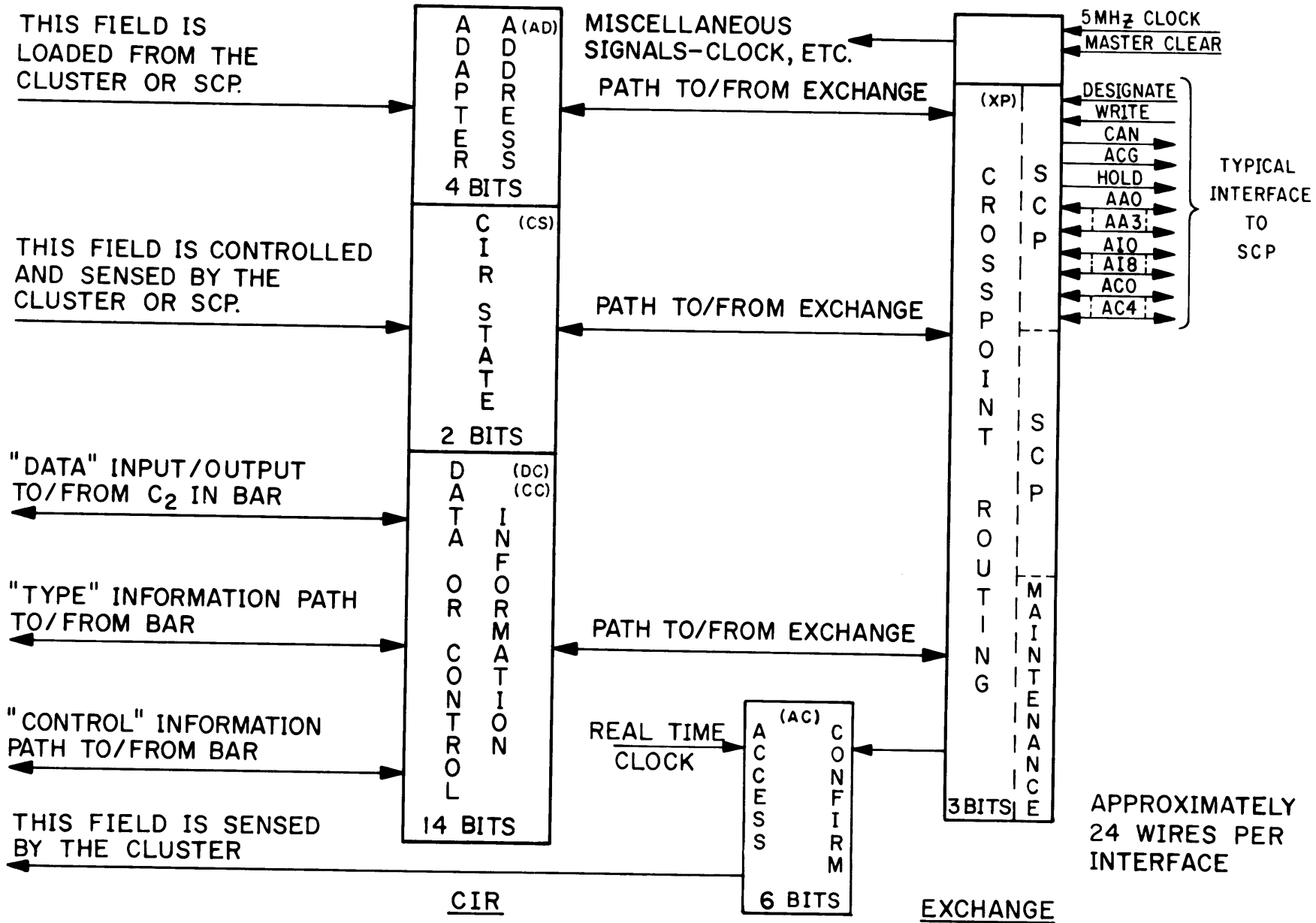

Figure 5-2. Adapter Cluster Interface

ADAPTER ADDRESS (AD). This four-bit field receives information from the Cluster Interface and the Adapter Designate Control section of the Adapter Cluster. The address of an adapter within the Adapter Cluster is contained in this field.

NOTE

The Cluster Interface selects the information for AD from AA [3:4] in the DCP or from the Cluster Display.

CLUSTER CONTROL (CC). This five-bit field receives information from the Cluster Interface, Buffer Associative register, and the Cluster Memory. Multiple paths exist between this field, BAR and Cluster Memory. This field carries only control information.

NOTE

The Cluster Interface selects the information for CC from AC in the DCP or from the Cluster Display.

DATA OR CONTROL (DC). This nine-bit field receives information from the Cluster Interface and the Cluster Memory. Multiple paths exist between this field, BAR, and Cluster Memory. This field carries control or data information as determined by CC.

NOTE

The Cluster Interface selects the information for DC from AI in the DCP or from the Cluster Display.

CIR PRIORITY.

The lower-numbered adapter positions take priority over the higher numbered adapters in CIR i.e., a CAN for adapter four overwrites a CAN for adapter five in CIR. Also, data has priority over control information. And, output to CIR has priority over a CAN from that CIR.

CROSSPOINT REGISTER (XP).

This three-bit register uses a single bit to designate the unit

communicating with the Cluster Interface. There is one bit each for DCP 1, DCP 2, or the maintenance display (Cluster Display). Only one bit will be on at a time.

BUFFERS ASSOCIATIVE REGISTER (BAR).

This 56-bit register is the heart of the Adapter Cluster. All transfer of control information and data between the adapters and the Cluster Memory is through this register. This register is time-shared by all adapters continuously. The contents of this register are changing with every clock time as a result of sensing changes on paths to CIR, the Adapter Switching Matrix, and Read/Write control.

BAR is divided into eight fields as shown in figure 5-3. These fields are:

CHARACTER ONE (C1). This 11-bit field can accept a bit or character from the Adapter Switching Matrix or send one to it. Various paths to Cluster Memory are necessary to implement the basic control of this field. There is a path that shifts the entire field one bit position. There is a path which shifts the C1 field content to the Character Two field position within the buffer.

NOTE

This field includes start and stop bits of the character when applicable.

CHARACTER TWO (C2). This ten-bit field can accept a character from the DC field in the CIR register or send one to it. This field contains eight character bits, one parity bit, and an occupied bit. Various paths are necessary to implement the basic control of this field. There is a path which shifts the C2 field contents to the Character One field position within the buffer.

BIT TIMER (BT). This seven-bit field is used for information strobing within the Adapter Cluster. It is used for both synchronous and asynchronous adapter operation. During asynchronous

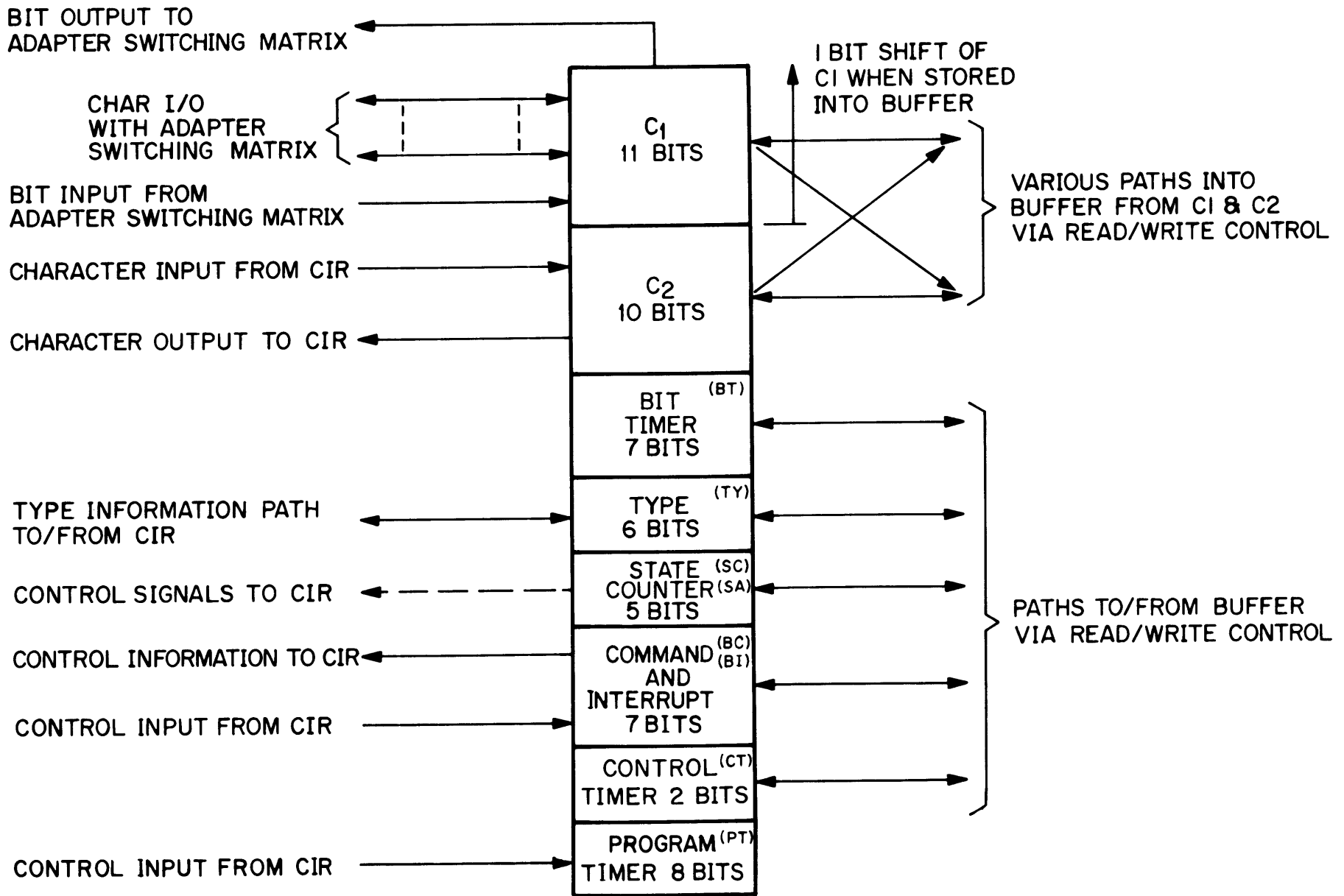

Figure 5-3. Buffers Associative Register (BAR)

operation, this field is basically an extension of the clock counter of the Clock Generation section of the cluster. During synchronous adapter operation, this field senses the clock lines of the Data Sets through the adapter and the Adapter Switching Matrix of the cluster. In either case, this field provides control signals for the adapter and the C1 field.

TYPE (TY). This six-bit field is used for basic control purposes within the Adapter Cluster. It provides for Type information transfer to or from the CIR register DC field. The information within this field defines the type of adapter being serviced with each buffer access. The sixth bit, Force Image Path (FIP), is used to signal BAR that it should not perform any functions on data except to return the current data to the appropriate word in Cluster Memory unchanged.

The Type field designations are given in table 5-2. Tables 5-3, 5-4, 5-5, and 5-6 define the A, B, and C terms found in table 5-2.

Table 5-2
Type Field Designations

TY4	TY3	TY2	TY1	TY0	Adapter Type
0	0	0	0	0	Unused
0	0	0	0	1	Unused
0	0	0	1	A0	Touch-Tone
0	0	1	0	0	Reserved
0	0	1	0	1	Voice Response Single Light
0	0	1	1	0	Unused
0	0	1	1	1	Automatic Calling Unit
0	1	B2	B1	B0	Synchronous
1	C3	C2	C1	C0	Asynchronous

Table 5-3
Touch-Tone Attended Light Control

AO	Description
0	Turns Data Set Attended light off.
1	Turns Data Set Attended light on.

Table 5-4
Synchronous Specifications

B2	B1	B0	Character Size	Sync Pattern
0	0	D0	9	011010000
0	1	D0	9	010011000
1	0	D0	8	01101000
1	1	D0	7	1010110

Table 5-5
Sync Editing

D0	Receive Mode	Transmit Mode
0	Edit all sync characters.	Inhibit Sync Fill interrupt.
1	Inhibit sync character editing: <ul style="list-style-type: none"> a. After first two sync characters. b. After Initiate Receive mode. 	Enable Sync Fill interrupt. (See Buffer interrupt.)

NOTE

Sync Fill occurs when necessary. The Sync Fill interrupt indicates that a Sync Fill has occurred.

Table 5-6
Asynchronous Specifications

C3	C2	C1	C0	BPS	Character Size	Unit Size
0	0	0	0	Unused	-	-
0	0	0	1	45.5	5	7.5
0	0	1	0	56.9	5	7.5
0	0	1	1	75	5	7.5
0	1	0	0	110	8	11
0	1	0	1	134.5	7	9
0	1	1	0	150	8	10
0	1	1	1	300	8	10
1	0	0	0	600	8	10
1	0	0	1	1200	8	10
1	0	1	0	1200	4	6
1	0	1	1	1800	8	10
1	1	0	0	2400	8	10
1	1	0	1	3600	8	10
1	1	1	0	4800	8	10
1	1	1	1	9600	8	10

STATE COUNTER (SC) AND STATE COUNTER AUXILIARY (SA). The two-bit SC field is used for sequence controlling within the Adapter Cluster. Along with the BC field of BAR, SC is used to define the existing state of an adapter as it is serviced with each buffer access. The three-bit SA field is used to buffer interrupt conditions before they are encoded into the BI field of BAR.

BAR COMMAND (BC). This three-bit field reflects and specifies the current command to the related adapter. These commands are specified in table 5-7 and described in the paragraphs that follow the table.

Table 5-7
BAR Commands

BC [2:3]	Operation
0 0 0	Out of service.
0 0 1	Look for CE (ring indicator).
0 1 0	Receive Ready.
0 1 1	Initiate Receive Ready.
1 0 0	Transmit Ready.
1 0 1	Initiate Transmit mode.
1 1 0	Finish Transmit.
1 1 1	Break.

Out Of Service.

Adapter is not ready and all interrupts for that adapter are inhibited.

Look For CE.

The adapter will notify the data set to become ready to answer a call and interrupt the system when the call is answered.

Receive Ready.

The adapter is in a status to receive data. This is not a software operation. It is the result of a completed Initiate Receive mode.

Initiate Receive Mode.

This operation initializes the line to Receive then goes to Receive Ready, barring no complications.

Transmit Ready.

The adapter is in a status to transmit data. This is not a software operation. It is the result of a completed Initiate Transmit mode.

Initiate Transmit Mode.

This operation initializes the line to Transmit status and then goes to Transmit Ready, barring no complications.

Finish Transmit.

This operation causes the adapter to leave Transmit mode and enter Initiate Receive mode and continues to Receive mode as in Initiate Receive mode.

Break Transmit.

This operation transmits a Break condition on the related line.

BAR INTERRUPT (BI). This four-bit field, in conjunction with BC, indicates the status of the various interrupts generated by the Adapter Cluster. These interrupts are designated in table 5-8 and described in the paragraphs that follow the table.

NOTE

Normally these interrupts will appear in the AI register when AC = 00010.
(See instruction codes.) However, they can be interrogated to determine the current status of an adapter.

For all of the interrupts with a BI of C or greater, there is a three-second wait (CID BUFF) which gives the program (DCP) time to respond to the condition before the interrupt is generated again.

Idle.

This indicates that the related adapter has no interrupts.

Idle Buffer.

This indicates that the related adapter has had an interrupt of the BI = C, D, E, or F within the last three seconds. If BC/BI is not

Table 5-8
BAR Interrupts

BC:BT	Asynchronous	Synchronous	Automatic Calling Unit	Teletype	Voice Response
1:0	IDLE	IDLE	IDLE	IDLE	IDLE
1:1	ID BUFF	ID BUFF	ID BUFF	ID BUFF	ID BUFF
1:F	RING IND	RING IND	PROG ERROR	RING IND	PROG ERROR
3:0	IDLE	IDLE	IDLE	IDLE	IDLE
3:1	ID BUFF	ID BUFF	ID BUFF	ID BUFF	ID BUFF
3:3	DATA PRESENT	DATA PRESENT		DATA PRESENT	
3:6	REC STATUS	REC STATUS		REC STATUS	
3:7	ICTO	3 SEC NO SYNC			
3:8	STOP BIT ERROR				
3:9	BUFF OVFLW	BUFF OVFLW		BUFF OVFLW	
3:A	30 SEC RNWY	30 SEC RNWY	PROG ERROR	30 SEC RNWY	PROG ERROR
3:B	3 SEC NT RDY	3 SEC NT RDY	PROG ERROR	3 SEC NT RDY	PROG ERROR
3:C	BREAK				
3:D	DISCONNECT				
3:E	CF←OFF	CF←OFF			
3:F	CC←OFF	CC←OFF		CC←OFF	
5:0	IDLE	IDLE	IDLE	IDLE	IDLE
5:1	ID BUFF	ID BUFF	ID BUFF	ID BUFF	ID BUFF
5:2	BYTE REQ	BYTE REQ	BYTE REQ	BYTE REQ	BYTE REQ
5:9		SYNC FILL		VR ENABLE	BUFF EMPTY
5:A	BYTE REQ BK UP	BYTE REQ BK UP	BYTE REQ BK UP	BYTE REQ BK UP	BYTE REQ BK UP

Table 5-8 (cont)
BAR Interrupts

BC:BT	Asynchronous	Synchronous	Automatic Calling Unit	Teletype	Voice Response
5:B	3 SEC NT RDY	3 SEC NT RDY	3 SEC NT RDY	3 SEC NT RDY	3 SEC NT RDY
5:C	BREAK	SB←ON	ACR←ON		
5:D	DISCONNECT		COS+DLO ←OFF		
5:E	CB←OFF	CB←OFF	COS←ON		
5:F	CC←OFF	CC←OFF	PWI←OFF	CC←OFF	RDY←OFF
7:0	IDLE	IDLE	IDLE	IDLE	IDLE
7:1	ID BUFF	ID BUFF	ID BUFF	ID BUFF	ID BUFF
7:F	BREAK CMPLT	BREAK CMPLT	PROG ERROR	PROG ERROR	PROG ERROR

serviced within these three seconds since the original interrupt, it will occur again if the interrupt condition still exists.

Three Second Not Ready (Receive).

This indicates that the data set interface has gone into Receive mode or Finish Transmit.

Break.

This indicates line spacing (Break) has been received on the line.

Disconnect.

This indicates that the data set went "On Hook".

CF←Off.

This indicates that the Data Carrier Detector is no longer being received, i.e., carrier from remote data set is lost.

CC-Off.

This indicates that the data set is no longer in the data mode.

Byte Request Back Up.

This indicates that no byte has been received from the DCP for 30 seconds after the AC byte request.

Three Second Not Ready (Transmit).

This indicates that the data set has not gone into the Transmit mode within three seconds after the Initiate Transmit Mode.

CB-Off.

This indicates that the Clear to Send signal is no longer on, i.e., the data set is no longer prepared to send data.

Ring Indicator.

This indicates that the data set associated with the related adapter is ringing.

Data Present.

This indicates that there is a full data character present in C2 for the related adapter. This will normally be seen in the AC register as 00001.

Byte Request.

This indicates that C2 is empty and that another output character is required. This will normally be seen in the AC register as 01001.

Receive Status.

This indicates that the adapter has successfully entered Receive mode after a Finish Transmit request.

Input Character Time Out (ICTO).

This indicates that no new character has been received for three seconds since the last character was received.

Stop Bit Error.

This indicates that there was a Stop bit error, i.e., it did not arrive.

Buffer Overflow.

This indicates that C2 was filled, C1 was filled and more data is being received, i.e., data is lost.

30 Second Runaway.

This indicates that 30 seconds has passed since the beginning of the first character in Receive mode or the last 30 Second Runaway.

Break Complete.

Break (two spacing characters) has been sent out by the adapter.

Three Seconds No Sync.

This indicates that there have been no initial sync characters within three seconds.

Sync Fill.

This, if enabled, indicates that there has been sync fill in Transmit mode.

SB←On.

This indicates that Supervisory Received Data is on, i.e., the reverse channel is sensing data.

Program Error.

This indicates an undefined operation has been requested.

ACR←On.

This indicates that Abandon Call and Retry has come on, i.e., time out after sending digit because of no response.

COS + DLO←Off.

This indicates that Data Line Occupied went off and the related data set did not go into the data mode.

COS←On.

This indicates that the related data set has gone into the data mode.

PWI←Off.

This indicates that Power is off at the ACU.

VR Enable.

This indicates that the related VRU may be used to transmit.

Buffer Empty.

This indicates that a Finish Transmit request is complete.

RDY-Off.

This indicates the VRU is not ready.

CONTROL TIMER (CT). This two-bit field is used to generate timing for a particular line discipline if it is required, i.e., poll or select time out.

PROGRAM TIMER (PT). This eight-bit field is used to count a certain prespecified amount of time and give an interrupt after the time has elapsed. After the interrupt PT = 11111111. PT [7:3] specifies the period of the clock as shown below. PT [4:5] specifies the number of periods, PT [7:3], required for the desired time delay. If PT [4:5] is zero, the Program Timer interrupt will occur immediately. If PT [4:5] is 31, the timer will be disabled. To minimize the error in the total time, use the period related to the range within which the desired time falls.

Table 5-9
PT Time Periods

Range (to minimize error) Microseconds	Period (microseconds)	PT [7:3]
.0064 - .192	.0064	000
.192 - 1.536	.0512	001
1.536 - 12.228	.4096	010
12.228 - 98.1	3.27	011
98.1 - 786.	26.2	100
786. - 6291.	209.7	101
6291. - 50310.	1677.	110
50310. - 402630.	13421.	111

NOTE

CT is disabled whenever
PT is not disabled.

INPUT REGISTER (IR).

This ten-bit register carries the input status and information from the adapter currently being serviced (figure 5-1).

OUTPUT REGISTER (OR).

This six-bit register carries the output status and information to the currently serviced adapter (figure 5-1).

READ/WRITE TIMER REGISTER.

This 26-bit register is the basic five megaHertz clock for the Adapter Cluster and is divided into two fields (See figure 5-4).

SCAN COUNTER. These four bits provide three operations when addressing the adapters:

- a. Scan each adapter to perform the operation requested by the BAR translation of the Cluster Memory word.
- b. Transfer information from CIR to BAR when these four low-order bits in RT match AD in the CIR register.
- c. Address a particular Cluster Memory word for the Read/Write control logic.

REAL TIME COUNTER. These 22 bits are used for timing the necessary clocks during the transmission and reception of asynchronous data for the various adapters via the BT field and for clocking the timer in the CT and PT fields.

MAINTENANCE REGISTER (MR).

To be specified.

CLUSTER MEMORY.

The Adapter Cluster Memory is a 56-bit, 16-word, integrated circuit memory. One word is assigned to each of the 16 adapters. The bit

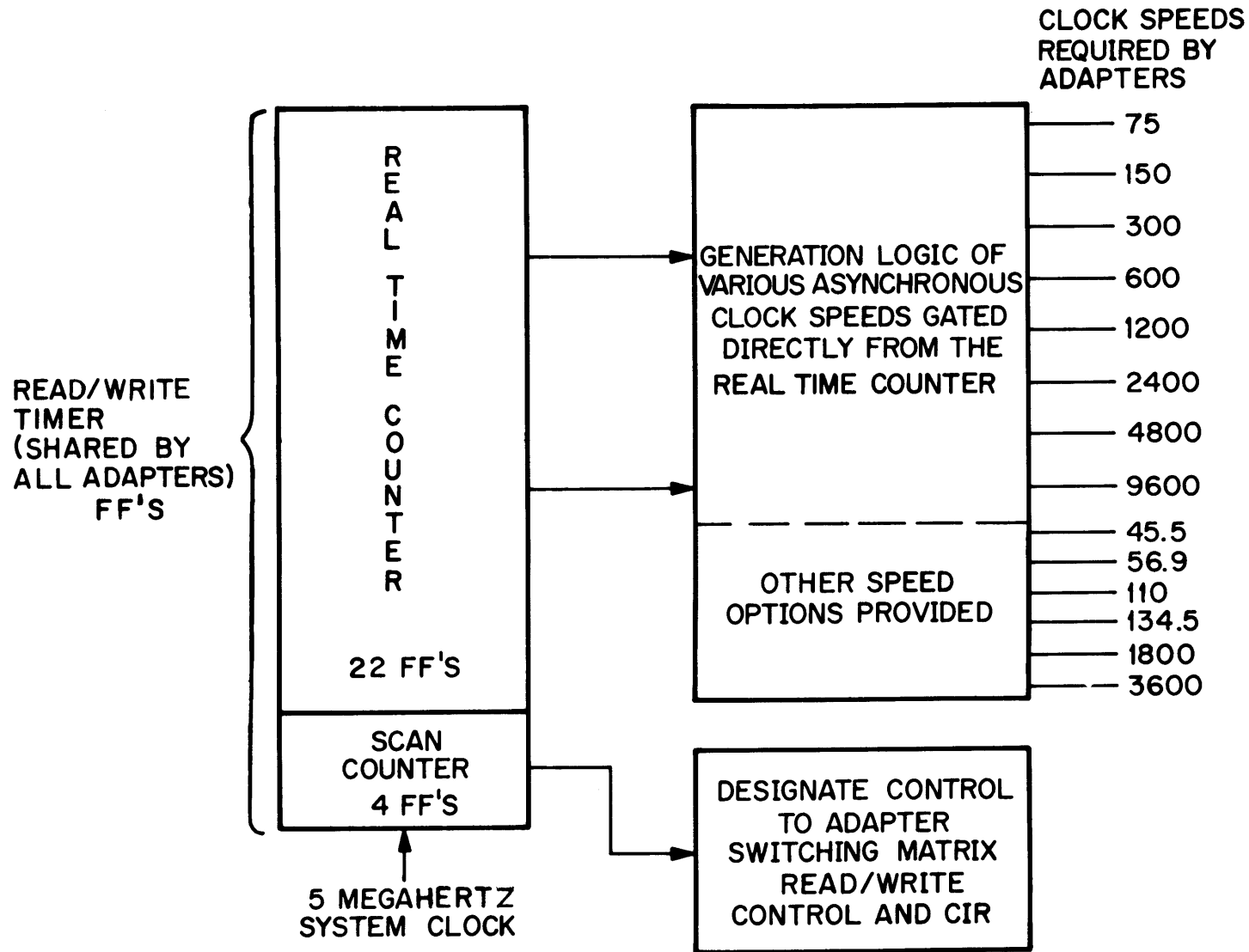

Figure 5-4. Clock Generator Within the Cluster for Asynchronous Operation

configuration within each word is identical to that which is specified for BAR. BAR is the source for information stored in the Cluster Memory and the destination for the information read out of Cluster Memory. Basic read and write times are 50 nanoseconds and are done simultaneously on consecutive words where word zero follows word 15 i.e., circular operation.

CONTROL FUNCTIONS.

This section contains the logic for driving most of the functions of the Adapter Cluster. It uses the contents of the different fields of BAR to specify the operations required of the data in BAR and IR. And finally, the results of these operations are directed back into the Cluster Memory or OR.

READ/WRITE CONTROL SECTION.

This section contains the control logic for simultaneous read and write cycles of the Cluster Memory words. The operation allows an adapter word to be written into the Cluster Memory as another adapter word is read from the Cluster Memory.

ADAPTER SWITCHING MATRIX SECTION.

This section contains designate control logic for the individual adapters. The designation generated within this section allows the adapters to time-share common busses for IR and OR.

DATA AND INSTRUCTION FORMATS.

The data and instruction formats are defined in relation to the Cluster Interface register (CIR) CC and DC fields.

DATA FORMATS.

The following data formats are shown in relation to the DC field of the CIR register. Unspecified bits of the DC field are always equal to zero. The least significant bit is found in bit position zero in all cases. See figures 5-5 through 5-11.

8 7 6 5 4 3 2 1 0 Bit designation.

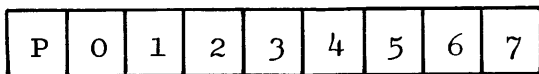

[8:1] = Parity bit.

[7:8] = Data bits.

Figure 5-5. EBCDIC Coded Data (Character)

8 7 6 5 4 3 2 1 0 Bit designation.

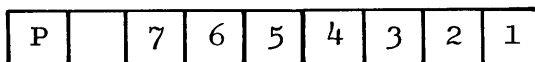

[8:1] = Parity bit.

[6:7] = Data bits.

Figure 5-6. USASCII Coded Data (Character)

8 7 6 5 4 3 2 1 0 Bit designation.

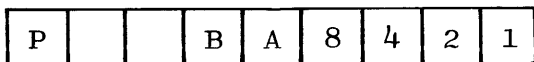

[8:1] = Parity bit.

[5:6] = Data bits.

Figure 5-7. BCL Coded Data (Character)

8 7 6 5 4 3 2 1 0 Bit designation.

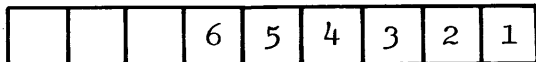

[5:1] = Shift bit.

[4:5] = Data bits.

Figure 5-8. BAUDOT Coded Data (Character)

8 7 6 5 4 3 2 1 0 Bit designation.

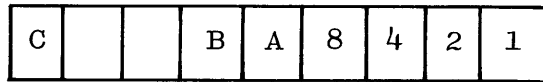

[8:1] = Parity bit.

[5:6] = Data bits.

Figure 5-9. PTT CODE/6 Coded Data (Character)

8 7 6 5 4 3 2 1 0 Bit designation.

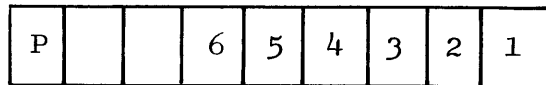

[8:1] = Parity bit.

[5:6] = Data bits.

Figure 5-10. XS-3 Coded Data (Character)

8 7 6 5 4 3 2 1 0 Bit designation.



[3:4] = Data bits.

Figure 5-11. Burroughs Numeric Coded Data (Character)

INSTRUCTION CODES.

There are three groups of instruction codes that may be used on the Adapter Cluster. They are the Write, Interrogate, and Interrupt instruction codes. These are used to construct and monitor the various fields in BAR and IR.

WRITE INSTRUCTIONS.

These instructions are used to fill or initialize the different fields of BAR, IR, and MR. Normally, only TY, C2, BC, and PT will

be used by the software. The other writes are provided for hardware maintenance and testing. The codes and fields used to write data are listed in table 5-10. CWR = 1 for these instructions.

Table 5-10
Write Codes and Formats

Write	AI [8:9]	AC [4:5]
TY	000 FIP TY [4:5]	00000
C2 (Data)	C2 [8:9]	0a001
BC/BI	00 BC [2:3] BI [3:4]	00010
SC/SA	00 C110 C100 SC [1:2] SA [2:3]	00011
CT/BT	CT [1:2] BT [6:7]	00100
C1	C1 [9:9]	00101
IR	IR [8:9]	0b110
MR	00 MR [6:7]	00111
BC*	00 BC [2:3] 0000	01010
PT	0 PT [7:8]	01011

a = C2 occupied bit b = IR9

* This write is the same as the BC/BI write except that the times in BAR are initialized, TY is left unchanged, BC is set as specified, and the other fields are zeroed.

INTERROGATE INSTRUCTIONS.

These instructions are used in conjunction with AWRR in the DCP to interrogate the different fields of BAR, IR, and MR. Before the interrogate, AC is specified as in table 5-11. This causes the Adapter Cluster to read the desired field and transfer the information to the AI register in the DCP for the responsive read portion of the AWRR. CWR = 1 for the write portion of the interrogate; CWR = 0 and CAN = 1 for the responsive read.

Table 5-11
Interrogate Codes and Formats

Interrogate	AI [8:9]	AC [4:5]
TY	000 FIP TY [4:5]	10000
C2	C2 [8:9]	1a001
BC/BI	00 BC [2:3] BI [3:4]	10010
SC/SA	00 C110 C100 SC [1:2] SA [2:3]	10011
CT/BT	CT [1:2] BT [6:7]	10100
C1	C1 [9:9]	10101
IR	IR [8:9]	1b110
MR	00 MR [6:7]	10111
C2 clear**	C2 [8:9]	11001
BC/BI control*	00 BC [2:2] 1 BI [3:4]	11010
OR	000 OR [5:6]	11111

a = C2 occupied (zero before interrogate)

b = IR9 (zero before interrogate)

* This interrogate is identical to the BC/BI interrogate except that BCO is set to one forcing a BC/BI interrupt condition for the software.

INTERRUPT INSTRUCTIONS.

These instructions are not programmatic and are the result of specific hardware conditions in the Adapter Cluster. When any of these interrupts occur, CWR = 0 and CAN = 1.

DATA PRESENT. This indicates that C2 has a complete character ready to be read in by the DCP. This requires a reading or clearing of C2.

BC/BI. This indicates that there was a BAR interrupt. BI will

have to be analyzed to determine the cause of the interrupt (see BAR interrupt).

Table 5-12
Interrupt Codes and Formats

Interrupt	AI [8:9]	AC [4:5]
Data Present	C2 [8:9]	00001
BC/BI	00 BC [2:2] 1 BI [3:4]	00010
Byte Request	0 0 0 0 0 0 0 0	01001
PT	0 0 0 0 0 0 0 0	01011

BYTE REQUEST. This indicates that C2 is empty and that it has been shifted to C1 where it is being transmitted. Therefore, another character is required for transmission.

PT. This indicates that the desired total time period as originally specified in PT has elapsed (see program timer).

CHARACTER SYNCHRONIZATION.

The Adapter Cluster provides for both asynchronous and synchronous transmission of characters over the communication lines. Asynchronous transmission makes use of start-stop synchronization to identify the bits on the line. Synchronous transmission makes use of bit or character patterns to attain or retain synchronization on the line. The specified pattern (sync pattern) is dependent upon the line discipline being used on a line. The sync pattern precedes the transmission of a message and may be interspersed with the transmission of a message.

SERIALIZATION AND DESERIALIZATION OF DATA.

The Adapter Cluster provides for serial-by-bit or parallel-by-bit transmission of characters over communications lines. Within the

cluster, characters are transferred parallel-by-bit, adding or deleting bits as required for the various line disciplines.

CHARACTER FORMATS ON COMMUNICATION LINES.

The Adapter Cluster handles the following character formats on the communication lines as shown in figures 5-12 through 5-19.

SERIAL-BY-BIT CHARACTER FORMATS.

START-STOP SIX UNIT CHARACTER. Transmission speed is 1200 bits per second.



Figure 5-12. Six Unit Character

START-STOP 7.5 UNIT CHARACTER. Transmission speeds of 45.5, 56.9 and 75 bits per second.

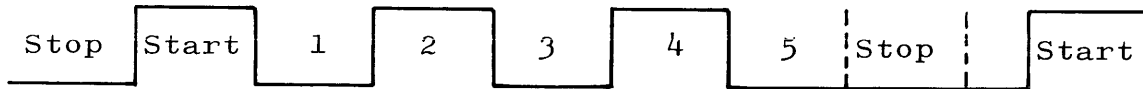

Figure 5-13. 7.5 Unit Character

START-STOP NINE UNIT CHARACTER. Transmission speed of 134.5 bits per second.

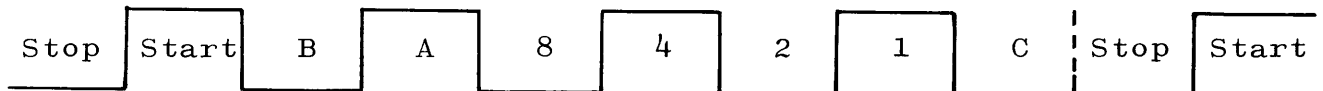

Figure 5-14. Nine Unit Character

START-STOP TEN UNIT CHARACTER. Transmission speeds of 150, 300, 600, 1200, 1800, 2400, 3600, 4800, and 9600 bits per second.

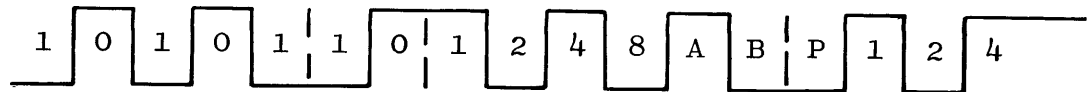

Figure 5-19. Seven-Bit Character Sync Pattern

PARALLEL-BY-BIT CHARACTER FORMATS.

DIALING DIGIT BITS (OUTPUT). Transmission speed is controlled by the Automatic Calling Unit.

Number Bit 1	-----
Number Bit 2	-----
Number Bit 4	-----
Number Bit 8	-----

TOUCH TONE CHARACTER 4 BITS (INPUT). Transmission speed is a maximum of 14 input characters per second.

-----	Bit 1
-----	Bit 2
-----	Bit 3
-----	Bit 4

SECTION 6

CLUSTER DISPLAY PANEL AND MAINTENANCE AIDS

GENERAL.

The Cluster Display Panel is independent of the data communications system. It may be temporarily connected to groups of up to 16 Adapter Clusters for maintenance purposes. The Cluster Display has various switches and push-button indicators which are used to provide full control capabilities of the cluster interface in the same way a DCP controls the cluster interface (figure 6-1).

OPERATION.

This display may be used interactively while the Adapter Cluster is also being used by the data communications system (DCP). The Cluster Display contends for the Adapter Cluster just as does the DCP causing no timing conflicts.

The Cluster Display provides the ability to set up the A register, as does the DCP, and performs the same reads, writes, or interrogates and then looks at the results in the A register again.

SWITCHES AND INDICATORS.

SWITCHES AA7F THROUGH AA4F.

These two-position switches designate the adapter cluster address (as does the AA [7:4] register in the DCP) selected by the Cluster Display Panel.

SWITCH-INDICATORS AA3F THROUGH AAOF.

These push-button switches designate the particular adapter (as does the AA [3:4] register in the DCP) selected by the Cluster Display Panel.

SWITCH-INDICATORS AC4F THROUGH ACOF.

These push-button indicators designate the specific operation (as in the five low-order bits of the AC register in the DCP) requested by the Cluster Display Panel.

SWITCH-INDICATORS AI8F THROUGH AIOF.

These push-button indicators designate the information required as specified by the AC field (as in the AI register in the DCP) for the Cluster Display Panel.

MASTER CLEAR SWITCH.

This switch clears all of the push-button indicators to zero.

BIT RESET SWITCH.

This push-button switch, when used in conjunction with a push-button indicator, clears it to zero.

ACTION SWITCH.

This three-position switch specifies the action to be taken by the Cluster Display Panel.

NEUTRAL. No operations are initiated from the Cluster Display Panel.

RUN. The designated operation recycles until the switch is returned to NEUTRAL.

STEP. This spring-loaded position returns to NEUTRAL after permitting a single operation of the specified operation.

OPERATION SWITCH.

This five-position rotary switch provides the following functions:

INTERROGATE. A Write operation occurs using the information in the Cluster Display Panel. The Cluster Display Panel waits until a response is returned to the display push-button indicators.

WRITE. A Write operation occurs using the information in the Cluster Display Panel without waiting for a response.

CAN. Any Cluster Attention Needed signal (CAN) is serviced by the Cluster Display Panel when the switch is in this position.

EXCHANGE. This position allows monitoring the various control signals from the cluster interface by displaying them in the AI bits of the Cluster Display Panel.

LOCAL. No operations occur when the switch is in this position.

COUNT ENABLE SWITCH.

This two-position switch counts up AA3F-AA0F by one after each Cluster Display Panel operation when in the ON position. Otherwise, these bits remain unchanged.

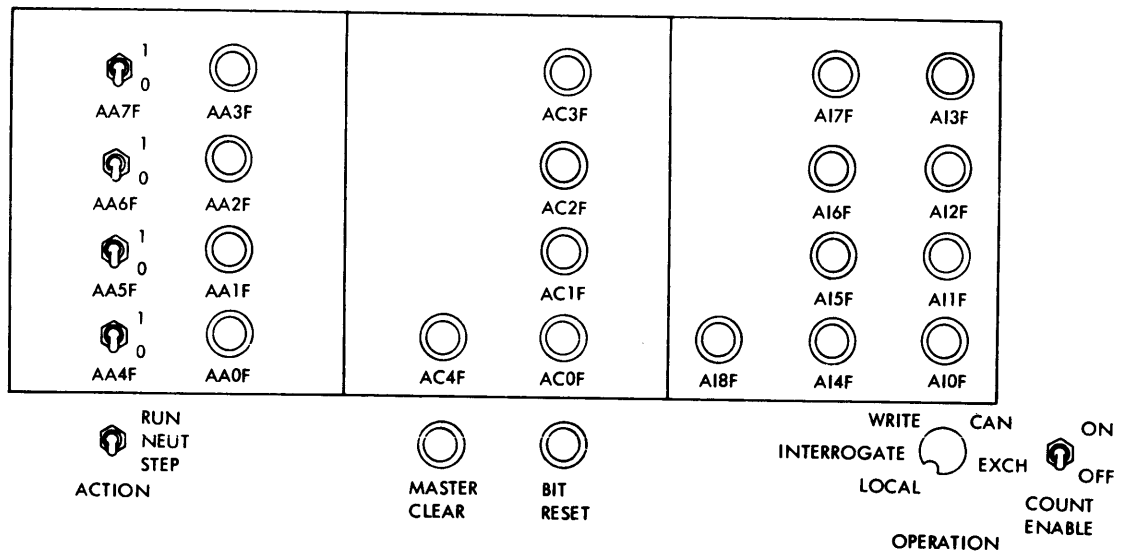

Figure 6-1. Cluster Display Panel

SECTION 7 ADAPTERS

GENERAL.

A maximum of 16 adapters can be housed in one Adapter Cluster. Each adapter exchanges bits or characters between the Adapter Cluster memory and the data lines. The temporary storage capability of the adapter ranges from one bit to two characters depending upon the type of adapter. An adapter is physically mounted on one card and included with the adapter is an etched card connector which attaches to a cable. The cable connects directly to the data set or to the remote device in the case of direct connection. The various types of adapters that are provided allow the DCP to interface with data sets, the Voice Response system and by direct connection to remote devices. The various adapters are defined below:

MODEM CONNECT ADAPTERS.

This adapter has the following characteristics:

- a. Interfaces directly with the Adapter Switching Matrix of the Adapter Cluster.
- b. Interfaces directly data sets using the RS 232 C defined interface.
- c. Accommodates either synchronous or asynchronous data transmissions.
- d. Operates in a serial-by-bit mode.
- e. Information transfer rates accommodated by this adapter range from 75 to 9600 bits per second.
 - 1) B 6650-1. Up to 600 BPS.
 - 2) B 6650-2. Up to 1800 BPS.
 - 3) B 6650-3. Up to 2400 BPS.
 - 4) B 6650-4. Up to 4800 BPS.
 - 5) B 6650-5. Up to 9600 BPS.

- f. Transmission to and from this adapter is in the half-duplex mode.
- g. The control timer of the Adapter Cluster is used in conjunction with the operation of this adapter.

DIRECT CONNECT ADAPTERS.

This adapter has the following characteristics:

- a. Interfaces directly with the Adapter Switching Matrix of the Adapter Cluster.
- b. Interfaces directly with the remote terminal using either a two-wire current or voltage interface.
- c. Accommodates asynchronous data transmission.
- d. Operates in a serial-by-bit mode.
- e. Information transfer rates range from 45.5 to 1800 bits per second.
 - 1) B 6650-1. Up to 600 BPS.
 - 2) B 6650-2. Up to 1800 BPS.
- f. Transmission to and from this adapter is in the half-duplex mode.
- g. The control timer of the Adapter Cluster is used in conjunction with the operation of this adapter.

AUTOMATIC CALLING UNIT ADAPTER.

This adapter (B 6650-8) has the following characteristics:

- a. Interfaces directly with the Adapter Switching Matrix of the Adapter Cluster.
- b. Interfaces directly with the 801 Automatic Calling Unit (ACU) types A or C.

- c. Operates in a synchronous mode.
- d. Outputs one dialing digit (character) at a time.
- e. The information transfer rate is controlled by the Automatic Calling Unit (ACU).
- f. Transmission from the adapter is always in a simplex mode.
- g. The Automatic Calling Unit specified for use with this adapter has a provision which allows the associated data set to disconnect the line.

TOUCH-TONE ADAPTER.

This adapter (B 6650-6) has the following characteristics:

- a. Interfaces directly with the Adapter Switching Matrix of the Adapter Cluster.
- b. Interfaces directly with the 403E3/403D5 data set using an EIA voltage interface.
- c. Operates in the synchronous mode on input.
- d. Receives four-bit digits (characters) from the data set in BCD code.
- e. The 14 character-per-second maximum information transfer rate is controlled by the remote station and the data set. The remote station is a touch-tone telephone pad containing 12 buttons.
- f. Transmission to the adapter is normally in a simplex mode.
- g. Two leads couple a voice output through the adapter to a telephone receiver.
- h. The control timer of the Adapter Cluster is used in conjunction with the input operation of this adapter.

- i. Houses the driving elements that control the tone control leads of the data set.

AUDIO RESPONSE ADAPTER.

This adapter (B 6650-7) has the following characteristics:

- a. Interfaces the Adapter Cluster by a special interface.
- b. Interfaces the companion adapters (B 6650-6) by the two leads which couple the voice output to the 403 Data Set.
- c. Interfaces with the Voice Response Unit using a voltage interface.
- d. Operates in synchronization with the Voice Response Unit on output.
- e. The eight-bit address sent from an adapter to the Voice Response Unit has the following format:

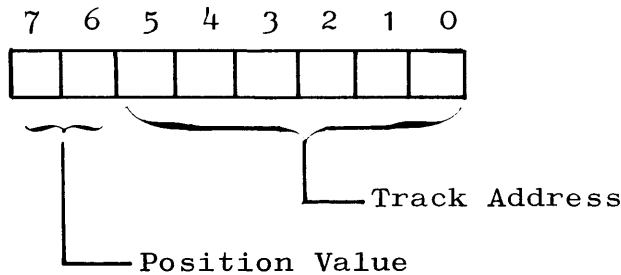

Position Value	Description
0 0	Selects next position.
0 1	Selects position 1.
1 0	Selects position 2.
1 1	Selects position 3.

Figure 7-1. Voice Response Unit Address Format

- f. The Voice Response Unit initiates an address transfer cycle with a word time pulse occurring every .5 seconds.
- g. Address bits are sent from the adapter with the high-order bit first.
- h. The adapter generates shift pulses for the serial transfer of the address.

APPENDIX A
Translation Chart EBCDIC to USASCII

EBCDIC	USASCII	EBCDIC	USASCII	EBCDIC	USASCII	EBCDIC	USASCII	EBCDIC	USASCII	EBCDIC	USASCII	EBCDIC	USASCII	EBCDIC	USASCII
00	00 NUL	10	10 DLE	20	1	30	1	40	20 SP	50	26 &	60	2D -	70	1
01	01 SOH	11	11 DC1	21	1	31	1	41	1	51	1	61	2F /	71	1
02	02 STX	12	12 DC2	22	1	32	16 SYN	42	1	52	1	62	1	72	1
03	03 ETX	13	13 DC3	23	1	33	1	43	1	53	1	63	1	73	1
04	1	14	1	24	1	34	1	44	1	54	1	64	1	74	1
05	09 HT	15	1	25	0A LF	35	1	45	1	55	1	65	1	75	1
06	1	16	08 BS	26	17 ETB	36	1	46	1	56	1	66	1	76	1
07	7F DEL	17	1	27	1B ESC	37	04 EOT	47	1	57	1	67	1	77	1
08	1	18	18 CAN	28	1	38	1	48	1	58	1	68	1	78	1
09	1	19	19 EM	29	1	39	1	49	1	59	1	69	1	79	60
0A	1	1A	1	2A	1	3A	1	4A	5B [5A	5D]	6A	7C ;	7A	3A :
0B	0B VT	1B	1	2B	1	3B	1	4B	2E .	5B	24 \$	6B	2C ,	7B	23 #
0C	0C FF	1C	1C FS	2C	1	3C	14 DC4	4C	3C <	5C	2A *	6C	25 %	7C	40 @
0D	0D CR	1D	1D GS	2D	05 ENQ	3D	15 NAK	4D	28 (5D	29)	6D	5F -	7D	27 ' ,
0E	0E SO	1E	1E RS	2E	06 ACK	3E	1	4E	2B +	5E	3B ;	6E	3E >	7E	3D =
0F	0F SI	1F	1F US	2F	07 BEL	3F	1A SUB	4F	21 !	5F	5E -	6F	3F ?	7F	22 " ,
80	1	90	1	A0	1	B0	1	C0	7B {	D0	7D }	E0	5C \	F0	30 0
81	61 a	91	6A j	A1	7E ~	B1	1	C1	41 A	D1	4A J	E1	1	F1	31 1
82	62 b	92	6B k	A2	73 s	B2	1	C2	42 B	D2	4B K	E2	53 S	F2	32 2
83	63 c	93	6C l	A3	74 t	B3	1	C3	43 C	D3	4C L	E3	54 T	F3	33 3
84	64 d	94	6D m	A4	75 u	B4	1	C4	44 D	D4	4D M	E4	55 U	F4	34 4
85	65 e	95	6E n	A5	76 v	B5	1	C5	45 E	D5	4E N	E5	56 V	F5	35 5
86	66 f	96	6F o	A6	77 w	B6	1	C6	46 F	D6	4F O	E6	57 W	F6	36 6
87	67 g	97	70 p	A7	78 x	B7	1	C7	47 G	D7	50 P	E7	58 X	F7	37 7

1 EBCDIC input codes without correspondence in USASCII are translated to USASCII 00 NULL

EBCDIC	USASCII		EBCDIC	USASCII		EBCDIC	USASCII		EBCDIC	USASCII		EBCDIC	USASCII		EBCDIC	USASCII							
88	68	h	98	71	q	A8	79	y	B8	1		C8	48	H	D8	51	Q	E8	59	Y	F8	38	8
89	69	i	99	72	r	A9	7A	z	B9	1		C9	49	I	D9	52	R	E9	5A	Z	F9	39	9
8A	1		9A	1		AA	1		BA	1		CA	1		DA	1		EA	1		FA	1	
8B	1		9B	1		AB	1		BB	1		CB	1		DB	1		EB	1		FB	1	
8C	1		9C	1		AC	1		BC	1		CC	1		DC	1		EC	1		FC	1	
8D	1		9D	1		AD	1		BD	1		CD	1		DD	1		ED	1		FD	1	
8E	1		9E	1		AE	1		BE	1		CE	1		DE	1		EE	1		FE	1	
8F	1		9F	1		AF	1		BF	1		CF	1		DF	1		EF	1		FF	1	

1 EBCDIC input codes without correspondence in USASCII are translated to USASCII 00 NULL

EBCDIC	BCL	EBCDIC	BCL	EBCDIC	BCL	EBCDIC	BCL	EBCDIC	BCL	EBCDIC	BCL	EBCDIC	BCL	EBCDIC	BCL
00	1	10	1	20	1	30	1	40	10 SP	50	30 &	60	20 -	70	1
01	1	11	1	21	1	31	1	41	1	51	1	61	11 /	71	1
02	1	12	1	22	1	32	1	42	1	52	1	62	1	72	1
03	1	13	1	23	1	33	1	43	1	53	1	63	1	73	1
04	1	14	1	24	1	34	1	44	1	54	1	64	1	74	1
05	1	15	1	25	1	35	1	45	1	55	1	65	1	75	1
06	1	16	1	26	1	36	1	46	1	56	1	66	1	76	1
07	1	17	1	27	1	37	1	47	1	57	1	67	1	77	1
08	1	18	1	28	1	38	1	48	1	58	1	68	1	78	1
09	1	19	1	29	1	39	1	49	1	59	1	69	1	79	1
0A	1	1A	1	2A	1	3A	1	4A	3C [5A	1E]	6A	1	7A	OD :
0B	1	1B	1	2B	1	3B	1	4B	3B .	5B	2B \$	6B	1B ,	7B	OB #
0C	1	1C	1	2C	1	3C	1	4C	3E <	5C	2C *	6C	1C %	7C	OC @
0D	1	1D	1	2D	1	3D	1	4D	3D (5D	2D)	6D	1	7D	1
0E	1	1E	1	2E	1	3E	1	4E	3A +	5E	2E ;	6E	0E >	7E	1D =
0F	1	1F	1	2F	1	3F	1	4F	1	5F	1	6F	00 ?	7F	1F "
80	1	90	1	A0	1	B0	1	C0	3A +	D0	2A x	E0	1	F0	0A 0
81	1	91	1	A1	1	B1	1	C1	31 A	D1	21 J	E1	1	F1	01 1
82	1	92	1	A2	1	B2	1	C2	32 B	D2	22 K	E2	12 S	F2	02 2
83	1	93	1	A3	1	B3	1	C3	33 C	D3	23 L	E3	13 T	F3	03 3
84	1	94	1	A4	1	B4	1	C4	34 D	D4	24 M	E4	14 U	F4	04 4
85	1	95	1	A5	1	B5	1	C5	35 E	D5	25 N	E5	15 V	F5	05 5
86	1	96	1	A6	1	B6	1	C6	36 F	D6	26 O	E6	16 W	F6	06 6

Translation Chart EBCDIC to BCL

APPENDIX B

B-1

1 EBCDIC input codes without correspondence in BCL are translated to BCL 00 ?
(question mark)

EBCDIC	BCL	EBCDIC	BCL	EBCDIC	BCL	EBCDIC	BCL	EBCDIC	BCL	EBCDIC	BCL	EBCDIC	BCL	EBCDIC	BCL
87	1	97	1	A7	1	B7	1	C7	37 G	D7	27 P	E7	17 X	F7	07 7
88	1	98	1	A8	1	B8	1	C8	38 H	D8	28 Q	E8	18 Y	F8	08 8
89	1	99	1	A9	1	B9	1	C9	39 I	D9	29 R	E9	19 Z	F9	09 9
8A	1	9A	1	AA	1	BA	1	CA	1	DA	1	EA	1	FA	1
8B	1	9B	1	AB	1	BB	1	CB	1	DB	1	EB	1	FB	1
8C	1	9C	1	AC	1	BC	1	CC	1	DC	1	EC	1	FC	1
8D	1	9D	1	AD	1	BD	1	CD	1	DD	1	ED	1	FD	1
8E	1	9E	1	AE	1	BE	1	CE	1	DE	1	EE	1	FE	1
8F	1	9F	1	AF	1	BF	1	CF	1	DF	1	EF	1	FF	1

1 EBCDIC input codes without correspondence in BCL are translated to BCL 00 ?
(question mark)

USASCIIT	EBCDIC	USASCIIT	EBCDIC	USASCIIT	EBCDIC	USASCIIT	EBCDIC	USASCIIT	EBCDIC	USASCIIT	EBCDIC	USASCIIT	EBCDIC	USASCIIT	EBCDIC
00	00 NUL	10	10 DLE	20	40 SP	30	FO 0	40	7C @	50	D7 P	60	79 \	70	97 p
01	01 SOH	11	11 DC1	21	4F !	31	F1 1	41	C1 A	51	D8 Q	61	81 a	71	98 q
02	02 STX	12	12 DC2	22	7F "	32	F2 2	42	C2 B	52	D9 R	62	82 b	72	99 r
03	03 ETX	13	13 DC3	23	7B #	33	F3 3	43	C3 C	53	E2 S	63	83 c	73	A2 s
04	37 ECT	14	3C DC4	24	5B \$	34	F4 4	44	C4 D	54	E3 T	64	84 d	74	A3 t
05	2D ENQ	15	3D NAK	25	6C %	35	F5 5	45	C5 E	55	E4 U	65	85 e	75	A4 u
06	2E ACK	16	32 SYN	26	50 &	36	F6 6	46	C6 F	56	E5 V	66	86 f	76	A5 v
07	2F BEL	17	26 ETB	27	7D '	37	F7 7	47	C7 G	57	E6 W	67	87 g	77	A6 w
08	16 BS	18	18 CAN	28	4D (38	F8 8	48	C8 H	58	E7 X	68	88 h	78	A7 x
09	05 HT	19	19 EM	29	5D)	39	F9 9	49	C9 I	59	E8 Y	69	89 i	79	A8 y
0A	25 LF	1A	3F SUB	2A	5C *	3A	7A :	4A	D1 J	5A	E9 Z	6A	91 j	7A	A9 z
0B	OB VT	1B	27 ESC	2B	4E +	3B	5E ;	4B	D2 K	5B	4A [6B	92 k	7B	CO {
0C	OC FF	1C	1C FS	2C	6B ,	3C	4C <	4C	D3 L	5C	EO \	6C	93 l	7C	6A !
0D	OD CR	1D	1D GS	2D	60 -	3D	7E =	4D	D4 M	5D	5A]	6D	94 m	7D	DO }
0E	OE SO	1E	1E RS	2E	4B .	3E	6E >	4E	D5 N	5E	5F ^	6E	95 n	7E	A1 ~
0F	OF SI	1F	1F US	2F	61 /	3F	6F ?	4F	D6 O	5F	6D _	6F	96 o	7F	07 DEL

NOTE: All other input codes (80 through FF) are translated to EBCDIC 00 NULL.

APPENDIX D
Translation Chart BCL to EBCDIC

B C L	EBCDIC	B C L	EBCDIC	B C L	EBCDIC	B C L	EBCDIC
00	6F ?	10	40 SP	20	60 -	30	50 &
01	F1 1	11	61 /	21	D1 J	31	C1 A
02	F2 2	12	E2 S	22	D2 K	32	C2 B
03	F3 3	13	E3 T	23	D3 L	33	C3 C
04	F4 4	14	E4 U	24	D4 M	34	C4 D
05	F5 5	15	E5 V	25	D5 N	35	C5 E
06	F6 6	16	E6 W	26	D6 O	36	C6 F
07	F7 7	17	E7 X	27	D7 P	37	C7 G
08	F8 8	18	E8 Y	28	D8 Q	38	C8 H
09	F9 9	19	E9 Z	29	D9 R	39	C9 I
0A	F0 0	1A	6F ^① ?	2A	D0 ^② }	3A	4E +
0B	7B #	1B	6B ,	2B	5B \$	3B	4B .
0C	7C @	1C	6C %	2C	5C *	3C	4A [
0D	7A :	1D	7E =	2D	5D)	3D	4D (
0E	6E >	1E	5A]	2E	5E ;	3E	4C <
0F	6F ^① ?	1F	7F "	2F	6F ^① ?	3F	6F ^① ?

NOTE: All other input codes
(40 through FF) are trans-
lated to EBCDIC 00 NUL

- ① BCL input codes without correspondence in EBCDIC are translated to EBCDIC 6F ? (question mark)
- ② Denotes "minus zero"

APPENDIX E
Instruction List

Group	Op Code	A Field	MNE	Operation
0	00000	000	IDLE	Idle
	00010	0VV	AWI	Adapter Write
	00010	1VV	AWRR	Adapter Interrogate
	00001	VVV	BKP	Stop/Branch on Breakpoint
	00011	100	SHFT	Shift MA Registers Right
	00011	101	HEYU	Set System Interrupt
	00011	000	SCMR	Set Cluster Mask Register
	00011	001	RCMR	Read Cluster Mask Register
	1	00100	000	ARWN
00100		001	ARIN	Adapter Read If Needed
00100		010	DBYZ	Decrement Branch Y Is Zero
00100		011	DBYN	Decrement Branch Y Is Non-Zero
00100		100	BRAN	Branch If System Attention Needed
00101		VVV	GOTO	Branch
00110		VVV	GOX	Branch Relative with X
00111		VVV	GOI	Branch Relative Indirect
2		01000	000	MOVE
	01000	001	LMRI	Local Memory Read Indirect
	01000	010	SMRD	Scratchpad Memory Read Direct
	01000	011	LMRD	Local Memory Read Direct
	01000	101	LMWI	Local Memory Write Indirect
	01000	110	SMWD	Scratchpad Memory Write Direct
	01000	111	LMWD	Local Memory Write Direct
	01001	001	MMR	Main Memory Read
	01001	100	MMWU	Main Memory Write Unconditional
	01001	101	MMWR	Main Memory Write Unconditional Retain Readout
	01001	110	MMPW	Main Memory Protected Write
	01001	111	MMPR	Main Memory Protected Write Retain Readout

APPENDIX E (cont)
Instruction list

Group	Op Code	A Field	MNE	Operation
3	01100	000	HAD	Halfword Add
	01101	000	HADB	Halfword Add B Literal
	01100	100	HSB	Halfword Subtract
	01101	100	HSUB	Halfword Subtract B Literal
	01110	VVV	TRAN	Translate
	01111	OOV	PARY	Parity
4	11101	AAA	ADD	Add
	11110	AAA	ADDB	Add B Literal
	11111	AAA	ADDC	Add C Literal
	10000	AAA	SUB	Subtract
	11000	AAA	SUBB	Subtract B Literal
	11100	AAA	SUBC	Subtract C Literal
	10101	AAA	LAN	Logical AND
	10110	AAA	LANB	Logical AND B Literal
	10111	AAA	LANC	Logical AND C Literal
	10100	AAA	LAOM	Logical AND-OR MA
	10001	AAA	LOR	Logical OR
	10010	AAA	LORB	Logical OR B Literal
	10011	AAA	LORC	Logical OR C Literal
	11001	AAA	LEO	Logical Exclusive OR
	11010	AAA	LEOB	Logical Exclusive OR B Literal
	11011	AAA	LEOC	Logical Exclusive OR C Literal

APPENDIX F
Instruction Description Chart

IDLE	Idle until SCAN-OUT INITIALIZE
AWI	A1=1 => AC←B; A0=1 => AI←C; CLIN←AA.AC.AI;
AWRR	A1=1 => AC←B; A0=1 => AI←C; CLIN←AA.AC.AI; AA.AC.AI←CLIN;
BKP	MATCH => IA←B.C OR HALT ELSE NO-OP;
SHFT	(MA[N:1]←MA[N+1:1])*(B[7:2]=01 => Y[2:3]+1 ELSE B[2:3]+1);
HEYU	SYSTEM DATACOM INTERRUPT ← TRUE;
MSKW	CM←AC.AI;
MSKR	AC.AI←CM;
ARWN	CAN => AA.AC.AI←CLIN; SAN => IA←B.C;
ARIN	CAN => AA.AC.AI←CLIN; IA←B.C;
DBYZ	Y=0 => IA←B.C ELSE Y←Y-1;
DBYN	Y≠0 => IA←B.C, Y←Y-1;
BRAN	SAN => IA←B.C;
GOTO	TRUE => IA←B.C;
GOX	TRUE => IA←B.C+X;
GOI	TRUE => IA←B.C+(Y);
MOVE	(C)←MA; MA←(B);
LMRD	W←LM(B.C);
LMRI	(C)←MA; MA←(B); W←LM(MA);
LMWD	LM(B.C)←W;
LMWI	(C)←MA; MA←(B); LM(MA)←W;
SMRD	W←SM(B) or RG(B); (C)←MA;
SMWD	MA←(B); SM(C) or RG(C)←W;
MMR	(C)←MA; MA←(B); W←MM(MA);
MMWU	(C)←MA; MA←(B); MM(MA)←W; UNCONDITIONAL;
MMWR	(C)←MA; MA←(B); MM(MA)←W; W←MM(MA) PREVIOUS CONTENTS; UNCONDITIONAL;
MMWP	(C)←MA; MA←(B); MM(MA)←W; PROTECTED;
MWRP	(C)←MA; MA←(B); MM(MA)←W; W←MM(MA) PREVIOUS CONTENTS; PROTECTED;

APPENDIX F (cont)
Instruction Description Chart

HAD	$(C) \leftarrow (B) + MA;$
HADB	$(C) \leftarrow B + MA;$
HSB	$(C) \leftarrow MA - (B);$
HSBB	$(C) \leftarrow MA - B;$
TRAN	$(C) \leftarrow TRAN(B);$
PARY	$(C) \leftarrow PARY(B);$
ADD	$(C) \leftarrow (A) + (B) + CFO;$
ADDB	$(C) \leftarrow (A) + B + CFO;$
ADDC	$(A) \leftarrow (B) + C + CFO;$
SUB	$(C) \leftarrow (A) - (B) - CFO;$
SUBB	$(C) \leftarrow (A) - B - CFO;$
SUBC	$(A) \leftarrow C - (B) - CFO;$
LAN	$(C) \leftarrow (A) \text{ AND } (B);$
LANB	$(C) \leftarrow (A) \text{ AND } B;$
LANC	$(A) \leftarrow (B) \text{ AND } C;$
LAOM	$(A) \leftarrow [(B) \text{ AND } C] \text{ OR } MA(B);$
LOR	$(C) \leftarrow (A) \text{ OR } (B);$
LORB	$(C) \leftarrow (A) \text{ OR } B;$
LORC	$(A) \leftarrow (B) \text{ OR } C;$
LEO	$(C) \leftarrow (A) \text{ XOR } (B);$
LEOB	$(C) \leftarrow (A) \text{ XOR } B;$
LEOC	$(A) \leftarrow (B) \text{ XOR } C;$

APPENDIX G
Operand Selection Charts

C7 B7	C6 B6	C5 B5	C4 B4	C3 B3	C2 B2	C1 B1	C0 B0
0	0	0	0	0	ZERO	ZERO	ZERO
0	0	0	0	1	AA	AC	AI
0	0	0	1	0	D	Y	X
0	0	0	1	1	MA-2	MA-1	MA-0
0	0	1	0	0	CF	IA-1	IA-0
0	0	1	0	1	W-0	W-1	W-2
0	0	1	1	0	W-3	W-4	W-5
0	0	1	1	1	RSVD	RSVD	RSVD
0	1	IF B THEN B ← Y ELSE C ← D;					
1	0	SCRATCHPAD MEMORY WORD			HALF WORD	0	0
1	0	SCRATCHPAD MEMORY WORD			BYTE NMBR + ONE		
1	1	1	1	1	BYTE NMBR + ONE (w)		

A field			Instruction is not "literal in C field"	Instruction is "literal in C field"
			Register selected as source	Register selected as destination
A2	A1	AO		
0	0	0	None (data = zeros)	None (no data stored)
0	0	1	AA	Indirect (The B field selects both the source and the destination)
0	1	0	X	X
0	1	1	Y	Y
1	0	0	D	D
1	0	1	MA0	MA0
1	1	0	MA1	MA1
1	1	1	MA2	MA2

APPENDIX H
Instruction Matrix Chart

OPCODE	000	001	010	011	100	101	110	111
00000	<u>IDLE</u>							
00001	<u>BKP</u> BREAKPOINT CODE - - - - -							
00010	<u>AWI</u> AI←C AC←B		AI←C AC←B		<u>AWRR</u> AI←C AC←B		AI←C AC←B	
00011	<u>MSKW</u>	<u>MSKR</u>			<u>SHFT</u>	<u>HEYU</u>		
00100	<u>ARWN</u>	<u>ARIN</u>	<u>DBYZ</u>	<u>DBYN</u>	<u>BRAN</u>			
00101	<u>GOTO</u> NOOP	CF1=0 CFO≠0	CFO=1	CF1=0	CF1=1	CFO=0	CF1=1 CFO≠1	UNCON
00110	<u>GOX</u> NOOP	CF1=0 CFO≠0	CFO=1	CF1=0	CF1=1	CFO=0	CF1=1 CFO≠1	UNCON
00111	<u>GOI</u> NOOP	CF1=0 CFO≠0	CFO=1	CF1=0	CF1=1	CFO=0	CF1=1 CFO≠1	UNCON
01000	<u>MOVE</u>	<u>LMRI</u>	<u>SMRD</u>	<u>LMRD</u>		<u>LMWI</u>	<u>SMWD</u>	<u>LMWD</u>
01001		<u>MMR</u>			<u>MMWU</u>	<u>MMWR</u>	<u>MMWP</u>	<u>MWRP</u>
01010	and 01011 are not used							
01100	<u>HAD</u>				<u>HSB</u>			
01101	<u>HADB</u>				<u>HSBB</u>			
01110	<u>TRAN</u> US←EB BC←EB				EB←US EB←BC			
01111	<u>PARY</u> EVEN ODD							
10000	<u>SUB</u> A FIELD OPERAND - - - - -							
10001	<u>LOR</u> A FIELD OPERAND - - - - -							
10010	<u>LORB</u> A FIELD OPERAND - - - - -							

APPENDIX H (cont)
Instruction Matrix Chart

OPCODE	000	001	010	011	100	101	110	111
10011	<u>LORC</u> A FIELD OPERAND - - - - -							
10100	<u>LAOM</u> A FIELD OPERAND - - - - -							
10101	<u>LAN</u> A FIELD OPERAND - - - - -							
10110	<u>LANB</u> A FIELD OPERAND - - - - -							
10111	<u>LANC</u> A FIELD OPERAND - - - - -							
11000	<u>SUBB</u> A FIELD OPERAND - - - - -							
11001	<u>LEO</u> A FIELD OPERAND - - - - -							
11010	<u>LEOB</u> A FIELD OPERAND - - - - -							
11011	<u>LEOC</u> A FIELD OPERAND - - - - -							
11100	<u>SUBC</u> A FIELD OPERAND - - - - -							
11101	<u>ADD</u> A FIELD OPERAND - - - - -							
11110	<u>ADDB</u> A FIELD OPERAND - - - - -							
11111	<u>ADDC</u> A FIELD OPERAND - - - - -							

APPENDIX I
Carry Flip-Flop Chart

	CFO=0	CFO=1	CF1=0	CF1=1
IDLE	N/A	N/A	N/A	N/A
AWI	N/A	N/A	N/A	N/A
AWRR	N/A	N/A	N/A	N/A
BKP	BRANCH CLEARED	BRANCH CLEARED	BRANCH CLEARED	BRANCH CLEARED
SHFT	CLEARED	CLEARED	CLEARED	CLEARED
HEYU	N/A	N/A	N/A	N/A
MSKW	N/A	N/A	N/A	N/A
MSKR	N/A	N/A	N/A	N/A
ARWN	BRANCH CLEARED	BRANCH CLEARED	BRANCH CLEARED	BRANCH CLEARED
ARIN	BRANCH CLEARED	BRANCH CLEARED	BRANCH CLEARED	BRANCH CLEARED
DBYZ	BRANCH CLEARED	BRANCH CLEARED	BRANCH CLEARED	BRANCH CLEARED
DBYN	BRANCH CLEARED	BRANCH CLEARED	BRANCH CLEARED	BRANCH CLEARED
BRAN	BRANCH CLEARED	BRANCH CLEARED	BRANCH CLEARED	BRANCH CLEARED
GOTO	BRANCH CLEARED	BRANCH CLEARED	BRANCH CLEARED	BRANCH CLEARED
GOX	BRANCH CLEARED	BRANCH CLEARED	BRANCH CLEARED	BRANCH CLEARED
GOI	BRANCH CLEARED	BRANCH CLEARED	BRANCH CLEARED	BRANCH CLEARED
MOVE	N/A	N/A	N/A	N/A
LMRD	N/A	N/A	N/A	N/A
LMRI	N/A	N/A	N/A	N/A
LMWD	N/A	N/A	N/A	N/A
LMWI	N/A	N/A	N/A	N/A
SMRD	N/A	N/A	N/A	N/A
SMWD	N/A	N/A	N/A	N/A
MMR	N/A	N/A	N/A	N/A
MMWU	N/A	N/A	N/A	N/A
MMWR	N/A	N/A	N/A	N/A
MMWP	N/A	N/A	N/A	N/A
MWRP	N/A	N/A	N/A	N/A

APPENDIX I (cont)
Carry Flip-Flop Chart

	CFO=0	CFO=1	CF1=0	CF1=1
HAD	NO CARRY	CARRY	NONZERO RESULT	ZERO RESULT
HADB	NO CARRY	CARRY	NONZERO RESULT	ZERO RESULT
HSB	NO CARRY	CARRY	NONZERO RESULT	ZERO RESULT
HSBB	NO CARRY	CARRY	NONZERO RESULT	ZERO RESULT
TRAN	N/A	N/A	N/A	N/A
PARY	CLEARED	CLEARED	PARITY ERROR	GOOD PARITY
ADD	NO CARRY	CARRY	NONZERO RESULT	ZERO RESULT
ADDB	NO CARRY	CARRY	NONZERO RESULT	ZERO RESULT
ADDC	NO CARRY	CARRY	NONZERO RESULT	ZERO RESULT
SUB	NO BORROW	BORROW	NONZERO RESULT	ZERO RESULT
SUBB	NO BORROW	BORROW	NONZERO RESULT	ZERO RESULT
SUBC	NO BORROW	BORROW	NONZERO RESULT	ZERO RESULT
LAN	CLEARED	CLEARED	NONZERO RESULT	ZERO RESULT
LANB	CLEARED	CLEARED	NONZERO RESULT	ZERO RESULT
LANC	CLEARED	CLEARED	NONZERO RESULT	ZERO RESULT
LAOM	CLEARED	CLEARED	NONZERO RESULT	ZERO RESULT
LOR	CLEARED	CLEARED	NONZERO RESULT	ZERO RESULT
LORB	CLEARED	CLEARED	NONZERO RESULT	ZERO RESULT
LORC	CLEARED	CLEARED	NONZERO RESULT	ZERO RESULT
LEO	CLEARED	CLEARED	NONZERO RESULT	ZERO RESULT
LEOB	CLEARED	CLEARED	NONZERO RESULT	ZERO RESULT
LEOC	CLEARED	CLEARED	NONZERO RESULT	ZERO RESULT

INDEX

- A Bus, 2-15
- Access Confirm Register, 5-6
- Access Granted, 5-5
- ACR - On, 5-19
- Actions Related to Fetch Cycles, 2-27
- Adapter Address, 5-5, 5-8
- Adapter Address Registers, 2-5
- Adapter Cluster, 1-1, 5-1
- Adapter Cluster Interface Registers, 2-5
- Adapter Control, 5-5
- Adapter Control Register, 2-5
- Adapter-Audio Response, 7-4
- Adapter-ACU, 7-2
- Adapter-Direct Connect, 7-2
- Adapter-Modem Connect, 7-1
- Adapter-Touch-Tone, 7-3
- Adapter Information, 5-5
- Adapter Information Register, 2-5
- Adapter Interrogate, 3-4
- Adapter Read If Needed, 3-12
- Adapter Read When Attention Needed, 3-10
- Adapters, 7-1
- Adapter Switching Matrix, 5-23
- Adapter Write, 3-4
- Adapter Write Timing Specification, 3-1
- Add, 3-29
- Add, Literal in B, 3-30
- Add, Literal in C, 3-30
- A Field, 2-17
- Arithmetic Section, 2-13
- Attention Needed Timer, 2-31
- B Address, 2-19
- B Address Used As Destination Address, 2-24
- BAR Command, 5-14
- BAR Interrupt, 5-15
- Basic Half-word and Byte Organization, 2-12
- B Bus, 2-15
- B:C Branch Address, 2-18
- B:C Local Memory Address, 2-19
- B Field, 2-17
- B Indirect Address, 2-23
- Bit Numbering, 2-1
- Bit Reset Button, 4-5
- Bit Set Button, 4-5
- Bit Timer, 5-9
- Branch, 3-14
- Branch If System Attention Needed, 3-14
- Branch Relative Indirect, 3-16
- Branch Relative With X, 3-15
- Break, 5-17
- Break Complete, 5-19
- Breakpoint Control, 4-6
- Break Transmit, 5-15
- B Register Address, 2-19
- B Scratchpad Memory Address, 2-20
- B Special Indirect Address, 2-23
- Buffer Empty, 5-20
- Buffer Overflow, 5-19
- Buffers Associative Register, 5-9

INDEX (cont)

- B Word Register Byte Address, 2-22
- Byte Designation, 2-4
- Byte Request, 5-18
- Byte Request Back Up, 5-18
- B 6500 Address Register, 2-9

- CB-Off, 5-18
- C Bus, 2-15
- CC-Off, 5-18
- C Field, 2-24
- CF-Off, 5-17
- Character Format (On Data Com Lines), 5-29
- Character One (C1), 5-9
- Character Synchronization, 5-28
- Character Two (C2), 5-9
- CIR Priority, 5-8
- CIR State, 5-6
- Clear Button, 4-5
- Clear (CLR), 5-4
- C Literal, 2-24
- Cluster Action Switch, 6-2
- Cluster Attention Needed, 5-5
- Cluster BC/BI, 5-27
- Cluster Bit Reset Switch, 6-2
- Cluster Byte Request, 5-28
- Cluster Cable, 1-5
- Cluster Character Codes And Formats, 5-1
- Cluster Control, 5-8
- Cluster Control Of The DCP, 5-1
- Cluster Count Enable Switch, 6-3
- Cluster Data Formats, 5-23
- Cluster Data Present, 5-27
- Cluster Display Panel, 6-1, 6-3
- Cluster Exchange, 1-5
- Cluster Instruction Codes, 5-25
- Cluster Interface, 5-4
- Cluster Interface Register, 5-6
- Cluster Interrogate Instruction, 5-26
- Cluster Interrupt Instruction, 5-27
- Cluster Mask Register, 2-11
- Cluster Master Clear Switch, 6-2
- Cluster Memory, 5-21
- Cluster Operation Switch, 6-2
- Cluster Organization, 5-3
- Cluster PT, 5-28
- Cluster Sw-Indicators AA3F-AA0F, 6-1
- Cluster Sw-Indicators AC4F-AC0F, 6-1
- Cluster Sw-Indicators AI8F-AI0F, 6-2
- Cluster Switches AA7F-AA4F, 6-1
- Cluster Switches and Indicators, 6-1
- Cluster Write, 5-4
- Cluster Write Instructions, 5-25
- CM Register Button, 4-5
- Comparison Register, 2-6
- Control Display, 4-3
- Control Functions, 5-23
- Control Signals (Cluster to DCP), 5-5
- Control Timer, 5-20
- COS + DLO - Off, 5-19
- COS-On, 5-19

INDEX (cont)

- C Register Address, 2-24
- Crosspoint Register, 5-8
- C Scratchpad Memory Address, 2-24
- C Word Register Byte Address, 2-24

- Data Communications Cabinet, 1-5
- Data Communications Processor, 1-1
- Data Communications Processor, Optional Local Memory, 1-6
- Data Communications System Configuration, 1-1
- Data Display, 4-3
- Data Formats (Cluster), 5-23
- Data Or Control (DC), 5-8
- Data Present, 5-18
- D Bus, 2-12
- DCP Display Panel, 4-1
- Decrement Y, Branch If Y Is Non-Zero, 3-13
- Decrement Y, Branch If Y Is Zero, 3-12
- Deserialization of Data, 5-28
- Designate, 5-4
- Designation Of Fields, 2-3
- Designation Of Single Bits, 2-3
- Dialing Digit Bits, 5-31
- Disconnect, 5-17
- Display Address Switch, 4-7
- Display Mode, 4-1
- Display Type Switch, 4-7
- D Register, 2-5

- E Bus, 2-13

- Fault Instruction Execution, 2-31
- Fault Interrupts, 2-28
- Fetch Cycle, 2-25
- Fetch From B 6500 Memory, 2-26
- Fetch From Local Memory, After Branch, 2-26
- Fetch From Local Memory, Normal Sequence, 2-26
- Finish Transmit, 5-15
- Full Word Registers, 2-10
- Full Word Transfer, 2-13

- General Purpose Register, 2-5
- Group 0 Instructions, 3-3
- Group 1 Instructions, 3-10
- Group 2 Instructions, 3-17
- Group 3 Instructions, 3-25
- Group 4 Instructions, 3-29

- Half-word Add, 3-25
- Half-word Add, Literal in B, 3-26
- Half-word Designation, 2-4
- Half-word Subtract, 3-26
- Half-word Subtract, Literal In B, 3-27
- Halt, 2-34
- Hold P-L/Off/Stop on Fault Switch, 4-5
- Hold Signal, 5-5

- Idle, 3-3, 5-15
- Idle Buffer, 5-15
- Indirect Address, 3-1, 2-25

INDEX (cont)

- Information Signals, 5-5
- Initialize, 2-33
- Initiate Receive Mode, 5-14
- Initiate Transmit Mode, 5-15
- Input Character Time Out, 5-18
- Input Register, 5-21
- Instruction Address, 2-25
- Instruction Address Count Up 2-28
- Instruction Address Registers, 2-9
- Instruction Display, 4-1
- Instruction Fetch, 2-25
- Instruction Format, 2-15, 3-3
- Instructions (General), 3-1
- Instruction Register, 2-10
- Instruction Unit Time, 3-1
- Invalid Scan Orders, 2-33

- Line Adapters, 1-3
- L Instruction Passed Over, 2-27
- Literal, 2-18
- Local Memory, 2-12
- Local Memory Read, Direct Address, 3-19
- Local Memory Read, Indirect Address, 3-17
- Local Memory Write, Direct Address, 3-20
- Local Memory Write, Indirect Address, 3-19
- Logical AND, 3-32
- Logical AND, Literal In B, 3-33
- Logical AND, Literal In C, 3-34
- Logical AND-OR MA, Literal in C, 3-34
- Logical Exclusive OR, 3-37
- Logical Exclusive OR, Literal in B, 3-38
- Logical Exclusive OR, Literal in C, 3-38
- Logical OR, 3-35
- Logical OR, Literal in B, 3-36
- Logical OR, Literal in C, 3-36
- Logical Section, 2-13
- Look For CE, 5-14

- Main Memory Access, 3-1
- Main Memory Protected Write, 3-23
- Main Memory Read, 3-21
- Main Memory Write-Read Protected, 3-24
- Main Memory Write-Read Unconditional, 3-22
- Main Memory Write Unconditional, 3-22
- Maintenance Register, 5-21
- Memories, 2-11
- Memory Address Registers, 2-8

- Nomenclature, 2-1
- Not Ready, 2-33

- Off-Line/On-Line Switch, 4-4
- Operating Mode, 4-1
- Operation (DCP), 1-3
- Op Field, 2-16
- Out Of Service, 5-14
- Output Register, 5-21

- Parallel By Bit Character Formats, 5-31

INDEX (cont)

- Parity, 3-28
- Parity Check, 2-27
- Priority Among Faults, 2-30
- Program Error, 5-19
- Program Timer, 5-20
- P-R Position (Display Type), 4-7
- Pulse Switch, 4-7
- PWI-Off, 5-19

- RDY-Off, 5-20
- Read Cluster Mask Register, 3-10
- Read/Write Control Section, 5-23
- Read/Write Timer Register, 5-21
- Ready and Scan Access Obtained, 2-33
- Real Time Counter, 5-21
- Receive Ready, 5-14
- Receive Status, 5-18
- Registers (Cluster), 5-6
- Reg Position (Display Type), 4-7
- Reserved Memory Locations, 2-11
- Ring Indicator, 5-18

- SB-On, 5-19
- Scan BUS, 2-32
- Scan Counter, 5-21
- Scan-Out Information Word, 2-32
- Scratchpad Memory, 2-11
- Scratchpad Memory Read, 3-18
- Scratchpad Memory Write, 3-20
- Serial By Bit Character Formats, 5-29
- Serialization Of Data, 5-28
- Set Attention Needed, 2-34
- Set Cluster Mask Register, 3-9
- Set System Interrupt, 3-8
- Shift MA Right, 3-7
- SM-L Position (Display Type), 4-7
- SM-R Position (Display Type), 4-7
- Start-Stop Nine Unit Character, 5-29
- Start-Stop Six Unit Character, 5-29
- Start-Stop Ten Unit Character, 5-29
- Start-Stop 7.5 Unit Character, 5-29
- Start-Stop 11 Unit Character, 5-30
- State Counter, 5-13
- State Counter Auxiliary, 5-13
- Stop Bit Error, 5-18
- Stop/Branch On Breakpoint, 3-6
- Stop Immed/Off/Stop On Fetch Switch, 4-5
- Stop/Off/Branch Switch, 4-6
- Subtract, 3-31
- Subtract, Literal in B, 3-31
- Subtract, Literal in C, 3-32
- Sync Fill, 5-19
- Sync Pattern, Eight-Bit Character, 5-30
- Sync Pattern, Nine-Bit Character, 5-30

INDEX (cont)

Sync Pattern, Seven-Bit
Character, 5-30

Tag Check, 2-27

Tag Display, 4-3

Three Seconds No Sync, 5-19

Three Seconds Not Ready
(Receive), 5-17

Three Seconds Not Ready
(Transmit), 5-18

Touch Tone Character 4 Bits,
5-31

Transfer Of R Instruction,
2-28

Translate, 3-27

Transmit Ready, 5-15

Type, 5-11

Undefined Addresses, 3-2

Undefined Operation Codes,
3-2

Unit Time (Instruction),
3-1

VR Enable, 5-20

Word Register, 2-10

X Register, 2-6

Y Register, 2-6

30 Second Runaway, 5-19

BURROUGHS CORPORATION
DATA PROCESSING PUBLICATIONS
REMARKS FORM

TITLE: _____

FORM: _____
DATE: _____

CHECK TYPE OF SUGGESTION:

ADDITION

DELETION

REVISION

ERROR

cut along jotted line

GENERAL COMMENTS AND/OR SUGGESTIONS FOR IMPROVEMENT OF PUBLICATION:

FROM: NAME _____
TITLE _____
COMPANY _____
ADDRESS _____

DATE _____

STAPLE

FOLD DOWN

SECOND

FOLD DOWN

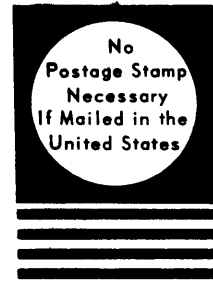

BUSINESS REPLY MAIL
First Class Permit No. 817, Detroit, Mich. 48232

Burroughs Corporation
6071 Second Avenue
Detroit, Michigan 48232



attn: Sales Technical Services
Systems Documentation

FOLD UP

FIRST

FOLD UP

