

WIDGET CONTROLLER BLOCK DIAGRAM.

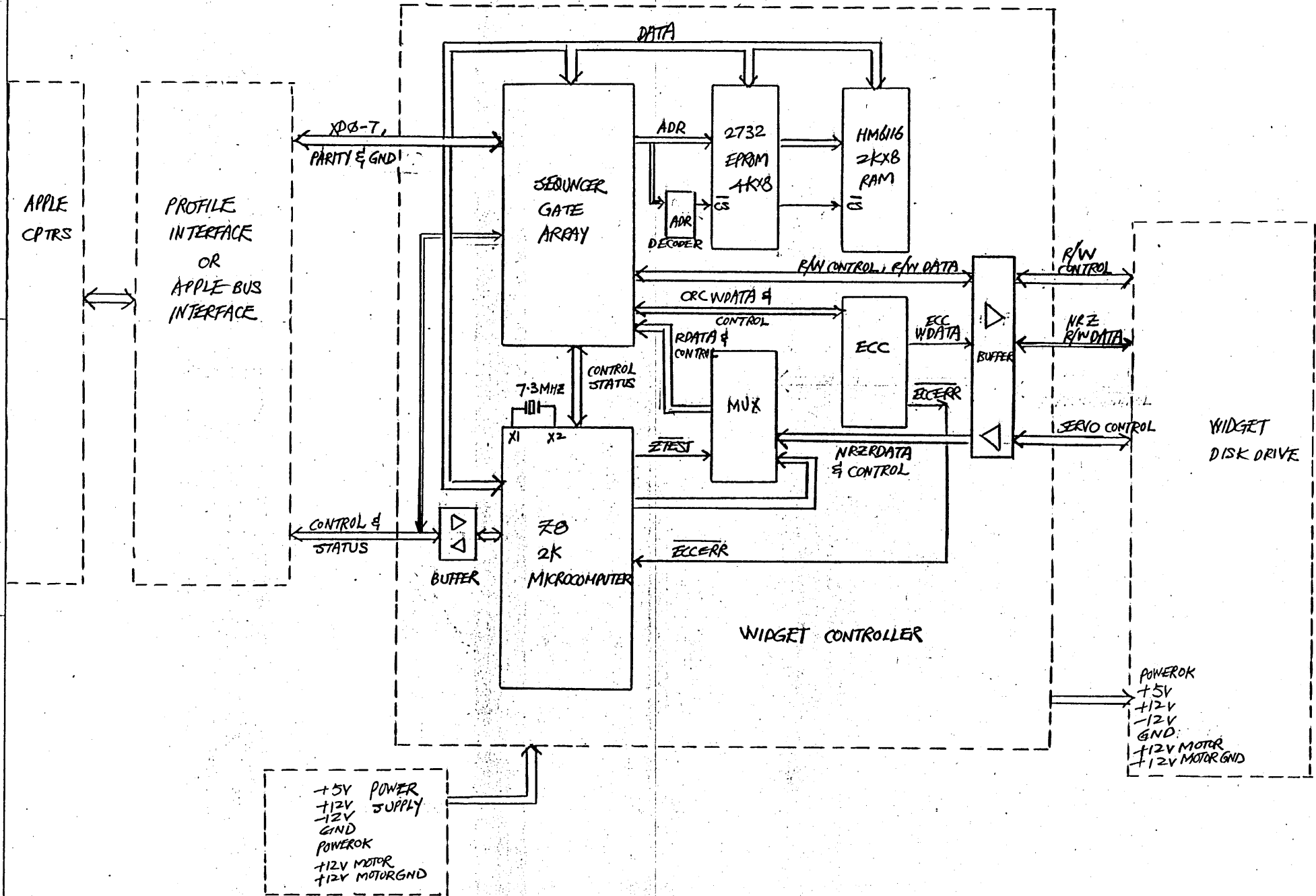

10/18/82

P1

WIDGET STATE DIAGRAM

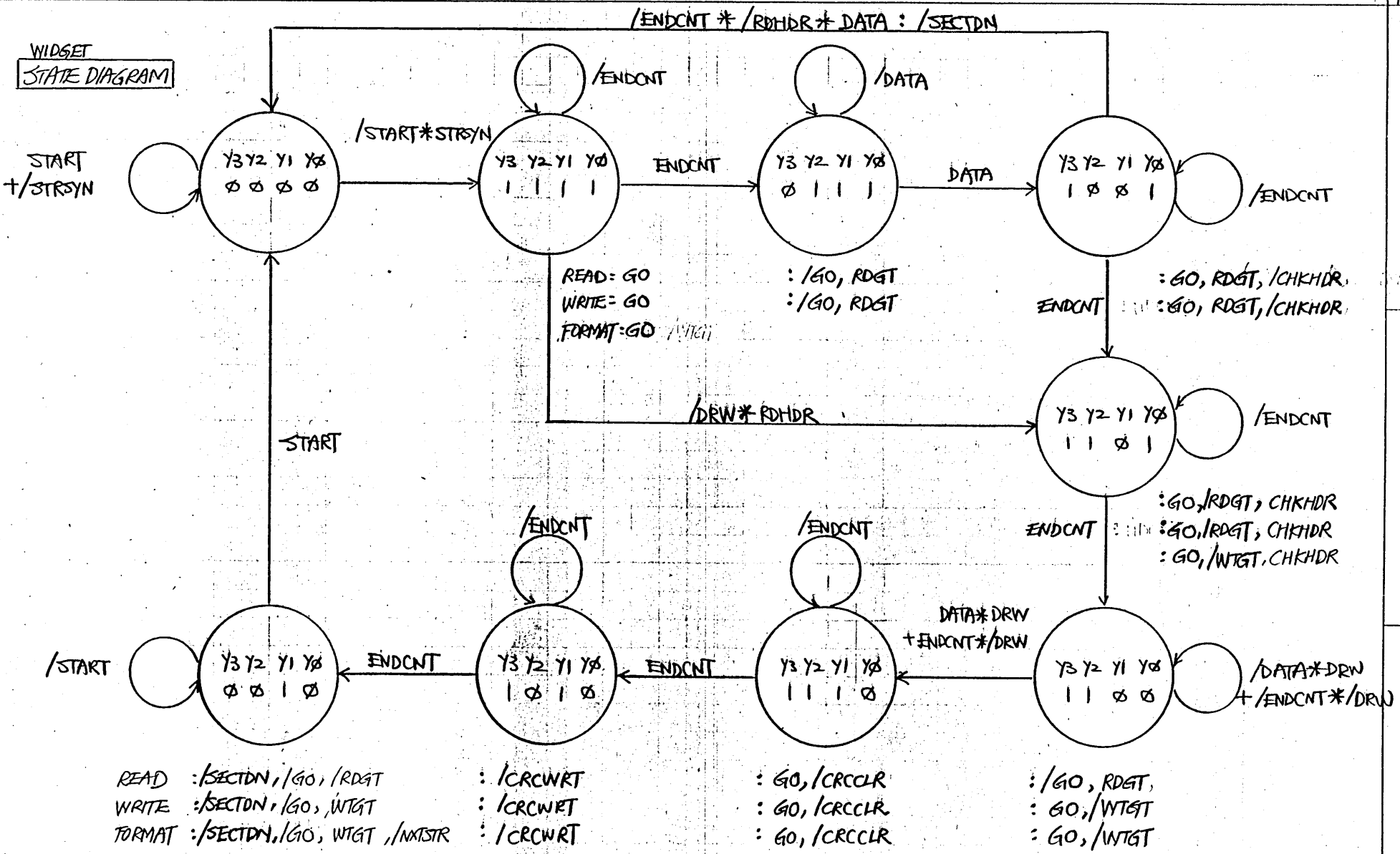

10/18/82

READ OPERATION



42-381 50 SHEETS 5 SQUARE
42-382 100 SHEETS 3 SQUARE
42-389 200 SHEETS 5 SQUARE

P2A

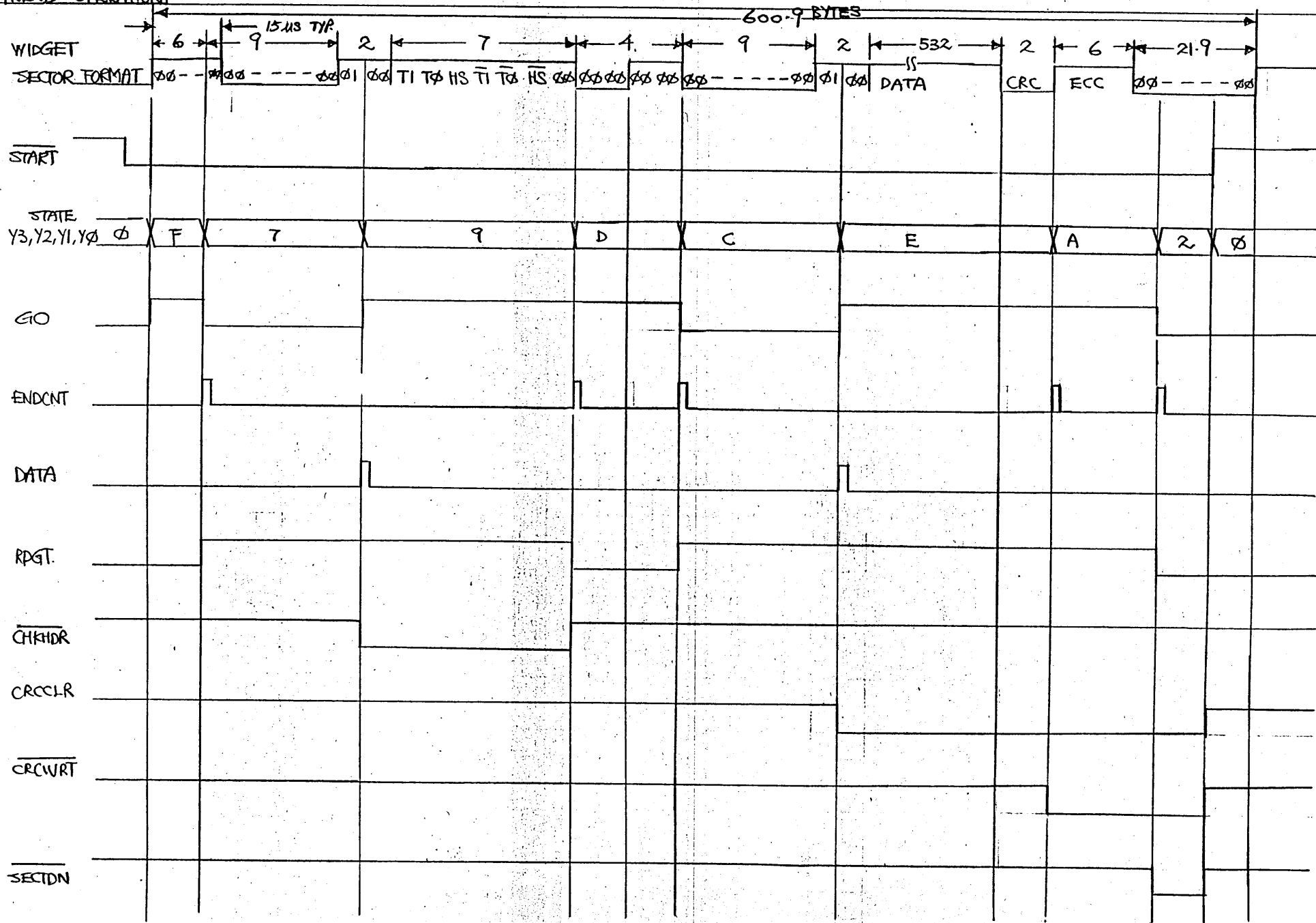

10/18/82

FORMAT



42-381 50 SHEETS 5 SQUARE
42-382 100 SHEETS 5 SQUARE
42-383 200 SHEETS 5 SQUARE
NATIONAL Made in U.S.A.

P4

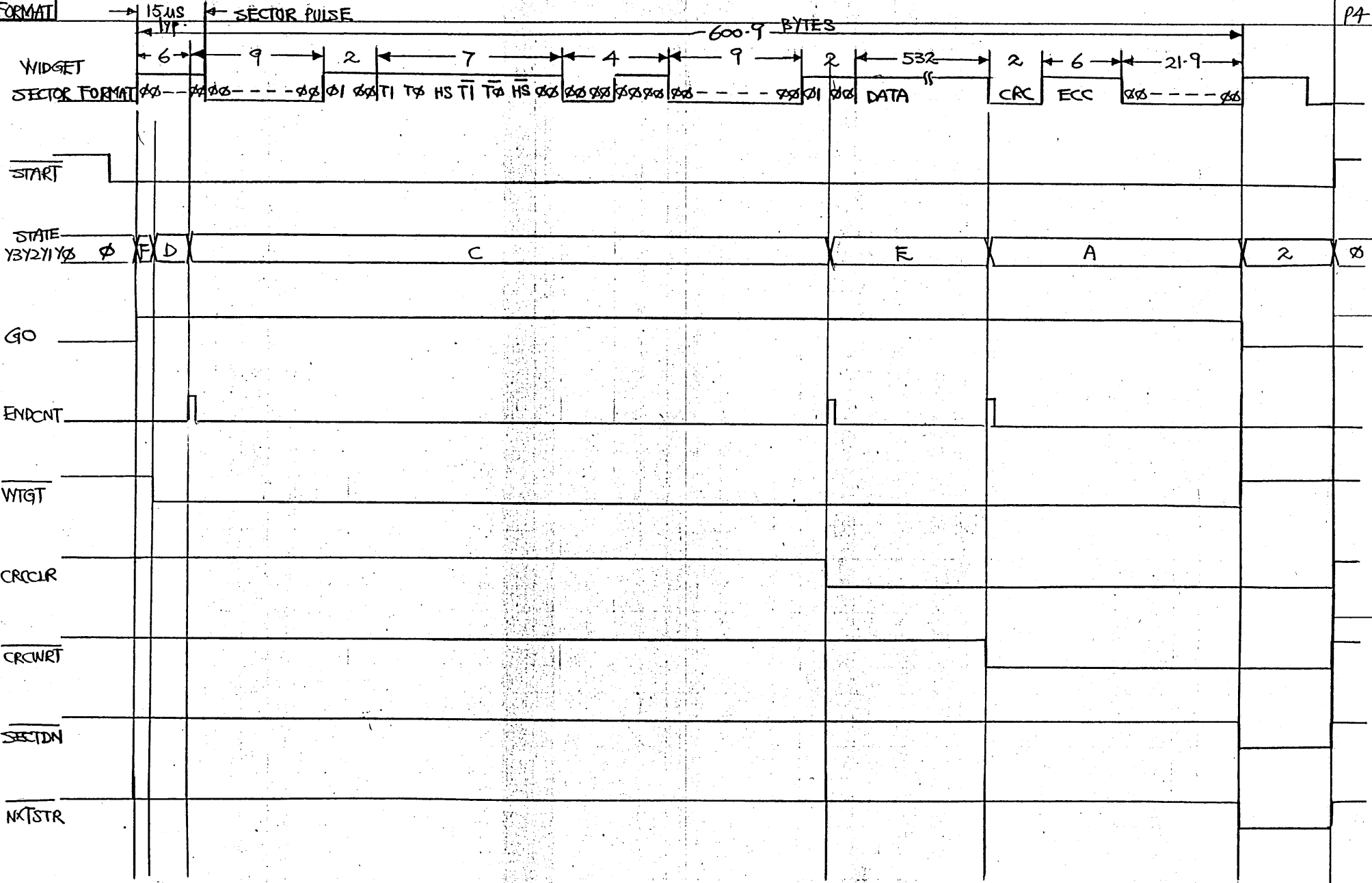

10/18/82

WIDGET

TIMING ϕ



42-381 50 SHEETS 5 SQUARE
42-382 100 SHEETS 5 SQUARE
42-389 200 SHEETS 5 SQUARE
MADE IN U.S.A.

P5

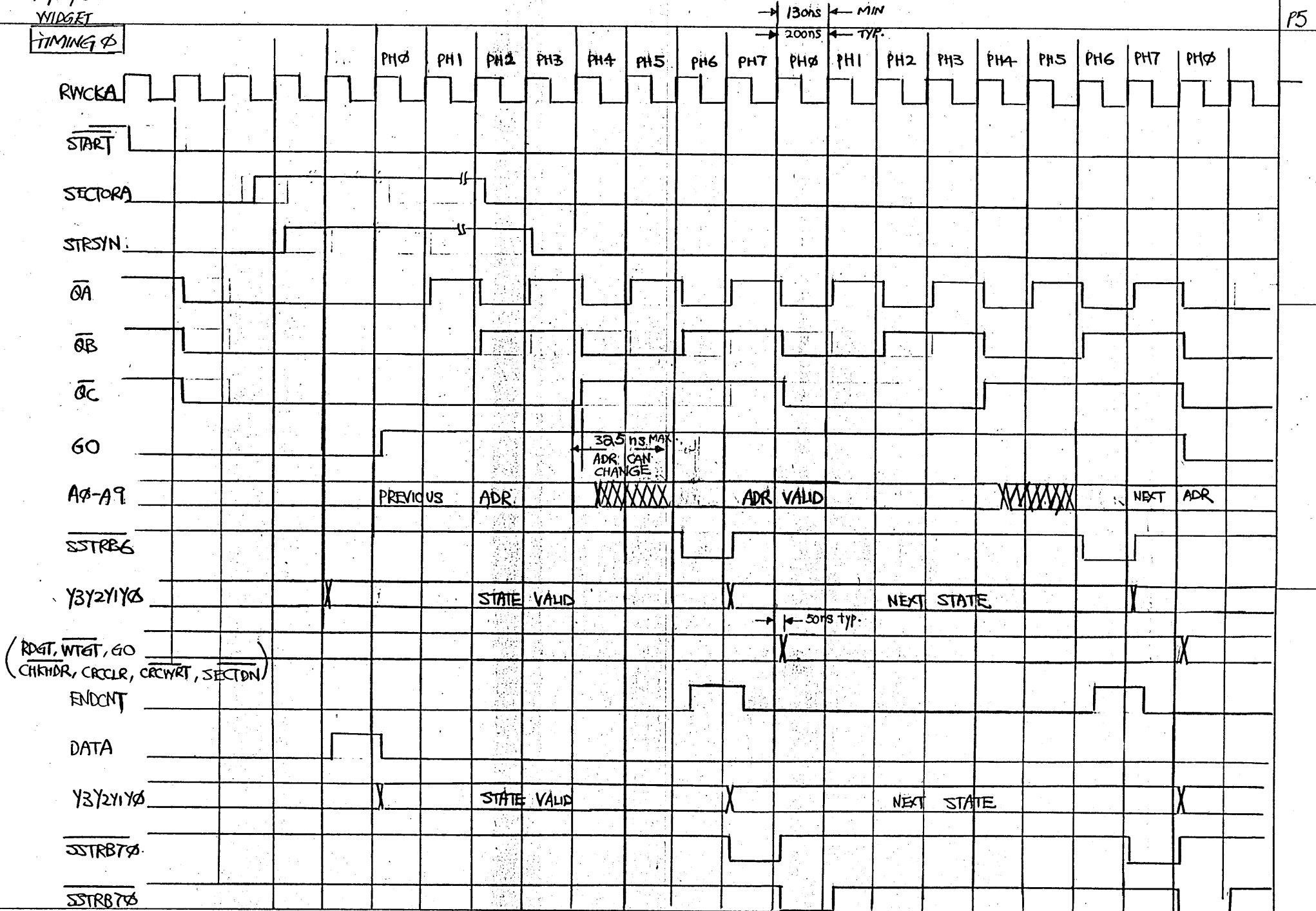

10/18/82

WIDGET
TIMING 1

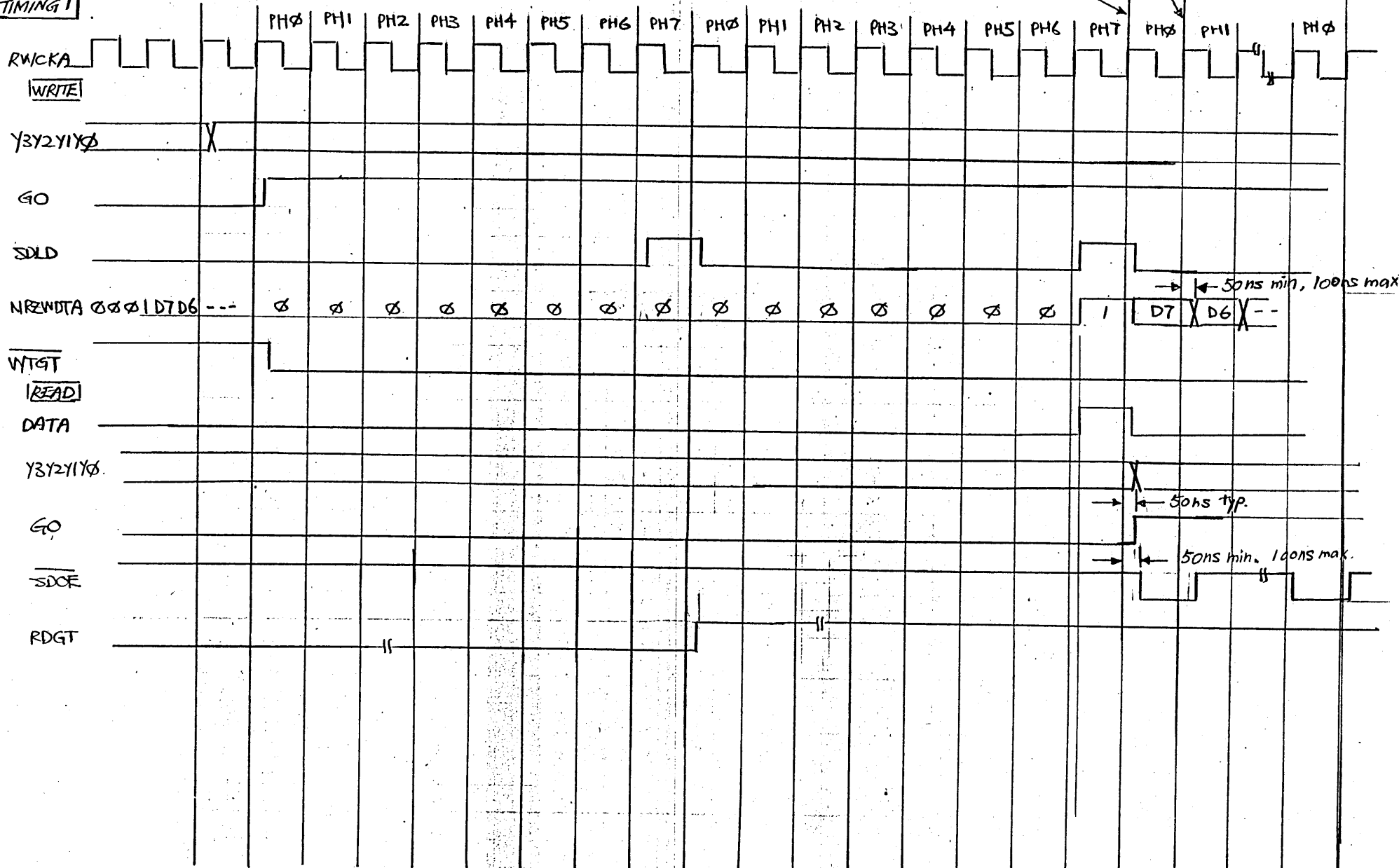

(LSB) LAST DATA R/W
 (MSB) FIRST DATA R/W

50ns min, 100ns max

50ns typ.

50ns min, 100ns max

10/18/82



42-381 50 SHEETS 5 SQUARE
42-382 100 SHEETS 5 SQUARE
42-389 200 SHEETS 5 SQUARE

WIDGET
FORMAT 16 SECTORS : 3 REVOLUTIONS / TRACK

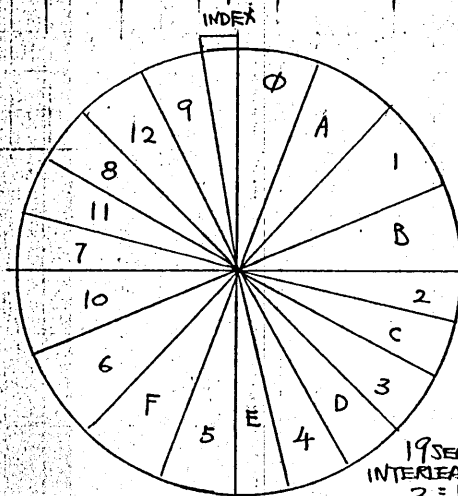
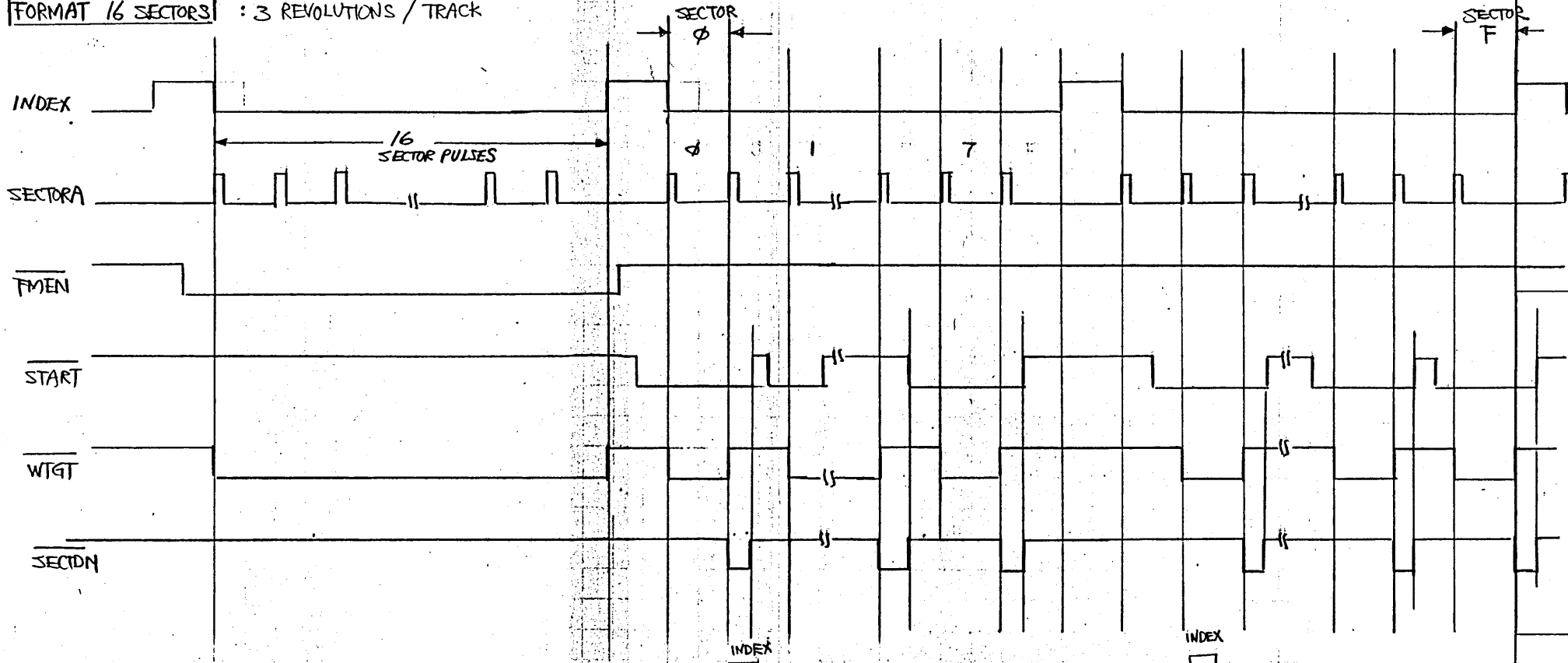

19 SECTORS
INTERLEAVING
FACTOR 2 = 1

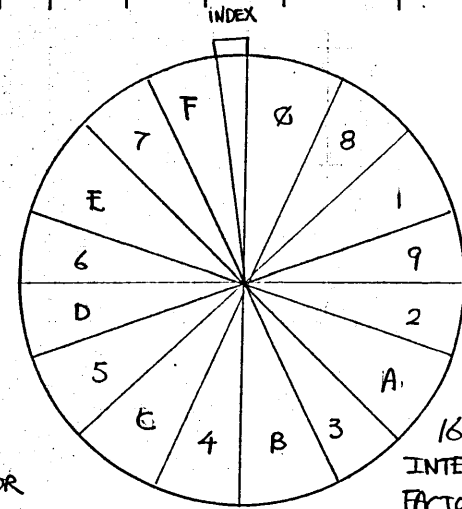

16 SECTORS
INTERLEAVING
FACTOR 2 = 1

10/18/82

WIDGET

	SI (SERVO IN) ZRWCK HSØ DM SECTDN INDEX SECTOR SO (SERVO OUT)	DRW SIORDY MSEL1 MSELØ BUSY CMD SERVORST START	RDADR TEST FMEN MBSØ A11/PC A1Ø/RN1 AØ9 AØ8	AD7 / CRERR AD6 / WRTVALID AD5 / SERVORDY AD4 / SERVORERR AD3 / Y3 AD2 / Y2 AD1 / Y1 ADØ / YØ
FUNCTIONS	0 0 0 0 1 1 1 1 P37 P36 P35 P34 P33 P32 P31 P3Ø	0 1 0 0 0 1 0 0 P27 P26 P25 P24 P23 P22 P21 P2Ø	0 0 0 0 PØ7 PØ6 PØ5 PØ4 PØ3 PØ2 PØ1 PØØ	7/Ø 7/Ø 7/Ø 7/Ø 7/Ø 7/Ø 7/Ø 7/Ø P17 P16 P15 P14 P13 P12 P11 P1Ø
APPLE WR RAM	0	Ø Ø Ø	1 X 1 1	OUTPUT HIZ
APPLE RD RAM	0	1 Ø Ø	1 X 1 1	OUTPUT HIZ
APPLE RD/WR ZØ	X	X 1 1	1 X 1 1	OUTPUT I/O
SEQUENCER RD DISK DATA	0	1 1 Ø	Ø Ø 1 1	OUTPUT HIZ
SEQUENCER WR DISK DATA	0	Ø 1 Ø	Ø Ø 1 1	OUTPUT HIZ
SEQUENCER RD ID	0	1 1 Ø	Ø 1 1 1	OUTPUT HIZ
SEQUENCER FORMAT	0	Ø 1 Ø	Ø 1 1 1	OUTPUT HIZ
SEQUENCER WR ZF	1	X X X	1 X 1 Ø	ADR ADR/DATA
ZØ LOAD RAM ADR	1	X 1 Ø	1 X 1 1	ADR ADR/DATA
ZØ RD/WR RAM	ADR	X Ø 1	1 X 1 1	ADR ADR/DATA

X=1000

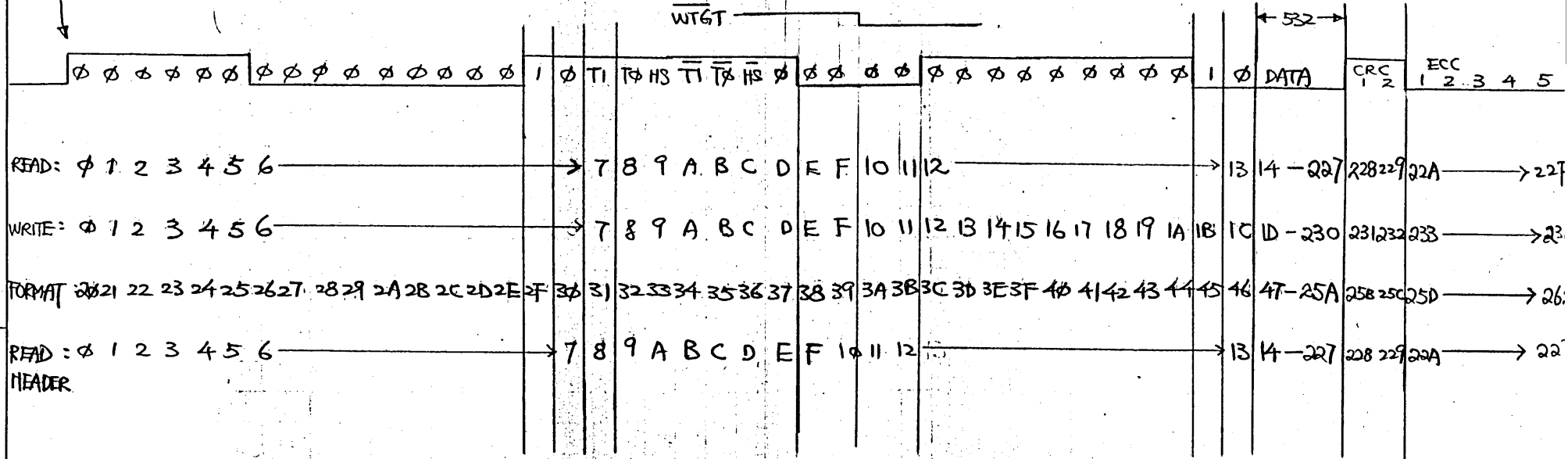
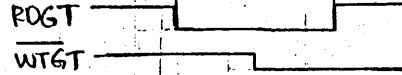

P10

WIDGET CONTROLLER (19 SECTORS) Z8 PINOUTS..

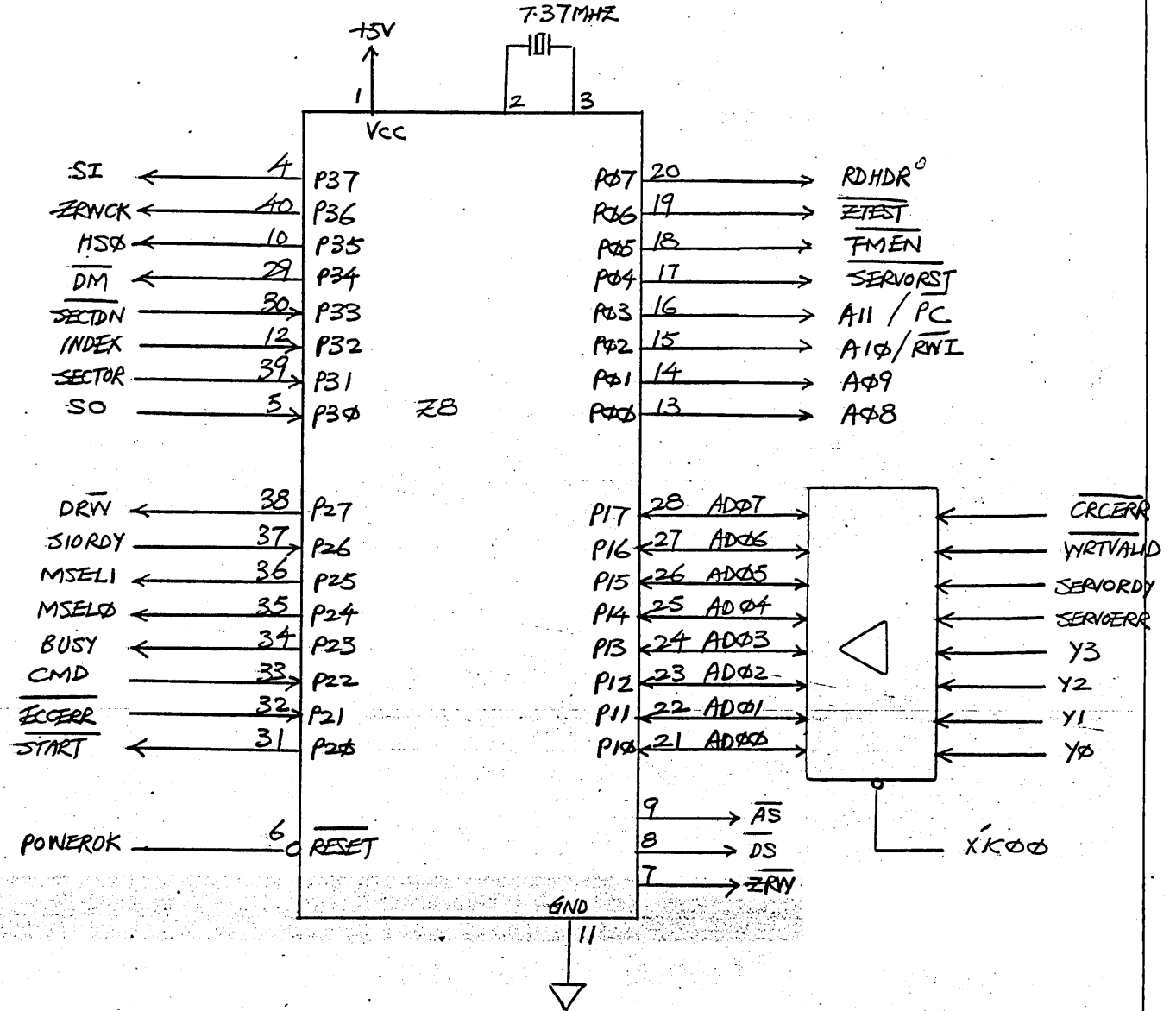

42-381 50 SHEETS 5 SQUARE
 42-382 100 SHEETS 5 SQUARE
 42-383 200 SHEETS 5 SQUARE
 NATIONAL