

Catalog No. 1809551-04  
Issued: December 1984

**ADO**

**AMPEX DIGITAL OPTICS**

OPERATOR'S GUIDE

**AMPEX**

**Prepared by**

**AVSD Technical Publications  
Ampex Corporation  
401 Broadway  
Redwood City, CA 94063**

**Copyright 1984 by Ampex Corporation  
Catalog No. 1809551-04  
Issued: December 1984**

# FOR ADDITIONAL TECHNICAL INFORMATION

## FIELD ENGINEERING BULLETIN SERVICE

The Ampex Audio-Video Systems Division's Technical Support Group publishes Field Engineering Bulletins (FEBs) describing approved equipment modifications, special tools and accessories plus information on improved operating and maintenance techniques.

**AMPEX**  
AMPEX CORPORATION  
AUDIO-VIDEO SYSTEMS DIVISION  
**FIELD ENGINEERING BULLETIN**  
Model: VHS-20/VPR-20B  
Serial: 40864  
Date: 12/82 AH-8212-19

REGULATOR PWA PULSE WIDTH MODULATOR CIRCUIT IMPROVEMENT

I. APPLICABILITY  
All VPR-20/VPP-20B Recorders with all versions of Regulator PWA, part number 1407050.

II. PURPOSE  
The following modification will improve the reliability of the Pulse Width Modulator Circuit and eliminate the possible necessity of selecting A5 and A6.

III. DISCUSSION  
The output at A5-3 and A6-3 should be equally spaced positive going pulses of about 3V in amplitude at about a 45KHz rate.  
On all versions of the Regulator PWA (P/N 1407050) without the following modification, it is sometimes necessary to select A5 and/or A6 to achieve this desired output.  
The following modifications will eliminate the possible necessity of selecting A5 and/or A6.

Modification "A"  
A common feedback circuit is added by connecting the existing feedback at A5 Pin 16 to A6 Pin 19.

Modification "B"  
A common PC network is added by removing C9 and R32 and connecting A5 Pin 7 to A6 Pin 7.

IV. PARTS REQUIRED  
Parts required for this update may be purchased through Ampex. Installation assistance can be obtained through your local Ampex regional office at current Ampex Field Engineering rates.

Qty	Description	Ampex Part Number
1 ft.	Wire, Kyax 30 AWG	615-995

AMPEX CORPORATION, 401 BROADWAY, MAIL STOP 3-46, REDWOOD CITY, CALIFORNIA 94063. © 1982 AMPLEX CORPORATION. ALL RIGHTS RESERVED. THIS DOCUMENT IS UNCLASSIFIED AND IS AVAILABLE TO THE PUBLIC. IT IS THE PROPERTY OF AMPLEX CORPORATION AND IS LOANED TO YOU. IT IS NOT TO BE REPRODUCED OR TRANSMITTED IN ANY FORM OR BY ANY MEANS, ELECTRONIC OR MECHANICAL, INCLUDING PHOTOCOPYING, RECORDING, OR BY ANY INFORMATION STORAGE AND RETRIEVAL SYSTEM. AMPLEX CORPORATION IS NOT RESPONSIBLE FOR ANY DAMAGE TO YOUR EQUIPMENT OR DATA CAUSED BY THE USE OF THIS DOCUMENT.

To receive these bulletins,  
send us the following information:

Owner's Name  
Owner's Address

Model No.  
Serial No.  
Date of Purchase

Dealer's Name  
Dealer's Address

In the United States send to:

**AMPEX CORPORATION**  
Audio-Video Systems Division  
Technical Support Group  
401 Broadway, Mail Stop 3-46  
Redwood City, California 94063

Outside United States send to:

**YOUR NEAREST SALES COMPANY**

(Addresses on rear of this page)

## TRAINING SERVICES

Technical (maintenance) training on this and other Ampex video, audio, disc and instrumentation products is offered on a scheduled basis at Corporate Headquarters in Redwood City, California, and at Headquarters European Area in Reading, England. For further information regarding this training, please contact your local Ampex Sales Office.

# SALES / SERVICE OFFICES

UNITED STATES	INTERNATIONAL	
<p><b>CALIFORNIA</b> 500 Rodier Drive Glendale, CA 91201 <b>(213) 240-5000</b></p> <p>401 Broadway Redwood City, CA 94063-3199 <b>(415) 387-2202</b></p> <p><b>GEORGIA</b> 1872 Montreal Road Tucker, GA 30084 <b>(404) 491-7112</b></p> <p><b>ILLINOIS</b> 719 W. Algonquin Road Arlington Heights, IL 60005 <b>(312) 593-6000</b></p> <p><b>MARYLAND</b> 10215 Fernwood Road Bethesda, MD 20817 <b>(301) 530-8800</b></p> <p><b>NEW JERSEY</b> 5 Pearl Court Allendale, NJ 07401 <b>(201) 825-9600</b></p> <p><b>TEXAS</b> 3353 Earhart Drive Carrollton, TX 75006 <b>(214) 960-1162</b></p> <p><b>UTAH</b> 2880 South Main, Suite 111 Salt Lake City, UT 84115 <b>(801) 487-8181</b></p> <p><b>AMPEX CORPORATION</b> <b>AUDIO-VIDEO SYSTEMS DIVISION</b> <b>401 BROADWAY</b> <b>REDWOOD CITY, CALIFORNIA 94063</b> <b>(415) 387-2011</b></p> <p><b>Effective: 21 March 1985</b></p>	<p><b>AUSTRALIA</b> Ampex Australia Pty. Ltd. P.O. Box 199 55-61 Talavera Road, Unit A North Ryde, 2113 New South Wales, Australia</p> <p>21 Terra-Cotta Drive Blackburn Victoria, Australia</p> <p><b>BAHRAIN</b> Ampex World Operations Abu Fateh Building, #499 Road 1706, Diplomatic Area P.O. Box 26627 State of Bahrain</p> <p><b>BELGIUM</b> Ampex S.A. Nivelles Rue de l'Industrie, 8 1400 Nivelles, Belgium</p> <p><b>BRAZIL</b> Ampex do Brasil Electronica Ltda. Rua Visconde de Pirajá 595, Grupo 1104 Ipanema - 22410 Rio de Janeiro, RJ Brazil</p> <p><b>CANADA</b> Ampex Canada Inc. 1770 Argenta Road Mississauga, Ontario Canada, L5N 3S7</p> <p>1116-55 Avenue, N.E. Calgary, Alberta T2E 6Y4, Canada</p> <p>729 Meloche Avenue Dorval, Quebec H9P 2S4, Canada</p> <p><b>COLOMBIA</b> Ampex South America Apartado Aereo 29613 Carrera 16A Nr. 79-25 Bogota, Colombia</p> <p><b>CYPRUS</b> Ampex World Operations, S.A. Apt. 802, Ghinis Building 58-60 Dighenis Akritas Ave. Nicosia, Cyprus</p> <p><b>ENGLAND</b> Ampex International Acre Road, Reading Berkshire, RG2 OQR, England</p> <p>Ampex Great Britain Ltd. Acre Road, Reading Berkshire, RG2 OQR, England</p> <p><b>FRANCE</b> Ampex SARL Courcellor I, 2 Rue Curnonsky 75017 Paris, France</p> <p><b>GERMANY</b> Ampex Europa GmbH Walter-Kolb-Str. 9-11 6000 Frankfurt (Main) 70 West Germany</p>	<p><b>HONG KONG</b> Ampex World Operations, S.A. Rooms 908-911, 9th Floor TSIM SHA Centre (East Wing) 66 Mody Road Tsim Sha Tsui East Kowloon, Hong Kong</p> <p><b>ITALY</b> Ampex Marketing Services SRL Casella Postale 10720 00143 Rome Rome, Italy</p> <p>Ampex Italiana S.p.A. 4 Via Riccardo Gigante 00143 Rome, Italy</p> <p>Ampex Italiana S.p.A. Via Cristoforo Colombo, 48 20090 Trezzano Sul Naviglio Milano, Italy</p> <p><b>JAPAN</b> Ampex Japan Ltd. P.O. Box 15 Tokyo Ryutsu Center 6-1-1 Heiwajima, Ota-ku Tokyo 143, Japan</p> <p><b>MEXICO</b> Ampex de Mexico, S.A. De C.V. Apdo, Postal No. 13-615 Division del Norte No. 1832 Col. Postales Delegacion Benito Juarez Mexico 13, D.F. 03300</p> <p><b>NETHERLANDS</b> Ampex B.V. P.O. Box 9026 Colorado-Dreef 36 3506 GA Utrecht, The Netherlands</p> <p><b>SINGAPORE</b> Ampex International Sales Corp. 151 Chin Swee Road #08-13 Manhattan House Singapore 0316 Republic of Singapore</p> <p><b>SPAIN</b> Ampex Trading Co. S.A. Calle Princesa No. 47 5th Floor C &amp; D Madrid 8, Spain</p> <p><b>SWEDEN</b> Ampex Scandinavia A.B. P.O. Box 7056 (Rissneleden 8) S-172 07 Sundbyberg, Sweden</p> <p><b>SWITZERLAND</b> Ampex World Operations S.A. Rue de Simplon 13 1700 Fribourg Switzerland</p> <p><b>VENEZUELA</b> OTACCA-AMPEX Apartado 76825 Caracas 1070-A Venezuela</p>

# SAFETY AND FIRST AID SUGGESTIONS

Regardless of how well electrical equipment is designed, personnel can be exposed to **dangerous electrical shock** when protective covers are removed for maintenance or other activities. Therefore, it is incumbent on the user to see that all safety regulations are consistently observed and that each individual assigned to the equipment has a clear understanding of first aid related to electrical hazards.

In addition, the following safety practices must be followed:



- 1 Do not attempt to adjust unprotected circuit controls or to dress leads with power on.

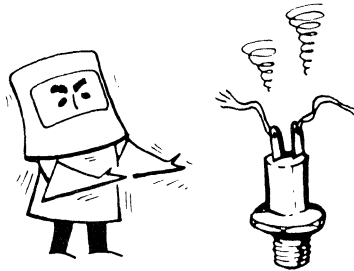

- 2 Do not touch heavily loaded or overheated components without precaution to avoid burns.



- 3 Do not assume that all danger of electrical shock is removed when power is off. Charged capacitors can retain dangerous voltages for a long time after power is removed. These capacitors should be discharged through a suitable resistor before any circuit points are touched.



- 4 Always avoid placing parts of the body in series between ground and circuit points.

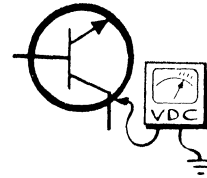

- 5 Remember that some semiconductor cases and solid-state circuits carry high voltages.



- 6 Don't take chances. Be fully trained. Ampex equipment should be operated and maintained by fully qualified personnel.

If someone seems unable to free himself while receiving an electrical shock, **turn power off** before attempting to render aid. A muscular spasm or unconsciousness can make a victim unable to free himself from the electrical power.

## WARNING

**DO NOT TOUCH VICTIM OR HIS CLOTHING BEFORE POWER IS REMOVED OR YOU MAY ALSO BECOME A SHOCK VICTIM.**

If power cannot be removed immediately, **very carefully** loop a length of dry nonconducting material (such as rope, insulating material, or clothing) around the victim and pull him free of the power. Carefully avoid touching him or his clothing until free of power. Immediately start the appropriate first aid procedures.

## **GOOD PRACTICES**

In maintaining the equipment covered in this manual, please keep in mind the following standard good practices:

- 1** When connecting any instrument (oscilloscope, waveform monitor, etc.) to a high-frequency output, use the appropriate termination resistor at the input of the instrument, unless the instrument is terminated internally.
- 2** When inserting or removing printed wiring assemblies (PWAs), cable connectors, or fuses, always turn off power to the affected portion of the equipment. After power is removed, allow sufficient time for the power supplies to bleed down before reinserting PWAs.
- 3** When troubleshooting, remember that FETs and other metal-oxide-semiconductor (MOS) devices may appear defective because of leakage between traces or component leads on the printed wiring board. Clean the printed wiring board and recheck the MOS device before assuming it is defective.
- 4** When replacing MOS devices, follow standard practices to avoid damage caused by static charges and soldering.
- 5** When removing components from PWAs (particularly ICs), use care to avoid damaging PWA traces.

### **WARNING**

This equipment generates, uses, and can radiate radio frequency energy and, if not installed and used in accordance with the instruction manual, may cause interference to radio communications. It has been tested and found to comply with the limits for a Class A computing device pursuant to Subpart J of Part 15 of FCC rules, which are designed to provide reasonable protection against such interference when operated in a commercial environment. Operation of this equipment in a residential area is likely to cause interference, in which case, the user, at his own expense, will be required to take whatever measures may be necessary to correct the interference.





# TABLE OF CONTENTS

PARAGRAPH NO.	TITLE	PAGE NO.
<b>SECTION 1 INTRODUCTION</b>		
1-1	Introduction . . . . .	1-1
1-2	What ADO Does . . . . .	1-1
1-3	Digital Image Processing . . . . .	1-1
1-4	Real-Time Image Transformation . . . . .	1-1
1-5	Image Transformation Capabilities . . . . .	1-2
1-6	Three-Dimensional Effects . . . . .	1-2
1-7	Global Control . . . . .	1-2
1-8	Motion . . . . .	1-4
1-9	Image Modification . . . . .	1-4
1-10	Key Channel . . . . .	1-4
1-11	Effect Control . . . . .	1-4
1-12	Effect Storage . . . . .	1-5
1-13	What the Concentrator Does . . . . .	1-5
1-14	System Integration . . . . .	1-5
1-15	Contents of this Guide . . . . .	1-5
1-16	Related Publications . . . . .	1-6
<b>SECTION 2 OPERATOR CONTROLS AND SYSTEM MENUS</b>		
2-1	Definitions and Conventions . . . . .	2-1
2-2	Axis Definition . . . . .	2-1
2-3	Scale Factors . . . . .	2-2
2-4	Source Space . . . . .	2-4
2-5	Grids . . . . .	2-4
2-6	Noise Reduction . . . . .	2-6
2-7	Motion . . . . .	2-6
2-8	Keyframe Terminology and Definitions . . . . .	2-6
2-9	Keyframe Parameters . . . . .	2-8
2-10	Source Selection . . . . .	2-9
2-11	Mirror Mode . . . . .	2-9
2-12	Global Mode . . . . .	2-9
2-13	Auto Cube Mode . . . . .	2-10
2-14	Concentrator Parameters . . . . .	2-10
2-15	Single-Channel/Multichannel Operation . . . . .	2-10
2-16	Keyboard . . . . .	2-11
2-17	Mode Select Keys . . . . .	2-12
2-18	MORE Key . . . . .	2-12
2-19	Run Mode Key . . . . .	2-12
2-20	Logical Channel Select Keys . . . . .	2-12

# TABLE OF CONTENTS

## (Continued)

PARAGRAPH NO.	TITLE	PAGE NO.
<b>SECTION 2 OPERATOR CONTROLS AND SYSTEM MENUS (CONTINUED)</b>		
Keyboard (Continued)		
2-21	Soft Keys/Physical Channel Select Keys . . . . .	2-12
2-22	Keyframe Parameter Keys . . . . .	2-12
2-23	Clear Keys . . . . .	2-12
2-24	Store/Recall Effect Keys . . . . .	2-13
2-25	Numeric Entry Keypad . . . . .	2-13
2-26	Numeric Entry Sign Select Key . . . . .	2-14
2-27	TIME Key . . . . .	2-14
2-28	Soft Keys . . . . .	2-14
2-29	Joystick . . . . .	2-14
2-30	Menus . . . . .	2-14
2-31	Communications Mode Menu . . . . .	2-14
2-32	Setup Mode Menu . . . . .	2-16
2-33	Program Menu . . . . .	2-16
2-34	Many-Parameter Display . . . . .	2-19
2-35	One-Parameter Display . . . . .	2-20
2-36	Global Mode Menu . . . . .	2-20
2-37	Run Mode Menu . . . . .	2-20
2-38	Run Mode Menu, Local-Concentrator . . . . .	2-22
2-39	Run Mode Menu, Global-Concentrator . . . . .	2-23
2-40	Soft Key Menus . . . . .	2-24
2-41	Setup Mode Soft Keys . . . . .	2-24
2-42	Program Mode Soft Keys . . . . .	2-25
2-43	Run Mode Soft Keys . . . . .	2-31
2-44	Communications Soft Keys . . . . .	2-33
2-45	Menu Road Map . . . . .	2-33
2-46	Floppy Disks . . . . .	2-33
2-47	Disk Handling and Storage . . . . .	2-33
2-48	Formatting Disks . . . . .	2-34
<b>SECTION 3 OPERATING PROCEDURES</b>		
3-1	Introduction . . . . .	3-1
3-2	Getting Started . . . . .	3-1
3-3	Acquiring a Signal System . . . . .	3-1
3-4	Basic Effects . . . . .	3-4
3-5	Positioning Images . . . . .	3-4
3-6	Horizontal Movement . . . . .	3-4
3-7	Vertical Movement . . . . .	3-5

# TABLE OF CONTENTS (Continued)

PARAGRAPH NO.	TITLE	PAGE NO.
<b>SECTION 3 OPERATING PROCEDURES (CONTINUED)</b>		
	Basic Effects (Continued)	
3-8	Diagonal Movement . . . . .	3-5
3-9	Zooming Images . . . . .	3-6
3-10	Combining Diagonal Movement and Zooming . .	3-6
3-11	Rotating Images . . . . .	3-7
3-12	Y-Axis Rotation . . . . .	3-7
3-13	X-Axis Rotation . . . . .	3-8
3-14	Z-Axis Rotation . . . . .	3-9
3-15	Rotation with Horizontal Movement . . . . .	3-9
3-16	Rotation with Axis Shifted . . . . .	3-10
3-17	Keyframe Flags. . . . .	3-10
3-18	Setting a Source Flag . . . . .	3-11
3-19	Setting a Freeze Flag . . . . .	3-12
3-20	Other Keyframe Flags . . . . .	3-13
3-21	Running an Effect. . . . .	3-14
3-22	Setting Up an Initial Effect. . . . .	3-14
3-23	Running the Effect . . . . .	3-14
3-24	Adding and Deleting Pauses and Events . . . . .	3-15
3-25	Changing Start and End Times . . . . .	3-15
3-26	Changing Effect Length . . . . .	3-15
3-27	Selecting Concentrator Channels . . . . .	3-16
3-28	Setting Concentrator Priority. . . . .	3-16
3-29	Adjusting Concentrator Parameters . . . . .	3-16
3-30	Moving to a Specified Time in an Effect . . . . .	3-17
3-31	Moving to a Specified Event in an Effect . . . . .	3-17
3-32	Editing Effects . . . . .	3-17
3-33	Naming Effects . . . . .	3-18
3-34	Storing and Recalling Effects . . . . .	3-18
3-35	Storing and Recalling Effects from On-Line Memory (Single Channel Mode Only) . . . . .	3-19
3-36	Storing and Recalling Effects from a Disk . . . . .	3-19
3-37	Erasing Effects from a Disk . . . . .	3-20
3-38	Copying a Disk . . . . .	3-20
3-39	Inserting and Deleting Keyframes . . . . .	3-21
3-40	Advanced Effects . . . . .	3-21
3-41	Off-Axis Rotation. . . . .	3-21
3-42	Rotation with Perspective . . . . .	3-21
3-43	Creating Mosaic Effects . . . . .	3-22
3-44	Creating Solarized and Posterized Effects . . . . .	3-23

# TABLE OF CONTENTS

## (Continued)

PARAGRAPH NO.	TITLE	PAGE NO.
<b>SECTION 3 OPERATING PROCEDURES (CONTINUED)</b>		
	Advanced Effects (Continued)	
3-45	Creating Colored Borders . . . . .	3-23
3-46	Using the Key Channel. . . . .	3-24
3-47	Programming a Cube . . . . .	3-25
3-48	Multichannel Software Example . . . . .	3-25
3-49	Single-Channel Software Example . . . . .	3-26
3-50	Engineering Setup Mode . . . . .	3-27
3-51	Adjusting Luma/Chroma Gain. . . . .	3-27
3-52	Adjusting Output Horizontal Phase . . . . .	3-27
3-53	Adjusting Subcarrier Phase . . . . .	3-28
3-54	Adjusting Burst/Gain Phase. . . . .	3-28
3-55	Adjusting Sync Amplitude . . . . .	3-28
3-56	Key Gain (Digi-Matte Option Only) . . . . .	3-28
3-57	Adjusting Key In H Phase (Digi-Matte Option Only) . . . . .	3-28
3-58	Adjusting Key In Offset . . . . .	3-29
3-59	Storing Setup Parameters . . . . .	3-29
3-60	Storing Setup Parameters in Memory . . . . .	3-29
3-61	Saving Setup Parameters on a Disk . . . . .	3-29
3-62	Digi-Matte Adjustment . . . . .	3-30
3-63	Automatic Horizontal Phase Correction (Auto H-Phase). . . . .	3-31
3-64	High Level Controller/Control Processor Switch Settings . . . . .	3-31
3-65	Error Messages . . . . .	3-33

### INDEX

### APPENDIX

# LIST OF ILLUSTRATIONS

FIGURE NO.	TITLE	PAGE NO.
1-1	Typical ADO System Configuration . . . . .	1-3
2-1	Axis Definition . . . . .	2-1
2-2	Grids and Safe Area . . . . .	2-5
2-3	Motion Types . . . . .	2-7
2-4	Keyboard . . . . .	2-11
2-5	Communications Mode Menu . . . . .	2-15
2-6	Setup Mode Menu . . . . .	2-16
2-7	Program Menu, Many-Parameter Version . . . . .	2-18
2-8	Program Menu, One-Parameter Version . . . . .	2-19
2-9	Global Mode Menu . . . . .	2-21
2-10	Run Mode Menu . . . . .	2-21
2-11	Run Mode Menu, Local-Concentrator . . . . .	2-22
2-12	Run Mode Menu, Global-Concentrator . . . . .	2-23
2-13	List Disk Menu . . . . .	2-25
2-14	Keyframe Flags Menu . . . . .	2-26
2-15	Channel Grids Menu . . . . .	2-27
2-16	Enter Name Menu . . . . .	2-28
2-17	Input Video Parameters Menu . . . . .	2-29
2-18	Input Video Flags Menu . . . . .	2-30
2-19	Key Control Menu . . . . .	2-31
2-20	Menu Road Map . . . . .	2-35
2-21	Inserting Disk in Disk Drive . . . . .	2-38
2-22	Disk Handling and Storage . . . . .	2-39
3-1	Power Switch Locations . . . . .	3-2
3-2	Communications Mode Menu . . . . .	3-3
3-3	Cube Faces . . . . .	3-25
3-4	Key Input System Block Diagram . . . . .	3-30

# LIST OF TABLES

TABLE NO.	TITLE	PAGE NO.
2-1	Setup Parameters . . . . .	2-17
3-1	Control Processor PWA Switch S1 . . . . .	3-32
3-2	High Level Controller PWA Switch S1 . . . . .	3-32
3-3	High Level Controller PWA Switch S2 . . . . .	3-33
3-4	Control Panel Error Messages. . . . .	3-33



**ADO**



**Ampex Digital Optics**



## **SECTION 1**

# **INTRODUCTION**

### **1-1 INTRODUCTION**

This manual provides operating information for the Ampex Digital Optics (ADO) system. You may use the information in this guide for first-time operation, or as a reference after you have used the system for a while.

The material in this section describes ADO real-time digital effects capability and how to use this capability to create high-quality video images with true three-dimensional characteristics. Multi-image effects are created in real time by the optional ADO concentrator.

### **1-2 WHAT ADO DOES**

Following is a description of ADO image processing capability. Some of the capabilities require optional equipment; where this is the case, it is noted in the description. A typical ADO system configuration is shown in Figure 1-1.

### **1-3 Digital Image Processing**

ADO processes images by converting the analog video input signal to digital form and storing the resulting digital information. Each picture element (pixel) is mapped, in the form of a matrix, into what is termed *source* space. The source image is transformed in the desired way by calculating the location of pixels in what is termed *target* space. The transformation is done with precise mathematical formulas applied by distributed microprocessor circuits.

To preserve picture quality when images are compressed or expanded, digital interpolation and extrapolation circuits fill in or remove pixels from the original image.

There are many advantages gained by using digital processing. Because all image transformation is done digitally, noise, phase shift, and other undesirable picture effects are virtually eliminated. Digital processing circuits also provide smooth image motion, allowing images to be moved slowly or rapidly without jerkiness. Thus ADO system's high-quality video output ensures that broadcast standards are met without exception.

### **1-4 Real-Time Image Transformation**

Image transformation is done in real time, allowing live sources (e.g., from a camera) to be used as well as moving images from a video tape recorder. The output from a real-time graphics system such as a character generator can be processed while in crawl, reveal, or flash modes.

# **ADO**

Spectacular effects such as rotating cubes with different moving images on each face are created as easily as is a single, static image. With the optional ADO Concentrator, separate images can be mixed to provide multichannel effects in real time.

Freeze mode captures a single frame from an incoming video signal. This image can then be processed in any way the user requires. A control-panel pushbutton allows the operator to choose manually a frame from an incoming video source. A programmable freeze flag freezes an image while an effect is running.

## **1-5 Image Transformation Capabilities**

Images are transformed in three ways:

1. Aspect ratio can be changed, and image size can be modified before rotation and three-dimensional transformation.
2. Images can be compressed, expanded, and positioned after rotation and three-dimensional transformation.
3. Using optional rotation capability, images can be rotated and transformed in three-dimensional space.

Image transformation capabilities include:

- Image compression: From normal size to vanishing.
- Image expansion: From normal size to 32,767 x normal size.
- Image positioning: Images can be positioned anywhere in target space; includes positioning along X, Y, and Z axes.
- Off-axis moves: Using AXIS SELECT 3D, X, Y, and Z axes can be moved away from the normal center of target space (the video monitor screen).
- Rotation: Images can be rotated around all three axes, either in normal center position or in shifted position. Rotation gives the effect of an image spinning, tumbling, or flipping.

## **1-6 Three-Dimensional Effects**

ADO creates three-dimensional effects by combining perspective with rotation and three-dimensional positioning to give the effect of viewing an image at a distance or from above, below, or from the side. Perspective capability is a system option.

ADO also creates three-dimensional solids by combining two or more images from two or more separate signal systems. A production switcher or the optional ADO Concentrator accessory must be used to achieve an effect containing solids.

## **1-7 Global Control**

Global mode allows the user to control parameters simultaneously. This control allows simultaneous rotation and translation to give the effect of a spinning or tumbling image moving toward or away from the viewer.

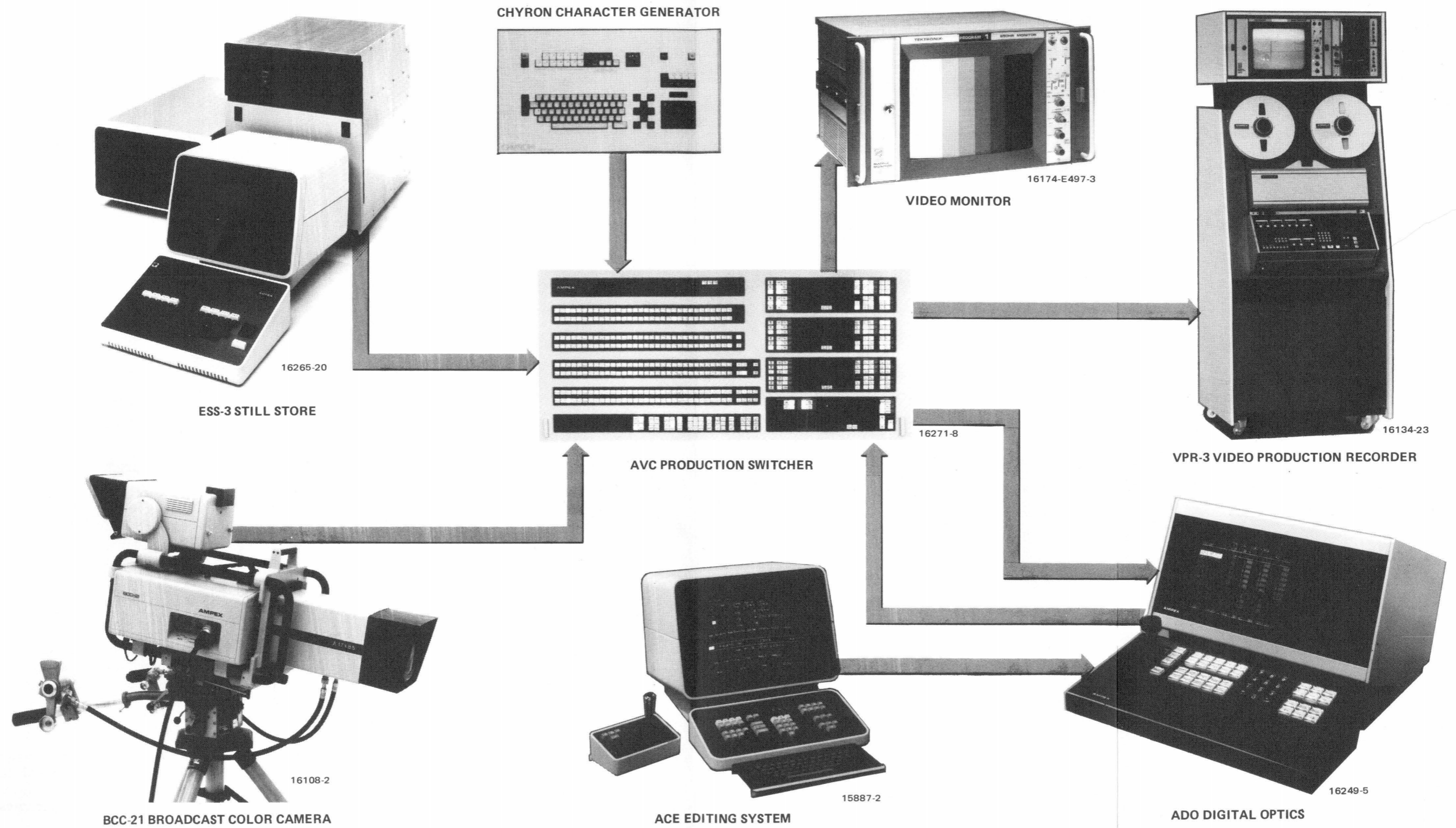

Figure 1-1.  
Typical ADO System Configuration

# **ADO**

Another possibility for global parameter control is combined X, Z rotation in which an image is rotated around the Z axis while maintaining edges parallel to the Y axis.

## **1-8 Motion**

By programming keyframes you can create the effect of motion. Effects such as a spinning object moving toward the viewer are created by using size, position, and rotation functions simultaneously.

Motion can be smooth or linear depending on the user's requirement. Pauses can be programmed in effect sequences to give the effect of motion stopping.

Or, each keyframe can have a variable duration programmed by the user, in one-frame increments.

## **1-9 Image Modification**

Images can be modified using one of ADO video modification capabilities as follows:

- Mosaic mode converts an image into rectangles. Extent of mosaic area and size of rectangles are user-programmed. An external key signal can be used to define an area for mosaic conversion, using the Digi-Matte\* key option.
- Solarization and posterization modes create high-contrast images. Extent of effect is programmed.
- Blur mode softens the edges of graphics such as those produced by a title generator.
- In multichannel operation with a concentrator, images can be modified by simulated light sources of two types and by variations in image transparency and image reflectance.

## **1-10 Key Channel**

The system's key output provides a means of keying through a production switcher so that the image processed by ADO can be superimposed over a background. Normal key output is a luminance key signal that follows any image transformation. If the Digi-Matte option is installed, the key channel can be used to process an externally supplied key signal. A color background generator creates color borders after the image created by the system has been keyed over a background. Key edge softness can be controlled by the user.

## **1-11 Effect Control**

An effect is built from a series of keyframes, each of which specifies image transformation parameters (see paragraph 2-9). As keyframes are assembled to form an effect, the user modifies parameters as required. Existing keyframes, stored in control unit local memory, can be modified or deleted, and new keyframes

\*Trademark, Ampex Corporation

can be inserted. By using run mode, the effect can be viewed and then trimmed as required.

With the optional disk drive installed, effects can be stored on a disk and then recalled for editing or running.

## **1-12 Effect Storage**

Each 5-1/4-in. floppy disk stores over 50 single-channel effects of up to 25 keyframes each or over 10 multichannel effects of up to 25 keyframes each. Effects and disks can be given titles up to 15 characters for easy identification.

## **1-13 WHAT THE CONCENTRATOR DOES**

The optional ADO Concentrator creates multichannel effects. Under control of one user, the concentrator accepts images in digital form from two or more ADO signal systems. The images are then combined digitally and transferred to a signal system for reconstruction into a composite video signal.

Two users may independently produce a two-channel effect simultaneously. The ability of the concentrator to control processing automatically and its ability to synchronize the video channels in use, improves the quality of effects. Because the concentrator uses digital processing techniques, the user can program image priorities--which image is seen in front of another--for multi-image effects such as three-dimensional solids. In addition, the user can control image transparency, allowing channels to be superimposed. Other parameters controlled by the operator are reflectance and two types of lighting sources for the image. All of these parameters can be individually changed at selected times throughout the effect. The system tolerates errors in horizontal phasing without image quality being affected. Because timing errors between video channels are eliminated, combined effects produced by the concentrator are aligned perfectly. The concentrator also produces soft edge keying when provided with a soft edge key signal from an ADO signal system. To a single channel user, the concentrator is transparent.

## **1-14 SYSTEM INTEGRATION**

An integrated system can consist of up to four signal systems controlled by up to eight control panels. One control panel can acquire up to four signal systems for multichannel effects. The ADO Concentrator can be acquired and controlled by any one or two of the control panels in an integrated system. Whenever two or more channels are acquired, the concentrator is automatically acquired.

An integrated system can be reconfigured at any time by issuing commands from control panels. Signal systems can be acquired or released.

## **1-15 CONTENTS OF THIS GUIDE**

### **Note**

**Operating information contained in this guide pertains to ADO operating software, version 5. If subsequent software changes which**

# **ADO**

**affect system operation occur, these changes will be described in a change package which supplements this guide. This change package should be referred to before operating the system.**

This guide is an operating manual for the ADO system operator, and can be used for instruction or as a reference during editing sessions. It is divided into three sections:

Section 1 provides preliminary information an operator should know before using the system.

Section 2 describes operator controls and system menus. This section also discusses the XYZ axis system used to describe image location. A paragraph on scale factors lists each image modification parameter and lists the factors pertaining to the parameter.

Section 3 gives step-by-step operating procedures for simple and complex effects. This section also discusses mosaic and posterization/solarization, and using the key channel. Procedures for adjusting engineering parameters in setup mode are described at the end of the section.

## **1-16 RELATED PUBLICATIONS**

The following publications should be referred to, as applicable, when using this guide:

- *ADO Service Manual*, Catalog No. 1809550-03
- *ADO Parts Lists and Schematics*, Catalog No. 1809621-04.
- *ADO Concentrator Service Manual*, Catalog No. 1809633-01.

## SECTION 2

# OPERATOR CONTROLS AND SYSTEM MENUS

### 2-1 DEFINITIONS AND CONVENTIONS

Throughout this manual we refer to X, Y, and Z axes, movement with respect to the axes, and rotation around the axes.

In addition, we refer to source space and target space. Image size, location, and rotation parameters are chosen with respect to axes in source or target space.

### 2-2 Axis Definition

In both source and target space, axes are aligned in the same way. The X axis is horizontal, extending out on both sides from the picture monitor screen. The Y axis is vertical, extending up and down from the picture monitor screen. The Z axis is perpendicular to the X and Y axes, extending toward and away from the screen. See Figure 2-1.

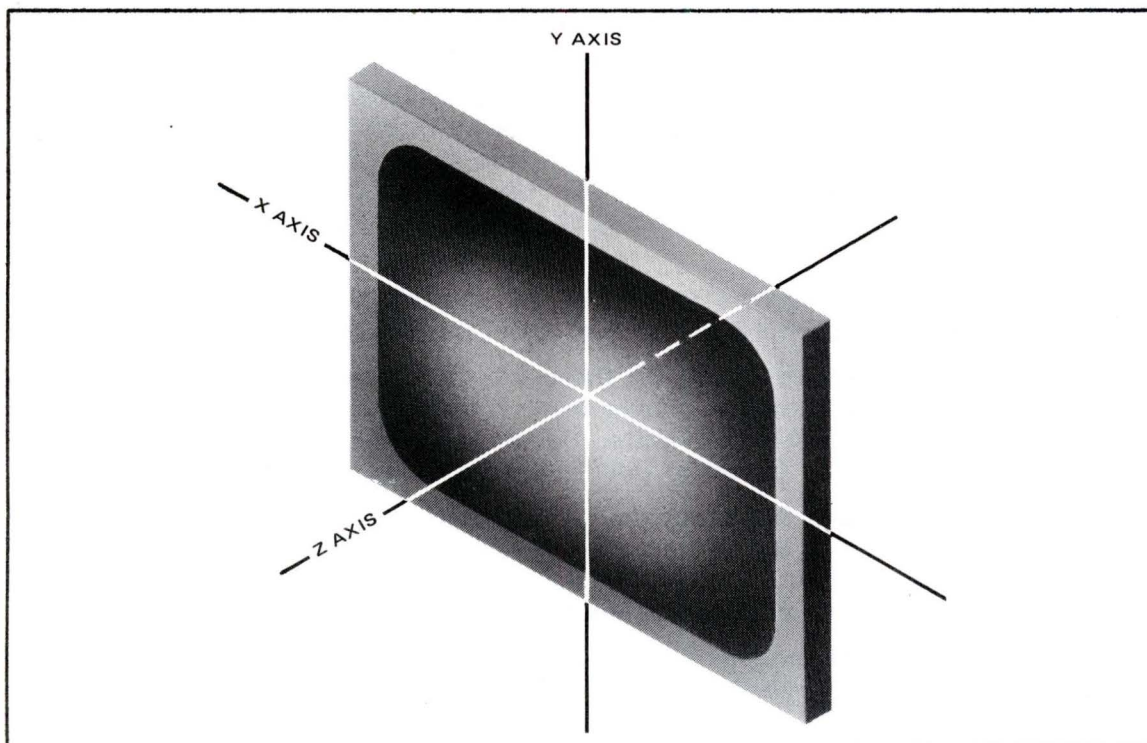

Figure 2-1. Axis Definition

# ADO

## 2-3 Scale Factors

Position and size factors are based on a picture monitor screen which has a 4:3 aspect ratio.

- *Vertical (Y) Dimension:* 6 units; +3 and -3 units from screen center.
- *Horizontal (X) Dimension:* 8 units; +4 and -4 units from screen center.
- *Perpendicular (Z) Dimension:* An indeterminate number of units toward and away from the viewer. Positive values of Z are out of the screen, toward the viewer. Negative values of Z are into the screen, away from the viewer. Higher positive Z values appear to enlarge the image; higher negative values appear to reduce the image.
- *Rotation Values:* 1.0 is equal to  $360^\circ$  rotation. Values are programmed with 0.0001 unit resolution, corresponding to  $0.036^\circ$  increments.
- *Size Values:* 1.0 is full image size—0.5 is half size, etc.
- *Skew:* Changes image geometry so that parallel edges are slanted. A skew value of 1.0 gives an unskewed image; negative values skew image to left, positive values to right.
- *Post-Y Values:* 1.0 is equal to  $360^\circ$  rotation. Values are programmed with 0.0001 unit resolution, corresponding to  $0.036^\circ$  increments. This parameter allows Y rotation about an alternate axis.
- *Perspective Factors:* For perspective approximating the field of view of the human eye ( $46^\circ$ ), the value is 0.06. This is the value assigned by the system at power-up. A perspective value of 0.06 corresponds to a viewing distance (from eye to screen) of 16.67 units. The distance from the eye to the screen is always one divided by the perspective number. Perspective values are programmed from zero (viewing distance infinitely far from the screen and so having no perspective), up to 10 (eye 0.10 units from screen, and so having very large perspective). As the perspective number is varied a picture with zero Z value (exactly at screen depth) will not change apparent size.
- *Border Width:* Programs the width of colored border around an image. Values can be set from 0 (no border) to 3.0 (no image).
- *Border Color Values:* Programs three sets of values—saturation, luminance, and hue. Saturation values range from 0 to 100%. Luminance values range from -6.6 to +106.1 IRE units. Border hue can be programmed in  $1^\circ$  increments from  $0^\circ$  (cyan) to  $180^\circ$  (purple) and back to cyan at  $359^\circ$ .
- *Crop Left/Top and Right/Bottom:* System-assigned values are -4, 3, 4, and -3, corresponding to the uncropped edges of the 8 x 6 unit image as measured from screen center. Values lower than  $\pm 4$  and  $\pm 3$  crop the image from full screen areas, approaching zero image size.
- *Source Aspect/Size:* Changes image size and aspect ratio in source space. Rightward joystick movement (or X values greater than +1) expands the image horizontally. Leftward joystick movement (or X values less than +1) compresses the image horizontally. When X has a value of zero the image is infinitesimally small. Further leftward joystick movement (or negative X



values) again expands the image horizontally but as a mirror image. An X value of -1 regains original image size, but the image is reversed.

Upward joystick movement (or Y values greater than +1) expands the image vertically. When Y has a value of zero, the image is infinitesimally small. Further downward joystick movement (or negative Y values) again expands the image horizontally, but as a mirror image. A Y value of -1 regains original image size, but the image is reversed.

Aspect ratio values of 1 are assigned by the system when power is turned on. Both X and Y values range from 1.0000 (normal aspect ratio) to  $\pm 32,000$  (highly compressed or expanded).

Counterclockwise joystick knob rotation (or Z values less than 1) reduces image size. A Z value of 1.0000 is assigned by the system when power is turned on. Size values range from 1.0000 (normal size) to 0 (vanishing).

Clockwise joystick knob rotation (or Z values greater than 1) increases image size. Size values range from 1.0000 (normal size) to 32,000 (extremely large).

- **Target Position/Size:** Changes image size and scale factors in target space. Leftward joystick movement (or negative X values) moves the image to the left. An X value of -4 moves the center of the image to the extreme left of the screen. Rightward joystick movement (or positive X values) moves the image to the right. An X value of +4 moves the center of the image to the extreme right of the screen.

Upward joystick deflection (or positive Y values) moves the image up. A Y value of +3 moves the center of the image to the top of the screen. Downward joystick deflection (or negative Y values) moves the image down. A Y value of -3 moves the center of the image to the bottom of the screen.

Counterclockwise joystick knob rotation (or Z values less than 1) reduces image size. A Z value of 1.0000 is assigned by the system when power is turned on. Size values range from 1.0000 (normal size) to 0 (vanishing).

Clockwise joystick knob rotation (or Z values greater than 1) increases image size. Size values range from 1.0000 (normal size) to 32,000 (extremely large).

- **Axis Select 3D:** Moves image away from the intersection of source space axes. When the system is turned on, X, Y, and Z axes are located at the center of target space (values are 0, 0, 0).

Leftward joystick movement (or negative X values) moves the image to the left of the axis of rotation. Rightward joystick movement (or positive X values) moves the image to the right of the axis of rotation.

Upward joystick movement (or positive Y values) moves the image up from the axis of rotation. Downward joystick movement (or negative Y values) moves the image down from the axis of rotation.

Clockwise joystick knob rotation (or positive Z values) moves the image further from the viewer and away from the axis of rotation (apparently into the screen). Counterclockwise joystick knob rotation (or negative Z values)

# ADO

moves the image toward the viewer and toward the axis of rotation (apparently out of the screen).

- *Rotate 3D*: Rotates the image around each of the source space axes at a location determined by previous axis select parameters. Left and right joystick movements rotate the image around the Y axis. A value of 1.0000 is one complete rotation; a value of 0.5 is 180°, etc.

Up and down joystick movements rotate the image around the X axis. A value of 1.0000 is one complete rotation; a value of 0.5 is 180°, etc.

Clockwise joystick knob rotation (or positive Z values) rotates the image clockwise around the Z axis. A value of 1.0000 is one complete rotation; a value of 0.5 is 180°, etc.

Counterclockwise joystick knob rotation (or negative Z values) rotates the image counterclockwise around the Z axis. A value of -1.0000 is one complete rotation; a value of -0.5 is 180°, etc.

- *Locate 3D*: Moves the image and the axis of rotation with respect to the viewer—as if the object were on a platform which can be raised, lowered, moved from side to side, or moved toward and away from the viewer. Leftward joystick movement (or negative X values) moves the image to the left. A value of -4 moves the center of the image to the extreme left of the screen.

Rightward joystick movement (or positive X values) moves the image to the right. A value of +4 moves the center of the image to the extreme right of the screen.

Upward joystick movement (or positive Y values) moves the center of the image up. A value of +3 moves the center of the image to the top of the screen.

Downward joystick movement (or negative Y values) moves the center of the image down. A value of -3 moves the center of the image to the bottom of the screen.

Clockwise joystick knob rotation (or positive Z values) moves the image away from the viewer (apparently into the screen). Counterclockwise joystick knob rotation (or negative Z values) moves the image toward the viewer (apparently out of the screen).

## 2-4 Source Space

ADO processes images in three stages. The first stage performs source aspect/size, crop, border, and skew functions. The second stage performs three-dimensional functions such as axis select, locate 3D, rotate, and perspective. The third stage performs position and size functions. Stage one operates in source space. These functions are then translated by stage two into target space (stage 3).

## 2-5 Grids

Grids provide the user with precise location references. Two kinds of grid are provided: a single, cross-hair grid in source space and a multiple grid in target space. In addition, a safe area display can be selected. See Figure 2-2. Also a channel identification display may be used.

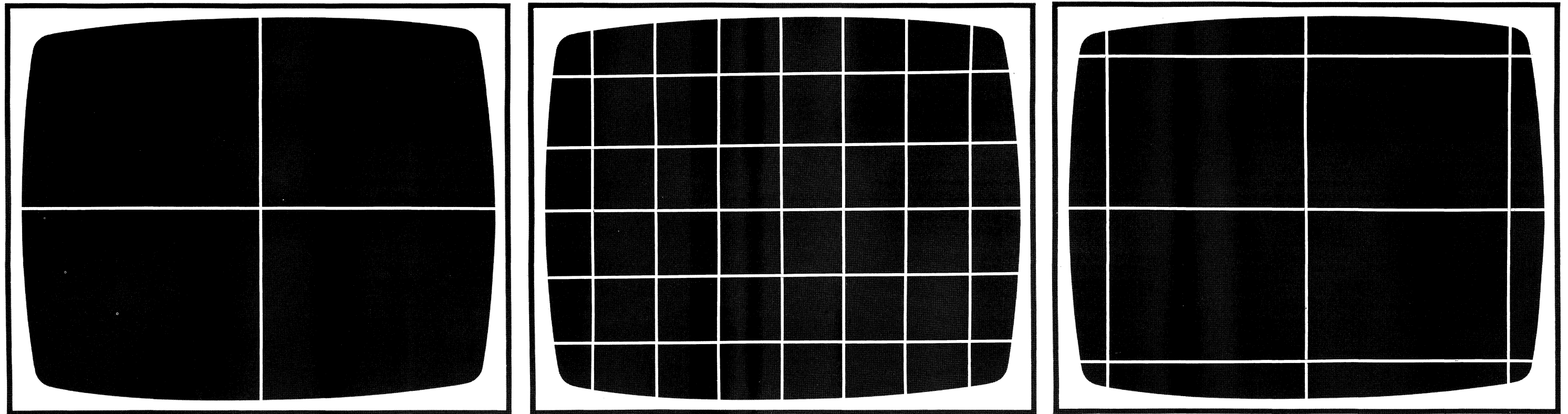

SOURCE GRID

TARGET GRID

SAFE AREA

Figure 2-2.  
Grids and Safe Area

# ADO

The source grid is a single cross hair centered on the image. This grid moves with the image in source space. This grid indicates the axis of rotation.

The target grid is a crosshatch with operator-controllable spacing and position. This grid, unlike the source grid, stays in place and does not change as the image is rotated or translated.

The safe area function displays a rectangle on the normally over-scanned TV monitor, outlining the picture area that appears on the standard underscanned receiver. This shows the operator just how much of the effect is really visible to the television viewer.

The channel ID display is superimposed on the image in source space, and provides three functions. It indicates the channel number of each video image in a multichannel effect; it indicates whether the A or B video input is being used; it indicates whether the front or back of the picture is being shown. The channel ID display is especially useful when programming multichannel effects.

## 2-6 Noise Reduction

The noise reduction function filters out low-level noise in the luminance signal, tending to produce snow in the output video. An intrinsically noisy signal is not noticeably improved by noise reduction, but a good signal is made better.

## 2-7 Motion

Motion is defined as any parameter change. ADO provides three motion types: smooth, linear, and hold. See Figure 2-3. A different motion type can be programmed, for any parameter, as follows:

- Smooth motion changes an image parameter value smoothly, with acceleration and deceleration, attempting to take the smoothest path between keyframes. (All smooth effects accelerate gradually from zero when leaving first keyframe and decelerate gradually to zero when reaching last keyframe.)
- Linear motion changes an image parameter value at a constant rate. The parameter changes at a linear rate determined by keyframe duration.
- Hold mode changes an image parameter value abruptly at a keyframe, the value remaining constant for the keyframe duration.
- Break function causes motion to decelerate to zero as it reaches keyframe and accelerate from zero as it leaves keyframe. Turning break off (no break) forces the same rate of change, or speed, going into and out of keyframe.

## 2-8 Keyframe Terminology and Definitions

A keyframe is one complete set of image modification and transformation parameters, including size, rotation, skew, perspective, and border width/color. Each keyframe is programmed independently by the operator and may include different motion types and image modification parameters such as mosaic and freeze. Keyframe duration specifies the length of time between the current keyframe and the next keyframe.

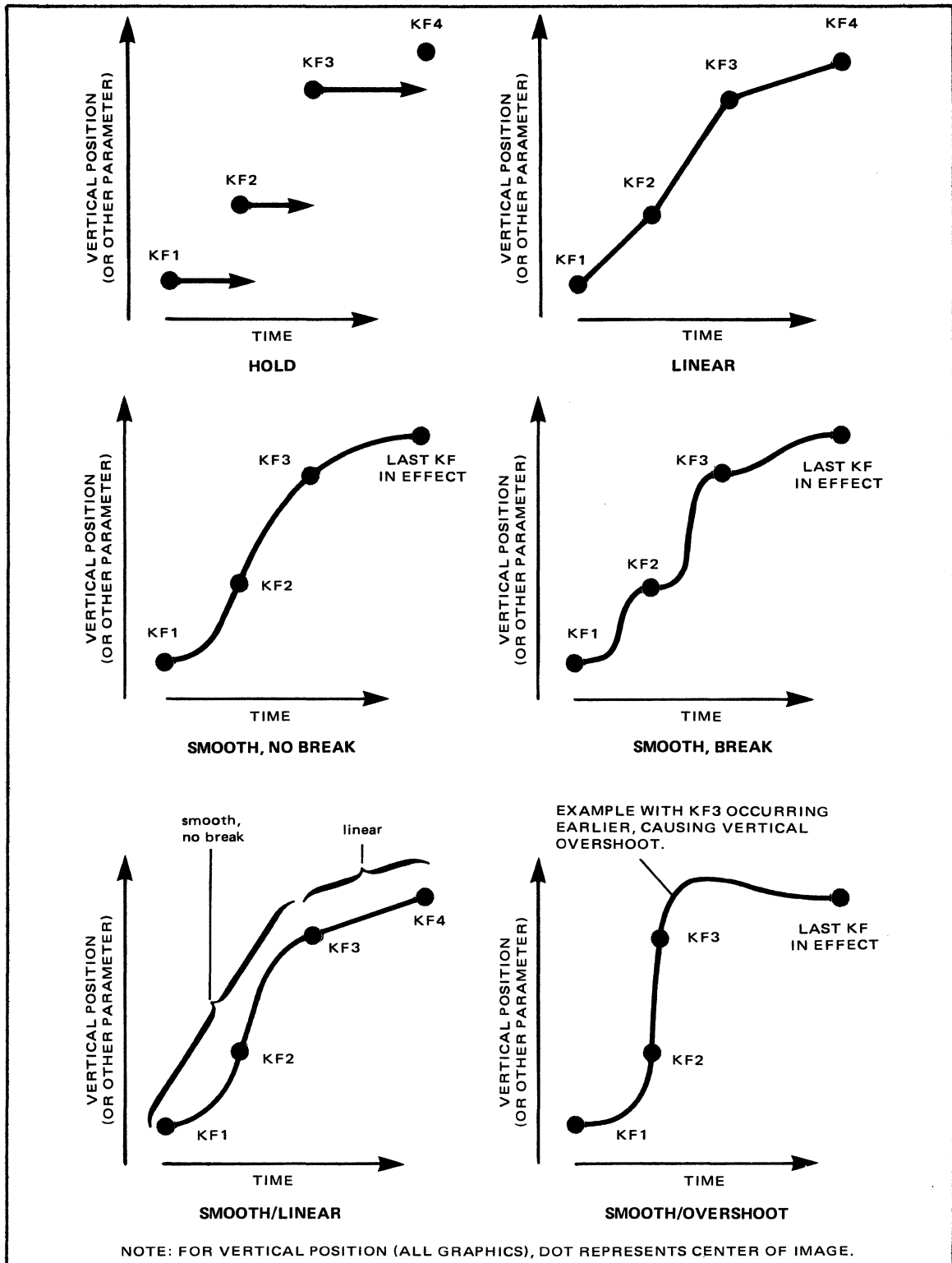

Figure 2-3. Motion Types

# ADO

Keyframes are assembled into effects-integrated series of image transformations. Individual effects can be stored on disk and then recalled to run the effect. Any or all keyframe parameters can be edited at any time.

Keyframe flags are conditions which affect such things as image mirrors, image source, cube mode, freeze, or global. Flags can be set, for example, to change to mosaic mode or to switch sources partway through an effect.

## 2-9 Keyframe Parameters

Each keyframe has parameters which may or may not change during an effect. The primary parameters for each channel are:

- Source aspect and size
- Target position and size
- Axis select 3-D
- Rotate 3-D
- Locate 3-D
- Skew, post-Y rotation, and perspective
- Border width
- Border color
- Crop top and left
- Crop bottom and right

Secondary keyframe parameters, designated as keyframe flags, are:

- Freeze on or off
- Source A or B or A/B
- A mirror—none, X, Y, or X and Y
- B mirror—none, X, Y, or X and Y
- Global on or off
- Interlace—frame, field, auto 1 or auto 2
- Cube on or off (auto cube mode available with multichannel software only)
- Y blur on or off

For keyframes flags details, see paragraph 3-17.

In addition to keyframe parameters and flags listed previously, input video parameters such as solarization and mosaic can be programmed for each keyframe. Input video parameters include:

- Chroma and luminance mapping for solarization and posterization
- Vertical and horizontal mosaic block size

- Window location and size for mosaic, solarization, and posterization functions.

Input video keyframe flags include:

- Mosaic on/off, all over image, inside window, or outside window.
- Solarization on/off, all over image, inside window, or outside window.
- Mosaic window rectangular, set by key, set by luminance level, or set by combination of rectangular shape and key shape.
- Solarization window rectangular, set by key, set by luminance level, or set by combination of rectangular shape and key shape.
- Mosaic chroma in X axis, Y axis, both X and Y axes, or neither axis.

The key signal is also controlled by keyframe flags which include:

- Softness
- Blur
- Digi-Matte option A/B on/off
- Digi-Matte option A/B inversion
- Digi-Matte option A/B gain

The global parameters that may effect all channels simultaneously are:

- Axis select 3D
- Rotate 3D
- Locate 3D

## **2-10 Source Selection**

The same or different image source can be chosen for each keyframe by setting the source flag. Different sources can be chosen for front and back of a rotating image. Selection is automatic in A/B or B/A source modes.

## **2-11 Mirror Mode**

Mirror flags are set to reverse images when they are rotated. An X mirror flag reverses the image horizontally; a Y mirror flag reverses the image vertically. An X, Y flag reverses images in both directions. Different mirror flags can be set for both sources.

## **2-12 Global Mode**

In global mode, operations can be performed on two or more channels simultaneously. For example, two channels which have been positioned to form two faces of a cube can be rotated together. The global flag is used to enable or disable the effect of the global parameters for each channel.

# ADO

## 2-13 Auto Cube Mode

This mode uses ADO system's precise geometric properties to construct opposite faces of a rotating cube or any other three-dimensional solid having parallel faces. It should be noted that constructing a solid other than a cube may require calculating keyframe parameters with a programmable scientific calculator. Refer to the Appendix, *Construction of Solids Using ADO Multichannel Software*, by Ampex Corporation, included at the end of this guide. By using A/B auto mode, different images can appear on opposite cube faces. By combining global, A/B auto, and auto cube modes, six different images can appear on all six faces of a moving cube. For cube programming examples, refer to paragraphs 3-47, 3-48, and 3-49 of this guide.

## 2-14 Concentrator Parameters

In local (non-global) mode the concentrator parameters are transparency (TRANS), and reflectance (REFLECT). If images from two or more channels are stacked, one behind another, transparency allows you to see through images to the ones behind them. The default value is 0% transparency. At values of about 80-90%, ghost-like images are produced. The reflectance value determines how bright the image will be; that is, how much of the light that falls on it will be reflected. The default value for reflectance is 100%, or no dimming.

In global mode the concentrator parameters are light and ambient. LIGHT provides a light source that appears to be directed from in front of the screen; as a channel image turns away (toward a plane perpendicular to the screen), it will become dimmer if the light parameter is active. AMBIENT provides a non-directional, general lighting. SAT, LUMA, and HUE provide selection of background color. The default values for LIGHT and AMBIENT are 0% and 100%, respectively, so no dimming occurs.

The brightness of each channel is described by:

$$\text{brightness} = \text{lessor of: } 100\% \text{ or } (\text{reflectance} \times (\text{ambient} + (\cos \theta \times \text{light})))$$

where  $\theta$  is the angle between the light source and the image. The light is always directed perpendicularly to the screen. The other variables, described above, are directly programmable on an event basis.

See Run Mode Menu, paragraphs 2-37, 2-38, and 2-39, and Run Mode Soft Keys, paragraph 2-43, for concentrator programming information. Also, see paragraphs 3-25 and 3-26.

## 2-15 Single-Channel/Multichannel Operation

Software is available either for single-channel or multichannel operation. When the multichannel option is installed, one control panel controls one, two, three, or four signal-system channels. Each signal system is a single channel, with two video inputs, two identical, buffered video outputs, a separate key output, and a reference black video input. Each video image is generated by a separate signal-system channel, and the multichannel option allows up to four signal-system



channels to be controlled by a single control unit. All channels may be controlled simultaneously, using global mode.

Alternatively, from one to eight control units can be connected to the four signal systems. The four channels can be controlled by any four of the eight control units, or by fewer than four if any control unit is in multichannel operating mode.

**2-16 KEYBOARD**

The keyboard (see Figure 2-4) and associated joystick are the primary operator controls. All keyframe parameters are set using function keys, soft keys, and either numeric entry keypad or joystick. The following paragraphs describe each keyboard function.

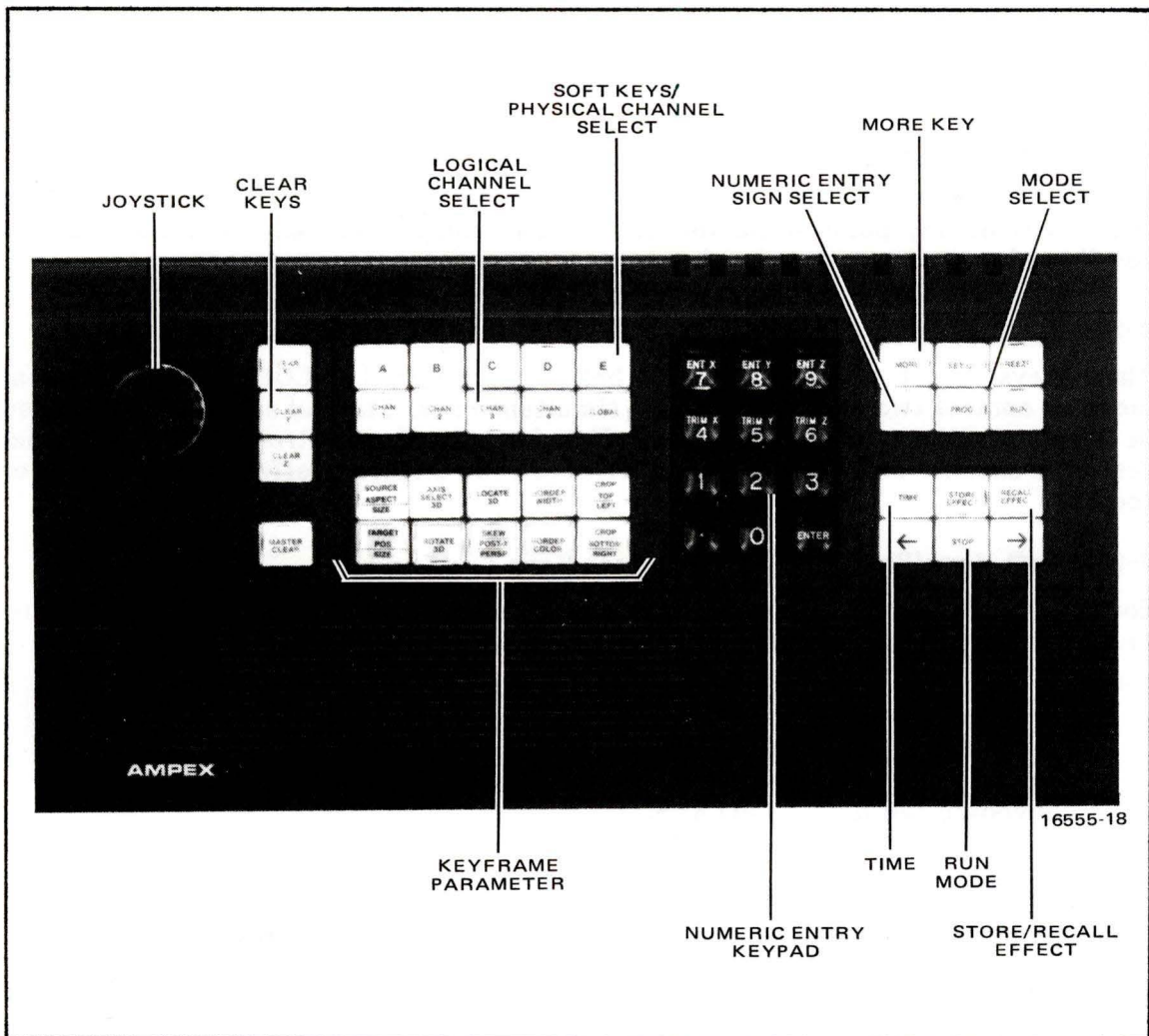

**Figure 2-4. Keyboard**

# ADO

## 2-17 Mode Select Keys

The following group of keys selects operating mode:

- SET-UP selects setup mode. This mode includes engineering parameter adjustment ( paragraph 3-50) and disk formatting (paragraph 2-48).
- PROG selects program mode, used to specify keyframe parameters and create effects.
- RUN selects run mode and enables ← , STOP, and → keys. Effects are run or previewed in this mode.
- FREEZE freezes and stores an image from incoming video. This mode allows the image to be transformed or modified as a still. Pressing FREEZE a second time unfreezes the image.

## 2-18 MORE Key

This key is used to select soft key menus in setup, program, and run modes. Pressing the key brings up new menus in sequence.

## 2-19 Run Mode Keys

The ← and → keys control direction in which the effect runs. The STOP key stops the effect at any point while the effect is running. These keys are also used to scroll keyframes in program mode.

## 2-20 Logical Channel Select Keys

These keys select which channel is being programmed. GLOBAL selects global mode to control two or more channels simultaneously. Channel select keys are used in communications mode to acquire a signal system for control. In single channel systems, channel select keys give access to four different effects for storage or recall.

## 2-21 Soft Keys/Physical Channel Select Keys

Soft keys select operating modes, keyframe parameters, or other soft key menus. In addition, these keys select a physical signal system in communications mode.

### Note

In descriptions of soft keys, soft key menus, all displayed messages, words, and symbols are printed in boldface. Other keys on the keyboard are ALL CAPITALS.

## 2-22 Keyframe Parameter Keys

These 10 keys select keyframe parameters for modification in program mode.

## 2-23 Clear Keys

These four keys clear values entered for X, Y, and Z portions of the parameter selected currently.

- **CLEAR X**, in all keyframe parameters except rotate 3D, clears X value currently displayed to the system default value.  
For rotate 3D parameter only, when pressed once, clears X axis to the nearest 90° point. When pressed again, clears axis to system-assigned value (0.0).
- **CLEAR Y**, in all keyframe parameters except rotate 3D, clears Y value currently displayed to the system default value.  
For rotate 3D parameter only, when pressed once, clears Y axis to the nearest 90° point. When pressed again, clears axis to system-assigned value (0.0).
- **CLEAR Z**, for all keyframe parameters except rotate 3D, clears Z value currently displayed to the system default value.  
For rotate 3D parameter only, when pressed once, clears Z axis to the nearest 90° point. When pressed again, clears axis to system-assigned value (0.0).
- **MASTER CLEAR**, when pushed once, clears all movement parameters programmed for the keyframe; when pushed twice, clears all keyframe parameters. With setup mode menu selected, press **MASTER CLEAR** twice to clear all setup parameters to system-assigned values.

#### **2-24 Store/Recall Effect Keys**

These keys provide access to the disk drive so that new or modified effects can be stored or effects previously stored can be recalled. When either key is pressed, **Enter effect number:** appears at the bottom of the screen to prompt the operator to enter a number from the keypad. Store/recall effect keys are also used to store and recall setup parameters in setup mode.

#### **2-25 Numeric Entry Keypad**

This keypad is used to enter numeric values for keyframe parameters, set time duration values, enter and recall effects, and assign values to setup parameters. Press **ENT X** (or **Y** or **Z**), then select numeric value, to set an X (or Y or Z) value. Press **ENTER** key. Press **TRIM X** (or **Y** or **Z**) to display message: **enter trim value**. Enter numeric value you want to add to or subtract from displayed X (or Y or Z) value. Press **ENTER** key.

Normal entry sets a parameter value for the current keyframe only; this is the default entry mode. You can use the number 1 key to apply a numerical entry to all keyframes, one channel, or to all keyframes all channels, as follows: Prior to entering the parameter value, push number 1 once. This displays the message: **set all keyframes this channel**. Push number 1 again to display **set all keyframes all channels**. The message alternates with repeated use of number 1 key. With proper message displayed, follow standard procedure for entering parameter numeric value.

This function can be used to apply the current parameter value to all keyframes this channel, or all channels, as follows: Push number 1 key once, or twice, to select proper message. Then push **ENT X** (or **Y** or **Z**), and push **ENTER**.

# ADO

## 2-26 Numeric Entry Sign Select Key

This key changes the sign of the value entered on the numeric keypad from positive to negative. This function is not enabled in time entry.

## 2-27 TIME Key

Keyframe or effect duration is set by pressing TIME and then entering a value in seconds and frames from the keypad.

## 2-28 Soft Keys

Keys A through E are soft keys, so designated because their function changes with each mode. Soft key functions and menus are described in paragraphs 2-40 through 2-42.

## 2-29 JOYSTICK

The joystick gives the operator manual control over keyframe and setup parameters and control over effect run mode.

In general, rightward joystick movement increases X values and leftward movement decreases X values. Upward joystick movement increases Y values and downward movement decreases Y values. Clockwise joystick knob rotation increases Z values; counterclockwise rotation decreases Z values. In rotation, position, and size parameters the image moves in the same direction as the joystick.

## 2-30 MENUS

Each screen display is termed a menu because it allows the operator to choose a mode or select a keyframe parameter for modification. The following paragraphs describe each menu and point out features that are used to inform the operator of system operating conditions and modes in use.

## 2-31 Communications Mode Menu

This menu, shown in Figure 2-5, comes on the screen when the system is first turned on. The top line of the display shows the operating software version and date. The option matrix at the right of the display shows which options are installed in each signal system available to the operator. A **Y** means that the option is installed; an **N** means that the option is not installed. The options shown are:

- **IVP:** Input video processing option which gives mosaic and solarization capability.
- **D Mat:** Digi-Matte option processes externally supplied key signals.
- **Opt 3 and Opt 4** are future options.
- **Persp:** The perspective option, which gives an image three-dimensional qualities.
- **Rotat:** The image rotation option.

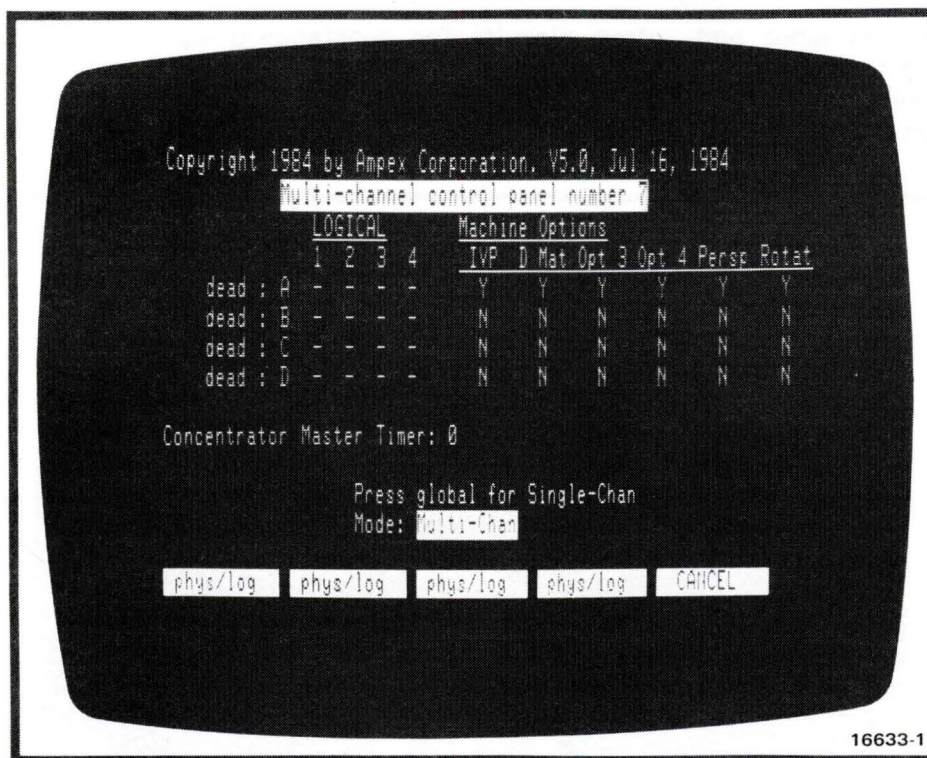

**Figure 2-5. Communications Mode Menu**

The routing matrix at the left of the menu displays the current status of each signal system in the system relative to each control unit. Refer to Figure 2-5.

Each signal system can be in one of four states, listed at the left of the routing matrix: **free**, **acquired**, **busy N**, or **dead**.

- In free state, the physical signal system is available, and is not in use by any control unit. The corresponding horizontal row in the routing matrix contains four dashes.
- In acquired state, the physical signal system is under control of the control unit used to acquire the system. The corresponding horizontal row contains an X in the vertical column corresponding to the logical assignment of the signal system, and three dashes in the other columns.
- In busy N state, the physical signal system has been taken over by some other control unit, identified by N which is a number from 0 to 7. Each control unit has a number established by the setting of three internal switches.
- In dead state, either that physical signal system has its power turned off or the communication line to it from the control unit is not operating.

## 2-32 Setup Mode Menu

This menu, shown in Figure 2-6, shows engineering parameters used to adjust the system's video input and output circuits for nonstandard signal input timing or levels. The top line of the display shows the operating software version and date. The physical channel (signal system) for which adjustment parameters are effective is shown at the upper right of the display.

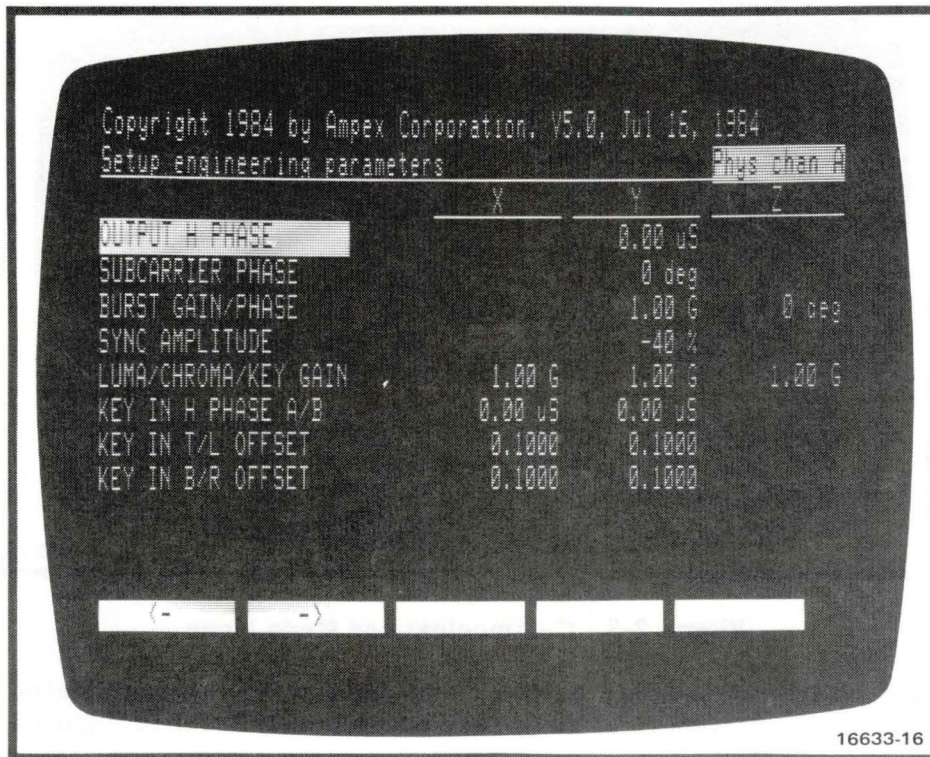

Figure 2-6. Setup Mode Menu

The main body of the Setup Mode menu shows the parameters listed in Table 2-1 below. The OUTPUT H PHASE through SYNC AMPLITUDE adjustments (Table 2-1) affect circuits that are used after picture processing (target adjustments). The LUMA GAIN through KEY IN B/R OFFSET adjustments affect circuits that are used prior to picture processing (source adjustments).

## 2-33 Program Menu

This menu is the starting point for keyframe parameter entry and effect construction. There are two versions of the Program menu: many-parameter and one-parameter. The many-parameter version, illustrated in Figure 2-7, displays all parameters for one keyframe. The one-parameter version, (Figure 2-8) displays one parameter for all keyframes. When a lower level program menu is selected it will display the same version (many-parameter or one-parameter) as the program menu exited from.

**Table 2-1. Setup Parameters**

Setup Parameter	Function	Approximate Range	System-Assigned Value
OUTPUT H PHASE	Adjusts horizontal timing with respect to input video. In auto H-phase mode, or with a concentrator, adjusts horizontal timing with respect to reference.	-3 + 7 $\mu$ s	0.00 $\mu$ s
SUBCARRIER PHASE	Adjusts subcarrier phase of output video with respect to reference.	0°-359°	0°
BURST GAIN*	Adjusts burst amplitude; 1.00 is equal to 40 IRE units.	0-2.38	1.00
BURST PHASE* (Quadrature)	Adjusts burst phase with respect to reference video; adjusts burst quadrature 0°-359° in PAL systems.	0°-359°	0° NTSC 90° PAL
SYNC AMPLITUDE*	Adjusts sync amplitude in percentage of peak white amplitude.	0-113%	-40% NTSC 43% PAL
LUMA GAIN	Adjusts level of input signal before digitizing circuits; used to normalize nonstandard input levels.	0.71-1.28	1.00
CHROMA GAIN	Adjusts level of input signal before digitizing circuits; used to normalize nonstandard input levels.	0.44-1.55	1.00
KEY GAIN	Adjusts level of key input signal in key processing circuits.	0.71-1.28	1.00
KEY IN H PHASE A/B	Adjusts horizontal phase of key signal with respect to input video.	$\pm$ 7.99 $\mu$ s (X and Y)	0.00 $\mu$ s
KEY IN T/L OFFSET*	Adjusts internal key generation timing edges. Offset is in screen units (8 horizontally and 6 vertically). Offset is with respect to 50% levels of key output waveshape.	0-.9999 (X and Y)	0.1000 X 0.1000 Y
* It is recommended that these adjustments not be made.			

(Continued next page)

**Table 2-1. Setup Parameters (Continued)**

Setup Parameter	Function	Approximate Range	System-Assigned Value
KEY IN B/R OFFSET*	Adjusts internal key generation timing edges. Offset is in screen units (8 horizontally and 6 vertically). Offset is with respect to 50% levels of key output waveshape. This is a source adjustment.	0-.9999 (X and Y)	0.1000 X 0.1000 Y
align stick	Soft key selects joystick alignment mode. Line on top row of display shows actual X, Y, and Z values for joystick position together with maximum and minimum values since align stick was pressed.		

\* It is recommended that these adjustments not be made.

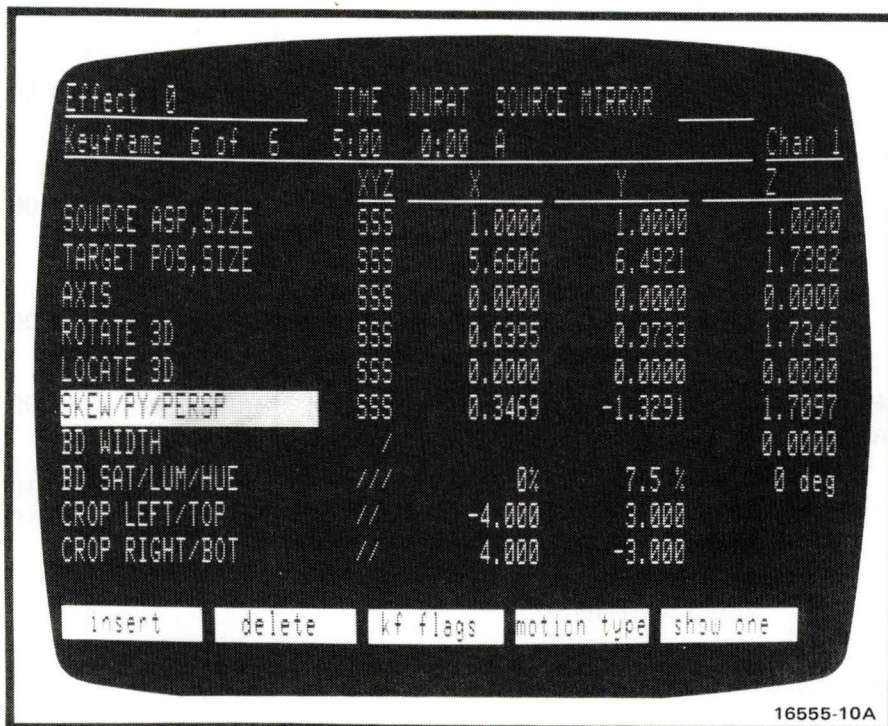

**Figure 2-7. Program Menu—Many Parameter Version**



Effect 0	SKEW/PY/PERSP						Chan 1
KEYF	TIME	DURAT	SRC	XYZ	X	Y	Z
1:	0:00	1:00	A	SSS	0.0000	0.0000	0.0600
2:	1:00	1:00	A	SSS	0.0000	0.0000	0.0600
3:	2:00	1:00	A	SSS	0.0000	0.0000	0.0600
4:	3:00	1:00	A	SSS	0.0000	0.0000	0.0600
5:	4:00	1:00	A	SSS	0.0000	0.0000	0.0600
<b>6:</b>	5:00	0:00	A	SSS	0.3469	-1.3291	1.7097

insert   delete   kf flags   motion type   show many

16555-9A

Figure 2-8. Program Menu—One Parameter Version

### 2-34 Many-Parameter Display

The many-parameter display provides complete keyframe parameter information, including keyframe duration, source, cube, mirror, and freeze flags.

The top two lines of the display show:

- **Effect number:** The number assigned to an effect which has been recalled from a disk.
- **Keyframe:** Identifies keyframe for which parameters are displayed.
- **TIME display:** Shows keyframe beginning time in seconds and frames.
- **DURAT display:** Shows keyframe duration in seconds and frames.
- **SOURCE display:** Shows video source form keyframe: A, B, A/B auto, or B/A auto.
- **MIRROR:** Shows mirror flags: Ax, Ay, Axy, Bx, By, or Bxy.
- **CUB:** Indicates that auto cube mode is enabled.
- **NOG:** Indicates that global mode is disabled (no global).
- **FRZ:** Shows that the freeze flag is set for this keyframe.
- **Chan display:** Shows which logical channel is being programmed.

# ADO

The main body of the display shows keyframe parameters. Image transformation parameters are listed in the column at the left of the display. Values assigned to each parameter are shown in the center of the display.

- The column labeled XYZ shows motion types selected for each parameter. An **S** indicates smooth motion, a / indicates linear motion, and a — indicates hold. Reverse video around the motion symbol indicates a break is set.

## 2-35 One-Parameter Display

This display shows one parameter for all keyframes. Many, but not all, of the items displayed on the many-parameter display are included in the one-parameter display.

The top line of the display lists effect number, transformation parameter (**SKEW/PY/PERSP** in Figure 2-8), and channel selected. The second display line shows:

- **KEYF:** The keyframe number. Reverse video block indicates keyframe is enabled for entry from keypad or for modification by joystick movement. Use ← and → keys to scroll display.
- **TIME:** Indicates time at which keyframe starts in effect.
- **DURAT:** Indicates keyframe duration.
- **SRC:** Shows image source; A, B, A/B auto, or B/A auto. An F indicates that a freeze flag is set.
- **XYZ:** Shows motion types selected for each parameter. An **S** indicates smooth motion, a / indicates linear motion, and a — indicates hold. Reverse video around the motion symbol indicates a break is set.

## 2-36 Global Mode Menu

Pressing GLOBAL in program mode brings up the Global Mode menu shown in Figure 2-9. This menu is similar to the Program menu shown in Figure 2-7, but only three parameters are used: GLOBAL AXIS (axis select 3D), GLOBAL ROTATE 3D, and GLOBAL LOCATE 3D. The Global Mode menu is used to set keyframe parameters for global effects. Soft key menus are the same as those described in paragraph 2-42.

## 2-37 Run Mode Menu

This menu, shown in Figure 2-10, is used when running or editing effects. The display shows run mode parameters such as effect starting time, ending time, and length. This display is shown when RUN is pressed, and also with the second and third run soft key menus. A different display is provided with the fourth run soft key menu. See paragraphs 2-38 and 2-39.

The top line gives the number of the effect to be run, and the physical channels currently in use. Just below this line, **Multi-Channel** or **Single-Channel** is highlighted to indicate the mode of operation. To the right of this is the concentrator channel status display. The in/out portion of the display shows

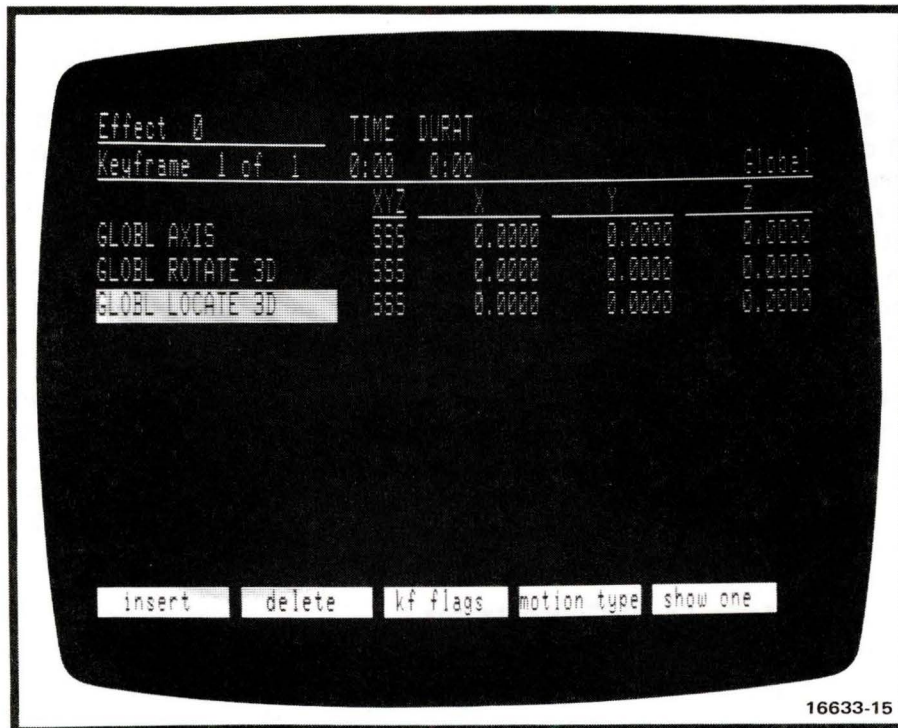

Figure 2-9. Global Mode Menu

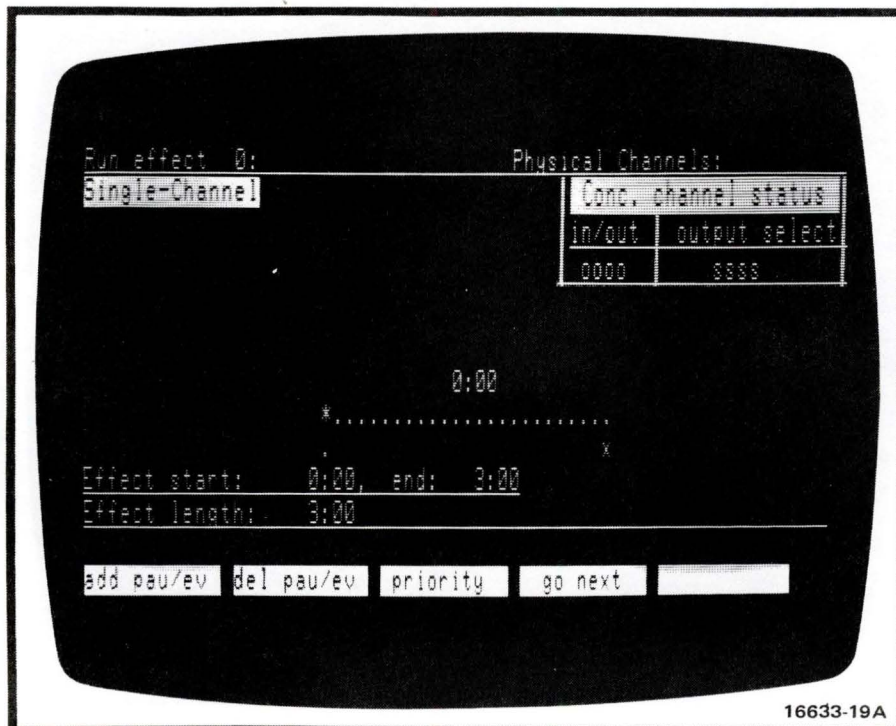

Figure 2-10. Run Mode Menu

# ADO

whether each of logical channels 1, 2, 3, and 4 is in the combine (I, for in) or not in the combine (o, for out). The output select portion of the display shows whether the output of each of logical channels 1, 2, 3 and 4 is the combined image (C, for combined) or is its own image (s, for self). The effect status display, in the middle of the screen, gives a visual indication of effect timing. The first line of this display shows the current position on the effect time line, in seconds and frames. The effect time line consists of a row of dots just below this line. An asterisk (\*) represents the current position on the effect time line. The letter X, just below the time line, represents a programmed pause. A dot just below the time line represents an event, such as a change in concentrator parameter value.

A line of arrows extending to the left and right of the time display indicates run direction and speed. In run mode, joystick movement in the Y direction runs the effect forward or in reverse. The greater the movement from center, the faster the effect runs. Near center, the effect runs at 2 to 3 frames/second. At the extremes of joystick movement, the effect runs at approximately 30 frames/second. The length of the line of arrows indicates run speed.

## 2-38 Run Mode Menu, Local-Concentrator

To select this menu while in non-global mode, press RUN then press MORE three times. See Figure 2-11. The top line gives the effect number. The second line

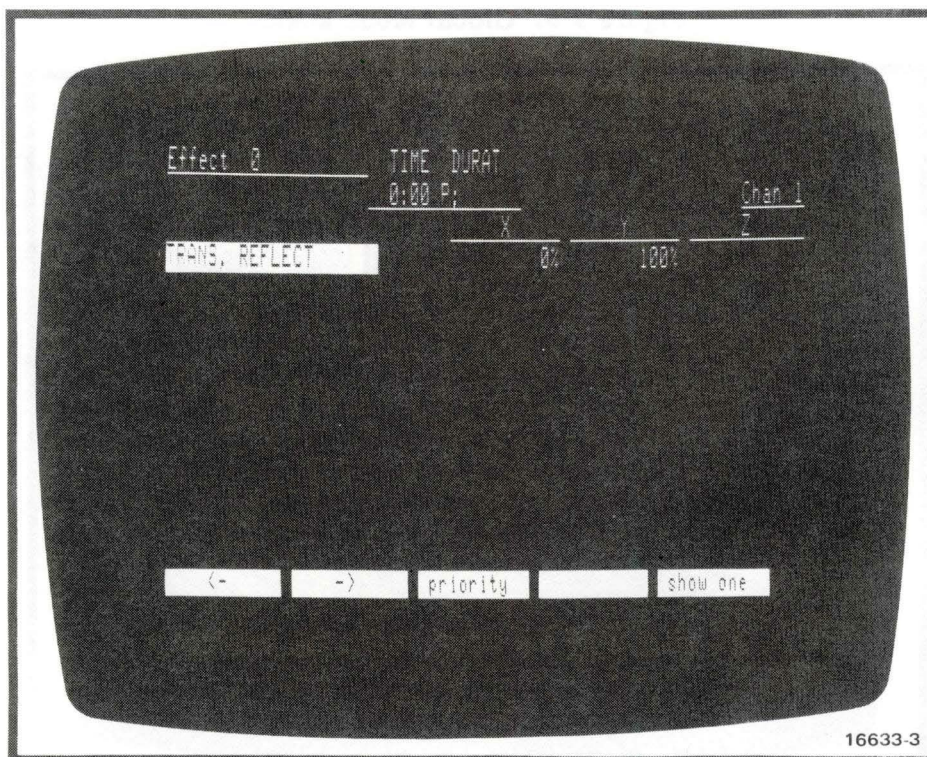

Figure 2-11. Run Mode Menu, Local-Concentrator

displays the time for which the parameter values are given and displays a **P** if there is a pause at this time. The logical control channel number is also displayed. The next display line shows the parameters to be selected:

- **TRANS:** Visual transparency of image. Select X value (0-100%).
- **REFLECT:** Reflectance of the image. Select Y value (0-100%).

**2-39 Run Mode Menu, Global-Concentrator**

To select this menu while in global mode, press **RUN** then press **MORE** three times. Or, select run mode menu, local-concentrator, and press **GLOBAL**. See Figure 2-12. This display is arranged in the same manner as the local concentrator menu, except that there are more parameters to be selected:

- **LIGHT:** Provides a light source that appears to be directed from in front of the screen. Select X value (0-100%).
- **AMBIENT:** Provides non-directional, general lighting. Select Y value (0-100%).
- **SAT:** Select X saturation value (0-100%).
- **LUMA:** Select Y luminance value (0-100%).

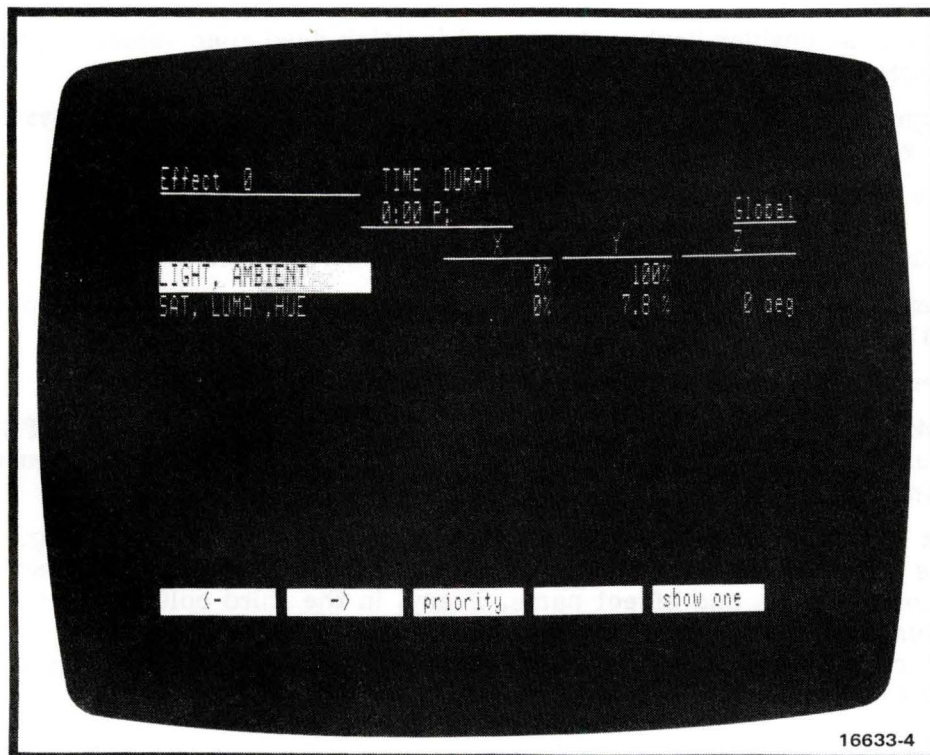

**Figure 2-12. Run Mode Menu, Global-Concentrator**

# ADO

- **HUE:** Select Z hue value (0-359°).

**SAT, LUMA,** and **HUE** determine background values.

## 2-40 Soft Key Menus

Subsidiary soft key menus are associated with the menus described in previous paragraphs. Soft key functions appear at the bottom of the menu display and correspond to keys A through E on the keyboard.

### Note

**All soft keys have repeat function. When key is held down for more than 2 seconds, the function repeats. This continues as long as the key is held down.**

## 2-41 Setup Mode Soft Keys

Setup mode has three soft key menus, reached by pressing MORE key. The first menu consists of:

- **<- and ->** soft keys select the setup parameter for adjustment. The selected parameter is highlighted with reverse video.

A second menu is reached by pressing MORE:

- **dead zone** enables keyboard entry of joystick dead zone values (approximate range: 10-200).
- **align stick** brings up joystick alignment display, used to adjust joystick A/D converter. Refer to Table 2-1.
- **disk stat** brings up disk test display.

Pressing MORE again brings up the third soft key menu, consisting of:

- **comm mode** soft key selects communications mode described in paragraph 2-31.
- **format disk** is used to format new disks for use in storing effects.
- **disk store** is used to store setup parameters on a disk. STORE EFFECT key is used to store setup parameters in the control unit's internal non-volatile memory.
- **list disk** brings up directory of effects stored on a disk. See Figure 2-13. The directory shows effect number in the first column, effect length in the second column, and effect name, if any, in the third column. The next five columns list the number of keyframes stored in on-line memory for channels 1 through 4 and global. The column at far right lists keyframes using the ADO Concentrator.

Pressing MORE again brings up the fourth soft key menu, consisting of:

- **copy disk** is used to copy one disk to another disk. See paragraph 3-38.

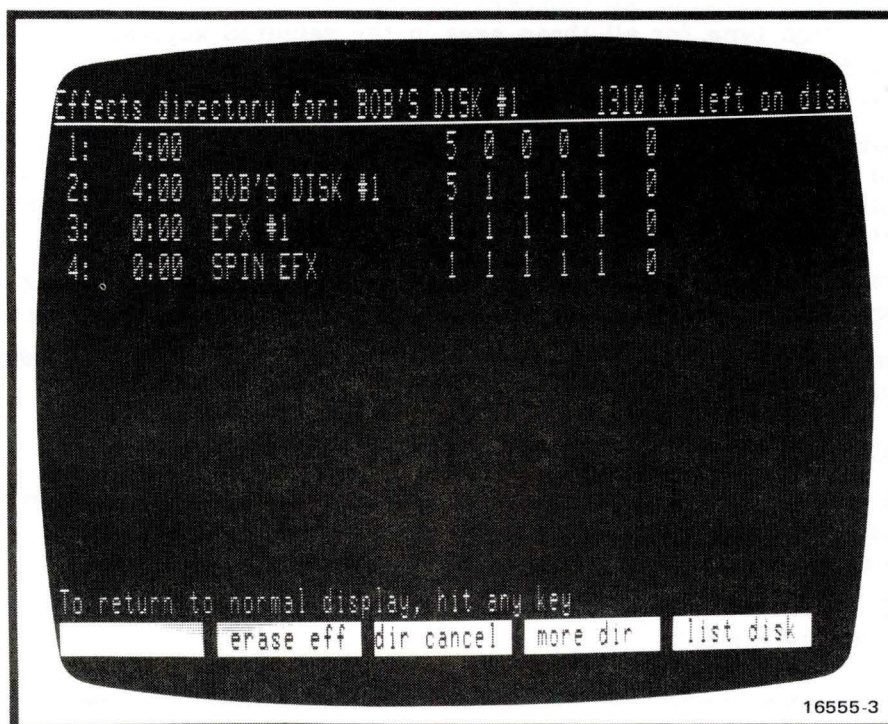

Figure 2-13. List Disk Menu

#### 2-42 Program Mode Soft Keys

The initial soft key menu, which appears after PROG key is pressed, shows the following:

- **insert** duplicates the current keyframe, placing the duplicate immediately after the current keyframe. The keyframe just inserted becomes the current keyframe.
- **delete** removes the current keyframe from the effect.
- **keyf flags** brings up the keyframe flags menu (see Figure 2-14) and a soft key menu consisting of:
  - <- and -> soft keys select which flag is to be modified.
  - change** selects new value for flag in selected keyframe.
  - all** changes flag in all keyframes to that of current keyframe.
- **motion type** brings up the motion type soft key menu, consisting of:
  - set** enters motion type chosen with other soft keys on the motion type menu.
  - all keyf** sets motion type for all keyframes in effect. Pressing **all keyf** soft key changes key display to **this keyf**, which sets motion type for this keyframe only.

# ADO

**all numbers** sets motion type for X, Y, and Z axes in all keyframe parameters. Pressing **all numbers** soft key brings up **X, Y, Z** soft key which sets motion type for all three axes in the selected keyframe. Pressing this key again brings up **X, Y, and Z** soft keys in turn. These keys set motion type for X, Y, and Z axes individually.

**smooth** selects smooth motion between keyframes; pressing this soft key again brings up **linear**, which gives constant rate motion between keyframes. Pressing this key again brings up **hold**, which pauses the effect for the duration of the keyframe.

**no break** selects motion without breaks at keyframes. Pressing **no break** brings up **break** soft key, which selects movement breaks at each keyframe.

- **show one** selects one parameter version of program menu; **show many** selects many parameter version.

Pressing MORE brings up a second soft key menu consisting of

- **save -> mem** stores the current keyframe in memory (but not on the disk). Pressing this key writes over any keyframe stored previously. Keyframe data is lost when power is turned off at the control panel.
- **get <- mem** recalls keyframe stored in memory previously, writing it into the current keyframe.

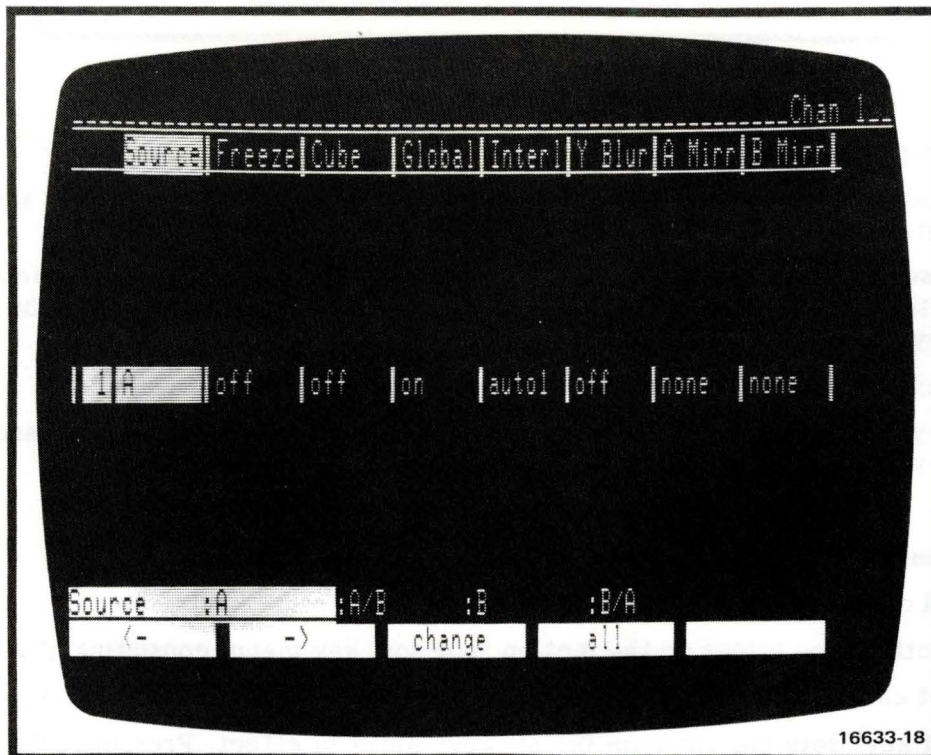

Figure 2-14. Keyframe Flags Menu



## ADO

- **grid, nr** brings up the grid and noise reduction soft key menu.  
**grid pos** brings up channel grids menu (see Figure 2-15) to allow setting grid position.

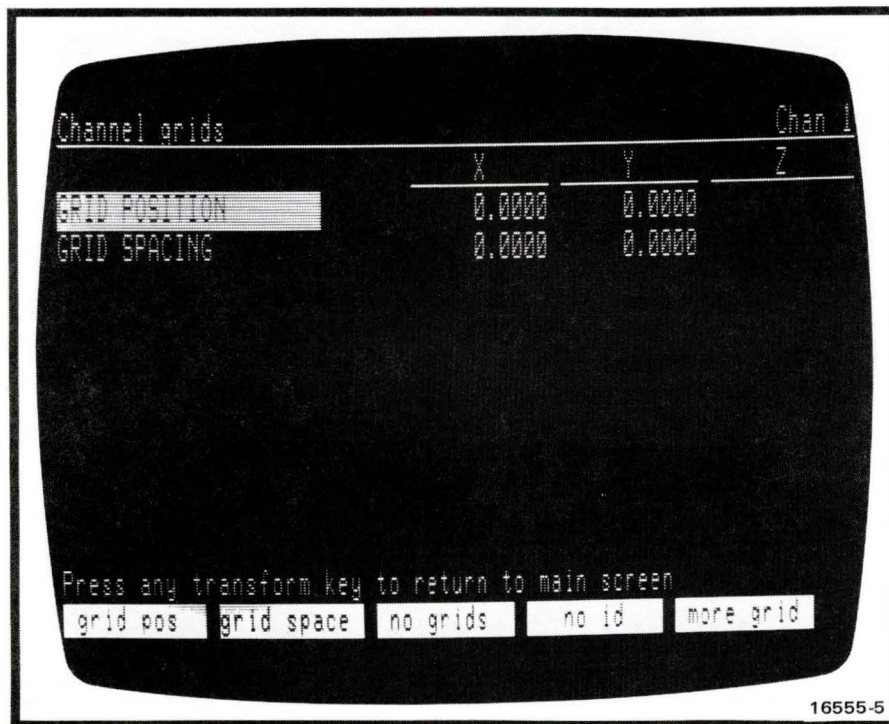

Figure 2-15. Channel Grids Menu

**grid space** brings up the channel grids menu; if menu is on screen, enables grid spacing for entry of spacing value.

**no grids** disables grid functions. Pressing **no grids** brings up **source grids** for grid in source space. Pressing **source grids** brings up **target grid** for grids in target space. Pressing **target grid** brings up **safe area** for rectangle outlining picture area available for effects.

**no id**, disables source channel identification on video monitor. Pressing **no id** brings up **id**, which enables function.

**more grid** brings up a subsidiary menu consisting of:

**NR** selects noise reduction to reduce noise visible in image. Pressing **NR** brings up **no NR** to disable noise reduction function.

**white** selects white channel ID letters and white grid lines. Pressing **white** brings up **invert**. **invert** selects channel ID letters, and source grid lines, that are contrasted with the picture.

## ADO

- **enter name** brings up menu shown in Figure 2-16. Use this menu to assign names to disks before formatting or to effects before storing them on a disk.

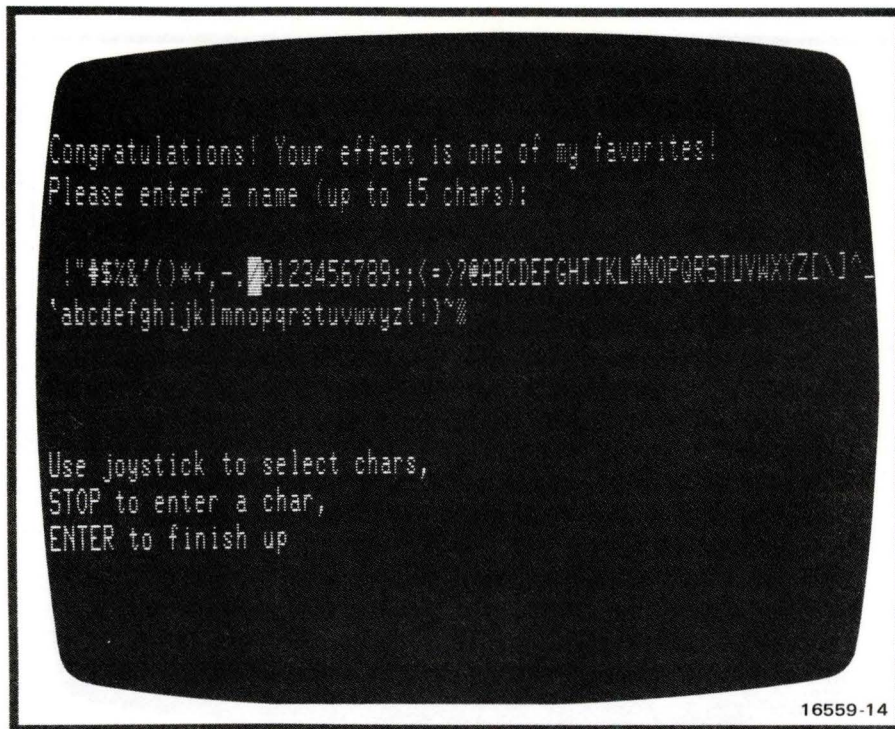

Figure 2-16. Enter Name Menu

- **delete all** deletes all keyframes in the effect under assembly on the current channel. Pressing **delete all** again deletes all keyframes on all channels.

Pressing MORE brings up a third soft key menu:

- **iv parms** brings up input video parameters display (see Figure 2-17) and a soft key menu consisting of:
  - <- and -> soft keys select mosaic and solarization parameters. Refer to paragraphs 3-43 and 3-44 for a complete description of these functions.
- **motion type** brings up the motion type soft key menu, consisting of:
  - set** enters motion type chosen with other soft keys on the motion type menu.
  - all keyf** sets motion type for all keyframes in effect. Pressing **all keyf** soft key changes key display to **this keyf**, which sets motion type for this keyframe only.

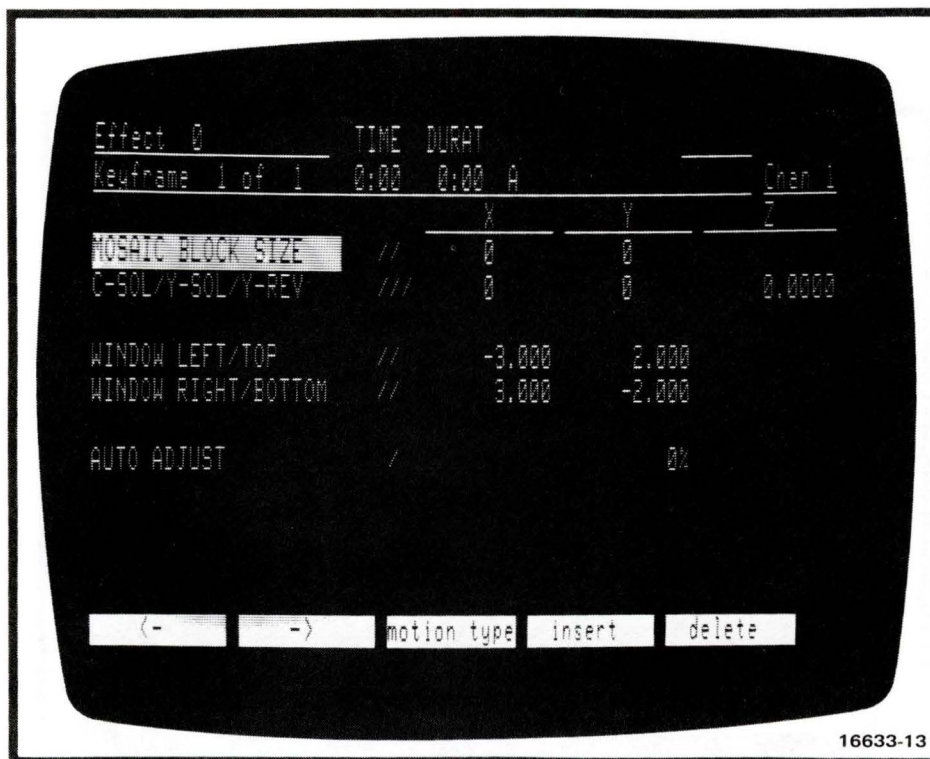

Figure 2-17. Input Video Parameters Menu

**all numbers** sets motion type for X, Y, and Z axes in all keyframe parameters. Pressing **all numbers** soft key brings up **X,Y,Z** soft key which sets motion type for all three axes in the selected keyframe. Pressing this key again brings up **X**, **Y**, and **Z** soft keys in turn. These keys set motion type for X, Y, and Z axes individually.

**smooth** soft key is not operational in input video parameters mode; pressing this soft key brings up **linear**, which gives constant rate motion between keyframes. Pressing this key again brings up **hold**, which pauses the effect for the duration of the keyframe.

**no break** selects motion without breaks at keyframe transitions. Pressing **no break** brings up **break** soft key, which selects breaks at each keyframe transition.

- **insert** duplicates the current keyframe, placing the duplicate immediately after the current keyframe. The keyframe just inserted becomes the current keyframe.
- **delete** removes the current keyframe from the effect.
- **iv flags** brings up input video flags menu (see Figure 2-18) and a soft key menu consisting of:

**<-** and **->** soft keys select the flag parameter for change. The selected parameter is highlighted with reverse video.

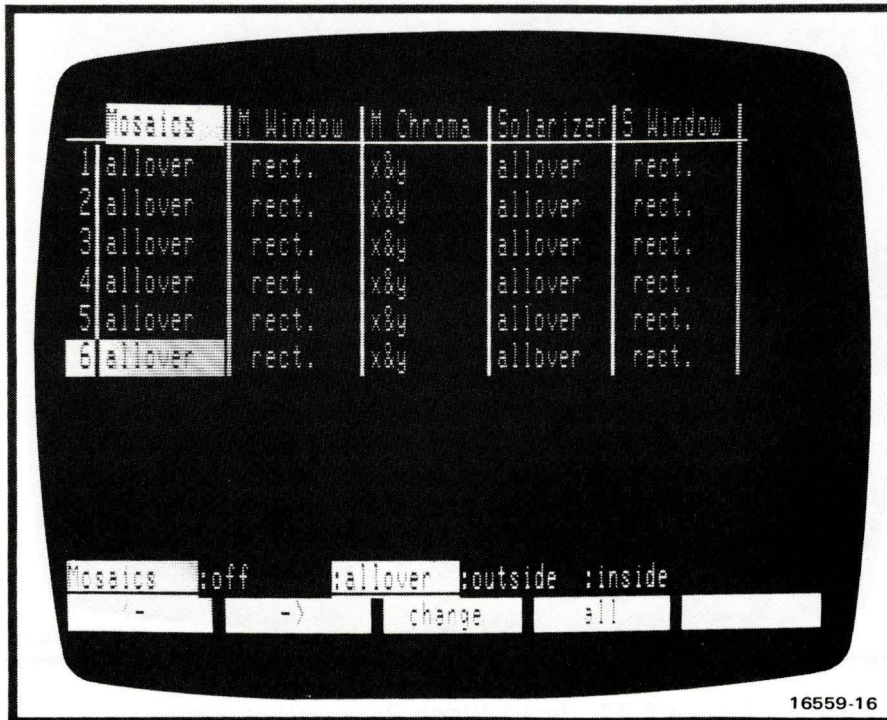

**Figure 2-18. Input Video Flags Menu**

**change** selects new value for flag in selected keyframe.

**all** changes flag in all keyframes.

- **key control** brings up key control display (see Figure 2-19) and a soft key menu consisting of:

<- and -> soft keys select the key parameter for change. The selected parameter is highlighted with reverse video.

**change** selects new value for flag in selected keyframe.

**all** changes flag in all keyframes.

Pressing MORE brings up the fourth and last soft key menu, consisting of:

- **comm mode** soft key selects communications mode menu, described in paragraph 2-31.
- **erase eff** deletes an effect from the disk. See paragraph 3-37.
- **list disk** brings up directory of effects stored on a disk.

Key control functions are described in paragraph 3-46.

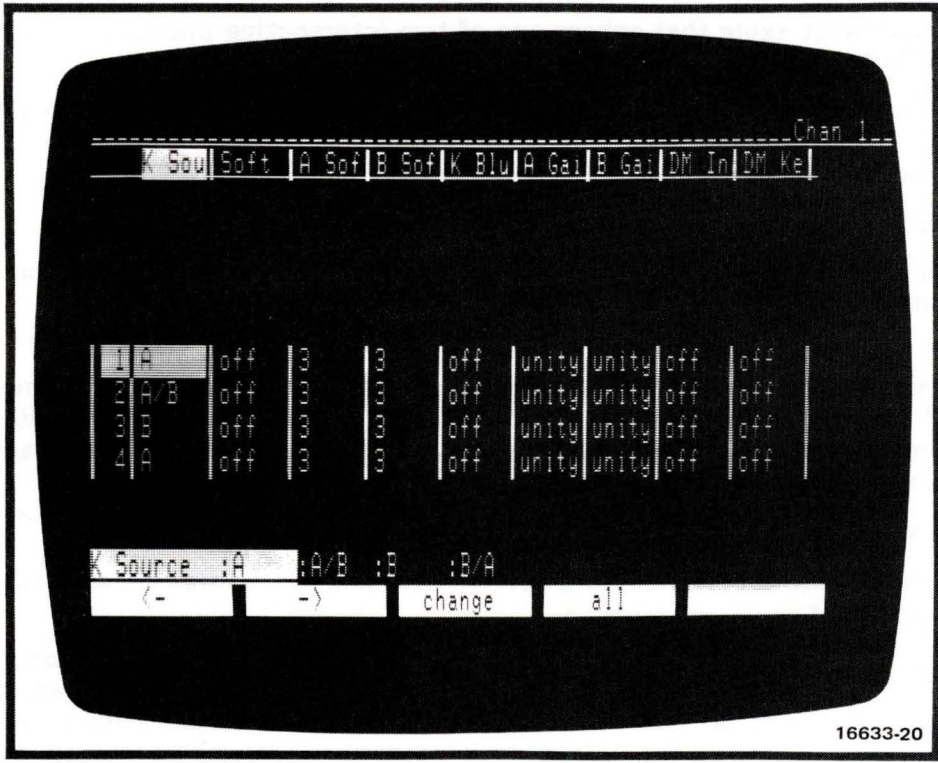

Figure 2-19. Key Control Menu

2-43 Run Mode Soft Keys

Pressing RUN brings up the first run mode soft key menu, showing:

- **add pau/ev** selects pause and event. Press soft key to add event. Press again to add pause.
- **del pau/ev** deletes pause and event. Press soft key to delete pause. Press again to delete event.
- **priority** is used to enter system priority for channels 1 through 4. Four numbers must be entered. As an example, a priority of 1, 2, 0, 0 places the channel 1 image in front of the channel 2 image. Channels 3 and 4 have auto priority and so will automatically change priority between themselves as appropriate, but will always be behind channels 1 and 2. If four zeros are entered, the concentrator will attempt to determine the priorities for the channels based on the three dimensional positions of the channels. If the planes intersect, the auto priority will not function. If the amount of intersection is small, try using auto adjust mode, displayed on the input parameter menu.

# ADO

## Note

To use auto adjust mode, select **iv parameters** menu. Set **Y** value to required level (0.000 to 1.000). The default value (no adjustment) is 0. Use lowest value that causes one of two intersecting planes to appear definitely in front of other plane.

- **go next** causes an immediate move to the next event on the effect time line.

Pressing **MORE** brings up a second soft key menu, showing:

- **ch in/out** selects whether a channel is in or is not in the combine.
- **ch output** selects whether a channel output is the combined image or a single image.

## Note

The status of each channel is displayed in the upper right hand corner of the screen (see paragraph 2-37). The channels being controlled here, and shown in the status display, are logical channels 1, 2, 3, and 4, not physical channels A, B, C, and D.

Pressing **MORE** brings up a third soft key menu, showing:

- **comm mode** soft key selects communications mode menu, described in paragraph 2-31.
- **start t** allows an effect start time to be changed temporarily from the 0:00 value set by the system at the first keyframe in an effect. When **start t** is pressed, the effect start value on the display flashes. Entering a value from the keypad moves the effect position asterisk to the new start point and places a dot underneath the effect time line. (Refer to Figure 2-10.) The effect moves to the keyframe corresponding to the new time, as well.
- **end time** allows an effect end time to be changed temporarily from the value set for the last keyframe in an effect. When **end time** is pressed, the effect end value on the display flashes. Entering a value from the keypad moves the effect position asterisk to the new end point and places a dot underneath the effect time line. The effect moves to the keyframe corresponding to the new time, as well.
- **goto time** allows the operator to move to any point on the effect time line. When **goto time** is pressed, **enter goto time:** appears on the display. Entering a time value in seconds and frames moves the effect position asterisk to the selected time. The image also changes to its new position in the effect. A warning message appears if the value chosen is beyond effect start or end (temporary values included).
- **list disk** brings up directory of effects stored on a disk.

Pressing **MORE** brings up a fourth soft key menu and new display, showing:

- **<- and ->** soft keys select the parameter for change. The selected parameter is highlighted with reverse video.
- **priority** soft key is same as described for initial soft key menu of run mode.

- **show one** selects menu that displays values of one parameter for all pause/event times. **show many** selects menu that displays all parameters for a single pause/event time.

#### **2-44 Communications Mode Soft Keys**

The first communications mode soft key menu appears at power up, or when the **comm mode** soft key is pressed (run mode, program mode, and setup mode menus), showing:

- **phys/log** is used to select physical system A, B, C, or D, and to enable selection of logical channel by CHAN 1, 2, 3 or 4 key.
- **CANCEL** aborts a signal system or channel choice. (An alternate method is to press the selected physical system key or channel key.)

Press **MORE** to bring up the second soft key menu, showing:

- **master** selects channel used as master timer, or reference, for concentrator operation.

#### **2-45 MENU ROAD MAP**

Figure 2-20 is a graphic presentation of soft key menus, showing how each menu can be reached from any other menu.

#### **2-46 FLOPPY DISKS**

The system uses 5-1/4-in., single-sided, double-density, soft-sectored floppy disks to store effects. Disks must be inserted with write protect notch up and with read/write access slot toward the drive. See Figure 2-21.

Each disk supplied with the system has a write protect notch which prevents data from being overwritten accidentally. To protect data on the disk, a tape strip (supplied) must be placed over the notch. Remove tape strip to enable the disk for data recording.

#### **2-47 Disk Handling and Storage**

Disks are critical to storing and recalling effects. Disks must be handled and stored properly to ensure that their contents are not damaged or destroyed. Be sure to follow the precautions below. Also see Figure 2-22.

- Do not touch disk surface; hold disk only by edges or labels. Fingerprints or dust may cause errors.
- Do not turn control panel power on or off with disks inserted; you may destroy data on the disk.
- Do not use alcohol, Freon, or thinners to clean disk.
- Do not use magnets or magnetized objects near disk. Magnetic fields erase or distort data on the disk.
- Do not bend or fold disk.

# ADO

- Do not place heavy objects on disk.
- Do not use rubber bands or paper clips on disk.
- Do not write on disk label with pencil or ballpoint pen; use felt tip pen only.
- Do not use erasers on disk.
- Do not apply labels on top of other labels.
- Keep disk in protective envelope when not in use.
- Disks not in use should be stored vertically in a dust-free, covered container.
- Do not expose disk to sunlight or excessive heat.
- Operating environment:
  - Temperature: 10° to 50°C (50° to 122°F)
  - Wet bulb temperature: Less than 29° C (84° F)
  - Relative humidity: 20% to 80%
- Storage environment:
  - Temperature: 4° to 53°C (40° to 127°F)
  - Relative humidity: 8% to 80%
- Transit environment (stored in a protective box):
  - Temperature: -40° to 53°C (-40° to 127°F)
  - Relative Humidity: 8% to 90%

## 2-48 Formatting Disks

Every new disk must be formatted before it can be used. Old disks containing effects that are no longer needed can also be reformatted, if the disks are not damaged. A disk must be formatted before another disk is copied onto it.

### CAUTION

**BEFORE REFORMATTING AN OLD DISK, BE SURE ITS EFFECTS ARE NO LONGER NEEDED. REFORMATTING DESTROYS ALL DATA RECORDED PREVIOUSLY.**

Use the procedure below to format or reformat a disk and assign a name to the disk. If you don't wish to name the disk, skip steps 2 and 3.

**STEP 1** Put disk in drive with read-write slot toward drive and write protect notch up.

**STEP 2** From program menu, press **MORE** and then **enter name** soft key. A menu with instructions and two rows of alphanumeric characters appears on the screen. Refer to Figure 2-16.



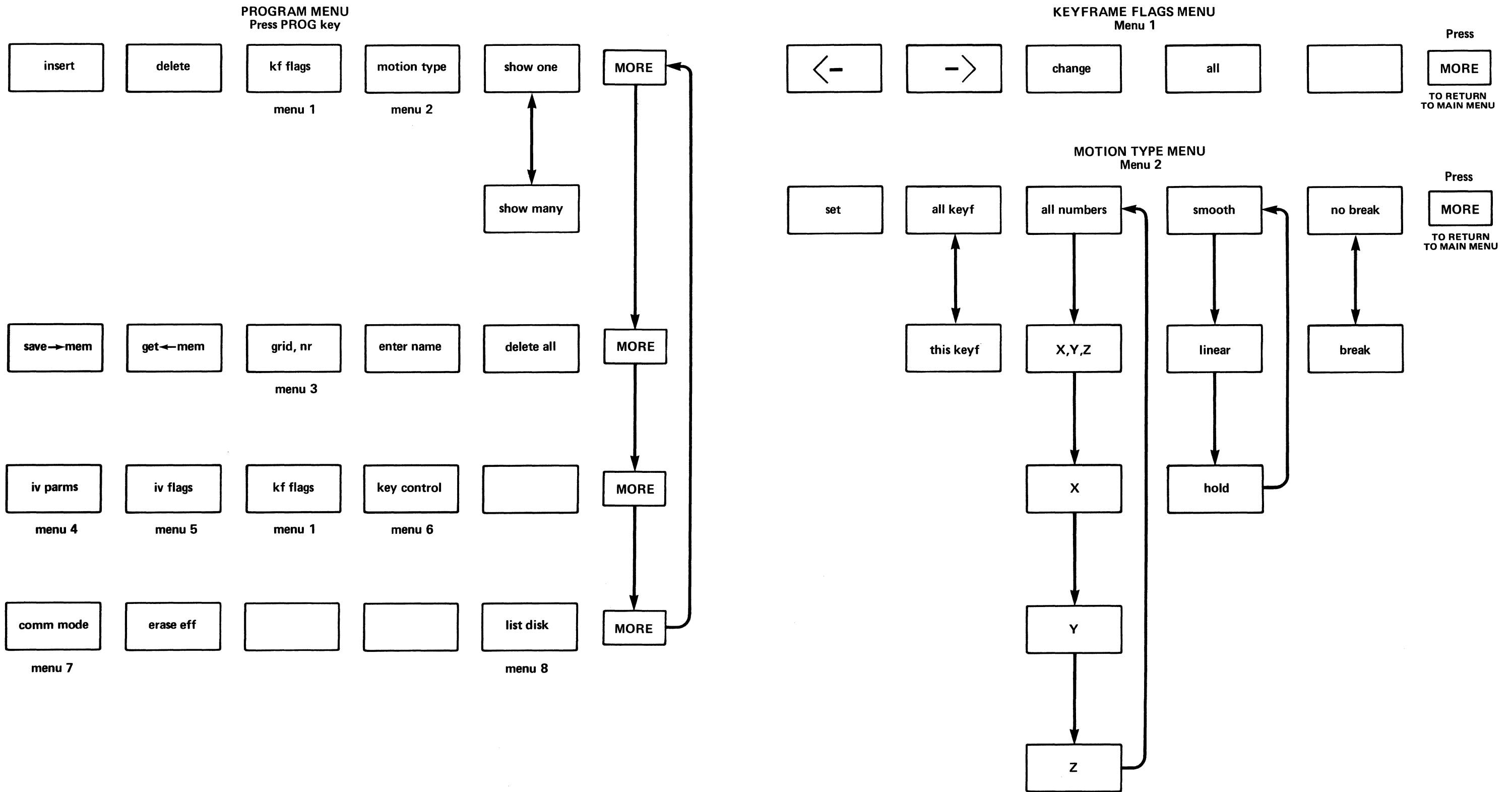
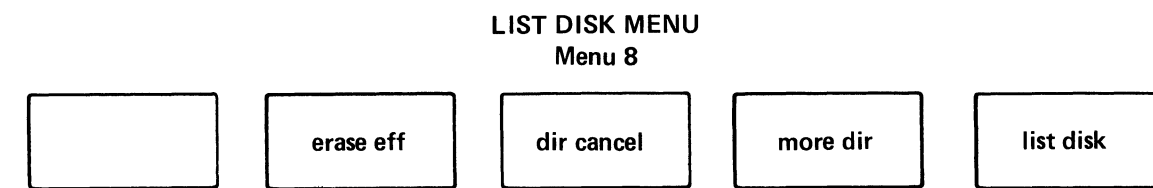
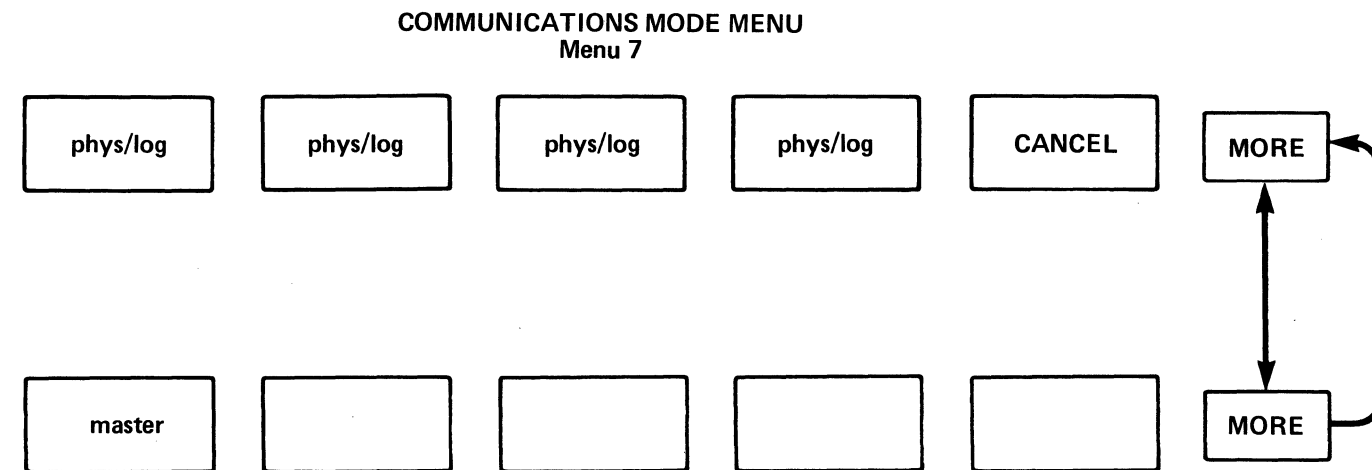
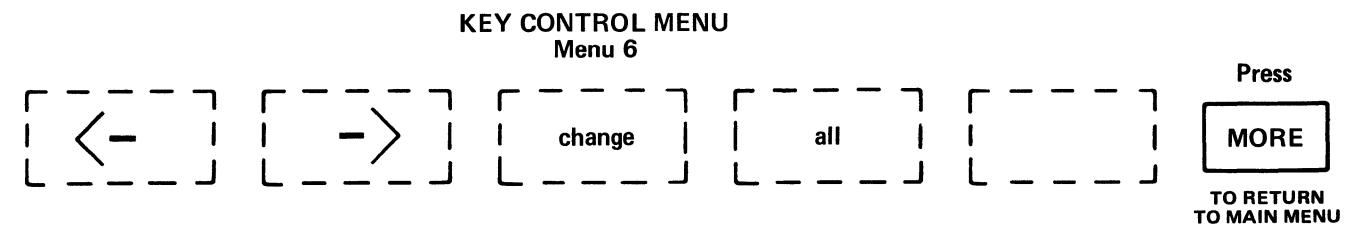
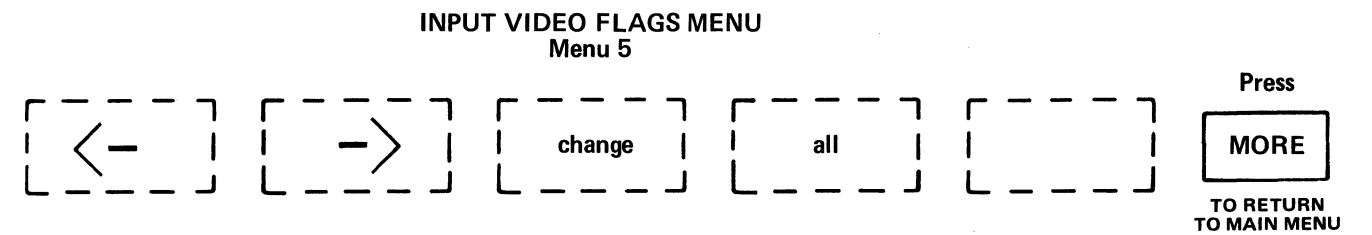
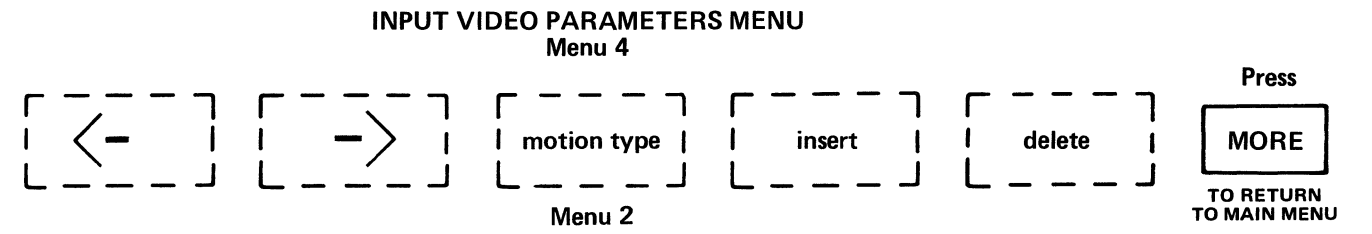
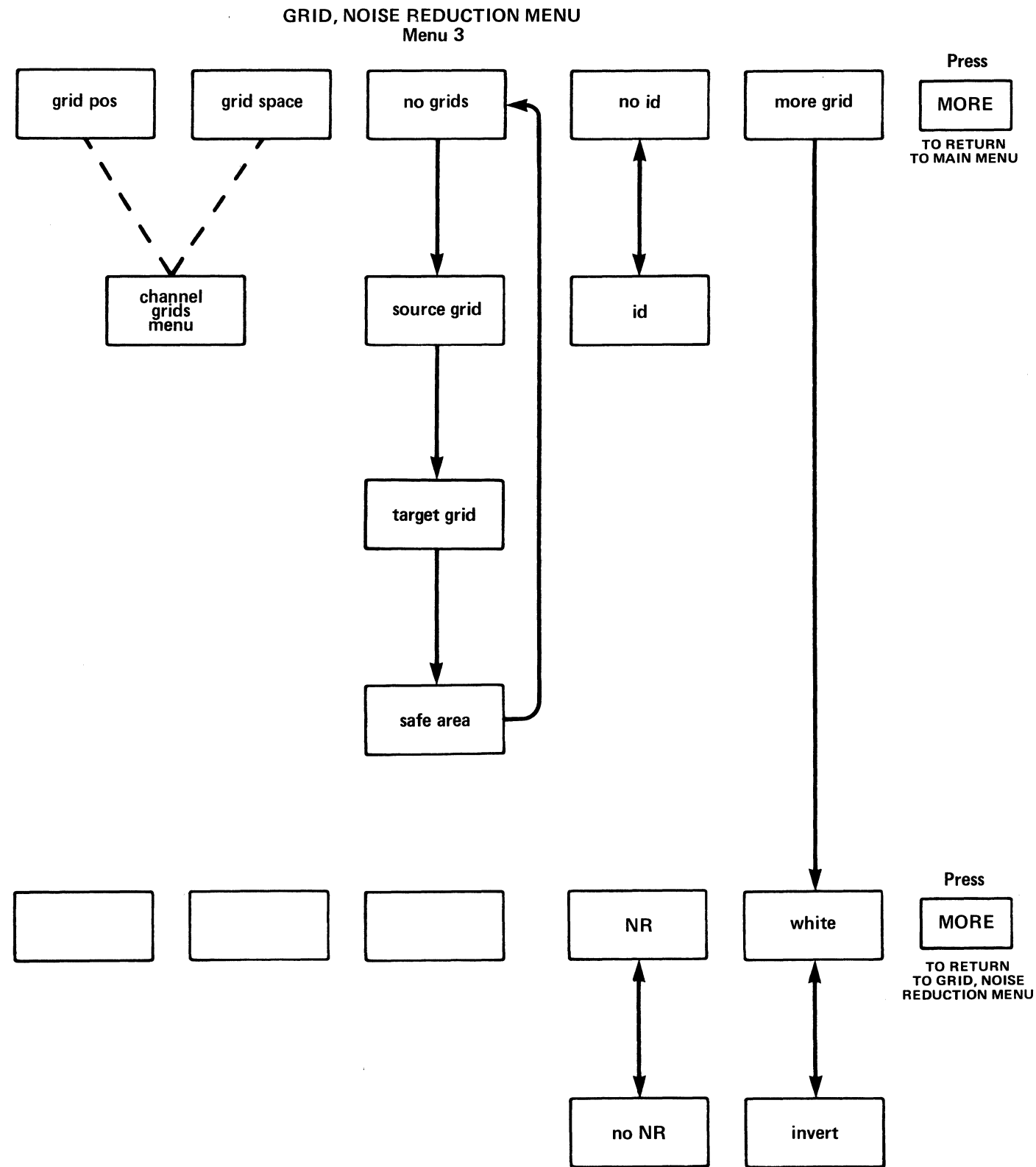

Figure 2-20. Menu Road Map (Sheet 1 of 3)

**ADO**



**Figure 2-20.**  
**Menu Road Map**  
**(Sheet 2 of 3)**

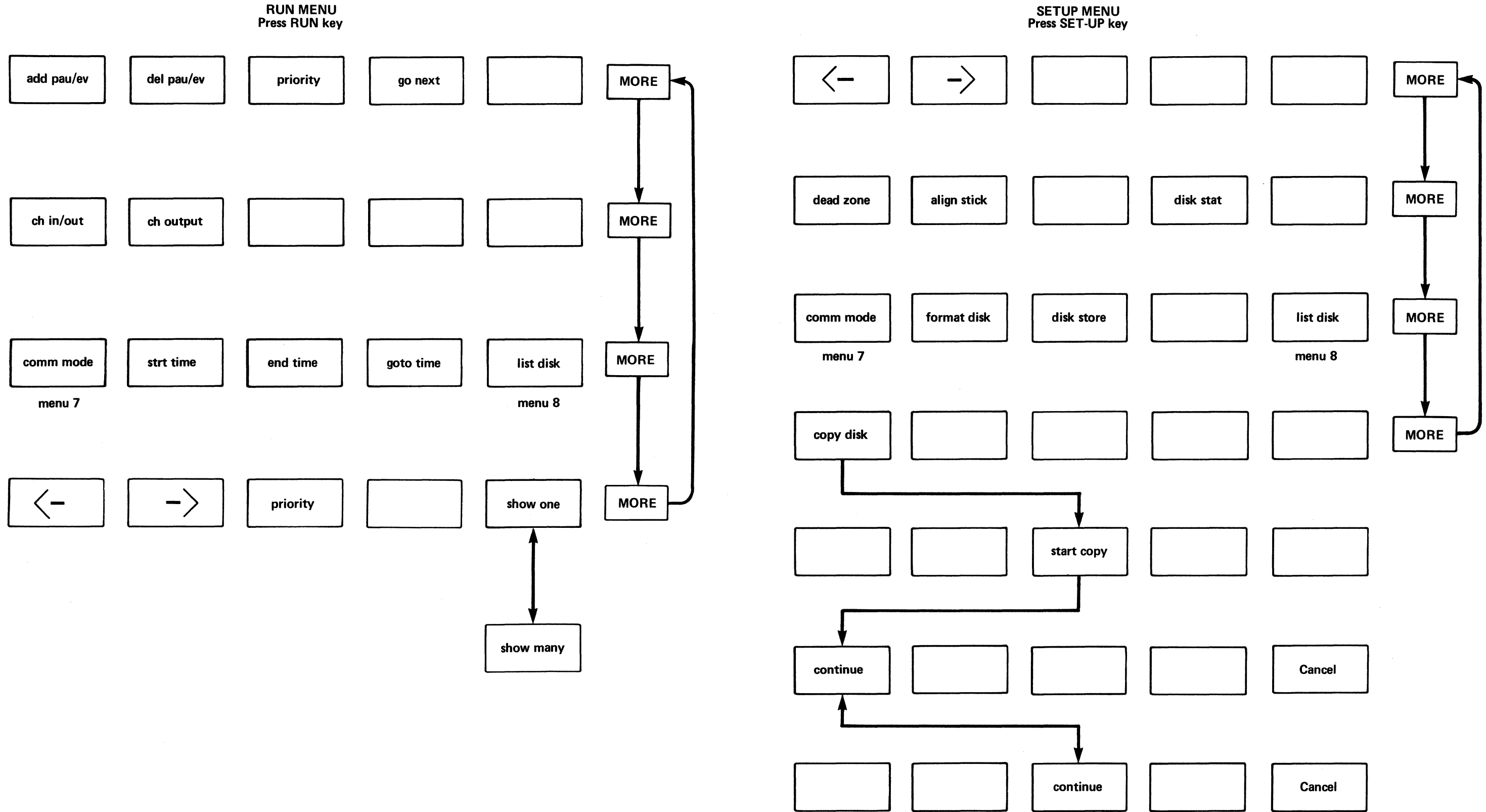
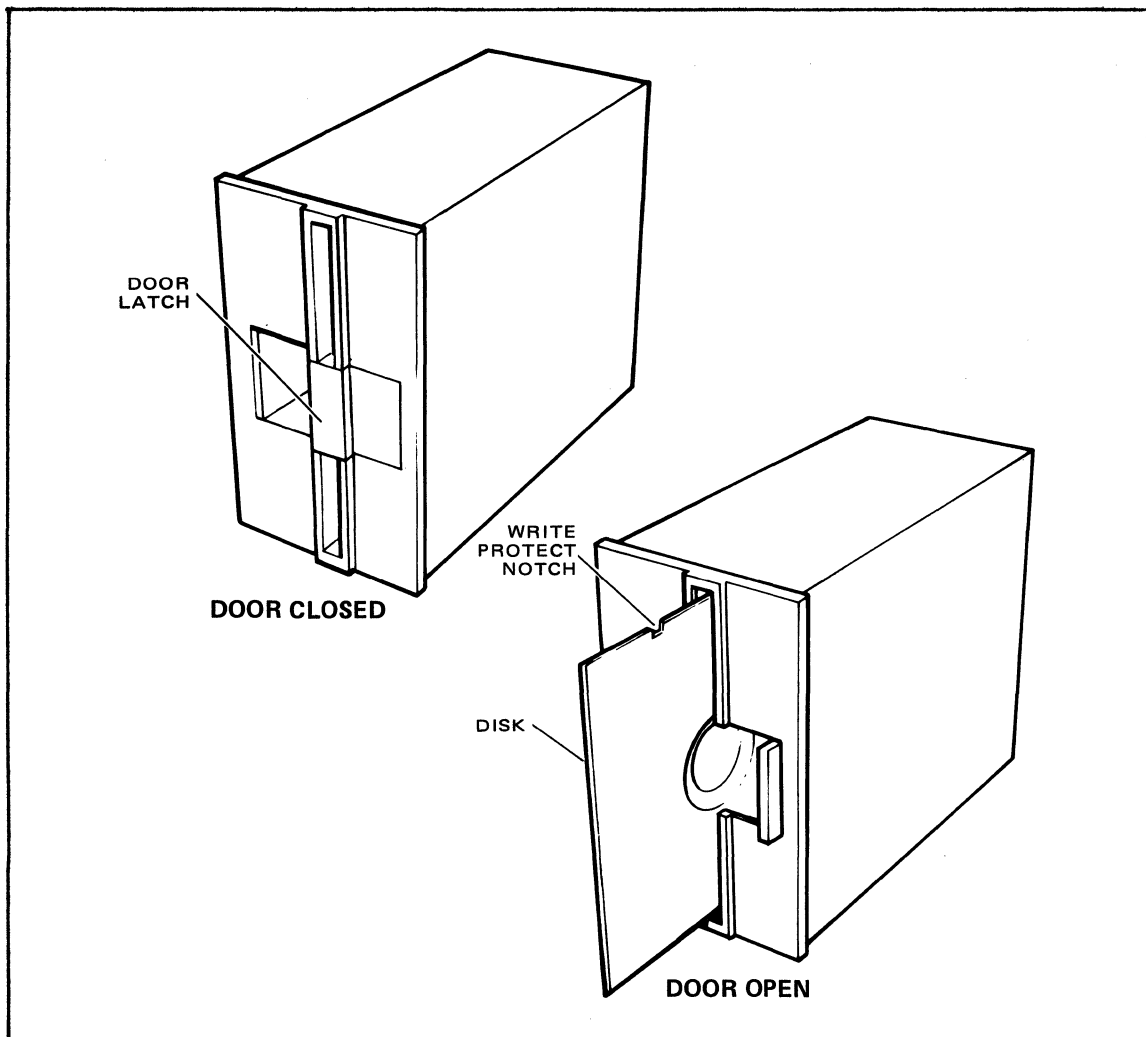

Figure 2-20. Menu Road Map (Sheet 3 of 3)

# ADO

- STEP 3** Use the joystick or the ← and → keys to move the cursor horizontally from one character to another. To reach lower row of display, go beyond left- or right-most character with joystick or ← and → keys. Press STOP to enter each character in the name as you spell it out. The space character is at the far left of the top line of characters (it shows as a space in the line). The character chosen appears at the top line on the screen. When the entire name has been spelled out, press ENTER to enter the disk name in a temporary name register.
- STEP 4** Press SET-UP twice. The first soft key menu appears at the bottom of the screen.
- STEP 5** Press MORE twice. A soft key menu with **format disk** at the left appears at the bottom of the display.



**Figure 2-21. Inserting Disk in Disk Drive**

- STEP 6** Press format disk soft key. A warning message, **Hit format again to re-format: effects will be lost**, appears. Press format disk soft key again; formatting begins automatically and continues for about 20 seconds. During this time the red indicator on the disk drive comes on. When formatting is completed, the red indicator on the disk drive goes out.
- STEP 7** If more disks are to be formatted, remove the newly formatted disk from the drive, put in the next disk, and press format disk soft key. If formatting is finished, press PROG to return to the program menu.

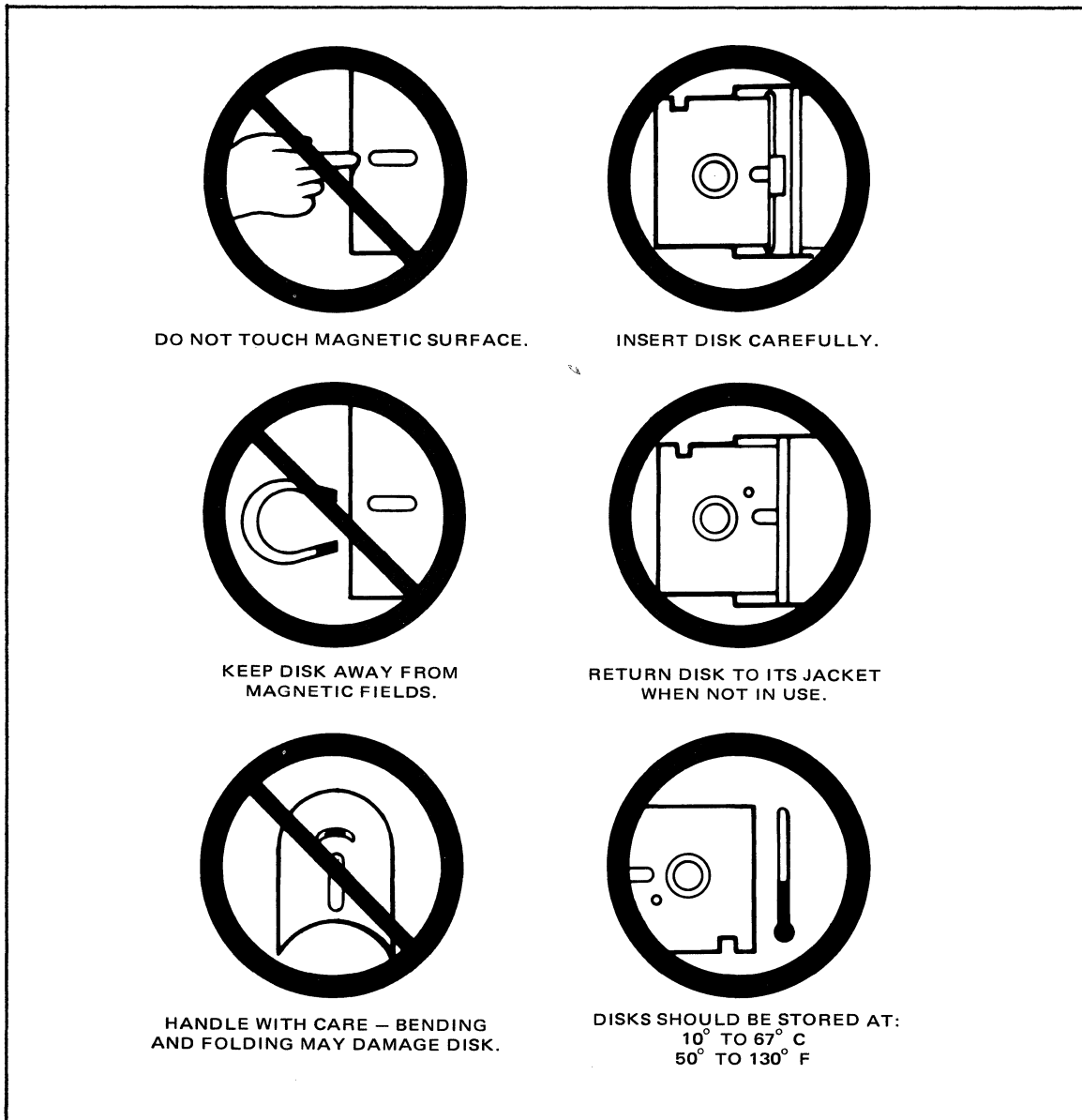

**Figure 2-22. Disk Handling and Storage**



## SECTION 3

# OPERATING PROCEDURES

### 3-1 INTRODUCTION

This section outlines procedures for creating, editing, and running effects. The first portion describes initial turn-on and signal system acquisition. The second portion of the section describes basic effects—positioning, rotating, and moving images. The third portion gives typical procedures for using ADO advanced effect capability—multichannel effects, three-dimensional solids, mosaic, posterization, and keys. The last portion describes engineering setup adjustments.

### 3-2 GETTING STARTED

Before turning on the system, be sure that all power and signal cables are connected properly. Turn on power to all signal systems, any hub box accessories, the ADO Concentrator, if installed, and all control panels. Figure 3-1 shows the location of power switches in all units, as well as the location of the control unit CRT display brightness control.

### 3-3 ACQUIRING A SIGNAL SYSTEM

The system comes up in communications mode at turn-on. This mode permits any logical (programmed) channel to acquire any physical (signal-system) channel. From communications mode, press PROG to reach the main program menu, and then MORE once or twice to reach subsidiary program menus. In communications mode, a menu containing a routing matrix appears on the display. This matrix displays the current status of each signal system in the system relative to each control unit. See Figure 3-2.

Each signal system can be in one of four states, listed at the left of the routing matrix: **free**, **acquired**, **busy N**, or **dead**.

- In free state, the physical signal system is available, and is not in use by any control unit. The corresponding horizontal row in the routing matrix contains four dashes.
- When a menu shows a physical signal system to be acquired, that control unit is the one controlling the system. The corresponding horizontal row contains an **X** in the vertical column corresponding to the logical assignment of the signal system, and three dashes in the other columns.
- In busy **N** state, the physical signal system has been taken over by some other control unit, identified by **N** which is a number from 0 to 7. Each control unit has a number established by the setting of three internal switches.

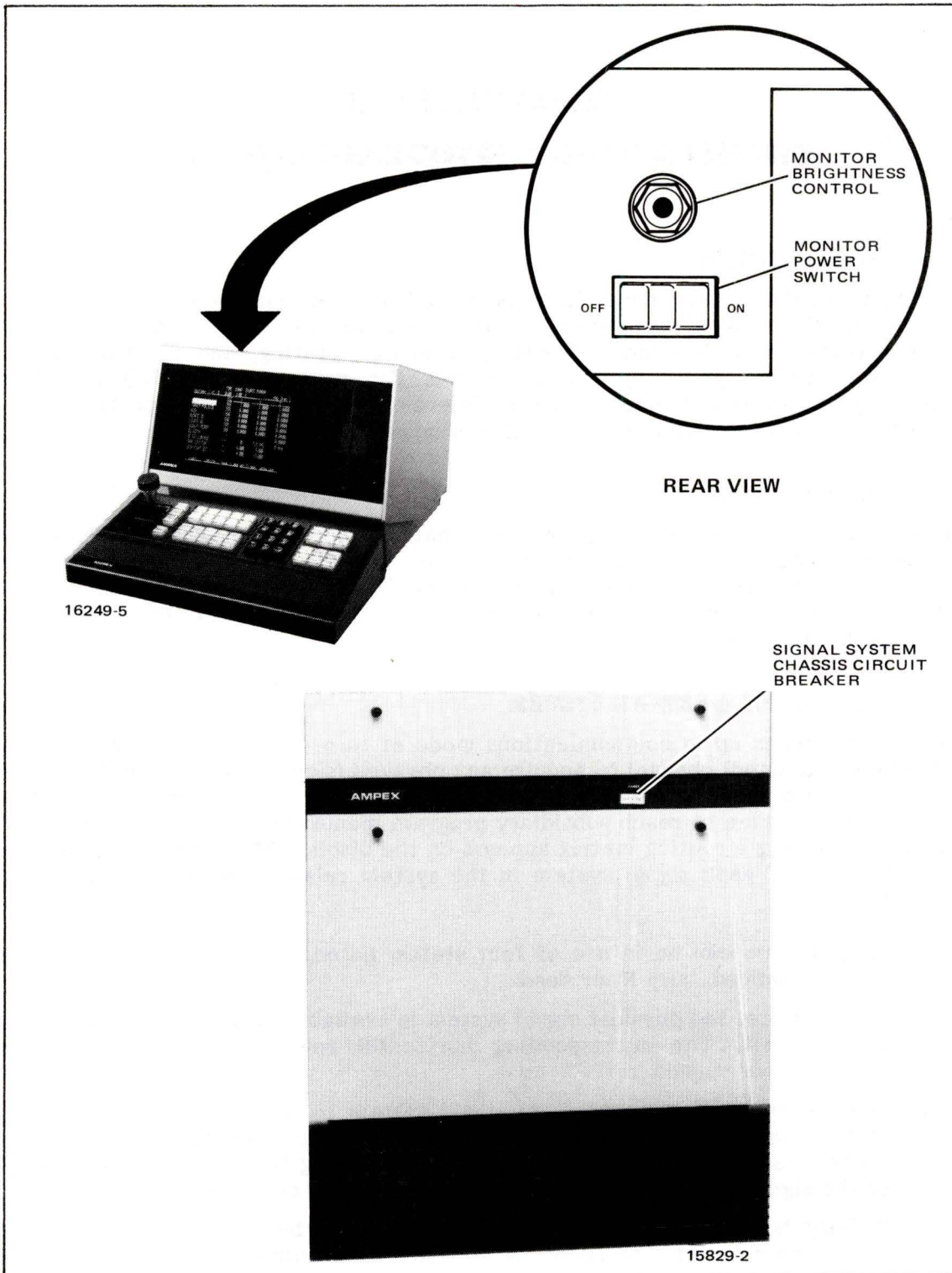

**Figure 3-1. Power Switch Locations**



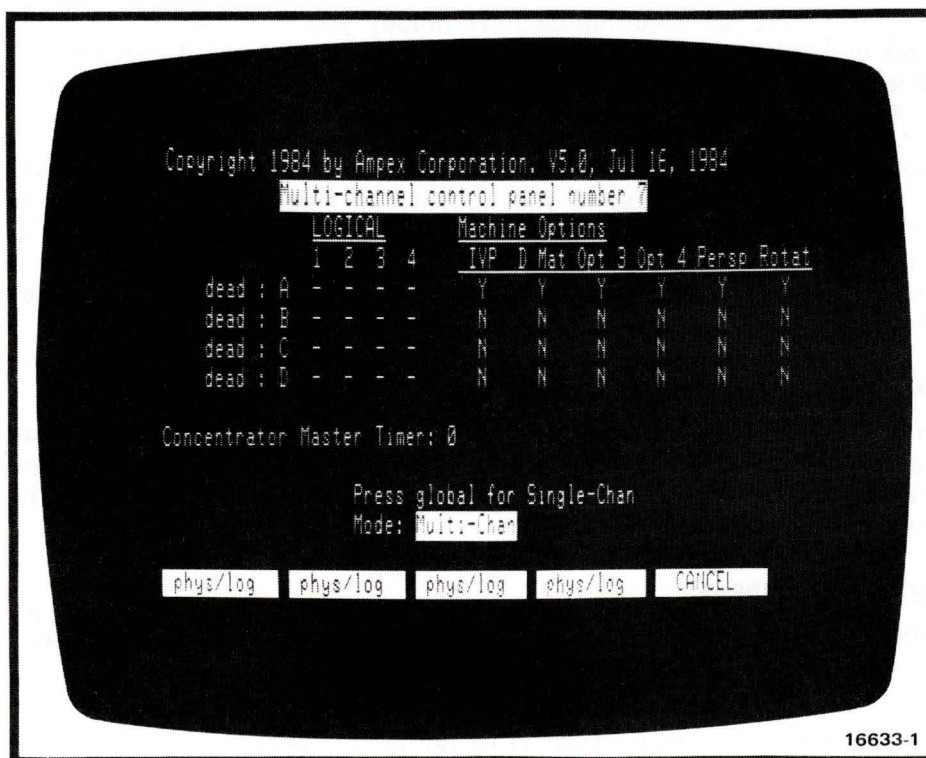

Figure 3-2. Communications Mode Menu

- In dead state, either that physical signal system has its power turned off or the communication line to it from the control unit is not operating.

To acquire one or more signal systems for control:

- STEP 1 Enter communications mode and verify from the matrix that the desired signal system or systems are free.
- STEP 2 Press soft key whose letter corresponds to desired physical signal system. The corresponding row in the matrix begins blinking.
- STEP 3 Select the logical channel (channel programmed for the effect) by pressing CHAN key whose number corresponds to the channel to be used. An X appears at intersection of selected row and column, and the new state appears on routing matrix, showing **acquired** for physical channel just acquired. All other control units show **busy N** for the channel.
- STEP 4 Repeat steps 1-3 for additional signal systems if required.

To release an acquired channel, press the corresponding channel key. To redesignate a signal system or channel choice, press **cancel** soft key or press the chosen row or column key.

# ADO

By pressing GLOBAL in communications mode, you can switch between single-channel and multichannel modes. If you have a single-channel system, you do not have multichannel control; auto-cube and multiple control panel modes are not available. All menu displays indicate single-channel capability only.

If you operate in multichannel mode, then you may have only one multichannel effect in memory at one time. If you operate in single-channel mode, then your control panel may have up to four single-channel effects in memory at one time. These four effects are accessed by pressing channel keys 1 through 4. Other differences between single-channel and multichannel modes are discussed in paragraphs 3-48 and 3-49 of this guide.

## 3-4 BASIC EFFECTS

The following paragraphs describe simple effects such as making horizontal, vertical, and diagonal moves, reducing images in size, and rotating images around one axis. In later paragraphs we describe how to combine keyframes, edit effects, and create multichannel effects.

## 3-5 Positioning Images

These procedures demonstrate horizontal (X-axis) and vertical (Y-axis) movement.

## 3-6 Horizontal Movement

This procedure demonstrates horizontal image movement.

- STEP 1 Acquire a signal system as described in paragraph 3-3.
- STEP 2 Press PROG and then SOURCE ASPECT/SIZE.
- STEP 3 Press ENT Z, . (decimal point), 5, and then ENTER to reduce image to one-half original size.
- STEP 4 Press TARGET POS/SIZE.
- STEP 5 Press ENT X. Note that X value on display flashes. Press 4 and then ENTER to move image to right side of picture monitor.
- STEP 6 Press insert soft key.
- STEP 7 Press ENT X, +/-, 4, and then ENTER to move image to left side of picture monitor.
- STEP 8 Press ← key to change menu display to keyframe 1.
- STEP 9 Press TIME. Note that keyframe duration (DURAT) value flashes. Press 5 and then ENTER to set keyframe duration to 5 seconds.
- STEP 10 Press RUN to bring up Run Mode menu.
- STEP 11 Press → key. The image on the monitor should move from right to left, taking 5 seconds to cross the screen.

**3-7 Vertical Movement**

This procedure demonstrates vertical image movement.

- STEP 1 Press PROG and then SOURCE ASPECT/SIZE.
- STEP 2 Press MORE and then delete all soft key to clear previous keyframes.
- STEP 3 Press MORE three times to bring up initial soft key menu.
- STEP 4 Press ENT Z, . (decimal point), 5, and then ENTER to reduce image to one-half original size.
- STEP 5 Press TARGET POS/SIZE.
- STEP 6 Press ENT Y. Note that Y value on display flashes. Press 3 and then ENTER to move image to top of picture monitor.
- STEP 7 Press insert soft.
- STEP 8 Press ENT Y, +/-, 3 and then ENTER to move image to bottom of picture monitor.
- STEP 9 Press ← to change display to keyframe 1.
- STEP 10 Press TIME. Press 5 and then ENTER to set keyframe duration to 5 seconds.
- STEP 11 Press RUN to bring up Run Mode menu.
- STEP 12 Press →. The image on the monitor should move from top to bottom, taking 5 seconds to cross the screen.

**3-8 Diagonal Movement**

This procedure combines vertical and horizontal movement to demonstrate diagonal image movement. This is done, in this example, by editing the effect of paragraph 3-7.

- STEP 1 Press TARGET POS/SIZE.
- STEP 2 Press ENT X. Press 4 and then ENTER to move image to right side of monitor.
- STEP 3 Press → key to move to keyframe 2.
- STEP 4 Press Press ENT X, +/-, 4, and then ENTER to move image to left side of monitor.
- STEP 5 Press RUN to bring up run mode menu.
- STEP 6 Press ← key. The image on the monitor should move diagonally from top right to bottom left, taking 5 seconds to cross the screen.

# ADO

## 3-9 Zooming Images

This procedure demonstrates apparent movement of an image from a distance toward the viewer.

- STEP 1 Press PROG.
- STEP 2 Press MORE and then **delete all** soft key to clear previous keyframes.
- STEP 3 Press MORE three times to bring up initial soft key menu.
- STEP 4 Press LOCATE 3D.
- STEP 5 Turn joystick Z axis knob clockwise until picture appears located at a suitable distance
- STEP 6 Press **insert** soft key to add a keyframe.
- STEP 7 Press CLEAR Z to move image to normal viewing distance.
- STEP 8 Press **show one** soft key.
- STEP 9 Press ← key to change menu display to keyframe 1.
- STEP 10 Press TIME. Press 2.15 and then ENTER to set keyframe duration to 2 seconds and 15 frames.
- STEP 11 Press RUN to bring up run mode menu.
- STEP 12 Press → key. The image on the monitor should appear to move from a distance toward the viewer, taking 2 seconds and 15 frames to make the move.

## 3-10 Combining Diagonal Movement and Zooming

This procedure combines diagonal movement and zooming to give the effect of an image crossing the screen and moving from a distance to the foreground.

- STEP 1 Press PROG and then SOURCE ASPECT/SIZE.
- STEP 2 Press MORE and then **delete all** soft key to clear previous keyframes.
- STEP 3 Press MORE three times to bring up initial soft key menu.
- STEP 4 Press ENT Z, . (decimal point), 5, and then ENTER to reduce image to one-half original size.
- STEP 5 Press LOCATE 3D.
- STEP 6 Press ENT Z. Press 5, 0, and then ENTER to move image to a distance away from the viewer.

- STEP 7 Press ENT Y. Press 1, 2, and then ENTER to move image to top of picture monitor.
- STEP 8 Press ENT X. Press 1, 6, and then ENTER to move image to right side of monitor.
- STEP 9 Press **insert** soft key.
- STEP 10 Press ENT Y, +/-, 3 and then ENTER to move image to bottom of picture monitor.
- STEP 11 Press ENT X, +/-, 4 and then ENTER to move image to left side of monitor.
- STEP 12 Press CLEAR Z to move image to normal viewing distance.
- STEP 13 Press ← key to change menu display to keyframe 1.
- STEP 14 Press TIME. Press 5 and then ENTER to set keyframe duration to 5 seconds.
- STEP 15 Press RUN to bring up Run Mode menu.
- STEP 16 Press → key. The image on the monitor should move diagonally from top right to bottom left and zoom toward the viewer, taking 5 seconds to cross the screen.

### **3-11 Rotating Images**

The following procedures demonstrate image rotation.

#### **3-12 Y-Axis Rotation**

This procedure demonstrates Y-axis rotation. Note that rotation around the Y axis is done by changing X values or by moving the joystick left or right.

- STEP 1 Press PROG, and then SOURCE/ASPECT/SIZE.
- STEP 2 Press MORE key and then **delete all** soft key to clear previous keyframes.
- STEP 3 Press MORE key three times to bring up initial soft key menu.
- STEP 4 Press ENT Z, . (decimal point), 5, and then ENTER to reduce image to one-half original size.
- STEP 5 Press ROTATE 3D.
- STEP 6 Press **insert** soft key.
- STEP 7 Press ENT X. Press 3 and then ENTER to rotate image three complete revolutions.

# ADO

- STEP 8 Press ← key to change menu display to keyframe 1.
- STEP 9 Press TIME. Press 5 and then ENTER to set keyframe duration to 5 seconds.
- STEP 10 Press RUN to bring up run mode menu.
- STEP 11 Press → key. The image on the monitor should rotate, taking 5 seconds to complete three complete revolutions.
- STEP 12 Return to program mode by pressing PROG.
- STEP 13 Use → key to go to keyframe 2.
- STEP 14 Press SKEW/POST-Y/PERSP.
- STEP 15 Enter a Y value of 1 from the keypad.
- STEP 16 Return to run mode and run effect again. Note that image rotates around both X and Y axes simultaneously.

## 3-13 X-Axis Rotation

This procedure demonstrates X-axis rotation. Note that rotation around the X axis is done by changing Y values or by moving the joystick up or down.

- STEP 1 Press PROG and then SOURCE ASPECT/SIZE.
- STEP 2 Press MORE and then delete all soft key to clear previous keyframes.
- STEP 3 Press MORE three times to bring up initial soft key menu.
- STEP 4 Press ENT Z, . (decimal point), 5, and then ENTER to reduce image to one-half original size.
- STEP 5 Press ROTATE 3D.
- STEP 6 Press insert soft key.
- STEP 7 Press ENT Y. Press 3 and then ENTER to rotate image three complete revolutions.
- STEP 8 Press ← key to change menu display to keyframe 1.
- STEP 9 Press TIME. Press 5 and then ENTER to set keyframe duration to 5 seconds.
- STEP 10 Press RUN to bring up run mode menu.
- STEP 11 Press → key. The image on the monitor should rotate, taking 5 seconds to make three revolutions.

**3-14 Z-Axis Rotation**

This procedure demonstrates rotation around the Z-axis, giving the appearance of a spinning image.

- STEP 1 Press PROG and then SOURCE ASPECT/SIZE.
- STEP 2 Press MORE and then **delete all** soft key to clear previous keyframes.
- STEP 3 Press ENT Z, . (decimal point), 5, and then ENTER to reduce image to one-half original size.
- STEP 4 Press MORE three times to bring up initial soft key menu.
- STEP 5 Press ROTATE 3D.
- STEP 6 Press **insert** soft key.
- STEP 7 Rotate joystick Z axis clockwise until picture has rotated about three times. The Z axis value should be near 3.0000.
- STEP 8 Press CLEAR Z once; you will see the value for the Z axis change to exactly 3.0000.
- STEP 9 Press ← key to change menu display to keyframe 1.
- STEP 10 Press TIME. Press 5 and then ENTER to set keyframe duration to 5 seconds.
- STEP 11 Press RUN to bring up run mode menu.
- STEP 12 Press → key. The image on the monitor should rotate, taking 5 seconds to make three revolutions.

**3-15 Rotation with Horizontal Movement**

This procedure demonstrates combined image rotation and horizontal movement. This is done, in this example, by editing the previous effect.

- STEP 1 Press PROG.
- STEP 2 Press TARGET POS/SIZE.
- STEP 3 Press ENT X. Press 4 and then ENTER to move image to right side of picture monitor.
- STEP 4 Press the → key to move to the second keyframe.
- STEP 5 Press ENT X, +/-, 4 and then ENTER to move image to left side of monitor.

## **ADO**

STEP 6 Press RUN to bring up run mode menu.

STEP 7 Press → key. The image on the monitor should rotate and move from right to left, taking 5 seconds to cross the screen.

### **3-16 Rotation with Axis Shifted**

This procedure shifts the axis of rotation to give the effect of an image rotating, as a page of a book being turned.

STEP 1 Press PROG.

STEP 2 Press MORE, then **delete all** soft key, to clear previous keyframes.

STEP 3 Press MORE three times to bring up initial soft key menu.

STEP 4 Press ENT Z, . (decimal point), 5, and then ENTER to reduce image to one-half original size.

STEP 5 Press AXIS SELECT 3D.

STEP 6 Press ENT X. Press +/-, 3, and then ENTER to shift X axis to left of picture monitor.

STEP 7 Press insert soft key.

STEP 8 Press ROTATE 3D.

STEP 9 Press ENT X, 3, and ENTER to rotate image three complete revolutions.

STEP 10 Press ← key to change menu display to keyframe 1.

STEP 11 Press TIME. Press 5 and then ENTER to set keyframe duration to 5 seconds.

STEP 12 Press RUN to bring up run mode menu.

STEP 13 Press → key. The image on the monitor should rotate around the displaced Y axis, appearing as a page of a book being turned. Three complete revolutions should take 5 seconds.

### **3-17 KEYFRAME FLAGS**

The examples given previously used only two keyframes—beginning and end—to define an effect. In practice, an effect usually consists of many keyframes. Although keyframes are usually related, entirely different transformations can be programmed for each keyframe. For example, in one keyframe an image can zoom in from the background. In the next keyframe the image can rotate. In the next keyframe the image can be switched to another video source, and in a final keyframe the image can be frozen.



It is important to remember that the setting of a keyframe flag takes effect beginning at the keyframe where set, and ending just before the next keyframe. (In next keyframe, setting of its keyframe flag, or default value, takes effect.) This differs from the effect of keyframe parameters, which are only exactly true at the exact time of the keyframe itself (but affect picture position equally as much before and after the keyframe time). However, when hold motion is used the effect of the parameters becomes much like that of the flags.

The following procedures demonstrate the use of keyframe flags.

### **3-18 Setting a Source Flag**

This procedure demonstrates how to program an effect that moves an image from right to left, changing image sources at midscreen (assuming two different sources applied to the ADO signal system).

- STEP 1 Acquire a signal system as described in paragraph 3-3.
- STEP 2 Press PROG and then SOURCE ASPECT/SIZE.
- STEP 3 Press ENT Z, . (decimal point), 5, and then ENTER to reduce image to one-half original size.
- STEP 4 Press TARGET POS/SIZE.
- STEP 5 Press ENT X. Press 4 and then ENTER to move image to right side of picture monitor.
- STEP 6 Press **insert** soft key.
- STEP 7 Press CLEAR X to set X value to 0 (center screen).
- STEP 8 Press **insert** soft key.
- STEP 9 Press ENT X, +/-, 4, and then ENTER to move image to left side of picture monitor.
- STEP 10 Press ← key to change menu display to keyframe 2.
- STEP 11 Press TIME. Press 5 and then ENTER to set keyframe duration to 5 seconds.
- STEP 12 Press ← key to change menu display to keyframe 1.
- STEP 13 Press TIME. Press 5 and then ENTER to set keyframe duration to 5 seconds.
- STEP 14 Press → key to change menu display to keyframe 2.
- STEP 15 Press **kf flags** soft key. This brings up the keyframe flags menu.

## ADO

- STEP 16 Use **change** soft key to set source flag to B video source.
- STEP 17 Press → key to change menu display to keyframe 3.
- STEP 18 Use **change** soft key to set source flag to B video source.
- STEP 19 Press RUN to bring up run mode menu.
- STEP 20 Press → key. The image on the monitor should move from right to left, changing inputs at center screen.

### 3-19 Setting a Freeze Flag

This procedure is similar to setting a source flag, but sets a freeze flag at midscreen to freeze the incoming video image. You will need a source which includes moving images to see the effects of freezing the image.

- STEP 1 Acquire a signal system as described in paragraph 3-3.
- STEP 2 Press PROG and then SOURCE ASPECT/SIZE.
- STEP 3 Press ENT Z, . (decimal point), 5, and then ENTER to reduce image to one-half original size.
- STEP 4 Press TARGET POS/SIZE.
- STEP 5 Press ENT X. Press 4 and then ENTER to move image to right side of picture monitor.
- STEP 6 Press **insert** soft key.
- STEP 7 Press CLEAR X to set X value to 0 (center screen).
- STEP 8 Press **insert** soft key.
- STEP 9 Press ENT X, +/-, 4, and then ENTER to move image to left side of picture monitor.
- STEP 10 Press ← key to change menu display to keyframe 2.
- STEP 11 Press TIME. Press 5 and then ENTER to set keyframe duration to 5 seconds.
- STEP 12 Press ← key to change menu display to keyframe 1.
- STEP 13 Press TIME. Press 5 and then ENTER to set keyframe duration to 5 seconds.
- STEP 14 Press **kf flags** soft key. This brings up the keyframe flags menu.
- STEP 15 Use -> soft key to move highlight to **Freeze** column.

STEP 16 Press → to change menu display to keyframe 2.

STEP 17 Use **change** key to set freeze flag on.

STEP 18 Use → key to change menu display to keyframe 3.

STEP 19 Use **change** key to set freeze flag on.

### Note

**FRZ** appears in the many parameter display for the keyframe where a freeze flag is set; an **F** appears in the one parameter display.

STEP 20 Press RUN to bring up Run Mode menu.

STEP 21 Press → key. The image on the monitor should move from right to left, freezing the image at center screen.

### 3-20 Other Keyframe Flags

Other keyframe flags can be set in the same way as freeze and source flags. These flags include:

- **A mirr** sets mirror mode for source A:
  - none** disables mirror mode
  - X** sets mirror mode for X axis
  - Y** sets mirror mode for Y axis
  - X,Y** sets mirror mode for both axes.
- **B mirr** sets mirror mode for source B.
- **Global** enables the effect of the global parameters on the particular channel. **NOG** appears in the many parameter display in keyframes where the global disable flag is set, disabling global control on that channel.
- **Interl** sets interlace mode at the keyframe where the flag is set.

**auto1.** In this mode the system looks at the last four fields on a pixel-by-pixel basis. If any object in the picture is moving rapidly, the system uses only the most recent field in image transformation. If no object is moving, the system computes a value for the corresponding pixels from all four fields.

**Frame.** The system uses only the most recent frame in image transformation. This mode is useful for cleaning up the edges of graphics from a camera. When freezing a rapidly moving object in frame mode, the object appears to flicker because of its different positions in the two fields in the frame.

**Field.** The system uses only the most recent field in image transformation. Each line of the other field is synthesized as the average of the two nearest lines. The result is a picture very close to the original full-frame picture, but with slightly reduced vertical resolution, and with no flicker in a rapidly moving object.

# ADO

**auto2.** This mode is the same as auto 1 but with a higher threshold of motion as the basis of a decision to use one field or four.

The interlace mode can be changed after freezing the picture to find the optimum mode for a particular effect.

- **Cube** enables auto cube mode beginning at the keyframe where the flag is set. **CUB** appears in the many parameter display for a keyframe where auto cube mode is enabled.
- **Y blur** reduces luminance resolution, giving the effect of a lens out of focus.

## 3-21 RUNNING AN EFFECT

In addition to the running of completed effects, run mode is useful for previewing effects being constructed before they are committed to final form. Effects can be run forward or backward and examined at any point to determine any adjustments needed. Effect length can be trimmed to suit the operator's requirements. Using program mode, keyframes can then be edited to make any changes found necessary during preview runs. Also, previewing helps determine the best position on the time line for certain operations occurring between keyframes, including pauses and channel priorities for concentrator use.

The following procedures demonstrate use of run mode features.

### 3-22 Setting Up an Initial Effect

- STEP 1 Acquire a signal system as described in paragraph 3-3.
- STEP 2 Press PROG and then SOURCE ASPECT/SIZE.
- STEP 3 Press ENT Z, . (decimal point), 5, and then ENTER to reduce image to one-half original size.
- STEP 4 Press TARGET POS/SIZE.
- STEP 5 Press ENT X. Press 4 and then ENTER to move image to right side of picture monitor.
- STEP 6 Press **insert** soft key.
- STEP 7 Press ENT X, +/-, 4, and then ENTER to move image to left side of picture monitor.
- STEP 8 Press ← key to change menu display to keyframe 1.
- STEP 9 Press TIME. Press 5 and then ENTER to set keyframe duration to 5 seconds.

### 3-23 Running the Effect

- STEP 1 Press RUN to bring up Run Mode menu.

**STEP 2** Move joystick upward. The effect begins to run at a speed determined by joystick position—the further from center, the faster the effect runs. Move joystick downward and the effect runs backward. At center position of joystick the effect stops running. If joystick is held near center position, the effect can be run very slowly in sub-frame increments.

### **3-24 Adding and Deleting Pauses and Events**

**STEP 1** Press RUN to bring up Run Mode menu.

**STEP 2** Use the joystick to move the effect to some arbitrary point on the time line. Press **add pau/ev**. Note that a dot denoting an event appears underneath the time line (even though no event has been programmed). Press **add pau/ev** again. Note that an X denoting a pause appears under the time line. Run the effect using the → key. The effect pauses at the newly-added pause, and may be continued by pressing the → key again.

**STEP 3** With the effect stopped at the new pause, press **del pau/ev** key. This removes the pause set previously. Push again to delete dot denoting event (and event if programmed).

### **3-25 Changing Start and End Times**

**STEP 1** With Run Mode menu selected, press MORE twice.

**STEP 2** Press **strt time** soft key. The effect start value flashes.

**STEP 3** Press 2 and then ENTER to change start time to 2:00 seconds. Note that a dot appears below the time line at the 2 second point.

**STEP 4** Press **end time** soft key. The effect end value flashes.

**STEP 5** Press 4 and then ENTER to change end time to 4:00 seconds. Note that a dot appears below the time line at the 4-second point.

**STEP 6** Press → key. The effect now runs between 2- and 4-second start and end times.

### **3-26 Changing Effect Length**

**STEP 1** Use **strt time** and **end time** soft keys to return times to original 0:00 and 5:00 second values.

**STEP 2** Press TIME. Effect length value flashes.

**STEP 3** Press 3 and ENTER. Time line shortens to 3 seconds.

**STEP 4** Press → key. Effect runs as before, but with 3-second duration.

# ADO

## **3-27 Selecting Concentrator Channels**

- STEP 1 With desired channels acquired, select run mode menu and press MORE key once.
- STEP 2 To change the status of a channel (whether the channel is to be in or out of the combine), press corresponding channel key then use **ch in/out** soft key as follows: press **ch in/out** soft key as needed to display I (in combine) or o (out of combine).
- STEP 3 To change the status of a channel output (whether the output is the combine or is the channel itself), press corresponding channel key then use **ch output** soft key as follows: press **ch output** soft key as needed to display C (combine) or s (self).

### **Note**

**If there is no concentrator, the concentrator flags must be left in the power-up default state (in/out = 0; output select = s) to assure proper operation.**

## **3-28 Setting Concentrator Priority**

- STEP 1 Select Run Mode menu.
- STEP 2 Go to position in effect time line where you wish to change priority.

### **Note**

**Use one of three methods: 1) in general use joystick, 2) use go next soft key to change priority of an existing event, or 3) use go to time soft key to select an exact time, via keypad entry.**

- STEP 3 Press **priority** soft key to enable setting of priority. (If not exactly on an existing event, a new event will be created.)
- STEP 4 Press, for example, keypad numbers 4, 2, 1, then 3 to set the following order of priority: 4 over 2, over 1, over 3. (See paragraph 2-43 for additional information regarding priorities.)

### **Note**

**Priorities take effect starting at the current event, up to the next event. Remember that beginning and end of effect are always events.**

## **3-29 Adjusting Concentrator Parameters**

- STEP 1 Select Run Mode menu then press MORE three times.
- STEP 2 Press CHAN or GLOBAL as desired to select channel(s) for adjustment.
- STEP 3 Press **show one** and **show many** soft keys as needed (same effect as for Program menus).

- STEP 4 Use <- and -> soft keys to select parameters for change.
- STEP 5 Use ← and → on keyboard to select event for change.
- STEP 6 Use joystick or keypad to change parameters as required.
- STEP 7 If desired, change priority (paragraph 3-28).
- STEP 8 Repeat steps 2 through 7 as needed to accomplish other changes desired.

**Note**

If there is no event at the time desired for parameter change, you must add an event (paragraph 3-24).

**3-30 Moving to a Specified Time in an Effect**

- STEP 1 Press **goto time** soft key. **Enter goto time:** appears in the lower portion of the run mode display.
- STEP 2 Key in a time in seconds and press ENTER. The effect moves to the time specified.

**3-31 Moving to a Specified Event in an Effect**

- STEP 1 Select Run Mode menu.
- STEP 2 Press **go next** soft key to move to next event on effect time line.
- STEP 2 Repeat until desired event is reached.

**Note**

To modify anything at an event, the time line position must be exactly at an event; the go next soft key should be used to assure this.

**3-32 EDITING EFFECTS**

You can edit keyframes at any time during the process of assembling an effect. You can also build keyframes one parameter at a time by going back through each keyframe and adding new parameters. You can use either the numeric keypad or the joystick to change values. For example, to build an effect combining horizontal movement, rotation, and zoom, start with horizontal movement, then go back and add rotation, and finally add zoom.

The procedure below describes keyframe editing.

- STEP 1 Clear any previous keyframes by pressing **delete all** soft key in program mode.
- STEP 2 Press SOURCE ASPECT/SIZE and enter a Z value of .4.

## ADO

- STEP 3 Set up horizontal movement by pressing TARGET POS/SIZE and entering an X value of 4 for the first keyframe, and an X value of -4 for the second and last keyframe.
- STEP 4 Go to keyframe 2 and press ROTATE 3D. Enter a Y value of 2 for keyframe 2.
- STEP 5 Return to keyframe 1 and press TARGET POS/SIZE. Enter a Z value of 0.1.
- STEP 6 Go to keyframe 2 and enter a Z value of 2.
- STEP 7 Go to run mode and run the effect. The image should appear to make two complete revolutions while moving from right to left and zooming in from the background.
- STEP 8 Return to program mode and press TARGET POS/SIZE.
- STEP 9 Return to keyframe 1 and use joystick to move image to top of screen.
- STEP 10 Move to keyframe 2 and use joystick to move image to bottom of screen.
- STEP 11 Go to run mode and run the effect. The image should move diagonally while rotating and zooming from the background.

### 3-33 NAMING EFFECTS

You can use name entry mode to assign a name to each effect as the effect is stored on a disk. Use the following procedure:

- STEP 1 From Program menu, press MORE and then **enter name** soft key. A menu with instructions and two rows of alphanumeric characters appears on the screen. Refer to Figure 2-16.
- STEP 2 Use the joystick or the → and ← keys to move the cursor horizontally from one character to another. To reach lower row of display, go beyond left- or right-most character with joystick or ← and → keys. Press STOP to enter each character in the name as you spell it out. The space character is at the far left of the top line of characters (it shows as a blank space in the line). The character chosen appears at the top line on the screen. When the entire name has been spelled out, press ENTER to enter the disk name in a temporary name register.

### 3-34 STORING AND RECALLING EFFECTS

Effects can be stored in two ways: on a disk or in on-line memory. Up to four single-channel effects can be stored in on-line memory using the four CHAN (channel) keys. Each disk stores over 50 effects of up to 25 keyframes each.



Effects stored in on-line memory are lost if power is turned off at the control panel. Effects stored on a disk are reasonably permanent.

### **3-35 Storing and Recalling Effects from On-Line Memory (Single-Channel Mode Only)**

This procedure illustrates use of on-line memory.

- STEP 1 Press CHAN 1 and set up an effect several keyframes long.
- STEP 2 Press CHAN 2, CHAN 3, and CHAN 4 in sequence, setting up effects for each channel.
- STEP 3 Recall effects by pressing the channel key used to set up the effect originally.

### **3-36 Storing and Recalling Effects from a Disk**

This procedure demonstrates use of a disk for storage recall

#### **Note**

**This procedure stores keyframes from all four channels as well as keyframes on the global channel.**

- STEP 1 Set up effects on any or all channels.
- STEP 2 If you wish to assign a name to the effect, use the procedure given in paragraph 3-33.
- STEP 3 Press STORE EFFECT. **Enter effect number:** appears in the lower portion of the display.
- STEP 4 Enter an effect number from 1 to 60 from the keypad.
- STEP 5 Press ENTER. The disk drive indicator comes on for a few seconds and then goes off. At the same time, **Enter effect number:** disappears to indicate that the effect has been recorded on the disk.
- STEP 6 To recall an effect stored previously, press RECALL EFFECT. **Enter effect number:** appears in the lower portion of the display.
- STEP 7 Enter an effect number from 1 to 60 from the keypad.
- STEP 8 Press ENTER. The disk drive indicator comes on for a few seconds and then goes off. At the same time, **Enter effect number:** disappears to indicate that the effect has been recalled from the disk. Run and program mode display shows keyframe parameters for the effect which was recalled.

# ADO

## Note

If the effect number duplicates an effect already on the disk, the system indicates that the effect exists. Press ENTER again to overwrite the existing effect.

An effect can be recalled, edited, and then stored again under the same effect name and number by following steps 3 through 5 of this procedure.

### 3-37 Erasing Effects from a Disk

Single effects can be erased from a disk by using the **erase eff** soft key in the program menu. To erase an effect:

- STEP 1 Press **erase eff** soft key. **Enter erase effect number:** appears at bottom of display.
- STEP 2 Enter number of the effect you want to delete from the keypad. Press enter. The effect has now been deleted from the disk.

### 3-38 Copying a Disk

## Note

When doing a disk copy, the current effect will be lost; current effect should first be stored on disk.

To copy a disk to another disk, proceed as follows:

- STEP 1 Select SETUP.
- STEP 2 Push MORE three times.

## Note

The master disk should be write-protected; be sure the disk notch is covered by a write-protect tab, to prevent recording.

- STEP 3 Insert disk to be copied from (master disk).
- STEP 4 Push **copy disk** soft key. This selects next soft key display, showing **start copy**.
- STEP 5 Push **start copy**. When disk is read, **continue** soft key appears (in C position). Message appears: **put in copy disk**.
- STEP 6 Disk to be copied to (copy disk) must be formatted. Insert copy disk, then push **continue**. Message appears: **writing on copy**. If disk is completely copied in one pass, message appears: **done**. Also, **continue** soft key position becomes blank. Master disk has been copied to copy disk. Message appears: **hit any soft key to exit**.
- STEP 7 If disk not completely copied in one pass, message appears: **put in master disk**. Also, **continue** soft key moves to A position.

- STEP 8 Insert master disk and push continue. Message appears: **reading master disk**. Then message appears: **put in copy disk**.
- STEP 9 Repeat steps 6, 7, and 8 as needed until **done** message appears. Exit as directed in step 6.

### Note

If procedure terminated before master disk fully copied, the copy disk directory will list all master disk material, even though some of it is missing. Copy disk procedure will have to be repeated from the beginning.

An effect can be recalled, edited, and then stored again under the same effect name and number by following steps 3 through 5 of this procedure.

### 3-39 INSERTING AND DELETING KEYFRAMES

Keyframes can be inserted or deleted at any time during effect construction. To insert a keyframe, move to the keyframe before the point where a new keyframe is to be inserted. Press **insert**. The keyframe which you selected has now been duplicated. You may now modify the new keyframe for the parameters required.

To delete a keyframe, go to the keyframe to be deleted, then press **delete** soft key.

### 3-40 ADVANCED EFFECTS

So far we have demonstrated effects using simple movement and rotation. The following paragraphs outline other capabilities which can be used in constructing effects.

#### 3-41 Off-Axis Rotation

The previous rotation examples used axes positioned in the plane of the picture monitor screen. The procedure following illustrates rotation around the Y axis, displaced two units away from its normal position.

- STEP 1 Press SOURCE ASPECT/SIZE. Enter a Z value of 0.5 to reduce image to one-half original size.
- STEP 2 Press AXIS SELECT 3D.
- STEP 3 Enter a Z value of -2.
- STEP 4 Press ROTATE 3D.
- STEP 5 Move joystick to the right; the image rotates around displaced Y axis, appearing to move around the surface of a cylinder with 2 units radius.

#### 3-42 Rotation with Perspective

When images are moved from the normal X-Y plane using LOCATE 3D, the image is affected by perspective. The amount of perspective can be changed from the

# ADO

system-assigned value of 0.06. This change results in the image appearing to be viewed through lenses of differing focal lengths. That is, for each perspective value, the effect will be more or less pronounced. The following procedure demonstrates the use of three-dimensional location, perspective, and rotation.

- STEP 1 Press LOCATE 3D.
- STEP 2 Enter a Z value of 10 from the keypad.
- STEP 3 Press ROTATE 3D. Rotate the image and note apparent perspective.
- STEP 4 Press SKEW/POST-Y/PERSP.
- STEP 5 Enter a Z value of 0.4 from the keypad.
- STEP 6 Press ROTATE 3D.
- STEP 7 Use joystick to rotate image around the Y axis. Note that image appears to have more perspective and seems to be further away. This is because the system has created the effect of viewing the image through a wide-angle lens.
- STEP 8 Press LOCATE 3D and move image closer to and further away from screen. Note that control seems more sensitive due to perspective changes.

### **3-43 Creating Mosaic Effects**

Mosaic mode is used to create effects in which the image appears to be composed of colored tiles. Tile size and area converted to mosaic are operator controllable. The following procedure demonstrates mosaic mode.

- STEP 1 Acquire a signal system and select a video input which provides an image with a range of colors and brightness.
- STEP 2 From program mode, press MORE until the Input Video Parameters menu appears in the display.
- STEP 3 Press **iv parms** soft key to bring up mosaic mode menu.
- STEP 4 Press <- soft key to highlight **MOSAIC BLOCK SIZE** on display.
- STEP 5 Move joystick to right and upward to increase size of mosaic blocks.
- STEP 6 Press MORE key and then **iv flags** soft key.
- STEP 7 Press -> soft key to select **MOSAICS**.
- STEP 8 Press **change** soft key to highlight **inside** on menu.

- STEP 9 Press MORE and then **iv parms** soft key.
- STEP 10 Use -> soft key to highlight **WINDOW LEFT/TOP** in display.
- STEP 11 Use joystick to increase X and Y values and reduce image area converted to mosaic.
- STEP 12 Highlight **WINDOW RIGHT/BOTTOM** and use joystick to reduce size of mosaic area. If you return to input video flags menu and set flag to outside, then only area outside window is converted to mosaic.

### **3-44 Creating Solarized and Posterized Effects**

Images are given solarized (high contrast) or posterized (high contrast with color highlights) characteristics using solarizer flag and chroma/luminance mapping parameters. The following procedure illustrates solarization and posterization mode.

- STEP 1 Acquire a signal system and select a video input which provides an image with a range of colors and brightness.
- STEP 2 From program mode, press MORE until the Input Video Parameters menu appears in the display.
- STEP 3 Press **iv parms** soft key.
- STEP 4 With **C-SOL/Y-SOL/Y-REV** highlighted, move joystick to the right to vary C-SOL (chroma posterization) value. Note color changes in image.
- STEP 5 Move joystick up to vary Y-SOL (luminance posterization) value. Note contrast change.
- STEP 6 Rotate joystick clockwise and counterclockwise to vary Y-REV (luminance reversal) value. Note image change from positive to reverse video.

### **3-45 Creating Colored Borders**

Under operator control, the system creates color background for effects. The following procedure illustrates color background effects. This color background will become a border when keyed over an image in the concentrator, or downstream in your switcher.

- STEP 1 Acquire a signal system and switch in a video source.
- STEP 2 In program mode, press **BORDER COLOR**.
- STEP 3 Enter an X value of 80 from the keypad to set saturation to 80%.
- STEP 4 Enter a Y value of 20 from the keypad to set luminance value to 20%.

# ADO

STEP 5 Press BORDER WIDTH.

STEP 6 Rotate joystick knob to increase border width to some convenient size.

STEP 7 Press BORDER COLOR. Rotate joystick knob clockwise to change border color.

## 3-46 Using the Key Channel

The Key Control menu allows the operator to control ADO key system. The following paragraphs describe key control flags.

- **K Sou** (key source) sets the source for the key signal:
  - A selects A signal input only
  - A/B selects A and B inputs automatically, as in A/B auto source keyframe flag
  - B selects B signal input only
  - B/A selects B and A signal inputs automatically, as in B/A auto source keyframe flag
- **Soft** (edge softness) sets soft edges for key output:
  - off disables key softness mode
  - A sets softness for A key signal
  - B sets softness for B key signal
  - AB sets softness for both key signals
- **A Sof** (A channel edge softness level) sets softness levels for A signal:
  - 0 through 7 set softness level from hardest to softest; **special** sets sawtooth edge waveform which gives a highlight at the edge.
- **B Sof** (B channel edge softness level) sets softness levels for B signal:
  - 0 through 7 set softness level from hardest to softest; **special** sets sawtooth edge waveform which gives a highlight at the edge.
- **K Blu** (key blur) is similar to Y blur keyframe flag; reduces key signal bandwidth to soften edge of graphics used as key signal.
  - off disables blur function
  - A sets blur mode for A key signal
  - B sets blur mode for B key signal
  - AB sets blur mode for both key signals
- **DM In** (Digi-Matte invert function)
  - off disables Digi-Matte invert function.
  - A **Inv** inverts external Digi-Matte key A input.
  - B **Inv** inverts external Digi-Matte key B input.
  - A&B inverts external Digi-Matte key A and key B inputs.
- **DM Ke** (optional Digi-Matte key channel)
  - off disables external key input.
  - A enables external key A input onto internal key source A.

**B** enables external key B input onto internal key source B.  
**A&B** enables external key A and key B inputs onto internal key sources A and B, respectively.

- **A gai** (A channel gain) sets gain of optional Digi-Matte input to reduce noise or to increase signal level to eliminate background feedthrough:

**unity** sets gain to one  
**+1** increases gain one unit  
**+2** increases gain two units  
**max** sets gain to maximum

- **B gai** (B channel gain) sets gain of optional Digi-Matte input to reduce noise or to increase signal level to eliminate background feedthrough:

**unity** sets gain to one  
**+1** increases gain one unit  
**+2** increases gain two units  
**max** sets gain to maximum

**3-47 Programming a Cube**

Examples are given below for programming cubes using multichannel and single-channel software versions.

**3-48 Multichannel Software Example**

An example is described for single channel and multichannel operation, using multi-channel software in both cases. To make the cube, either make three passes with one channel or use three channels. For multichannel operation use any priority to put the cube together. For single-channel operation, key pass 2 over pass 1, then key pass 3 over passes 1 and 2. In this example, each of three pictures is cropped to a square; referring to Figure 3-3, A = B = C = 6 screen units. The programming steps for this example are:

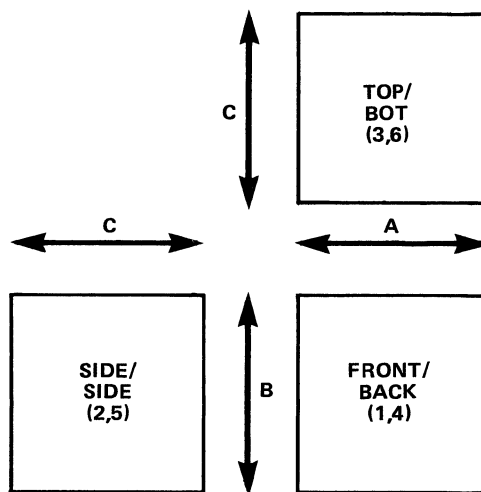

**Figure 3-3. Cube Faces**

## **ADO**

- STEP 1** Crop each of the three faces to 6 x 6. For channels (or passes) 1, 2, and 3, enter -3.0000 for left crop, and enter 3.0000 for right crop
- STEP 2** Use global and locate 3D functions to move pictures back for better viewing while you finish the cube.
- STEP 3** To put each face in place on the cube, locating its axis of rotation in the center of the cube:
- For channel (or pass) 1, axis select = 1/2 C. Enter -3.0000 for Z axis select.
  - For channel (or pass) 2, axis select = 1/2 A. Enter -3.0000 for Z axis select and -0.2500 for X rotate (to rotate face into place).
  - For channel (or pass) 3, axis select = 1/2 B. Enter -3.0000 for Z axis select and 0.2500 for Y rotate (to rotate face into place).
- STEP 4** For each channel or pass, turn auto cube on.
- STEP 5** Use global, rotate 3D, locate 3D, and axis select 3D functions for moving entire cube.
- STEP 6** Use A/B auto switching to put different inputs on the front/back, top/bottom, and left/right sides.
- STEP 7** You can now program an effect that involves the cube as a single object by inserting keyframes in global mode.

### **3-49 Single-Channel Software Example**

For a system using single-channel software, six passes—and therefore six effects—are required, since the auto cube mode cannot be used. Note that the globals used for all six effects must be the same. Referring to Figure 3-3, the programming steps for the single-channel software example are:

- STEP 1** Crop each of the six faces to 6 x 6. For each pass, enter -3.0000 for left crop and 3.0000 for right crop.
- STEP 2** Use global and locate 3D functions to move pictures back for better viewing while you finish the cube.
- STEP 3** To put each face in place, locating its axis of rotation in the center of the cube:
- For pass 1, axis select = 1/2 C. Enter -3.0000 for Z axis select.
  - For pass 2, axis select = 1/2 A. Enter -3.0000 for Z axis select and -0.2500 for X rotate (to rotate face into place).
  - For pass 3, axis select = 1/2 B. Enter -3.0000 for Z axis select and 0.2500 for Y rotate (to rotate face into place).
  - For pass 4, axis select = -1/2 C. Enter -3.0000 for Z axis select.



- e. For pass 5, axis select = -1/2 A. Enter -3.0000 for Z axis select and -0.2500 for X rotate (to rotate face into place).
- f. For pass 6, axis select = -1/2 B. Enter -3.0000 for Z axis select and 0.2500 for Y rotate (to rotate face into place).

**STEP 4** Use global, locate 3D, and axis select 3D functions for moving entire cube.

**STEP 5** You can now program an effect that involves the cube as a single object by inserting keyframes in global mode, creating identical keyframes in each of the six effects.

### **3-50 ENGINEERING SETUP MODE**

The following procedures adjust setup parameters to match studio conditions.

#### **Note**

**Adjustment of setup parameters should be done by qualified engineers using proper test equipment.**

### **3-51 Adjusting Luma/Chroma Gain**

This procedure adjusts luminance and chrominance gain through the ADO system to unity.

**STEP 1** Loop color bar signal through to waveform monitor channel A input.

**STEP 2** Connect color bar input to ADO signal system.

**STEP 3** Connect ADO output to switcher input. Connect switcher output to waveform monitor channel B input.

**STEP 4** Set waveform monitor for A-B display.

**STEP 5** Using luma/chroma/key gain and subcarrier phase modes, move joystick to adjust gain and phase so that display on waveform monitor is zero (a straight line).

### **3-52 Adjusting Output Horizontal Phase**

This procedure adjusts ADO output horizontal sync phase to match house reference sync.

**STEP 1** Connect a waveform monitor to the switcher output.

**STEP 2** Connect house reference to switcher input.

**STEP 3** Switch reference to waveform monitor input.

**STEP 4** Note position of negative-going edge of reference sync waveform on monitor.

# **ADO**

**STEP 5** Switch ADO output to waveform monitor input.

**STEP 6** Highlight **OUTPUT H PHASE** on setup menu and use joystick to adjust ADO output so that negative-going edge of sync matches position of reference sync on waveform monitor.

## **3-53 Adjusting Subcarrier Phase**

This procedure adjusts ADO output subcarrier phase to match house reference sync.

**STEP 1** Connect a vectorscope to the switcher output.

**STEP 2** Connect house reference to switcher input.

**STEP 3** Switch reference to vectorscope input.

**STEP 4** Adjust vectorscope phase so that burst vector lies on horizontal graticule reference line.

**STEP 5** Switch ADO output to waveform monitor input.

**STEP 6** Highlight **SUBCARRIER PHASE** on setup menu and use joystick to adjust ADO output so that burst vector is aligned on reference line.

## **3-54 Adjusting Burst Gain/Phase (NTSC Systems Only)**

Ampex does not recommend making this adjustment in the field.

## **3-55 Adjusting Sync Amplitude**

Ampex does not recommend making this adjustment in the field.

## **3-56 Key Gain (Digi-Matte Option Only)**

This procedure adjusts key gain. See paragraph 3-62 for overall Digi-Matte adjustment.

**STEP 1** Connect signal input and enable Digi-Matte mode.

**STEP 2** Highlight **LUMA/CHROMA/KEY GAIN** on setup menu and use joystick to adjust key output to 100 IRE units maximum, with a 100 IRE unit input signal.

## **3-57 Adjusting Key In H Phase (Digi-Matte Option Only)**

This procedure adjusts key input phasing to match switcher key phasing. See paragraph 3-62 for overall Digi-Matte adjustment.

**STEP 1** Connect signal to key input and enable Digi-Matte function.

**STEP 2** Use ADO key output to key switcher video.

- STEP 3 Look at keyhole edges on picture monitor.
- STEP 4 Highlight **KEY IN H PHASE A/B** on setup menu. Use joystick to adjust phase so that window and key video edges are aligned.
- STEP 5 Rotate image 180° around the Z axis. Edges should still be aligned. If not, there is a timing problem downstream from the ADO system which must be corrected.

### **3-58 Adjusting Key In Offset**

It is recommended that this adjustment not be used.

### **3-59 Storing Setup Parameters**

Setup parameters can be stored in two ways: in non-volatile internal memory, or on a disk. When stored in memory, the parameters are recalled each time the system is turned on after shutdown. When parameters are stored on a disk, they must be recalled from the disk each time they are needed. Use the following procedures to store parameters:

### **3-60 Storing Setup Parameters in Memory**

- STEP 1 Adjust parameters as required.
- STEP 2 Press STORE EFFECT key. The message, **Hit store again to permanently save engineering parameters** appears at the top of the screen.
- STEP 3 Press STORE EFFECT again to save parameters. (Press RECALL EFFECT key at any time to return to these parameters.)

### **3-61 Saving Setup Parameters on a Disk**

- STEP 1 With a disk inserted in the disk drive, select Setup menu and press MORE twice to bring up the soft key menu that includes **disk store**.
- STEP 2 Press **disk store** soft key.
- STEP 3 Press STORE EFFECT key. The message, **Hit store again to permanently save engineering parameters** appears at the top of the screen. Press STORE EFFECT again. The message, **Enter effect number** appears at the bottom of the screen.

#### **Note**

**You cannot name "setup effects" on the disk; however to differentiate between normal effects and setup effects when you display the effect list, the name "setup parameter" appears in place of the normal effect name, for any setup effect.**

- STEP 4 Enter a number from the keypad.

# ADO

STEP 5 To recall parameters from the disk, press DISK STORE and then RECALL EFFECT. Then enter the setup parameter effect number from the keypad.

## 3-62 DIGI-MATTE ADJUSTMENT

Refer to key input system block diagram, Figure 3-4, and adjust Digi-Matte A and B systems as follows:

- STEP 1 Provide foreground video to ADO A video input.
- STEP 2 Provide externally derived key or Digi-Matte signal to A key input.
- STEP 3 Place ADO in master cleared position.
- STEP 4 Select Key Control menu.
- STEP 5 Change DM Ke from off to A.
- STEP 6 If key signal is black on white (rather than white foreground on black background), switch DM Inv from off to A invert.

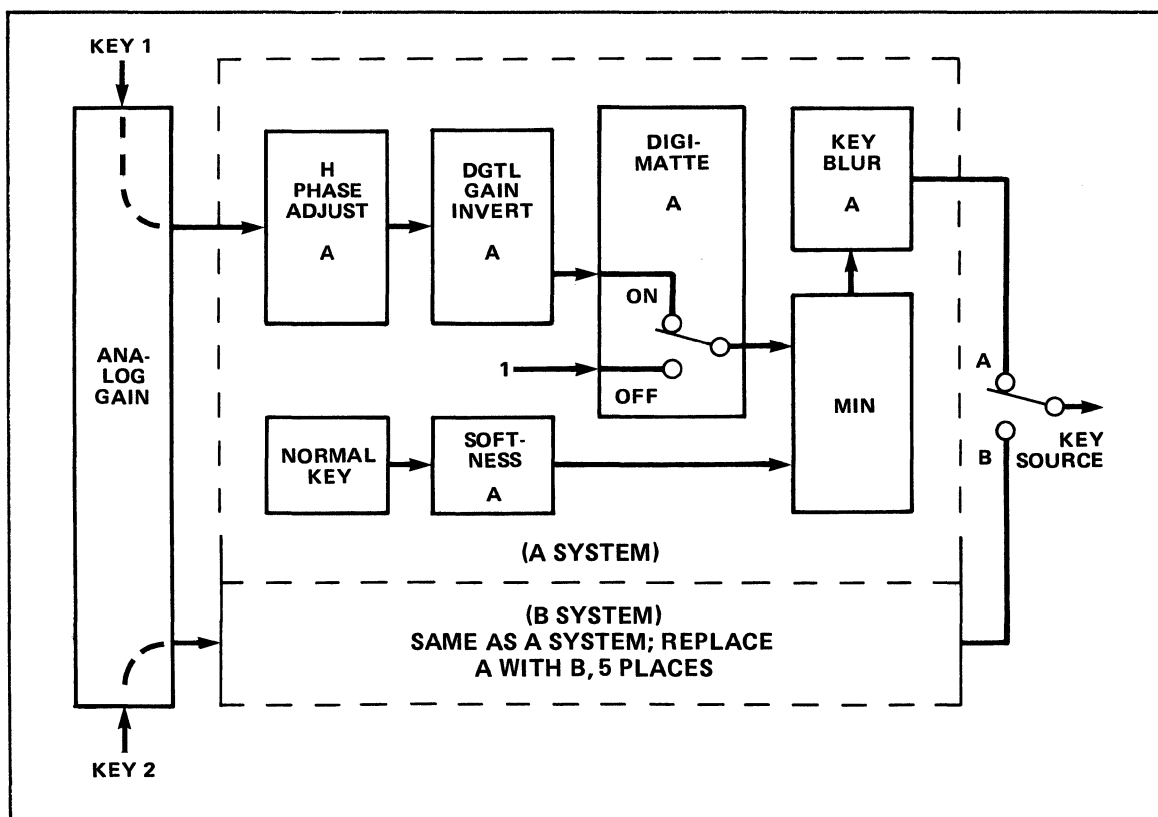

Figure 3-4. Key Input System Block Diagram

- STEP 7 Key the ADO output (using its key signal over a background), either in external switcher or in ADO concentrator.
- STEP 8 In setup mode, adjust key gain (Z axis). Then with Key Control menu selected, adjust A gain (unity, +1, +2), to achieve desired edge softness and to remove foreground print-through and transparency.
- STEP 9 In Setup Mode menu, adjust KEY IN H PHASE for A input to minimize black lines in transition area between foreground and background, in composite image. For best adjustment, expand ADO picture.
- STEP 10 Adjust Digi-Matte B system in similar manner.

### **3-63 AUTOMATIC HORIZONTAL PHASE CORRECTION (AUTO H-PHASE)**

Auto H-phase mode locks output video horizontal sync to house reference horizontal sync, despite variations in input video timing. Correction operates over an input video timing range of 2  $\mu$ s with respect to output video. The correction circuit requires five to seven fields to stabilize timing after an input video timing change. Auto H-phase mode is useful if video sources have timing differences due to their position in the video distribution system, such as upstream or downstream from the switcher. If horizontal phase has been adjusted during setup, the adjustment should be reset so that the timing difference is zero before enabling auto H-phase mode. Otherwise, the correction circuit may not be able to lock input signal timing. Once the system is in auto H-phase mode, the horizontal phase setup control adjusts output video timing with respect to reference video.

#### **Note**

**A and B input signals must be synchronized with each other for proper operation; auto H-phase mode corrects input/reference timing differences.**

The user can choose either manual or automatic H-phase with a switch inside the signal system chassis. This switch is section 8 of S2 on the High Level Controller PWA. When the switch is ON, auto H-phase is disabled (manual H-phase is enabled); when the switch is OFF, auto H-phase is enabled. The High Level Controller PWA is at the farthest right (slot no. 27) in the signal system chassis (see Table 4-3 in the ADO Service Manual, Catalog No. 1809550-03). Turn off power and remove the High Level Controller PWA from its slot. Two switches are mounted on this PWA, both near the edge connector at the back of the board. S2 is the one nearer the corner. Section 8 is marked on the switch, as are the ON and OFF positions.

### **3-64 HIGH LEVEL CONTROLLER/CONTROL PROCESSOR SWITCH SETTINGS**

Both High Level Controller and Control Processor PWAs have switches which control operating parameters. Tables 3-1, 3-2, and 3-3 list switches and settings for various functions.

**Table 3-1. Control Processor PWA Switch S1**

Switch Section	Function																																								
1	Not used																																								
2	ON: PAL OFF: NTSC																																								
3 through 5	Control panel ID (see below)																																								
	<table border="1"> <thead> <tr> <th>ID No.</th> <th colspan="3">Section</th> </tr> <tr> <td></td> <th>3</th> <th>4</th> <th>5</th> </tr> </thead> <tbody> <tr> <td>0</td> <td>ON</td> <td>ON</td> <td>ON</td> </tr> <tr> <td>1</td> <td>OFF</td> <td>ON</td> <td>ON</td> </tr> <tr> <td>2</td> <td>ON</td> <td>OFF</td> <td>ON</td> </tr> <tr> <td>3</td> <td>OFF</td> <td>OFF</td> <td>ON</td> </tr> <tr> <td>4</td> <td>ON</td> <td>ON</td> <td>OFF</td> </tr> <tr> <td>5</td> <td>OFF</td> <td>ON</td> <td>OFF</td> </tr> <tr> <td>6</td> <td>ON</td> <td>OFF</td> <td>OFF</td> </tr> <tr> <td>7</td> <td>OFF</td> <td>OFF</td> <td>OFF</td> </tr> </tbody> </table>	ID No.	Section				3	4	5	0	ON	ON	ON	1	OFF	ON	ON	2	ON	OFF	ON	3	OFF	OFF	ON	4	ON	ON	OFF	5	OFF	ON	OFF	6	ON	OFF	OFF	7	OFF	OFF	OFF
ID No.	Section																																								
	3	4	5																																						
0	ON	ON	ON																																						
1	OFF	ON	ON																																						
2	ON	OFF	ON																																						
3	OFF	OFF	ON																																						
4	ON	ON	OFF																																						
5	OFF	ON	OFF																																						
6	ON	OFF	OFF																																						
7	OFF	OFF	OFF																																						
6 through 8	Not used																																								

**Table 3-2. High Level Controller PWA Switch S1**

Switch Section	Function	Switch Section	Function
1	Not used	5	Not used
2	Not used	6	Not used
3	ON: rotation OFF: no rotation	7	ON: Digi-Matte OFF: no Digi-Matte
4	ON: perspective OFF: no perspective	8	ON: IVP OFF: no IVP

**Table 3-3. High Level Controller PWA Switch S2**

Switch Section	Function	Switch Section	Function
1	Maintenance port baud rate ON: 9600 baud OFF: 2400 baud	5	High-level controller auto-release ON: no auto-release OFF: auto-release*
2	Not used	6	ON: NTSC OFF: PAL
3	ON: V5 key processor OFF: no V5 key processor	7	ON: no concentrator** OFF: concentrator
4	ON: no chan ID OFF: chan ID	8	ON: no auto H-phase*** OFF: auto H-phase
<p>* When auto-release function is enabled, the high-level controller releases from the control unit which acquired it, if communication between controller and control unit has failed.</p> <p>** If a concentrator is not installed in the system, this switch section must be set to the ON position to allow normal setup mode.</p> <p>*** Should be in no auto H-phase if a concentrator is installed, as the concentrator takes over the auto H-phase function.</p>			

**3-65 ERROR MESSAGES**

Error messages are displayed on the control panel monitor. Table 3-4 lists these messages, and remarks.

**Table 3-4. Control Panel Error Messages**

Messages	Remarks
<b>Bad data on disk</b>	Disk problem. Salvage effects and replace disk.
<b>Bad data on disk: seek errors</b>	Disk problem. Salvage effects and replace disk.
<b>Bad disk, cannot write</b>	Disk problem. Salvage effects and replace disk.
<b>Can't store setups on old disk</b>	Format new disk and use it.
<b>Crc or record-not-found error</b>	Disk problem. Salvage effects and replace disk.

(Continued next page)

# ADO

**Table 3-4. Control Panel Error Messages (Continued)**

Messages	Remarks
<b>Can only own one channel for single-chan</b>	Attempted to acquire second channel when in single channel mode.
<b>Channel already acquired</b>	Already own the channel; acquire another channel.
<b>Channel is busy</b>	Channel was acquired by another control panel. (Or data communication error.)
<b>Channel is dead</b>	Either tried to acquire dead channel or channel already acquired failed or was disconnected.
<b>Disk error on read</b>	Disk problem. Salvage effects and replace disk.
<b>Disk error on write, try again</b>	Disk problem. After trying again, salvage effects and replace disk.
<b>Disk: bad keyframe count</b>	Disk problem. Salvage effects and replace disk.
<b>Eerom write failure</b>	EEROM or support circuit failure. Contact Ampex Field Engineer.
<b>Effect exists - hit "enter" to overwrite.</b>	Attempted to store effect on disk where one already existed; push ENTER to overwrite existing effect.
<b>Effect not found</b>	Effect not on disk.
<b>Sys error in getfree</b>	Contact Ampex Field Engineer.
<b>Hit format again to reformat: effects will be lost</b>	Reminder to push <b>format disk</b> again.
<b>Hit store again to permanently save engineering parameters</b>	Reminder to push STORE again.
<b>Insert disk and close door</b>	Reminder that disk is not in.
<b>Last keyframe has no duration</b>	Reminder that you can't enter a duration for the last keyframe.
<b>No setups on old style disk</b>	Attempted to recall setups from old format disk; can't do this.
<b>Not enough space on disk</b>	Use another disk.
<b>Name truncated, length exceeded</b>	Use name as truncated or use shorter name.
<b>No stored parameters</b>	Attempted to get setup parameters from empty EEPROM; reset parameters and store in EEPROM.
<b>Sys error: fd-npad less than 0</b>	Disk problem. Salvage effects and replace disk.
<b>Sys error: wrong sector size</b>	Disk problem. Salvage effects and replace disk.

(Continued next page)



**Table 3-4. Control Panel Error Messages (Continued)**

Messages	Remarks
<p><b>Hit prog and select a local channel first</b></p> <p><b>Setup effect-hit "enter" to overwrite</b></p> <p><b>That is a setup effect!</b></p> <p><b>That is not a setup effect!</b></p> <p><b>Write to old disk</b></p> <p><b>Sys error in eerom</b></p> <p><b>CHANGED FROM GLOBAL TO CHANNEL 1</b></p>	<p>Attempted an illegal mode change.</p> <p>Push ENTER to overwrite existing effect</p> <p>Attempted to recall normal effect, but got setup effect.</p> <p>Attempted to recall setup effect, but got other effect.</p> <p>Attempted to write to old-format disk (version 3 or earlier); can't do this.</p> <p>Contact Ampex Field Engineer.</p> <p>Attempted to use a soft key that is inoperative in global mode (although appearing on menu). Machine automatically switched out of global mode.</p>



**APPENDIX****CONSTRUCTION OF SOLIDS USING ADO MULTICHANNEL SOFTWARE**

Ampex Corporation, Redwood City, CA

**ABSTRACT**

With the introduction of multichannel software it has become possible to construct a certain class of three dimensional solids. This paper gives a systematic way to construct a general member of this family and program some unique effects.

**1. GENERAL SOLID DEFINITION AND INITIAL ORIENTATION**

In general the solid has six degrees of freedom, three angles and three linear dimensions:

$$\theta_1, \theta_2, \theta_3 \quad h_1, h_2, h_3$$

See Figure A-1.

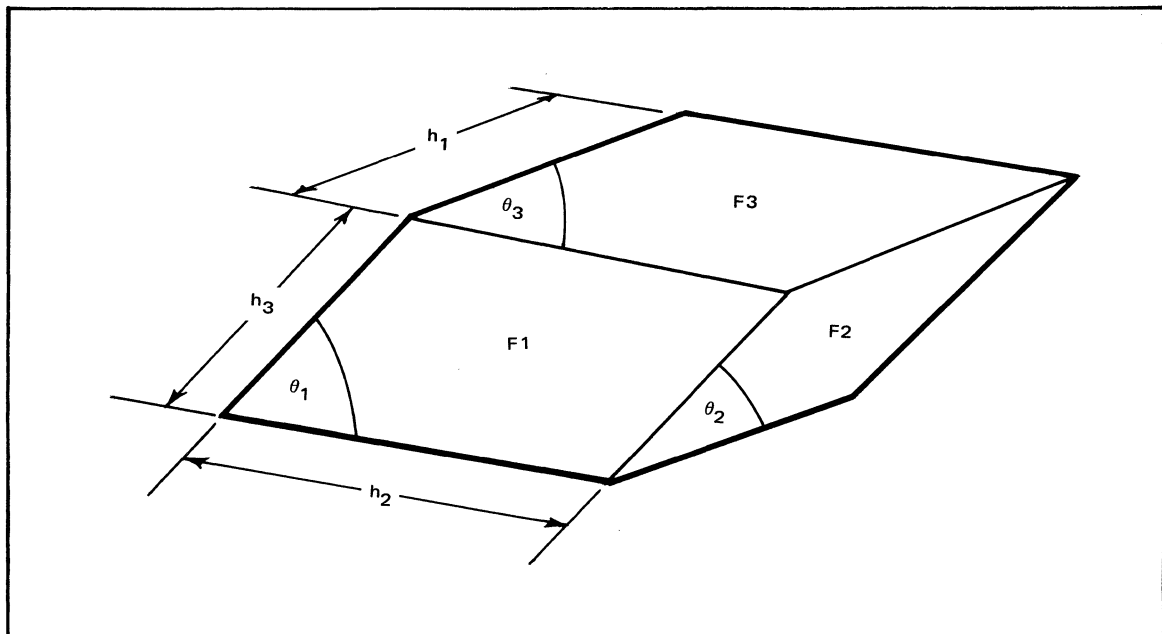

**Figure A-1. Solid Definition**

# ADO

We define the three visible faces as F1, F2, F3, and their opposing hidden faces as HF1, HF2, and HF3. Each face is a parallelogram and opposing faces are alike and separated in space by a simple 3-D translation. This relationship between two opposing faces allows ADO's auto cube mode to generate the optical effect of a closed solid object.

For any two opposing faces there will be a plane midway between the two and parallel to both. There will be three such planes and these will intersect at a point called the center of solid. This point is denoted by C in Figure A-2.

Initially the solid is oriented so that:

- C is at the system origin.
- F3 is parallel to the XZ plane.
- The line of intersection of F1 and F3 is parallel to the X axis.

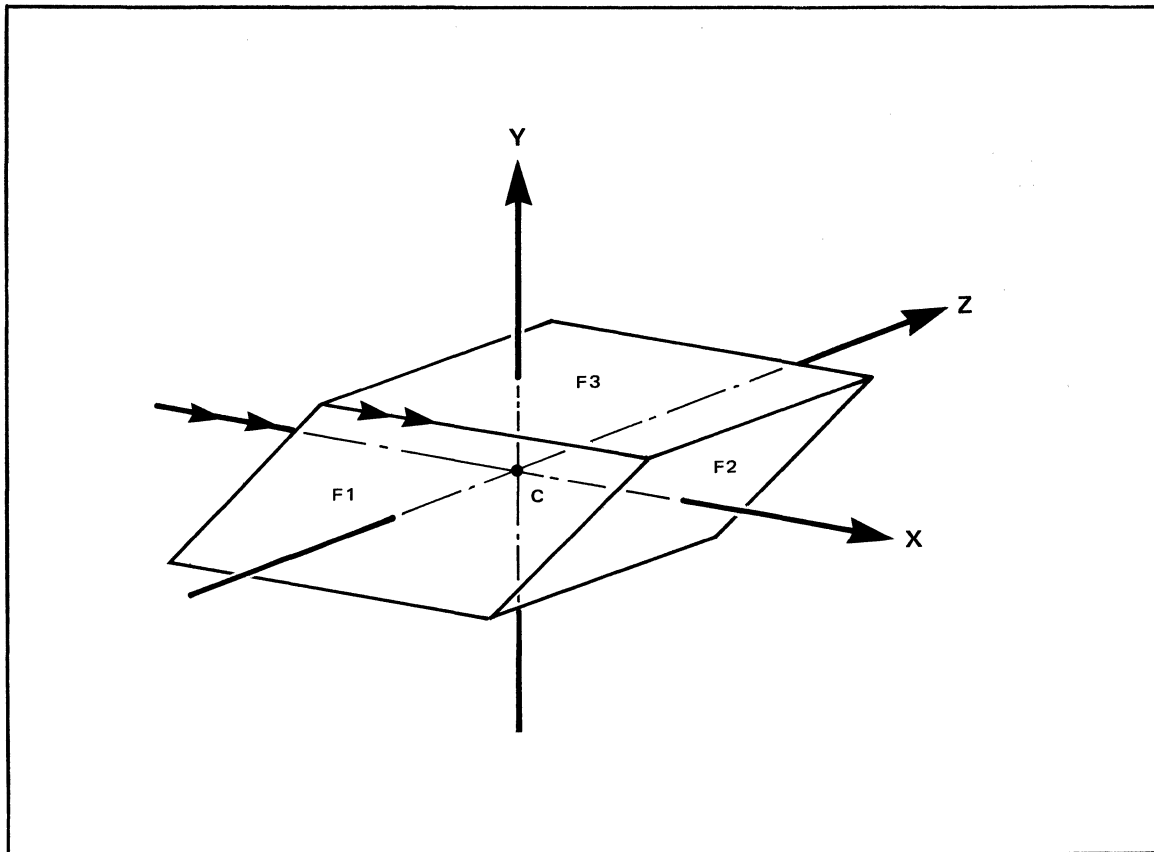

Figure A-2. Initial Orientation

## 2. PARAMETER FORMULAS

The following mathematical formulas are given for the general case. Only parameter values that change are given. The first step is to generate appropriate

dimensions for each face. See Figure A-3. To produce the dimensions indicated in this figure, one or several of the following parameters should be used:

- LT and BR crops
- Aspect
- Source size

The following two angles should be calculated, to be used in the various formulas. Note that all angles are in degrees.

$$\varphi_1 = \cos^{-1} \left\{ \left[ \frac{\cos\theta_1}{\sin\theta_1} \right] \left[ \frac{\cos\theta_2}{\cos\theta_1 \sin\theta_3} - \frac{1}{\tan\theta_3} \right] \right\}$$

$$\varphi_2 = \cos^{-1} \left\{ \left[ \frac{\cos\theta_2}{\sin\theta_2} \right] \left[ \frac{\cos\theta_1}{\cos\theta_2 \sin\theta_3} - \frac{1}{\tan\theta_3} \right] \right\}$$

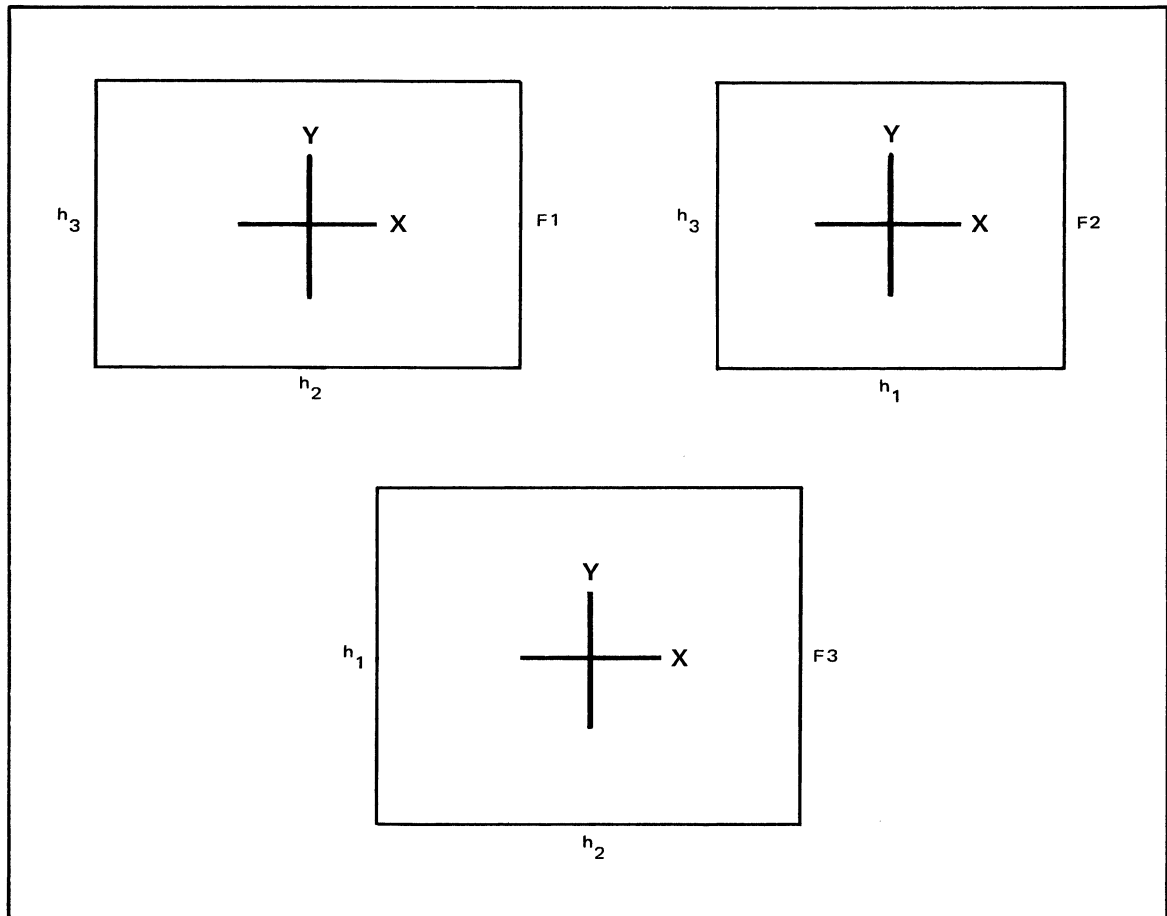

**Figure A-3. Facial Dimensions**

# ADO

## 2-1. Face 1 Parameters

$$\begin{array}{l}
 \text{skew} = \left[ \frac{90 - \Theta_1}{360} \right] \\
 \text{X-axis} = + \frac{h_1}{2} \left[ \frac{\sin \Theta_3 \cos \varphi_1}{\tan \Theta_1} - \cos \Theta_3 \right] \\
 \text{Y-axis} = - \frac{h_1}{2} \left[ \frac{\sin \Theta_3 \cos \varphi_1}{\sin \Theta_1} \right]
 \end{array}
 \left|
 \begin{array}{l}
 \text{Z-axis} = - \frac{h_1}{2} \left[ \sin \Theta_3 \sin \varphi_1 \right] \\
 \text{Y-rotate} = \left[ \frac{90 - \varphi_1}{360} \right]
 \end{array}
 \right.$$

## 2-2. Face 2 Parameters

$$\begin{array}{l}
 \text{skew} = \left[ \frac{90 - \Theta_2}{360} \right] \\
 \text{X-axis} = - \frac{h_2}{2} \left[ \frac{\sin \Theta_3 \cos \varphi_2}{\tan \Theta_2} - \cos \Theta_3 \right] \\
 \text{Y-axis} = \frac{h_2}{2} \left[ \frac{\sin \Theta_3 \cos \varphi_2}{\sin \Theta_2} \right]
 \end{array}
 \left|
 \begin{array}{l}
 \text{Z-axis} = - \frac{h_2}{2} \left[ \sin \Theta_3 \sin \varphi_2 \right] \\
 \text{X-rotate} = \left[ \frac{\Theta_3}{360} \right] \\
 \text{Y-rotate} = - \left[ \frac{90 - \varphi_2}{360} \right]
 \end{array}
 \right.$$

## 2-3. Face 3 Parameters

$$\begin{array}{l}
 \text{skew} = \left[ \frac{90 - \Theta_3}{360} \right] \\
 \text{X-axis} = \frac{h_3}{2} \cos \Theta_1 \left[ 1 - \frac{\cos \varphi_1 \tan \Theta_1}{\tan \Theta_3} \right] \\
 \text{Y-axis} = \frac{h_3}{2} \left[ \frac{\cos \Theta_1}{\sin \Theta_3} \right] \left[ \frac{\cos \Theta_2}{\cos \Theta_1 \sin \Theta_3} - \frac{1}{\tan \Theta_3} \right]
 \end{array}
 \left|
 \begin{array}{l}
 \text{Z-axis} = - \frac{h_3}{2} \sin \Theta_1 \sin \varphi_1 \\
 \text{Y-rotate} = 0.25
 \end{array}
 \right.$$

**3. ADDITIONAL FORMULAS**

Having used the above parameters to construct the solid, there are additional numerical values useful in producing various effects.

- The perpendicular distance between the faces F3 and HF3,

$$d = h_3 \sin \Theta_2 \sin \varphi_2$$

- The coordinates of the point P shown in Figure A-4 are a, b, c where:

$$a = \frac{1}{2} \left[ h_3 \cos \Theta_1 + h_2 + h_1 \cos \Theta_3 \right] \quad b = \frac{1}{2} \left[ h_3 \sin \Theta_2 \sin \varphi_2 \right]$$

$$c = \frac{1}{2} \left\{ h_3 \cos \Theta_1 \left[ \frac{\cos \Theta_2}{\cos \Theta_1 \sin \Theta_3} - \frac{1}{\tan \Theta_3} \right] + h_1 \sin \Theta_3 \right\}$$

The point P' has coordinates -a,-b,-c.

- The distance between the point P and the center of solid, C. See Figure A-4.

$$D = \sqrt{a^2 + b^2 + c^2}$$

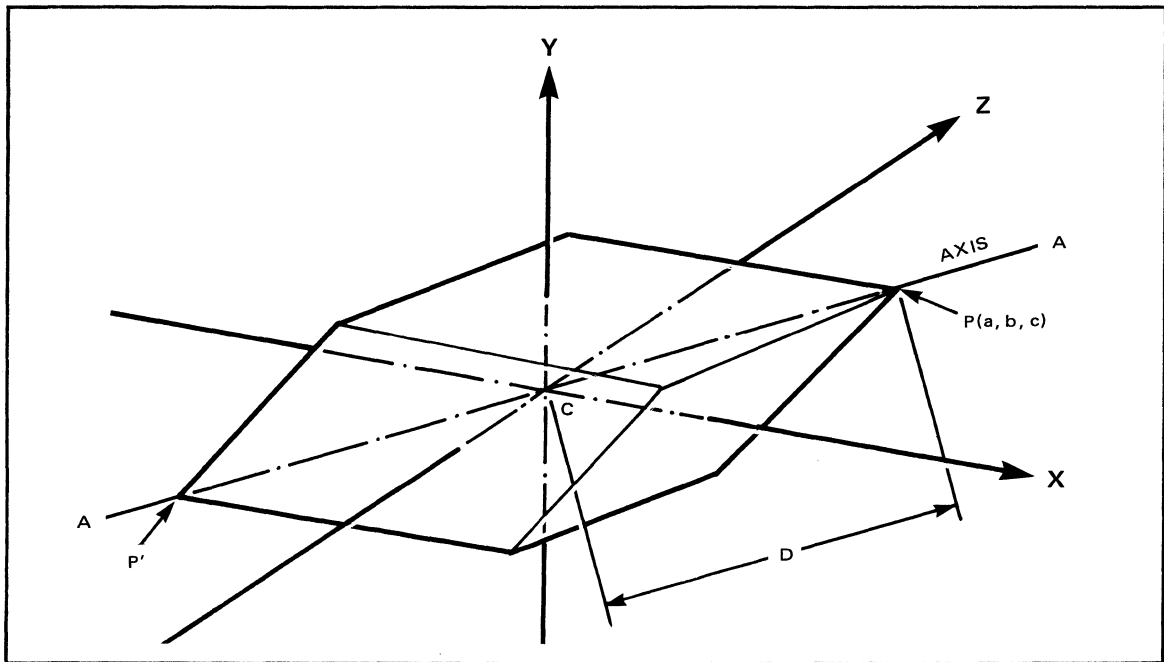
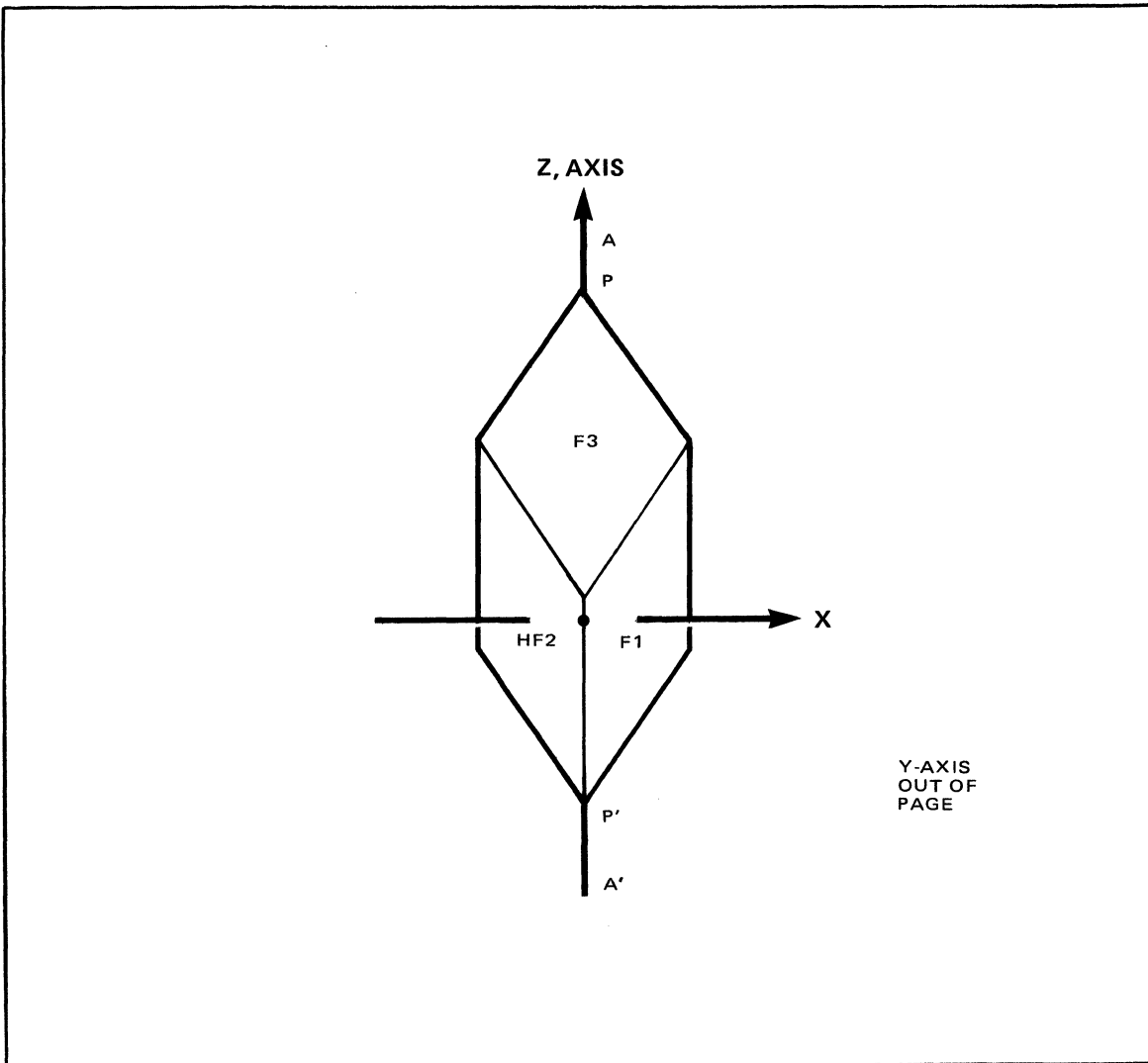

**Figure A-4. Axis**

**4. USEFUL ORIENTATION CHANGES AND EFFECTS**

In Figure A-4 the line AA' is called the axis of the solid and it will pass through points P, P' and C.

It is convenient to change the orientation of the solid so its axis is coincident with the system Z-axis. See Figure A-5. The first step is to increment each local X-rotate so that AA' lies in the YZ plane, then increment each local post-X-rotate so that AA' becomes coincident with the system z-axis.



**Figure A-5. Z-Axis Coincidence**

By doing this we can use the global Z-rotate as a spin control and the global X- and Y-rotates to incline the solid's axis to any inclination in 3-D space. This is possible because the order in which the global rotations are done is z, y, and x. We define:



$\omega$  = Local X-rotate increment.

$\nu$  = Local post X-rotate increment.

where,

$$\omega = \left\{ 0.25 - \left[ \frac{\tan^{-1} \frac{c}{a}}{360} \right] \right\} \quad \nu = \left\{ \frac{\tan^{-1} \left\{ \frac{b}{a} \cos \left[ \tan^{-1} \frac{c}{a} \right] \right\}}{360} \right\}$$

With these additions to the local parameters, the global rotates can be used to orient the solid as shown in Figure A-6.

From this position we can change the global Z-axis to the value D. This will have the effect of translating point P' to the system origin. That is, the solid will appear to have pivoted at the system origin about point P'. By programming suitable values for the global X and Y rotates, the multichannel software will produce a spinning solid which will precess about the Y-axis. See Figure A-7.

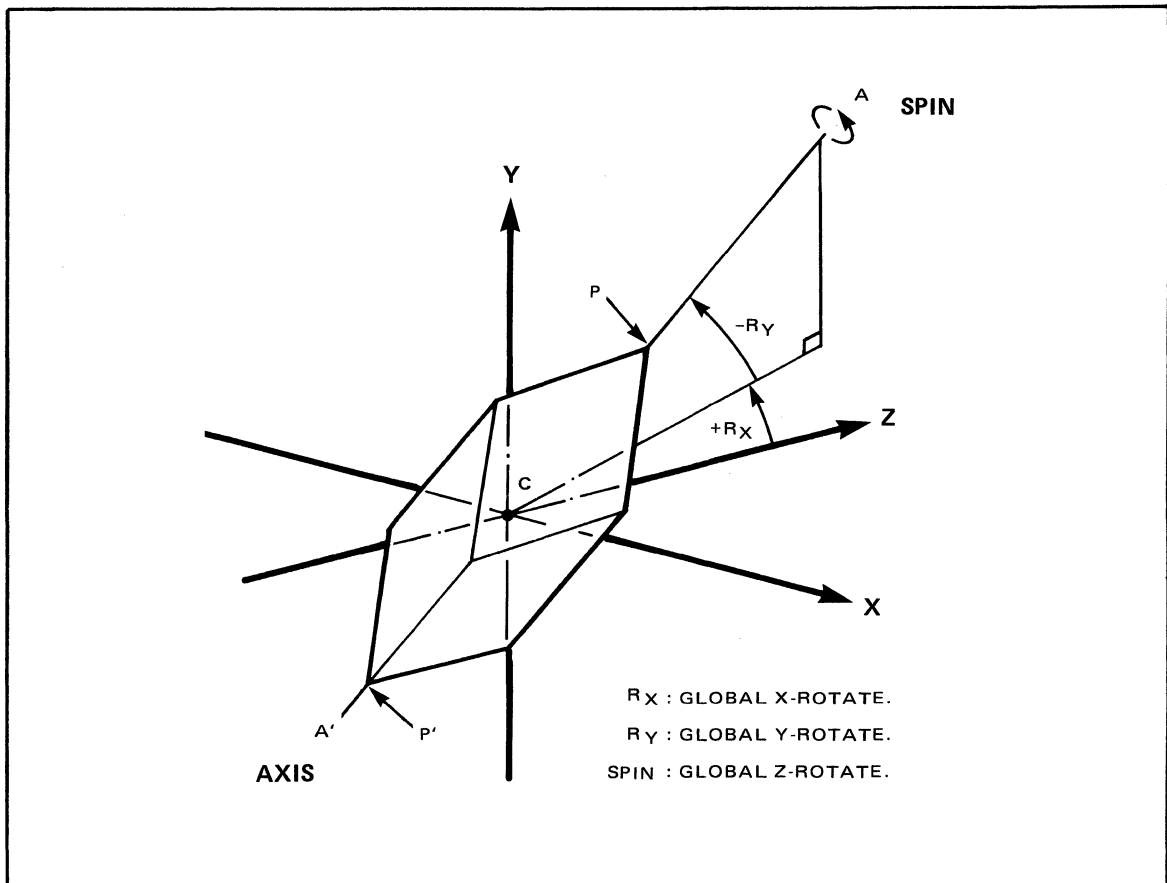

**Figure A-6. Global Rotation**

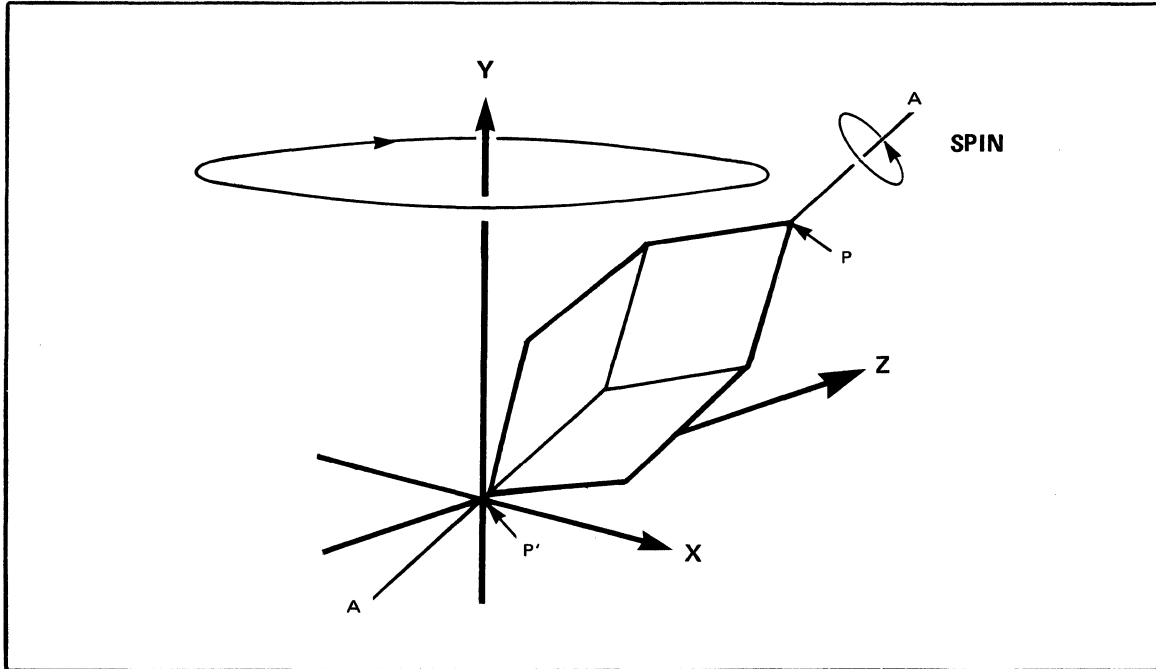

**Figure A-7. Precession**

**5. SPECIFIC EXAMPLE**

It is anticipated that in order to make the generation of such solids a fast and error-free exercise, the operator will use a small programmable calculator or computer. As a means of program verification, a table of known good data for a particular solid is given.

Define Solid

$\Theta_1$	40	degrees	$h_1$	8	units
$\Theta_2$	30	degrees	$h_2$	4	units
$\Theta_3$	50	degrees	$h_3$	6	units

Generate solid as in Figure A-3.

Face	F1	F2	F3
Skew	0.1389	0.1667	0.1111
X-axis	0.1998	-0.1650	1.0704
Y-axis	-3.6172	1.6750	1.9101
Z-axis	-1.9958	-1.2829	-1.2561
X-rotate	0.0000	0.1389	0.0000
Y-rotate	0.1371	-0.0920	0.2500

Orient solid with axis coincident with Z axis as in Figure A-5.

X-Rotate	0.1573	0.2962	0.1573
Post-X	0.0241	0.0241	0.0241

This corresponds to:

$$\omega = 0.1573$$

$$\nu = 0.0241$$

Pivot P' at the origin.

	Globals	
Z-Axis		8.3224
XYZ-Rotates		to suit

This global parameter listing will move P' to be coincident with the system origin. The relevant numerical value used is: D = 8.3224

**Note**

**Use global Z-locate to move the solid so that it can be fully viewed. Parameters to change facial dimensions are not given.**

**6. LIMITATIONS**

The previous mathematical approach should be used with the following two limitations.

- The solid that you try to construct must be physically possible. As a general rule, "the sum of the two lesser angles should be greater than or equal to the largest." For the previous example:

$$30 + 40 > 50$$

When the equality holds, the solid formed has six sides but no volume.

- Problems occur at angles of 0° and 90°, resulting in equations that have division by zero. Ideally we should take a limit, but the easiest solution is to use 89.9999999 for 90 and 0.00000001 for 0.

**7. TRANSITIONS BETWEEN SOLIDS**

Using ADO's splines it is possible to change from one general solid to another. This has the restriction that any angle must not change more than about 10° between keyframes. If this is not done, some breakup of the solid will be seen. This restriction can be greatly relaxed depending on the amount of movement of the solid. For example, any breakup in a solid that is spinning will be disguised by the spinning motion itself.

# ADO

## 8. DEGENERATE SOLIDS

The case of the solid being reduced to having no volume is an example of a degenerate solid. Another example is when the solid reduces to a single line when all angles are zero. Both cases may prove useful start and/or end points for a particular effect.

## 9. OTHER EFFECTS

Two other interesting effects which may be of use are:

- The principle of conservation of angular momentum can be implemented using transitions between two solids. See Figure A-8. This has the same visual effect as an ice-skater; i.e., when skater's arms are pulled in, rotational speed increases.

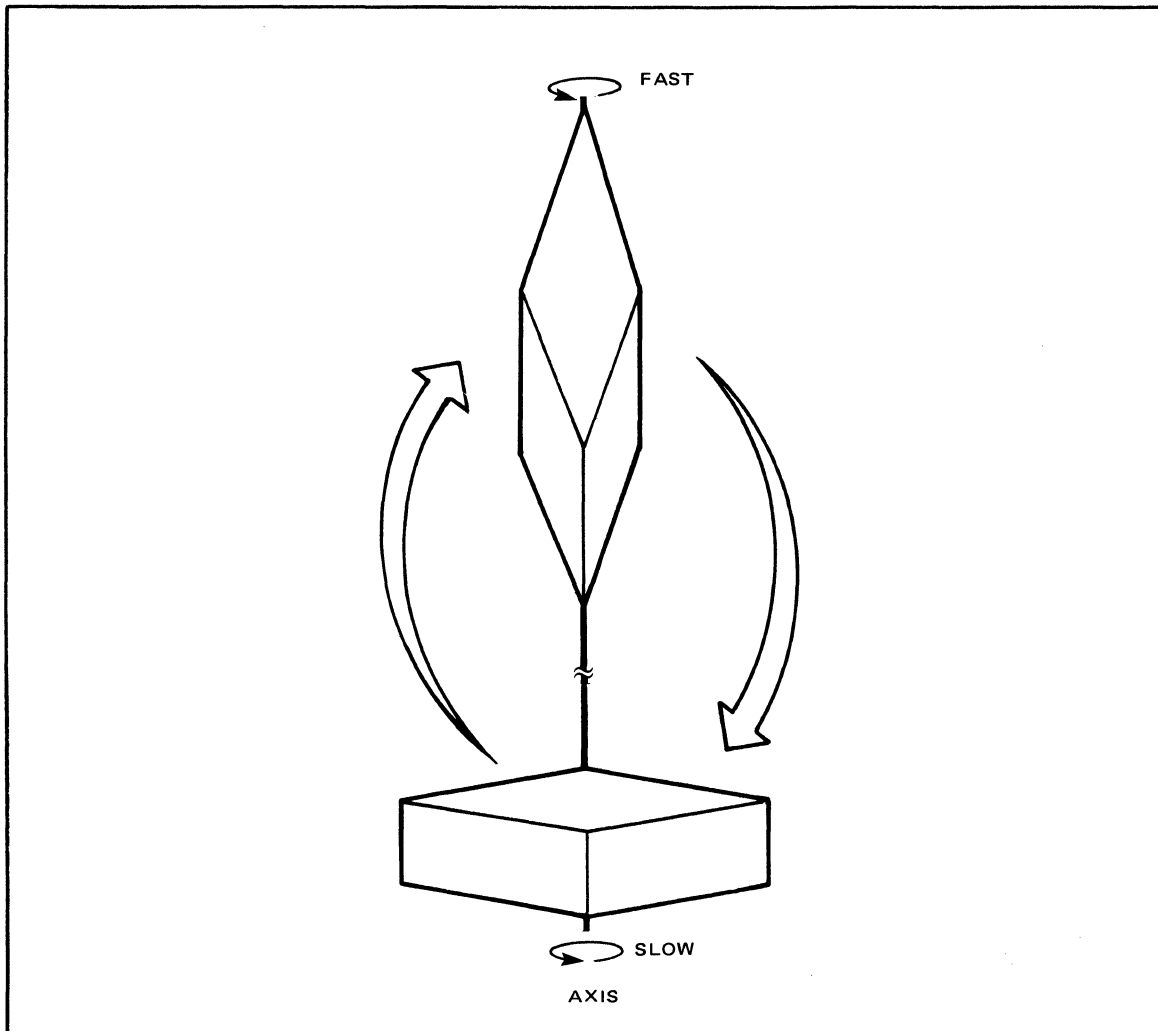
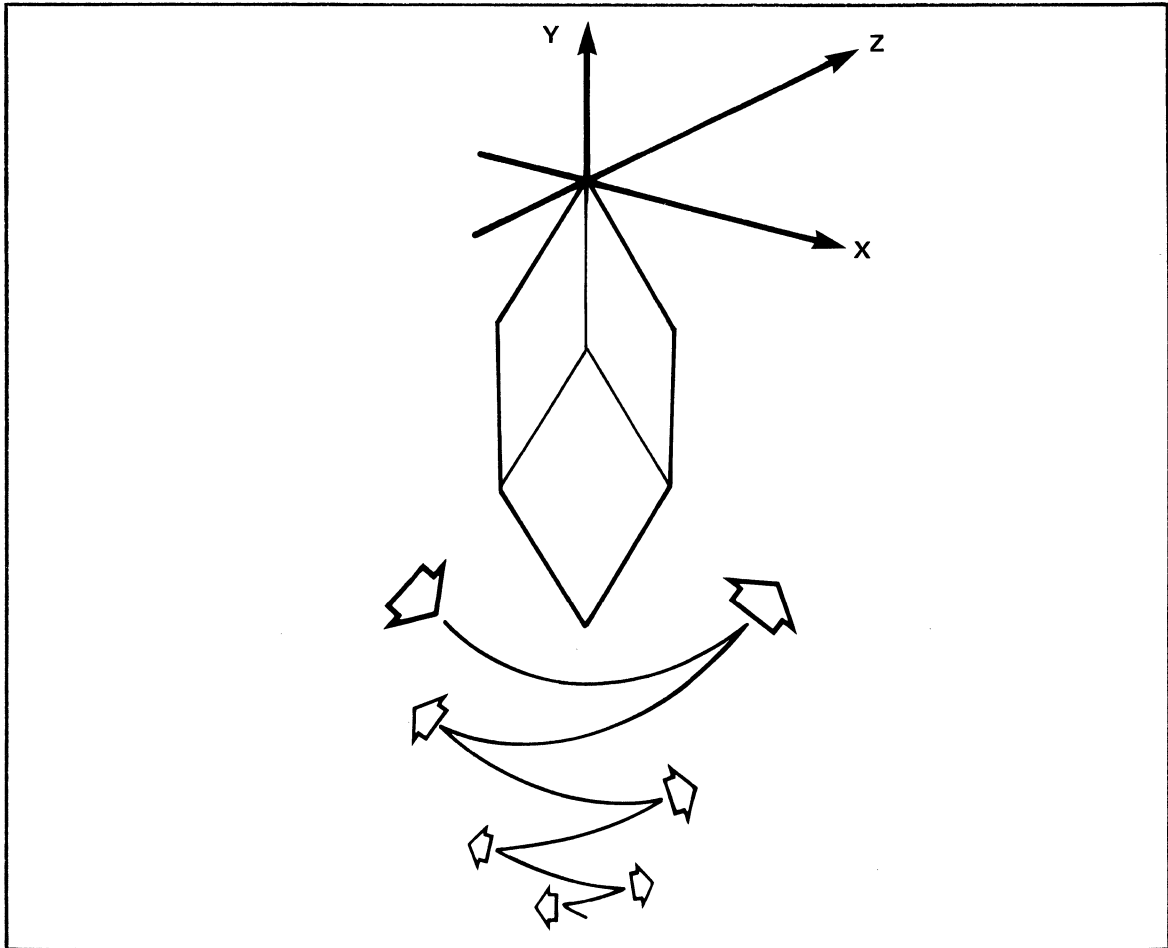

Figure A-8. Ice Skater

- By using the solid pivoted about P', it is possible to make the solid act as a simple pendulum, gradually coming to rest from some start position. See Figure A-9.



**Figure A-9. Pendulum**

**10. RECTANGULAR SOLIDS AND CUBES**

The rectangular solids are a particular sub-class of the general family the has just been described. The cube is a member of this sub-class. All rectangular solids have the following property:

$$\Theta_1 = \Theta_2 = \Theta_3 = 90.$$

Further, the cube has the additional property of:

$$h_1 = h_2 = h_3 = S.....\text{some constant}$$

# ADO

The following parameter listing will generate a general rectangular solid. See Figure A-10. Only parameter values that change are given. Using one or several of the following parameters, the dimensions shown in Figure A-3 should be produced.

- LT and BR crops
- Aspect
- Source size

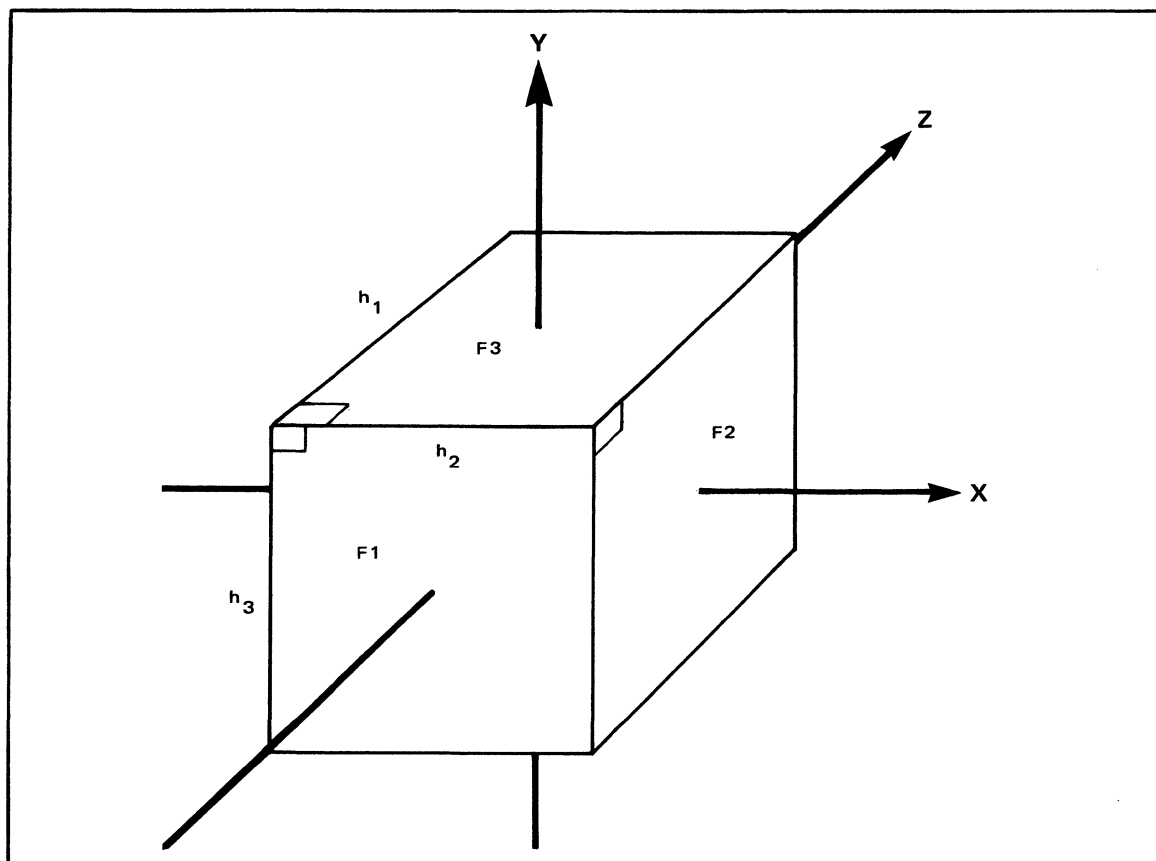

Figure A-10. Rectangular Solid

## 10-1 Face 1 Parameters

$$Z\text{-axis} = - \frac{h_1}{2}$$

## 10-2 Face 2 Parameters

$$Z\text{-axis} = - \frac{h_2}{2} \quad X\text{-rotate} = 0.25$$

**10-3 Face 3 Parameters**

$$Z\text{-axis} = -\frac{h_3}{2}$$

Y-rotate = 0.25

**11. EXAMPLE: THE CUBE**

The following table will generate a cube with sides of six-unit length; i.e., S = 6

Face	F1	F2	F3
L-Crop	-3.0000	-3.0000	-3.0000
R-Crop	3.0000	3.0000	3.0000
Z-Axis	-3.0000	-3.0000	-3.0000
X-Rotate	0.0000	0.2500	0.0000
Y-Rotate	0.0000	0.0000	0.2500

- Left and right crops are used to set the facial dimensions.
- Use global Z-locate to move the cube so it can be fully viewed.

**12. PROGRAM LISTING FOR THE HEWLETT-PACKARD HP-41C/41CV PROGRAMMABLE CALCULATOR**

The following is a list of a program that does the calculations in paragraph 2 of this paper. This listing is for the HP-41 calculator and it adheres to the format used by Hewlett-Packard in their manuals distributed with the HP-41. The program can be adapted for other programmable calculators without trouble.

The HP-41C requires at least one memory module to accommodate the program. Parameters to enter into the CPP are computed and displayed for each of the three faces of the solid. The single digit suffix on a variable name (e.g. YROT2, ZAXS3) indicates which face is being referred to.

**Table A-1. Main Program**

Listing	Comments
01 LBL $\tau$ SOLID	Program Name
02 $\tau$ ANG1	Prompt for angle 1
03 PROMPT	
04 STO 00	Save angle 1
05 $\tau$ ANG2	Prompt for angle 2
06 PROMPT	

(Continued next page)

**Table A-1. Main Program (Continued)**

Listing	Comments
07 STO 01	Save angle 2
08 $\tau$ ANG3	Prompt for angle 3
09 PROMPT	
10 STO 02	Save angle 3
11 $\tau$ DIM1	Prompt for dimension 1
12 PROMPT	
13 STO 03	Save dimension 1
14 $\tau$ DIM2	Prompt for dimension 2
15 PROMPT	
16 STO 04	Save dimension 2
17 $\tau$ DIM3	Prompt for dimension 3
18 PROMPT	
19 STO 05	Save dimension 3
20 0	Setup pointers for $\varphi_1$
21 STO 11	
22 STO 14	
23 1	
24 STO 12	
25 2	
26 STO 13	
27 XEQ $\tau$ PHI	Calculate $\varphi_1$
28 ACOS	
29 STO 06	Save $\varphi_1$ for latter use
30 XEQ $\tau$ SKEW	Calculate skew of face 1
31 $\tau$ SKEW1	Print answer
32 XEQ $\tau$ DIS	Display answer
33 6	Setup pointers for x axis of face 1
34 STO 12	
35 3	

(Continued next page)



**Table A-1. Main Program (Continued)**

Listing	Comments
36 STO 14	
37 XEQ $\tau$ XAXIS	Calculate x axis of face 1
38 $\tau$ XAXS1	
39 XEQ $\tau$ DIS	Display answer
40 XEQ $\tau$ YAXIS	Calculate y axis of face 1
41 $\tau$ YAXS1	
42 CHS	
43 XEQ $\tau$ DIS	Display answer
44 XEQ $\tau$ ZAXIS	Calculate z axis of face 1
45 $\tau$ ZAXS1	Display answer
46 XEQ $\tau$ DIS	
47 6	Setup pointers for y rotation of face 1
48 STO 11	
49 XEQ $\tau$ SKEW	Calculate y rotation
50 $\tau$ YROT1	Display answer
51 XEQ $\tau$ DIS	
52 1	Setup parameters for $\varphi_2$
53 STO 11	
54 STO 14	
55 0	
56 STO 12	
57 XEQ $\tau$ PHI	Calculate $\varphi_2$
58 ACOS	
59 STO 07	Save $\varphi_2$ for later
60 XEQ $\tau$ SKEW	Calculate skew for face 2
61 $\tau$ SKEW2	Display answer
62 7	Setup pointers for x axis of face 2
63 STO 12	

(Continued next page)

**Table A-1. Main Program (Continued)**

Listing	Comments
64 4	
65 STO 14	
66 XEQ $\tau$ XAXIS	Calculate x axis for face 2
67 CHS	
68 $\tau$ XAXS2	Display 2
69 XEQ $\tau$ DIS	
70 XEQ $\tau$ YAXIS	Calculate y axis for face 2
71 $\tau$ YAXS2	Display answer
72 XEQ $\tau$ DIS	
73 XEQ $\tau$ ZAXIS	Calculate z axis for face 2
74 $\tau$ ZAXS2	Display answer
75 XEQ $\tau$ DIS	
76 RCL 02	Calculate x rotation for face 2
77 360	
78 /	
79 $\tau$ XROT2	Display answer
80 XEQ $\tau$ DIS	
81 7	Setup pointers for y rotation of face 2
82 STO 11	
83 XEQ $\tau$ SKEW	Calculate y rotation for face 2
84 CHS	
85 $\tau$ YROT2	Display answer
86 XEQ $\tau$ DIS	
87 2	Setup pointers for skew of face 3
88 STO 11	
89 XEQ $\tau$ SKEW	Calculate skew for face 3
90 $\tau$ SKEW3	Display answer
91 1	Calculate x axis of face 3

(Continued next page)

**Table A-1. Main Program (Continued)**

Listing	Comments
92 RCL 00	
93 TAN	
94 RCL 06	
95 COS	
96 *	
97 RCL 02	
98 TAN	
99 /	
100 -	
101 RCL 00	
102 COS	
103 *	
104 RCL 05	
105 *	
106 2	
107 /	
108 $\tau$ XAXS3	Display answer
109 XEQ $\tau$ DIS	
110 0	Setup pointers for y axis of face 3
111 STO 11	
112 1	
113 STO 12	
114 2	
115 STO 14	
116 XEQ $\tau$ PHI	Calculate y axis for face 3
117 RCL 05	
118 *	
119 2	
120 /	

(Continued next page)

# ADO

Table A-1. Main Program (Continued)

Listing	Comments
121 $\tau$ YAXS3	Display answer
122 0	Setup pointers for z axis of face 3
123 STO 12	
124 6	
125 STO 13	
126 5	
127 STO 14	
128 XEQ ZAXIS	Calculate z axis for face 3
129 $\tau$ ZAXS3	Display answer
130 .25	
131 $\tau$ YROT3	Display y rotation for face 3
132 XEQ $\tau$ DIS	
133 END	

Table A-2. Subroutine DIS

Listing	Comments
01 LBL $\tau$ DIS	This routine displays the answers
02 10000	Round off to four decimal places
03 *	
04 INT	
05 10000	
06 /	
07 ARCL X	Append X register into the Alpha register
08 PROMPT	Display answer
09 END	

**Table A-3. Subroutine PHI**

Listing	Comments
01 LBL $\tau$ PHI 02 RCL IND 12	This subroutine does the equation:
03 COS 04 RCL IND 11 05 COS 06 /	$\frac{\cos\vartheta_a}{\sin\vartheta_d} \left[ \frac{\cos\vartheta_b}{\cos\vartheta_a \sin\vartheta_c} - \frac{1}{\tan\vartheta_c} \right]$
07 RCL IND 13 08 SIN 09 /	Where:
10 RCL IND 13 11 TAN 12 1/X 13 -	$\vartheta_a$ is pointed to by register 11 $\vartheta_b$ is pointed to by register 12 $\vartheta_c$ is pointed to by register 13 $\vartheta_d$ is pointed to by register 14
14 RCL IND 11 15 COS 16 RCL IND 14 17 SIN 18 /	
19 * 20 END	

**Table A-4. Subroutine Skew**

Listing	Comments
01 LBL $\tau$ SKEW 02 90 03 RCL IND 11 04 -	This subroutine does the equation:
05 360 07 /	$\frac{90 - \vartheta_a}{360}$
08 END	Where:
	$\vartheta_a$ is pointed to by register 11

# ADO

**Table A-5. Subroutine X-Axis**

Listing	Comments
01 LBL $\tau$ XAXIS 02 RCL IND 13 03 SIN 04 RCL IND 12 05 COS 06 * 07 RCL IND 11 08 TAN 09 / 10 RCL IND 13 11 COS 12 - 13 RCL IND 14 14 * 15 2 16 / 17 END	<p>This subroutine does the equation:</p> $\frac{h_d}{2} \frac{\sin\vartheta_c \cos\vartheta_b}{\tan\vartheta_a} - \cos\vartheta_c$ <p>Where:</p> <p><math>\vartheta_a</math> is pointed to by register 11  <math>\vartheta_b</math> is pointed to by register 12  <math>\vartheta_c</math> is pointed to by register 13  <math>h_d</math> is pointed to by register 14</p>

**Table A-6. Subroutine Y-Axis**

Listing	Comments
01 LBL $\tau$ YAXIS 02 RCL IND 13 03 SIN 04 RCL IND 12 05 COS 06 * 07 RCL IND 11 08 SIN 09 / 10 RCL IND 14 11 * 12 2 13 / 14 END	<p>This subroutine does the equation:</p> $\frac{h_d}{2} \frac{\sin\vartheta_c \cos\vartheta_b}{\sin\vartheta_a}$ <p>Where:</p> <p><math>\vartheta_a</math> is pointed to by register 11  <math>\vartheta_b</math> is pointed to by register 12  <math>\vartheta_c</math> is pointed to by register 13  <math>h_d</math> is pointed to by register 14</p>

Table A-7. Subroutine Z-Axis

Listing	Comments
01 LBL <sup>T</sup> ZAXIS	This subroutine does the equation:  $\frac{h_d}{2} \sin\vartheta_c \sin\vartheta_b$  Where:  $\vartheta_b$ is pointed to by register 12 $\vartheta_c$ is pointed to by register 13 $h_d$ is pointed to by register 14
02 RCL IND 13	
03 SIN	
04 RCL IND 12	
05 SIN	
06 *	
07 RCL IND 14	
08 *	
09 2	
10 /	
11 CHS	
12 END	

13. MICROSOFT BASIC PROGRAM FOR ADO FACE PARAMETERS

The following Microsoft Basic program (Table A-8) performs the calculations of paragraph 2 of this appendix.

Table A-8. Microsoft Basic V5.2 Program

```

100 REM *****
110 REM *
120 REM *          ADO FACE PARAMETER CALCULATION PROGRAM
130 REM *
140 REM * Translated from Appendix A of the ADO Operators Guide
150 REM *
160 REM * This program calculates the parameters for a six sided object with
170 REM * parallel sides.
180 REM *
190 REM * Written in MicroSoft Basic V5.2
200 REM *
210 REM *****
220 DIM POSTY<3>, HEIGHT<3>, FANGLE<3>, SIZE<3>, RADIAN<3>, FDSPLY#<3>
230 DIM XMOD<3>, XROT<3>, YROT<3>, ZROT<3>, SKEW<3>, XAXIS<3>, YAXIS<3>
240 DIM TCROP<3>, BCROP<3>, LCROP<3>, RCROP<3>, XASPECT<3>, YASPECT<3>
250 DIM ZAXIS<3>
260 POSTY<1> = 0 : POSTY<2> = 0 : POSTY<3> = 0
270 DEFDBL A-H : DEFDBL K-Z : DEFINT I-J
280 PI = 3.141592653589796#
290 PI2 = 2# * PI
300 FDSPLY#<1> = " ONE "
310 FDSPLY#<2> = " TWO "
320 FDSPLY#<3> = "THREE"
330 REM
340 REM ***** DATA INPUT SECTION *****
350 REM
360 PRINT CHR$(26) : REM Clear terminal screen
370 REM
380 INPUT "          Effect Name: " , EFFECT# : PRINT
390 INPUT "          Face One Height (H3): " , HEIGHT<3>
    
```

(Continued next page)

**Table A-8. Microsoft Basic V5.2 Program (Continued)**

```

400 INPUT "          Face One Width (H2): " , HEIGHT(2)
410 INPUT "          Face Two Width (H1): " , HEIGHT(1) : PRINT
420 REM
430 REM Size and Aspect values will default to 1.0000 if no parameter is
440 REM entered in that parameter
450 REM
460 INPUT " Bottom left angle of Face One: " , FANGLE(1)
470 INPUT " Bottom left angle of Face Two: " , FANGLE(2)
480 INPUT "Bottom left angle of Face Three: " , FANGLE(3) : PRINT
490 REM
500 INPUT "          Face One Source Size: " , SIZE(1)
510 INPUT "          Face Two Source Size: " , SIZE(2)
520 INPUT "          Face Three Source Size: " , SIZE(3) : PRINT
530 REM
540 INPUT "          Face One X Aspect: " , XASP(1)
550 INPUT "          Face Two X Aspect: " , XASP(2)
560 INPUT "          Face Three X Aspect: " , XASP(3) : PRINT
570 REM
580 INPUT "          Face One Y Aspect: " , YASP(1)
590 INPUT "          Face Two Y Aspect: " , YASP(2)
600 INPUT "          Face Three Y Aspect: " , YASP(3) : PRINT
610 REM
620 REM Set the default conditions if a parameter was not entered in the
630 REM Face Size or Aspect parameters
640 REM
650 FOR I = 1 TO 3
660 IF SIZE(I) = 0 THEN SIZE(I) = 1
670 IF XASP(I) = 0 THEN XASP(I) = 1
680 IF YASP(I) = 0 THEN YASP(I) = 1
690 NEXT I
700 REM
710 REM If the angles are 90 degrees subtract .00001 degrees or if the angle
720 REM is 0 degrees add .00001 degrees to prevent the math from blowing up at
730 REM these two points
740 REM
750 FOR I = 1 TO 3
760 IF FANGLE(I) = 90 THEN FANGLE(I) = 89.99999000000000#
770 IF FANGLE(I) = 0 THEN FANGLE(I) = .00001#
780 NEXT I
790 REM
800 REM ***** ANGLE CONVERSION *****
810 REM
820 REM          Degree to Radian conversion
830 REM Microsoft Basic uses radians for angles in the trig functions
840 REM
850 REM 2 * PI RADIANS = 360 DEGREES
860 REM
870 FOR I = 1 TO 3 : RADIAN(I) = PI * FANGLE(I) / 180 : NEXT I
880 A11 = RADIAN(1) : A14 = RADIAN(1) : A12 = RADIAN(2) : A13 = RADIAN(3)
890 GOSUB 2240 : APhi1 = APhi
900 REM
910 REM ***** FACE 1 CALCULATIONS *****
920 REM
930 GOSUB 2040 : SKEW(1) = SKEW
940 A12 = APhi1 : A14 = HEIGHT(1) : GOSUB 2090 : XAXIS(1) = XAXIS / SIZE(1)
950 GOSUB 2140 : YAXIS(1) = - YAXIS / SIZE(1)
960 GOSUB 2190 : ZAXIS(1) = ZAXIS
970 A11 = APhi1 : GOSUB 2040 : YROT(1) = SKEW
980 A11 = RADIAN(2) : A14 = RADIAN(2) : A12 = RADIAN(1)
990 GOSUB 2240 : APhi2 = APhi
1000 REM
1010 REM ***** FACE 2 CALCULATIONS *****
1020 REM

```

(Continued next page)



Table A-8. Microsoft Basic V5.2 Program (Continued)

```

1030 GOSUB 2040 : SKEW(2) = SKEW
1040 A12 = APHI2 : A14 = HEIGHT(2) : GOSUB 2090 : XAXIS(2) = - XAXIS / SIZE(2)
1050 GOSUB 2140 : YAXIS(2) = YAXIS / SIZE(2)
1060 GOSUB 2190 : ZAXIS(2) = ZAXIS
1070 XROT(2) = FANGLE(3) / 360
1080 A11 = APHI2 : GOSUB 2040 : YROT(2) = - SKEW
1090 REM
1100 REM ***** FACE 3 CALCULATIONS *****
1110 REM
1120 SIZE = SSIZE3 : A11 = RADIAN(3) : GOSUB 2040 : SKEW(3) = SKEW
1130 XAXIS(3) = COS(RADIAN(1)) * (1 - (COS(APHI1) * TAN(RADIAN(1))) / TAN(RADIAN(3)))
1140 YAXIS(3) = (HEIGHT(3) * XAXIS(3) * .5) / SIZE(3)
1150 A11 = RADIAN(1) : A12 = RADIAN(2) : A14 = RADIAN(3) : GOSUB 2240
1160 YAXIS(3) = HEIGHT(3) * .5 * PHI / SIZE(3)
1170 A12 = RADIAN(1) : A13 = APHI1 : A14 = HEIGHT(3)
1180 GOSUB 2190 : ZAXIS(3) = ZAXIS
1190 YROT(3) = .25
1200 REM
1210 REM Calculate the image crops.
1220 REM
1230 GOSUB 2560
1240 REM
1250 REM ***** Display and Print Controls *****
1260 REM
1270 REM The display will ask if axis shifted values are desired. If yes,
1280 REM then the shifted values only will be displayed. If no, then the
1290 REM values for an unshifted solid only will be displayed.
1300 REM
1310 PRINT : PRINT TAB(10) :
1320 INPUT : "Do you want axis shifted parameters (RETURN = no)? " : CHK$
1330 CHK$ = LEFT$(CHK$,1)
1340 IF CHK$ <> "Y" AND CHK$ <> "y" GOTO 1480
1350 GOSUB 2340 : REM calculate the shifted parameters
1360 GOSUB 4530 : REM print the parameters
1370 GOSUB 4660 : REM print the Global parameters
1380 INPUT "Do you want to print the results (RETURN = no)" : CHK$
1390 CHK$ = LEFT$(CHK$,1)
1400 IF CHK$ <> "Y" AND CHK$ <> "y" THEN GOTO 1580
1410 LPRINT TAB(40 - LEN(EFFECT$) / 2) : EFFECT$ : LPRINT
1420 FOR IFACE = 1 TO 3
1430 GOSUB 3110 : REM Print a face of calculations
1440 NEXT IFACE
1450 GOSUB 5070 : REM Print Face input parameters
1460 GOSUB 5330 : REM Print the Global Axis shift
1470 GOTO 1570 : REM Eject paper and continue
1480 GOSUB 4530 : REM Print the unshifted parameters
1490 INPUT "Do you want to print the results (RETURN = no)" : CHK$
1500 CHK$ = LEFT$(CHK$,1)
1510 IF CHK$ <> "Y" AND CHK$ <> "y" THEN GOTO 1580
1520 LPRINT TAB(40 - LEN(EFFECT$) / 2) : EFFECT$ : LPRINT
1530 FOR IFACE = 1 TO 3
1540 GOSUB 3120 : REM Print a face of calculations
1550 NEXT IFACE
1560 GOSUB 5070 : REM Print Face input parameters
1570 LPRINT CHR$(12) : REM Eject the page
1580 INPUT "Do you want to continue (RETURN = no)" : CHK$
1590 CHK$ = LEFT$(CHK$,1)
1600 IF CHK$ <> "Y" AND CHK$ <> "y" THEN END
1610 GOTO 360
1620 REM
2000 REM ***** START OF SUBROUTINE AREA *****
2010 REM

```

(Continued next page)

**Table A-8. Microsoft Basic V5.2 Program (Continued)**

```

2020 REM          SKEW FACTOR CALCULATION
2030 REM
2040 SKEW = .25 - A11 / PI2
2050 RETURN
2060 REM
2070 REM ***** X - AXIS CALCULATION *****
2080 REM
2090 XAXIS = A14 * ( (SIN(A13) * COS(A12)) / TAN(A11) - COS(A13) ) / 2#
2100 RETURN
2110 REM
2120 REM ***** Y - AXIS CALCULATION *****
2130 REM
2140 YAXIS = A14 * SIN(A13) * COS(A12) / SIN(A11) / 2#
2150 RETURN
2160 REM
2170 REM ***** Z - AXIS CALCULATION *****
2180 REM
2190 ZAXIS = - A14 * SIN(A13) * SIN(A12) / 2#
2200 RETURN
2210 REM
2220 REM ***** PHI CALCULATION FOR MODIFIED ANGLES *****
2230 REM
2240 PHI = (COS(A12)/(COS(A11)*SIN(A13)) - 1/TAN(A13)) * COS(A11) / SIN(A14)
2250 APhi = ATN( ( 1 - PHI ^ 2 ) ^ .5 / PHI )
2260 RETURN
2270 REM
2280 REM ***** Shifted Axis Calculations *****
2290 REM
2300 REM This will calculate the axis shift and rotations required for placing
2310 REM the Z Axis through the corners of the solid as shown in Fig. A-5 of
2320 REM the Appendix.
2330 REM
2340 A = (HEIGHT(3)*COS(RADIAN(1))+HEIGHT(2)+HEIGHT(1)*COS(RADIAN(3))) / 2#
2350 B = HEIGHT(3) * SIN(RADIAN(2)) * SIN(APHI2) / 2#
2360 A11 = RADIAN(1) : A12 = RADIAN(2) : A13 = RADIAN(3) : A14 = RADIAN(1)
2370 GOSUB 2240
2380 C = (HEIGHT(3)*PHI*SIN(RADIAN(1))+HEIGHT(1)*SIN(RADIAN(3))) / 2#
2390 DIST = ( A * A + B * B + C * C ) ^ .5#
2400 OMEGA = .25# - ATN(C/A) / PI2
2410 NU = ATN( COS( ATN(C/A) ) * B / A ) / PI2
2420 FOR I = 1 TO 3 : POSTY(I) = NU + POSTY(I) : NEXT I
2430 FOR I = 1 TO 3 : XROT(I) = XROT(I) + OMEGA : NEXT I
2440 RETURN
2500 REM
2510 REM ***** Crop Computation *****
2520 REM
2530 REM This calculates the crops necessary to generate the proper size
2540 REM of the image required for each face.
2550 REM
2560 FOR IFACE = 1 TO 3
2570 IF IFACE = 2 THEN HWIDTH = HEIGHT(1) ELSE HWIDTH = HEIGHT(2)
2580 IF IFACE = 3 THEN VHEIGHT = HEIGHT(1) ELSE VHEIGHT = HEIGHT(3)
2590 HCROP = ( XASP(IFACE) * SIZE(IFACE) * 8# - HWIDTH ) / ( SIZE(IFACE) * 2 )
2600 VCROP = ( YASP(IFACE) * SIZE(IFACE) * 6# - VHEIGHT ) / ( SIZE(IFACE) * 2 )
2610 LCROP(IFACE) = HCROP - 4
2620 RCROP(IFACE) = 4 - HCROP
2630 TCROP(IFACE) = 3 - VCROP
2640 BCROP(IFACE) = VCROP - 3
2650 IF ABS(LCROP(IFACE))>4.00001# OR ABS(RCROP(IFACE))>4.00005# THEN GOTO 2690
2660 IF ABS(TCROP(IFACE))>3.00005 OR ABS(BCROP(IFACE))>3.00005 THEN GOTO 2690
2670 NEXT IFACE
2680 RETURN

```

(Continued next page)

Table A-8. Microsoft Basic V5.2 Program (Continued)

```

2690 PRINT "Error in input values of SIZE or ASPECT, re-enter values"
2700 FOR I = 1 TO 4000 : NEXT I : REM Prompt delay loop
2710 GOTO 360
3000 REM
3010 REM ***** Print Results *****
3020 REM
3030 REM This is to print a hard copy of the calculations.
3040 REM The parameters marked with "x.xxxx" are parameters that are not
3050 REM critical to the formation of the solid object.
3060 REM
3070 REM It will print two sets of results: One set displaying the results
3080 REM of a normal solid object. The second set gives the axis shifted
3090 REM results to align the solid as shown in described in section 4
3100 REM of the Appendix.
3110 REM
3120 WIDTH LPRINT 80 : REM Set Printer Print width
3130 LPRINT TAB(30) : "FACE " : FDSPLY*(IFACE) : " PARAMETERS" : LPRINT
3140 LPRINT TAB(34) : "X" : TAB(46) : "Y" : TAB(58) : "Z"
3150 LPRINT TAB(10) : "SOURCE ASP,SIZE" : TAB(29) :
3160 LPRINT USING "#####.#####" : XASP(IFACE) : : LPRINT TAB(41) :
3170 LPRINT USING "#####.#####" : YASP(IFACE) : : LPRINT TAB(53) :
3180 LPRINT USING "#####.#####" : SIZE(IFACE)
3190 LPRINT TAB(10) : "TARGET POS,SIZE" : TAB(34) : "x.xxxx" : TAB(46) : "x.xxxx" :
3200 LPRINT TAB(58) : "1.0000"
3210 LPRINT TAB(10) : "AXIS" : TAB(29) :
3220 LPRINT USING "#####.#####" : XAXIS(IFACE) : : LPRINT TAB(41) :
3230 LPRINT USING "#####.#####" : YAXIS(IFACE) : : LPRINT TAB(53) :
3240 LPRINT USING "#####.#####" : ZAXIS(IFACE)
3250 LPRINT TAB(10) : "ROTATE 3D" : TAB(29) :
3260 LPRINT USING "#####.#####" : XROT(IFACE) : : LPRINT TAB(41) :
3270 LPRINT USING "#####.#####" : YROT(IFACE) : : LPRINT TAB(53) :
3280 LPRINT USING "#####.#####" : ZROT(IFACE)
3290 LPRINT TAB(10) : "LOCATE 3D" : TAB(34) : "x.xxxx" : TAB(46) : "x.xxxx" :
3300 LPRINT TAB(58) : "x.xxxx"
3310 LPRINT TAB(10) : "SKEW/PY/PERSP" : TAB(29) :
3330 LPRINT USING "#####.#####" : POSTY(IFACE) : : LPRINT TAB(58) : "x.xxxx"
3340 LPRINT TAB(10) : "BD WIDTH" : TAB(58) : "x.xxxx"
3350 LPRINT TAB(10) : "BD SAT/LUM/HUE" : TAB(34) : "x.xxxx" : TAB(46) : "x.xxxx" :
3360 LPRINT TAB(58) : "x.xxxx"
3370 LPRINT TAB(10) : "CROP LEFT/TOP" : TAB(29) :
3380 LPRINT USING "#####.#####" : LCROP(IFACE) : : LPRINT TAB(41) :
3390 LPRINT USING "#####.#####" : TCROP(IFACE)
3400 LPRINT TAB(10) : "CROP RIGHT/BOT" : TAB(29) :
3410 LPRINT USING "#####.#####" : RCROP(IFACE) : : LPRINT TAB(41) :
3420 LPRINT USING "#####.#####" : BCROP(IFACE)
3430 LPRINT : LPRINT : LPRINT
3440 RETURN
4000 REM
4010 REM ***** Screen Display *****
4020 REM
4030 REM This is to display the results on the terminal.
4040 REM The parameters marked with "x.xxxx" are parameters that are not
4050 REM critical to the formation of the solid object.
4060 REM
4070 REM It will display two sets of results: One set displaying the results
4080 REM of a normal solid object. The second set gives the axis shifted
4090 REM results to align the solid as shown in described in section 4
4100 REM of the Appendix.
4110 REM
4120 WIDTH 80 : REM Set screen Print width
4130 PRINT : PRINT
4140 PRINT TAB(40 - LEN(EFFECT#) / 2) : EFFECT# : PRINT

```

(Continued next page)

**Table A-8. Microsoft Basic V5.2 Program (Continued)**

```

4150 PRINT TAB(30) : "FACE " : FDSPLY$(IFACE) : " PARAMETERS" : PRINT
4160 PRINT TAB(10) : "FACE WIDTH = " :
4170 PRINT USING "#####.####" : W : : PRINT TAB(40) : "FACE HEIGHT = " :
4180 PRINT USING "#####.####" : H : PRINT TAB(10) : "FACE ANGLE = " :
4190 PRINT USING "#####.####" : FANGLE(IFACE) : PRINT
4200 PRINT TAB(34) : "X" : TAB(46) : "Y" : TAB(58) : "Z"
4210 PRINT TAB(10) : "SOURCE ASP,SIZE" : TAB(29) :
4220 PRINT USING "#####.####" : XASP(IFACE) : : PRINT TAB(41) :
4230 PRINT USING "#####.####" : YASP(IFACE) : : PRINT TAB(53) :
4240 PRINT USING "#####.####" : SIZE(IFACE)
4250 PRINT TAB(10) : "TARGET POS,SIZE" : TAB(34) : "x.xxxx" : TAB(46) : "x.xxxx" :
4260 PRINT TAB(58) : "1.0000"
4270 PRINT TAB(10) : "AXIS" : TAB(29) :
4280 PRINT USING "#####.####" : XAXIS(IFACE) : : PRINT TAB(41) :
4290 PRINT USING "#####.####" : YAXIS(IFACE) : : PRINT TAB(53) :
4300 PRINT USING "#####.####" : ZAXIS(IFACE)
4310 PRINT TAB(10) : "ROTATE 3D" : TAB(29) :
4320 PRINT USING "#####.####" : XROT(IFACE) : : PRINT TAB(41) :
4330 PRINT USING "#####.####" : YROT(IFACE) : : PRINT TAB(53) :
4340 PRINT USING "#####.####" : ZROT(IFACE)
4350 PRINT TAB(10) : "LOCATE 3D" : TAB(34) : "x.xxxx" : TAB(46) : "x.xxxx" :
4360 PRINT TAB(58) : "x.xxxx"
4370 PRINT TAB(10) : "SKEW/PY/PERSP" : TAB(29) :
4380 PRINT USING "#####.####" : SKEW(IFACE) : : PRINT TAB(41) :
4390 PRINT USING "#####.####" : POSTV(IFACE) : : PRINT TAB(58) : "x.xxxx"
4400 PRINT TAB(10) : "BD WIDTH" : TAB(58) : "x.xxxx"
4410 PRINT TAB(10) : "BD SAT/LUM/HUE" : TAB(34) : "x.xxxx" : TAB(46) : "x.xxxx" :
4420 PRINT TAB(58) : "x.xxxx"
4430 PRINT TAB(10) : "CROP LEFT/TOP" : TAB(29) :
4440 PRINT USING "#####.####" : LCROP(IFACE) : : PRINT TAB(41) :
4450 PRINT USING "#####.####" : TCROP(IFACE)
4460 PRINT TAB(10) : "CROP RIGHT/BOT" : TAB(29) :
4470 PRINT USING "#####.####" : RCROP(IFACE) : : PRINT TAB(41) :
4480 PRINT USING "#####.####" : BCROP(IFACE)
4490 RETURN
4500 REM
4510 REM ***** Screen Control *****
4520 REM
4530 FOR IFACE = 1 TO 3
4540 PRINT CHR$(26) : REM Clear the terminal screen.
4550 IF IFACE = 2 THEN W = HEIGHT(1) ELSE W = HEIGHT(2)
4560 IF IFACE = 3 THEN H = HEIGHT(1) ELSE H = HEIGHT(3)
4570 GOSUB 4120 : REM Print the calculated values.
4580 IF IFACE = 3 GOTO 4600
4590 PRINT : INPUT : "Press RETURN for the next screen" , CHK$
4600 NEXT IFACE
4610 PRINT : PRINT
4620 RETURN
4630 REM
4640 REM ***** Global Print Routine *****
4650 REM
4660 PRINT TAB(10) : "Global Z - Axis = " : : PRINT USING "#####.####" : DIST
4670 RETURN
5000 REM
5010 REM ***** Print Input and Global Variables *****
5020 REM
5030 REM This will print the face height and width, face angles and the
5040 REM Global position shift required to move the axis to the point P'
5050 REM as shown in section 4 and 5 of the Appendix
5060 REM
5070 LPRINT TAB(34) : "FACE 1" : TAB(46) : "FACE 2" : TAB(58) : "FACE 3"
5080 LPRINT
5090 LPRINT TAB(10) : "FACE WIDTH" :

```

(Continued next page)

**Table A-8. Microsoft Basic V5.2 Program (Continued)**

```

5100 FOR IFACE = 1 TO 3
5110 IF IFACE = 2 THEN FWIDTH = HEIGHT<1> ELSE FWIDTH = HEIGHT<2>
5120 LPRINT TAB<17 + IFACE * 12> ;
5130 LPRINT USING "#####.#####" ; FWIDTH ;
5140 NEXT IFACE
5150 LPRINT
5160 LPRINT TAB<10> ; "FACE HEIGHT" ;
5170 FOR IFACE = 1 TO 3
5180 IF IFACE = 3 THEN FHEIGHT = HEIGHT<1> ELSE FHEIGHT = HEIGHT<3>
5190 LPRINT TAB<17 + IFACE * 12> ;
5200 LPRINT USING "#####.#####" ; FHEIGHT ;
5210 NEXT IFACE
5220 LPRINT
5230 LPRINT TAB<10> ; "FACE ANGLE" ;
5240 FOR IFACE = 1 TO 3
5250 LPRINT TAB<17 + IFACE * 12> ;
5260 LPRINT USING "#####.#####" ; FANGLE<IFACE> ;
5270 NEXT IFACE
5280 LPRINT
5290 RETURN
5300 REM
5310 REM Print the Globals if it is a shifted axis
5320 REM
5330 LPRINT : LPRINT TAB<10> ; "GLOBAL Z - AXIS" ; TAB<29> ;
5340 LPRINT USING "#####.#####" ; DIST
5350 LPRINT TAB<10> ; "ROTATE 3D" ; TAB<34> ; "X, Y, Z TO SUIT EFFECT"
5360 RETURN

```

**ADO Face Calculation Example I**

FACE ONE PARAMETERS			
	X	Y	Z
SOURCE ASP, SIZE	1.0000	1.0000	1.0000
TARGET POS, SIZE	x.xxxxx	x.xxxxx	1.0000
AXIS	0.1997	-3.6171	-1.9959
ROTATE 3D	0.1573	0.1371	0.0000
LOCATE 3D	x.xxxxx	x.xxxxx	x.xxxxx
SKEW/PY/PERSP	0.1389	0.0241	x.xxxxx
BD WIDTH			x.xxxxx
BD SAT/LUM/HUE	x.xxxxx	x.xxxxx	x.xxxxx
CROP LEFT/TOP	-2.0000	3.0000	
CROP RIGHT/BOT	2.0000	-3.0000	

(Continued next page)

# ADO

## ADO Face Calculation Example I (Continued)

FACE TWO PARAMETERS			
	X	Y	Z
SOURCE ASP. SIZE	1.0000	1.0000	1.0000
TARGET POS. SIZE	x.xxxxx	x.xxxxx	1.0000
AXIS	-0.1650	1.6750	-1.2829
ROTATE 3D	0.1389	-0.0920	0.0000
LOCATE 3D	x.xxxxx	x.xxxxx	x.xxxxx
SKEW/PY/PERSP	0.1667	0.0241	x.xxxxx
BD WIDTH			x.xxxxx
BD SAT/LUM/HUE	x.xxxxx	x.xxxxx	x.xxxxx
CROP LEFT/TOP	-4.0000	3.0000	
CROP RIGHT/BOT	4.0000	-3.0000	

FACE THREE PARAMETERS			
	X	Y	Z
SOURCE ASP. SIZE	1.0000	1.3333	1.0000
TARGET POS. SIZE	x.xxxxx	x.xxxxx	1.0000
AXIS	1.0704	1.9101	-1.2561
ROTATE 3D	0.1573	0.2500	0.0000
LOCATE 3D	x.xxxxx	x.xxxxx	x.xxxxx
SKEW/PY/PERSP	0.1111	0.0241	x.xxxxx
BD WIDTH			x.xxxxx
BD SAT/LUM/HUE	x.xxxxx	x.xxxxx	x.xxxxx
CROP LEFT/TOP	-2.0000	3.0000	
CROP RIGHT/BOT	2.0000	-3.0000	

	FACE 1	FACE 2	FACE 3
FACE WIDTH	4.0000	8.0000	4.0000
FACE HEIGHT	6.0000	6.0000	8.0000
FACE ANGLE	40.0000	30.0000	50.0000

**ADO Face Calculation Example II**

FACE ONE PARAMETERS			
	X	Y	Z
SOURCE ASP. SIZE	1.0000	1.0000	1.0000
TARGET POS. SIZE	x.xxxxx	x.xxxxx	1.0000
AXIS	0.1997	-3.6171	-1.9959
ROTATE 3D	0.3145	0.1371	0.0000
LOCATE 3D	x.xxxxx	x.xxxxx	x.xxxxx
SKEW/PY/PERSP	0.1389	0.0482	x.xxxxx
BD WIDTH			x.xxxxx
BD SAT/LUM/HUE	x.xxxxx	x.xxxxx	x.xxxxx
CROP LEFT/TOP	-2.0000	3.0000	
CROP RIGHT/BOT	2.0000	-3.0000	
FACE TWO PARAMETERS			
	X	Y	Z
SOURCE ASP. SIZE	1.0000	1.0000	1.0000
TARGET POS. SIZE	x.xxxxx	x.xxxxx	1.0000
AXIS	-0.1650	1.6750	-1.2829
ROTATE 3D	0.2961	-0.0920	0.0000
LOCATE 3D	x.xxxxx	x.xxxxx	x.xxxxx
SKEW/PY/PERSP	0.1667	0.0482	x.xxxxx
BD WIDTH			x.xxxxx
BD SAT/LUM/HUE	x.xxxxx	x.xxxxx	x.xxxxx
CROP LEFT/TOP	-4.0000	3.0000	
CROP RIGHT/BOT	4.0000	-3.0000	

(Continued next page)

# ADO

## ADO Face Calculation Example II (Continued)

FACE THREE PARAMETERS			
	X	Y	Z
SOURCE ASP. SIZE	1.0000	1.3333	1.0000
TARGET POS. SIZE	x.xxxxx	x.xxxxx	1.0000
AXIS	1.0704	1.9101	-1.2561
ROTATE 3D	0.3145	0.2500	0.0000
LOCATE 3D	x.xxxxx	x.xxxxx	x.xxxxx
SKEW/PY/PERSP	0.1111	0.0482	x.xxxxx
BD WIDTH			x.xxxxx
BD SAT/LUM/HUE	x.xxxxx	x.xxxxx	x.xxxxx
CROP LEFT/TOP	-2.0000	3.0000	
CROP RIGHT/BOT	2.0000	-3.0000	
	FACE 1	FACE 2	FACE 3
FACE WIDTH	4.0000	8.0000	4.0000
FACE HEIGHT	6.0000	6.0000	8.0000
FACE ANGLE	40.0000	30.0000	50.0000
GLOBAL Z - AXIS	8.3224		
ROTATE 3D	X, Y, Z TO SUIT EFFECT		



## INDEX

- and soft keys, 2-42
- A gai**, 3-46
- A Sof**, 3-46
- Acquired state, 3-3
- Acquiring signal systems, 3-3
- Add pause/event, 2-43, 3-24
- ADO Concentrator, 1-13, 1-14
- Advanced Effects, 3-40
- align stick**, 2-41
- all**, 2-42
- all keyf**, 2-42
- all numbers**, 2-42
- Ambient parameter, 2-14
- Auto cube, 2-10, 3-48
- Auto H-phase, 3-63
- Axis definition, 2-2
- Axis select 3D, 2-3, 3-16
  
- B gai**, 3-46
- B Sof**, 3-46
- Basic effects, 3-4
- Blur, 1-9, 3-20
- Borders, 2-3, 3-45
- break**, 2-42
- Break function, 2-7
- Brightness, channel, 2-14
- Burst gain/phase, 3-54
- Busy N state, 3-3
  
- CANCEL, 2-44
- change**, 2-42
- Channel identification, 2-5, 2-42
- ch in/out** soft key, 2-43
- ch output** soft key, 2-43
- Clear keys, 2-23
- Color background, 1-10
- Colored borders, 3-45
- Combined movement, 3-10
- Communications mode, 2-31, 2-42, 2-43, 3-3
- Concentrator, 1-3
  - adjusting parameters, 3-29
  - brightness, 2-14
  - parameters, 2-14
  - setting priority, 3-28
  - selecting channels, 3-26
- Copying a disk, 2-41, 3-38
- Cube, 3-20
  
- Cube programming, 3-38, 3-47, 3-48, 3-49
  
- D Mat**, 2-31
- dead zone**, 2-41
- delete** soft key, 2-42
- Deleting keyframes, 3-37
- Diagonal movement, 3-8
- Digi-Matte adjustment, 3-62
- Digi-Matte option, 1-10
- Digital image processing, 1-3
- Disk drive access, 2-24
- Disk handling and storage, 2-47
- disk stat**, 2-41
- disk store**, 2-41
- DM In**, 3-46
- DM Ke**, 3-46
  
- Effect control, 1-11
- Effects, 3-4
  - changing length, 3-26
  - deleting, 3-42
  - diagonal, 3-8
  - editing, 3-32
  - horizontal, 3-6
  - running, 3-21, 3-23
  - setting up, 3-22
  - storage, 1-12
  - vertical, 3-7
- end time**, 2-43
- Engineering setup, 3-50
- enter name** soft key, 2-42
- erase eff**, 2-42
- Erasing effects from a disk, 3-37
- Error messages, 3-65
  
- Flags
  - freeze, 2-9, 3-19
  - keyframe, 2-9, 3-17
  - mirror, 2-9, 3-20
  - source, 2-9, 3-18
- Floppy disks, 2-46
- format disk**, 2-41
- Formatting disks, 2-48
- Free state, 3-3
- Freeze mode 1-4
  
- get mem**, 2-42

**INDEX**

- Global control, 1-7
- Global mode, 2-10
- Global mode menu, 2-36
- Global parameters, 2-9
- goto** time, 2-43
- grid**, nr soft key, 2-42
- grid pos**, 2-42
- grid space**, 2-42
- Grids, 2-5
  
- hold**, 2-42
- Hold mode, 2-7
- Horizontal Movement, 3-6
- Horizontal Phase, 3-52
- Horizontal (X) Dimension, 2-3
  
- id** soft key, 2-42
- Image
  - compression, 1-5
  - expansion, 1-5
  - modification, 1-9
  - transformation, 1-5
  - transformation parameters, 2-32
  - transparency, 2-14
- Input video flags, 2-9
- Input video parameters, 2-9
- insert**, 2-42
- Inserting keyframes, 3-39
- Integrated system, 1-14
- Interlace mode, 3-20
- invert**, 2-42
- iv flags**, 2-42
- iv parms**, 2-42
- iv parms** soft key, 2-42
- IVP**, 2-31
  
- Joystick, 2-29
- Joystick alignment, 2-41
  
- K Blur**, 3-46
- K Sou**, 3-46
- Key
  - channel, 1-10, 3-46
  - control, 2-42
  - menu, 3-46
  - signal, 2-9
- Key control menu, 3-46
  
- Key gain, 3-56
- Key-in H phase, 3-57
- Key-in offset, 3-58
- Keyboard, 2-16
- keyf flags** soft key, 2-42
- Keyframe
  - inserting and deleting, 3-39
  - parameters, 2-9, 2-22
  - terminology, 2-8
- Keyframe flags, 2-8, 3-17, 3-20
  - A mir**, 3-20
  - B mir**, 3-20
  - Global**, 3-20
  - Inter**, 3-20
- Keys, mode select, 2-17
  
- Light parameter, 2-14
- linear**, 2-42
- Linear motion, 2-7
- list disk**, 2-41, 2-42, 2-43
- Locate 3D, 2-3
- Logical channel select keys, 2-20
- Luma/chroma gain, 3-51
  
- Many-parameter display, 2-34
- master** soft key, 2-445
- Menu road map, 2-45
- Menus, 2-30
  - communications mode, 2-31
  - global mode, 2-36
  - program, 2-33
  - program, many-parameter, 2-34
  - program, one parameter, 2-35
  - run mode, 2-37
  - run mode, global-concentrator, 2-39
  - run mode, local-concentrator, 2-38
  - setup mode, 2-32
- Mirror mode, 2-11
- more grid**, 2-42
- MORE** key, 2-18
- Mosaic, 2-9
- Mosaic mode, 1-9, 3-43
- Motion, 1-8, 2-7
- motion type** soft key, 2-42
- Movement
  - combined, 3-10
  - diagonal, 3-8

## INDEX

- Movement (Continued)
  - horizontal, 3-6
  - vertical, 3-7
- Moving to a specified event, 3-31
- Moving to a specified time, 3-30
- Multichannel mode, 3-3
- Multichannel operation, 1-9, 2-15
  
- no break**, 2-42
- no grids**, 2-42
- no id**, 2-42
- no NR**, 2-42
- Naming effects, 3-33
- Noise reduction, 2-6
- NR**, 2-42
- Numeric entry keypad, 2-25
  
- Off-axis rotation, 3-41
- One-parameter display, 2-35
  
- Pauses and events, 3-24
- Perpendicular (Z) dimension, 2-3
- Perspective factors, 2-3
- Persp**, 2-31
- phys/log**, 2-44
- Pixel, 1-3
- Posterization, 1-9, 2-9, 3-44
- Post-Y values, 2-3
- priority**, 2-43
- Program mode soft keys, 2-42
- Programming a cube, 3-47
  
- Real-time image transformation, 1-4
- Reflectance parameter, 2-14
- Recalling effects, 3-34
  - from a disk, 3-36
  - from memory, 3-35
- Rotat**, 2-31
- Rotate 3D, 2-3
- Rotation, 1-5, 3-11
  - off-axis, 3-41
  - post-Y, 2-3
  - values, 2-3
  - with axis shifted, 3-16
  - with horizontal movement, 3-15
  - with perspective, 3-42
  - X-axis, 3-13
- Rotation (Continued)
  - Y-axis, 3-12
  - Z-axis, 3-14
- Routing matrix, 2-31
- Run mode keys, 2-19
- Run mode menu, 2-37
  
- safe area**, 2-42
- save mem** soft key, 2-42
- Saving setup parameters, 3-61
- Scale factors, 2-3
- set**, 2-42
- Setup mode, 2-41, 3-50
- Setup parameters, 3-50, 3-57
- show many**, 2-42
- show one**, 2-42
- Sign select key, 2-26
- Signal system states, 2-31, 3-3
- Single-channel operation, 2-15, 3-3
- Size values, 2-3
- Skew, 2-3
- smooth**, 2-42
- Smooth motion, 2-7
- Soft keys, 2-21, 2-28
- Solarization, 1-9, 2-9, 2-42
- Solids, construction of, 2-13, Appendix
- Source aspect/size, 2-3
- Source flag, 2-10, 3-18
- Source grids, 2-5, 2-42
- Source selection, 2-10
- Source space, 1-3, 2-2, 2-4
- Spinning image, 3-14
- start t**, 2-43
- Start and end times, 3-25
- Store/recall effect keys, 2-24
- Storing and recalling effects, 3-34
- Storing setup parameters, 3-59
- Subcarrier phase, 3-53
- Sync amplitude, 3-55
  
- Target grid, 2-5, 2-42
- Target position/size, 2-3
- Target space, 1-3, 2-2
- this keyf**, 2-42
- Three-dimensional effects 1-6
- TIME key, 2-27
- Transparency, 2-14

# **ADO**

## **INDEX**

Vertical movement, 3-7  
Vertical (Y) dimension, 2-3

**white**, 2-42

X-axis rotation, 3-13

Y blur, 3-20  
Y-axis rotation, 3-12

Zooming images, 3-9  
Z-axis rotation, 3-14

**AMPEX**