

# ACS-8990/89200/89230 Controller User Manual



**U320 SCSI/2Gb FIBRE to SATA RAID**

# ACS-8990/89200/89230 Controller User Manual

Copyright 2004 Accusys, Inc. Version 1.1

[Http://www.accusys.com.tw](http://www.accusys.com.tw) ; [Http://www.accusys.com.cn](http://www.accusys.com.cn)

***The RAID Architects***

# Preface

## Notice

Product features and specifications described in this manual are subject to change without notice.

The manufacturer shall not be liable for any damage, or for the loss of information resulting from the performance or use of the information contained herein

## Trademarks

Accusys and the names of Accusys products and logos referred to herein are either trademarks and/or service marks or registered trademarks and/or service marks of Accusys, Inc.

Microsoft, Windows, Windows NT, MS-DOS are either trademarks or registered trademarks of Microsoft Corporation.

Intel and Pentium are registered trademarks of Intel Corporation.

Other product and company names mentioned herein may be trademarks and/or service marks of their respective owners.

All contents of this manual are copyrighted by Accusys, Inc.

The information contained herein is the exclusive property of Accusys, Inc. and shall not be copied, transferred, photocopied, translated on paper, film, electronic media, or computer-readable form, or otherwise reproduced in any way, without the express written permission of Accusys Inc.

© Copyright 2004 Accusys, Inc.  
All rights reserved.

This manual version 1.1

## Regulatory information



This drive is in conformity with the EMC directive.

### **Federal Communications Commission (FCC) Statement**

This equipment has been tested and found to comply with the limits for a Class B digital device, pursuant to part 15 of the FCC Rules.

Those limits are designed to provide reasonable protection against harmful interference in a residential installation. This equipment generates, uses and can radiate radio frequency energy and, if not installed and used in accordance with the instructions, may cause harmful interference to radio communications. However, there is no guarantee that interference will not occur in a particular installation. If this equipment does cause harmful interference to radio or television reception, which can be determined by turning the equipment off and on, the user is encouraged to try to correct the interference by one or more of the following measures:

- Reorient or relocate the receiving antennas.

- Increase the separation between the equipment and receiver.

- Connect the equipment into an outlet on a circuit different from that to which the receiver is connected.

- Consult the dealer or an experienced radio/TV technician for help.

### **Warning:**

A shielded-type power cord is required in order to meet FCC emission limits and also to prevent interference to the nearby radio and television reception. It is essential that only the supplied power cord be used.

Use only shielded cables to connect I/O devices to this equipment.

You are cautioned that changes or modifications not expressly approved by the party responsible for compliance could void your authority to operate the equipment.

## About this manual

### Intended user

This manual is designed and written for users of the ACS-8990, ACS-89200 and ACS-89230 RAID controllers. These models are very similar, differing only in certain components and the software support disk. The user should ideally be familiar with RAID planning and data storage operations and have experience in electronic or computer engineering.

### Organization of the manual

This manual contains the following sections:

- Chapter 1: **Introduction** provides details of key features, checklists of package contents and user requirements, and an overview of the controller box and its features.
- Chapter 2: **Installation** guides you through process of installing memory in ACS-8990/89200/89230 and integrating the controller into a system. This chapter also details procedures for replacing components.
- Chapter 3: **Quick Setup** explains how to set up an array in seconds.
- Chapter 4: **Accessing the Monitor Utility** tells you how to access and start using the firmware-based Monitor Utility on the host terminal.
- Chapter 5: **Configuration** details and explains the rich configuration options available for ACS-8990 arrays, using either the control panel or Monitor Utility.
  
- Appendix A: **Troubleshooting** helps you deal with encountered problems in the form of Q&A.
- Appendix B: **Introduction to RAID levels** contains all the information you need to understand the features of different RAID levels.
- Appendix C: **Introduction to Serial ATA** gives a full introduction to the disk interface standard used by ACS-8990.
- Appendix D: **Control Panel Messages** defines the status messages of the control panel LCD display.
- Appendix E: **Glossary** defines relevant technical terms used in this manual.
- Appendix F: **Specifications** list technical specification of ACS-8990.
- Appendix G: **Statistics** instructs how to interpret the information displayed using the Statistic command
- Appendix H: **Updating the Firmware** details the procedure for installing new or upgraded editions of firmware to the controller.
- Appendix I: **Contact Us** lists contact details of Accusys business units around the world.

## Using this manual

This guide contains all the information you need to set up and start using your RAID controller and to monitor its performance in real time. It is intended to be read in a linear manner, though some instructions may not be applicable to all users. Users may prefer to skip more familiar sections, but each of the steps below must be completed.



### Note

*This manual covers three models: ACS-8990, ACS-89200 and ACS-89230. Where references are made to ACS-8990, they should be taken as applying to all three models. The three models differ in the maximum number of hard disks they support::*

*ACS-8990 – 16 disks*

*ACS-89230 – 12 disks*

*ACS-89200 – 8 disks*

The setup process follows these steps:

#### Step 1

- Prepare:**
- ◆ Familiarize yourself with the features and capabilities of ACS-8990 (**Chapter 1**)
  - ◆ Make sure you have everything (**Chapter 1**)

#### Step 2

- Install:**
- ◆ Install SODIMM cache memory and attach the necessary cables (**Chapter 2**)
  - ◆ Turn on (**Chapter 2**)

#### Step 3

- Configure:**
- ◆ Perform Quick Setup (**Chapter 3, optional**)
  - ◆ Open Monitor Utility (**Chapter 4, recommended**)
  - ◆ Configure (**Chapter 5**)



### Note

*ACS-8990 is available in two configurations differing in their host interfaces:*

- ⇒ SCSI (host) to Serial ATA (disk)
- ⇒ Fibre (host) to Serial ATA (disk)

*This manual contains the information necessary to set up both configurations. Where procedures for the two configurations differ, they are described separately and clearly marked.*

## Guide to conventions

Important information that users should be aware of is indicated with the following icons:



### Caution

*This icon indicates the existence of a potential hazard that could result in personal injury, damage to your equipment or loss of data if the safety instruction is not observed.*



### Note

*This icon indicates useful tips on getting the most from your RAID controller.*

Important terms, commands and programs are put in **Boldface** font.

Screen text is given in **screen** font.

## Related documents for reference

ACSView/AccuSet User's Manual: A guide to the GUI applications designed for use with Accusys 8 series and 9 series RAID controllers. The applications serve as handy and effective tools for remote, cross-platform monitoring and control of RAID controllers.

# Table of Contents

<b>PREFACE</b> .....	<b>1</b>
NOTICE.....	1
TRADEMARKS .....	1
REGULATORY INFORMATION.....	2
ABOUT THIS MANUAL.....	3
<i>Intended user</i> .....	3
<i>Organization of the manual</i> .....	3
USING THIS MANUAL .....	4
GUIDE TO CONVENTIONS .....	5
RELATED DOCUMENTS FOR REFERENCE .....	5
<b>CHAPTER 1 - INTRODUCTION</b> .....	<b>11</b>
OVERVIEW .....	11
KEY FEATURES .....	12
<i>Serial ATA Compatible</i> .....	13
<i>Three Operating Modes</i> .....	13
<i>Self-Diagnostic Mode</i> .....	13
<i>Configuration Mode</i> .....	13
<i>Operation Mode</i> .....	14
<i>Three Configuration Utilities</i> .....	14
<i>Control Panel</i> .....	14
<i>Monitor Utility</i> .....	14
<i>AccuSet</i> .....	14
<i>Array Management</i> .....	14
<i>Hard Drive Hot Swapping</i> .....	14
<i>Automatic Global Hot Spare</i> .....	15
<i>Automatic Drive Rebuild</i> .....	15
<i>Instant Remote Notification</i> .....	15
<i>UPS Support</i> .....	15
BEFORE YOU BEGIN .....	15
<i>What's in the box</i> .....	15
<i>ACS-8990 SCSI-SATA package</i> .....	15
<i>ACS-8990 FC-to-SATA package</i> .....	16
<i>What else you need</i> .....	16



FAMILIARIZING YOURSELF WITH THE RAID CONTROLLER.....	17
<i>Overview</i> .....	17
<i>Control Panel</i> .....	18
<i>Rear view</i> .....	18
SUPPLIED ACCESSORIES.....	19
<i>3-in-1 Combo Cable</i> .....	19
<i>RS232 Connection for VT-100/ANSI Terminal-Emulation</i> .....	19
<i>Default Serial Port Settings</i> .....	19
<i>Modem Connection</i> .....	19
<i>UPS Connection</i> .....	20
<b>CHAPTER 2 - INSTALLATION .....</b>	<b>21</b>
INSTALLATION FLOWCHART .....	21
PRE-INSTALLATION NOTICES .....	22
HARDWARE CONFIGURATIONS .....	23
<i>SCSI to Serial ATA</i> .....	23
<i>Fibre to Serial ATA</i> .....	23
<i>The bridge board links to the daughterboard through the HSSDC2 cable(s) provided.</i> .....	23
CHANGING HARDWARE CONFIGURATIONS.....	24
<i>Removing / replacing control panel</i> .....	25
<i>Removing / replacing the daughterboard</i> .....	25
<i>Removing / replacing backplane</i> .....	26
<i>Removing / replacing controller board</i> .....	26
INSTALLING / UPGRADING SODIMM.....	27
<i>SODIMM specifications:</i> .....	27
<i>Architecture of supported SODIMM:</i> .....	28
<i>Installing SODIMM</i> .....	28
<i>Removing SODIMM</i> .....	28
HOST CONNECTION.....	29
<i>SCSI configuration</i> .....	29
<i>Fibre configuration</i> .....	29
CABLING .....	30
TURNING ON FOR THE FIRST TIME.....	31
TURNING OFF .....	31
RESTARTING.....	31
<b>CHAPTER 3 - QUICK SETUP .....</b>	<b>32</b>

QUICK SETUP WITH THE CONTROL PANEL ..... 33

QUICK SETUP WITH THE MONITOR UTILITY ..... 34

**CHAPTER 4 - ACCESSING THE MONITOR UTILITY ..... 35**

ESTABLISHING A TERMINAL CONNECTION ..... 35

USING THE MONITOR UTILITY ..... 37

*Monitor utility control keys*..... 39

*Menu area controls*..... 39

*Output area controls*..... 39

**CHAPTER 5 - CONFIGURATION ..... 40**

CONFIGURATION OVERVIEW ..... 40

*System configuration*..... 40

*RAID configuration – simple* ..... 41

*RAID configuration – standard*..... 41

*RAID configuration – advanced* ..... 42

*How to configure ACS-8990*..... 43

FINDING YOUR WAY AROUND THE MENUS ..... 44

ACCESSING THE MAIN MENU ..... 45

*Accessing the main menu using Monitor Utility* ..... 45

*Accessing the main menu using the control panel* ..... 47

SETTING ARRAY PARAMETERS ..... 48

*RAID params menu*..... 49

SETTING SCSI PARAMETERS ..... 53

*SCSI params menu*..... 53

SETTING FIBRE CHANNEL PARAMETERS..... 56

*FC params menu*..... 57

SETTING PORT PARAMETERS ..... 58

*RS232 Params menu* ..... 58

*Modem Port menu*..... 59

*Terminal Port menu*..... 59

PASSWORD SECURITY ..... 60

*Password Info menu*..... 60

ENTERING AND EDITING ALERT SETTINGS ..... 60

PAGER ALERT SETTINGS ..... 61

*Pager Info menu*..... 61

FAX ALERT SETTINGS ..... 62

*Fax Info menu*..... 62

<i>Company Info menu</i> .....	63
MODEM SETTINGS .....	63
<i>Modem Init St menu</i> .....	63
SAVING CONFIGURATIONS .....	64
<i>NVRAM menu</i> .....	64
ADVANCED SETTINGS .....	65
<i>RAID Functions menu</i> .....	65
<b>APPENDIX A - TROUBLESHOOTING .....</b>	<b>73</b>
<b>APPENDIX B - INTRODUCTION TO RAID LEVELS.....</b>	<b>78</b>
<i>RAID 0</i> .....	79
<i>RAID 1</i> .....	80
<i>RAID 0+1</i> .....	81
<i>RAID 3</i> .....	82
<i>RAID 30</i> .....	83
<i>RAID 5</i> .....	84
<i>RAID 50</i> .....	85
<i>JBOD</i> .....	86
<i>NRAID</i> .....	87
<b>APPENDIX C - INTRODUCTION TO SERIAL ATA .....</b>	<b>88</b>
<i>Cabling</i> .....	88
<i>Simplicity of configuration</i> .....	88
<i>Hot-Swap capability</i> .....	88
<i>Performance</i> .....	89
<i>Cost effectiveness</i> .....	89
<b>APPENDIX D - CONTROL PANEL MESSAGES.....</b>	<b>90</b>
<b>APPENDIX E - GLOSSARY .....</b>	<b>91</b>
<b>APPENDIX F - SPECIFICATIONS .....</b>	<b>93</b>
<b>APPENDIX G - STATISTICS.....</b>	<b>94</b>
<i>System information</i> .....	94
<i>RAID information</i> .....	94
<i>SCSI information</i> .....	96
<i>Fibre information</i> .....	97
<i>RS232 information</i> .....	97
<i>Company information</i> .....	97
<i>Fax information</i> .....	98

*Pager information*..... 98  
*IO statistics* ..... 98  
*Battery Backup Module information*..... 98

**APPENDIX H - UPDATING THE FIRMWARE ..... 99**

**APPENDIX I - CONTACT US ..... 101**

ACCUSYS, INC. .... 101  
ACCUSYS U.S.A., INC. .... 101  
ACCUSYS KOREA, INC. .... 101  
ACCUSYS CHINA, INC. .... 101

## Chapter 1

# Introduction

---

**This chapter introduces the features and capabilities of ACS-8990.**

**You will find:**

- ⇒ **A full introduction to your ACS-8990 RAID controller**
  - ⇒ **Details of key features and supplied accessories**
  - ⇒ **A checklist of package contents**
  - ⇒ **A checklist of what else you need to start installation**
- 

## Overview

Congratulations on your selection of the Accusys 8990 (ACS-8990) – a high-performance and extremely flexible RAID (Redundant Array of Independent/Inexpensive Disks) controller. RAID is a storage technology used to improve the processing capabilities of the storage system, providing a combination of reliability and performance.

ACS-8990 is designed to meet today's demand for higher storage solutions. Ideally suited for integration with databases, e-mail, web servers and imaging systems, ACS-8990 provides maximum data protection and exceptional performance. ACS-8990 is designed for easy integration, smooth data expansion and server migration.

ACS-8990 is the ultimate flexible RAID solution. It can manage seven different RAID levels , plus JBOD, NRAID, providing functions including

- Striping (RAID 0)
- Striping with Mirroring (RAID 0+1)
- Mirroring and Duplexing (RAID 1)
- Striping with Parity on Dedicated Disk (RAID 3)
- Striping with Parity on Dedicated Disk plus Block Striping (RAID 30)
- Striping with Interspersed Parity (RAID 5)
- Striping with Interspersed Parity plus Block Striping (RAID 50)
- Spanning (JBOD)
- Disk spanning (NRAID)

As a result, the ACS-8990 RAID Controller offers a higher range of choices and better security.

**Note**

*This manual covers three models: ACS-8990, ACS-89200 and ACS-89230. Where references are made to ACS-8990, they should be taken as applying to all three models. The three models differ in the maximum number of hard disks they support::*

*ACS-8990 – 16 disks*

*ACS-89230 – 12 disks*

*ACS-89200 – 8 disks*

**Note**

*ACS-8990 is available in two configurations differing in their host interfaces:*

*⇒ SCSI (host) to Serial ATA (disk)*

*⇒ Fibre (host) to Serial ATA (disk)*

*This manual contains the information necessary to set up both configurations. Where procedures for the two configurations differ, they are described separately and clearly marked.*

## Key Features

ACS-8990 features the following:

- Support for RAID levels 0, 1, 0+1, 3, 30, 5, 50, JBOD and NRAID
- Independence from host system
- Independence from operating system
- Intel i80321 64-bit RISC high performance processor
- Supports high performance Serial ATA hard disk drives
- Supports Dual Ultra320 SCSI or 2G fibre channel
- Supports 16 Serial ATA channels
- Superior Accusys Array Management Firmware
- Flexible cache size of up to 1GB
- Supports up to 16 logical units
- Supports on-line capacity expansion.
- Automatic Hot Swap, Hot Spare and Drive Rebuild Support
- Bad sector reassignment
- Programmable FAX event notification
- Remote monitoring through RS232 terminal interface
- UPS support through standard UPS interface
- Battery backup support through Accusys standard module (option)
- Support Disk Cloning & SMART & Scrubbing
- Support Slice over 2TB

## Serial ATA Compatible

ACS-8990 is designed for use with the latest generation of high performance HDDs. The serial ATA disk interface offers 150 MByte/s data transfer, the capacity for hot-plugging, and compatibility with parallel ATA standards. Serial ATA cables can reach up to 1 meter (2.5 times the maximum length of IDE ribbon cables) and are far narrower than ribbon cables. This leads to improved ventilation inside system cases and wider options for disk placement. For further details of Serial ATA, turn to Appendix C.

## Three Operating Modes

ACS-8990 operates in three modes: Self-Diagnostic Mode, Configuration Mode and Operation Mode.

### Self-Diagnostic Mode

To ensure flawless operation, ACS-8990 has a built-in self-diagnostic utility. Self-diagnostic Mode is entered automatically upon power up, or after the ACS-8990 has been reset. In this mode, all components are tested, and any potential problems are reported. Once the tests are complete, ACS-8990 switches automatically to Operation Mode.

Self-Diagnostic Mode runs three major tests. The first diagnostic test covers the CPU and supporting core logic chips, the internal bus, memory, SCSI controller, Serial ATA controllers, and RS-232 controllers. The second diagnostic test checks for the presence of disks on each individual disk channel and the functionality of each disk found. The final diagnostic test checks RAID functionality.

### Configuration Mode

Configuration Mode enables the RAID administrator to configure and modify the settings of ACS-8990 and fine-tune the configuration. Configuration Mode is entered from Operation Mode:

1. When the Enter button on the control panel is pressed, or:
2. When the Monitor Utility is invoked from the remote terminal.



#### Caution

*ACS-8990 should be off-line and not being accessed by any application when Configuration Mode is run.*



#### Note

*ACS-8990 will automatically switch from Configuration Mode to Operation Mode after 3 minutes if no buttons are pressed on the controller box control panel and no action is taken on the Monitor Utility*

Full details on changing configurations are given in Chapter 5

## Operation Mode

Operation Mode is the default state of ACS-8990. In this mode, the controller box front panel LCD continuously displays the current status of ACS-8990. A typical display looks like the following:

```
ACS-8990
1111111111111111 S → 1 → [Raid No.]
```

A full explanation of control panel LCD messages is given in Appendix D.

## Three Configuration Utilities

There are three ways to configure ACS-8990:

1. Control Panel
2. Monitor Utility
3. AccuSet

### Control Panel

ACS-8990 can be configured directly using the LCD control panel.

### Monitor Utility

This embedded menu-based configuration utility is accessed through the host computer.

### AccuSet

AccuSet is a Graphical User Interface that empowers you to configure your RAID Controllers through a local or remote terminal. Contact your dealer for information.

## Array Management

The unique ACS-8990 array management firmware utilizes multitasking real-time kernel technology to manage the controller. Additional features are real-time I/O load analysis, on-line diagnostics, event logging and broadcasting, and device inventory management. These features can be accessed locally or via modem to allow centralized monitoring and control of the ACS-8990.

## Hard Drive Hot Swapping

Hot Swapping allows for the removal and installation of disk drives without interruption of data access while the ACS-8990 system is in use. This is usually performed when there is no Hot Spare drive configured. There is no need to power down the system.



### Note

*The Hard Drive Hot Swapping facility is not supported by all brands of disk rack. Contact your vendor for details*



## Automatic Global Hot Spare

Hot Spare allows for the automatic replacement of a failed drive without requiring intervention from the administrator. When a disk fails the ACS-8990 will automatically replace the faulty drive with the configured hot spare disk.

The Global Spare Drive does not serve only a specified logical drive. When a member drive from any of the logical drives fails, the Global Spare Drive will join that logical drive and automatically start to rebuild.

## Automatic Drive Rebuild

If a member drive in a logical drive fails, the controller will search for a **Global Spare Drive**. If there is a Global Spare Drive, it will automatically rebuild the logical drive.

## Instant Remote Notification

ACS-8990 supports but does not require additional software for system monitoring and analysis. The ACS-8990 array management firmware continuously monitors the system activity and immediately launches the fax event notification feature if any failure occurs. Up to two pager numbers and two fax numbers can be notified instantaneously and repeatedly for extra insurance.

## UPS Support

ACS-8990 supports the use of an uninterruptible power supply. In the event of a power breakdown, a UPS will keep the RAID controller online long enough for its internal cache memory to be saved to a hard drive.

## Before you begin

### What's in the box

Some vendors may ship certain components as standard, while other vendors treat the same component as optional. In its most basic configuration, your package should include the following:

#### ACS-8990 SCSI-SATA package

- ACS-8990 Controller Box ×1 with:
  - ACS-8990 controller
  - ACS-7485 SCSI daughter board
  - ACS-8961 Backplane
  - Panel module
  - 10 pin panel cable & LCD cable
- ACS-8990 Controller User's Manual ×1
- Serial ATA cables ×16
- 3-in-1 Combo Cable ×1
- Mounting screws (bag) ×1
- GUI CD Drive ×1



**ACS-8990 FC-to-SATA package**

- ACS-8990 Controller Box ×1 with:
  - ACS-8990 controller
  - ACS-7145 daughter board
  - ACS-5160 bridge board
  - ACS-8961 Backplane
  - Panel module
  - 10 pin panel cable & LCD cable
- ACS-8990 Controller User's Manual ×1
- Serial ATA cable x 16
- 3-in-1 Combo Cable ×1
- HSSDC2 to HSSDC2 cable (50cm) x 2
- 10-pin power cable x 1
- Mounting screws (bag) ×1
- GUI CD Drive ×1

**What else you need**

- Serial ATA hard disk drives (different RAID levels requires different numbers of HDDs. Turn to Appendix B to determine how many HDDs you require)
- Disk array enclosure
- SCSI cable (SCSI host interface only)
- LC Fibre cable (fibre host interface only)
- Small form-factor pluggable (SFP) cable (fibre host interface only)
- DDR SODIMM memory module
- Host adapters with SCSI interface (SCSI host interface only)
- Host adapters with fibre interface (fibre host interface only)
- External power connector (same type as for CDROM)
- External terminator (SCSI host interface only)
- Static grounding strap or electrostatic discharge (ESD) safe work area
- Dedicated terminal or PC with third party communication software that supports ANSI terminal emulation (required for viewing Monitor Utility)

**Note**

*For non-proprietary accessories, such as memory modules, cables, etc., your vendor may be able to recommend compatible and reliable brands.*



**Note**

*The hard drives in a RAID should match in size and speed. All drives in any array should be identical models with the same firmware versions. RAID's can use any size drive, however the smallest drive will determine the size of the array.*



**Note**

*There's no set formula to determine how much cache memory to use, but as a general rule, a workstation, with mostly very large files, such as for audio or video editing and playback, graphics or CAD files, can benefit from a large cache. File servers, with multiple random access of varying file size, generally have little or no performance improvement with additional cache.*



**Note**

*ACS-8990 disk arrays do not require the installation of different drivers for use with different operating systems. ACS-8990 is independent and transparent to the host operating system.*

## Familiarizing yourself with the RAID controller

### Overview

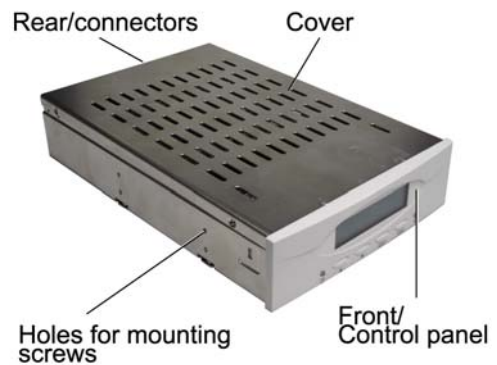

### Control Panel

The two-line, 16-character **LCD** displays the status and configuration information for ACS-8990.

The **Scroll buttons** are used to scroll through screens and highlight menu items

The **Enter button** is used to select an option

The **Escape button** is used to cancel a selection or return to the previous menu

The **Power LED** lights solid when power is on

The **Activity LED** indicates that the RAID is being accessed:

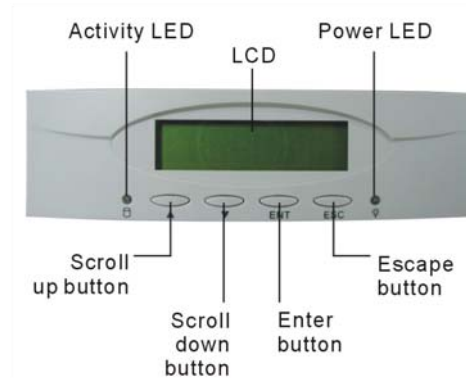

Activity LED status	Controller status
▪ Flashing	▪ Data being accessed
▪ Solid	▪ Unprocessed data still cached in memory
▪ Unlit	▪ No activity

Full details on configuring with the control panel are given in Chapter 5.

A full list of LCD display messages is given in Appendix D.

### Rear view

All ports are located on the rear panel of the controller.

There are 16 **Serial ATA connectors**, numbered one to 16 from right to left.

The **Combo connector** is for the insertion of the combo cable introduced below.

The **Power connector** fits a standard hard drive power cable head.

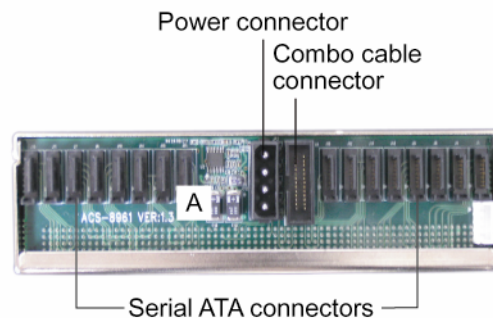

## Supplied accessories

### 3-in-1 Combo Cable

The combo cable includes the following connectors:

- An RS232 connector to link to the host terminal COM port enabling use of the monitor utility
- A modem connector enabling the automatic dispatch of alert faxes
- A monitor connector enabling various monitoring facilities. The default pin assignments are:

Pins 1+3: Fan failure

Pins 2+4: Temperature failure

Pins 5+7: Power source failure

Pins 6+8: UPS warning

Pins 9 and A are unassigned

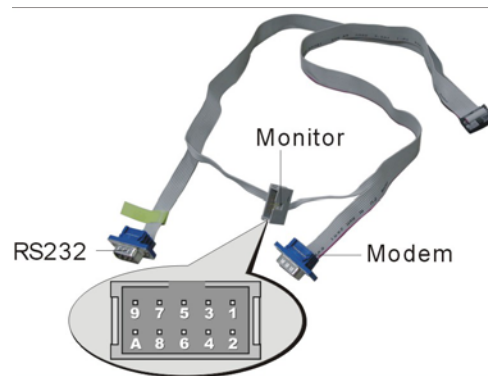

### RS232 Connection for VT-100/ANSI Terminal-Emulation

The ACS-8990 controller can be configured via a PC running a VT-100 or ANSI terminal-emulation. In order to connect to a PC, you may need to connect an additional interface cable to the combo cable, which converts the RS-232 signal of the 10-pin header connector into a 9-pin D-sub male connector. The pin-layout of the 9-pin D-sub male connector is similar to that of a PC's serial power and is set as a DTE device.

### Default Serial Port Settings

Property	Default
Baud Rate (bps)	115200
Stop Bit	1
Data Bit	8
Parity	None

The baud rate can be changed using the interface on the front panel.

### Modem Connection

ACS-8990 can be connected to a modem to allow remote notification in the event of an error. If a modem is properly connected to the modem header of the combo cable, you can configure the ACS-8990 to notify the administrator in case of malfunction. Supported notification devices are fax and pager.

## UPS Connection

The ACS-8990 controller can be connected to a UPS (Uninterrupted Power Supply) device for additional power supply security. In the event of any power failure on the main power connector, the UPS will take over and assure sustained operation for a certain period of time.



### Note

*A UPS connected to the ACS-8990 will keep the controller box running. You still need to ensure that the system of which the ACS-8990 also has a separate sufficient backup power solution. In order to protect the continuous operation of the ACS-8990 and all disks connected, you need to ensure that the power supplied by the UPS suffices the demand. Check your UPS vendor for more information.*

## Chapter 2

# Installation

### This chapter presents:

- ⇒ An overview of the ACS-8990 hardware, including the two available configurations
- ⇒ Full instructions on changing hardware configurations
- ⇒ Instructions on how to install and upgrade DRAM
- ⇒ Instructions on cabling

## Installation flowchart

Installation of ACS-8990 is simple. This chapter will lead you through the following steps:

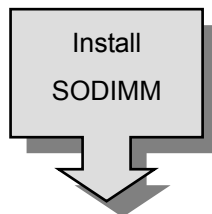

- Install minimum 64 MB SODIMM in the socket on the controller board

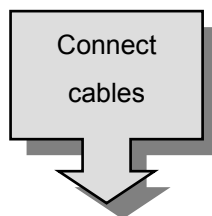

- Connect a SCSI cable (SCSI configuration) or fibre cable (fibre configuration) from each host to the controller
- Connect a serial ATA cable from each hard disk drive in the intended array to the connector on the controller box
- Connect the combo cable to the controller
- Connect the power cable

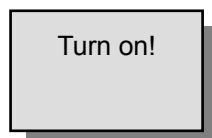

- Hardware installation complete.



### Note

*This manual covers three models: ACS-8990, ACS-89200 and ACS-89230. Where references are made to ACS-8990, they should be taken as applying to all three models.*

## Pre-installation notices



### Caution

*Before starting any kind of hardware installation, please ensure that all power switches have been turned off and all power cords disconnected to prevent personal injury and damage to the hardware*



### Caution

*To avoid overheating, ACS-8990 should be installed in a well-ventilated area and in such a way that sufficient airflow is maintained across the controller chips.*



### Caution

*Static electricity can damage electronic components. To guard against such damage:*

*Work in a static-free environment*

*Wear a grounded anti-static wrist strap*

*Store uninstalled components in anti-static bags*

*Handle PCBs by their edges and avoid touching chips and connectors.*



### Caution

*Environmental requirements    Temperature: 0°C to 50°C (32°F to 122°F)*

*Humidity: 5-95%, non-condensing*

*Altitude: Sea level to 10,000 ft*



## Hardware configurations

ACS-8990 is supplied in two configurations – with either a SCSI or a fibre host interface and a different daughterboard for each. Other components of the two configurations (controller board, backboard, control panel and controller box) and are identical.

### SCSI to Serial ATA

The SCSI to Serial ATA package contains the ACS-7485 daughterboard. The model name is printed on the daughterboard.



### Fibre to Serial ATA

The Fibre to Serial ATA package contains the ACS-7145 daughterboard. ACS-7145 should be connected through an optical cable to the ACS-5160 bridge board, which acts as the host interface.

The model name is printed on the daughterboard.

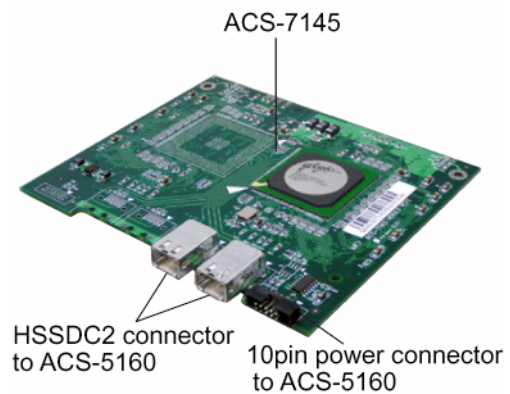

ACS-5160 requires a separate power cable as indicated.

The bridge board links to the host(s) through a small form-factor pluggable (SFP) module (a separate cable is required for each of the two host channels)

The bridge board links to the daughterboard through the HSSDC2 cable(s) provided.

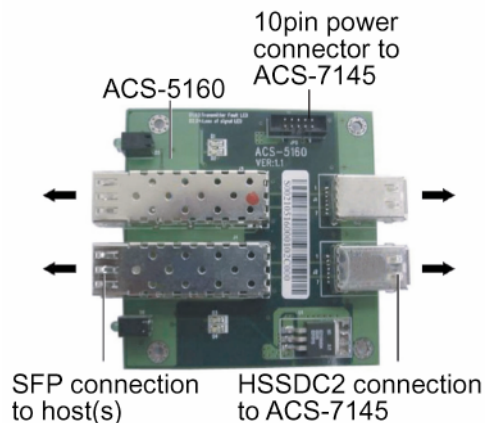

## Changing hardware configurations



### Caution

*Read the pre-installation notices earlier in this chapter before proceeding with installation.*

Most users should not need to replace components but users need to remove components to install or remove a DDR RAM module. Instructions on installing and removing DDR RAM are given separately in the next section. This section provides instructions for the removal and installation of the following components:

- Control Panel
- Backplane
- Daughterboard
- Controller board

In order to access internal components:

1. Remove any screws securing the top cover.
2. Remove the cover by sliding it back and lifting off.

The position of the removable components is shown in the figure on the right.

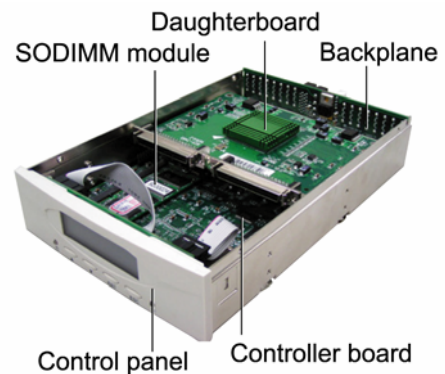

## Removing / replacing control panel

To **remove** the control panel:

1. Release the two latches securing the control panel to the controller box casing.
2. Ease the control panel forward out of the controller box.
3. Release the two control panel cables from the control panel.

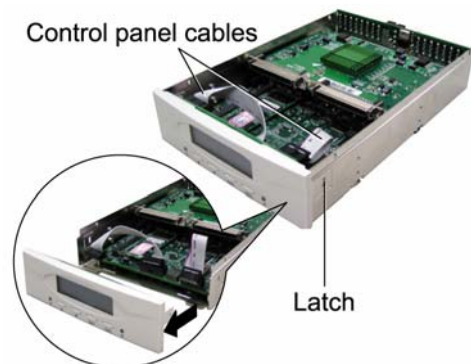

To **install** the control panel:

1. Connect the two control panel cables to the control panel.
2. Slot the control panel into position, ensuring that the two latches lock the control panel into position on the controller box casing.

## Removing / replacing the daughterboard

To **remove** the daughterboard:

Lift the daughterboard gently but firmly to disconnect it from the controller board connectors.

To **install** the daughterboard:

Line the daughter board connectors up with the controller board connectors and press down firmly.



## Removing / replacing backplane

To **remove** the backplane:

1. Remove the daughterboard (see previous section).
2. Remove two screws securing the rear of the controller board to the controller box casing.
3. Gently push the two sides of the controller box apart and ease out the backplane.



To **install** the backplane:

1. Align the controller board connector with the backplane connector pins and push together firmly, so that the pins are fully inserted.



### Caution

*The pins on the backplane are fragile and easily damaged. Take great care when connecting the backplane and controller board.*

2. Ease the backplane into the correct position.
3. Secure the controller board to the controller box casing using two screws.
4. Replace the daughter board.

## Removing / replacing controller board

To **remove** the controller board:

1. Remove the control panel (see earlier section).
2. Remove the daughterboard (see earlier section).
3. Remove the backplane (see previous section).
4. Remove two screws securing the front edge of the controller board.
5. Ease the controller board out from the case.
6. Remove any installed DDR RAM (see instructions on following page).

To **install** the controller board:

1. Position the controller board in the case and secure with four screws.
2. Ensure that a DDR RAM module is installed (see next section).
3. Replace the backplane, control panel and daughterboard.

## Installing / Upgrading SODIMM



### Caution

*Read the pre-installation notices earlier in this chapter before proceeding with installation.*

ACS-8990 is normally supplied without any on-board memory installed. The ACS-8990 controller requires a minimum 64 MB SODIMM installed in the socket on the controller board in order to operate.



### Note

*There's no set formula to determine how much cache memory to use, but as a general rule, a workstation, with mostly very large files, such as for audio or video editing and playback, graphics or CAD files, can benefit from a large cache. File servers, with multiple random access of varying file size, generally have little or no performance improvement with additional cache.*

### SODIMM specifications:

Minimum	Recommended
<ul style="list-style-type: none"><li>200-pin DDR SODIMM module (PC-200).</li></ul>	<ul style="list-style-type: none"><li>DDR RAM</li></ul>
<ul style="list-style-type: none"><li>SODIMM, with or without parity (ECC or non-ECC)</li></ul>	<ul style="list-style-type: none"><li>With parity, for security</li></ul>
<ul style="list-style-type: none"><li>Minimum of one SODIMM with 64 MB. The memory card socket can support 64, 128, 256, 512 MB or 1 GB of memory.</li></ul>	<ul style="list-style-type: none"><li>Minimum of 64 MB. More memory (up to 1 GB) equals better performance: the size of the memory module defines the cache writing space available to the ACS-8990.</li></ul>

**Architecture of supported SODIMM:**

**DDR SDRAM Architecture**

▪ 1 GB	▪ 16 (64M bit x 8)
▪ 512 MB	▪ 16 (32M bit x 8), 8 (32M bit x16) <b>or</b> ▪ 8 (64M bit x 8)
▪ 256 MB	▪ 16 (16M bit x 8), 8 (32M bit x8), 8 (16M bit x16) <b>or</b> ▪ 4 (32M bit x 16)
▪ 128 MB	▪ 8 (16M bit x 8), 8 (8M bit x 16) <b>or</b> ▪ 4 (16M bit x 16), 16 (8M bit x 8)
▪ 64 MB	▪ 4 (8M bit x 16), 8 (8M bit x 8)



**Caution**

*ACS-8990 supports both non-registered ECC memory (also known as non-buffer ECC memory) and non-ECC memory.*

**Installing SODIMM**

To install a SODIMM, ensure the system power is off and disconnected. Then:

1. Remove any screws securing the controller box cover, then slide the cover back and lift off.
2. Remove the daughter board.
3. Insert a memory card at a 45-degree angle into the memory card socket on the controller board so that the gold teeth of the card are no longer visible.
4. Press the card down firmly until the latches lock it into place.

Memory card socket

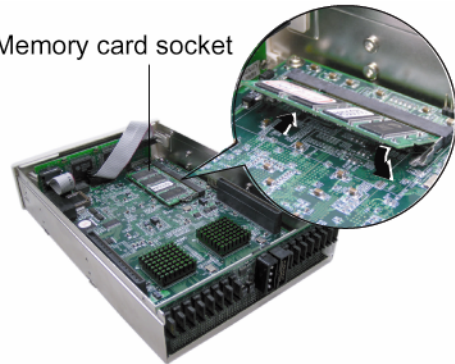

**Removing SODIMM**

1. Remove the daughter board (if any has been installed).
2. Release the latches securing the SODIMM to the controller board. The SODIMM will pop up.
3. Lift the SODIMM gently out of the memory card socket.



## Host connection



### Caution

*Read the pre-installation notices earlier in this chapter before proceeding with host connection.*

### SCSI configuration

Connect a SCSI cable from the host system SCSI card to one of the SCSI connectors on the daughter board and to an external terminator. Users setting up a dual host configuration should connect two SCSI cables – one linking to each host.

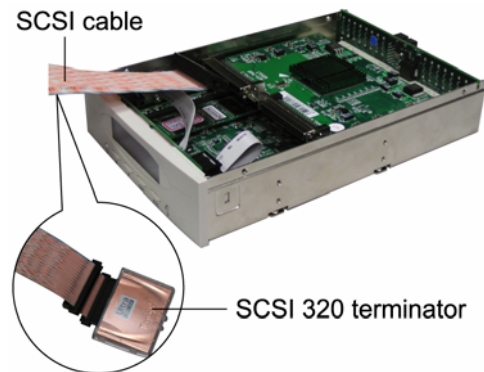

### Fibre configuration

1. Use an HSSDC2 cable to connect the bridge board (ACS-5160) to the daughterboard. Users setting up a dual host configuration should connect two cables.
2. Connect the bridge board to each host using a separate small form-factor pluggable (SFP) module and optical cable.

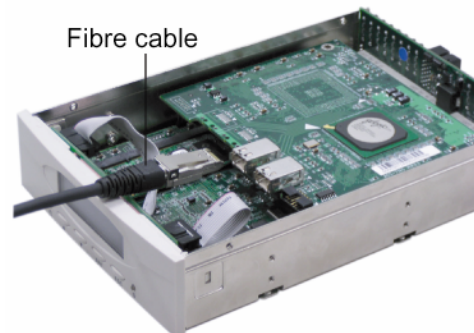

## Cabling



### Caution

*Read the pre-installation notices earlier in this chapter before proceeding with cabling.*

1. Ensure that each of the host systems is connected to the daughterboard as described in the previous section.
2. Connect a serial ATA cable from each hard disk drive in the intended array to a connector on the backplane. The disk channels are numbered one to 16 from right to left.
3. Connect the combo cable to the connector on the backplane. The notch on the combo cable connector should be aligned with the corresponding slot on the backplane connector to ensure correct insertion.

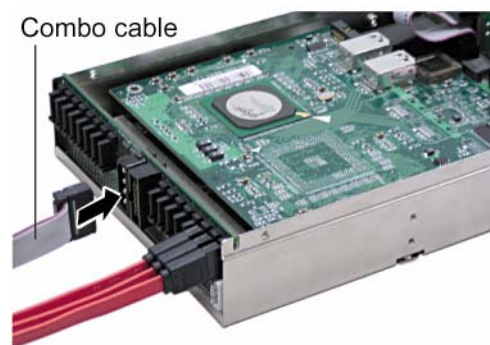

### Note

*The combo cable provides a variety of monitoring options:*

- ⇒ *The RS232 cable is required for the use of the Monitor Utility*
- ⇒ *The modem connector enables the automatic dispatch of alert faxes*
- ⇒ *The monitor connector enables simultaneous monitoring of a subsystem fan, temperature gauge and UPS (uninterruptible power source)*

*See Supplied accessories in Chapter 1 for more on the combo cable.*



4. Connect a power cable to the connector on the backplane. The power input connector is identical to a standard hard drive power connector.

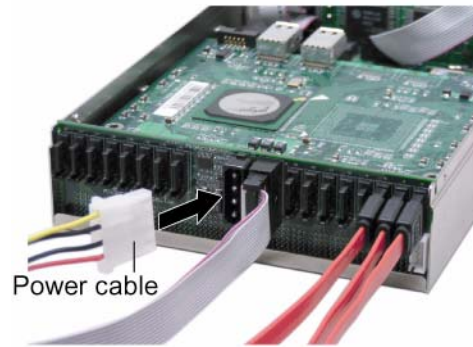

## Turning on for the first time

When cabling is complete, ACS-8990 can be turned on. This should be done in the following order:

1. First turn on the power source
2. Then boot the host computer(s)

When ACS-8990 is running, you are ready to configure one or more RAIDs. You have the following options:

1. Turn to Chapter 3 to perform a quick setup of a single array using the control panel.
2. Turn to Chapter 4 to access the Monitor Utility. Once the Monitor Utility is accessed, you can perform a quick setup (Chapter 3) or complete configuration (Chapter 5) with either the control panel or Monitor Utility.
3. Turn to Chapter 5 to perform a full configuration using the control panel.

## Turning off

The Shut Down command should be used to turn off ACS-8990 to ensure that data is not lost or corrupted. To shut down, first shut down the terminal/host system, then select Shut Down from the NVRAM menu (see *Saving Configurations* in Chapter 5, *Configuration*). Finally, power off ACS-8990.

## Restarting

When restarting ACS-8990, users are advised to first restart the terminal/host system, then power on ACS-8990.

## Chapter 3

# Quick setup

Once ACS-8990 is set up and connected, the array should be initialized. The initialization process is automatic.

By performing Quick Setup, users can establish an array in seconds. There are two ways to perform Quick Setup:

- ⇒ Using the control panel
- ⇒ Using the embedded Monitor Utility

Both methods are explained in this chapter.

The control panel can be accessed immediately and Quick Setup can be completed very quickly using it. The Monitor Utility is easier to use once set up. It requires a connection to be established first between the host terminal and ACS-8990.

**Note**

*Quick Setup can only be used to establish a single array. To establish a multiple array, turn to Chapter 5.*

**Note**

*Quick Setup cannot be used to reconfigure an existing array. To do this, turn to Chapter 5.*

**Note**

*This manual covers three models: ACS-8990, ACS-89200 and ACS-89230. Where references are made to ACS-8990, they should be taken as applying to all three models.*

## Quick Setup with the control panel

1. Turn on ACS-8990. The controller will first enter Self-Diagnostic Mode, then Operation Mode. A typical Operation Mode screen is shown.

```
ACS-8990   
xxxJJJxxxxxxxxxx
```



### Note

Full explanation of the control panel messages is given in Appendix D.

NOTE: Instructions on using the control panel are given in the section **Control Panel** in Chapter 1

2. Press **Enter** to enter Configuration Mode. You will be prompted to enter the Password. The default password is **00000000** (eight zeros). To enter this, simply press **Enter** eight times. Press **Enter** again to submit.
3. You enter the main menu. The first item on the main menu is the Quick Setup submenu. Press **Enter** to select.

```
Enter Passwd:   
0 [XXXXXXXXXX]
```

```
Main menu  
0 Quick Setup
```



### Note

The contents of other submenus are explained in detail in Chapter 5.

4. The Quick Setup submenu lists the RAID levels available (0, 1, 3, 5, 30, 50, 0+1 and RAID). Scroll through the list until the appropriate level for the RAID you want to set up is showing. Press **Enter**.

```
0 Quick Setup  
Level 0+1
```



### Note

Full explanation of the different RAID levels available is given in Appendix B.



### Note

A JBOD array cannot be setup using the Quick Setup option

## Quick Setup with the monitor utility



### Note

*This section is intended as a Quick Setup guide only. Full instructions on accessing and using the Monitor Utility are given in Chapter 4.*

Users wishing to perform Quick Setup via the monitor utility must first establish a connection between the host terminal and ACS-8990. Follow the instructions in Chapter 5, *Accessing the Monitor Utility*. Then:

1. Press **Ctrl** and **D** together to launch the monitor utility.
2. Press **Enter**. You will be prompted to enter a password.
3. Enter the default password **00000000** (eight zeros). Press **Enter**.
4. The main menu will appear.
5. Use the arrow keys to select **0 Quick Setup**. Press **Enter**.

```

----- RAID 8990-16STD Monitor Utility v0.600A Beta5 -----
LCD                                     OUTPUT
RAID 8990-16STD  xxxxxxxxxxxxxx122S  DISK: # 1 not installed !
MENU                                                    DISK: # 3 not installed !
                                                    DISK: #14 ST3120023AS
                                                    (C,H,S,M) = (232581, 16, 63, 16)
                                                    DISK: #16 ST3120023AS
                                                    (C,H,S,M) = (232581, 16, 63, 16)
                                                    DISK: #15 ST3120023AS
                                                    (C,H,S,M) = (232581, 16, 63, 16)
                                                    DISK: #13 ST3120023AS
                                                    (C,H,S,M) = (232581, 16, 63, 16)
                                                    DISK: # 7 not installed !
                                                    DISK: # 8 not installed !
                                                    DISK: # 6 not installed !
                                                    Disk config info found.
                                                    Use NVRAM config info.
                                                    Disk config info found.
                                                    Use NVRAM config info.
                                                    Array 1 Member: Disk(D)
                                                    Array 2 Member: Disk(EF)
                                                    Hot-Plug function ready.
Please input key: ' '..']'
  
```

6. The Quick Setup submenu lists the RAID levels available (5, 3, 1, 0, 0+1, 50, 30 and NRAID). Scroll through the list until the appropriate level for the RAID you want to set up is highlighted. Press **Enter**.
7. You will be prompted for confirmation of your selection. Select **Yes** and press **Enter**.



### Note

*A JBOD array cannot be setup using the Quick Setup option*

## Chapter 4

# Accessing the Monitor Utility

---

Configuration of ACS-8990 can be accomplished using either the control panel or the embedded Monitor Utility, a convenient menu-based configuration utility, which is accessed through a dedicated terminal or host computer.

This chapter explains how to establish a connection between ACS-8990 and the host computer so that the Monitor Utility can be used. If you do not intend to access the Monitor Utility, this chapter can be ignored.

## Establishing a terminal connection

The Monitor Utility can be accessed from a dedicated terminal or a host PC with third party communication software that supports ANSI terminal emulation.

To use a dedicated terminal, simply connect the terminal to the RS232 head of the RAID controller's combo cable.

To access the Monitor Utility from a host PC, ensure that the RS232 head of the RAID controller's combo cable is attached to the host computer's COM port before. A connection must then be established between the host computer and the ACS-8990 RAID controller. This is done by means of a terminal program, such as HyperTerminal. This section outlines the process to set up a HyperTerminal connection.

Other terminal programs may be used in place of HyperTerminal to communicate with the RAID controller. However, the setup process for other terminal software may differ from that outlined in this chapter.



### Note

*HyperTerminal is bundled as standard with Microsoft Windows operating systems. It will be found in the Communications folder. The program can also be downloaded from Hilgraeve Software at <http://www.hilgraeve.com/hpte/>*



### Note

*This manual covers three models: ACS-8990, ACS-89200 and ACS-89230. Where references are made to ACS-8990, they should be taken as applying to all three models.*

1. Launch HyperTerminal from the desktop of the host computer (**Start > Programs > Accessories > Communications > HyperTerminal**).



2. The **Connection Description** dialog box will appear (if this is the first time you have run HyperTerminal, you will first be prompted to enter information about your location). Enter a name to identify the RAID controller connection (e.g. **Accusys** or **8990**) and select an icon to represent the connection. Press **OK**.

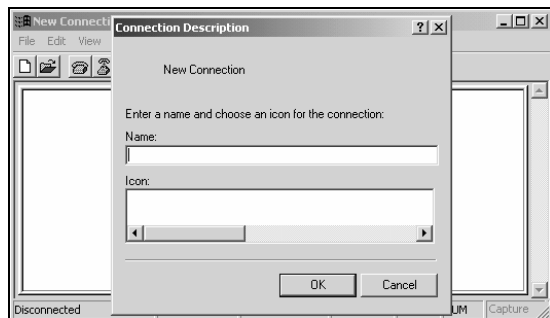

3. The **Connect to** dialog box appears. Select **COM1** or **COM2** from the **Connect using:** dropdown menu, depending on which port is linked to ACS-8990. Click **OK**.



4. The **COM Properties** dialog box will appear. Set the following values:  
 Bits per second: 115,200  
 Data bits: 8  
 Parity: None  
 Stop bits: 1  
 Flow Control: None
5. Click **OK**. The HyperTerminal connection to ACS-8990 is now established.

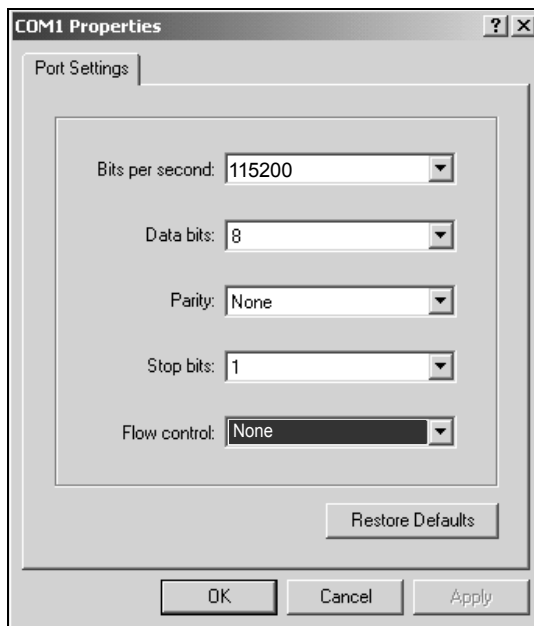

## Using the Monitor Utility

Once a connection has been set up between ACS-8990 and the host computer, first make sure ACS-8990 is turned on.

When ACS-8990 boots up, it enters Self-Diagnostic Mode and runs diagnostic tests. The first test covers the CPU and supporting core logic chips, the internal bus, memory, SCSI controller, Serial ATA controllers, and RS-232 controllers. The second diagnostic test checks for the presence of disks on each individual disk channel and the functionality of each disk found. The final diagnostic test checks RAID functionality.

The messages shown on the right will display as ACS-8990 runs through the tests. When complete, ACS-8990 will enter Operation Mode and the Monitor Utility window will show.

```
LCD initialize OK
Memory sizing...256MB
Memory testing.....OK
Move ROM code to System Memory...OK
Jump to System Memory
Startup system, please wait...
```



### Note

*To enlarge the size of the Monitor Utility window in HyperTerminal, select **Font...** from the **View** menu and increase the font size.*

RAID controller and Monitor Utility firmware model numbers

Control Panel LCD output

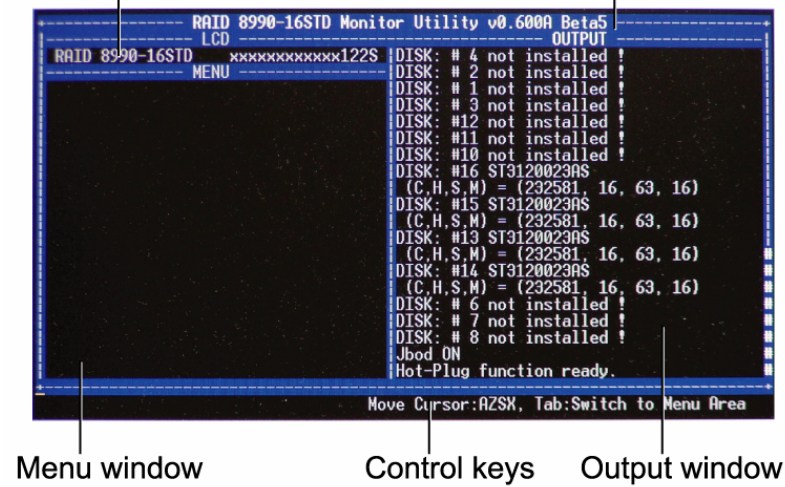

The Monitor Utility has four sections:

The **Top Bar** lists the RAID controller model number and the firmware (Monitor Utility) model number.

The **Control Panel LCD Output** panel mirrors the appearance of the controller box LCD. Full explanation of LCD messages is given in Appendix D.

The **Menu window** is the space into which menus are called up.

The **Output window** displays the current status of the RAID controller and RAID.

The **Control keys** enable the user to navigate through and between the output and menu areas.



### Monitor utility control keys

The monitor utility control keys differ depending on which area is active: Menu area or Output area. The control keys are listed at the bottom of the Monitor Utility screen.

#### Menu area controls

- A / ↑ Move cursor up
- Z / ↓ Move cursor down
- Esc Cancel a selection / return to previous menu
- Enter Select an option
- Tab Switch to Output area

#### Output area controls

- A Move cursor one line up
- Z Move cursor one line down
- S Scroll one page up
- X Scroll one page down
- Tab Switch to Output area



#### Note

*The Monitor Utility and control panel cannot be used at the same time.*

## Chapter 5

# Configuration

This chapter explains how to access and implement the complete suite of ACS-8990 configuration options using either the Monitor Utility or control panel. It contains:

- ⇒ An outline of the configuration process
- ⇒ An explanation of the configuration menu structure
- ⇒ Instructions on accessing the configuration menus
- ⇒ Diagrams of all menu options
- ⇒ Explanations of menu options
- ⇒ Instructions on how to update the ACS-8990 firmware

## Configuration overview

There are two aspects to configuration:

- Configuration of the RAID system and communication parameters
- Setting up and configuration of arrays within the RAID system

Users are advised to attend first to the system, then to the arrays.



### Note

*This manual covers three models: ACS-8990, ACS-89200 and ACS-89230. Where references are made to ACS-8990, they should be taken as applying to all three models.*

## System configuration

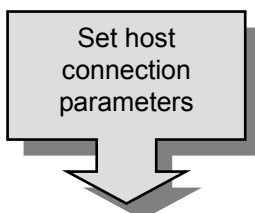
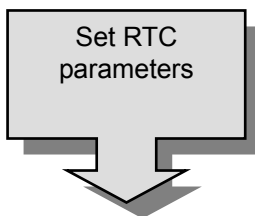

- When using the ACS-8990 for the first time, users will need to set the “**RTC parameters**”. Setting the **RTC** parameters will enable the controller to have **RTC** function. When an event occurs, the Log Event will therefore be able to record the event real time.
- Set host connection parameters. Users of the fibre host interface configuration of ACS-8990 should turn to *Setting fibre parameters*. Users of the SCSI host interface configuration of ACS-8990 should turn to *Setting SCSI parameters*.

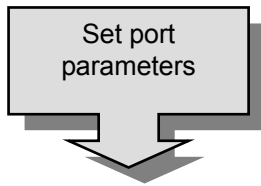

- Specify *communication* protocols between ACS-8990 and the external modem and between ACS-8990 and the remote terminal or terminal emulation software (if used). Turn to *Setting port parameters*.

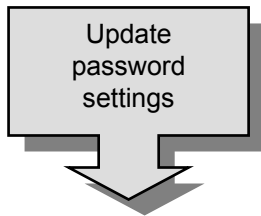

- The administrator should replace the default password. Turn to *Password security*.

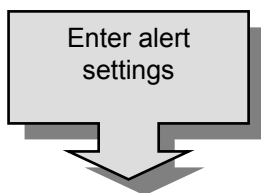

- The administrator can specify up to two fax numbers and two pager numbers to which alert messages will be sent in the event of an error with ACS-8990. Turn to *Entering and editing alert settings*.

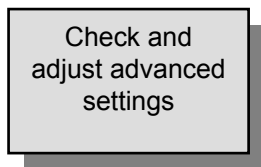

- The default settings are appropriate for most users. Turn to *Advanced settings*. Then proceed with RAID configuration.

### RAID configuration – simple

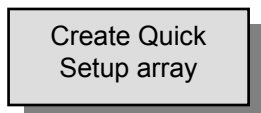

- Use the Quick Setup facility to set up an array using as many connected drives as possible. Turn to Chapter 3, *Quick Setup*.

### RAID configuration – standard

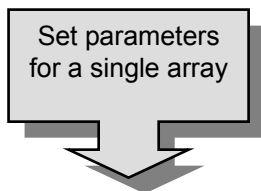

- Create a single array then set the following individual parameters:
  - RAID level
  - Number of disks
  - Number and size of slices

Turn to *Setting array parameters*

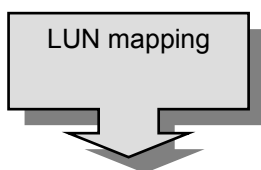

- Map each slice to a LUN. Users of the SCSI interface model should turn to *Setting SCSI parameters*. Users of the fibre channel interface model should turn to *Setting fibre channel parameters*.



- Save settings and restart. Turn to *Saving configurations*.

## RAID configuration – advanced

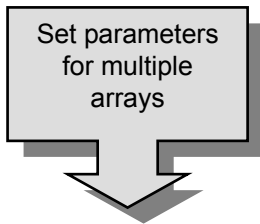

- Create several arrays. For each in turn set the following individual parameters:
  - RAID level
  - Number of disks
  - Number and size of slices

Turn to *Setting array parameters*

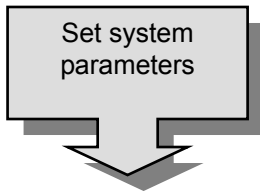

- Set the following parameters for the RAID system:
  - Striping block size
  - Write buffer (enable/disable)
  - Writing method (random / sequential)

Turn to *Setting array parameters*

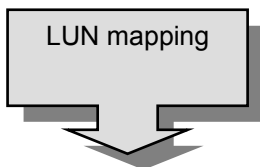

- Map each slice to a LUN  
Users of the SCSI interface model should turn to *Setting SCSI parameters*. Users of the fibre channel interface model should turn to *Setting fibre channel parameters*.



- Save settings and restart. Turn to *Saving configurations*.

## How to configure ACS-8990

There are two ways to configure ACS-8990:

- Using the Control Panel
- Using the Monitor Utility

These two methods are functionally identical. Only the interface differs. In each, the user scrolls through menus and submenus to locate and select the desired configuration option.



### Note

*For instructions on navigating through menus using the control panel, turn to the section **Control Panel** in Chapter 1.*



### Note

*A full list of Control Panel LCD messages is given in Appendix D.*



### Note

*For instructions on using the Monitor Utility, turn to the section **Using the Monitor Utility** in Chapter 4.*



### Note

*The control panel cannot be used in configuration mode while a Monitor Utility connection is running. If you wish to configure using the control panel, first exit the remote terminal.*

## Finding your way around the menus

The main menu is the hub for all configuration choices. It consists of seven submenus and one hidden submenu. All configuration options are exercised from within these submenus. The main menu, as viewed from the Monitor Utility, for the two available hardware configurations of ACS-8990 are shown below:

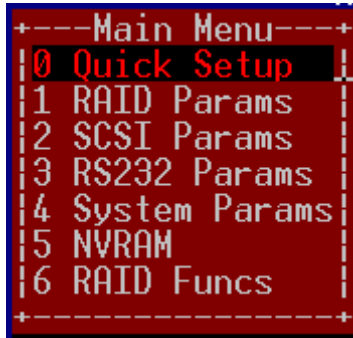

SCSI host interface configuration

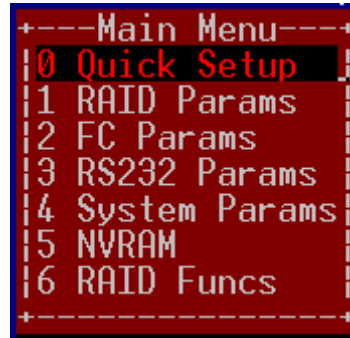

Fibre host interface configuration

The table below is a quick reference resource to help you find your way around the submenus:

Name of submenu	Functions
▪ Quick setup	▪ Quickly establish a single RAID– see Chapter 3
▪ RAID params	▪ Set parameters for a single or multiple arrays
▪ SCSI params*	▪ Set SCSI parameters such as SCSI ID, speed and LUN mapping
▪ FC params**	▪ Set fibre channel parameters, such as hard loop ID, connection mode, data rate and LUN mapping and enable/disable SAN masking
▪ RS232 params	▪ Set parameters for modem connection and RS232 connection to terminal
▪ System params	▪ Set / enable / disable password security ▪ Configure fax and pager alert settings
▪ NVRAM	▪ Save new configurations and restart RAID controller
▪ RAID funcs	▪ Initialize and check RAID 5 / 3 / 50/ 30 arrays ▪ Add and remove disks to existing arrays ▪ View system statistics ▪ Cancel error messages ▪ Alarm settings ▪ Expand array ▪ Disk Scrubbing /Clone/SMART ▪ Update firmware

\*SCSI host interface configuration only

\*\*Fibre host interface configuration only

## Accessing the main menu

The section describes in detail the steps needed to call up the main menu using both the Monitor Utility and Control Panel.

### Accessing the main menu using Monitor Utility

1. Run HyperTerminal (or the terminal program used to establish an RS232 connection with ACS-8990) and open the connection established with ACS-8990 in Chapter 4.
2. Press Ctrl D to launch the Monitor Utility.

When ACS-8990 boots up, it enters Self-Diagnostic Mode and runs diagnostic tests. The first test covers the CPU and supporting core logic chips, the internal bus, memory, SCSI controller, Serial ATA controllers, and RS-232 controllers. The second diagnostic test checks for the presence of disks on each individual disk channel and the functionality of each disk found. The final diagnostic test checks RAID functionality.

The messages shown on the right will display as ACS-8990 runs through the tests. When complete, ACS-8990 will enter Operation Mode and the Monitor Utility window will show. The menu area will be blank.

```

LCD initialize OK
Memory sizing...256MB
Memory testing.....OK
Move ROM code to System Memory...OK
Jump to System Memory
Startup system, please wait...

```

3. The Output area is active, press **Tab** once to switch to the Menu area.
4. With the Menu area active, press **Enter**. You will be prompted to enter a password.

```

----- RAID 8990-16 STD Monitor Utility v0.600A Beta11 -----
LCD
RAID 8990-16 STD *****
MENU
----- MENU -----
+----Password:----+
|  00000000      |
+----+
Use LBA Mode
Marvell 0: 64 bit PCI-X 100 MHz B0
Marvell 1: 64 bit PCI-X 100 MHz B0
DISK: #15 not installed !
DISK: #16 not installed !
DISK: #12 not installed !
DISK: #11 not installed !
DISK: #10 not installed !
DISK: # 9 not installed !
DISK: #14 not installed !
DISK: #13 not installed !
DISK: # 4 not installed !
DISK: # 2 not installed !
DISK: # 1 not installed !
DISK: # 3 not installed !
DISK: # 6 not installed !
DISK: # 7 not installed !
DISK: # 8 not installed !
DISK: # 5 not installed !
Hot-Plug function ready.
----- OUTPUT -----

```

5. Enter the password.



**Note**

The default password is **00000000** (eight zeros). The system administrator should change this on first login. The password can be changed under the *System params* menu.

6. Press **Enter**. The **Main Menu** will appear.

```

----- RAID 8990-16 STD Monitor Utility v0.600A Beta11 -----
LCD ----- OUTPUT -----
RAID 8990-16 STD  xxxxxxxxxxxxxxxxxxxx | Use LBA Mode
----- MENU ----- | Marvell 0: 64 bit PCI-X 100 MHz B0
+--- Main Menu ---+ | Marvell 1: 64 bit PCI-X 100 MHz B0
| 0 Quick Setup   | | DISK: #12 not installed !
| 1 RAID Params   | | DISK: #11 not installed !
| 2 SCSI Params   | | DISK: #10 not installed !
| 3 RS232 Params  | | DISK: # 9 not installed !
| 4 System Params | | DISK: #14 not installed !
| 5 NVRAM         | | DISK: #13 not installed !
| 6 RAID Funcs   | | DISK: #15 not installed !
+---+            | | DISK: #16 not installed !
                  | | DISK: # 4 not installed !
                  | | DISK: # 2 not installed !
                  | | DISK: # 1 not installed !
                  | | DISK: # 3 not installed !
                  | | DISK: # 6 not installed !
                  | | DISK: # 7 not installed !
                  | | DISK: # 8 not installed !
                  | | DISK: # 5 not installed !
                  | | Hot-Plug function ready.
-----+-----+-----+
AZ:Move Cursor, ESC:Exit, Enter:Enter, Tab:Switch to Output Area
    
```



**Note**

The main menu varies slightly depending on the hardware configuration of the model purchased. The main menu of the fibre host interface configuration has a *FC (fibre channel)* submenu. The main menu of the SCSI host interface configuration has a *SCSI params* submenu. These submenus are dealt with separately in this chapter.



## Accessing the main menu using the control panel

ACS-8990-16 STD   
xx111xxxxxxxxxxxx

Enter Passwd:   
00000000

1. Turn on ACS-8990. The controller will first enter Self-Diagnostic Mode and then enter Operation Mode. A typical Operation Mode screen is shown
2. Press **Enter** to enter Configuration Mode. You will be prompted to enter the password. The default password is **00000000** (eight zeros). To enter this, simply press **Enter** eight times. Press **Enter** again to submit.



### Note

*The default password is **00000000** (eight zeros). The system administrator should change this on first login. The password can be changed under the **System params** menu. See **Password Security**.*

Main menu  
0 Quick Setup

3. You enter the main menu. Use the scroll keys to highlight the names of submenus and press **Enter** to select.



### Note

*The main menu varies slightly depending on the hardware configuration of the model purchased. The main menu of the fibre host interface configuration has an **FC** (fibre channel) submenu. The main menu of the SCSI host interface configuration has a **SCSI params** submenu. These submenus are dealt with separately in this chapter.*

## Setting array parameters

The parameters of the single or multiple ACS-8990 RAID arrays are set and reconfigured from the **RAID params** submenu located at Main menu > RAID Params menu.

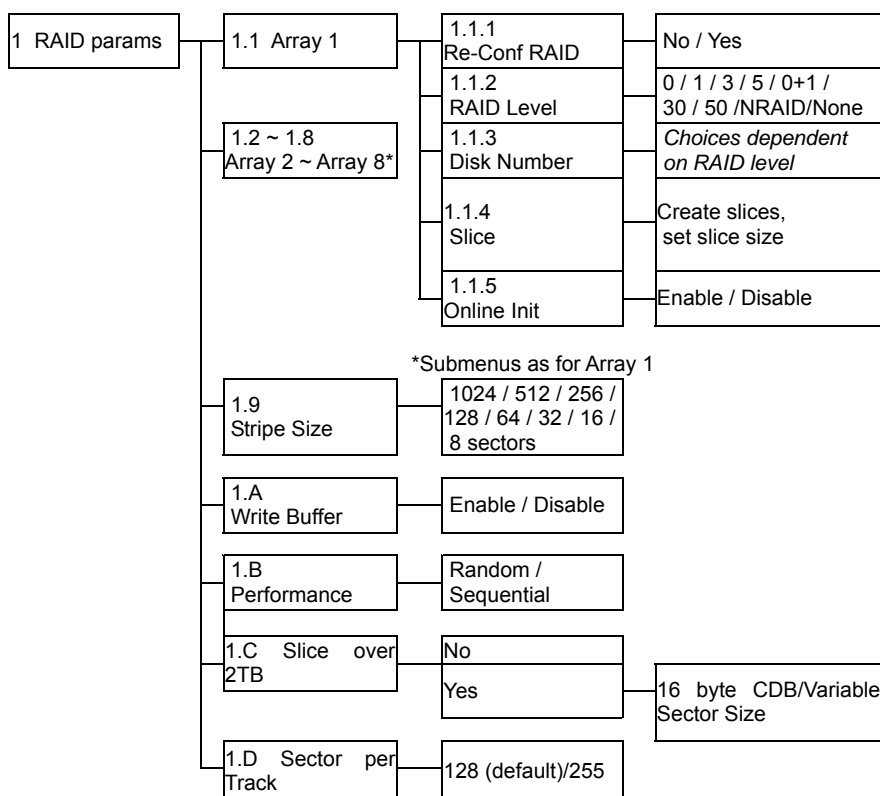

To create one or several arrays and to set their parameters:

1. If you have no existing arrays that you wish to keep, select Array 1 (1.1). Otherwise, select the next available array (1.2 ~ 1.8)
2. Signal intent to reconfigure the selected array (1.x.1)
3. Choose a RAID level for the selected array (1.x.2)
4. Indicate the number of disks to be included in the selected array (1.x.3). Remember to leave at least 1 disk free if you want a hot spare disk to be automatically configured
5. Partition the array into one or more slices (1.x.4)
6. If you wish to create another array, repeat from step one. If not, continue

Next, make sure these parameters are set for the arrays collectively:

7. Set the striping block size (1.9)
8. Enable or disable the buffer for write operations to memory (1.A)
9. Set writing method as random or sequential (1.B)
10. Set the Slice over 2TB or not (1.C)
11. Set the Sector Per Track as 128 or 255 (1.D)

Finally,

12. Go to the NVRAM menu to save the new configuration (5.1). Then restart (5.3)

## RAID params menu

### 1.1 Array 1

Configure / reconfigure array 1

#### 1.1.1 Re-Conf RAID

Select **No** or **Yes**.



**Note**

*To avoid accidental erasure of an existing RAID, **Yes** must be selected prior to saving of any RAID configuration*



**Caution**

*Data lost during reconfiguration cannot be recovered. You are strongly advised to backup all data before reconfiguring.*

#### 1.1.2 RAID Level

Select **0, 1, 0+1, 3, 5, 30, 50, NRAID** or **None**.



**Note**

*To remove an existing RAID, reconfigure the array with RAID level set to **None**. The disks will be configured as a JBOD array. If, for instance, four disks are connected, the Control Panel / Monitor Utility readout will show  
XXXXXXXXXXXXXXXXJJJJ.*

#### 1.1.3 Disk Number

Select the number of disks in the RAID.



**Note**

*Ensure the required number of disks for all arrays is connected before configuring an array. RAID Levels 3 and 5 require a minimum of 3 disks, RAID Level 1 a minimum of 2 disks, RAID Level 0 a minimum of 1 disk, RAID 0+1 a minimum of 4 disks and RAID 30 and RAID 50 each a minimum of six disks.*



**Note**

*The number of disks in the array does not include the “hot spare” disk. A hot spare disk will automatically be added to an array if extra disks are connected. If, for instance 4 disks are connected and a RAID 0 is set up with just three disks, the extra disk will be added to the array as a hot spare. The Control Panel / Monitor Utility readout will show  
XXXXXXXXXXXXXXXX111S signaling that three disks are configured in array 1 and a fourth disk is a spare.*

**1.1.4 Slice**

Open this submenu to partition the array into different slices (identified as Slice 0, Slice 1 etc.). All RAID capacity is assigned by default to Slice 0 – i.e. to a single partition.

**1.1.4.1~ Slice 0~**

**1.1.4.G Slice 15**

Input the size in MB of each slice. All RAID capacity is assigned by default to Slice 0. If the user reduces the size of Slice 0, all excess capacity will be assigned automatically to Slice 1, and so on through the list. Slices (partitions) are created in this way. If no capacity is allocated to a slice, that slice will not be created.



**Note**

*A slice must be mapped to a LUN before it can be accessed. After creating slices, users should go to the FC (fibre channel) / SCSI Params menu (depending on ACS-8990 model) to map each to a LUN.*

**1.1.5 Online Init**

Host can access data while array is in initiation

**1.2 Array 2  
~ 1.8 ~ Array 8**

Configure / reconfigure arrays 2, 3, 4, 5, 6, 7 and 8 (ignore if a single array is sufficient)



**Note**

*The Control Panel / Monitor Utility readout shows which disks are part of which array. If the readout shows xxxxxxxxxxxxxx1112S, five disks are connected: three in array 1, one in array 2 and one as a spare.*

### 1.9 Stripe Size

Set the striping block size, either **8, 16, 32, 64, 128, 256, 512** or **1024** sectors (Default: 128 sectors).



#### Note

*Stripe size is constant for any RAID system, whether it consists of a single or multiple arrays.*



#### Note

*User could not set "Stripe size" again when array been created.*



#### Note

*Smaller stripe sizes provide faster access for small randomly-accessed files. Larger stripe sizes increase transfer rates for large sequentially-accessed files (such as video).*

### 1.A Write Buffer

**Enable** or **Disable** buffer for write operations to memory (Default: Enable).

### 1.B Performance

Set writing method as **Random** or **Sequential**.



#### Note

***Sequential** is best suited to saving large amount of data, **Random** to saving smaller amounts of data.*



#### Note

*Configuration changes made in the RAID Params menu must be saved to the ACS-8990 non-volatile memory and ACS-8990 restarted for the changes to take effect. This is done in the NVRAM menu accessed from the Main menu.. See Saving Configurations later in this chapter.*

### 1.C Slice over 2TB

Select "16 Byte CDB" or "Variable Sector Size" to create the slice could over 2TB

**16 Byte CDB** (Command description block): It's a standard SCSI command

**Variable Sector Size:** under this option, you could select **1K/sector (4T)** or **2K/sector (8T)** or **4K/sector (16T)**.

The value in ( ) means the maximum capacity limitation per slice.



**Note**

*User need to set the params of "slice over 2TB" before array been created.*

**1.D**

**Sector per Track**

Select 128 or 255 (Default:128)

All OS configures as 128 except Solaris X86.

If your OS is Solaris X86, and LUN with size over 500GB, this option should be configures as 255.



**Note**

*User could not use "Slive over 2TB" and "Sector per Track" function when the array been created..*

## Setting SCSI parameters

The parameters of the SCSI connection(s) to the host(s) are set and reconfigured from the SCSI Params submenu located at Main menu > SCSI Params menu. The settings are needed to avoid conflict with the SCSI adapter or other SCSI devices



### Note

*ACS-8990 is available in two hardware configurations: With a fibre channel interface and with a SCSI interface. The SCSI Params menu is only present on the SCSI interface configuration. User of the fibre channel interface model should ignore this section.*

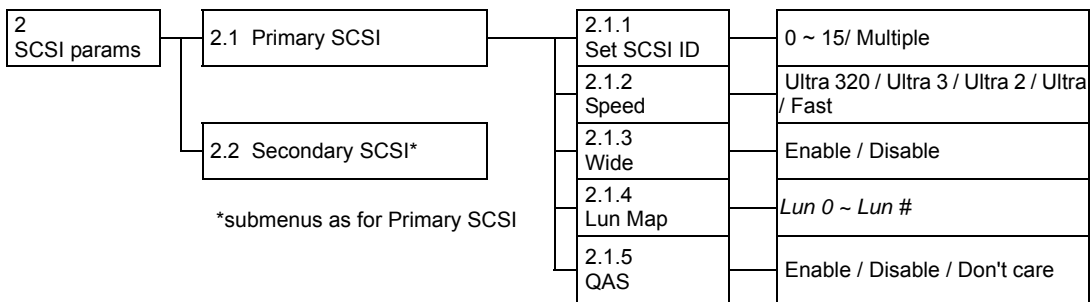

### SCSI params menu

#### 2.1 Primary SCSI

Submenu for configuring Primary SCSI settings

#### 2.1.1 Set SCSI ID

Select **0** to **15** or **Multiple** (Default: 0). ID 7 is reserved for the SCSI card.

#### 2.1.2 Speed

**Ultra 320**, **Ultra 3**, **Ultra 2**, **Ultra** or **Fast** (Default: Ultra 320). See table below for settings.

2.1.3 Wide

Enable or Disable (Default: Enable).

SCSI Interface	Wide	Fast	Ultra	Ultra2	Ultra 3	Ultra 320
SCSI-2	Disable	[ENT]				
Wide SCSI	Enable	[ENT]				
Ultra SCSI	Disable		[ENT]			
Ultra Wide SCSI	Enable		[ENT]			
Ultra 2 SCSI	Enable			[ENT]		
Ultra 160 SCSI	Enable				[ENT]	
Ultra 320 SCSI	Enable					[ENT]

2.1.4 Lun Map

Select a Logical Unit Number (LUN 0 to LUN 7) or enter the desired LUN (LUN #, up to LUN 127) and a corresponding slice on which to map it.



**Note**

*A RAID may be divided into several logical units (that portion of a disk array seen by the host system as a single logical device). ACS-8990 can support up to 16 logical units in total.*

2.1.5 QAS

Enable or Disable (Default: Enable).

Quick Arbitration and Selection provides increased overall system performance by allowing arbitration to occur without incurring the overhead of intervening BUS FREE phases, saving up to microseconds per operation. This is significant when compared to the 1.6 microseconds it takes to transfer each 512-byte sector of data at 320MB/sec. Rather than waiting for a BUS FREE phase, a target may initiate arbitration by issuing a QAS REQUEST message. The devices on the bus may "SNOOP" the message and participate in the arbitration. QAS can only be enabled if information unit transfers are **enabled**.

Because of ACS7485 (LSI53C1030T SCSI chip) had some compatible issue with other HBA vendor, so F/W had created a QAS menu item to avoid this issues.

HBA Vendor	QAS setting
-----	
Adaptec	Enable (Default)
LSI	Disable
ATTO	Don't care

Please follow above table to match your test environment.





**Note**

*Please turn on the QAS option if HBA vendor is Adaptec.  
Please turn off the QAS option if HBA vendor is LSI.*

**2.2 Secondary SCSI**

Submenu for configuring Secondary SCSI settings for use in multiple host topology (submenu items as above)



**Note**

*Configuration changes made in the SCSI Params menu must be saved to the ACS-8990 non-volatile memory and ACS-8990 restarted for the changes to take effect. This is done in the NVRAM menu accessed from the Main menu.. See Saving Configurations later in this chapter.*

## Setting fibre channel parameters

The parameters of the fibre channel connection(s) to the host(s) are set and reconfigured from the FC (fibre channel) params submenu located at Main menu > FC params menu.



### Note

ACS-8990 is available in two hardware configurations: With a fibre channel interface and with a SCSI interface. The FC Params menu is only present on the fibre channel interface configuration. User of the SCSI interface model should ignore this section.

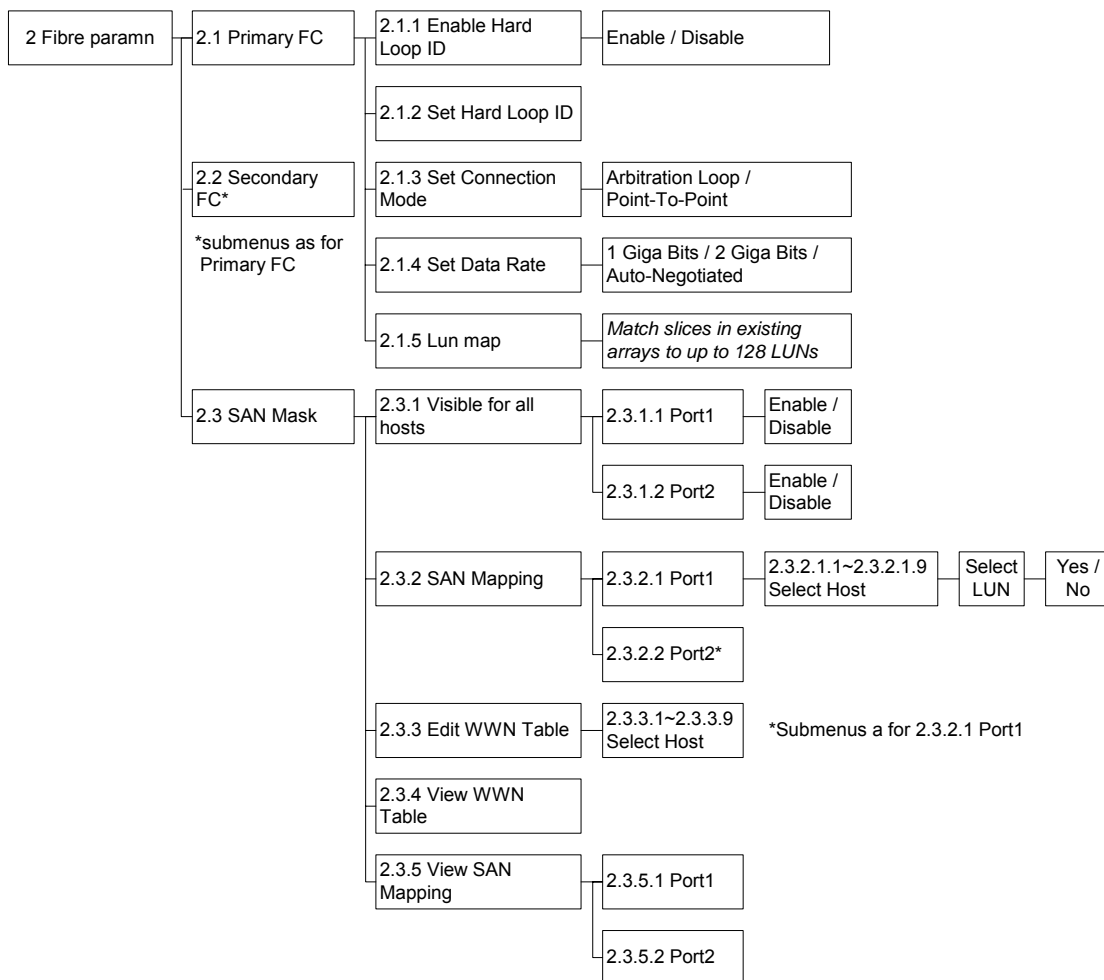

## FC params menu

### 2.1 Primary Fibre

Submenu for configuring Primary Fibre settings

#### 2.1.1 Enable Hard Loop ID

**Enable** Hard Loop ID if you wish to enter the ID manually. **Disable** to have the ID set by the controller (Default: Disable).

#### 2.1.2 Set Hard Loop ID

Enter the Hard Loop ID for this controller (only applicable if 2.1.1 is set to Enable).

#### 2.1.3 Set Connection Mode

**Arbitration Loop** or **Point-to-Point** (Default: Arbitration Loop).

#### 2.1.4 Set Data Rate

**1 Giga-bits**, **2 Giga-bits** or **Auto-negotiated** (Default: Auto-negotiated).

#### 2.1.5 Lun Map

Select a *Logical Unit Number* (**LUN 0** to **LUN 7**) or enter the desired LUN (**LUN #**, up to LUN 127) and a corresponding slice on which to map it.

### 2.2 Secondary FC

Submenu for configuring Secondary Fibre Channel settings for use in multiple host topology (submenu items 2.2.1 to 2.2.5 as above)



#### Note

*Configuration changes made in the FC Params menu must be saved to the ACS-8990 non-volatile memory and ACS-8990 restarted for the changes to take effect. This is done in the NVRAM menu accessed from the Main menu.. See Saving Configurations later in this chapter.*

### 2.3 SAN Mask

SAN Mask (LUN Masking) is a differentiation tool for use on fibre networks based on the unique Worldwide Name (WWN) of each fibre card. SAN Masking allows an administrator to specify which hosts are able to see the RAID controller.

#### 2.3.1 Visible For All Hosts

Use this submenu to select whether the RAID controller is visible to connected hosts.

#### 2.3.1.1 / 2.3.1.2 Select Port

**Port 1** or **Port 2**. The two ports are equivalent to the two host channels. Then choose **Enable** (to allow hosts on that channel to view ACS-8990) or **Disable** (to make ACS-8990 invisible to hosts on that channel).

**2.3.2 SAN Mapping**

SAN Mapping allows the administrator to map individual LUNs to a specified host thereby limiting access to certain slices to single hosts even in a dual host configuration.

**2.3.2.1 / 2.3.2.2 Select Port**

**Port 1** or **Port 2**. The two ports are equivalent to the two host channels.

**2.3.2.x.1 Select Host**

~

**2.3.2.x.9** Select **Host 1 ~ Host 8** or enter host number (**Host #**, up to 32), then select LUN (**LUN 0 ~ LUN 7**, **LUN #**, up to 127) and confirm selection.

**2.3.3 Edit WWN Table**

This submenu allows the administrator to enter individual host WWNs to the controller.

**2.3.3.1 ~ 2.3.3.9 Select Host**

Select **Host 1 ~ Host 8** or enter host number (**Host #**, up to 32).

**2.3.4 View WWN Table**

Select to view a list of host WWNs in the output window (this information cannot be viewed from the control panel).

**2.3.5 View SAN Mapping**

Use this submenu to view a table indicating mapping of LUNs to hosts in the output window (this information cannot be viewed from the control panel).

**2.3.5.1 / 2.3.5.2 Select Port**

**Port 1** or **Port 2**. The two ports are equivalent to the two host channels.

## Setting port parameters

### RS232 Params menu

The administrator should specify the communication protocols between ACS-8990 and the external modem and between ACS-8990 and the remote terminal or terminal emulation software. This is done in the **Modem Port menu** located at Main menu > RS232 Params menu > Modem Port menu and the **Terminal Port menu** located at Main menu > RS232 Params menu > Terminal Port menu.

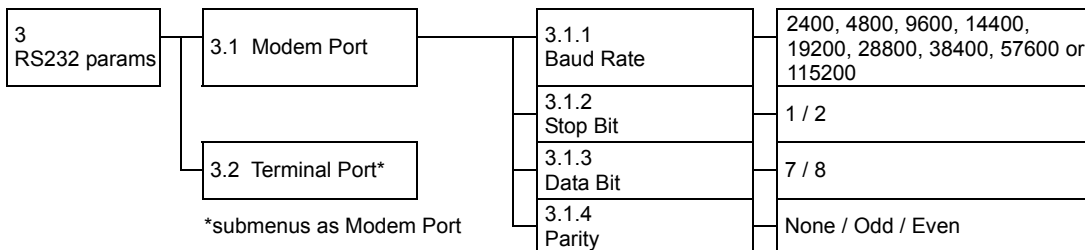

## Modem Port menu

### 3.1 Modem port

Set the baud rate, Stop bit, data bit and parity parameters for the modem port to match those of the modem (see modem product documentation).

#### 3.1.1 Baud Rate

**2400, 4800, 9600, 14400, 19200, 28800, 38400, 57600** or **115200** (Default: 19,200)

#### 3.1.2 Stop Bit

**1** or **2** (Default: 1)

#### 3.1.3 Data Bit

**7** or **8** (Default: 8)

#### 3.1.4 Parity

**None, Odd** or **Even** (Default: None)

## Terminal Port menu

### 3.2 Terminal Port

Set the baud rate, Stop bit, data bit and parity parameters for the terminal port to match those of the host.

#### 3.2.1 Baud Rate

**2400, 4800, 9600, 14400, 19200, 28800, 38400, 57600** or **115200** (Default: 115,200)

#### 3.2.2 Stop Bit

**1** or **2** (Default: 1)

#### 3.2.3 Data Bit

**7** or **8** (Default: 8)

#### 3.2.4 Parity

**None, Odd** or **Even** (Default: None)



#### Note

*The remote terminal settings and those of ACS-8990 must match. So, if the administrator increases the baud rate of the ACS-8990 port, the baud rate of the terminal emulation software (e.g. HyperTerminal) connection must likewise be increased.*

## Password security

The administrator can enable password security and set the password from the **Password Info** submenu located at Main menu > System Params menu > Password Info

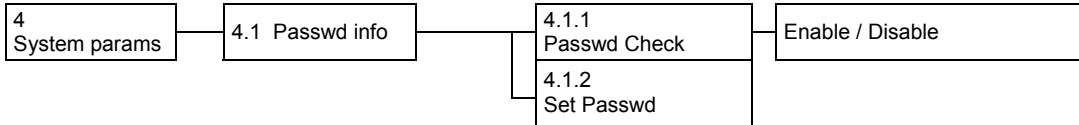

### Password Info menu

#### 4.1.1 Passwd check

**Enable** or **Disable** the Password security feature. When enabled, users will be asked to enter the password when first accessing the main menu (Default: Disable).

#### 4.1.2 Set Passwd

Enter a password of up to eight alphanumeric figures. The default password is **00000000** (eight zeros).



#### Note

*Configuration changes made in the Password Info menu must be saved to the ACS-8990 non-volatile memory to take effect. This is done in the NVRAM menu accessed from the Main menu.. See Saving Configurations later in this chapter.*

## Entering and editing alert settings

The administrator can specify two fax numbers and two pager numbers to which alert messages will be sent in the event of an error with ACS-8990. To configure alert settings, follow the instructions in succeeding sections to:

1. Configure pager settings
2. Configure fax settings
3. Configure modem

Update settings in the NVRAM submenu



#### Note

*A modem must be connected to ACS-8990 via the combo cable modem connector for the alert feature to work.*

## Pager alert settings

Pager alert settings are all entered and edited from the **Pager Info** submenu, located at Main menu > System Params menu > Pager Info

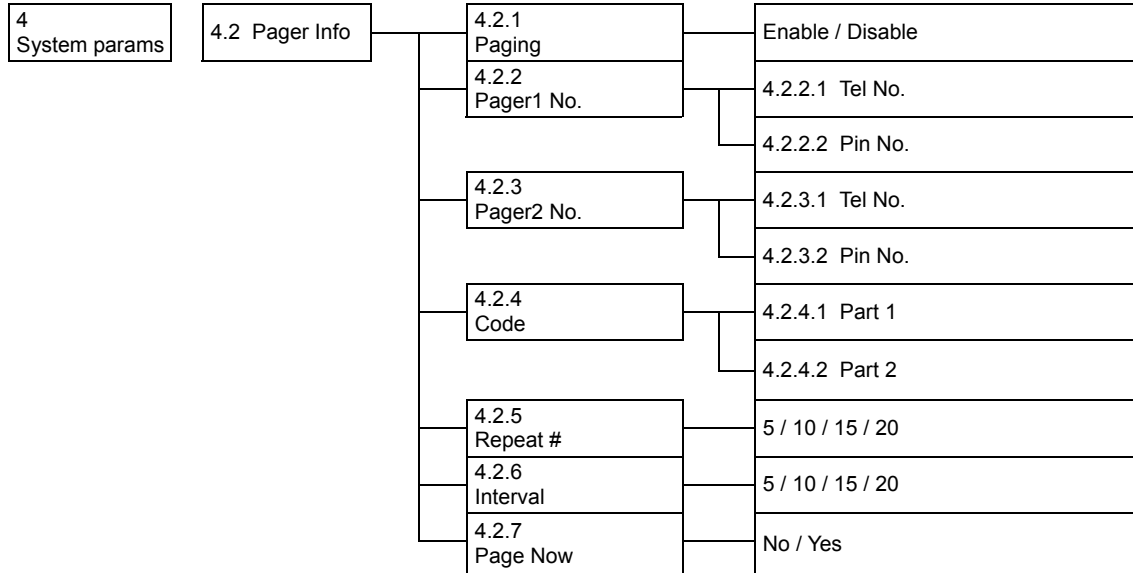

### Pager Info menu

#### 4.2.1 Paging

**Enable** or **Disable** the Pager alert function (Default: Disable)

#### 4.2.2 Pager1 No.

Enter the first pager's terminal **telephone number** (also called the 'port number' or 'TAP port number') and the pager **pin number** (if required for pager). Maximum 16 characters.

#### 4.2.3 Pager2 No.

Enter the second pager's terminal telephone number (also called the 'port number' or 'TAP port number') and the pager pin number (if required for pager). Maximum 16 characters.

#### 4.2.4 Code

Enter the alert message for pager 1 under **Part 1**.  
Enter the alert message for pager 2 under **Part 2**.



**Note**

*Pager alert messages may be up to 16 alphanumeric characters in length for part 1 and may be up to 12 alphanumeric characters in length for part 2.*

#### 4.2.5 Repeat #

Select how many times the alert message(s) should be sent: **5, 10, 15** or **20** times (Default: 5).

**4.2.6 Interval**

Select the interval between dispatch of repeated alert messages: **5, 10, 15** or **20** minutes (Default: 5).

**4.2.7 Page Now**

Select **Yes** to instruct ACS-8990 to send a test pager alert immediately.



**Note**

*When the above data has been entered appropriately, go to the NVRAM submenu to update settings so that the configuration changes are saved.*

**Fax alert settings**

Fax alert settings are entered and edited from the **Fax Info** submenu, located at Main menu > System Params menu > Fax Info

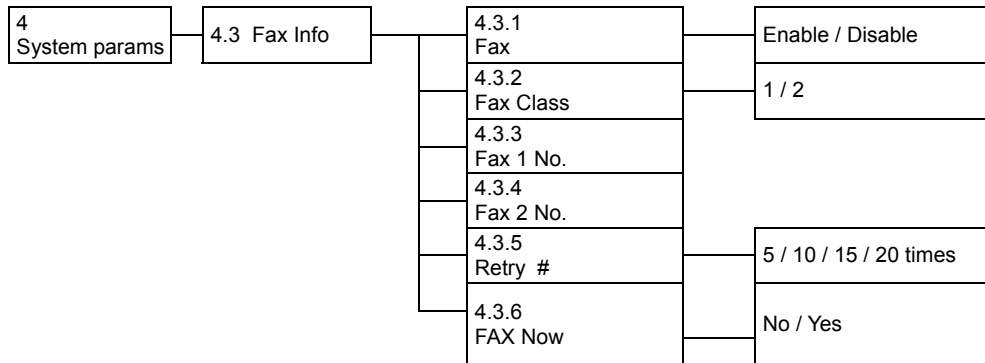

The fax content is the system data displayed from the **Statistic** submenu (7.7)

**Fax Info menu**

**4.3.1 FAX**

**Enable** or **Disable** the Fax alert function (Default: disable).

**4.3.2 FAX Class**

Define the Fax class supported by the modem, either **1** or **2**.

**4.3.3 FAX1 No.**

Enter the first fax number (two alert fax numbers can be input).

**4.3.4 FAX2 No.**

Enter the second fax number (two alert fax numbers can be input).

**4.3.5 Retry #**

Select how many times the alert message(s) should be sent: **5, 10, 15** or **20** times (Default: 5).

**4.3.6 FAX Now**

Select **Yes** to instruct ACS-8990 to send a test fax alert immediately.



The alert fax header should be input in the **Company Info** submenu, located at Main menu > System Params menu > Company Info

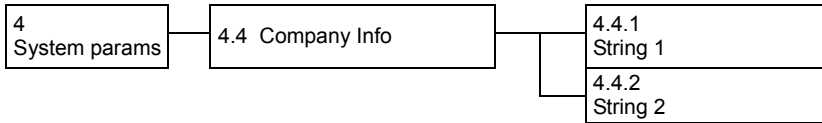

### Company Info menu

#### 4.4.1 String 1

Enter the first line of information to be used as the alert fax header (up to 16 alphanumeric characters).

#### 4.4.2 String 2

Enter the second line of information to be used as the alert fax header (up to 16 alphanumeric characters).

**Note**

*When the above data has been entered appropriately, go to the NVRAM submenu to update settings so that the configuration changes are saved.*

### Modem settings

Before the fax and pager alerts are used the default Modem Initialization string should be confirmed or a new string entered. Do this in the **Modem Init St** submenu, located at Main menu > System Params menu > Modem Init St

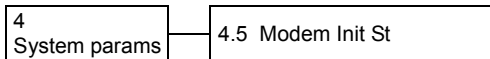

### Modem Init St menu

#### 4.5 Modem Init St

Configures the modem you are using for the remote notification feature.

**Note**

*The default string is a generic string compatible with most modems. Refer to your modem user's guide to check if your modem requires a different string.*

**Note**

*Configuration changes made in the System Params menu must be saved to the ACS-8990 non-volatile memory for the changes to take effect. This is done in the NVRAM menu accessed from the Main menu.. See Saving Configurations later in this chapter.*

## Saving configurations

Any configuration changes made by the administrator must be saved to the non-volatile memory (NVRAM). This is done in the **NVRAM menu** accessed from the Main menu



### Caution

*Any changes made in this menu will cause data on the drives to be permanently erased. ACS-8990 should be offline before configuration changes are saved.*

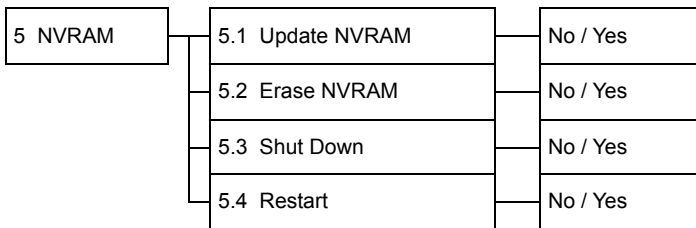

## NVRAM menu

### 5.1 Update NVRAM

**Yes** or **No** (default: No)

Select **Yes** to store latest configuration settings in NVRAM

### 5.2 Erase NVRAM

**Yes** or **No** (default: No)

Select **Yes** to clear contents of NVRAM and restore configuration defaults

### 5.3 Shut Down

**Yes** or **No** (default: No)

To ensure that data is not lost or corrupted, always turn off ACS-8990 using the Shut Down command. To shut down, first shut down the terminal/host system, then select Shut Down from the NVRAM menu. Finally, power off ACS-8990.

### 5.4 Restart

**Yes** or **No** (default: No)

Select **Yes** to restart ACS-8990.



### Note

*ACS-8990 must be restarted for any configuration changes made within the Quick Setup, RAID params and SCSI//FC params menus to take effect.*

*Configuration changes made from the RS232, System Params and RAID Funcs menus do not require restart.*

## Advanced settings

### RAID Functions menu

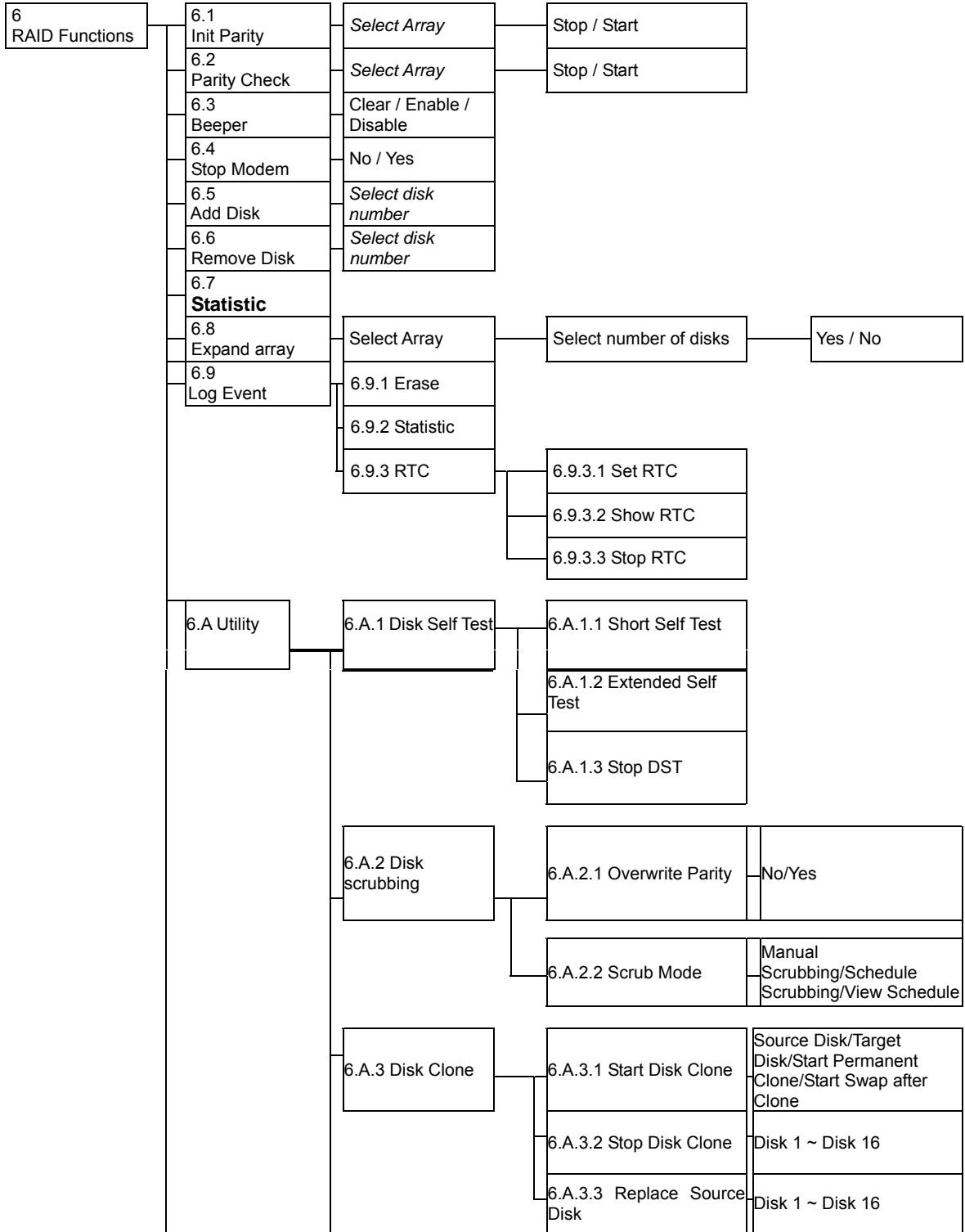

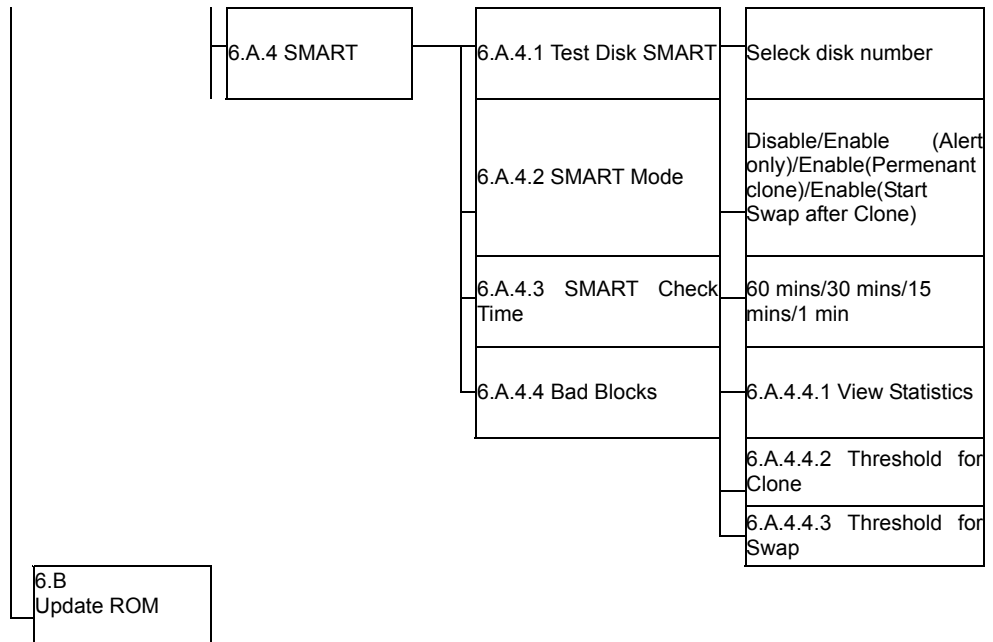

6.1

**Init Parity**

Select an **Array** and then **Stop** or **Start** (Default: Stop) to initialize an existing RAID 5 or RAID 3 array

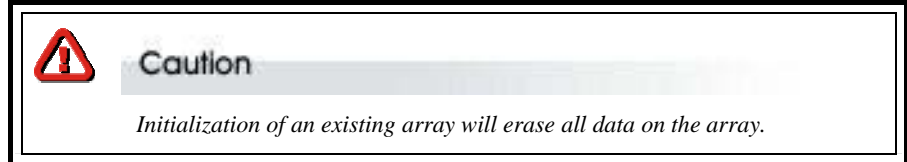

6.2

**Parity Check**

Select an **Array** and then **Stop** or **Start** (Default: Stop) to check a RAID 5 or RAID 3 array for errors.

6.3

**Beeper**

**Clear** (to silence a sounding beeper), **Enable** or **Disable** beeper function (Default: Enable).

6.4

**Stop Modem**

**No** or **Yes**

Select **Yes** to halt the transmission of subsequent alert faxes / pager messages when the message has been received and acknowledged (Default: No).

6.5

**Add Disk**

Select disk number (1 to 16)  
Add a disk to an existing configuration while ACS-8990 is online (Default: None).

6.6

**Remove Disk**

Select disk number (1 to 16)

Remove a disk from an existing configuration while ACS-8990 is online. This function enables the administrator to shut down a potentially faulty disk. If a spare drive is present, it will automatically be added (Default: None).

6.7

## Statistic

Display system data in Monitor Utility output window (this information cannot be viewed from the control panel). Data includes:

- Current settings saved in NVRAM
- Statistical analysis of read and write operations plus percentage of cache hits

For full details of the **Statistics** output, see Appendix G, **Statistics**.

6.8

## Expand Array

Select array to be expanded and then the number of disks in the new array.



### Note

*Ensure that new disk capacity is equal to or larger than current on-line capacity. To expand an array. To expand disk capacity:*

- ⇒ Connect new disk
- ⇒ Use Expand Array menu to select the number of disks in the array
- ⇒ Go to the Slice menu (1.1.4). The new capacity will appear in a new slice. So if you have already set up Slice0, Slice1 and Slice2, the new capacity will form Slice3. If no slices have been formed before (i.e. there is only one partition: Slice0), the new capacity will be in Slice1.



### Caution

*Expanding an array increases array capacity but data may sometimes be lost. You are strongly advised to make a system backup before proceeding.*

6.9

## Log Event

6.9.1

### Erase

Erase event log

6.9.2

### Statistic

6.9.3

### RTC

Adjust Real Time Clock Settings.



### Note

*When using the ACS-8990 for the first time, users will need to set the “RTC parameters”. Setting the RTC parameters will enable the controller to have RTC function. When an event occurs, the Log Event will therefore be able to record the event real time.*

- 6.9.3.1 Set RTC**  
 Enter time in MM/DD/YY W HH:MM format.  
 MM: Month; DD: Day; YY: Year; W: Week; HH: Hour; MM: Minute.
- 6.9.3.2 Show RTC**  
 Select to have time displayed on control panel
- 6.9.3.3 Stop RTC**  
 Select to turn off RTC
- 6.A.1 Disk Self Test (DST)**  
 To detect the disk's status
- 6.A.1.1~6.A.1.2 Short Self Test or Extended Self Test**  
 Choose one of the two functions to do all disks or Disk 1~Disk 16 detection
- 6.A.1.3 Stop DST**
- 6.A.2 Disk Scrubbing**  
 To prevent unrecoverable data loss & recover bad blocks & fix parity errors  
 It provides below advantage:

  1. without halting normal access, but it has impact to the system's overall performance.
  2. disk scrubbing can be started and processed simultaneously for multiple array



**Note**

1. *Before disk scrubbing starts, the array must be in optimal state, that means, there is no failed member disk and no background task, such as adding a disk , expanding array **or degraded mode***
2. *After disk scrubbing starts, users can not start any other background task and the array cannot be deleted. But, the disk scrubbing could be stopped by users manually or by the controller exception conditions.*

- 6.A.2.1 Overwrite Parity**  
**No or Yes (Default:No???)**  
 If parity inconsistency is detected during the disk scrubbing, the controller will overwrite the parity
- 6.A.2.2 Scrub Mode**
- 6.A.2.2.1 Manual Scrubbing**  
 Users can select one or all arrays for start disk scrubbing or stop it any time
- 6.A.2.2.2 Schedule Scrubbing**

Users could set up the schedule for disk scrubbing for one or all arrays . After select ON, users could select Once / Once per 1 week/Once per 4 weeks/ Once per 8 weeks/ Once per 12 weeks / Once per 16 weeks / Once per 20 weeks / Once per 24 weeks to execute scrubbing schedule function



**Note**

1. *When the array is not in the optimal state, the controller will give up disk scrubbing and record this event in the event log. Or,*
2. *If the controller is not in power-on state at the schedule time, when restart, the controller will record this event to notify users that the disk scrubbing is not executed.*

**6.A.2.2.3 View Schedule**

User could select this option to check the disk scrubbing schedule

**6.A.3 Disk Clone**

Disk Clone is like as mirroring, it's to prevent failure of hard disks from data loss and unscheduled performance degradation.

It provides below advantage:

1. Disk cloning can be started and process without halting the host's normal access, it will impact the system's overall performance.
2. Disk cloning can be started and process for multiple array simultanelously.



**Note**

*Before disk cloning starts, the array must be in optimal state:*

- ✓ *No failed member disk*
- ✓ *No background task, such as adding a disk or disk scrubbing or array expanding or degraded mode*

*After disk cloning starts,*

- ✓ *No background task can be started for the array of the selected source disk*
- ✓ *Array cannot be deleted*
- ✓ *User could stop disk cloning manually or by controller cause of some exception conditions such as controller power off, disk failures, array failure, or unrecoverable bad blocks on source disk.*

**6.A.3.1 Start Disk Clone**

Users can select this function if they want to do disk clone

**6.A.3.1.1~6.A.3.1.2 Source Disk & Target Disk**

Choose the source disk first from the displayed array member and then choose which one disk will be the target disk to be cloned.

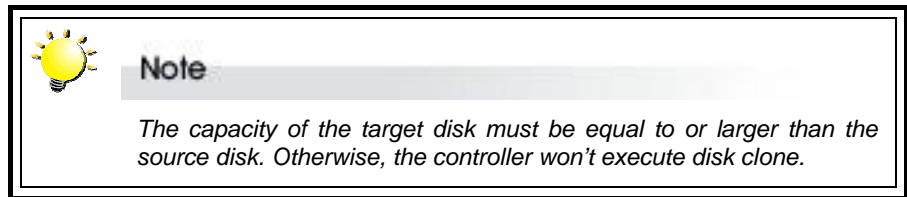

**6.A.3.1.3**

**Start Permanent Clone**

**YES or NO**

After the background copying is done, the disk cloning will remain in the mirroring state . If select YES, the controller will keep both disks synchronized permanently and replace the source disks when needed.

**6.A.3.1.4**

**Start Swap after Clone**

After execute this function, the source disk array will be replaced by the clone disk, and it will be taken off-line.

**6.A.3.2**

**Stop Disk Clone**

The disk cloning operation could be stopped any time by users manually.

**6.A.3.3**

**Replace Source Disk**

Users can manually replace the source disk by the clone disk when a clone disk has completed the background copying task, and stays in the mirroring state.

**6.A.4**

**SMART (Self-Monitoring, Analysis, and Reporting Technology)**

It is to protect user data and minimize the likelihood of unscheduled system downtime that may be caused by predictable degradation and/or fault of the drive. By monitoring and storing critical performance and calibration parameters, drives with SMART / DST feature enabled attempt to predict the likelihood of near-term degradation or fault condition. Providing the host system the knowledge of a negative reliability condition allows the host system to warn the user of the impending risk of a data loss and advise the user of appropriate action.

**Remark: above data was refered from Maxtor GEN0339 user guide**

**6.A.4.1**

**Test Disk SMART**

Users can check if a hard disk supports SMART and the current status of one or all disks.

**6.A.4.2**

**SMART Mode**



- **Disable:**if users select Disable, the SMART function of all hard disks will be disabled. If a hard disk warn, users could not get the warning message and check the hard disks' health status.
- **Enable(Alert only):**if this mode be selected, the controller will enable the SMART function to check the health status of all disks, but, it won't have clone function. When disks signal SMART warning, the controller will alert users through beeper and display "W" in the LCD panel.
- **Enable(Permenant Clone):** In this mode, the controller will select one spare disk and execute clone activity when disks warn. If there is no spare disk, no action will be taken. And, after the disk cloning done, the source disk still keep in the mirroring state without replacement.
- **Enable(Start Swap after Clone):**In this mode, all operations are same as "Enable (Permenant Clone), the difference is after the disk cloning done, the clone disk will replace the source disk.

#### 6.A.4.3 **SMART Check Time**

Users could select how long to execute the SMART function ? 60mins or 30 mins or 15 mins or 1 min.

#### 6.A.4.4 **Bad Blocks**

##### 6.A.4.4.1 **View statistics**

Users could get the disk status from this function

##### 6.A.4.4.2 **Threshold for clone**

**Disable/ 2 per GB/ 3 per GB/ 5 per GB/ 10 per GB**

Users could set how many times to execute disk cloning when the number of bad sectors in the remap area is over the threshold specified by users.

##### 6.A.4.4.3 **Threshold for Swap**

**Disable/ 3 per GB/ 5 per GB/ 8 per GB/ 14 per GB**

Users could set how many times to execute swap of disk cloning when the number of bad sectors in the remap area is over the threshold specified by users.



#### **Note**

*The number of threshold for swap must be bigger than threshold for clone.*

#### 6.A **Update ROM**

Use this option to update the ACS-8990 programmable firmware. See Appendix H, *Updating the Firmware*.



**Note**

*Configuration changes made in the RAID Functions menu must be saved to the ACS-8990 non-volatile memory for the changes to take effect. This is done in the NVRAM menu accessed from the Main menu.. See Saving Configurations earlier in this chapter.*

## Appendix A

# Troubleshooting

## Problems setting up

### **Newly installed memory fails during Self-Test or is not detected.**

Possible Cause: The SO-DIMM memory module may not be properly seated or may not be supported by ACS-8990.

Fix: Re-sit the memory module in the socket and retry. If it continues to fail try moving it to the other memory socket. Make sure the correct memory type is being installed. ACS-8990 supports 200-pin DDR SODIMM.

### **Unable to access ACS-8990 after the operating system boots up.**

Possible Cause: ACS-8990 is not configured.

Fix: Make sure ACS-8990 is configured for a RAID level. If no RAID level is configured the operating system will not detect ACS-8990 as a disk drive.

### **I try to set up an array using Quick Setup but fail. Why?**

Possible Cause: If the error message Array1 Exists! appears, an array has already been configured. Quick Setup can only be used to set up new RAIDs.

Fix: Reconfigure the array from the RAID params submenu

### **Why does disk scrubbing function non-effective ?**

Possible Cause:

1. Controller is shut down during disk scrubbing and restarted: Under this situation, the controller will record the event in the event log, but the disk scrubbing will not be renew and all information related to disk scrubbing is cleared.
2. Disk failure or been removed: If any disk of an array under disk scrubbing operation fails or been removed, the disk scrubbing will stop immediately.
3. Remap area failures: If any write to remap area fails, the disk scrubbing operation stops immediately.

### **What will controller do when controller power-off and there is clone disk exist ?**

1. The controller will keep the state of a clone disk in the NVRAM and after the controller restart, the operation will be renew from previous stopping point.

### **What will controller do when controller power-off and change disk's location?**

Fix:the controller will result in incorrect operation and then prohibited.

**When controller power off, will the data be changed ?**

Ans: If controller is powered off, the data will still be guaranteed identically between the source disk and the clone disk. All writes are saved in the NVRAM, and when controller restart, the cloning process will be continuous

**If a source disk fail, what will controller do ?**

Ans: If a source disk fails during the background copying operation, the cloning process will be aborted. And the controller will use the clone disk for data rebuilding.

**If a clone disk fails, what will controller do?**

Ans: If a clone disk fail, the clone disk will be taken off-line and select a spare disk as the new clone disk to start the background copying operation. If there is no spare disk or the spare disk without enough capacity, the controller will report warning messages.

**If array member disk fail and with spare disk , what will controller do?**

Ans: If a disk besides the source disk in the same array fails, the controller will select a spare disk for rebuilding data of the failed disk. But, if the failed disk is in different array, the state and the operations of the clone disk are not affected.

**If array member disk fail and without spare disk , what will controller do?**

Ans: If there is no spare disk for disk adding, a clone disk will be selected for the rebuilding. This can ensure the array to return to optimal mode ASAP so as to avoid array failure. If there is more than one clone disk, the controller will select the clone disk with the least copying progress. If all clone disks are in the mirroring state, the clone disk with the smallest disk number will be used.

**If an array fails, what will controller do?**

Ans: If an array with clone disks fails, the background copying tasks will be aborted, and the clone disks will become a spare disk.

**If there is unrecoverable bad blocks on source disk, what will controller do ?**

Ans: If the data is unrecoverable , the copying task will writes zero to the corresponding block on the source disk.

**I have 16 HDDs and each HDD capacity is 400 GB, how can I create a single slice over 2TB ?**

ANS: First, you need to set up the params of "slice over 2TB" in RAID params. Then, execute quick setup to set the RAID level you want. If your OS is UNIX base (include FreeBSD, Linux,...), please select "16 byte CDB" this item which is standard SCSI command. But, if your OS is Windows base (include Win2K, WinXP, Win2003), please set as "variable sector size" which is only support NTFS file system.

**I have set done for slice over 2 TB, why I can't recognize over 2 TB capacity in OS site?**

Ans: First, you should check if the params of "slice over 2TB" been set to enable. If yes, then it possible cause the compatible issue due to some OS and HBA do not support over 2TB

capacity function for single partition. If you get this problem, please confirm with the OS and HBA vendor if they do support this function or contact with your vendor for the compatibility list.

## Problems during operation

### **The front panel LCD displays alternating “Zz” characters.**

Possible Cause: These characters are displayed when the cache is full with write request data that have not been processed. Requests from the host are halted to flush the data in the cache.

Fix: None needed.

### **The front panel LCD displays alternating “Ww” characters.**

Possible Cause: These characters are displayed to indicate that write requests in the cache are being processed. When these characters are displayed, ACS-8990 will halt requests from the host (see above).

Fix: Make sure the *Write Buffer* option of the *RAID Params* menu is enabled. In addition, more cache memory may be required. By increasing the cache memory, the write buffer space increases and will be able to handle the higher write requests.

### **LCD display shows owoooos**

Possible Cause: “W” means “warning” - there are many bad sectors on your HDD.

Fix: Change hard drives.

### **Invalid NVRAM message appears**

Possible Cause: NVRAM error or malfunction.

Fix: Save settings and restart the controller. If the problem persists, contact your vendor.

### **What is the correct system shutdown procedure?**

Fix Step 1: Shut down host OS.

Fix Step 2: Select “Shut Down” from the NVRAM menu.

Fix Step 3: When shutdown is complete, turn off controller system power.

## Remote terminal problems

### **Unable to access Configuration Mode using the remote terminal interface.**

Possible Cause 1: The terminal communication settings do not match the settings of the ACS-8990 RS-232 interface.

Fix: The default settings for the RS-232 port are 115,200 Baud rate, 8 Data bits, 1 Stop bit, No Parity, and None Flow control. Make sure the terminal is configured for these settings. If the settings were changed in Configuration Mode, verify the settings of the ACS-8990 in the RS-232 Params, Terminal option and change the terminal settings accordingly.

Possible Cause 2: Incompatible RS232 cable.

Fix: Cross pins on the RS-232 cable as shown below (or use a null modem cable). The only pins used are 2 3 & 5.

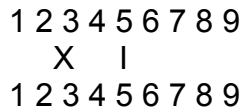

## Alert message problems

### I am unable to send a Page or FAX using the modem port.

Possible Cause 1: The Page and Fax options are not enabled.

Fix: Go to the Configuration Mode and enable Page and FAX notification via the System Params menu option.

Possible Cause 2: The default modem initialization string is not compatible with your modem.

Fix: Change the modem initialization string in the System Params option. Refer to your modem manual for its initialization string.

The following modem models require their own initialization strings.

Modem Model	Initialization String	Baud Rate	FAX Class
Motorola ModemSURFR V.34 28.8	AT&D\Q1E	Up to 38400	1 & 2
Multitech Multimodem 2834ZDX	AT&D0&E5E0	Up to 38400	2 only
Hayes Accura 288 V.34+FAX	AT&D0&K4E0	38400 only	1 & 2
Practical Peripherals PM144MT II	AT&K4	Up to 38400	2 only
GVC F-1128V/T2	AT&D0&B1&H2	38400 only	1 & 2
US Robotics Sportster 28800	AT&H2&I1&R1&B1	38400 only	1 only

## SCSI problems

### ACS-8990 is not properly identified by the SCSI adapter during initialization of the computer system.

Possible Cause: The SCSI ID set for the ACS-8990 is being used by another SCSI device attached to the same SCSI card.

Fix: Select the Set SCSI ID option from the SCSI Params menu and specify a different SCSI ID. Most SCSI host adapters provide an onboard ROM BIOS, or software utility, that displays the devices attached and their SCSI IDs. Disconnect ACS-8990 from the SCSI host adapter card and during the system boot, or by running the utility, note the SCSI IDs already in use.

The ACS-8990 is identified as all SCSI IDs.

Possible Cause: The SCSI ID set for ACS-8990 is identical to the reserved SCSI ID used by the SCSI card in your system.

Fix: Select the Set SCSI ID option from the SCSI Params menu and specify a different SCSI ID. Most SCSI host adapter cards reserve SCSI ID 7 for the card ID.

**The SCSI host adapter card does not detect ACS-8990.**

Possible Cause: Incorrect termination in a daisy chain configuration or a loose cable in a stand-alone configuration.

Fix: In a daisy chain configuration, verify that only the SCSI host adapter and the last SCSI device is terminated.

## Appendix B

# Introduction to RAID levels

The ACS-8990 can support the following RAID levels: 0, 1, 3, 5, 0+1, 30, 50, NRAID and JBOD.

Which is the right level for you? The answer depends on the application you use your RAID for.

**RAID Level 0** offers high transfer rates, and is ideal for large blocks of data where speed is of importance. Computer Aided Design, Graphics, Scientific Computing, Image and Multimedia applications are all good examples. If one drive in a RAID 0 array fails however, the data on the whole array is lost.

**RAID Level 1** may be an appropriate choice if cost and performance are of significantly less importance than fault tolerance and reliability.

**RAID Level 0+1** offers a compromise between the reliability and tolerance of level 1 and the high transfer rates provided by level 0.

**RAID Level 3** is similar to the more commonly used level 5. Both offer a good level of fault tolerance and overall system reliability at a reasonable cost for redundancy overhead.

**RAID Level 30** offers a compromise between the reliability and tolerance of level 3 and the high transfer rates provided by level 0.

**RAID Level 5** arrays offer high I/O transaction rates, and are the ideal choice when used with on-line transaction processing applications, such as those used in banks, insurance companies, hospitals, and all manner of office environments. These applications typically perform large numbers of concurrent requests, each of which makes a small number of disk accesses. If one drive in a RAID 5 array fails, the lost data can be rebuilt from data on the functioning disks.

**RAID Level 50** offers a compromise between the reliability and tolerance of level 5 and the high transfer rates provided by level 0.

**JBOD** is a method of arranging multiple disks that is not technically a RAID at all. Under JBOD ("Just a Bunch of Disks") all disks are treated as a single independent volume JBOD providing no fault tolerance, or performance improvements over the independent use of its constituent drives.

**NRAID (Non-RAID)** combines the space of all physical disks and forms a large logical disk. The space presented by the NRAID starts sequentially from the first member disk to the last member disk without striping, mirroring, or parity. The capacity of the logical disk is the direct sum of all physical hard disks.

This appendix provides a summary of the features of each RAID level to enable users with differing requirements to make the best choice.



## RAID 0

RAID 0 links each drive in the array as one huge drive. Storage capacity is determined by the smallest drive in the array. That capacity is then applied to format all other drives in the array. If using a 40 GB, 60 GB, and 50 GB drive in a RAID 0 array, your system will see one huge drive of 120 GB (40 GB×3).

RAID 0 offers double or more performance under sustained data transfers when one drive per ATA port is used. In such a configuration, unlike SCSI, ATA drives are always available to the system. SCSI requires more management of the SCSI bus.

### RAID 0: *Striped disk array without fault tolerance*

#### Characteristics:

- RAID 0 implements a striped disk array, the data is broken down into blocks and each block is written to a separate disk drive.
- I/O performance is greatly improved by spreading the I/O load across many channels and drives.
- Fastest and most efficient array type but offers no fault-tolerance.
- Storage capacity = (No. of disks) × (capacity of smallest disk)

#### Recommended use:

- Video production and editing
- Image editing
- Pre-press applications
- Any application requiring high bandwidth

The diagram below represents the writing of data on a RAID 0 array composed of four HDDs connected to the controller. Data blocks are distributed across all disks in the array.

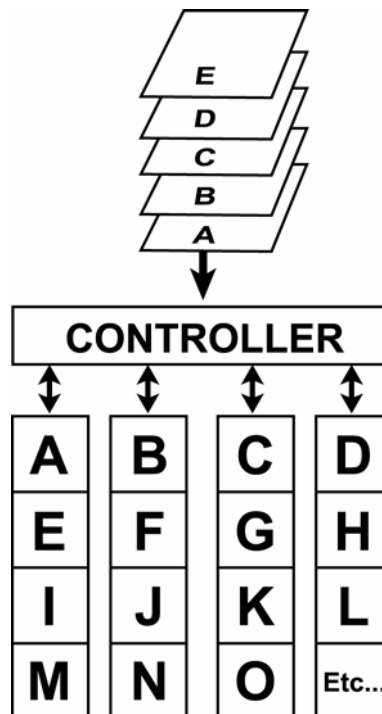

Arrangement of data blocks saved on a Level 0 RAID

## RAID 1

RAID 1 is commonly referred to as Disk Mirroring, Disk Shadowing or Disk Duplexing as all data is duplicated across all disks. As data is identical on all disks, storage capacity is that of the smaller disk. RAID 1 has poor performance for write operations but very high performance for read intensive operations.

### RAID 1: *Mirroring*

#### Characteristics:

- Better Read transaction rate than single disks, same Write transaction rate as single disks.
- 100% redundancy of data means no rebuild of data is necessary in case of disk failure, just a copy to the replacement disk.
- All the disks have the same data.
- Raid level 1 requires at least two drives.
- Storage capacity = Capacity of smallest disk

#### Recommended use:

- Accounting
- Payroll
- Financial
- Any application requiring high availability

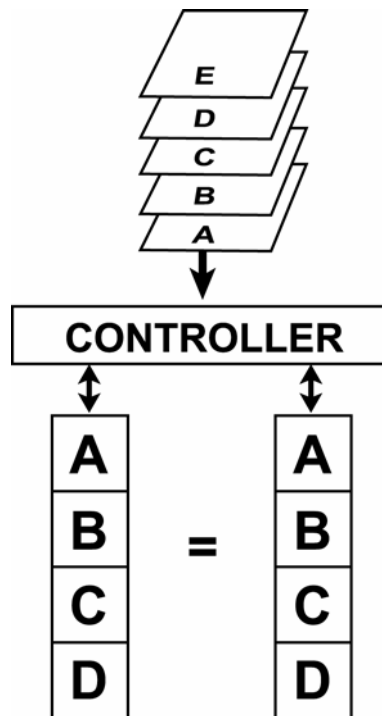

Arrangement of data blocks saved on a Level 1 array

### RAID 0+1

RAID 0+1 combines mirroring and striping functions on a minimum of four hard disks. Mirroring provides full redundancy and protects data in case of multiple drive failure (providing that data on one of each mirrored pair of drives is intact).

#### RAID 0+1: *Combination of mirroring and striping*

##### Characteristics:

- This configuration provides optimal speed and reliability.
- Requires even number of disks (minimum 4 disks)

The diagram below represents the writing of data on a RAID 0+1 array composed of four HDDS connected to the controller. The controller creates a RAID 0 array from two RAID 1 sub-arrays.

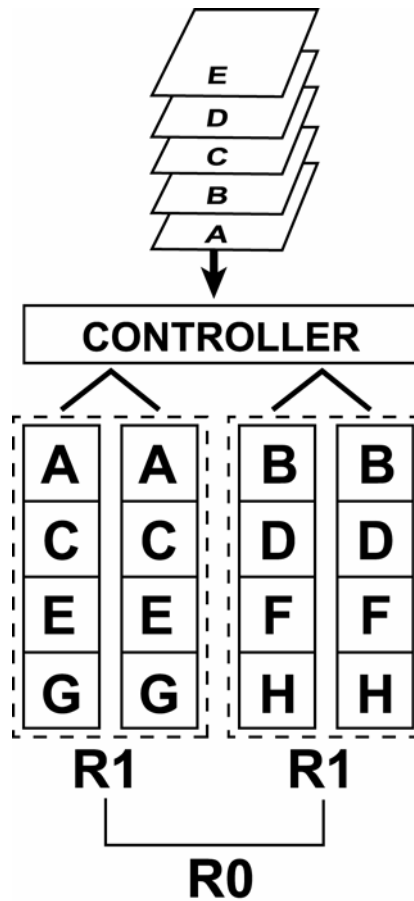

Arrangement of data blocks saved on a Level 0+1 array

### RAID 3

RAID 3 uses a mathematical expression that compares data from two drives and calculates a third piece of data called "parity". Should one of the drives fail, parity data can be used to rebuild the failed data. Under RAID 3, parity data is stored on a dedicated parity disk. If two or more disks were to fail however, data would be lost. Data on RAID 3 is byte-interleaved. While the low ratio of parity disks to data disks ensures high efficiency, the parity disk is accessed more than the others and so is also more likely to fail.

#### RAID 3: *Parallel transfer with parity*

##### Characteristics:

- The data block is subdivided, i.e. striped, and written on the data disks. Stripe activity is generated on Writes, recorded on the parity disk, and checked on Reads.
- Very high Read and Write data transfer rates.
- Disk failure has a low impact on throughput.
- Low ratio of ECC (Parity) disks to data disks means high efficiency.
- Requires a minimum of three drives.

##### Recommended use:

- Video production and live streaming
- Image editing
- Video editing
- Any application requiring high throughput

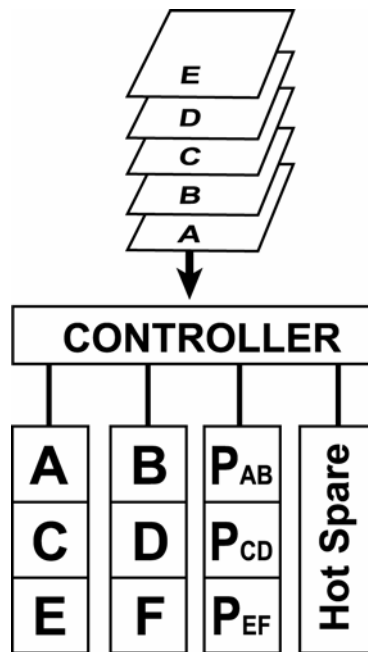

Arrangement of data blocks saved on a Level 3 array

### RAID 30

RAID 30 arrays are formed by striping data across RAID 3 sub-arrays. They offer better performance than RAID 3 alone but do not have the speed of a pure RAID 0 array. Storage efficiency and fault tolerance vary depending on the number and size of sub-arrays compared to the array as a whole. RAID 30 resembles RAID 50 in its characteristics. RAID 30 is better suited for use with larger files.

#### RAID 30: *Byte striping with parity combined with block striping*

**Characteristics:**

- Capacity: (Size of smallest drive) × (No. of drives in each subarray - 1) × (No. of subarrays).
- Requires a minimum of six drives. Number of drives must be divisible by two numbers: 2 or higher (no. of subarrays) and 3 or higher (drives within each RAID 3 subarray)
- Excellent fault tolerance, increasing with the number of RAID 3 subarrays (and hence the number of parity disks)

**Recommended use:**

- Critical multimedia / file servers requiring speed, resilience and high capacity.

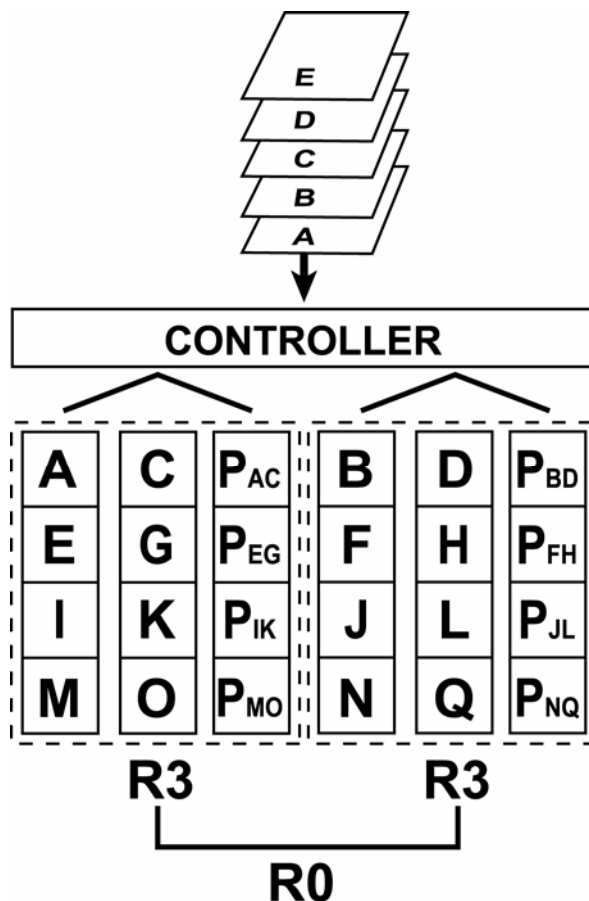

Arrangement of data blocks saved on a six-drive Level 30 array

## RAID 5

RAID 5 uses a mathematical expression that compares data from two drives and calculates a third piece of data called "parity". Should one of the drives fail, parity data can be used to rebuild the failed data. Under RAID 5, parity data is stored across all drives in the array. This maximizes the amount of storage capacity available from all drives in the array while still providing data redundancy. Data on RAID 5 is block-interleaved.

### RAID 5: *Independent data disks with distributed parity blocks*

#### Characteristics:

- Each entire data block is written on a data disk. Parity for blocks in the same rank is generated on Writes, recorded in a distributed location and checked on Reads.
- Highest Read data transaction, medium Write data transaction rate.
- Relatively low ratio of ECC (Parity) disks to data disks means high efficiency (compared to other RAID levels).
- Good aggregate transfer rate.
- Storage capacity = (No. of disks – 1) × (capacity of smallest disk)

#### Recommended use:

- File and application servers
- Database servers
- WWW, E-mail and News servers
- Intranet servers
- Most versatile Raid level

The diagram below represents the writing of data on a RAID 5 array composed of four HDDS connected to the controller. Parity blocks are represented by the letter P.

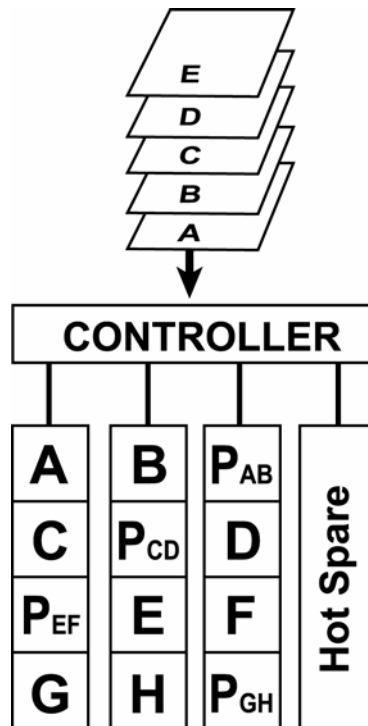

Arrangement of data and parity blocks saved on a Level 5 RAID

## RAID 50

RAID 50 arrays are formed by striping data across RAID 5 sub-arrays. They offer better performance than RAID 5 alone, particularly in write speed, but do not have the speed of a pure RAID 0 array. Storage efficiency and fault tolerance vary depending on the number and size of sub-arrays compared to the array as a whole. RAID 50 resembles RAID 30 in its characteristics. RAID 50 is better suited for use with smaller files.

**RAID 50: Block striping with interspersed parity combined with block striping**

**Characteristics:**

- Capacity: (Size of smallest drive) × (No. of drives in each subarray - 1) × (No. of subarrays).
- Requires a minimum of six drives. Number of drives must be divisible by two numbers: 2 or higher (no. of subarrays) and 3 or higher (disks within each RAID 3 subarray)
- Excellent fault tolerance, increasing with the number of RAID 5 subarrays (and hence the number of parity disks)

**Recommended use:**

- Critical databases requiring speed, resilience and high capacity.

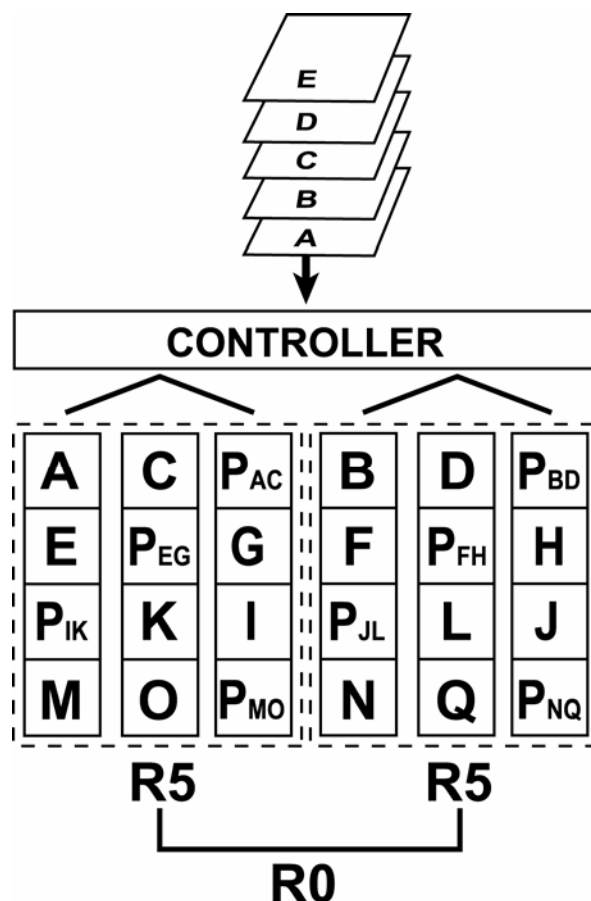

Arrangement of data blocks saved on a six-drive Level 50 array

**JBOD**

JBOD (“Just a Bunch of Disks”) reports the individual drives. The operating system will see each drive in the JBOD mode as a individual drive. There is no RAID protection in the JBOD mode. The JBOD mode allows the user to connect more hard drives without taking up IDE connections on the motherboard.

**JBOD: *Spanned disk array without fault tolerance***

**Characteristics:**

- JBOD reports individual disks.
- No fault-tolerance.
- Storage capacity = Sum of constituent drive capacities

**Recommended use:**

- For most uses not requiring fault tolerance, RAID 0 is better. JBOD has the advantage if you are using several drives of different capacities.

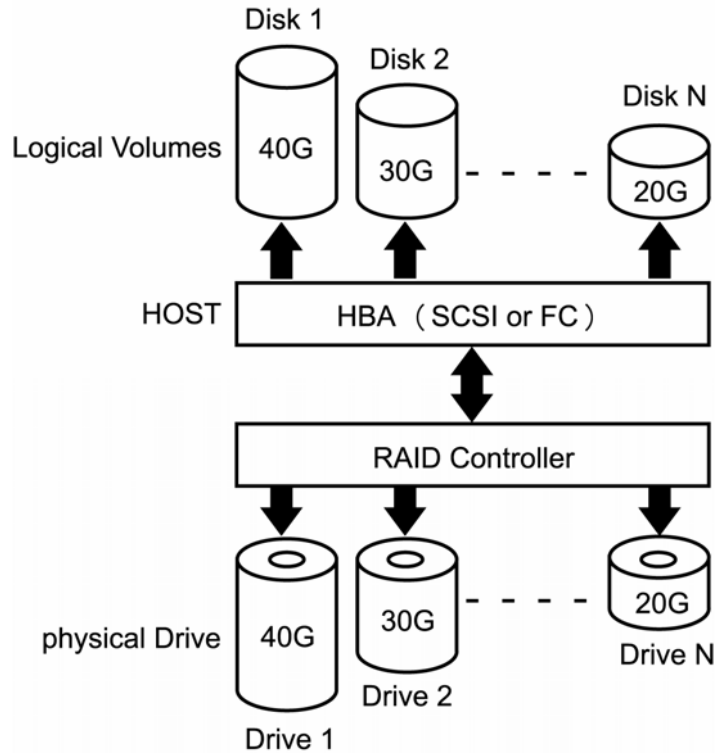

Arrangement of data saved on a JBOD array



## NRAID

NRAID (“Non-RAID”) , the capacity of all the drives is combined to become one logical drive (no block striping). That is to say, the capacity of the logical drive is the total capacity of the physical drives. NRAID does not provide data redundancy

### NRAID: *Disk spanning*

#### Characteristics:

- No fault-tolerance.
- Minimum no. of drives:1
- Storage capacity = Sum of constituent drive capacities

#### Recommended use:

- For most uses not requiring fault tolerance, RAID 0 is better.
- Mass data, NRAID is only good for applications where large and expandable capacity is required while performance is of no concern and the capacity of disks is different.
- Storage

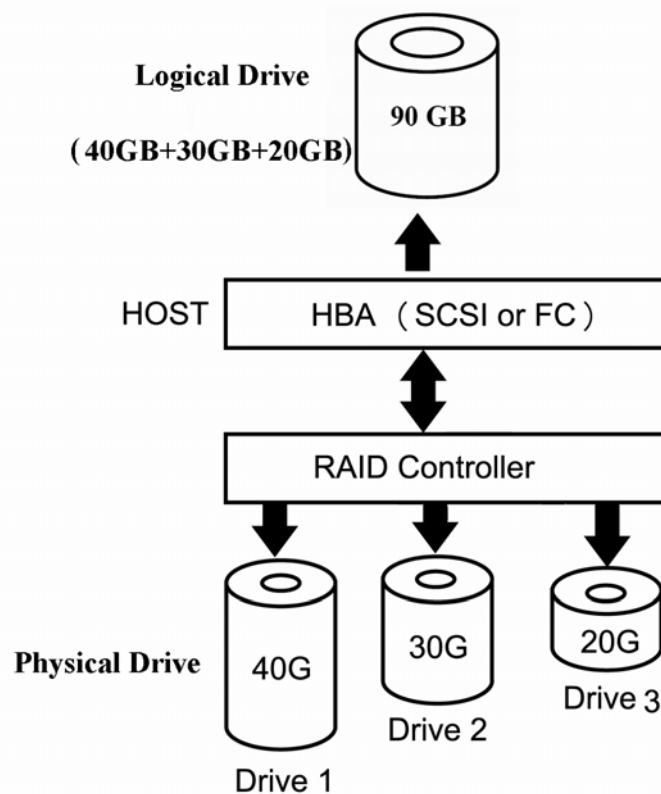

Arrangement of data saved on a NRAID

Appendix C

# Introduction to Serial ATA

Serial ATA is a disk-interface technology that is an evolutionary advance on Parallel ATA (IDE). Compatible with today's software and OS-transparent, Serial ATA offers several compelling advantages for RAID storage solutions. These include cables that are easier to route and install; smaller connectors; faster and more reliable performance; and backwards compatibility. This section introduces and gives an overview of the advantages of using Serial ATA in RAID.

## Cabling

Serial ATA requires just seven wires (a differential pair for both transmit and receive, as well as three grounds) working at a low voltage (0.7volts). Parallel ATA (IDE) on the other hand transmits through 40 wires.

With far fewer wires, Serial ATA connectors and cables are narrower (just 8mm wide), easier to manipulate and connect and do not block airflow within a system case. Heat in Serial ATA systems disperses more easily, aiding system stability.

A further bonus of Serial ATA is that cables can stretch up to one meter in length giving RAID system administrators great flexibility in setting up their arrays. IDE cables by contrast cannot exceed 40cm.



## Simplicity of configuration

Serial ATA is based around point-to-point connections with a single cable for each drive. The master/slave, "daisy-chaining", and termination issues associated with Parallel ATA are eliminated.

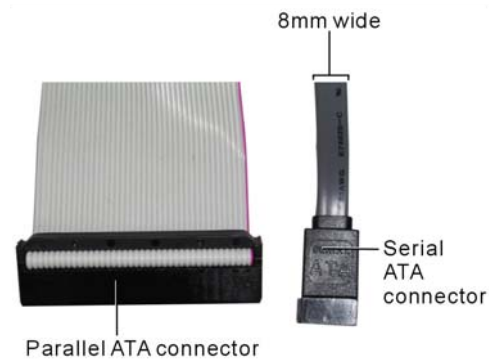

## Hot-Swap capability

Serial ATA drives can be connected and disconnected at any time with no need to power down the system. RAID system administrators benefit from a more flexible and scalable system. Upgrades and expansion of arrays can be performed in an instant.

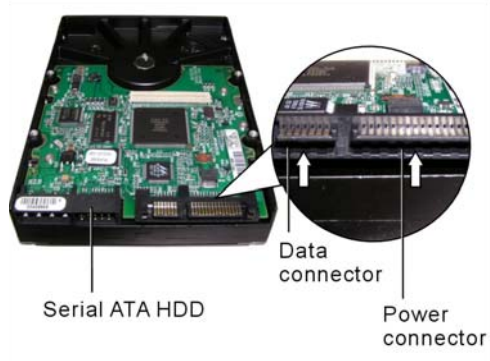

## **Performance**

Serial ATA technology delivers up to 1.5Gb/sec of performance to each drive within a disk drive array – more than enough to help you get the most out of the current generation of hard drives.

Serial ATA is also more reliable than Parallel ATA: instructions as well as data are checked for errors, resulting in higher reliability, and less frequent corruption of data.

Electrical interference is reduced by the use of differential signaling (which also reduces the need for grounding).

## **Cost effectiveness**

The scalability of Serial ATA solutions means that RAID's can be built, expanded and reconfigured according to requirements with minimal cost to the administrator.

Serial ATA-compatible HDDs are priced similarly to Parallel ATA equivalents, their improved performance notwithstanding.

Serial ATA is also fully backwards compatible. Users can swap easily between formats and use Parallel ATA drive in a Serial ATA drive array (this may require use of a cabling adapter). Such flexibility ensures that Serial ATA can provide low cost solutions.

## Appendix D

## Control Panel Messages

## Status messages

When ACS-8990 is in operation mode, scroll buttons ▼ and ▲ can be used to display the following system data:

- Installed Memory
- RAID Capacity
- Firmware Version
- Serial Number
- CPU Type
- RAID Members
- RAID Level
- SCSI ID

The table below explains the meaning of status messages:

Field / Symbol	Description
ACS-8990	The ACS-8990 model number.
OOOOOOOS	The 8 or 16 disks channel status. The first left O is channel 1. You can press [▼] button to view the next page. Other symbols are:
x	Disk not installed
A	Disk being Added
1	Array 1 Disk On-line (Multiple array)
2	Array 2 Disk On-line (Multiple array)
3	Array 3 Disk On-line (Multiple array)
4	Array 4 Disk On-line (Multiple array)
5	Array 5 Disk On-line (Multiple array)
6	Array 6 Disk On-line (Multiple array)
7	Array 7 Disk On-line (Multiple array)
8	Array 8 Disk On-line (Multiple array)
J	JBOD (Just a Bunch of Disks)
S	Spare disk
R	Disk removed
I	Disk is being checked
R5	RAID level (0, 1,0+1,3, 5, 30, 50, NRAID)
ID:0	SCSI ID (0 - 15) Multiple
	Alternating cursor indicating operational status.

## Appendix E

# Glossary

### **Array**

See Disk Array.

### **Array Management Software**

The body of software that provides common control and management for a disk array. Array Management Software most often executes in a disk controller or intelligent host bus adapter, but may also execute in a host computer. When it executes in a disk controller or adapter, Array Management Software is often referred to as Firmware.

### **Cache**

Controller memory used to speed up data transfer to and from a disk.

### **Disk Array**

A collection of disks from one or more commonly accessible disk controllers, combined with a body of Array Management Software. Array Management Software controls the disks and presents them to the array operating environment as one or more virtual disks.

### **Disk Striping**

The practice of dividing data into blocks and writing the blocks across several drives for increased performance.

### **Disk Mirroring**

The practice of duplicating data on different sets of disks in an array.

### **Firmware**

See Array Management Software.

### **Host Computer**

Any computer system to which disks are directly attached and accessible for I/O. Mainframes, and servers, as well as workstations and personal computers, can all be considered host computers in the context of this manual, as long as they have disks attached to them.

### **Hot Spare**

A physical drive, not part of an array, on which the controller can rebuild data if an array drive malfunctions.

## Hot Swap

The substitution of a (usually defective) unit by a replacement that takes place while the system is online.

## Logical Unit

Disk storage space on one or more physical drives that appears to the host computer as a single drive.

## LUN (Logical unit number)

The number assigned to a logical unit. Slices of a RAID are assigned (mapped to) LUNs by which they appear to the host computer.

## Mirroring

See Disk Mirroring.

## Parity

Parity information is redundancy information calculated from actual data values. If any single piece of data is lost, the data remaining and the parity information can be used together to compute the lost data. Parity information can either be stored on a separate, dedicated drive, or be mixed with the data across all the drives in the array.

## RAID (Redundant Array of Independent / Inexpensive Disks)

A disk array in which part of the storage capacity is used to store redundant information about user data stored on the remainder of the storage capacity. The redundant information enables regeneration of user data in the event that one of the array member disks or the access path to it fails. See Parity. Different RAID levels offer different data throughput speeds and fault tolerance (data redundancy). RAID 0 does not feature redundant information but is nonetheless considered a special type of RAID.

## SCSI

Small Computer System Interface.

## Slice

A partition of an array. See LUN.

## Striping

See Disk Striping.

**Appendix F**

**Specifications**

Item	Specifications
<b>Operation System</b>	OS Independent and Transparent
<b>CPU</b>	Intel i80321 64-bit RISC microprocessor
<b>SCSI or FC I/O Processor</b>	LSI 53C1030T or Qlogic ISP2312
<b>RAID Level</b>	0, 1, 3, 5, 0+1,30,50,and JBOD,NRAID
<b>Cache Memory</b>	PC 200 DDR 64 1G memory with ECC support
<b>SCSI Channel to Host</b>	2(Max) Ultra 320 SCSI LVD
<b>Fibre Channel to Host</b>	2(Max) Optional for 2Gb FC
<b>Serial ATA1 Channel to Device</b>	16(Max) SATA1 with Ultra DMA 150
<b>Data Transfer Rate</b>	Up to 320MB (dual CH.)
<b>Tagged Command Queuing</b>	Yes, up to 256 Commands
<b>Stripe Size</b>	Variable
<b>Write Option</b>	Write through or Write back
<b>Hot Swap</b>	Yes
<b>On Line Expansion</b>	Yes
<b>Battery Backup Module (BBM)</b>	Yes
<b>Hot Spare</b>	Yes (Rebuild Transparently & Automatically)
<b>Remote Management</b>	RS-232 terminal emulation for configuration and monitoring
<b>Remote Alerts</b>	Fax, Pager
<b>Local Alerts</b>	Built-in buzzer



**Note**

*Specifications subject to change without notice.*

## Appendix G

# Statistics

System and array settings and statistics can be viewed by selecting the submenu RAID funcns > Statistic

Information is displayed in the Monitor Utility output window (this information cannot be viewed from the control panel) under the following headings:

- System information
- RAID information
- SCSI / Fibre information (depending on daughterboard fitted)
- RS232 information
- Company information
- Fax information
- Pager information
- IO statistics

As usual in the Monitor Utility, use the keys AZSX to scroll through the information.

### System information

**Firmware version:** keep track and ensure you are up to date with the latest firmware release. To update firmware, consult the following section.

**Serial number:** serial number of controller (if any)

**Installed memory:** capacity of SODIMM installed on controller

**Status:** View the current status of each disk channel. The status statistic is given in the form of a string such as xxxxxxxxxxxx11222S. Each character represents a disk channel:

A number (1,2 etc) indicates the array to which a disk belongs

S signifies that the disk is a hot spare

J signifies that the disk is part of a JBOD array

x signifies that the disk channel is empty

Beneath the status string, the status of each disk channel is given separately. If a disk is installed, the serial number is shown. Otherwise, the message Not Installed is displayed.

### RAID information

**RAID number:** the array number. RAID information is given for each existing array

**RAID capacity:** the capacity, in megabytes, of the array.

**RAID level:** the RAID level of the array

**Stripe size:** the strip size, in sectors, of the array

**Write buffer:** Enable or Disable

**RAID member:** the disks, identified by disk channel number, which are part of the array.



**Slice information:** the size of each slice in the array is given. If no extra slices have been created, the entire RAID capacity is assigned to a single slice (Slice 0) by default.

## SCSI information



**Note**

*SCSI information is given only for controllers with a SCSI interface daughterboard. Equivalent fibre statistics are given for controllers with fibre daughterboards. See following section.*

SCSI information is listed separately for the primary SCSI channel and secondary channel, if a second channel is being used. The following data are shown. Refer to *Setting SCSI parameters* earlier in Chapter 5 for configuration details.

- **SCSI ID**
- **Speed**
- **Wide**
- **LUN map**

**LUN map:** ACS-8990 supports up to 16 logical units in total. Slices must be mapped to logical units to be accessible by the operating system. The LUN map shows which slices map to logical units. A typical readout may show:

```
LUN Map:      (10 11 20 21 12 x x x x x x x
x x x x x x x x x x x x x x x x x x x x
x x x x x x x x x x x x x x x x x x x x)
```

In this case, five slices have been mapped. The operating system will be able to access each of these as a distinct logical unit. Furthermore, the LUN map shows that the operating system can access two separate arrays. Array 1 contains three logical units / mapped slices denoted 10, 11 and 12. Array two has two logical units / mapped slices, 20 and 21.

## Fibre information



### Note

*Fibre information is given only for controllers with a Fibre interface daughterboard. Equivalent SCSI statistics are given for controllers with SCSI daughterboards. See preceding section.*

Fibre information is listed separately for the primary fibre channel and secondary channel, if a second channel is being used. The following data are shown. See *Setting fibre parameters* in Chapter 5 for configuration details.

- **Hardloop ID**
- **Mode**
- **Data Rate**
- **LUN map**

**LUN map:** ACS-8990 supports up to 16 logical units in total. Slices must be mapped to logical units to be accessible by the operating system. The LUN map shows which slices map to logical units. A typical readout may show:

```
LUN Map:      (10 11 20 21 12 x x x x x x x
x x x x x x x x x x x x x x x x x x x
x x x x x x x x x x x x x x x x x x x)
```

In this case, five slices have been mapped. The operating system will be able to access each of these as a distinct logical unit. Furthermore, the LUN map shows that the operating system can access two separate arrays. Array 1 contains three logical units / mapped slices denoted 10, 11 and 12. Array two has two logical units / mapped slices, 20 and 21.

## RS232 information

RS232 information applies to the modem and terminal connection. The following data are shown. Refer to *Setting port parameters* in Chapter 5 for details.

- **Baud Rate**
- **Data Bit**
- **Stop Bit**
- **Parity**

## Company information

Two company string numbers are listed. Refer to *Company info menu* in *Fax alert settings* in Chapter 5 for details.

### **Fax information**

The following data are shown. Refer to *Fax info menu* in *Fax alert settings* in Chapter 5 for details.

- **Fax mode**
- **Fax number:**
- **Retry count**

### **Pager information**

The following data are shown. Refer to *Pager alert settings* in Chapter 5 for details.

- **Paging mode**
- **Pager numbers**
- **Paging count**
- **Repeat count**
- **Repeat interval**

### **IO statistics**

Host Read, Host Write and Total Disk I/O statistics are listed.

### **Battery Backup Module information**

If a BBM is installed the following data are shown

- **Battery temperature**
- **Battery capacity**
- **Battery status**
- **Battery serial number**
- **Battery device chemistry**

## Appendix H

# Updating the Firmware

ACS-8990 is shipped with firmware installed. The user may however wish to download new or upgraded editions of the firmware to the controller. Ask your vendor about the latest firmware edition or refer to the website [www.accusys.com.tw](http://www.accusys.com.tw)

A terminal emulation program, such as HyperTerminal, is required to download firmware.



### Caution

*Shut down the host computer system(s) before downloading the new firmware.*



### Note

*Array data and configurations are not affected by updating of firmware.*

To update the firmware:

1. Open the Update ROM submenu (6B) located at Main menu > RAID funcs > Update ROM menu.

```
+---Main Menu---+
0 Quick Setup
1 RAID Params
2 SCSI Params
3 RS232 Params
4 +---RAID Funcs---+
5 |61 Init Parity|
6 |62 Parity Check|
+---|63 Beeper|
|64 Stop Modem|
|65 Add Disk|
|66 Remove Disk|
|67 Statistic|
|68 Expand Array|
|69 Log Event|
|6A Utility|
|6B Update ROM|
+-----+
```

2. You will be asked:  
Are you ready to download the new firmware? (Y/N)  
Type **Y** to continue.
3. When asked: Are you sure? (Y/N), type **Y** to confirm.

```
Before downloading the new firmware,
shutdown the host computer system.
Are you ready to download the new firmware?(Y/N) Y
Are you sure? (Y/N) Y
Boot flash type: AM29LV040
System flash type: AM29LV017
Begin firmware file transfer now.
To abort download restart the RAID system.
```

4. Locate the updated firmware file to send. If using HyperTerminal, go to the **Transfer** menu and select **Send Text File...**

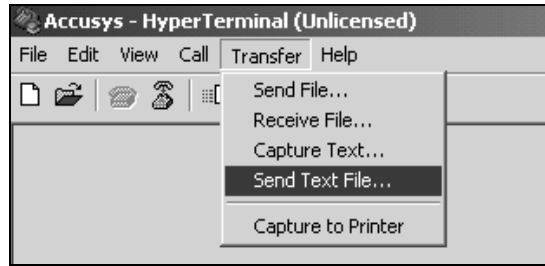

5. Send firmware file as a text file. The file will start to download. When prompted, enter **Go** (case sensitive) to update the firmware.
6. When prompted, enter **Go** (case sensitive) to reconfirm. The firmware will start to update.
7. If asked whether you want to replace the existing file, enter **Yes**

```
Before downloading the new firmware,
shutdown the host computer system.
Are you ready to download the new firmware?(Y/N) Y
Are you sure? (Y/N) Y
Boot flash type: AM29LV040
System flash type: AM29LV017
Begin firmware file transfer now.
To abort download restart the RAID system.
00126C00
File transfer complete.
Checksum = 0xB78A : OK.
New firmware transfer complete.
Enter 'Go' to update the firmware. Go
Enter 'Go' to reconfirm. _
```

## *Appendix I*

# Contact Us

### **Accusys, Inc.**

- 8F, No.47, Lane 2, Sec. 2, Guangfu Rd., Hsinchu, Taiwan, R.O.C.
- Tel : +886-3-575-0668
- Fax : +886-3-575-0866
- <http://www.accusys.com.tw/>
- e-mail : [sales@accusys.com.tw](mailto:sales@accusys.com.tw)

### **Accusys U.S.A., Inc.**

- Address: 46710 Fremont Blvd. Fremont, CA 94538, U.S.A.
- Tel:+1-510-661-0800
- FAX:+1-510-661-9800
- Toll-free number:+1-866-277-5888
- <http://www.accusysusa.com/>
- e-mail : [support@accusysUSA.com](mailto:support@accusysUSA.com), [sales@accusysusa.com](mailto:sales@accusysusa.com)

### **Accusys Korea, Inc.**

- Baegang B/D 5F Shinsa-Dong 666-14 Kangnam-Gu, Seoul, Korea
- Tel : (02)6245-9050
- Fax : (02)3443-9050
- <http://www.accusys.co.kr/>
- e-mail : [sales@accusys.co.kr](mailto:sales@accusys.co.kr)

### **Accusys China, Inc.**

- 1808 Anzhen Plaza, No. 2, Andingmenwai Street, Dongcheng District, Beijing, postcode 100013, China.
- Tel : 010-6448-2530
- Fax : 010-6448-2233
- <http://www.accusys.com.cn/>
- Email:[sales@accusys.com.cn](mailto:sales@accusys.com.cn), [support@accusys.com.cn](mailto:support@accusys.com.cn)