

Mini-Micro Systems

A CAHNERS PUBLICATION

MARCH 1985

**Making PC power
pocket-sized**

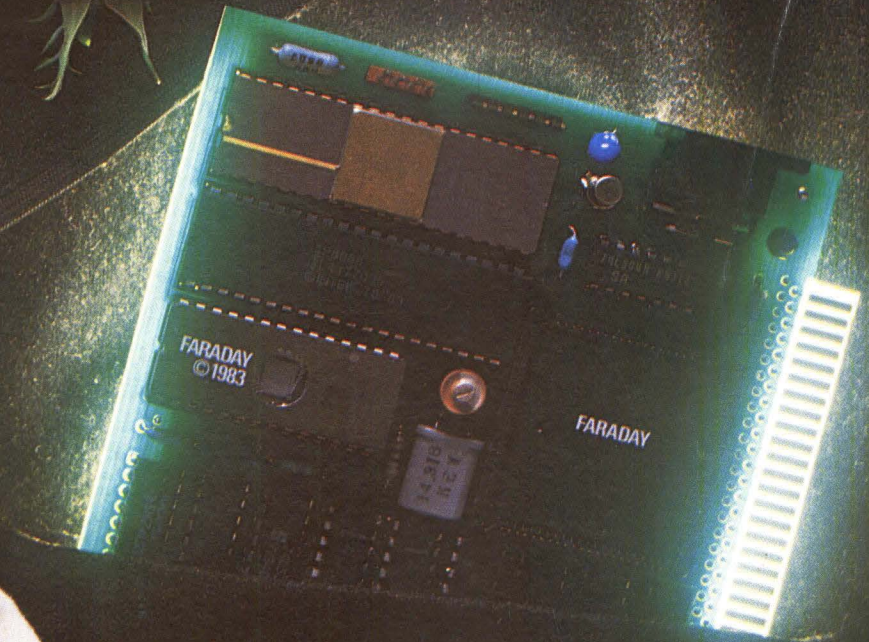

**Do portable-
computer
makers
listen to
the market?**

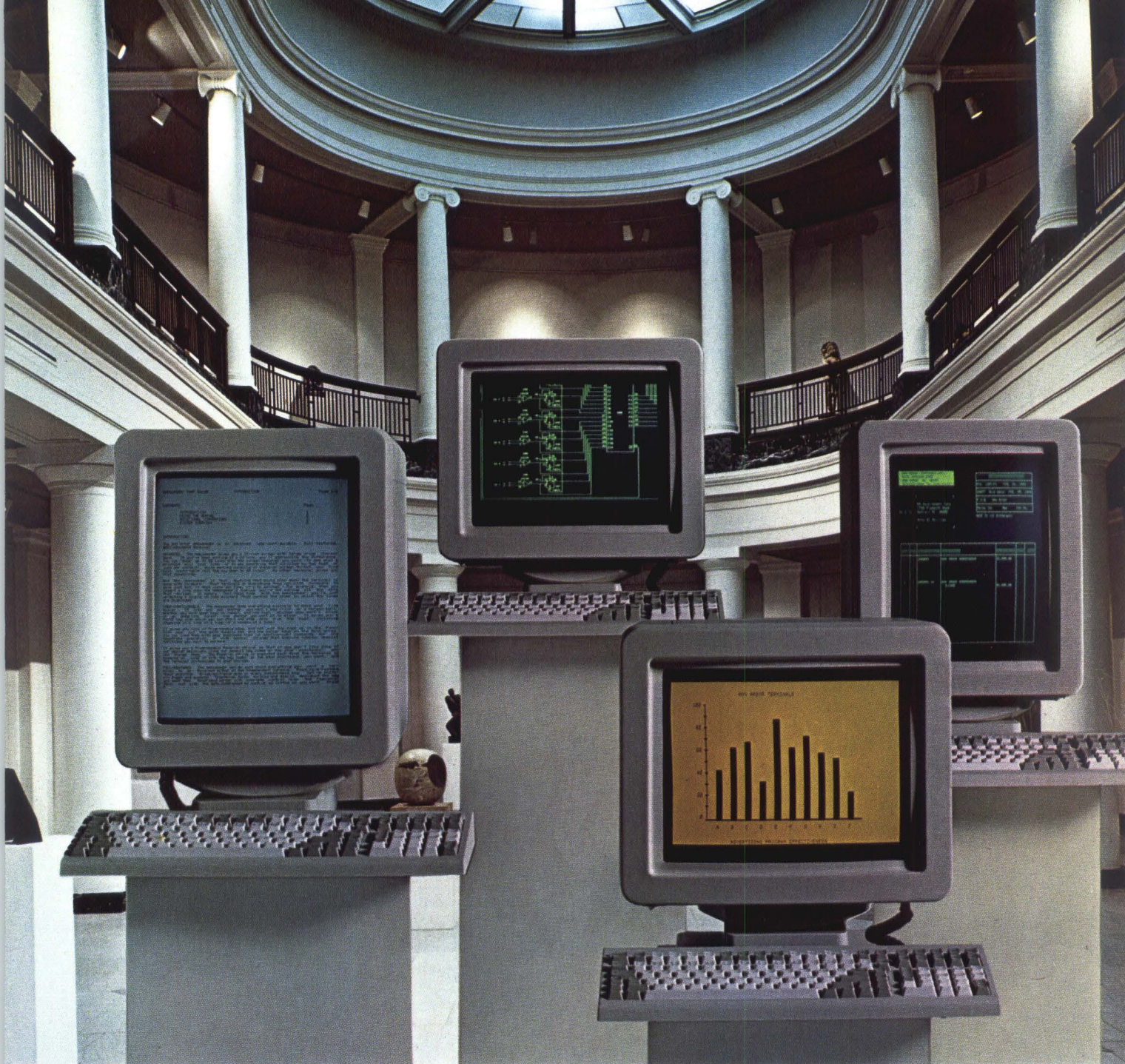

ANN ARBOR INTRODUCES THE XL SERIES:

A DISPLAY OF EXCELLENCE IN FORM & FUNCTION

Product excellence doesn't happen overnight. At Ann Arbor we've been designing quality terminals for professionals for over 15 years. We've innovated many of the time- and eye-saving features you now take for granted. And many you don't, if you're not already an Ann Arbor user. Now we're unveiling another masterpiece: Our XL Series of ANSI-Standard Terminals.

Designed with you in mind.

The real beauty of the XL Series is its focus on your comfort. Its fully programmable keyboard saves you typing time and effort. Its dynamically selectable display lets you zoom more data onto the screen when you want more context, and

less data when you just want bigger characters. With 15-inch or 17-inch portrait or landscape screens, offered in a full spectrum of phosphors, Ann Arbor is easy on your eyes.

Within the XL Series you'll find displays up to 170 characters per line and up to 66 lines per screen.

With plain English setup lines that give you a free hand in feature selection. And a whole palette of diagnostics and data-line monitoring aids to complete the picture.

There's an XL for every application.

Start with the Genie+Plus XL to meet your basic terminal needs. Move to the Ann Arbor Ambassador XL when you want a full-page display.

When words alone no longer tell the story, switch to the GXL and add vector graphics. Finally, when you need even more memory and display than any other terminal provides, move all the way to the Guru® XL.

Take a closer look.

Study the specs. View the ergonomic design. See for yourself what it is that makes the Ann Arbor XL Series the state-of-the-art display terminal you've been looking for.

For more information, write to Ann Arbor Terminals, Inc. at 6175 Jackson Road, Ann Arbor, Michigan 48103. Or call 313/663-8000.

ANN ARBOR
TERMINALS

CIRCLE NO. 1 ON INQUIRY CARD



**If you have one of these,
Infotron can have you
communicating data
in just 48 hours.**

**Modems and stat
muxes, to go.**

Infotron offers a complete line. And now, with our unique distributor warehousing program, we can have any of them on your doorstep within 48 hours of your call. 48 hours, max. Just say the word.

Full system flexibility.

Infotron modems combine advanced features and inherent reliability.



bility. Our statistical multiplexers handle from 4 to 32 channels in a range of models—with full provision for expansion.

All with the same high quality that earns us top marks in performance and reliability from our present users.

Add competitive pricing, and we start making real sense.

Then add our 48-hour delivery, and we're awfully hard to beat.

1-800-345-4636

**To find out more.
Your Infotron distributor.**

There are Infotron distributors nationwide, ready to give you more information, provide equipment and offer expert advice on the best way to meet your needs. For the name of the distributor near you, dial toll-free 1-800-345-4636 and ask for ISO. Or write Infotron Independent Sales Organization, 9 North Olney Avenue, Cherry Hill, NJ 08003.

**Infotron. First in
performance and reliability.**

 **INFOTRON** SYSTEMS

CIRCLE NO. 2 ON INQUIRY CARD



p. 33 Art direction by Melanie McGinnis Kaye and Vicki Blake. Photography by Paul Franz-Moore. Courtesy of Faraday Electronics.

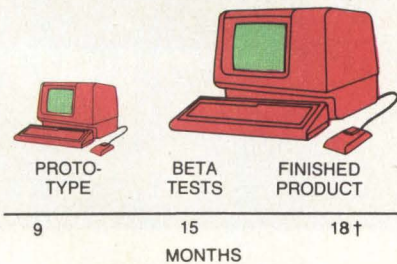

p. 34 Some like it, some don't



p. 73. . . Just what the doctor ordered

MINI-MICRO WORLD

NEWS

- 33 Tiny single-board PC may spark big markets
- 34 Some IBM mimics jump, some stall at PC-AT delays
- 43 3Com brings network servers to small LANs
- 47 Atari reaches for a comeback with Macintosh look-alike

CORPORATE AND FINANCIAL

- 57 When doing business in China, expect the unexpected

INTERNATIONAL

- 65 Taiwanese court gives light fine to Apple counterfeiters
- 68 Overheard Overseas: Europeans adopt alternative OS as IBM becomes proprietary

- *EUROPEAN NEWS: E1 Europeans adopt major personal computer networks
- E3 Printers and disk drives to dominate Hannover Fair

*Appearing in the European edition only

INTERPRETER

- 73 Vendors veer toward VARs, vertical markets
- 85 Computer standards: The jury is still out

INTEGRATOR

- 93 PC network outperforms UNIX
- 101 Disk drive scores with video game maker

MINI-MICRO SYSTEMS (ISSN 0364-9342) is published monthly (with 4 special Digest issues) by Cahners Publishing Company, Division of Reed Holdings, Inc., 221 Columbus Avenue, Boston, MA 02116. Norman L. Cahners, Chairman; Saul Goldweitz, President and Chief Executive Officer; Ronald G. Segel, Executive Vice President and Chief Operating Officer. MINI-MICRO SYSTEMS is published by the Cahners Magazine Division: J. A. Sheehan, President; William Platt, Executive Vice President. Circulation records are maintained at Cahners Publishing Co., 270 St. Paul St., Denver, CO 80206. Second class postage paid at Denver, CO 80202 and additional mailing offices. Postmaster: Send address changes to MINI-MICRO SYS-

FEATURES

- 113 **Feature Highlights**
- 115 **Environmental software opens system windows**
OS shells promise understandable interfaces for end users and new windows of opportunity for system integrators
- 135 **New portable computers better aimed at market**
Ignoring clear indications of what transportable-portable computer users want has cost manufacturers dearly, but signs are the message is getting through
- 147 **System integrators exploit PC compatibility**
Hardware and software infrastructure surrounding IBM PC proves ideal for system integration
- 159 **'LAN in a box' provides multiuser system**
An IBM PC-compatible multiprocessor system offers an alternative route to office automation
- 173 **Processor board handles virtual memory**
Numerous attributes enable Z8000-based board to support speed and memory requirements of multiuser systems
- 183 **Foundation module simplifies integration**
Single-board device merges components common to many micro applications to increase capacity and decrease cost

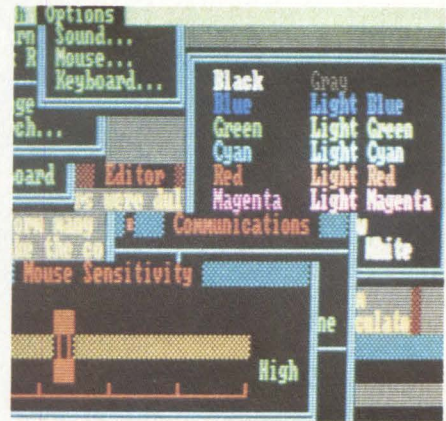

p. 115. .Opening opportunity's window

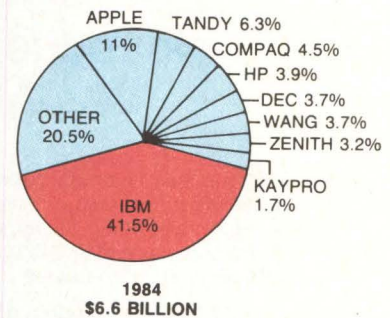

p. 147 Compatibility is key

DEPARTMENTS

- | | |
|--------------------------|----------------------------------|
| 4 Editorial Staff | 222 Classified Advertising |
| 11 Editorial | 223 System Integrators' Notebook |
| 17 Breakpoints | 224 Index to Advertisers |
| 193 New Products | 225 Market Track |
| 216 Calendar | 226 Artful Intelligence |
| 218 Career Opportunities | 227 Mini-Micro Marketplace |
| 221 Guest Viewpoint | |



p. 159. . .Offering an alternative route

TEMS, 270 St. Paul St., Denver, CO 80206. MINI-MICRO SYSTEMS is circulated without charge by name and title to U.S.- and Western European-based corporate and technical management, systems engineers, and other personnel who meet qualification procedures. Available to others at the rate of \$65.00 per year in the U.S.; \$70.00 in Canada and Mexico; \$95 surface mail in all other countries; air mail surcharge, \$35.00 (16 issues). Special DIGEST issues, \$15.00. Single issues \$5.00 in the U.S.; \$6.00 in Canada and Mexico; \$7.00 in all other countries.
© 1985 by Cahners Publishing Company, Division of Reed Holdings, Inc. All rights reserved.



Before you buy
a 2400 baud modem,
check the one with
89 years of reliability
built in.



Introducing the CTS 2424AD modem

CTS has been manufacturing reliable products since 1896 when we introduced our first hand cranked, wall mounted, wooden telephone. Today, we're introducing a sophisticated, full duplex, autodial, 2400 baud modem, and our **promise of reliability** stays the same.

The CTS 2424AD modem offers **technological reliability** in its signal processor. Originally designed for more expensive and complex modems, the patent pending CTS signal processor provides integral adaptive equalizing for noticeably clearer, error free transmissions.

Our 2424AD meets CCITT V.22bis requirements and operates both synchronously and asynchronously at 2400 and 1200 bits per second. Other features include autodial with memory storage of up to ten telephone numbers (40 characters per number).

The CTS 2424AD offers **field reliability** with its two year warranty. And we demand our distributors provide you with the service you deserve.

Brand reliability is important at CTS, because it's important to you. That's why we suggest you check out our 2424AD before you buy a 2400 baud modem. You'll find what's built in to a CTS DATA COMM product is what you're looking for.

CTS

DATA COMM Products Division
6900 Shady Oak Road
Eden Prairie, MN 55344

800-328-6104

NEW TO THE INDUSTRY SINCE 1896.

CIRCLE NO. 3 ON INQUIRY CARD

STAFF

Vice President/Publisher
S. Henry Sacks

Editor-in-Chief
George V. Kotely

Managing Editor
James F. Donohue

Assistant Managing Editor
Bruce J. MacDonald

Senior Western Editor: **Jerry Borrell**
San Jose, (408) 296-0868
Senior Editor: **Lori Valigra**
Senior Projects Editor: **Rick Dalrymple**

Western Editor: **Carl Warren**
Los Angeles, (213) 826-5818
Senior Associate Editor: **David Simpson**
Associate Editor: **Frances T. Granville**
Associate Editor: **Lynn Haber**
Associate Editor/Research: **Frances C. Michalski**
Associate Editor: **Gregory Solman**
Associate Editor: **Michael Tucker**
Associate Editor: **Jesse Victor**
Assistant Editor: **David Bright**
Assistant Editor/New Products: **Eileen Milauskas**
Assistant Editor/Research: **Pamela Gorski**
Assistant Editor/Research: **Megan Nields**

Contributing Editors

Raymond C. Freeman Jr.
Freeman Associates
Taiwan: **Charles Hintermeister**
London: **Keith Jones**, (011-441-661-3040)
Tokyo: **Ichiro Kakehashi**
Data Communications: **Walter A. Levy**
Frankfurt: **Maureen O'Gara**
United Kingdom: **Denise Danks**
Washington, D.C.: **Stephen J. Shaw**
(202) 387-8666
Gene R. Talsky
Professional Marketing Management Inc.

Editorial Production

Senior Copy Editor: **Arsene C. Davignon**
Production Editor: **Mary Anne Weeks**
Assistant Copy Editor: **Sharon Hassell**
Administrative Assistant: **Nancy Norton**

Editorial Services

Dorlis French, Terri Gellegos

Assistant to the Publisher: **Linda L. Lovett**

Executive Editor,
Cahners Computer Publications
Alan R. Kaplan

Art Staff

Art Director: **Vicki Blake**
Assistant Art Director: **Cynthia McManus**
Artist: **Anne Tregay**

Director of Art Dept.: **Norm Graf**

Production Staff

VP Production: **Wayne Hulitzky**
Supervisor: **William Tomaselli**
Production Manager: **Lisa Sisterhenm**
Composition: **Diane Malone**

Editorial Offices

Boston: 221 Columbus Ave., Boston, MA 02116., (617) 536-7780. **Irvine:** 2041 Business Center Dr., Suite 109, Irvine, CA 92715. **Los Angeles:** 12233 W. Olympic Blvd., Los Angeles, CA 90064. **San Jose:** 3031 Tisch Way, San Jose, CA 95128. **London:** P.O. Box 37E, Worcester Park, Surrey, KT4 8RQ, England.

Reprints of Mini-Micro Systems articles are available on a custom printing basis at reasonable prices in quantities of 500 or more. For an exact quote, contact Art Lehmann, Cahners Reprint Service, Cahners Plaza, 1350 E. Touhy Ave., Box 5080, Des Plaines, IL 60018. Phone (312) 635-8800.

Gould... Innovation and Quality in Real-time Systems

THE FIREBREATHERS. **Leaders since the beginning** **of Real-time.**

Legends have a way of being based on fact. Gould Firebreathers are legendary in the land of Real-time and our leadership and superiority are no myth.

Gould ignited the Real-time fire two decades ago. Since then, scientific and industrial computer users have been hot on Gould. In the simulation,

energy, oil and gas, laboratory and computational markets, Gould Firebreathers are the choice of virtually all the leading companies that implement Real-time systems.

Gould had the first Real-time minicomputer in 1965. We again brought sophisticated Real-time users out of the Dark Ages with the first 32-bit Real-time mini in 1969 and the first supermini in 1975. And we're still the leader in superminicomputer performance. When it works and it's proven, history does repeat itself.

Be a part of history in the making. Bring Gould into your Real-time realm. Firebreathing power from the beginning, for today...and tomorrow.

Gould Inc.,
Computer Systems Division,
6901 West Sunrise Boulevard,
Fort Lauderdale, FL 33313
1-800-327-9716.



GOULD
Electronics

CIRCLE NO. 4 ON INQUIRY CARD

A DECLAR DATA INDE



When In The Course Of Business Events . . .

OEMs designing systems for today's businesses face two realities. One, data processing is rapidly becoming more decentralized. It is pushing outwards into individualized work units, defined more by job function and applications, performed by more people in

more places, demanding more data flexibility—more data independence.

Which brings OEMs face to face with a second reality. Winchester. Because the prevailing mass storage technology—in the form of large storage units used for access or downloading, or smaller, high capacity desk-top mechanisms—continues to head in

the opposite direction. Rather than freeing users to operate effectively in the new environments of distributed data processing, Winchester keep them device-dependent, keep them tied to a shared system of storage.

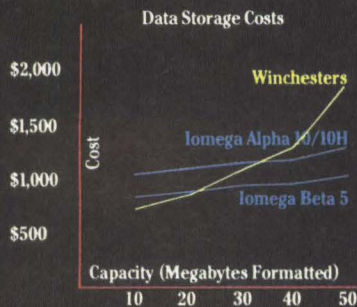

Slavery By Any Name . . .

There are lessons here. That the central issue isn't more data, but more data dynamics. And that Winchester are hardly data dynamic at all.

Consider the aggravations of "wait your turn" access, or the need for lots of "system savvy" on the user's part. Consider the time consumed in backing up and restoring data. And consider the ever-present risk of a system going down or files lost to expensive head crashes.

Now consider the alternative.

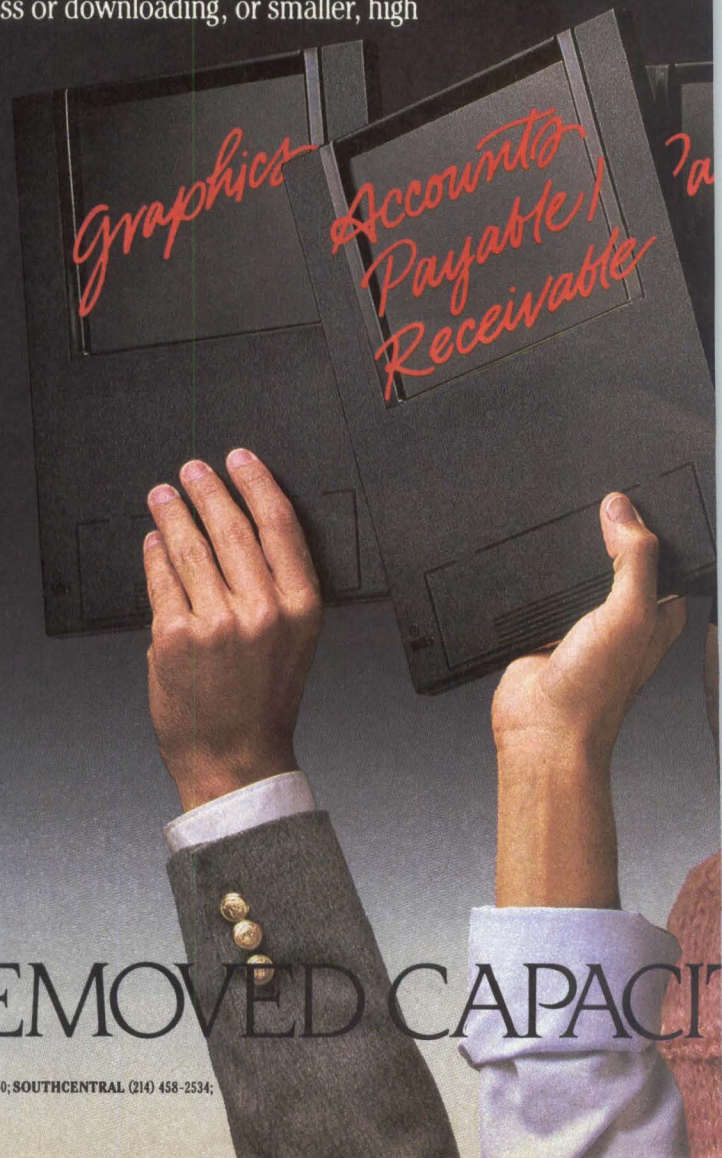

IOMEGA HAS REMOVED CAPACIT

ATION OF PENDENCE.

IOMEGA's Distributed Data Storage: Freedom Of Information.

The IOMEGA family of data management/storage systems effectively matches today's distributed data processing reality with a new reality: *distributed data storage*. Because IOMEGA's reliability and performance specs often exceed Winchester's, particularly in access times and transfer rates. And they deliver cost-per-megabyte figures that Winchester's cannot figure at all.

	IOMEGA BETA 5	IOMEGA ALPHA 10/10H	TYPICAL WINCHESTER
Formatted Capacity	5.0 Mbytes per cartridge	10.0 Mbytes per cartridge	10.0 Mbytes fixed
Data Transfer Rate	5.0 Mbits/Sec	9.0 Mbits/Sec	5.0 Mbits/Sec
Average Access Time	50 msec includes settling	35 msec includes settling	85 msec
Form Factor	5.25"	8"/8" Half Height	5.25"

The key is "in/out" simple—the IOMEGA cartridge. Think about downloading data and software to a single 5- or 10-megabyte cartridge, then manipulating, updating, and uploading with maximum convenience and cost efficiency. And think about a total enterprise solution, about storing individual applications, complex software programs, or data sets—all of which can be passed along to others without expensive networking resources. And when you need more storage, you use more cartridges, not more hardware.

Accept No Other Alternatives.

IOMEGA's distributed data storage solutions—in full- and half-height 8-inch 10-megabyte solutions, and a 5-megabyte, 5¼-inch version as well—give OEMs Winchester performance and reliability, and floppy convenience and cost efficiency. They are proven, risk-free solutions. And of the few cartridge opportunities on the market today, IOMEGA's—besides being available—are the only ones that are rugged, absolutely interchangeable, and inexpensive. As such, they give OEMs the most precious commodity of all: *the freedom of designed-in freedom*. The freedom your customers require.

Take The Liberty.

Get in touch with an IOMEGA representative today. One is conveniently located in an area near you.

IOMEGA™ THE FUTURE IN DISTRIBUTED DATA STORAGE

IOMEGA CORPORATION
1821 West 4000 South
Roy, Utah 84067
(801) 776-7330

Y AS THE MASS STORAGE ISSUE.

WESTERN (714) 855-1211, (408) 263-4476; NORTHEAST (617) 933-2000; MIDWEST (312) 397-4234; EASTERN (203) 359-9858.

CIRCLE NO. 5 ON INQUIRY CARD

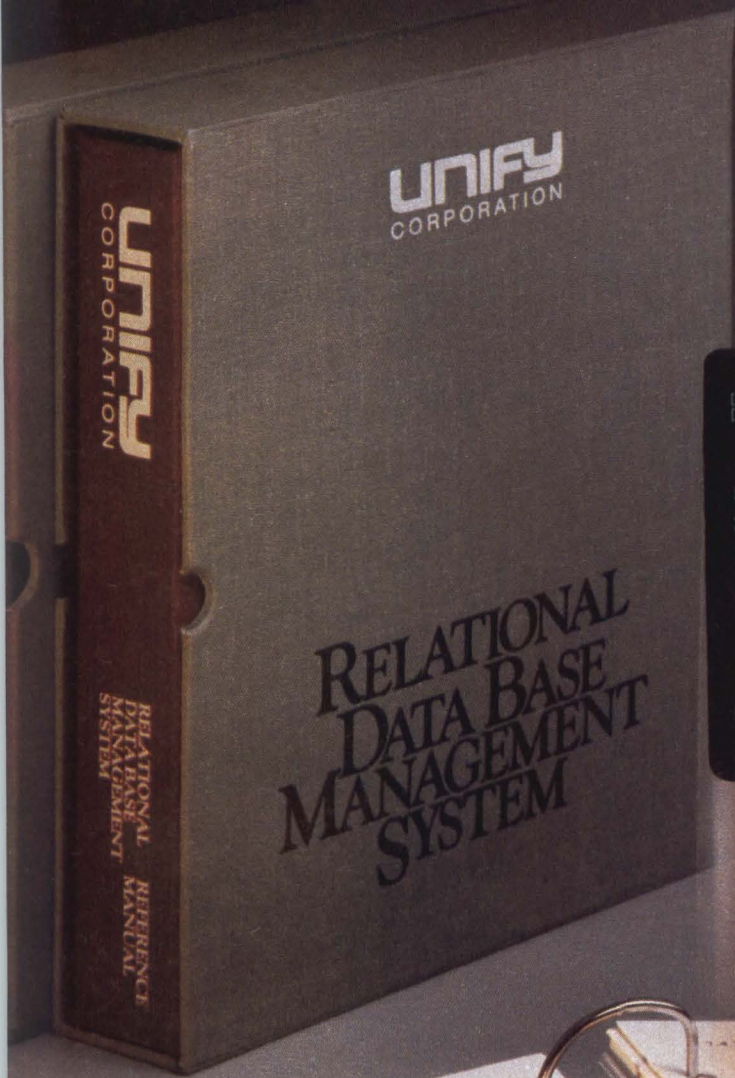

```
[ysmenu]
17
1. Schema Maintenance
2. Schema Listing
3. Create Data Base
4. SFORN Menu
5. ENTER Screen Registration
6. SQL - Query/DML Language
7. SQL Screen Registration
8. Listing Processor
SELECTION: █
```

```
UNIFY SYSTEM
SEP 1984 - 10:01
System Menu
9. Data Base Test Driver
10. MENUH Screen Menu
11. MENUH Report Menu
12. Reconfigure Data Base
13. Write Data Base Backup
14. Read Data Base Backup
15. Data Base Maintenance Menu
```

```
[student]
[INQUIRE]
UNIFY SYSTEM
25 Aug 1985 - 10:45
Student Registration Form
Invoice Number: 458
Last Name: Gordon First Name: Richard
Company: Silicon Design Labs
: 5550 Industrial Hwy
: Basking Ridge NJ 07008
: (201) 555-5488
Student's phone number (if different): (201) 555-5421
Class code (assembly): CP0905 Subject: C Programming
Class fee: 995.00 Class date: 9/1/85
Deposit date: 8/15/85 Deposit amount ($): 100.00
Payment date: 8/25/85 Payment amount ($): 895.00
```

```
[student]
[INQUIRE]
UNIFY SYSTEM
25 Aug 1985 - 10:45
Student Registration Form
Current: 1
REPORT TO: SCREEN PRINT FILE FILENAME
1. Student Registration Listing (x) ( ) (x)--listing
2. Student Billing ( ) ( )
3. Billing Summary ( ) ( )
REPORT #: 1
```

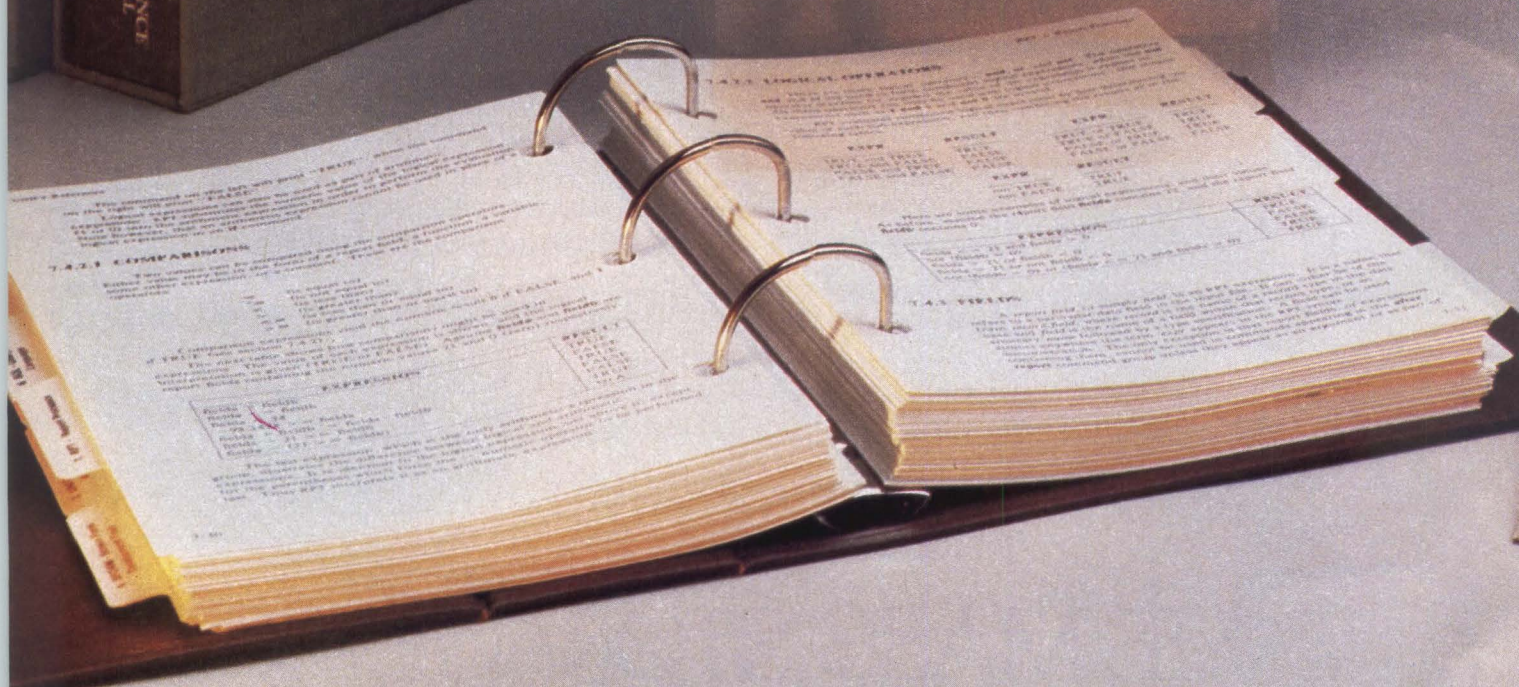

*UNIX is a trademark of AT&T Bell Laboratories.
 UNIFY is a trademark of Unify Corporation.
 Copyright © 1984, Unify Corporation, Lake Oswego, OR 97034

UNIFY. THE MIGHTY EASY DBMS.

UNIFY isn't only the fastest and most powerful of all UNIX*-based data base management systems—it's also one of the simplest to use. Which is why some 75 percent of those who see our manuals and buy a DBMS, buy UNIFY.

UNIFY guides the nonprogrammer through data base development with minimal steps, comprehensive menus, on-line HELP, elementary Query By Forms capability, and clear documentation.

UNIFY expedites applications development for users of all skill levels with features like PAINT, for effortless forms design; SQL, the powerful, English-like query language; and a menu-handler that lets you quickly compile screens, queries and reports into menus customized to each user.

And for the skilled programmer, UNIFY offers the most extensive host language interface, for limitless flexibility when you need it.

All of which makes it mighty easy to see why UNIFY has been selected by more computer manufacturers than any other UNIX-based DBMS.

Judge for yourself. Send for our demo kit—disks, tutorial and reference manuals, all for only \$150—that shows you how to build virtually any application. Contact UNIFY, 4000 Kruse Way Place, Lake Oswego, OR 97034, 503/635-6265.

CIRCLE NO. 6 ON INQUIRY CARD



UNIFY®
THE PREFERRED DBMS.

Introducing high speed laser-based detection of micro-size surface flaws.

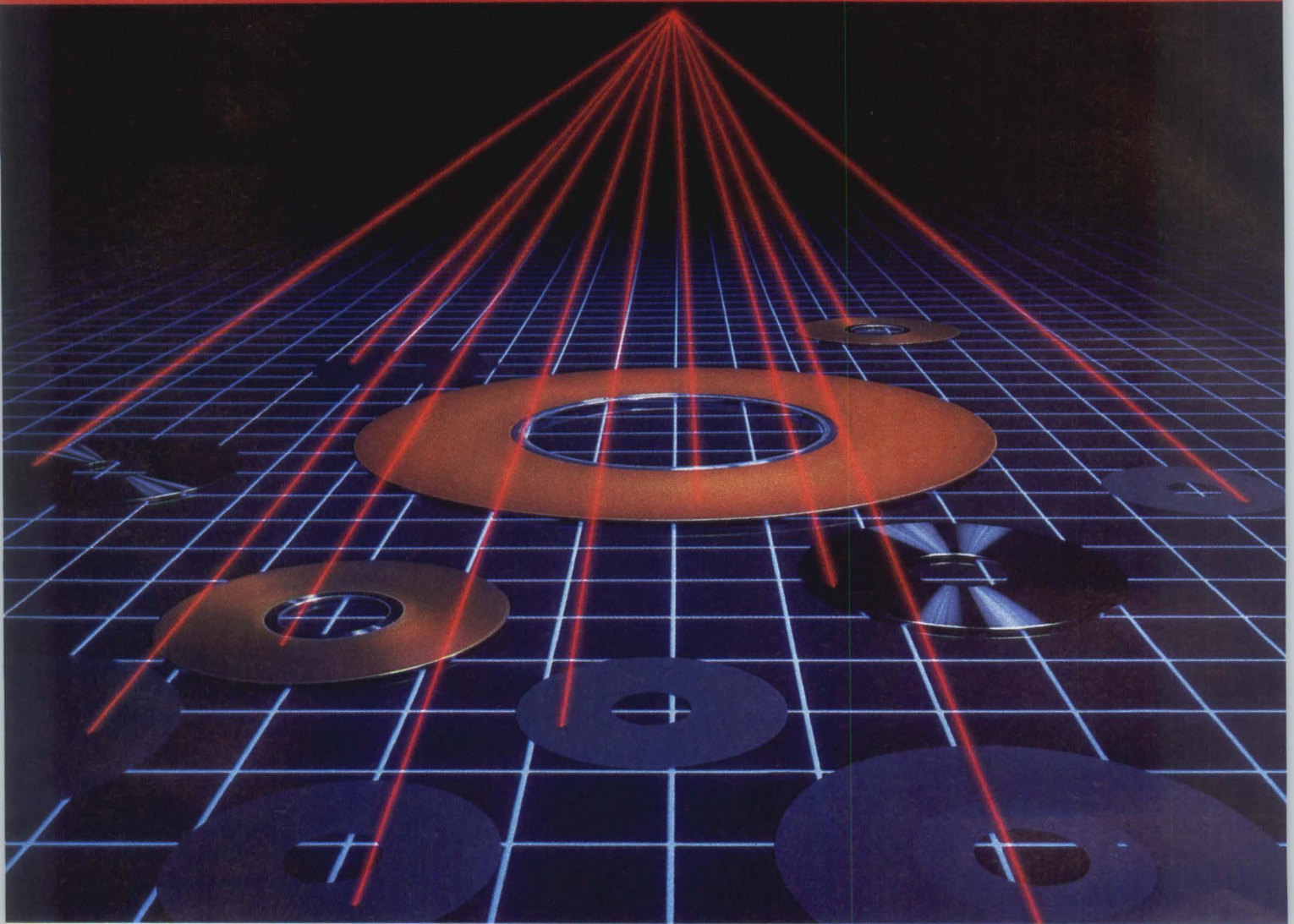

Four new laser-based optical inspection systems offer high speed detection on magnetic media and other surfaces.

Our new laser-based, on-line intelligent inspection systems allow non-contact, automatic, high throughput inspection of disks, webs, cylinders, and glass plates. Each system includes an intelligent programmable controller, automatic handling of the inspected product, and automatic reporting to a local display/printer.

Systems available include: GCA DISKAN-1000™ for post-burnished

and pre-jacketed floppy disks
• GCA DISKAN-5000™ for rigid disks including substrates, soft coated, plated, thin film, and final end products • GCA WEBSKAN-1000™



Cylinders and drums for inspection.

for floppy disk webs prior to punching • GCA-DRUMSKAN-1000™ for precision ground cylinders and coated drums.

CIRCLE NO. 7 ON INQUIRY CARD

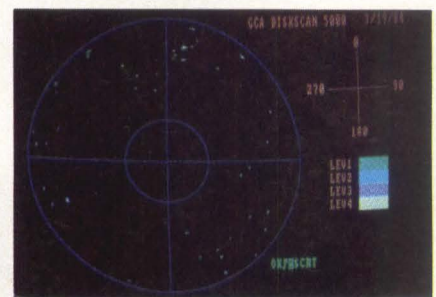

Typical disk defect map.

For further information, call or write to the Marketing Manager for Laser Inspection Systems.



GCA CORPORATION
Technology Division
213 Burlington Road
Bedford, Mass. 01730
(617) 275-5444
Telex 92-3339
© 1985 GCA Corporation

EDITORIAL



PERSONAL COMPUTER MARKET GROWTH DECELERATES

According to InfoCorp, a Cupertino, Calif., market research company, bankruptcy, poor financial results and layoffs have become commonplace among computer and peripheral manufacturers. Based on their recent study, "The Personal Computer Market, The Pieces Add Up to a Slowdown," the two key causes center on industry maturation and a softening U.S. economy. Both have created computer-market conditions that have exposed deficient product sales strategies. The report concludes that the decline in high-end, personal-computer sales has rippled down to, and is similarly affecting, computer-system, mass-storage-device, media and component sales.

On the bright side, though, personal-computer shipments totaled more than 7.5 million units during 1984, states International Data Corp. (IDC), a Framingham, Mass., research company. Furthermore, IDC claims that 1985 computer shipments will exceed 9.6 million units. The growth rate, however, will slacken to about 28 percent. Recent years have rung up growth rates in excess of 50 percent.

Similar analyses are presented by International Resource Development Inc. (IRD), a Norwalk, Conn., research organization. IRD estimates that 1985 personal-computer shipments will increase to about 7.6 million, a 36 percent growth rate over 1984's 5.6 million. The ever-expanding, installed personal-computer base, says IRD, is limiting percentage growth.

If computer shipments are still increasing, then why is the market's growth rate slowing down? Industry experts all agree that the omnipresence of IBM Corp. shakes and moves the personal-computer marketplace. In 1984, according to Future Computing Inc., a Dallas research house, IBM emerged as the sales leader in the office personal-computer market. IBM grabbed 41.5 percent of U.S. market

share with revenues of \$2.75 billion. Over the past two years, IBM has more than doubled its market share, while runner-up Apple Computer Inc. has dropped to 11 percent from 22 percent. Trailing far behind, in third and fourth place, respectively, are Tandy Corp. at 6.3 percent of market share and Compaq Computer Corp. at 4.5 percent.

This surge to the forefront by IBM has caused a shakeout in the personal-computer industry. Companies that ranked high in sales and profits in 1982, such as Columbia Data Products, Eagle Computer Inc., Franklin Computer Corp. and Osborne Computer Corp., have dropped out of the market or been pushed to the brink. Therefore, fewer companies are producing more computer products. And because fewer computer manufacturers need less product support, the number of peripheral-device vendors is shrinking rapidly. In particular, disk drive companies are down to a precious few.

The survival tactic for 1985, say industry experts, in unison, lies in the value-added reseller (VAR) sales channel. Conceding the computer retail channel to IBM, Apple, Tandy and Compaq, the remaining competition is, therefore, moving briskly to establish growth positions in vertical VAR markets. For example, IDC claims that VARs sold \$4.3 billion worth of microcomputers in 1984. In 1985, VAR sales should top \$5.8 billion, and reach \$13.9 billion by 1989.

But the VAR channel looks good to IBM as well. Future Computing says that IBM will have 500 value-added dealers (VADs) in place during 1985 and will sell about 170,000 personal-computer systems. The key determinants for future success in the computer market, therefore, says George D. Elling, vice president and security analyst at New York-based Oppenheimer and Co. Inc., include strong, new products and solutions targeted to high-growth, vertical markets.

A handwritten signature in cursive script that reads "George V. Kotlley".

George V. Kotlley
Editor-in-Chief

TEKTRONIX INTRODUCES THE WORLD'S BROADEST LINE OF 32-BIT GRAPHICS WORKSTATIONS.

Introducing the first workstations whose breadth of options will satisfy the unique needs of every user — yet whose compatibility with hosts, PCs, terminals, and each other will answer the equally demanding needs of every company. From its low-cost personal workstations to its multiple 32-bit, multi-processing engines... from its new graphics displays to its integrated software... from its immediate potential to its long-range value, the new Tek 6000 Family of Intelligent Graphics Workstations is far and away the price/performance leader.

Keep your software, hardware, and host. The workstations' open architecture lowers the cost of developing and porting software. You can use Tek 4000 Family terminals or our all-new window-managed displays. You can specify IBM-PC compatibility. Continue to use your host compute power. And connect with other workstations via the LAN.

Immediate solutions and software tools. Most UNIX-based software is easily ported, as are packages written with GKS and PLOT 10 TCS and IGL. As a result, major third party applications packages are already available, with many more on the way.

In addition, Tek offers a range of superb software tools, including a document processor, project planner, graphics editor and relational DBMS.

Call 1-800-547-1512 today, to learn how you can get everything you've wanted in a workstation: High performance. Host compatibility. More options to start with. And a standard you can grow with. In Oregon, call 1-800-452-1877. Many sales and leasing agreements are available.

Tek Intelligent Graphics Workstations: The standard you can grow with.

1. Tek 4107 terminal in-use with PLOT 10 TekniCAD Computer-Aided Drafting package.

2. Low-cost, personal UNIX system configuration.

3. Peripheral cabinet houses 9-track tape and SMD disks.



Copyright © 1984, Tektronix, Inc. All rights reserved. ZEO-102

4. Tek 4115B terminal
integrated into
workstation.

5

5. Instrument controller
with real-time operating
system.

4

6

6

8

7

6. New window-
managed displays help
deliver the full benefits of
multi-processing.

8. Keyboards, displays and
display stands all incor-
porate human engineer-
ing at its best.

7. Tek 6200 dual-wide
configuration enables
limitless expansion.

UNIX and IBM-PC are trademarks or registered trademarks of, respectively, AT&T Bell Laboratories, Inc., and International Business Machines. 4115B display courtesy of PDA Engineering. Drawing courtesy of Manufacturing and Consulting Services, Inc., shown on display 6.

Tektronix[®]
COMMITTED TO EXCELLENCE

Now for \$799, a VT-220 with perfect function,

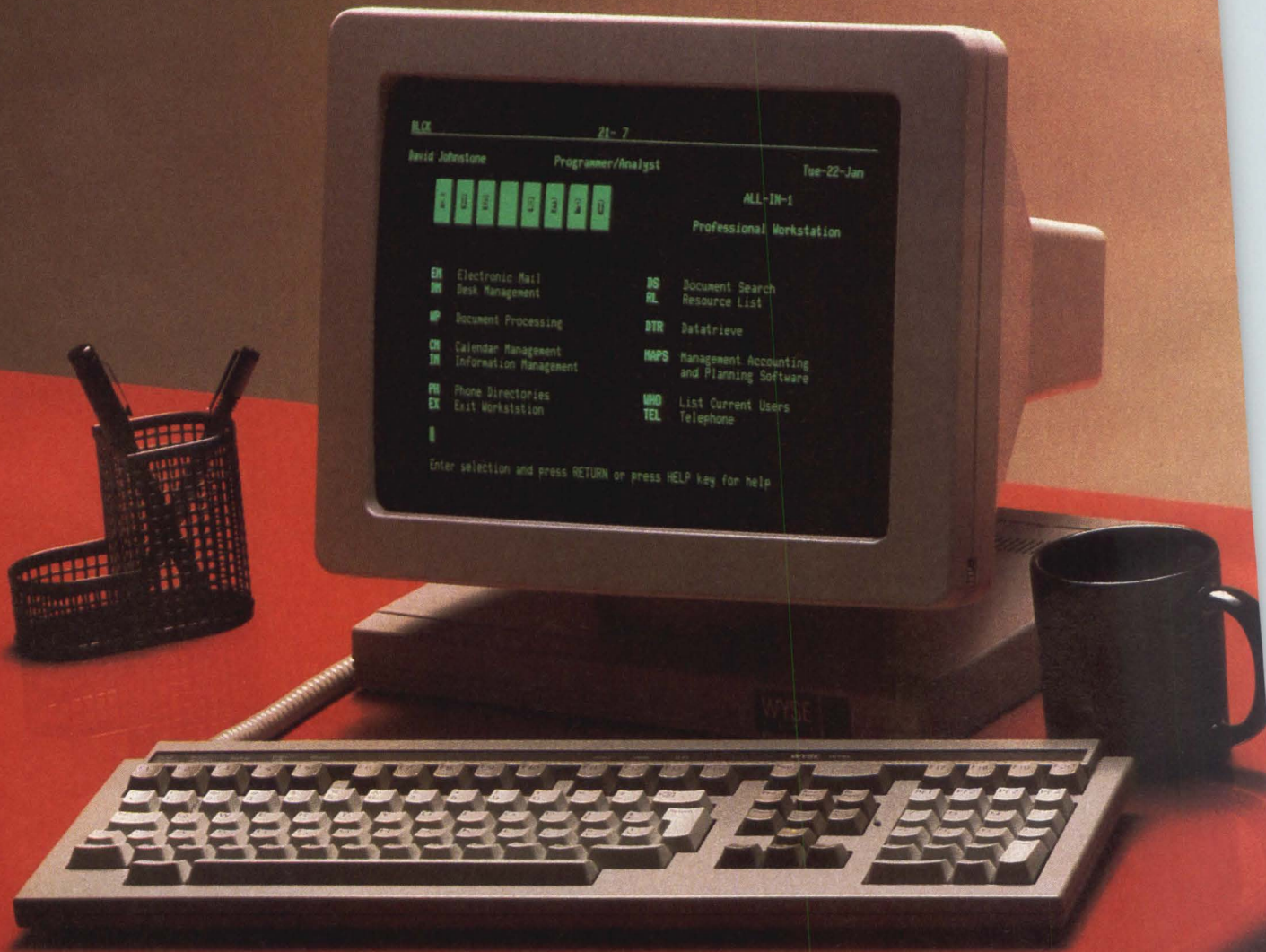

compatible terminal fit and form.

Our WY-85 gives you complete DEC VT-220™ software compatibility in function and fit, plus a form that beats all, for a price that beats all.

Like all our terminals, the WY-85 packs all the ergonomic features you want into an unusually small footprint. The generous 14" non-glare screen tilts, swivels, and handles a full 132-column format. Even the sculpted, low-profile keyboard adjusts for perfect fit and easier function.

So you get not just emulation, but the full operational compatibility you're looking for, including keyboard layout. For a lot less money, in a lot less space, with a lot more style.

No wonder Wyse terminals are now on more than 150,000 desktops worldwide.

For more information about our full line of computer display products, call the regional office nearest you.

WYSE
| | | |

Regional Offices:

Northeast (201) 725-5054

Southeast (305) 862-2221

Midwest (313) 471-1565

Southwest (818) 340-2013

Northwest (408) 559-5911

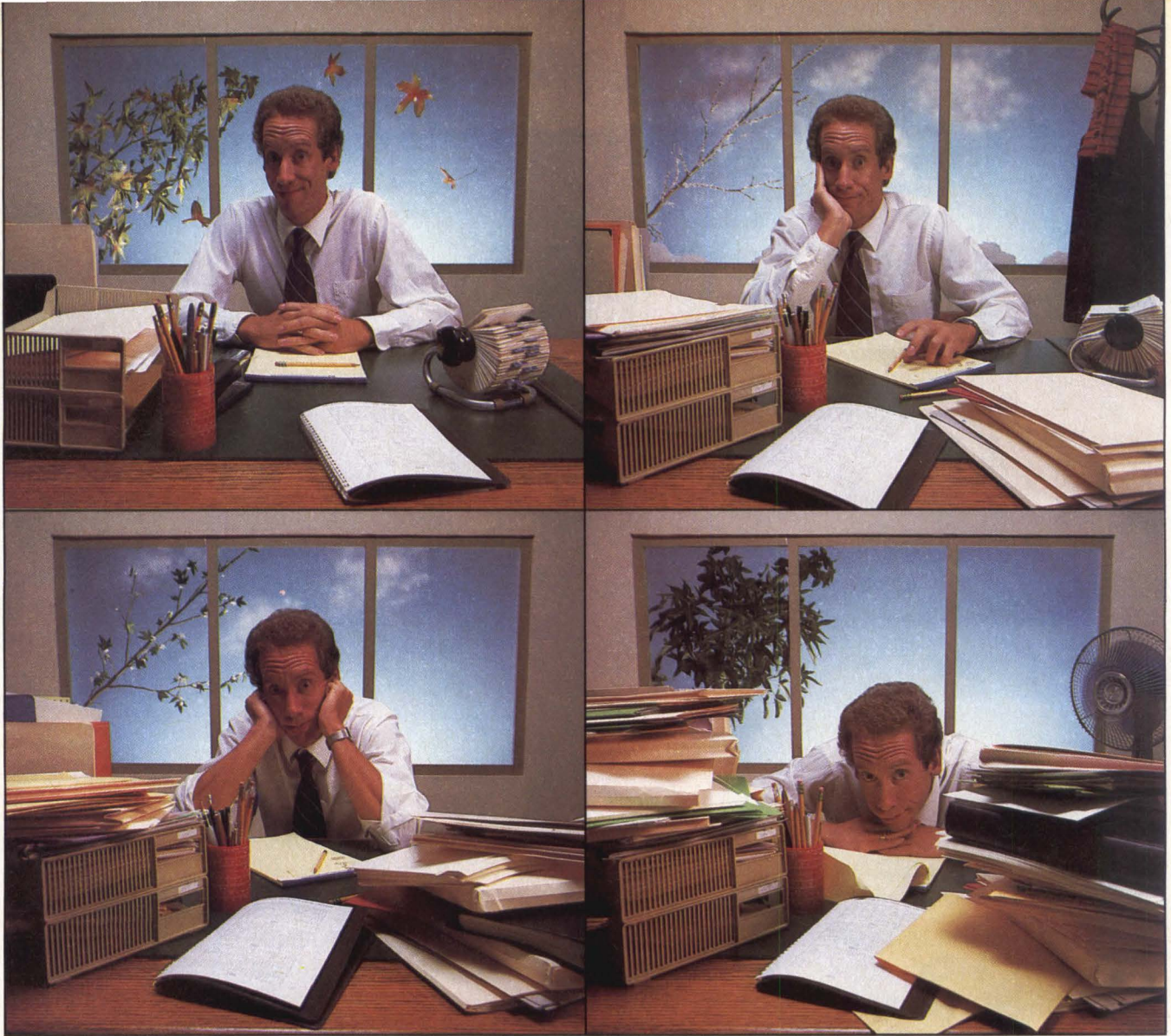

The DEC® VT220 you've waited for still isn't here.

**But the No. 1
alternative is.**



pluses over a DEC. Yet, it costs less.

The pluses:

Four additional enhanced menus. Display. General. Auxiliary Port. And Keyboard.

A convenient front-mounted on/off switch, not rear mounted like DEC's. A keyboard jack near the front, providing more cable length. And a 3-position keyboard elevating mechanism.

Plus, two more LED's than you'll find on the DEC keyboard. One for online, the other for shift lock.

What DEC announces, CIE Terminals delivers. Faster. Better. And more economically.

The new CIE220+ is available right now. It has at least a dozen

A bi-directional Auxiliary Port, not just uni-directional like DEC's. So you can add either a printer or second host.

Plus, variable speed smooth scroll for fast or slow review.

And the pluses go on, including even more built-in reliability. So it stumps us why anyone would go on waiting for a DEC when you can get the 220 with all the pluses right now.

For immediate information, call (714) 660-1421 or phone toll free 1-800-624-2516. Ask for our Information Desk. Or write CIE Terminals, 2505 McCabe Way, Irvine, CA 92714.

CIE TERMINALS
A CITECH ELECTRONICS COMPANY

® DEC is a Registered Trademark of Digital Equipment Corp.
© 1984 CIE Terminals.

CIRCLE NO. 10 ON INQUIRY CARD

BREAKPOINTS

HEWLETT-PACKARD TO ANNOUNCE LAN FOR HP 3000 MINICOMPUTERS

Hewlett-Packard Co. was expected to introduce LAN/3000 Link, the first local area network for its HP 3000 family of minicomputers, at The Interface Group Inc.'s annual communications show in Atlanta this month. The LAN/3000 Link is a full implementation of the IEEE 802.3 carrier sense multiple access with collision detection baseband LAN standard for office applications and the IEEE 802.2 logical-link-control specification. Because of the network's high speed—10M bits per second—throughput is two to six times better than that of the currently used point-to-point links, according to HP officials. As many as 100 HP 3000 minicomputers can be connected. HP also planned to introduce a product, called HP SNA IMF, to enable interactive communications between the HP 3000 machines and IBM Corp. mainframes using the IBM Systems Network Architecture (SNA) protocol. Link prices start at \$5,000, and SNA product licenses are \$3,500.—D. Bright

JAPANESE LEGISLATORS NEAR PROTECTION OF CHIPS

Japan's version of chip-copyright-protection legislation is nearing approval in the Diet, the national legislative body. The Diet still needs to determine at what point in the design process a semiconductor device is protected and whether criminal penalties should be provided in addition to a designer's right to sue for damages in civil court. In other respects, the chip-copyright bill resembles the American law that took effect last October. The developer of a semiconductor pattern would have rights similar to a patent for 10 years and would be able to seek court injunctions to stop alleged copyright violators. The Japanese are recommending that American and Japanese semiconductor makers, which produce 90 percent of the world's chips, should work for an international chip-copyright convention through the World Intellectual Property Organization. That body helps protect music and literary compositions from piracy.—I. Kakehashi

DIGITAL RESEARCH, KOREAN COMPANY SIGN SOFTWARE-DISTRIBUTION AGREEMENT

Digital Research (Japan) Inc., and A.I. Soft Korea Inc., Seoul, have formed a sales agreement in which the Korean software developer will modify and distribute operating systems and development and application programs based on programs from Digital Research Inc., Pacific Grove, Calif. The initial emphasis will be on Korean versions of CP/M operating systems and Concurrent DOS for 16-bit computers. M. Morimoto, general manager of Digital Research (Japan), says the agreement will encourage Korean software development and make it easier to promote software based on the big library of CP/M- and MS-DOS-based programs available in other languages. That software will be translated into Korean hangul characters for Korean-made microcomputers.—I. Kakehashi

BREAKPOINTS

BRITISH COMPANY WANTS U.S. DATABASE-PACKAGE CONTRACTS

Compsoft Plc., Guildford, England, wants to link up with U.S. manufacturers of 16-bit personal computers running MS-DOS to sell Compsoft's new database-management system, Delta 4. Compsoft marketing director Heather Kearsley says Delta 4 already is being sold by IBM United Kingdom Ltd., the British subsidiary of IBM Corp. She hopes IBM will soon offer Delta 4 in Belgium, France, Italy, Spain, and Switzerland as well. IBM already sells an earlier product, Delta 1, in those countries. Digital Equipment Corp. and Hewlett-Packard Co. also sell Delta 1 in most parts of Europe. Delta 4 is priced at a bit more than \$500 for end users. It is designed for ease of use by non-programmers, says Kearsley.—K. Jones

XEROX, DATAPRODUCTS REMARKET AI-BASED GRAPHICS SOFTWARE

InfoGraphics Inc., Irvine, Calif., has introduced an artificial-intelligence-based business-graphics software package for MS-DOS- and CP/M-based personal computers. Called Choice, the package will be jointly marketed by InfoGraphics, Xerox Corp. and Dataproducts Corp. With Choice, users can select graphics parameters or have the software make the decisions. The package accesses data from Lotus Development Corp.'s 1-2-3 integrated package, other business programs and optical character readers. Users can also input data directly. Choice, which prints on 32 printers and plotters, does not require a graphics card or color monitor. List price is \$395. Xerox and Dataproducts will bundle the software with their personal computer products.—D. Bright

SIEMENS 16-BIT MICROCOMPUTER BUS TO BECOME A STANDARD

The AMS 16-bit microcomputer bus defined by Siemens AG, Munich, West Germany, should be published as a standard this year by the International Electrotechnical Commission (IEC), Geneva, Switzerland. AMS is electrically identical to the IEEE's Multibus I standard, notes Udo Schöllmann, assistant marketing manager in the microcomputer systems division of the Siemens component group. But it possesses some mechanical characteristics that are more widely used by board builders in Europe than in the United States. The two notable characteristics are the Eurocard form factor and the two-part connector defined by the West German standards body, the Deutsche Institut für Normung. Schöllmann says Siemens now is encouraging other European manufacturers to build boards complying with the standard it initiated, which the IEC has designated the Microprocessor Systems Bus I. More than 40 countries worldwide, including the United States, belong to IEC.—K. Jones

PLEXUS BROADENS SYSTEM CAPABILITIES

Plexus Computers Inc., San Jose, Calif., is broadening its P series of UNIX-based systems with the P-15 and P-20 models. The P-15, which

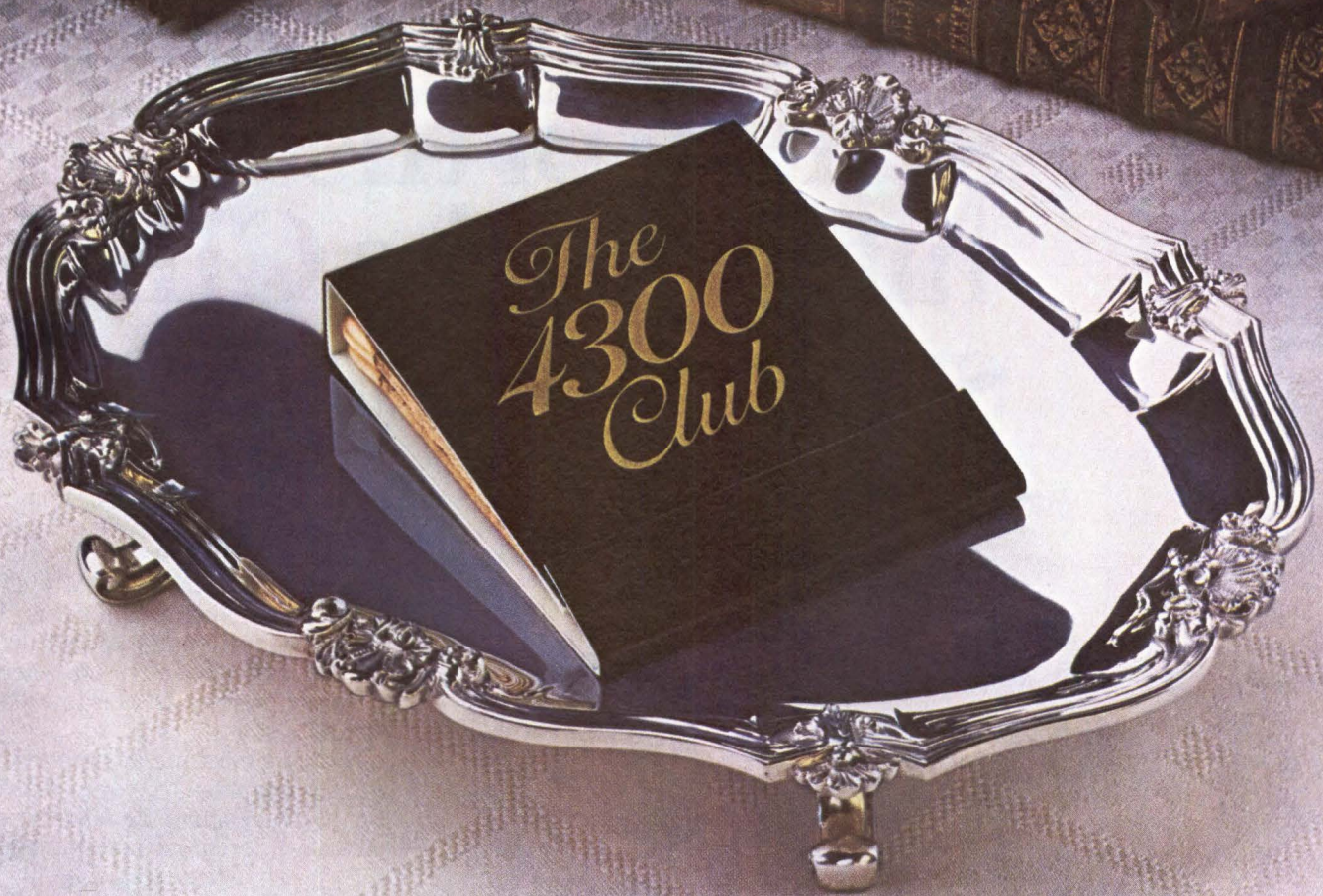

For remarketers, there's still room at the top.

We're looking for new members for the "4300 Club."

If your company creates application software that will run on an IBM 4300, we invite you to consider matching *your* skills to *our* systems.

In short, IBM is looking for experienced firms that will remarket the 4300—and become what we call Value Added Remarketers.

The standards are high, but for companies that meet them, IBM has much to offer.

To start with, IBM can add strength to your marketing efforts. We can, for instance, help with product literature, with direct mail and with business show support. IBM also has a wide range of professional classes for VARs.

And thanks to an online referencing system used by IBM's own sales force, we can refer prospects with special needs to VARs who have unique solutions.

In addition, IBM offers to VARs that qualify

other highly competitive products: System/36, Series/1, System/38, the IBM Personal Computer and the System 9000 family.

For more information on qualifying as an IBM VAR, simply send in the coupon or call 1 800 IBM-VARS, Ext. 96.

Larry Humphreys
IBM Distribution Channels
P.O. Box 76477
Atlanta, GA 30358
Please send me your free booklet, "Looking for Leaders."

96/3-85

Name _____

Title _____

Company _____

Address _____

City _____ State _____ Zip _____

Phone _____ Product Interest _____

CIRCLE NO. 11 ON INQUIRY CARD

IBM's® Unix-™-based system of the future is the CIES system of today.



"Let's wait and see what IBM does."

Sound familiar? Maybe some of your customers are holding off on a UNIX-based system purchase until IBM introduces its own version.

You can't blame them, in a way. Their nightmare goes something like this:

The ink isn't even dry on the contract they've signed with you when, suddenly, the new IBM is unveiled in all its glory.

What a machine. It supports 12 terminals, or maybe even 40. Not only that, each of the 40 users can run a different job simultaneously.

What engineering. The 10 MHz processor performs with no wait states.

What a big memory. Up to 2 MB RAM, upgradeable to 8 MB.

And get this. A hard disk from 84 to 300-plus MB. Along with a 500 KB floppy and a 20 MB cartridge tape drive for backup.

Maybe you should tell them that the systems of their dreams are available from you, today, at an affordable price. Better yet, they've already had two years of on-the-job experience and refinement engineering. They're the 680/100 and 680/200 from CIE Systems.

And if they say they're more comfortable with a big company, tell them that multi-national C. Itoh & Company, Ltd., with \$60-billion in sales and over 125 years of experience, is behind CIES.

Just write or call for the whole story. CIE Systems, Inc., 2515 McCabe Way, Irvine, CA 92713-6579. (714) 660-1800. Call toll free 1-800-854-5959. In California, 1-800-432-3687.

™ CIES 680 is a Trademark of CIE Systems, Inc.
UNIX is a Trademark of Bell Laboratories

® IBM is a Registered Trademark of International Business Machines Corp.
© 1984 CIE Systems, Inc.



A C. ITOH ELECTRONICS COMPANY

CIES SYSTEMS SALES OFFICES

Southwest
2515 McCabe Way
Irvine, CA 92713
(714) 660-1800

Northeast
Executive Mews, M64,
1930 East Marlton Pike
Cherry Hill, NJ 08003
(609) 424-6925

North Central
1 Cross Roads of Commerce
Suite 305
Rolling Meadows, IL 60008
(312) 392-1331

South Central
17311 Dallas Parkway
Suite 230
Dallas, TX 75248
(214) 248-8355

Southeast
4501 Circle 75 Parkway
Suite 1190 A
Atlanta, GA 30339
(404) 953-1876

New England
400 Amherst St.
Space #41
Nashua, NH 03063
(603) 881-7031

Northwest
2700 Augustine Dr.
Suite 238
Santa Clara, CA 92504
(408) 748-0452

England
Beacon House
26/28 Worpole Road
Wimbledon, SW 19, 4EE
01-946-4960

CIE Systems

a giant step ahead...

BREAKPOINTS

should be shipped this month, supports as many as six users and runs AT&T's latest version of UNIX with the Berkeley enhancements, UNIX 5.2. A standard unit with 512K bytes of RAM, eight serial ports, UNIX, one 12M-byte Winchester drive and a floppy disk drive is priced at \$10,950. The P-20, which Plexus plans to ship in May, has a three-slot Multibus card cage that supports an advanced communications processor. That processor, which should be ready by fall, is expected to yield an aggregate throughput of 700,000 characters per second and will use direct memory access to transfer data to the system bus.—C. Warren

BOARD MANUFACTURERS ADOPT NATIONAL'S 32-BIT CHIP

Board manufacturers are starting to use National Semiconductor Corp.'s series of 32-bit microprocessors. Owl Computers Inc., Encinitas, Calif., this month plans to ship its Owl 32032M Multibus board set, which includes the National 32032 CPU, the 32201 interrupt-control unit, the 32202 timing-control unit, the 32081 floating-point chip and the 32082 memory-management unit. The price is \$3,540 per 100 units. The board supports as much as 128K bytes of EPROM and has two RS232C channels. Another company, Definicon Systems Inc., Calabasas, Calif., has implemented the 32032 on its model DSI-32 coprocessor board, which houses as much as 1M byte of RAM. The board can be added to the IBM Corp. PC and is priced at \$2,300 per 100 units. It includes two serial ports, a 32081 floating-point processor and the option to add an IEEE-488 bus. Definicon is supplying software utilities that allow the National processor to work in an MS-DOS environment.—C. Warren

BILL TO COUNTERATTACK FOREIGN COPYRIGHT VIOLATIONS

Senator Frank Lautenberg, D-N.J., has introduced legislation to pressure foreign governments to maintain copyright protection of U.S. computer software. The bill provides that, if a nation establishes less than 25 years of copyright protection for software or lessens protection in any other way, the software developed in that foreign nation will receive no copyright protection in the United States. The bill, according to a Lautenberg aide, has been introduced in response to proposals in certain countries, notably Japan and Brazil, to weaken or abandon copyright protection afforded to foreign software sold in those countries. The bill has received the support of the Association of Data Processing Service Organizations, an industry trade group, and other associations.—S. Shaw

HEWLETT-PACKARD UNVEILS GROUP OF PERSONAL COMPUTER SOFTWARE PACKAGES

Hewlett-Packard Co. planned to introduce late last month a series of software products for its HP 150 touch-screen personal computer and for the IBM Corp. PC. Two "Gallery" graphics programs for the HP 150 are used for creating shapes with text and charts. The packages are integrated

BREAKPOINTS

and can be used with HP's Laser Jet laser printer. Several packages, including Microsoft Corp.'s Word word-processing software, have been ported to the HP 150 from the IBM PC. There now are about 1,500 programs for the HP 150 available worldwide. HP also has ported some of its own software, such as MemoMaker, to the IBM PC.—D. Bright

KAYPRO READIES TWO IBM-COMPATIBLE COMPUTERS

Kaypro Computers Inc., Solana Beach, Calif., late last month planned to introduce an IBM Corp. PC-AT-compatible computer called the 286i. Running DOS 3.0 and including dual 1.2M-byte floppy disk drives, two parallel ports, one serial port, 512K bytes of RAM and eight expansion slots, the unit will be priced at \$4,550. Kaypro also plans to release early next month an IBM-compatible portable computer called the Kaypro 2000.—C. Warren

TECH FILES: A QUICK LOOK AT INDUSTRY DEVELOPMENTS

SOFTWARE FILES: **Network Innovations**, San Jose, Calif., has been formed by James Groff and Paul Weinberg, both formerly with Plexus Computers Inc. The new company's first product is Multiplex, a \$695 software package that networks PC/XTs and PC-ATs to UNIX-hosted databases and downloads information in Symphony, dBase II and III, SYLK, DIF or ASCII formats. Multiplex, which fits into 128K bytes of memory, runs over Ethernet or RS232 links.—A. Kaplan

GRAPHICS FILES: After recently taking volume orders from Gould Inc. and Data General Corp., **Raster Technologies Inc.**, North Billerica, Mass., has signed a \$10 million contract with West Germany's Siemens AG. Siemens plans to introduce a computer-aided design/computer-aided manufacturing workstation based on Raster's Model One/380, a high-resolution 3-D system, at next month's fair in Hannover, West Germany.—D. Bright

MINI FILES: The Department of Justice has notified executives of **C3 Inc.**, a Reston, Va., computer system integrator, that the government has terminated one of two investigations into alleged contract improprieties. The company has released a statement that it has been informed by the department that the U.S. attorney's office of the Eastern District of Virginia is ending its investigation into a C3 contract to supply the U.S. Army with several minicomputer systems at the White Sands (N.M.) Missile Range. C3 said it had been told that no indictments were to be filed. The U.S. attorney's office is still investigating another government contract with C3.—S. Shaw

NOTES FROM OVERSEAS: **Nixdorf Computer AG**, Paderborn, West Germany, is easing itself into the retail market with an OEM contract for Panasonic of Japan's IBM-



You won't get over what this 350 CPS printer does for under \$2,000.

When you see what the CI-3500 Serial Printer can do, you might not believe it's priced under \$2,000. Besides giving you data processing printing at 350 CPS, the CI-3500 delivers letter quality printing at a rapid 87 CPS—more than twice the speed of most daisy wheel printers.

And you also get the capability for high resolution graphics, up to 240 X 144 DPI.

The office friendly CI-3500 is as flexible as it is versatile, especially for a table top, workstation printer. For example, a convenient interface cartridge system allows you to change your printer interface simply by changing cartridges.

A DEC-LA100® compatible cartridge is standard, but additional cartridges are available for interfacing with other systems, such as the IBM PC.

A similar font cartridge system accommodates multiple fonts and character sets, so you can avoid costly PROM installations.

The CI-3500 Serial Printer for under \$2,000. Whatever you need in a printer, you won't get over what it will do for you. To find out more, just write or call CIE Terminals, 2505 McCabe Way, Irvine, Ca. 92714-6297. (714) 660-1421.

Or call toll-free 1-800-624-2516
In California, call 1-800-432-3687.



CIE TERMINALS
A CITECH ELECTRONICS COMPANY

® DEC LA100 is a Registered Trademark of Digital Equipment Corp.
© CIE TERMINALS, INC. 1984

CIRCLE NO. 13 ON INQUIRY CARD

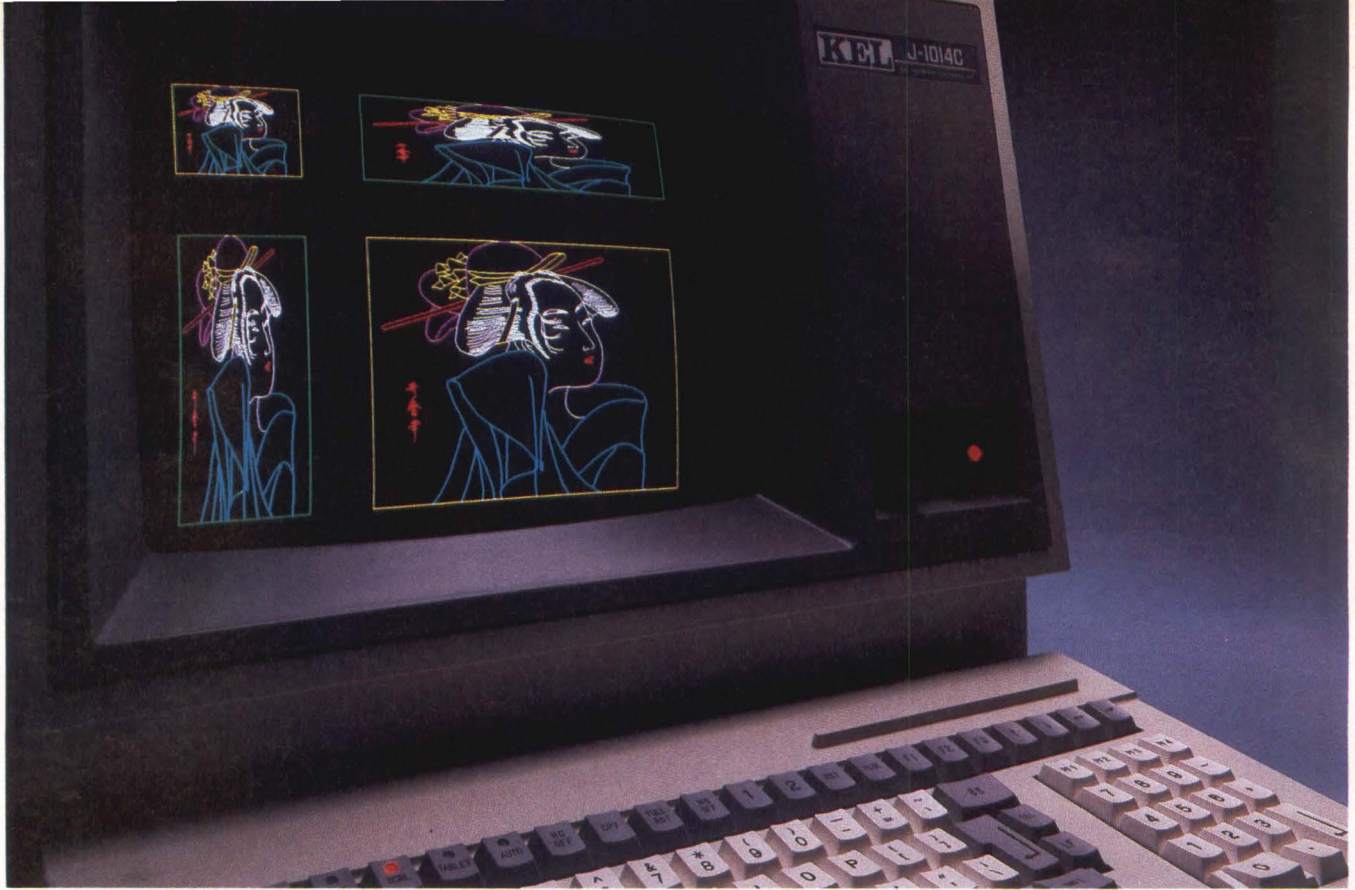

KEL Graphics. So explicit we suggest you discover them in the privacy of your office.

An affordable, high-resolution graphics family

If you could personally test a KEL graphics terminal or printer—in your own office, on your own applications—you would discover a presentation so remarkably sharp and clear it leaves virtually nothing to the imagination.

You would also discover a product that offers exceptional performance at a highly competitive price. One that's easy to use. Reliable. Versatile enough to handle the most demanding business, engineering, scientific and medical applications. Fully compatible with standard industry software such as PLOT 10, DISSPLA and TELL-A-GRAPH. And readily integrated into your OEM or end-user system.

Tektronix and PLOT 10 are trademarks of Tektronix, Inc. DISSPLA and TELL-A-GRAPH are trademarks of Integrated Software Systems Corporation. DEC and VT100 are trademarks of Digital Equipment Corporation.

J1000-Series graphics terminals

KEL J1000-Series terminals are available with the J1014 14" and J1019 19" monochrome, and J1014C 14" and J1019C 19" color displays. All offer the economy of raster scan technology, 1024x780 screen resolution, and Tektronix 4010/4014 and DEC VT100 emulation, including color with the J1014C and J1019C terminals. Standard features include circle generation, user-programmable PF keys, rectangle fill and erase, bit scrolling, selective character and vector erase, menu set-up mode, and built-in interfaces for a digitizer tablet, mouse, and hard copy device. An optional dual-plane feature is available for the J1014 and J1019 terminals.

Model J1014 Monochrome Display



The KEL 4120 hard copy printer

The KEL 4120 Printer produces hard copy directly from any KEL terminal, ending long waits for computer-room copies. At 120 dot-per-inch resolution, even the smallest size screen characters are clearly legible when printed. The Model 4120 is a dot-matrix impact printer which uses a 16-wire head and provides a full screen dump in 60 seconds (bi-directional mode). The Model 4120 also operates as a receive-only ASCII printer. In the ASCII mode, it prints at 120 CPS, 136 characters per line, and six lines per inch. The 4120 Printer is equipped with a tractor-feed mechanism and an 11-inch forms control.



Model 4120 Hard Copy Printer

Discover for yourself, in your own office

Please use this magazine's reply card for more information, or contact KEL directly. We'll be glad to arrange a no-cost, no-obligation trial for qualified prospects. Call us now to discover—in your own office—how truly impressive a KEL terminal or printer is.



400 West Cummings Park
Woburn, MA 01801
(617) 933-7852

KEL, INC. is a subsidiary of Kanematsu Electronics Ltd., one of the leading Japanese suppliers of computer products.

CIRCLE NO. 14

BREAKPOINTS

compatible personal computer. According to Nixdorf's sales manager, Frederick-Karl Conrad, his company is buying a slightly modified version of the 8088 floppy disk-based Panasonic RL-H7000W "luggable," whose chief distinction is its built-in printer. Nixdorf has dubbed the new machine the 8810/25. The systems are earmarked for a chain of Nixdorf-owned stores to be started this year as solution-oriented information and sales centers inside the Nixdorf branch offices in Munich, Dusseldorf and Hamburg. To back up the centers, Nixdorf plans to recruit value-added resellers, system houses and software companies to move the new personal computers into vertical markets while its own worldwide sales force tries to offset IBM Corp.'s impact on Nixdorf's large accounts. Nixdorf expects to sell 10,000 IBM-compatibles in Germany this year.—M. O'Gara

Considerable research is being done in Japan on alternatives to CRT displays. **The Asahi Glass Co.**, increasingly involved in electronics, has developed a glass with an electrochromic dimmer effect that changes the transmissivity of the glass after application of an electric current. Asahi Glass engineers say that the glass uses electrolytic and tungsten-oxide films to create a "sandwich." The amount of light passing through can be changed from 85 percent transparency to a nearly opaque 10 percent by one touch of a switch. The films have a memory effect that retains the degree of transmissivity without constant voltage application. Among potential applications—still two or three years away—are simpler display- and shutter-matrix panels for terminal screens and printers.—I. Kakehashi

Having been rebuffed in its multiple bids to buy Inmos, the British 32-bit-chip maker, **AT&T** is now offering to set up its own advanced microchip center in the United Kingdom. The center is part of a strategic move to woo millions of dollars worth of private-automatic-branch-exchange contracts out of British Telecom on behalf of the year-old AT&T/N.V. Philips joint telecommunications venture. There are apparently several proposals on the table, including one for a \$123 million facility that would be equipped to design and produce custom chips with tiny, 1.7-micron-wide circuitry. Such a plant would be the most advanced in Britain, and AT&T is promising to make it available to British industry. The U.S. giant nonetheless faces stiff competition from Northern Telecom and a Thorn EMI/Ericsson partnership.—M. O'Gara

At the upcoming Hannover Fair in West Germany next month, **Panasonic** of Japan plans to unveil an IBM-compatible prototype personal computer featuring an 11-inch, 640-by-400-pixel plasma screen display. The unit fits into an attache case, and Panasonic will be pegging it as breakthrough technology. The Japanese company has reportedly found a way to prolong the life of typical plasma displays, which normally last about two years.

BREAKPOINTS

Panasonic, which reportedly has been working on the product for IBM Corp., expects to go into production with the unit in June or July.—M. O'Gara

Fujitsu Ltd. and **Amdahl Corp.**, the Sunnyvale, Calif., computer company that Fujitsu controls, are expanding the ability of their machines to run under UNIX-based operating systems. Amdahl has licensed Fujitsu to use its universal time-sharing system (UTS). Fujitsu expects to have its own version available for domestic and export marketing by the year-end. Fujitsu emphasizes that it will continue to produce its MSP, FSP and other primary operating systems, which are not UNIX-compatible.—I. Kakehashi

Mitsubishi Rayon Co. is preparing to make available in June a display-screen filter that it says improves color perception while reducing eyestrain for terminal operators. The filter panels are made of Acry-Filter Nd, a compound of neodymium and rare earths applied as a film over an acrylic base. Mitsubishi Rayon says the compound has a high absorption rate for light wavelengths.—I. Kakehashi

Oki Electric Industry Co. Ltd. of Tokyo should start marketing in Japan this month high-end extensions of its if-800 series of 16-bit microcomputers based on the Intel 8086. The new Model 60 uses a multiple-windowing program called SuperView that provides overlays of several pieces of information from a large common database without scrolling. The basic machine has 512K bytes of ROM, expandable to 1.02M bytes, and can handle up to three 1M-byte, 5¼-inch floppy disk drives and a 10M-byte hard disk drive. An optical mouse cursor controller is standard. The basic package is priced in Japan at about \$1,830.—I. Kakehashi

A compound that makes erasable, re-recordable optical disks much longer-lasting and more stable than those now available, has been developed by **Fujitsu Ltd.** of Japan. The compound of selenium, antimony and indium crystal is applied by vapor deposition over a silicon film on an acrylic base. When activated by a 830-nanometer semiconductor laser with 1-micron beam concentration for 100 to 200 nsec, a depression appears on the film surface. A weaker pulse on the same area restores the surface to its original smoothness. Laboratory tests indicate that a disk surface could withstand more than 1 million changes—erase, record, erase again—with a storage life of at least 10 years. Fujitsu Labs says that a 20-cm-diameter disk coated with the compound could store 1G byte of information. That would be about 600 times as much data capacity as an 8-inch floppy disk, or roughly 15,000 letter-size documents. A product using the material is still two to three years away from market, Fujitsu engineers say.—I. Kakehashi

Viasyn (vī' uh sin) *n.* [L., *via*, a way or road; Gr., *syn*, together or integrated], formerly *CompuPro*.
1. *n.* a twelve year old manufacturer of microprocessor systems, subsystems and components, notably multi-user computers used in business, science and industry. 2. *adj.* related to Viasyn, formerly *CompuPro*, quality, i.e., possessing extraordinary reliability, performance, modularity and ruggedness. See *CompuPro* (previous name).

VIASYN

3506 Breakwater Court
Hayward, California 94545
(800) 367-7816 (Outside California)
(415) 786-0909 (California)

Viasyn is a trademark, and CompuPro is a registered trademark, of Viasyn Corporation.

CIRCLE NO. 15 ON INQUIRY CARD

CITIZENS
FOR WORKING
WITHIN
THE SYSTEM.

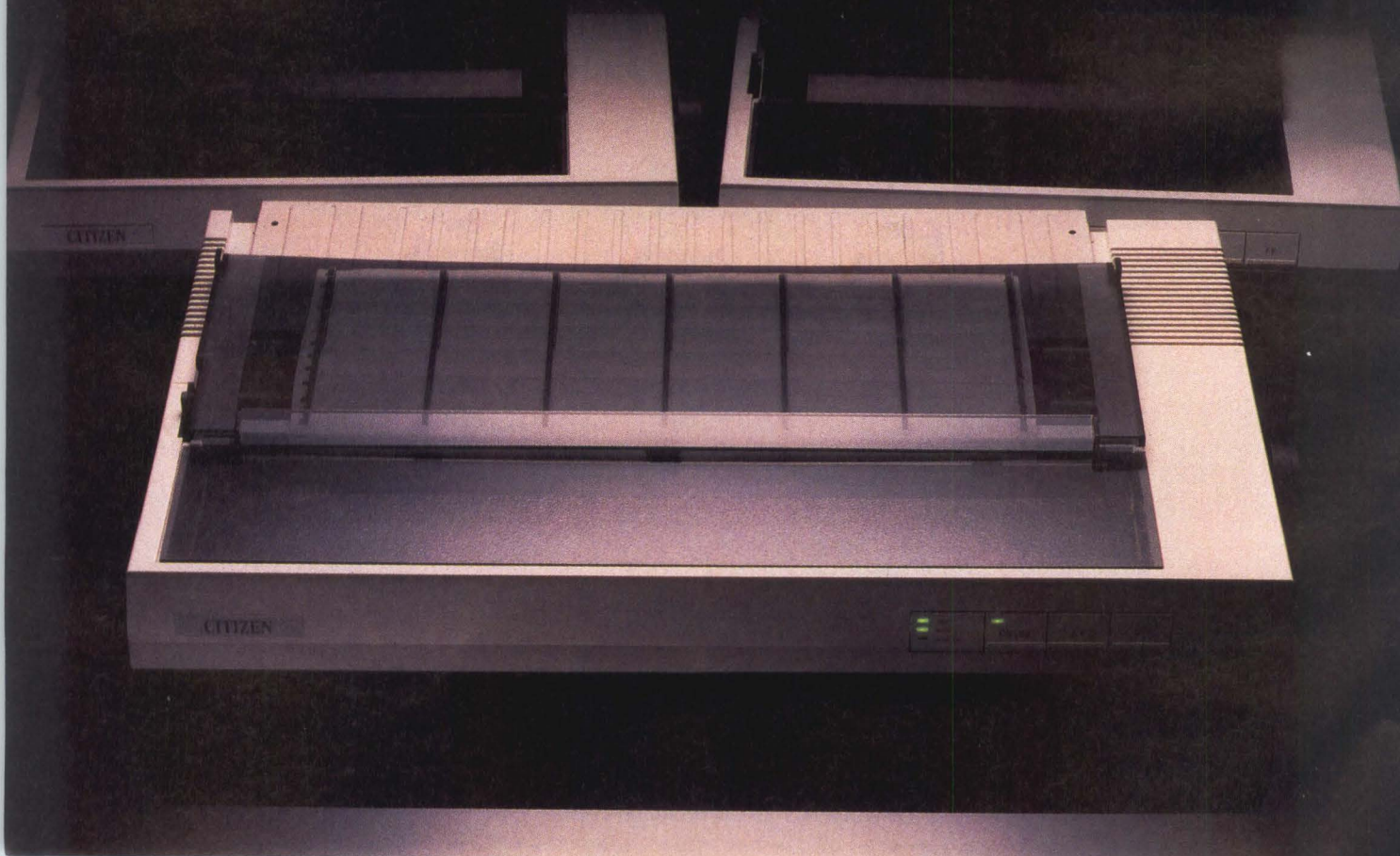

The last thing you need when you're putting together a hardware package is a printer that bucks the system.

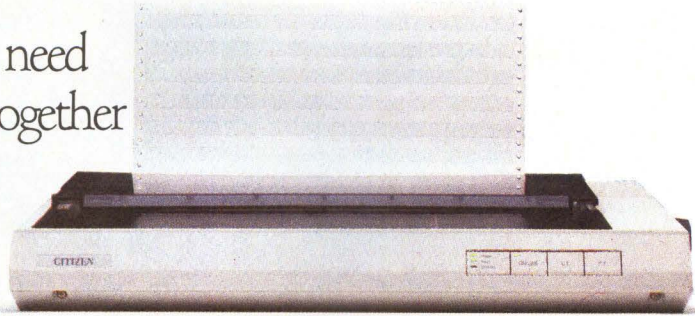

Introducing the Citizens. Four new economical dot matrix printers.

Citizens know how to work within the system. They're rugged, reliable, and fully IBM® or Epson®-compatible.

They deliver output speeds of 160 cps (40 cps correspondence-quality) or a speedy 200 cps (50 cps correspondence-quality). Quietly and accurately. Just what you'd expect from a company famous for precision-engineered watches. Plus, our unique push-feed paper loading system makes loading easy. And customers happy.

The Citizen™ MSP-10 and 15, and MSP-20 and 25 printers. Because every system works better when there's at least one responsible Citizen.

For more information, call 1-800-556-1234, Ext. 34. In California, 1-800-441-2345, Ext. 34.

Or write Citizen America Corporation, 2425 Colorado Avenue, Santa Monica, CA 90404.



© 1984 Citizen America Corporation

Citizen and the Citizen logo are trademarks of Citizen America Corporation. IBM is a registered trademark of International Business Machines Corporation. Epson is a registered trademark of Epson Corporation.

CIRCLE NO. 16 ON INQUIRY CARD



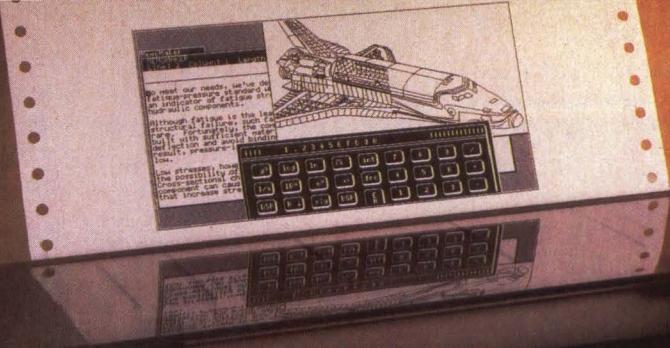

HEWLETT PACKARD Integral Personal Computer

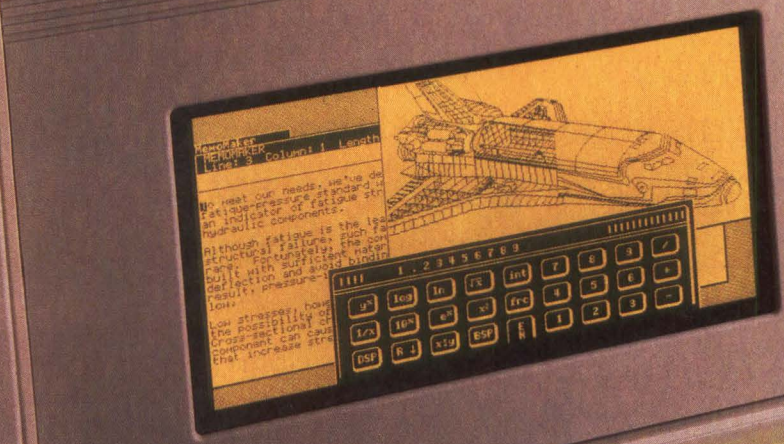

Almost priceless.

Hewlett-Packard presents
the first 32-bit UNIX™ system
under \$5,000.

Introducing the Integral Personal Computer.

It's the newest member of the HP 9000 family of HP-UX workstations. And it delivers the kind of power and flexibility the name implies.

With a 16/32-bit MC68000. A graphics co-processor. And 800KB of standard memory, expandable to 5.8MB.

Its UNIX kernel (HP-UX/RO) is built into ROM. Which means the Integral PC can run most applications *without* an expensive hard disc. Which means more

people can afford to run your UNIX software than ever before. But not only can they afford to run it. They can learn to *use* it in

minutes. Because the Integral PC is one UNIX system that's easy to use. Its see-and-select user interface, built-in window manager and optional mouse mean even novices can tap the power of your software. No one has to learn a bunch of cryptic commands or go through a lot of expensive training. There's even an entry-level, self-paced tutor disc with every machine.

What's more, the Integral PC goes where you need it. The complete system — including our revolutionary ThinkJet printer — packs into a single 25-pound package that takes up less than a cubic foot.

So get started porting your software now. HP-UX is an enhanced version of UNIX System III, including Berkeley 4.2 BSD features.

For the name of the authorized HP dealer or HP sales office nearest you, call toll-free 1-800-FOR-HPPC.

The value of your investment in UNIX software just went up. Because the price of a complete UNIX system just came down.

The Integral Personal Computer. Just \$4,995*



CIRCLE NO. 17 ON INQUIRY CARD



ARTIFICIAL INTELLIGENCE: TEK INTRODUCES A NEW SOURCE OF POWER.

Tek's new personal 4404 AI development system bypasses one of the last bottlenecks to making artificial intelligence systems commonplace. That bottleneck: the high price and scarcity of AI compute power.

The powerful, 32-bit 4404 supports three major development languages. The Smalltalk-80™ programming environment is standard. Franz LISP and Prolog are available as options. And Tek

supports the industry-wide Common LISP standardization effort. Standard configuration also includes virtual memory, expandable hard disk mass storage and much more. Its new window-managed display is everything you expect from a world graphics leader.

But what really makes the 4404 a major new force in AI is its price: at less than \$15,000, it is the first personal AI development system.

The power of Tek is behind it. Thanks to Tektronix technology, AI specialists and worldwide service organization, the 4404 is truly the first AI system you can use without reservations. And it is only the beginning of Tek's growing commitment to the AI community.

For more information, contact your nearest Tektronix field office. Or call toll-free 1-800-547-1512. In Oregon, 1-800-452-1877.

Smalltalk-80 is a trademark of Xerox Corporation.
Price stated is for U.S. domestic, quantity one.
OEM prices and leasing programs (U.S. only) are available.
Copyright ©1984, Tektronix, Inc. All rights reserved. HUT-101

Tektronix®
COMMITTED TO EXCELLENCE

CIRCLE NO. 18 ON INQUIRY CARD

MINI-MICRO WORLD

NEWS

Tiny single-board PC may spark big markets

IBM PC-compatible board with passive backplane poses challenge to STDbus

Rick Dalrymple, Senior Editor

Faraday Electronics hopes to crack new and emerging markets with a recently produced IBM PC-compatible board of reduced size and power consumption. New markets eyed by the Sunnyvale, Calif., manufacturer include harsh-environment applications in science, industry and engineering—which could put the board in almost head-to-head competition with the STDbus.

According to computer-industry analysts, who had a pre-introduction peek at Faraday's new Micro PC

board, system integrators have a host of new application possibilities for this 3.9-by-5.5-inch, PC-compatible, single-board computer. Introduced this month, the Micro PC shrinks all the functions of an IBM Corp. PC motherboard down to its near-note-card size by using Faraday's FE2010 custom very large-scale integration (VSLI), complimentary metal-oxide semiconductor (CMOS) chip. The chip contains all the motherboard components except the 8088 microprocessor, optional 8087 coprocessor, 64K-byte basic input/output system (BIOS), EPROM and 256K bytes of RAM.

At \$495, or about \$300 apiece in quantities of 500, the Micro PC price matches the current price of Faraday's first motherboard—the FE6400. Unlike the FE6400, however, the Micro PC plugs into a passive backplane (also available from Fara-

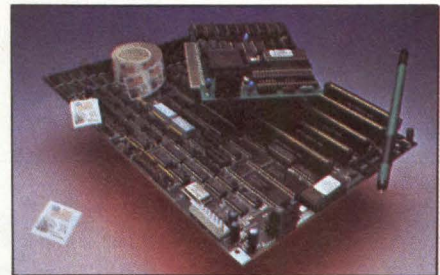

Faraday Electronics' new Micro PC board (3.9 by 5.5 inches) rests on top of Faraday's first IBM PC-compatible motherboard.

day), which means it does not require on-board expansion slot connectors.

Motherboards limit the number of expansion slots available to the system integrator. A backplane arrangement, on the other hand, allows system integrators to use as many available slots

FARADAY'S PROGRAM TO ADD FUNCTIONS, REDUCE SIZE

Product	Introduction date	Dimensions (inches)	Number of expansion slots	Price (\$ Q1)	Comments
Motherboards					
FE6400	February 1983	8.5 x 12	5	495	Faraday's first IBM PC-compatible board; one parallel and two serial ports; 32K-byte ROM.
FE6410 Series	May 1984	8.5 x 12	3	596-695	expanded memory to 512K bytes; one serial and one parallel port; added on-board floppy disk controller or monochrome video controller; 32K-byte ROM space
FE620 Series	June 1984	8.5 x 12	8	515-595	expanded memory to 640K bytes; one parallel and two serial ports; added 8087 coprocessor socket; on-board floppy disk controller; 64K-byte ROM space
Plug-in boards (used with passive backplane)					
Bus PC	January 1985	3.9 x 13.15	none	495	64K to 256K bytes of memory; one parallel and two serial ports; 8087 coprocessor socket; 32K-byte ROM space
Micro PC	March 1985	3.9 x 5.5	none	495	64K to 256K bytes of memory; no serial or parallel ports; 8087 coprocessor socket; 32K-byte ROM space

NEWS

as the power supply allows.

The next step for Faraday is a total CMOS Micro PC. This version would further reduce power consumption and allow the tiny board to be sealed in an enclosure so that it can be used in harsh environments. Even though CMOS versions of the 8088 and RAM chips are available today, however, the price tag on a total CMOS Micro PC may preclude widespread use.

Could challenge STDbus

Norm DeWitt, director of personal computer service at Dataquest Inc., San Jose, Calif., sees the Faraday board as the first step in an eventual challenge to the STDbus. DeWitt points out that the 3.9-inch-by-5.5-inch Micro PC is close in size to the 4.5-

inch-by-6.5-inch STD boards. The passive backplane of the Micro PC performs many of the same functions as the STDbus backplane. "What makes the [situation] very different," observes DeWitt, "is that STDbus boards are available from many different manufacturers, while boards about the size of the Micro PC are now only available from Faraday."

If the manufacturers of IBM PC add-in boards begin to adopt board sizes in the range of Faraday's Micro PC, says DeWitt, the Micro PC bus could be a formidable STDbus alternative, even threatening areas where the STDbus is entrenched, such as industrial and scientific applications, he says. Faraday's vice president of marketing, Ron Mazza, says the company

is beginning to call on STDbus distributors to point out what Faraday sees as the advantages of the Micro PC bus over the STDbus. Mazza argues that, in addition to accessing the huge library of MS-DOS-based software, system integrators also gain the advantage of a software-development machine that is identical to the target processor—an IBM PC.

Paul Virgo, STDbus products marketing manager at PRO-LOG Corp., Monterey, Calif., notes that the PC bus is an attractive way to build human interfaces. Many STDbus systems, he points out, do not have a user interface. PRO-LOG markets an STDbus-to-PC-bus connector and Virgo sees value in exploiting the advantages of both buses. But Virgo does not expect

Some IBM mimics jump, some stall at PC-AT delays

Lori Valigra, Senior Editor

If the battered IBM PC-compatible makers don't have enough worries with IBM Corp.'s aggressive pricing and prosecution of counterfeiters, they can add another concern to their list: when and how to produce a PC-AT look-alike.

Major mimickers agree that designing PC-AT-compatibles is more complex than making earlier PC work-alikes. For one thing, IBM incorporates a different processor with an incompatible instruction set—an Intel Corp. 80286 rather than the standard Intel 8088. For another, the PC-DOS 3.0 operating systems' ROM basic input/output system (BIOS) that controls most input/output routines for attaching peripherals differs from the earlier operating system's ROM BIOS.

But making even those who claim to have mastered these issues gun-shy is the shortage of PC-ATs, which some industry participants say has held back third-party development. There also is the lack of key software for the PC-AT, such as the PC-DOS 3.1 and XENIX operating systems, networking soft-

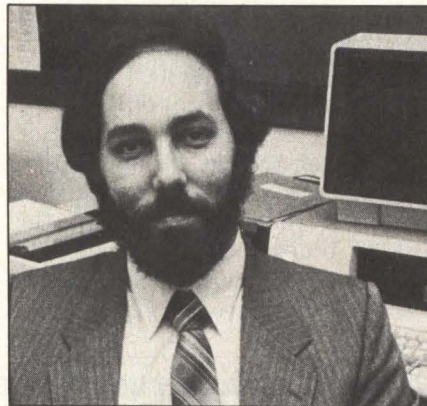

Neil Colvin, president of Phoenix Software, says compatibility has turned from a hardware to a software issue with IBM's PC-AT.

ware and the TopView windowing program. Those four products are scheduled for availability this quarter but had not been shipped as of press time.

Shortages, rumors persist

Before last Christmas, IBM reallocated shipments of the enhanced PC-AT computers with 20M-byte Winchester disk drives. A spokesman ac-

knowledges the company told dealers that IBM would be unable to fill all orders for enhanced PC-ATs during the first quarter because of demand and shortages of the 20M-byte drives. But he says IBM increased allocation of the floppy disk-based PC-ATs.

This led to industry speculation that IBM had stopped shipping hard disk-based PC-ATs and that there was a problem with the system. One major IBM PC-AT retailer says customers complained that the PC-AT lost files written to the 20M-byte Winchester disk drive. That retailer suspected there were problems with the operating system and thought IBM might alter it. But the IBM spokesman says there are no problems with the disk drive or operating system. "Speculations that there will be major changes to the operating system or BIOS are way out of line," he says. He says shipments have not stopped and maintains there will be "no changes in the machine."

George Colony, president of Forrester Research, Cambridge, Mass., says retailers head the queue for PC-AT supplies, even ahead of IBM's own direct sales force. Because of this, large end users will not receive shipments of PC-ATs until April or May. He cites two contacts of his who are waiting for large PC-AT shipments—one for 250 units and the other for 350.

an early demise for the STDbus: "I think the STDbus has another five- to 10-year lease on life."

Possibilities beckon

For the Micro PC, the key to success in the STDbus market will be the participation of other manufacturers of similar boards. Jerry Orosz, director of OEM marketing at AST Research Inc., Irvine, Calif., is aware of the application possibilities of the Micro PC. While declining to comment on his company's plans to build Micro PC-size boards, Orosz did say that some of AST's customers, who are involved in energy management in construction and industry, may find a small, low-powered, PC-compatible, single-board computer attractive for the control of

lights, air conditioning and heat exchangers. Orosz could also see the product finding its way into protocol converters and network file servers, as well as intelligent telephones, terminals, printers and disk drives. "If the board could run on battery power," says Orosz, "obviously portable computers and instrumentation would be logical markets."

Asked about the market for a PC-compatible, single-board computer, Faraday's president John Lemons answered, "Our economies of scale are such that companies can't design and build their own CPU for less than they could buy them from us—and we intend to keep it that way." Lemons claims that, from scratch, it could cost as much as \$300,000 to develop an

IBM PC-compatible board with supporting software.

Future markets which Mazza says he foresees include using PC-compatible computers as part of a milking-machine system. Using a spreadsheet program like Lotus Development Corp.'s Symphony to log milking records, calculate feed and vitamin dosage, plus forecast the expected pounds of milk per cow for next Tuesday, will help the dairy farmer improve efficiency.

And, when a totally CMOS Micro PC is available, Mazza thinks the fact that it can fit into a small, sealed enclosure will allow scientists to use PC-compatible computers for weather monitors at sea and to control experiments on board probes launched into space. □

Until the supply problem eases, Colony predicts, the PC-AT-compatible market will not be really active. "Independent software vendors will slow down development until there is more of an installed base of PC-ATs," he maintains. Forrester Research calculates 40,000 PC-ATs were installed by the end of last year and expects 250,000 to be installed by the end of this year.

Jumping IBM is dangerous

Leapfrogging IBM to get a compatible computer system to market makes some manufacturers nervous. Any hardware changes IBM might make are not of as much concern to top-seeded compatible maker Compaq Computer Corp., Houston, as are undelivered software products, explains Michael S. Swavely, director of marketing at Compaq. "Until [PC Network software, XENIX and TopView] are deliverable, any product delivered in the meantime may not be compatible with the PC-AT. [This situation] is more dangerous than if there were major hardware changes to the PC-AT."

Nonetheless, Compaq and others have gone over the PC-AT with a fine-tooth comb. Swavely claims Compaq could quickly produce a PC-AT-compatible computer, should the market demand it. "We considered using

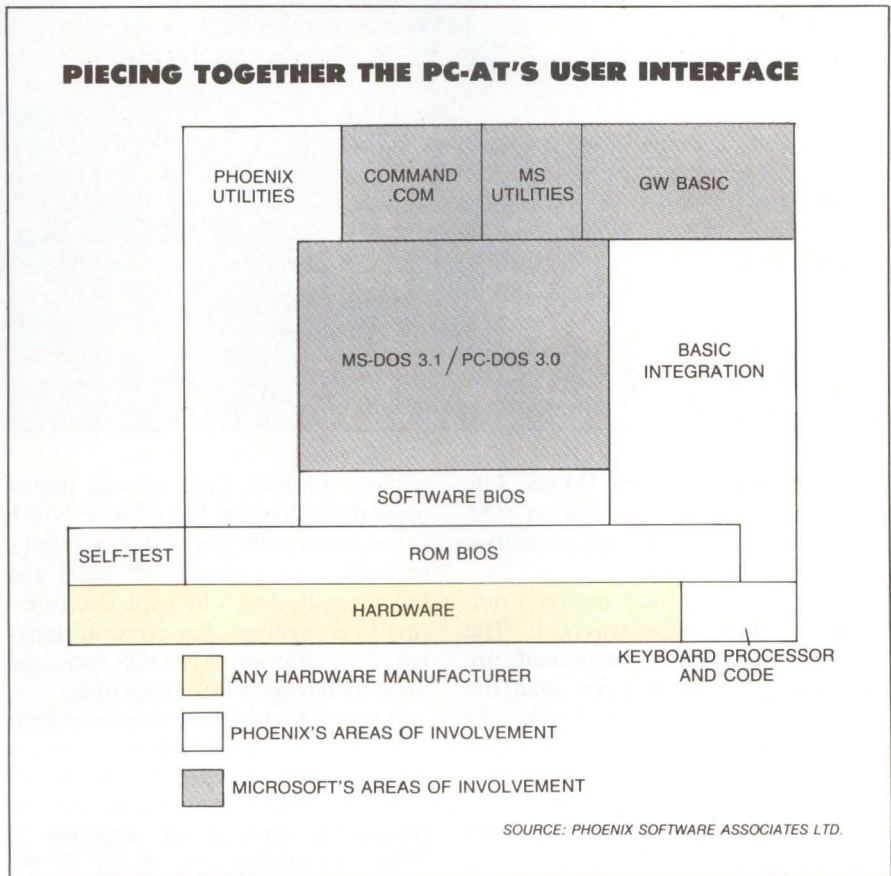

Phoenix's adjuncts to Microsoft's MS-DOS operating system (used by IBM as PC-DOS) include the software BIOS and the ROM BIOS.

the 80286 in the Deskpro but did not because the compatibility level [with the IBM PC] was unacceptable," he says. Compaq's Deskpro desktop sys-

NEWS

What is PC-AT compatibility?

As with IBM Corp.'s PC, suppliers of compatible systems, components and software must assess what the PC-AT is, and what compatibility with it means. Many major independent product developers already agree that IBM's implementation of Intel Corp.'s 80286 must be strictly followed and that producing the basic input/output system (BIOS) is necessary for a complete match.

In its publication for independent developers of IBM PC products, IBM underlines its commitment to making major compatibility testing efforts. "Our first priority is to remove any incompatibilities which we discover in the hardware. The next priority is to mask the incompatibility in the ROM BIOS. If this is not feasible, then we attempt to mask the difference in the new DOS. Only if these alternatives fail will we allow the incompatibility to remain," the publication states. IBM lists three areas in which compatibility failed: the faster performance of the 80286 and its clock speed, the 20M-byte fixed disk and instruction differences between the PC's and PC/XT's 8088 and the PC-AT's 80286 processors.

Following are major differences between the PC and PC/XT and the PC-AT as listed by major compatible producers and by IBM in its publication.

- The PC-AT works in two modes, real-address mode and protected, virtual-address mode. In real-address mode, the PC-AT acts like an 8088, so that PC and PC/XT programs can be run. In protected mode as an 80286, the PC-AT uses memory management to support multitasking, which in turn provides as much as 1G byte of virtual address

space per task. The PC-AT's 1M byte of memory can only be accessed in the protected mode by two new BIOS function calls.

- The PC-AT's ROM BIOS includes some limited multitasking capabilities, such as wait loops and interrupt service routines. But IBM does not support asynchronous communications. The company claims that will allow a multitasking operating system to be implemented using the ROM BIOS. This means that the software BIOS portion of PC-DOS would require a minimal rewrite.

- The PC-DOS BIOS microcode for the PC-AT is not the same as that for other PCs. For example, the fixed-disk BIOS was rewritten, and the keyboard BIOS was modified. However, the interrupt codes and function codes remain the same. IBM recommends that application programs use only the BIOS and DOS interrupt interfaces. If a program bypasses BIOS interrupt calls to speed performance and directly accesses routines and/or storage locations in one system, it may not run on another PC model.

- The ROM BIOS also is different. Extra code handles differences between the adapter interfaces for PC/XT and PC-AT fixed-disk drives. The adapter interface chip for the PC-AT's 20M-byte fixed disk is not compatible with the adapter for the PC/XT.

- The new disk adapter also includes circuitry for the 1.2M-byte floppy disk drive and the 320K/360K-byte disk drive. That disk adapter is a superset of the PC's disk adapter, so that the PC-AT can support the higher data rates in the 1.2M-byte drives and select various data rates (250K, 300K or 500K bps). The ROM BIOS controls data-rate selection. This means that applications operating at

tem, introduced last June (MMS, July 1984, Page 31), incorporates an 8086 processor for speed and begins in price at about \$2,500.

Swavely says another reason Compaq bypassed the 80286 was cost. "The 80286 and its support components are 50 percent higher in price than the 8088. So we'd have to add 50 percent to the retail price margin to justify putting them in. A 25-percent incremental speed advantage [with the 80286] doesn't justify a 50-percent higher price."

Sticking to PC-AT compatibility

Compaq's Swavely cautions compatible manufacturers against improving IBM's design and thus risking incompatibilities. "If you do a PC-AT-com-

patible product, [you should implement the 80286] the PC-AT way, which is not necessarily the best way. That's the difference between MS-DOS and PC compatibility," he explains, referring to companies that erred in thinking that offering MS-DOS was the same as having a PC-compatible.

Another major clone-market player, systems software publisher Phoenix Software Associates Ltd., Norwood, Mass., seconds the importance for compatible makers of keeping to IBM's implementation of the 80286. "We are doing a PC-AT-compatible [ROM BIOS]. It is compatible with the PC-AT and the 80286 implementation in the PC-AT," explains Neil Colvin, Phoenix's president.

Every company licensing the

MS-DOS operating system must write a BIOS for it. IBM wrote part of the BIOS in software and implemented part in a ROM. The software BIOS effectively "supervises" the ROM BIOS.

Colvin says that, while the Phoenix ROM BIOS supports IBM's PC-AT implementation of the 80286, it remains compatible with earlier 8088-based PCs. IBM also took this tack with its own ROM BIOS and BIOS. IBM's published guide for independent developers notes that the BIOS interrupt codes and function codes remain the same for the PC and PC-AT models but that added function codes support unique features in the PC-AT and assist in masking hardware differences.

the BIOS interface level will run, but programs directly addressing the disk interface hardware will fall victim to any data-rate variation, the increased track density on the 1.2M-byte drives and possibly the drive's rotational speed difference.

- Disks for the 1.2M-byte drive can't be used in the 320K/360K-byte drive. Also, although the 1.2M-byte drive can read and write to disks for the 320K/360K-byte drive, once the 1.2M-byte drive writes information onto the lower capacity disk, only the 1.2M-byte drive can read that information.

- Since the PC-AT's 80286 runs faster than the 8088 in PCs, application programs depending on time must account for the speed differences. IBM recommends not depending on instruction execution speed to get specific application timing. Timing functions are available in BASIC or on the system timer for assembly language programs.

- I/O devices may perform differently on different PC models, so IBM notes third parties should avoid using I/O device timing in an application.

- Expansion slots on the PC-AT's system board have a 62-pin connector and a 36-pin connector. Add-in boards using the 36-pin connector will not work with other PCs.

- The PC-AT's keyboard uses its own processor and is not plug-compatible with other PC keyboards. It performs all functions of other PCs.

- Some copy-protection schemes will not work on the PC-AT. This is the case when copy protection bypasses the BIOS and works directly with the track density and data-transfer rate on drives. Also, protection depending on the rotational speed, access time, head geometry or disk-change signal on a drive

HOW THE ROM BIOS DIFFERS AMONG IBM'S PCs

Model	PC	PC/XT	PC-AT
Winchester hard disk support	no	yes	yes
High-density floppy disk support	no	no	yes
80286 support	no	no	yes
Cassette I/O support	yes	yes	no
Extended memory support (more than 1M byte)	no	no	yes
SYS. REQ key support	no	no	yes
Keyboard status lights	no	no	yes*
Day/date clock support	no	no	yes*
Extended video function	no	no	yes*

*functions specific to the PC-AT and not the 80286 processor

Source: Phoenix Software Associates Ltd.

IBM has changed its ROM BIOS to accommodate new hardware in the PC-AT, such as the 80286 processor.

will not work on the 1.2M-byte drive. If the method employs the current used to write on a fixed disk, it will not work on the PC-AT.

- PC-DOS 3.0 for the PC-AT includes the functions of the earlier PC-DOS 2.1 but includes enhancements supporting the PC-AT's hardware.

Colvin explains that changes in the PC-AT's ROM BIOS from the PC and PC/XT make the PC-AT more efficient. Some functions in the PC-AT ROM BIOS support the 80286 only, and not the 8088. Other changes in the PC-AT ROM BIOS are not specific to the 80286, such as support for the 1.2M-byte, higher density disk drives.

Phoenix's PC-AT ROM BIOS takes advantage of the enhanced functions of the PC-AT. Those enhancements include support for 1.2M-byte and 360K-byte floppy drives and video features such as saving time by writing a string of characters in one ROM call rather than character-by-character as in earlier PC models. It also supports the PC-AT's intelligent keyboard, which uses its own processor. Other 80286

functions in the BIOS include diagnostic routines for the 80286 and 80287 mathematics coprocessor and support for more than 1M byte of main memory.

Software controls compatibility

Colvin says compatibility is becoming more of a software than a hardware issue. Because the PC-AT uses a different processor than the PC, Phoenix officials maintain that, to be compatible with IBM's PC family, the industry must shift from being driven by hardware to being driven by software. "By coming out with a machine [the PC-AT] that is incompatible with its own PC, IBM is...enabling a greater level of creativity and flexibility in the [software] industry," says Colvin. He

recommends that software writers adopt as a new standard a subset of the PC and PC-AT software interfaces.

Mirroring the image

Phoenix spokesmen contend that, since the first round of compatibility, PC mimickers have learned from their mistakes—copying the ROM BIOS, using different hardware from IBM and not offering completely compatible software. "Every manufacturer has learned this time around that PC-AT [compatibility] must take into account all hardware and software dependencies made by IBM," says Richard Levandov, vice president of marketing at Phoenix. This is why, he says, most major hardware manufacturers are considering adopting IBM's 80286 im-

**EMULEX HAS
THE CORNERSTONE
FOR SYSTEM BUILDING
FLEXIBILITY.**

SCSI

EMULEX

AND, WE'VE GOT ALL THE OTHER BUILDING BLOCKS, TOO.

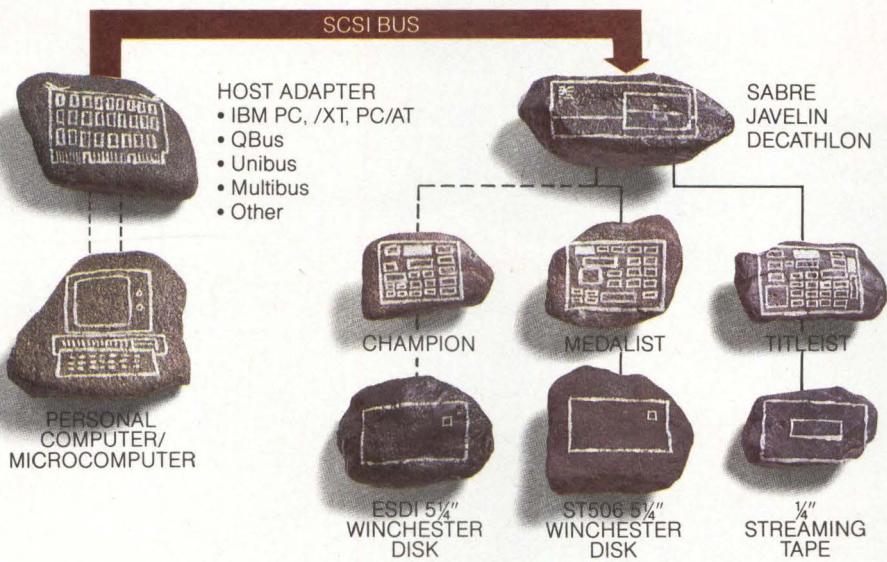

THE SCSI POTENTIAL. THERE'S PLENTY OF IT. SCSI allows you system building ease and maximum flexibility through the use of a common I/O bus and standard peripheral interface. All Emulex/SCSI-based products feature these enhancement benefits.

FEATURE	BENEFIT
Arbitration	Permits concurrent I/O operations between different devices by prioritizing bus usage.
Disconnect/Reselect	Maximizes bus utilization by providing devices an orderly scheme to release and regain bus control.
Copy	Permits data transfer between devices without host intervention.
Search Data	Used to search one or more logical blocks for less than, greater than or equal to a specified data pattern.
Reserve/Release	Device can be reserved for exclusive use by a single host in multiple host configuration.
High Level Command Set	Provides host with device independence for a given type of device.

With Emulex's SCSI products as the cornerstone for your mini/micro computer systems, you can continue to build on your investment. Our SCSI-based products offer you convenient building blocks with which to assemble, update, mix or interchange different types of peripheral storage devices to your computer system. Couple that with the industry's widest range of advanced products and you have the single best source for your system building needs. Products with performance, quality and reliability that's unsurpassed.

PUT MORE INTO YOUR SYSTEMS WITH EMULEX/SCSI MICRO SUBSYSTEMS.

Compact, versatile Emulex/SCSI micro subsystems provide you a variety of cost-effective storage and backup devices. Choose the enclosure you desire—desktop, rack or tower—disk size—36, 67 or 110 MB formatted capacity—and the type of backup most meaningful to your application. Top that off with the ability to interface virtually any CPU type and you have a powerful and complete storage solution.

SABRE, combines on-line storage and file backup capability in a compact unit housing a 5 1/4" Winchester disk drive and an 8" removable cartridge disk.

Javelin, an extremely versatile storage system designed to satisfy

a wide range of OEM and end user applications. Space accommodations for two SCSI peripherals, either one 5 1/4" disk drive and one 60 MB 1/4" cartridge tape streamer, or two disks.

Decathlon, available in a rack mount or an attractive tower/pedestal model, contains up to three 5 1/4" peripherals, with a choice of Winchester disks and a 60 MB 1/4" streaming tape drive.

EMULEX'S HOST ADAPTERS CAN FIT SCSI INTO YOUR PLANS.

Emulex/SCSI host adapters are available for QBus and Unibus systems, IEEE 796 Multibus systems, the IBM PC/XT and PC/AT and compatibles. We've designed these host adapters to take full advantage of the versatility and high performance of the SCSI.

GET MORE INTO YOUR SYSTEMS WITH EMULEX/SCSI CONTROLLERS.

Our Medalist and Champion SCSI controllers can interface any ST506 or ESDI 5 1/4" Winchester disk drive. And our Titleist can interface most 1/4" streaming tape drives.

EMULEX CAN FIT SCSI INTO YOUR PLANS.

If you're looking for a solid cornerstone and the widest range of building blocks to put together powerful and efficient mini/micro subsystems, then talk to Emulex.

For detailed information on Emulex/SCSI products, call toll free (800) 854-7112. In California (714) 662-5600. Or write: Emulex Corporation, 3545 Harbor Blvd., P.O. Box 6725, Costa Mesa, CA 92626.

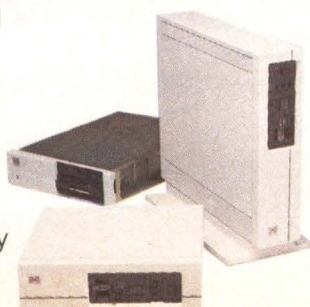

Yes! Please send me your new **Micro Products Handbook**.

My needs are: Immediate 60-120 days Info. only

Have Salesman call Quantity per year: _____

Specify Computer/Peripherals in use or planned:

DEC _____ Multibus _____

IBM _____ Other _____

Name _____

Title _____ Phone _____

Company _____

Address _____

City _____ State _____ Zip _____

MM



CIRCLE NO. 19 ON INQUIRY CARD

IBM PC, XT, AT are registered trademarks of International Business Machines Corporation. QBus and Unibus are registered trademarks of Digital Equipment Corporation.

We Put the World in Your Hands.

DTC

The Choice is Yours:

Our New VLSI Chip Set...

Data Technology's new advanced VLSI chip set offers OEMs a world of opportunity. With these four custom third generation CMOS chips, virtually the sky's the limit when it comes to configuring controllers.

And because we offer each chip individually, OEMs can incorporate them in the design of boards for unique hosts.

But that's not all. These chips can accommodate a variety of storage devices, too. Such as Winchester disk drives, Winchester/Floppy subsystems, Winchester/Quarter-inch streaming tape. Or Winchester/Floppy/Quarter-inch streaming tape units.

No matter how you choose to configure them, the chips support universal standards. Like ST 506 or ESDI disk drives. Standard or KODAK 3.3 megabyte floppies. And QIC 02 streaming tapes.

Or Our New Controller Boards

Data Technology even offers the chips already configured on our controller boards. Which means you can select them in the form that best suits your needs. For example, you can select one to support the IBM PC, XT and AT, SASI/SCSI bus, or Multibus.

Whatever you choose, you can be certain of our unsurpassed performance at down to earth prices. These chips also feature both a minimum real estate and parts count for maximum flexibility and reliability. And low heat and power consumption makes them perfectly suited for add-in storage devices.

Controller Boards:	SASI/SCSI	MULTI-BUS	IBM PC RC/AT
Winchester (ST506 or ESDI)	510D	5186D	5150D
Winchester (ST506 or ESDI) Floppy (5 1/4" 8" or KODAK)	520D	5286D	5250D
Winchester (ST506 or ESDI) Streaming Tape (QIC 02)	530D	5386D	5350D
Winchester (ST506 or ESDI) Floppy (5 1/4" 8" or KODAK) Streaming Tape (QIC 02)	540D	5486D	5450D



Data Technology Corporation

2775 Northwestern Parkway
Santa Clara, California 95051
Telephone: (408) 496-0434
TWX: 910-338-2044

Eastern Regional Sales
15 Wiggins Avenue
Bedford, MA 01730
Telephone: (617) 275-4044

CIRCLE NO. 20 ON INQUIRY CARD

plementation on the PC-AT.

Levandov claims companies now are designing compatibility into their hardware. For example, IBM uses an 8250 communications controller. Some software companies, explains Levandov,

wrote software calls in programs directly to the 8250 for performance. This means that if a hardware designer chooses to use the less expensive 8251 communications controller, the level of PC compatibility will be diminished.

This demand for hardware compatibility has led Phoenix to begin licensing an 8088 processor-based motherboard design within the last two months. Each purchaser receives a computer-aided-design/computer-aid-

Off-the-shelf parts hasten cloning of IBM's PC-AT

While IBM Corp. stretches lead times for its new PC-AT 16-bit computer, some PC-AT-compatible suppliers are jumping into the market in hopes of finding a rich bounty of new applications.

Phoenix Software Associates Ltd., Norwood, Mass., brings to market this month PC-AT-compatible hardware and software components to help manufacturers ready products quickly by reducing design time.

The software comprises a ROM basic input/output system (BIOS), GW BASIC, MS-DOS, keyboard support code and utilities for \$420,000. The company also will offer a PC-AT-compatible board design for license at an as-yet-undetermined fee.

George Colony, president of Cambridge, Mass., consulting company Forrester Research, says Phoenix is on the right track. "Why would anyone want to reinvent the wheel?" asks Colony. He says there are no PC-AT-compatible systems yet, although Durango Systems Inc., San Jose, Calif., and Corona Data Systems Inc., Westlake Village, Calif., have 80286-based computers.

Phoenix's vice president of marketing, Richard Levandov, says the trend in PC-AT compatibility is for

purchasers to license the BIOS rather than trying to write it themselves. With the PC, compatible makers either wrote the BIOS themselves, licensed it from a third party or copied it from IBM and were hauled into litigation.

Companies can cut their product development time in about half by buying off-the-shelf parts, Levandov says. "We're forcing the major computer companies to make a make-or-buy decision. The companies must make rapid announcements of new personal computer products...which strains the companies' resources," he maintains. Colony agrees that most companies will buy ready-made parts from companies like Phoenix and Faraday Electronics, Sunnyvale, Calif., which makes IBM-compatible motherboards.

Neil Colvin, president of Phoenix, points to new applications opening up for machines with the PC-AT's power (the PC-AT is two to three times faster than the PC), such as the scientific and engineering applications once dominated by Digital Equipment Corp. and Data General Corp. minicomputers. He says process control is one application in which the PC-AT is fast enough but the basic PC is not.

TRIMMING THE IBM PC-COMPATIBLE MICROCOMPUTER DEVELOPMENT CYCLE

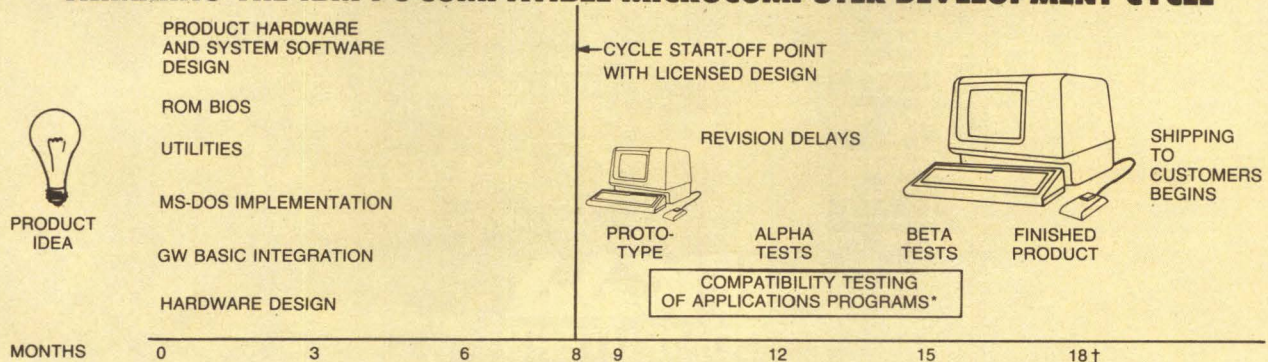

* TYPICALLY 100 TO 200 PROGRAMS, REQUIRING 4 TO 6 MAN-MONTHS.
† 18 MONTHS BASED ON DEVELOPMENT STAFF OF 18-24.

SOURCE: PHOENIX SOFTWARE ASSOCIATES LTD.

Ready-made components for PC-compatible manufacturers can cut the first eight months from a product's development time.

THE COMPATIBILITY[®] BOX

is a family of complementary data communication modules. One of the most successful members of this family is the P.I.T., Programmable Interface Translator.

THE MOST COMPLETE RS232C INTERFACE PROBLEM SOLVER

The P.I.T. is a black box type converter for RS232C/V24 based interfaces and is able to cope not only with asynchronous transmission differences such as handshakes, code/string conversion, and all sorts of transmission parameters, but also with synchronous protocols: IBM BSC 2780/3780, 3270, 3741, SIEMENS MSV1/MSV2 and BURROUGHS poll/select. The programming principle is unique: The micro system inside the box runs a program covering the stated possibilities. In PROGRAM mode, selected by the only switch on the box, the user may configure the P.I.T. in the field using a temporarily connected dumb terminal. The set-up parameters will not be lost after power-off. The unit can be reconfigured at any time (so extremely useful for overcoming unforeseen difficulties on site). When the switch is set to RUN, the P.I.T. is ready to do the job.

A FULL RANGE OF PROTOCOL CONVERTERS IN ONLY ONE BOX

MORE THAN JUST A PROTOCOL CONVERTER. The emulation of a 3278 terminal or a 3287 printer is often called protocol conversion. The P.I.T. can do much more: Batch (RJE) as well as 3270; file transfer as well as interactive, but also just async to async. In addition to acting as a tributary station, the P.I.T. can also emulate a (3705) front end processor at one or both ports. Functions such as code counting, word wrap, timer, data diversion, and many others may be selected meaning that one and the same model is able to cover an endless range of applications allowing greater flexibility and the minimization of stock and spares. The unit is complete with built-in power supply and extensive user's guide.

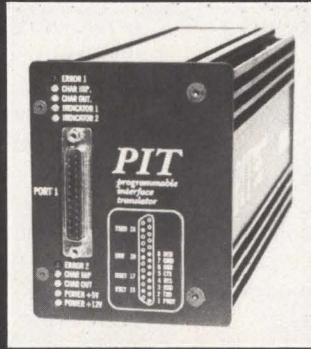

MORE THAN 2000 UNITS HAVE ALREADY BEEN INSTALLED THROUGHOUT EUROPE.



EXTENSION OF YOUR MAINFRAME WITH ALMOST ANY PERIPHERAL

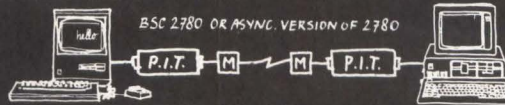

PROTOCOL SECURED COMMUNICATION

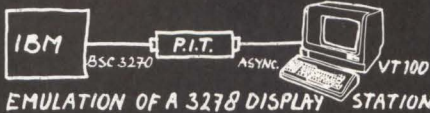

EMULATION OF A 3278 DISPLAY STATION

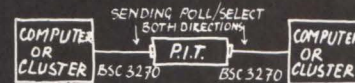

INTERFACING TWO 3274 TYPE DEVICES BY EMULATING A COMM. CONTROLLER AT BOTH SIDES

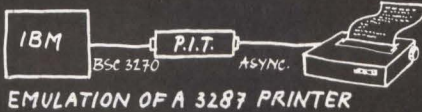

EMULATION OF A 3287 PRINTER

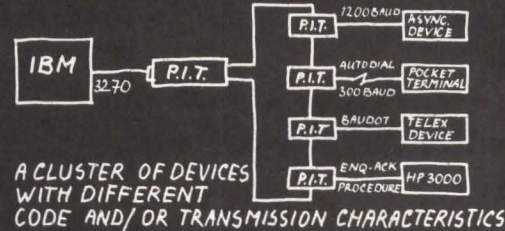

A CLUSTER OF DEVICES WITH DIFFERENT CODE AND/OR TRANSMISSION CHARACTERISTICS

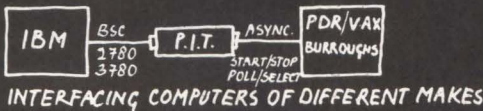

INTERFACING COMPUTERS OF DIFFERENT MAKES

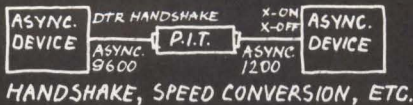

HANDSHAKE, SPEED CONVERSION, ETC.

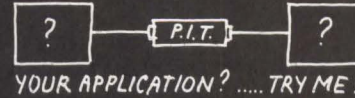

YOUR APPLICATION? TRY ME!

INCAA
COMPUTERS

INCAA B.V. P.O. Box 211, 7300 AE Apeldoorn - Holland. Tel. 055-551262. TLX 49632

Price 100+ quantity
US \$ 495 (F.O.B.)

We are primarily interested in companies willing to enter into an OEM or Distributor agreement. Would those interested please respond directly to us by letter or telex.

Authorized distributors:

Austria Gebrueder Schoeller Vienna 0222-842 631
Belgium Telindus S.A. Brussels 02-648 4470
Finland Symmetric Oy Helsinki 0-90 585 322

Gr. Britain INCAA Branch Off. Bedford 0234-781 300
Italy INCAA s.r.l. Varese 0332-310 231
Sweden Data Distribution AB Alvsjo 08-749 1575
Switzerland Interep SA Geneva 022-431 150

ed-manufacturing tape that can be customized for a desired board layout before the customer manufactures the board. Levandov says this comes in handy to potential customers such as voice data-terminal suppliers wanting to respond to Rolm Corp.'s announcement of an IBM PC-compatible voice and data system (MMS, November 1984, Page 31). The company also planned to introduce this quarter a PC-AT-compatible motherboard design, also up for license. Prices had not been set as of press time.

Phoenix's PC-AT ROM BIOS should be available now. The price is \$200,000 for the ROM BIOS, \$20,000 for the 8042 processor code required for keyboard operation, \$100,000 for GW BASIC, \$50,000 for MS-DOS and \$50,000 for utilities, totaling \$420,000. Customers who have purchased Phoenix's PC/XT ROM BIOS will get a 30-percent discount on a PC-AT ROM BIOS license. Levandov says Phoenix can work out an extended payment schedule for small, start-up companies.

Because little software has been written so far to take advantage of the PC-AT hardware, Phoenix sources say the company has been unable to completely test its PC-AT ROM BIOS.

Food for the smaller fish

Levandov says most purchasers will ship more than 10,000 PC-compatible computers with the ROM BIOS, which would amortize the ROM BIOS cost to less than \$50 a system. For Phoenix's standard PC BIOS, the cost would be about \$29 per system. But another company is catering to the smaller companies that can't afford more than \$290,000 for a PC ROM BIOS from Phoenix or that don't intend to produce 10,000 computers.

Display Telecommunications Corp., Dallas, has shipped thousands of PC/XT ROM BIOS units and motherboards in a product called the MegaBoard XT. Prices range from \$99.95 for a bare-bones board to \$595 for a complete board. Robert E. Lindsley, company president, explains the products are marketed to small customers and to large customers for limited ap-

plications. For example, many of his products are sold to General Electric Co. and Ford Motor Co. for industrial applications.

This month, Display Telecommunications plans to introduce a MegaBoard AT-compatible listing for \$199.95. Lindsley will not comment on specifics about the product until it's ready to be shipped.

Lindsley says marketers will see a huge opportunity as long as IBM can-

not meet demand. "A lot of companies will rush in so fast they will not have done their homework well. They'll come into [the market] with marginally compatible machines and will do well at first." But he says that later, when full PC-AT compatibility is demanded by customers, interest in less compatible computers will taper off. He says that how companies implement PC-AT compatibility will make or break their market entry. □

3Com brings network servers to small LANs

Tom Moran, Associate Editor
and Michael Tucker, Associate Editor

Saying "a new kind of beast has entered the world," officials of 3Com Corp., Mountain View, Calif., have introduced "3Server," a network file server for local area networks (LANs) of personal computers. One of the first servers in the low-end LAN market, the 3Server provides file, printer and electronic-mail services for 3Com's EtherSeries network.

"We wanted to build a machine that was a network for a low-end market," says 3Com founder and chairman Bob Metcalfe. 3Server is designed for small business and office networks of up to 50 microcomputers. The price is \$7,495.

3Server has an 8MHz Intel Corp. 80186 microprocessor, an 82586 Ethernet controller, a 36M-byte Winchester disk drive, a small computer systems interface (SCSI), 512K bytes of RAM and a 60M-byte tape-backup option. It can also support one serial and one parallel printer.

Up to six 36M-byte Winchester disk drives can be added to the basic system at \$3,295 apiece for a total of 252M bytes of storage. Suggested retail price of the optional tape backup is \$2,995. Shared-disk, utility software will list for \$695, printer-sharing software for \$395 and electronic-mail software, available later this year, for \$995.



Options: Users can expand 3Server (bottom) with an optional 60M-byte tape-backup unit (center) and 36M-byte expansion disk (top).

During the second quarter of this year, 3Com plans to introduce communications packages to support IBM Corp. Systems Network Architecture (SNA) communication protocols and

NEWS

allow personal computers to access networks over phone lines.

The company believes 3Server will fit into a market niche between large network file servers and microcomputers operating as file servers in small networks of other microcomputers. It's being distributed through retail channels. The 3Server can run popular personal computer database and accounting software—notably Lotus Development Corp.'s 1-2-3.

"I think our market can be broken down into two segments," says Doug Pollack, 3Com's server-product manager. "On one hand we have department-sized organizations that have found networks of personal computers increasingly useful. On the other, we have people in small business who are looking to networks of personal computers as an alternative to multiuser supermicrocomputers or low-end minis."

While file and network servers for

HOW LITTLE LANs STACK UP

Manufacturer, product	Server type	Processor	RAM (K bytes)	Disk storage (M bytes)	Ports	Network type
Corvus Systems, OmniDrive	disk server	6801	8	5.5	1 OmniNet	OmniNet
IBM, IBM PC-AT with PC Network	file server	8088 80188 on adapter card	256	20		PC Network
Nestar, PLAN 3000	file server, plus two additional functions of the user's choice	6800	250	24-56		ARCnet
TeleVideo, TeleVideo Personal Mini	file server, disk server, print server, opt. electronic mail server	80186, Z80	256-512	22	1 parallel 1 serial 4 RS422	proprietary Star Network
3Com, 3Server	file server, print server, electronic mail server	80186	512	36	1 parallel 1 serial 2 SCSI-bus	Ethernet

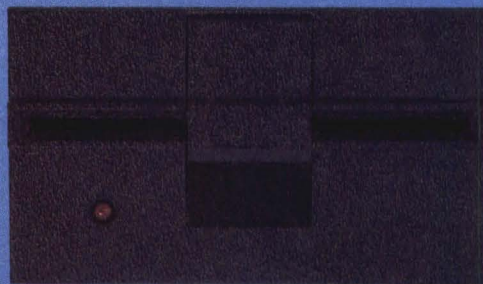

THE END OF THE SECONDARY STORAGE SPECTRUM EVERYONE FORGOT ABOUT WAS THE MIDDLE.

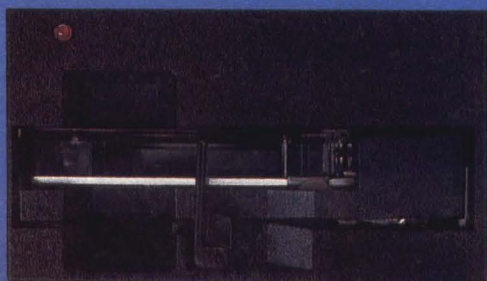

Maximum users	Price (\$)	Backup
63	2,095	optional streaming tape
72	6,515 (IBM PC-AT plus PC Network hard- and software)	various products
255	10,000	streaming tape
8-16	6,995	streaming tape
50	7,495	optional streaming tape

large LANs are fairly common, file servers dedicated solely to small LANs of personal computers are rare. Integrators have usually turned one of the personal computers in a network into a file server.

3Server's main competition may come from personal computers doing double duty as file servers—particularly the IBM PC-AT with a hard disk. Last August, IBM announced plans for a PC LAN, now expected to be available this quarter.

Analysts have speculated that a PC networking product would dominate the low-end LAN market due to IBM's sheer mass. But 3Com officials are confident that 3Server can withstand the IBM threat. The PC-AT, notes Metcalfe, "was designed to be a personal computer. It has option slots, a keyboard, a monitor and, by running some software, it can masquerade as a network server."

An IBM representative says that al-

though the PC-AT was not designed as a file server it can function as one "because it is a very powerful and versatile system." IBM has not made any announcement of a dedicated file server for networked personal computers, and the representative declined to reveal the company's plans.

Market analysts seem generally enthusiastic about the 3Server. Louis Herndon Wells, analyst with the research concern Dataquest Inc., San Jose, Calif., says, "We think it's terrific. A file server is an indispensable element of a functional local area network...the 3Server also adds network-management capability."

Aaron Goldberg, director of microsystems research for International Data Corp., Santa Clara, Calif., is equally upbeat about the 3Server. "It's designed as a solution rather than as [just] a piece of hardware, or software, or cabling. Essentially, what they have done is a very intelligent design that

It wasn't long ago that when you wanted to back up a 5¼" Winchester, you only had two choices: floppies or QIC-compatible ¼" tape.

Well, now there's a third choice: Cipher's FloppyTape™. It gives you the best of both worlds — without the drawbacks of either.

Economical like a floppy.

FloppyTape is the perfect secondary storage device for low-cost systems. It offers a substantially lower cost-per-megabyte than floppies. Yet the actual cost of the drive is only slightly more.

What's more, FloppyTape uses a standard floppy interface. And it works perfectly with most regular floppy controllers. So you can share your system's existing floppy controller.

High capacity like a streamer.

Using a standard ¼" tape cartridge, FloppyTape gives you up to 32 megabytes of storage.

It eliminates the problems of handling a large number of floppy disks.

And FloppyTape is priced well below QIC-compatible ¼" streamers. With QIC, you also need a new host adapter or controller. But you don't with FloppyTape.

If the part of the secondary storage spectrum that's best for your system is the middle, call 800-982-8808. Or write Cipher Data Products, P.O. Box 85509, San Diego, CA 92138.

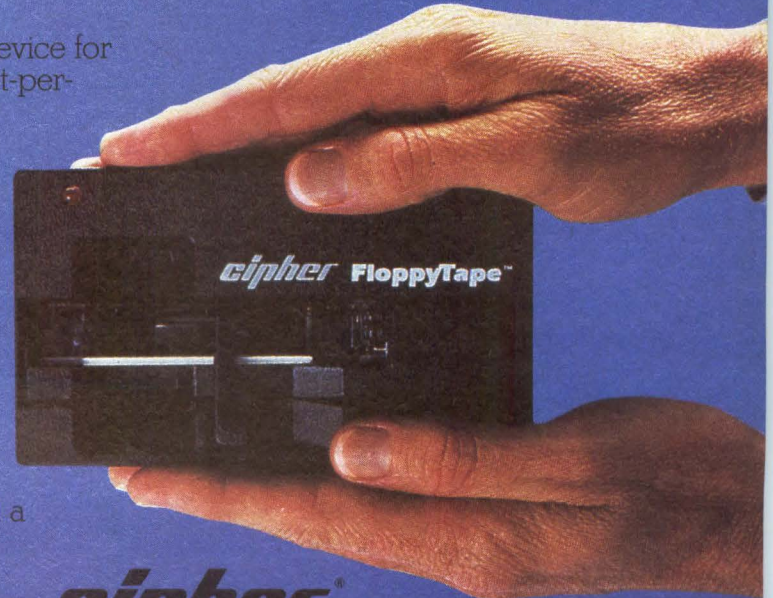

cipher
data products, inc.

WE PUT THE BEST IDEAS
INTO STORAGE.

The first smart terminal under \$400.

THE NEW
**QVT
101™**

Block mode editing, multiple emulations, 16 host or user-programmable functions, a 14-inch screen, and more. All the editing power of the \$695 terminals, all for only \$395! Nothing is missing except the high price — you still get the industry's only one-year warranty. And its best reliability record.

No one else comes even close. Not Wyse. Not Esprit. Not TeleVideo. Only Qume can offer this unheard-of value, with smarter design, smarter sourcing, and greater resources behind us. For the best buy in VDT history, call (800) 223-2479. Qume Corporation, 2350 Qume Drive, San Jose, CA 95131. We'll be there.

Qume®
A Subsidiary of **ITT**

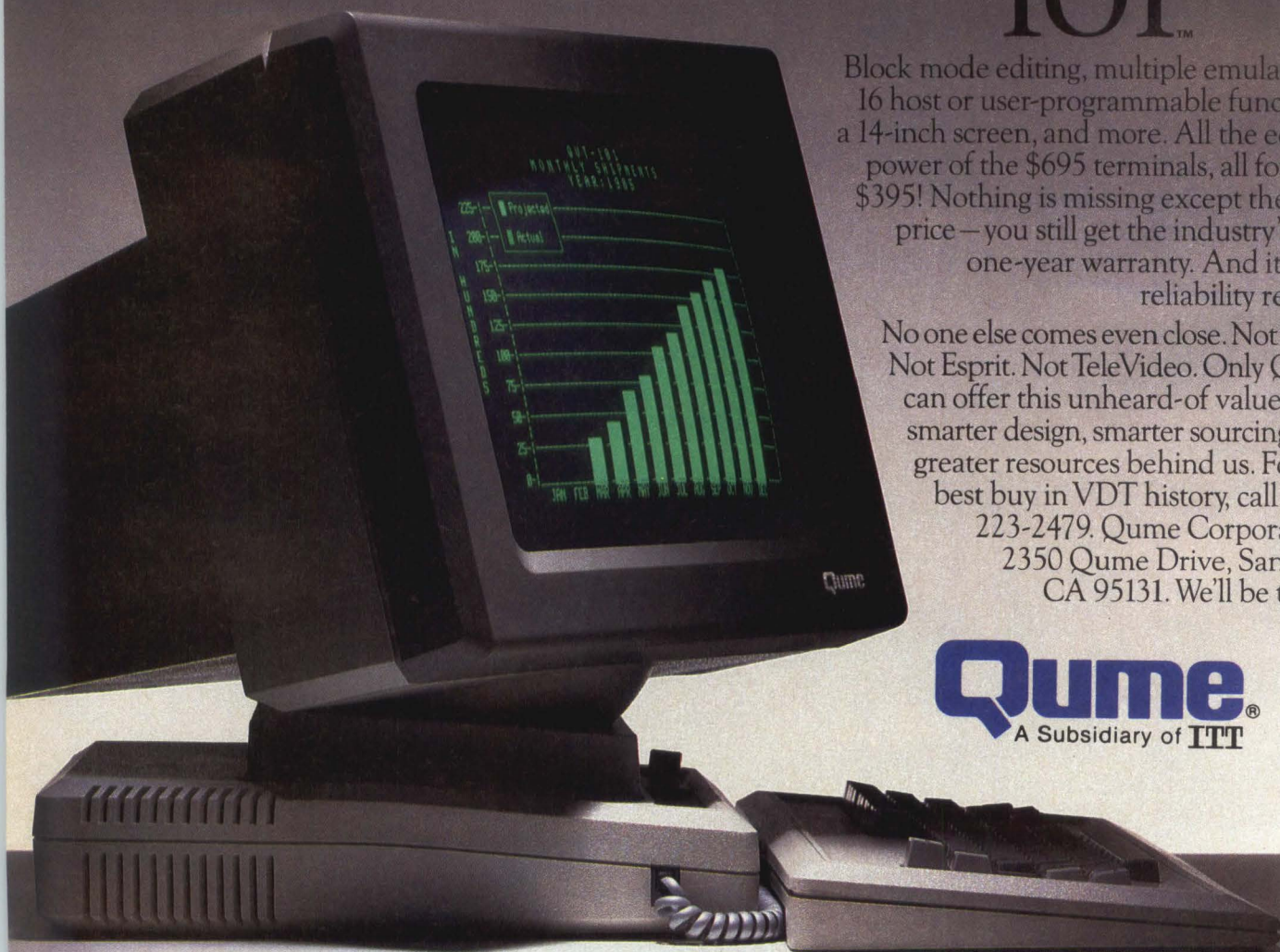

makes administration of the file server far less taxing than [using] a Xerox copier...that's important because [file servers] are going to sit in administrative offices, and the system administrator is unlikely to be a trained data processor."

Analysts also suggest the 3Server may be able to take advantage of a file-server market boom. "Our research shows that a personal computer in a business environment will [currently] have anywhere from one to five people who use it at [various] times,"

notes Goldberg. "When multitasking occurs, and a personal computer becomes good for so many things that you do the bulk of your work on it, it becomes impossible to share."

The result, he says, will be more personal computers and file servers. □

Atari strives for a comeback with Macintosh look-alike

Lucy Huffman

Contributing Correspondent

In a major bid to re-establish itself in the personal computer market, Atari Inc., Sunnyvale, Calif., has introduced a new line of computers with the same power and features of Apple Computer Inc.'s Macintosh, but for half the price. The two new Atari ST computers also mark the company's first new product announcement since Jack Tramiel, former chairman of competing Commodore International, took over the ailing Atari six months ago. While the market for, and certain aspects of, the line remain unclear, many analysts are bullish about Tramiel's ability to turn Atari around.

The new models were unveiled in prototype at the recent winter Consumer Electronics Show in Las Vegas. Conference attendees dubbed them "Jackintosh": a play on Tramiel's first name and the machines' similarity to the Apple computer. Atari officials, however, claim one major difference. Both ST models, including monitors and disk drives, will be available for less than \$1,000. What's more, the ST machines feature color graphics, unlike the black-and-white Macintosh. Said one enthusiastic analyst who saw the prototype, "It's like delivering a color Macintosh for under \$1,000."

The Atari ST computers use a 16/32-bit Motorola Inc. MC68000 microprocessor, the same chip used in the Macintosh. The 130ST has 131K bytes of RAM, while the 520ST has 524K bytes of RAM. Both have 512 available colors for graphics. Each has

196K bytes of built-in ROM, expandable to 327K bytes with plug-in cartridges.

Atari adopts GEM graphics

What makes the new line so similar to the Macintosh is its operating environment. Atari is one of the first companies to use the Graphics Environ-

ment Manager (GEM) recently introduced by Digital Research Inc. GEM eliminates cryptic operating-system commands by using a pictorial representation of a desk's surface, including such familiar icons as a wastebasket or file folder. The user commands the machine by moving a mouse and clicking a button. For ex-

First TRULY Universal Microprocessor Development System

Compu-Mech's Universal Development Laboratory (UDL)

Now you can transform your PDP11, VAX or PC into a complete development system including emulator, analyzer and EPROM programmer for less than the cost of the emulator pod alone on other systems!

Our UDL eliminates the "POD". The target micro's personality is defined in software. This means you can "re-tool" for a different processor for hundreds of dollars rather than the thousands required up to now.

The UDL is controlled from your PDP11, VAX or PC over an RS232 serial link using a software package supplied which provides complete in-circuit emulation for hardware and software checkout.

Fifteen day trial period. Free brochure.

Compu-Mech

Compu-Mech, Inc.
5242 Angola Rd. Suite 75
Toledo, OH 43615
419-535-6702

CD1000 Universal Development Laboratory

NEWS

ample, a cut-and-paste feature allows users to merge spreadsheet, data or files.

Other internal features of the new ST line include a high-speed hard disk interface, direct-memory access at 1.33M bytes per second, built-in cartridge access and an integrated floppy disk controller. Also included are a Centronics parallel interface for printers, an RS232C serial modem interface, a disk interface and two joystick ports, one configured for the mouse.

To complement the ST line, Atari is also coming out with a new set of peripherals. While both STs can be used with a standard television set, Atari monitors will feature 12-inch, individually addressable, 32K bit-mapped screens and will be available in high-resolution monochrome or medium-resolution RGB (red, green, blue) color. Either 3½-inch floppy disk (500K bytes) or 3½-inch hard disk (10M bytes) drives are available for the

ST machines. Atari is also developing both color and black-and-white printers.

Low price, comparable features

Atari is touting the new line as offering customers "power without the price." The ST models are expected to retail from \$400 to \$600, with monitors and disk drives running less than \$200 apiece. Hard disks are said to be in the \$600 range. At those prices, the Atari 520ST would cost about \$1,000, compared with a similarly outfitted Macintosh retailing for more than \$2,000. Atari would not confirm those preliminary prices, however. The company has scheduled delivery for April, but the fourth quarter of 1985 is a more likely date, say industry experts.

Hoopla aside, as many questions as answers surround the Atari ST line. "A lot about this product is vague," said Peter Teige, an analyst with Dataquest Inc., a San Jose, Calif., research

firm. "You don't know who it's for or what software there is."

Most industry analysts believe that software will be the key to the new line's success, but experts say virtually no third-party software for the machines exists yet. "With Atari, nothing has really been said about software," said Teige.

The new GEM environment may account for at least part of the software uncertainty. GEM was introduced just last November and, besides Atari, only one European manufacturer is using it. But DRI officials say GEM software can run on any MS-DOS-based or Concurrent-DOS-based machine, thus allowing programmers using an IBM Corp. PC, for example, to develop software that can be recompiled for the new Atari personal computer.

What's more, the DRI officials say eight independent software vendors have agreed to write to the GEM environment with potentially "hundreds" more ready to commit themselves by spring. Among those already committed are Chang Laboratories, San Jose, Calif., Matrix Systems Group Corp., Boston, and Thorn EMI, Costa Mesa, Calif.

Software slow in coming

Jan Lewis, an analyst with InfoCorp, Cupertino, Calif., believes that momentum among programmers for using GEM will be slow, even though those designing for the Macintosh may be lured by the similarity of Atari's STs to the Macintosh. And, she added, Atari may be trying to defy internationally conventional wisdom that says it will be in trouble unless it develops the ST software market on its own. "Maybe Atari believes it can sell its razors cheaper than anyone else, and let everyone else sell the blades," she said.

In addition to the uncertainties about software availability, the company is not clear about who its customers will be, industry sources say. "The philosophy of the company is not to separate the different markets," said an Atari spokesman. "We deliver to individuals. We don't make home computer/business computer distinctions."

Despite that claim and the ST line's

SAIC
VME MICROSYSTEMS DIVISION
"LEADING THE INDUSTRY IN VME SOLUTIONS"
VMEbus DIGITAL I/O MODULES

DESCRIPTION	MODEL NO. SAIVME-	LIST PRICE**
● 128-BIT TTL I/O TURBOMODULE™	2528	\$ 995
● 64-BIT TTL I/O MEGAMODULE™ WITH BUILT-IN-TEST	2510	\$ 695*
● 64-BIT HIGH VOLTAGE OUTPUT MEGAMODULE™ WITH BUILT-IN-TEST	2120	\$ 695*
● 64-BIT HIGH VOLTAGE INPUT MEGAMODULE™ WITH BUILT-IN-TEST	1110	\$ 695*
● 64-BIT CONTACT BOUNCE ELIMINATOR	1130	\$ 695
● 64-BIT NEGATIVE VOLTAGE RELAY MODULE	2132	\$ 695
● 64-BIT OPTICALLY COUPLED INPUT MODULE	1150	\$ 895
● 48-BIT PIO MODULE WITH INTERRUPTS	2511	\$ 695
● 32-BIT OPTICALLY COUPLED INPUT WITH CHANGE-OF-STATE INTERRUPTS	1160	\$ 795
● 32-BIT TTL INPUT MODULE WITH CHANGE- OF-STATE INTERRUPTS	1101	\$ 595
● 32-BIT HIGH VOLTAGE DIGITAL INPUT WITH CHANGE-OF-STATE INTERRUPTS	1180	\$ 595
● 32-BIT OPTICALLY COUPLED OUTPUT MODULE	2170	\$ 795
● 32-BIT RELAY OUTPUT MODULE	2200	\$ 895
● 32-BIT INPUT/32-BIT OUTPUT-HIGH VOLTAGE I/O WITH BUILT-IN-TEST	2532	\$ 595

* ADD \$100 FOR 32 BIT TRANSFER OPTION
** PRICES SUBJECT TO CHANGE WITHOUT NOTICE

ONE YEAR WARRANTY
DELIVERY-STOCK TO 90 DAYS

VME MICROSYSTEMS DIVISION
SCIENCE APPLICATIONS INTERNATIONAL CORPORATION
2109 W. CLINTON AVENUE
HUNTSVILLE, AL 35905
(205) 533-5900, X338
CARROLL WILLIAMS

CIRCLE NO. 25 ON INQUIRY CARD

WIDE WORD™

200 MB/second!

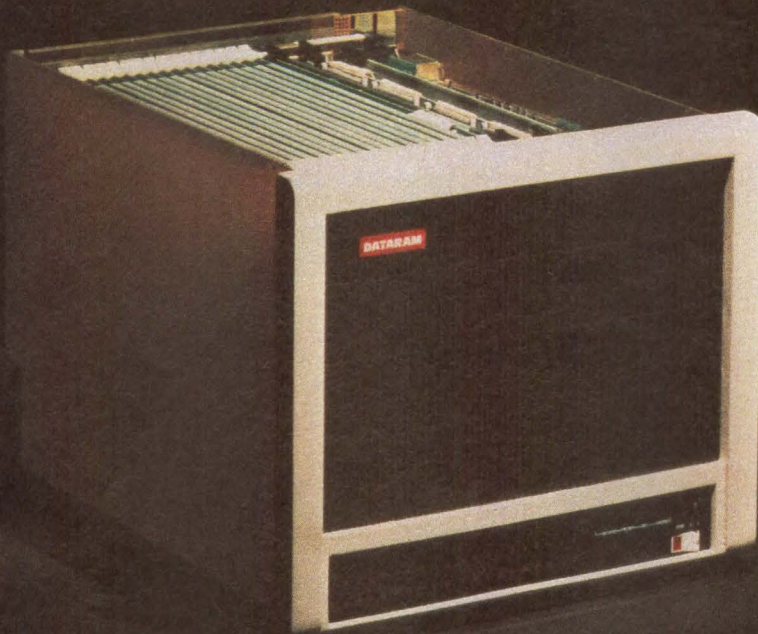

World's Fastest Bulk Memory System

It's true. Dataram's WIDE WORD memory system delivers an incredible data rate of 200 MB/sec! Achieved by utilizing 80 or 160 bits per word and four-way interleaving.

Much faster than even the fastest minicomputers can handle...but not too fast for your real-time applications, image processing, array processing or data acquisition needs.

Multi-port capability enables you to bring WIDE WORD speed to your host minicomputer. Simply connect one port to your high-speed input; the other to your mini.

Our library of dedicated interfaces allows you to run with Digital Equipment, Data General, Ampex, Control Data, CSPI, Honeywell, Intel (MULTIBUS), MODCOMP, Motorola (VERSAbus), Perkin-Elmer, ROLM, and SEL. And, possibly even more importantly, we can work with you to develop a custom WIDE WORD interface.

WIDE WORD, 128 MB of high-performance memory in a compact 15 3/4" system. Word lengths up to 160 bits. And, of course, a data rate of 200 MB/second.

Our new WIDE WORD brochure will tell you more. And you can have it at no charge by circling the Reader Response Number or calling us at (609) 799-0071.

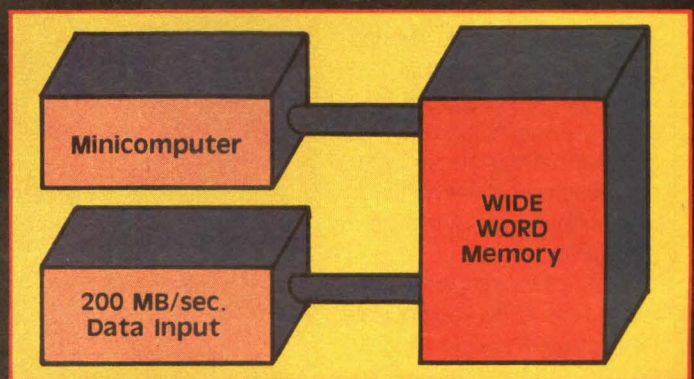

DATARAM

Princeton Road □ Cranbury, NJ 08512 □ (609) 799-0071 □ TWX: 510-685-2542

CIRCLE NO. 26 ON INQUIRY CARD

WIDE WORD is a trademark of Dataram Corporation. MULTIBUS is a registered trademark of Intel Corporation. VERSAbus is a trademark of Motorola, Inc.

MICROVAX I LETS YOU START SMALL IN A VERY BIG WAY.

All supermicros let you start out small. Most run into problems, however, when your applications start getting big.

That's why Digital's MicroVAX I™ supermicro is such an intelligent solution. It limits your risk – not your capabilities.

For starters, MicroVAX I is a member of the VAX™ systems family; it provides a full set of VAX resources. That's saying a lot, because VAX systems are the industry standard for 32-bit computing.

MicroVMS™, our VMS™ operating system for MicroVAX, lets you develop applications for any VAX using the comprehensive set of proven development tools provided by the VAX computing environment.

You get all the VMS editors, debuggers, database managers, screen managers, utilities and communications options. You can use advanced VMS languages – including Pascal, FORTRAN, C, Bliss, COBOL and Ada.® And through the VMS common calling standard, you can combine routines written in different languages within the same program.

This software sophistication lets you cost-effectively dedicate the MicroVAX I system to highly complex tasks. In areas like proc-

ess control, signal and image processing, CAD/CAM, mathematical simulation, seismic analysis and automatic test. There's no end to the uses for MicroVAX.

THE BIGGEST GROWTH PATH IN THE INDUSTRY STARTS HERE.

The sky's the limit for applications you develop on MicroVAX. They can run on every VAX in the family – including our top-of-the-line VAX 8600 and VAXcluster™ systems. Through upward expansion and shared resource networking, the computing power at your disposal is virtually inexhaustible. You can go from a supermicro to a mainframe-level system without changing your software. And that's an advantage no other supermicro supplier can match.

Conversely, you can download VAX applications to MicroVAX I systems. All non-privileged commands and the full VAX instruction set are supported, so your applications will run with little or no modification.

There's even VAXELN™ software, a complete Pascal-based development toolkit, that runs on VMS and MicroVMS. With VAXELN, it's easy to create dedicated realtime applications for MicroVAX and VAX systems. By leaving out the overhead, VAXELN gives you a highly efficient runtime environment.



© Digital Equipment Corporation 1985. Digital, the Digital logo, MicroVAX, VAX, MicroVMS, VMS, VAXcluster, PDP-11, VAXELN, MicroPDP-11, Q-bus, DECnet and ULTRIX-32m are trademarks of Digital Equipment Corporation. Ada® is a trademark of the U.S. Government Department of Defense. UNIX® is a trademark of AT&T Bell Laboratories.

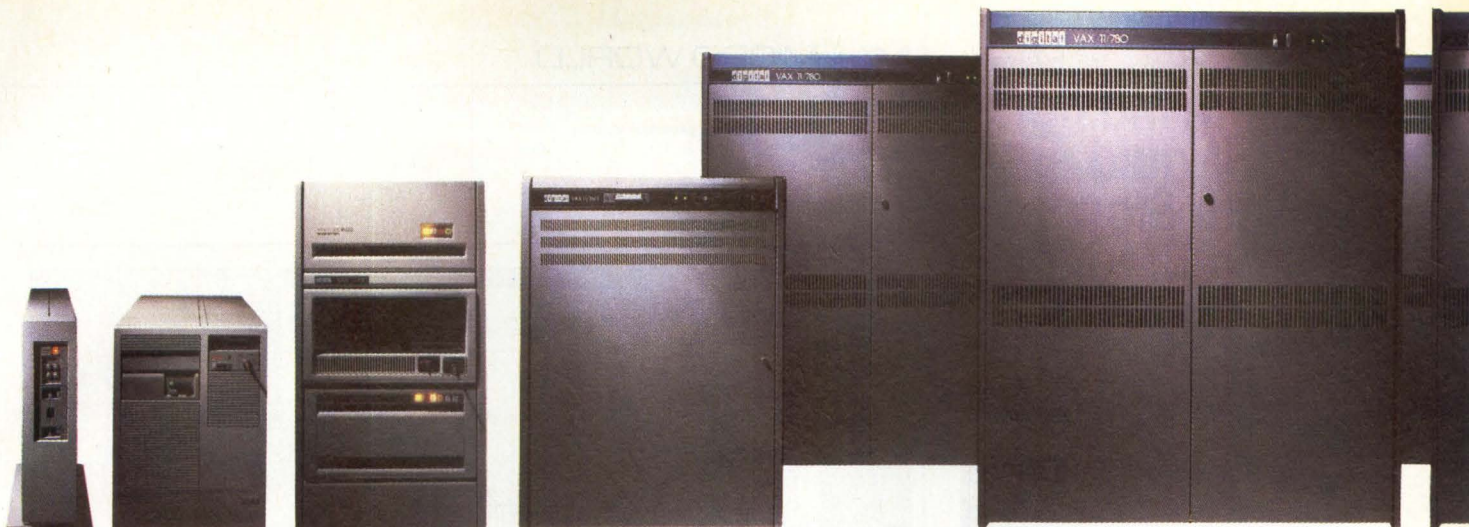

Starting with MicroVAX I, you can grow all the way to the VAX 8600 system . . .

PART OF A GROWING FAMILY OF SUPERMICROS.

Our 32-bit MicroVAX I systems have a lot in common with our 16-bit MicroPDP-11™ super-

micros. They all use the same Q-bus™ data transfer architecture. So they all support the same peripherals.

That's a substantial benefit, because Q-bus is an industry-standard bus, with many options available from Digital and independent vendors. Hundreds of peripheral products are available to make your MicroVAX configurations complete.

Commonality between MicroVAX I and MicroPDP-11 systems is also maintained in file structure, communications options, languages and even many applications. All of which expands your options and provides unlimited opportunities for growth.

DECNET, YOUR UNIVERSAL NETWORKING STRATEGY.

When you're ready to distribute your applications via MicroVAX I systems, DECnet™ software makes it easy. MicroVAX supports DECnet to give you a

complete set of local and wide area networking facilities.

Your options include local communications via our implementation of the most advanced level of the Ethernet local area network available today.

And wide area communications via dial up or leased lines, or public packet-switched X.25 networks. Further, you can establish these local and remote systems links transparently to the user and the program.

Digital's networking facilities also let you take advantage of the computing resources of non-Digital systems. The extensive selection of standard protocols

available to you with the MicroVAX I system includes 2780/3780, 3271, X.25 and SNA. All these facilities are fully implemented not just at the hardware level, but through software as well.

So if you want to start small,

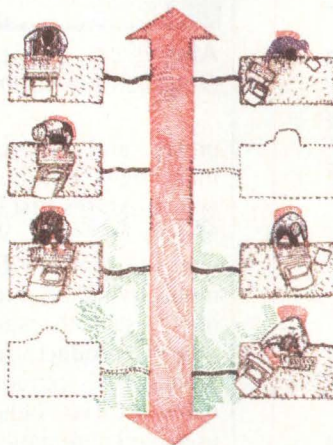

start big with the MicroVAX I system. You'll get the 4-gigabyte address range, the powerful instruction sets, the incomparable development tools and vast software selection that has made our VAX systems the most popular 32-bit computers in the world. And you'll get it all with the economy and convenience of a supermicro package.

BEST ENGINEERED MEANS ENGINEERED TO A PLAN.

Our MicroVAX I supermicro, like all Digital hardware and software products, is engineered to conform to an overall computing strategy. This means our systems are engineered to work together easily and expand economically. Only Digital provides you with a single, integrated computing strategy, from chips to 32-bit VAX systems and direct from desktop to data center.

If you believe that your company could benefit from our very growth-oriented MicroVAX I system, contact your nearest Digital sales office or a Digital Authorized Industrial Distributor. Or call: 1-800-DIGITAL, ext. 230.

THE BEST ENGINEERED COMPUTERS IN THE WORLD.

ULTRIX, YOUR TRANSPORTABLE OPERATING SYSTEM.

If you need UNIX® software capabilities, our MicroVAX I system can readily provide them. It supports ULTRIX-32m™ software, our enhanced, fully supported UNIX software for MicroVAX.



ULTRIX-32m includes all Berkeley 4.2 features, in addition to Digital's enhancements that simplify error reporting and recovery. ULTRIX-32m applications can run throughout the VAX family. Our PDP-11™ and MicroPDP-11 systems families also support a version of ULTRIX software. And that lets you extend a single application across a vast range of systems. You can go from low-cost MicroPDP-11/23 and MicroVAX I systems all the way to our high performance VAX 8600 systems with one, multi-purpose solution. Think how that will extend your reach in your market.

ULTRIX-32m includes all Berkeley 4.2 features, in addition to Digital's enhancements that simplify error reporting and recovery.

digital™

Which Master Would Your Slaves Recommend?

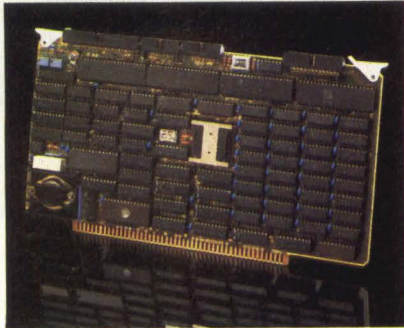

Our New CPZ-186 Has It All

Intercontinental Micro Systems, the leader in the 8-bit single board computer world, has done it again. The CPZ-186, based on the 80186 CPU with integrated 2 channel Direct Memory Access Controller, has a 4-drive floppy controller, 2 serial I/O ports, 2½ parallel I/O ports, Memory Management Unit, Interrupt Controller, up to 1 Megabyte of Dynamic RAM, and up to 8K EPROM, all on a single IEEE S-100 Bus Board.

Talk about speed and flexibility. The CPZ-186 runs at 8 MHz and can be used for single user systems or in powerful multi-user applications. As a Network Master (File Server), the CPZ-186 can network 8-bit and 16-bit S-100 Bus Slaves as well as PC's using Intercontinental's complete line of hardware and software networking products.

Find out what support really is. Everyone talks about support, but at Intercontinental you deal directly with our hardware and software design team. Who else could know more about solving your problems?

Best of all, we're delivering now, and our price allows building cost effective systems and networks.

Circle the bingo number below or contact us directly, and ask about our complete line of S-100 Bus and Local Area Networking Boards.



4015 Leaverton Ct., Anaheim, Ca 92807,
(714) 630-0964, TELEX: 821375 SUPPORT UD

CIRCLE NO. 28 ON INQUIRY CARD

MINI-MICRO WORLD NEWS

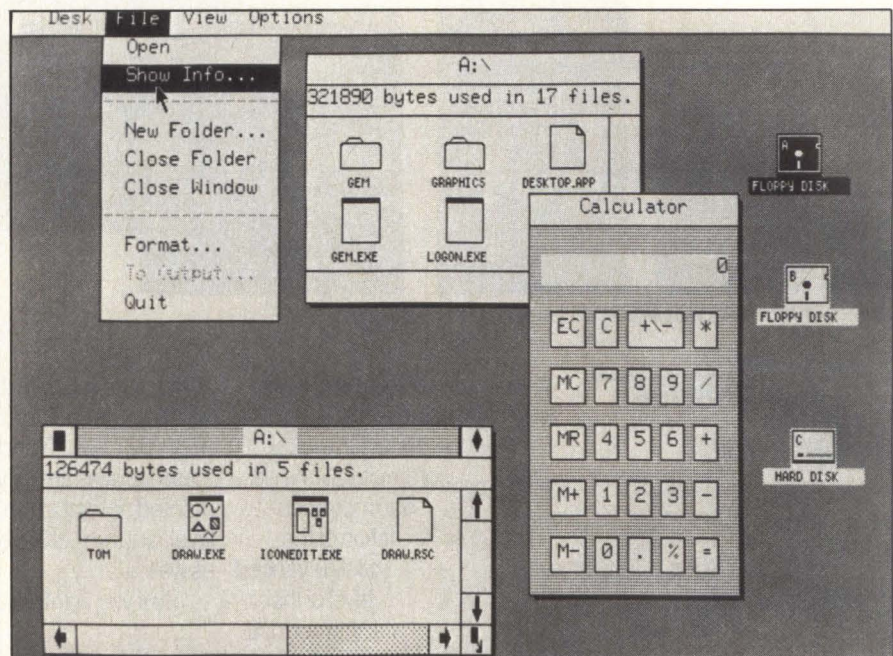

Atari is one of the first companies to use Digital Research's GEM Graphics Environment Manager in Atari's Macintosh look-alikes.

power and performance capability, many signs indicate the home market will be Atari's first goal. One example is the name itself. When Tramiel took over the company from Warner Communications, he intentionally kept the name, said the spokesman, because Atari's product recognition among consumers is extraordinarily high. But many experts believe that business users will automatically shy away from a firm whose fortunes so publicly rose and crashed with the video game craze. As Dataquest's Teige put it, "If they wanted the business market, they bought the wrong name."

Then there is Atari's planned marketing scheme. The company has said it will not distribute through computer retailers, as presently do IBM and Apple, but instead will go through mass marketers such as Sears Roebuck & Co., Toys R Us and K Mart Discount Department Stores. Atari has also devised a system of color coding each new computer model and its related software and peripherals. The company expects color coding to reduce confusion, especially among novices, and to aid in the self-service methods of mass-merchant business.

The distinction between the home market and the low end of the business market may eventually break of its own accord, particularly if IBM or Apple begin selling in mass-market outlets. What's more, if software is developed quickly for the Atari line, business users could be lured by the lower price, all else being equal. While Teige says the firm appears to initially be going after the home market, he adds, "I'm not clear that that's their ultimate strategy."

Can success return?

Finally, questions remain about the company itself as a result of the video game debacle. Most experts agree that the biggest asset Atari has is its chairman, Tramiel, the aggressive entrepreneur who built Commodore into a billion-dollar company.

According to the Atari spokesman, 95 percent of the firm's personnel are new to Atari and "everybody's wearing 50 million different hats."

InfoCorp's Lewis is enthusiastic about Tramiel's ability to raise financing, now that the product has been introduced: "Every time I say 'Atari,' I really mean Jack Tramiel." □

40-column, 3½" wide sales receipt prints at two lines per second and includes *everything* involved in the sale.

PCI is Pacesetting Computers, Inc.—a leader in point-of-sale technology since 1978.

Larger-than-most 80-column by 24-line (9-inch) CRT screen. Clerk will bring up almost any item in less than one second!

Full alpha and full numeric cash register-type keyboard (CASH, CHARGE, etc.). Custom keyboards available.

Disk drive uses 5¼" floppy to store 11,000 records (inventory, customers, etc.). Optional hard disks can handle up to 100,000 records!

The perfect size: 19" by 17" by 12".
The perfect weight: only 32 pounds.
The perfect color: off-white ivory

Cash drawer works automatically or manually with key.

The PCI CASH REGISTER SYSTEM: It sells itself. It sells your computers!

No matter what sign he's under—hardware, liquor, bicycles, flowers, stationery—your retailer prospect wants this system now. He wants the low-cost, state-of-the-art electronic point of sale terminals...with complete data processing.

And he wants a choice: a computer-dependent model that hooks up to the computer he already owns; a stand-alone model with its own disk storage; or one that combines a POS terminal and data processor in one package.

Who offers him all that—plus the best price/performance in the industry? One company only. PCI.

Who will be the only dealer in your area to sell him that system? Maybe you.

If you want to make 40% or higher profits in a known retail market of 940,000 cash register systems. If you want a product guaranteed to help you sell more computers. And if you want to be a PCI Dealer with a guaranteed-to-go product and full dealer support: free training, program source codes, 800 number hot line,

national advertising, direct mail, trade show entries... everything.

If this sounds like you, mail in the coupon for PCI's free, comprehensive PCI DEALER KIT. Or call our toll-free number now.



PACESETTING COMPUTERS, INC.

2859 Gundry Avenue, Long Beach, CA 90806 • Phone (213) 595-8441

Please send me a free PCI DEALER KIT now!

Name _____

Title _____

Company _____

Address _____ Ph. _____

City _____ State _____ Zip _____

Or call toll free: **800-833-9317**

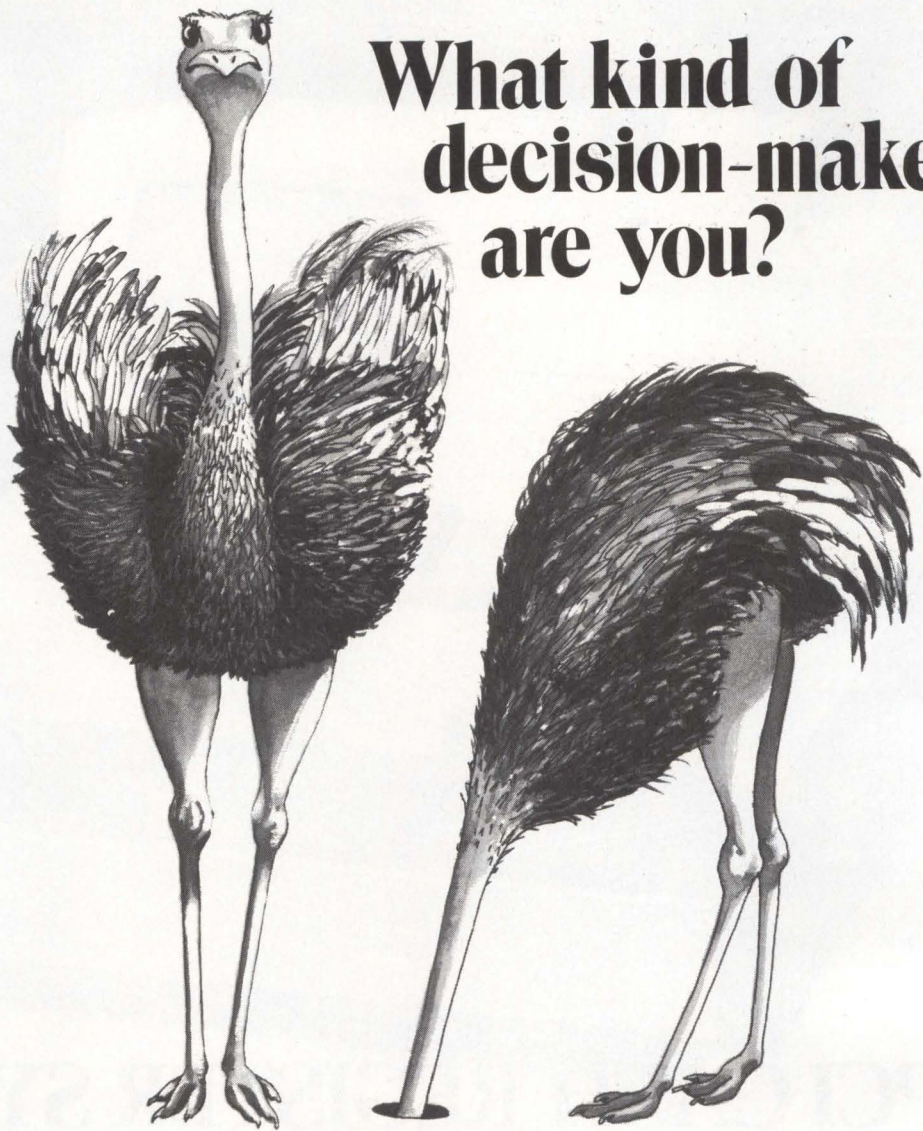

What kind of decision-maker are you?

It's a rare bird that will boldly stand up and look at problems right in the eye.

But when it comes to problems as complex as communications systems, information systems, or integrated office systems, you need more than just stout-hearted resolve. You need the facts.

That's why if you're responsible for influencing or specifying your organization's office systems integration purchases, you should attend The 13th Annual INTERFACE '85 Conference & Exposition.

You can learn the facts at INTERFACE. INTERFACE is presented for people who are expected to confront and solve issues like local area networking. Desktop systems integration. Networking. Specialized carrier systems. These, and related issues, are examined from both technical & senior management perspectives at INTERFACE. The prestigious Conference has

sessions conducted by expert industry leaders. There are sessions that will help untangle the problems you face, then suggest practical solutions that you can use to fulfill your day to day responsibilities and help you plan for the future.

Also at INTERFACE will be more than 300 exhibits with the latest products. Talk with exhibitors about your specific problems and needs. They'll be happy to tell you how they can help you. That's why they're there.

If you don't have the facts to confront your communications problems, you might as well have your head in the sand. Attend the 13th Annual INTERFACE '85 Conference & Exposition.

For more information about attending The 13th Annual INTERFACE '85 Conference & Exposition, call (617) 449-6600. Or write The 13th Annual INTERFACE '85 Conference & Exposition, 300 First Avenue, Needham, MA 02194.

INTERFACE '85

MARCH 4-7, 1985 ATLANTA, GEORGIA

Co-Sponsored by **BusinessWeek** and **Data Communications**



Presented by **THE INTERFACE GROUP, Inc.**, world's leading producer of computer conferences and expositions including INTERFACE, FEDERAL DP EXPO, COMDEX/Winter, COMDEX/Spring, COMDEX/Fall, COMDEX/Europe, COMDEX in JAPAN, the nationwide COMPUTER SHOWCASE EXPOs and The BYTE Computer Shows. 300 First Avenue, Needham, MA 02194 • (617) 449-6600



Motorola VME/10 Development Systems at Hall-Mark.



Hall-Mark Electronics Corp. • Dallas, Texas • Subsidiary of Tyler Corp. 

Northeast

Boston 617/935-9777
Cherry Hill 609/424-7300
Fairfield 201/575-4415
New York 516/737-0600
Philadelphia 215/355-7300
Connecticut 203/269-0100

Southeast

Atlanta 404/447-8000
Baltimore 301/988-9800
Ft. Lauderdale 305/971-9280
Huntsville 205/837-8700
Orlando 305/855-4020
Raleigh 919/872-0712
Tampa Bay 813/530-4543

North Central

Chicago 312/860-3800
Cincinnati 513/563-5980
Cleveland 216/349-4632
Columbus 614/891-4555
Milwaukee 414/761-3000
Minneapolis 612/854-3223

South Central

Austin 512/258-8848
Dallas 214/553-4300
Houston 713/781-6100
Kansas City 913/888-4747
St. Louis 314/291-5350
Tulsa 918/665-3200

Northwest

Bay Area 408/946-0900
Denver 303/790-1662
Sacramento 916/722-8600

Southwest

Orange County 714/669-4700
Phoenix 602/437-1200
San Diego 619/268-1201
San Fernando Valley 818/716-7300
West Los Angeles 213/643-9101

© 1984 Hall-Mark Electronics Corp./5692

Only Microware's OS-9 Operating System Covers the Entire 68000 Spectrum

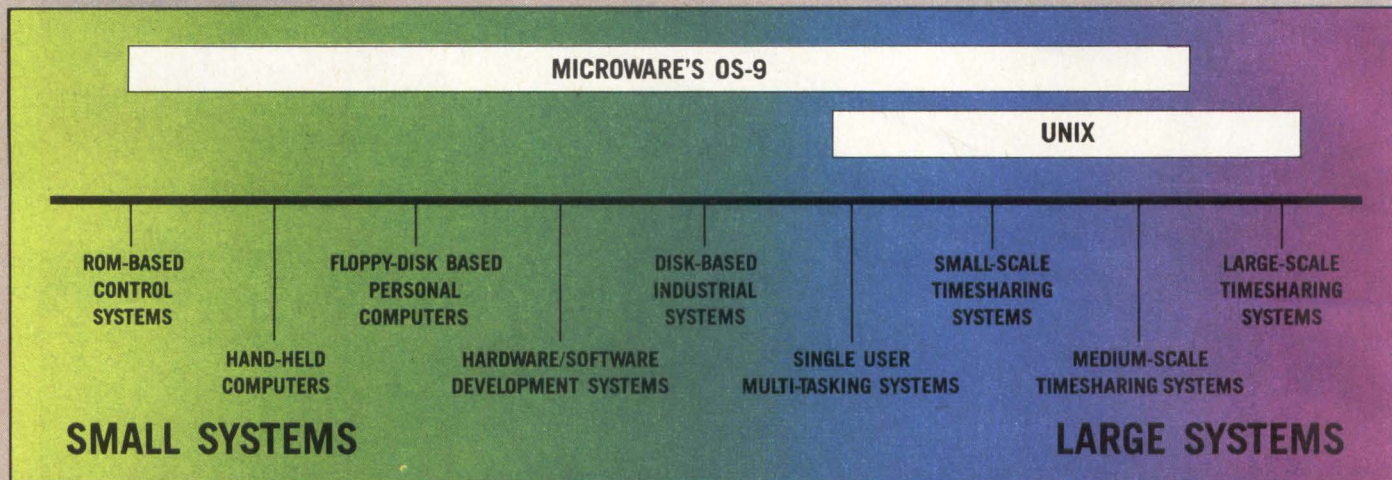

Is complicated software and expensive hardware keeping you back from Unix? Look into OS-9, the operating system from Microware that gives 68000 systems a Unix-style environment with much less overhead and complexity.

OS-9 is versatile, inexpensive, and delivers outstanding performance on any size system. The OS-9 executive is much smaller and far more efficient than Unix because it's written in fast, compact assembly language, making it ideal for critical real-time applications. OS-9 can run on a broad range of 8 to 32 bit systems based on the 68000 or 6809 family MPUs from ROM-based industrial controllers up to large multiuser systems.

OS-9'S OUTSTANDING C COMPILER IS YOUR BRIDGE TO UNIX

Microware's C compiler technology is another OS-9 advantage. The compiler produces extremely fast, compact, and ROMable code. You can easily develop and port system or application software back and forth to standard Unix systems. Cross-compiler versions for

VAX and PDP-11 make coordinated Unix/OS-9 software development a pleasure.

SUPPORT FOR MODULAR SOFTWARE — AN OS-9 EXCLUSIVE

Comprehensive support for modular software puts OS-9 a generation ahead of other operating systems. It multiplies programmer productivity and memory efficiency. Application software can be built from individually testable software modules including standard "library" modules. The modular structure lets you customize and reconfigure OS-9 for specific hardware easily and quickly.

A SYSTEM WITH
A PROVEN
TRACK RECORD

Once an underground classic, OS-9 is now a solid hit. Since 1980 OS-9 has been ported to over a hundred 6809 and 68000

systems under license to some of the biggest names in the business. OS-9 has been imbedded in numerous consumer, industrial, and OEM products, and is supported by many independent software suppliers.

Key OS-9 Features At A Glance

- Compact (16K) ROMable executive written in assembly language
- User "shell" and complete utility set written in C
- C-source code level compatibility with Unix
- Full Multitasking/multiuser capabilities
- Modular design - extremely easy to adapt, modify, or expand
- Unix-type tree structured file system
- Rugged "crash-proof" file structure with record locking
- Works well with floppy disk or ROM-based systems
- Uses hardware or software memory management
- High performance C, Pascal, Basic and Cobol compilers

microware[®]
OS-9[™]

MICROWARE SYSTEMS CORPORATION
1866 NW 114th Street
Des Moines, Iowa 50322
Phone 515-224-1929
Telex 910-520-2535

Microware Japan, Ltd
3-8-9 Baraki, Ichikawa City
Chiba 272-01, Japan
Phone 0473(28)4493
Telex 299-3122

OS-9 is a trademark of Microware and Motorola. Unix is a trademark of Bell Labs.

CIRCLE NO. 32 ON INQUIRY CARD

MINI-MICRO WORLD

CORPORATE AND FINANCIAL

When doing business in China, expect the unexpected

China is no place like home when East meets West in joint-venture projects

Lori Valigra, Senior Editor

A European businessman, resting after a long day at a computer show in China, was awakened by a loud knock on his hotel room door. Four Chinese he had met at the Beijing (Peking) exhibition stood before him, unannounced, eager to resume discussing business.

An American businessman decided to fly to Shanghai, for two extra days of work, thus requiring a change in his flight schedule back to the United States. He found that the next available flight was 11 days later.

Still another Western businessman plugged in a computer system exhibited at a show. An electrical surge burned a hole in the computer's I/O board.

Such incidents are common in China. The country, open to Americans for less than a decade, still has a long way to go toward providing Western-style services.

Phones are a luxury

For example, one Beijing representative for computer retailer Computer-Land is pleased when he can successfully complete four telephone calls in a day. The phone is not casually regarded as a communications tool in China. There, most people devote more than 50 percent of their income



LM Ericsson's Chinese contract for a 7,500-line digital-telephone exchange helped inspire other companies to do business in China.

to food and clothing, so the phone is a luxury. Beijing, with a population of more than 9 million, has only 250,000 phones, according to U.S. Embassy Commercial Service figures.

According to the Commercial Service, China wants to boost the number of telephones to at least 2.8 per 100 people by the year 2000, an eightfold increase. Comparatively, there were 70 phones per 100 people in the United States in 1975.

Indicative of China's push to modernize quickly, Sweden's telecommunications giant, LM Ericsson, last November secured an order for a 7,500-line digital-telephone exchange for use in several major Beijing hotels. In January, Ericsson set up a subsidiary to cover China.

In search of contracts like the one awarded Ericsson, Americans, Europeans and Southeast Asians are willing to forsake the comforts of home to do business in China.

Hoping endurance brings rewards

Many market analysts look on China as the world's largest untapped market for high-technology equipment. The country plans to spend more than \$14.2 billion over the next three years on foreign technology. The investment is primarily for modernizing industry and is expected to support 4,820 projects, according to the *China Daily*, an English-language newspaper in China. Another move China's government made to spur technological growth was to increase the buying power of local governments. They now can select technical upgrading projects requiring an investment of \$5 million, a fivefold hike in their allocation dollars.

Additionally, China has set up 14 so-called "Special Economic Zones" that offer better city infrastructures (water, housing and transportation) and tax breaks. It is in these zones that joint-venture manufacturing and assembly reside.

But companies rushing in to take advantage of the seemingly open opportunities in China might heed the advice of veteran China travelers, whose general recommendation is to abandon any preconceived notions about the country and expect the unexpected.

Most companies doing business in China caution against trying to make

CORPORATE AND FINANCIAL

money fast. "You can't come anywhere in the Far East to make a quick buck," says Jon Covington, international markets manager for Apple Computer Inc., Cupertino, Calif. "And you have to be willing to give as much as you get. You must make [a long-term] investment. It isn't just harvest time all the time." His advice to first-time business visitors to China is to be patient: "Don't expect to make a sale on the first trip. Don't even expect to know what you're doing."

Covington also advises China-bound travelers to get rid of certain preconceived notions, such as "putting a plug into the wall and expecting electricity." Amperage can fluctuate greatly at 220V, "if someone turns on a factory," he says. Reportedly, because China is still developing its power industry, electricity is sometimes rerouted from a plant to a convention site, for example, and fluctuations are common.

"Nothing is standard," seconds Pete Sillari, a representative in ComputerLand's Beijing office, which is setting

up a joint venture with the Chinese. He says the Chinese make things work but not necessarily in the way to which Westerners are accustomed. For example, he says, a wall socket for two plugs may have the lead wire on the right for one plug and on the left for the other.

Those expecting to set up manufacturing quickly must be aware that many factories in China are not equipped for high-volume production, explains Raymond S. Shimrak, director of international sales at Datamedia Corp., Pennsauken, N.J. "There's no climate control, power is intermittent, there's lots of dust, and there's no static electricity control."

Other business services spotty

Getting money can also be a problem. Even if a company is willing to wait overnight to place an overseas phone call, problems arise in having money wired to China. Shimrak says one reason many large companies locate in Hong Kong instead of in China is to avoid the problem of moving cash.

AS CHINA OPENS ITS DOORS TO HIGH TECHNOLOGY, JOINT-VENTURE PROPOSALS POUR IN

Partners	Activities
Charles River Data Systems Inc. and Tianjin Electronic Computer Factory	Charles River sold \$5 million in UNIX-compatible computers to Tianjin Electronic.
Cullinet Software Inc. and China Computer Technical Service Corp. of the Ministry of Electronics	China Computer acts as a marketing agent for Cullinet.
Georgia Institute of Technology and China Association for Science and Technology	Pair created a joint venture called C/Tech to assist China in purchasing technology-related factories, licenses and equipment, to expand technology transfer between the United States and China and to stage educational conferences.
Hewlett-Packard Co. and China Electronics Import & Export Corp. (CEIEC)	China-Hewlett-Packard Co. Ltd., will manufacture HP computers and instruments.
IBM China Inc. and Ministry of Machine Building Industry and Beijing Municipal Government	They will establish a data-services center and conduct customer-education classes.
IBM China Inc. and Ministry of Electronics	They will establish an assembly and test facility for IBM's 5550 Chinese personal computer.
IBM China Inc. and Ministry of Electronics	The Ministry is to develop software for IBM.
Wang Laboratories Inc. and Ministry of Electronics	Wang to get \$50 million to produce low-end VS computers and develop software and also help manufacture 50,000 office automation systems in Shanghai, develop Chinese language software and assemble 30,000 Professional microcomputers in Xiamen.
Prime Computer Inc., ComputerLand, and others either plan, are negotiating or have recently concluded deals with China.	

DISTRIBUTORS SOUGHT

Team-Up With Vectrix Now and Share Our Growth and Success in Graphics.

Customer acceptance and satisfaction resulting in greater than anticipated growth are prompting us to expand our family of international distributors.

If you're an established distributor with a strong graphics/electronics background and possess the technical resources to handle our expanding line of graphics products, then we want to talk with you.

To learn how you too can share in our growing graphics product sales, contact us *immediately*. Inquiries should be sent to Elizabeth Stotler-Ferrill, International Sales Administrator at Vectrix Corporation, 2606 Branchwood Drive, Greensboro, North Carolina 27408. Phone (919) 288-0520, Telex 574417

Vectrix International Distributors

Terry Gray, *Managing Director*
Microprocessor Applications
Pty., Ltd.

48 Rutland Road, Box Hill
Victoria 3128, Australia
Telex 31187

Cliff Cawood, *Director*
Systems Link Pty., Ltd.
216 South Wing
Benmore Gardens Complex
Benmore Road
Sandton 2010, Johannesburg
Republic of South Africa
Telephone 783-1177



CIRCLE NO. 33 ON INQUIRY CARD

MINI-MICRO SYSTEMS/March 1985

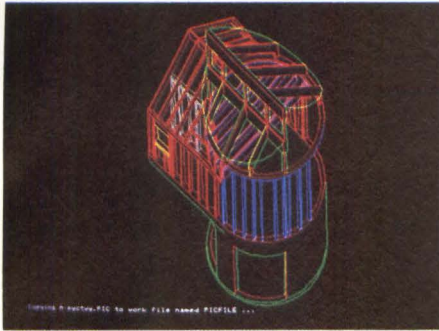

1. High Speed (MicroCAD Software)

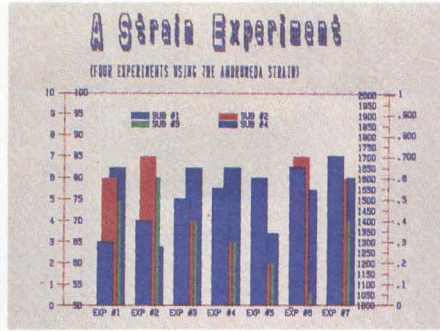

2. Dual Display Modes (Energraphics Software)

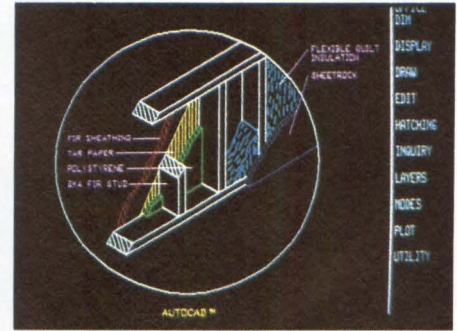

3. Simplified Processing (AutoCAD Software)

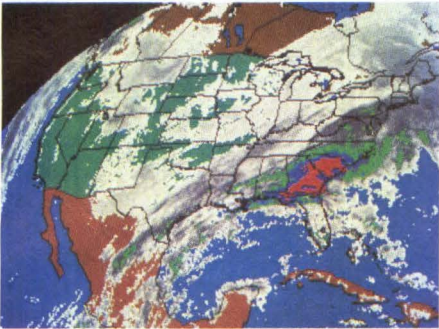

4. 9 Bit Planes (Courtesy WSI Inc., Bedford, MA)

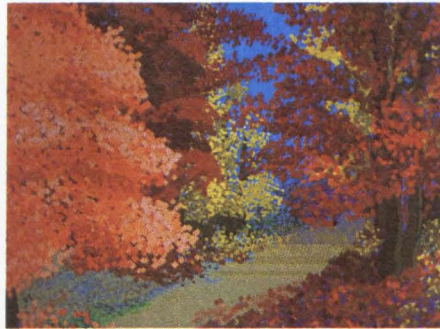

5. 16.8M Color Shades (Courtesy Catherine Del Tito, Wave Graphics)

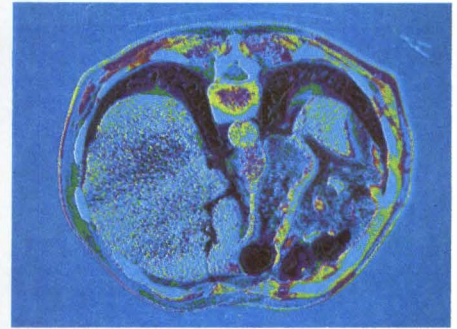

6. High Resolution (Courtesy University of North Carolina at Chapel Hill, Depts of Computer Science and Radiology)

Six reasons why professionals continue to choose Vectrix for quality IBM XT/PC graphics.

Even though IBM offers a color graphics card, professionals still choose Vectrix. It's not surprising. Especially once they've seen us in action. Professionals know that our VX/PC Board Set delivers the quality and performance they need for serious color graphics.

The VX/PC Board Set provides advanced features that help simplify sophisticated graphics design. Besides displaying 512 simultaneous colors from a palette of 16.8 million, the VX/PC supports an extensive library of on-board graphics macros for ease of programming and fast design, as well as full emulation of the IBM color card. And, an on-board 16-bit micro-

processor frees your computer to concentrate on other tasks.

But that's not all. Our 9 bit planes

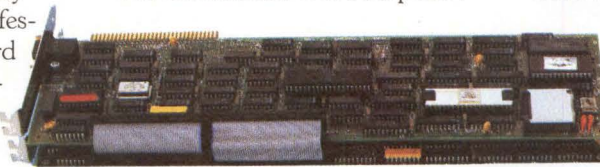

add an extra dimension of sharpness and clarity to your image that must really be seen to be appreciated. That's why it's not surprising to see Vectrix color cards in applications such as medical imaging, weather satellite data mapping, computer aided design and drafting, and graphics arts, to name a few.

What you will find most surprising, however, is the price. Our VX/PC Board Set was designed with the OEM in mind. So when comparing the performance of Vectrix with the competition, check the price too. You'll like what you see. For more information, contact Vectrix Corporation, 2606

Branchwood Drive, Greensboro, North Carolina 27408. Phone (919) 288-0520. Telex 574417.



Distributor inquiries welcome.

IBM XT, IBM AT, and IBM PC are trademarks of International Business Machines Corporation, White Plains, NY.
MicroCAD is a trademark of Imagimedia Technologies, Inc., San Francisco, CA.
AutoCAD is a trademark of AutoDesk, Inc., Sausalito, CA.
EnerGraphics is a trademark of Enertronics Research, Inc., St. Louis, MO.

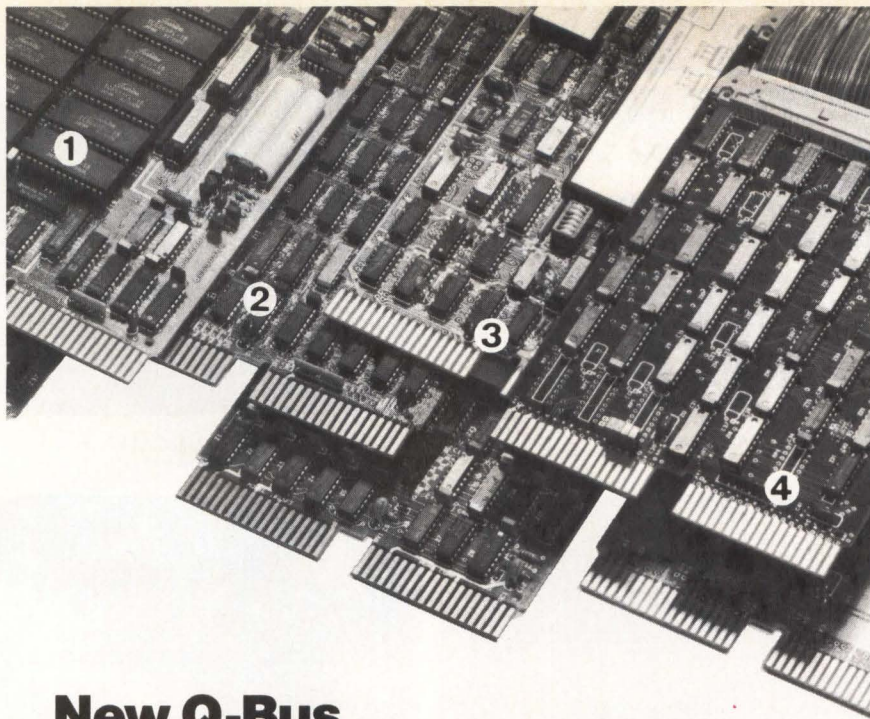

New Q-Bus function cards boost density and performance for memory, data acquisition and control.

These new ADAC Q-BUS compatible cards mean improved performance and lower systems cost for DEC users and systems builders.

1 MEMORY • Battery-backed CMOS RAM offers up to 128K bytes on a single half-quad module. ... PROM board available up to 512K bytes. ... Model 1822CMOS and 1822PROM are compatible with 16, 18, 22 bit addressing.

2 WIDE RANGE A/D • Allows any mix of high or low level signals on the same board with range selection under program control. ... Model 1114AD features sampling up to 200 samples/sec., a range of 10 mvolt to 10 volts full scale, thermocouple cold junction compensation, and 250 volt common mode protection.

3 SILO BUFFERED A/D SUB-SYSTEM • A new three board set provides sampling rates of up to 100,000 kHz. Software sustains this throughput continuously to disk. ... SILO buffer insures constant, and "jitter free," triggering of conversions with no gaps for buffer switch-

ing. ... The 1023S consists of a high level A/D converter with 64 word SILO buffer, coupled with two of ADAC's 1622DMA controllers, all Q-BUS compatible. RT-11 software drivers are also included.

4 Q-BUS REPEATER • Supports 22 bit addressing, 4 interrupt levels and Block-mode DMA. ... Plugs into any Q-BUS. ... Model 1953 repowers the bus signals in both directions for high performance expansion. ... Also supports any of ADAC's Q-BUS chassis.

ADAC offers the world's widest selection of Q-BUS function cards.



U.S.A. Headquarters: 70 Tower Office Park • Woburn, MA 01801
Tel. (617) 935-6668 • Tlx. 951802

U.K. Headquarters: P.O. Box 42, Epsom KT18 7SP • Surrey, England
Tel. 3727-42577 • Tlx. 918179

MINI-MICRO WORLD CORPORATE AND FINANCIAL

It can take up to two weeks to get money wired to China. Some experienced Westerners suspect that the money may come in but is intercepted, temporarily deposited for its interest and then passed on to its intended recipient.

Those who do choose to locate in China are assigned offices in hotels by the government. Prime Computer Inc., Natick, Mass., recently opened an office in Beijing's Jianguo Hotel. Prime Computer (Hong Kong) Ltd.'s managing director, Joseph R. Thompson, says it costs \$65,000 yearly to have "one room, a typewriter and a teapot" in the Jianguo. Since the hotel room is wired for either a private telex or telephone, Thompson says, Prime opted to use the hotel's telex and has its own telephone line. He says Prime had to pay the first six months' rent in advance, plus service and tax.

Larger operations can cost more than \$200,000 a year. John Y.B. Hood, business development specialist with Western Geophysical, Houston, a value-added dealer for IBM Corp. PCs, says it costs \$200,000 to \$250,000 annually to support a one-man staff in China, including office space and housing. Western Geophysical has offices in Beijing's new Great Wall Hotel.

But even at the Great Wall Hotel, long tours of duty can be trying. Cultural events are scarce, and work occupies most of the employee's time. "Hotels are the housing, food is from the hotel restaurant, and the laundry is the hotel laundry," says Hood.

However, it's getting more difficult to single out a business partner in China, some sources say. The established channels of importing and distributing products are becoming less and less clear. Until last fall, each ministry purchasing or selling products did so through the Ministry of Foreign Economic Relations and Trade (MOFERT), a state trading company, explains Dana I. Robinson, marketing manager for Prime's China Project. However, reforms in China last October decentralized the MOFERT, and now there are several "foreign trade corporations," and outsiders must discern which one or ones to contact. □

CIRCLE NO. 35 ON INQUIRY CARD

Multibus/VMEbus

PACKAGING THAT MAKES THE DIFFERENCE

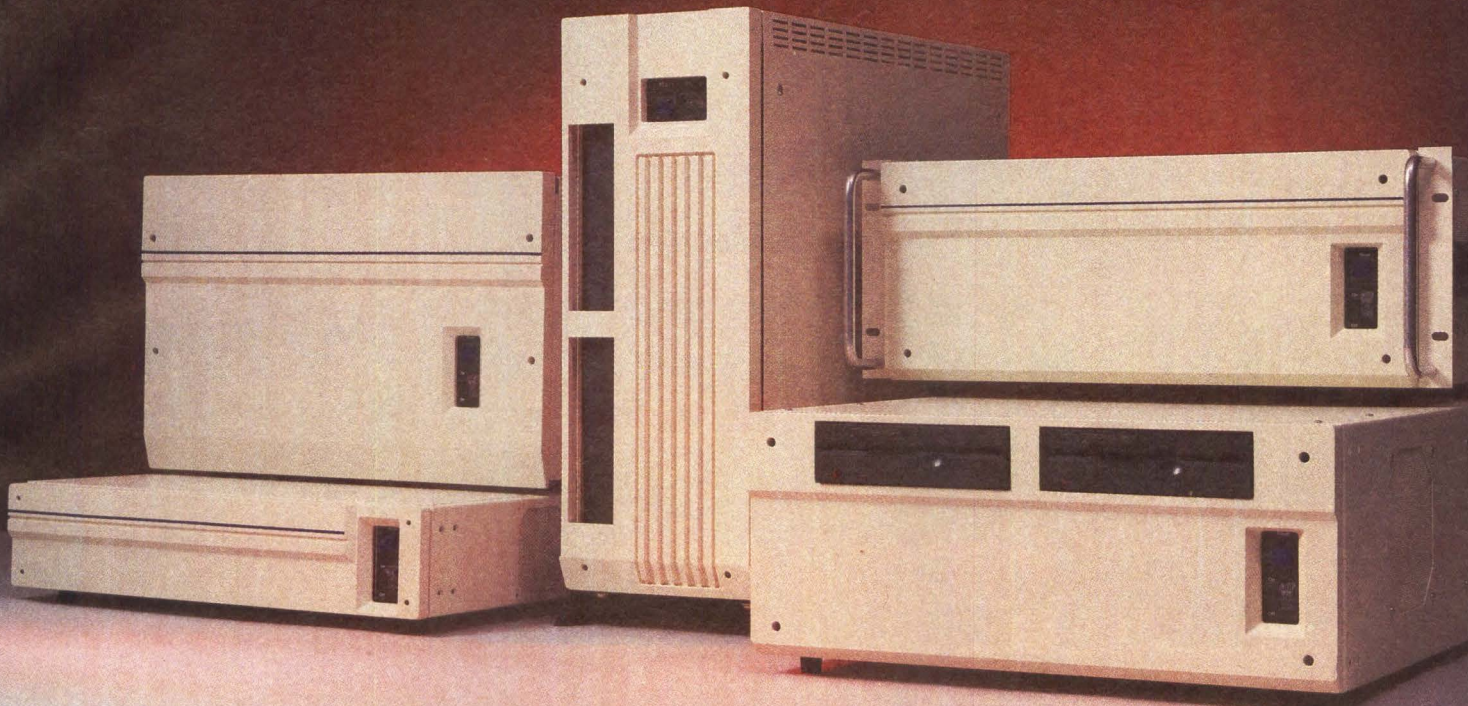

Now there's a complete, integrated line of Multibus™ and VMEbus system enclosures that lets you match your system needs today — with the flexibility to expand or reduce your requirements in the future.

For Multibus, choose from visually-compatible 4, 7, 10, 12, and 15-slot enclosures with Multi-Cage® card cages and backplanes, all designed to meet FCC class A EMI/RFI requirements with typical systems installed. The 7-slot upright DeskMate™ and the 7-slot tabletop models have room for two half-height 5¼" peripherals, plus an additional 5¼" full height Winchester drive. All but the DeskMate are available for rack mounting.

For VMEbus, there are 5, 7 and 12-slot models, with peripherals available on the DeskMate, rack mount and tabletop 5-slot versions. All use Electronic Solutions' VMEasy™ card cage and backplane design for rugged, reliable card mounting and easy servicing. If you're into Multibus now, you can even convert your enclosures later for VME.

Talk to us about your unique requirements. Build upon the industry's most comprehensive system of

Multibus and VMEbus enclosures, and reduce your lead time to market. We'll provide front or rear card loading, or special slot spacing, special power supplies, or I/O connections. See how our custom design gives you an entire enclosure line instead of a single box.

Call us today, and find out how Electronic Solutions can make the difference in *your* system packaging.

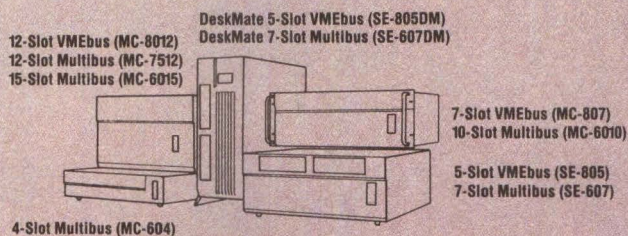

 **Electronic
Solutions**

9255 Chesapeake Drive, San Diego, CA 92123 • (619) 292-0242 Telex II (TWX): 910-335-1169

Call Toll Free: (800) 854-7086 In Calif: (800) 772-7086

CIRCLE NO. 36 ON INQUIRY CARD



MOTOROLA

VME130 MC68020

VME128 MC68010

VME117 MC68010

VME120/121 MC68010

VME115M MC68010

VME110-1 MC68000

VME101 MC68000

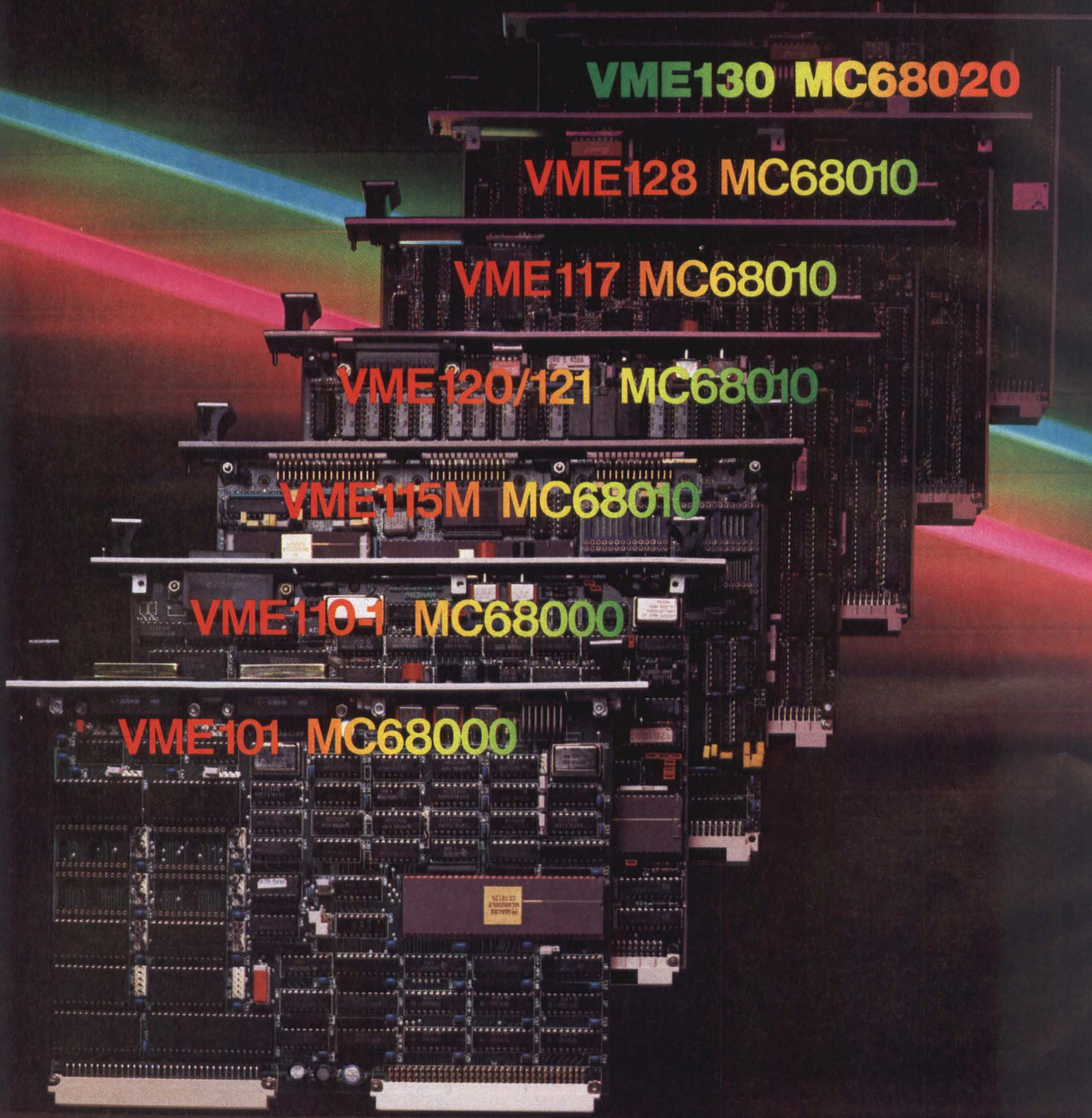

Leadership runs in the Family.

Motorola's VMEmodules™ provide the M68000 Family for your OEM/VAR applications.

Eliminate the confusion in choosing your microcomputer architecture. Your design-in decision is assured with VMEbus processor and memory modules centered around M68000 Family MPUs.

VMEbus has arrived as the most widely accepted 8/16/32-bit micro-computer architecture in the world. With mechanical standards rooted in Europe, VMEbus has had world-wide impact in applications that require high reliability, speed, large bandwidth processing capabilities, high throughput, security and redundancy.

Being years ahead of all our competitors can get you to market well before your competitors.

Strong tested standards for your success.

Experience in industrial automation, image processing, engineering work stations and digital network communications has set a standard of performance matched by none. VMEbus standardization projects are near completion in North America by the IEEE and the IEC for the international community.

Over its short, three-year history, VMEbus has shown its flexibility, versatility and assured compatibility, all within an open architecture free of trademark, copyright or patent restraints, allowing an open and free exchange of technical innovation among 120 vendors worldwide.

Since the beginning, Motorola has remained in the lead position in VMEbus board development. A result of a conscientious and continuous use of standards. VMEbus. SYSTEM V/68™ UNIX™ operating system port. The M68000 Family of microprocessors.

Even with VMEbus specifications offering the ability to use other processors, designers overwhelmingly choose the high-performance standard M68000 Family for the processors in their VMEbus systems. Capped now by the only true and complete 32-bit processing power of the MC68020, you're assured thoroughbred performance with a Motorola M68000 Family and

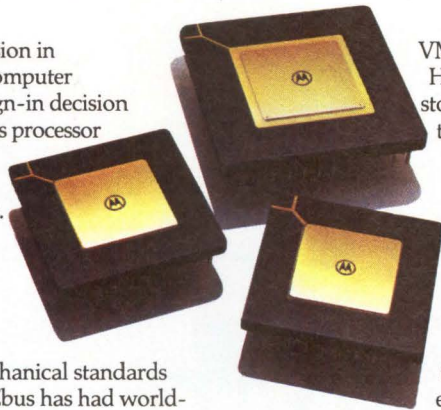

VMEbus decision. Hardware is only half the story. The operating systems are ready. Choose an AT&T-validated SYSTEM V/68 for the richness and versatility of a UNIX operating system or Motorola's own VERSAdos™ operating to control multiple tasks in real time on each and every board.

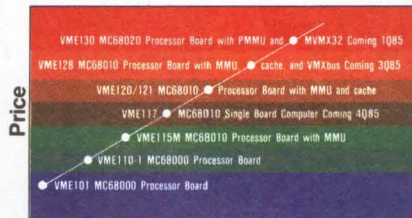

Performance

A complete selection assures your integration

With a broad line of over 50 VME-modules and accessories, Motorola offers the best selection of high-performance VMEbus-compatible products.

Start with processor modules and system controllers. Add memory modules and an extensive list of peripheral controllers. Motorola's exclusive I/O Channel allows even greater flexibility by providing modular I/O expansion on a local processor bus.

Industrial I/O, non-Eurocard I/O and mass storage support products complete the module offerings.

Combine these with the chassis, hardware and extenders. Now you have the complete VMEbus system saving you time and money.

Serious support gives you safety.

Motorola supports and is supported by the VMEbus International Trade Association, which continually promotes the world compatibility of VMEbus products. With 120 vendors supplying over 600 VMEbus-based products, you're in good company for the long term.

Motorola provides comprehensive support for VMEsystem hardware and software. Our complete package of support includes detailed user documentation, technical training seminars, regular updates and a direct, 800 line for design-in assistance.

One-on-one design-in help.

In person or on the phone, anywhere in the US or Canada, now you can get an engineer-to-engineer update on all the latest VMEsystem products for your unique system designs.

1-800-521-6274

Call toll-free any weekday, 9 a.m.-5 p.m. your time. If the phone call can't cover your needs, we'll have a local field application engineer drop by. And get you to market. Faster.

For more information on VMEsystem products fill out the coupon and send it to Motorola Semiconductor Products, Inc., P.O. Box 20912, Phoenix, AZ 85036.

We're
on your
design-in
team.



MOTOROLA

VMEmodule, SYSTEM V/68 and VERSAdos are trademarks of Motorola Inc. UNIX is a trademark of AT&T Bell Laboratories.

TO: Motorola Semiconductor Products, Inc. P.O. Box 20912, Phoenix, AZ 85036
Please send more information on VMEsystem products. 228MMS030085

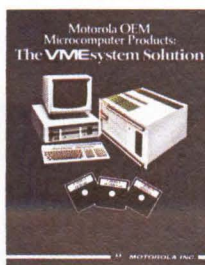

Name _____
 Title _____
 Company _____
 Address _____
 City _____ State _____ Zip _____
 Call Me () _____

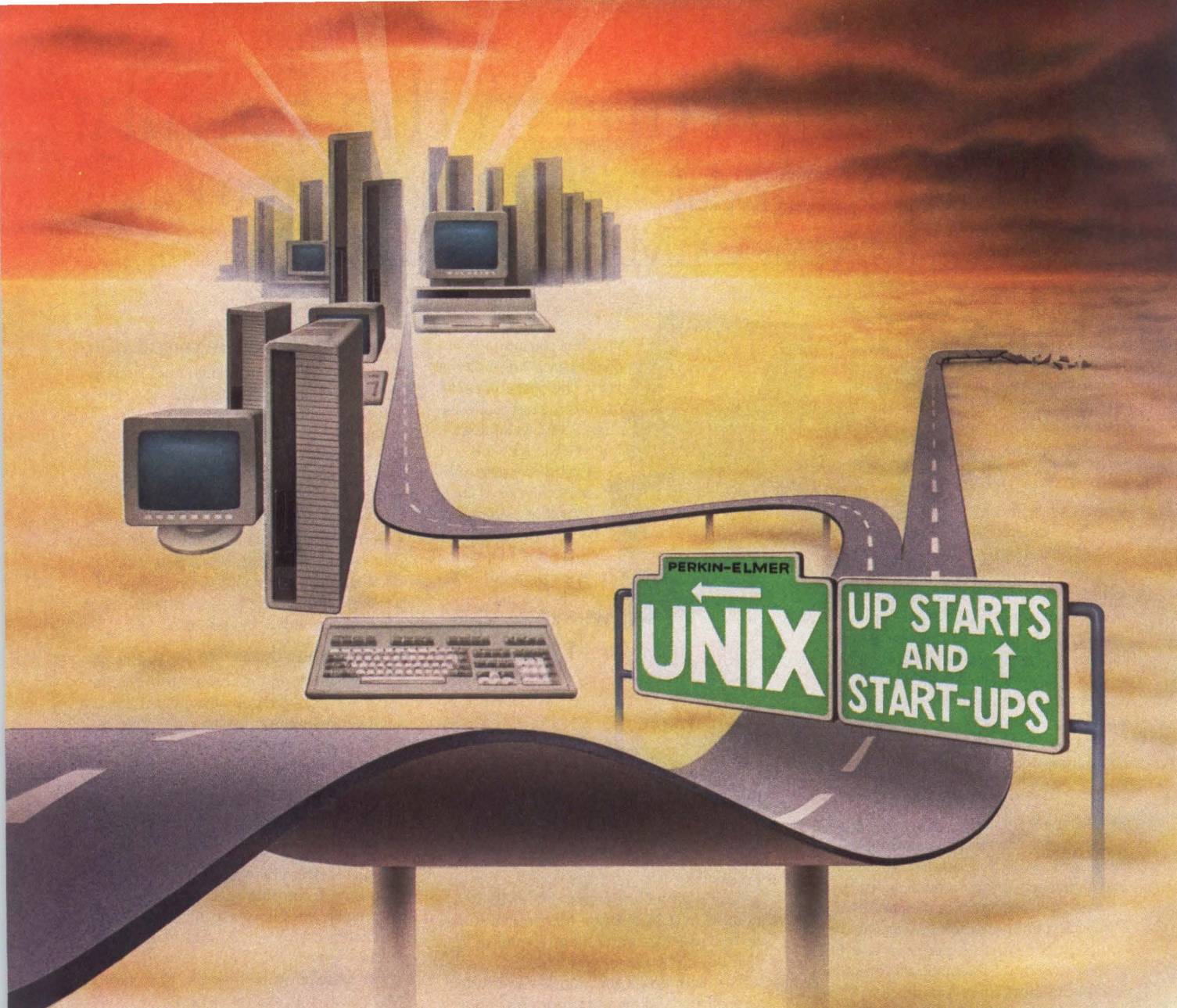

Get on the fast track.

For low cost UNIX* applications turn to Perkin-Elmer's 7350A supermicro.

Perkin-Elmer gives you a head start in the growing world of UNIX system computing with the fastest supermicro in its class.** And we can keep you ahead because we're a Fortune 300 company with nearly a decade of experience with the UNIX operating system.

Move forward confidently with a fully supported, cost-effective solution; up to five users can share a single system. For the long haul, go the distance with the broadest range of compatible superminicomputers available today.

Why risk your future with start-ups or upstarts? Let Perkin-Elmer help put you on the path to success.

**Choose the fast track:
call 1-800-631-2154.**

Or write to the Perkin-Elmer Corporation, Two Crescent Place, Oceanport, N.J. 07757. In N.J. call (201) 870-4712.

*UniPlus, UNIX, RM-COBOL and SIBOL are trademarks of UniSoft, AT&T Bell Laboratories, Ryan-McFarland and Software Ireland, respectively.

**In nine UNIX benchmark tests, the 7350A outperformed the published results of similar supermicrocomputers in its price range, while comparing favorably with many other larger and more costly systems. Prices and specifications subject to change without notice.

SPECIFICATIONS & OPTIONS

- 8MHz MC68000
- 512KB to 3MB RAM
- Floppy Disk
- 15MB or 40MB Winchester
- 12" or 15" Monochrome; 13" Color Graphics Monitors
- 4 x RS-232C ports (Ethernet optional)
- UniPlus* port of UNIX System III
- MenuMaker/C Shell//AT&T Shell
- Word Processing, Spreadsheet, Relational DBMS, Graphics Libraries
- C, FORTRAN, BASIC-PLUS, RM-COBOL* SIBOL*
- System prices start at \$5,115 (quantity 100, U.S. only)

PERKIN-ELMER

CIRCLE NO. 37 ON INQUIRY CARD

MINI-MICRO WORLD

INTERNATIONAL

Taiwanese court gives light fine to Apple counterfeiters

Charles Hintermeister
Taiwan Correspondent

Taiwan's high court has upheld the 1983 criminal convictions of officials of six Taiwanese computer companies charged with counterfeiting the Auto-start and Applesoft Basic programs in the Apple Computer Inc. Apple II personal computer.

Taiwan is well known as a center of computer counterfeiters, and the Taiwanese press hailed the convictions as evidence of the government's determination to stamp it out. But the sentences were mere slaps on the wrist. The counterfeiters got six-month jail sentences they won't even serve. Instead, they took the option, standard in Taiwan for jail sentences of less than eight months, of paying a small fine. In this case the fine amounted to 22 cents for each of the 180 days of jail time they were sentenced to serve.

The sentences were announced shortly after another, earlier, computer counterfeiting appeals trial ended in eight- and nine-month jail terms for the owners of Sunrise Computer Co. and Guan Huar Industrial Co. Because both of these firms, which were among the first to mass-produce counterfeit Apples in Taiwan, have reportedly paid substantial damages to Apple, the jail terms were commuted to three years' probation for each of the convicted officials.

The reason for the stiffer original sentences in the Sunrise and Guan Huar cases, says a Taiwanese lawyer, is that the two firms were found guilty

not only of counterfeiting software but also of violating trademark law when they distributed exact copies of the Apple II user's manual with their machines.

Counterfeiting still widespread

High-ranking Taiwanese government officials continue to talk about cracking down on commercial counterfeiting, and there's an extensive campaign to educate the public about the evils of counterfeiting. But the problem remains widespread. Taiwan's judicial system is still learning the basics of how to deal with problems of intellectual and industrial property rights.

Few of the convicted officials deny that they were manufacturing so-called "Apple-compatible" systems, but they all claimed, with some justification, that they were not guilty of breaking any Taiwanese law.

Until recently, there was no specific provision in Taiwan's copyright law to protect software. The law mentioned only literary works, music scores, graphic works and recordings as eligible for copyright protection. To help guide the court system, Taiwan's Ministry of the Interior last year devised an interpretation of the copyright law that makes software classifiable as a literary work, and therefore eligible for copyright protection. Lawyers defending the accused counterfeiters argued that, because there was no specific law against counterfeiting software at the time the charges were brought, there could be no convictions.

Defense lawyers also brought up a



Illegal copies of software priced at about \$5 each are displayed over some counterfeit computers in a Taiwanese retail store. Photo: Asia On-Line/Hintermeister.

number of technicalities which they say should have gotten the case thrown out of court. Among them is the fact that, at the time the charges were brought, Apple had not yet registered its copyright with the Taiwanese government and, said defense attorneys, had no legal standing to bring a lawsuit in Taiwan. Prosecuting attorneys countered that, registered or not, Apple had the right to bring suit under the provisions of a 1948 Friendship and Commerce Treaty between the United States and the Republic of China. The treaty, said prosecuting attorney Ted Yang, entitles companies in the two nations to take legal action against each other in the courts of either nation.

Software as literary work

Prosecuting attorneys, in claiming that software is classifiable as a literary work, referred to the Ministry of the Interior's interpretation. They also



There are
4,000
 resellers ready to bring your
 product to the marketplace.

**AND INTERNATIONAL DATA CORPORATION
 CAN HELP YOU REACH THEM.**

Let's face it. If you're not one of the microcomputer industry's "top three vendors", chances are you've had trouble moving your product through the retail channel and into the hands of end users. **Is there a better way?**

International Data Corporation thinks so. Through our MicroFocus '85 continuous information service, we can help you compete...

- by providing tactical information on alternative channels of distribution, like the Value Added Reseller (VAR).
- by examining user buying patterns and assessing end user needs in vertical markets and Corporate America.

In fact, MicroFocus '85 will help you take advantage of the Value Added Reseller as a means of reaching the largest number of potential end users with your product. How? By providing...

- information on how VARs do business so you can successfully compete for the leading resellers.
- quarterly tracking of product flow through the VAR Channel to keep you on top of buying trends.
- competitive analysis of the VAR programs of micro vendors to help you impact the market with your own program.

International Data Corporation has helped hundreds of vendors, like yourself, plan and execute successful marketing strategies. We know what works.

Call Evan Moltz, at 617-872-8200 x 220 today to discuss how MicroFocus '85 can help your company THRIVE IN 1985.



5 Speen Street, Framingham, MA 01701 / (617) 872-8200 / Telex 95-1168

**See us in March at SOFTCON, Booth 2150
 and pick up your "Keys to Success Kit."**

CIRCLE NO. 38 ON INQUIRY CARD

MINI-MICRO WORLD INTERNATIONAL

pointed out that in the United States, software may be classified as a literary work and therefore be eligible for copyright protection.

Appeal to be sought

In spite of the light sentences handed down, several of the convicted officials hope to have a second appeal heard in court. "I haven't broken any law," said Tom Kou, general manager of Pison Science Technique Co., "and I don't want to have a criminal conviction on my record."

As more complicated computer-related cases reach the courts, lawyers and judges often find themselves struggling with technical terms and concepts unfamiliar to them. Paul Hsu, a senior partner in the law firm of Lee and Li, which represented Apple in the case, says the government may establish a court with specially trained judges to hear cases involving high-technology issues.

If it does not take vigorous steps to eradicate commercial counterfeiting, Taiwan may lose its valuable most-favored-nation privileges in the U.S. tariff laws, under which a wide range of Taiwanese-made products are given preferential tax treatment by the United States. Taiwan's huge trade surplus with the United States, estimated at \$10 billion for 1984, is cited by U.S. legislators as the reason for trying to halt counterfeiting in Taiwan of U.S. products. According to one of the defense lawyers, the convictions were brought about more by fear of lost trade privileges than by the merits of the prosecution's case.

Other goods counterfeited

Counterfeit computer products represent a minor part of the counterfeit products that originate in Taiwan. Name-brand textiles are the most frequently counterfeited products in Taiwan, followed by watches, cosmetics and auto parts, according to Taiwan's Board of Foreign Trade.

A revision to Taiwan's copyright law that would create an independent category for software has been given preliminary approval by the country's legislature and is expected to go into

MINI-MICRO WORLD
INTERNATIONAL

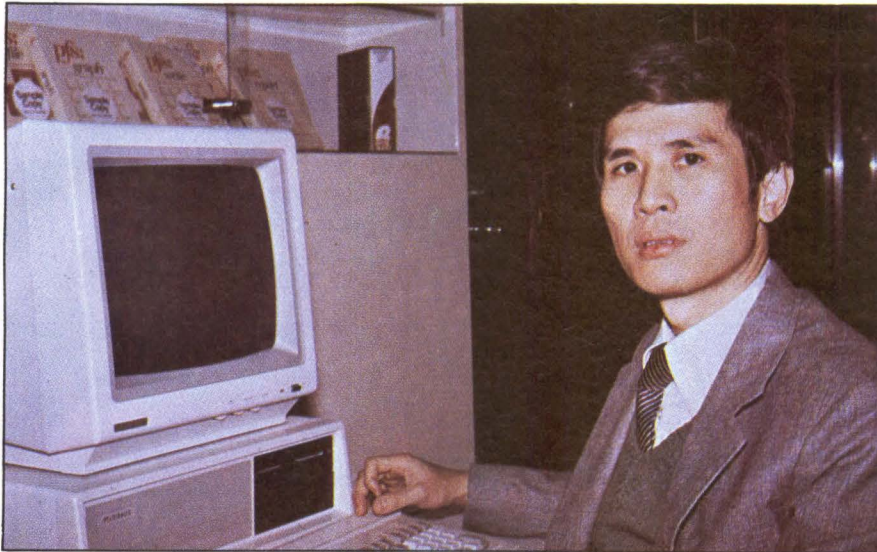

Andrew Chen, manager of Taiwanese software distributor Multisoft, says only Taiwan's more reputable companies can be expected to obey copyright laws. Photo: Asia On-Line/Hintermeister.

effect by June. "Calling software a 'literary work' cannot be a long-term solution," says Andrew Chen, manager of Multisoft, Taiwan's first software bank. Literary works differ from software programs in a number of respects, he points out. "There is no time limit for copyright protection for books," he notes, "but this would not be suitable for software, which usually has a product life of only a few years."

"This will be the most advanced software protection law in the world," boasts Victor Cheng, a lawyer with Multitech Industrial Corp. who is part of the committee now formulating the revision. In its present form, however, the proposed revision leaves much room for uncertainty. "The chief problem," Cheng says, "is that, in its present state, the revision does not clearly define what software is."

A more serious problem, however, is that the new law may not be any more effective than the present one. In the view of Multisoft's Chen, only Taiwan's more reputable companies can reasonably be expected to obey the law. Multisoft, the island's first distributor of fully documented, legal English- and Chinese-language software, has run afoul of counterfeiters, admits Chen. Few Taiwanese computer users

are willing to pay full price for software when they can just as easily purchase pirated versions for little more than the cost of the disk onto which they are copied. Counterfeit versions of the WordStar word-processing program from MicroPro International Corp., San Rafael, Calif., for example, are openly available at many local computer and book stores for about \$5, a fraction of the price in the United States.

Copyright must be registered

One of the chief reasons why Taiwanese police don't arrest the managers of such establishments and confiscate the counterfeit goods, Chen says, is that the original copyright holders never registered with the Ministry of the Interior. He suggests that foreign software firms hoping to market their programs in Taiwan first register their copyrights and then appoint a local agent who will be able to prosecute counterfeiters.

But failure to register is not the only reason that computer counterfeiting goes on in Taiwan. Apple has now registered its copyrights in Taiwan, but counterfeit Apple II computers are still readily available on the local market. "It is very hard to catch computer and

UNITRONIX
distributes
DIGITAL
computers

As a member of Digital Equipment Corporation's network of independent computer distributors, Unitronix can define your needs and help you choose the right Digital computer system for your company. Best of all, Unitronix provides fast delivery of your Digital computer from our multi-million dollar inventory.

Powerful systems using these CPUs . . . tailored to your needs

- Micro 11
- MICROVAX I
- PDP-11/23+
- VAX 11/725
- PDP-11/24
- VAX 11/730
- PDP-11/44
- VAX 11/750
- PDP-11/73
- VAX 11/782

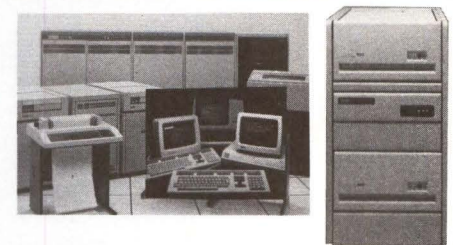
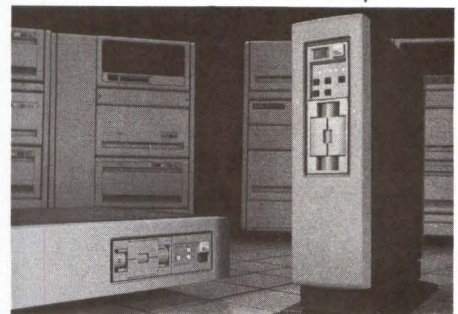

COMPLETE DATA SYSTEMS
with Unitronix-developed
standard, customized and
custom applications software

CALL TODAY . . .
FOR LATEST PRICING, DELIVERY
. . . AND LEASE OR RENTAL INFO
(201) 231-9400

UNITRONIX
CORPORATION

AUTHORIZED
digital
COMPUTER DISTRIBUTOR

50 County Line Road
Somerville, NJ 08876
(201) 231-9400 ■ TELEX: 833184

CIRCLE NO. 39 ON INQUIRY CARD

INTERNATIONAL

software counterfeiters and to make the charges stick," says Cheng. He does not believe the government can enforce the revision when it becomes law, despite his enthusiasm for its language.

Most of Taiwan's Apple II counterfeiters have either upgraded to "IBM-compatible" systems or have gone out of business. According to Cheng, there

are far fewer counterfeit Apples being made in Taiwan today than there were two years ago.

The reason for this change has more to do with market trends and internal competition than with the legal maneuverings of any of those involved. Few of Taiwan's large computer companies make "Apple-compatible" systems, and those that do generally don't dare

export them. The majority of the counterfeit Apples still available on the local market are used in small, garage-type factories and are notoriously unreliable. Taiwanese manufacturers still export significant numbers of counterfeit Apple IIs to places where they believe there will be no customs seizures or other legal difficulties—Hong Kong, the Middle East and Africa. □

OVERHEARD OVERSEAS

Europeans adopt alternative OS as IBM becomes proprietary

Denise Danks

European Correspondent

Concurrent DOS is achieving more success among OEMs and users in Europe than in the United States as a multitasking, single-user and multi-user operating system for IBM Corp.'s PC. European users say the United States has not entirely rejected the system from Digital Research Inc. (DRI) of Pacific Grove, Calif. But they claim Europe has been more forward-thinking than the United States in preparing for a future alongside IBM.

And what is that future? It is one in which the Europeans see IBM increasingly developing its own software, including operating systems and programs such as the TopView windowing software. Concurrent DOS could be established in the marketplace as the compatible, high-performance alternative to TopView running under IBM operating systems in computers configured around the Intel Corp. 80286 processor.

DRI has issued some 100 licenses for Concurrent DOS worldwide. Major European manufacturers have signed for and, more importantly, brought to market 30 to 35 of those licenses. The manufacturers offer Concurrent DOS in addition to MS-DOS from Microsoft Corp., Bellevue, Wash. Those manufacturers include the Ericsson Information Systems division of L.M. Ericsson AB,

Ferranti Computer Systems Ltd., Olivetti SpA, Siemens AG, Applied Computer Techniques Plc. (ACT), ICL Plc. and British Telecom Merlin Ltd.

One of the Concurrent DOS enthusiasts among European manufacturers is Martin Healey, research director of Future Technology Systems Ltd., Beith, Scotland, which includes the British subsidiary of Honeywell Information Systems, a Concurrent DOS licensee, among its major OEM customers.

"Concurrent DOS will be the only vehicle for vendors like Honeywell to stay alongside IBM on the multitasking route," Healey declares. "After all, where will the likes of Honeywell go to get an alternative multitasking operating system which will run PC-DOS and TopView programs? Honeywell will have to find a source and Concurrent DOS will be the well-established alternative."

Healey thinks that the United States is at least six months behind Europe in its appreciation of the power and potential of Concurrent DOS. He also thinks that the multitasking of Concurrent DOS makes it more suitable for networking than MS-DOS and PC-DOS.

ACT manager John Upton agrees with Healey that Europe is ahead of the United States with Concurrent DOS. He says that U.S. users think exclusively of the IBM PC and Apple Computer Inc.'s Macintosh. Paul Bailey, DRI's European vice president,

also concurs that, "In the United States, the market rapidly polarized into Apple and IBM camps and there was a scramble to make IBM PC clones. Those PC-compatible manufacturers now find themselves [in] difficulties," because of the fierce competition and the existence of too many look-alikes.

Bailey says the market in Europe is more independent, focusing more on performance and innovation than on a pure standard. "There is very little standardization in Europe. In fact, they seem to make it a religion not to [standardize] and this has often made life difficult for them. They see Concurrent DOS as a high-performance system which will differentiate their products from IBM and its compatibles."

But Bailey adds that European companies realize they have to provide compatibility with IBM to satisfy the U.S. customer base. He says: "We developed DOS emulation under Concurrent CP/M and renamed it Concurrent DOS in April 1984. It has made a difference in the United States but not a dramatic one in terms of [competing with] PC-DOS and MS-DOS. But IBM has stepped ahead of the U.S. clone market with TopView and, given that TopView provides the [multitasking] facilities of Concurrent DOS but will not be sold to other computer manufacturers, we believe that Concurrent DOS now provides the only viable environment to compete with IBM."

250 Reasons Why You're Probably Using the Wrong Products to Clean Your Computer

Unfortunately, most people use the wrong products to clean their CRT terminals, microcomputers, printers, tape transports and other data processing and office equipment. If you're one of these people you stand an excellent chance of damaging costly precision components and equipment.

The new TEXWIPE Computer Cleaning Products

Catalog features over 250 products, each engineered to fulfill a specific preventive maintenance function. **The right way. The TEXWIPE way.**

Take advantage of Texwipe's 20 years of experience as the leader in the design and manufacture of precision cleaning products. Send for your **FREE** 52-page catalog today.

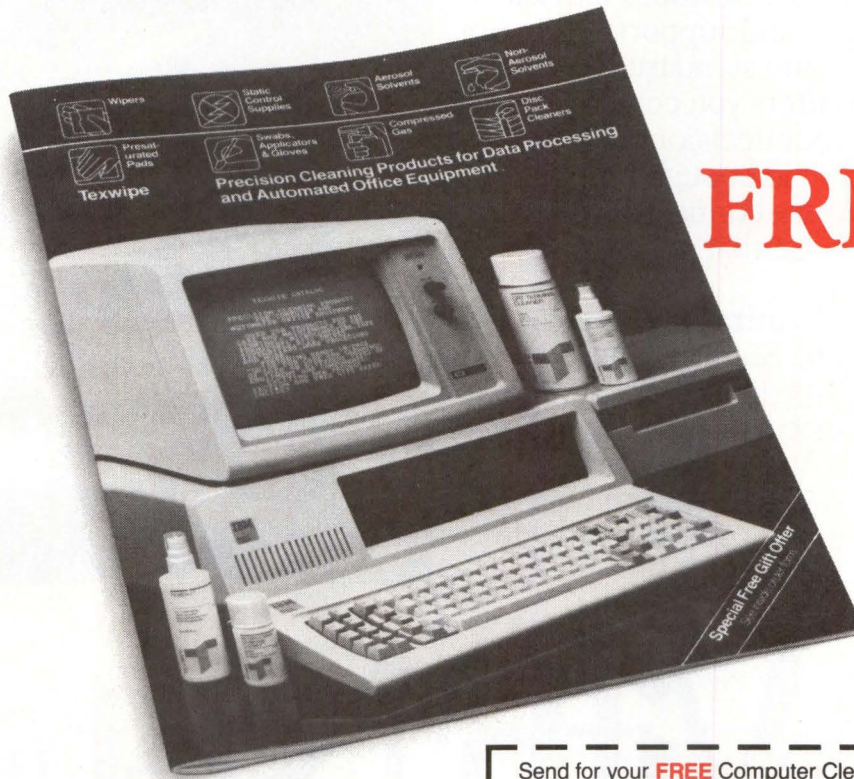

FREE!

TEXWIPE

650 East Crescent Avenue • P.O. Box 308
Upper Saddle River, NJ 07458
Sales/Service (201) 327-5577
Executive Office (201) 327-9100 • Telex 130370

Send for your **FREE** Computer Cleaning Products Catalog

NAME _____ TITLE _____

COMPANY _____

ADDRESS _____ P.O. BOX _____

CITY _____ STATE _____ ZIP _____

TEL.# (_____) _____



TEXWIPE

650 East Crescent Avenue • P.O. Box 308
Upper Saddle River, NJ 07458
Sales/Service (201) 327-5577
Executive Office (201) 327-9100 • Telex 130370

MMS 3/85

202

We are the only people in the business who can, in fact, do it all for you. Regardless of what your networking requirements are. Regardless of which combination of networking media you go with. Regardless of the kind of equipment you're hooking up now or in the future. And regardless of how many sites, how many hundreds or thousands of nodes are involved.

**NO MATTER WHERE YOU ARE
IN THE PROCESS RIGHT NOW,
WE CAN HELP.**

Whether you're looking at blueprints, steel framing, or buildings full of data processing equipment, we can help you take an objective look at the whole range of local area networking options. Since Net/One® is vendor-independent and supports all major LAN technologies and standards, it's the one network that offers you complete independence in your decisions. And it's the one network broad enough in scope to handle virtually every connection in your plans, as well as those that aren't in your plans yet.

From PCs to mainframes. Async, Bisync, SNA or X.25. Standard industry I/O interfaces or intelligent network adaptors for high performance use with the major bus architectures. Any of the growing list of standards in physical media and network access techniques. It's all available from us.

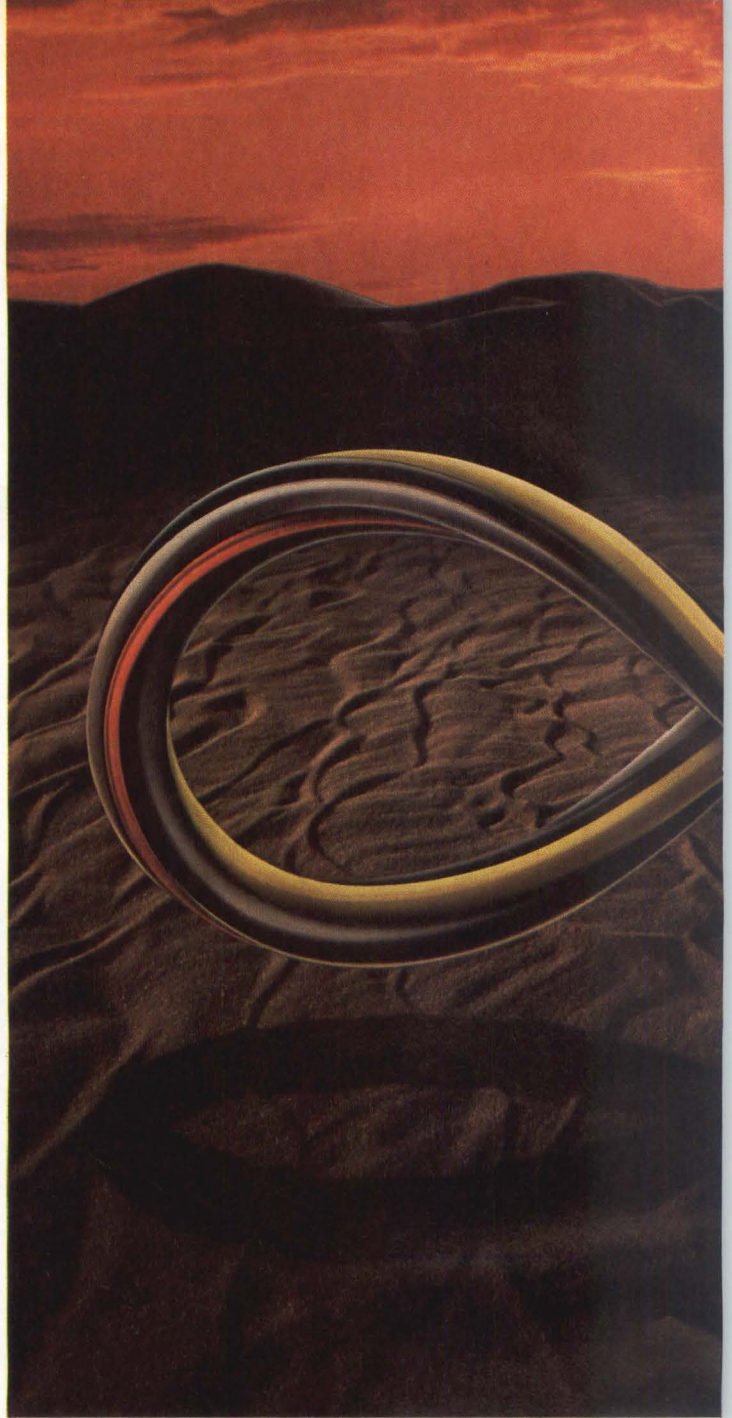

With Net/One possibilities



WITH NET/ONE, THE INFINITE IS NOT ONLY POSSIBLE, BUT MANAGEABLE.

Net/One's powerful enhanced Network Management services let you control, monitor, diagnose and reconfigure any node on the network. If your LAN installation is extensive, this capability will be one of your first considerations.

Another need we're in a unique position to fill is the management of your LAN project, from start to finish. Beginning with initial planning and design meetings, through supervision of phased installation, testing and certification, and training of your personnel.

With Net/One, you get not only the equipment to bring it all together; you get the dedicated intelligence and judgment of Ungermann-Bass Project Management to make it all work.

To keep it all working, you get the continuing support available from our experienced field service personnel, locally and regionally, as well as from our Santa Clara headquarters.

If you're exploring LAN possibilities, these are only a few of the reasons to include us in the loop. Give us a call, and let's talk about some of the others.

Ungermann-Bass, Inc., 2560 Mission College Blvd., Santa Clara, CA 95050, (408) 496-0111.

Net/One from Ungermann-Bass 

e, your LAN
are infinite.

3 OUT OF 5 SUPERMICRO OEM RELATIONSHIPS WILL END IN TRAGEDY.



We've seen it happen again and again.

An OEM commits to a UNIX supermicro supplier on the strength of big promises and low prices. Months are spent developing or porting software. For a while, everything seems OK.

Then comes the day when your best customer tries to add a couple more terminals, and the whole system bogs down to a snail's pace.

That's when it's time to call Plexus.

Because for just a bit more than a "vanilla" 68000-in-a-black-box-running-UNIX, you can get a 32-bit Plexus multiprocessor system and enjoy

dramatically improved responsiveness — with the ability to expand all the way to 40 users (even more, with our networking option).

With separate 16-bit processors to handle terminal and disk I/O, Plexus systems run rings around the single-CPU competition (we've got benchmarks to prove it). And with years of in-the-field experience (and a complete service network), we give you uptime to match our high performance.

So if your supermicro application involves 5 or more users, better call Plexus.



PLEXIUS

Supermicros built for speed.

Anything less is inviting tragedy.

Plexus Computers Inc., 3833 North First Street, San Jose, CA 95134 (800) 556-1234 Ext. 560 (in Calif. (800) 441-2345 Ext. 560)

©1984. UNIX is a trademark of AT&T Bell Laboratories.

CIRCLE NO. 42 ON INQUIRY CARD

INTERPRETER

An analysis of news, issues and trends affecting the computer industry

VENDORS VEER TOWARD VARS, VERTICAL MARKETS

Stiff competition turns many computer-equipment vendors away from retail and direct sales to value-added resellers (VARs) and lucrative vertical markets

David Simpson, Senior Associate Editor

Bumped from retail shelves or forced out of direct sales, hardware and software vendors are jumping into the value-added reseller (VAR) distribution channel with unprecedented vigor. Reasons for the shift range from mediocre retail sales at the low end of the market to the impracticalities of direct sales at the high end. But the vendors have a common goal: survival.

Companies like Apple Computer Inc., Compaq Computer Corp. and IBM Corp. rule the retail arena, but even they are making substantial forays into the VAR channel. Facing more difficult times, manufacturers such as Eagle Computer Inc. and Victor Technologies Inc. have one foot in the VAR channel and one foot in Chapter 11.

In 1984, the sale of microcomputers (single-user and multiuser systems for up to 16 users) through VARs reached approximately \$4.3 billion, according to International Data Corp. (IDC), Framingham, Mass. The research company expects this figure to approach \$14 billion by 1989. Explains IDC's manager of micro-services, Evan Moltz: "The reason for the success of the VAR channel is that it offers a solution that cannot be obtained through the horizontal marketplace."

Erna Arnesen, senior analyst at Future Computing Inc., Dallas, concurs with Moltz and adds that VARs account for 18 percent of all personal computer sales and about 7 percent of productivity software sales. Future Computing pegs the number of personal computer VARs at 4,000, with 5,500 expected by 1987. This compares to

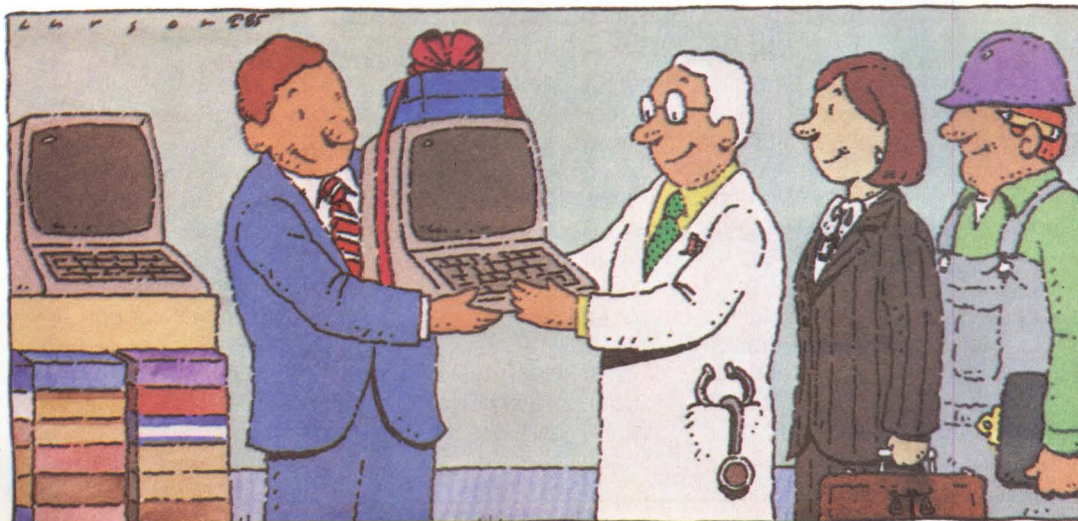
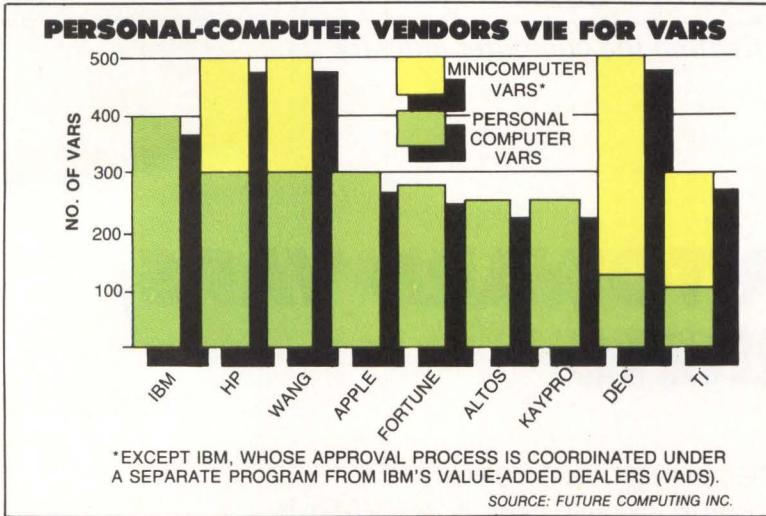

Illustration by Jim Carson

Value-added resellers (VARs) often target vertical markets, providing complete solutions for specific applications.



only 1,100 VARs in 1981.

The shift to the VAR channel has been well-documented in the trade press, but one question is still not fully answered: "What does it all mean to the VAR?"

VARs defined

According to Future Computing's definition, a personal computer VAR must meet five criteria: (1) Value must be added to the personal computer, (2) significant effort must be devoted to personal computer-related activity (i.e., at least one person in the company dedicated to the area), (3) a portion of sales must be made directly to an end-user client base, (4) the company can't have a retail storefront and (5) the company must sell some personal-computer product. These guidelines differentiate a VAR from a manufacturer, retailer, distributor or publisher (see "Acronyms clog the distribution

channels," below).

Equipment vendors are offering various inducements to system integrators, system houses and other value-adders. These inducements include:

- Equality with retailers in terms of discounts
- Volume commitments from manufacturers
- Hardware support and access to manufacturers' service centers
- Training support and marketing assistance
- Better partnership with the manufacturer in terms of product availability.

As an example of this last benefit, VARs can now get product announcements and the products at the same time as—or even ahead of—retailers. IBM, for instance, supports its value-adders in a variety of ways, including supplying machines for use in shows, providing marketing kits (mailers, prospect lists and suggested telemarketing strategies) and running seminars and classes for resellers. Other support includes an on-line, national, remarketer database for use by IBM field representatives, technical support and on-site training and consulting.

According to Future Computing's Arnesen, IBM controls about 40 percent of the personal-computer VAR channel in terms of total end-user dollars. That represents about 10 percent of its personal computer business.

IDC's Moltz believes that the retail expectations of companies other than Apple, Compaq, IBM and Kaypro Corp. are unrealistically high. The research company contends that only about 20 of the 150 microcomputer vendors have a shot at surviving the next three to four years. The top 10 vendors account for 80 percent of all microcomputer shipments.

Companies with a heavy presence in the VAR

Acronyms clog the distribution channels

If the terms value-added dealer, value-added reseller and value-added remarketer seem confusing, you're not alone. IBM Corp., for example, has its own set of acronyms and distribution-channel classifications. The following definitions should help clear things up.

VAR: Value-added resellers sell systems after adding value in the way of additional hardware or software. VARs often target vertical markets with specific solutions. Unlike retailers, VARs don't have storefronts. VARs include system integrators and system houses.

VAR, IBM-style: IBM uses the acronym VAR to represent value-added remarketers. IBM VARs buy a

non-PC-family computer from Big Blue and resell it to an end user after adding software to create a turnkey system.

VAD: A value-added dealer, in a non-IBM sense, meets all of the qualifications of a VAR, except that a VAD has a storefront. Companies such as Hewlett-Packard Co. consider retailers like ComputerLand and Entré to be value-added dealers because some franchises provide nominal support or service.

VAD, IBM-style: Primarily an IBM term, value-added dealers resell products in the IBM PC family. VADs must pass stringent qualification standards. The term includes organizations selling turnkey systems.

Hayes sets the standard for personal computer communications. Again. Smartmodem 2400.TM

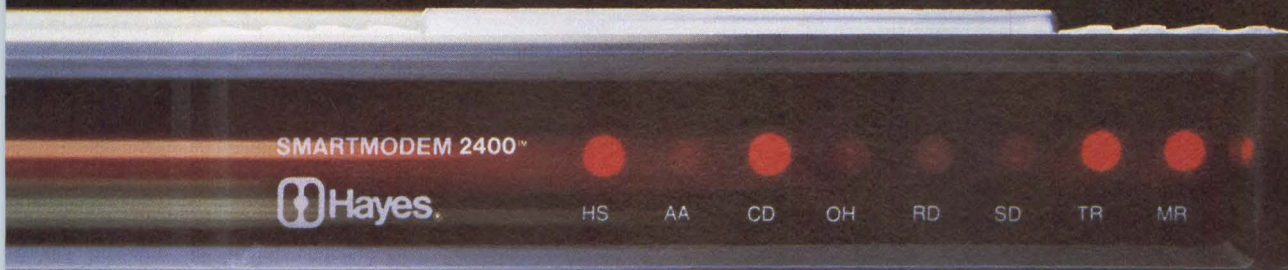

The new fast mover from Hayes. The telecomputing leader. When it comes to communications products for personal computers, we're the leader! Hayes Smartmodem 1200TM set the industry standard for quality, reliability and performance.

Now our new, faster Smartmodem 2400 goes even further to lower telephone line costs and improve user productivity. So, at twice the speed of a 1200 bps modem, it quickly pays for itself in any high-volume communications operation.

Smartmodem 2400 provides a quick link to minis and mainframes. Both synchronous and asynchronous transmissions are supported by an advanced version of the well-known Hayes "AT" command set. You can download from the IBM mainframe at the home office. Send data to the mini upstairs. And guarantee accurate transmission with information services.

With worldwide communications in mind, Smartmodem 2400 was

designed to meet CCITT international standards. It provides a fast, cost-effective way to transmit data between approved countries, even when they're continents apart.

New version of Hayes Smartcom II[®] communications software creates a complete telecomputing system with Smartmodem 2400. Our new Smartcom II, Version 2.1, is available for the IBM* PC and many popular compatibles. Smartcom II makes the most of Smartmodem's exceptional features, at the same time it makes communicating easy for you. And, if you're currently using an earlier version of Smartcom II, Hayes offers a \$25 upgrade to Version 2.1.

So if you're involved with linking micros and streamlining corporate communications, rely on Hayes Smartcom II and Smartmodem 2400. The new communications standard. Again.

For information, see your authorized Hayes dealer or call us direct.

Hayes Microcomputer Products, Inc., 5923 Peachtree Industrial Blvd., Norcross, Georgia 30092. 404/441-1617.

Smartmodem 2400

- Direct connect • Asynchronous and synchronous communications
- Accommodates Hayes-compatible modems of slower speeds
- Meets CCITT worldwide standards • Keyboard control of all communications parameters • High speed indicator • Voice/data capabilities • Call progress monitoring • Two-year limited warranty with optional four-year extended warranty available.

Smartcom II

- Hayes Verification and XMODEM protocols • Emulates DEC* VT52 and VT100/102 • Totally unattended operation • Voice/data capabilities.

Hayes[®]

Smartcom II is a registered trademark and Smartmodem 2400 and Smartmodem 1200 are trademarks of Hayes Microcomputer Products, Inc. *Trademarks of their respective companies. ©1985 Hayes Microcomputer Products, Inc.

DEC OFFERS EVERYTHING YOU NEED TO BUILD A POWERFUL Q-BUS COMPUTER SYSTEM. EXCEPT THIS.

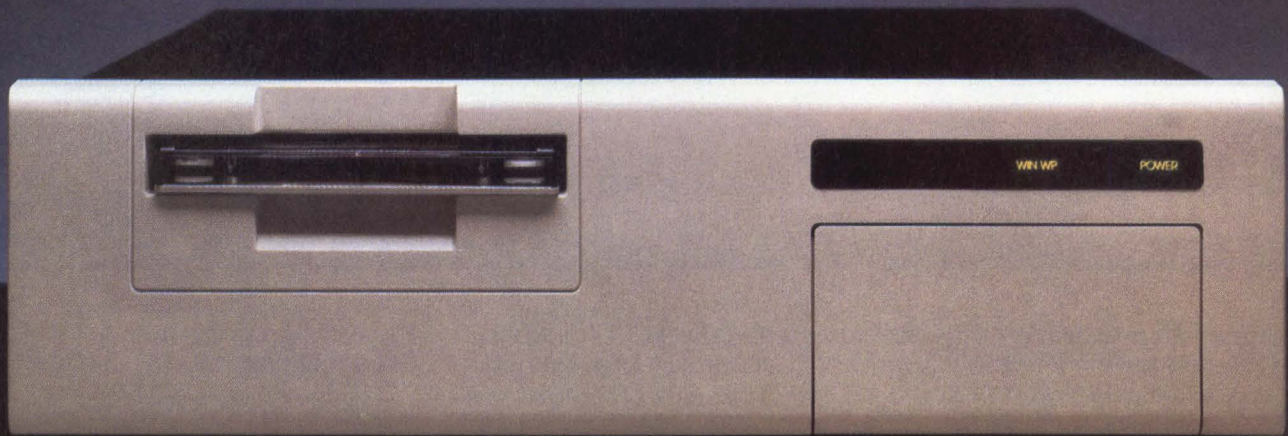

It's called Cyclone™. A high-capacity, high-reliability Winchester/tape storage system that's priced to blow your socks off.

For starters, Cyclone's 5¼" Winchester packs formatted capacities from 36 up to 120 megabytes.

So you can use your Q-Bus based system (PDP®-11/23, 11/73, MICRO/PDP-11 and MicroVAX®) for applications that require large amounts of storage. At the lowest cost per megabyte.

But, of course, we offer more than the highest capacity for the lowest price in DEC-compatible storage.

For instance, Cyclone has faster throughput. And access times are twice as fast as an RLO2's.

It's compatible with DEC's Digital Storage Architecture (DSA). And its ¼-inch start/stop tape drive emulates DEC's TSV05/TS11.

For your commercial applications, there's the tabletop StacPac™—in addition to the rackmount version that's popular with the industrial and scientific users.

And no matter what kind of system you're building, Cyclone features a comprehensive self-diagnostic system, Customer Service Hotline and Rapid Module Exchange™ program.

To see what Cyclone can do for your Q-Bus system, call the Qualogy sales office nearest you. And hang on to your socks.

*Now MicroVAX
compatible.*

QUALOGY

Formerly Data Systems Design

Literature Hotline: 800-556-1234 ext. 86; in California 800-441-2345 ext. 86.

Regional Sales Offices: Eastern Regional Sales: Norwood, MA (617) 769-7620. Southcentral Regional Sales: Dallas, TX (214) 980-4884. Northcentral Regional Sales: Chicago, IL (312) 920-0444. Western Regional Sales: Santa Clara, CA (408) 727-3163. Distributors Worldwide. Corporate Headquarters: 2241 Lundy Avenue, San Jose, CA 95131

™ Cyclone, StacPac and Rapid Module Exchange are trademarks of Qualogy, Inc. ® DEC, PDP, and VAX are registered trademarks of Digital Equipment Corporation © 1985 Qualogy, Inc.

CIRCLE NO. 46 ON INQUIRY CARD

market can be divided into three categories:

- Small companies with sophisticated multi-user products, such as Altos Computer Systems, Corona Data Systems Inc., Fortune Systems Corp., North Star Computers Inc. and Tele-Video Systems Inc. These companies have previously done business in the retail channel but now consider the VAR channel the primary distribution mechanism.

- Large companies that have traditionally had a strong presence in the VAR channel with minicomputer equipment, such as Data General Corp., Digital Equipment Corp. (DEC) and Texas Instruments Inc.

- Companies with secure retail sales that are targeting the VAR market as a means for greater mass distribution. Those companies include Apple, AT&T, Hewlett-Packard Co. (HP) and IBM, as well as smaller companies such as Compaq.

In 1983, IBM formed the National Distribution Division (NDD), which has responsibility for IBM product centers, its value-added-remarketer channel that supports non-PC small systems and the value-added-dealer (VAD) channel that supports PC-family products. IBM formed the division to bolster non-retail sales and to focus those sales through a single organization.

Apple and Tandy Corp.'s Radio Shack division have had VAR programs for several years, but neither has been particularly successful. Now, both companies are stepping up VAR efforts with new programs. "Apple has a real chance of getting into the office market through the VAR channel," predicts Future Computing's Arnesen.

Apple officials contend that the Macintosh personal computer offers a good path into the VAR market. According to industry analysts,

Honeywell shifts distribution gears

Most of the attention surrounding the market shift from direct sales or retail to indirect or value-added-reseller (VAR) channels focuses on the low end of the market, represented by products like the IBM Corp. PC and the Apple Computer Inc. Macintosh. But medium to large computer companies are also recognizing the abundant lure of indirect distribution channels.

Unlike Digital Equipment Corp., Data General Corp. and, to a degree, Hewlett-Packard Co., Honeywell Information Systems Inc. has a history of being a direct sales company. But 1984 marked the beginning of a concerted effort to increase indirect sales revenues.

Jim Murphy, Honeywell's director of indirect sales operations, attributes the shift to a declining price/performance curve. "In the under-\$200,000 range, price/performance has put the technology in the hands of many more people, fostering a tremendous increase in applications. Big companies like Honeywell cannot compete in the creation, maintenance and support of the horrendous demand for specialized applications." Murphy admits that third-party companies that do not have huge overhead costs can provide solutions that are much cheaper and more specific.

Early last year, Honeywell targeted two groups of resellers: traditional VARs and the emerging "cottage industry" of application writers. To address the cottage industry, Honeywell set up the Manufacturer's Representative Program. The company treats independent representatives as though they were extensions of the Honeywell sales force, chartering them to sell in either a specific geographic area or a

vertical-market specialty. Honeywell signed up 130 manufacturer's representatives in 1984 and is aiming for 300 by the end of 1985.

Honeywell gives traditional VARs advance discounts of up to 30 percent. Manufacturer's representatives don't get advance discounts. When the representative sells a system, Honeywell pays him a commission once the end-user customer is satisfied that the system is working.

To bolster the indirect sales effort, Honeywell put an indirect sales specialist (ISS) into each local branch. The ISS' only role is to sell into indirect channels. The key to the program, says Murphy, is that the local branch manager is responsible for both direct and indirect sales.

How does Honeywell minimize competition between those two channels of distribution? The company credits each sales branch for all shipments to its assigned territory. In other words, if one of the indirect channels—VAR or manufacturer's representative—makes a sale, Honeywell gives double credit (for example, to the indirect sales entity and to the direct sales branch in which the sale was made).

Honeywell markets approximately 35 percent of its DPS 6 machines and small business systems through its two indirect sales programs (VAR and Manufacturer's Representative Program). Most of its VARs have revenues in the \$25 million to \$100 million range. "We're looking for \$5 million to \$6 million a year from these people," says Jim Murphy. Honeywell's reseller channel revenue grew at about 30 percent during 1984 and the company is aiming for 35 percent to 40 percent growth for 1985.

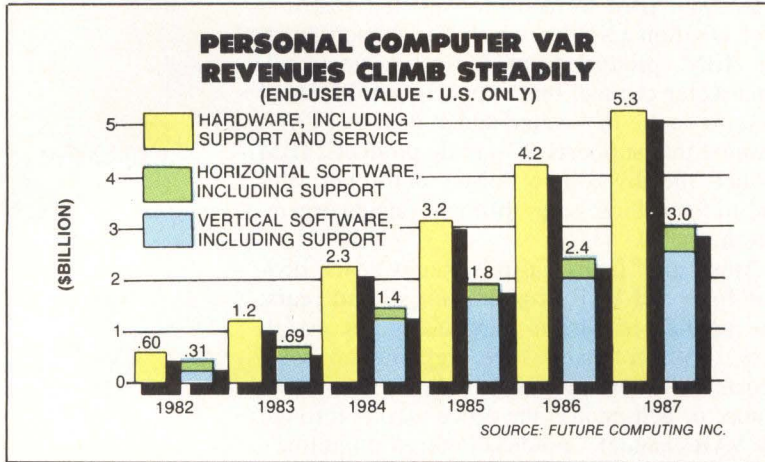

Revenue flow through value-added resellers (VARs) is expected to increase at a 56-percent annual growth rate.

Apple's troubles in the VAR channel have been due to its difficulty in protecting its retailers while wooing VARs, a lack of software for the Macintosh and the perception that the Macintosh is not a business computer.

Most traditional minicomputer vendors have always been in the VAR-OEM business, but the exceptional growth of microcomputers like the Apple II has spurred minicomputer manufacturers to offer competitive low-end products. These companies view the VAR channel as crucial to their success, and all have established VAR channels for their low-end products to complement third-party sales efforts in the midrange.

HP, for example, successfully entered the mainstream personal computer market last year with the HP 150 series and a portable unit. Although HP claims strong retail sales, it has recently restructured its marketing emphasis toward VARs.

According to Jody Ryden, HP's VAR-OEM market manager for the personal computer group, the company recently adjusted its discount schedule to enable small VARs to participate in HP's value-added distribution channel.

Almost half of the value-added resellers (VARs) have revenues of less than \$1 million each. Figures are based on a survey of 3,886 VARs.

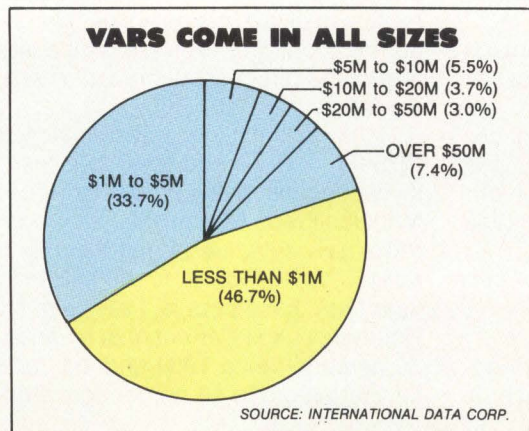

Most of HP's personal computer VARs have annual revenues of under \$1 million. Ryden declines to reveal specific discount schedules but adds that they start at 25 percent. Discounts are equitable between retailers and VARs because they are based purely on volume.

Benefits HP VARs enjoy include support mechanisms such as in-field system engineers, loaner systems for evaluation and access to service centers. An end user who buys a system from a VAR can send the system back to HP for repair, contract with HP to have on-site service or have the VAR perform the maintenance after being trained by HP. All HP products are available to the VAR channel. The local OEM sales representative acts as liaison between the VAR and the manufacturer.

Ryden adds that HP works closely with software houses to develop vertical-market packages. In the future, HP might offer those packages under the HP logo, marking a stronger entry into the vertical-market arena.

Putting the squeeze on profits

Discussing the pitfalls of the retail channel, Corona's vice president of sales, George McMurtry, points out, "If you're already discounting to beat the band, what are your profits going to be?" Like most of its competitors, Corona had its share of retail sales a few years ago, but, once IBM was able to deliver PCs in quantity, many microcomputer vendors were shunted aside. For many companies, the only thing left is the value-added channel.

Companies like Corona offer VARs attractive discounts, usually through distributors, and varying degrees of service and support. Corona offers discounts starting at 28 percent. McMurtry notes that "Unless the VAR does over \$1.5 million of business, it will behoove him to go through a distributor instead of through Corona" because the distributor's discounts are higher. One service Corona offers is a software directory, which lists VAR software available for sale or exchange to other VARs.

For other companies, the retail channel has been a dismal failure, and the VAR channel is the only hope for survival. After declaring bankruptcy in early 1984, Victor Technologies rebounded late last year with its sights set on the VAR market. The company also began packaging specialized software and is selling directly into vertical markets. Eagle Computer, decimated by IBM's price cuts last year, laid off about a third of its work force and reorganized its distribution strategy to emphasize VARs.

"Vertical markets represent about 80 percent of VAR business," says Future Computing's

The new Canon TX-50 desktop computer.

It fits any customer's business as well as his desk.

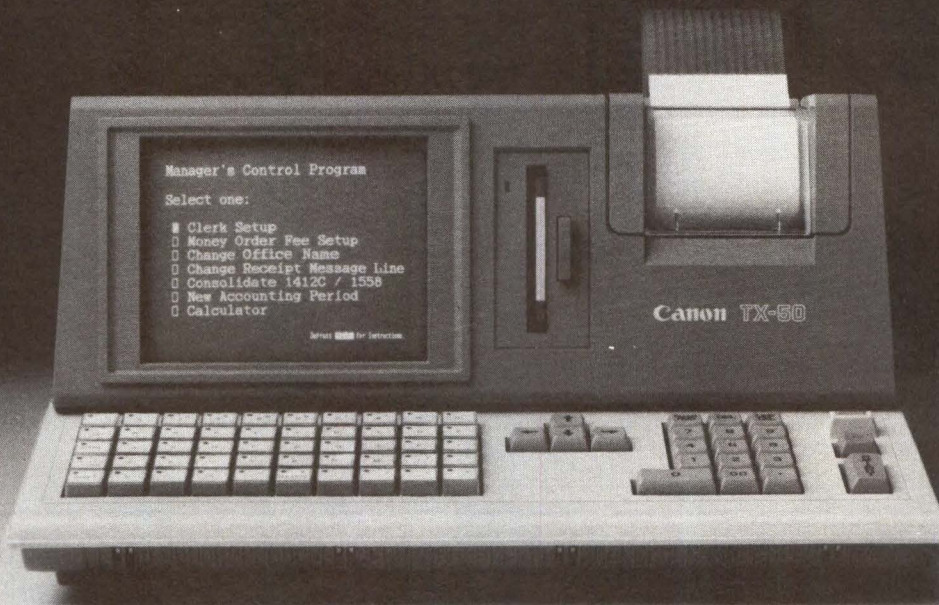

No matter how specialized your customers' business needs, Canon's new compact desktop computer is uniquely designed to accommodate them.

Because the TX-50 is a self-contained computer that can be customized for a wide range of specific business applications.

Its all-in-one design includes:

- A high-performance 16-bit microprocessor with MS-DOS[†] operating system. Standard 128KB memory is expandable to 256KB.
- Seven-inch high-resolution monochrome CRT display.
- Fifty-function LED keyboard plus separate ten-key calculator pad and cursor control keys.
- Three-inch compact floppy disk drive with 150 K-bytes memory capacity per side.
- Optional RS-232C serial interface and Centronics-type parallel interface available.
- Wire dot impact printer that gives a

sharp 5X7 dot matrix and has a maximum 30 characters per line. It prints a black or red original on plain paper plus two copies.

With such impressive, self-contained flexibility, the TX-50 is ideal in areas such as customer operations and counter service. Especially since the TX-50 provides such a huge range of varied functions, yet takes up so little space.

Businesses such as gasoline stations, banks, mail rooms, real estate brokers and numerous others will find the TX-50 particularly useful for sales, credit, loan or general customer calculations.

So if you're dealing with business, whether large or small, and you feel they need a rather special computer, consider the new Canon[®] TX-50 desktop computer.

There isn't a desk it won't fit.

For more information:

**Call 1-800-323-1717, Ext. 302.
(In Illinois call 1-800-942-8881, Ext. 302.)
Or write Canon U.S.A., Inc.
Systems Division/TX-Series
P.O. Box CN 11250, Trenton, N.J. 08650**

Canon Systems Division

© 1985 Canon U.S.A., Inc.
[†]MS-DOS is a trademark of MICRO SOFT.

CIRCLE NO. 47 ON INQUIRY CARD

Arnesen. VARs have mechanisms to contact and familiarize themselves with specific businesses, such as the medical or legal professions. VARs

often address vertical markets via specialized software, acting as both developers and distributors. Personal computer manufacturers develop and distribute a small amount of vertical market software, but most have not been able to identify and meet the needs of the vertical market arena.

Vertical markets range from pet shops and racquetball clubs to hospitals and automobile engine testing plants. The top five vertical markets, according to IDC, are manufacturing, government, medical/dental, banking/finance and wholesale/distribution.

One way to appreciate the importance of vertical markets is to look at the flow of venture capital into that area. "We expect vertical market-oriented companies to be one of the next havens for venture capital dollars," says David E. Gold, publisher of *Vertical Market Report*, San Jose, Calif. Gold predicts that well over \$10 million in venture capital will flow into vertical markets in 1985. That figure does not include money going into start-ups. □

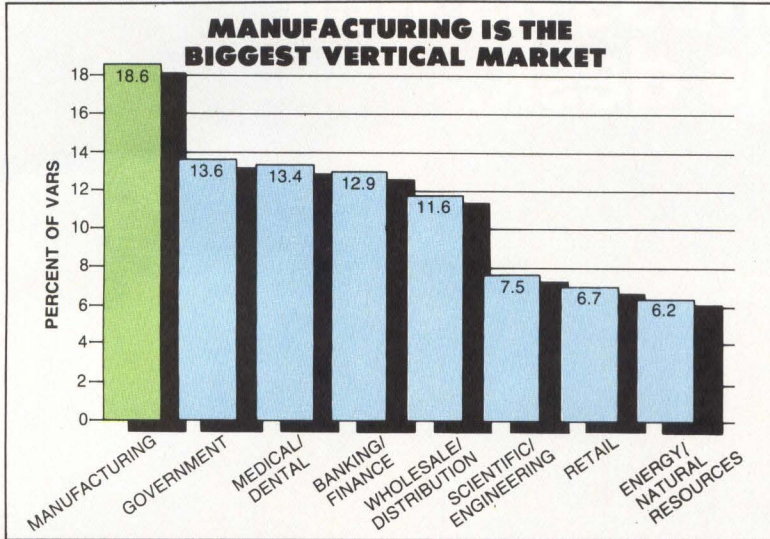

Value-added resellers (VARs) deal primarily in specialized vertical markets. Sixty-one percent of VARs sell to more than one vertical market, but usually in the same application area.

Interest Quotient (Circle One)
High 465 Medium 466 Low 467



HIGH PERFORMANCE, VERSATILITY, VIVID COLOR, CRISP IMAGE
TOEI COLOR DISPLAYS FTC/CDM – SERIES.

TOEI, experienced Display Monitor specialists, offer a wide selection of Color CRT Displays. You can choose from our versatile standard models or OEM versions to meet your exacting requirements.

•Housed in lightweight, impact-resistant Cabinet. •Hi-Contrast (Black Face), Hi-Brightness CRT displays a crisp, sharp image. •Limitless colors can be displayed through Analog Input.

FTC-12" Series



CDM-14" Series

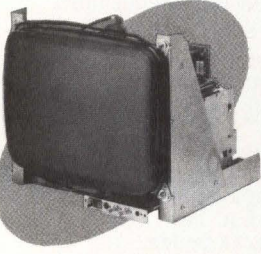

Item	Versions	RGB Version	NTSC Version	NTSC & RGB Version	IBM PC Compatible only	
12" (CRT Pitch)		FTC-1208-R (0.28mm Dot trio)	FTC-1201-N (0.47mm Stripe)	FTC-1201-NR (0.47mm Stripe)	FTC-1208-HF (0.28mm Stripe)	FTC-1208-W (0.28mm Dot trio)
		FTC-1203-R (0.38mm Dot trio)	FTC-1200-N (0.63mm Stripe)		FTC-1203-HF (0.38mm Stripe)	
		FTC-1201-R (0.47mm Stripe)				
14" (CRT Pitch)		FTC-1455-R (0.31mm Dot trio)	FTC-1410-N (0.52mm Stripe)	FTC-1410-NR (0.52mm Stripe)	FTC-1455-HF (0.31mm Dot trio)	FTC-1455-W (0.31mm Dot trio)
		FTC-1485-R (0.39mm Dot trio)	FTC-1416-N (0.64mm Stripe)		FTC-1435-HF (0.39mm Dot trio)	
		FTC-1423-R (0.42mm Stripe)				
Input Signal Level		RGB Analog RGB plus Intensity RGB TTL	NTSC (PAL)	NTSC (PAL) RGB Analog RGB plus Intensity RGB TTL	RGB plus Intensity / RGB TTL	
Applications, Others		IBM PC · PC jr. Apple IIc, IIe *	IBM PC · PC jr., Apple IIc · IIe, Commodore C-64		H. F. 25kHz	Scanning Doubler

* With RGB card. FTC-1203-R, FTC-1203-HF: Non-Glare

CDM Series (Unit for OEM)

Model	CRT Size	CRT Pitch
CDM-1208-PC	12"	0.28mm Dot trio
CDM-1203-PC	12"	0.38mm Dot trio
CDM-1201-PC	12"	0.47mm Stripe
CDM-1455-PC	14"	0.31mm Dot trio
CDM-1435-PC	14"	0.39mm Dot trio
CDM-1423-PC	14"	0.42mm Stripe
CDM-1410-PC	14"	0.52mm Stripe

- OEM versions include Color 6"-26" in addition to the above, Monochrome 3"-26", CRT Pitch 0.64mm - 0.21mm, Horizontal frequency less than 64kHz, Non-glare to meet your requirements.
- Green/Orange CRT Displays are also available. (Included IBM PC Compatible.) CRT size: 9" or 12".
- We are looking for reliable and established distributor worldwide.

"SEE OUR BOOTH 1100 AT COMDEX IN JAPAN"

TOEI ELECTRONICS (MFG) CO., LTD.
Kanda Cent Bldg., 2-4, Yushima 1-chome Bunkyo-ku, 113 Tokyo JAPAN
Tel. (03) 257-1131 Telex. 0222-2555 TOEICO J FAX (03) 258-3560

IBM PC is a Trademark of IBM Corp. Apple IIc, IIe are Trademarks of Apple Computer Inc. Commodore C-64 is a Trademark of Commodore Business Machine Inc.

The new Canon[®] Handy Terminal makes any computer system go farther.



The new Canon[®] Handy Terminal 5000 is the portable unit that lets you gather and process information out of the office.

With a maximum 32K internal user RAM file memory, it's perfect for jobs like retail audits, warehouse inventories, order-taking anywhere in the field or any one of hundreds of business applications.

It can be programmed to perform almost any task, adopting BASIC and Assembler languages.

And can even relay information to your computer via phone hookup.

Portability is also the key word of the 5000, because Canon's Handy Terminal was especially designed for traveling light.

At a weight of less than 2 lbs., it can operate on a rechargeable battery and can be carried by neck strap or in an attache case. Yet it's highly durable, water resistant and shock resistant. Which means it can take its fair share of hard knocks.

© 1985 Canon U.S.A., Inc.

Also available is the 5000P (shown above) which has a built-in thermal dot printer that can print one original and a copy.

And both terminals can incorporate an optional bar code reader.

So why not widen your computer horizons with Canon's new Handy Terminal. It lets you go as far as you like.

For more information:
Call 1-800-323-1717, Ext. 302.
(In Illinois call 1-800-942-8881, Ext. 302.)
Or Write Canon U.S.A., Inc.,
Systems Division/Handy Terminal,
P.O. Box CN 11250, Trenton, N.J. 08638.

Canon Systems Division

CIRCLE NO. 49 ON INQUIRY CARD

Archive puts with backup.



This is a success story. Starring the industry's #1 half-height 5 1/4" streaming tape drive. And you.

The right time for backup.

The systems you're designing today need backup more than ever.

That's because they're being used in more important applications than ever. For accounting and word processing. As engineering workstations. And multi-user, multi-station systems. With more complex software. Growing data bases. Winchester that have 10MB to over 100MB capac-

you out front

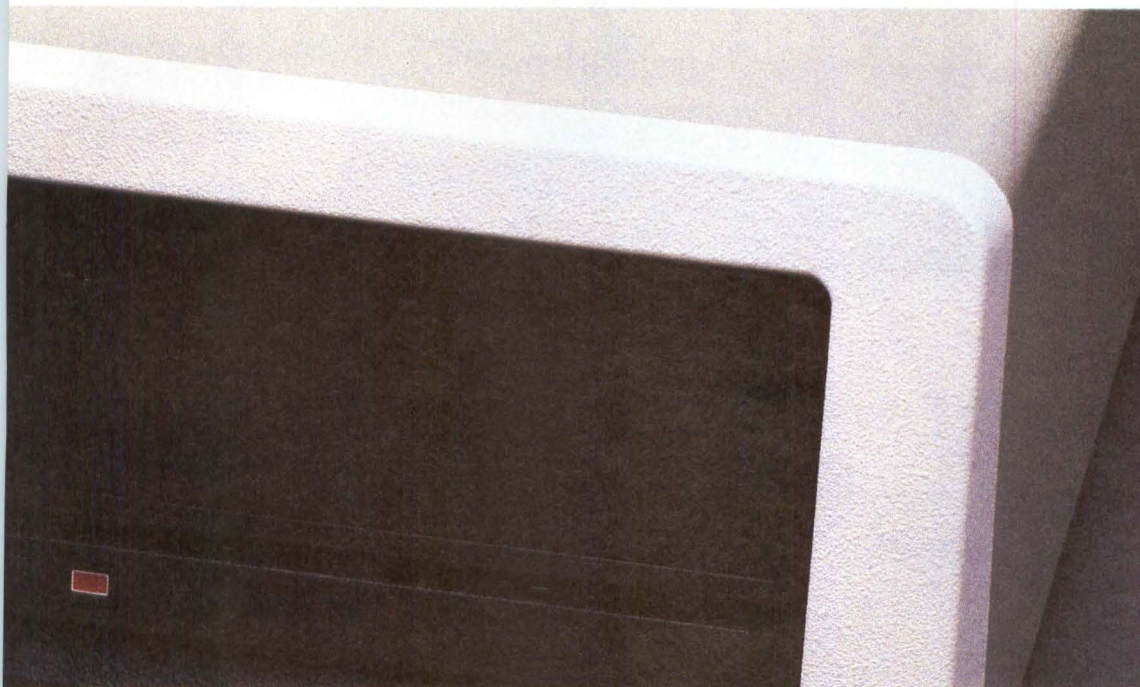

ity. And customers who demand dependability and the simplicity of tape backup.

The right time for Archive.

The time's right for Archive. We've got the right product for you. At the right price. With the right support.

Put our half-height 1/4" streamer into your system and you've got 20 to 60MB of fast (four to nine minutes), convenient backup with a single cartridge.

We build the most dependable 5 1/4" drive in the

industry. With a more reliable motor — brushless DC. A better loading mechanism — fewer moving parts. Proprietary LSI. And the dependability that comes from devoting over three years to building 1/4" streaming tape drives and nothing but 1/4" streaming tape drives.

We've got you covered.

We've got the right approach to system integration, too. We build a half-height drive with the industry-standard QIC-36 Basic Interface. Use our SCSI, IBM PC or QIC-02

controllers/formatter boards for simple, quick system integration.

No matter how successful you are we've got the manufacturing capacity to meet your volume needs, including a new off-shore plant to support you worldwide. Nobody's shipped more half-height 5 1/4" tape drives than Archive. No one ever will.

Write your own success story.

We'll put you out front in tape backup. With the support you need to ensure system success. Just dial (714) 641-0279. And backup is on the way. Archive Corporation, 3540 Cadillac Avenue, Costa Mesa, CA 92626. Telex: 4722063.



ARCHIVE

Out front with backup.

CIRCLE NO. 50 ON INQUIRY CARD

TIE IT ALL TOGETHER WITH THE ANY-PORT-TO-ANY-PORT SMART SWITCH. \$1895.

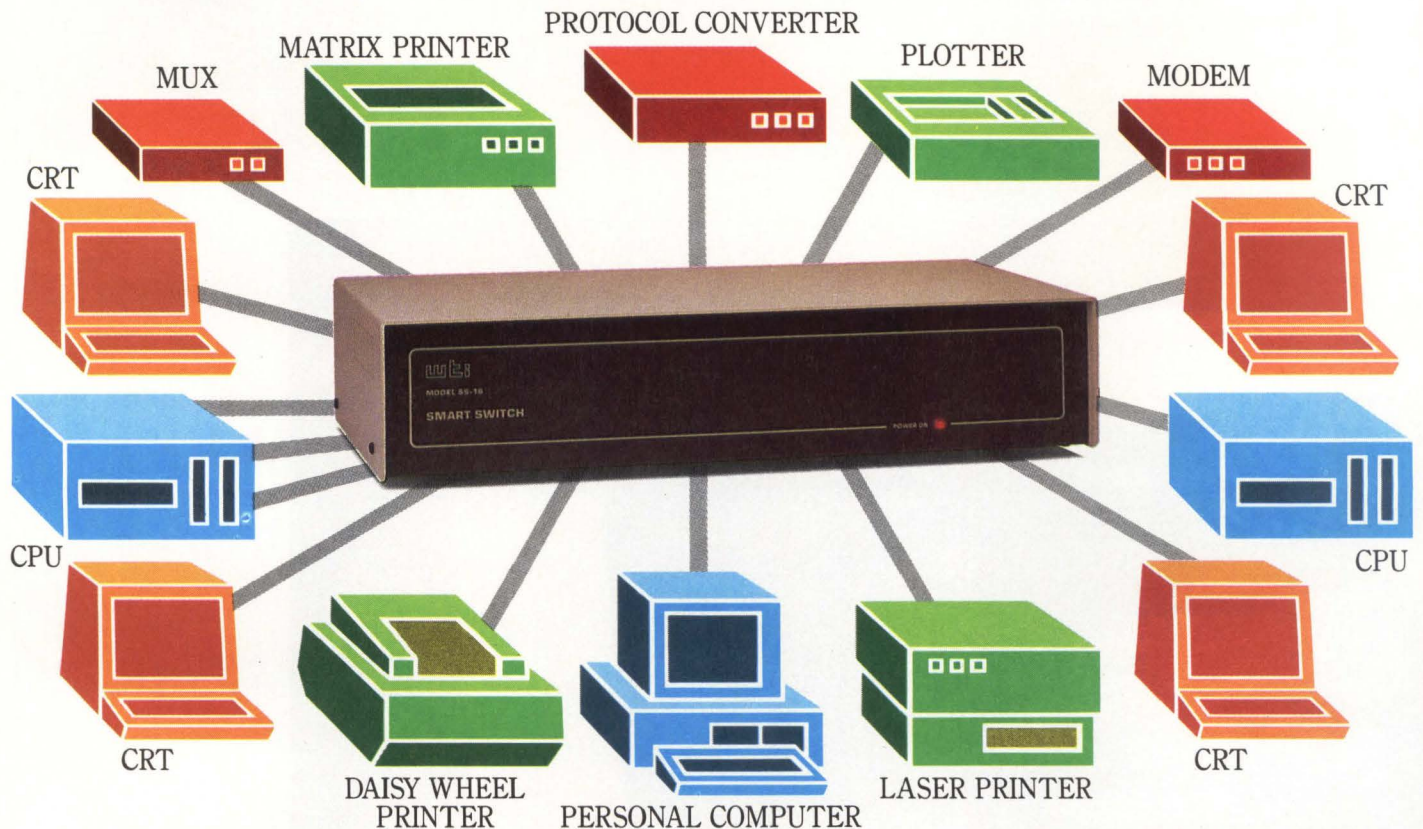

Here's an affordable way to switch up to sixteen RS-232 ports in any interconnection. It's called the Smart Switch™ controller.

The SS-16 accommodates any peripheral: terminals, printers, CPUs and modems. Any port can select any other port. With up to eight pairs of ports communicating at the same time.

Create your own local network. The SS-16 is ideal for computer port expansion, computer sharing, engineering work clusters, and much more.

Each port has its own spooling buffer. So any baud rate can

communicate with any other baud rate. Anywhere in the system.

You can name your ports. Like "PRINTER," "MODEM," or whatever. Or give multiple ports the same name, like "CPU," and the SS-16 will connect you to the first "CPU" port available.

A battery backup system ensures your system configuration and port names are maintained anytime the system is shut off.

A special supervisory port lets you monitor any other port. Connect ports together. Broadcast messages. Or designate the same supervisory power to other ports.

You'll also find the SS-16

user-friendly. It tells you when your selected port is busy. Sends a "port available" message if you choose to wait. And optionally times-out ports not in use.

There's even a HELP command. And for quick and easy installation, a push button defines each port for either DTE or DCE.

So if you need an intelligent, affordable way to link your RS-232 system, you're ready for WTI's Smart Switch.

For more information on the SS-16, or our other RS-232 switches, call Western Telematic toll-free at (800) 854-7226. In California call (714) 979-0363. Or write WTI, 2435 South Anne Street, Santa Ana, California 92704. Or telex 467741.

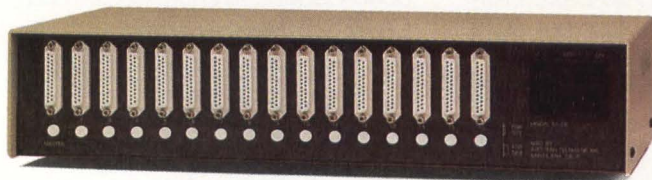

wti western telematic inc.

INTERPRETER

COMPUTER STANDARDS: THE JURY IS STILL OUT

Computer manufacturers resist implementing
a common computer network architecture

Keith Jones, European Editor

The Open System Interconnection (OSI), a set of standards being defined by the International Standards Organization (ISO), aims at facilitating communication among computers from different manufacturers across any type of network. But doubts prevail as to the degree of commitment computer manufacturers have when it comes to implementing OSI standards in place of their own proprietary network architectures.

Donald Toombs, a European associate of The Yankee Group, Boston, notes that vendors promote proprietary architectures to ensure the continued sale of their terminals and network equipment to the vendors' captive users. Based on this reasoning, Toombs believes that European vendors will offer only a degree of compatibility with OSI. Connection to OSI networks will be made via gateways, as opposed to full implementation.

Toombs' view is echoed by Richard Amster, director of data communications at The Yankee Group. He believes that U.S. manufacturers that express wholehearted support for OSI are merely paying lip service to the standards and are unlikely to modify their architectures enough to be totally OSI-compatible. Amster suggests that the dominance of IBM Corp.'s proprietary Systems Network Architecture (SNA) is a key reason for the U.S. government's promotion of OSI. He points out that 70 percent to 80 percent of major U.S. corporations implement SNA and, as a result, the government perceives IBM as a monopoly.

If competing vendors want to penetrate IBM installations, they must implement SNA on their equipment. The government's backing of the

non-proprietary OSI helps IBM's competitors gain a greater market share.

Major users of SNA such as General Motors Corp. and Boeing Corp., encourage the government's initiative, according to Dr. John F. Heafner, head of the systems and network architectures division at the National Bureau of Standards (NBS), Gaithersburg, Md. The NBS is the main government agency promoting OSI. Heafner observes that most computer users want the multinetworking environment that OSI offers.

In a scenario similar to one in the United States, authorities in Europe are pressuring IBM to make concessions to the OSI lobby. The Brussels-based European Commission, which runs the Common Market, last year persuaded IBM to publicly state its commitment to OSI.

As a result, IBM has reportedly promised its European users support for selected functions of OSI on its mainframes. The company plans to start testing a product this year. Functional changes will be made at layers four and five, the transport and session layers, respectively, of the OSI model. IBM reports that work on the sixth and seventh layers, presentation and applications, will continue for some years.

European manufacturers commit to OSI

In contrast to IBM's cautious approach toward OSI, 12 of the largest European computer manufacturers have issued a joint statement expressing ardent support for the standards and their intentions to implement OSI on their computers. ICL Plc., London, one of the largest vendors in this group, says that its proprietary architecture, Information Processing Architecture (IPA), can implement OSI standards. Jacques Stern, chairman of Groupe Bull, Paris, also among the 12,

IBM has reportedly promised its European users support for selected functions of OSI on its mainframes

GOOD LOOKS RUN IN THE FAMILY.

LEXIDATA'S LEX 90 FAMILY OF HIGH-PERFORMANCE DISPLAY PROCESSORS.

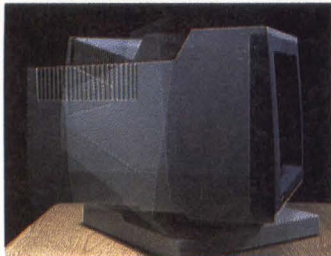

Lexidata's monitor enclosure design features a unique tilt and swivel movement with smooth and easy operation. All monitor connections and peripheral power supplies are located in the enclosure's base.

and with our popular Series 3000 line. So performance upgrades are easy and economical. And software investments are well protected.

Every LEX 90 model has the same basic components which use the latest bit-slice technology for rapid execution of complex calculations and set-up times.

The family's flexibility allows you to buy only the functionality you need now, and gives you the ability to add on later as required.

Exclusive SimulRes functionality allows simultaneous display of



A tiger shows off its "true colors" with the LEX 90 True Color display system from Lexidata.

8-bit color lookup table for each color. And where you're looking for high performance with high resolution, there's a LEX 90 model that can support up to 24 planes of 1280x1024 display memory at 60Hz non-interlaced refresh.

LOOKING GOOD.

The LEX 90™ family is a good family to know. It's as advanced in a business sense as it is technologically. And what it has, compared to what it costs, makes it look very good indeed. For example:

Its software architecture is compatible both within the family

The extraordinary solid modeling display capability of our patented SOLIDVIEW™ technology is available in a 640x512 version. And for petrochemical applications, there's GEOVIEW™, a three-dimensional geological interpretation package.

On-board diagnostics, based on a 6801 micro-processor, help maximize uptime. And the unique tilt-and-swivel movement of our monitor allows smooth and easy operation of your display.

Of course, the entire family is

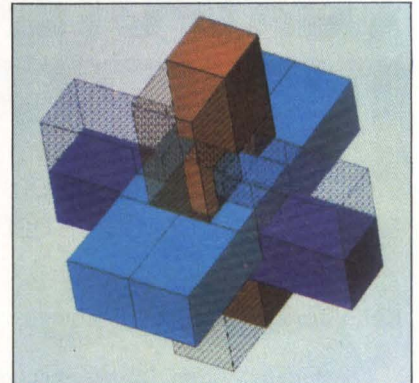

SOLIDVIEW, Lexidata's patented technology for the display of solid models, is available as an option on selected LEX 90 display processors. Its translucent shading pattern allows you to see inside your solid model.

compatible with a variety of leading application software packages and minicomputers. Which makes everyone look even better.

For a good look at the LEX 90 family and its expanding capabilities, call us at 1-800-472-4747. In Massachusetts, call (617) 663-8550. Or write: Lexidata™ Corporation, 755 Middlesex Turnpike, Billerica, Massachusetts

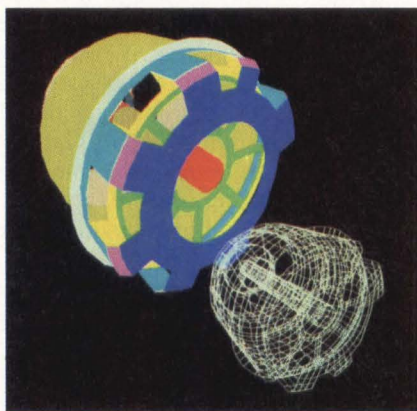

LEX 90's SimulRes enables the designer to mix theory with reality by allowing the simultaneous display of a wire-frame model with the real-life product. (Courtesy of PDA Engineering)

640x512 and 1280x1024 images on the same screen. A True Color configuration offers two buffers of 640x512x24 with an

USA 01865. TWX: 710-347-1574. In UNITED

KINGDOM call: Lexidata Ltd., Hook (025672) 3411.

In FRANCE call:

Lexidata SARL, Rungis (1) 686-56-71.

In JAPAN call: Lexidata Technical Center, Tokyo 486-0670.



LEXIDATA®
LOOKING GOOD.

also declares his company's commitment to OSI: "The only way to benefit from technological advances and render the distributed data-processing market more dynamic is by providing a basic communication structure that guarantees the user freedom to choose his suppliers."

Groupe Bull and Honeywell Information Systems, Brentford, England, the computer division of Honeywell Inc., Minneapolis, have cooperated on a proprietary architecture known as Distributed Systems Architecture (DSA). According to Robert Mills, a communications consultant with Honeywell in England, compatibility between DSA and OSI exists within levels one through five of the OSI model. Mills notes that these DSA functions are being implemented on Honeywell's minicomputer and microcomputer products, as well as its mainframe systems.

Another minicomputer supplier, Digital Equipment Corp. (DEC), will change some protocols in DECnet, the company's proprietary network architecture, to OSI standards, according to Patrick Cheveaux, marketing specialist with DEC, Valbonne, France. But, Cheveaux adds, some application layer functions will remain specific to DECnet.

Honeywell's Mills points out that the absence

of a network management component is currently one of the major shortcomings of OSI. DSA, on the other hand, provides this set of facilities, he adds.

Richard desJardins, head of the ISO subcommittee working on the upper layer of OSI standards, acknowledges that network management is one of the most important issues to be resolved before OSI can provide users with a complete service. Peter Kenny, director of software technology at LDR Systems Ltd., Aldershot, England, a company specializing in OSI software, believes that the lack of network management facilities is a "huge deficiency" of OSI. IBM emphasizes that SNA is "rich in network management functions," providing security, administrative and diagnostic features, and a directory service.

LDR's Kenny believes that future OSI management functions, which will be decentralized, may be better suited for large networks than is SNA. He notes that OSI, in contrast with SNA, does not require the central control of a mainframe, because OSI was defined in an era of highly intelligent workstations and local area networks. An ISO working group examining network management standards is reportedly

Twelve of Europe's largest computer manufacturers have expressed ardent support for standards

Building an OSI network standard

Open Systems Interconnection (OSI) is a seven-layer model first envisioned for networking by the International Standards Organization in the late 1970s. The lowest layer, or physical, defines the electrical characteristics needed to transmit bits of data across a communications path. Moving upward, the data-link layer deals with framing the bits that make up a message and with error correction. The next level up, the network layer, handles the routing of a message across and between the networks over which a message has to pass. It includes the X.25 protocol widely used in packet-switched networks. The transport and session layers are concerned with such functions as multiplexing messages over the one connection and synchronizing the exchange of data.

Standards for the two highest layers, presentation and application, are reportedly at an advanced stage of definition and are expected to become technically stable this year.

The presentation layer provides negotiation of a common syntax for the transfer of data between programs on different computers. The application layer selects appropriate service for user application processing and also manages the interfacing of user applications with other OSI layers.

OPEN SYSTEMS INTERCONNECTION (OSI) REFERENCE MODEL

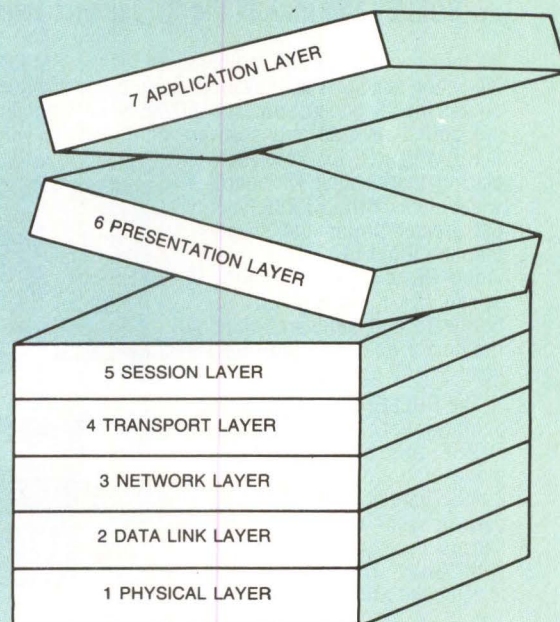

U.S. manufacturers are paying lip service to OSI standards and are unlikely to sufficiently modify their architectures

making progress on a directory service, one network management feature.

Virtual Terminal Protocols (VTP) is another OSI feature that still requires study. VTP defines standard protocols that can be accepted by all types and brands of terminals. The work toward VTP has been slow because of the variety of available terminals. Christopher Makemson, chairman of the VTP panel with the British Standards Institution, London, explains that ISO has defined several classifications of terminals, which include basic, forms, graphics and mixed mode. Makemson says that standardization work is currently confined to the "basic class" of terminals— simple, glass, teletype units.

OSI efforts prevail

Despite issues and obstacles regarding OSI, efforts to help computer vendors implement the protocols and services defined by OSI are under way. The NBS has proposed a worldwide network, called Catnet (short for concatenated, or linked, network) to assist vendors in making their private subnetworks more compatible with the OSI model.

According to NBS' Heafner, more than 30 companies have expressed interest in Catnet, which will be financed and run by group participants, not NBS. Interested companies include IBM, DEC, Hewlett-Packard Co., Intel Corp. and Motorola Inc., all of which participated in a demonstration of OSI functions at last summer's National Computer Conference in Las Vegas. Heafner hopes to see European involvement in Catnet. □

Interest Quotient (Circle One)
High 468 Medium 469 Low 470

LOOKING AHEAD IN MMS

Be sure to watch for these editorial highlights in coming issues of Mini-Micro Systems:

- The April issue will include reviews on minicomputers, mini software and UPSes.
- Office automation will be featured in the May issue.

WAVE MATE BRINGS MUSCLE TO YOUR IBM PC/XT WITH IT'S 80286 MOTHERBOARD

BULLET-286 makes the XT perform with greater power and speed than the IBM PC/AT

It's the new **BULLET-286** motherboard for the IBM PC/XT marketplace. This advanced-technology product utilizes the Intel microprocessor 80286 while maintaining both hardware and software compatibility with the IBM PC/XT. By simply replacing the existing XT board with our new **BULLET-286**, you get greater power and speed than the IBM PC-AT. Thus, existing PC/XT users can preserve their investment in hardware and software while moving a quantum leap beyond PC-AT performance.

The **BULLET-286** contains a 6 megahertz no wait state 80286 microprocessor in place of the XT's 4.77 MHz 8088. There is an 80287 math co-processor option, 8 IBM expansion slots, and enhanced ROM BIOS. The **BULLET-286** is equipped with 256K bytes of

memory, expandable to 1 megabyte on-board.

The **BULLET-286** is compatible with the IBM PC/XT to a degree far beyond the IBM PC-AT product. Application programs and operating systems (PC-DOS, CP/M, UCSD Pascal, Pick, Oasis, Unix-derivatives) available for the XT, can run without incompatibilities on the **BULLET-286**.

You can order now. The **BULLET-286** is available with 256K RAM, with options to 1 full megabyte. Prices start at \$1,995.

Quantity discounts available. OEM and dealer inquiries welcome.

WAVE MATE INC.

14009 S. Crenshaw Blvd.
Hawthorne, CA 90250
(213) 978-8600 Telex: 194369

WAVE MATE EUROPE

159 Chee de Veurgat
1050 Brussels, Belgium
Tel: (02) 649 1070 Telex 846 61828

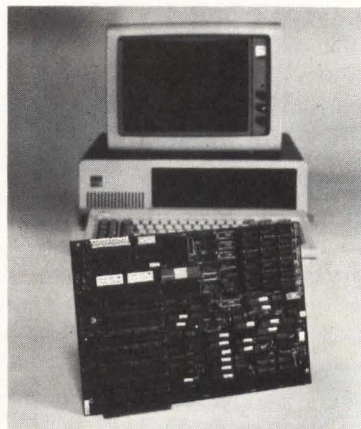



Our Low-Cost Voice Data Entry Peripheral Could Double Your Computer System's Productivity

Verbox voice data entry has improved the speed and accuracy of data entry operations for companies across the country. We're helping firms in material handling, inventory control, inspection, test and other applications save thousands of dollars in time and labor costs, often resulting in productivity gains of 100% and more. Now *you* can offer this proven technology in a new, low-cost voice data entry peripheral—the Verbox Series 4000 Voice Recognizer.

Integrating seamlessly with your own system, the Series 4000 Voice Recognizer adds simultaneous voice input to keyboard data entry for virtually any mainframe, mini, micro or personal computer. It loads voice patterns and applications vocabularies

directly from your host system, or from its own reusable CMOS voice cartridges. Users simply drop their own cartridges into the Series 4000 Voice Recognizer console and it instantly responds to verbal commands despite accent, dialect, or interference from loud background noise.

Simple software tools let you create custom vocabularies.

With our Series 4000 Voice Planner™ software, you can program vocabularies for any customer application. Voice Planner software runs on IBM® PC, PC compatible, and DEC VAX™ systems, and is readily adaptable to other computing environments.

True continuous speech recognition: the key to your success.

With Verbox, the user inputs data in a natural voice, so there's no risk of fatigue or irritation caused by the staccato diction that other products require. And while others may claim it, only Verbox's patented continuous speech recognition achieves this natural man/machine interface without sacrificing accuracy or vocabulary size.

For details on the Series 4000 or our OEM/VAR programs, call toll-free 1-800-343-4458. In Mass., call (617) 275-5160. Or write on company letterhead and ask for a free video tape of voice applications. Verbox, Two Oak Park, Bedford, MA 01730.

Verbox

A DIVISION OF EXON ENTERPRISES

Voice Planner is a trademark of Verbox. IBM is a registered trademark of International Business Machines Corp. VAX is a trademark of Digital Equipment Corp.

CIRCLE NO. 54 ON INQUIRY CARD

THE ONE &

UNIX SYSTEM V. FROM AT&T. THE

There's only one UNIX System V. The one created and supported by AT&T. The one fast becoming a universal standard.

It's another reason why good business decisions are based on UNIX System V.

In more ways than one, it pays to make certain that the products you offer are based on UNIX System V. It is the stable foundation on which all of our future enhancements will be developed. It's here to stay because we pledge that our future software enhancements will be compatible with it.

Configure your systems now with products based on UNIX System V and you'll be at the forefront of its establishment as a worldwide standard. AT&T has expanded its role in markets in Europe, Japan, and the Far East to create opportunities for machine-independent, portable solutions to operating system needs. Around the world you can profit from our initiatives when you invest in UNIX System V solutions.

On the inside track

If you develop products based on UNIX System V, you'll be in

on the latest advances from the custodians of the UNIX System standard. A growing number of microprocessor ports to choose from. Expanded networking capabilities. A growing number of applications packages from software vendors. And, the power of the system that spans generations of machines as well as models and sizes—from micros to mainframes.

Service from the source

Along with its various technical and commercial advantages, UNIX System V offers something the other systems can't match—

SYSTEM V

ONLY

STANDARD BEARER.

the full backing of AT&T.

That includes worldwide support and training programs. Our commitment to work with computer manufacturers and resellers as well as user groups to develop standard products for the future. And for software vendors writing applications programs, a complete service and support program from AT&T.

The one and only from AT&T is UNIX System V—backed by AT&T service and support—designed to make UNIX System V the one for one and all.

For more information on UNIX System V from AT&T,

send in the coupon.

**UNIX System V. From AT&T.
From now on, consider it standard.**

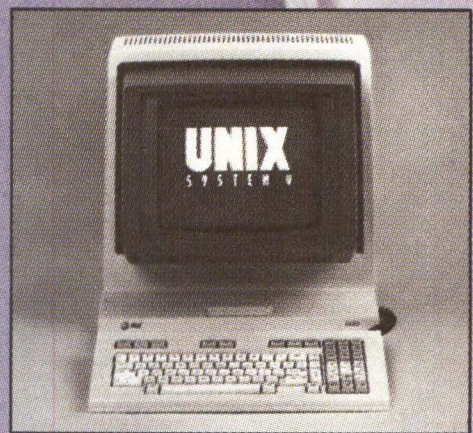

Please send me "UNIX Software."
Mail to: AT&T, Box 967, Madison Square Station
New York, New York 10159

Name _____

Title _____

Department _____

Company _____

Address _____

City _____ State _____ Zip _____

Phone _____

UNIX™ System Licensee Yes No

Don't Know

MS-0300-FF

The full-time computer for part-time users

Not everyone who needs a personal computer in your company needs one full time. That's why full-function COMPAQ® portable computers give you more for your money than most desktop computers. They're built tough enough to share.

In a single day, your research department can use a COMPAQ portable to access information, accounting can borrow it to track receivables, and marketing can take it to make sales forecasts. Everyone can use it as an "extra" computer to take home or on the road.

COMPAQ's unique cross-braced aluminum frame, shock-mounted disk drives and outer case molded from the kind of plastic used to make bulletproof windows help it withstand the rigors of being passed around.

Plus COMPAQ portable computers are software and hardware compatible with the IBM® PC and XT, offer high-resolution text and graphics on one screen, and can expand to 10 megabytes of storage.

No wonder they outsell the IBM Portable Computer in retail stores by 6 to 1.

Every small company should have one. Large companies should have one for every department.

So check it out. For a free brochure or for the location of your nearest Authorized COMPAQ Computer Dealer, call 1-800-231-0900 and ask for Operator 2.

COMPAQ®

It simply works better.

COMPAQ® is a registered trademark and COMPAQ PLUS™ is a trademark of COMPAQ Computer Corporation. IBM® is a registered trademark of International Business Machines Corporation.

©1985 COMPAQ Computer Corporation

VERTICAL MARKET INTEGRATOR

*Applying integrated systems
in industry, engineering and commerce*

PC NETWORK OUTPERFORMS UNIX

Novell provides multiuser functionality using file-server operating system

C.A. Harshman, Reliable Data Systems Inc.

Early last year, Reliable Data Systems Inc., a systems house and software supplier in Los Altos, Calif., began considering the feasibility of supplying large-scale, full-featured, multiuser business systems software on the IBM Corp. PC and work-alikes. Reliable had adapted Mini-Computer Business Applications (MCBA) Inc.'s integrated packages, written in COBOL, from minicomputer and superminicomputer environments to run under UNIX. So one solution would seem to have been to run the integrated packages under UNIX on the PCs.

However, after examining current offerings of UNIX on the PC and the PC/XT, Reliable concluded that the UNIX versions were inadequate because they did not provide enough processing power, and, consequently, response time to users was too long. Reliable also found that the UNIX products could typically support only two or three users at a time and could execute only a limited number of applications simultaneously because of space limitations.

As an alternative to UNIX, Reliable considered the possibility of running the software on a network of PCs. One reason for considering this approach was that, according to Reliable's projections, configurations of networked PCs will soon become commonplace in the company's target market—organizations grossing \$1 million to \$50 million in revenues. In addition, with

networking, Reliable would be able to add significant computing power at each node as the network expanded and the number of users grew.

Nevertheless, the networked approach might involve some disadvantages. For one thing, Reliable had to consider whether the architecture of networked PCs would be adequate in multiuser facilities, particularly when users required shared-file support. Networked PCs might also degrade performance, especially in applications calling for fast file-access response time. The company wanted to ensure that users on the networked system would have access to all the features and functions of the software that the UNIX system would offer, without simplifying or pruning the source code. Thus, the network users would see no difference from UNIX in the service at their terminals. Reliable had satisfied this condition in its previous UNIX port and wanted to preserve uniformity across the product line.

File-server software is key

After deciding on a networked approach, Reliable's next decision was to choose the network. The testers based their choice on software for the network file server, for which they stipulated five essential criteria:

- support of full COBOL multiuser facilities
- file- and record-locking
- adequate backup/restore facilities

Response to functions requiring only local CPU service within the PC was immediate.

- expandability of disk storage
- user-dependent file-access controls

After a survey of available systems, Reliable chose the Novell Inc. NetWare file-server operating system as the software that best met all of the criteria (MMS, May 1984, Page 161). Via Novell's modified run-time version of Ryan-McFarland Corp.'s RM/COBOL, NetWare accepted the current embedded file-control commands in the application code without further modification. In addition, the NetWare system is available on all major networks—Corvus Systems Inc.'s Omninet, Davong Systems Inc.'s ARCnet, Gateway Communications Inc.'s G-Net, 3Com Corp.'s EtherLink, Nestar Systems Inc.'s PLAN 2000, Novell's Netware/S, Orchid Technology Inc.'s PCnet and Proteon Associates Inc.'s proNet—which would allow Reliable to give customers their choice of network hardware.

To test the network approach, Reliable chose MCBA's general ledger package, which consists of 2½M bits of source code and can support as many as 10 users at once. Although the general ledger package had been ported from a mini-computer to a Motorola Inc. 68000-based UNIX system, Reliable had to perform a substantial amount of additional work to bring the package up under the PC-DOS/NetWare/RM/COBOL environment. In addition to revising file names and extensions, Reliable had to rewrite a collection of routines to replace the system-service routines in the original environment—an ap-

proach used in Reliable's previous UNIX ports. Similarly, a convenient extension in the run-time RM/COBOL allowed the addition of duplicate extensions to the run-time library for the PC-DOS environment. After completing these revisions, Reliable performed extensive testing, using detailed scenarios, to complete this phase.

Testing the network

The testers used an IBM PC/XT running NetWare as the file-server hardware and, for workstations, IBM PCs running PC-DOS. The network hardware was Gateway's 1.2M-bit-per-second (bps) linear local area network (LAN). To perform the tests, the testers first ensured that the networked PCs preserved all the functionality of UNIX in the single-user mode. The testers expected that to be the case because no source-code changes were permitted. The testers then went on to the multiuser mode, with special attention to file- and record-locking protection. The tests revealed that a user sitting at the networked PC terminal would have difficulty distinguishing whether he was using UNIX or NetWare.

Reliable also found response times to be good. Response to functions requiring only local CPU service within the PC was immediate, and the time for functions requiring file service depended on the amount of data transfer required. Response time for simple transfers, such as storage or retrieval of accounting data, was a fraction of a second, and larger transfers, such as program-module loading, took 1 to 2 seconds—comparable with response times for UNIX. Adding users up to the limit of Reliable's test configuration of four nodes did not significantly affect response times. This is because response time degradation is gradual until a system reaches either the saturation point of network communication bandwidth or the limit of disk accesses.

The NetWare monitor provided a real-time indicator of the file-server machine's percentage of use. For the test, the indicator showed a utilization range of 5 percent to 10 percent per user, depending on the user's activity level. Adding users caused the percentage to increase. With four users, the indicator hovered at around 30 percent. With this information, the testers extrapolated that six to eight users would be a safe load for the PC/XT file server. Faster machines, such as the PC-AT or Compaq Computer Corp.'s Deskpro desktop computers, and higher-speed networks could handle more users.

In comparing the PC network to UNIX, Reliable's testers found the network approach to be better, although a comparison of the two approaches for multiuser applications would re-

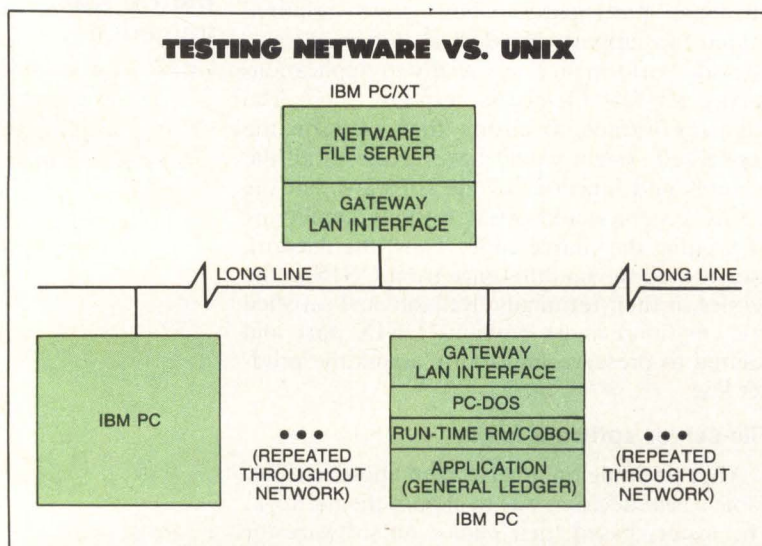

Reliable used an IBM PC/XT running NetWare for the file-server hardware to test the network of PCs and, for workstations, IBM PCs running PC-DOS. The network hardware was Gateway's 1.2M-bit-per-second (bps) linear LAN.

WINCHESTER, FLOPPY AND TAPE All on one board

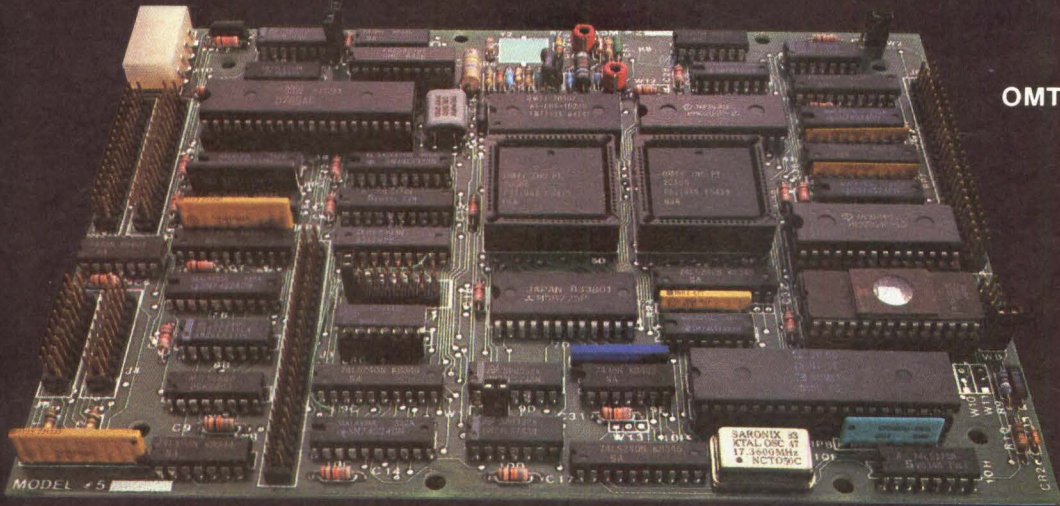

OMTI 5400

Our OMTI 5400 SCSI (SASI) controller offers Winchester, floppy and tape support all on a single 5 1/4" footprint PC board. By using our proprietary VLSI chip technology, we were able to squeeze all these functions onto a board size that most controller companies are still using for single function controllers. This means increased capability and improved cost-effectiveness in your application.

As a forward-looking OEM, you want multifunction SCSI (SASI) data controllers that meet your needs today and can meet the challenges of future developments in peripheral device technology. As you would expect, we've applied our new technology to meet these challenges in a whole family of SCSI (SASI) data controllers, the OMTI Series 5000.

UNBEATABLE FLEXIBILITY

Our OMTI Series 5000 family of SCSI (SASI) controllers supports industry standard ST506/412 5 1/4" fixed and removable Winchester disks, 5 1/4" and 8" floppy disks and QIC-02 compatible streaming tape. Each controller is SCSI (SASI) compatible to protect your software from change as you add next generation disk and tape technologies. And they are all second-sourced to guarantee availability.

HIGH PERFORMANCE

The Series 5000 controllers provide consecutive sector, non-interleaved data transfer and multisector buffering between host and peripherals. In addition, our data buffer supports simultaneous transfers between Winchester and streaming tape for fast image backup operation. No other manufacturer offers you performance like this!

EASY TO USE

Our high-level SCSI (SASI) command set off-loads your host CPU. Only one command is required to completely backup or restore Winchester data to and from tape, all without host intervention. Separate host-initiated commands allow selective file backup and restore. A sophisticated 32-bit ECC and automatic error retry means that reliable data is always available to the host. Finally, automatic Winchester flaw management handling prevents disk defects from corrupting your system.

To learn more about the OMTI Series 5000 data controllers, please contact us for additional information.

OMTI 5100
Winchester



OMTI 5300
Winchester
plus Tape

OMTI 5200
Winchester plus Floppy

OMTI
A Subsidiary of
Scientific Micro Systems, Inc.

339 N. Bernardo Avenue, Mountain View, CA 94043 (415) 964-5700

SALES OFFICES: Seattle, WA (206) 883-8303; Boston, MA (617) 246-2540; Atlanta, GA (404) 296-2029; Morton Grove, IL (312) 966-2711; Melrose Park, IL (312) 345-5320; Arlington, TX (817) 429-8527; Laguna Hills, CA (714) 643-8046; Greensboro, NC (919) 292-8072; Mountain View, CA (415) 964-5700; Philadelphia, PA (215) 860-8626.

DISTRIBUTORS: United States-Arrow Electronics, Inc. (516) 694-6800; Canada-Allan Crawford Associates Ltd. (416) 678-1500; International-Prima International (408) 732-4620.

CIRCLE NO. 56 ON INQUIRY CARD

FIVE AGAINST ONE

It Hardly Seems Fair

Five against one is just as unfair in a business environment as it is on a basketball court. IBC's Multi-Star I™ five user business computer—priced as low as a single user personal computer with all of the attributes of a true multi-user system has the full court advantage.

The Multi-Star isn't just another single user personal computer that can be "Networked" to pretend you have multi-user capabilities. It is a true multi-user business system like the high priced multi-user mini-computers of old. And, a low cost "Dumb" CRT terminal is all that you need for each user.

Sophisticated multi-user software with big system features such as record locking, user accounting, privilege levels, and system security provide capabilities well beyond those available on any personal computer.

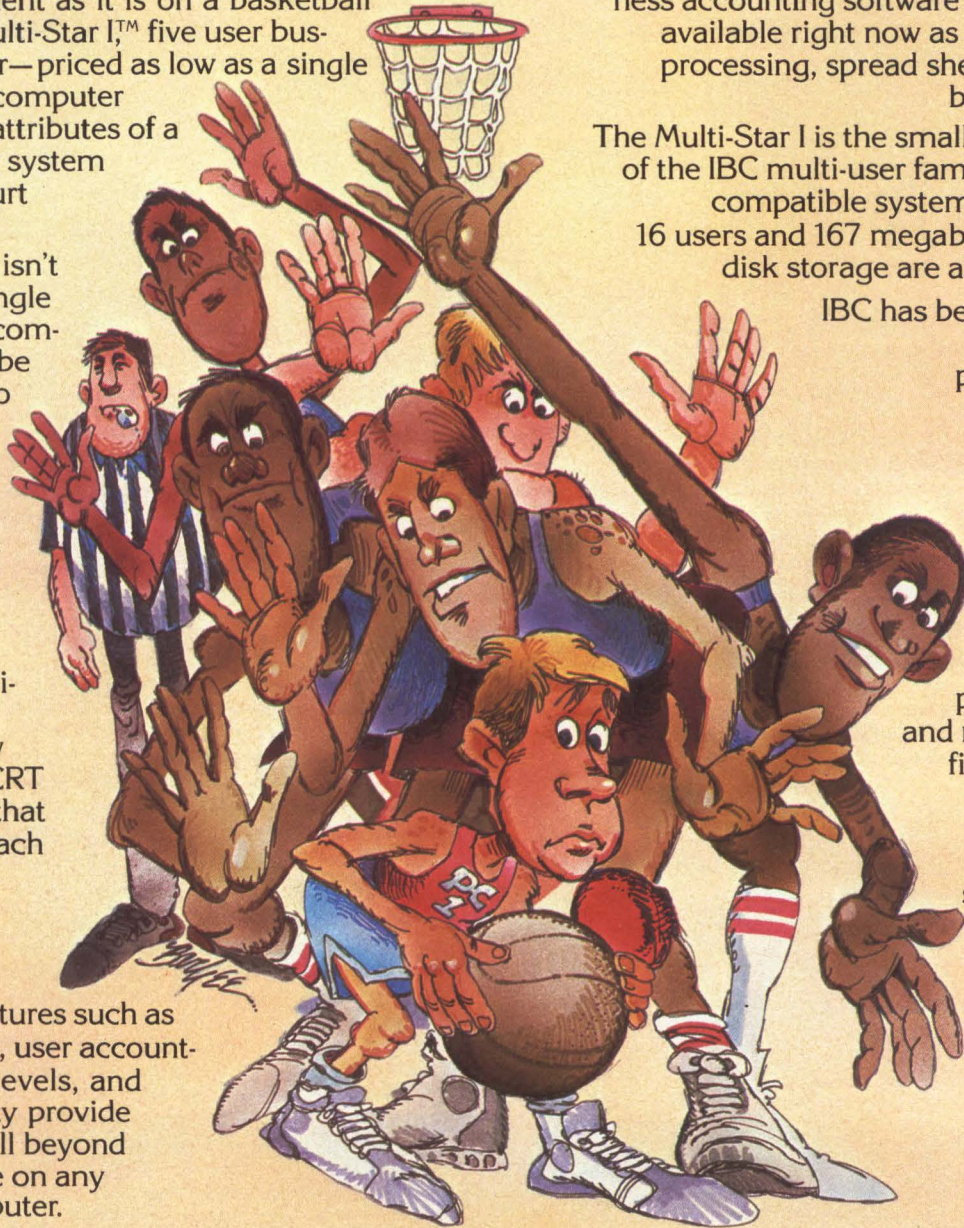

There are hundreds of multi-user business accounting software applications available right now as well as word processing, spread sheet, and data base software.

The Multi-Star I is the smallest member of the IBC multi-user family. Software compatible systems with up to 16 users and 167 megabytes of hard disk storage are also available.

IBC has been manufacturing high-performance, multi-user micro-computers since 1979.

Their reputation has been built on quality, performance, and reliability. To find out more about the multi-user business systems that is priced like a single user personal computer, please call or write:

IBC

Integrated Business Computers
21621 Nordhoff Street
Chatsworth, CA 91311
(818) 882-9007
Telex No. 215349

quire a more thorough analysis of program and data traffic. Among the results, the testers found that, as more users sign on to UNIX, the two major system resources—CPU time and file-access I/O handling—must be allocated and shared. This reduces the availability of those resources to current users. With the network approach, users must share only the file-service resources because the additional node supplies its own CPU. Thus, each additional user of the network adds more CPU resource.

As a result, the network behaves as a single-user system at each node with a full processor devoted to each user, except for data file-access functions, which the network provides via the shared file server. Therefore, an increase in file traffic as more users sign on can degrade the system's performance, but an increased computational load cannot.

Another advantage of using the network involves file-server resources. NetWare provides a cache system that further enhances performance—a technique not available on standard UNIX.

Reliable found UNIX and its tools unsurpassed for the creation of integrated software packages. UNIX's facilities, such as "make," "sed" and "sh," greatly speed conversion and help support ongoing maintenance. For end users, however, the simplicity of DOS and the growing wealth of software that runs under it is appealing. The test case proved that a network of PCs is viable for large-scale software applications. Large-scale programs can run in a multi-user environment without sacrificing function or performance using networking and NetWare. Thus, networks allow companies to begin with simple applications, such as word processing and spreadsheets, and expand gracefully up to very large full-function business software.

Looking at the future

On the basis of the results achieved in the test case, Reliable will begin to supply MCBA's accounting and manufacturing support packages on a variety of networks, thus providing users with a fully integrated line of business software. In addition, users can employ network technologies other than NetWare that would work with corresponding performance. Without changing software, users could employ technologies with data-transfer rates of 200K to more than 10M bps. Future broadband technologies promise even further extension, and the technology to link diverse networks is now emerging.

Reliable predicts that UNIX and DOS will grow more similar. Software companies are now beginning to supply sophisticated file-server

software that offers much of the multiuser appeal of UNIX and utilities that add some of the UNIX tool-kit functions to DOS. Meanwhile, they are extending UNIX to interface to LANs, and shared file-storage and file-transfer facilities are emerging.

Users can also obtain multiple file servers that provide effective data backup. Reliable also expects transparent data backup on a duplicate file server to become available soon, thus affording a degree of protection from data loss that UNIX does not yet provide. □

The simplicity of DOS and the growing wealth of software that runs under it is appealing.

C.A. Harshman is founder and president of Reliable Data Systems Inc., Los Altos, Calif., an MCBA software distributor for UNIX and PC-network-based systems. Harshman was formerly consultant to Centigram Corp., Sunnyvale, Calif., for systems product development.

Interest Quotient (Circle One)
High 471 Medium 472 Low 473

Yes! Mupac
has everything you need
for Multibus* Compatible
Packaging...



This flexible, compact and reliable packaging system can handle from 2 to 26 panels in easy to use modular increments. Features include panel guides on .60 and .75 inch centers, a backplane designed to eliminate crosstalk and noise, terminated bus lines and provision for parallel priority. Look to Mupac for multiple solutions to Multibus Compatible Packaging. Call or write for complete details today!

*Multibus is a registered trademark of Intel Corporation.



MUPAC

10 Mupac Drive, Brockton, MA 02401
TEL (617) 588-6110 TWX (710) 345-8458

**WHAT GOOD IS
THE LATEST
DISK DRIVE
IF IT ARRIVES
TOO LATE?**

Our 3 1/2" floppy
won't keep you waiting.

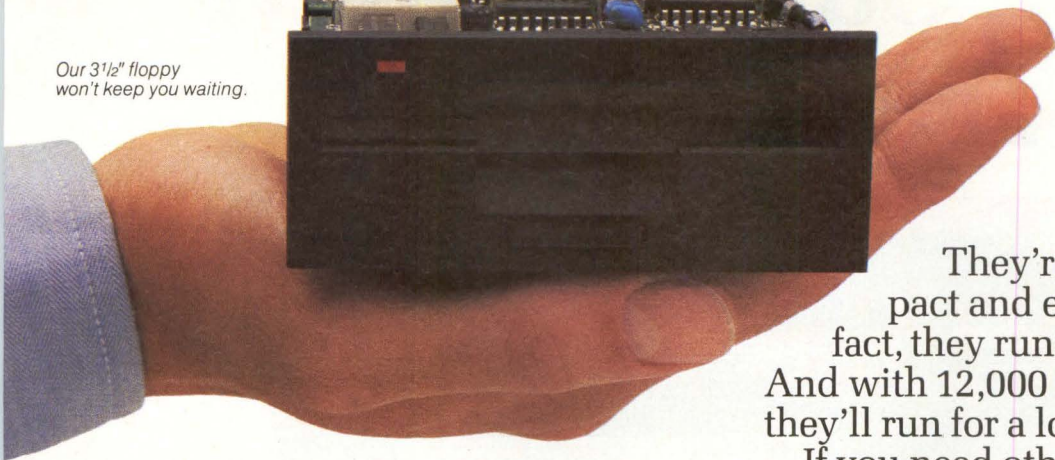

Not a lot of good, obviously. But that's how some disk drive suppliers do business.

They announce a new drive. Everyone gets excited. Everyone places an order. And then everyone waits. And waits.

At NEC, we do things differently.

When we announce a new drive, we deliver.

It's that simple. No games. No false alarms. And very little waiting.

Just the newest disk drive in your hands. Ready to go.

Why do we do it?

Because time is precious. Yours. And ours. And there are better ways to spend that time than waiting for phantom disk drives.

That's what experience teaches you. And we've got over 25 years experience. Way back in 1959, we were one of the first to develop magnetic recording devices.

Today we're an \$8 billion company. And that means we're in this business for the long run.

Now we're delivering our 3 1/2" floppy.

How many do you want? This year, we're ready to deliver thousands of our new 3 1/2" drives.

CIRCLE NO. 59 ON INQUIRY CARD

They're low-cost, compact and energy efficient. In fact, they run on just 3.4 watts. And with 12,000 hours MTBF, they'll run for a long, long time.

If you need other disk drives, NEC also makes 5 1/4" Winchester and floppies, 8" Winchester and floppies, and 9" Winchester.

Shorten your drive time with NEC.

So why wait any longer? Call 1-800-343-4418. (In Massachusetts call 617-264-8635.) Or fill out the coupon below.

And find out why more and more OEM's are saying, "NEC and me."

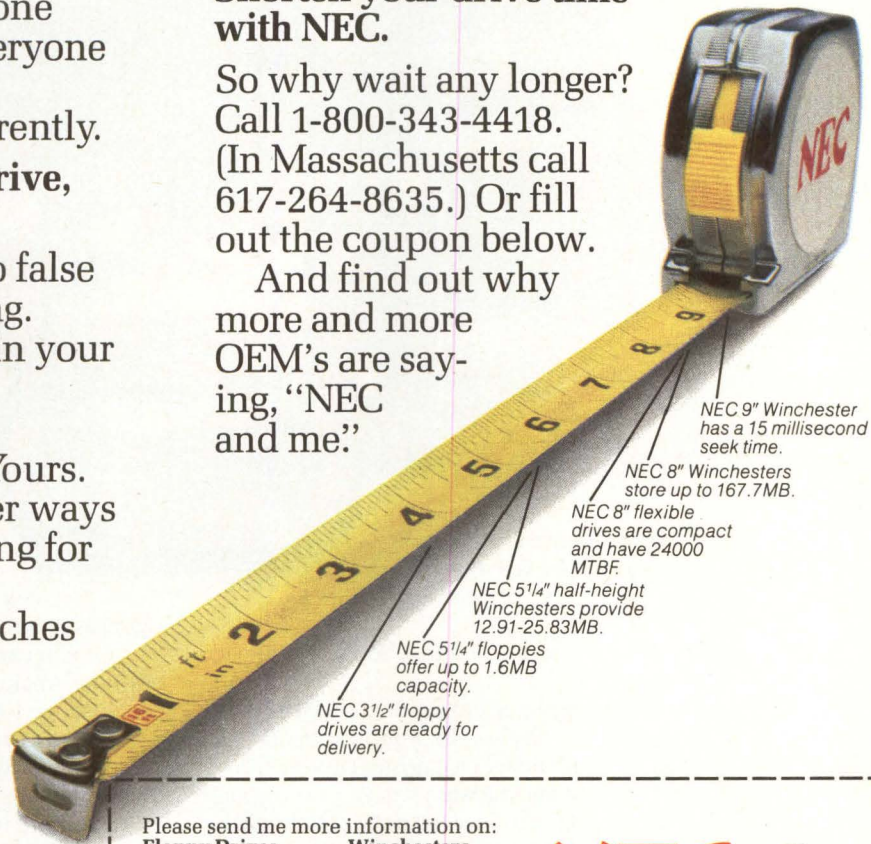

NEC 9" Winchester has a 15 millisecond seek time.

NEC 8" Winchester store up to 167.7MB.

NEC 8" flexible drives are compact and have 24000 MTBF.

NEC 5 1/4" half-height Winchester provide 12.91-25.83MB.

NEC 5 1/4" floppies offer up to 1.6MB capacity.

NEC 3 1/2" floppy drives are ready for delivery.

Please send me more information on:

Floppy Drives

- 3 1/2"
- 5 1/4" half-height
- 8"

Winchesters

- 8"
- 5 1/4" half-height
- 9"

Name _____

Title _____

Company _____

Address _____

City _____

State _____ Zip _____

Tel () _____

**NEC
AND
ME**



NEC Information Systems, Inc.
1414 Massachusetts Avenue
Department 1610
Boxborough, MA 01719

Going out for a drive? Travel light.



Now you don't have to go out of your way to find a complete line of fast, accurate floppy disc drive diagnostic and alignment tools.

Dysan makes them all. And they're all so compact they fit in a briefcase.

Which makes them perfect for field service.

Or (without the briefcase) for your test bench.

For instance, our Digital Diagnostic Diskette (DDD™) with appropriate software lets you zip through digital tests like head positioner linearity. Head radial alignment. Diskette centering. Head azimuth alignment. Index timing. All in just minutes.

And you get the results right on the screen of the machine you're testing.

Our Interrogator™ is a DDD packaged with menu-driven software and instructions that simplify drive tests on the IBM® PC and XT, Zenith Z/H 100 Series, Osborne® 1 (and more to come).

The hand-held Performance and Alignment Tester (PAT-2+™) and the DDD enable you to step through a

complete series of drive diagnostic tests. Plus performance tests like read/write data handling capabilities and rigorous head positioner testing.

Or you can use the PAT-2+ as a drive exerciser with our Analog Alignment Diskette (AAD™) and an oscilloscope for precision drive alignment.

Dysan's drive diagnostic and alignment tools.

Whether you go out for a drive or just walk over to the test bench, take them along.

For more information or to place an order, call toll free, 800-551-9000.

Dysan Corporation, 5201 Patrick Henry Drive, P.O. Box 58053, Santa Clara, CA 95050, (408) 988-3472.

Dysan®

**Somebody has to be better
than everybody else.**

Dysan is a registered trademark, DDD, Interrogator, PAT-2+, and AAD are trademarks of Dysan Corporation. IBM and Osborne are registered trademarks of International Business Machines Corporation and Osborne Computer Corporation, respectively.

© 1984 Dysan Corporation

CIRCLE NO. 60 ON INQUIRY CARD

VERTICAL MARKET INTEGRATOR

DISK DRIVE SCORES HIGH WITH VIDEO GAME MAKER

A 160M-byte fixed disk drive solves problems that an 8-inch Winchester couldn't handle

George Kunstadt, Alpha Data Inc.

In 1983, electronic engineering and computer science company Cheshire Engineering Corp., Pasadena, Calif., faced a problem of overburdened equipment. Although business was going well for the fledgling computer game developer—with three games on the market within 18 months of start-up in 1982—the computer system the company had chosen couldn't handle increased demands. As a result, the company, which was working on two more games, the real-time control software for a videotape recorder/animation controller and several other applications, had to turn away potential business.

Cheshire's system comprised a Digital Equipment Corp. (DEC) PDP-11/23 minicomputer, an 8-inch, 20M-byte model 880/20 Winchester disk drive from Data Systems Design (DSD) Inc. and a Cipher Data Products Inc. floppy disk drive backup. This configuration, although inexpensive and reliable, lacked adequate speed and performance.

Cheshire employees tested the system to track down the problem. The results showed that the system's weakest component was its disk drive. With 10 employees working on the system, often simultaneously, the drive could not always respond to the heavy load of requests. The system would "clog up" while doing payroll and other financial work, halting programming, editing and word processing. Otherwise, "the drive seemed to rattle along all day, spending most of its time seeking files rather than retrieving them," says Cheshire software design engineer Larry Zwick.



Using a 50-head, 160M-byte Atlas fixed disk drive from Alpha Data, Cheshire Engineering claims to improve user response rate by 70 percent over the company's previous, 8-inch Winchester-based system.

As a result, the company began looking for a higher performance, higher capacity disk drive. At the time, says Cheshire president and co-founder Shal Farley, the Atlas fixed disk drive from Alpha Data Inc., Chatsworth, Calif., was the highest capacity and fastest drive for the money on the market. "The only other one that we considered was the Fujitsu Eagle [10½-inch, 474M-byte Winchester]," he says. But the Eagle was selling for \$12,000 compared with the Atlas'

\$8,000 price tag, so Cheshire purchased the Atlas.

The Atlas has 50 read/write heads—instead of the 10 or fewer typical on more conventional fixed disk drives. As a result, it responds two to five times faster than conventional mass-storage devices in a high-demand, multiuser environment, claims the company. The drive employs three disks, or platters, on which float the 50 moving heads and four clock heads driven by a rotary actuator. The heads can be stepped to 160 cylinders, or 8,000 tracks. In contrast, other mass-storage drives typically employ 10 heads and must step to 800 cylinders. The Atlas can write or read 1M byte of data almost instantaneously without head movement and has an average on-line access time of 18 msec under normal demand conditions.

When a user turns on the Atlas, it automatically comes up to speed, resets itself, initializes its counters and immediately begins to read or write. Its electronic circuits are packaged on printed circuit boards that can be changed easily. The electronic circuits are designed to simplify the controller interface; thus, the disk performs many functions conventionally performed by the controller or formatter. In addition, the drive's

components are enclosed in a sealed, shock-mount, suspended head/disk assembly that prevents the entrance of contaminants, allowing the drive to operate in dusty environments with widely fluctuating temperatures without the need for air conditioning or filtering.

Drive speeds programming

The Atlas' 50-head configuration works better than a 10-head system because the 50 heads radically reduce the amount of arm movement the drive must make. This enables the drive to accommodate 70 percent more user requests than the Winchester had accommodated (see "Fifty heads are better than 10," below). In contrast, the Winchester that Cheshire previously had used caused the computer to become "disk-bound"—overloaded with disk commands—especially when Cheshire programmers wanted to use the system for their main task of programming.

In developing programs, each Cheshire programmer must access the disk drive hundreds of times a day. With the old system, this could be time-consuming because of long disk access time. More important, this time increased as more users made requests, causing a frustrating

Fifty heads are better than 10

The main difference between the Alpha Data Inc. Atlas drive and other drives of similar capacity is that the Atlas employs 50 heads. This is important because most computer transactions require disk access; thus, disk speed significantly affects computer transaction speed.

On most disk drives, a moving element, such as an arm or a sliding carriage, carries several heads across the disk surface to cover every available track on all surfaces. A typical disk structure might include three platters, totaling six surfaces, of which five might be used for data recording. If two heads service each of these five surfaces, the total number of heads would be 10. With 10 heads, the moving elements must traverse only half the available radial disk space to cover the entire recording area.

For a storage-module-device drive, a track typically has a capacity of 20K bytes. This means that a drive with 10 recording heads can read or write 200K bytes of data without head movement. Access to data beyond the 200K-byte limit requires movement of the 10-head assembly to the next requested 200K-byte cylinder, followed by a search along the track until the desired sector appears under the recording head. At

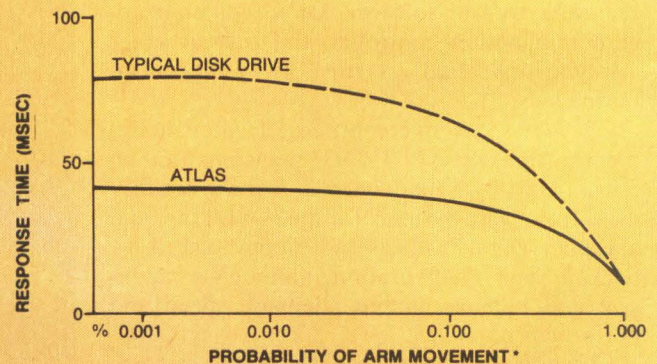

*COMPUTED AT 18 REQUESTS PER SECOND

SOURCE: ALPHA DATA INC.

A comparison of the Atlas drive's response time with that of a typical storage-module-device drive shows that the disk request will result in head movement. The Atlas' response time is typically 60 percent of the SMD drive's response time. The curve is plotted for a moderate rate of 18 requests per second.

wait for computer operators and programmers.

To program for Cheshire, a programmer first writes a block of code, called a module. It might, for instance, describe the pictures and graphics for a computer game. The programmer then tests the program by assembling the module on the main system, translating what he has written to machine-readable form. The Atlas disk drive performs this assembly function at least two times faster than did the DSD drive, claims Cheshire. Next, the programmer links the module to the other modules in the program. Finally, the programmer down-loads the modules to the development system.

Cheshire programmers must also debug the programs they write. The Atlas drive's fast response time aids in the debugging chore because it allows programmers to debug on a one-bug-at-a-time basis. With the old drive, a response delay of 20 seconds to 10 minutes forced programmers to "save" errors for debugging all together at the end of the program. Saving errors, in turn, meant lost time and caused programmers to lose their concentration.

Cheshire ran some tests to measure the performance improvement of the Atlas drive over the old drive. Programmers developed a program to

count the requests the computer made and inserted that program into the point in the operating system at which requests are made. Using a timer board, they measured how much time the computer spent waiting for the disk drive to transfer data. The previous Winchester disk took an average of 70 msec per transfer, whereas the Atlas disk averaged 16 to 20 msec, depending on how many employees were using the system at once.

The testers made the same measurement during the backup operation that saves each day's work. Because this operation involves large chunks of data, it requires greater disk movement than most other operations. The testers found the old disk's average transfer time to be 134 msec, while the Atlas required 22 to 24 msec.

The tests at Cheshire also revealed that roughly 40 percent of the requests made to a time-sharing system are for only 1K byte of data. The disk drive takes the same amount of time to find an address, regardless of the length of the block of data in question. As a result, requests for short data blocks necessitate fast access.

Another test result showed that the previous disk drive hadn't kept up with the streaming tape

The Atlas drive's fast response time aids in the debugging chore because it allows programmers to debug on a one-bug-at-a-time basis.

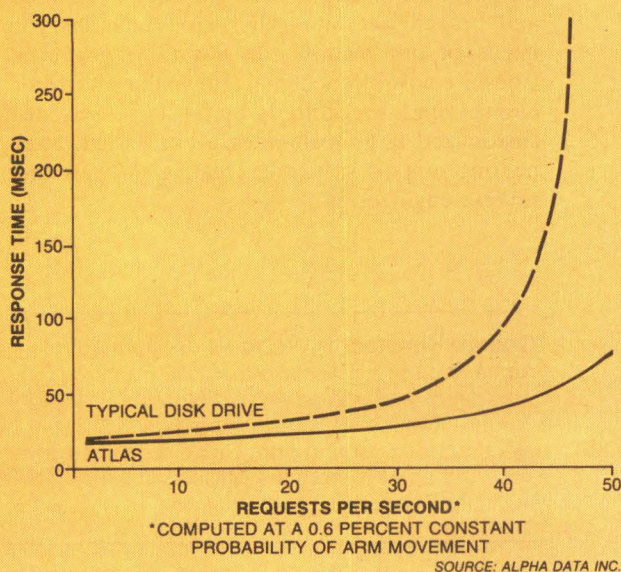

As the request rate rises to about 40 per second, the response rate of the typical storage-module-device drive increases dramatically, while that of the Atlas rises only slightly.

this point, reading or writing can begin, typically at 1M byte per second.

Thus, the average elapsed time from the instant the computer makes a request for the disk until the data is read is a total of access time, rotational latency time, data-transfer time and the time that this request must spend waiting in the queue before an operation can begin. Based on the likely assumption that the disk will be busy at the time this request arrives, the total elapsed time can vary from 20 msec to a few seconds.

At a request rate of 40 per second, the 50-head Atlas achieves a response time of approximately 40 msec because the heads can be stepped to 160 cylinders, containing 8,000 tracks. It speeds execution time because it reduces by five the need to perform stepping at all. A conventional disk, on the other hand, becomes so overloaded with requests that it cannot keep up with them. For every 40 new requests, it completes only 11. As time goes on, the queue becomes longer, the response time becomes longer, and the computer becomes hopelessly "disk-bound." Under the same high-volume demand conditions, the Atlas shows only a moderate increase in response time.

Although much larger in capacity than the Winchester, the Atlas can transfer a larger amount of data to the backup unit in the same amount of time.

drive that had been used for daily backup. Although the company employees considered the tape drive slow, they were surprised to find that the Winchester was even slower. The Winchester's slowness caused the tape drive to make several mechanical starts, stops and repositionings during backup to accommodate the pace of the Winchester. Although much larger in capacity than the Winchester, the Atlas can transfer a larger amount of data to the backup unit in the same amount of time, according to Cheshire vice president Will McCown.

The tests also revealed that the new drive excels in handling the increasing number of employees using the system. As in most other time-sharing systems, the CPU lacks sufficient memory to handle all users' requests at once. To solve the problem, the computer usually saves the information of active users and copies inactive users' requests from memory images on the disk. When inactive users again become active, they often have to wait for the computer to access the information from the drive. The DSD

drive took 0.10 second to access this information, which can become prohibitive when 10 users are using a system at once. The Atlas drive, on the other hand, takes 30 msec.

Cheshire estimates that using the Atlas drive yields a time savings of 5 percent to 10 percent per day per employee compared to the DSD drive and that the Atlas costs less. As a result, the company can propose lower bids on contracts and still increase its profit margin. In a recent hypothetical test, Cheshire found that it could charge customers about 5 percent less than it had previously for a 13-week, 500-hour project while maintaining a 5 percent greater profit margin.

Planning for the future

Cheshire has upgraded its PDP-11/23 system to a 16-bit DEC PDP-11/70, which has more memory than the PDP-11/23. The PDP-11/70 is connected to the staff members' terminals—10 DEC VT101-compatible model CIT 101 terminals from C. Itoh Electronics Inc. But company executives plan to expand the company, and they will continue using the Atlas disk drive because it can support as many as 20 users. Moreover, the company will begin to focus on applications other than computer games.

"Two years ago, electronic games were hot," says McCown. "But now the market is changing. With the time and dollar savings we are achieving [with the Atlas], we can continue to develop and branch out into other areas meeting the needs of our clients." In addition to games, Cheshire now offers digital and analog electronic engineering, specialized digital logic systems, customized large-scale-integration design, engineering support software, creative software and reverse-engineering. □

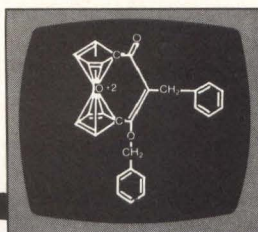

The Graphics Link between your IBM PC and your Computer Network

PC-PLOT TEKTRONIX 4010 Terminal Emulator for your IBM PC

Your IBM Personal Computer becomes a powerful graphics workstation with PC-Plot and your mainframe graphics software from ISSCO, SAS, Precision Visuals, or Tektronix. Allows direct access to CAS OnLine and Questel DARC chemical databases. Save picture files on PC diskette, redraw on IBM printer or Hewlett-Packard 7470A plotter. Includes VT-100 emulation and autodial modem support.

Call for immediate shipment with purchase order number or VISA/MasterCard number or send check.

Call or write for complete technical brochure.

\$95 plus \$3 shipping

For information call: 800-633-2252 ext 260



2152 E. DUBLIN GRANVILLE RD. SUITE 205 COLUMBUS, OHIO 43229 614-882-4786

George Kunstadt is president and founder of Alpha Data Inc., Chatsworth, Calif. Previously, he was director of engineering at General Precision Singer Librascope. Kunstadt holds a B.S. in electrical engineering from City College of New York and an M.S. from the Massachusetts Institute of Technology.

Interest Quotient (Circle One)
High 474 Medium 475 Low 476

SIEMENS

The Finishing Touch!

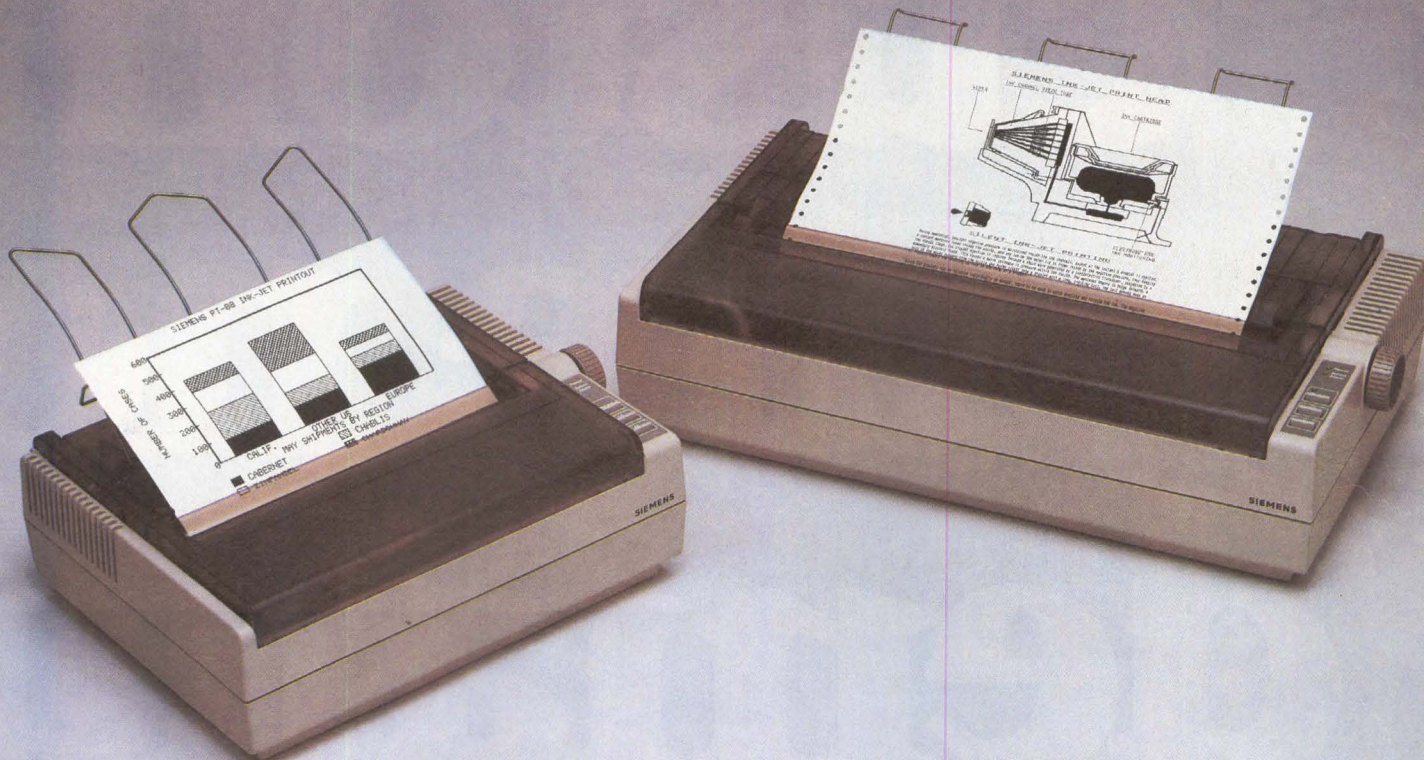

A golden opportunity to include Siemens PT-88/89 printers in your OEM system.

In today's "look-alike, sound-alike" PC systems market, the printer you select for OEM system integration reflects the importance you place on superior performance and long-term reliability. In fact, anything less than a quality printer not only compromises your system's total performance...it undermines customer perception of your system in a highly competitive marketplace.

That's why you owe it to yourself, and the success of your system, to make our incomparable PT-88 ink-jet printer...or the wide-carriage PT-89, part of your OEM system package. Just look at these unique features designed to enhance your system's performance...and give it the all-important "competitive edge":

- Ultra-silent operation (≤ 45 dBa)
- Exceptionally high reliability...the print head is rated in excess of 10 billion characters!
- High speed (150 cps bi-directional) performance
- "Drop-on-demand" ink-jet quality printing...crisp, clean, consistent
- IBM-PC, EPSON, and other compatibilities available
- Full graphics capability
- Multiple interfaces
- Friction/traction or roll paper capabilities
- Downloadable character generator
- Siemens quality at no extra cost.

And here's more good news! Siemens PT-88/89 ink-jet printers offer OEMs the cost pricing benefits of high value-added reseller (VAR) margins. And of course, PT-88/89 printers are fully warranted and backed by one of the world's largest technical service/support organizations.

Take advantage of this golden opportunity. Fill out the attached postcard for our detailed information package on the PT-88/89 ink-jet printers.

Or call toll-free: 1-800-343-4300, ask for Operator Number 236.

Siemens Communication Systems, Inc.,
Office Systems Group, 5500 Broken
Sound Blvd., Boca Raton, FL 33431
(305) 994-8800 Extension 7608.

Silence is golden...the quiet ink-jet printers from Siemens.

**Our 8
customers
are no
demand
less of**

”
ers
w
ing
us.

Our 5¼" drives are now very much in demand by the same customers who keep our 8" drives at the top of the charts. Since our 8" customers include the biggest, toughest OEMs in the world, we think it's noteworthy that our existing customers have given our smaller drives such a big reception.

So big, in fact, that we now make more medium-capacity Winchester disk drives than anybody.

If you've been thinking of us as the people who make the most reliable 8" Winchesters on the market, great. But in the future, we hope you'll think less of us, as well.

5¼" drives, from 20 to 40 megabytes.
8" drives, from 10 to 85 megabytes.

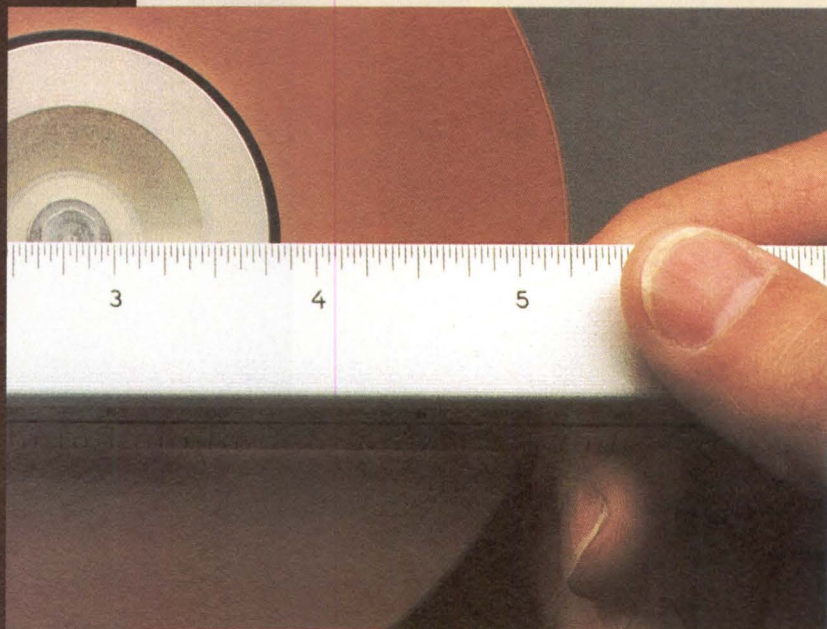

Quantum Corporation, 1804
McCarthy Boulevard, Milpitas, CA 95035,
(408) 262-1100, TWX 910-338-2203.
Eastern Regional Sales Office: Salem, NH
(603) 893-2672. Western Regional Sales
Office: Santa Clara, CA (408) 980-8555.
European Sales Office: Frankfurt, West
Germany 069-666-6167.

QUANTUM

Quantum products are distributed in the United States
by Arrow Electronics, Inc.

CIRCLE NO. 62 ON INQUIRY CARD

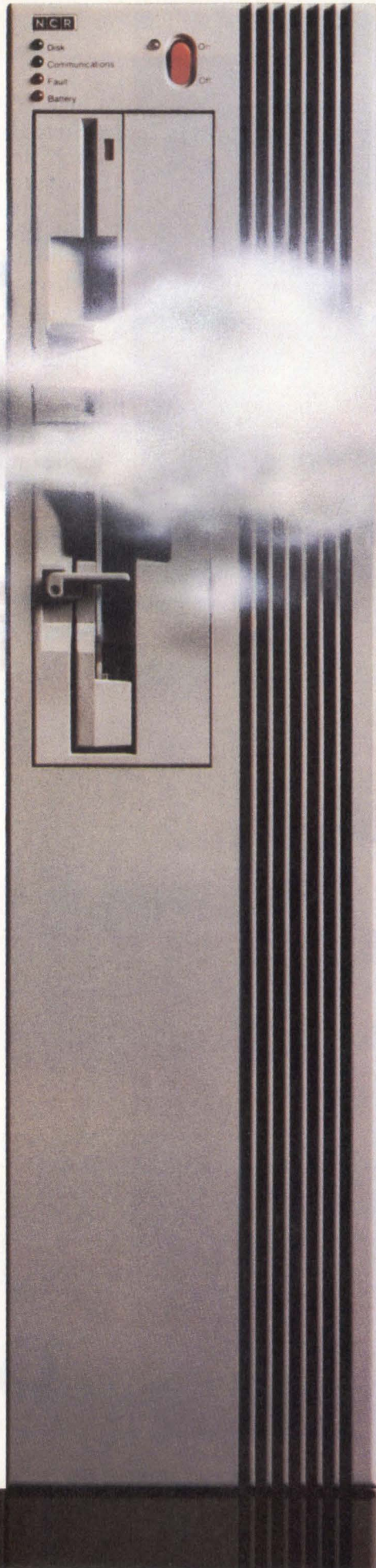

THE MORE YOU KNOW ABOUT UNIX,* THE TALLER THE TOWER XP STANDS.

The engineers at NCR are now convinced that UNIX is the best operating system in the industry.

Of course, to convince these reliability fanatics, UNIX had to endure thousands of hours of grueling tests. But that's simply the price any component must pay to get into an NCR product.

And it's a better UNIX for the experience.

The NCR-enhanced UNIX in the Tower XP is the first UNIX of true, commercial reliability.

It virtually never PANICs. Consequently, neither do your customers.

So that this UNIX might be all things to all users, we employed the Tower XP's menu builder to create the five faces of UNIX. A remarkable case of multiple menu personalities. One for each of five user levels, from sophisticated user to data duffer.

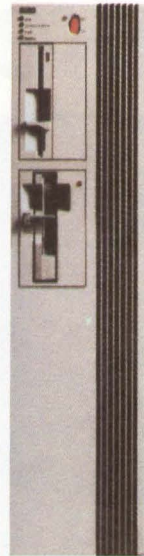

And our UNIX speaks a language for each of five programmer types: Business BASIC, Pascal, Fortran, C, and Cobol.

Team this powerful operating system with the Tower XP's other prodigious features; consistent error logging, extensive remote and in-service diagnostics, Automatic Power Failure Recovery, and more, and you've got a monumental mixture. Capped by NCR's towering commitment to OEMs.

The more you know about Tower XP, the better NCR looks.

**TOWER XP.
BUILT FOR SYSTEMS BUILDERS
BY NIT-PICKING FANATICS.**

NCR

OEM Systems Division

NCR Corporation, U.S. Data Processing Group, OEM Systems Division, USG-1, Dayton, Ohio 45479. Nationwide (800) CALL NCR. In Ohio (513) 445-2190. In Canada (800) 268-3966.
*UNIX is a registered trademark of AT&T.

CIRCLE NO. 63 ON INQUIRY CARD

Before **TEMPLATE**,[®] graphics software that ran on mainframes and minis and micros all looked like this.

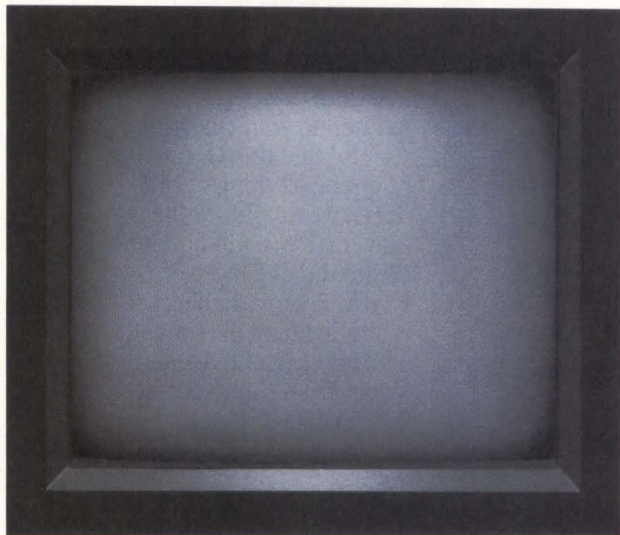

Which is to say, nonexistent. Some manufacturers make graphics software packages for mainframes. Others for minis. Still others make it for micros. But no one made high-level graphics software that ran on all three.

TEMPLATE just changed all that. By becoming the *only* high-level graphics software available on micros, minis and mainframes. And it took our extensive experience in graphics software to do it.

Now all computer-using design engineers and scientists can utilize the industry's finest software. And bring mainframe applications right to the bench. Or vice versa. Which means TEMPLATE's device-intelligence and computer-independence is even further enhanced. And you get the graphics functionality for mechanical and electrical CAD,

scientific analysis, seismic work, VLSI, and molecular modeling that puts TEMPLATE in a class by itself. In

any environment, whether it's batch or interactive, 2D or 3D.

TEMPLATE features table-driven architecture, 3D software display lists, metafile capability over 250 user-callable FORTRAN routines, workstation model, post processing capability, run-time selection, and complete support functions.

So when you're looking for graphics software that'll run on *all* your computers, call Megatek.

And find out all about TEMPLATE.

The product that just gave micros, minis, and mainframes a new computer graphics image.



See us at AUTOFACT, Booth 515, October 2-4. **Making History out of State-of-the-Art**

World Headquarters • 9645 Scranton Road • San Diego, CA. 92121 • 619/455-5590 • TWX: 910-337-1270

TEMPLATE is a registered trademark of MEGATEK CORPORATION.

FEATURE HIGHLIGHTS

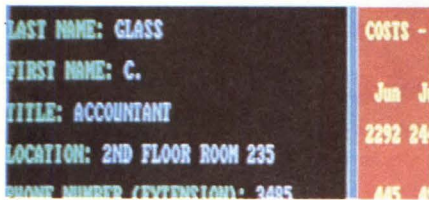

Windows of opportunity p.115

INTEGRATED SOFTWARE: ENVIRONMENTAL SOFTWARE OPENS SYSTEM WINDOWS 115

Multifunction, integrated software packages such as Framework and Symphony may soon be upstaged by environment managers, which offer an enhanced level of integration. But don't expect a major battle between software giants Digital Research, IBM and Microsoft.

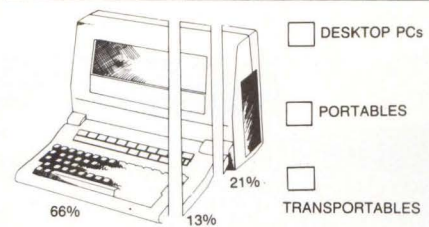

Portables carve up the market . . . p.135

TRANS/PORTABLES: NEW PORTABLE COMPUTERS BETTER AIMED AT MARKET 135

Many manufacturers of transportable/portable computers have ignored market needs, resulting in hundreds of millions of investor dollars lost, years of wasted labor and warehouses full of unsold inventory. Recent introductions, however, indicate that manufacturers are beginning to respond.



Making the IBM connection . . . p.147

PC PERSPECTIVE: SYSTEM INTEGRATORS EXPLOIT PC COMPATIBILITY 147

Integrators who haven't moved to exploit the PC infrastructure (hardware configured for the PC bus and software that runs on PC-DOS or MS-DOS) may be missing an excellent opportunity for profit.

SYSTEM ARCHITECTURE: 'LAN IN A BOX' PROVIDES MULTIUSER SYSTEM 159

One approach to supplying multiuser capabilities is a multiprocessor that looks like a LAN to software. This PC-compatible system dedicates a microprocessor to each user and is accessed via inexpensive terminals.

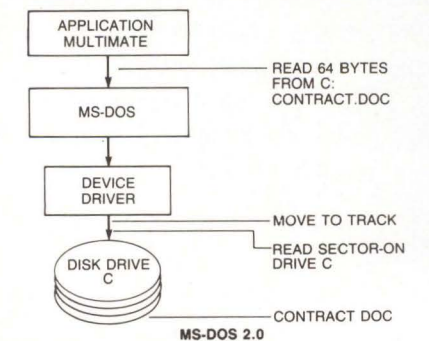

Creating a LAN look-alike p.159

PROCESSORS: PROCESSOR BOARD HANDLES VIRTUAL MEMORY 173

This Z8000-based board boasts demand-paged virtual memory, a 10-MHz clock, a Multibus interface with iLBX extension and a powerful state sequencer that handles processor cycles.

SYSTEM ARCHITECTURE: FOUNDATION MODULE SIMPLIFIES INTEGRATION 183

Don't want to be tied to a specific bus, processor and controller configuration? Create your own system with a "foundation module" approach.

LETTER QUALITY
AND
COLOR GRAPHIC
PRINTER

JDL-750

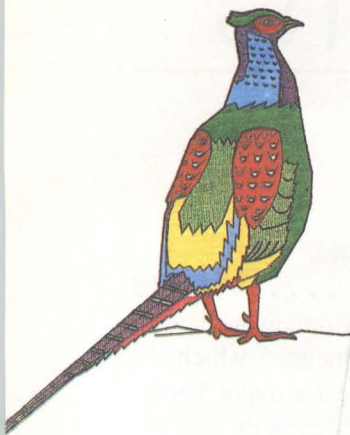

JDL INC

The target area beneath the wafer position is 200mm and 250mm in diameter for a 125mm wafer; both target sizes up to 2.5mm thick. The target is metal-bonded to a wafer through which a bath of cooling water flows. The magnet is exposed. This simplifies changing the target without cooling water connection.

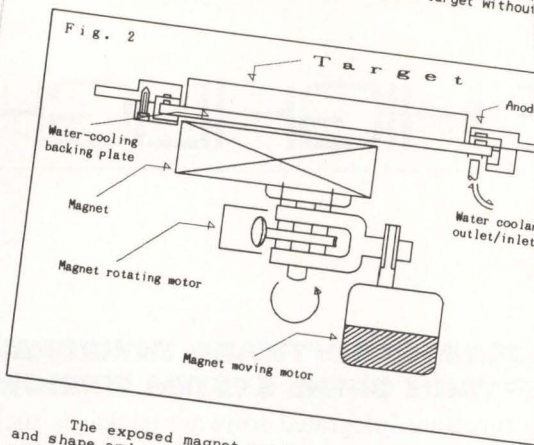

The exposed magnet position allows for greater freedom of target shape and size, since the magnet is not near the cooling water path is not subject to rust. The target uses the magnetic field technology patented by Smith to raise the temperature of the target in the path of the magnetic field that flows

To All District Managers:

Congratulations, for the first six months of this year we have exceeded projected by a healthy margin.

With the exception of an expected dip in March, month after month continuing to increase. Given our current growth rate and potential, we now expect to exceed sales of \$1,500,000 year end.

The bar graph below dramatically indicates our revenue growth and the improvement over projected sales. The pie chart shows the revenue generated by district.

% Revenue (by district)

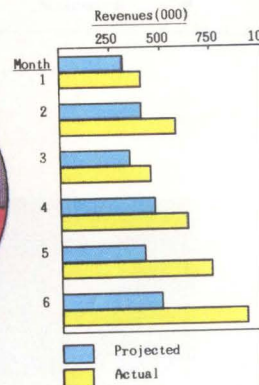
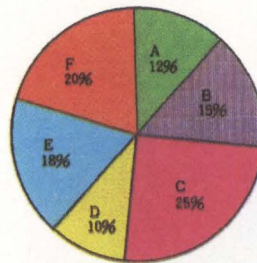

Call for the print samples that make our competition pale.

What OEM's are saying. OEM's who have seen these print samples for themselves call our graphics CAD-quality. The kind that reproduces the finest detail with superb accuracy and registration. The JDL-750's color graphics are so vivid, images seem to jump off the page. Add to that letter quality printing, and font versatility that surpass fully-formed character printers. Now you know why we're the perfect match for OA and CAD workstations.

What JDL is doing. The JDL-750 brings the best of Japanese printer design and

manufacturing together with American OEM marketing and custom engineering. This gives JDL, Inc. the flexibility and responsiveness necessary to deliver printers that meet your requirements and schedules.

You be the judge. If your workstations need exceptional color graphics, letter quality, font versatility, reliability and value that can't be matched by any competing technology, call us for print samples and product specs. One look and we're sure you'll call us again... for an evaluation unit.



(805) 495-3451

JDL
INCORPORATED

2801 Townsgate Rd., Suite #104, Westlake Village, CA 91361

CIRCLE NO. 65 ON INQUIRY CARD

ENVIRONMENTAL SOFTWARE OPENS SYSTEM WINDOWS

Operating system shells promise to please end users while opening up new windows of opportunity for system integrators

Carl Warren, Western Editor

Environment managers, or shells, are the latest trend in system software. They function as system supervisors, encompassing portions of the operating system, and as links to diverse applications.

Shell environments provide a standard interface to the rest of the system; an understandable and easy-to-use presentation interface for the user; and the ability to move, or transport, data from one application to another. This last element, say industry observers, will have a positive effect on the system as a whole because transporting data requires common data structures.

As with many new-generation software products for graphics and networking, a common level interface and the sharing of data among applications are becoming important factors. Problems arise, however, on what is meant by "standard," and whether one vendor's solution will prevail.

No war on the horizon

If you're expecting a major battle between such software giants as Digital Research Inc. (DRI) with its Graphic Environmental Manager (GEM), IBM Corp. with its TopView and Microsoft Corp. with its MS-Windows, it isn't going to happen. Although these companies are establishing some of the ground rules for handling the system environment, what is clear to developers and end users alike is that no single method is wanted.

Furthermore, system integrators find that application requirements are more important than

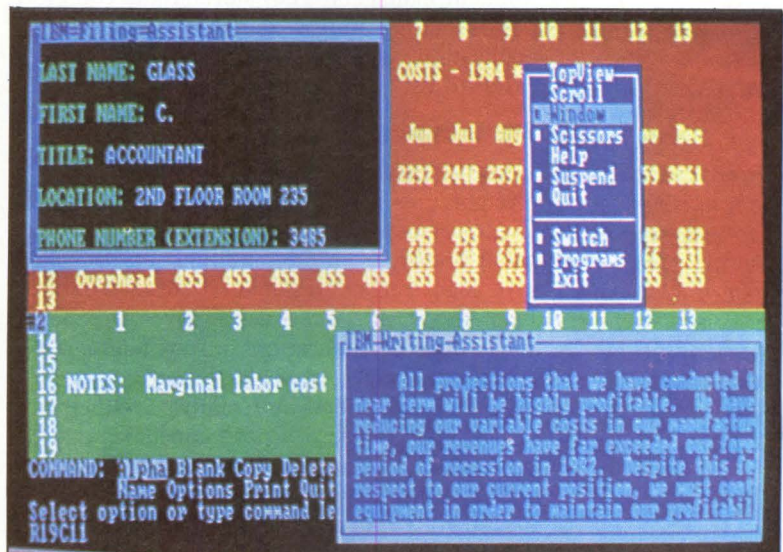

Fig. 1. IBM's TopView is a character-oriented, rather than graphics-oriented, environment manager. TopView displays multiple windows and supports concurrent operation of multiple applications.

a common interface. As a result, many opt for the alternative solution of slipping a "sleeve" over the application to simplify use. A sleeve is a piece of software that maintains pointers to on-line applications and provides pipes to move data from one application to another and from system device to system device.

Functionally, sleeves closely resemble envi-

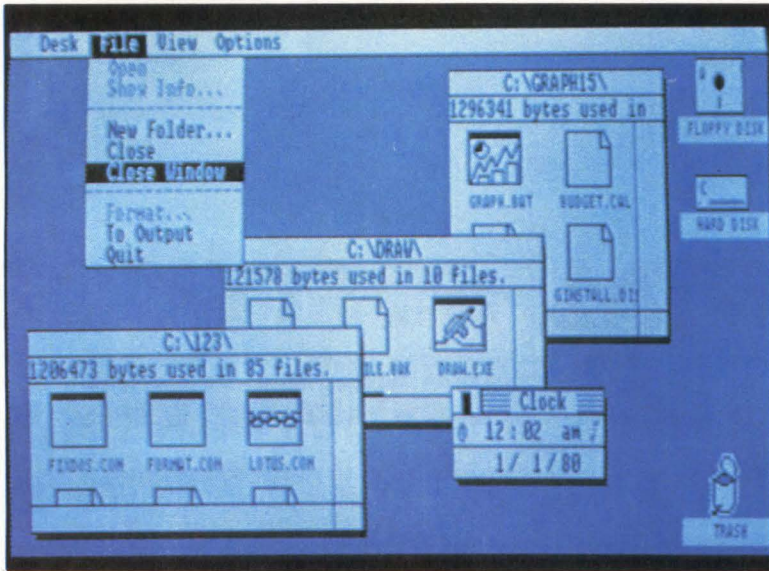

Fig. 2. Digital Research's GEM gives the appearance of an Apple Macintosh to the IBM PC. GEM is a single-tasking, graphics front-end for applications and the operating system. Disk and file operations are denoted by icons selected by a mouse.

ronment managers. They sidestep the complexities of the operating system and, frequently, the application. The goal is to make the system easier to use.

Shells bypass multifunction packages

Multifunction software vendors may be brought up short by the enhanced integration level promised by environment managers. "The trend is away from the multifunction package," says Jean Yates, president of Yates Ventures, Palo Alto, Calif. Yates sees a movement back to single-purpose applications linked under an environment manager, or shell.

A study published by Creative Strategies International, San Jose, Calif., concludes that the new operating environments offered by shells will undermine the need and reduce the market for integrated software packages such as Ashton-Tate's Framework and Lotus Development Corp.'s 1-2-3 and Symphony.

Environment managers, says the report, offer users the ability to combine several diverse applications under a single environment. Users can thus choose the desired mix, rather than being pinned to a specific metaphor prescribed by the integrated-software vendor.

"Primarily, what people want," says Bonnie Digrius, director of the microcomputer software industry group for Creative Strategies, "is word processing and spreadsheet—single-purpose, but tied together in some way." Stephen A. MacDonald, vice president of marketing at Adobe Systems Inc., Palo Alto, Calif., contends that ease of integration is what is wanted. "System people want to be able to draw on a library of functions, such as printer drivers, and not have

to worry about creating them. To us, that's where the value of fully integrated environment managers comes in."

Market projections are sketchy

Because the market for environmental management software is only about a year old, projections are sketchy at best. Analysts are predicting a large share of the market will go to IBM's TopView, and possibly an equal amount to DRI's GEM.

Mary Ellen Dick, research analyst for Software Access International, Mountain View, Calif., maintains that environment managers are still too technically difficult for most users, or are at least perceived to be. "The environmental managers [such as TopView or MS-Windows] require a lot of work to set up and use. There's no single keystroke solution there, and that's an inhibiting factor toward their acceptance."

Software Access surveyed 8,000 households, 4,300 of which were random samples that didn't necessarily have computers. The others were known users. The company found that none of the households surveyed had any plans to purchase an environment manager. The survey revealed that most wanted a simple, two-function solution that combined a spreadsheet with graphics or with a database.

Andrew Czernek, director of marketing for Zenith Data Systems, Glenview, Ill., says that the market is looking for a consistent user interface, not complex solutions. "This is something Wang [Laboratories Inc.] and Digital Equipment [Corp.] have been saying for years: Keep the user interface consistent. The environment managers are one way of handling the problem."

In Billerica, Mass., Honeywell Information Systems Inc.'s manager of microcomputer systems, Gary B. White, says that environment managers ideally should provide support to link the broadest possible range of applications. "The software strategy that lets OEMs and system integrators do that will be the one that wins," states White.

IBM may set the stage

IBM's TopView (Fig. 1) is a single-user, multi-tasking, environment manager. TopView is an event-driven supervisor that permits applications to operate in both foreground mode (i.e., dominating the screen) or in background mode (i.e., not necessarily displayed). The application that has control of the display buffer is the one that gets updated.

The TopView environment is character-oriented rather than graphics-oriented. As a result, TopView detractors see it as not very functional because more and more applications use graph-

ONE LANGUAGE. ONE SOLUTION.



PC/FOCUS

Put The Database Power of a Mainframe In Your PC.

Now you can turn your Personal Computer into a mainframe-level applications development system with **PC/FOCUS**, the most powerful DBMS available for your PC.

As a tried-and-proven, user-friendly, 4th generation system, PC/FOCUS gives you the ability to query and report from files, build systems and manipulate data. It incorporates a relational database, screen manager & report writer, and offers dramatic abilities in graphics, financial modeling and statistical analysis.

But unlike older database technologies which require training and practice to master, PC/FOCUS uses simple English

statements you can learn in minutes! In fact, just a few moments of familiarization with **TableTalk™** its new natural language window, is all that's needed for even a novice to become immediately productive.

Best of all, PC/FOCUS lets you download data extracted from mainframe files and DB's, then upload data and procedures from the PC to the mainframe for production execution. So your PC becomes almost as powerful as a mainframe, and you become almost as capable as a trained systems analyst.

Let PC/FOCUS with TableTalk™ unlock the mainframe power hidden within **your** PC. For de-

tails, fill out and mail the coupon or write to **Don Wszolek, Dept. U1, Information Builders, Inc., 1250 Broadway, New York, NY 10001.**

Dear Don;

Yes! I'd like to unlock the mainframe hidden in my PC with **PC/FOCUS**. Mail full details to:

NAME _____

COMPANY _____

TITLE _____

ADDRESS _____

CITY _____

STATE _____ ZIP _____

TELEPHONE _____

INFORMATION BUILDERS, INC.

New York: (212) 736-4433 • Washington, D.C.: (703) 276-9006 • St. Louis: (314) 434-7500 • Chicago: (312) 789-0515
Dallas: (214) 659-9890 • Palo Alto: (415) 324-9014 • Los Angeles: (213) 615-0735 • Houston: (713) 952-0260

Dealer Inquiries Invited.

“Tell me what you want in a custom OEM modem, and I’ll give it to you in 60 days.”

Weldon S. Bankston
National OEM Sales Manager
CTS DATACOMM



“I’ll give you Computer Aided Design capability.”

Using Computer Aided Design equipment our engineering staff can create the custom electrical interfaces or unique board configurations you demand. Then, within 60 days, you’ll have a prototype modem. Standard RS232C, TTL or custom interfaces are also available.

“I’ll give you a high performance, quality modem at a competitive price in whatever quantities you need.”

CTS’ signal processor/micro processor approach to modem design is so unique and reliable we’ve applied for a patent with over fifty claims. And years of experience in OEM support manufacturing with the latest in sophisticated production equipment insures your modem will be of the highest quality and at the best price and on time.

“And I’ll give you 89 years of reliability and stability.”

CTS Corporation has supplied the communications industries since 1896 when it began manufacturing wooden, hand cranked, wall mounted telephones for rural communities. Today, for your current modem needs, we can give you design flexibility, experienced engineers, advanced technology, reliability and a competitive price. And all within 60 days. Call Weldon at 408-356-3868 or write us and find out more about what you can get.

CTS®

DATACOMM Products Division
6900 Shady Oak Rd.
Eden Prairie, MN 55344
612-941-9100

New to the industry since 1896.

INTEGRATED SOFTWARE

ics. But TopView's chief architect, Ross Cook, defends his product by pointing out that 70 percent of IBM PCs have monochrome displays, and, according to IBM's studies, 90 percent of the applications are character-oriented. "We do support graphics, but they can't be windowed in TopView since they take over the display buffer. What we do is store the TopView environment until the graphics application is finished," explains Cook.

TopView runs the environment until another piece of software takes over. Thus, a variety of

applications, IBM claims, can operate in a TopView environment.

That may be about as far as IBM's willingness to share may extend. For example, TopView isn't for IBM-compatibles because it relies heavily on the interrupt structure of the PC and PC-AT to function properly.

Even with industry pundits predicting a market takeover by TopView, software developers remain divided. To date, more than 250 independent software vendors (ISVs) and value-added resellers (VARs) have taken advantage of the

REPRESENTATIVE ENVIRONMENT MANAGERS AND SHELLS

Product/ Company	Memory/ K Bytes	Application shell	O/S extension	Systems	Price (\$)	Multitasking	Notes, features, options
A-TO-Z INTEGRATED SYSTEM Digital Equipment Corp. 146 Main St. Maynard, MA 01754 (617) 897-5111 Circle 413	512	•	•	VAX PDP-11	400	•	multiuser operating system extension for PDP family, RSX operating systems and VAX systems; open architecture which can be built upon by system OEMs and VARs
ABILITY Xanaro Technologies Inc. 321 Bloor St. East, Suite 321 Toronto, Canada M4W169 (416) 927-8369 Circle 424	256	•	•	see notes	495		requires color monitor and bit-mapped graphics; combines word processor, database manager, communications; written in C language; transportable to most systems
APX CORE Application Executive Corp. 600 Broadway, Suite 4C New York, NY 10012 (212) 226-6347 Circle 410	48	•	•	MS/PC DOS based on 8088/8086	95	•	multiwindowed, character-oriented; operates with monochrome monitor; comes with utilities to assist in tailoring programs such as Lotus 1-2-3; supports data import and export functions
CONCURRENT PC DOS GRAPHIC ENVIRONMENT MANAGER (GEM) Digital Research Inc. 60 Garden Court P.O. Box DRI Monterey, CA 93942 (408) 649-3896 Circle 414	256	•	•	MS/PC DOS based on 8088/8086	295	•	supports CP/M-86, PC-DOS functions, windows, menus; requires at least two floppy disk drives; works with color, monochrome and bit-mapped graphics; includes communications; supports multiple users
DESQ Quarterdeck Office Systems 1918 Main St., Suite 240 Santa Monica, CA 90405 (213) 392-9851 Circle 420	128	•	•	same			OEM product price varies; graphics front-end for DOS; single-tasking only
DESQ Quarterdeck Office Systems 1918 Main St., Suite 240 Santa Monica, CA 90405 (213) 392-9851 Circle 420	256	•		MS/PC DOS based on 8088/8086	399		single-tasking, single-user shell; allows data import and export between applications; some graphics packages may need tailoring to environment
DOS COMMANDER Applitek, care of: Connecticut Software 30 Wilson Ave. Rowayton, CT 06853 (203) 838-1844 Circle 411	16	•		MS/PC DOS based on 8088/8086	79.95		essentially a shell for DOS—speeds up DOS functions; can be used with monochrome or color displays; although character-oriented, uses graphics adapter to enhance display in color mode

TopView tool kit. For the most part, all admit that TopView is easier to interface to than is Microsoft's MS-Windows. But according to one major developer, who asked to remain anonymous, applications run much more slowly (reportedly 40 percent more slowly) in the TopView environment than in MS-Windows. The developer attributes the slowness to an extra filter, which he feels doesn't offer much advantage.

Application developers may find that developing for TopView is not easy. The IBM TopView tool kit guide lists some critical "don'ts." For example, the use of BATCH files (files that execute DOS commands en masse) are incompatible with TopView. This may be critical to some applications that rely on the DOS BATCH

facility to perform various functions. In addition, TopView can't use some critical system vectors that handle DOS calls and allow the termination of an application while keeping it in main memory. Because of these inconsistencies, graphics applications using the proposed virtual device interface (VDI) drivers can't be run with TopView resident. However, TopView is expected to be available this month, and most developers assume IBM will solve these problems.

Simple may be best

To keep pace with the needs of software developers and end users, DRI developed the GEM. Unlike TopView, GEM isn't multitasking. Rather, it's a graphics front-end for

REPRESENTATIVE ENVIRONMENT MANAGERS AND SHELLS

Product/ Company	Memory/ K Bytes	Application shell	O/S extension	Systems	Price (\$)	Multitasking	Notes, features, options
DOSEASE Software Solutions Inc. 30 Bic Drive Milford, CT 06460 (203) 877-9268 Circle 423	68	•		MS/PC DOS based on 8088/8086	66		menu-driven system will transport ASCII files; uses basic DOS utilities for file functions
DOSSHELL XTC Handcrafted Software P.O. Box 902 Santa Barbara, CA 93102 (805) 967-7837 Circle 425	note	•	•	MS/PC DOS based on 8088/8086	70		can only be used with hard disks; uses DOS command BATCH files to segment hard disk and established directories
DUNSPUS Dunspus Inc. 187 Danbury Rd. Wilton, CT 06897 (203) 762-1212 Circle 415	256	•	•	MS/PC DOS based on 8088/8086	1,700		provides menu shell around DOS and application; comes with PC DOS 2.0, Multimate word-processing, Lotus 1-2-3, communications, 3270 emulation; allows 43 other applications to be combined; supports data import and export functions
METAWINDOWS Metagraphics Software Corp. 444 Castro St., Suite 400 Mountain View, CA 94041 (408) 438-5352 Circle 417	128	•	•	MS/PC DOS based on 8088/8086	150		OEM window shell; uses mouse or keyboard for cursor movement
MS-WINDOWS Microsoft Corp. 10700 Northrup Way P.O. Box 97200 Bellevue, WA 98009 (206) 828-8080 Circle 418	note	•	•	MS/PC DOS based on 8088/8086	note		currently a single-tasking, single-user package with tiled windows; undergoing extensive re-design, dropping in size from 320K bytes to under 128K bytes; will use mouse pointers, windows and provide data-transport functions
1 DIR Bourbaki Inc. 431 Main St. P.O. Box 2867 Boise, ID 53701 (208) 342-5849 Circle 412	0	•		MS/PC DOS based on 8088/8086	95		menu shell that handles DOS functions; allows creation of multiple menus that can be nested and celled by each other

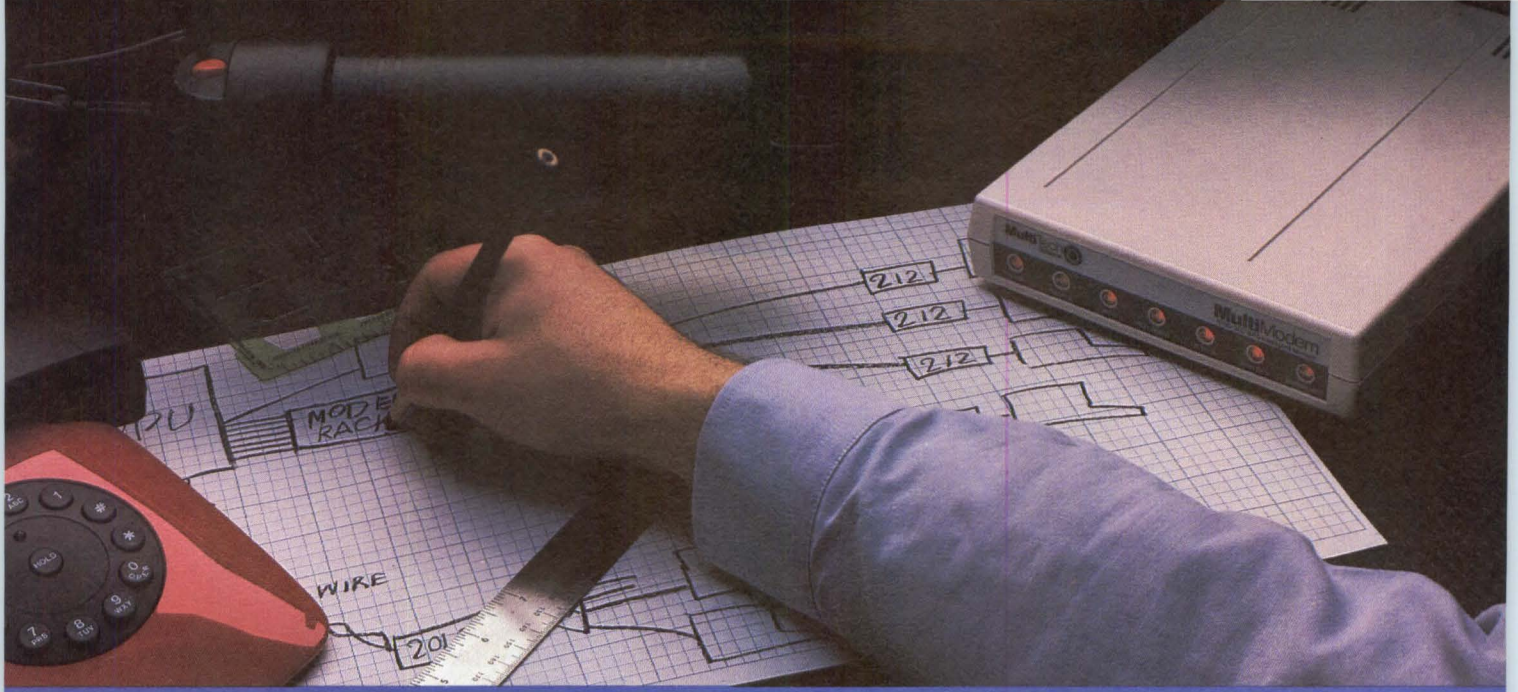

Is this the year of the Modem?

- If you aren't already including modems in your systems, maybe you should be. Because whether you do or not, there is an increasing user demand for on-line capability. This trend will make communications a selling advantage for you now, and an absolute necessity in the not-too-distant future. Communications can now expand the potential of your systems, without creating more headaches for you.

- When looking for a communications supplier, experience and support can be as important as price. Multi-Tech Systems has been providing modems and other datacomm equipment to systems integrators since 1970. Our Technical Support people are second to none. Our products include 300, 1200 and 2400 bps intelligent modems (Hayes-compatible autodial and auto-answer, in desktop, in-board and rack-mount versions), multiplexers, breakout boxes and communications software. And our prices (and margins) are right where they should be.

- So whether your systems are for your own use, or you sell systems to others, Multi-Tech modems can make them better. On-line software updates and maintenance make life easier for you, and on-line capability provides better system versatility for your users.

- Why not let Multi-Tech help make this year of the modem your best year yet?

CIRCLE NO. 68 ON INQUIRY CARD

MultiTech
Systems

The right answer every time.

82 Second Ave. S.E., New Brighton, MN 55112 (612) 631-3550. TWX: 910-563-3610

MultiTech
Systems

MultiModem
1200/300 BPS Intelligent Modem

QUIETLY BUILDING THE BEST

Some people prefer performance to promises. To those we quietly offer our family of 30MB, 51MB, 72MB and 85MB 5¼" Winchester.

You see, we have an old fashioned attitude. Performance ought to speak for itself. That's why we're quietly becoming a leader in high performance 5¼" Winchester. With volume deliveries of very reliable drives. To a diverse customer base which includes some of the most successful OEM's in the business.

We could brag more about specs and design integrity. We could holler about our great manufacturing capability.

Yeah, we could shout with the best of 'em.

But we'd rather *build* the best of 'em.

Call us for a quiet conversation. Vertex
Peripherals, 800 Tasman Drive, Milpitas, CA 95035,
(408) 943-9530. Eastern Region Sales, (617)
435-5348. Midwest Region
Sales, (612) 784-0347.
Western Region Sales,
(714) 937-0384.

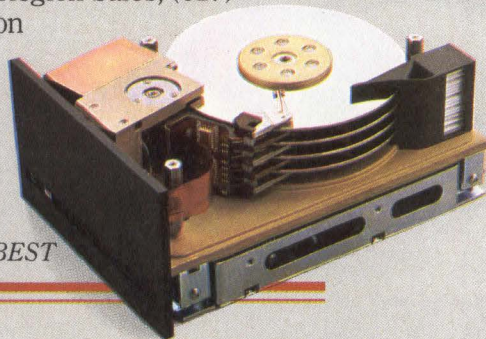

VERTEX
QUIETLY BUILDING THE BEST

INTEGRATED SOFTWARE

applications to aid inexperienced users.

William J. Higgs, DRI's GEM product line manager, says GEM aims at the presentation graphics market, a different market segment from that of TopView or MS-Windows, and possibly shouldn't be compared. But others disagree. Independent software engineer Robert Anton Byers, for one, sees GEM as a solid alternative to the more complex solutions offered by Microsoft and IBM. "Getting the job done is far more important than a complex interface," says Byers.

GEM uses icons, or pictures, to replace MS-DOS and PC-DOS commands (Fig. 2). For example, pictures of disks represent storage, and trash cans represent a way of erasing information. Screen operation is similar to that of Apple Computer Inc.'s Lisa and Macintosh personal computers, but is supported by the power of the IBM PC.

To handle peripherals and graphics properly,

GEM also uses VDI graphics drivers, which were recently endorsed by IBM to link to all applications and peripherals.

Even though GEM is an extension of the operating system, it is primarily a single-task solution. Thus, only one application can run at a time. As a result, unlike TopView and, reportedly, MS-Windows, applications tend to run at normal speed and aren't impeded by errant system calls. Users can quickly move from one application to another using the icon-based menu system.

Because GEM is primarily a front-end package, it requires only 128K bytes of RAM. By contrast, Microsoft's MS-Windows demands 340K bytes in the current version. The newer version is expected to need less than 128K bytes, according to a company spokesman.

Taking a similar tack as IBM and Microsoft, DRI also offers a developer's tool kit. Because the package is classified as a presentation graph-

Environment managers, or shells, are the latest trend in system software.

REPRESENTATIVE ENVIRONMENT MANAGERS AND SHELLS

Product/ Company	Memory/ K Bytes	Application shell	O/S extension	Systems	Price (\$)	Multitasking	Notes, features, options
SIMPLEX Quest Research 214 N. River Ridge Circle Burnsville, MN 55337 (612) 894-7752 Circle 421	128	•	•	MS/PC DOS based on 8088/8086	245-695		object-oriented shell taking the place of DOS; windows, menus and variety of applications and development tools provided; price includes Quest applications; virtual memory and device functions built in
SMARTSTAR Signal Technology Inc. 5951 Encina Rd. Goleta, CA 93117 (805) 683-3771 Circle 422	note	•	•	VAX		•	series of "smart" applications making use of VAX Information Architecture; windows, virtual memory and virtual device drivers used; pricing for MicroVAX version is \$700 per module
TOP VIEW IBM Corp. Entry Systems Division P.O. Box 1328 Boca Raton, FL 33432 Circle 416	128	•	•	IBM PC/XT AT and jr	149	•	full-function, character-oriented manager only for monochrome screens; uses interrupt structure to handle tasks and support varied applications
USI-WINDOW MACHINE Amber Systems Inc. 1171 S. Saratoga-Sunnyvale Rd. San Jose, CA 95129 (408) 996-1883 Circle 409	12	•		MS/PC DOS	59.95		language-binding for all Microsoft languages plus Borland International Inc.'s Turbo Pascal and various COBOL and C compilers; maintains 64K-byte buffer for virtual screens used by applications; character-oriented
VISI ON Visicorp 2895 Zanker Rd. San Jose, CA 95134 (408) 946-9000 Circle 419	256	•	•	MS/PC DOS based on 8088/8086	495		single-tasking, single-user software; requires major modification to applications; supports mouse pointers; allows use of other Visi software

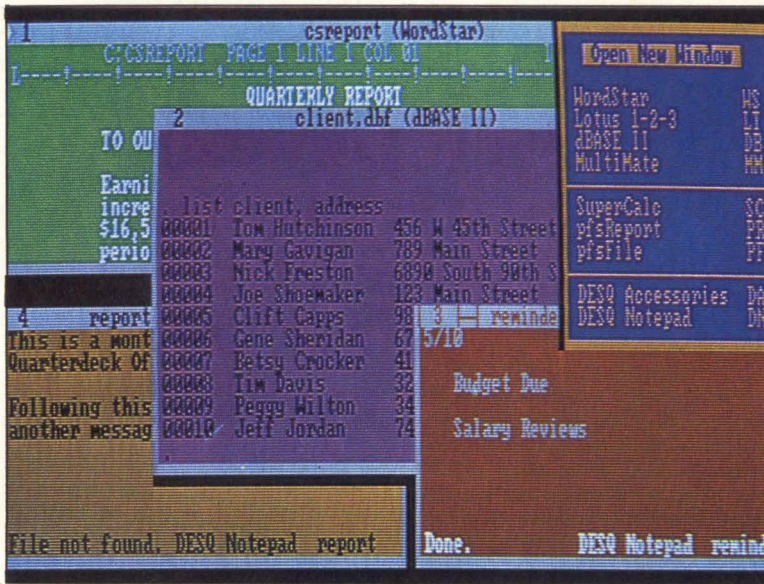
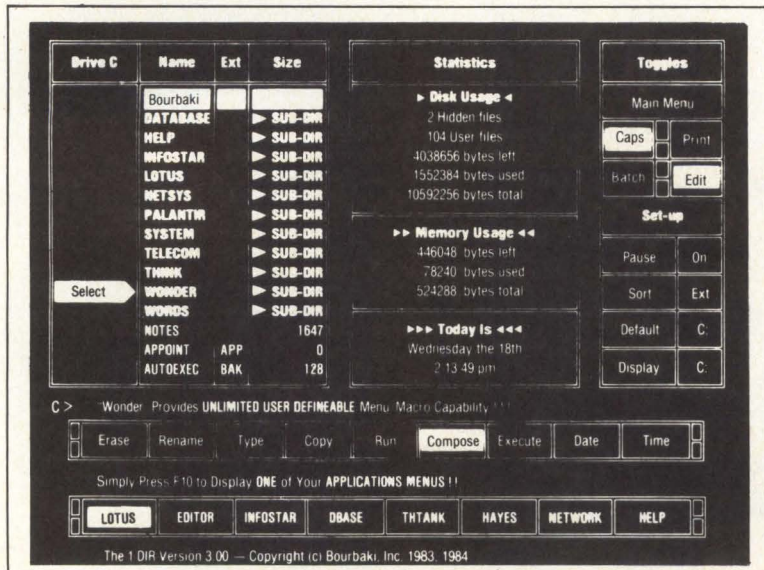

Fig. 3. Quarterdeck's DesQ serves as a sophisticated "sleeve" that surrounds both the operating system and the applications. DesQ employs overlapping windows and manages inter-application communication.

Fig. 4. Bourbaki's 1 DIR takes the place of the DOS standard prompt and hides the complex operation of the operating system from the user, while providing a menu-driven selection display.



ics system, DRI provides GEM Draw for creating presentation graphics and GEM Wordchart for designing such things as organizational charts.

DRI expects to offer a concurrent version of GEM this year. According to Tom Byers, DRI's marketing manager for application environments, "What we are shipping [GEM shipments began in February] is a single-task version, something we call the MAC-mode. We aren't trying to be all things to all people, and are establishing a firm base to build on."

DRI isn't without developer support. An estimated total of 300 ISVs and VARs have latched onto GEM and are expected to begin shipping soon.

Microsoft waits in the background

An estimated total of 400 ISVs and VARs support Microsoft's MS-Windows. Characterized by Jean Yates as mediocre, the much-touted environment manager has been plagued by development and delivery slippages.

MS-Windows faces other problems, among them speed of applications. But Microsoft designers are aware of the problems and expect to solve the difficulties, including shrinking the memory demands, by the next release cycle, expected this fall.

Using device-independent drivers conforming to the proposed VDI standard, MS-Windows provides a convenient method of handling a barrage of peripherals. The functionality of windows, however, comes from the common link interface that removes the software developer from the complexities of the hardware. Like TopView and GEM, MS-Windows is an extension of the operating system and supports the cliché of the electronic desktop.

Unlike the other packages, MS-Windows uses a tiled approach to windowing. Each application is shown in a window that abuts the next, allowing as many as eight displays of windows. The windows all appear active, but only become so when pointed to. The tiling method tends to require more memory than overlapping windows, however, so new releases are expected to use the overlapping approach.

Microsoft is also preparing to support multi-tasking and concurrent operation. Ultimately, the package is expected to work in tandem with MS-DOS 3.1, which supports Microsoft's Networks 1.0. Thus, a fully supervised environment can be created.

What many in the industry have been wondering, due to the lateness of the Microsoft product, is whether anyone will still want to support MS-Windows. Zenith's Czernek says the product



Our Smart-Frame™ will put you in touch.

One of the easiest ways to interact with a computer is through a touch activated display. One that lets you merely point your finger at what you want your computer to do.

With touch, even the most complex application can become user friendly. And less susceptible to user error.

But the advantages of the highly reliable infrared touch input systems have been overshadowed by cost. Placing them out of the range of medium to low-cost turnkey systems manufacturers.

Which is the main reason Carroll Touch completely redesigned its line of touch input products.

We call it Smart-Frame™. Because it contains a powerful microprocessor built into the frame. And because it uses scanning infrared technology—a touch technology which is incredibly reliable, rugged, accurate, and fast. A technology Carroll Touch pioneered and refined.

As a result of the Smart-Frame design, Carroll Touch units contain 45 percent fewer components than before. Which means the cost to you is about 50 percent lower too.

We think that's pretty smart. And Carroll Touch did it just so you could get in touch. Today.

Carroll Touch

a subsidiary of AMP Incorporated

In Touch with Technology

P.O. Box 1309
Round Rock, Texas 78680
512/244-3500, Telex 881906

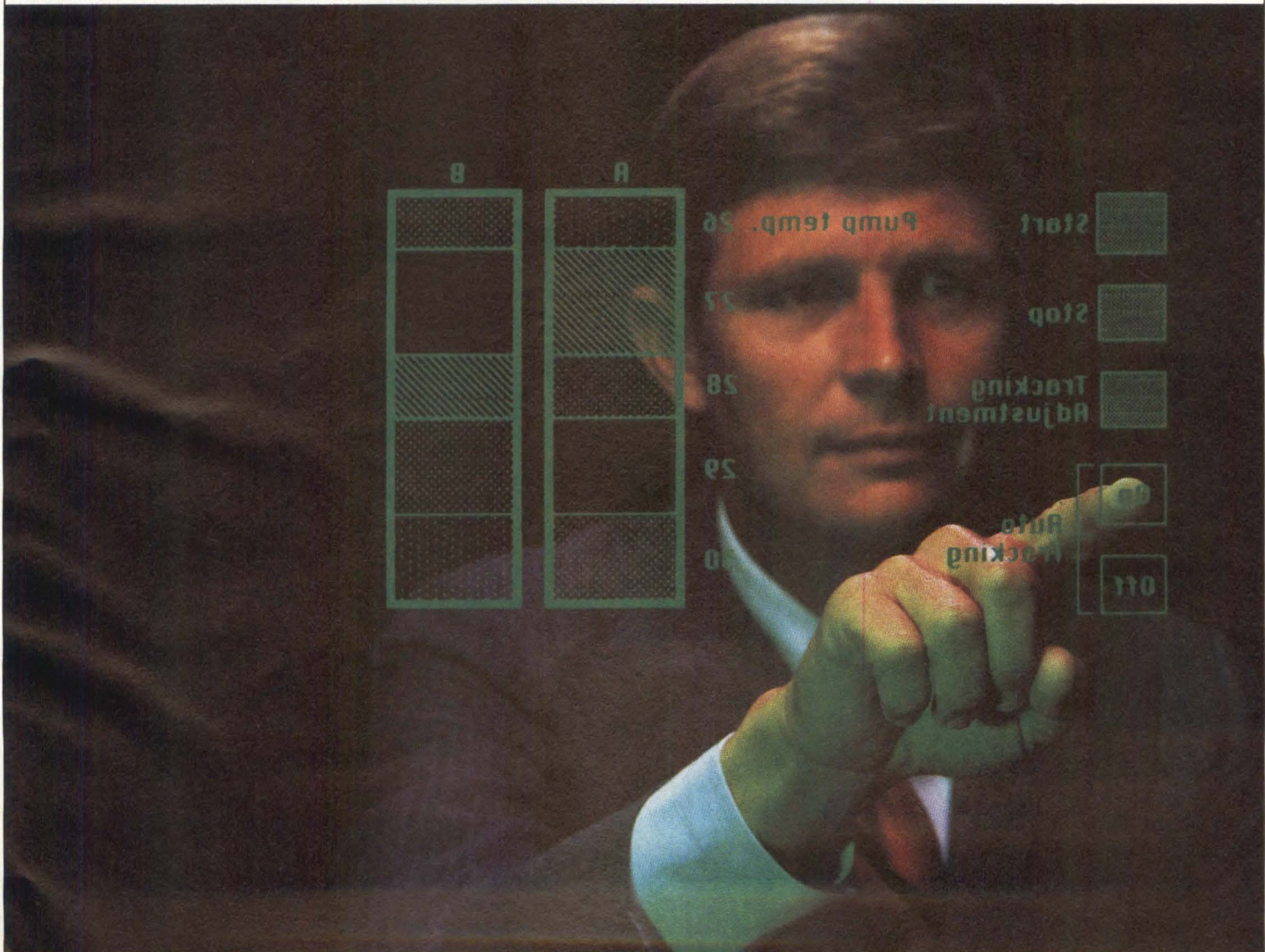

CIRCLE NO. 70 ON INQUIRY CARD

TeleVideo is the multiuser system for companies who expect to grow.

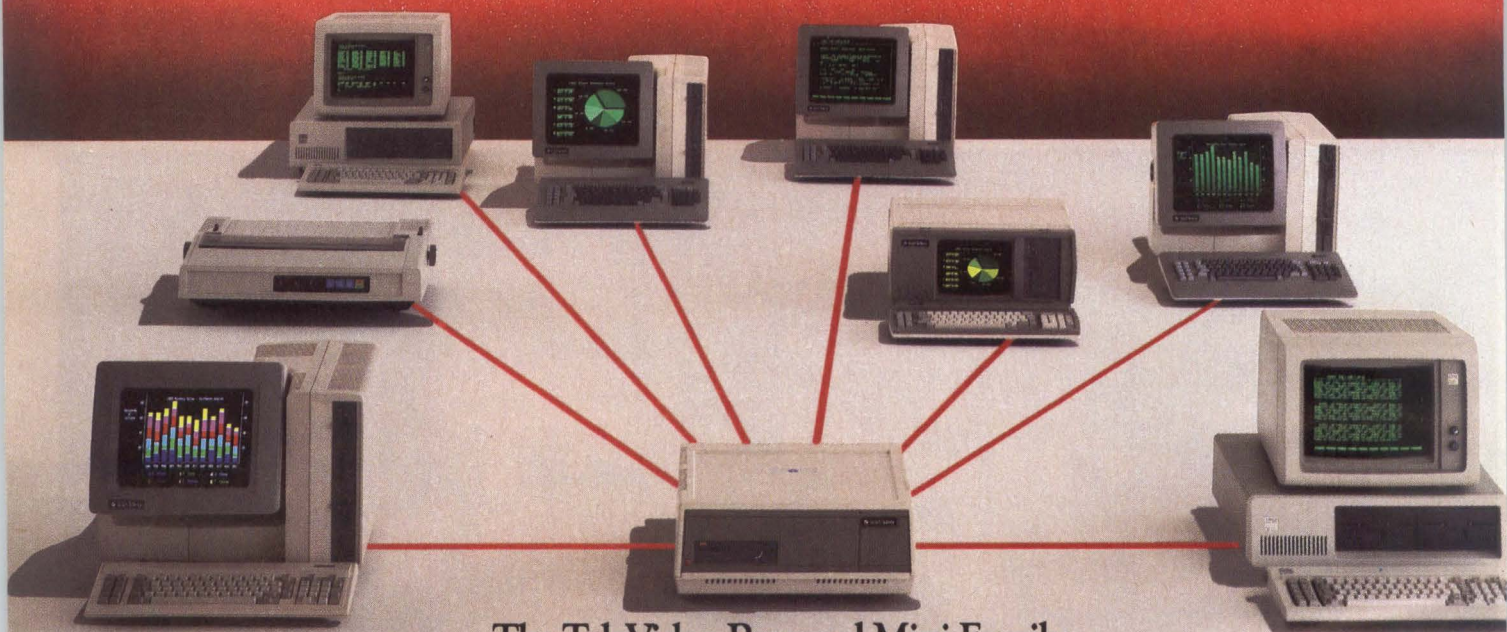

The TeleVideo Personal Mini Family

Growing companies need a computer system that will grow right along with them. Simply and economically.

A computer system that lets people communicate and share resources. Even work on the same file simultaneously.

The TeleVideo® Personal Mini™ Family is that system.

Runs PC, mini and multiuser software.

With the TeleVideo Personal Mini, users of IBM® or TeleVideo PCs, XTs, and portable computers can share data, as well as expensive peripherals, like printers and plotters.

The Personal Mini dramatically increases computing power. So it not

only runs PC software, but also hundreds of popular, fast mini-computer and multiuser programs. Without destroying your established PC environment.

And, unlike less advanced networks, the Personal Mini never sacrifices performance or speed regardless of how many workstations are on line.

Build on your original PC investment.

Even our system expansion costs are substantially less than what you'd pay to add new IBM PCs. And your original investment in hardware, software and personal computer education is never lost.

Your TeleVideo dealer has the Personal Mini. Arrange to see it today by calling toll free, 800-521-4897. In California, call 800-821-3774. Ask for operator 10.

The TeleVideo Personal Mini. The growing business computer.

Regional Sales Offices: Northwest (408) 971-0255, Southwest (714) 476-0244, Southcentral (214) 258-6776, Midwest (312) 397-5400, Southeast (404) 447-1231, Mid-Atlantic (703) 556-7764, Northeast (617) 890-3282, East (516) 496-4777, Rocky Mountain (714) 476-0244.



Systems
TeleVideo Systems, Inc.

IBM is a registered trademark of International Business Machines

has been a disappointment but plans to offer it eventually. Honeywell's White, however, says that his company is fully behind Microsoft and expects MS-Windows to be the ultimate winner of major market share.

Perspectives change with applications

Because all applications do not require the same degree of integration, approaches other than those offered by DRI, IBM and Microsoft are equally viable. Some integrators are finding that the command-language capability in MS-DOS, PC-DOS and UNIX makes it possible to develop workable application shells. In practice, the DOS shells can be used to create selection menus and establish PATH directions for locating an application.

Some developers of vertical market applications, such as Query Computing Services, Redondo Beach, Calif., find that developing application-specific front-ends in a high-level language serves most of their needs. Company president Steve Bostwick says that, because of the diversity of the applications he deals with, no single solution is workable. "Each application has to be addressed on an ad hoc basis. That doesn't mean we ignore tools that help us build a solution; it just means that we don't lock ourselves into a single way of doing things," says Bostwick.

One company that has been on the leading edge of environment manager development is Quarterdeck Office Systems. Its DesQ product (Fig. 3) lets users choose what they want.

DesQ is based on a high-level language that Quarterdeck president Terry Myers describes as similar to LISP. Artificial-intelligence techniques embodied in the product let it "learn" application characteristics. As do other products, DesQ makes generous use of overlapping and pop-down windows. And, like GEM, MS-Windows and TopView, DesQ supports mouse pointer devices.

DesQ was the first environment manager to be shipped, but has met with less-than-spectacular market acceptance. Some analysts, such as Creative's Bonnie Digrius, believe it was premature: "Basically, the industry wasn't ready for it."

Even so, system consultant Phil Lieberman, president of Los Angeles-based Lieberman and Associates, thinks Quarterdeck is on the right track. "The use of artificial-intelligence techniques that 'teach' an application to an environment has a lot of potential," he says.

All the environment managers share a common element: a pointing device for users.

The mouse is most favored for moving the pictures around on the display screen. IBM

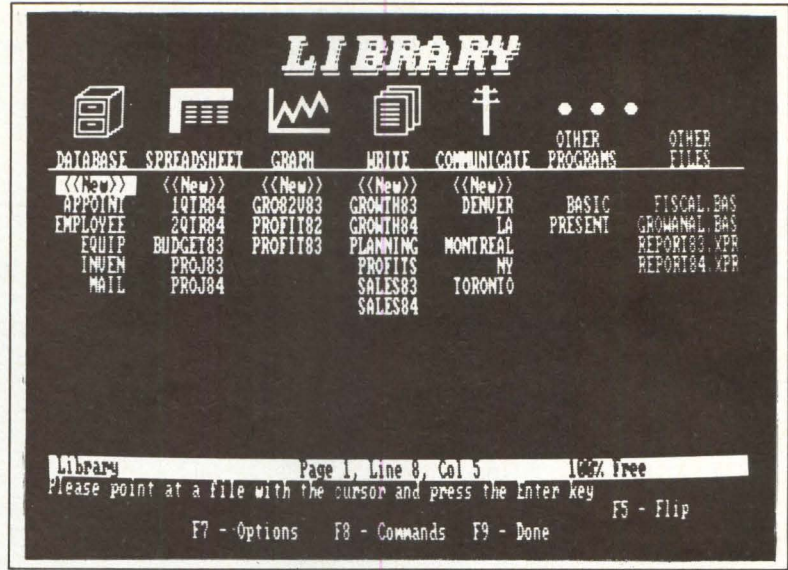

Fig. 5. Xanaro Technologies' Ability takes the tack that simple is best, using icons to represent various functions, with a menu below each item. Ability uses the PC's arrow position and function keys to assist in making application choices.

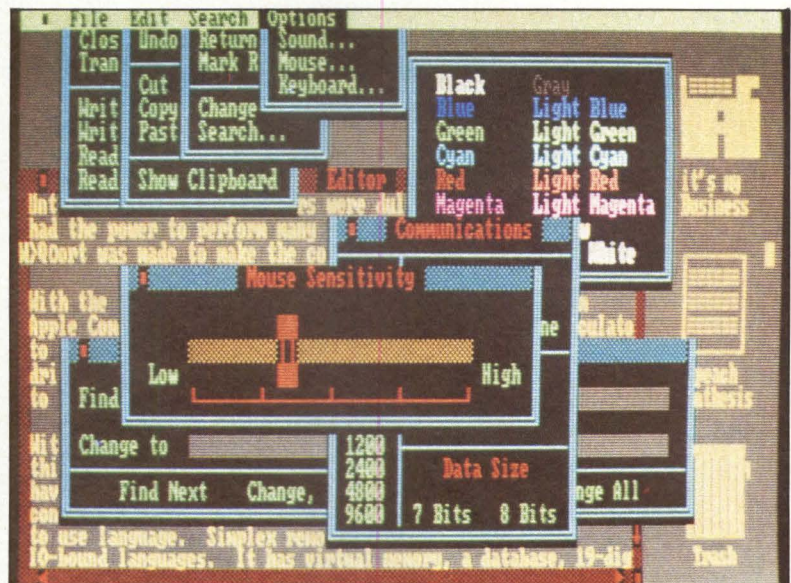

Fig. 6. Quest Research's Simplex environment manager comes with a database manager, an editor and a set of application-development tools that allow VARs and end users to create vertical-market application templates.

recommends use of the mouse and supports both optical and mechanical versions, but also supports keyboard arrows for those who prefer them.

Not everyone is planning on tacking on software from the big three. A number of companies are offering solutions of their own. One company that is taking advantage of the basic capabilities of the IBM PC software architecture is DUNSPPlus, a subsidiary of Wall Street invest-

ment giant Dun and Bradstreet. According to Kathy Groll, company marketing manager, DUNSPPlus tried to create a total work environment that integrated the necessary software. "We aren't a TopView or an MS-Windows. We provide an overall supervisor that combines up

Looking into the window environment

The concept of using bit-mapped display screens and mouse pointer devices for creation and manipulation of graphics isn't new. The technique was developed by the Xerox Corp. Palo Alto Research Center (PARC) in 1973 and was known as SuperPaint, from which Apple Computer Inc.'s MacPaint was taken. What is new, however, is the combination of graphics front-ends with the operating system to create an environment manager, or shell.

Windowing is a basic tool that uses such underlying techniques as pop-up menus and single-screen viewing, while controlling multiple contexts, or applications. Essentially, the screen is made up of the actual display screen and a virtual screen. The windows, also called viewports, show a copy of the information in the virtual screen area.

Each window has its own coordinate system, specified by the application, or, in the case of environment managers, the manager window supervisor. These windows can be adjusted in size and can be made to overlap. The overlapping effect is achieved by allowing display windows to share virtual memory.

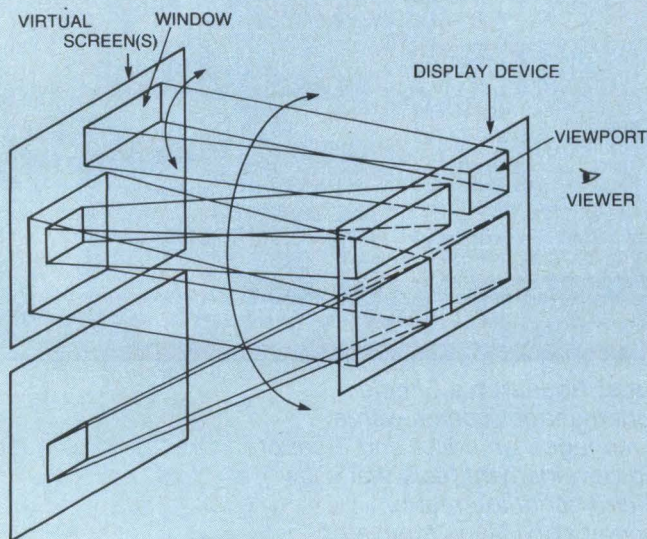

In windowing, the screen consists of the actual display screen and a virtual screen. The windows, also called viewports, show a copy of the information in the virtual screen area.

The notion of the "current window" simplifies not only the window interfacing but also the understanding of windowing itself. In operation, such as with IBM Corp.'s TopView, the current window is that which, at any instant, dominates the screen display buffers and contains the active application. This is true until another window is made active, typically by pointing to it with a mouse.

Because the viewports share a virtual memory buffer within the system, many windows can be made to appear to have control over the screen.

While an application requires full use of the display buffers and full attention from the graphics primitives, only one window is displayed. This is the case in using a package such as Lotus Development Corp.'s 1-2-3, which uses all the display facilities of the IBM PC and thus pushes everything else aside, placing them in the system heap.

Since the graphics front-end adds a user-pleasing interface, it seems only natural that multitasking should also come into play. Currently, however, only a few packages, such as Application Executive Corp.'s APX Core, Digital Research Inc.'s GEM and IBM's TopView, support multitasking operations. This is achieved by sharing time with the microprocessor to allow applications in the background to run. The notion of the current window is still preserved, and background applications may still be shown on the display screen but not updated until made current.

As with the sharing of window space in the memory for display purposes, multitasking also requires the sharing of many resources on the system. Specifically, all the applications must share processor registers and system memory. Hence, special areas of memory are preserved for stacks and heaps to keep track of the application status.

The proposed virtual device interface (VDI) standard would provide the necessary tools for handling the interface tasks. And, in the case of the IBM PC, the interrupt structure of the processor is used to manage swapping applications in and out.

Because the process is so new, multitasking environment managers tend to slow operations. However, more powerful microprocessors such as the Intel Corp. 286 and Motorola Inc. 68020 and 68032 can handle tasks at higher speeds.

FOR REEL RELIEF, TAKE ONE EVERY 500MB.

Imagine: half a gigabyte of storage on a single, cost effective, book size cartridge. A drive that streams at 180 ips and transfers approximately 10 megabytes per minute. With random access that lets you get to any file in a matter of seconds. Using industry standard data rates and controllers.

Remember, these are the same MegaTape recording wizards who gave OEM's the first truly cost effective solution to Winchester disk back up with 300 MB on 1/2" tape. Now, a whopping 50% capacity increase



making this the world's highest capacity cartridge — still using proven reliable tape technology.

MegaTape's unique features open up exciting new applications for OEM's in areas like digital image storing, CAD/CAM, networking, archiving and large scale data base distribution.

Sound too good to be true? Convince yourself — call MegaTape for complete details. Better yet, order a drive for evaluation. In no time at all, you'll find out what a great feeling reel relief can be.

Call Carl Cox, Product Marketing Manager, (818) 357-9921
MegaTape Corporation, P.O. Box 317, Duarte, CA 91010-0317

 **MegaTape**
The great leap forward in backup.

CIRCLE NO. 71 ON INQUIRY CARD

© 1985 MegaTape Corp.



Norman B. Petersen
Senior Vice President
Fujitsu America, Inc.

“The 8” disk drive contest is over. Fujitsu just doubled the capacity and the transfer rate.”

Your best choice in 8” disk drives just got twice as good. Because we took our popular 168 megabyte model and doubled both its capacity (to 336 megabytes) and its transfer rate (to 2.4 megabytes per second). And we did it in the same form factor, using RLL (Run Length Limited) encoding methods and an SMD-compatible interface.

Which means you can now get twice the capacity from a drive with proven technology. It also means you can readily integrate this new maximum-performance drive into your current system design.

This drive is just what you need to help satisfy those complex, multi-user applications requiring fast access and huge amounts of data. You can stack up to four of these drives together in a 19” rack, and thereby provide a total of 1.3 gigabytes of storage, with an average positioning time of 20 milliseconds. Now that’s performance!

You also get compatibility with our



MODEL	M2322	M2333
CAPACITY (MB) Unformatted	168	336
AVERAGE POSITIONING TIME (msec)	20	20
TRANSFER RATE (KB/sec)	1229	2458
INTERFACE	SMD	SMD
POSITIONING METHOD	Rotary Voice Coil	Rotary Voice Coil

new 689 megabyte Eagle. They have the same track capacity, the same high-speed SMD interface, and can attach to a common controller. Off-the-shelf controllers are readily available for both drives.

But best of all, you get Fujitsu’s dedication to maximum quality. And it’s our quality which has helped establish Fujitsu America as one of today’s leading OEM disk drive suppliers.

Get the full story. Call Fujitsu America today, at (408) 946-8777. Or write Fujitsu America, Inc., Storage Products Division, 3055 Orchard Drive, San Jose, CA 95134. We’ll show you why the performance contest is over in 8” disk drives.

Fujitsu Storage Products. Maximum Performance. Maximum Quality.

FUJITSU AMERICA, INC.



INTEGRATED SOFTWARE

to 43 different applications." To allow full use of the data, DUNSPPlus provides utilities that handle inter-application data transfer and formatting.

Jeffrey W. Hulton, vice president of Access Technology Inc., South Natick, Mass., contends that what will determine the real usefulness of environment managers is their ability to translate data files for use by all system entities. "What people in the office want is common data. It doesn't matter what spreadsheet they're using; they just want to know that they can use the available information, regardless of what software created it," says Hulton.

Making use of the DOS command functions and BATCH file capability, Bourbaki Inc.'s 1 DIR (pronounced "wonder") serves as a front-end by encasing the operating system and using BATCH files to call applications (Fig. 4). The menu-style front-end is manipulated by using the IBM PC arrow keys to locate applications, thus eliminating the need for the user to locate applications.

Taking a similar approach, but adding a spreadsheet, a database manager, word processing, graphics and communications—all folded into a menu-driven environment—is Ability, developed by Xanaro Technologies Inc. (Fig. 5). Another company that has taken an innovative approach is Application Executive Corp., with APX Core. This package, like TopView, provides a multiwindow, multitasking environment for users of the IBM PC and compatibles. APX Core comes with a series of utilities that enable it to work with such products as Lotus 1-2-3 to ensure proper operation in a windowed environment. APX Core also provides a powerful block-transfer function. Thus data can be transferred task-to-task without special conversions or system utilities.

Quest Research Inc. expects to enjoy a share of the environment manager market with Simplex (Fig. 6). Simplex stands out due to the number of functions it offers. Simplex offers windows, a consistent interface to applications and mouse support, but Simplex also combines communications, word processing and database management. And, unlike any of the other packages, Simplex comes with a complete development language and development tools so that ISVs and VARs can build specialized vertical-market applications. □

Interest Quotient (Circle One)
High 477 Medium 478 Low 479

BYTCOM MODEMS

FOR YOUR PCs
OR DATA TERMINALS



Feature after feature!

- Full Bell 212A compatibility (0-300, 1200 baud) with remote digital loopback and internal self test.
- 16 character security password.
- Designed for use with either "dumb" terminals or PCs.
- Synchronous and Asynchronous transmission modes.
- Internal storage of nine names and numbers to forty characters in length.
- Exclusive ability to "Reboot" your computer.
- User-friendly help menu.
- Rack mountable version available.

Free "SuperScout" Communications Software

This unique \$249 software value allows data file transfer using a sophisticated error checking protocol. It also gives automatic access to COMPUSERVE™, Western Union's EASYLINK™ and 13 other data bases without individual sign-up or monthly minimum fees.

A very broad warranty!

The 212AD is a proved-in-service product whose high reliability allows Bytcom to offer an *Immediate Unit Replacement Warranty* within the first two years of ownership. Details on request.

Contact Bytcom for additional information and name of your nearest distributor.

Software Supplied By
BUSINESS COMPUTER NETWORK
SUPERSCOOT™

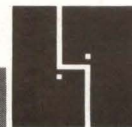

BYTCOM

2169 Francisco Blvd. Suite H,
San Rafael, CA 94901

(415) 485-0700 (800) 227-3254 (outside CA).

CIRCLE NO. 73 ON INQUIRY CARD

TOGETHER,
STOPPING
YOU.



RUN-TIME VERSION AVAILABLE

THERE'S NO

KnowledgeMan™ and You. The possibilities are endless.

To succeed in business, you need a partner that's fast, flexible, intelligent and easy to work with. A partner that can help turn your big ideas into well-conceived reality. One that gives you the support you need to make critical decisions confidently.

No partner can give you more of what you need than KnowledgeMan, the knowledge management software from MDBS.

A powerful partner.

KnowledgeMan helps you manage more knowledge, in more ways, than ordinary software. It can help you make better decisions on just about everything from production scheduling to financial planning to market

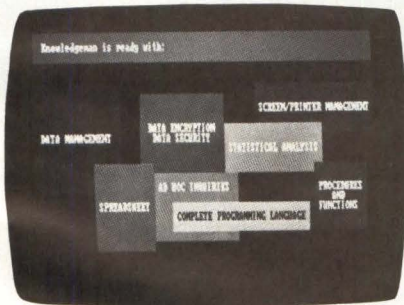

forecasting. KnowledgeMan and its optional components offer data management, spreadsheet analysis, statistical analysis, text processing, forms management, business graphics, programming and more.

The key to KnowledgeMan's versatility is its exclusive synergistic integration, allowing you to accomplish your computing needs within one program. Unlike other software, there's no need to exit one function before entering another. The result: different kinds of processing can be intermingled. Quickly and easily.

A partner that speaks your language.

For all of its power and sophistication, KnowledgeMan is remarkably simple to understand. Even a beginner can start putting KnowledgeMan to work in minutes. With a single query, you can obtain related data from unlimited multiple tables. You can even teach KnowledgeMan to understand your own jargon.

A partner that helps you along.

The on-line HELP facility allows you to draw on 6800 lines of helpful information organized into 380 screens. If you have a problem or question, KnowledgeMan allows you to access the pertinent HELP screen immediately. Each screen is carefully designed to provide a quick reference guide to KnowledgeMan commands.

A partner that gives you room to grow.

Ordinary software packages can be frustratingly easy to outgrow. Not KnowledgeMan. Each KnowledgeMan component has more power than you'll probably ever need—far more than conventional integrated programs. With KnowledgeMan, you don't sacrifice capability, capacity or convenience. So with KnowledgeMan, you spend your time solving problems—not trying to overcome software limitations.

A partner that protects your interests.

KnowledgeMan offers sophisticated security features. Unauthorized access to data is next to impossible, thanks to password checking, thousands of access code combinations and data encryption.

So your secrets are safe with KnowledgeMan.

A partner you can build on.

To add yet another dimension to KnowledgeMan's capabilities, you can get fully-integrated options like K-Graph, an extensive business graphics facility that

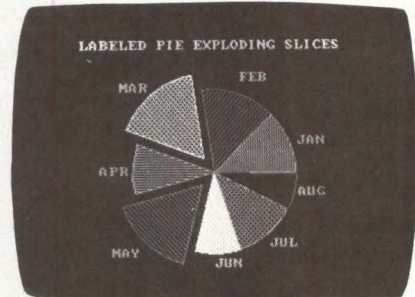

lets you plot information in a variety of colorful graphs, charts and diagrams. For text processing, the K-Text option lets you incorporate data into written documents quickly and easily. Or, create highly-polished, full-color customized forms with K-Paint, our forms painting option. To short-cut the keyboard, put the K-Mouse option to work.

A partner you should get to know better.

To see KnowledgeMan in action, visit your dealer. Or contact Micro Data Base Systems, Inc., P.O. Box 248, Lafayette, IN 47902, (317) 463-2581, Telex: 209147 ISE UR.

It may be the beginning of a long, successful partnership.

Current version is 1.07 as of 9/10/84. KnowledgeMan, K-Graph, K-Paint, K-Text, and K-Mouse are trademarks of Micro Data Base Systems, Inc. MDBS is a registered trademark of Micro Data Base Systems, Inc.

KNOWLEDGE man

The Knowledge Management Software
from MDBS

Operating Systems: PCDOS, MSDOS, CP/M-86. Minimum RAM required: 192K. K-Graph: PCDOS only.

CIRCLE NO. 74 ON INQUIRY CARD



No Paper Wait.

Waiting gets you nowhere. Waiting wastes time. It wastes money.

▶ To save both, Tally presents the MT400 FlexiForm printers. And to help you boost efficiency, these high volume, high speed serial printers have productivity features you won't find anywhere else.

▶ For about half the cost of a line printer, a Tally FlexiForm will whip through paper work at up to 300 LPM.

▶ You'll produce draft copy at a consistent 400 CPS. Your correspondence will have a high resolution, professional look. From inventory reports and spreadsheets to business graphics and bar codes, nothing in their class is engineered to perform like FlexiForms.



MT440L

▶ For speed and ease of programming, direct menu access lets you arrange page and print formats with just a few front panel commands. And there's always the ideal paper handling choice for the work you do. Because FlexiForm printers can have tractors that push and pull, friction feed, a quick-tear bar, automatic feeders for single sheets and more.

▶ Waiting for important information is the last thing you want. So wait no more. Call Mannesmann Tally today for information on the world's best engineered serial printers: (206) 251-5524.

MANNESMANN
TALLY

NEW PORTABLE COMPUTERS BETTER AIMED AT MARKET

Ignoring clear indications of what transportable-portable computer users want has cost manufacturers dearly, but signs are the message is getting through

Gene R. Talsky
Contributing Editor

Two factors that dominated the computer industry's transportable-portable market segment in 1984 continue to exert an influence in 1985. The first is that never before had what can be called the trans/portable market made its voice so clear, while being so stubbornly ignored by the industry. And the second is that more manufacturers have begun to heed user demands by applying advanced technology and packaging techniques in emerging trans/portable systems.

The cost of not meeting the demands of the market has been the loss of hundreds of millions of investor dollars, the waste of years of labor and warehouses full of unsold inventory. The lesson has been hard on both established companies and start-ups.

In retrospect, the trans/portable market has been predictable. When Adam Osborne introduced the first portable computer in 1981, it set off a wave of buying that many attributed to the need for portability. In reality, the Osborn I sold simply because it was the first full-capability CP/M computer system bundled with extensive application software for under \$2,000. Unfortunately, Osborne Computer Corp. was losing money on every sale and eventually was forced into a Chapter 11 federal bankruptcy, from which it emerged in 1984.

In 1982, Teleram Communications Corp. introduced the first battery-operated, full-function CP/M system. Priced at \$3,000, it met market resistance. When Tandy Corp. introduced its Model 100, with limited editing and calendar



Compact packaging, dual disk drives, a 25-line, 80-column liquid crystal display and MS-DOS and CP/M-86 distinguish International Quartz's 9242 transportable.

functions for under \$1,000, it sold large volumes during most of 1983. But, after the first wave of buyers, sales fell to a trickle and didn't increase significantly, even in response to price reductions to less than \$500. Epson America Inc. and NEC America Inc. also offered attractive products, only to find that the market for inexpensive, limited-function, battery-powered systems was quickly saturated.

Compaq Computer Corp. did set sales records with a relatively compact product in 1983. However, much of its success was due to an ability to deliver true compatibility with the IBM Corp. PC at less cost during a period when PCs were

A pioneer in upright design, the Morrow Pivot portable also offers dual 5¼-inch disk drives, a CMOS 80C86 processor, a calculator and clock function keys.



difficult to obtain. Compaq's strong commitment and loyalty to its dealer base enabled it to maintain growth through 1984. Nevertheless, the product's transportability is marginal at best.

The early success of Osborne and Tandy led many market research firms to project phenomenal growth for the trans/portable market in the '80s. Thus encouraged, more than 150 manufacturers developed trans/portable systems. Few efforts succeeded. Some companies ran out of money before they could bring their products to the market. More failed because their systems did not meet market expectations—they found neither distribution channels nor buyers. Even IBM learned that the market will reject inadequate products. Examining some of 1984's failures proves illustrative.

\$100 million+ marketing lessons

Gavilan Computer Corp., armed with venture investments that reportedly totaled more than \$31 million, racked up the most widely publicized failure of 1984. In the aftermath it's easy to conclude that its product and marketing strategies were the reasons for the downfall. Apparently Gavilan didn't believe that MS-DOS was the de facto standard operating system for personal computers, so it developed its own. Gavilan didn't believe existing word processors, spreadsheets and other applications were satisfying market needs, so it developed its own. Gavilan also determined that a new, state-of-the-art, touch panel for cursor movement and menu selection would meet the demands of the market, but it ignored the full impact of development and production costs.

However, Gavilan was among the earliest to recognize the need for integrated disk storage. Unfortunately, the company was premature in selecting first 3- and then 3½-inch drives. Gavilan came to recognize its problems with product strategy and began to take corrective steps. For one thing, it offered an MS-DOS option—but it was too late. As to marketing, Gavilan bypassed established distribution channels in favor of value-added resellers (VARs), who are fewer in number, less well-established in trans/portable markets and who are more difficult (more costly) to identify and contract.

Convergent Technologies Inc.'s Workslate and the Xerox/Sunrise 1800 series, exemplify the result of what might be referred to as myopic development programs. Convergent failed to recognize the market's long history of rejecting non-standard keyboards and limited displays and functionality. It offered all those drawbacks for \$1,500, competing with Tandy's Model 100 and NEC's 8200 portables at half that price. Xerox

WHAT ADVANCED PORTABLES DO AND DON'T OFFER

Manufacturer, model	Advanced features	Required to meet market needs
Data General/One	dual 3½-inch disks; 25 line x 80 column LCD; MS-DOS and CP/M-86; expansion chassis	IBM-compatible 5¼-inch disk drive(s); improved LCDs
Hewlett-Packard HP110 The Portable	CMOS 80C86; RAM Disk; ROM MS-DOS; ROM applications	removable storage; 25 line x 80 column display; video/CRT interface; parallel interface
Micro Office RoadRunner	friendliest software operating environment; RAMdisk and RAM cartridges	25 line x 80 column display; 16-bit IBM-compatible processor; 5¼-inch disk drive(s)
Morrow Pivot	CMOS 80C86; dual 5¼-inch disk drives; single-key modem; calculator; clock function keys; upright packaging	25 line x 80 column display; detachable keyboard; video/CRT interface
Quadram Datavue 25	25 line x 80 column LCD; 5¼-inch disk drive; detachable infrared keyboard, upright packaging	video/CRT interface; second integral disk drive
TIME. Office Computers (Ex: Dulmont Magnum)	80186; ROM MS-DOS; removable ROM and RAM packs	25 line x 80 column display; 5¼-inch disk drive(s); U.S. distribution and support
Zenith ZP 150	Microsoft ROM-based HH-DOS; Microsoft ROM-based applications; expansion chassis	5¼-inch disk drive(s); 25 line x 80 column display; ROM cartridges (instead of components); video/CRT interface

From landscape to portrait in one second

Screen can be *lifted and tilted* to ensure optimum work level.

ERGONOMICS AND TECHNIQUE
FROM AN ENTIRELY NEW ANGLE

Flickerfree black characters for picture-perfect performance. (Amber characters available as option).

The screen actually turns to give instant choice between landscape format (24x80 char.) for data-entry applications and portrait format (72x80 char.) for word-processing applications.

Superlim keyboard with integrated palmrest and two tilt levels. *12 function keys* give a total of 36 user-definable character strings.

Details or overview – the choice is yours with the Facit Twist asynchronous terminal. Just turn the 15" high resolution screen and the landscape format of 24 lines changes into a portrait format of 72 lines – a full page! Now you can instantly choose the ideal format for your data-entry, word processing or program development application.

But there is much more to Facit Twist than meets the eye. It has the total flexibility that qualifies it as a really multi-purpose workstation –

a command protocol of your choice (including ANSI X 3.64), printer handling, semi-graphics, programmable function keys as well as outstanding ergonomics.

And the price really confirms the attraction of Facit Twist in your system solution.

So the next time you need a terminal for your system, choose the one that adjusts to your way of working – rather than the other way around.

The Facit Twist!

FACIT

Head Office: Facit AB, S-17291 Sundbyberg, Sweden. Phone: (8) 7643000. USA: Facit Inc. P.O. Box 334, Merrimack, NH 03054. Phone: (603) 424-8000

CIRCLE NO. 76 ON INQUIRY CARD

What do these popular micro printers have in common?

Access
Apple
Atari
Burroughs
C.Itoh
Commodore
Coleco
CPT
Cromemco
Digital
Epson
Hewlett Packard
IBM
Integral Data
Leading Edge
NEC
Northstar
Okidata
Radio Shack
Seiko
Sord
Toshiba
Xerox
Zenith Data
Systems

Quality replacement ribbons from Pelikan!

Pelikan 

Franklin, Tennessee 37064

Pelikan offers an outstanding product line as well as a comprehensive dealer support program. For more information call toll free: 800-251-3365 (in Tenn. call collect: 615-790-6171).

The brand names listed are intended only to show the compatibility of the above machines with products manufactured by Pelikan.

CIRCLE NO. 77 ON INQUIRY CARD

Corp. and its defunct spin-off, Sunrise Co., asked too much for too little with predictable results.

Bytec-Comterm Inc. reportedly lost \$48 million trying to market its IBM-PC clone, which included some nice hardware and software features in an attractive package. Unfortunately, its Hyperions wouldn't keep running, which quickly closed off reseller channels and sealed corporate doors. Otrona Corp., one of the earliest to appear after Osborne, offered advanced engineering in an outstanding and compact CP/M package. It developed a loyal cult of dealers and users for its innovative Attaché system. However, the initial PC-compatible offering appeared patched together and didn't impress. Then, new management led the company away from its advanced technology philosophy, resulting in the model 2000, which was perceived as just another PC clone, albeit in more attractive clothing. At that point, the company failed.

Market needs are clear

Such real-world case studies should serve as warning signs. But more companies continue to offer products that ignore the market's less-than-subtle directions.

These include clear indications that:

- Full displays such as 25 lines by 80 columns are mandatory
- Liquid crystal displays (LCDs) are marginally acceptable and interfaces for all display options, including RGB (red, green, blue) are required for extended use
- Integral, removable storage that is PC-compatible is required
- Would-be buyers doubt that a 5-pound computer offers the same capabilities as a desktop unit.

Integral, removable storage is essential because, while application software is becoming more readily available on 3½-inch disks, users have a substantial amount of copyrighted software on 5¼-inch media. Business files developed on personal computers are almost universally stored on 5¼-inch disks and will continue to be updated on existing desktop systems in that format.

Doubts about the functionality of the hand-carried portables are not being effectively addressed by current promotional campaigns that ignore the lessons of the past five years. Manufacturers are still promoting features (5 pounds, 10-hour battery operation, 720K-byte disk drives, etc.) rather than benefits.

Finally, pricing is critical. The market has not been willing to spend \$3,000 for a battery-powered system that it doesn't regard as a full-

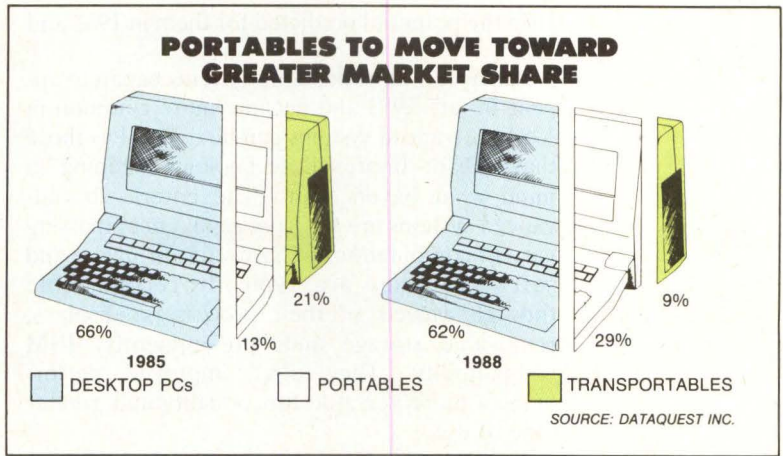

function personal computer, when a "real" desktop IBM PC is readily available for as little as \$1,500.

It is apparent that the marketplace is driving product design, marketing strategy, pricing and distribution. Buyers have refused to cooperate with the industry pundits who, too early, predicted monumental sales of trans/portable systems, without due regard to market realities. Real opportunities do exist for companies with products that meet all or most of the market's demands. Indications are that sales of advanced trans/portable systems should begin to realize in

WHAT ADVANCED TRANSPORTABLES DO AND DON'T OFFER		
Manufacturer, model	Advanced features	Required to meet market needs
ACT Apricot Portable	80186; 25 x 80 LCD; voice recognition; infrared keyboard; mouse; advanced MS-DOS front-end environment	standard keyboard layout, size and keys; articulating display; IBM-compatible 5¼-inch disk drives; greater IBM-PC compatibility
Grid Systems Compass	8086 & 8087; bubble memory; electroluminescent display; expansion chassis; application software; compact packaging	integrated removable storage, more competitive pricing, greater IBM-PC compatibility
International Quartz 9242	80186; dual 5¼-inch disk drives; 25 x 80 LCD; MS-DOS & CP/M-86; expansion chassis; compact packaging	distribution and support
STM Portable Personal Computer	80186; 25 x 80 LCD with electroluminescent backlight; compact packaging	greater IBM-PC compatibility, articulating display
Visual Technology Commuter	dual 5¼-inch disk drives; 25 x 80 LCD; compact packaging	U.S. distribution and support

1985 the potential predicted for them in 1983 and 1984.

Advanced trans/portable systems began to appear in late 1983 and became more common in 1984. Advanced systems can be defined as those that deliver improved technology, keeping in mind what buyers want. The criteria for advanced systems are far from rigid, encompassing various combinations of hardware, firmware and software. They are typically recognizable through aspects of their processors, displays, removable storage and, pre-eminently, IBM compatibility. They offer improved performance, more versatile functionality and greater ease of use.

Grid Systems Corp. led the field in 1982 with its 8086-based system, which also included an 8087 processor chip, offering phenomenal performance at that time. However, buyers must still pay a premium for Grid's advanced engineering and performance. In 1984, led by STM Electronics Corp., with its 80186-based system, a number of manufacturers, including Hewlett-Packard Co. (HP), Morrow Designs Inc. and TIME.Office Computers of Australia, offered either 8086 or 80186 processors in their trans/portables. TIME.Office acquired Dulmont Electronics Systems PTY. Ltd.

Intel Corp.'s 8088, although lacking in horsepower, enabled volume delivery of low-cost por-

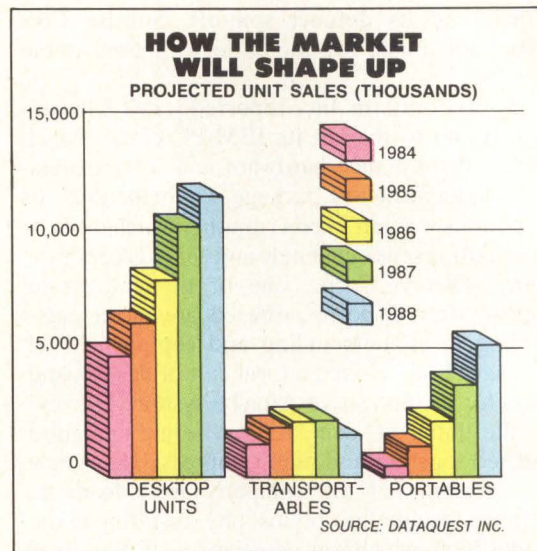

table computers. Pricing became the primary competitive factor when Seequa Computer Corp., following Osborne's lead in the Z80 CP/M market, offered PC-compatible systems with the 8088 and substantial bundled software at low cost. It competed successfully until IBM reduced its prices for the PC and PC/XT after the introduction of the PC-AT. However, the 8088 offers limited performance and expansion capability and does not qualify as advanced.

Three who eliminated 'A>,' User Enemy No. 1

Micro Office Systems Technology Inc.

Roadrunner: This 5-pound portable was the first clamshell design. It also was the first CP/M-compatible system to incorporate firmware and software to provide text editing, calendar and scheduling, telephone directory and autodial, spreadsheets and other applications without the end user's ever having to confront A>. (It never appears on the screen.) Solely with the use of function keys, users quickly home in on whichever operations they wish to perform and load the files on which they wish to perform them. They can even change the baud rate for the modem and the RS232 port without ever touching anything except function keys. Additionally, a separate HELP key provides ready access to instructional information. This is the only system that truly enables a novice to use a computer without opening the manual.

Hewlett-Packard Co. Series 110 Portable: HP has incorporated its Personal Application Manager (PAM) software in ROM on its 8086-based portable system. Originally introduced with the HP 150 desktop personal computer, PAM offers users the ability to move from application to application with menu

selections. However, PAM is best suited for experienced computer users. The action required and the support are not always self-evident. However, it is a major improvement over confronting the A>.

Zenith Data Systems ZP 150: This is the first system based upon Microsoft Corp.'s HH-DOS, which is resident in ROM. It also includes modified versions of Microsoft Word and Multiplan, as well as communications, calendar and scheduler functions, which can be initiated in a window concurrently with applications. While Word and Multiplan are two of the more capable office tools, they are also more difficult to learn and to use. They diverge from the single-command line structure standardized by VisiCalc, using instead cursor-selected commands from several lines of options on the bottom of each screen. Zenith uses HH-DOS to narrow those optional commands down to a single line. However, instead of selecting commands with function keys, users must still move the cursor to the command or type it. Although users never see the villain A>, they need to understand Microsoft's command structure in order to use the software. Undoubtedly, HH-DOS is a step in the right direction.

In a one-to-one comparison, Westrex-One.



The one printer you can rely on.

Prints in 120 different type fonts.
Elite or Pica, single or multiple pass.
Emphasizes, italicizes, condenses, underscores.
Prints at 145 characters per second.
With RS 232 and Centronics parallel interfaces.

These are actual print samples

Prints in 120 different type fonts.
Elite or Pica, Single or Double pass.
Emphasizes, italicizes, condenses, underscores.
Prints at 145 characters per second.
Available with serial or parallel interface.
Accepts single sheets or continuous forms.
1,000 hour MTBF, 15 minute MTRR!
Extremely small footprint.
Off-the-shelf delivery.
Attractive OEM pricing.
And built-in Litton quality you can count on.

Accepts single sheets or continuous forms.

1,000 hour MTBF, 15 minute MTRR.

And graphics, too.

The new Westrex One. Compare it for yourself.

See the Westrex One in action, and you'll understand why it's far and away the winner in any one-on-one comparison.

Westrex One has the versatility that gives your product extra value. It produces some of the crispest, clearest Dot Matrix printing you can find. Plus a comprehensive variety of type fonts and styles. And the ability to handle intricate graphics. Custom interfaces where required.

Naturally, because it's built and backed by Westrex/Division of Litton, it's a reliable, long lasting product. We kept moving parts to a minimum, so there's less to go wrong.

If you need a printer with Flexibility... Quality... High Performance, the Westrex One is the 1 for you.

Send for free comparative performance matrix and make your own "one-to-one" evaluation. Contact Westrex/Division of Litton OEM Products, 51 Penn Street, Fall River, MA 02724, (617) 676-1016. TELEX: 651490, Please Relay WNWJW.



WESTREX OEM PRODUCTS

Litton

CIRCLE NO. 78 ON INQUIRY CARD

Parallel computer. Unparalleled capability.



Introducing the Flex/32 MultiComputer™. A revolutionary parallel computer with performance that's scalable from supermini to supercomputer – a capability for growth beyond the needs of any application.

An entry-level Flex/32™ system starts you out with two 32-bit superminis, 2 megabytes of local memory, 128 kilobytes of common memory and two VMEbus interfaces. That's more power than two stand-alone superminis. But that's just the beginning.

Each Flex/32 MultiComputer cabinet can contain up to twenty supermini CPUs, each with 1 megabyte of RAM and a VMEbus interface, each performing more than one million instructions per second. And since there's no limit to the number of cabinets you can connect, Flex/32 can be configured and reconfigured easily as your applications demand. In fact, Flex/32 is the most change-tolerant system available today.

What's more, since Flex/32 is a Multi-Computer, it can provide true concurrency in processing. Which means it can run many programs at precisely the same instant in time. That's the kind of teamwork you need in large-scale real-time and scientific applications.

The Flex/32 comes with the software tools you'll need to help make the best use of its outstanding processing capabilities. Like our concurrent UNIX™ System V operating systems. And languages like C, our own ConCurrent C™, FORTRAN 77 with ISA extensions, RATFOR and the Flex/32 ConCurrency Simulator. A performance evaluation option is available to enable you to tune run-time performance for optimized applications.

The Flex/32 MultiComputer. The only general-purpose MultiComputer. No other system offers more performance and more capability for growth. So contact us today for more details.

Flexible Computer Corporation

Corporate Office: 1801 Royal Lane, Building 8, Dallas, TX 75229, (214) 869-1234; Eastern Regional Office: 5 Great Valley Parkway, Suite 226, Great Valley Corporate Center, Malvern, PA 19355, (215) 648-3916/7; Western Regional Office: 2250 E. Imperial Hwy., Suite 252, El Segundo, CA 90245, (213) 640-3322.

Flex/32, Flex/32 MultiComputer and ConCurrent C are trademarks of Flexible Computer Corporation. UNIX is a trademark of AT&T Bell Laboratories. © 1984 Flexible Computer Corporation

CIRCLE NO. 79 ON INQUIRY CARD

New products must offer faster, more powerful processors.

Although LCDs now are vastly improved over those used earlier in wristwatches and calculators, and are still improving, they remain one of the two primary deterrents to broad market acceptance of portables. Except for Grid with its electroluminescent display and Strategic Technologies Inc.'s PC Traveler, which uses a gas plasma, flat-panel display, portable computers employ LCDs. STM is the only company that has adopted a dual-technology display, backlighting its 25-line-by-80-column LCD with an electroluminescent panel, enabling a visible display in bad (or no) lighting. Development of electrophoretic panels and gas plasma continues, but they remain costly and require too much power for battery-operated systems.

Lack of compatible removable-storage devices represents the second primary deterrent to broader acceptance of portables. Until IBM validates 3½-inch drives by incorporating them in both desktops and portables, that format will remain in relatively limited use. When included in portables such as the Data General Corp. (DG) Data General/One, 3½-inch drives must be able to interface with 5¼-inch drives through standalone disk drives or an expansion chassis, or with other systems through local-area-network, direct-cable or RS232 interfaces.

Requiring users to buy external 5¼-inch disk drives causes the price for HP 110s, Data General/Ones or Zenith Data Systems' ZP 150 portables to increase to well above the cost of dual-drive desktop systems. The alternative is to use such portables in conjunction with a desktop microcomputer, minicomputer or mainframe computer. Such a product strategy limits wide general acceptance in small-business markets.

PC compatibility remains the primary criterion for buyers considering alternative systems. Compaq's success is due in great measure to its compatibility strategy. Interestingly, IBM itself does not offer 100-percent compatibility throughout its personal computer lines, from the PCjr to PCs and PC/XTs and now the PC-AT. Although Compaq's DeskPro line offers advanced capabilities, its portable line does not reflect such innovation. Hardware and software compatibility with PCs and broader availability, aided greatly by the inadequacies of IBM's portable offering, helped Compaq to attain its record-breaking sales levels in 1984. Undoubtedly, the company will introduce more capable and innovative Compaq trans/portables in 1985.

Japanese systems, including Sharp Electronics Corp.'s 5000, Sord Computer of America Inc.'s IS-11 Consultant, NEC's PC-8401A and Epson's

PX-Geneva offer excellent capabilities at low prices. Unfortunately, except for the Sharp 5000, they fail to address U.S. business practice, which currently centers around Microsoft Corp.'s MS-DOS operating systems.

In January, HP released its 68000-based Integral Personal Computer, a UNIX system that incorporates an electroluminescent display (MMS, January, Page 31). Also this year, Zenith plans to release the first portable based upon Microsoft's HH-DOS. Although HH-DOS is a step in the right direction, it doesn't offer as much user friendliness as it could. Tandy also has released its Model 200, a disappointing follow-up to the Model 100, which, because of low price, remains the most successful "lap" portable, in spite of limited functionality.

The biggest question for 1985 is posed by IBM's "clamshell" system. Undoubtedly, no other company has IBM's expertise in the critical technologies for advanced portable systems. It has flat-panel, plasma display systems, a long history of development in bubble-memory technology and proven expertise in removable-storage devices. However, IBM rarely brings its most advanced technology to the market. It relies instead upon its unchallenged marketing position and capability to attain record sales of products that offer little technological innovation. The company's current portable PC is inadequate, providing less than 100-percent software and hardware compatibility with its own PCs and XTs, as well as expansion limitations. In spite of its reported volume purchases of 3½-inch disk drives, it is not in IBM's best marketing interests to validate the HP, DG and TI formats. Once again, in 1985, IBM will have the market waiting for its newest microcomputer release—its portable computer.

It may be hoped that someone this year will put together a system that takes the best hardware features of the STM transportable along with those of the Data General/One, the Morrow Pivot and Quadram Corp.'s Datavue 25 portables and combine them with the firmware and software of the Micro Office Systems Technology Inc. Roadrunner. Or, perhaps Grid will put two Canon U.S.A. Inc. one-third height, 5¼-inch disk drives and batteries in its systems and reduce the price to \$3,000. As manufacturers bring technology and manufacturing efficiencies to meet market realities, 1985 should prove to be the year in which past, unfulfilled sales projections will finally be realized. □

Gene R. Talsky is president of Professional Marketing Management Inc. (PROMARK), Old Lyme, Conn. His company provides strategic planning, business development and marketing planning services for hardware, software and services companies. He has held management positions with IBM Corp., Computer Sciences Corp. and Informatics General Corp. and has started four successful companies.

Interest Quotient (Circle One)
High 480 Medium 481 Low 482



**IN AN AGE
OF STANDALONE
WORKSTATIONS,
IT ISN'T ENOUGH
FOR A WORKSTATION
TO STAND ALONE.**



It's a well-accepted dictum that the bigger the technical problem, the more compute power needed to solve it. A valid reason for engineers and scientists to demand their own standalone computers and the processing power that comes with them.

But experience tells us that the results of one person's efforts are inevitably meant to be shared with other people. A requirement that even the best standalone computers fail to meet.

One computer company has successfully solved this apparent dilemma. Apollo. Instead of simply building standalone computers, we've engineered DOMAIN[®] processing. A computing environment that adheres to our belief that both processing power and the ability to share that power are equally important in measuring a computer system's true value.

Thus DOMAIN combines dedicated 32-bit workstations in a computer system that lets users transparently share both information and resources across a high-speed local area network. Logically offering the advantages of both timesharing and dedicated computers without the drawbacks of either. Timesharing without a terminal case of limited power. Dedicated

workstations without isolation from co-workers and their data.

DOMAIN processing also delivers something else uncommon to standalone computers. A family of compatible workstations. They range from high performance color units for demanding applications such as solids modeling to monochromatic workstations for applications like software engineering.

Adding to DOMAIN's range and choice are more than 300 applications from the world's best software suppliers. Applications that cover electronic design, mechanical design, computer integrated manufacturing and much more. Letting you automate entire development processes rather than individual tasks.

While these facts no doubt attest to the efficacy of DOMAIN processing, it's also reassuring to know that the DOMAIN network even connects to other computer systems via industry standard protocols such as X.25 and ETHERNET.[®] Of course DOMAIN supports the UNIX[®] software environment as well.

A reminder that it's because our workstations don't stand alone, that we do stand alone.

Call (617) 256-6600 x4497. Or write Apollo, 330 Billerica Rd., Chelmsford, MA 01824, MS 29.



Our workstations don't stand alone because you don't work alone.



apollo

ETHERNET is a registered trademark of Xerox Corporation.
UNIX is a trademark of Bell Telephone Laboratories, Inc.
DOMAIN is a registered trademark of Apollo Computer, Inc.



CIRCLE NO. 80 ON INQUIRY CARD



Tandon Disk Drives at Hall-Mark.

When you need a reliable, low-cost Winchester drive or Winchester subsystem, we're the source you can rely on.



Hall-Mark Electronic Corp. • Dallas, Texas • Subsidiary of Tyler Corp. 

Northeast

Boston 617/935-9777
Cherry Hill 609/424-7300
Fairfield 201/575-4415
New York 516/737-0600
Philadelphia 215/355-7300

Southeast

Atlanta 404/447-8000
Baltimore 301/988-9800
Ft. Lauderdale 305/971-9280
Huntsville 205/837-8700
Orlando 305/855-4020
Raleigh 919/872-0712
Tampa Bay 813/530-4543

North Central

Chicago 312/860-3800
Cincinnati 513/563-5980
Cleveland 216/349-4632
Columbus 614/891-4555
Milwaukee 414/761-3000
Minneapolis 612/854-3223

South Central

Austin 512/258-8848
Dallas 214/553-4300
Houston 713/781-6100
Kansas City 913/888-4747
St. Louis 314/291-5350
Tulsa 918/665-3200

Northwest

Bay Area 408/946-0900
Denver 303/790-1662
Sacramento 916/722-8600

Southwest

Orange County 714/669-4700
Phoenix 602/437-1200
San Diego 619/268-1201
San Fernando Valley 818/716-7300
West Los Angeles 213/643-9101

© 1984 Hall-Mark Electronics Corp./5661

SYSTEM INTEGRATORS EXPLOIT PC COMPATIBILITY

Hardware and software infrastructure surrounding the IBM PC proves ideal for system integration

Rick Dalrymple, Senior Editor

Like a snowball that grows as it rolls downhill, the August 1981 introduction of the IBM Corp. PC set off a flurry of activity by vendors other than IBM. That flurry has now grown into an avalanche of hardware and software products for the PC. The true magnitude of the infrastructure building around the PC is just now being revealed. Those system integrators who have not been analyzing how to exploit this infrastructure (hardware configured for the PC bus and software designed to run either on PC-DOS or MS-DOS operating systems) may be missing an optimum opportunity for product profitability.

A major portion of the infrastructure, the networking of PCs and PC-compatibles, has

recently been outlined in announcements from Microsoft Corp. and Intel Corp. Microsoft has announced that it is ready to ship Networks 1.0, the software that implements IBM's PC Network (MMS, February, Page 47), and Intel has announced its new 82588 single-chip local-area-network (LAN) controller, a device that Intel expects to be used in network interfaces for both the PC Network and Starlan.

Integrators who have not been monitoring the full activities of the IEEE 802.3 committee will find that Starlan, implemented with unshielded, twisted-pair telephone lines, is one of two lower cost "modified Ethernets" now under subcommittee review. The other is Cheapernet, which uses the less expensive RG58 coaxial cable typically found in public address systems (MMS,

IBM RULES THE OFFICE PERSONAL-COMPUTER MARKET

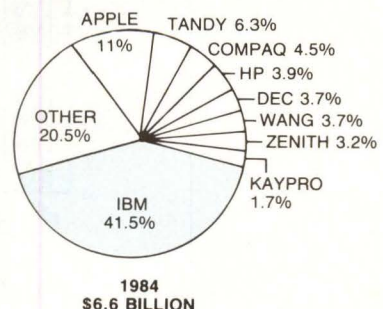
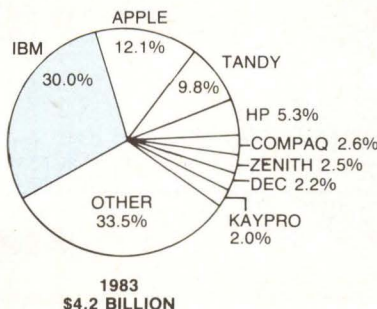
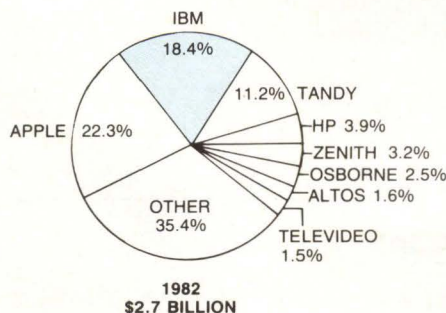

SOURCE: FUTURE COMPUTING INC.

System integrators are free to build networks that are compatible with PC Network but configured with hardware and software from vendors other than IBM.

January, Page 74).

Since Microsoft's Networks 1.0 can be purchased independently and can use network interfaces from vendors other than IBM, system integrators are free to build networks that are compatible with PC Network but configured with hardware and software from vendors other than IBM.

IBM's open-system approach to the PC Network is consistent with its previous open-architecture policy for the PC. In the case of the PC, IBM benefited greatly from an outpouring of software and hardware products that made the PC the world's most versatile computer. Early enthusiasm for the PC Network portends that a new outpouring, one of networked, multiuser application software, will soon appear.

Confusion surrounding LAN standards has also largely been cleared. There will be several standards for LANs (MMS Communications Digest, Feb. 15, Page 59). And this month, Intel will explain how its corporate strategy for LANs will allow the various emerging standards to be connected in configurations of "backbone" and "local" networks.

Although it is not exactly clear how application-software developers will exploit the capabilities of Microsoft's Networks 1.0 or how the

various LANs will interconnect, it is clear that PC-compatible products will connect to the PC Network and that ways will be found to connect the PC Network to other LANs. That means that sometime in the near future system integrators can expect to find off-the-shelf LANs that will match well with multiuser application-software packages that include the necessary networking software.

PC sets de facto standards

But the introduction of software for PC Network is only the most recent reason why the PC has set de facto standards for workstations in the office, on the engineering bench, inside the factory and even in the lab.

Some of the other reasons are that, soon, more hardware add-in and add-on products and application software will be available for the PC than for any other computer. This trend makes it easy to see why the PC has become the world's most emulated computer. (So far, nearly 60 manufacturers claim that their computers are PC-compatible.) And finally, because PC compatibility is so desirable, there are now companies that will help system integrators build their own custom-configured PC-compatible computers (OEMtek Inc., San Jose, Calif., and Personal

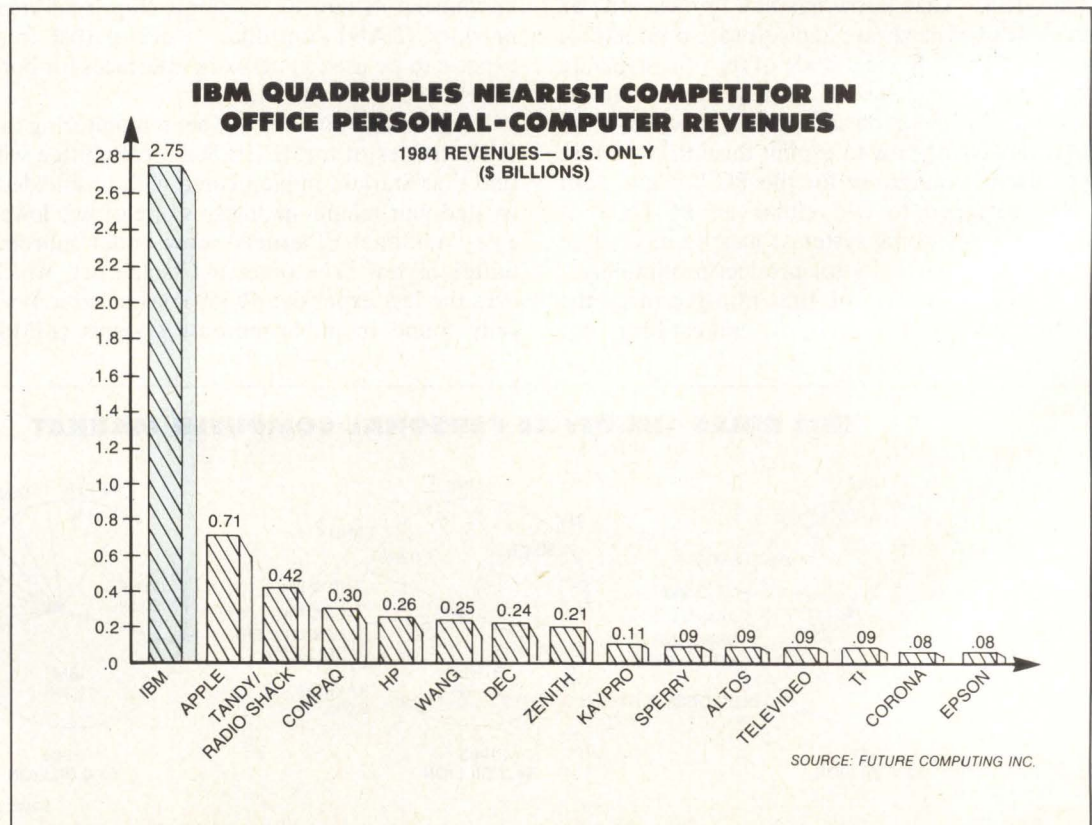

Only FARADAY

gives you packaging flexibility with integrated IBM® PC BUS single board computers and VLSI circuits

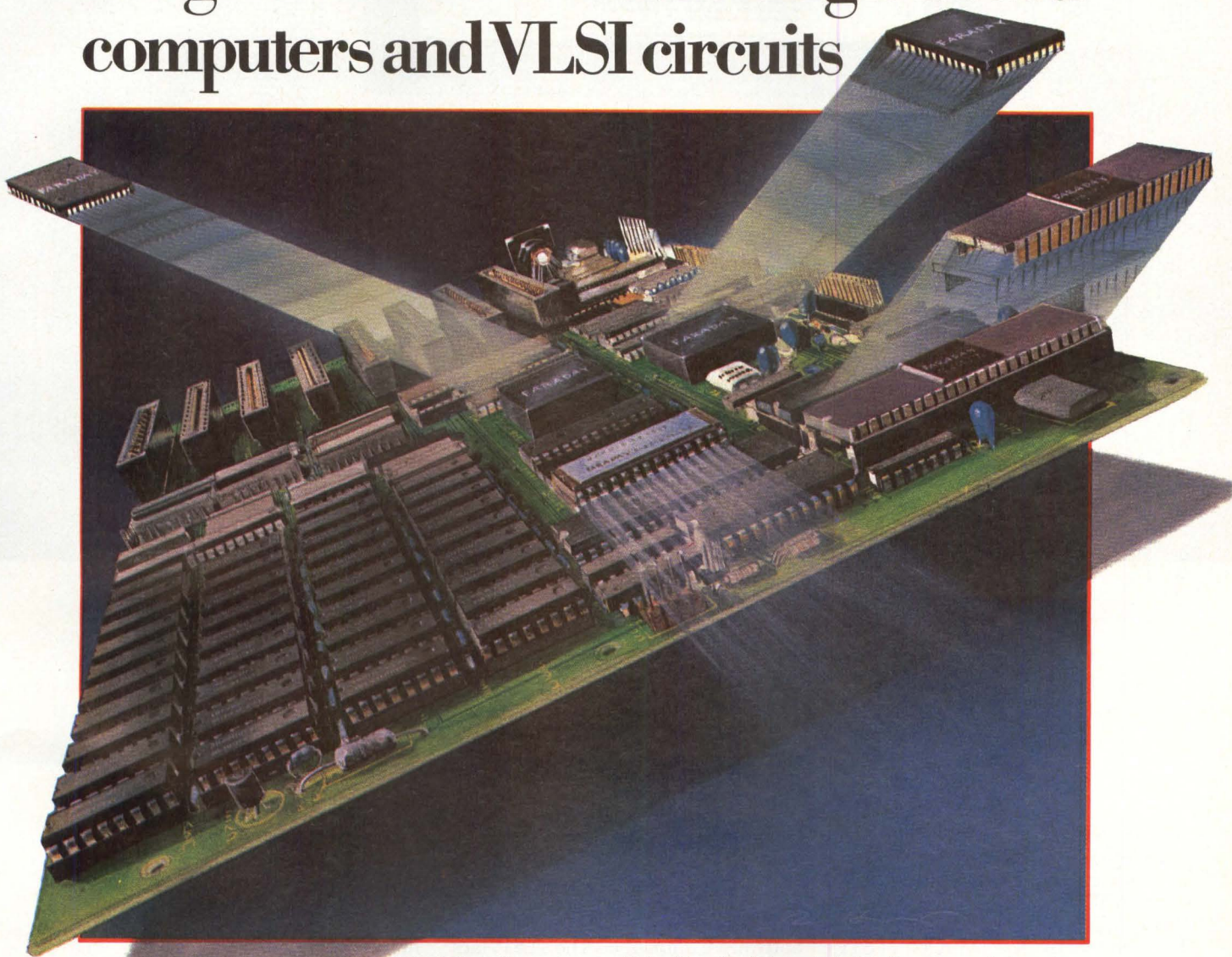

With Faraday state-of-the-art single board computers and CMOS VLSI circuits, you can implement PC-DOS compatibility in various system configurations. At lower cost. And with a shorter time to market.

Faraday single board computers are available with various combinations of integrated disk, video display and CPU controller functions. These and other functions are also available on Faraday adapter cards.

The single board computers include the Faraday BIOS in EPROM and support Faraday PC-DOS (enhanced MS™-DOS). Faraday provides MS-DOS and GW™-BASIC under license from Microsoft.

Using Faraday integrated circuits, you can integrate disk, monochrome display and CPU controller functions. These devices replace more than 75 integrated circuits.

To take advantage of the powerful cost, packaging and time advantages you'll get with this and future levels of integration, simply contact Ron Mazza, Director of Marketing, Faraday Electronics, 743 Pastoria Avenue, Sunnyvale, California 94086, (408) 749-1900.

MS and GW are trademarks of Microsoft Corporation.
IBM is a registered trademark of International Business Machines.

 **FARADAY**

The OEM PC Compatible Company.

Both letter-quality and draft hard copy

Fastest document throughput in its class

Both friction and tractor paper feed

Industry standard serial and parallel interfaces.

Better, more versatile operator controls

TI reliability

Compatibility with third-party and proprietary software

Better, more durable easy-access font modules

The TI 855 microprinter. No other printer says better so many ways.

Feature for feature, no other microprinter can match the versatility, compatibility, reliability and productivity of the OMNI 800* Model 855 microprinter. Here's why.

Two Printers In One. With the TI 855 you get the speed of dot matrix draft copy. Plus the precise clarity of the most advanced matrix technology for letter-quality print. It's two printers in one — at one low price.

A Great Family Name. Texas Instruments is known for providing the world with the industry standard for printers — the TI 810. TI builds the same reliability into every 800 series microprinter. Both the 855 and the data processing Model 850 are part of the expanding TI line of high-performance, low-cost microprinters.

Hardware Compatible. The TI 855 microprinter is compatible with all major PC hardware. And it provides both serial RS232C subset and "Centronics-type" parallel as standard interfaces.

Software Compatible. The TI 855 uses industry standard escape sequences for compatibility with virtually all third-party software. And for those with proprietary software needs, a model is available with ANSI standard escape sequences.

Tough Font Modules For Quick Character Change. Three font modules can be inserted into the front of the printer at one time, and are accessed individually. Each contains both draft- and letter-quality character sets. They're easier to use, more reliable and more durable than traditional metal or plastic daisy wheels.

More Productivity Than Any Other Microprinter. The 855 offers both friction and tractor paper feed, to handle all types of word and data processing applications. A quick-change snap-in cartridge ribbon. Raster and mosaic graphics. And intelligent printing which maximizes document throughput — regardless of format.

Get the printer that makes for better information systems. For more information visit your nearest TI authorized dealer or write Texas Instruments Incorporated, P.O. Box 809063, Dept. DPF-00000, Dallas, TX 75380-9063. Or call toll-free: 1-800-527-3500.



TEXAS INSTRUMENTS
Creating useful products
and services for you.

Computer Products Inc., San Diego).

In light of these developments, the obvious thing for some system integrators to do is become an IBM value-added dealer (VAD). This allows the integrator to take advantage of both the IBM name and products sold with the system.

The MicroAnalyst Logic Analysis Workstation is a fine example of how purchased PC products can be leveraged. Northwest Instrument Systems Inc., Beaverton, Ore., builds logic analyzers. The MicroAnalyst, a \$17,900 system, combines Northwest's Series 2000 logic analyzer with a PC-AT running Lotus Development Corp.'s Symphony multifunction software (MMS, January, Page 46). According to Northwest's president, Larry Sutter, "Five years ago the test equipment alone was \$18,000. Now users can purchase a computer and logic analyzer for that amount." Northwest, by the way, was one of the first PC-AT VADs.

Of course, it should surprise no one that introductions of PC-AT compatibles are on the horizon, a subject covered in this issue of *Mini-Micro Systems* (see "Some IBM mimics jump, some stall at PC-AT delays," Page 34).

Mix-and-match PC compatibles

For many system integrators, however, joining the IBM bandwagon may not be the most profitable course. An analysis of the networking opportunities seen by some system integrators may argue for a mix-and-match strategy based on several types of PC-compatible computers. Such a strategy would allow system integrators to use the PC-compatible computer that best fits the application requirements of the individual workstation.

For example, some workstations may need computational speed that exceeds that of the PC. IBM's solution, of course, would be the PC-AT. However, a close look at the application may reveal that a PC-AT would be overkill. Instead, the system integrator could turn to a PC-compatible vendor like AT&T Information Systems Inc. (ATTIS) or Compaq Computer Corp. for a more effective cost/performance solution.

ATTIS' PC 6300 and Compaq's Deskpro Model 4 both claim greater speed than an IBM PC through use of Intel's 8086 microprocessor, instead of the 8088 found in the IBM PC. ATTIS claims that, by clocking the 8086 at 8 MHz, the PC 6300 runs programs 50 percent to 80 percent faster than the IBM PC. Deskpro's speed is a little lower because its 8086 is clocked at 7.14 MHz (exactly double that of the IBM PC). Compaq claims the clock rate was chosen because it provides greater compatibility with



older PC programs that are sensitive to clock speed.

In addition to selecting the right PC-compatible for the application, system integrators must take into account the hardware functions that can be added into the workstation. Like the PC, most PC-compatibles have open expansion slots that accept PC bus add-in boards. This feature provides a convenient method to add hardware functions not already resident in the computer. And, because most of these expansion slots are readily accessible, sophisticated users can upgrade or change the configuration without professional help.

Some PC compatibles do not provide expansion slots. The 9.1-pound Data General/One from Data General Corp. (DG), is a PC-compatible portable computer. Its 13.7-by-11.7-by-2.8-inch size does not allow sufficient space for expansion-board slots. A forthcoming expansion chassis will allow this computer to take advantage of add-in PC boards, but the addition will also diminish the unit's portability.

The Data General/One is a traveling workstation that can be connected to DG's CEO office-automation equipment. The key is CEO connection software that resides in both the CEO MV/family superminicomputer and the Data General/One. Equipped with an internal 300-baud, auto-dial modem, the Data General/One can act as an attached terminal to the CEO MV superminicomputer (MMS, October 1984, Page 51).

PC-compatible terminals

Terminals that incorporate PC-compatible computers comprise another category of PC-

The Esprit ESP-9310 IBM PC-compatible computer, attached to an ESP-6310 video terminal, right, offers both a full-function terminal and PC-compatible computer in a \$3,590 package. Esprit makes the combination practical by using a (patent-pending) monitor driver that allows the PC to use the ESP 6310's 14-inch, 60-Hz, non-interlaced display, left.

Joining the IBM bandwagon may not be the most profitable course.

compatibles. Instead of building a PC-compatible computer and adding terminal-emulation software, which can compromise terminal performance, Esprit Systems Inc., Melville, N.Y., builds a PC-compatible computer that attaches to an Esprit terminal. According to Allan Maurer, Esprit's vice president of marketing, "Our approach does not sacrifice functionality. In terminal mode, our product is 100 percent terminal. As a computer, it's 100 percent PC."

Esprit's PC-compatible computer, the ESP-9310, is a straightforward emulation of the PC that can be used in conjunction with Esprit's ESP-6115 video-display terminal. For users who would like to have both a terminal and a PC-compatible computer, Esprit's solution is attractive. The ESP-9310, combined with the ESP-6115, lists for \$3,590.

Esprit makes the combination practical by using a (patent-pending) monitor driver that allows the PC to use the ESP-6115's 14-inch, 60-Hz non-interlaced display. As a terminal, the ESP-6115 emulates several popular terminals including TeleVideo Systems Inc.'s 925/910PLUS, Wyse Technology's 50, Lear Siegler Inc.'s ADM 3A and Esprit's Hazeltine 1500.

Looking for a PC or PC-compatible that combines voice and data? Consider what can happen

Integrated voice/data computers combine desktop functions such as a Rolodex, telephone, answering machine and word processor in one small-footprint package. Zaisan ES.3, above, is comparable in price to existing IBM PC-compatible computers.

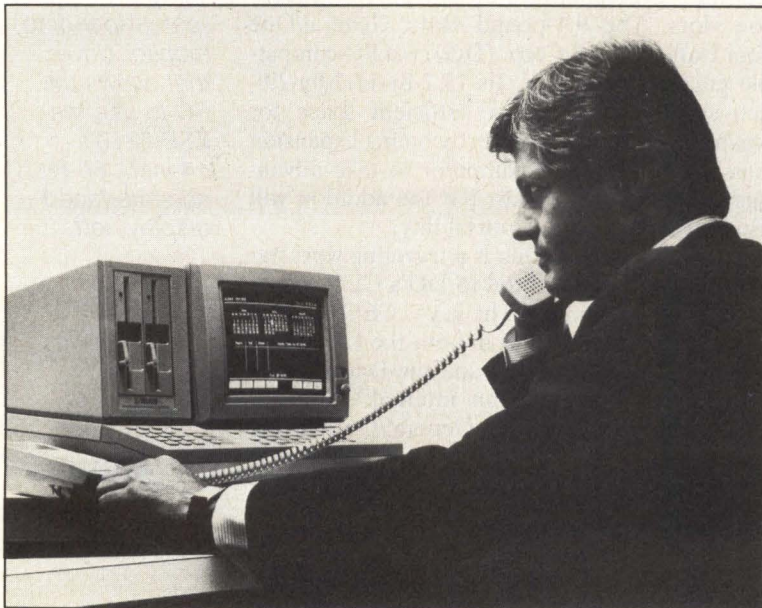

when the functions found in existing desktop products are consolidated. If a Rolodex, phone-answering device, note pad, typewriter, telephone, word processor and computer are integrated into a single product, system integrators can claim overall cost savings along with improved productivity.

Products that offer this level of functionality are the new PC-compatible integrated voice/data (IVD) computers. Not only can these products be configured to plug into a PC Network, but they can also plug into a programmable branch exchange.

This fast-growing category was discussed in last month's Communications Digest (MMS, Communications Digest, Feb. 15, Page 97). Recent joint ventures and OEM agreements will make this category of PC-compatibles worth monitoring during the next few months. Look for product announcements from companies such as ATTIS, Hewlett-Packard Co. and Wang Laboratories Inc.

PC bus connects to other buses

Among the products being built for the PC bus are boards that interface the PC bus to other computer buses. Already on the market are boards that interface the PC bus to Multibus I, STDbus and the IEEE 488 bus. The IEEE 488 connection, for example, has allowed PCs and PC-compatibles to perform as measurement-system workstations.

As part of a development contract, Advanced Systems Design Corp. a system house in Cambridge, Mass., has designed a Fourier transform infrared (FTIR) analyzer that incorporates a PC bus-to-Multibus I connection. One application of the product is toxic-gas-leak detection in semiconductor manufacturing plants.

FTIR instruments have historically been expensive research tools for the analytical chemist. In structuring the system, Advanced Systems Design had to solve some challenging integration problems. One of those was to increase the speed of complex mathematical calculations so that a dangerous gas leak could be identified in time to set off alarms and begin plant evacuation. Another was to slash the cost of the system so that plants using dangerous chemicals could afford the investment.

Both objectives were met by exploiting the best elements of products that connect to the Multibus and the math coprocessor option of Faraday Electronics' FE6400 PC-compatible, single-board computer.

The most time-consuming portions of the calculation process were analog-to-digital (A/D) conversion and the fast Fourier transforms of the

E.I. DuPont
Butler Manufacturing
T.R.W.
Ford Aerospace
University Of California
U.S. Navy
United Technologies
Honeywell
Polaroid
Harvard University
RCA
Mass. General Hospital
General Electric
N.Y. Public Library
GTE
Digital Equipment Corp.
Eastman Kodak
U.S. Steel
Westinghouse
Chrysler Corporation
Johns Hopkins University
Shell Oil Company
U.S. Army

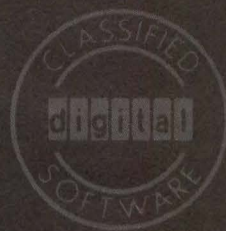

After extensive comparative evaluation and testing, these organizations selected LEX-11 ... the word and data processing system that does it all.

**Make your choice
the right choice.**

LEX-11 ... the choice of those who know.

Call today for your free demonstration.



DEC SYSTEMS INC.

Millbrook Park
327/E Boston Post Road
Sudbury, MA 01776

(617) 443-5106/6376

LEX-11 runs on all DEC MINIS and MICROS, IBM PC, ALTOS and many other machines.

OEM/Dealer inquiries welcome.

CIRCLE NO. 84 ON INQUIRY CARD

The UNIX* operating system in your computer is:

- a. a clever imitation of the real thing;
- b. a price/performance disappointment;
- c. unable to support enough application software;
- d. tied to an expensive minicomputer;
- e. none of the above.

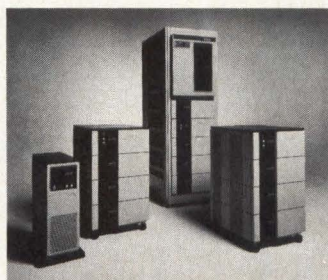

If your computer system is one of Zilog's UNIX-based System 8000 Series 2 super-micros, the answer is "e," none of the above. Twice as fast as previous system 8000 models, no other microcomputer system gives you access to real UNIX power like Zilog's new family of multi-user systems.

Instead of designing a computer and then choosing an operating system, we designed the System 8000 to best optimize the UNIX operating system. Now, you can move up and away from costly minicomputers to Zilog's affordable System 8000 Series 2.

Zilog's System 8000 Series 2 systems. They give you the power of the UNIX operating system without the high price, a full range of software languages and applications tools and comprehensive service and support. Call our toll-free number for details: (800) 272-6560.

*UNIX is a trademark of AT&T Bell Laboratories. Zilog is licensed by AT&T Technologies, Inc.

*Systems
Division*
Zilog

an affiliate of EXON Corporation

collected data. A 16-bit, high-frequency A/D converter loading directly into a paged, dual-plane memory solved the A/D conversion problem. To speed up the fast Fourier transform, number-crunching tasks were assigned to the 8087 math coprocessor. This arrangement leaves the FE6400's 8088 microprocessor free to act as the system's host processor. Both the A/D converter and dual-plane memory board connect to the Multibus; a two-card PC/Multibus interface connects the 16-bit Multibus to the 8-bit PC bus.

When the system integrators reviewed this project, they saw a new opportunity to exploit the concepts used in the FTIR project in a new product—Advanced Systems Designs' floating point peripheral (FPP). The FPP is a high-speed, floating-point-calculation unit that connects to a PC or PC-compatible in much the same manner as does a printer. With this unit, the processing speed of a PC-based system can be increased 1,000 times.

The \$8,000 FPP, claims its engineers, provides processing performance equal to superminicomputer systems selling for \$150,000 or more. The

FPP is also available as a board set, and, in applications like the FTIR system, the unit can dramatically increase both measurement speed and resolution.

Even geographically and astronomically, there seems to be no limit to systems that may benefit from PC compatibility. Faraday Electronics' new 3.9-by-5.5-inch, Micro PC single-board computer may lead PC compatibility into harsh-environment applications such as undersea monitors and space probes (see "Tiny single-board PC may spark big markets," Page 33). Quite a journey for a computer that was originally expected to stay on a desktop. □

Interest Quotient (Circle One)
High 483 Medium 484 Low 485

LOOKING AHEAD IN MMS

- The April issue will include reviews on minicomputers, mini software and UPSs.
- Office automation will be featured in the May issue.

Multibus communications become faster and smarter with a 68000-\$1395.

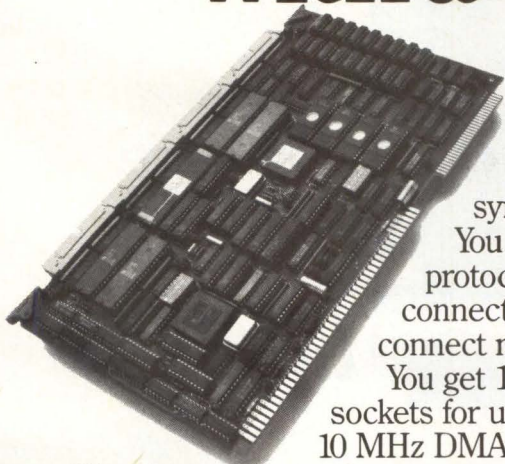

As fast as 800,000 bps. Smart enough to run any programmed protocol on any of eight full-duplex data channels. And a best buy at \$1395 in quantities of 100. Our M68COM processor board takes on any bit-synchronous, byte-synchronous, or asynchronous protocol. You can use X.25, SDLC, HDLC, BISYNC or a proprietary protocol. What's more, you can configure just about any hardware connection: RS-232, RS-422, RS-423, fiber optics or direct-connect modem.

You get 128K bytes of dual-ported RAM (expandable to 512K), sockets for up to 256K bytes of EPROM, plus an optional on-board 10 MHz DMA controller.

We offer ongoing software support hard to find elsewhere. It's all from SBE, Inc., 2400 Bisso Lane, Concord, CA 94520. TWX: 910-366-2116.

Phone free 800-221-6458 for literature mailed today.
In California call (415) 680-7722.



Computer boards and systems.

CIRCLE NO. 86 ON INQUIRY CARD

FIND THE SHIP TO MAKE

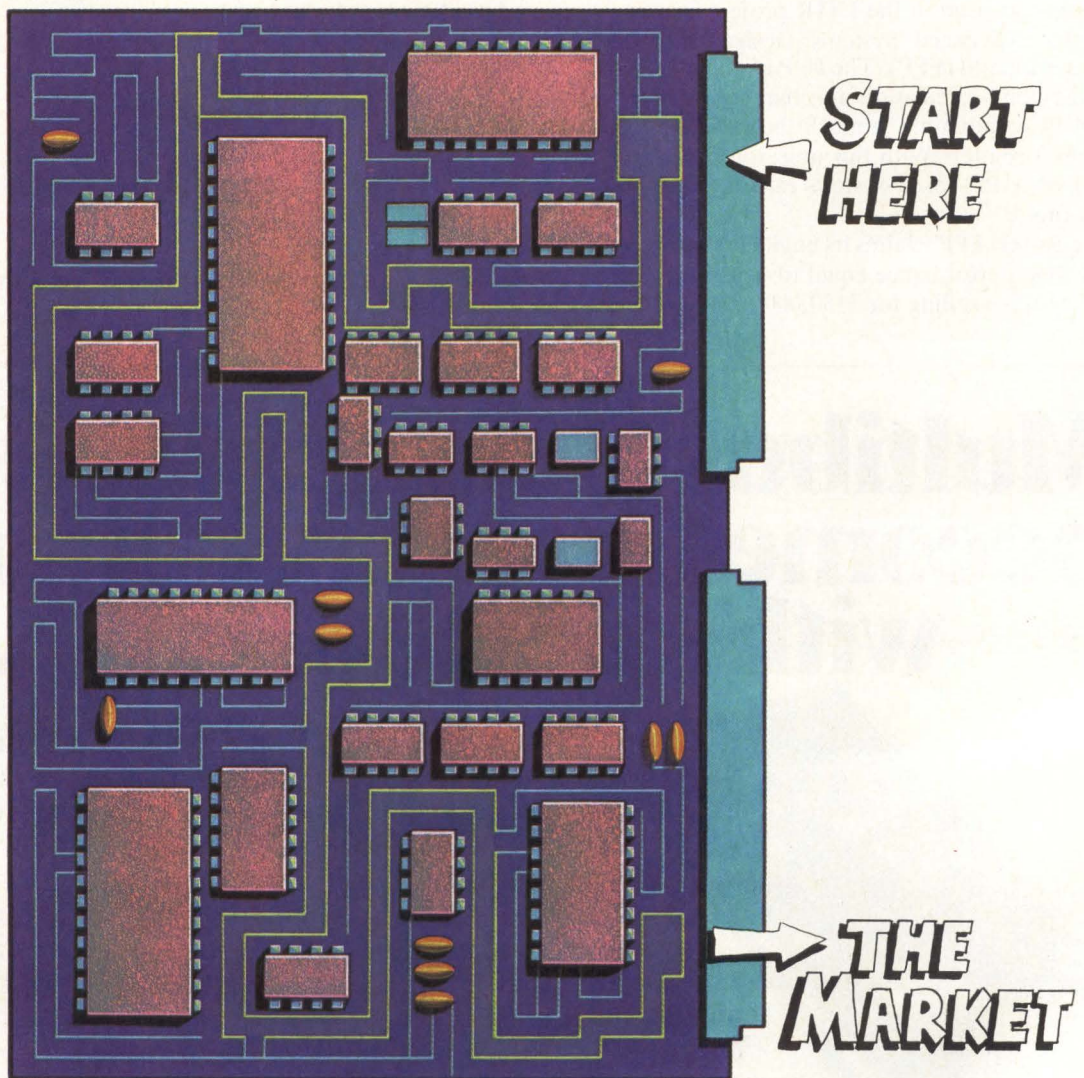

SHORTEST PATH TO MARKET.

Spend more time on your specific application. And get your product to market sooner with system and subsystem products from Mostek.

And because Mostek has a range of more than 100 predesigned bus boards and development software tools, we can serve almost any application you can create. Or we can design a custom board solution.

Take our high-performance 68000 family-based VMEbus boards and systems, for example. They're fast. And fast becoming the 16-bit industry standard. Then there's our VME Matrix 68K™, a multi-user UNIX™ system designed to meet and exceed the challenges of today's 16-bit applications. As well as serving as the base for tomorrow's 32-bit applications.

We're also one of the world's largest suppliers of 8-bit, Z80®-based, CP/M®-compatible STD BUS boards and systems. Like the I488 and ISIO, the newest members of our family of intelligent STD BUS boards, and a new STD BUS system, the Matrix 800™.

Mostek also produces a wide range of add-in/add-on memory boards for DEC®, Data General™ and Perkin-Elmer® computers. Fact is, most major manufacturers look to Mostek for innovative system solutions.

But it doesn't end there. Mostek also offers both custom and standard line SIPs and single in-line memory modules.

So whether your market is personal computers, large computer systems, large-scale memory processing or specialized applications, Mostek can get you there sooner.

For more information, contact Mostek Corp., 1215 W. Crosby Road, MS2205, Carrollton, TX 75006, 1-800-635-0200. In Europe, (32) 02/762.18.80. In Japan, 03/496-4221. In the Far East (Hong Kong), 5.681.157-9.

Matrix 68K and Matrix 800 are trademarks of Mostek Corporation.
UNIX is a trademark of Bell Laboratories.
Z80 is a registered trademark of Zilog, Inc.

CP/M is a registered trademark of Digital Research, Incorporated.
DEC is a registered trademark of Digital Equipment Corporation.
Data General is a trademark of Data General Corporation.
Perkin-Elmer is a registered trademark of Perkin-Elmer Corporation.



You can't build tomorrow's systems with yesterday's drives.

You've seen one small disk drive, you've seen them all, right? Not exactly. One disk drive stands above all the rest.

It comes from Maxtor.

The company that refuses to produce disk drives merely as good as everybody else. Instead, we set new standards by producing the only 5¼" disk drives worthy of the next generation of supermicros. Winchester with 65 to 380 megabytes of storage. And average access times of less than 30 msec.

And we don't mean prototypes. We mean full production. So, you can build the systems of tomorrow, today. And that can be a big advantage.

For you. Or your competition.

Maxtor Corporation, 150 River Oaks Parkway,
San Jose, California 95134,
(408) 942-1700, TELEX: 171074.
Eastern Regional Sales Office:
(617) 872-8556.
Southwest Regional Sales Office:
(714) 859-3100.

Maxtor

CIRCLE NO. 88 ON INQUIRY CARD

'LAN IN A BOX' PROVIDES MULTIUSER SYSTEM

An IBM PC-compatible multiprocessor system offers an alternate route to office automation

Dr. Robert S. Harp
Corona Data Systems Inc.

A centralized multiprocessor system that looks like a local area network (LAN) to software—"a LAN in a box"—tackles the traditional problems surrounding development of a multiuser computer system in a business setting.

An example of the centralized multiprocessor approach is the Mega PC, from Corona Data Systems Inc. The Mega PC acts as a multiuser system in which each of as many as eight users has an individual IBM Corp. PC-compatible processor at his disposal. Unlike a traditional multiuser system, a multiprocessor dedicates a microprocessor to each user, complete with memory. Unlike personal-computer LANs, the processors would reside in a central location and permit easy interconnection of shared data and system resources. Users access individual processors via inexpensive video terminals.

Mini-based systems pose problems

Previously, system integrators turned to personal-computer LAN multiprocessor minicomputers for office automation projects because business users need the interactive capabilities of personal computers and a large amount of data sharing. But, besides the high cost factor, both LANs and minicomputer-based multiprocessor systems carry with them the weight of many years of hardware and software development for ends quite different from business applications. Minicomputer-based multiuser systems, for instance, emerged when minicomputers served as workhorses. Because such machines were expensive, they had to support as many users as



The Mega PC from Corona is a multiprocessor computer offering both IBM PC/XT-compatible standalone processing and shared integrated processing. Single-user terminals connect to the central system by coaxial cable.

possible to justify the investment. Because they were powerful, though, they could time-share many users.

But, since several users were working on a single processor, the computer's operating system had to protect them from one another. Multiuser operating systems, such as UNIX, have become increasingly complex as they incorporate more and more security features. Worse yet, these complex systems were developed by computer scientists for other computer scientists rather than for business-oriented, non-technical users. Such systems' cryptic commands and lack of on-line help information permit efficient operation but create a barrier against non-technical users.

Because minicomputer hardware is extremely reliable, multiuser operating systems incorporate little file- or error-recovery capability. Even

In addition to having a dedicated processor, each user has access to global resources.

if there were a failure, computer scientists are normally expert enough to reconstruct the files.

Business users, on the other hand, aren't interested in learning how to delve into a complex system to salvage lost data. Furthermore, scientific users deal with data that can usually be rewritten in an emergency, whereas business users often deal with data that cannot be recovered if lost. Billing information, for instance, is worth millions of dollars and is impossible to reconstruct in binary form.

LANs fail to break the cost barrier

Personal computers corrected many of the problems associated with minicomputers by allowing greater interaction between the user and the hardware and software at a lower cost through LANs. To attract non-technical business users, though, these systems simplified operation while offering an expanding range of capabilities.

But microcomputers, too, come with a history. For one thing, IBM dominates the field of business computing. Market analysts estimate that 85 percent of the software developed last year for 16-bit systems is targeted for the IBM PC and compatibles. Thus, if you're going to network personal computers, they'd better be IBM-compatible.

In addition to maintaining IBM PC compatibility, business users also need to obtain the lowest computer cost possible and still share data and system resources. Although LANs allow the single-user IBM PCs to share data and resources, they fail to break the cost barrier. Even with expensive rigid disk drives and printers shared by a number of users, each user must still have an individual microcomputer costing several thousand dollars compared to a few hundred for a terminal on a multiuser system. Thus, while the initial cost of a personal computer is much lower than that of a minicomputer, the overall cost of an entire office of personal computers can weight the cost equation in favor of multiuser minicomputer systems.

It's also not yet clear what protocol will be standard for LANs. A protocol standard is crucial to furnishing transparent access to system resources via popular software packages.

Networks get very local

Multiprocessor systems like the Mega PC offer the benefits of LANs and multiuser systems without their drawbacks. For instance, in the Mega PC, the processor boards dedicated to different users are connected by a parallel bus rather than by an actual LAN. The bus allows the system to look like a LAN for data and

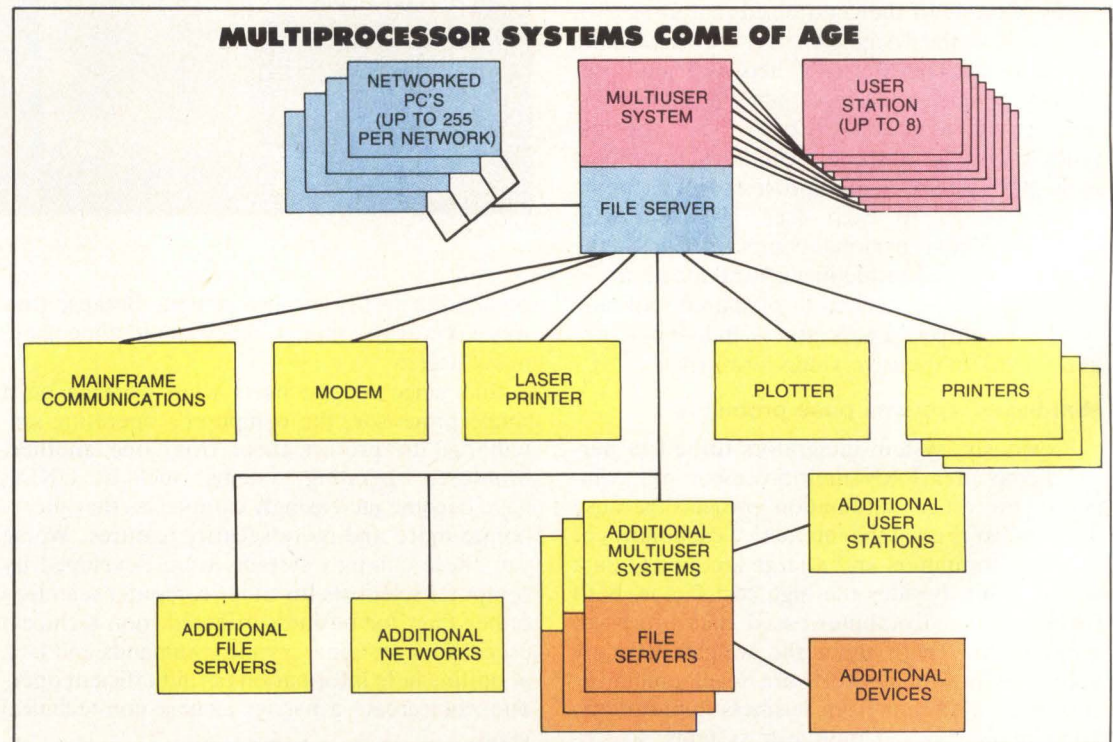

A multiuser, multiprocessor system can be the basis of an extensive computing resource. The number of networks,

individual computers and peripherals that can connect to such architecture is almost unlimited.

Kimtron

The KT-7

**Perfect
Performance**

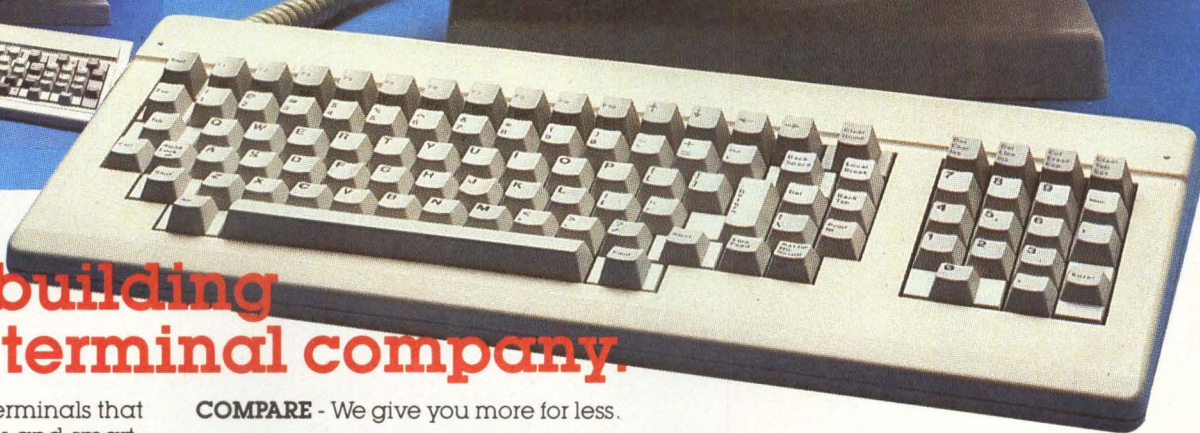
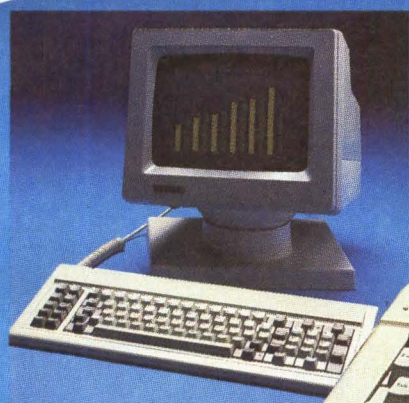
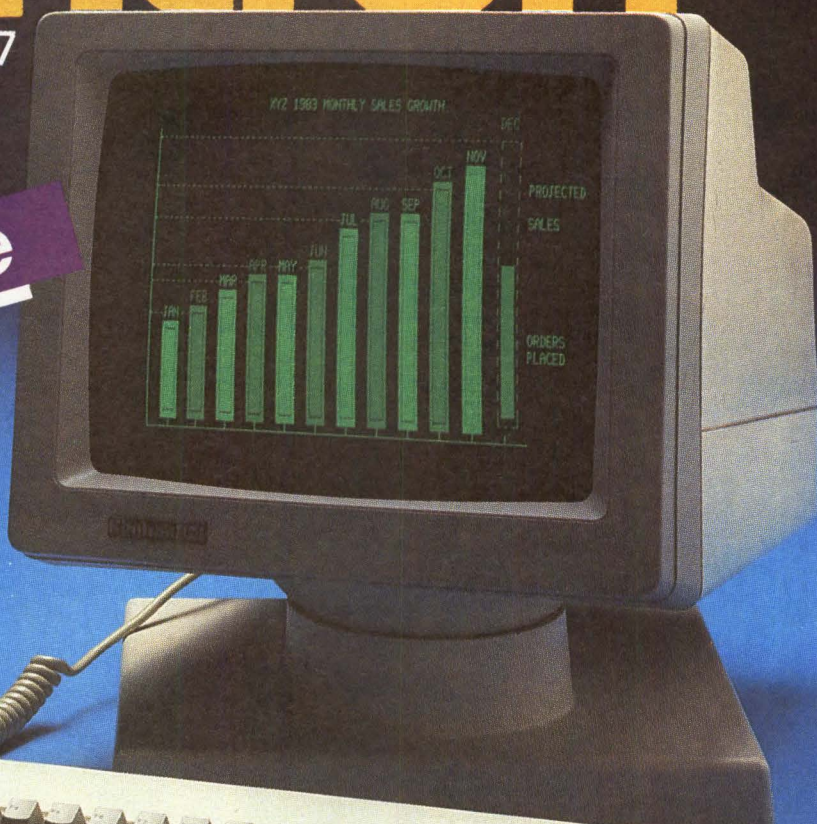

**We're building
the #1 terminal company.**

Kimtron delivers terminals that are not only pretty and smart, but so reliable they seldom fail. Kimtron technology enables many useful features to be available at no extra cost like user selectable Hidden/Embedded attributes, so you're not limited to Embedded attributes as you are with the others. Plus, we make the only low-cost terminals to take true Ergonomic standards that extra step - to provide adjustable display height in addition to swivel and tilt. Kimtron terminals are designed to be flexible and compatible to systems like IBM PC/XT/AT, DEC, DG, and many more to avoid obsolescence.

COMPARE - We give you more for less.

Kimtron KT-7	Wyse 50	Qume 102	TeleVideo 925/925E	Features
Yes	No	No	No	IBM PC Emulation Option
Yes	No	No	No	DEC VT-100/ANSI X3.64 Option
Yes	No	No	Yes	TeleVideo 925 Emulation
Yes	No	No	No	DG D100/200 Emulation Option
Yes	Yes	Yes	No	14 inch screen available
Yes	No	No	No	Amber option at no extra cost
Yes	No	No	No	Selectible Hidden/Embedded Attributes
Yes	Part	No	No	Programmable Function Keys in NVM
Yes	No	No	Yes	Bi-Directional Aux Port
Yes	No	No	No	96 Business Graphics Characters
Yes	No	No	No	4 Page Memory Option
Yes	No	No	No	Height Adjust, Tilt & Swivel
\$595	\$695	\$695	\$995/\$795	Suggested Retail Price

CIRCLE NO. 89 ON INQUIRY CARD

Kimtron, a 5-year technology leader - we're going places and want you to join the Kimtron family of satisfied users. For more information about our KT-7 or KT-10, call the Kimtron Corporation. (408) 727-1510

NOTE: The above comparison is based on information available at the time of preparation and is subject to change without prior notice. IBM, DEC, TeleVideo, DG, Wyse and Qume are trademarks of IBM Corp., Digital Equipment Corporation, TeleVideo Systems, Inc., Data General Corporation, Wyse Technology, and Qume Corporation.



2225 - I Martin Avenue
Santa Clara, CA 95050
408-727-1510 TWX. 910-338-0237

Kimtron

WREN—SUPER-PERFORMING 5¼" WINCHESTERS IN 21 TO 86 MEGABYTE CAPACITIES.

**TOLL FREE
HOTLINE**
1-800-828-8001
EXT. 82
IN MINNESOTA
(612) 921-4400

HEADS never land on data areas. All WREN drives use a dedicated media zone for head take-off and landing. Even in the event of a total power loss to the system, the actuator will return the heads to the dedicated landing zone.

ROTARY VOICE COIL ACTUATOR provides 40 millisecond typical average access for the 21 and 36 MB capacities and a 30 millisecond average typically for the 48, 67 and 86 MB models (includes head settling).

DEDICATED CLOSE-LOOP SERVO SYSTEM for added positioning accuracy and maximum system performance.

INTERFACE FLEXIBILITY: Two industry standard interfaces ST506/412 and Enhanced Small Device Interface (ESDI). The ST506/412 interface is available in all capacity versions up to 86 MB. The ESDI is available in the 48, 67 and 86 MB models.

T H E W R E N™

High Technology from Control Data delivers a 5-1/4" Winchester with truly outstanding performance and reliability. Compare for yourself. Call our Information Hotline 1-800-828-8001 or write OEM Product Marketing, HQN08H, Control Data Corporation, P.O. Box 0, Minneapolis, MN 55440. Also available through your Arrow or Kierulff distributor.



CD CONTROL DATA

resource sharing but offers several performance advantages over LANs. First, the bus allows faster access to rigid disk storage. Second, there's no need to worry about a standard LAN protocol because data is transmitted over a bus as a simple file transfer rather than having to be formatted and given address codes as it would be on a LAN. Third, the bus avoids the expense of the hardware an actual LAN would require at each microcomputer.

User terminals connect to the central system via inexpensive coaxial cable instead of the serial data line that most terminals demand. Rather than act as terminals in the traditional sense, the Mega PC terminals operate like 640-by-400-pixel monitors, and the interface to the processor boards is a 24-MHz composite video connection. The terminal's keyboard data and mouse inputs are multiplexed with the video signal.

Connecting the terminals with video cable allows sophisticated screen handling. The Mega PC produces memory-mapped screens, just as a standalone personal computer does. The difference is that the terminal screen can be located as far as 300 feet away from its processor.

The terminals are relatively low in cost and readily available. System integrators can add users simply and inexpensively by adding more terminals—as in traditional multiuser systems—along with more processor boards. In addition, system integrators can keep initial cost down because the system requires only as many terminals and processor boards as there are users.

The processor boards employ the same architecture as the IBM PC/XT but with the powerful Advanced Micro Devices Inc. 8088-2 processor

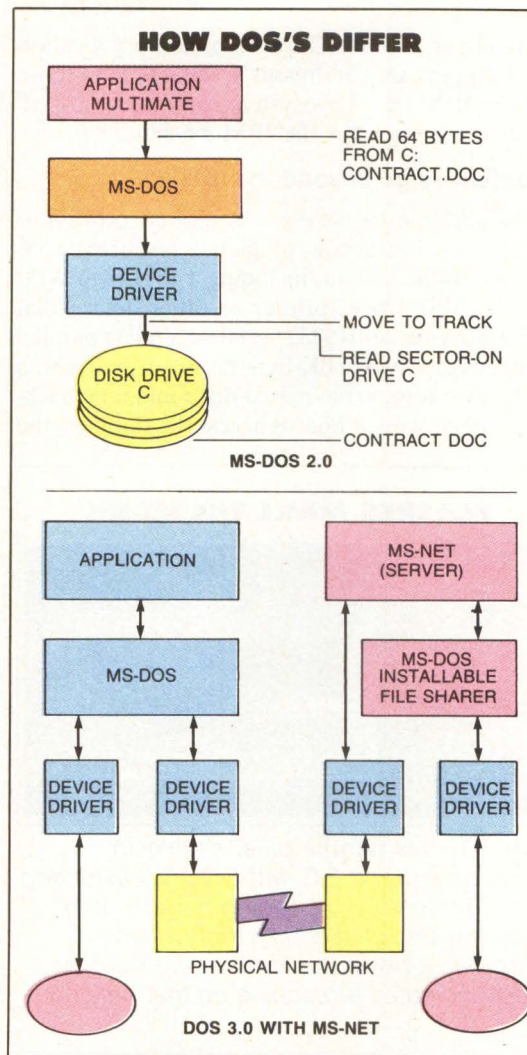

Though similar, MS-DOS 2.0 and MS-DOS 3.0 with MS-NET differ in that the newer software supports calls to remote system resources.

Distribution is key to market success

"I think their marketing strategy is fabulous" is how Evan Moltz, manager of microcomputer services for research concern International Data Corp., Framingham, Mass., describes Corona Data Systems Inc. "Basically, [Corona is] going after OEMs and value-added resellers, and staying as far away from the retail channel as possible. That alone will almost guarantee them success.

"You know, the product is almost secondary. The Mega PC is good—not on the forefront of the technology, maybe, but good. It's the deals they're cutting, though, with companies like Sperry, for example, that are really impressive.

"In fact," Moltz says, "Corona is one of the few companies in the field that has a clear vision of what its marketing strategy is and should be."

According to another market researcher, Corona

may need all the vision it can get. "Multiuser microcomputer systems are a tremendous growth market, but that market faces tremendous problems," says Maxwell Steinhardt, vice president of information systems for research company Strategic Inc., Cupertino, Calif. Particularly in the area of distribution, "People became aware of how they could benefit from computer systems because of their experiences with personal computers, but PCs can be sold to relatively unsophisticated users through relatively unsophisticated channels. For multiuser systems that isn't true. At this time there really isn't a distribution network for multiuser systems. The real problem is getting to the user with the product. It's a case of the technology outstripping the distribution capacity."

—Michael Tucker, Associate Editor

running at 8 MHz. The screen memory location and support chip addresses are identical to those in the IBM PC. This system can run almost all software written for the IBM machine.

Resources go beyond the IBM PC

In addition to having a dedicated processor, each user has access to global resources connected to the system, including a 40M-byte Winchester disk drive, printer or other device that interfaces via an RS232 serial or similar parallel port, one or two 360K-byte floppy disk drives, a 10M-byte removable-media drive and tape backup. The processor boards access the floppies, the

serial port and the parallel port through a file-server board that manages requests for service from multiple users.

The system handles multiple users by recognizing three types of files: those that can be read and written by a user, those that are accessible only by a specific user and those that can be accessed only by users who have the correct password. Additionally, to speed disk access, the controller employs a cache technique that permits many disk calls to be satisfied at RAM speeds.

In addition to the LAN-like interconnection method, the Mega PC can contain two LAN controllers. The system uses controllers to connect with other computer networks or individual personal computers. Integrating personal computers is important because of the large number of standalone computers being used in offices.

```

SLASHES MAKE THE MARK

MS-DOS File Names

MS-DOS 1.X
d: filename.ext

MS-DOS 2.0
d:\dir1\dir2\filename.ext

MS-DOS 3.0
\\network\machine\d:\dir1\dir2\filename.ext
ASSIGN Q: \\MULTIPLAN\CHARLESS\C:\MP\MSDOS\
Q: MP.COM
    
```

MS-DOS 3.0 plays a key role

Software used for LANs of IBM PCs and their compatibles works equally well with the Mega PC. Generally, this software runs under Microsoft Corp.'s MS-DOS 2.0. Even better performance has recently become available with the introduction of MS-DOS 3.0 and MS-NET, a networking package. These products give the business computer market a PC-compatible operating system that supports networking functions.

MS-DOS file names differ slightly in versions 2.0 and 3.0. MS-DOS 3.0 extended the 2.0 directory by adding network and machine designations. A triple slash indicates a network name, and a double slash indicates a machine on that network.

Under MS-DOS 3.0, users and software packages can refer to another network, a machine within that network and subdirectories on that machine by including the correct number of dashes. The operating system interprets the command and routes it level-by-level, from networks to machines and eventually to files.

MS-DOS 2.0 and MS-DOS 3.0 with MS-NET are identical, except that the newer software supports calls to remote system resources. For example, if a user of MS-DOS 2.0 wanted to access a file named "Contract.DOC" stored on drive C, his application program would specify the number of bytes from drive C. The operating system then relays the command to the device driver for drive C, which then reads the specified number of bytes.

Under MS-DOS 3.0, this same procedure follows a different path after leaving the operating system. Here, the command passes through a device driver that acts as a port to another processor, in which a similar driver relays the command to MS-NET. In the Mega PC, the drivers are simple interfaces to the parallel bus between processor boards. The processor receiving the disk access command is the file-server board. MS-NET deals with the disk access commands from all users on the network and allows MS-DOS 3.0's file sharer to fulfill the request for "Contract.DOC" when appropriate. All these operations can be completely user-transparent, depending on how the system is set up. When it boots, for example, the system can run a batch program that automatically assigns the proper

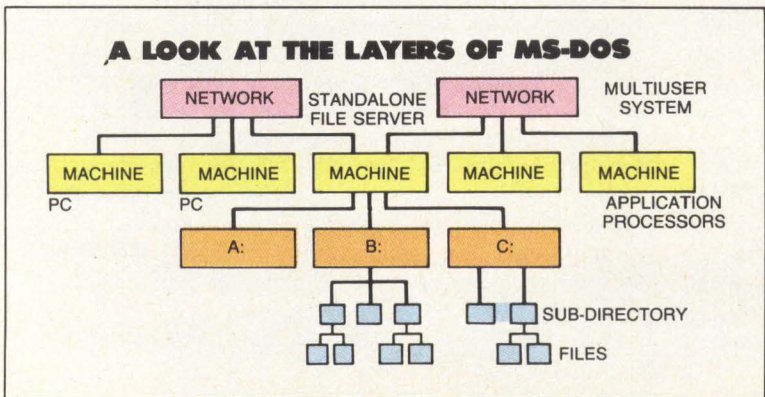

Introducing the little backup with the 20 megabyte appetite.

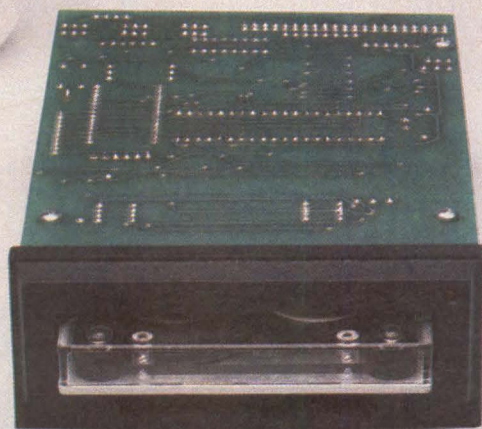

When Irwin came out with the Irwin 110 and 210 tape drives, both of which fit 10 megabytes of formatted capacity in a DC-1000™ cartridge, a lot of people said we bit off more than we could chew.

A lot of people ate their words.

Now we're backing you up with the Irwin 125 tape drive—20 megabytes of formatted data on a DC-1000 cartridge.

The Irwin Recipe: Simplicity, Reliability, and Ease of Use.

Because the Irwin 125 has a standard minifloppy interface, it daisy chains right onto your existing controller — without any additional cables, controllers or hardware. Add a simple software driver and an applications program for file transfer or streaming, and the Irwin 125 is ready to go.

And if you are PC DOS compatible we'll provide you with all the software required—without charge!

Irwin's closed-loop servo technology guarantees simpler operation, media interchangeability and greater reliability. With an error rate of 1 in 10¹¹ and MTBF greater than

12,000 hours, the Irwin 125 is one of the most reliable, trouble-free back-up drives available anywhere today.

The Biggest Surprise is the Little Price.

Best of all, the cost of the Irwin 125 tape drive is about the same as a floppy disk drive. And it provides from 20 to 40 times the storage capacity on a single cartridge.

For those who don't need 20 megabytes of storage capacity, there's the Irwin 110, a 5 ¼ -inch half-high and the Irwin 210, a 3 ½ -inch form factor. We put a big byte in every backup we build.

If we've whetted your appetite, perhaps it's time you ordered a 125 tape drive for evaluation.

Irwin Magnetics. We back you up with integrity.

The DC-1000, 185 feet of .150" width tape, is a trademark of the 3M Company.

Irwin Magnetics
2311 Green Road
Ann Arbor, Michigan 48105
313/996-3300
TWX 810-223-6050

IRWIN™
IRWIN
MAGNETICS

Only from Topaz...

Line 2[®] Power Conditioners with PowerLogic[®] Control

**The logical choice
in computer-grade
power**

They're in a class by themselves.

Highly efficient and completely reliable, these microcomputer-based Line 2 Power Conditioners eliminate computer problems caused by power-line noise and voltage disturbances.

With exclusive Powerlogic control, our Power Conditioners are able to perform with exceptional speed and accuracy. An internal microcomputer monitors incoming power and instantaneously corrects overvoltages and undervoltages.

Harmful power-line noise is also eliminated. A built-in Ultra-Isolator[®] Noise Suppressor provides common-mode noise attenuation in excess of 2 million-to-one (126 dB).

Available in micro, mini, and mainframe models, Line 2 Power Conditioners feature computer-compatible design, durability and top performance.

Find out more about our new Line 2 Power Conditioners. Call us today at (619) 279-0831, or contact your local Square D distributor.

CIRCLE NO. 91 ON INQUIRY CARD



TOPAZ[®]
Excellence in Computer Power

SQUARE D COMPANY

destination addresses. All access calls from application packages then go to the assigned destinations in a way that's transparent to both users and software.

The access designation for files does differ between MS-DOS 2.0 and 3.0. The 2.0 version differed from its "1.X" predecessor by adding slashes to signify subdirectories, which simplified file management. MS-DOS 3.0 adds two more sets of slashes: "\\" designates another logical machine in the same system, and "\\\" designates another logical network. Users and software packages can refer to another network, a machine within that network and subdirectories on that machine by including the correct number of slashes. The operating system then interprets the command and routes it level-by-level to the intended destination.

A user need not bother with this routing syntax if working with a single-user program such as Ashton-Tate's dBASE II. MS-DOS 3.0's ASSIGN command lets the user associate an appropriate path name on the network, say, drive B. Then, whenever that user refers through "B:", the operating system automatical-

ly routes the command to the associated path.

MS-DOS 3.0 differs from the 2.0 version mostly in the hooks needed to interface with MS-NET. The networking package is responsible for interacting with the network controller, blocking messages, recovering from errors and implementing file and record locking. The locking functions permit safe multiuser database access by preventing users from interfering with one another when they try to work with the same data. □

Robert S. Harp is the founder, chairman and chief executive officer of Corona Data Systems Inc. He had held similar positions at Vector Graphic Inc., a microcomputer manufacturer he founded in 1976. Before that, Harp served as senior staff engineer at Hughes Research Laboratories. He earned a Ph.D. in electrical engineering at Stanford University, Stanford, Calif.

Interest Quotient (Circle One)
High 486 Medium 487 Low 488

Add IBM Format-Compatible Magnetic Tape To Any RS-232 Port With The IBEX STC-100

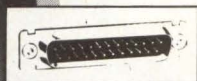

Plug-In 1/2" mag.
tape drives to any
mini or micro computer
Full read/write capability
Data logging
Call-detail recording

Write, phone or TWX
for information

IBEX

IBEX COMPUTER CORP.

20741 Marilla Street,
Chatsworth, CA 91311
(818) 709-8100
TWX 910-493-2071

CIRCLE NO. 92 ON INQUIRY CARD



Get... High quality low cost data switches

Compare Craig prices. RS232C AB Data Switches —

- Makes most efficient use of costly computer peripherals
- Eliminates redundant hardware, wasted time plugging/unplugging cables • Switches all 24 signals (Pin 1 through)

RS232C EXTENDED DISTANCE DATA CABLES

EDC04 \$11 both ends + .20 per ft.
EDC08 \$12 both ends + .30 per ft.
EDC12 \$12 both ends + .40 per ft.
EDC25 \$16 both ends + .60 per ft.

FREE GENDER MENDER WITH FIRST \$100 ORDER!

To order or request literature,
call toll-free 800-243-5760. In CT: 356-9315

CRAIG
DATA CABLE

652 Glenbrook Road, Stamford, CT 06906
CIRCLE NO. 93 ON INQUIRY CARD

The light inside Hitachi's Laser Beam Printer

Hitachi's SL-1000 is more than an answer. It's more like a revolution because it just about eliminates the bottleneck in producing hard copy, releasing the full potential of office computers, work-processing systems, and high capacity filing systems of your product line.

Try speed. Twelve pages per minute — that's if your system can transmit a page of data in less than 5 seconds! Operation is also quick because it's so easy. Single-action cassette insertion, double cassettes and space-saving one-side paper handling let anyone get the most out of

this printer without any special skills.

Try print quality. Just examine Hitachi's quality for yourself by looking at ill. (1). Quality speaks for itself — up to 400×400 dots per inch. That's far beyond what a dot matrix printer can even dream of. An optical scanning system with built-in facet error correction, an automatic toner concentration controller and thermal fixing are the unseen advanced extras that result in the impressive print quality.

The nitty gritty: reliability

Speed, high capacity, excellent print quality and

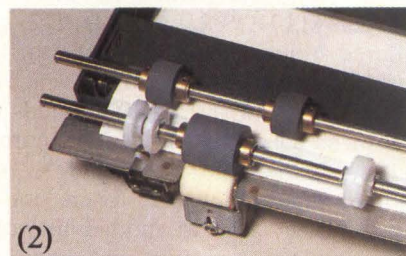

easy operation can mean much less if you waste time with downtime. Look at ill. (2). What you see is Hitachi's special clawless mechanism. Since only a single sheet of

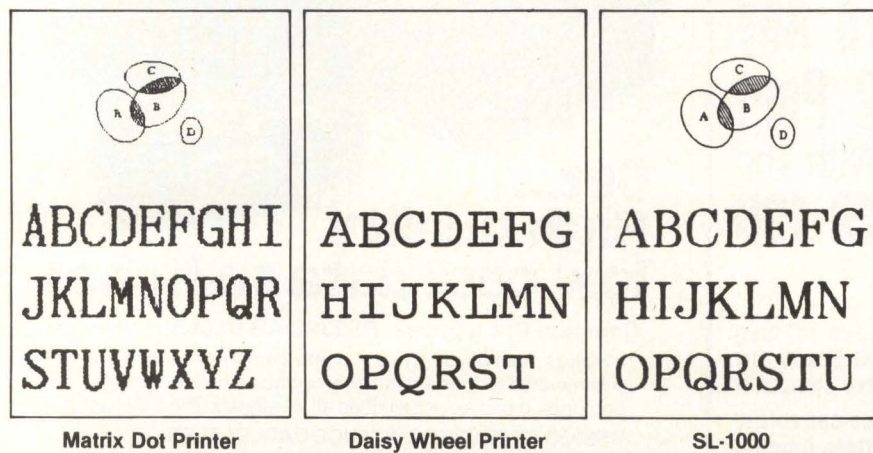

(1)



paper can be fed through, the major cause of paper jam has been cleverly eliminated. So you can offer an MCBJ of only 1 jam for 5,000 sheets!

And you can promise over 25,000 sheets, on the average, before our laser beam printer benefits from any maintenance (MCBPM: 25,000 sheets).

The light inside

Here is another fact. Weigh it. Mull it over. Compare. Our laser will last over 1 million sheets.

Don't be surprised. After all, we are an experienced OEM supplier and make our own semiconductor lasers so we know a thing or two about them. The laser inside our printer, that crucial inner light, has reliability that is absolutely second to none.

It's none of our business

We are not here to tell you how to present the SL-1000. If you want to offer rapid copy of CAD or CAM designs or quiet

telex messages (our printer is quite quiet) or wish to hook the printer to LAN or computers and word processors, that's for you to decide.

Our business is to provide your line with state-of-the-art print quality, smooth swift speeds, easy operation and reliability that's not just a word but a year-in, year-out operating reality. For that important competitive edge, here is the desktop LBP of choice for you to put your own label on.

The light inside Hitachi's laser beam printer brings data to printed life and can point to a new peak in sales.

OEM

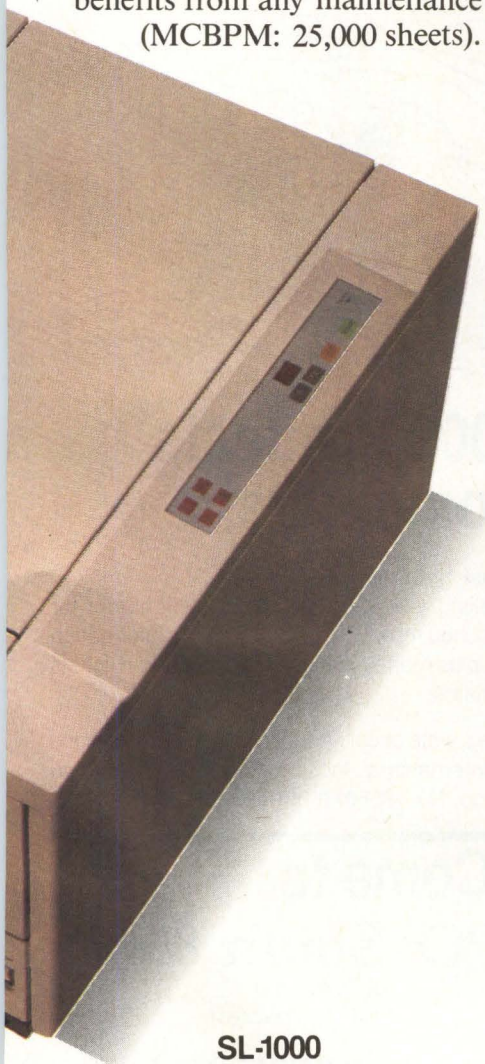
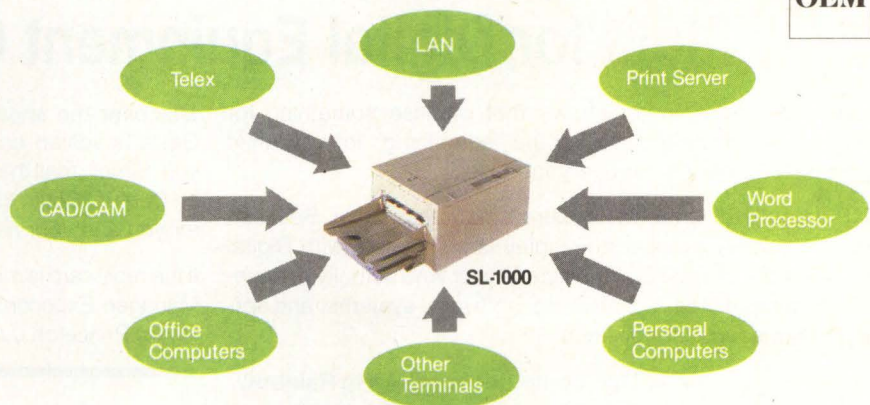

SL-1000



Hitachi America, Ltd.
Industrial Components Sales & Service Division
50 Prospect Avenue, Tarrytown, N.Y. 10591-4698,
Tel: (914) 332-5800

Come out of the computer show jungle

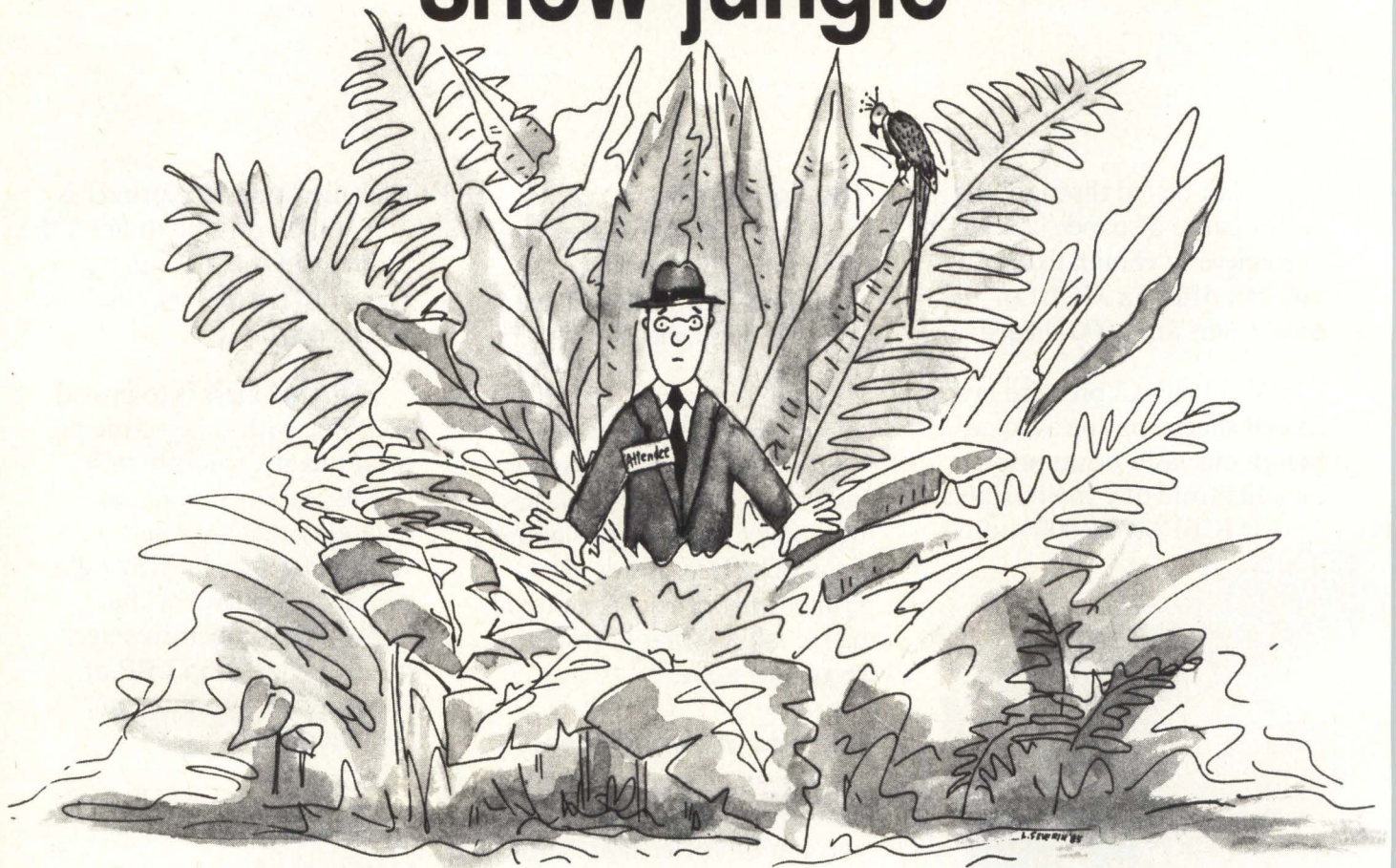

Come to the Show with Over 5,000 Products Just for Digital Equipment Computers.

You've been to computer shows that promise something for everyone. The trouble is finding the "something" for you amid thousands of products for everyone else.

DEXPO South 85 is the DEC user's smart alternative. Because at DEXPO, *every* product on display is compatible with Digital Equipment computers. So you'll spend your time actually *examining* DEC-compatibles ... hardware, software, systems, and services ... not searching for them.

Ways to improve every DEC computer from VAX to Rainbow.

Whether you have one DEC computer or an entire range, you'll find just what you need to enhance your system's productivity. From terminals and memory boards to turnkey systems; from applications to communications — DEXPO South has it all.

With over 300 vendors on hand, you can be sure of seeing the latest advances in DEC-compatible technology. So, you'll have plenty of opportunities to compare and evaluate products *before* you choose.

A bonus for DECUS* symposium attendees.

If you attend the DEC Users Society (DECUS) New Orleans symposium, you'll receive FREE admission to DEXPO South 85. Use the attached reply card to get complete details.

Discover the show that helps you do more.

Get a headstart on making your DEC computer work harder for you. Simply mail the attached reply card to receive more information on DEXPO South 85 ... plus money-saving V.I.P. admission tickets for you and your associates.

If the reply card is missing, write or call: Angela Wright, Registrations Manager, Expoconsul International, Inc., 55 Princeton-Hightstown Road, Princeton Junction, NJ 08550; (609) 799-1661.

Come to DEXPO® South 85

The Seventh National
DEC*-Compatible Exposition

New Orleans Superdome

May 28-31, 1985

Tuesday - Friday

*Registered trademarks of Digital Equipment Corp. DEXPO is not sponsored by or affiliated with DECUS.

PROCESSOR BOARD HANDLES VIRTUAL MEMORY

Memory-management circuitry, a state sequencer, bus-vectored interrupts and fault-recovery logic enable Z8000-based board to support speed and memory requirements of complex multiuser systems

Jeffery J. Roloff, Central Data Corp.

Today's complex multiuser computer systems demand large amounts of memory and fast memory access. They also require more functions to be integrated into their central processors. Central Data Corp.'s Z8000-based processor board meets these needs with a 10-MHz processing speed, full demand-paged virtual memory management circuitry, an interface to the Intel Corp. Multibus and iLBX extension (including bus-vectored interrupts). A powerful state-sequence machine handles all processor cycles on the board.

Designed for use as the central processor in a multiuser computer system, the board employs the Zilog Z8003 segmented virtual memory processor. Its iLBX interface, on the P2 connector of the Multibus card, provides a very high-speed memory interface in addition to the relatively slow Multibus system bus.

The iLBX interface allows the board to work with Central Data's cache-memory board or other iLBX memory products. The cache-memory board gives 100-nsec access time to all hit memory accesses, implementing an effective memory access time of approximately 160 nsec and providing excellent performance in comparison to other Multibus single-board computers.

Because the board is intended for use in multiuser systems that distribute memory and I/O functions onto separate boards, it contains no RAM or serial I/O devices. However, as much as 32K bytes of PROM can be plugged into the board for bootstrap and testing purposes.

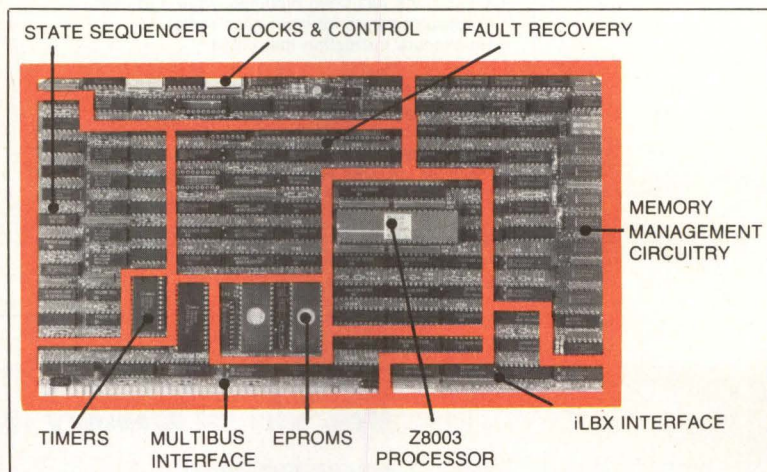

Four diagnostic light emitting diodes (LEDs) are provided for error indications when power is turned on. A monitor permits small-program development, downloading and debugging.

An upgrade of its 4-MHz Z8000-based predecessor, the board retains software compatibility with that product, while furnishing twice the performance. With cache memory, it achieves three times the performance.

Interrupt handling has become a very important part of multiuser systems, and the board supports full bus-vectored interrupts, in addition to the Multibus' normal level/edge triggered interrupts. With bus-vectored interrupts, a device on the Multibus interrupts the host and returns a vector directly when the host acknowledges the interrupt. This procedure is less time-

The Z8000 board contains fault-recovery and memory-management circuitry, a state sequence machine and interfaces to the Multibus and the iLBX bus.

Control bits work with the board's control-logic circuitry to implement the demand-paged virtual memory system.

Recovery from several kinds of fault conditions, such as those listed in (A) is handled by software routines similar to those in (B).

BOARD IMPLEMENTS RECOVERY FROM FAULT CONDITIONS

(A)

Invalid page fault

Occurs when the invalid page bit is active in the page map, indicating page location is uninitialized.

Write fault

Occurs when a write is attempted to write-protected area of memory.

Stack warning fault

Occurs if an access is made to lower 256 bytes of a stack page, indicating that the stack should be continued down one more page to prevent stack overflow.

System access fault

Occurs when a non-system-mode program attempts to read or write a memory area reserved for system-mode programs.

(B)

If invalid page:

- Find physical page in memory to be overwritten.
- If that page has been modified, write it to disk.
- Prepare registers for instruction restart.
- Re-execute instruction that failed.

If stack warning:

- Add 2K page to process' stack.
- Mark new page as stack-warning page; new page is now the lowest stack page.
- Mark old page as normal page.
- Return to process execution.

If system access or write-protected access:

- Kill process.
- Exit to scheduler.

consuming than the normal method of polling the device to determine the type of interrupt condition that occurred.

Digital counters are used instead of nondigital timing circuitry, thereby increasing reliability and noise immunity. Most of the board's circuitry consists of 74F FAST advanced Schottky devices, allowing tight tolerances over the full commercial temperature/voltage range.

The processor board's demand-paged virtual memory system uses 15 independent memory maps. The map in use is determined by a processor-assigned process number. The logical address process number plus the processor-assigned segment number serve as address inputs to a segment map in a 1024-bit-by-5-bit RAM array. The segment map's output helps determine a page address, which results in the generation of the final physical address.

The page map also contains control bits, including ones to indicate whether a portion of memory is write-protected, not available (an unused entry), or serves as a stack page where a warning should be generated should an access occur near the bottom of the page.

When an error occurs on an access to a location in memory, the processor must be informed. Significant amounts of fault-recovery logic are required to support the Z8003 processor chip. The board must determine the type of fault—invalid page, write, system-segment, stack-warning or fatal trap—and initiate the appropriate corrective action.

How virtual memory systems work

Virtual memory allows a computer program to access a larger addressing space than the main memory of the central processing unit (CPU) would otherwise hold. For example, a virtual memory system containing only 512K bytes of RAM could accommodate several programs each having an addressing space of 16M bytes. This is accomplished by having only part of each program's addressing space in system memory at one time. The remainder is kept in secondary memory on hard disk or other storage media.

For most programs, only a small subset of the addressing space is being accessed at any one time. The subset currently in use changes as program execution proceeds through routines and as succeeding data areas are accessed. The operating system's virtual-memory handler loads from disk into RAM only those sections of memory currently being accessed. The sections are typically loaded in "pages," 512 bytes to 2K bytes in length. The system

thus only loads pages into main memory throughout a program's addressing space as they are needed. The operation is transparent to the end user's program—it appears as though the entire addressing space remains in RAM at all times.

When a program accesses a page not currently in main memory, an operating system interrupt occurs, causing that page to be loaded into RAM from disk. The page is usually written over an area of memory holding another page's data. Because overwritten pages are the least recently accessed pages, the most recently accessed pages tend to be kept in main memory. Overwritten pages are copied onto disk if there were changes made to them when they resided in RAM.

There is, however, a performance tradeoff involved in virtual-memory systems: They permit a computer to access a larger addressing space than would otherwise be available in RAM, but at the cost of a slower-running computer system.

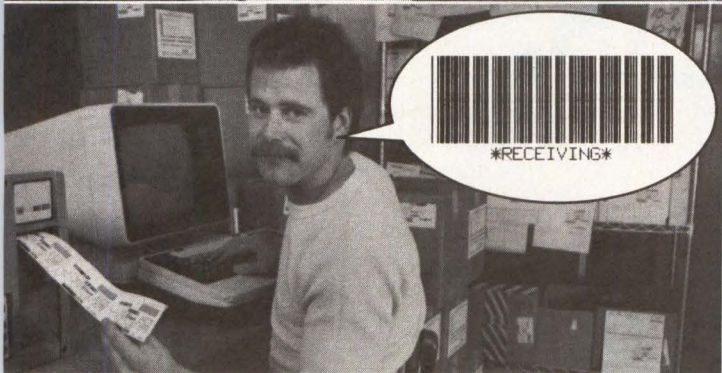
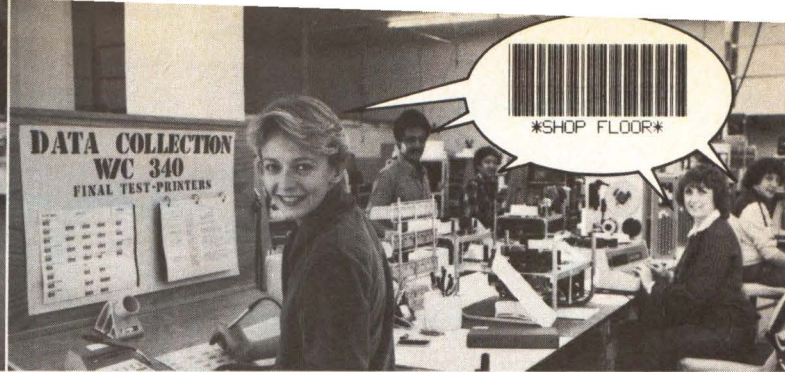
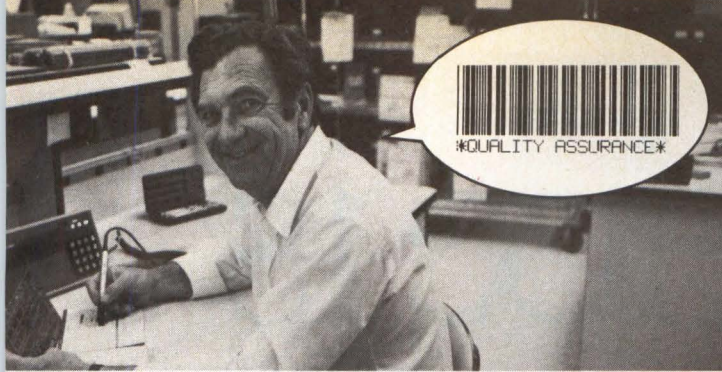

EMPLOY THE LANGUAGE OF PRODUCTIVITY.

The level of on-the-job productivity often depends upon your employees' ability to quickly and accurately perform, control and report their given responsibilities. A bar code data collection system sets your personnel free from cumbersome, and often inaccurate, paperwork data tracking. Free of paperwork, your people have more time for productive tasks. Output increases without raising manufacturing or service costs.

Since bar code data collection continually updates management on company-wide activities, you have improved control of inventories, shop floor tracking,

quality control, shipping/receiving, security and service. Inefficiencies are quickly recognized and corrected, and productivity is further improved.

Systems Approach

A U T O M A T E D
D A T A
C O L L E C T I O N



Find out why so many companies are taking advantage of the INTERMEC *Systems Approach*. It includes the industry's broadest integrated product line, sophisticated programming language, systems associates and worldwide factory service. It's all backed by INTERMEC — the world's largest bar code equipment manufacturer.

To learn more about our products and *Systems Approach*, contact INTERMEC, 4405 Russell Road, P.O. Box 360602, Lynnwood, WA 98046. Call 206/743-7036. TELEX: US 152447 Int'l (ITT) 4740080.

 **INTERMEC**[®]

Circle 151 for demonstration

Circle 150 for literature

The price is just one of its qualities.

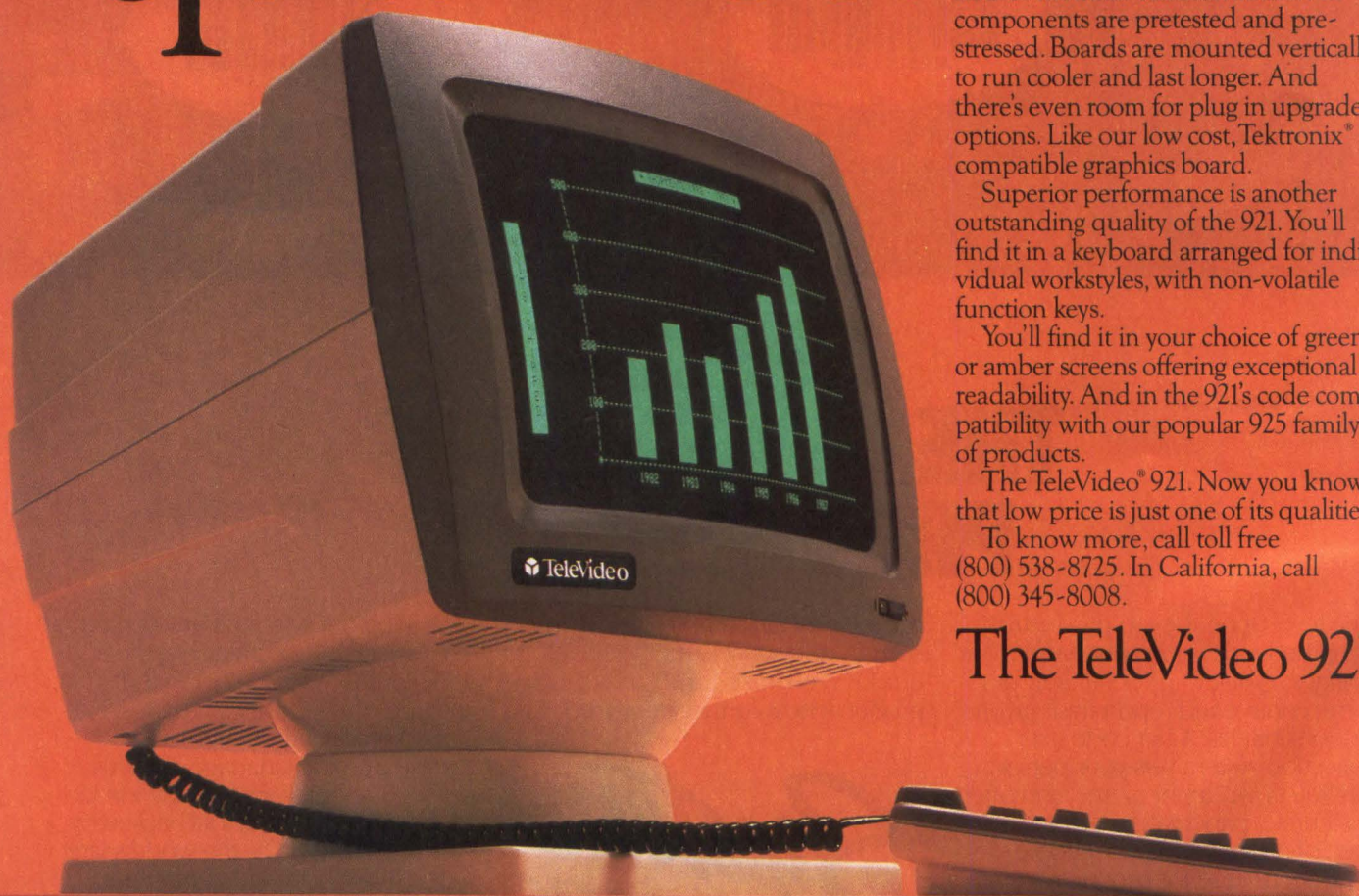

The 921 is built to the highest quality standards in the industry — our own.

The efficient, contemporary case houses modular subassemblies. All components are pretested and pre-stressed. Boards are mounted vertically to run cooler and last longer. And there's even room for plug in upgrade options. Like our low cost, Tektronix® compatible graphics board.

Superior performance is another outstanding quality of the 921. You'll find it in a keyboard arranged for individual workstyles, with non-volatile function keys.

You'll find it in your choice of green or amber screens offering exceptional readability. And in the 921's code compatibility with our popular 925 family of products.

The TeleVideo® 921. Now you know that low price is just one of its qualities.

To know more, call toll free (800) 538-8725. In California, call (800) 345-8008.

The TeleVideo 921

Tektronix is a registered trademark of Tektronix, Inc.



Terminals
TeleVideo Systems, Inc.

CIRCLE NO. 95 ON INQUIRY CARD

The board latches the address of the instruction that caused the fault, as well as the accessed address. The processor status lines are also latched, and a data-access counter is provided for looping instructions in order to restart them at the proper place. Software routines handle fault recovery using on-board registers.

If, for example, an invalid-page fault occurs, the operating system determines whether the page is available on secondary disk storage. If it is, a page of working memory is chosen to be swapped out, that disk buffer is loaded, and the stopped process is allowed to run again. While these disk transfers are occurring, other processes continue to execute, permitting full use of processor resources.

To maximize board performance and the speed of iLBX bus memory cycles, a state-sequence machine, comprising a 96-bit-by-16-

bit EPROM (erasable PROM) array, address-sequencing circuit and condition multiplexers, controls processor operation. The EPROM array is divided into six sections, with each section supervising one of the board's six cycles: Multibus memory, Multibus I/O, iLBX memory, vectored interrupt acknowledge, internal PROM and internal I/O.

At the beginning of a processor cycle, the relevant EPROM area is activated, and the address begins at 0. The EPROM's outputs then determine the next state of the sequencer, which can either stay at the current state, evolve toward the next state, or jump to an entirely new state.

The EPROM's output consists of 16 lines, of which three bits denote the cycle type, four bits the jump address, another four bits the delay time and five bits the cycle-control signals.

Circuitry enlarges available memory

A logical address is translated into a physical memory address by the memory-mapping circuitry, permitting the board to address a larger address space than is contained in RAM.

The segment-mapping RAM turns process and

segment numbers into a segment address that is added to the upper five bits of the Z8000 address to find the page address in the page-mapping RAM. The page address plus the remaining 11 bits of the Z8000 address make up the 24-bit physical address.

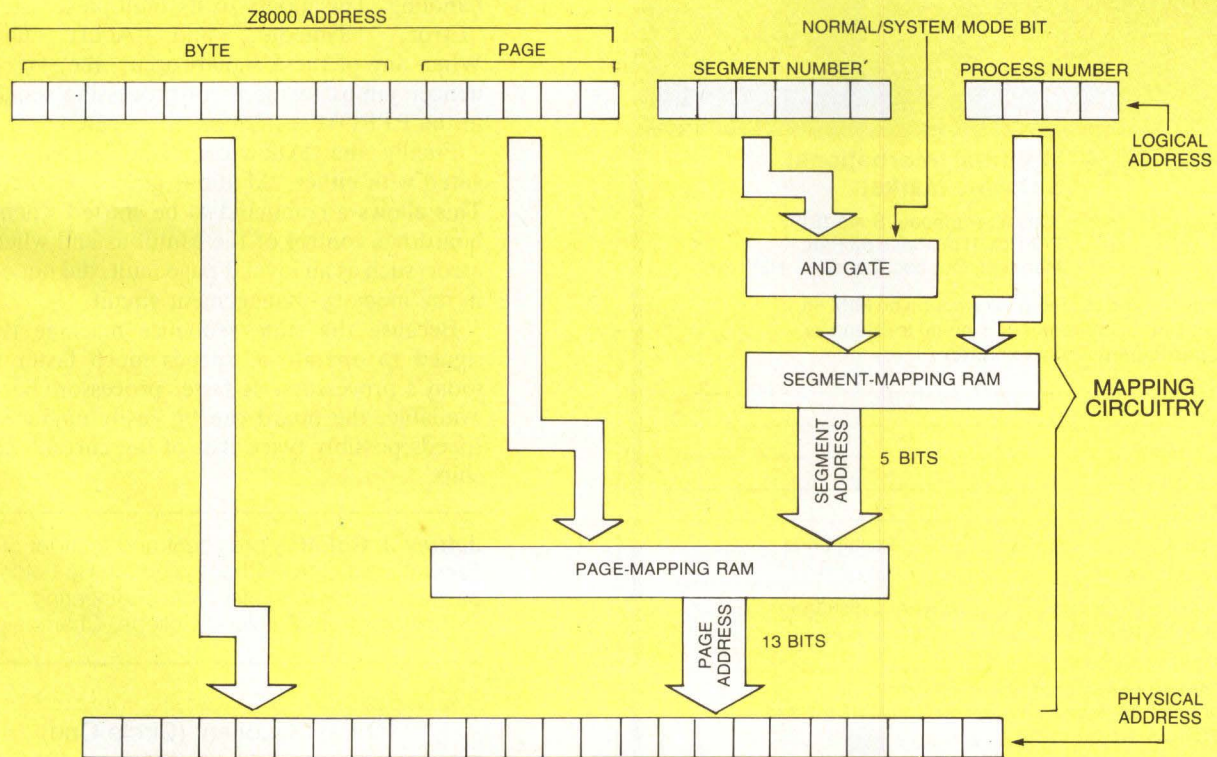

MIM85

A FIRST FOR THE SOFTWARE INDUSTRY

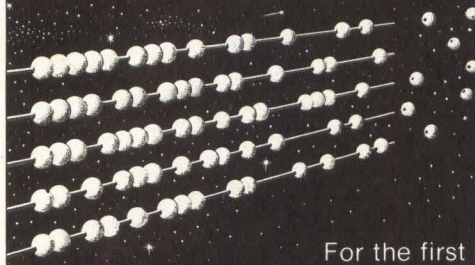

For the first time ever, anywhere, the collective genius that has brought about the worldwide software revolution will come together to sell product, share ideas and join forces in the international software marketplace.

The first international software marketplace.
More than 42 countries will be present to buy and sell.

The first international software import/export conference.
Internationally renowned specialists will lecture on software importing/exporting.

It all takes place June 3, 4 and 5, 1985 in Montreal, Canada for the world community of software producers, distributors and buyers.

MIM85 Montreal International Software Market

Tel.: (514) 288-8811
Telex: 055-62495

MIM85 Montreal International Software Market

300 Léo-Pariseau, Suite 1919
P.O. Box 1119, Place du Parc
Montreal, Quebec, Canada H2W 2P4

Please send me more information on MIM 85, in English , in French . I intend to attend as a participant , an exhibitor .

Name

Title

Company

Address

City

Country Postal Code

Telephone Telex

I am a software producer , buyer , distributor , manufacturer .

Types of product

For fast convenient phone registration or exhibit space booking call: (514) 288-8811

Visitors, we honor

Please print



C-USA-001-MM

The cycle-type signals are of major importance, because they are used as the address inputs for a condition multiplexer that generates various control signals for the state sequencer. The first control signal is "Do not proceed." When this signal is active, the address for the sequencer's next cycle will remain the same as it was in its previous cycle, overriding any jump address that may be pending. The second is the "Jump" signal, which, when active, causes a jump to the jump address on the sequencer's next cycle.

The last multiplexer output is the "Allow Command" signal. This gates certain cycle control lines to start and stop the various on-board "enable" signals and those to the Multibus/iLBX bus.

Because the state sequencer runs at the speed of the processor clock, and some timing sequences (for internal PROMs, bus vectored interrupt acknowledgement, etc.) need fairly long pulse widths, a delay timer permits a certain state to be held for as many as 15 cycles. Other inputs to the "Do not proceed" multiplexer are the "Multibus Grant" signal, which is active only when the board has control of the Multibus, and the "Wait" signal, which is active whenever the processor has received an acknowledgement from the Multibus or the iLBX bus.

The "Jump" signal is generally used for error handling. The inputs to its multiplexer are the "Error," "Timeout," and "Abort" signals. When any of these signals occur, the state sequencer jumps to the error-processing sequence in the EPROM section being executed.

Finally, the "Allow command" signal can be gated with either "Multibus grant" or "Error." This allows a command to be started when the board has control of the Multibus and when an error, such as an invalid-page fault, did not occur in the memory-management circuit.

Because the state sequence machine is designed to operate at speeds much faster than today's processors, as faster processors become available, the board can be easily upgraded to speeds possibly twice that of the current Z8003 chip.

Jeffrey J. Roloff is president and founder of Central Data Corp., Champaign, Ill. He holds an associate degree in electrical engineering technology from Parkland College, Champaign.

Interest Quotient (Circle One)
High 489 Medium 490 Low 491

CIRCLE NO. 96 ON INQUIRY CARD

VALUE ADDED CREDIBILITY.

ITT XTRA

You already know ITT makes an exceptional personal computer.

The ITT XTRA™ Personal Computer.

What you may not know is that ITT also has an exceptional VAR program.

A program designed for both large and small VARs.

You get one of the most tightly-engineered PCs in the marketplace — all the capabilities of the IBM PC or XT in a smaller package. And lower cost.

You also get the support of a world-wide telecommunications company with annual sales of over \$20 billion.

The ITT XTRA is the IBM-

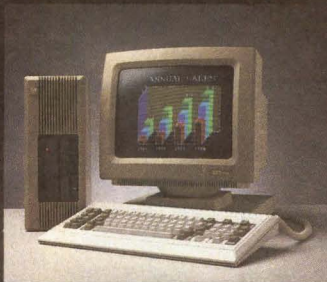

compatible that gives you instant access to the world's largest software library.

Full expansion capability. Integrated Graphics Adapter — supports both color

and monochrome monitors plus memory to 640K in one card slot.

IBM 3270 PC and 3278/79 terminal emulation. Voice recognition digitization, storage and playback.

A built-in telecommunications port. Internal self-test diagnostics. A 14" color tilt-and-swivel monitor. Three-position Selectric® style keyboard and much more.

Plus that all-important ITT

service and support.

Give us a call at (408) 945-8950.

Or return the coupon today for all the information on how hard the ITT name can work for you.

ITT Information Systems, Inc.
2041 Lundy Avenue
San Jose, California 95131

Please send me more information on the ITT VAR Program.

Name _____

Title _____

Company _____

Address _____

City _____

State _____ Zip _____

Phone _____

ITT
PERSONAL COMPUTERS

HELPING AMERICA WORK SMART.

© 1985, ITT Systems, Inc.

IBM is a registered trademark of International Business Machines.
IBM Selectric is a registered trademark of International Business Machines.

CIRCLE NO. 97 ON INQUIRY CARD

Xebec's New Owl Reduc Storage To

Then.



Microcomputer storage history has progressed by a series of small "next logical steps." A replacement of a component here, a refinement of technology there. But now Xebec has taken a giant step, with its Owl intelligent disk file.

On the surface, the Owl might look like other 10-megabyte, 5¼" half-high Winchester. Underneath, however, it's an example of superior technology. The integration of controller logic and drive electronics on a single board means not just one less PCB, but the elimination of expensive connectors and cabling, low power consumption (15 watts typical) and enhanced data integrity.

We've put data separation in the HDA for precise control of data windowing and the elimination of background noise. We've provided a diagnostics channel to the host that delivers meaningful error messages.

Single-board drive and controller electronics insure higher reliability

Integrated data separation within disk drive delivers higher data integrity

Ruggedized design includes bead landing zone

Comprehensive diagnostics eliminate "What's wrong?" guesswork

Compatible with industry-standard Xebec SASI bus for faster system integration

Just as our superiority in minicomputer controllers led the way to a similar superiority in micro controllers, and our tested pairs solutions evolved from our considerable sub-system and testing experience, so too the Owl

reflects our "top-down" engineering strategy—creating both technological and cost-of-owner-

CORPORATE HEADQUARTERS
2055 Gateway Place, Suite 600
San Jose, California 95110 U.S.A.
(408) 287-2700

es Microcomputer Disk Two Words.

Now.

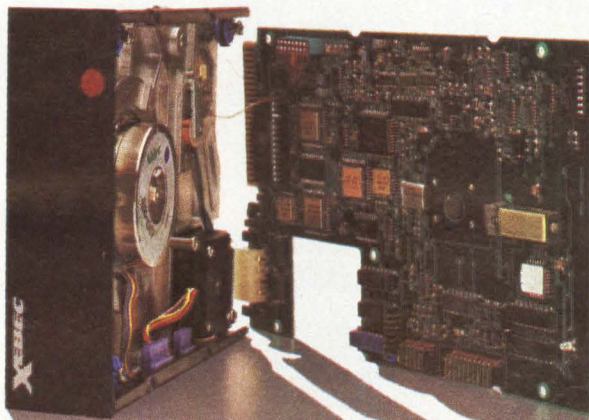

ship breakthroughs by designing sophisticated high performance, multi-user features into small-system, single-user environments.

The System-Engineered Solution.™

As a major user of drives, and a major testing resource for other drive manufacturers, we are concerned about drive reliability. And we've learned that it's not just a question of improving a component or consolidating some board real estate. The answer lies in careful consideration of overall system integration requirements.

The Owl epitomizes what we call the Xebec System-Engineered Solution. The focus is two-fold: on today and on tomorrow. Compatible now with industry-standard Xebec SASI, the Owl—by eliminating the ST506 interface—is

upwardly compatible for future higher densities, capacities and performance.

In broader perspective, Xebec's approach to OEM satisfaction rests on our proven experience, our vertical integration strengths—which now include production of heads and plated media—and our commitment to zero defect quality, by way of computer-aided design and robotics manufacturing.

Call Xebec today. Let us tell you more about the Owl. And how we can deliver the difference between then and now. Now.

CIRCLE NO. 98 ON INQUIRY CARD

SALES, INTERNATIONAL,
Belgium
32-02-762-9494
England
44-734-693511
Italy
39-6-350201

SALES, U.S.A.
Sunnyvale, CA (408) 732-7330
Irvine, CA (714) 851-1437
Atlanta, GA (404) 457-9872
Boston, MA (617) 740-1707
Dallas, TX (214) 361-0687
Baltimore, MD (301) 992-7377
Federal (301) 621-3010
Chicago, IL (312) 931-1420

U.S.A. AND CANADA DISTRIBUTORS
Kierulff
Hamilton-Avnet
Avnet Electronics
Hamilton Electro Sales

XEBEC
*The Quality
Investment*

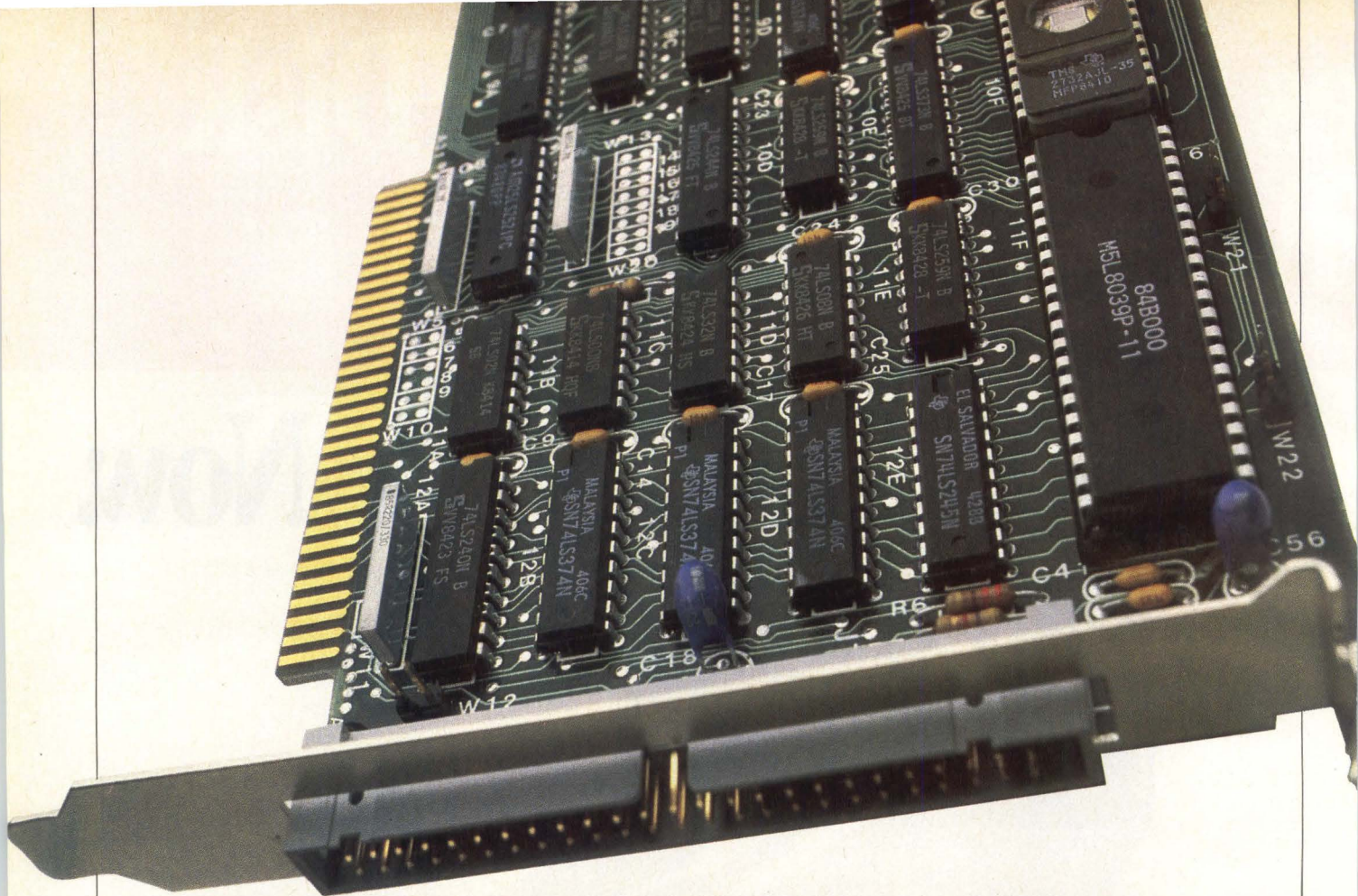

NEED STREAMING TAPE FOR THE PC? SYSGEN DELIVERS.

Install a Sysgen™ SC4500™ tape controller and the basic (non-intelligent) streaming tape drive of your choice.

You've got the fastest, most intelligent, most cost effective back-up system around for the PC, XT, AT™, or PC-workalike.

The same controller that drives Sysgen's top-selling tape back-up systems. Unbundled.

You get a proven, reliable, high performance microprocessor-based single-board controller with QIC-24 data format.

You get data transfer to the tape at rates of up to 3.75 Mbytes per minute.

You get automatic error correction. (Sysgen's high-speed "verify-on-the-fly" technology verifies data accuracy as the controller is writing, so users don't have to wait for the tape to rewind to verify.)

You get fast "image" back-up. And you get intelligent, fast "file-by-file" back-up.

The controller is so intelligent, it turns dumb peripherals into the smartest buy.

Advanced, local-intelligence architecture means you get all this performance with less burden on the system CPU, using less expensive *basic* (non-intelligent) tape drives.

Your system cost and system electronics are minimized. Power requirements are minimized.

Result: greater economics and reliability.

The controller fits any PC-compatible full-length slot. It runs any standard basic drive with DCAS or QIC-36 interface.

It is the most economical way you will find to integrate tape back-up into a PC-class system.

And it is available now.

For more information, including specifications, and the name of your local rep, call Sysgen direct: **(415) 490-6770.**

47853 Warm Springs Blvd.
Fremont, CA. 94539

SYSGEN

I N C O R P O R A T E D

Trademarks: Sysgen, SC4500—Sysgen, Inc.; AT—International Business Machines Corporation.

FOUNDATION MODULE SIMPLIFIES INTEGRATION

Single-board device merges components common to many microcomputer applications to increase system capacity while decreasing system cost

Daniel A. Dawson
Scientific Micro Systems Inc.

A new method for structuring a computer system furnishes all major components common to a wide variety of microcomputer applications in a single integrated package. This "foundation module"—housed in an air-cooled, fully shielded cabinet containing a card cage and power supply—consists of a single circuit board with RS232 serial ports, system bus interface, disk and tape controller, bootstrap, diagnostics and monitor systems. Adding a user-specified CPU, memory and peripherals results in a product that fits snugly into the specialized niche between a

minicomputer and a personal computer, for use in business, laboratory and industrial environments.

The foundation module concept, as executed by Scientific Micro Systems Inc., Mountain View, Calif., in their SMS 1000 Model 40, contrasts sharply with approaches taken in building traditional computer systems. Ordinarily, a minicomputer system integrator might connect a CPU, memory, disk controller, serial I/O controller, diagnostic hardware and system-support hardware to an existing bus. This method offers system flexibility but requires numerous interconnected boards that increase size and cost, and reduce reliability.

Integrators can be crippled by conflicting design philosophies. *Minicomputers' single-bus architecture increases their*

flexibility, but also their cost. Microcomputers' single circuit boards cost less, but flexibility is the toll.

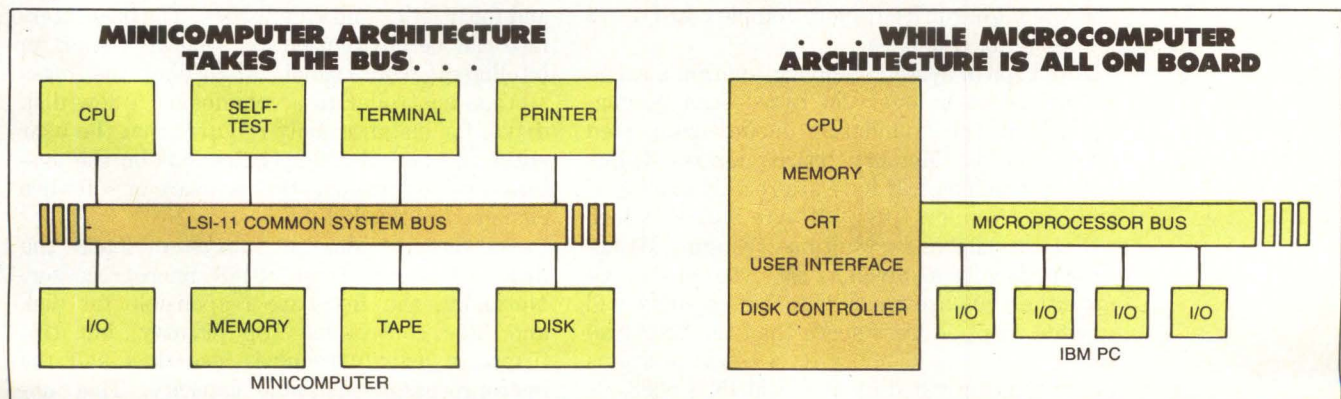

The Support Monitor Subsystem is useful in a number of functions that would otherwise require specialized CPU software.

Computer users who integrate personal computers tend to eliminate the system bus and merge everything on a single board to avoid interconnections, overhead and hardware. Individual pieces are coupled more closely to eliminate cumbersome connectors, bus interfaces and protocols. But flexibility is sacrificed, because the system cannot be modified or expanded easily.

The corresponding lack of CPU options further exacerbates versatility problems. For example, a purchaser of an Apple IIe microcomputer for industrial applications must use a 6502 CPU—which might have less than optimum memory addressing capability. Likewise, an IBM Corp. PC interfaces with a 5-MHz Intel Corp. 8088 microprocessor, which may not prove fast enough. In these cases, the performance level of the expansion bus is the manufacturer's choice, not the user's. In addition, the system user may have a significant investment in applications software and hardware for use with a more traditional microcomputer, and this investment is lost if the new system is incompatible. This is not a serious problem where the personal computer is applicable, because personal computer environments rarely require particularly high performance or extensive hardware.

User specifies what's added

The foundation-module concept provides a broad choice of CPUs. Here, parts of the system common to one another are combined, and the system integrator may specify the CPU, I/O and memory to be added to a standard bus that allows optimum communications speed. To couple with a Q-bus, for example, the integrator may choose the LSI-11/23 CPU. But recently, the new CMOS high-performance LSI-11/73 processor has become available to provide more processing power and to split instruction and data space. The integrator now has the option of choosing an LSI-11/23 for some applications, and the higher priced, more complex LSI-11/73 for high-end machines.

Any type of system memory—within a range of 16K bytes to over 2M bytes—can be connected to the foundation module-supported standard bus. Memory boards for the Q-bus with as much as ½M byte are readily available, and some vendors offer 1M-byte boards, which are also available for Multibus systems. Memory boards with as much as 2M bytes of storage for either bus are upcoming; that capacity will provide more address space than the 6502 processor and more memory on a single Multibus board than provided by the IBM PC's 8088.

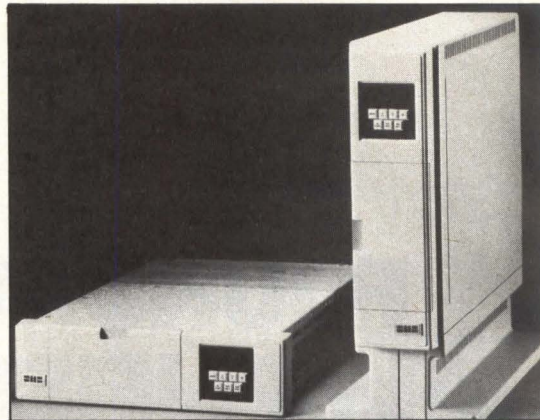

The SMS 1000 Model 40, an LSI-11 Q-bus-compatible microcomputer from SMS, is an example of foundation module-based computers. The product is packaged in either rack-mount (left) or floor-mount (right) versions.

The disk controllers for foundation modules' mass storage subsystems are industry-standard. The peripheral controller supports a range of 5¼-inch Winchester disk drives, 8-inch or 5¼-inch floppy disk drives and a ¼-inch cartridge tape for high-speed/high-capacity distribution and backup. The floppy system itself supports a variety of formats, including all DEC and IBM single- or double-sided disks.

Two RS232 serial ports integrated on a Q-bus foundation module require no Q-bus slots. Baud rate is programmable. Additional users can be accommodated with configured DEC-standard DLVII-J interfaces. Remote dial-up users can access the system through a four-port DZV-11 modem support module.

Support Monitor Subsystem checks status

A key component of the foundation module, the Support Monitor Subsystem, contains software and hardware for system status analysis and for utilities and diagnostics. The user interface can be customized and operated from an intelligent front panel. Modifying the mass storage controller to accommodate a new disk drive, for instance, only requires that the user enter the new drive specifications on the system console terminal. No hardware or software changes are needed.

The Support Monitor Subsystem shares the disk-controller's Intel 80188 microprocessor. Normally, the firmware responsible for disk and tape control has top priority, but this firmware usually requires less than half the microprocessor's possible capacity. That un-

OEMs... Is Your Input Strategy As Sound As Your CPU Strategy?



A. **Joy Disk** — Four keys in one; rapid cursor control.

B. **Touch Pad** — Multi-purpose input device; programmable key pad, cursor control, drawing tablet.

C. **Speech Recognition** — Natural, language independent command entry. Hands free operation.

D. **Mouse** — Popular pointing and selecting tool.

E. **Bar Code** — Fast, accurate data capture.

Computer users are demanding additional input devices from you. Key Tronic can help you meet the demand for these input devices, and minimize your development costs.

Key Tronic is integrating the most popular input devices into OEM keyboards. All processing is done in the keyboard and no additional system ports are required . . . using existing electronics saves money. Also, all input can be presented as a series

of key presses to assure compatibility with existing and future software.

Speech Recognition, Touch Pad, Mouse, Bar Code and Joy Disk are available to enhance your product with unique, value added benefits. Distinguish your product from the ordinary! Talk to your Key Tronic representative today.

“Feel the Key Tronic Touch”

key tronic
The Responsive Input Company

P.O. Box 14687 • Spokane, WA 99214 • USA
(509) 928-8000 • TWX 510-773-1885

CIRCLE NO. 99 ON INQUIRY CARD

Sell someone a Genicom 3000, and it may be some time before you hear from them again.

Genicom 3000 printer reliability can keep a customer happy for years.

From offices to factories across the country—hour after hour, day after day—Genicom 3000 printers have been proving their quality and reliability under even the toughest conditions for years.

The result has been a large number of very satisfied customers, which means a large number of satisfied OEM's. But durability is only part of the Genicom 3000 printer advantage.

The Genicom 3000 family of printers offers multi-model flexibility combined with single design simplicity to give OEM's real dollar savings with price/performance matching for every customer. Parts

commonality. Easier servicing. Single source supply. Plus you can select speeds from 180-500 cps draft/EDP, 45-100 cps NLQ, single or multi-

mode printing, automatic sheet feeders, document inserters, multi-color printing and graphics, plus more. There's such a diversity of models, features and options, you can choose just the right printer and you don't have to pay for things you don't need.

See how long you can keep your customers satisfied...with the long lasting, field proven printers that have earned the respect of OEM's nationwide—the Genicom 3000 family.

GENICOM
™
The New Printer Company.

Genicom Corporation, One General Electric Drive, Waynesboro, VA 22980 In Virginia, call 1-703-949-1170

For the solution to your printing needs call

TOLL FREE 1-800-437-7468



CIRCLE NO. 100 ON INQUIRY CARD

used capacity combines with the module's hardware-accessing ability to share an inexpensive increment in ROM and RAM space, while using minimal additional hardware.

The microprocessor system is separate from the architecture of the computer. This separation allows a broad range of processor capabilities not available to the system CPU—such as system-level monitoring and exercising. The processor also provides the intelligence necessary to drive an alphanumeric display and the keyboard; this front panel interface reports status data from within the running system, including power-supply voltages, internal-package temperature, Winchester write-protect status and general drive activity. A keypad is used to select data to be displayed as well as to control a range of system specifications such as disk formats, terminal baud rates and error processing.

Because the Support Monitor Subsystem is a complete resident microprocessor, it is useful in a number of functions that would otherwise

require specialized CPU software. Its internal interface to the disk controller system, for example, allows it to act as disk-drive exerciser and diagnostic tool. This capability is especially valuable because it is always available; the users don't have to worry about not being able to bootstrap maintenance software when diagnosing a disk sub-system failure. Because it includes a nonvolatile memory, the Support Monitor Subsystem can implement a flexible array of user-configured options.

Bootstrap for code gets special attention

Several foundation-module facilities combine to provide user flexibility and enhancement for system power-up and bootstrap. These extra capabilities rate special importance in LSI-11 Q-bus based systems, in which a 256-word space in the CPU's I/O page is reserved for ROM-based bootstrap code. But this space is too small for system confidence testing, multiple bootstrap device drivers and an operator communications facility. What's worse, bootstrap

Foundation module 'supports' the system

The foundation module is so called because it "supports" the rest of the system.

The module contains serial ports, disk controllers and other common components. An industry-standard bus interfaces the module with a user-specified CPU, memory, software and "user modules." (Any Q-bus or Multibus-compatible hardware which the user may find of value and wishes to purchase or produce

in-house may be used.)

Winchester disk drives, floppy disk drives, cartridge tape back-up and other peripherals connect with the module by means of a Mass Storage Control Protocol (MSCP) Controller.

A Support Monitor Subsystem, which also contains software and hardware for system status analysis, furnishes the user's interface with the module.

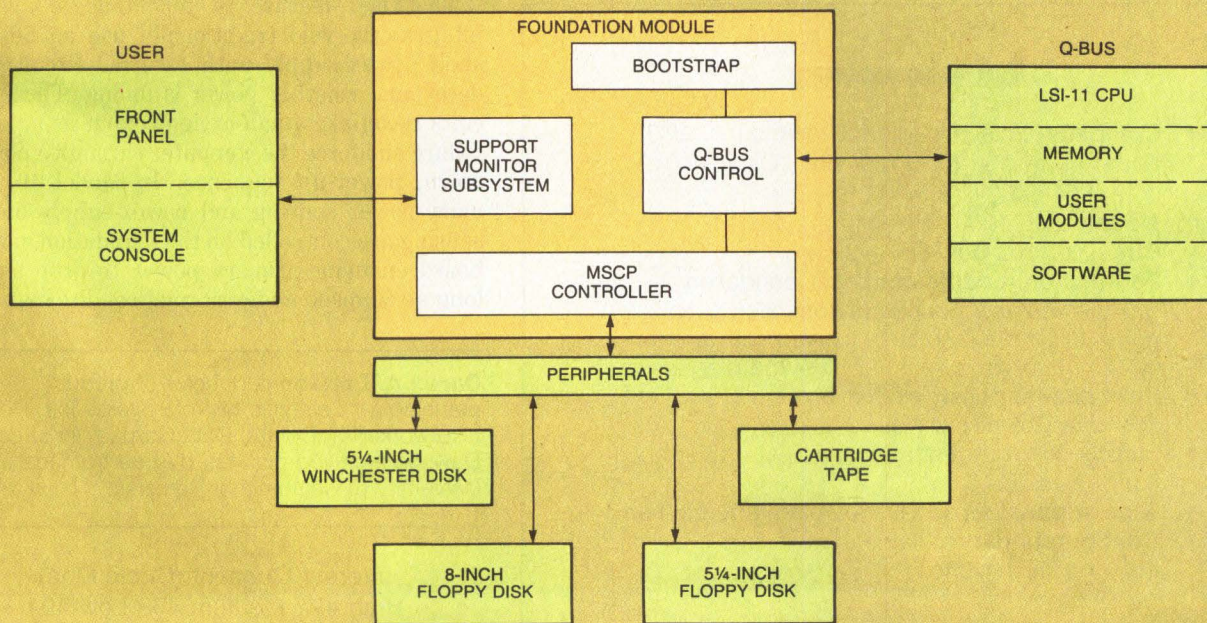

Primary power [can] drop out as long as 50 msec under normal conditions.

code, supplied in ROM by the system manufacturer, cannot be modified or enhanced by the user.

The most common solution to the lack of adequate ROM space is to add hardware that implements a paging scheme to allow a large ROM to be accessed 256 words at a time. But this method demands additional paging hardware and that the code stored in the ROM be programmed to handle the constant page swapping incurred as even a moderate-size program is executed.

The foundation-module approach solves the code space problem by supporting an extra level of bootstrap. The 256-word ROM program is resident in the foundation module; the straightforward code's only function is to load a far larger bootstrap package into system memory from the foundation module.

Once this transfer is complete, the LSI-11 executes the large program and, because this code is loaded as a contiguous block in memory, no paging overhead or complexity is necessary, while flexibility is maintained.

Adds options inexpensively

Hardware straps (jumpers) are generally used to configure minicomputers and microcomputers. These straps either control hardware directly with the logic levels associated with them, or they are read by a processor. For example, hardware straps might establish the address of a board on the Q-bus.

But hardware straps mean additional mechanical devices, usually the least reliable parts

of the system; hardware straps are a form of nonvolatile memory because functional parameters established by jumpers do not change when power is removed. Foundation modules replace hardware straps on a one-for-one basis with bits in a nonvolatile, semiconductor memory which, because they can be modified programatically, are called "soft straps."

Users employ software through the front panel to change baud rate, interrupt levels or other parameters, without the need for tools or system assembly. Device addresses for each peripheral device, disk formats or configuration of the entire disk drive system are software driven. Adding eight hardware straps is costly, space-consuming and inefficient; on the other hand, eight more options in the EEPROM require just one byte of memory.

Other features of foundation modules include:

- A line-time clock operating at 50 Hz, 60 Hz or 400 Hz for nonline-driven applications, providing timing for task-switching and multitask operating systems.

- A display/control panel with a top panel section consisting of a 16-character, 5-by-7 dot matrix vacuum-fluorescent alphanumeric display.

- Four pushbuttons used in conjunction with the display that access system data and change system parameters. Most switch functions can be duplicated on the keyboard of a terminal that interfaces with the support monitor.

- A sensing system in the foundation module that evaluates the capacity left in the power supply.

That last feature is important to system integrators, who traditionally use an off-the-shelf power supply with external circuitry to determine whether power is failing. These circuits recognize a half-cycle dropout as a power failure and force the computer through a power-down, power-up sequence. In Model 40, primary-power sensing and power-supply output sensing are controlled on the foundation module board, enabling primary power to drop out as long as 50 msec under normal conditions. □

Spec summary

- **Company:** Scientific Micro Systems Inc., 339 N. Bernardo Ave. Mountain View, Calif., 94043, (415) 964-5700
- **Model:** SMS 1000 Model 40
- **Bus:** LSI-11 Q-bus-compatible
- **Foundation module concept:** foundation module contains peripheral controller, serial ports, full backplane circuitry and software for system analysis, system utilities and diagnostics
- **Hard disk support:** one or, optionally, two 5¼-inch hard disk drives
- **Floppy disk support:** optional 5¼- or 8-inch floppy backup
- **Tape support:** optional streaming tape backup
- **Configurations:** available in rack- and floor-mount versions

Daniel A. Dawson is director of product planning for Scientific Micro Systems Inc. He has also worked at Control Data Corp., Minneapolis. Dawson received his M.S. degree from the University of California at Berkeley.

Interest Quotient (Circle One)
High 492 Medium 493 Low 494

Alloy takes your PC to the limit.

QICSTOR-PLUS. The ultimate in PC expansion with five IBM compatible slots, hard disk storage, and streaming tape backup in one neat package.

Alloy's QICSTOR-PLUS meets all your expansion needs. It's the ideal upgrade for a growing PC or AT system.

QICSTOR-PLUS has five full size expansion slots which are completely compatible with the IBM PC bus and they also support Alloy's PC-SLAVE/16 multi-processor, multi-user capability. Its high performance hard disk has a capac-

ity of 36 to 128 MBytes. And QICSTOR-PLUS has file-oriented streaming tape backup with a formatted capacity of over 50 MBytes. Alloy provides file-oriented QTIP software with a transfer rate of 2 MBytes/minute.

QICSTOR-PLUS is available right now. So call Alloy today at (617) 875-6100.

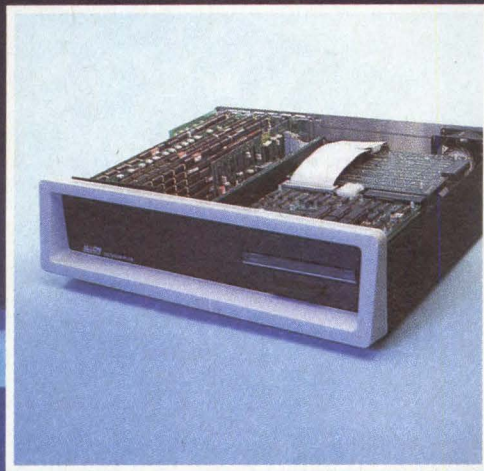

ALLOY QICSTOR-PLUS

COMDEX/Winter '85

ALLOY
Computer Products, Inc.

Alloy Computer Products Inc., 100 Pennsylvania Avenue, Framingham, Massachusetts 01701. Tel: (617) 875-6100, TWX: 710-346-0394
In Europe: Alloy Computer Products (Europe), Ltd., Cirencester, Gloucestershire, England. Tel: 0285-68709, Tlx: 43340

BIG FOR YOUR



NEWS LITTLE VAX.

Extra! Extra! DILOG announces the only combined hardware, software driver and diagnostic packages for integrating high-performance disk and tape backup to the MicroVAX®. At last, it's possible to get increased speed and capacity in peripheral devices, without spending more for the controller than the cost of the actual drive.

DISK PACKAGES.

The new MicroSMD™ (MV210) includes a DILOG disk controller and software for interfacing any SMD-type Winchester or removable disk drive with capacities to 450 megabytes.

There's also a product for small Winchesters. The Micro506™ (MV610) controller and software interfaces ST506/412-type 5¼" Winchesters.

TAPE PACKAGES.

DILOG's new MicroTK™ (MV342) coupler and software interfaces ¼" CDC Sentinel® cartridge tape drives to the MicroVAX.

For ½" tape drives, there's the MicroTAPE™ (MV132). The accompanying software allows you to interface most popular ½" streaming and start-stop drives, with densities to 6250 bpi.

If you'd like to learn more about our MicroVAX mass storage products, call (714) 937-5700. Or write DILOG, P.O. Box 6270, Anaheim, CA 92806. We'll send you a spec sheet that's hot off the press.

DILOG
EMULATION IS NOT ENOUGH.



NEW PRODUCTS

SYSTEMS

Eileen Milauskas, Assistant Editor

Graphics workstations meet CAE, process-control needs

- NS32016 processor
- Global Bus interface
- GKS support

Built around a 32-bit architecture, the 6000 Series intelligent graphics workstations by Tektronix Inc. target CAD/CAM/CAE and process-control applications. The series comprises two compatible families, the 6100 Series, consisting of an instrument controller and two graphics workstations, and the higher performance 6200 Series of workstations. Applications developed on the 6100 Series run on the 6200 Series.

All models of the 6100 Series employ National Semiconductor Corp.'s NS32016 processor with an external 16-bit bus. The 6110 instrument controller monitors process and instrument control. Running a real-time operating system (RTOS), the controller executes object-code programs written in BASIC, C, Pascal or FORTRAN generated on other 6000 family workstations and downloaded to the 6110 via an RS232 interface, IEEE-488 bus or flexible disk. The unit comes with a general-purpose interface bus (GPIB) port including pass control with optional direct-memory access (DMA), 256K bytes of memory, dual RS232 ports and a 360K-byte flexible disk. Options include 512K bytes of memory, a 10M- or 20M-byte Winchester disk, additional ports and a Multibus connector.

Addressing data-analysis needs of scientific, engineer-

Consisting of an instrument controller and two graphics workstations, the 6100 Series suits process-control, data-analysis and CAE applications.

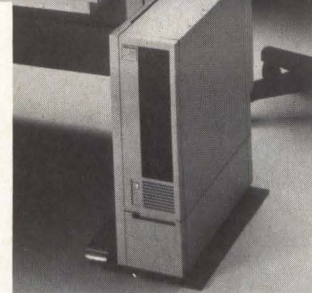

Based on a 32-bit architecture, the 6200 Series intelligent graphics workstations are object-compatible and source-code-compatible with the 6100 Series.

ing and instrument-control applications, the 6120 intelligent graphics workstation incorporates American National Standards Institute (ANSI) BASIC for graphics functions, extended I/O capabilities and interactive editing. It comes with keyboard, mouse, 1M byte of memory, floating-point processor, 360K-byte, 5¼-inch flexible disk and 10M-byte Winchester disk.

Similar to the 6120, the 6130 intelligent graphics workstation adds 10M bytes to the Winchester disk and offers an enhanced UNIX

operating system. The mouse is not included. The 6130 suits data-analysis, software-development and CAE purposes. Both models include RS232, local area network (LAN) and GPIB ports. Supporting Tektronix's 4010, 4100 and 4110 Series computer display terminals, models 6120 and 6130 supply an optional 15-inch, monochrome or 13-inch, color display with 640-dot-by-480-dot-per-inch (dpi) resolution. Capabilities include window management, fast vector performance, smooth text scrolling, multi-

ple fonts and variable cursors.

Using National Semiconductor's NS32032 processor, the 6200 Series intelligent graphics workstations are object-compatible and source-code-compatible with the 6100 Series. The Global Bus, a 40M-byte-per-second interface that connects the modules, achieves 6200 Series system expandability. In addition to supporting Tektronix's 4010, 4100 and 4110 Series computer display terminals, the 6200 Series' window-oriented display supports the Graphical Kernel

A TERMINAL IS A TERMINAL IS A TERMINAL.

YES

I simply can't be bothered making comparisons.

NO

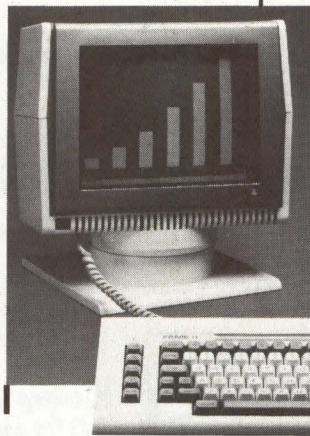

I make informed purchase decisions. Show me how Falco gives me better price-performance, more features, and better quality than TeleVideo or Wyse.

Name _____

Company _____

Address _____

City/State/Zip _____

Phone _____

I am an Integrator OEM End User

Call

800-835-8765

(in California call 800-538-5383)

Falco

Data Products

1286 Lawrence Station Road, Sunnyvale, CA 94089

CIRCLE NO. 103 ON INQUIRY CARD

NEW PRODUCTS SYSTEMS

System (GKS) and contains a 32-bit processor and a bit-slice, display-list processor. Optional to all three models is a 19-inch, 1,024-by-768-dpi monochrome or color display.

The model 6205 multiprocessor workstation, an entry point into the 6200 Series of workstations, includes a 32016 I/O processor, a 32-bit display-list processor, bit-slice vector processor, a 32081 floating-point processor and 1M byte of memory, expandable to 9M bytes. Optional on the 6205 is a 40M- or 80M-byte Winchester disk, 40M-

byte cartridge tape, nine-track tape, a 300M-byte storage module device (SMD) disk and 360K-byte disks.

The 6210 comes with a 32032 CPU, a 32016 I/O processor and a 32081 floating-point processor, storing 1M byte of RAM and 40M bytes of hard disk capacity. The 6212 holds 4M bytes of RAM and 80M bytes of disk capacity, includes all the 6210 processors but adds a dual 32032 processor. The 6210 and 6212 can accommodate 9M bytes and 16M bytes of memory respectively, an 80M-byte

Winchester disk, 40M-byte cartridge tape, nine-track tape and 300M-byte disks. Common to all three models are standard 8-bit parallel, RS232, RS422, RS232C and LAN interfaces. Small computer systems interface (SCSI), high-speed GPIB, serial and 24-bit parallel interfaces as well as a Multibus adapter and additional RS232 interfaces are optional.

Supporting SMD disk drives, nine-track tape drives and hard-copy devices, the model 6210 can act as a file and peripheral server for

LAN workstations. Its dual processors allow separate tasks to run simultaneously on separate CPUs and on different display windows. The 6212 concurrently edits engineering drawings and executes circuit simulation tasks. \$4,995, model 6110; \$7,995 to \$30,995, model 6120; \$9,500 to \$32,500, model 6130; \$14,000 to \$36,950, model 6205; \$17,950 to \$40,950, model 6210; \$35,950 to \$58,950, model 6212. **Tektronix Inc.**, P.O. Box 500, Beaverton, Ore. 97077, (503) 644-0161. **Circle No 300**

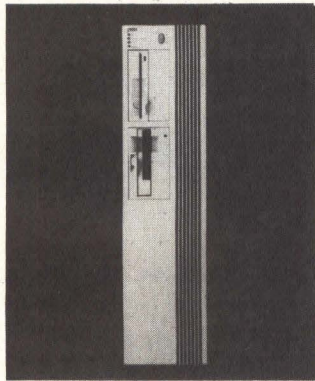

System employs UNIX System V

- 68010 microprocessor
- 128K bytes of RAM
- 2K bytes of cache memory

Increasing the performance capability of the Tower 1632, the Tower XP operates as a standalone data processing system in distributed data processing environments. The system supports 16 users and comes configured with 1M byte of memory; 46M bytes of disk storage and a 45M-byte cartridge tape drive; ST506, SMD, QIC-02 and Multibus interfaces; networking capabilities such as SNA, X.25 and local area networks; and battery backup. New features consist of UNIX System V operating software, including Berkeley UNIX Version 4.2 utilities, a serial I/O controller with a 68010 processor, 128K bytes of RAM, 4K-byte

page registers and a 2K-byte cache memory. \$19,495. **NCR Corp.**, 1700 S. Patterson Blvd., Dayton, Ohio 45479, (513) 445-2075.

Circle No 301

Personal computers suit OEMs

- 14-inch monochrome display
- Supports MS-DOS 2.11 and GW-BASIC
- IBM PC-compatible

Consisting of models WY-1100-1 and WY-1100-2, the WYSEpc family of personal computers is IBM-compatible. The model WY-1100-1 entry-level system is configured with two 360K-byte, 5¼-inch floppy disk drives, a 256K-byte RAM, two serial ports and a parallel printer port. Other features include a 14-inch, monochrome display, 101-key keyboard, three I/O ports and two expansion slots. Each system is supplied with MS-DOS 2.11 and GW-BASIC. The model WY-1100-2 is IBM PC/XT-compatible and includes a 10M-byte Winchester disk drive and one 360K-byte, 5¼-inch, double-density floppy disk drive. A color graphics option consists of an IBM PC-compatible, 14-inch color monitor and color graphics card. Model WY-1100-1, \$1,995; model WY-1100-2,

\$3,495. **Wyse Technology**, 3040 N. First St., San Jose, Calif. 95134, (408) 946-3075.

Circle No 302

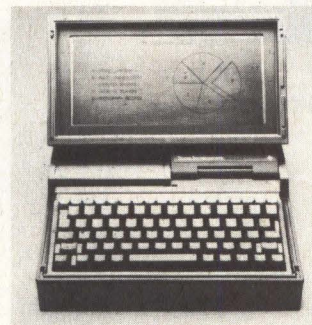

Computer weighs 10½ pounds

- 3½-inch floppy disk drive
- 16-bit 80C88 CPU
- 12-inch, 80-by-25-format LCD

Containing as much as 768K bytes of RAM, the Pro-Lite briefcase-size personal computer helps professionals generate inventory, market and order/shipment status reports and presentations. Standard features include 256K bytes of memory; a 16-bit 80C88 microprocessor; and a 12-inch LCD, which shows 80 columns by 25 lines of characters or complex graphics. The 10½-pound computer has one 3½-inch floppy disk drive that stores 720K bytes. Its 79-key keyboard includes 12 programmable function keys and

a numeric keypad. A parallel printer port is standard; an internal 300-baud modem and a 45-cps thermal transfer printer are optional. \$2,995. **Texas Instruments Inc.**, Data Systems Group, P.O. Box 809063, Dallas, Texas 75380-9063, (800) 527-3500.

Circle No 303

IBM mini uses two processors

- 18 channels
- 8- to 32M-byte memory

An enhanced IBM 4300 superminicomputer, the 4381 model group 3 has two central processors operating under a single operating system. Each processing unit has its own channels and high-speed buffer and shares a common main storage. For commercial applications, the system processes workloads at internal throughput rates 1.7 times greater than that of the compatible 4381 model group 2; in engineering and scientific environments, it is 1.9 times greater. The system utilizes 256K-bit dynamic RAMs to provide eight to 32M bytes of main memory. It furnishes as many as 18 channels. \$825,000 for 8M bytes of storage and 12 standard channels. **IBM Corp., Information Systems Group**, 900 King St., Rye Brook, N.Y. 10573, (914) 934-4488.

Circle No 304

Take a fast step forward in backup.

Introducing FasTape, the fully assembled subsystem from Archive. Now systems integrators, VARs, VADs and OEMs can add streaming tape to their Winchester disk-based systems almost as fast as you can say "backup."

Get Serious.

You can't turn a PC into an effective engineering workstation, office automation file server, small business accounting system or any sort of "serious" computer without backup.

Today's advanced personal computers have more power than yesterday's minis, and with 20MB to 100MB Winchesters, they have backup needs to match.

FasTape is the answer. It's the serious solution for serious data.

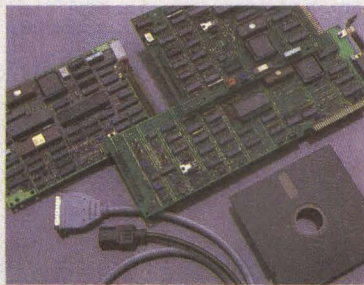

FasTape is a complete solution, including 1/4" streaming tape drive, power supply, switch selectable 115/230VAC, enclosure, cables, and utility software, with controllers available to interface FasTape to your system.



It's About Time.

Until now if you wanted to add tape backup to your system, you had two choices. You could take the time, invest the money and put up with the aggravation of selecting a drive,

bending metal, specifying a power supply, adding a fan, building a controller and developing software. Or you could pay a small fortune to have a subsystem house do it for you.

Now just call Archive. We've done all the work for you. So you save time. And money.

We've Got Your Number.

As the industry's leading manufacturer of 1/4" streaming tape drives we're able to offer 20MB, 45MB and 60MB backup systems at low OEM pricing.

As a tried and true OEM supplier we also understand what it takes to make you successful. Like controller/formatter boards—IBM PC, SCSI and QIC-02—technical support, fast delivery, volume pricing and a very reliable product.

You've Got Our Number.

Take the first step. Call Archive today at (714) 641-0279 and you can have a FasTape system up, running and fully integrated in less than a megasecond. Or write for more information. Archive Corporation, 3540 Cadillac Ave., Costa Mesa, CA 92626.

ARCHIVE

Out front with backup.

CIRCLE NO. 104 ON INQUIRY CARD

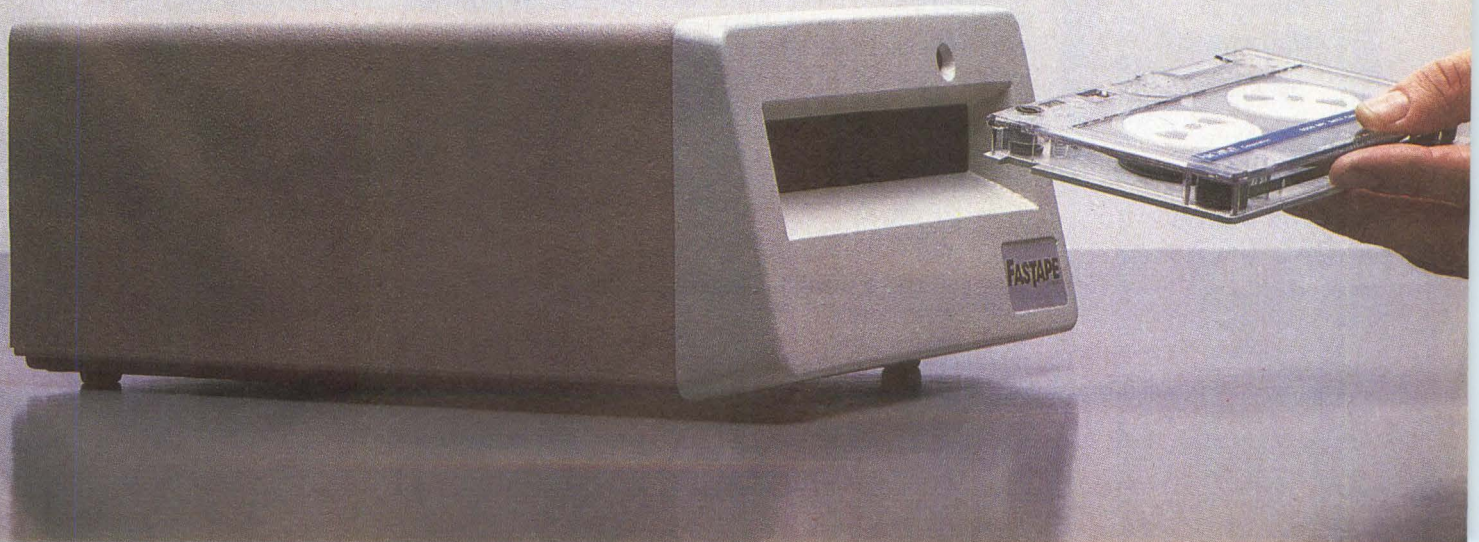

DISK/TAPE

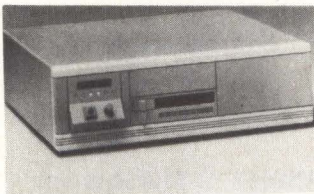

Storage systems up access time

- 80186 CPU
- IBM PC-AT interface
- Disk-caching scheme

Providing 45M and 75M bytes of formatted capacity, the PC Core 45 and PC Core 75 disk/tape mass-storage systems use a real-time, multi-tasking kernel for concurrent disk and tape operations. Tape-image backup speeds are 9 and 15 minutes, respectively; average access time is 30 msec. Features include a disk-caching scheme, 128K bytes of RAM, an 80186 CPU, an IBM PC-AT interface and bus architecture and a VRTX/86 operating system. An SCSI interface board daisy-chains seven personal computer workstations without application software modification. \$5,400, PC-Core 45; \$6,400, PC-Core 75. **Lancore Technologies Inc.**, 31324 Via Colinas, Westlake Village, Calif. 91361, (818) 991-5100.

Circle No 305

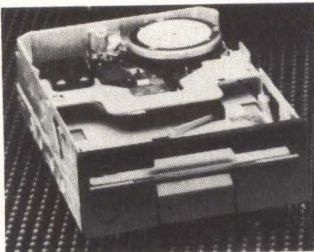

Drives store 0.5M, 1M bytes

- 3½-inch size
- 80, 160 tracks
- 3-, 5-msec access times

Interface- and format-compatible with many 5¼-inch drives, the YD-620/25 and

YD-640/45 3½-inch flexible disk drives hold 0.5M and 1M bytes on 80 and 160 tracks, respectively. The drives have a double-sided head for large-capacity recording and a 3W power consumption to suit portable applications. CMOS custom LSI allows the drive motor and electronic circuits to be mounted on a single printed circuit board. The data-transfer rate for both models is 250K bps. With a track-to-track access time of 5 msecs, the model YD-620/25 offers a 67.5-tpi track density and an 8,547-bpi recording density. The YD-640/45 provides a 3-msec track-to-track access time, a 135-tpi track density and an 8,717-bpi recording density. MTBF is 10,000 power-on hours (POH). \$200, YD-620/25; \$235, YD-640/45. **C. Itoh Electronics Inc.**, 5301 Beethoven St., P.O. Box 66903, Los Angeles, Calif. 90066 (213) 306-6700.

Circle No 306

Subsystem suits VAXes

- 10M-byte-per-second transfers
- 12M-byte-per-second interface
- 24M-byte-per-second bus

Interfacing to the VAX Unibus via the proprietary DPS-2400 intelligent I/O subsystem, the DSS-1412 disk subsystem stores 1.2G bytes. The DSS-1412 disk subsystem employs the model 1400 disk drive from Ibis Systems Inc., achieving an average access time of 10M bytes per second. The DPS-2400 connects a 12M-byte-per-second intelligent interface to the disk; a 24M-byte-per-second internal bus links to fast internal memory. The mass memory serves as a buffer area that is expandable from 1M byte to

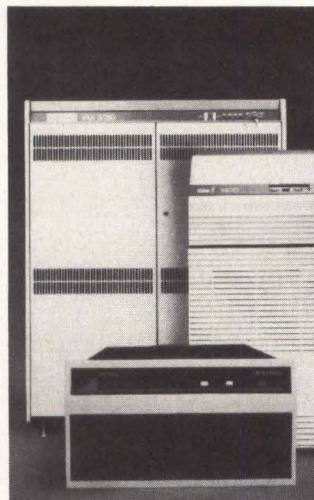

200M bytes. The subsystem suits signal and image processing, high-speed data acquisition, computer simulation and modeling, and scientific and engineering applications. \$123,000. **Aptec Computer Systems Inc.**, 10180 S.W. Nimbus Ave., Portland, Ore. 97223, (503) 620-9840.

Circle No 307



Tape subsystem works with PC/XT

- 20M-byte capacity
- 6,400-bpi recording density
- 30-ips read/write speed

Storing 20M bytes, the 5¼-inch, tape-cartridge-based File Selectable Tape Subsystem includes a file-selectable SL-6 tape drive, controller, software and cable. Recording 6,400 bpi, the ANSI X3.55-compatible tape cartridge uses an MFM recording

mode. Data-transfer rate is 24K bytes per second at 30 ips, read/write speed. Search speed is 90 ips. The unit achieves a maximum start/stop time of 25 to 26 msec at 30 ips and 71/74 msec at 90 ips. \$2,195. **Data Electronics Inc.**, 10150 Sorrento Valley Road, San Diego, Calif. 92121-1699, (619) 452-7840.

Circle No 308

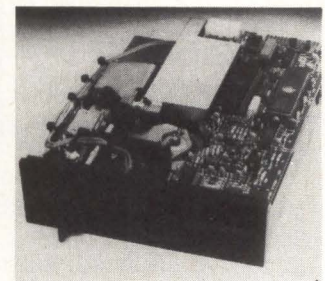

Half-height drive stores 1.6M bytes

- 500K-bps transfer rate
- 3-msec access time
- 5¼-inch size

For use with desktop computer systems, word-processing hardware, intelligent peripherals and test instrumentation systems, the TM65-8 5¼-inch, half-height, flexible disk drive holds 1.6M bytes. Transferring data at 500K bps, the unit achieves a 3-msec track-to-track access time and a 360-rpm spindle speed. Its microprocessor controls the spindle speed, positions the head for minimum hysteresis and provides a programmable ready signal. Linear recording density is 9,646 flux reversals per inch in double density. Features include a brushless DC direct-drive motor for disk rotation and a proprietary double-sided, manganese and zinc recording head. \$150, OEM quantity. **Tandon Corp.**, 20320 Prairie St., Chatsworth, Calif. 91311, (818) 993-6644.

Circle No 309

8 INCH DISK MEMORIES



Quality Performers

Century Data Systems now introduces its new C-Series, a line of higher capacity, 8-inch disk memories. These memories are available in a variety of models to offer OEMs the versatility they want, along with the quality and reliability they have come to expect.

This new family of high performance, 8-inch disk memories uses advanced technology and provides compact, reliable mass storage. For example, our new 8-inch Winchester, the C2476, is the ideal choice for computer systems utilizing disk memories in multi-user and multi-task environments which require fast access to large files of data. The C2476 stores 476 megabytes in significantly less cabinet space than previously available models and has an average positioning time of 15 milliseconds.

The C2075, our initial C-Series offering, is an 8-inch fixed/removable disk memory containing 80.2 megabytes of storage. Continuing this line of disk memories is the C2120, our new 122.9 megabyte fixed/removable disk. Both of these disk memories provide OEMs with powerful new sales tools. The fixed Winchester disk portion of the device provides high-capacity, reliable, on-line storage while the removable cartridge extends the on-line storage and provides faster, more convenient backup than tape.

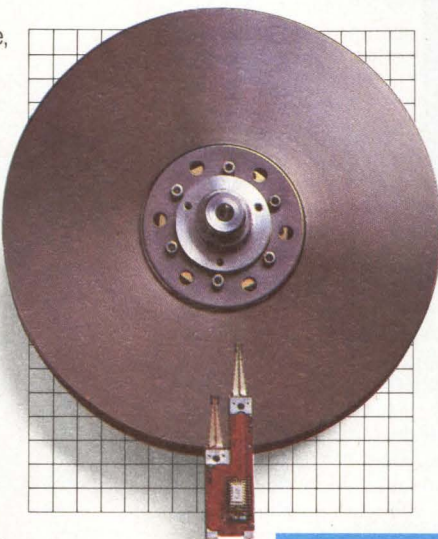

These compact, fixed/removable 8-inch disk memories are the perfect match with large personal computers, microcomputer systems or transaction-oriented systems.

All C-Series products fit in our new, standard 8.5-inch wide package. OEMs using large disk memories can now standardize on one compact package for installation in computer cabinets, equipment pedestals, or on desktops.

Like all our disk memories, the new 8-inch product line is reasonably priced, easy to install, and includes the quality and performance OEM systems require. We invite your inquiries. Write or call: Century Data Systems, Product Marketing, 1270 N. Kraemer Blvd., Anaheim, CA 92806 (714) 632-7500.

Specifications	C2075	C2120	C2476
Storage capacity, fixed disks	53.5 megabytes	87.8 megabytes	475.9 megabytes
Storage capacity, removable cartridge	26.7 megabytes	35.1 megabytes	—
Positioning time, average	32 milliseconds	32 milliseconds	15 milliseconds
Interface	SMD/LMD	SMD/LMD	ESMD
Transfer rate	1209 kilobytes/sec	1209 kilobytes/sec	1859 kilobytes/sec

New products

 **Century Data Systems**
A Xerox Company



WITH THE RIGHT TOOLS YOU CAN NAIL THE COMPETITION.

If you guessed that those tools are the capabilities of a QMS Lasergrafix printer, then you hit the nail on the head. And if you're an OEM, you can feel sorry for the competition. A QMS Lasergrafix printer system fulfills every requirement you can imagine.



Flexibility—the software intelligence to handle page composition, plus many other applications with our powerful QUIC™ language. Performance—at speeds up to 8, 12 and 24 pages a minute. Reliability—with support for the widest range of applications in the industry. And serviceability—print engines from the world's best

manufacturers and optional third party service. What's more, a QMS Lasergrafix printer will replicate and download standard quality fonts, interfacing with just about any system. All of which makes it the perfect replacement for multiple printers and plotters—and at OEM discounts, too. Imagine where that leaves the competition. Now, how can you resist a demonstration?

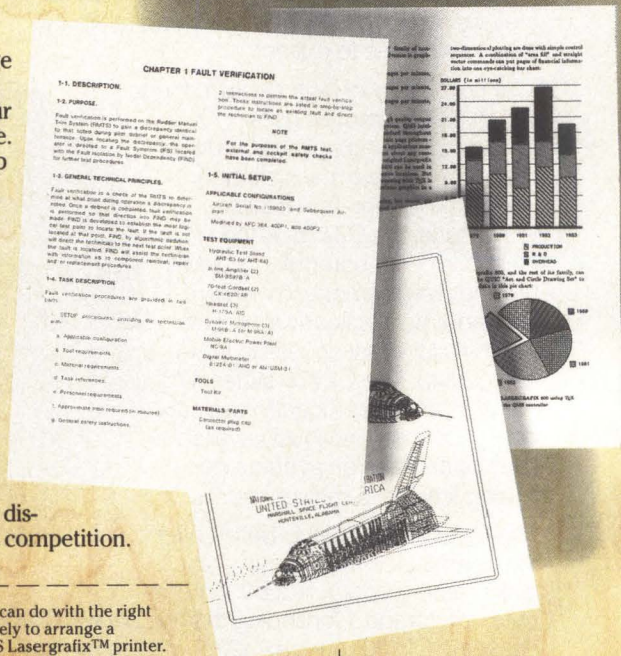

QMS
QUALITY MICRO SYSTEMS
WHERE IMAGINATION LEADS™

I'd like to see what I can do with the right tools. Call me immediately to arrange a demonstration of a QMS Lasergrafix™ printer.
 Please send me the QMS Lasergrafix™ Family of Non-Impact Printers information packet today. Be sure to include samples of graphics applications.

Name _____ Title _____
 Company _____
 Address _____
 City _____ State/Zip _____ Phone () _____
 Are you a VAR, VAD, OEM or systems integrator? _____
 If VAR or VAD, what manufacturer's equipment? _____
 Prime application for your product. _____
 Number of printers/plotters you are considering. _____

P.O. Box 81250 Mobile, AL 36689 Telephone (205) 633-4300 Telex RCA 26 60 13

MMS 35

CIRCLE NO. 106

©1985 QMS®, Inc.

PRINTERS

Ink-jet printer achieves 300 dpi

- 18 ppm
- 128K bytes of RAM
- 4- to 36-point fonts

Offering full-page, all-points-addressable printing, the Dijit 1 ink-jet printer for office automation applications combines text and graphics at a letter-quality resolution of 300 dpi at 18 ppm. Its near-typographic-

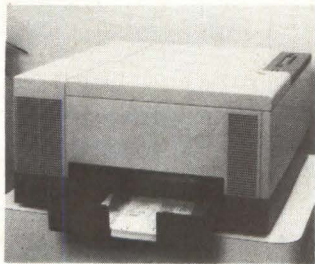

quality output employs roman and italic styles in medium and bold weights. Standard features include 128K bytes of buffered RAM, a resident 4- to 36-point font set, duplex printing, Centronics interface, Xerox 2700 emulation, 500-sheet input/output bin capacity and self-test and operator diagnostics. The printer uses plain bond, 16- to 24-pound cut-sheet paper or transparencies and accommodates letter-size, legal-size or A4 European standard stock. Formats are controlled by the host terminal. \$5,000. **Diconix Inc.**, A Kodak Company, 3800 Space Drive, P.O. Box 3230, Dayton, Ohio 45431, (513) 898-3644.

Circle No 310

Matrix printer forms 200 cps

- 100 cps, letter-quality
- 24-wire printhead
- 8K-byte RAM buffer

A serial matrix printer combining text and color graphics, the Model 750 prints letter-quality text at 100 cps, data processing at 200 cps and graphics at 10 ips.

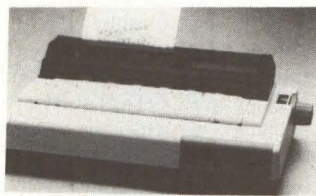

Letter-quality character resolution is 180 by 360 dpi; draft quality and graphics resolution, 180 by 180 dpi. Courier 10 LQ/DQ, Letter Gothic 12 LQ/DQ and Gothic 17.1 DQ fonts come standard; font capacity totals six resident fonts and six downloadable fonts. Compatible with the Diablo 630 protocol and Fujitsu DPL24 graphics printers, the unit provides friction feed, multiple-part forms printing (as many as four parts), a Centronics parallel interface and an 8K buffer. RAM is expandable to 72K. \$1,990. **JDL Inc.**, Suite 104, 2801 Townsgate Road, Westlake Village, Calif. 91361, (805) 495-3451. Circle No 311

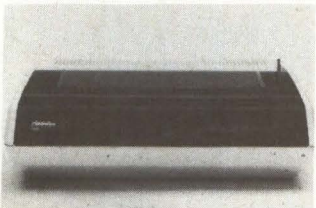
**Daisywheel printer word processes**

- 25 cps
- 58-dBa noise level
- 132 columns in 10 pitch

The Advantage D25 daisywheel printer meets word-processing, data analysis, database and spreadsheet requirements. Operating at 58 dBa, the 25-cps printer provides proportional spacing, auto-underscore, bold and shadow printing and graphics and program mode for direct spoke addressing. Its proprietary All Purpose Interface (API) enables compatibility with personal computers and word processors. Handling paper as wide as 15.2 inches, the unit prints

132 columns in 10 pitch, 158 columns in 12 pitch or 198 columns in 15 pitch; it can also print multipart forms. The 96-character set supports English, French, German and Scandinavian languages. \$800. **Diablo Systems Inc.**, A Xerox Company, 901 Page Ave., P.O. Box 5030, Fremont, Calif. 94537 (415) 498-7000. Circle No 312

Laser printer produces 12 ppm

- 90,000 dpi
- Tektronix 4014 emulation
- 20 fonts

Printing 12 ppm at a resolution of 90,000 dpi using dry toner and plain paper, the company's 12/300 tabletop laser printer merges text and graphics. Printer functions include page collation, page reversal and portrait and/or landscape printing. Features include serial, parallel and Ethernet interfaces; multiple-copies facility; 20 fonts; and proprietary imPRESS language. The unit supports the UNIX operating system and document composition systems such as AT&T Bell Laboratories' troff, the American Mathematical Society's TeX and Unilogic Inc.'s Scribe. Tektronix 4014 printers as well as daisywheel and line printers are emulated. \$19,950. **Imagen Corp.**, 2674 North First St., San Jose, Calif. 95134, (408) 946-1400. Circle No 313

Printers operate in three modes

- 10-, 17-inch carriage
- 160 cps in draft mode
- 27 cps in near-letter-quality mode

The Personal Printer I and Personal Printer II multimode dot-matrix impact printers are compatible with many micro-computer applications pro-

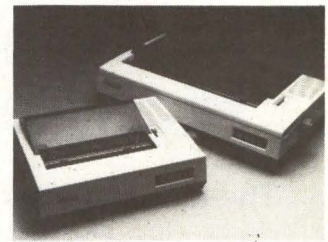

grams. Both models operate at 160 cps in draft mode and 27 cps in near-letter-quality mode and feature dot-addressable graphics. The Personal Printer I prints as many as 80 columns at 10 pitch or 136 columns at 17 pitch with a 10-inch carriage. The Personal Printer II prints as many as 156 columns at 10 pitch or 256 columns at 17 pitch with a 17-inch carriage. Both printers print on three-part forms with either friction feed or pin feed. Other features include bidirectional printing, nine international character sets, a 2K buffer and close forms tear off. A Centronics parallel interface is standard. Noise level is less than 60 dBa. \$695, Personal Printer I; \$895, Personal Printer II. **Datasouth Computer Corp.**, 4216 Stuart Andrew Blvd., Charlotte, N.C. 28210, (704) 523-8500.

Circle No 314

Laser printers suit CAD applications

- Supported by the VAX/VMS operating system
- 300-by-300-dpi resolution
- 16 or 12 text fonts

The LN01B and LN01S 300-by-300-dpi-resolution laser printers provide graphics output and capabilities for variable-font text on the same page. Suited for computer-aided design and business graphics applications, the two printers are supported by the VAX/VMS operating systems. The LN01B provides plotter-type graphics from base ReGIS (Remote Graphics Instruction Set) and Calcomp files and prints 12 pages

Solid-State Disc Emulators for Dramatically Increased Throughput and High Reliability

The MegaRam for Minicomputers

Used with the following computers:

- DEC • Data General
- Sperry Univac (V77 Series)
- Hewlett Packard (HP1000 Series)
- Modcomp
- SEL • CDC (System 17)

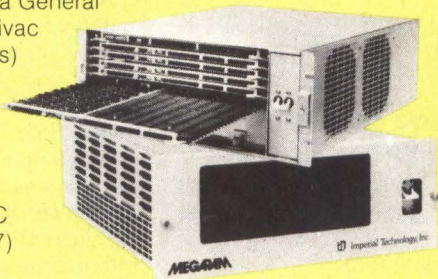

The MegaRam-PC for Personal Computers and Microprocessors



- Access time: 1.2 microseconds
- Transfer rates: .095 megabytes/second
- Capacity: 0.5 to 8.0 megabytes
- Battery back-up option

Outstanding throughput increases are achieved with the fast access and high transfer rates of these disc emulators. They provide full error detection and correction, and the non-mechanical construction withstands harsh environments and improves reliability.

Typical Applications: • Disc Replacement • UNIX/XENIX • Local Area Networks • Process Control • Telecommunications • Mobile Equipment • Shipboard Equipment • Data Base Management • Large Scratch Files • Matrix Transformation • Graphics • Array Processing • Data Acquisition • Automated Test Equipment • Overlay Storage • Swapping Files.



Imperial Technology, Inc.

831 S. Douglas Street • El Segundo, CA 90245
Telephone: (213) 536-0018 • Telex: 664469

CIRCLE NO. 107 ON INQUIRY CARD

NEW PRODUCTS

PRINTERS

of plots per minute. It contains 16 Courierlike fonts in four orientations and in four sizes. The PLOTLN software package, which runs under the VAX/VMS operating system, furnishes graphics functions. The LN01S printer supports Tektronix 4010 and 4014 graphics protocols and is capable of bit-mapping via an external controller with a 1.4M-byte page buffer. A 512K-byte memory in the controller stores as many as 96 fonts. Resident LN01S text fonts include eight Courier-like typefaces in Roman, Bold, Italic and Bold Italic weights. The LN01S is supported by PDP-11 operating systems. \$22,520, Model LN01B; \$29,995, Model LN01S. **Digital Equipment Corp.**, 146 Main St., Maynard, Mass. 01754, (617) 897-5111. **Circle No. 215**

printer generates 228 ASCII-standard characters and graphics with a 9-wire print head that is warranted for 50 million characters. It handles single sheets, 3-part paper or mailing labels; paper width is adjustable from four inches to 10 inches. The front panel includes controls for line feed, forms feed and character-pattern self-test. \$279. **Cal-Abco**, 14722 Oxnard St., Van Nuys, Calif. 91401, (818) 994-0909. **Circle No. 216**

Printer compatible with VDI standard

- 300-dpi text, graphics resolution
- Eight ppm
- Five modes of operation

Compatible with IBM personal computers including the PC-AT, the Concept Laser 8 printer achieves 300-dpi resolution at a speed of eight pages per minute (ppm). It operates in five modes to interface with graphics, alphanumeric and image applications. Compatible with VDI (Virtual Device Interface) graphics based on the ANSI GKS (Graphical Kernel Standard), it executes fill polygon or draw polyline commands to produce graphics, drawings, computer-aided design diagrams and documents integrating text and graphics. The printer emulates the de facto standards Tektronix 4014 for graphics output and Diablo 630 daisywheel printer for letter-quality output and compatibility with word-processing software. It implements the ANSI X3.64 standard and uses a bit-image mode that provides a direct path to the bit map RAM for imaging applications. \$7,995. **Concept Technologies Inc.**, 6950 P.O. Box 5277, Portland, Ore. 97208, (503) 684-3314. **Circle No. 247**

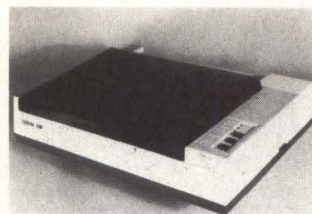

Printer offers 40 character fonts

- 80- or 142-column print density
- 228 ASCII-standard characters
- 80 cps

Printing 80-column lines at 80 cps, the Legend 880 dot-matrix printer offers 40 character fonts, selectable in real time by the host computer. All fonts are mixable on one line. Print density is 80-column standard lines or 142-column compressed lines. The logic-seeking unit operates bidirectionally and comes with an 8-bit Centronics parallel interface. Standard handshake protocol accepts input data for buffering at any rate up to 4,000 cps. The

TECHNOLOGY FORUMS

ANNOUNCES TWO UNIQUE NEW COMPUTER CONFERENCES:

IPI FORUM

PERIPHERAL FORUM

<ul style="list-style-type: none"> Devoted to furthering the understanding and utilization of IPI (Intelligent Peripheral Interface) as one of the most important Input/Output interface standards for the industry 	<p>PURPOSE</p>	<ul style="list-style-type: none"> Charged with educating peripheral purchasers and suppliers on all facets of the process by which system integrators select and integrate peripherals into their product line
<ul style="list-style-type: none"> Engineering, marketing, and planning personnel of companies who are using or considering the use of IPI in systems, subsystems, intelligent peripherals, boards, or chips 	<p>WHO SHOULD ATTEND</p>	<ul style="list-style-type: none"> Engineering, marketing, planning, purchasing, test, quality assurance, and maintenance personnel who are involved in the peripheral selection and integration process of system integrators Sales and marketing personnel of peripheral suppliers
<ul style="list-style-type: none"> Listen to the world's leading experts on IPI and IPI applications Take a guided tour through the interface "jungle" Participate interactively in workshops and panel discussions and forums Meet others to share IPI experience Keep abreast of related peripheral technologies See the latest in IPI products 	<p>BENEFITS</p>	<ul style="list-style-type: none"> Listen to the world's leading experts on disk, tape, printer, and optical technology Participate interactively in panel discussions Meet others to share peripheral selection experience Take a guided tour through the interface "jungle" Learn what's important in an OEM contract Discuss how to improve your product planning process Improve your peripheral selection process
<ul style="list-style-type: none"> The importance of standardization IPI status with ANSI, ECMA, and ISO IPI software What happened to ISI? The impact of IPI on suppliers of chips, boards, peripherals, subsystems and systems The future of IPI Comparison of IPI and SCSI How is IPI being used? 	<p>KEY ISSUES AND TOPICS</p>	<ul style="list-style-type: none"> The importance of standardization Single-source products Peripheral selection criteria Cost-of-ownership Testing tips RAS (Reliability, Availability, and Serviceability) trends Pricing trends Product life How much "technology" to buy
<p style="text-align: center;">San Jose Hyatt</p> <p>8:00 a.m. Monday, June 17th through 12:00 p.m. Wednesday, June 19th, 1985.</p>	<p>TIME AND PLACE</p>	<p style="text-align: center;">San Jose Hyatt</p> <p>8:00 a.m. Thursday, June 20th through 4:00 p.m. Friday, June 21st, 1985.</p>

EXHIBITORS' RECEPTION

Both Forums will include an evening Exhibitors' Reception (cocktails and buffet hosted by the exhibitors) wherein delegates and other invited guests may view products which directly relate to the subject matter of the forum. Representatives from the exhibitors will also be on hand to discuss technical details. For information on becoming a forum exhibitor, please call (714) 861-3339.

FORUM PROCEEDINGS

Copies or Tapes of all forum sessions, workshops, and panel discussions are available including those from SCSI forums, please call (714) 861-3339 for further information.

REGISTRATION INFORMATION

- Fees:**
The registration fee of \$895 for the 2½ day IPI Forum includes attendance at all sessions, conference materials, exhibitors reception (cocktails and buffet), 2 luncheons, refreshments during breaks, banquet, gratuities, and taxes. The registration fee of \$695 for the 2 day Peripheral Forum includes all of the same items as for the IPI Forum, except the banquet.
- Hotel Accommodation:**
A block of rooms has been reserved for forum delegates at the San Jose Hyatt. It is recommended that you register early by returning the hotel registration card mailed to you with your conference registration confirmation or by calling (408) 298-0300 and identifying yourself as a forum delegate.
- Attendance:**
Since attendance will be limited in order to preserve an appropriate atmosphere within which to learn and interact with other delegates, it is recommended that your registration form and payment be mailed early.
- For further information call (714) 861-3339**

REGISTRATION FORM

- Please Register me for the following:
 - IPI Forum, San Jose Hyatt, June 17-19, 1985. \$895
 - Peripheral Forum, San Jose Hyatt, June 20-21, 1985. \$695
- Delegate Information:
 - Name _____
 - Title _____ Phone _____
 - Company _____
 - Address _____
- I have enclosed the names and titles of additional personnel from my company and noted which Forum(s) they wish to attend.
- 25% Consecutive Forum Discount applies. I/We are attending both Forums as indicated above and in the enclosure.
- 25% Group Discount applies. There are a minimum of 4 additional delegates from my company whose names are enclosed.
- Registrations cannot be accepted unless accompanied by full payment. Please make checks payable to **Technology Forums** and mail to 23409 Coyote Springs Dr., Diamond Bar, CA 91765.

Interactive terminal system accesses multiple hosts, peripherals

- Five port interfaces
- 9-, 12- or 23-inch CRT
- Supports varied protocols

Multiport II is an interactive terminal system, consisting of a model 2750 video display terminal (VDT) and a model 2700 control unit. The system furnishes a cluster of terminals and printers with independent and simultaneous access to multiple-host computers utilizing both leased-line and packet-switching networks. Performing asynchronous and synchronous communications in character and block modes, the system is compatible with 3270 Binary Synchronous Communications (BSC), X.25/3270, X.25/Interactive Terminal Interface (ITI) and SDLC and HDLC protocols. The model 2700 control unit supports eight VDTs and two printers.

In 3270 mode, the control unit communicates to the host computer as an IBM Corp. 3274 model 51C control unit, which supports the BSC protocol. No hardware or soft-



The Multiport II interactive terminal system provides a cluster of terminals and printers with independent and simultaneous access to a variety of host computers and data communications networks.

ware changes are required at the host. Data on the model 2750 VDT appears as an IBM 3278-02 screen display. The control unit supervises 3270 BSC communications over leased lines in point-to-point and multipoint network configurations at speeds up to 9,600 baud. A Multilink feature lets four model 2700 control units access one 3270 communications port, permitting the operation of 32 devices,

eight of which can be printers.

The system's X.25/ITI communications port supports the CCITT X.25 standard and conforms to the Bell Canada DATAPAC Standard Network Access Protocol (SNAP) and the higher-level ITI conventions. The port can be configured to accommodate HDLC LAP or LAPB Frame-Level procedures.

An optional proprietary

Packet-Switching Processor (PSP) provides access to 3270 hosts over packet-switching networks handling CCITT X.25. The 3270 communications port is compatible with DATAPAC 3303, providing 3270 communications over the DATAPAC packet-switching network. The hosts can connect to the network by PSPs or with DATAPAC Access Software (DAS) in the front-end processor. By using the packet-switching network, DAS software allows SNA hosts to communicate with Multiport II.

The 12-inch, green, monochrome monitor displays 80 characters by 24 lines in a 5-by-7 dot-matrix format; the keyboard comprises 124 alphanumeric, function and control keys and generates as many as 256 ASCII character codes. An EIA RS232C printer interface is provided. \$4,600, control unit; \$1,375, display terminal. **CMQ Communications Inc.**, Suite 920, 60 Yonge St., Toronto, Ontario, M5E 1H5, Canada, (416) 365-7171. **Circle No 217**



Monitors achieve high resolution

- 9- or 12-inch screen
- Up to 4,096 colors
- 25 columns lines by 80 columns

The HX-9E 9-inch, RGB monitor is compatible with IBM PCs and compatibles

and Apple computers with RGB capability. Showing 2,000 characters or 25 lines by 80 columns of text, the unit operates on dual-scan frequencies. At 15.75 kHz, the monitor supports IBM graphics software and displays 640 dots by 200 lines; at 22 kHz, 640 dots by 350 lines. A 0.28-mm, dot-pitch, dark-face tube displays 16 colors in the Apple mode and 16 or 24 colors in the IBM mode. The SR-12P, 12-inch RGB monitor displays 690-by-480-dot, non-interlaced resolution on a 0.31-mm, dot-pitch tube. The monitor's analog input permits 4,096 colors. When configured with the IBM Profes-

sional Graphics Card, the monitor shows 256 colors simultaneously with 640-by-480-dot resolution. In the emulation mode, the unit achieves 640-by-400-dpi resolution, and generates 25 lines by 80 columns. \$650, model HX-9E; \$999, model SR-12P. **Princeton Graphic Systems**, 170 Wall St., Princeton, N.J. 08540, (609) 683-1660 or (800) 221-1490.

Circle No 218

Terminal reduces eye fatigue

- 15-inch screen
- 80 or 132 columns

• 33 control keys

Reducing eye fatigue with clearer characters, the E-32 ergonomic terminal offers a 15-inch, non-glare, tilt-and-swivel screen. Displaying 80 or 132 columns, the unit is compatible with the ANSI 3.64 standard and the DEC VT52, VT100 and VT132. Transmission speeds range from 50 to 19.2K baud in half- or full-duplex mode. The keyboard includes 33 control keys, a 14-key numeric pad and three character sets. \$1,275. **Tab Products Co.**, 1400 Mill Page Road, Palo Alto, Calif. 94304, (415) 852-2400.

Circle No 219

We couldn't improve on you. So we improved on your terminal.

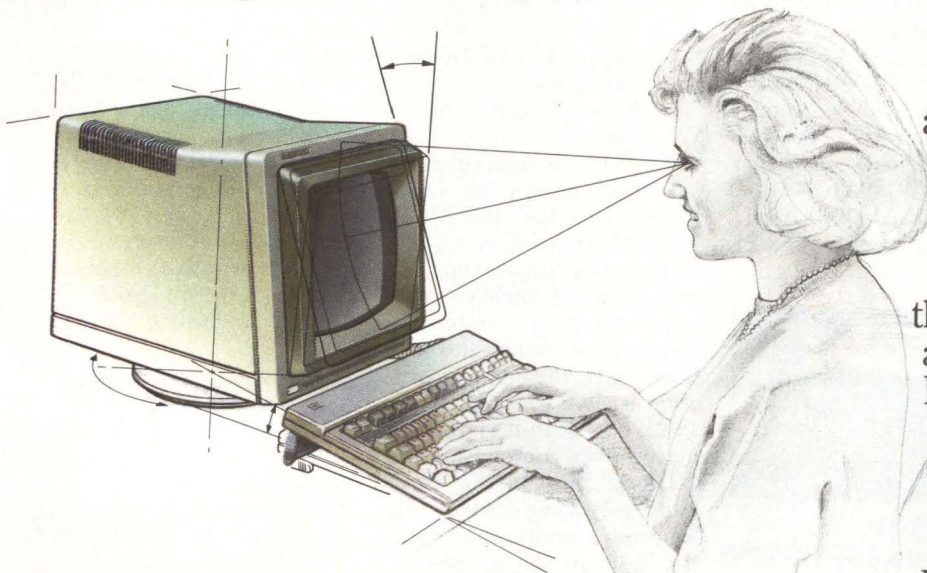

You're as good as you can be, just the way Nature made you. Unfortunately, Nature doesn't make computer terminals. So at Hewlett-Packard, we've been making improvements on terminals, to make them work more agreeably with you.

Our newest display terminal, the HP2392A, is a case in point. It has an adjustable keyboard, a screen with an integral tilt, and a monitor that can revolve.

So your people won't have to adjust, tilt, or revolve to use it.

The keyboard can be angled to lay flat on a desk, and it has contoured keys

arranged in clusters, to sit easily beneath the hands. We also made it detachable, to sit easily in the lap.

And all that is just with the unit turned off. Turn it on, and you'll see the famous HP display screen, with characters that are sharp, clear, and distinct.

What's more, the HP2392A has ANSI, so it's DEC-compatible.

All for only \$1375*:

The HP2392A. The terminal that works with people.

Find out more. Just call your local HP sales office, listed in the white pages. Or write to Terry Eastham, Hewlett-Packard, Dept. 008215, 8020 Foothills Boulevard, Roseville, CA 95678.

 **HEWLETT
PACKARD**

DATACOMM

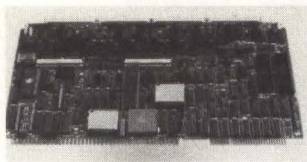

Computer has cluster-control

- Eight I/O channels
- 64K bytes of RAM
- Four controllers

Managing multiuser, multi-protocol communications tasks, the iSBC 188/48 single-board computer functions as a cluster controller, a front-end processor or as a standalone system. Firmware supports 12 asynchronous terminals. The unit contains four 82530 serial communications controllers that provide eight channels of I/O, 64K bytes of dual-port RAM and two universal memory sites accommodating 64K bytes of PROM/EPROM. Six of the eight I/O channels support RS232 interfaces; two are configurable among RS232C/422/449. The controllers support asynchronous and synchronous communications and incorporate HDLC and SDLC protocols. iRMX and XENIX operating systems are supported. \$2,995. **Intel Corp.**, 5200 N.E. Elam Young Parkway, Hillsboro, Ore. 97123, (503) 640-7147. **Circle No 320**

Modems are Bell-compatible

- EIA RS232C port
- 300 to 1,200 baud
- Auto answer

For telecommunications systems with an EIA RS232C port and a modular telephone jack, the models KX-D4130, KX-D401 and KX-D402 automatic modems are Bell 103- and 113-compatible. All three models offer an auto-answer function that receives data automatically when left unattended. The 300-baud KX-D4130 contains a 24-station

automatic dialer that stores 30 digits in each station. Other features include auto redial and speakerphone with on-hook dialing capability. In receive mode, the model KX-D402 furnishes an auto selector function at 300 or 1,200 baud. The model KX-D401 transmits data at 300 baud; features include originate, answer and auto-answer power controls as well as LED indicators for auto answer, data, carrier, answer and power. \$199.95, model KX-D4130; \$299.95, model KX-D402; \$99.95, model KX-D401. **Panasonic Industrial Co.**, One Panasonic Way, Secaucus, N.J. 07094, (201) 348-7182. **Circle No 321**

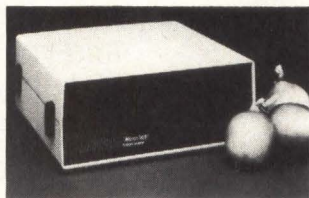

Converter emulates IBM 3270

- 16 channels
- Inbound priority levels
- Password protection

Emulating standard IBM 3270 functions, the 16-channel Micro 7400 protocol converter allows asynchronous ASCII terminals and personal computers to access IBM mainframes as 3270-class devices. Appearing to the host computer as an IBM 3274 Model 61C cluster controller, the protocol converter communicates in either bisynchronous or SNA/SDLC protocol. Attached asynchronous devices function as IBM 3278 display stations, IBM 3279 color display stations or IBM 3287 printers. Features include automatic logon, inbound priority levels, banner and broadcast messages and password protection security features. The unit can switch between two IBM host com-

puters or between an IBM host and an many as eight asynchronous computer ports. \$5,650. **Micom Systems Inc.**, 20151 Nordhoff St., Chatsworth, Calif. 91311, (818) 998-8844.

Circle No 322

System handles networking

- Supports 19.2K-bps data rates
- Menu-driven console control
- 16-bit microprocessor

Linking groups of workstations together, the PACX 2000 distributed switching system aids networking requirements of intelligent devices. Based on a 16-bit microprocessor, bandwidth and fiber optics, the unit supports asynchronous data rates to 19.2K bps. Features include a menu-driven console control, network configuration flexibility, messaging capacity, diagnostic capabilities and security structure via passwords. Prices begin at \$8,500; \$200 for each attachment. **Gandalf Data Inc.**, 1019 South Noel, Wheeling, Ill. 60090, (312) 541-6060. **Circle No 323**

Modem operates at 4,800 bps

- Bell 208AB-compatible
- Full- or half-duplex mode
- Leased or dial-up lines

Intended for full- or half-duplex, synchronous operation, the 48/208AB Model 1 Bell 208AB-compatible modem transmits data at 4,800 bps over leased or dial-up lines. The modem serves personal computers using asynchronous protocols in synchronous networks. Front panel switches permit selection between the 208A and 208B modes. Features include

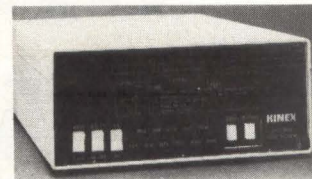

auto-answer and auto-disconnect capabilities, auto-dialer compatibility and low power consumption. Diagnostics include a line-quality display feature providing continuous information on the condition of the telephone line; display of all EIA connector leads; analog, local and digital loopbacks for problem isolation; self-test; test-pattern generator and an integral bit-error-rate (BER) tester. \$1,700. **Nokia-Kinex Corp.**, 6950 Bryan Dairy Road, Largo, Fla. 33543, (813) 541-6404.

Circle No 324

Multiplexers work with VAX, PDP-11

- Support 16 and 24 lines
- DMA operation
- Half- or full-duplex communication

The DHU11 multiplexer interfaces as many as 16 asynchronous lines between DEC PDP-11 or VAX computers with an integral UNIBUS operating under Version 4.0 of the VAX/VMS operating system. It connects to external equipment through RS232C and RS432A interfaces. The DMZ32 multiplexer, which supports as many as 24 asynchronous lines to Unibus-based VAX computers, permits a terminal distribution panel to be located 5,000 feet away. Both multiplexers operate in DMA mode, provide half- or full-duplex communications and furnish a 256-character first-in-first-out (FIFO) buffer. \$3,120, DHU11; \$3,215, DMZ32. **Digital Equipment Corp.**, 146 Main St., Maynard, Mass. 01754, (617) 897-5111. **Circle No 325**

IT'S FUN TO BUY



AMDEK Plotters at Hall-Mark.

HALL-MARK

Hall-Mark Electronics Corp. • Dallas, Texas • Subsidiary of Tyler Corp. 

Northeast

Boston 617/935-9777
 Cherry Hill 609/424-7300
 Fairfield 201/575-4415
 New York 516/737-0600
 Philadelphia 215/355-7300

Southeast

Atlanta 404/447-8000
 Baltimore 301/988-9800
 Ft. Lauderdale 305/971-9280
 Huntsville 205/837-8700
 Orlando 305/855-4020
 Raleigh 919/872-0712
 Tampa Bay 813/530-4543

North Central

Chicago 312/860-3800
 Cincinnati 513/563-5980
 Cleveland 216/349-4632
 Columbus 614/891-4555
 Milwaukee 414/761-3000
 Minneapolis 612/854-3223

South Central

Austin 512/258-8848
 Dallas 214/553-4300
 Houston 713/781-6100
 Kansas City 913/688-4747
 St. Louis 314/291-5350
 Tulsa 918/665-3200

Northwest

Bay Area 408/946-0900
 Denver 303/790-1662
 Sacramento 916/722-8600

Southwest

Orange County 714/669-4700
 Phoenix 602/437-1200
 San Diego 619/268-1201
 San Fernando Valley 818/716-7300
 West Los Angeles 213/643-9101

© 1984 Hall-Mark Electronics Corp./5750

Name-dropping just isn't enough to impress the network critics.

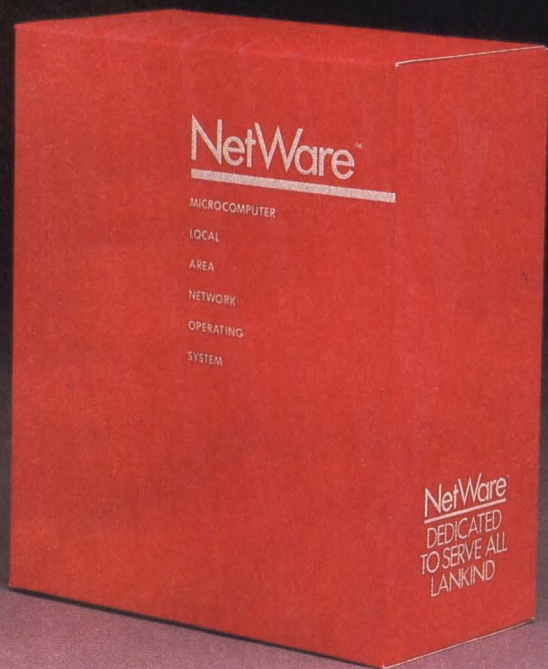

Now that the local area network (LAN) industry is booming, some pretty big names in the computer business are jumping on the bandwagon. Their goal is simple: get a LAN on the market and let all those who pay homage to The Name run out and buy it.

At Novell, we don't have a big name to drop when selling NetWare, our high-performance LAN operating system. So we let our technology do the talking. And the network critics are not only listening, they are taking notice.

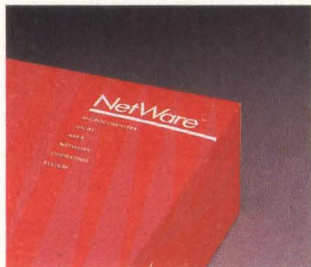

Performance.

No LAN operating software outperforms NetWare. With speed, flexibility, security and

hundreds of multiuser applications, NetWare sets a standard for the entire LAN industry.

Versatility.

NetWare is more than a LAN operating system. Currently, NetWare software is available for 24 LAN hardware systems. Plus, four complete LAN systems are sold and serviced by Novell.

Compatibility.

Because NetWare is compatible with DOS 3.1, it can run any application written for the IBM PC Network Program. And NetWare greatly increases IBM PC Network performance and applications software useability.

Internetworks.

Using bridges, NetWare can connect separate LAN systems into one large internetwork. In fact, every LAN Novell supports can be interconnected—any number, in any of the various topologies.

Remember the name.

The one LAN system making a big impression on the network critics is the one with the not-so-big name: NetWare, from Novell. Remember it when you want a high-performance LAN instead of a high-powered name.

For more information, call or write:



Novell

Novell, Inc. 1170 N. Industrial Park Drive,
Orem, Utah 84057 (801) 226-8202

NEW PRODUCTS DATACOMM



Protocol converter adds ports

- Two SNA/SDLC ports
- 15 programmed protocols
- 12 or 28 expandable ports

The 8814 and 8830 protocol converters enable users to add ports, to configure protocols when an ASCII device is changed and to communicate among ports. Model 8814 furnishes six ASCII ports, expandable to 12; model 8830, eight ports, expandable to 28. Both models provide two 19,200-bps SNA/SDLC ports emulating the IBM 3270 cluster controller and supporting 32 logic units of Types 1, 2 and 3. Protocols for 15 terminals, printers and personal computers are permanently programmed. Asynchronous "side door" ports permit terminals to communicate with minicomputers and microcomputers equipped with asynchronous communications handlers. \$4,000, model 8814; \$10,000, model 8830. **Kaufman Data Communications Inc., an Orange Nassau Electronics Co., 145 E. Dana St., Mountain View, Calif. 94041, (415) 962-8811.**

Circle No 326

Modem operates at 2,400 bps

- Auto-dial
- Auto-answer
- Bell 212A-compatible

Operating asynchronously or synchronously with dial-up phone lines, the Cermetek 2400 modem runs at 2,400 or 1,200 bps. The auto-dial, auto-answer modem is com-

patible with the CCITT V.22bis and Bell 212A standards. The modem's compatibility with the Hayes "AT" software commands allows use with Microstuf's Crosstalk, Lotus' Symphony and Ashton-Tate's Framework software. Features include an error-correcting protocol, an electronic call-progress tone detection and two front-panel buttons used to switch between voice and data on the same line. \$795. **Cermetek Microelectronics Inc., 1308 Borregas Ave., P.O. Box 3565, Sunnyvale, Calif. 94088-3565, (408) 752-5000.**

Circle No 327



Multiplexer has five channels

- SDLC error control
- Channel switching
- Password security

The LineMux switching multiplexer statistically concentrates as many as five asynchronous ASCII devices over a synchronous data link. Features include channel switching, ID and password security with automatic call-back, network control and management and synchronous data-link control, error control and retransmission. The unit supports 16-bit CRC and input speeds of 50 to 9,600 baud. Available are X-on/X-off, CTS and RTS flow control. A report generator and printer port are optional. \$1,545. **Backus Data Systems Inc., 1440 Koll Circle, Suite 110, San Jose, Calif. 95112, (408) 279-8711.**

Circle No 328

Little Board™ \$349*

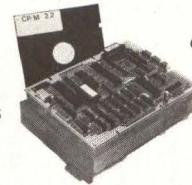

CP/M 2.2 INCLUDED

*UNDER \$200 IN OEM QUANTITIES

- 4-MHz Z80A CPU, 64K RAM, Z80A CTC, and 2732 Boot ROM
- Mini/Micro Floppy controller (1-4 Drives, Single/Double Density, 1-2 sided, 40/80 track)
- Only 5.75 x 7.75 inches, mounts directly to a 5 1/4" floppy drive
- Two RS232C Serial Ports (75-9600 baud and 75-38,400 baud), 1 Centronics Printer Port
- Power Requirements: +5VDC at 0.75A; +12VDC at 0.05A/On-board -12V Converter
- CP/M 2.2 BDOS • ZCPR3 CCP
- Enhanced AM-PRO BIOS
- AMPRO Utilities included:
 - Read/write to more than two dozen other formats (Kaypro, Teletype, IBM CP/M86...)
 - Format disks for more than a dozen other computers
 - Menu-based system customization
- BIOS and Utilities Source Code available

BOOKSHELF™ Series 100

AS LOW AS \$635 IN OEM QTY

MODEL	QTY	1 PRICE
121 1 400K DSDD Drive	\$	895.00
122 2 400K DSDD Drives	\$	995.00
142 2 800K DSQD Drives	\$	1,095.00



- Little Board CPU
- Runs thousands of CP/M programs
- Enhanced Operating System including ZCPR3 CCP and FRIENDLY™ Integrated Operating Environment
- Word Processing, Electronic Spreadsheet, Database Management, Spelling Checker all included (complete T/maker Pkg.)
- 10 MB hard disk version available
- 6 1/2" high, 7 1/4" wide, 10 1/2" deep, 12 1/2" lbs.

SCSI/PLUS™ Adapter

Compatible with most Z80 Systems (send \$10 for complete specifications)

- Mounts directly to Little Board
- Multi-Master high-speed parallel bus \$99
- SASI-SCSI compatible QTY 1
- General purpose I/O expansion bus
- Supports up to 64 bus devices
- Allows multi-Little Board Systems and resource sharing
- Little Board hard disk software/source \$79 QTY 1

DISTRIBUTORS

Argentina-Factorial, S.A.	1-41-0018
Australia-ASP Microcomputers	613-500-0628
Belgium-Centre Electronique Lempereur	041-23-45-41
Canada-Electronic Sales Assoc.	(604) 986-5447
Denmark-Danbit	03-66-90-20
England-Quant Systems	01-534-3158
Finland-Symmetric OY	358-0-585-322
France-EGAL+	1-502-1800
Israel-Alpha Terminals	03-491695
Spain-Xenios Informatica	3-593-0822
Sweden-AB AKTA	08-54-20-20
USA:	CALL AMPRO

Z80A is a registered trademark of Zilog, Inc.
CP/M is a registered trademark of Digital Research.

AMPRO

COMPUTERS, INCORPORATED
67 East Evelyn Ave. • Mountain View, CA 94041
(415) 962-0230 • TELEX 4940302

CIRCLE NO. 112 ON INQUIRY CARD

SOFTWARE

Graphics software suits Penpad tablet

- Operates on PC DOS 2.0, 2.1
- Compatible with IBM PC
- Supports Polaroid Palette

Developed for the Penpad 320 tablet, Videogram software enables the IBM PC user to draw, color, graph, label, chart or trace by touching the Pencept pen to the Penpad tablet. The pen acts as a brush, pointer or indicator to draw and write on the tablet and to invoke English commands. The software interfaces with the Polaroid Palette slidemaking system for in-house presentation graphics production. Features include a library of 24 "paint-brushes," 37 fonts, shape library, magnify and fill functions, a screen grabber utility and 16-color resolution with a 320-by-200-dot display. The software requires an IBM PC or AT with 320K bytes of memory, PC DOS 2.0 or 2.1, Penpad tablet, Plantronics Color Plus display card and a color display. \$300. **Pencept Inc.**, 39 Green St., Waltham, Mass. 02154, (617) 893-6390.

Circle No 329

Print manager is UNIX-based

- Multiple queue support
- Printer sharing
- Queueing by menu or UNIX format

Running on UNIX or UNIX-compatible operating systems, Spooler-PLUS software controls print functions for multiuser, multiprinter applications. The software directs, sequences and schedules print jobs by assigning priorities for each document. An interface with direct command options modifies and implements print assignments. The multiple-queue-

support function defines multiple queues, formats documents for selected specifications (type of paper or lines per page) and directs similar document groups to a single queue. Documents can be queued for processing using either the UNIX standard command format or a profile-driven menu screen. \$300, one to four users; \$600, four to eight users; \$995, eight to 64 users. **Rabbit Software Corp.**, Great Valley Corporate Center, One Great Valley Parkway East, Malvern, Pa. 19355, (215) 647-0440.

Circle No 330

Indexing software creates windows

- Telecommunications capability
- Indexing system
- Paragraph reform, pagination

WordStar 2000 and WordStar 2000 Plus software packages integrate word-processing functions with telecommunications and database applications. Creating screen windows for editing three documents, WordStar 2000 includes a spelling corrector, automatic paragraph reform, pagination and dictionary-based hyphenation. WordStar

2000 Plus sends or receives documents via electronic mail or accesses information services. An indexing system compiles indexes or tables of contents and numbers paragraphs. Both packages are compatible with the IBM PC, PC/XT and PC-AT. The programs require 256K bytes of RAM (320K bytes for DOS 3.0 and the PC-AT) and two floppy disk drives. WordStar 2000, \$495; WordStar 2000 Plus, \$595. **MicroPro International Corp.**, 33 San Pablo Ave., San Rafael, Calif. 94903, (415) 499-1200.

Circle No 331

Software builds schematics

- Multiple gate definitions
- 128 component pin names
- Text mode

Converting the IBM PC/XT into a PCB CAD system, the Dasoft 16S design automation software package comes with a component library, design and library editors and a graphics-oriented, design-entry routine. Building schematics on the CRT screen, the menu-driven software displays and positions symbols from the library. In-

formation stored for each component includes pin names, footprints (128 pins and four pad shapes), multiple gate definitions and symbol descriptions. A text mode with defined title blocks displays comments on the schematic page. \$2,000. **Dasoft Design Systems Inc.**, Suite 113, 2550 Ninth St., Berkeley, Calif. 94710, (415) 486-0822.

Circle No 332

Software handles incompatible OSs

- Suits VAX VMS and UNIX
- Implements Courier Presentation/Session protocol

Offering file-transfer, access and maintenance services through interactive and runtime interfaces, the ACCES Network File Management System (FMS) manipulates complete files or individual blocks across a network of incompatible operating systems. Adhering to the sixth layer of the Open Systems Interconnection (OSI) reference model, it integrates with protocol packages based on XNS that use the Courier Presentation/Session protocol. The network file header loses no information as the file is moved, even though the host maintains different file attri-

ANSWERS TO FEBRUARY'S PUZZLES

M	E	N	U	C	I	N	E	P	I	E
G	S	C	R	O	L	L	U			
M	O	D	E	T	S	P	L	I	T	
A	I	R	A	D	O	E	S	T	Y	
I	D	S	S	T	I	R	L	E	E	R
L	O	C	U	S	G	A	G	E	M	O
			V	A	N	I	L	L	A	
A	M	E	D	I	T	A	F	T	E	R
D	A	T	A	C	A	R	D	E	R	A
D	I	R	H	E	L	E	L	S	M	
S	N	A	K	E	A	A	T	A	P	
		C	R	A	S	T	E	R	R	
A	S	K	O	P	E	N	D	U	M	P

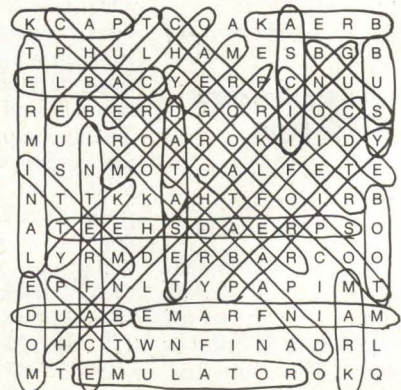

PLUG US IN.

A built-in RS-232C serial interface board lets NCR standalone 40 column printers work with any system configuration.

Just write the proper software program and plug in the standard 25-pin female "D" connector. Without needing to reconfigure your present system. Printer control codes are fed over the RS-232C lines.

And even in the roughest work environment, NCR standalone receipt printers average only a single service call a year. But you can count on years of loyal service.

Other features you can count on include:

- 40 column lines.
- Print head life of 150 million characters.
- Cash drawer activation.

- Easy to configure; adapts to any environment.
- Easy to maintain; needs no routine lubrication.
- Extremely cost-effective; exceptional reliability reduces life cycle costs.
- Ideal for system flexibility; available in a variety of slip, receipt or journal printer configurations.

All NCR standalone printers were originally developed for NCR by NCR. Built in America, they meet our established quality standards of reliability. And are now available to you, backed by NCR service and support.

For more information on NCR's family of standalone printers, just send in the enclosed coupon.

**INNOVATIVE COMPUTER
TECHNOLOGY.
YOU CAN EXPECT IT
FROM NCR.**

NCR



CIRCLE NO. 113 ON INQUIRY CARD

Yes, I'd like more information on NCR's family of standalone printers.

I prefer: a sales call a phone call

Our requirements are: up to 49 printers/year 50-500 printers/year over 500 printers/year

NAME _____ TITLE _____ COMPANY _____ ADDRESS _____

CITY _____ STATE _____ ZIP _____ PHONE _____ BEST TIME TO CALL _____

Please Mail To: Technology Marketing Division, NCR Corporation, Dayton, Ohio 45479 (513) 445-7443

CROMEMCO COMPUTERS: DESIGNED TO MAKE UNIX SYSTEM V EVEN BETTER...

UNIX System V, the new standard in multi-user microcomputer operating systems, gives you high performance features along with the portability and flexibility of a standard.

Cromemco computers can make UNIX System V even better. Because our systems are designed with UNIX in mind. First of all, we offer UNIX System V with Berkeley enhancements. Then, our hardware uses advanced features like 64K of on-board cache memory and our high speed STDC controller to speed up disk operations - very important with UNIX.

More capability and expandability

We have a high-speed, 68000-based CPU that runs at 10 MHz, coupled with a memory manager that uses demand-paging and scatter loading to work *with* UNIX, not for it.

We provide room for expanding RAM to 16 megabytes - with error detection and correction - for running even the most sophisticated and advanced microcomputer programs. And the power to accommodate up to 16 users - all with plenty of memory.

But we give you even more.

A complete solution

We give you a choice in systems: the System 100 series, expandable up to 4 megabytes of RAM, and the System 300 series, expandable to 16 megabytes. A high speed 50 megabyte hard disk drive is standard on the systems. And you can expand the hard disk capacity up to 1200 megabytes using standard SMD drives. You can add floating point processing. High resolution graphics. Video digitizing and imaging. Communications through

standard protocols. Mainframe interface.

And software support is here to meet your needs. We offer major programming languages, database management systems, communications software, including SNA architecture, X.25 protocol, and Ethernet, even a program to interface to an IBM PC if you need to. And, of course, access to the broad range of standard UNIX applications programs that is growing dramatically every day.

Easy to use.

We also make our systems easier to use, because we install the operating system before we ship your computer. No complicated installation procedures. And the Berkeley enhancements give you the standard UNIX System V operating system, but with the added convenience of these widely acclaimed improvements.

Cromemco's System 100 and System 300 computers: designed to be the highest performance UNIX systems available anywhere.

Just call or visit one of our UNIX System V Official System Centers to see for yourself. They'll also give you a copy of our new publication, "What you should know before you buy a UNIX system." Or contact us directly.

We'll be glad to show you how to get a better UNIX system.

Corporate Headquarters: Cromemco, Inc.,
280 Bernardo Avenue, P.O. Box 7400, Mountain
View, CA 94039. (415) 969-4710. In Europe:

Cromemco
GmbH, 6236
Eschborn 1,
Frankfurter Str.
33-35, P.O. 5267,
Frankfurt Main,
Germany.



UNIX is a trademark of Bell Laboratories.
IBM is a trademark of International Business Machines Corp.

Cromemco[®]

CIRCLE NO. 114 ON INQUIRY CARD

Serial board expands Multibus performance

- 10-MHz operation
- 68000 or 68010
- Eight channels

The latest addition to the ModulasTen Multibus-compatible line, the M68COM intelligent, octal serial board boosts the power and speed of a Multibus system. With eight independent, full-duplex channels and a 16- or 32-bit 68000 or 68010 microprocessor unit (MPU), the board runs at 10 MHz with no wait states for memory reads and writes. An optional 10-MHz, four-channel direct-memory-access (DMA) controller, programmable to switch among the eight channels, handles high-speed data links. The board comes with 128K bytes or 512K bytes of dual-ported, dynamic RAM with parity protection. Four EPROM sockets accommodate 256K bytes of EPROM.

Four multiprotocol serial-communications controllers program the eight channels independently to run in asynchronous, byte-synchronous or bit-synchronous mode. The eight ports can be independently configured as an RS232, RS422, RS423, fiber-optics or direct-connect modem channel.

The M68COM functions as the main master in a Multibus system, running the UNIX-like Regulus operating system. Used as a standalone data concentrator, the board connects a cluster of terminals and/or printers to a remote computer, delivering data at 880K bits per second (bps). For example, seven channels running in asynchronous mode can be multiplexed into a single, high-speed synchronous communications line. As a communications link, the

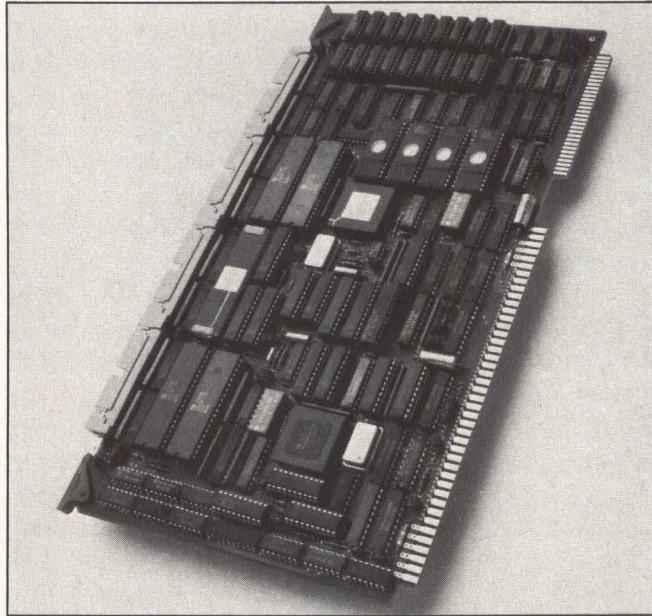

Offering a choice of 128K bytes or 512K bytes of dual-ported, dynamic RAM, the M68COM intelligent, octal serial board functions as the main master in a Multibus system or as a data concentrator.

board handles high-speed lines traveling to and from other computers or communications systems. It supports all communications protocols and handles store-and-forward and packet-switching communications protocols.

Used as a front-end to the main master in a Multibus system, the board relieves the main master of character-by-character interrupt handling required by serial devices. Acting as an I/O processor, the M68COM serves UNIX-based 68000 multiuser systems by receiving downloaded custom programs from the system.

Each channel on the M68COM has three interrupt sources that are software-programmable. A mailbox-interrupt feature, useful in multi-master applications requiring communication between the

main master and the M68COM's MPU, allows another Multibus master to generate a local interrupt on the board.

A 68230 Parallel Interface/Timer (PI/T) chip provides an on-board timer that generates periodic system interrupts to the M68COM. The board supports programmable baud rates from less than 5 baud to 38.4K baud. External baud-byte swapping or non-byte swapping can be selected for the board's accesses to shared memory through the Multibus.

PROBUG, a monitor for debugging programs written for the 68000, is included on the board. \$1,595 with 68000 MPU, dynamic RAM and a DMA controller, Q100. **SBE Inc.**, 2400 Bisso Lane, Concord, Calif. 94520, (415) 680-7722. **Circle No 337**

Board furnishes 256K-byte RAM

- 8088 CPU
- Two serial ports
- IBM PC-compatible

The PC-SLAVE/16 8-MHz, 16-bit single-board processor is hardware- and software-compatible with the IBM PC. The board becomes a second personal computer by plugging it into the PC bus and adding a dumb terminal. It includes an Intel 8088 CPU, 256K bytes of bank-selectable dynamic RAM, a PC bus in-

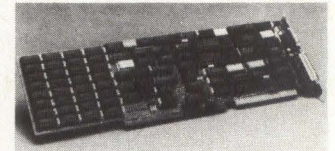

terface and two serial ports. For more than two users, only the PC-SLAVE/16 and a terminal is needed; the original PC becomes the master PC processor. The proprietary RTNX Executive Software allows the master PC and slave PCs (12 maximum) to share disks, peripherals and data. \$1,095. **Advanced Digital Corp.**, Huntington Beach, Calif. 92649, (714) 891-4004. **Circle No 338**

Memory board stores 256K bytes

- VME bus-compatible
- 200-nsec access time
- 8K-by-8 CMOS RAMs

Compatible with VME bus systems, the MM-6600C memory board provides as much as 256K bytes of non-volatile memory with a cycle and access time of 200 nsec, 8K-by-8 CMOS RAMs and two redundant, fused batteries. With no CMOS RAM, the board furnishes 512K bytes of 2128 EPROMs; it can mix CMOS RAM and EPROM in equal proportions. Features include 24-bit random access addressing of 16M bytes and address modifiers in EPROM that support

New from Data Technology

Our New Controllers Support Kodak Drives on:

- IBM AT
- IBM™ PC
- SCSI Bus
- Multibus
- Winchester/Kodak Combos
- Apple™ II

Kodak Drives Can Now Read IBM PC and IBM AT Diskettes

Off the Shelf Availability!

Data Technology Corporation

2775 Northwestern Parkway, Santa Clara, CA 95051 (408) 496-0434 Telex: 4940763 DTCSC
Eastern Regional Sales, 15 Wiggins Avenue, Bedford, MA 01730 (617) 275-4044
European Sales, Arabellastrasse 30/7, D8000 Munich 81, West Germany (089) 918047/48 Telex: 897213



CIRCLE NO. 115 ON INQUIRY CARD



KODAK

3.5



COMDEX WINTER HAS SOFTWARE FOR THE IT HARDWARE ...HARDWARE ALL FOR THE SOFTWARE.

COMDEX brings you
the whole computer industry under one roof
—hardware, software and everything else you need
to improve the profitability
of your business.

COMDEX™/WINTER '85

March 21 - 24, 1985
Anaheim Convention Center
Anaheim, California



Presented by THE INTERFACE GROUP, Inc., world's leading producer of computer conferences and expositions including The Nationwide COMPUTER SHOWCASE EXPOS, COMDEX/Winter, COMDEX/Spring, COMDEX/Fall, COMDEX/Europe, COMDEX in JAPAN, INTERFACE, FEDERAL DP EXPO & CONFERENCE and THE BYTE COMPUTER SHOWS.
300 First Avenue, Needham, MA 02194 • (617) 449-6600

user and supervisory modes. Available in 256K-, 128K-, 64K- and 32K-byte CMOS RAM versions. \$1,750. **Micro Memory Inc.**, 9436 Irondale Ave., Chatsworth, Calif. 91311, (818) 998-0070.

Circle No 339

Host adapter suits Multibus

- SCSI integration
- 8-bit data-path link
- 8- to 24-bit addressing

Installed on a printed-circuit board with a standard Multibus system interface, the MB01 host adapter integrates SCSI-based disk and tape storage devices with IEEE 796 Multibus systems. The unit provides an 8-bit data-path link between the microcomputer Multibus and the SCSI interface, which supports seven SCSI devices and the host adapter. Configured for serial or parallel bus arbitration through DIP switch selection, it responds to vectored and non-vectored interrupts. It supports 8-, 16- or 24-bit I/O addressing as well as 8- and 16-bit microprocessors. \$695. **Emulex Corp.**, 3545 Harbor Blvd., P.O. Box 6725, Costa Mesa, Calif. 92626, (714) 662-5600.

Circle No 340

SBC offers zero-wait-state RAM

- 128K byte of PROM
- 24 parallel I/O lines
- Two iSBX connectors

The ZX-186/30 single-board computer employs the 8207 dynamic RAM controller and 41K-bit or 41256 256K-bit DRAMS. With the 4164, the iSBC-compatible board provides 128K bytes of dual-ported RAM with parity; with the 41256 it provides 512K bytes or 1M byte of RAM. In the 128K-byte con-

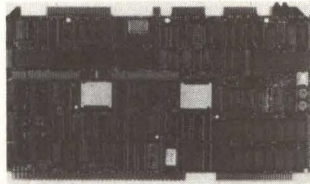

figurations, the board furnishes 128K bytes of dual-ported RAM or 64K bytes of local RAM and 64K bytes of dual-ported RAM. The second configuration gives the iAPX-186 processor local memory that cannot be accessed by other bus masters. The board provides four 24 or 28-pin PROM sockets for as much as 128K bytes of PROM. In minimum configuration, the computer supports one RS232C-compatible USART and 24 programmable parallel I/O lines. The second serial port is RS232C- or RS422A/449-compatible, which when combined with the two DMA channels on the 80186, gives the second port an 800K-byte baud rate in bit-sync mode. \$1,550 for 128K bytes of RAM; \$2,500 for 512K bytes of RAM, quantity 100. **Zen-dex Corp.**, 6644 Sierra Lane, Dublin, Calif. 94568, 828-3000.

Circle No 341

I/O board works with STDBus

- 12 programmable modes
- 4 differential analog inputs
- 8 analog outputs

Compatible with the STDBus, the RSD-7518 intelligent analog I/O board provides four differential analog inputs, eight single-end analog inputs and eight analog outputs. The board operates with a Z80 or 8085 CPU to 4 MHz, a 6800 or 6809 CPU to 2 MHz or an 8088 CPU to 8 MHz. It furnishes memory mapping to decode 16 addresses, or I/O mapping to decode 8 or 16 addresses, uses four consecutive bytes for addressing and

offers 12-bit resolution. The host commands the on-board microprocessor to operate in 12 modes: six input and six output. The differential inputs have resistor-programmable gain from X1 to X1000; the single-end inputs, from X1 to X10. \$595. **Robotrol Corp.**, 16100 Caputo Drive, Morgan Hill, Calif. 95037, (408) 778-0400.

Circle No 342

Computer board runs on G-64 bus

- Single-height Eurocard
- 4-MHz Z80 CPU
- 2K bytes of RAM

Based on the 8-bit, 4-MHz Z80 CPU, the GESMPU-5A microcomputer board conforms to the single-height Eurocard and is compatible with the G-64 bus. Features include a socket for 2K or 4K bytes of EPROM, 2K bytes of RAM with power-fail logic and an RS232C port with a programmable baud rate generator for 50 to 19.2K baud. A page register extends the addressing range to 128K bytes on the G-64 bus. The unit employs a DIN 41612 connector and runs on the CP/M operating system. \$375. **Gespac Inc.** 550 E. Grandview, Mesa, Ariz. 85203, (602) 962-5559.

Circle No 343

Computer board targets IBM OEMs

- IBM PC-compatible
- Two EPROM sockets
- Video, disk controllers

The SBM-88 PC Engine, an IBM PC-compatible, single-board microcomputer, supports the UNIX/XENIX, CP/M, MS-DOS and RMX operating systems. The board comes with monochrome video and floppy disk control-

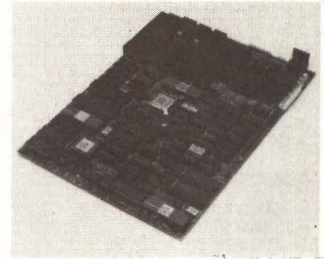

lers, parallel and serial I/O lines and connectors, five PC-compatible daughterboards and an expansion bus. Two 28-pin EPROM sockets support the proprietary BIOS ROM (one socket) or user-developed code. The board is also socketed for the 8087 mathematics coprocessor and 256K bytes of RAM. \$500. **Mostron Inc.**, 560 Valley Way, Milpitas, Calif. 95035, (408) 946-1727.

Circle No 345

Board converts terminal into PC

- Two RS232C ports
- 32K-byte RAM
- Z80 microprocessor

Requiring no changes to the terminal, the host computer or the personal computer, the Trilink integration board converts asynchronous terminals into a personal computer without disrupting the existing data-processing network. The board plugs directly into an IBM PC, PC/XT or PC/XT-compatible expansion slot and contains a Z80 microprocessor. Operating from two RS232C interface ports for host and terminal connections, it uses non-volatile memory to store 32K bytes of RAM; 8K bytes of ROM handle the firmware. An adapter cable connects the host communications line, the asynchronous terminal and the PC keyboard. \$494. **Tripos Technologies Inc.**, #203, 37053 Cherry St., Newark, Calif. 94560, (415) 794-1936.

Circle No 346

REGIONAL SALES OFFICES

BOSTON

Robert K. Singer
National Sales Manager
Norma E. Lindahl
Assistant To The National
Sales Manager

John J. Fahey
Regional Manager
Katie Kress
Sales Coordinator
221 Columbus Ave.
Boston, MA 02116
(617) 536-7780

PHILADELPHIA

Stephen B. Donohue
Regional Manager
1873 Route 70, Suite 302
Cherry Hill, NJ 08003
(609) 751-0170

ATLANTA

Larry Pullman
Regional Manager
6540 Powers Ferry Rd.,
Suite 170
Atlanta, GA 30339
(404) 955-6500

CHICAGO

Robert D. Wentz
Regional Manager
Marianne Majerus
Sales Coordinator
Cahners Plaza
1350 E. Touhy Ave.
P.O. Box 5080
Des Plaines, IL 60018
(312) 635-8800

DALLAS

Don Ward, Regional Manager
13740 Midway Suite 515
Dallas, TX 75234
(214) 980-0318

DENVER

John Huff
Regional Manager
270 St. Paul St.
Denver, CO 80206
(303) 388-4511

LOS ANGELES

Len Ganz
Regional Manager
12233 West Olympic Blvd.
Suite 236
Los Angeles, CA 90064
(213) 826-5818

ORANGE COUNTY

Debra Huisken
Regional Manager
2041 Business Center Dr.
Suite 109
Irvine, CA 92715
(714) 851-9422

SAN FRANCISCO

Frank Barbagallo
Northwestern Region Sales Manager
Rick Jamison
Regional Manager
Janet Ryan
Regional Manager
Kathleen Maxwell
Sales Coordinator
Sherman Building, Suite 200
3031 Tisch Way
San Jose, CA 95128
(408) 243-8838

AUSTRIA

Elan Marketing Group
Neutor g. 2
P.O. Box 84
1010 Vienna, Austria
Tel: 43-222-663012 or -638461

BENELUX

Elan Marketing Group
Boschdijk 199B
5612 HB Eindhoven
The Netherlands
Tel: 32-40-455724

ISRAEL

Elan Marketing Group
13 Haifa St., P.O. Box 33439
Tel Aviv, Israel
Tel: 972-3-252967 or -268020
Telex: 341667

JAPAN

Tomoyuki Inatsuki
General Manager
Trade Media Japan Inc.
R. 212 Azabu Heights
1-5-10 Roppongi Minato-ku,
106, Japan
Tel: (03) 587-0581

TAIWAN

Mr. Donald H. Shapiro
Trade Winds, 2nd Floor
132 Hsin Yi Road, Sec. 2
Taipei, Taiwan

UNITED KINGDOM

Elan Marketing Group
5th Floor, Suite 10
Chesham House
136 Regent St.
London W1R 5FA
Tel: 437-6900
Telex: 267653

SWEDEN

Elan Marketing Group
Humlegårdsgatan Nr. 5
11446 Stockholm, Sweden
Tel: 46-8-677243 or -676243

WEST GERMANY

Elan Marketing Group
Sudring 53
7240 Norb/Neckar, West Germany
Tel: 49-7451-7828

Mini-Micro Marketplace

Norma Lindahl
221 Columbus Ave.
Boston, MA 02116
(617) 536-7780

Direct-Response Postcards

Carol Flanagan
221 Columbus Ave.
Boston, MA 02116
(617) 536-7780

Career Opportunities

Peggy Gordon
Recruitment Advertising Manager
P.O. Box 10277
8 Stamford Forum
Stamford, CT 06904
(203) 328-2550

Cahners Magazine Division

J.A. Sheehan, President
William Platt
Executive Vice President
T.M. McDermott, Vice President
Electronics/Computer Group
Tom Dellamaria, VP/Production
Ira Siegel, VP/Research

Promotion Staff

Susan Rapaport
Marketing Communications Director
Mary Gregory
Promotion Manager
Liz Phillips
Promotion Assistant

Circulation

Denver, CO:
(303) 388-4511
Sherri Gronli
Group Manager

CALENDAR

APRIL

- 1-3 "Testing Computer Software" Seminar**, Holiday Inn Golden Gateway, San Francisco, sponsored by the Data Processing Management Association Education Foundation. Contact: Conference Manager, U.S. Professional Development Institute, 1620 Elton Road, Silver Spring, Md. 20903, (301) 445-4400.
- 2-4 1985 IEEE Microprocessor Forum: "Pathways to Design Productivity,"** Bally Park Place Casino Hotel, Atlantic City, N.J., sponsored by the Philadelphia Electric Co. Contact: Gerald W. Gordon, Philadelphia Electric Co., 2301 Market St., N3-1, Philadelphia, Pa. 19101, (215) 841-4676.
- 2-4 UNIX Systems Exposition '85**, Palais des Congrès, Paris, organized by Network Events Ltd. Contact: Network Events Ltd., Printers Mews, Market Hill, Buckingham, MK18 1JX, England, (0280) 815226.
- 9 SCSI Forum**, Fairmont Hotel, Denver, sponsored by Technology Forums. Contact: Joe Molina, Technology Forums, 23409 Coyote Springs Drive, Diamond Bar, Calif. 91765, (714) 861-3339.
- 9-10 Fiber Optic Market and Technology Trends for the '80s Conference**, Logan Airport Hilton, Boston, sponsored by Information Gatekeepers Inc. Contact: Information Gatekeepers Inc., 214 Harvard Ave., Boston, Mass. 02134, (617) 232-3111.
- 10-12 "New Generation PBX - The Path to Voice/Data Integration" Seminar**, Sheraton-Anaheim Hotel, Anaheim, Calif., sponsored by Data-Tech Institute. Contact: Douglas Grube, Data-Tech Institute, Lakeview Plaza, P.O. Box 2429, Clifton, N.J. 07015, (201) 478-5400. Also to be held on April 17-19 at the Milford Plaza, New York and April 24-26 at the Holiday Inn Somerset, Somerset, N.J.
- 10-13 International Personal Computer Business Software Market (MIL '85)**, Cannes, France, sponsored by the Midem Organisation. Contact: Gordan Curran, Commissariat Général, 179, Avenue Victor Hugo 75116, Paris, France, (33) (1) 306.63.99.
- 12-14 First Annual Philadelphia Computer Show and Business Equipment Expo**, Valley Forge Convention Center, King of Prussia, Pa., sponsored by Compu-shows Inc. Contact: Compu-shows Inc., P.O. Box 3315, Annapolis, Md. 21403, (301) 263-8044.
- 14-18 Computer Graphics '85**, Dallas Convention Center, Dallas, sponsored by National Computer Graphics Association. Contact: Christine Radiske or Anntherese Carlozzo, National Computer Graphics Association, Suite 601, 8401 Arlington Blvd., Fairfax, Va. 22031, (703) 698-9600.

CALENDAR

- 14-18 Conference on Human Factors in Computing Systems (CHI 85)**, Hyatt Regency at Embarcadero Center, San Francisco, sponsored by the Association for Computing Machinery's Special Interest Group on Computer and Human Interaction (ACM/SIGCHI) in cooperation with the Human Factors Society, ACM/SIGGRAPH, the Cognitive Science Society and the IEEE Computer Society. Contact: ACM Conference Management, 11 W. 42nd St., New York, N.Y. 10036, (212) 869-7440.
- 15-16 "Data Communications and Networking for the IBM PC and Other Personal Computers" Seminar**, New York, sponsored by Digital Consulting Associates Inc. Contact: Dorothy Daly Marshall, Operations Coordinator, Digital Consulting Association Inc., 6 Windsor St., Andover, Mass. 01810, (617) 470-3870. Also to be held on April 22-23, Chicago.
- 17-24 1985 Hannover Fair**, Hannover, West Germany, sponsored by Deutsche Messe Und Ausstellungs-AG. Contact: The Hannover Fair Information Center, P.O. Box 338, White House, N.J. 08888, (201) 534-9044.
- 18-19 Network Management/Technical Control Show**, Marriott Copley Place, Boston, sponsored by CW/Conference Management Group. Contact: Judie McDaid, National Sales Director, P.O. Box 880, 375 Cochituate Road, Framingham, Mass. 01701, (617) 879-0700 or (800) 225-4698.
- 20-22 Speech Tech 85 Voice Input/Output Applications Show**, Vista International Hotel, New York, sponsored by Media Dimensions Inc. Contact: Stanley Goldstein, Media Dimensions Inc., P.O. Box 1121, Gracie Station, New York, 10028, (212) 772-7068.
- 22-25 National Conference on Decision Support Systems**, Washington, sponsored by the U.S. Professional Development Institute (USPDI). Contact: Conference Manager, USPDI, 1620 Elton Road, Silver Spring, Md. 20903, (301) 445-4400.
- 27-(1) COMMON Spring '85 Conference**, Louisville, Ky., sponsored by COMMON, an IBM computer users group. Contact: David G. Lister, COMMON Spring '85 Conference, Suite 1717, 435 N. Michigan Ave., Chicago, Ill. 60611, (312) 644-0828.
- 30-(2) Artificial Intelligence and Advanced Computer Technology Conference and Exhibition (AI'85)**, Long Beach Convention Center, Long Beach, Calif., organized by Tower Conference Management Co. Contact: Tower Conference Management Co., 331 W. Wesley St., Wheaton, Ill. 60187, (312) 668-8100.

VME-SMD DISK-TAPE-CONTROLLER

Controls two disk drives and additional tape
Transferrate up to 16 MHz

User programmable drive characteristics
SMD/CMD/MMD/LMD-Interface

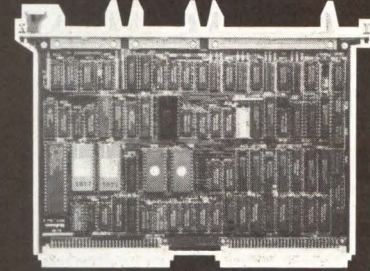

QIC-02-Tape-Interface
Unix*-software-driver

No Interleaving!
1 Double Eurocard

*Unix is a trademark of AT&T

DON'T WAIT! IT'S AVAILABLE

Stollmann

Stollmann GmbH
Computer- und Kommunikations-Technik
Max-Brauer-Alle 81
2000 Hamburg 50
W.-Germany
Telefon 0114940-389003-22
Telex 403226 = stollco
By Telex (17).403226 +

CIRCLE NO. 117 ON INQUIRY CARD

Distributor Wanted! Qualifikation:
Existing clientele, component
business (if possible VME),
abilities for
qualified support
in Hard- and
Software

**Wondering
Where
To Turn
Next?**

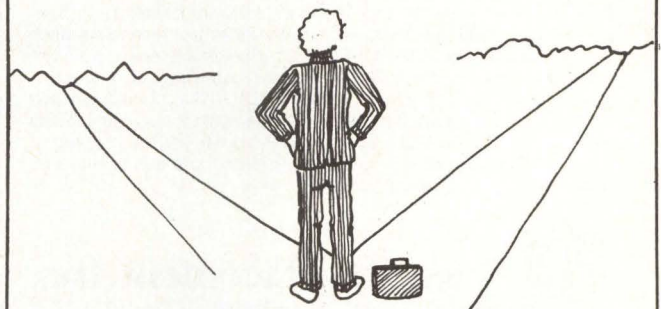

**Turn To
Mini-Micro Systems**

**Career
Opportunities
Section**

CIRCLE NO. 118 ON INQUIRY CARD

CAREER OPPORTUNITIES/ RECRUITMENT ADVERTISING

Rates

	Page	3/4	1/2	1/3	1/4	Col. Inch
1 x	\$4,475	\$3,425	\$2,340	\$1,750	\$1,170	\$120
3 x	4,235	3,300	2,245	1,690	1,105	110
6 x	4,105	3,200	2,175	1,625	1,075	105
9 x	3,985	3,100	2,110	1,575	1,040	100
12 x	3,850	3,005	2,050	1,560	1,015	95
15 x	3,735	2,915	1,985	1,510	980	85
18 x	3,590	2,800	1,910	1,495	950	80
24 x	3,525	2,750	1,875	1,430	925	75

Circulation

Over 122,000 technically sophisticated professionals in computer operations/systems management, data communications, engineering management, systems engineering/integrators, educators and systems programming specialists.

Recruitment
Hot Line
(203) 328-2550

Call your ad in—
we'll set the type
at no charge.

Mail Film to:

Peggy Gordon
Recruitment Manager

CAHNERS PUBLISHING CO.
8 Stamford Forum
P.O. Box 10277
Stamford, CT 06904

System Developers 800-231-5920

Inviting resumes from individuals in the more highly technical computer related vocations such as: PHD Computer Scientists, Operating System Developers, Data Base Developers, Porting Specialists, Networks and Telecommunications, Architecture, Artificial Intelligence, Graphics Systems Developers, Microcoders and Firmware Developers, Compiler Development, etc. Special interest in emerging technology such as novel architecture, UNIX, ADA, etc. Similar interest in scientific applications developers including military, process control, data acquisition, telemetry and communications, CAD/CAM, simulation and modeling, etc.—we are a professional employment firm managed by graduate engineers. Fees are paid by the employer. All geographic locations. Send resume or call D. A. Redwine and ask for our free resume workbook & career planner.



Scientific Placement, Inc.

P.O. Box 19949 CW, Dept. MMS 2 Houston, TX 77224 713/496-6100
UNIX is a trademark of Bell Labs

CIRCLE NO. 240 ON INQUIRY CARD

COMPUTER

Communications NEW DESIGN ★ HIGH VISIBILITY

We have immediate opportunities available with both our Washington, DC and nationally based clients. They are in urgent need of SOFTWARE ENGINEERS/SOFTWARE SYSTEMS ENGINEERS. This is your opportunity to join highly visible teams of professionals involved in design and development of State-of-the-Art in Voice & Data Communications and Software Display. Immediate positions exist for Project Mgrs. and Software and Systems Engineers. We are looking for people with 3+ years experience in Analysis, Simulation & Modeling; The Writing of Software Specifications; Software QA & Software V&V. Particular areas of interest include:

- VOICE & DATA COMMUNICATIONS
- REAL-TIME SOFTWARE DEV.
- OPERATING SYS. & DRIVERS
- SOFTWARE CONFIG. MGMT.
- COMPUTER DESIGN
- TELECOMMUNICATIONS
- TEST SOFTWARE
- SYSTEMS PROGRAMMING

If your experience includes: FORTRAN, ASSEMBLY, STRUCTURED FORTRAN, JOVIAL or UNIX/C and you are interested in investigating these exciting opportunities please send your resume today or call

800-336-3755

in VA call (703) 790-1284

STAFFING CONSULTANTS
8027 Leesburg Pike, Vienna, VA 22180

ALL FEES PAID BY CLIENT COMPANIES

More and more advertisers of minicomputers, microcomputers, CRT terminals, printers, disk drives, memories, modems, distributed data processing systems, etc., are consistently turning to **MINI-MICRO SYSTEMS**. Call **Peggy Gordon** at **203-328-2550**.

TEST SYSTEMS DESIGN & DEVELOPMENT

Test third generation gyro accuracy in TGII Test Stations as you advance within Northrop Electronics Division.

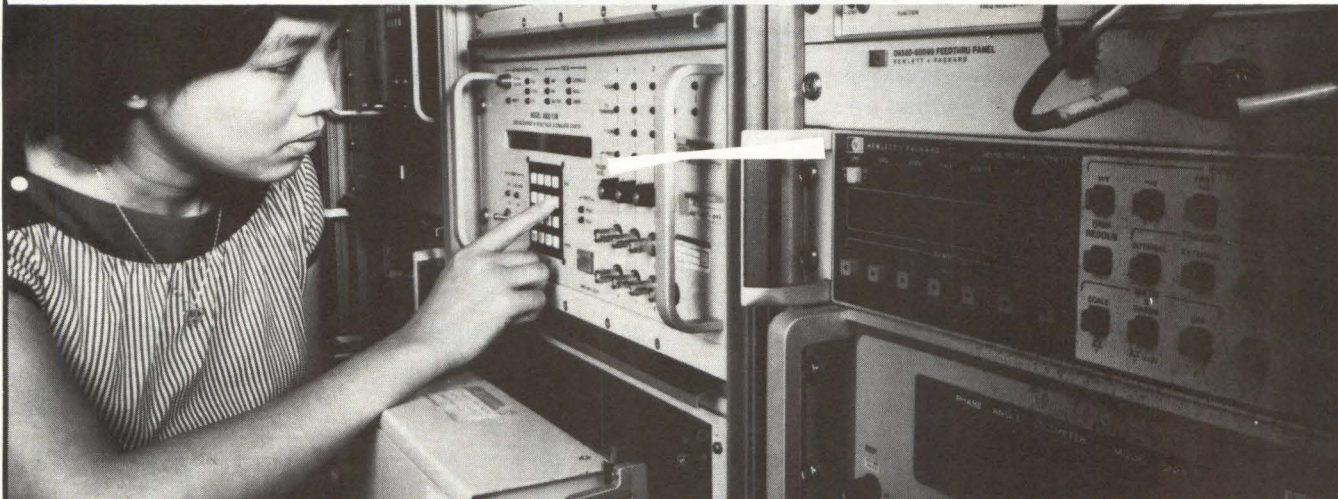

One-of-a-kind technologies are within your reach.

ATE Development Engineer

Design, analyze and develop automatic test equipment (ATE) for testing of electronic subsystems for avionics, inertial navigation and radar systems. Requires ATE background and 3 years' experience in aerospace systems. BSEE or equivalent required.

ATE Software Development Engineer

Develop software for control of ATE. Analyze requirements and develop design descriptions, functional flow charts and module subroutine allocations, code and integrate. Requires experience with HP200 series computer and working knowledge of PASCAL and FORTRAN; experience with HP Data Acquisition Control Unit 3497 desired. BSEE required.

ATE Specifications Engineer

Develop specifications for ATE hardware and software in accordance with MIL-STD's 490 & 483. Requires knowledge of ATLAS and experience with ATE or test program sets. MIL-STD 490/483 background preferred. BSEE required.

Firmware Development Engineer

Develop firmware for microprocessor-controlled test equipment. Requires 3+ years experience in firmware or real-time program applications. BSEE or BSCS required.

MATE Software Engineer

Design and develop Automatic Test Systems using the MATE philosophy. Requires background in Assembly and High Order Languages (JOVIAL J73). Experience with UNIX operating systems, VAX 11/780 and MIL-STD-1750A computers desirable.

Microprocessor Programming Engineer

Design and program microprocessor-controlled test equipment. Develop and debug software for 8086 microprocessor. Design and test digital hardware. Write design specifications, test procedures and manuals. Requires experience in electronic design and microprocessor programming; familiarity with MIL environment test equipment requirements preferred. BSEE required.

Metrology Engineer

Assume lead role in development and integration of a mobile automatic calibration system for depot ATE. Defines calibration requirements, selects standards and develops procedures. Assist in the development & implementation of ATE calibration software. BSEE and at least 7 years' experience required.

Test Equipment Systems Engineer

Responsible for systems analyses, concept definitions, trade studies, system architectural designs, interface control documents, test equipment specifications, and system integration plans and procedures for systems test equipment. Will perform hardware/software tradeoffs and configure new test systems. Test equipment background and BSEE or BSCS required.

Analog Design Engineer

To work on manual power supply test equipment. Positions exist at all levels of experience for degreed engineers with avionics or analog circuitry design background. BSEE preferred.

Test Program Set Development Engineer

Develop automated test program sets for avionics electronic subsystems, analyze test requirements, design adapter electronics, and develop and integrate ATLAS software. Requires 4 years' experience in electronic design and software development and knowledge of test equipment and ATLAS language. Experience with HP1000 system preferred plus BSEE, or equivalent, required.

Research Engineer/ATE Systems

Assume duties of a Senior Technical Staff Engineer in the area of Test Systems (ATE) serving as technical troubleshooter for senior management and providing the technical direction to other engineers in order to complete a project on schedule and within cost. Experience must include MTE/ATE detailed circuit design plus functional circuit analysis on complicated analog and digital system and subsystem units for test. Recent background required in the development of ATE station with multiple/compatible instruments controlled by HP 1000 or TEK 3260/3270 in BASIC or ATLAS. MSEE preferred.

ATE Systems Software Engineers

Design, code and integrate software modules relating to ATLAS compiler and test station operation system for automated test systems, working from new ATS requirements or change requests. Requires experience with HP 1000 automated test systems, HP RTE IVB, HPID and HP device subroutines, related software and ATLAS compilers. Fluent knowledge of FORTRAN IV required. BSEE, BSCS, MS/Math or equivalent experience required.

Please send your resume to: **John Cinege, Northrop Electronics Division, Professional Employment N1, Dept. MM 18115, 2301 W. 120th Street, Hawthorne, CA 90250.**

Proof of U.S. Citizenship Required. Northrop is an Equal Opportunity Employer M/F/H/V.

We're within your reach.

NORTHROP

Electronics Division
Electronics Systems Group

CAREER OPPORTUNITIES/ RECRUITMENT ADVERTISING

RESUME FORWARDING SERVICE

To have your resume forwarded on to the company of your choice, simply write in the box at the right the name of the company that interests you.

Forward my brief resume to:

(Never more than 3 companies, please)

Complete the following brief resume and mail to: Peggy Gordon

MINI-MICRO SYSTEMS
P.O. Box 10277
8 Stamford Forum
Stamford, CT 06904

(Please type, or print using all caps in dark ink.)

1.

Last Name _____ First _____ Middle Initial _____

Home Address (Street, City, State, Zip) _____

Home Phone (Area Code) _____

Other (Area Code) _____

2. EDUCATION INFORMATION: Schools Attended

Name _____ Location: _____ Degree: _____

Name _____ Location: _____ Degree: _____

3. EMPLOYMENT INFORMATION:

Name & Address of Present Employer (Will not be contacted) _____

Position (Please give brief description of your title and current job assignment) _____

Length of time with current employer _____

4. Are you willing to relocate? _____

What are your geographical preferences? _____

5. Please Check One:

U.S. Citizen _____ Permanent Resident _____ Student Visa _____

6. Foreign Language

Read _____ Write _____ Speak _____

7. Please indicate current salary _____

*Please Sign Here

Date

*Your signature will authorize us to forward the above information on to the company of your choice, in the strictest confidence. Your current employer will not be contacted.

3-85

GUEST VIEWPOINT

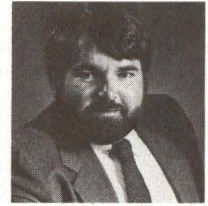

Lockbox may be the key to software piracy prevention

Stephen Auditore
Gordian Systems Inc.

Piracy is a bothersome problem for those who write and sell software for microcomputers. Although little hard data is available, many software publishers say that piracy cuts their revenues by 25 percent to 35 percent.

At a recent meeting of the Association of Data Processing Service Organizations (ADAPSO), Lotus Development Corp., the Cambridge, Mass., software publisher, presented a protection scheme that, if adopted, could resolve the software protection issue.

In the Lotus scheme, users attach a lockbox about the size of a portable radio to a computer through an RS232 port. The box takes keys about the size of car keys, which come with legitimately purchased copies of programs. These keys have codes in ROM or other mechanisms that make them difficult to duplicate. Each lockbox can accept as many as four keys so that users can run more than one program simultaneously. The idea is to put algorithms into a protection program that would prevent the program from running without the key in the lockbox.

This approach breaks from current practice, in which the battle against software piracy is seen as an issue of copy protection. Lotus offers a dra-

matic shift from media orientation to access—or use—orientation. Requiring possession of a hardware key for program operation might make copy protection a moot issue. Programs can be duplicated an infinite number of times, but the copies are useless without a key.

The impact of the lockbox protection scheme on the end user is still in question. No doubt it will introduce some user inconvenience. But several benefits are possible. These include lower prices and encryption of personal data files.

Lower end-user prices could result by eliminating "soft-lifting." It is not clear whether such lower prices will take the form of a reduction in price or of improved functionality.

Furthermore, intelligent lockboxes and keys could allow programs to operate for specified lengths of time or numbers of uses. From a marketing perspective, this permits subscription sales of software, establishment of a software rental industry, secure evaluation sales and development of lending libraries.

Legal ramifications of this protection scheme will be far-reaching. The major legal issues will revolve around possession of keys and what rights of use and ownership a key implies, rather than on whether making copies violates an intellectual property right.

Software protection has become a highly visible target of opportunity for many would-be entrepreneurs. New and existing companies have proposed over 120 software-protection schemes to major software publishers. Many of these companies will be severely affected should Lotus' proposal gain widespread acceptance.

Although the implementation and integration of this protection scheme may seem a *fait accompli* for some publishers, many issues need to be resolved before general industry acceptance and sanction by a standards organization. These items include the technical feasibility of the lockbox and keys, their availability and, most important, their acceptability.

Moreover, the industry cannot ignore the position of IBM Corp. as the largest software publisher. Until now, IBM has played a passive role in software protection.

Stephen Auditore is vice president of marketing for Gordian Systems Inc., Palo Alto, Calif. Before becoming one of the founders of Gordian, Auditore was vice president for corporate planning of Direct Inc.

CLASSIFIED ADS

software

FoxBASE™
Interpreter & Compiler
dBASE II® Source Compatible
 Enhanced far beyond dBASE II with:

- 3 to 20 times the speed
- 50% more fields per record
- 14-digit precision
- 8087 coprocessor support

Discounts & NO-RISK demo available
MS-DOS \$395 AOS/VS \$995
FOX SOFTWARE INC.
 (419) 354-3981 

CIRCLE NO. 225 ON INQUIRY CARD

WYSE 50 DEALER DEMO PROGRAM

IMPORTANT sales tool for Customer Demonstrations and Shows
 Explains terminal features/details
 Runs by itself or with salesperson
 Software plus manual for \$49.95
 Contact WDPA, 132 Sprague St.
 Portsmouth, RI 02871

CIRCLE NO. 226 ON INQUIRY CARD

inventions wanted

**Inventors, Entrepreneurs,
 Product Promoters**

wanted to display concepts at national technology trade show.

Call: 1-800-528-6050 X831

CIRCLE NO. 227 ON INQUIRY CARD

hardware

**HEWLETT
 PACKARD**
 Desktop CAD/CAM
 Computer
 Systems 

**SAVINGS ON ALL
 SERIES 200/500
 WORK STATIONS**

9836S 9000 Non-HP memory
 9020S 9826A and peripherals
 CALL OR WRITE FOR DISCOUNT PRICES

**graphic
 systems center**
 Box 23051 Portland, OR 97223 USA
 503-246-0202
 International Sales Telex 360-143

CIRCLE NO. 228 ON INQUIRY CARD

supplies & accessories

RS232C Signal Monitor/Tester

Connects in serial line at CPU or Device to display on 7 tristate LEDs common signals for problem analysis. No power connection required. Complete \$30 Spec Sheet & Instruction \$1.

**Marietta Computer
 Technology**
 1512 Roswell Road, Suite 110
 Marietta, GA 30062.

CIRCLE NO. 229 ON INQUIRY CARD

**This Publication
 is available in Microform.**

University Microfilms International

Please send additional information for _____
 Name _____
 Institution _____
 Street _____
 City _____
 State _____ Zip _____
 300 North Zeeb Road, Dept. P.R., Ann Arbor, Mi. 48106

Copy Deadline:

Space reservations and advertising copy must be received by the 10th of the month preceding the issue date. Camera-ready mechanicals must be received by the 15th of the month preceding the issue date. For example, to appear in the February issue, copy must be received by January 10; mechanicals by January 15.

CLASSIFIED ADVERTISING ORDER FORM

Mini-Micro Systems classifieds reach more mini-micro people

Rates: \$90.00 per column inch (non-commissionable)

6x program earns 5% discount; 12x program earns 10% discount.

There is no charge for typesetting classified listings. Plan approximately 50 average words to a column inch, 8 lines of approximately 38 characters per line (3 inch maximum). Please send clean typewritten (double-spaced) copy.

Category: The following categories are available; be sure to specify the category you wish to be listed under: Business Opportunities, New Literature, Selling, Buying, Trading, Seminars, Services, Software, Supplies & Accessories. (Other categories may be employed at our discretion.)

Run this ad in _____ (number issues) Reader Inquiry No. YES NO
 Ad size 1 col. wide by _____ inches deep Under _____ (category)
 Check enclosed for \$ _____ (Pre-paid orders only)

Signature _____
 Name _____ Title _____
 Company _____ Telephone No. _____
 Address _____
 City _____ State _____ Zip _____

**MAIL TO: Linda L. Lovett, Classified Advertising, Mini-Micro Systems,
 221 Columbus Ave., Boston, MA 02116**

SYSTEM INTEGRATORS' NOTEBOOK

Tips that make dollars and sense

TRY THESE SOFTWARE UTILITIES FOR PRINTER CONTROL

Carl Warren, Western Editor

Tying the Hewlett-Packard Co. (HP) laser printer to your system and word-processing software requires either a sophisticated, but complex, procedure or one that is inelegant, yet workable.

For example, in working with Ashton-Tate's dBase II or III, consulting software engineer Robert Anton Byers, La Crescenta, Calif., suggests a method that takes advantage of the output and command characteristics of those database packages. Byers recommends that you embed control characters in the word-processed document for use by the dBase post-formatter command file. The command file then uses those control characters to send the necessary format functions to the printer.

To implement this post-format control, Byers says, you must first pick various unused, control characters in your word-processing package and then use them to handle special functions. For example, MicroPro International Corp.'s WordStar allows the embedding of characters for special purposes and denotes them with a caret (^) and the letter. In Byers' file, a control A (^A) causes the HP laser printer to switch to portrait size and use a roman8 font with fixed pitch. Because each function is defined, functions can be combined to produce the desired output. For instance, look at this code listing:

```
Clear          usascii = esc + '(OU'   italic   = esc + '(s1S'
ESC = CHR(27)  prop      = esc + '(s1P'  upright = esc + '(s0S'
ulineon = esc + '&dD'  fixed   = esc + '(s0P'  light   = esc + '(s-1B'
ulineoff = esc + '&d@' point14 = esc + '(s14V' bold    = esc + '(s1B'
portrait = esc + '&100' point10 = esc + '(s10V' medium = esc + '(s0B'
roman8   = esc + '(8U'  point8   = esc + '(s8V'
```

```
A = portrait + roman8 + fixed
B = portrait + usascii + prop + point14 + upright + bold
C = portrait + usascii + prop + point10 + upright + medium
D = portrait + usascii + prop + point10 + upright + bold
E = portrait + usascii + prop + point10 + italic + medium
F = portrait + usascii + prop + point8 + upright + light
U = ulineon
W = ulineoff
code = chr(1)+chr(2)+chr(3)+chr(4)+chr(5)+chr(6)
```

According to Byers, the dBase command file isn't limited to the HP laser printer. He says that it can be modified for other printers as well.

If you need to build a library of printer-control software, Phillip Kahn, president of Borland International Inc., Scotts Valley, Calif., recommends that you build your own libraries using Borland Turbo Pascal.

Kahn says the process is straightforward and merely requires time at the keyboard to build the necessary files.

By using an approach similar to the one Byers did in the dBase command file, you can define specific functions for later use.

That is, if you're using an Epson America Inc. Model FX-80 dot-matrix printer and want to enter the enlarged-character mode, you can set it one of two ways: send ASCII device code DC4, denoted by decimal 14, or send Escape capital W, denoted by decimal 27 for Escape and decimal 87 for W. To cancel the command, use an ASCII space, decimal 20, or Escape !, decimal 27 plus decimal 33. To translate this into Turbo Pascal, you treat the printer as a file and use the standard WRITE statement:

```
WRITE (LST, CHR(14),)
```

This tells the printer to enter the enlarged-character mode, while:

```
WRITE (LST, CHR(20),)
```

shifts the printer back to a normal, 10-pitch character size.

By predefining the functions the printer is capable of, you can mix them to create the desired effects.

Another method of setting up a printer is suggested by consulting engineer Richard Steincross, RMS Laboratories, Long Beach, Calif. Steincross says to use the command functions of PC-DOS or MS-DOS. He does say that this method is slow, and should be considered a prototyping tool rather than an everyday application.

For example, to control a Prowriter dot-matrix printer from C. Itoh Electronics Inc., Los Angeles, Calif., you create a DOS command file that initializes the printer. Using this method, however, requires that you know what mode you want the printer in: pica, elite, proportional, boldface, bidirectional printing or reset to normal. (If you'd like a copy of the code listings for initializing the C. Itoh printer, write to *Mini-Micro Systems*, 221 Columbus Ave., Boston, Mass. 02116.)

Should you prefer not to create your own code, you might consider Printer Boss from Connecticut Software Systems Corp., 30 Wilson Ave., Rowayton, Conn. 06853, (203) 838-1844. This \$139 package, which runs on Epson and Epson-compatible dot-matrix printers, provides a full set of downloadable character sets, letter-quality, multipass printing and sideways printing. Additionally, it works with most word-processing and spreadsheet software. So that the host isn't tied up during the printing cycle, Printer Boss gives you the option of establishing a 32K-byte print buffer.

Interest Quotient (Circle One)
High 495 Medium 496 Low 497

ADVERTISERS INDEX

ADAC Corp.	60	Kimtron	161
Alloy Computer Products	189	Lexidata Corp.	86
Ampro	207	Mannesmann Tally	134
Ann Arbor Terminals Inc.	C2	Maxtor Corp.	158
Apollo Computer	144-145	Megatape	129
Archive Corp.	82-83, 195	Megatek Corp.	112
AT&T Technologies Inc.	90-91	Micro Data Base Systems	132-133
BASF	E4-E5	Microplot Systems	104
Bytcom	131	Microware	56
Canon U.S.A.	79, 81	Mini-Micro Systems	217
Carroll Touch Technology	125	Montreal International Software Market	178
Century Data Systems (a Xerox Co.)	197	Mostek Corp.	156-157
CIE Systems	20	Motorola Semiconductor Products	62-63
CIE Terminals	16, 23	Multi-Tech	121
Cipher Data Products Inc.	44-45	Mupac Corp.	97
Citizen America	28-29	NCR Corp.	110-111
Compaq Computer Corp.	92	NCR Technology Marketing Div.	209
Compu-Mech	47	NEC Peripherals	98-99
Control Data Corp.—OEM	162	Novell Data Systems	206
Craig Data Cable	167	OMTI (subsidiary of Scientific Micro Systems)	95
Cromemco Inc.	210-211	Pelikan	138
CTS Corp. - Datacomm Products	4, 118	PCI Cash Register Ssystem	53
Dataram	49	Perex	E8
Data Technology Corp. (DTC)	40, 213	Perkin-Elmer Corp.	64
Dexpo	170-172	Plexus Computers	72
Digital Equipment Corp.	50-51	Quality Micro Systems	198
Dilog (Distributed Logic Corp.)	190-191	Qualogy Inc.	76
Dysan Corp.	100	Quantum Corp.	108-109
EEC Systems	153	Qume	46
Electronic Solutions	61	SBE Inc.	155
Emulex Corp.	38-39	Science Applications International Corp.	48
Epson America Inc.	C3	Siemens Corp.	105-107
Facit Inc.	137	Stollman	217
Falco Data Products	193	Sysgen Inc.	182
Faraday Electronics	149	Technical Forums	201
Flexible Computer	142	Tektronix Inc.	12-13, 32
Fujitsu America Inc.	130	TeleVideo Systems Inc.	126
GCA Corp.	10	TeleVideo Terminals Inc.	176
Genicom	186	Texas Instruments Inc.	150
Gould Inc., Computer Systems Div.	5	Texwipe Co.	69
Hall-Mark Electronics	55, 146, 205	Toei Electronics	80
Hayes Microcomputer Products	75	Topaz Electronics Div.	166
Hewlett-Packard Co.	30-31, 203	Ungermann-Bass	70-71
Hitachi America Ltd.	168-169	Unify Corp.	8-9
IBC/Integrated Business Computers	96	Unitronix	67
Ibex Computers Corp.	167	Universal Data Systems Inc.	C4
IBM Corp.	19	Vectrix	58-59
Imperial Technology Inc.	200	Verbex	89
Incaa	42	Vertex Peripherals	122
Information Builders	117	Viasyn	27
Infotron Systems Corp.	1	Wave Mate	88
Intercontinental Micro	52	Western Telematic Inc.	84
Interface Group	54, 214	Westrex OEM Products	141
Intermec Inc.	175	Wyse Technology	14-15
International Data Corp. (IDC)	66	Xebec	180-181
Iomega Corp.	6-7	Zilog Inc.	154
Irwin Magnetics	165		
ITT Information Systems	179		
JDL	114		
Kel Inc.	24		
Keytronic	185		
		See P. 222 for Classified Advertisers	
		See P. 218-220 for Career Opportunity Advertisers	
		See P. 227-228 for Mini-Micro Marketplace	

MARKET TRACK

Sharon Hassell
Assistant Editor

User needs spur sales surge

As computer reliance in commerce and industry increases, so will the need for fault-tolerant computers, says a recent study by Frost & Sullivan Inc., a New York market research company. Reflecting this need, sales of fault-tolerant computers will grow from \$7.9 million in 1984 to \$7.4 billion by 1988, according to the study.

Fault-tolerant computers, which continue to operate when part of a system fails, are especially important in on-line transactions on banking and financial-service machines. According to the study, sales of fault-tolerant computers for use in on-line-transaction applications will total \$5.1 billion by 1988, representing 70 percent of the total fault-tolerant-computer market.

According to Frost & Sullivan, distributed data processing will be the second largest market segment for fault-tolerant computers. By 1988, sales of fault-tolerant models in distributed data processing will reach \$1.5 billion, a 40 percent increase over 1984 sales.

Office automation, or shared-resource word processing, will represent the smallest market segment for fault-tolerant computers, reaching only \$3.5 million in 1988, the study says.

In addition to sales figures, the study also discusses potential market figures and fault-tolerant computer suppliers, citing Tandem Computers Inc. as the market leader, followed by Computer Consoles Inc. and Stratus Computer Inc.

PBX survey results: Rolm beats AT&T

Private branch exchange (PBX) users planning to replace existing installed equipment with new systems, won't be turning to AT&T as often as they have in the past, according to The

Market Information Center Inc., Framingham, Mass. In a recent study, the market research company released findings from a survey of over 600 PBX, Centrex and key system users in the United States. The survey questioned users' plans to integrate voice/data and local area networks and to replace digital PBX systems over the next year.

In the study, Rolm Corp. was market leader for replacement systems, claiming 30.4 percent of the respondents. Northern Telecom Inc. and NEC America Inc. each received 10.7 percent, and 7.1 percent each went to

Mitel Corp. and Intecom Inc. AT&T was named by 19.6 percent of the users.

The survey also lists Rolm as the first choice of users planning to buy additional PBX systems for their organizations. Claiming 41.7 percent of the users surveyed, Rolm topped AT&T's figure of 35 percent.

Almost 90 percent of the users planning to install new systems said the systems would use digital PBX switches. In addition, 80 percent of these systems would be used in a combination voice/data environment, the study says.

Software demand to increase eightfold

The demand for integrated software packages for personal computers will increase from 445,000 units sold in 1983 to 3.6 million in 1988, according to a study by Venture Development Corp. (VDC), Wellesley, Mass. The

informative were demonstrations, followed, in order, by in-house consultants, independent product reports, experts in other companies, office-product magazines, manufacturers' literature, general-business magazines and independent consultants. However, in defense of computer stores,

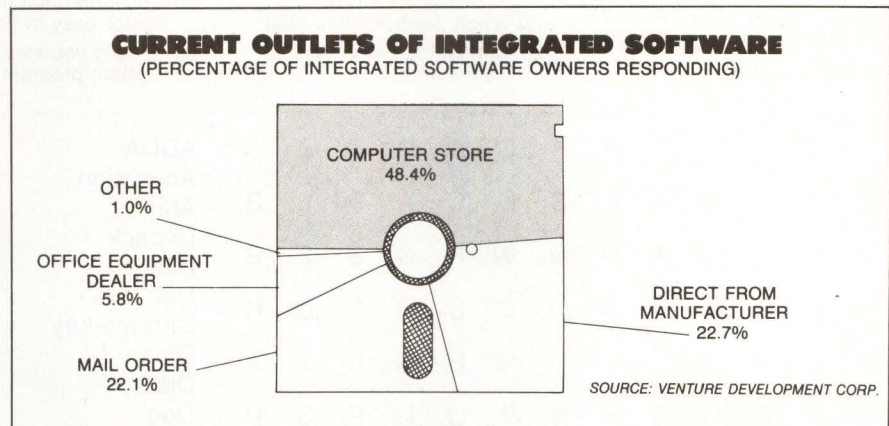

study says, however, that, if computer stores continue to sell almost half of the available integrated packages, problems will occur as the stores become inundated with new packages and retailers' knowledge of the packages becomes less reliable.

According to VDC, of the nine sources of integrated software product information, users listed computer store staffs as least informative. Most

VDC notes that some salespeople never get a chance to demonstrate their knowledge since customers generally go to a computer store to buy the software, not to ask how it works.

The study says that diversified distribution methods for integrated software programs, such as through office equipment dealers and stores specializing in integrated packages, will be used frequently as demand increases. □

ARTFUL INTELLIGENCE

By John K. Young

A C R O S S

- 1 Direct and table access
- 5 Makeshift computer
- 9 Function
- 11 Twelve months (Abbr.)
- 12 Start computer
- 13 Input-output device connected to computer
- 17 Strong desire people have to acquire a computer
- 18 Programming language
- 19 Smile derisively
- 22 Prefix meaning "early part of period"
- 23 Connection of computer resources
- 27 Those who do data processing (Abbr.)
- 29 Frozen water
- 30 Any device attached to computer
- 33 Regius Professor (Abbr.)
- 35 Programming language
- 37 Airman (Abbr.)
- 39 Fermented drink made from malt hops
- 41 Common graphics date file
- 42 What 38-Down gives you
- 43 Neo (Chem.)

- 44 Male heir
- 45 Graphics symbol indicating where next character will be displayed
- 46 Computer fanatic

D O W N

- 2 Remember information
- 3 Head covering
- 4 Printer's measure
- 6 Portray in words
- 7 Kind of pass that references one or more global sections
- 8 Alumnus
- 10 Set of identifying characters
- 12 Radix in numbers scale
- 15 Scottish writer: Andrew ____
- 16 Function
- 20 Point on vibrating string virtually free of vibration
- 21 Anything sword-shaped is ____ form
- 24 Scottish "mini"
- 25 _____ cycle
- 26 He fiddled while Rome burned
- 28 Example of 30-Across
- 30 Small, flat-bottomed boat
- 31 Combining form meaning "the sun"

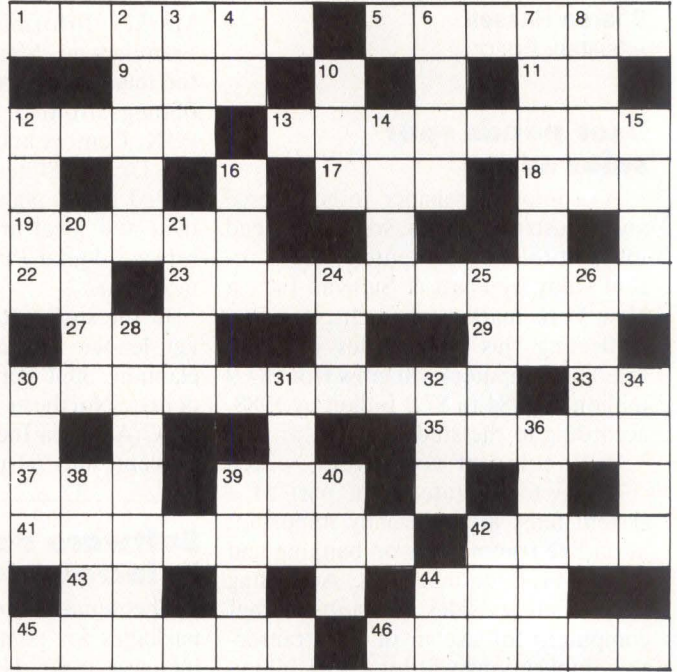

- 32 Do something
- 34 Control chart
- 36 Command that makes cursor easy to find
- 38 It leads you step by step through program
- 39 Hair style
- 40 Yale's nickname
- 42 Function
- 44 A continent (Abbr.)

M D I S K S K C A R T Z S
 E D T T R I S K C A P I B
 O I L O A U N W R D S E G
 B N B E E P O C S O T O R
 S O S C I L E M H G D T A
 T I E H G F N P O I F S P
 A T R R A S R R M O L N H
 T C V O S O L A R I Z E I
 A E O M M T G E T O A E C
 D L V A I E A S A S T N S
 L F T K S S C R D H A L O
 K E Y E E A T R D P R C N
 M R C Y N O I T A M I N A

ADDA	Graphics	Rods
Animation	Halo	Rotoscope
Atari	Images	Servo
Bi-pack	Metamorphosis	Slit-scan
Bits	Mist	Solarize
Cel	Neon	Star
Chroma-key	OEM	Starfield
Data	Pan	Tape
Disk	Reflection	Tracks
Dog	Risk	Zoom
Glow	Robot	

Solution will be printed next month.

Answers to February's puzzles
 can be found on Page 208.

Interest Quotient (Circle One)
 High 498 Medium 499 Low 500

MINI-MICRO MARKETPLACE

A special section for advertisers of hardware, software and services.

Please circle reader service numbers for additional information.

FOR SALE!



Like new
HP 2621B/050
Display Terminal

This 110-9600 baud asynch terminal has 1920 character display, 2 page memory, integral printer. **\$1,650.00** (\$1,255.00 off HP list). 30 Day Warranty. Quantity discount available. Subject to prior sale.

GENSTAR

REI Sales Company

6307 De Soto Avenue, Suite J
Woodland Hills, CA 91367

(800) 225-1008 (800) 227-8409
in MA (617) 938-0900 in CA (818) 887-4000

CIRCLE NO. 200 ON INQUIRY CARD

ENCLOSURE PRODUCTS

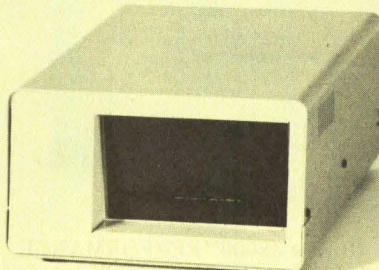

- Floppy and Hard Disk Drive Enclosures for all Major Micros.
- Xebec Controllers Optional
- Custom Design Available
- Class 'B' Certification Support Can Be Provided
- Call For Pricing and Catalog

Microware, Inc.

41711 Joy Road • Canton, MI 48187
(313) 459-3557

CIRCLE NO. 201 ON INQUIRY CARD

ZX-5000™ EXTENDED RANGE™ SURGE SUPPRESSORS

The ZX-5000 Extended Range series surge suppressors provide the most advanced protection available on the market today against spikes, surges and noise disturbances.



LISTED



SUTTON DESIGNS INC
COMPUTER SECURITY DIVISION

300 North Tioga • Ithaca, NY 14850
607-277-4301

CIRCLE NO. 202 ON INQUIRY CARD

Promote New Literature

at a **LOW
COST**

If you've got catalogs or literature, distribute them at a low cost in the **MINI-MICRO MARKETPLACE.**

Call Norma Lindahl
(617)536-7780

CIRCLE NO. 203 ON INQUIRY CARD

for Serious Software Developers

TARGET MICROPROCESSORS

80286, 8086/80186, 8096, 8080/8085, 8051, 8048, Z8002, Z80, Z8, NSC 800, 9900, 68000/08/10, 6809, 6800/01/02, 6805, 6301, 6305, 6500, G65SCXX, G65SC1XX, R65C00, R6500/1, and others.

HOST COMPUTERS

DEC VAX, PDP-11, DG MV-Series, DG Eclipse, Apollo, UNIX Systems, IBM PC, Data General/ONE, HP 150, DEC Rainbow and others.

SOFTWARE TOOLS

C Compilers, Pascal Compilers, PLM Compiler, Assemblers, Linking Loaders, Librarians, Download, Communications, VT-100 Emulator, CPM/80 Emulator.

If you are a serious software developer, shopping for software development tools, call or write today for more information. **800-551-5554** in CA call **(408) 733-2919**



**MICROTEC™
RESEARCH**

3930 Freedom Circle, Suite 101, Santa Clara, CA 95054
Mailing Address: P.O. Box 60337, Sunnyvale, CA 94088
(408) 733-2919 Telex (ITT) 4990808

CIRCLE NO. 204 ON INQUIRY CARD

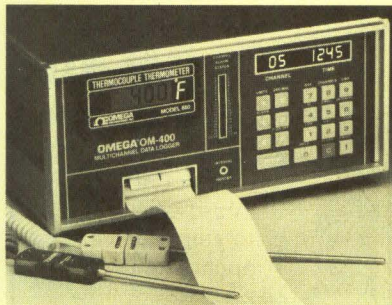

PROGRAMMABLE DATALOGGER - MULTICHANNEL MONITORING WITH OM 400 SERIES

The OM 400 Series Dataloggers are designed to read and digitally record input from up to six thermocouple types. Programmable for high and low limit alarms, day and time, number of channels scanned and much, much more. The easy to use keyboard allows the programming of all monitoring and logging functions.

For more information, call 203/359-7613 or write **OMEGA ENGINEERING**, One Omega Drive, Box 4047, Stamford, CT 06907.

CIRCLE NO. 205 ON INQUIRY CARD



NEW DIGITAL TEMPERATURE TESTER MODEL 383

Complete temperature tester in one compact hand-held instrument. Features include 3" display, dual type J thermocouple inputs, differential/normal temperature mode, DC millivolt range, analog output. All these features and more in this unique instrument. Unit is supplied with 2 type J glass-braided thermocouples, test lead kit, 9v battery, and operator's manual.
For more information, call 203/359-7613 or write **Omega Engineering**, One Omega Drive, Box 4047, Stamford, CT 06907.

CIRCLE NO. 206 ON INQUIRY CARD

PACKAGED SBC SUPPORTS 8 SBX INTERFACES

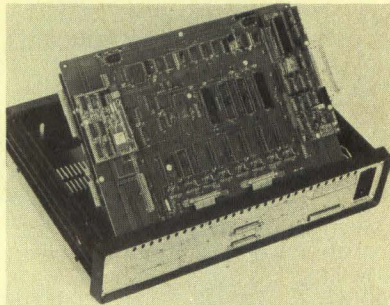

X-BOX:80 integrates enclosure, power supply, and single board computer in FCC-tested, low cost package. Support diverse applications with wide variety of available SBX I/O modules. Includes Z80A, PIO, CTC, and 8 byte-wide memory sockets, with SIO and two DMA optional. Ready to use in test equipment, product prototypes, custom systems...

\$895 - Quantity one

OPTIMIN CORPORATION, P.O. Box 36,
Issaquah, WA 98027 206-392-7698

CIRCLE NO. 209 ON INQUIRY CARD

Micromate CP/M 3.0 COMPUTER

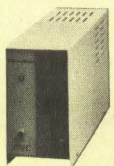

System or
Board Level
to suit your
application



- Use with RS 232C terminals
- Thousands delivered - in use
- 128KB RAM and autoboot ROM
- Interfaces four 400 KB disks
- 10-20MB hard drive add-on
- Abundant software available
- Excellent price/performance

Personal Micro Computers, Inc.
PMC 275 Santa Ana Court
Sunnyvale, CA 94086
Phone 408-737-8444

CIRCLE NO. 212 ON INQUIRY CARD

SAM...Prevents Computer MELTDOWN

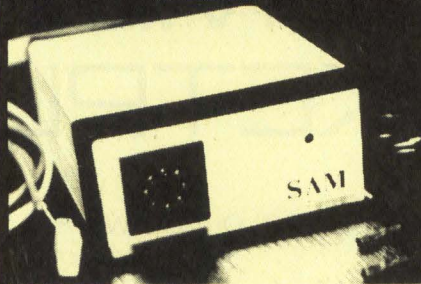

SAM, The Smart Ambient Temperature Monitor/Power Controller... measures computer room temperature and lets your computer know too! Automatic power-down is a simple task if your mini-computer gets too hot for comfort. There's no threat of computer damage or loss of data with SAM watching over your system.

Features:

- Utilizes a powerful single-chip micro
- Dual Solid State Temperature Sensors
- Controls Popular Mini-Computer Power Distribution Panels
- Standard RS-232 Interface
- Built-in Audible Warning Alarm
- Switch Selectable Baud Rates: 300, 1200, 4800, and 9600
- Auto Hi/Lo Temperature Storage
- Compact Size: 2 1/2" x 5 1/2" x 7"
- Metal Case
- One Year Warranty

Intra Computer 101 W. 31 ST., N.Y., N.Y. 10001 (212) 947-5533

CIRCLE NO. 207 ON INQUIRY CARD

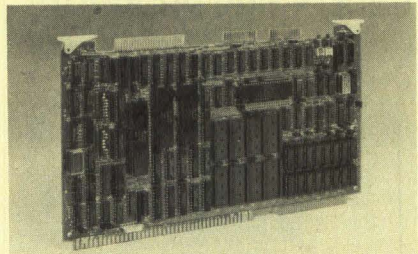

10 MHz Z8000™ PERFORMANCE

In addition to 10 MHz, the NEW MBx8000 SBC features a single width SBX connector for adding standard expansion modules, such as the SBSxFDC Floppy Controller. MBx8000 maintains all the capabilities of its predecessor, the MB8000: Z8001/Z8002 CPU 4/6/10 MHz; 32K/128K/512K DRAM; up to 48K static RAM or EEPROM; up to 128K EPROM; 2 RS-232 ports; 40 parallel I/O lines; six 16-bit counter-timers; etc. Z8000™ Zilog. SINGLE BOARD SOLUTIONS, 7669 Rainbow Drive, Cupertino, CA 95104. (408) 253-0181

CIRCLE NO. 210 ON INQUIRY CARD

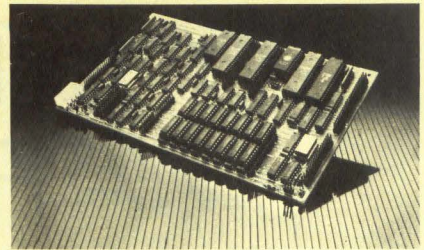

HIGH PERFORMANCE Z-80 SINGLE BOARD COMPUTERS

Available with either Z-80A or Z-80B CPU, 64-256K RAM, 2-64K ROM or EPROM, 2 or 4 RS-232 serial ports, high speed bi-directional parallel port or an I/O expansion bus. All models have 5 1/4" & 8" disk controller and Centronics parallel printer port. SCSI port and RS-422 ports are also available. Private label systems available, IBM PC compatible coming soon. **DAVIDGE CORPORATION**, P.O. Box 1869E, Buellton, CA 93427 (805) 688-9598

CIRCLE NO. 208 ON INQUIRY CARD

YOUR AD IN THE MINI-MICRO MARKETPLACE MEANS MORE SALES

for more information call
your regional sales manager

OR NORMA LINDAHL
AT (617) 536-7780

CIRCLE NO. 211 ON INQUIRY CARD

PIN GRID ARRAY & DIP SOCKETS



Leadless Chip Carrier Adapters
Test Accessories
In-Line Socket Strips

MUPAC
CIRCUIT 600A

10 Mupac Drive, Brockton, MA 02401
Tel (617) 588-6110 TWX (710) 345-8458

CIRCLE NO. 213 ON INQUIRY CARD

YOU KEEP THE QUALITY IN, WHEN YOU PUT A SHOCKWATCH ON!

The Shockwatch® Label is revolutionizing the way hi-tech shippers control the quality of shipments. This inexpensive and precision impact device is the basis of a shipping system that controls the quality of handling after the product leaves your dock. Abusive handling turns this device a bright red, warning your customer to inspect for possible damage. If you control quality inside your plant, why not control it after it leaves.

- Reduce damage, service cost, returns, dead inventory. Create customer goodwill & protect the quality product you manufacture.

Call 1-800-527-9497 for application information & a list of our Fortune 500 customers.
MEDIA RECOVERY, INC.
1435 Round Table Drive, Dallas, Texas 75247



CIRCLE NO. 214 ON INQUIRY CARD

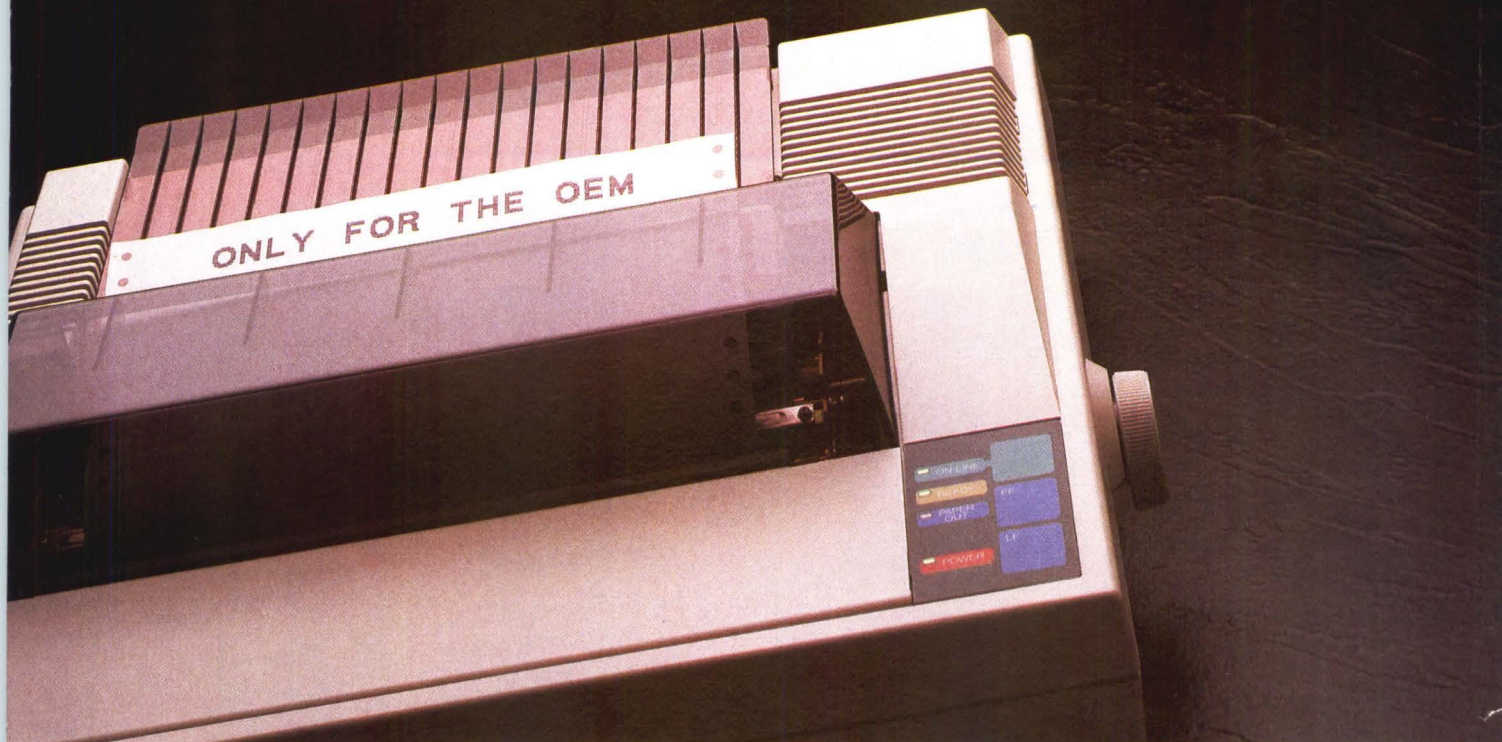

There's an Epsonomic answer to your printer needs.

Our new OEM printer is part of it.

Epsonomics means more than designing a printer exclusively for the OEM. Though we'll never market our CTM series through retail.

But Epsonomics means more. More than offering a printer with a unique custom case. More than Epson® reliability. Though that has become a byword in the printer world.

Epsonomics means even more than technical superiority and advanced performance. Though the CTM F-series of 160 cps printers boasts an increased line speed and data transfer rate that yields 20% greater throughput. And the universal power supply accommodates 100, 120, 220, and 240 volt inputs to match your domestic and international needs and simplify purchasing decisions.

Epsonomics means designing products that will increase the saleability of your products, lower their after-sale service costs and provide the OEM protection against similar products marketed through the retail channel. It means on time delivery to minimize your inventory costs. It means making that extra effort to help you grow so we can grow with you.

Epsonomics. Our new CTM F-series of OEM printers is only part of it. So are our LCDs, floppy drives and printer mechanisms, and the integrated technology behind them. The main part is that we do business so you can provide cost effective products to your customers.

Find out how Epsonomics can help you achieve an aggressive competitive posture in your marketplace. Call or write us today.

EPSON®
OEM

EPSON AMERICA, INC.
OEM Products Division
Peripherals Group
3415 Kashiwa Street, Torrance,
CA 90505 (213) 533-8277
TELEX: 664277



*The top lines for
your bottom line*

SW Region (714) 250-0111 · NW Region (408) 970-9977 · SE Region (404) 956-1934 · NE Region (617) 245-8007 · Central Region (815) 338-5810
© Registered trademark of the Epson Corporation.

CIRCLE NO. 119 ON INQUIRY CARD

Quick Study!

**New UDS
9600 bps
Fastpoll
Cuts
On-line
Training
Time 33%**

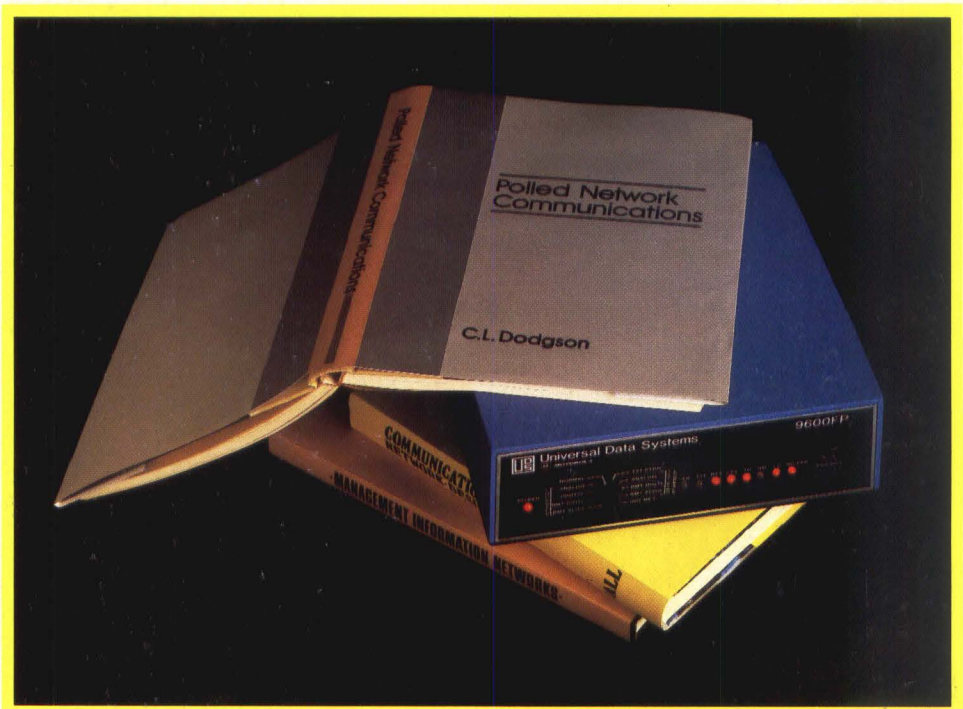

The new 9600 bps fastpoll modem from Universal Data Systems means extra throughput for your polled multipoint network! Until now the fastest on-line training time available anywhere has been 12 milliseconds. Since training time is non-productive time, UDS has increased system throughput by trimming the training cycle to 8 ms, producing a corresponding increase in overall system efficiency.

The device is suitable for operation over unconditioned four-wire leased lines in either fastpoll or

conventional CCITT V.29 mode. Integral test features allow for system performance evaluation and fault isolation within the communications link.

The UDS design incorporates LSI and microprocessor technologies to achieve significant size and power consumption advantages. For detailed specifications, contact Universal Data Systems, 5000 Bradford Drive, Huntsville, AL 35805. Phone 205/837-8100; Telex: 752602 UDS HTV.

\$1995

Quantity One

 **Universal Data Systems**

 **MOTOROLA INC.**
Information Systems Group

Inquiry Hotline: 800/633-2252, Ext. 360.

UDS modems are offered nationally by leading distributors. Call the nearest UDS office for distributor listings in your area.
DISTRICT OFFICES: Atlanta, GA, 404/998-2715 • Aurora, CO, 303/368-9000 • Bellevue, WA, 206/455-4429 • Blue Bell, PA, 215/643-2336 • Boston, MA, 617/875-8868
Columbus, OH, 614/895-3025 • East Brunswick, NJ, 201/238-1515 • Glenview, IL, 312/998-8180 • Houston, TX, 713/988-5506 • Huntsville, AL, 205/837-8100 • Mesa, AZ, 602/820-6611 • Minnetonka, MN, 612/938-9230 • Mountain View, CA, 415/969-3323 • Richardson, TX, 214/680-0002 • St. Louis, MO, 314/434-4919 • Silver Spring, MD, 301/942-8558
Tampa, FL, 813/684-0615 • Thousand Oaks, CA, 805/496-3777 • Tustin, CA, 714/669-8001 • Willowdale, Ont, Can, 416/495-0008 • Ypsilanti, MI, 313/483-2682

CIRCLE NO. 120 ON INQUIRY CARD

Created by Dayner/Hall, Inc., Winter Park, Florida