

Mini-MicroSystems

A CAHNNERS PUBLICATION

JANUARY 1985

**Hewlett-Packard's
new UNIX-based
microcomputer**

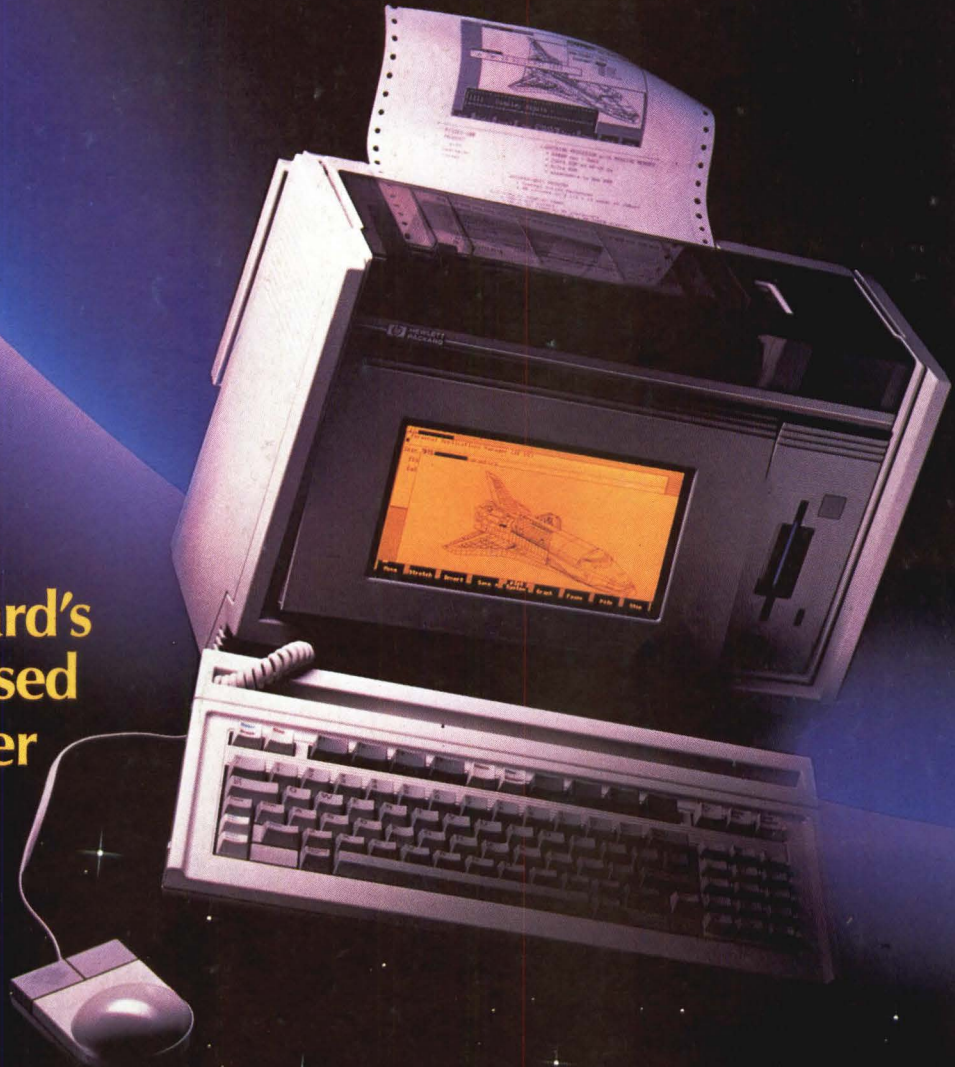

PRINTERS.

- Battles on the retail front
- Choosing a supplier
- The unbeatable daisywheel

WIDE WORD™

200 MB/second!

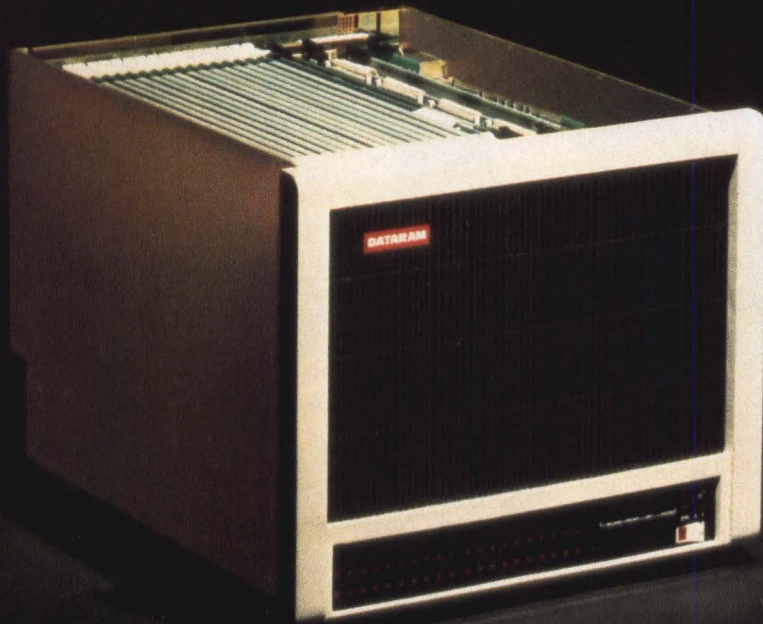

World's Fastest Bulk Memory System

It's true. Dataram's WIDE WORD memory system delivers an incredible data rate of 200 MB/sec! Achieved by utilizing 80 or 160 bits per word and four-way interleaving.

Much faster than even the fastest minicomputers can handle...but not too fast for your real-time applications, image processing, array processing or data acquisition needs.

Multi-port capability enables you to bring WIDE WORD speed to your host minicomputer. Simply connect one port to your high-speed input, the other to your mini.

Our library of dedicated interfaces allows you to run with Digital Equipment, Data General, Ampex, Control Data, CSPI, Honeywell, Intel (MULTIBUS), MODCOMP, Motorola (VERSAbus), Perkin-Elmer, ROLM, and SEL. And, possibly even more importantly, we can work with you to develop a custom WIDE WORD interface.

WIDE WORD. 128 MB of high-performance memory in a compact 15 1/4" system. Word lengths up to 160 bits. And, of course, a data rate of 200 MB/second.

Our new WIDE WORD brochure will tell you more. And you can have it at no charge by circling the Reader Response Number or calling us at (609) 799-0071.

WIDE WORD is a trademark of Dataram Corporation. MULTIBUS is a registered trademark of Intel Corporation. VERSAbus is a trademark of Motorola, Inc.

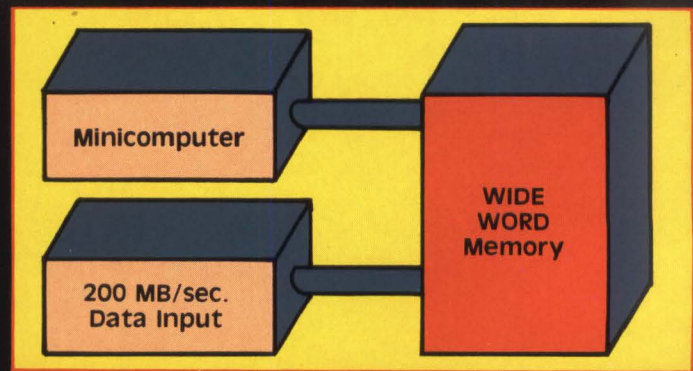

DATARAM

Princeton Road □ Cranbury, NJ 08512 □ (609) 799-0071 □ TWX: 510-685-2542

CIRCLE NO. 1 ON INQUIRY CARD



**If you have one of these,
Infotron can have you
communicating data
in just 48 hours.**

**Modems and stat
muxes, to go.**

Infotron offers a complete line. And now, with our unique distributor warehousing program, we can have any of them on your doorstep within 48 hours of your call. 48 hours, max. Just say the word.



Full system flexibility.

Infotron modems combine advanced features and inherent reliability.

Our statistical multiplexers handle from 4 to 32 channels in a range of models—with full provision for expansion.

All with the same high quality that earns us top marks in performance and reliability from our present users.

Add competitive pricing, and we start making real sense.

Then add our 48-hour delivery, and we're awfully hard to beat.

**To find out more.
Your Infotron distributor.**

There are Infotron distributors nationwide, ready to give you more information, provide equipment and offer expert advice on the best way to meet your needs. For the name of the distributor near you, dial toll-free 1-800-345-4636 and ask for ISO. Or write Infotron Independent Sales Organization, 9 North Olney Avenue, Cherry Hill, NJ 08003.

**Infotron. First in
performance and reliability.**

1-800-345-4636

CIRCLE NO. 2 ON INQUIRY CARD

 **INFOTRON** SYSTEMS

Mini-Micro Systems



p. 31 Art direction and design by Tim Mitchell. Photography by Richard Wahlstrom. Courtesy of Hewlett-Packard Co.

MINI-MICRO WORLD News

- 31 HP pursues technical markets with UNIX-based microcomputer
- 33 Once-exclusive modem market niche attracting sudden, heavy competition
- 35 Amidst glowing PC-AT sales expectations, the PC/XT wins new market life
- 42 Heard on the Hill: Congress rising to needs of high-tech industry
- 46 Northwest Instrument melds logic analyzer with IBM PC-AT
- 49 Kodak develops film processes for magnetic media market
- 54 Liquid crystal shutter technology shines new light on page printers
- 60 Sun's diskless engineering workstation lowers the cost of adding network users

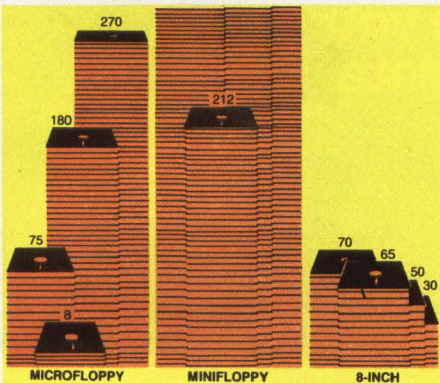

p. 49 Kodak offers floppies

Corporate and Financial

- 67 Guest Forum: High-tech temporary help booms amidst hiring and wage freezes
- 67 Corporate and financial briefs

International

- 71 Large Korean companies lead country's technology drive
- 74 Cheapernet makes local area networking more affordable

- *European News: E1 Optical print engine uses no moving parts
- E2 Single-board computers can tap each other's multiprocessor OS
- E6 Sweden's Ericsson challenges IBM in European PC market
- E7 Pacific Perspective: Japanese threaten to corner world's floppy drive market

*Appearing in the European edition only

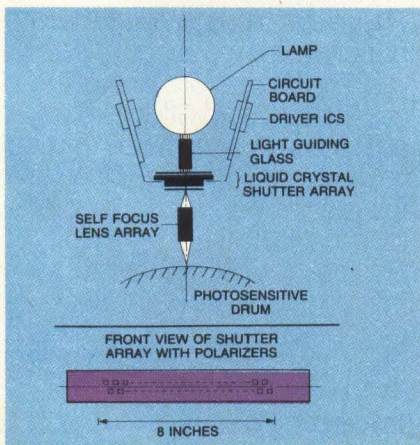

p. 54 . . . Epson debuts LCS technology

INTERPRETER

- 91 Scotland battles Ireland for foreign investment
- 107 Enhancement programs add features to IBM PC operating system, application software

INTEGRATOR

- 117 Network software bridges gap between local area networks

FEATURES

- 127 **Feature Highlights**
- 128 **Printer manufacturers elbow for shelf space . . .** retail price competition is reshaping the printer market
- 143 **Word-processing software injects text into pictures . . .** by combining graphics and digitized images and text, word-processing software transforms document processing
- 163 **Will the networked office save the daisywheel? . . .** despite new and exotic technologies, daisywheels remain unsurpassed for letter-quality printing
- 175 **How to choose a printer supplier . . .** new technologies and a market shift from micros to minis are forcing re-evaluation and new strategies
- 184 **High-capacity 8-inch Winchester aim to overtake 14-inch market . . .** pushed by 5¼-inch Winchesters, 8-inch drives are breaking past the 160M-byte barrier
- 195 **Hybrid technologies rewrite the rules for local area networks . . .** the LAN industry is being shaped by new applications

DEPARTMENTS

4 Editorial Staff	229 Classified Advertising	235 Market Track
11 Editorial	230 Calendar	236 Artful Intelligence
15 Breakpoints	232 Career Opportunities	237 Mini-Micro Marketplace
206 New Products	234 Index to Advertisers	

MINI-MICRO SYSTEMS (ISSN 0364-9342) is published monthly (with 4 special Digest issues) by Cahners Publishing Company, Division of Reed Holdings, Inc., 221 Columbus Avenue, Boston, MA 02116. Norman L. Cahners, Chairman; Saul Goldweitz, President and Chief Executive Officer; Ronald G. Segel, Executive Vice President and Chief Operating Officer. MINI-MICRO SYSTEMS is published by the Cahners Magazine Division: J. A. Sheehan, President; William Platt, Executive Vice President. Circulation records are maintained at Cahners Publishing Co., 270 St. Paul St., Denver, CO 80206. Second class postage paid at Denver, CO 80202 and additional mailing offices. Postmaster: Send address changes to MINI-MICRO SYSTEMS, 270 St. Paul St., Denver, CO 80206. MINI-MICRO SYSTEMS is circulated without charge by name and title to U.S.- and Western European-based corporate and technical management, systems engineers, and other personnel who meet qualification procedures. Available to others at the rate of \$65.00 per year in the U.S.; \$70.00 in Canada and Mexico; \$95 surface mail in all other countries; air mail surcharge, \$35.00 (16 issues). Special DIGEST issues, \$15.00. Single issues \$5.00 in the U.S.; \$6.00 in Canada and Mexico; \$7.00 in all other countries.

© 1985 by Cahners Publishing Company, Division of Reed Holdings, Inc. All rights reserved.



p. 91 Scotland versus Ireland

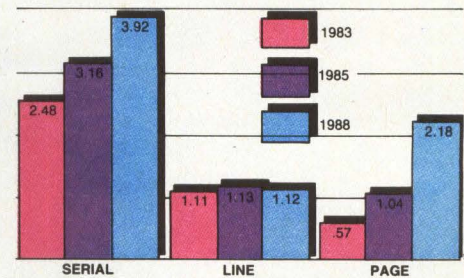

p. 163 Daisywheels are secure

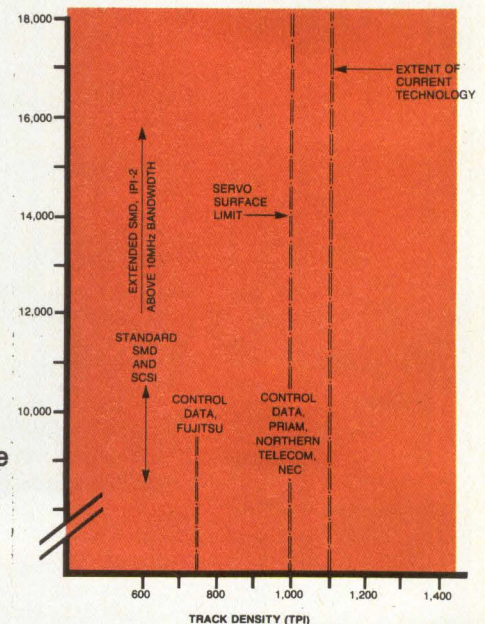

p. 184 . . . 8-inch Winchesters catch up



INTRODUCING THE CTS 212AH MODEM

Discover in nine minutes
what it's taken ninety years
to develop;
Reliability.



CTS Technological Reliability

The high speed, digital signal processor in our 212AH modem was originally engineered for very complex, custom modem systems. We now have applied this advanced technology to a standard Bell 212A compatible product. You get clear, error free transmission despite varying phone line conditions. Other features include auto dial/answer, remote digital loopback, full duplex 300 bps and 1200 bps asynchronous operation and 1200 bps synchronous operation. In a few minutes you'll discover our modem has all the bells and whistles you could ask for. Yet, at a surprisingly low price.

CTS Field Reliability

We warranty our 212AH modem for two years, and we demand our distributors service and support your needs immediately. Once in the field, our modems operate with all data terminals, more than 100 types of computers and are Hayes compatible.

CTS Brand Reliability

In 1896 CTS began manufacturing hand cranked, wooden, wall mounted telephones. Today, we offer the sophisticated 212AH modem. It's taken us almost ninety years of hard work, intensive research and innovative products to develop a reputation for reliability. Take nine minutes, examine our 212AH modem, and find out for yourself.

CTS[®]

DATACOMM Products Division

131 West St.

Danbury, CT 06810

203-743-3681

New to the industry since 1896.

STAFF

Vice President/Publisher
S. Henry Sacks

Editor-in-Chief
George V. Kotelly

Managing Editor
James F. Donohue

Assistant Managing Editor
Bruce J. MacDonald

Senior Western Editor: **Jerry Borrell**
San Jose, (408) 296-0868
Senior Editor: **Lori Valigra**
Senior Projects Editor: **Rick Dalrymple**

Western Editor: **Carl Warren**
Los Angeles, (213)826-5818
Senior Associate Editor: **David Simpson**
Associate Editor: **Frances T. Granville**
Associate Editor: **Lynn Haber**
Associate Editor/Research: **Frances C. Michalski**
Associate Editor: **Tom Moran**
San Jose, (408)296-0868
Associate Editor: **Gregory Solman**
Associate Editor: **Michael Tucker**
Associate Editor: **Jesse Victor**
Assistant Editor: **David Bright**
Assistant Editor/New Products: **Eileen Milauskas**
Assistant Editor/Research: **Pamela Gorski**
Assistant Editor/Research: **Megan Nields**

Contributing Editors

Tokyo: **Neil Gross**
Taiwan: **Charles Hintermeister**
London: **Keith Jones**, (011-441-661-3040)
Tokyo: **Ichiro Kakehashi**
Data Communications: **Walter A. Levy**
Frankfurt: **Maureen O'Gara**
United Kingdom: **Tim Palmer**
Washington, D.C.: **Stephen J. Shaw**
(202) 387-8666
Gene R. Talsky, Professional
Marketing Management Inc.

Editorial Production

Senior Copy Editor: **Arsene C. Davignon**
Production Editor: **Mary Anne Weeks**
Assistant Copy Editor: **Sharon Hassell**
Word Processing: **Kathleen Ewing**
Administrative Assistant: **Nancy Norton**

Editorial Services

Terri Geligos

Assistant to the Publisher: **Linda L. Lovett**

Executive Editor,
Cahners Computer Publications
Alan R. Kaplan

Art Staff

Art Director: **Vicki Blake**
Assistant Art Director: **Cynthia McManus**
Artist: **Anne Tregay**

Director of Art Dept.: **Norm Graf**

Production Staff

VP Production: **Wayne Hulitzky**
Supervisor: **William Tomaselli**
Production Manager: **Lisa Sisterhenm**
Composition: **Diane Malone**

Editorial Offices

Boston: 221 Columbus Ave., Boston, MA 02116. (617)536-7780. **Irvine:** 2041 Business Center Dr., Suite 109, Irvine, CA 92715. **Los Angeles:** 12233 W. Olympic Blvd., Los Angeles, CA 90064. **San Jose:** 3031 Tisch Way, San Jose, CA 95128. **New York:** 33 Arcadia Dr., Dix Hills, NY 11746. **London:** Business Press International, Quadrant House, The Quadrant, Sutton, Surrey, SM2 5AS, England.

Reprints of Mini-Micro Systems articles are available on a custom printing basis at reasonable prices in quantities of 500 or more. For an exact quote, contact Art Lehmann, Cahners Reprint Service, Cahners Plaza, 1350 E. Touhy Ave., Box 5080, Des Plaines, IL 60018. Phone (312)635-8800.

The Firebreathers from Gould blast the competition into oblivion.

With blazing performance.

Great leaps in raw performance are rare in the computer world. Usually, changes occur in increments of half-a-MIP or so. Now real Firebreathers roar into the arena, quadrupling the best the competition has to offer.

With scorching speed.

These creatures don't run a little faster. Running real production code supplied by VAX™ users, our PowerNode™ 9000 benchmarks at 4.5 times faster than the VAX 11/780... at a comparable price! Even our second-in-line

PowerNode 6000 runs 1.5 times faster. But with all this power and speed, the PN6000 has a dainty footprint... 60% less than the VAX 11/780.

With sizzling simplicity.

Even the hottest firebreather won't fly if it's hard to run. Ours are UNIX*-based, so ease of use and compatibility become part of the power. Plus we offer the "Compatibility Suite", application software packages which are consistent across our entire Gould PowerSeries™ product line... the widest range of UNIX-based systems in the world.

More than a myth.

We know these claims sound outrageous. Make us prove them. Give us your benchmarks and production code. We'll show you

numbers that surpass all expectations. Call 305-797-5459 for a test flight on the Firebreathers. Main-frame performance disguised as a supermini. The scorching performance you expect from Gould.

Gould Inc.,

Computer Systems Division
Distributed Systems Operation
6901 West Sunrise Boulevard
Ft. Lauderdale, FL 33313

* UNIX is a trademark of AT&T Bell Laboratories

™ PowerNode and PowerSeries are trademarks of Gould Inc.

™ VAX is a trademark of Digital Equipment Corp.



CIRCLE NO. 4 ON INQUIRY CARD



GOULD
Electronics

WHEN IT COMES TO WINCHESTERS, WE RUN CIRCLES AROUND THE COMPETITION.

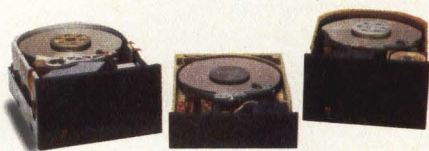

Tandon's made so many improvements in Winchesterst that the rest of the drive industry is dizzy just trying to keep up.

We build a wide range of drives. Open-loop and high performance closed-loop models. In both full and half-height versions ranging from 12.8 to 36.2MB unformatted capacities.

All are available in high quantities now, because Tandon's been ramping up capacities at a pace like never before. And we've kept up the pace of improving Winchester performance as well, so the most advanced technology is ready when you need it.

As far as our current line is concerned, the low-cost TM500 line has become the most reliable full-height 12.8 and 19.1MB drives you can get. The

new TM252 half-height 12.8MB surpasses the industry's most critical specifications. And our TM703 has been increased to 36.2MB to make it the ideal high capacity drive for desktop business systems.

Another part of our success revolves around our highly automated plated media plant in Northern California. Its buttoned-down efficiency and technological sophistication guarantee higher quality and higher volume production than ever.

What's more, our proprietary plated media is used in all our Winchesterst, no matter what the capacity. It's more durable, more reliable. And it has six times more storage capacity than oxide media. At less than half the cost.

In fact, it's so good, other drive manufacturers are buying their plated media from us.

So all around, Tandon Winchesterst have more capacity in less space at less cost.

And that's a pretty good circle to run around in.

Tandon

THE DRIVING FORCE BEHIND THE SMALL COMPUTER INDUSTRY.

Tandon Corporation, 20320 Prairie, Chatsworth, CA 91311. (818) 993-6644, TWX: 910-494-1721, Telex: 194794. Regional Sales Offices: Boston (603) 888-8612 • New York (201) 851-2322 • Atlanta (404) 934-0620 • Chicago (312) 530-7401 • Dallas (214) 423-6260 • Irvine (714) 669-9622 • Santa Clara (408) 727-4545 • Kelsterback/Frankfurt, West Germany 6107-2091, Telex: 411547 • Reading/London, England (0734) 664-676, Telex: 848411. Distributors: Hall-Mark, Kierulff, Schweber.

CIRCLE NO. 5 ON INQUIRY CARD

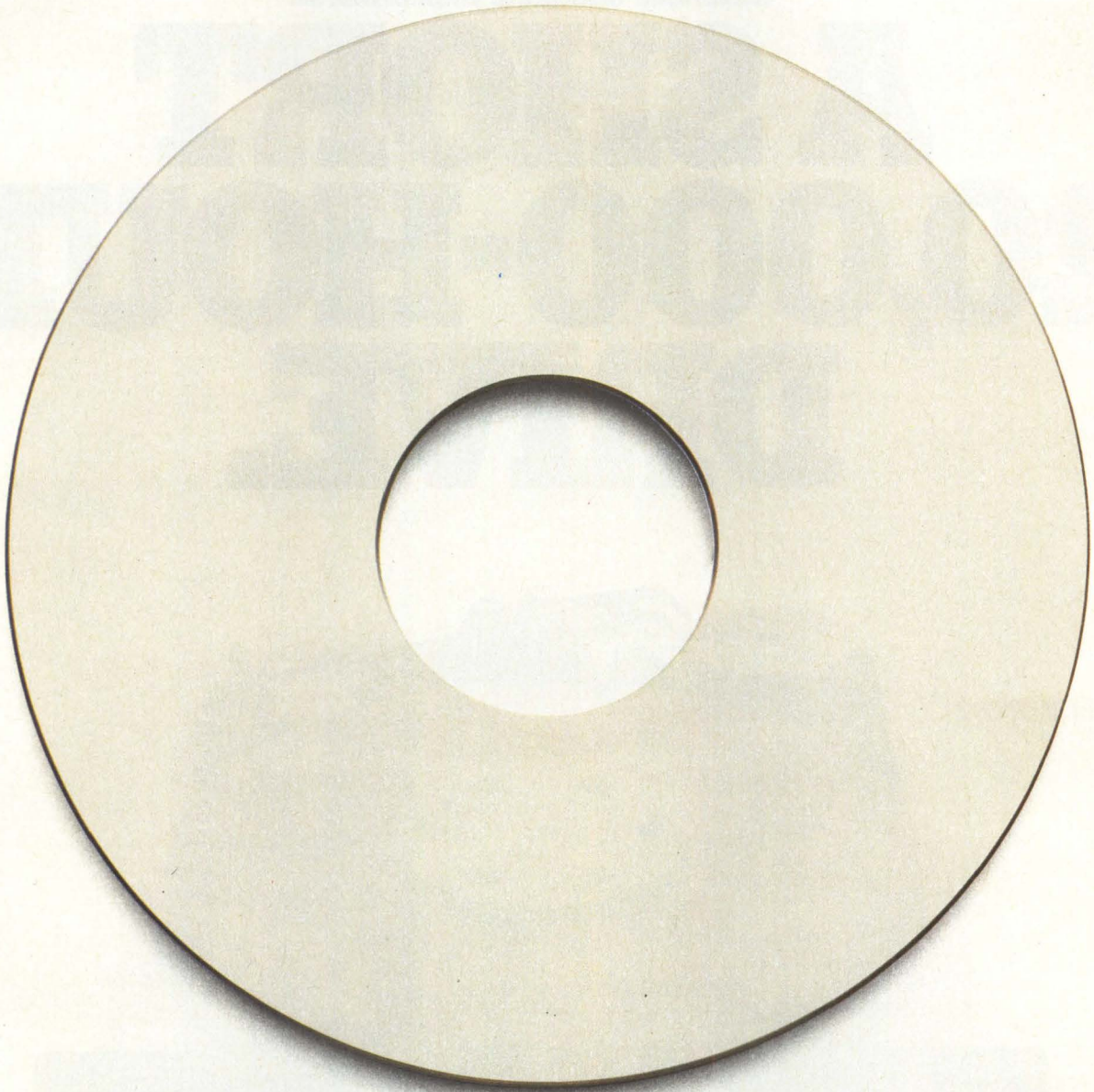

**TAKE
A SHORT
20,000-HOUR
DRIVE.**

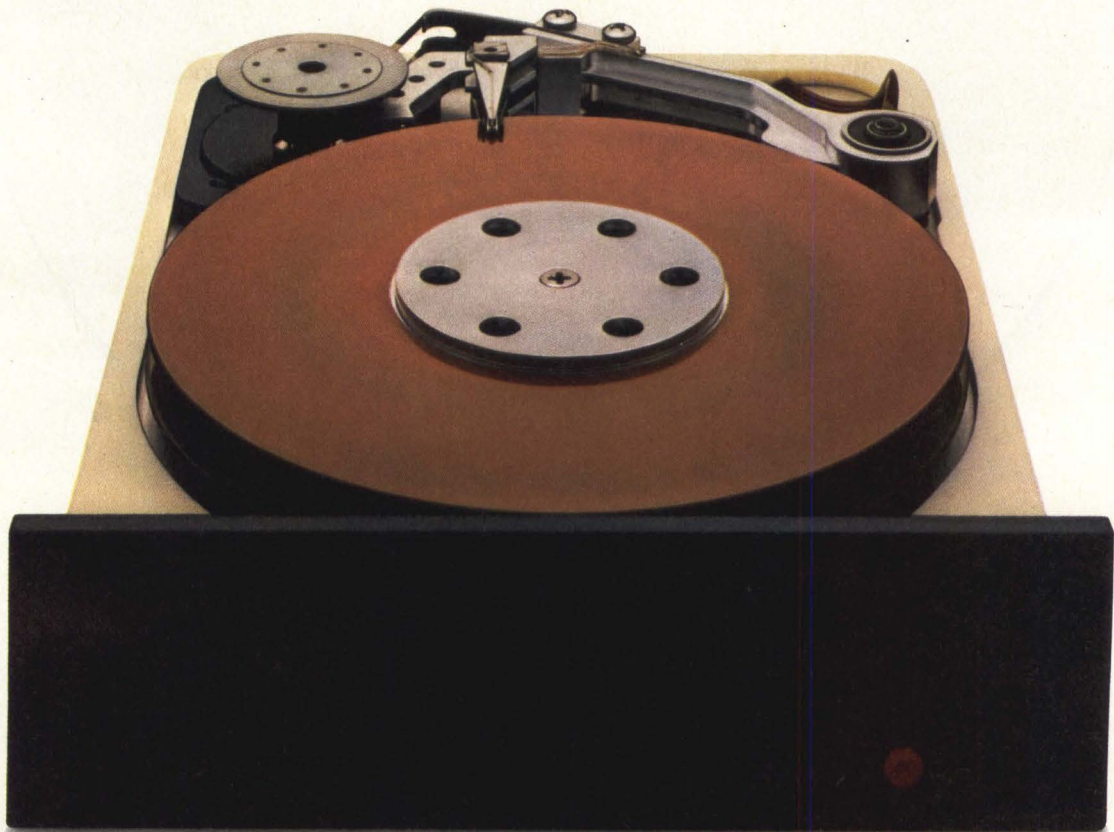

And wave goodbye to the competition.

Presenting the Shugart 712. Our new 5.25" half-height 10 Mbyte Winchester.

It's a high performance compact that redefines reliability. So much so, it outdistances all other half-height Winchester.

For starters, it runs at an MTBF of 20,000 power-on hours. That's 60% longer than other drives.

And it's roomy. With 10 Mbytes of formatted storage.

Plus four-point shock and vibration mountings, for a very smooth ride. And rugged enough to withstand up to 40 G's.

The 712 is based on 3370 flexure technology, bringing mainframe horsepower down to size.

And our new, low-mass head design complete with pre-amp is standard equipment, too. This makes flying height more uniform. And data integrity a given.

All this was made possible by our venture group approach. A specially chartered engineering and

manufacturing team that makes sure the bugs are out the first time out.

And we make sure they have everything they need. Like the \$40 million investment we made in capital equipment.

Which includes more progressive assembly lines. Class 100 clean tunnels. Even a more advanced spindle motor.

In short, everything you need for single-user personal computers. Intelligent workstations. And, down the road, multi-tasking software.

You won't have to reinvent the wheel every time you want to redesign, either. Thanks to our 1600 controller with built-in SCSI. Plus the drive level interface standard.

So test drive the 712 today. Or its 5 Mbyte version, the 706.

Just call your local Shugart sales office. Or, contact Hamilton/Avnet, our authorized distributor.

And find out how a little drive can take you a lot further.

Shugart

Right from the start.



Leading the way in touch technology

Carroll Touch

a subsidiary of AMP Incorporated

Touch technology is leading the way for more people to use computers in more ways than ever before... and Carroll Touch has been leading the way in touch technology for over a decade.

By using touch, you interact with your computer by simply touching the screen. With touch input systems, there are no command languages to learn and no typing skills to master.

When touch makes sense—with casual users, or in a harsh environment—we've got the touch. We're putting people in touch with these remarkable systems in applications ranging from industry, education and the military to public information and office automation.

Carroll Touch can lead you to the touch system that's right for your product. We design and manufacture hardware for a variety of standard monitors and terminals as well as custom designs. Get in touch with us to find out more.

In Touch With Technology

CIRCLE NO. 7 ON INQUIRY CARD

P.O. Box 1309
Round Rock, Texas 78680
512 244-3500 Telex 881906

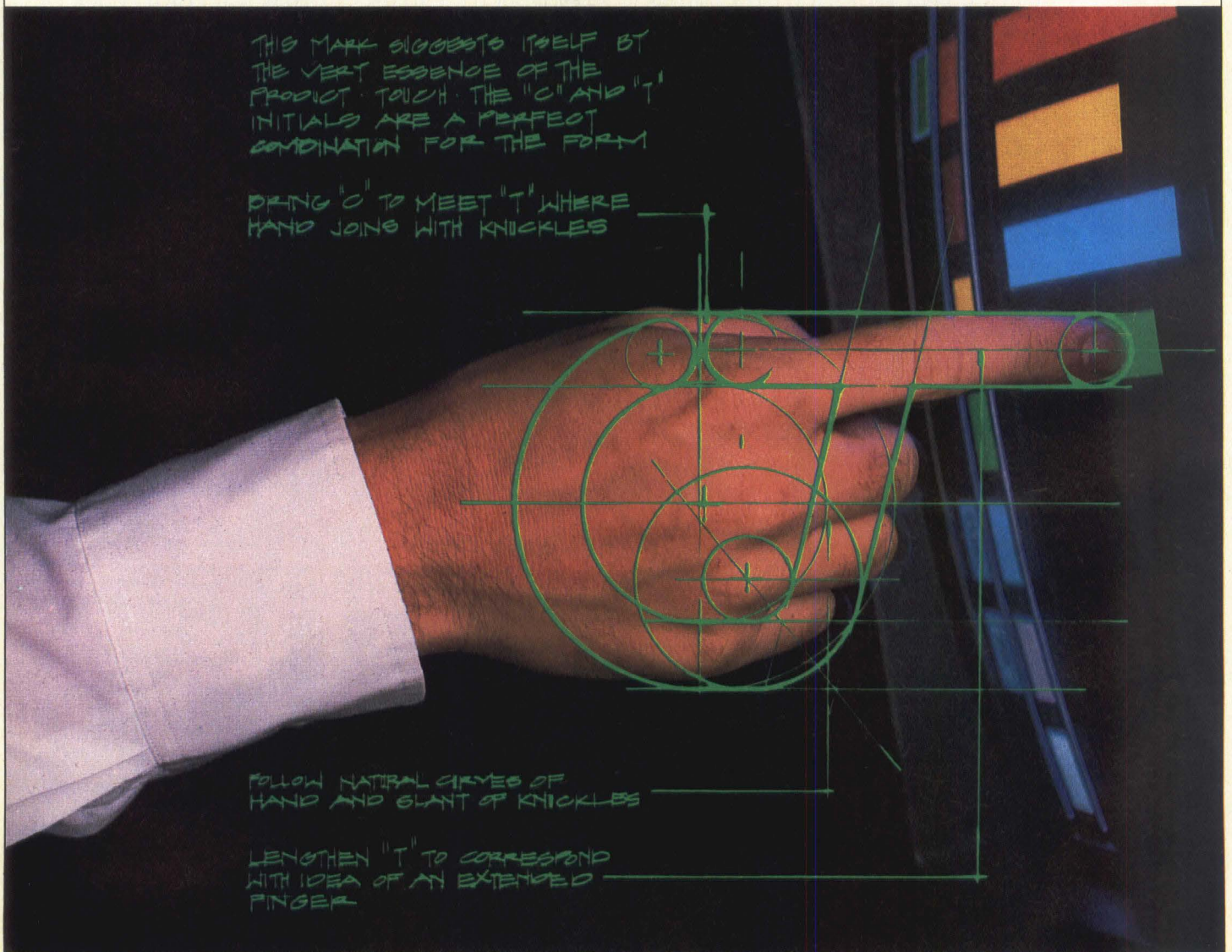



Printer market scores impressive gains

In nearly all markets and technologies, printer revenues and shipments established record statistics in 1983. In fact, according to the *1984 Printout Annual* published by Datek Information Services Inc. (Newtonville, Mass.), printer revenues and shipments by U.S. companies during 1983 jumped 32 percent to \$5.58 billion and 54 percent to 2.83 million units, respectively. And even though printers closely follow personal computer activities, current sales slowdowns in both areas won't block the achievement of still higher 1984 market levels.

As for overall market share, serial dot-matrix printers continued their dominant reign with 41 percent of the revenues and 66 percent of the shipments. Following far behind were serial, fully formed character printers cornering 25 percent of the market in both revenues and shipments. What's more, in 1983, about 65 percent of installed personal computers were connected to printers. By 1986, printer connectivity to computers, in the estimation of Datek, will leap to 80 percent.

Despite the boom in sales and deliveries, though, many U.S. printer manufacturers found it hard to stay in the profit column. Price cutting ran rampant throughout the printer industry and the resulting thin margins shrank profitability to shaky levels. Indeed, several U.S. printer manufacturers needed financial transfusions from their Japanese owners. Nevertheless, the U.S. printer industry pressed onward and continued to track the personal-computer industry in cost reductions and performance extensions. For example, by year-end 1983,

the average price of a daisywheel printer fell nearly 20 percent from its 1982 cost. As a result, low-cost daisywheels now list for under \$500.

But that's all in the past. What do system integrators have to look forward to in 1985? For one benefit, printer distribution channels should mature. After several years of battling for distribution positioning and visibility, most printer manufacturers have finally learned the values of generous margins, increased warranty periods, expanded ad support, skilled sales support and capable service centers. For another benefit, printer features abound and many once-optional parameters have become standard. The feature list is impressive: friction feed, continuous feed, near-letter-quality output, low noise levels, large print buffers, variable character fonts, dot-addressable graphics and multiple colors. Even the latest technologies sparkle with ink-jet color, non-impact thermal transfer and laser methods.

Consequently, printer market growth should advance unabated. For example, over the 1983 to 1986 period, Datek predicts that serial, fully formed character printers should nearly triple in units shipped; serial, dot-matrix printer shipments should increase by 2½ times; serial, non-impact printer shipments should skyrocket by more than 12 times and non-impact page printer shipments should zoom by 13 times. To keep posted on the fast-moving printer market during 1985, refer to this January issue, our annual printer special, and to our April and November Peripherals Digests.

A handwritten signature in cursive script that reads "George V. Kotelly".

George V. Kotelly
Editor-in-Chief

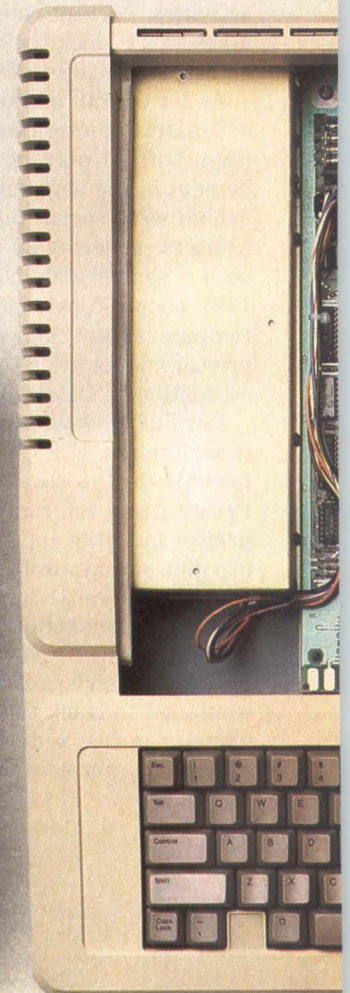
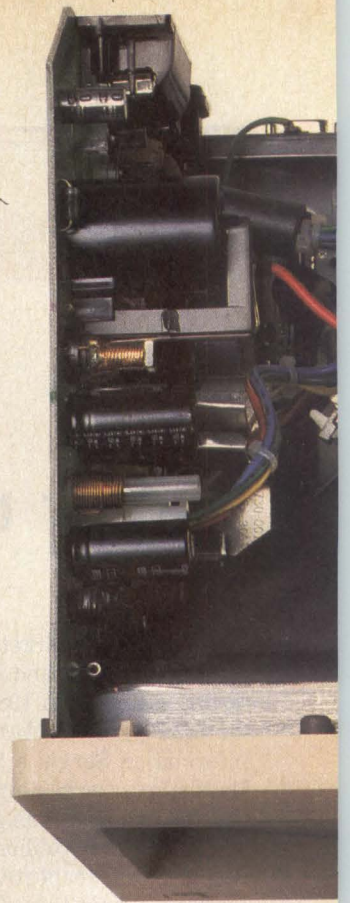
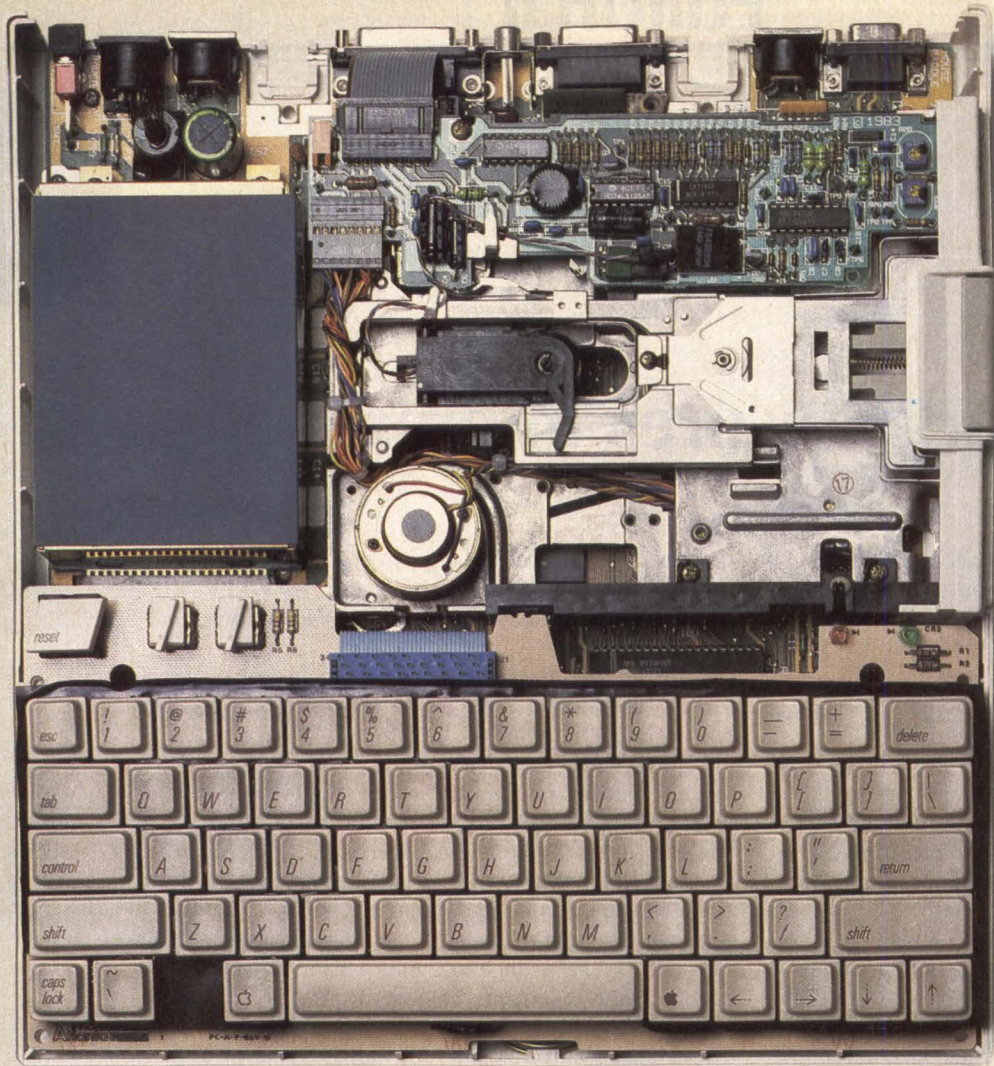

Pick our brains.

When you pick the technology you'll be building your name on, we not-so-humbly suggest you pick the technology we built our name on.

Apple technology.

Not, mind you, because we're the only ones who can offer VARs the technological versatility of the Apple® II family and the wizardry of Macintosh™ and Lisa®.

But because no matter which Apple you pick, you get all the brain power behind the machines that made the company. And the company that made the machines.

A complete VAR program that not only includes the standard technical documentation and programmer's tool kits, but financial, marketing, service and technical support. Plus VAR representatives to help you work out little details. Like how to merchandise your product. How to package it. How to develop it. How to pay for it. Even how to lease.

Just call 800-445-8277* and ask for the VAR sales representative nearest you.

Because picking our brains is as easy as picking up the phone.





The DEC[®] VT220 you've waited for still isn't here.

**But the No. 1
alternative is.**



pluses over a DEC. Yet, it costs less.

The pluses:

Four additional enhanced menus. Display. General. Auxiliary Port. And Keyboard.

A convenient front-mounted on/off switch, not rear mounted like DEC's. A keyboard jack near the front, providing more cable length. And a 3-position keyboard elevating mechanism.

Plus, two more LED's than you'll find on the DEC keyboard. One for online, the other for shift lock.

What DEC announces, CIE Terminals delivers. Faster. Better. And more economically.

The new CIT220+ is available right now.

It has at least a dozen

A bi-directional Auxiliary Port, not just uni-directional like DEC's. So you can add either a printer or second host.

Plus, variable speed smooth scroll for fast or slow review.

And the pluses go on, including even more built-in reliability. So it stumps us why anyone would go on waiting for a DEC when you can get the 220 with all the pluses right now.

For immediate information, call (714) 660-1421 or phone toll free 1-800-854-3322. Ask for our Information Desk. Or write CIE Terminals, 2505 McCabe Way, Irvine, CA 92714.

CIE TERMINALS
A C/TOH ELECTRONICS COMPANY

® DEC is a Registered Trademark of Digital Equipment Corp.
© 1984 CIE Terminals.

CIRCLE NO. 9 ON INQUIRY CARD

Breakpoints

PRIME PLANS TO BEAT DEC TO MARKET WITH HIGH-END 4-MIPS SUPERMINI

Several superminicomputer companies are known to be working on machines that will compete with Digital Equipment Corp.'s (DEC's) new high-end VAX 8600 system. Prime Computer Inc.'s offering—a 4-MIPS, ECL-based system priced around \$350,000—is expected late this month, according to industry sources. The Natick, Mass., company is also expected to beat DEC to the punch by shipping in volume next month—two months ahead of DEC's schedule. The new Prime system, which is said to be compatible with all other Prime 50 series superminicomputers, reportedly uses hardware refinements such as quadrupled cache memory and Primos operating system enhancements to boost performance by as much as 60 percent over the previous high-end 9950, but for \$20,000 less.—D. Bright

IBM SIGNS ON MCDONNELL DOUGLAS AS A CAD/CAM VALUE-ADDED RESELLER

In its drive into vertical industrial-automation markets, IBM Corp. has signed on yet another competitor as a value-added reseller of IBM equipment. McDonnell Douglas Corp., St. Louis, Mo., recently joined Computervision Corp. and Calma Co. as a reseller of IBM equipment. McDonnell Douglas plans to exhibit a system based on IBM's 4361 engineering minicomputer/mainframe at the National Design Engineering show in Chicago in March. McDonnell Douglas' Computer Integrated Manufacturing Technology Co. has reached \$105 million in revenue in CAD/CAM systems by using Digital Equipment Corp. and Data General Corp. computers. The company will continue to sell DEC and DG equipment, but it hopes the sale of IBM equipment will add \$100 million in revenues over the next two years. The basic McDonnell Douglas CAD/CAM system is about \$400,000.—L. Valigra

AT&T'S INTEGRATED VOICE-DATA WORKSTATION BASED ON CONVERGENT SYSTEM

According to documents filed with the Federal Communications Commission, AT&T Information Systems (ATTIS) plans to introduce an integrated voice-data workstation, the PC 7300, that features UNIX System V, advanced telephone features and a "mouse." Manufactured for ATTIS by Convergent Technologies Inc., Santa Clara, Calif., under the name "Safari 4," the workstation uses an MC68010 virtual memory processor and includes 512K bytes of RAM, a detachable keyboard, a 12-inch monochrome monitor and either a 10M-byte Winchester hard disk, or one or two ½M-byte, 5¼-inch floppy drives. Telephone features include call management dialing and line control services. The workstation's telephone circuits provide connections for a telephone headset and two telephone lines. ATTIS declined to comment on the product.—S. Shaw

NEC TO USE CP/M OPERATING SYSTEM IN JAPAN

NEC Corp., Tokyo, Japan, which traditionally uses proprietary operating systems with the hardware it sells in Japan, has signed an agreement with Digital Research Inc., Pacific Grove, Calif., and its Japanese subsidiary, Digital Research, Japan. The agreement is for use of Digital Research's standard CP/M operating system as the basis for NEC's series of

Breakpoints

microprocessors. The first stage of the agreement calls for Digital Research to deliver enhanced versions of CP/M for the V-30, a 16-bit processor scheduled to be marketed in May. Later, Digital Research will provide Concurrent DOS-86 and Personal CP/M modules, also enhanced for the V series processors.—I. Kakehashi

XEBEC PLANS TO REDEFINE STANDARDS TO HANDLE OPTICAL DISKS

Controller manufacturer Xebec, Sunnyvale, Calif., is considering redefining interface standards for small computer systems using optical disk drives. According to Phil Devin, Xebec's director of marketing, the company is thinking about redefining the Small Computer Systems Interface (SCSI) for 16-bit bus architectures. Devin claims this will provide a cost-effective alternative to the impending standard Intelligent Peripheral Interface (IPI). Xebec also planned to call together members of the Enhanced Small Disk Interface (ESDI) committee in mid January in Denver to discuss adding to the ESDI standard the proper track, error correction and timing to handle optical drives.—C. Warren

FARADAY TO INTRODUCE HALF-SIZE IBM PC-COMPATIBLE MOTHERBOARD

Faraday Electronics, Sunnyvale, Calif., plans to unveil this month the FE6500, a space-saving, half-size IBM PC-compatible motherboard in a standard IBM plug-in board format. The FE6500 is said to comprise all the functions of the IBM motherboard along with two serial ports and one parallel port. The board comes with 32K bytes of PROM and 64K bytes of RAM with an option for 256K bytes of RAM. Faraday expects to have prototypes available in the third week of January and production quantities in late March. The FE6500 is priced at \$495.—T. Moran

EXPANDABLE SUPERMINICOMPUTER SUPPORTS 256 USERS

Pyramid Technology Corp., Mountain View, Calif. will roll out its 90Mx expandable superminicomputer this month. Intended for large software development groups or distributed, computing network users, the master/slave proprietary processors are said to increase throughput 1.6 to 1.8 times over Pyramid's single-processor 90x system. A \$221,000, 16-user, entry-level 90Mx consists of the OSx operating system, a 415M-byte Winchester drive, a 1,600-bpi magnetic tape drive, and 4M bytes of RAM. A \$420,000 maximum configuration with 32M bytes of RAM and eight 415M-byte Winchester disk drives will support as many as 256 users. Present users of a 90x system can upgrade to a 90Mx for about \$75,000.—T. Moran

PROPOSED WORLDWIDE NETWORK WOULD TEST INTERCONNECTION PROTOCOLS

Manufacturers implementing the protocols specified by the International Standards Organization for Open Systems Interconnection (OSI) are being urged to set up a worldwide network to test the protocols by communicating with each others' computers. The National Bureau of Standards (NBS), Gaithersburg, Md., is promoting the network, but the participating companies will fund it, says the head of the NBS systems and architecture division, Dr. John Heafner. He notes that 35 companies have expressed an

OUR MULTIBUS CONTROLLERS ALREADY SPEAK YOUR LANGUAGE.

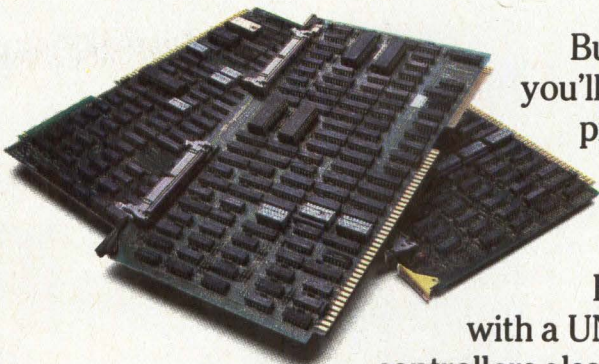

Buy anybody else's multibus* controllers and you'll probably spend a lot of time and money programming them to communicate with your system.

Buy ours and you can start talking right away.

Every Systech multibus controller comes with a UNIX Device Driver.** And because our controllers also contain a self-test program, you can install and check them out without CPU support or software development.

Systech engineers have considerable experience with the Motorola 68000 microprocessor, various hardware technologies and the UNIX operating system. This experience plus our software support ensures easy integration of our controllers into your systems.

We also ensure quality and reliability by subjecting our finished products to extreme variations of temperature and voltage in our environmental test chambers.

And we back our products with extensive technical documentation, a 12-month warranty and the best customer service program in the industry.

Applications of our multibus controllers include printer controllers, tape controllers and multi-channel communication controllers for multibus-based computer systems. For details, please send in the attached card. Or contact Systech Corporation, 6465 Nancy Ridge Drive, San Diego, CA 92121; (619) 453-8970.

You'll find that we speak your language, too.

ST **systech**™

*Multibus is a trademark of Intel Corp. **UNIX is a trademark of Bell Labs. Available to licensed users.

Our "Back to Basics" Solution To Your Accounting Needs.

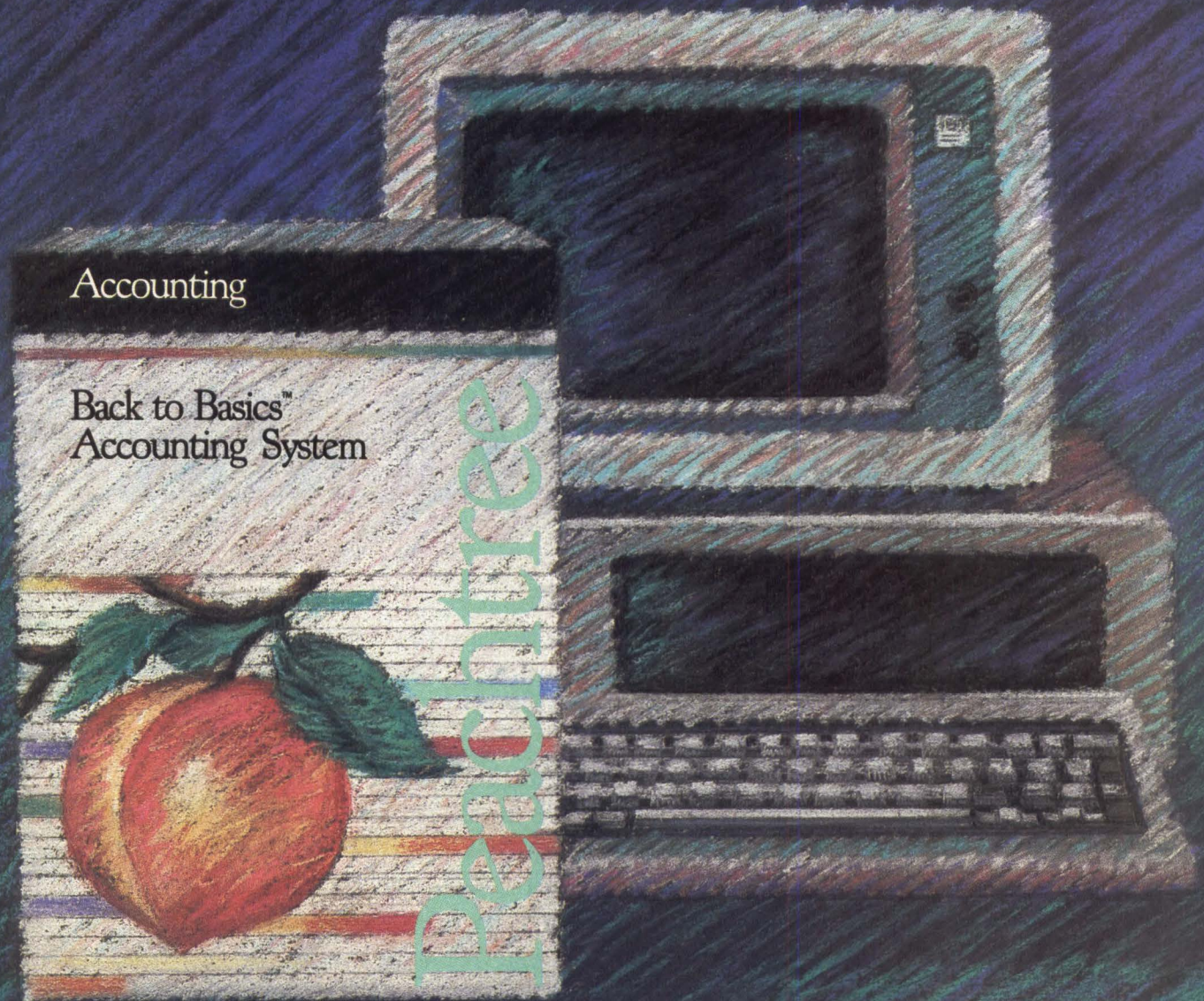

Back to Basics Accounting System by Peachtree Software® is an uncomplicated, easy-to-learn accounting system for small businesses.

You don't need any accounting experience and barely need any computing experience. The straightforward manual teaches both accounting and computing at the same time.

But make no mistake. This is a full-featured, interactive system including General Ledger, Accounts Payable and Accounts Receivable. And it's available for IBM®, Apple®, Atari® and Commodore microcomputers.

Uncomplicated—easy-to-learn—yet full featured. That's Back to Basics.

For more information, contact your local dealer or Peachtree Software, 1-800-554-8900.

**America's Software
grows on the Peachtree.**

Peachtree Software

Apple is a registered trademark licensed to Apple Computer, Inc. Atari is a registered trademark of Atari, Inc. IBM is a registered trademark of International Business Machines Corp. Peachtree and Peachtree Software are registered trademarks of Peachtree Software Incorporated, an MSA Company.



CIRCLE NO. 11 ON INQUIRY CARD

Breakpoints

interest in participating, including those that took part in the demonstration of OSI functions at last July's National Computer Conference. Those companies included IBM Corp., Digital Equipment Corp., Hewlett-Packard Co., Intel Corp. and Motorola Inc.—K. Jones

IBM EMPHASIZES TELECOMMUNICATIONS

IBM Corp. has realigned its Information Systems and Communications Group to emphasize its telecommunications products. The company has named Stephen B. Schwartz, former president of Satellite Business Systems Inc. (SBS), to be assistant group executive for telecommunications products in the newly formed Information Systems and Products Group. Effective January 1, Schwartz will coordinate product development and joint marketing efforts between IBM and recently acquired Rolm Corp. His added responsibilities include managing joint-marketing efforts between IBM and SBS, a satellite carrier in which IBM holds a 60 percent interest.—S. Shaw

COMPLEX SOFTWARE HINDERING MRP SYSTEMS

Three out of four materials resource planning (MRP) systems currently installed—representing about \$7 billion worth of hardware and software sales in the past eight years in the United States—are failing to some degree. That's according to a study by International Data Corp., Framingham, Mass. Adam Zais, senior analyst at IDC, says a principal reason for the failures is that the software is too complicated, making the systems too difficult to use. Better software and more predictable systems are on the way, he notes. Manufacturing-information systems, of which MRP is a part, represent a \$2.45 billion market that is growing at a compound annual rate of 35 percent.—J. Donohue

JAPANESE SOAP MAKER TO ENTER THE FLOPPY MEDIA BUSINESS

Fifteen Japanese companies making floppy-disk-drive media should be joined by Japan's largest soap maker, the Kao Corp., this spring. Kao plans to manufacture disks of its own design for OEMs, as well as sell them under its own label. A company spokesman dismissed skepticism expressed by several Tokyo-based analysts about the wisdom of Kao's entry. The spokesman refused to detail Kao's sales objectives, which have been estimated by industry sources at around one million disks per month. Japanese floppy media makers expect to sell 85.6 million disks during the fiscal year ending March 31.—I. Kakehashi

PRIVATE COMPANIES TO OFFER DATA, OTHER SERVICES VIA SATELLITE

Private trans-Atlantic data networks carried via satellite have been approved by the White House. That policy decision effectively breaks the 20-year monopoly enjoyed by Intelsat, the 109-country organization formed to provide international satellite services. In addition to data services, private satellite networks will now be able to offer video teleconferencing and corporate voice and digital transmission services, but will not be allowed to compete for public-switched message services. The prospect of competition to Intelsat was first raised two years ago when a Washington, D.C.,

Breakpoints

company, Orion Satellite Corp., applied to the government to build and operate a trans-Atlantic satellite system.—S. Shaw

EXXON PUTS UNPROFITABLE VERBEX ON AUCTION BLOCK

Verbex, a Bedford, Mass. vendor of voice-recognition systems, is up for sale by its parent, Exxon Enterprises Inc. Although Verbex is at the forefront of its technology, the emerging voice market has not developed quickly enough for the company to be profitable, says an Exxon spokeswoman. She confirms that Exxon has been talking secretly with potential buyers for several months, but emphasizes that nothing has been finalized and that Verbex will continue operations under Exxon's ownership. Verbex officials could not be reached for comment. In an effort to stimulate sales, Verbex had recently scaled its \$25,000 voice-recognition system down to a \$4,900 unit that attaches to the IBM PC.—D. Bright

LASER PRINTER EMULATES EPSON AND DIABLO PROTOCOLS

Corona Data Systems Inc., Thousand Oaks, Calif., will offer two printer-emulation software enhancements to its \$3,395 Corona Laser Printer, which is based on the Canon LBP-CX print engine. An Epson MX-80 and FX-80 emulation package that will support both text and graphics is expected to be available in the middle of this month, while a Diablo 630 emulation program is projected for February or March availability. Said to be the first of their kind for low-end laser printers, the upgrades will be included in the Corona Laser Printer's basic price. Present owners can receive free updates.—

T. Moran

TECH FILES: A QUICK LOOK AT INDUSTRY DEVELOPMENTS

MINI FILES: NYNEX Business Information Systems and Data General Corp. have signed a \$65 million agreement to market DG's office automation systems in New England and New York. Under the three-year contract, NYNEX will offer DG's Eclipse MV family of superminicomputers, the Desktop Generation microcomputers and the Data General/One portable computer. DG has a similar agreement with PacTel Communications Systems, which, like NYNEX, also is a regional Bell Operating Company.—D. Bright

For the second year running, **Digital Equipment Corp.** (DEC) has sponsored a large exhibition of its own equipment in Boston. While the first DECtown show attracted the company's sales staff and some customers, the DECworld show held last month was aimed at 6,000 to 8,000 large customers. The company used the week-long extravaganza to spotlight its interconnect capabilities: It tied together computers totalling 50 million instructions per second and disk drives totalling 50G bytes via an Ethernet local network.—L. Valigra

COMMUNICATIONS FILES: Intel Corp. recently joined the effort by networking companies to lower the price for local area networks. The company introduced a single-



You won't get over what this 350 CPS printer does for under \$2,000.

When you see what the CI-3500 Serial Printer can do, you might not believe it's priced under \$2,000.

Besides giving you data processing printing at 350 CPS, the CI-3500 delivers letter quality printing at a rapid 87 CPS—more than twice the speed of most daisy wheel printers.

And you also get the capability for high resolution graphics, up to 240 X 144 DPI.

The office friendly CI-3500 is as flexible as it is versatile, especially for a table top, workstation printer. For example, a convenient interface cartridge system allows you to change your printer interface simply by changing cartridges.

A DEC-LA100® compatible cartridge is standard, but additional cartridges are available for interfacing with other systems, such as the IBM PC.

A similar font cartridge system accommodates multiple fonts and character sets, so you can avoid costly PROM installations.

The CI-3500 Serial Printer for under \$2,000. Whatever you need in a printer, you won't get over what it will do for you. To find out more, just write or call CIE Terminals, 2505 McCabe Way, Irvine, Ca. 92714-6297. (714) 660-1421.

Or call toll-free 1-800-854-3322
In California, call 1-800-432-3687.



CIE TERMINALS
A CITECH ELECTRONICS COMPANY

® DEC LA100 is a Registered Trademark of Digital Equipment Corp.
© CIE TERMINALS, INC. 1984

They Called It Impossible.



We Call It Micronet.™

Imagine IBM PCs, intelligent workstations and S-100 BUS multiuser systems all on the same local area network.

Impossible?

Not with MicroNet, Intercontinental Micro's networking solution.

The key is a unique hardware and software approach to local area networks.

You get the flexibility of 8-bit and 16-bit processors on the same network, the cost savings of shared peripherals, and expandability to over 4000 users.

You simply organize the network the way you want, mixing IBM PCs, S-100 BUS multi-user systems, S-100 BUS file servers, and workstations.

Intercontinental's sophisticated single board computers, 8-bit and 16-bit slaves, memory and interface boards make your job even easier. MicroNet will work with almost any S-100 BUS system including IMS, Teletek, and any other S-100 master featuring phantom deselection or extended addressing capability.

The ability to run PC-DOS, MS-DOS, CP/M, MP/M, and other applications programs means whatever the future holds, MicroNet is ready.

And so is Intercontinental Micro.

You see, our S-100 BUS products revolutionized an industry. Intercontinental's slaves, masters and memory boards introduced advanced features like Direct Memory Access and Memory Management to micro environments. MicroNet.™ The new net-



working solution from the company that's been building networking solutions for years.

Still think MicroNet's impossible?

Then call, write or circle the bingo number below—we'll send you complete information on MicroNet and descriptions of all our products, including the most complete S-100 BUS product line in the business.

OUR COMPLETE MICRONET AND S-100 BUS PRODUCT LINE

CPS4800X-SINGLE BOARD COMPUTER.

4 or 6 MHz processor (Z80A/B), onboard floppy disk controller, 64K RAM, 4 channel DMA controller, 24 line parallel I/O port, two serial I/O channels, real time clock. Memory mapped or I/O mapped capability.

CPS-16X — 16-BIT 8086 SLAVE PROCESSOR.

256K, 512K or 1MB RAM, bank selectable, memory mapped, two serial ports, 24 line parallel I/O port, 8 MHz.

CPS-BMX/MX — Z80 SLAVE PROCESSORS

4 to 6 MHz processors, 64K RAM or 128K bank selectable memory, two serial ports, 24 line parallel I/O port.

256KMB — MEMORY BOARD.

Hard disk cache, linear addressable to two megabytes, bank selectable in 16K increments, configures for phantom deselection, parity error detection.

LANS100 — MICRONET FOR S-100 BUS SYSTEMS

ARCNET controller meets 696.2/D2S-100 spec, coax cable interface, 255 nodes per network segment, 2.5 megabit/sec. data rate.

LANPC MICRONET FOR THE IBMPC

Plug-in expansion board with custom software drivers integrates IBMPC into MicroNet networks. 64K or 256K RAM options available.

WS80X-DISKLESS WORKSTATION

Converts almost any dumb terminal into intelligent workstation with networking capability. Floppy and hard disk options available.

PERSONALITY BOARDS —

SASI, Centronix, PRIAM, Clock/Calendar, RS232, Modem, RS422, long distance serial communications (up to 4000 Ft.)



4015 Leaverton Ct., Anaheim, CA 92807, (714) 630-0964, TELEX: 821375 SUPPORT UD

TurboDOS is a Trademark of Software 2,000, Inc. ARCnet is a Trademark of Datapoint. CP/M, CP/M 86, MP/M, MP/M 86, CP/M PLUS, Concurrent CP/M 86 are Trademarks of Digital Research. PC-DOS, IBM-PC are Trademarks of International Business Machines. MS-DOS is a Trademark of Microsoft. TurboLAN, MicroNet are Trademarks of Intercontinental Micro Systems.

CIRCLE NO. 13 ON INQUIRY CARD

Breakpoints

chip LAN controller, designated the 82588, that lets users connect to a network for as little as \$250 per node, or about one-sixth the cost per user on the Ethernet. The 82588 supports the IEEE 802.3 local networking committee's emerging standard for personal computers. That proposal includes the IBM PC Network and the STARLAN. STARLAN is a low-cost network that uses existing telephone wire installations. The 82588 controller is \$45 in quantities of 1,000. Volume production is scheduled for next quarter, but samples are available now.—L. Valigra

MICRO FILES: Phoenix Software Associates Ltd., Norwood, Mass., recently sold its IBM PC-compatible, ROM basic input/output system for the DOS operating system to four manufacturers. The four—Tandy Corp., Kaypro Corp., Wyse Technology and Zaisan Inc.—have developed new IBM PC-compatible computers using off-the-shelf Phoenix firmware. Phoenix reports that it is also working with more than 22 manufacturers in developing 80286-based products. The IBM PC-AT is based on the 80286.—D. Bright

SOFTWARE FILES: Fulcrum Technologies Inc., Ottawa, Canada, is offering the Ful/Text information retrieval package that can locate any word, phrase or word in context in large, document files. The software package builds an index in batch mode of all the text items stored in a file. It is currently available only for UNIX-based systems. The company plans to have a network version and a version for the IBM PC running PC-DOS by March.—C. Warren

French software developer **Memosoft**, Paris, is introducing Memdos/PC and interpretive BASIC for the IBM PC. The new BASIC supports windows and mouse pointing devices and can address the full 640K bytes of system memory. In addition, the language has a binary-coded decimal floating point, a computer-aided software engineering function and an application screen generator. The planned price is less than \$100.—C. Warren

RANDOM DISK FILES: Fujitsu America Inc., San Jose, Calif., plans to introduce a new family of disk drives late this quarter. The family will include 500K-byte and 1M-byte, half-height, 3½-inch flexible drives, and a half-height, 1.6M-byte, 5¼-inch flexible drive, says Norman Peterson, senior vice president of Fujitsu's OEM storage division. To complement these products, Fujitsu also expects to introduce a family of half-height, 3½-inch Winchester drives with capacities of 6M, 12M and 20M bytes.—C. Warren

NOTES FROM OVERSEAS: With the blessings and financial backing of the British government, British companies **GEC Plc.**, **Ferranti Computer Systems Ltd.**, **ICL Plc.**, **Plessey Co. Plc.**, **Racal Electronics Plc.**, **Standard Telephone and Cable Plc.**, **British Telecom Plc.** and **Thorn EMI** are reportedly teaming up to challenge IBM Corp.'s effort to develop an advanced computer architecture. The companies' combined effort, code-named "AWSAP" for Advanced Workstation and Systems Architecture Project, is a four-year, \$5 million joint venture that is set to kick off in the next few weeks. Member companies will share the results of the common workstation architecture.

Breakpoints

The products should conform to international standards and hook into products such as IBM's systems network architecture.—M. O'Gara

The Yokogawa Hokushin Electric Corp., a big supplier of printers for OEM customers in the United States, plans to start offering products stateside under its own brand name. One of the first will be a thermal-transfer printer that can be switched to print either in draft or near-letter-quality mode within a 24-dot-square matrix. The printer works with thermal paper or with plain paper and a thermal-transfer ribbon, printing 60 characters per second. The initial model will take paper 10 inches wide, but Yokogawa Hokushin will follow later this spring with another model that will take 16-inch-wide paper. Prices have not been set yet, but a Japanese version of the same machine is available for ¥148,000 (about \$600).—I. Kakehashi

Now that Rolm Corp. has launched its IBM PC-compatible Cedar workstation (MMS, November, 1984, Page 31), Cedar-like machines are ready to flood the market. One of the first to say "me too" is Britain's premier computer maker, **ICL Plc.**, whose entry is called One Per Desk (OPD). Produced in collaboration with Sinclair Research, OPD looks like Sinclair's 68008-RUN QL microcomputer. Both machines run the same word processing, spreadsheet, database and graphics packages. ICL has included an advanced imbedded telephone, a proprietary real-time, multitasking operating system and communications in OPD. ICL claims the \$1,450 base price is the lowest in the industry. The product should be available in the United States later this year.—M. O'Gara

The first British-designed, British-built, half-height, ¼-inch cartridge drive for Winchester backup is being offered by the Sintrom Group's manufacturing arm, **Perex Ltd.** Perex wants to capture 20 percent of the European market in the next 12 months. Then it will move into the United States, where it hopes to gain a five-percent market share by the end of 1986. Perex' new 5¼-inch Peristream drive holds 45M bytes of formatted storage using standard tape cartridges, and 65M bytes with the company's new high-coercivity tape. The unit reportedly offers a 90K-byte-per-second transfer speed, or 300K bytes per second from a 2M-byte buffer. In 12 minutes, 45M bytes of data can be backed up. Peristream is hardware- and software-compatible with U.S. Quarter-Inch Cartridge (QIC) committee standards. It will be offered in England for \$800 in quantities of 500.—M. O'Gara

By 1986, **NEC Corp.** wants to pull ahead of Fujitsu Ltd. in production of gate arrays for the Japanese market. The demand for such semiconductor devices is now valued at \$12.2 million. NEC is building a plant at Sagamihara, which they expect to have ready by September, to raise its production capacity. NEC now holds about 16 to 17 percent of the domestic Japanese gate-array market. The demand in Japan for gate arrays is expected to grow 50 percent in this Japanese fiscal year, which ends March 31. NEC expects to sell about \$4.1 million in gate arrays for the fiscal year.—I. Kakehashi



BUILT FOR SPEED

CompuPro has now dramatically increased your micro-computing power and speed.

With our System 816/F™ super-micro with CPU 286/287™ board. The computer that gives you results. Fast.

Built to provide sophisticated computer users with the fastest 16-bit system available, the System 816/F is a multi-user computer so powerful it virtually has no supermicro peer.

The reason for such a strong statement? We configure the system around the 80286—among the most powerful 16-bit processors available anywhere and one that's built for speed. The 286/287 board lets you run anything from the 8086/8088 family and includes the 80287 math processor and as much as 16 Kb of EPROM on-board.

But this board is only part of the story. CompuPro has included a long list of features that enhance this exclusive system even more. Like 1.5 Mb of our

MDRIVE®/H—a solid-state disk with the capacity to dramatically increase the speed of the 286 processor even more ... 512 Kb of 16-bit main memory expandable to 16 Mb ... 1.2 Mb floppy disk and up to 80 Mb of hard disk storage ... 12 serial ports ... and much more.

And even though our System 816/F has set some industry standards, we still designed it to conform to the IEEE 696/S-100 bus standard. And virtually no one else can say that.

The time you save with CompuPro will save you money, too. Our System 816/F speeds up software development. So the quality and capacity of your programs is enhanced, and the value, maximized.

The CompuPro System 816/F. It's the essential system for OEMs and system integrators who want all the power and speed they can get. And best of all, we've shipped hundreds of them already.

CIRCLE NO. 14 ON INQUIRY CARD

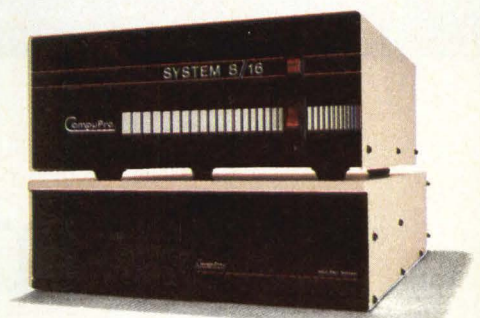

The Essential Computer™

CompuPro®

A GODBOUT COMPANY

3506 Breakwater Court, Hayward, CA 94545
(415) 786-0909

MDRIVE is a registered trademark and System 816/F, CPU 286/287 and The Essential Computer are trademarks of CompuPro. Front panel shown is available from Full Service CompuPro System Centers only. ©1984 CompuPro.

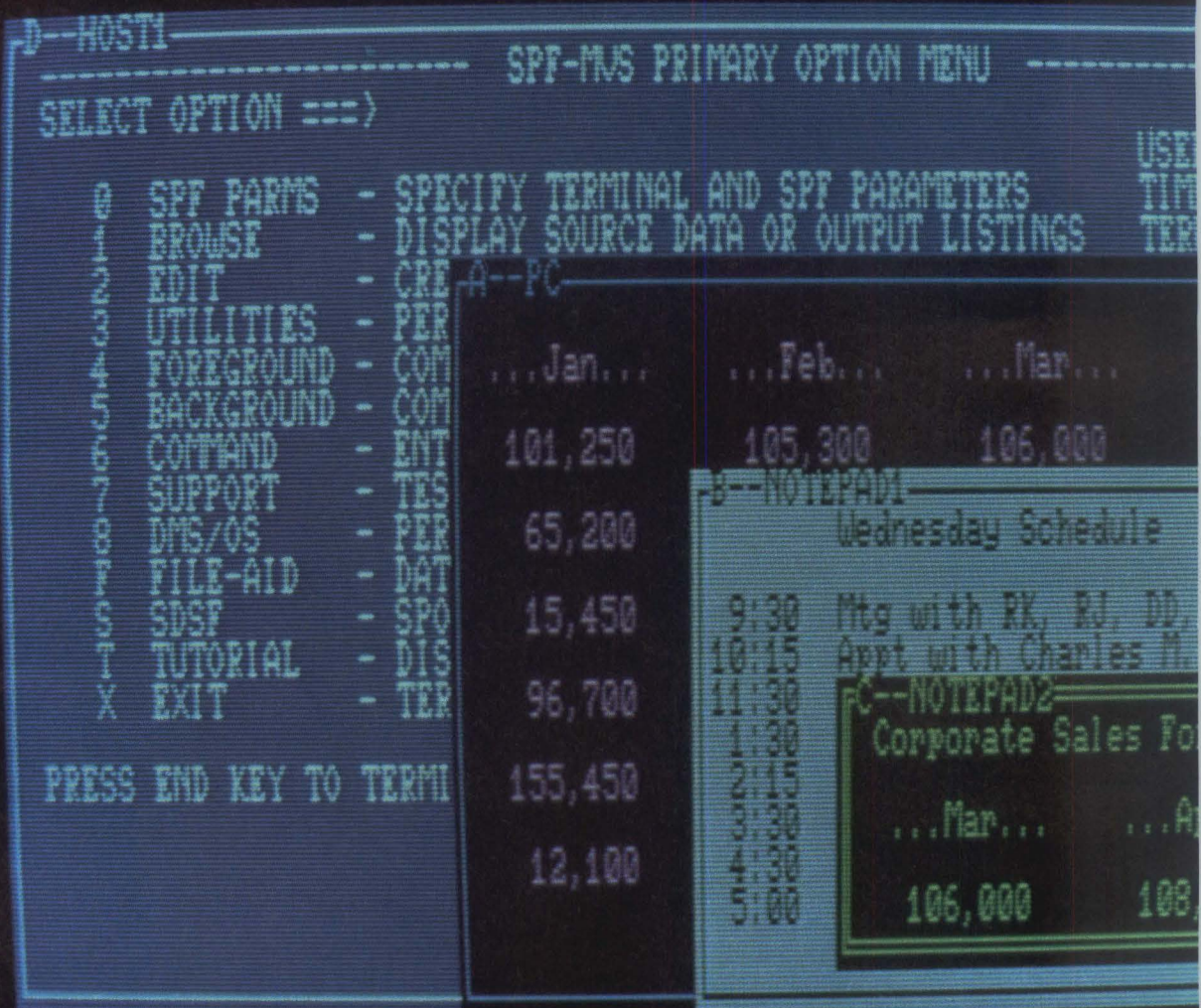

C9

Compared to this,
other 3278/79 emulators
aren't much to look at.



Look closely.

This isn't your everyday 3278/79 emulator. Ours gives you much more to work with. Namely, a host session, a PC DOS session and two notepads. All on the same screen. At the same time.

We call it the CXI 3278/79 PLUS PC connection.

Fortunately, it's easier to use than it is to say.

There's no toggling back and forth between sessions. No shuffling floppies to move information.

The 3278/79 PLUS turns an IBM[®] PC, XT or compatible into a 3278 or 3279 terminal. Plus a lot more. So now everyone can have the most current data at their fingertips. In a format they all can use.

It comes in two versions. Either a coaxial or modem connection. And both versions provide fast, easy file transfers between a PC and a CMS or TSO host. There's even a batch file generator that serves up multiple files with just a few keystrokes.

And for your colleagues overseas, international keyboard mapping comes standard.

But perhaps the biggest advantage of

our emulator board is its small size. It's just five inches long. (Or short, depending how you look at it.) Which means it fits conveniently into a PC's short expansion slot. Leaving the long slots for the rest of the world.

For those who need additional host sessions, we also offer the CXI 3270 PC connection. It displays five host applications, a PC DOS program and two notepads—simultaneously.

All our CONNECTWARE[™] products are available on a 30-day free trial basis. So for a closer look, call 800/221-6402. In California, call 415/424-0700. Or write CXI, Inc., 3606 West Bayshore Road, Palo Alto, CA 94303. Telex 821945.

Because compared to our 3278/79 emulator, there is no comparison.

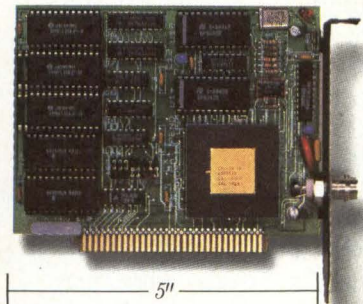

A custom gate array lets us fit our 3278/79 emulator on a 5" board and still offer more capability than all the rest.



DIGITAL DISPLAYS THE TERMINALS BEST ENGINEERED FOR BUSINESS.

Before you make any investment in business graphics terminals, it really pays to investigate what you'll be using them for.

If you're like most businesses, your terminals will be used approximately 70% of the time for generating text and numbers. And only around 30% of the time for strictly graphics purposes. The October 1983 *Infosystems* article, "How to Buy Graphics Displays," coauthored by Jim Warner, CEO of Precision Visuals, Inc.,[®] states, "While it may be true that one picture (chart, graph) is worth a thousand words, there will always be the need for words, thousands of words, in the day-to-day activity of the office. Special graphics-only devices can have limited value in a general office environment."

At Digital, the first step in engineering every product we make involves a thorough analysis of who will use it, what it will be used for and which features will help make people more productive in their jobs.

That's been true of every terminal we've designed and helps explain their widespread acceptance and popularity.

And you'll find it's equally true of Digital's latest entries, the VT240™ and VT241™ terminals.

ENGINEERED BEST FOR WHAT YOU NEED MOST.

As the newest members of Digital's family of terminals, the VT240, a conversational

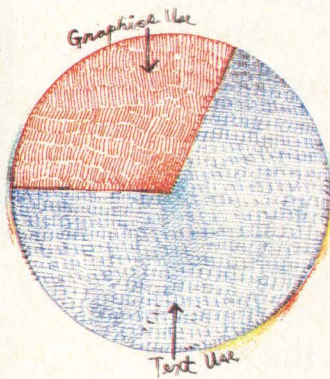

text and graphics terminal, and the VT241, with the added

dimension of color, continue the tradition of engineering excellence for performance. They offer full VT100™ compatibility to take advantage of a host of offerings already developed. And to meet the needs of the business environment, you'll find a set of standard text features that are either unavailable on other terminals or may have to be purchased at an additional cost.

These features include bidirectional smooth scrolling, split screen, a choice of 80 or 132 columns per line and a double width/double height format. A highly legible 8 by 10 dot matrix character font displays true ascenders and descenders for exceptional crispness and legibility. If cer-

tain information needs to be highlighted, you can select from a combination of bold print, blinking and underlining in either normal or reverse video. For your added convenience, there's even a built-in printer port for printing hard copy.

Both the VT240 and VT241 terminals give you the option of erasing selected character positions on the screen for more efficient communications and increased productivity. For those applications that require data to be entered by filling in the blanks of a form, once the data has been accepted by the host, the filled-in information—and only that—can be erased by means of a single command. The form itself remains up on the screen and is ready to accept the next data entry sequence.

Beyond this remarkable range of text capabilities, the VT240 and VT241 clearly answer your graphics needs as well.

HIGH-IMPACT PRESENTATIONS IN GRAPHIC DETAIL.

The inclusion of a diagram, chart or graph in any report or presentation can immediately transform complex data into easily understandable information.



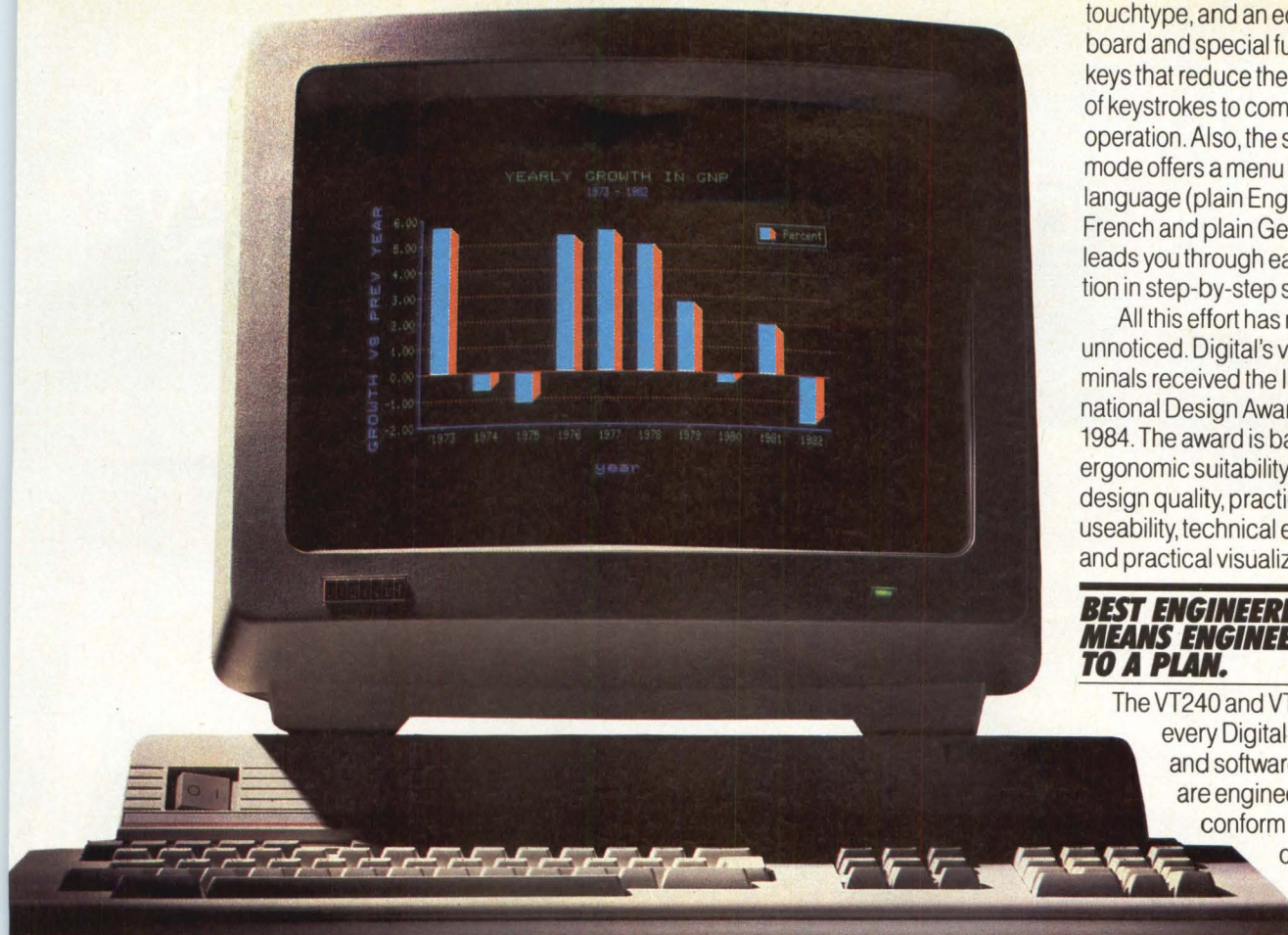

touchtype, and an editing keyboard and special function keys that reduce the number of keystrokes to complete an operation. Also, the set-up mode offers a menu in plain language (plain English, plain French and plain German) that leads you through each operation in step-by-step sequence.

All this effort has not gone unnoticed. Digital's video terminals received the International Design Award in 1984. The award is based on ergonomic suitability, safety, design quality, practical useability, technical excellence and practical visualization.

**BEST ENGINEERED
MEANS ENGINEERED
TO A PLAN.**

The VT240 and VT241, like every Digital hardware and software product, are engineered to conform to an overall

Both the VT240 and VT241 terminals generate bit map graphics in a choice of two protocols—Digital's ReGIS™ (Remote Graphics Instruction Set) and Tektronix 4010/4014™



ReGIS lets you create and store business graphics as simply as producing ASCII text. With VAX-11 DECgraph™ and VAX-11 DECslide™ software, even a novice can prepare graphs and charts and turn them into slides. Self-explanatory icons let you

choose a box, circle, line, polygon, triangle or arc.

The Tektronix 4010/4014 protocol supports the full array of existing 4010 compatible graphics software. Besides, Tektronix Plot 10,™ TELL-A-GRAF™ and DISSPLA™ from ISSCO® and DI-3000,™ GRAF-MAKER™ and GRAFMAS-TER™ from Precision Visuals are also supported.

When you're using third party software, Digital provides you with the total hardware/software solution: video terminals, hard copy with the LVP16™ Pen Plotter and the VAX™ computer.

**THE HIGHEST AWARD
FOR ERGONOMIC
DESIGN.**

Your people have to spend long hours in front of a terminal. It stands to reason the easier they are to use, the more productive the results.

That's why so much time and thought have gone into the

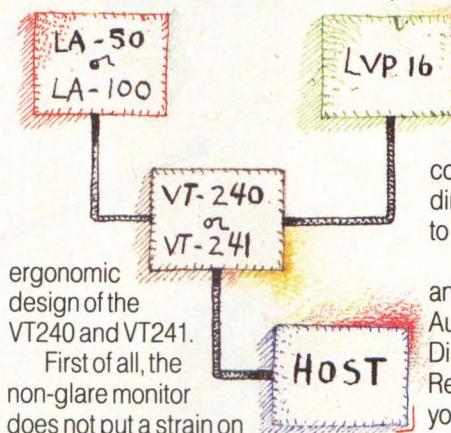

ergonomic design of the VT240 and VT241.

First of all, the non-glare monitor does not put a strain on the eyes. Plus, it tilts to adjust to the exact viewing angle that's most comfortable to work with. The detachable keyboard is ruggedly constructed, yet light enough to place on your lap. Even the way the keyboard has been arranged boosts productivity.

There's a standard typewriter keypad so you can

computing strategy. This means our products are engineered to

work together easily and expand economically. Only Digital provides you with a single, integrated computing strategy direct from desktop to data center.

For more information and the name of the Authorized Terminals Distributor or Digital Representative near you, call 1-800-DIGITAL, extension 700. Or write

Digital Equipment Corporation, 2 Mount Royal Avenue, UP01-5, Marlboro, MA 01752.

**THE BEST ENGINEERED
COMPUTERS
IN THE WORLD**

digital™

OEMs... Is Your Input Strategy As Sound As Your CPU Strategy?



A. **Joy Disk** — Four keys in one; rapid cursor control.

B. **Touch Pad** — Multi-purpose input device; programmable key pad, cursor control, drawing tablet.

C. **Speech Recognition** — Natural, language independent command entry. Hands free operation.

D. **Mouse** — Popular pointing and selecting tool.

E. **Bar Code** — Fast, accurate data capture.

Computer users are demanding additional input devices from you. Key Tronic can help you meet the demand for these input devices, and minimize your development costs.

Key Tronic is integrating the most popular input devices into OEM keyboards. All processing is done in the keyboard and no additional system ports are required . . . using existing electronics saves money. Also, all input can be presented as a series

of key presses to assure compatibility with existing and future software.

Speech Recognition, Touch Pad, Mouse, Bar Code and Joy Disk are available to enhance your product with unique, value added benefits. Distinguish your product from the ordinary! Talk to your Key Tronic representative today.

“Feel the Key Tronic Touch”

key tronic
The Responsive Input Company

P.O. Box 14687 • Spokane, WA 99214 • USA
(509) 928-8000 • TWX 510-773-1885

CIRCLE NO. 17 ON INQUIRY CARD

Mini-Micro World

NEWS

HP pursues technical markets with UNIX-based microcomputer

Tom Moran, Associate Editor

Although the number of companies introducing UNIX-based hardware and software is burgeoning, UNIX's bulky code, complex command structure and relatively expensive hardware requirements have limited its general appeal.

Now Hewlett-Packard Co. is rolling out the Integral Personal Computer (IPC), a transportable microcomputer with a UNIX kernel in ROM.

Initially targeted at engineers and software developers, it represents a long-term effort to hasten the system's move to business and commercial areas. The \$4,995 IPC runs unbundled UNIX applications using one 3¼-inch, 710K-byte, Sony microfloppy disk drive, a 9-inch electroluminescent screen and HP's 150-character-per-second (cps) ThinkJet lightweight printer. The IPC itself weighs 24 pounds and measures 16 inches wide, 13 inches high and 7 inches deep. It has 256K bytes of ROM, 512K bytes of RAM. Maximum internal memory is 1½M bytes.

Rich Baker, marketing manager for HP's portable computer division, Corvallis, Ore., stresses that the IPC is not yet a product for the commercial market. "You could think that this is a new wave for the computer market in general, but we will not position it that way—initially, at least." Baker says the transportable will be positioned "first of all for the traditional technical professional market, and second, for the UNIX development market. As the UNIX market develops and commercial software becomes available, then the system will appeal to a broader audience."



HP will initially aim its transportable Integral Personal Computer, which incorporates a UNIX kernel in ROM, a 9-inch electroluminescent display and HP's ThinkJet printer, at technical markets.

Applauding HP's conservative strategy for the new machine is Jan Lewis, senior analyst at InfoCorp, a Cupertino, Calif., market research group. The IPC represents "a very smart move for HP, because it's not an opportunistic product; it's part of a long-term strategy," notes Lewis. She predicts that the IPC will lead the technical marketplace, while UNIX becomes more important in the business and commercial environments. As a result, says Lewis, the IPC will uniquely position HP in the growing business/commercial arenas. As Lewis puts it, the new machine "will be a wedge into the commercial market, waiting for the hammer of UNIX business software to strike."

Indeed, UNIX market projections seem to support HP's strategy. According to InfoCorp figures, the worldwide market for UNIX hardware, software and technical support was \$2 billion in 1984. The technical sector, with 80 percent of the total sales, ruled the market, whereas the commercial sector accounted for only 20 percent of the total. But by 1989, when the market

is expected to swell to \$19.5 billion, the commercial and technical areas will have nearly reversed their shares to 70 percent and 30 percent, respectively.

Competition for Tandy

For now, the IPC will primarily compete with machines from Tandy Corp's Radio Shack division, Fort Worth, Texas. InfoCorp estimates that of the 33,500 UNIX-based microcomputer systems priced under \$12,000 that were installed in 1984, 40 percent were Tandy Radio Shack systems. Lewis says the IPC should compete head-on with Tandy's \$5,499 MC68000-based TRS-80 Model 16 that runs UNIX System III.

Model 16 comes with a 15M-byte Winchester disk drive, which is necessary to run the TRS-XENIX and proprietary TRS-DOS multiuser operating systems. Model 16 contains 256K bytes of RAM, four internal expansion slots, and an 8-inch floppy disk drive with a 1¼M-byte capacity. A non-integral printer is optional.

Although the IPC's transportabil-

Mini-Micro World

NEWS

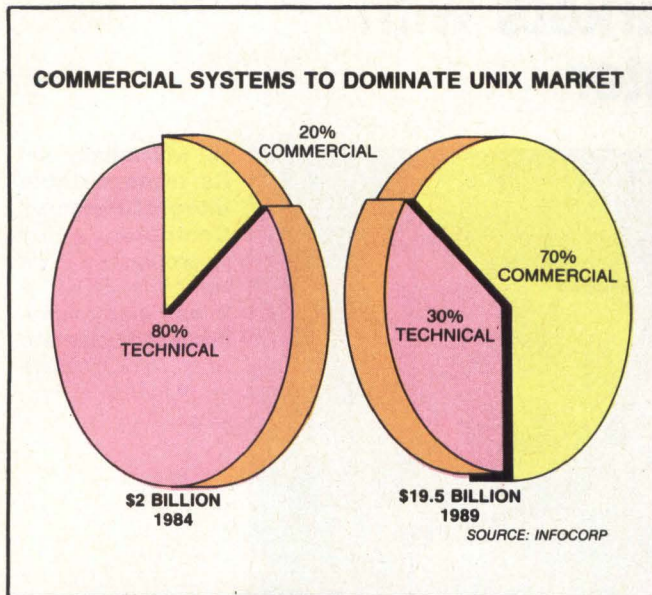

Most of the current UNIX sales are in the technical side of the market, but that should reverse in favor of business by 1989.

ments. Device-independent graphics software libraries give the same instrument-control capability to C, Pascal and FORTRAN.

Yensen thinks there is no danger of the IPC hurting sales of the HP150 desktop system, which runs MS-DOS. "We think the two product lines will coexist. The HP 150 operating in the MS-DOS environment, will clearly [beat the competition well] into the foreseeable future in terms of software availability."

The IPC's bit-mapped, 9-inch electro-luminescent display is the same as the HP150's. The screen contains 255 pixels by 512 pixels and displays 24 lines by 80 characters, although variable fonts and window sizes are available. Users can adjust the screen's viewing angle from 5 degrees to 17 degrees in 2-degree steps. A 16-bit HP-proprietary graphics processor with 32K bytes of dedicated RAM controls the display.

The ThinkJet dot-matrix printer uses thermal ink-jet technology to print 150 cps while producing less than 50 dB of noise. The ThinkJet can use fanfold paper or single sheets.

Interfaces for the IPC comprise one HP Interface Bus and two HP Human Interface Loops for support of devices such as mice and bar-code readers. Two input/output expansion slots are provided.

HP plans to market the IPC through approximately 100 to 200 dealers selected from its current 1,000 retail dealers, and through its direct sales force. The pricing of the various UNIX development systems had not been determined at press time.

The IPC comes with a tutorial disk, a user's guide, a utility disk, a customer diagnostic disk, a UNIX commands disk, a standard applications disk, and paper and ink for the integral printer. □

ity might increase the unit's appeal somewhat when compared to desktop machines like Model 16, that will probably not be a major issue. "Nobody needs a transportable," claims InfoCorp's Sandra Gant, associate director of the small-system service. The attractiveness of transportables stems mainly from their integration of components, rather than their mobility, claims Gant. She is enthusiastic over the IPC's performance features, however.

The IPC runs the HP-UX version of UNIX System III on an 8-MHz Motorola MC68000 microprocessor. With the addition of an external card cage, memory can be increased to 5½M bytes. As much as 50 percent of the RAM can be allocated as a RAM disk—a "cache-type" memory that speeds application program performance.

UNIX sits in ROM kernel

The 256K bytes of system ROM contains HP-UX/RO, HP's version of the UNIX kernel necessary to run applications software, HP's Personal Applications Manager, which is the user application interface, and HP's Windows Manager.

Software bundled on disk includes a tutorial, system utilities, 31 standard UNIX commands, customer diagnostics, and some standard applications such as editors, games and fonts.

Building the kernel into ROM eliminates the need for a hard disk to house the operating system, explains Kermit Yensen, product manager for HP's personal-computer group in Corvallis. "In an extended system [users] can buy HP-UX [2.1] commands on a microfloppy, and they can build up their development system." Yensen adds that HP has made some enhancements to HP-UX, which is the company's version of UNIX System III. He maintains that software written to run on System III is "very portable to HP-UX" because HP-UX is a superset of System III.

The additions to the operating system include the personal applications manager, which is similar to that of the HP150 personal computer, real-time extensions for response to interrupts, a technical version of BASIC, and series 80 BASIC, which provides high-level language calls to control instru-

Once-exclusive modem market niche attracting sudden, heavy competition



Three new entrants into the full-duplex, 2,400-bps modem market, from left, the \$1,295 Concord Data Systems 224, the \$899 Hayes Smartmodem 2400 and the \$895 Micom Dial Net 3000.

Stephen J. Shaw
Washington Editor

The breakup of the Bell System, advanced manufacturing techniques and rising demand for faster, more sophisticated equipment has caused a boom in the market for full-duplex modems that transmit information at 2,400 bits per second (bps) over the public telephone network. As a result, a niche that was once the exclusive domain of Concord Data Systems Inc., has recently attracted a spate of new products and vendors.

"We had the market to ourselves for almost two years," laments C. Kenneth Miller, president of the small Waltham, Mass., company. "There's a lot of people coming into the full-duplex, 2,400 [bps] area now."

Miller and his company had used their head start well, recording revenues of \$14.9 million in 1984, almost 10 times the \$1.5 million brought in during 1982, the first year of operation. But their success and changing times has bred competitors.

Yet, as late as November, only two other manufacturers, Codex Corp., Mansfield, Mass., and Micom Systems Inc., Chatsworth, Calif., were shipping full-duplex, 2,400-bps modems. That situation is about to change dramatically. Several other vendors announced full-duplex,

2,400-bps products at the fall COMDEX show and other recent computer conferences, or have indicated such intentions to industry sources.

Full-duplex wiring is common

The migration of modem manufacturers to the full-duplex, 2,400-bps market is being caused by the convergence of several industry trends, explains Kim Myhre, a communications analyst with International Data Corp. (IDC), a market-research organization based in Framingham, Mass. For one thing, "Private line costs are going up while long-distance (dial-up) rates are dropping," says Myhre. Large users, therefore, are looking at public dial-up switched service as a

more economical solution to their data-communications requirements than dedicated, leased lines, he says.

Besides the rates, full-duplex modems, as compared with the more conventional and more available half-duplex 2,400-bps modems, allow simultaneous bidirectional transmission of data through two-wire, rather than four-wire, telephone lines. The four-wire connections for half-duplex modems require that either a private line be leased from the telephone company and dedicated full-time to a customer, or that two dial-up calls be placed to achieve simultaneous bidirectional data transfer. So, although full-duplex modems are slightly

FULL-DUPLEX, MEDIUM-SPEED MODEMS TO SHOW STEADY GROWTH

Market segment (bps)	1983		1984 (est.)		1988 (est.)	
	No. shipped	Value (\$ millions)	No. shipped	Value (\$ millions)	No. shipped	Value (\$ millions)
0-600	299,500	53.9	351,000	57.6	525,000	58.8
1,200 half duplex	107,750	40.9	117,000	42.1	152,800	42.8
1,200 full duplex	268,600	128.9	370,500	172.6	845,000	334.0
2,400	184,000	119.6	217,000	135.6	420,000	193.2
4,800	129,490	246.0	161,900	291.4	305,900	397.7
9,600	84,000	361.2	107,500	435.4	243,800	768.0
14,400	3,200	35.2	4,600	50.6	11,600	127.6
Short-haul	248,000	86.8	340,000	119.0	625,000	218.7
Total	1,324,540	1,072.5	\$1,669,500	1,304.3	3,129,100	2,781.2

SOURCE: INTERNATIONAL DATA CORP.

From 184,000 units shipped in 1983, the 2,400-bps modem market is expected to grow to an estimated 420,000 units shipped in 1988. But the emergence of the full-duplex, 2,400-bps niche is so new that IDC does not yet separate full- and half-duplex modems at that speed.

Mini-Micro World

NEWS

more expensive than their half-duplex counterparts, they can take better advantage of the two-wire telephone connections commonplace in the public network.

Bell breakup slows leasing

Leasing is further impeded by the fact that the breakup of the Bell System has led to increased lead times for installation by AT&T Communications or the now-independent local telephone companies. Anderson-Jacobson Inc.'s (San Jose, Calif.) data-communications product manager, Gunnar Thordarson, reports that some of his company's customers have had to wait as long as 160 days for leased-line installation. The delays have created a market for modem manufacturers and suppliers that offer dial-up equipment as an interim solution.

For Hayes Microcomputer Products, Norcross, Ga., a pioneer in sophisticated, low-speed modems, joining the migration to the 2,400-bps modem for business applications is basically a function of increased data throughput. "We're reacting to user needs, and users have been crying for higher-speed modems over the past year," says Gary Betty, Hayes director of marketing and sales.

VLSI decreases costs

The demand from users for increased data speeds has been matched by decreasing costs for 2,400-bps-level modems by manufacturers due to increased use of very large-scale integration (VLSI) manufacturing techniques and the presence of additional supply sources. Concord Data Systems' first product offering for full-duplex, 2,400-bps modems was priced originally at \$1,695 for a single-quantity, end-user purchase. In 1983 the price was dropped to \$995 for Concord's basic 224 model, and cut again last September to \$845.

Depending on the value-added options included in the new product offerings coming from other manufacturers entering the full-duplex, 2,400-bps arena, prices are expected to range from \$795 to about \$1,000. According to Lee Schank, president of Case Rixon Communications Inc., another company which has declared an interest in the market, prices should remain stable during the next 12 months. "The price cuts, even though these are introductory prices, have already [in effect] occurred," Schank says.

Overall, the market for 2,400-bps modems is predicted to grow at an annual rate of 18 percent during the next five years, according to IDC. From 184,000 units shipped in 1983, the market is expected to grow to an estimated 420,000 units shipped in 1988. Shipment value in 1983 was \$119.6 million and is expected to reach \$193.2 million in 1988. But the emergence of the full-duplex, 2,400-bps niche is so new that IDC figures do not separate full- and half-duplex, 2,400-bps modems.

Because the market for these modems is still in its infancy, the keys to success for the new entrants are likely to be their ability to expand their customer bases, take advantage of the growing use of personal computers in the business environment, and differentiate their prod-

ucts by including value-added features, says IDC's Myhre.

Other companies that have indicated their intention to compete in the full-duplex, 2,400-bps modem market include: AT&T Information Systems, Cermetek Microelectronics Inc., Gandalf Data Inc., General Datacomm Industries Inc., Multi-Tech Systems Inc., Novation Inc., Penril/Datacomm Inc., Racal-Vadic Inc. and US Robotics Inc.

On the value-added front, the new vendors are touting such features as network diagnostics including digital and analog self-test programs, error detection and correction, adaptive line equalization and other advanced options in an effort to set themselves apart in the increasingly crowded field. The original supplier in 2,400-bps, full-duplex modems, Concord Data Systems, has already introduced a version of its CDS 224 modem equipped with automatic error detection and correction, a system that the company says guarantees error-free transmission over dial-up telephone lines.

What used to be considered value-added features—auto-dial, auto-answer, limited self-diagnostics—are now considered standard. "As the market starts to mature, we'll see even more exotic value-added features," predicts Case Rixon's Schank. □

PAY VIDEOTEX STATIONS CONSIDERED FOR JAPAN

Nippon Telephone and Telegraph Co. is looking at ways to provide a pay-for-use program with its newly instituted Captain videotex system. Captain (which stands for character and pattern telephone-access information network) is now available only at public facilities such as government offices, libraries, banks, and some of the larger railway stations. Individual terminals are available but, at \$800 or so, are beyond the range of most consumers. With the proposed service, individual users could draw three minutes of data from the central Captain files for about 12 cents via a pay terminal. The terminal is like a pay phone. Prototypes of the pay station are expected to be ready for testing in the first half of this year.

Amidst glowing PC-AT expectations, the PC/XT wins new market life

Tom Moran, Associate Editor

The full market effect of IBM Corp.'s PC-AT microcomputer still hasn't been felt, but industry analysts say the most obvious victim will be IBM's own PC/XT, the former high-end product. The basic AT, at \$5,795, is priced \$1,400 higher than the XT, but its integral hard disk drive has twice the storage of the XT's, it has almost four times the floppy disk storage and is considerably more powerful.

But, as analysts predict dizzying PC-AT sales (MMS, October 1984, Page 35), the comparatively slow-selling, \$4,395 PC/XT may get a mid-life market kicker from several sources. At least two companies, Seattle Telecom & Data Inc., Redmond, Wash., and Wave Mate Inc., Hawthorne, Calif., have introduced boards they claim will make the Intel 8088-based PC/XT compatible with the Intel 80286-based PC-AT, offering a savings for XT owners who would like AT capacity. Also, Tandy Corp.'s Radio Shack division, Fort Worth, Texas, has come out with its XT-compatible Tandy 1200 HD personal computer, which could help maintain interest in the XT and XT-compatible market, at least in the short term.

Analysts caution that, while the new offerings may breath new life into the XT market, that life may well depend on the willingness of users to upgrade and how long it will be before the ATs are in ready supply.

Enzo Toressi, senior executive vice president and co-founder of Businessland Inc., a San Jose, Calif., computer store franchise, says the PC-AT would have a nega-



The Tandy 1200 HD IBM PC/XT-compatible computer undercuts IBM's price for the PC/XT by as much as \$1,400.

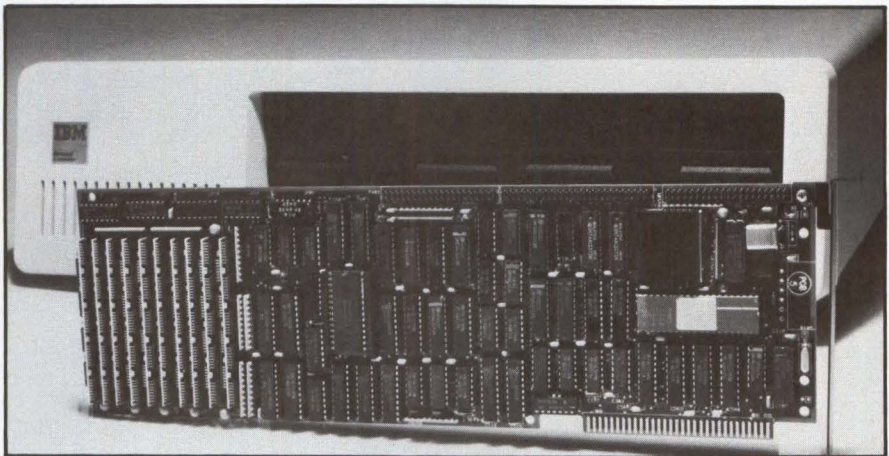

The PC-286 add-in board from Seattle Telecom & Data Inc. is designed to provide an upgrade to an 80286 processor for owners of IBM PCs, PC/XTs and PC-compatible machines.

tive impact on PC/XT and XT-compatible sales, except that "...it's more an issue of how available the [PC-AT] will be in the next six months." Toressi adds, "All I can say at this point is that [the AT] is in scarce supply right now and, as a result, is not affecting significantly the PC/XT sales."

Senior analyst Jan Lewis of InfoCorp, a Cupertino, Calif., market research concern, agrees with Toressi that the PC-AT appears to threaten the life cycle of the PC/XT.

"I would think [that] to give the PC/XT a kicker, [IBM] would need to drop its price. That would be consistent with IBM's marketing strategy." Lewis estimates that 30,000 PC-ATs were sold by the end of 1984.

Norm DeWitt, associate director of personal computer programs for Dataquest Inc., a San Jose, Calif., market researcher, had predicted loftier PC-AT shipments: 75,000 PC-ATs and 295,000 PC/XTs. DeWitt does not expect PC/XT sales to

**EMULEX HAS
THE CORNERSTONE
FOR SYSTEM BUILDING
FLEXIBILITY.**



AND, WE'VE GOT ALL THE OTHER BUILDING BLOCKS, TOO.

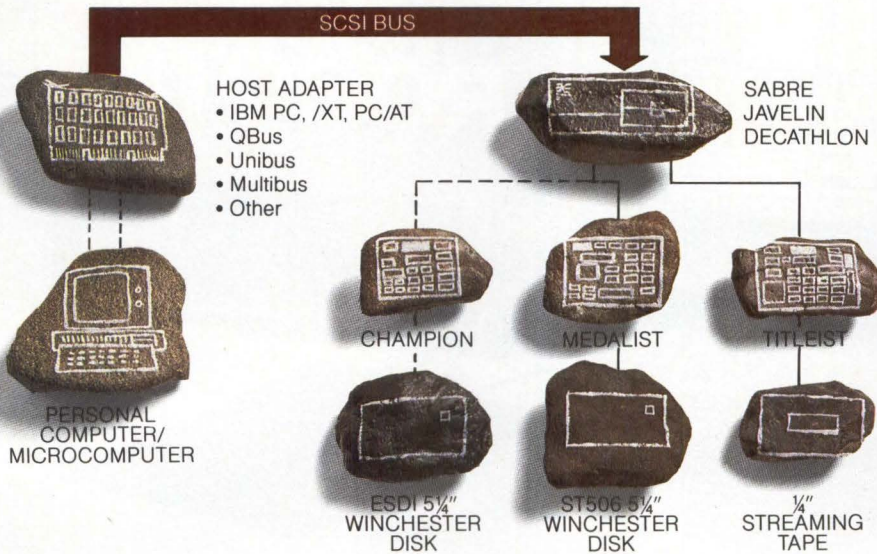

THE SCSI POTENTIAL. THERE'S PLENTY OF IT. SCSI allows you system building ease and maximum flexibility through the use of a common I/O bus and standard peripheral interface. All Emulex/SCSI-based products feature these enhancement benefits.

FEATURE	BENEFIT
Arbitration	Permits concurrent I/O operations between different devices by prioritizing bus usage.
Disconnect/Reselect	Maximizes bus utilization by providing devices an orderly scheme to release and regain bus control.
Copy	Permits data transfer between devices without host intervention.
Search Data	Used to search one or more logical blocks for less than, greater than or equal to a specified data pattern.
Reserve/Release	Device can be reserved for exclusive use by a single host in multiple host configuration.
High Level Command Set	Provides host with device independence for a given type of device.

With Emulex's SCSI products as the cornerstone for your mini/micro computer systems, you can continue to build on your investment. Our SCSI-based products offer you convenient building blocks with which to assemble, update, mix or interchange different types of peripheral storage devices to your computer system. Couple that with the industry's widest range of advanced products and you have the single best source for your system building needs. Products with performance, quality and reliability that's unsurpassed.

PUT MORE INTO YOUR SYSTEMS WITH EMULEX/SCSI MICRO SUBSYSTEMS.

Compact, versatile Emulex/SCSI micro subsystems provide you a variety of cost-effective storage and backup devices. Choose the enclosure you desire—desktop, rack or tower—disk size—36, 67 or 110 MB formatted capacity—and the type of backup most meaningful to your application. Top that off with the ability to interface virtually any CPU type and you have a powerful and complete storage solution.

SABRE, combines on-line storage and file backup capability in a compact unit housing a 5 1/4" Winchester disk drive and an 8" removable cartridge disk.

Javelin, an extremely versatile storage system designed to satisfy

a wide range of OEM and end user applications. Space accommodations for two SCSI peripherals, either one 5 1/4" disk drive and one 60 MB 1/4" cartridge tape streamer, or two disks.

Decathlon, available in a rack mount or an attractive tower/pedestal model, contains up to three 5 1/4" peripherals, with a choice of Winchester disks and a 60 MB 1/4" streaming tape drive.

EMULEX'S HOST ADAPTERS CAN FIT SCSI INTO YOUR PLANS.

Emulex/SCSI host adapters are available for QBus and Unibus systems, IEEE 796 Multibus systems, the IBM PC/XT and PC/AT and compatibles. We've designed these host adapters to take full advantage of the versatility and high performance of the SCSI.

GET MORE INTO YOUR SYSTEMS WITH EMULEX/SCSI CONTROLLERS.

Our Medalist and Champion SCSI controllers can interface any ST506 or ESDI 5 1/4" Winchester disk drive. And our Titleist can interface most 1/4" streaming tape drives.

EMULEX CAN FIT SCSI INTO YOUR PLANS.

If you're looking for a solid cornerstone and the widest range of building blocks to put together powerful and efficient mini/micro subsystems, then talk to Emulex.

For detailed information on Emulex/SCSI products, call toll free (800) 854-7112. In California (714) 662-5600. Or write: Emulex Corporation, 3445 Harbor Blvd., P.O. Box 6725, Costa Mesa, CA 92626.



Yes! Please send me your new **Micro Products Handbook**.

My needs are: Immediate 60-120 days Info. only

Have Salesman call Quantity per year: _____

Specify Computer/Peripherals in use or planned:

DEC _____ Multibus _____

IBM _____ Other _____

Name _____

Title _____ Phone _____

Company _____

Address _____

City _____ State _____ Zip _____



CIRCLE NO. 18 ON INQUIRY CARD



ARTIFICIAL INTELLIGENCE: TEK INTRODUCES A NEW SOURCE OF POWER.

Tek's new personal 4404 AI development system bypasses one of the last bottlenecks to making artificial intelligence systems commonplace. That bottleneck: the high price and scarcity of AI compute power.

The powerful, 32-bit 4404 supports three major development languages. The Smalltalk-80™ programming environment is standard. Franz LISP and Prolog are available as options. And Tek

supports the industry-wide Common LISP standardization effort. Standard configuration also includes virtual memory, expandable hard disk mass storage and much more. Its new window-managed display is everything you expect from a world graphics leader.

But what really makes the 4404 a major new force in AI is its price: at less than \$15,000, it is the first personal AI development system.

The power of Tek is behind it. Thanks to Tektronix technology, AI specialists and worldwide service organization, the 4404 is truly the first AI system you can use without reservations. And it is only the beginning of Tek's growing commitment to the AI community.

For more information, contact your nearest Tektronix field office. Or call toll-free 1-800-547-1512. In Oregon, 1-800-452-1877.

Smalltalk-80 is a trademark of Xerox Corporation.
Price stated is for U.S. domestic, quantity one.
OEM prices and leasing programs (U.S. only) are available.
Copyright ©1984, Tektronix, Inc. All rights reserved. HUT-101

Tektronix
COMMITTED TO EXCELLENCE

CIRCLE NO. 19 ON INQUIRY CARD

Mini-Micro World

NEWS

be damaged by the PC-AT in the short term. "Right now I think there's enough of a price differential between the PC-AT and the PC/XT that the PC/XT is still a viable product in IBM's product line. If you take street prices, the differential is even greater. It's not uncommon to see PC/XTs discounted 15 percent to 20 percent."

The \$2,999 Tandy 1200 HD personal computer, which is \$1,400 less than a PC/XT, still would be \$500 less if a PC/XT were discounted by 20 percent. Like the PC/XT, the 1200 HD is built around the 8088 processor and uses MS-DOS and Microsoft BASIC programs. The standard memory, like IBM's, is 256K bytes. Five expansion slots

are standard.

Tandy now has a line of IBM PC-compatible computers. Ed Juge, director of market planning for Tandy's Radio Shack division, explains. "The PC-AT is not necessarily in competition [with the 1200 HD.]" Juge maintains that the PC-AT will be more competitive with the Tandy 2000, an Intel 80186-based system

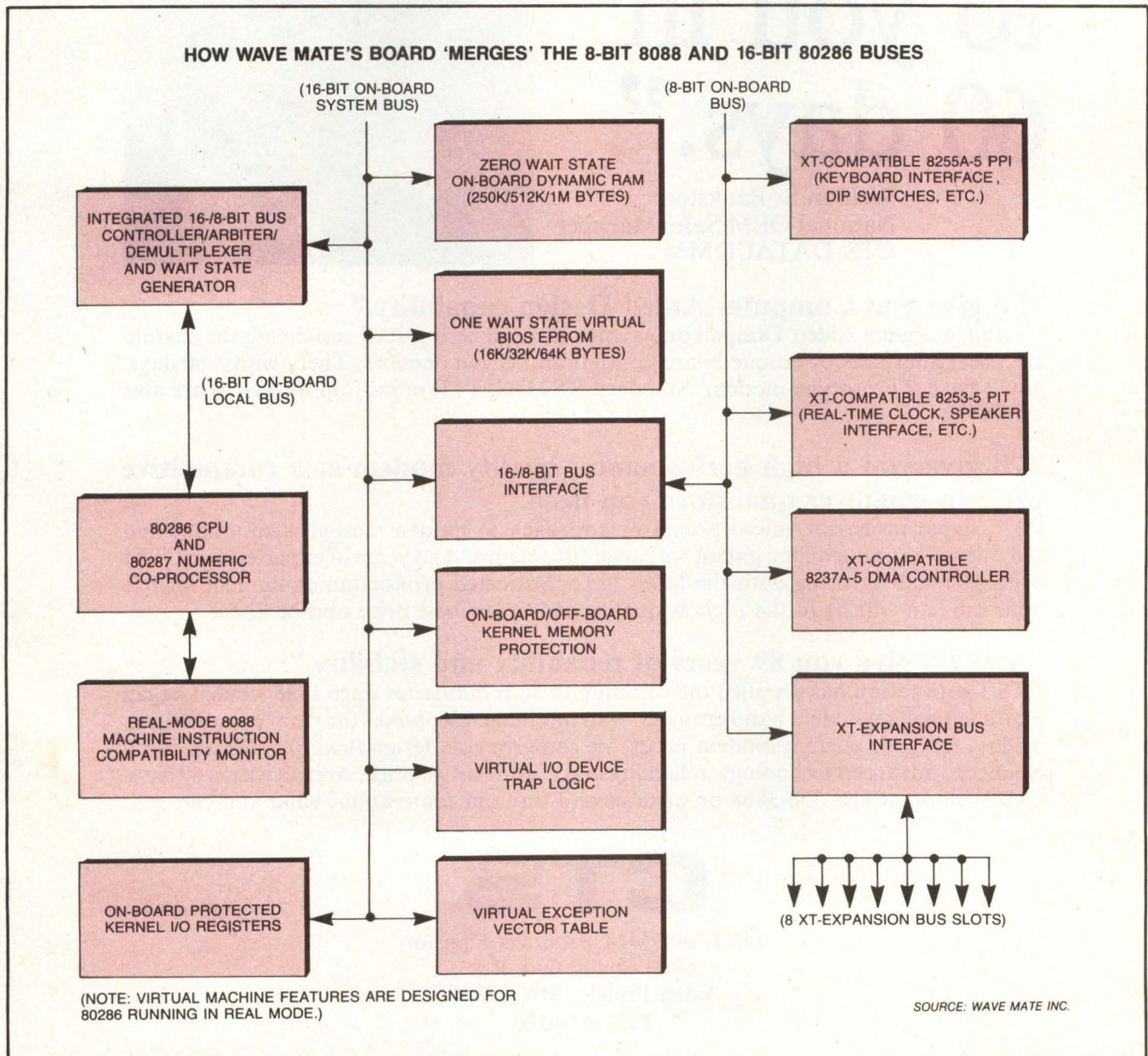

Wave Mate has multiplexed the 16-bit 80286 bus onto a slowed by multiple wait states. The company's Bullet-286 PC/XT-compatible 8-bit expansion bus; the 16-bit bus is acts as a substitute for the PC/XT's motherboard.

“Tell me what you want in a custom OEM modem, and I’ll give it to you in 60 days.”

Weldon S. Bankston
National OEM Sales Manager
CTS DATACOMM



“I’ll give you Computer Aided Design capability.”

Using Computer Aided Design equipment our engineering staff can create the custom electrical interfaces or unique board configurations you demand. Then, within 60 days, you’ll have a prototype modem. Standard RS232C, TTL or custom interfaces are also available.

“I’ll give you a high performance, quality modem at a competitive price in whatever quantities you need.”

CTS’ signal processor/micro processor approach to modem design is so unique and reliable we’ve applied for a patent with over fifty claims. And years of experience in OEM support manufacturing with the latest in sophisticated production equipment insures your modem will be of the highest quality and at the best price and on time.

“And I’ll give you 89 years of reliability and stability.”

CTS Corporation has supplied the communications industries since 1896 when it began manufacturing wooden, hand cranked, wall mounted telephones for rural communities. Today, for your current modem needs, we can give you design flexibility, experienced engineers, advanced technology, reliability and a competitive price. And all within 60 days. Call Weldon at 408-356-3868 or write us and find out more about what you can get.

CTS[®]

DATACOMM Products Division
6900 Shady Oak Rd.
Eden Prairie, MN 55344
612-941-9100

New to the industry since 1896.

Mini-Micro World

NEWS

introduced in November 1983. The 2000 runs at the same 6-MHz clock rate as the PC-AT, he says. Juge says Tandy will have XENIX on the 2000 eventually, "but we don't see it as a multiuser system. Our multiuser system is the [MC68000-based] Radio Shack TRS-80 model 16."

Boards boost PC/XT

Rather than introduce a line of PC-compatible systems, Seattle Telecom and Wave Mate announced \$2,400 to \$2,500 products designed to give the PC/XT the performance of a PC-AT. Seattle Telecom introduced the PC-286, an 80286-based add-in board for IBM PCs, PC/XTs and PC-compatibles. According to president Joseph DeCaro, the company will not try to compete with the IBM PC-AT, which is also based on the 80286. "We're trying to offer an expansion path to people who have invested significant dollars in a PC or PC/XT, and who don't want to throw that money away." DeCaro claims that "all the functionality of the AT" is available on the PC-286 board. That board, however, is not compatible with PC-AT expansion cards.

The PC-286 presently runs all PC-DOS, MS-DOS and Concurrent DOS operating system versions. DeCaro maintains that, if XENIX is ported to the PC-286, then "whatever software runs on the PC-AT under XENIX...would run on our board as well." The PC-286 includes up to 640K bytes of RAM and space for an Intel 80287 mathematics coprocessor. It will be priced at \$2,395 for single units, with quantity discounts available. The PC-286 should be available now.

Wave Mate also is giving PC/XT users a way to run their systems at the speed of a PC-AT. The company's Bullet-286 board is a 6-MHz 80286-based retrofit for the 4.77-MHz 8088-based PC/XT motherboard. Included are 640K bytes of

RADIO SHACK BEATS IBM's PC/XT BY \$1,400			
Company	Radio Shack	IBM	IBM
Product	1200 HD	PC/XT	PC-AT
Processor	8088	8088	80286
Memory (bytes)	256K	256K	256K
Floppy disk (bytes)	360K	360K	1.2M
Hard disk (bytes)	10M	10M	20M
Price	\$2,999	\$4,395	\$5,795

memory and a socket for an 80287 coprocessor, the same as is offered by Seattle Telecom. Wave Mate has multiplexed the 16-bit bus of the 80286 onto a PC/XT-compatible 8-bit expansion bus. The wait states necessary to multiplex the 80286 bus onto the PC/XT expansion, of course, slow down the 80286's execution speed. The Bullet-286 acts as a substitute for the PC/XT's motherboard, and thus gives PC/XT users some PC-AT compatibility.

Businessland's Toressi says the market for PC-286-type boards would comprise "all of those who already own a PC/XT or PC who might want to upgrade to a PC-AT-type performance, but would not

want to reinvest and buy an AT." He estimated that by the end of 1984, close to four million people will have IBM PCs, PC/XTs and PC-compatible machines. While Toressi says products such as the PC-286 make sense, he says Businessland is "very careful [in investigating] the compatibility issues of these add-on products. Compatibility is really the bottom line in attractiveness to consumers." Also, analysts note that some software tied to the timing of the 8088 processor in IBM PCs and PC/XTs may not run on the AT because the clock rate is different from that of the AT's 80286 processor.

InfoCorp's Lewis says there's no price advantage to buying such boards, as opposed to buying the PC-AT. Adding \$2,400 to the PC/XT's basic \$4,395 price makes the PC/XT, with the boards, \$1,000 more than the PC-AT's basic price. "If it [the boards] were compatible with all the existing software for the 8088, you'd get increased performance [with that software]. But whether it would be worth the price would be strictly based on performance." □

IBM PC-AT USERS MAY HAVE THREE UNIX CHOICES

In addition to XENIX, at least two other versions of the UNIX System III operating system should soon be available for the IBM PC-AT personal computer. A system identical to the System III-based PC-IX, which runs on the PC/XT, is being adapted for the PC-AT by Interactive Systems Corp., Santa Monica, Calif. PC-IX is derived from Interactive's System III-based IS/3. And Unisoft Systems, Berkeley, Calif., is planning a release based on one of the Berkeley versions. None of the three versions is based on System V, which is being heavily promoted by AT&T Co.

IBM SUBSIDIARY GETS NOD FOR ESPRIT R&D PROJECT

The European Commission has confirmed that the West German subsidiary of IBM Corp. will take part in two factory automation research and development projects. The Commission will contribute around \$2 million worth of funding to the projects, which are part of the Commission's Esprit transnational research program. More than 100 other proposed undertakings in the program have been delayed pending the signing of all contracts.

Mini-Micro World

NEWS

Stock, Boston/Bohdan Hrynewych

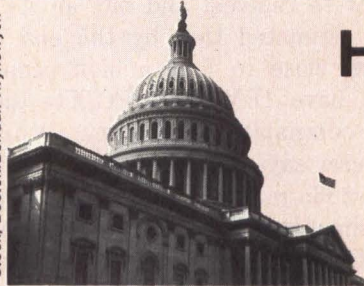

HEARD ON THE HILL

Congress rising to needs of high-tech industry

Stephen J. Shaw
Washington Editor

Computer industry associations in Washington are generally pleased with the overall record of the 98th Congress. Association executives say that Capitol Hill has displayed an unmatched degree of sensitivity to issues that are of major concern to the U.S. computer, and other high-technology, industries.

"A few years ago, the Hill didn't know the difference between hardware and software," comments Olga Grkavac, government relations director for the Association of Data Processing Service Organizations (ADAPSO). "There's an increased awareness there now of high-technology and that has resulted in a slew of legislation [on matters] that nobody was concerned with before."

Among the legislative initiatives that have been passed by Congress and were sent to the president for his signature are:

- A computer crime bill designed to prevent unauthorized access to computers used by the federal government, banks and credit bureaus. Deleted was coverage of computers used in interstate or foreign commerce. Sen. Paul Laxalt (R-Nev.) had insisted that additional study was required before including computers used by private industry. As passed, the bill carries a maximum penalty of 10 years in prison and/or a \$10,000 fine for unauthorized access to a computer system that contains classified, national-security information, and a one-year maximum prison term and/or a \$5,000 fine for anyone who

obtains unauthorized access to a computer system owned or operated by the federal government.

- Legislation that clarifies anti-trust laws to allow computer and other high-technology companies to engage in joint research and development projects. The bill will allow companies, especially smaller ones, to band together for research they might not have been able to pursue individually.

- The Semiconductor Chip Protection Act, which provides copyright protection for the mask design for semiconductor chips.

Computer-industry legislative initiatives that failed to pass the 98th Congress, but are expected to be reintroduced in the next session, include:

- Extension of research and development tax credits. That Congress did not extend tax credits for R&D expenses, now scheduled to expire at the end of 1985, was perhaps the biggest disappointment to the computer industry. Legislation to make the tax credit permanent was passed by the Senate and the House, and received the backing of the Reagan administration. But it died in a Senate-House conference committee as part of an agreement between members to pass a deficit-reduction package. Although the legislation is expected to be reintroduced this year, it will face a tougher time in Congress. "Reducing the deficit is going to be the dominant theme of the next Congress. The R&D tax credit bill is going to need more work," comments Ken Hagerty, vice president for government relations for the American

Electronics Association (AEA).

- No new Export Administration Act (EAA). Computer industry lobbyists had hoped for legislation to decrease the time involved in obtaining export licenses for sophisticated computer components and systems, and ease export controls on high-technology equipment available from U.S. allies. Despite that loss, computer associations and Commerce Department officials were successful in beating back Defense Department efforts to gain an oversight role equal to Commerce's in granting export licenses. "We could have had two managers of a process that's not working now," comments William Krist, AEA director of international trade. Defense is expected to try again this year. Provisions of the EAA, which expired Sept. 30, are presently in force under the National Emergency Powers Act.

- Legislation to prohibit software distributors from renting out software packages. Initially introduced by Sen. Charles Mathias (R-Md.), the bill would place computer software under the protection of copyright statutes to prevent unauthorized duplication.

New initiatives that are expected to be introduced during that next session of Congress include a bill to establish an Information Age Commission that would gather data on a variety of high-technology issues such as worker displacement, defense and education; and a telecommunications trade bill that would grant authority to the president to negotiate access to foreign telecommunications markets and automatically impose stiff tariffs on imports from countries without agreements.

"It was a good year, but we still have a long way to go," cautions ADAPSO's Grkavac.

A Picture's Worth:

U.S. SHIPMENTS (\$ BILLIONS)

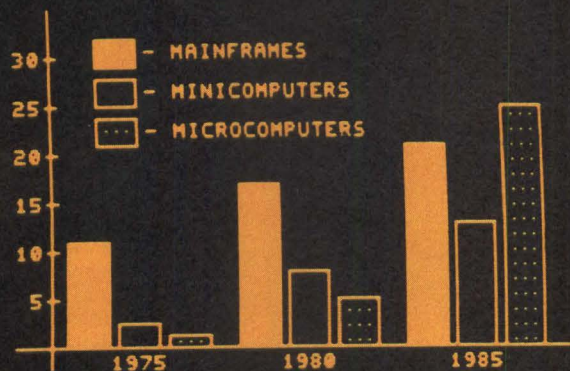

** GRAPHICS CAPABILITIES **

- ◆ HIGH PERFORMANCE GRAPHICS
- ◆ TEKTRONIX 4010 COMPATIBILITY
- ◆ AUTOMATIC SCALING (1023x1023) WITH 250x512 RESOLUTION
- ◆ ALPHA MODE (35 LINES x 73 COLS)
- ◆ OPTIONAL JOYSTICK
- ◆ CONNECTION TO LOW COST PRINTER FOR GRAPHICS HARDCOPY
- ◆ ASCII AND APL CHARACTER SETS
- ◆ BLOCK FILL, DOTTED/DASHED LINES

** DISPLAY TERMINAL CAPABILITIES **

- ◆ ANSI STANDARD CONFORMANCE
- ◆ DEC SOFTWARE COMPATIBILITY
- ◆ 80/132 COLUMNS, WINDOWING
- ◆ 4 PAGES OF MEMORY STANDARD (UP TO 8)
- ◆ 46 PROGRAMMABLE FUNCTIONS
- ◆ ASCII AND APL MODELS
- ◆ COMPACT ULTRA-THIN KEYBOARD
- ◆ HIGH INTENSITY AMBER PHOSPHOR



High performance graphics at a new low price!

\$1190*

CONCEPT GVT+™ Graphics Display Terminal

*Small quantity price



human designed systems, inc.

Whether used in video display mode or in its high-performance graphics mode, Human Designed Systems' GVT+™ Graphics Display Terminal offers more user friendliness, more design features, and more advanced functionality to optimize productivity — and encourage creativity — for the terminal operator, interactive user, and applications developer than any other terminal available today.

Atlanta — (404) 391-9763; Boston — (617) 449-6446; Chicago — (312) 825-2960; Dallas — (214) 437-1888; Delaware — Infocon: (302) 239-2942; Denver — (303) 469-1953; Detroit — (313) 471-2807; Hawaii — Gray Associates: (808) 261-3751; Houston — (713) 952-1403; Los Angeles — (213) 410-9454; Northern New Jersey — Infocon: (201) 624-1372; New York City Area — Infocon: (212) 689-8833; New York State — Naco Electronics: Rochester: (716) 223-4490; Syracuse: (315) 699-2651; San Francisco — (415) 692-4184; Washington, DC — International Systems Marketing: (301) 279-5775; Argentina — Itron SA: (01) 774-9369; Australia — Computer Clarity Pty. Ltd.: (02) 241 3385; Belgium — BELCOMP: 091-31.52.22; Canada — CAIL Systems: Toronto: (416) 362-1063; Denmark — ADCOM Data Aps: 1-19 44 66; Finland — Valitmatic Oy: 0-742 011; France — Walton: (1) 226.06.90; Japan — Ampere: 03 (365) 0825; Portugal — Soc. Com. Crocker, Dellatorce Co. Ltd.: 1-6801 41; Singapore — DTS Singapore: 33-88-566; South Africa — Psitac (Pty.) Ltd.: (11) 836-9181; Switzerland — Mitek ag: 01/461 22 52; United Kingdom — Shandell Systems Ltd.: 2407-2027; Venezuela — H. Blohm SA: 2541.21.22; West Germany — COMKO Computersysteme, mbH: 221-48 30 51. INTERNATIONAL DISTRIBUTORSHIP INQUIRIES INVITED.

GVT+ is a trademark of Human Designed Systems, Inc.

CIRCLE NO. 21 ON INQUIRY CARD

A DECLAR DATA INDE



When In The Course Of Business Events . . .

OEMs designing systems for today's businesses face two realities. One, data processing is rapidly becoming more decentralized. It is pushing outwards into individualized work units, defined more by job function and applications, performed by more people in

more places, demanding more data flexibility—more data independence.

Which brings OEMs face to face with a second reality. Winchester. Because the prevailing mass storage technology—in the form of large storage units used for access or downloading, or smaller, high capacity desk-top mechanisms—continues to head in

the opposite direction. Rather than freeing users to operate effectively in the new environments of distributed data processing, Winchester keep them device-dependent, keep them tied to a shared system of storage.

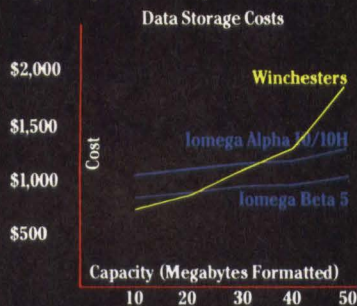

Slavery By Any Name . . .

There are lessons here. That the central issue isn't more data, but more data dynamics. And that Winchester are hardly data dynamic at all.

Consider the aggravations of "wait your turn" access, or the need for lots of "system savvy" on the user's part. Consider the time consumed in backing up and restoring data. And consider the ever-present risk of a system going down or files lost to expensive head crashes.

Now consider the alternative.

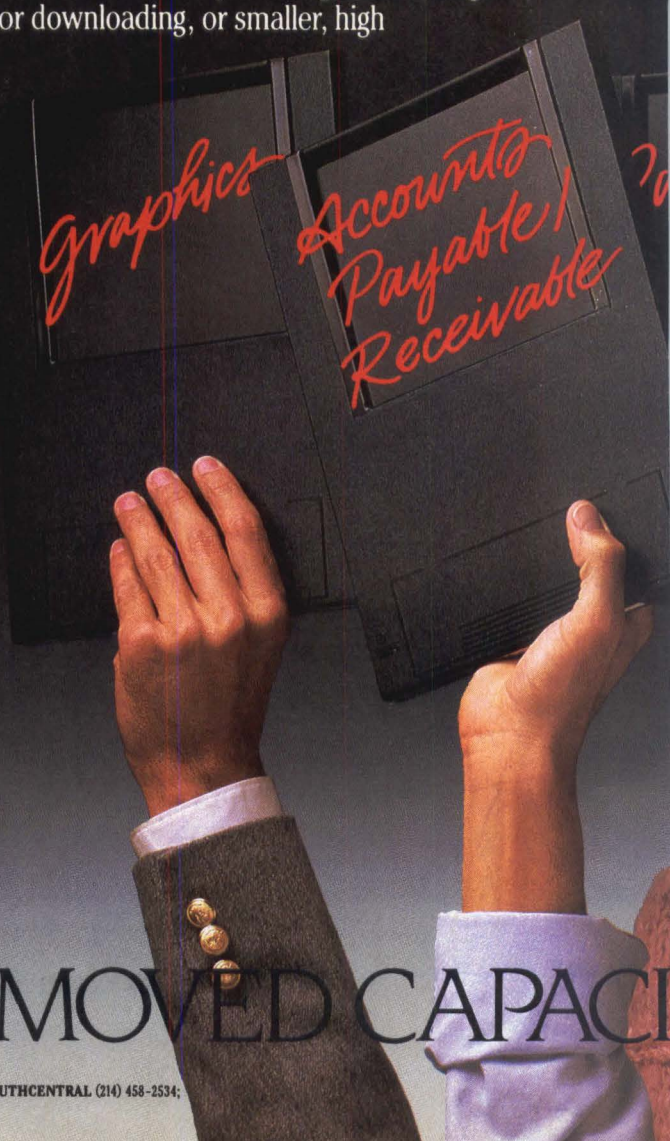

IOMEGA HAS REMOVED CAPACIT

ATION OF PENDENCE.

IOMEGA's Distributed Data Storage: Freedom Of Information.

The IOMEGA family of data management/storage systems effectively matches today's distributed data processing reality with a new reality: *distributed data storage*. Because IOMEGA's reliability and performance specs often exceed Winchester's, particularly in access times and transfer rates. And they deliver cost-per-megabyte figures that Winchester's cannot figure at all.

	IOMEGA BETA 5	IOMEGA ALPHA 10/10H	TYPICAL WINCHESTER
Formatted Capacity	5.0 Mbytes per cartridge	10.0 Mbytes per cartridge	10.0 Mbytes fixed
Data Transfer Rate	5.0 Mbits/Sec	9.0 Mbits/Sec	5.0 Mbits/Sec
Average Access Time	50 msec includes settling	35 msec includes settling	85 msec
Form Factor	5.25"	8"/8" Half Height	5.25"

The key is "in/out" simple—the IOMEGA cartridge. Think about downloading data and software to a single 5- or 10-megabyte cartridge, then manipulating, updating, and uploading with maximum convenience and cost efficiency. And think about a total enterprise solution, about storing individual applications, complex software programs, or data sets—all of which can be passed along to others without expensive networking resources. And when you need more storage, you use more cartridges, not more hardware.

Accept No Other Alternatives.

IOMEGA's distributed data storage solutions—in full- and half-height 8-inch 10-megabyte solutions, and a 5-megabyte, 5¼-inch version as well—give OEMs Winchester performance and reliability, and floppy convenience and cost efficiency. They are proven, risk-free solutions. And of the few cartridge opportunities on the market today, IOMEGA's—besides being available—are the only ones that are rugged, absolutely interchangeable, and inexpensive. As such, they give OEMs the most precious commodity of all: *the freedom of designed-in freedom*. The freedom your customers require.

Take The Liberty.

Get in touch with an IOMEGA representative today. One is conveniently located in an area near you.

IOMEGA™ THE FUTURE IN DISTRIBUTED DATA STORAGE

IOMEGA CORPORATION
1821 West 4000 South
Roy, Utah 84067
(801) 776-7330

TY AS THE MASS STORAGE ISSUE.

WESTERN (714) 855-1211, (408) 263-4476; NORTHEAST (617) 933-2000; MIDWEST (312) 397-4234; EASTERN (203) 359-9858.

CIRCLE NO. 22 ON INQUIRY CARD

Northwest Instrument melds logic analyzer with IBM PC-AT

Lori Valigra, Senior Editor

Add-on products from third-party suppliers already are flowing into the arteries and capillaries branching from IBM Corp.'s new main-

stream PC-AT computer.

Northwest Instrument Systems Inc., Beaverton, Ore., an IBM value-added dealer, recently announced a PC-AT-based logic analyzer called the MicroAnalyst Logic

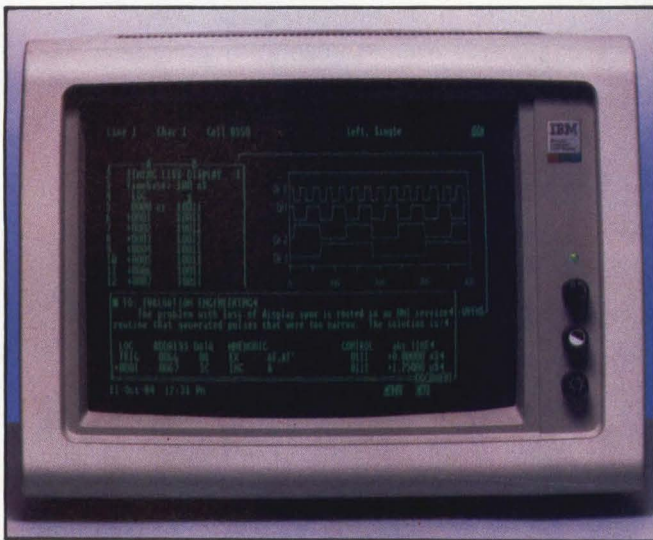

The IBM PC-AT-based Northwest Instrument Systems' logic analyzer lets users view several tasks—such as logic analysis, documentation, and timing—through windows within the Lotus Symphony package.

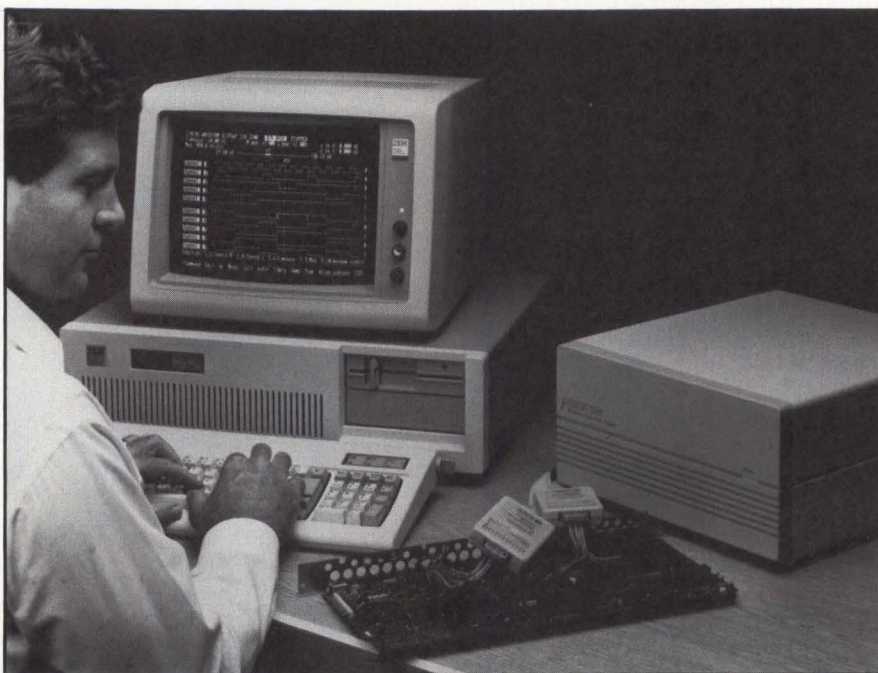

Northwest Instrument's MicroAnalyst workstation marries the IBM PC-AT to a logic analyzer and an integrated application program.

Analysis Workstation. The \$17,900 system combines the 80286-based PC-AT with Northwest's Series 2000 logic analyzer and Lotus Development Corp.'s Symphony integrated program. Shipments should begin by the middle of this month.

The company, which has been supplying other personal computer-based instruments, plans to make the MicroAnalyst its main product and to direct it at the burgeoning logic analyzer market. "[We expect] half of the products shipped to include Symphony used with the PC-AT," says Northwest president Larry Sutter.

IBM may crowd the market

The U.S. market for scientific and engineering personal computers was \$1.8 billion in 1983, and will be growing about 25 percent yearly by 1990, according to estimates by the market research firm International Data Corp., Framingham, Mass. While the CAD/CAM portion of that market will likely become crowded following IBM's announcement of its own engineering/scientific PC (MMS, December 1984, Page 37), Sutter hopes to find more breathing room in the instrument portion.

"We assume that one in three engineers will have a personal computer on his desk by 1988, and that 12 percent of the logic analyzers and microprocessor development systems sold in 1988 will be personal computer-based," Sutter explains. Five years ago, he says, the test equipment alone was priced at \$18,000; now users can purchase a computer and logic analyzer for that amount.

Fits into generic lab setting

The typical engineer or scientist uses the personal computer for a variety of applications. In an average workday, Sutter claims, engineers use their personal computers 77 percent of the workday. The ma-

YOUR BRAINS. OUR GUTS.

Parallel port included. Standard interface for popular printers.

Five full-length expansion slots for IBM PC/XT compatible option cards. Hard disk machine with 640K, real time clock, three I/O ports and display has two slots free.

Small overall dimensions, sturdy metal case, designed inside and out with horizontal or vertical operation in mind.

ROM BIOS AND MONITOR by ITT: Interrupt compatible with IBM PC/XT and more. Ever-ready menu-driven, diagnostic monitor debugger. Test hardware device by device and channel by channel. Examine registers, alter or dump memory, read or write tracks and sectors. Even set drive timing.

256K byte, parity-checked RAM on planar board. Combo board with one, two and three banks of 128K bytes each. Real time clock and parallel port also available to give 640K RAM total with only one slot used.

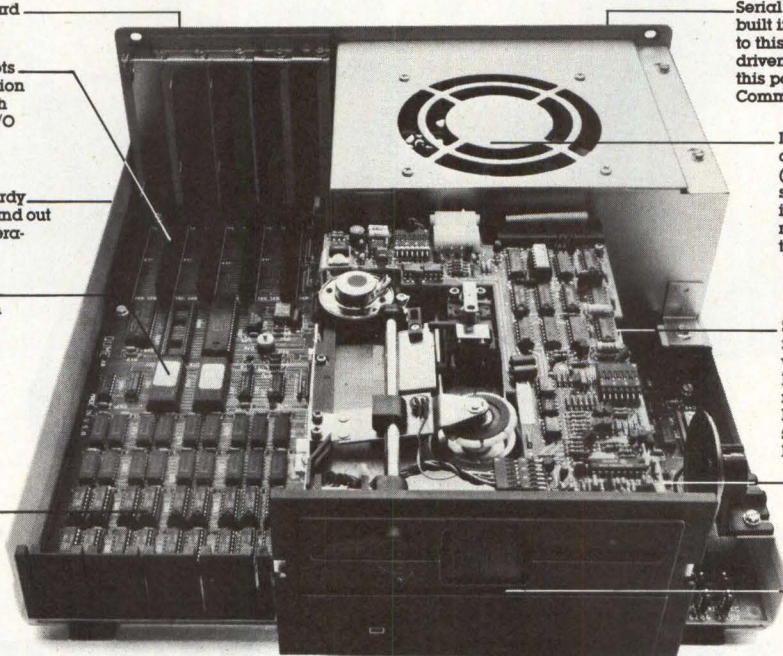

Serial (RS-232) communications port built in. Console I/O may be redirected to this port by switch setting. Menu-driven DOS utility (set up) to configure this port or redirect printer I/O to it. Communications program included.

ITT's own heavy duty, high efficiency, switching power supply (115 watts continuous service) saves weight without compromising support for fully-equipped machines. 95 to 132 volts or 180 to 240 volts.

Switch controls allow console I/O redirection to serial port — use whatever ASCII terminal you want. Enable/disable power-on memory test for faster starts on large machines. Enable/disable screen-saving blanking when left idle.

Floppy disk controller on planar. Saves a slot.

Space-saving half-height disk drives.



Monitor conveniently tilts and swivels. Green, amber or color. Three-position keyboard. Our very own, fully-supported ITT Mouse.

Brains.
So if you're interested, we're interested.

You know your marketplace. We know computers. A quick glance above will tell you that. Which could obviously mean a match made in VAR heaven. What will the ITT XTRA™ Personal Computer bring to the party? The best engineered system in the industry. IBM compatibility. Phenomenal dependability, flexibility, serviceability. All from a \$20 billion company committed to profitable partnerships with its resellers.

Guts.
What will you bring? The specific knowledge that can help us both tailor a useful tool for a specific market. For both large and small VARs.

Give us a call today at 800-321-9872. Or clip the coupon. It may well be the smartest thing you ever do. It's certainly the gutsiest.

IBM PC and XT are registered trademarks of International Business Machines.

Please send me more information on the ITT VAR Program.

Name _____ Title _____
Company _____
Address _____
City _____ State _____ Zip _____
Phone _____

Donna Sim
ITT Information Systems
P.O. Box 52016
Tempe, Arizona 85072-2016

ITT
PERSONAL COMPUTERS

HELPING AMERICA WORK SMART.

© 1984, ITT Information Systems



THERE'S ONLY ONE BAR CODE MANUFACTURER WHO SUPPLIES IT ALL.

Why struggle with multiple vendors when you can rely on *one* proven manufacturer who will supply virtually all of your bar code equipment needs? It's a fact that a single manufacturer's equipment will interface more easily, so your system will be on-line faster. And you will be supported by one company, so there's no "buck-passing."

INTERMEC is the only manufacturer in the world that is a single source for virtually all of your bar code system hardware needs. Our equipment includes on-line readers, portable readers, display readers, wand scanners,

laser scanners, slot scanners, non-contact scanners, thermal printers, logmars printers, high speed impact printers, port concentrators, labels and printing supplies.

Systems Approach

A U T O M A T E D

D A T A

C O L L E C T I O N



Take advantage of the INTERMEC *Systems Approach*. It includes the industry's broadest integrated product line, sophisticated programming language, systems integrators and worldwide factory service. It's all backed by INTERMEC — the world's largest bar code equipment manufacturer.

To learn more about our products and *Systems Approach*, contact INTERMEC 4405 Russell Road, P.O. Box 360602, Lynnwood, WA. 98046-9702. Call 206-743-7036
TELEX: US 152447
Int'l (ITT) 4740080.

 **INTERMEC**[®]

For demonstration circle number 202

For literature circle number 201

Mini-Micro World

NEWS

chine is used for logic analysis 36 percent of that time. The other 41 percent of that time, engineers use the computers for word processing, software development, database management and spreadsheets.

The wide uses of the general-purpose PC-AT, coupled with the logic analyzer, redefine and expand

the concept of logic analysis, Sutter says. For example, engineers and scientists can use database software to filter acquired data into user-defined criteria. This might include searching through microprocessor mnemonic data to extract address and instruction combinations.

Lotus' Symphony can support de-

bugging of A/D-based systems. When data from the analog-to-digital converter is acquired in digital format by the logic analyzer, the data can be transferred to Symphony and graphed in an analog format for review by the user.

Northwest's logic analyzer can be purchased separately for \$9,970. □

Kodak develops film processes for magnetic media market

Marjorie Stenzler-Centonze
Associate Editor

Eastman Kodak Co., Rochester, N.Y., a dabbler in magnetic media over the past year, has now created an Electronic Media Manufacturing Division and introduced a line of floppy disks.

The company will tackle the floppy disk business initially by placing its own label on other manufacturers' products. Then, armed with coating technology from its photographic film business, Kodak plans to begin manufacturing within the next year when new plants in Rochester and Guadalajara, Mexico, are completed. J. Phillip Samper, vice president of Kodak's Photographic Division, says the interim measure will enable the company to quickly enter the market and establish brand recognition.

Kodak to cover all bases

Kodak's Electronic Media Manufacturing Division will offer disk products in 5¼-, 8- and 3½-inch formats. The company will address the 5¼-inch, 300-oersted floppy disk market with a single-sided, double-density disk priced at \$3.85, a double-sided, double-density disk priced at \$4.85 and a double-sided, quad-density disk priced at \$6.60.

Its 8-inch offerings will consist of a single-sided, double-density disk at \$5 and a double-sided, double-density disk for \$5.80. Kodak's HD600 high-density line includes a double-sided 5¼-inch disk with 17 sectors, which will retail for \$16.50,

and a double-sided unformatted disk priced at \$8.50. The company is also making available a high-density 3½-inch single-sided disk for \$8.25.

Kodak's involvement in the magnetic media market has been limited to the production of a 600-oersted,

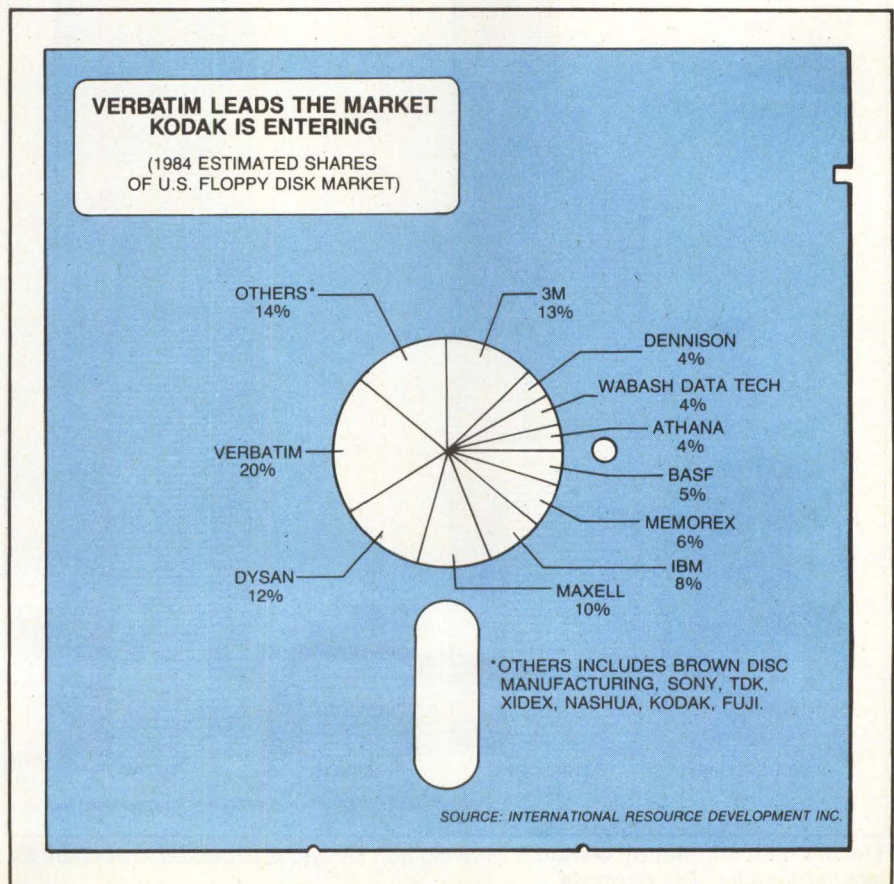

Mini-Micro World

NEWS

3.3M-byte, 5¼-inch floppy disk drive, which it licenses from Drivetec Inc., San Jose, Calif., and a 5¼-inch specialty disk for the Kodak version of the Drivetec drive. Kodak markets the drive primarily through Data Technology Corp., Santa Clara, Calif., which manufactures controllers, and by direct sales to major system integrators.

Joan de Regt, senior consultant at the research company International Resource Development Inc. (IRD), Norwalk, Conn., says getting into the floppy disk market is logical for

Kodak in light of its longtime mastery of coating technology. "Since Kodak has been involved in this process, it makes sense for them to develop products that use that expertise," de Regt states.

Carving out market share

The main problem for Kodak, de Regt points out, could be timing. The company is entering an intensely competitive market in which other companies already are well-entrenched. She sees Kodak's primary competitors as Verbatim Inc., Sunnyvale, Calif., which currently

holds a 20-percent share of the floppy disk market, and Dysan Corp., Santa Clara, Calif., which follows with a 12-percent market share. If Kodak is lucky, according to de Regt, it might be able to carve out a 3-percent to 4-percent share of the business. If Kodak manages to snag a significant share of the market, then it will probably draw some business away from Verbatim and Dysan, de Regt comments. It is more likely, however, that Kodak will slug it out with the assortment of new companies appearing on the scene, including a host of Japanese companies and Polaroid Corp., which has announced its plans to enter this field as well, de Regt says.

IRD estimates that 285 million flexible disks were shipped in the United States during 1984. That figure is expected to reach 650 million disks by 1989. The research company predicts strong growth in the microflop category and slackening interest in 8-inch disks. The 5¼-inch category is expected to hold a significant market share in the foreseeable future, even though it could drop from 74 percent of total shipments to 65 percent as microflopies pick up speed.

Kodak's marketing strategy includes distribution through retail, OEM, system integrator and direct sales channels. □

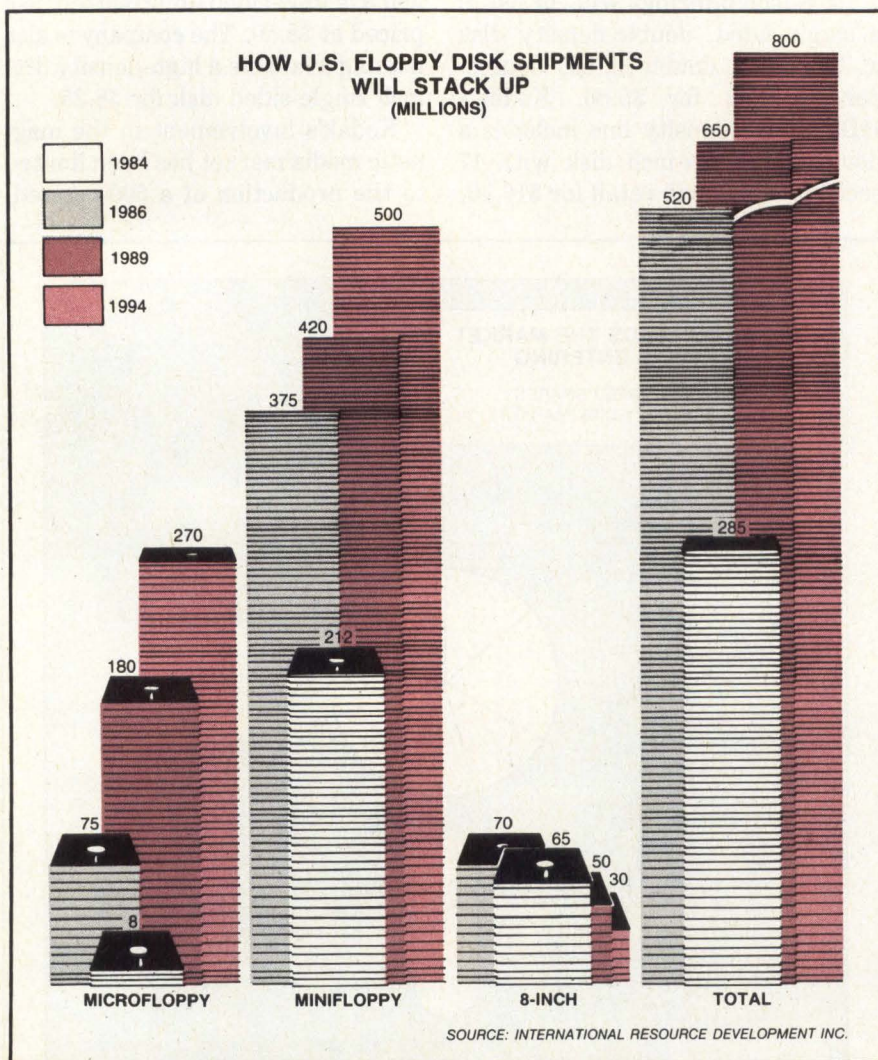

The 5¼-inch minifloppy market is growing quickly and is expected to account for most of Kodak's disk business.

NEXT MONTH IN MMS

The February issue of Mini-Micro Systems examines the Small Computer Systems Interface (SCSI)—one of a number of emerging intelligent interface solutions.

MMS will look at who is supporting SCSI's development and how its use will impact systems integrators, peripherals manufacturers and software developers.

HOW TO TAILOR YOUR COMPUTERS TO FIT ANY CUSTOMER.



MIX &

**Introducing OEMTEK.
First to put the
OEM first.**

Why don't OEM computer systems fit OEMs very well? Simple. They're "hand-me-downs." Designed for general applications. And sold to OEMs as an afterthought.

Not at OEMTEK.

We're the first "OEM-compatible" computer company, tailoring computer systems just for OEMs.

With OEMTEK, you're never out of style.

We shun the latest fads and fancies—and use only proven, industry-standard technology. Like Intel's 8086 and 8088. And the soon-to-be-standard 80286.

And all our systems are truly IBM™ software compatible.

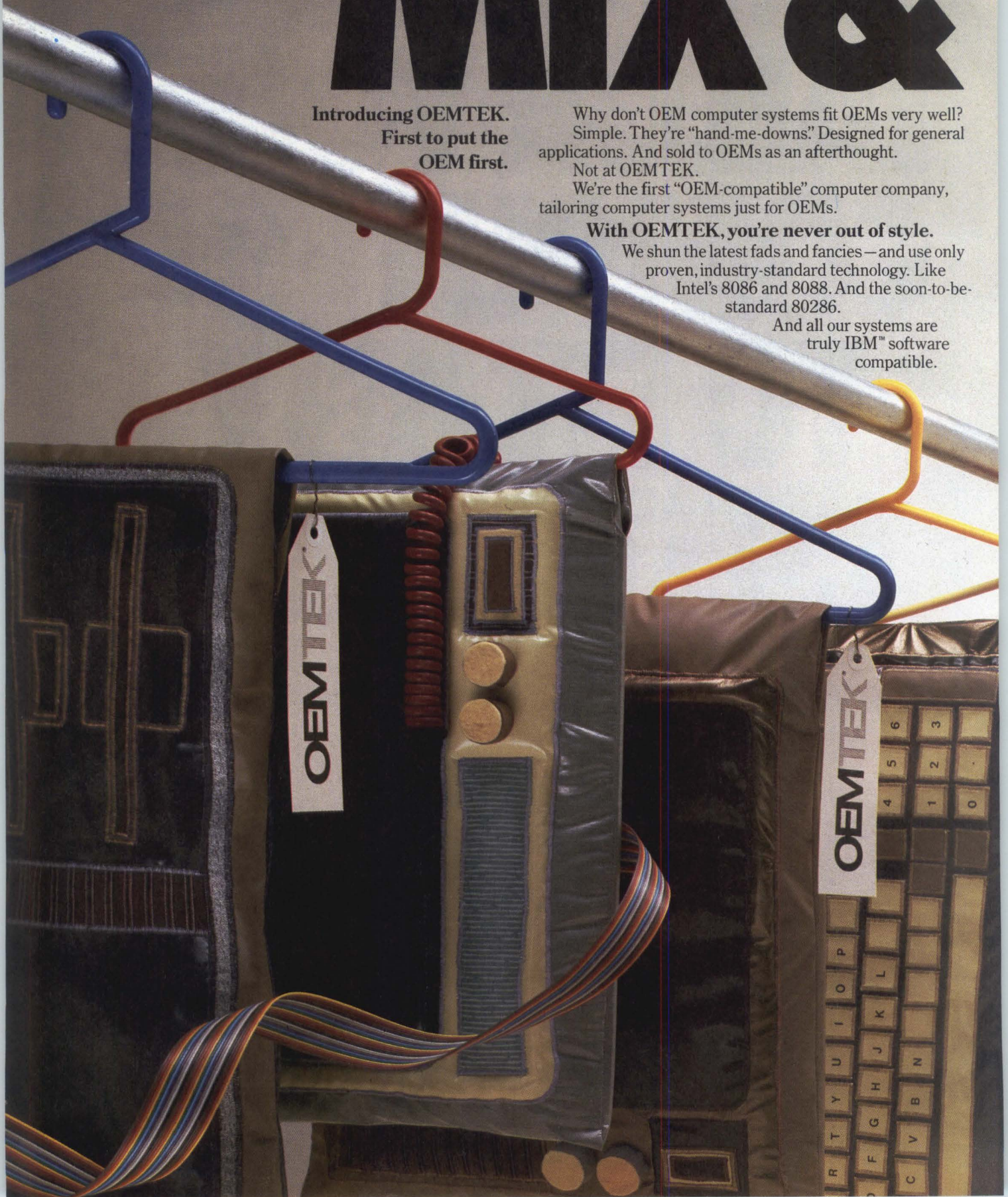

MATCH.

Which is about as "industry standard" as you can get.

So our systems work with standard PC and XT peripherals. And accommodate all industry standard interface cards.

But the crowning touch is that all our systems and components are interchangeable. You can literally take any off the rack. Arrange them any way you want. And create exactly the system you need.

Be a smooth operator no matter where you go.

With OEMTEK, you always operate in a comfortable environment. PC-DOS™, Concurrent CP/M™, And OEM Magix™, the most advanced yet easily maintained multi-user operating system.

And if you want to move data around, we've got all the right connections. Like the IBM PC™ bus and the MULTIBUS™.

We'll make you a screen star.

Naturally, the right CRT is essential to good looks. So we offer you both a vertical and horizontal 14-inch monochrome for word processing and standard applications. And a 13-inch color screen for graphics. Graphic proof that with OEMTEK, you get the exposure you need.

Outfit yourself a thousand different ways.

With all we give you to choose from, you can literally put together a system a thousand different ways.

Take keyboards. Having the right one is essential for sewing up the entire package. We give you a choice of three. A standard IBM-type. A standard IBM-type with 18 added function keys. And one with all of the preceding — plus an LCD panel.

In system and data storage modules, we'll outfit you nicely, too. With a standard module housing system board, eight expansion slots and two floppy or hard disk drives. And standard storage units holding up to two floppy and two hard disk drives. Want more? How about data base file servers handling up to 96 users.

But suppose even after looking over our incredible selection you still haven't found what you need?

Step over to our full custom department, please.

And let our expert design engineers customize a system to your exact specifications. Right down to packaging.

So if you want a 100 gigabyte file server, we'll tailor it for you. Or if you think a purple console with a green keyboard is your style, we'll make it for you.

Call for a fitting.

What's all this going to cost? Let's just say substantially less than the "industry standard." For details, get in touch with one of our regional managers by writing or calling OEMTEK, 3707 Williams Road, San Jose, CA 95117, (408) 247-1100.

And let us help you start dressing for success.

OEMTEK®

MULTIBUS is a trademark of Intel Corporation. Magix is a trademark of Science Dynamics Corporation. IBM PC and PC-DOS are registered trademarks of IBM Corporation. CP/M is a trademark of Digital Research Corp.
© 1984 OEMTEK, Inc.

CIRCLE NO. 24 ON INQUIRY CARD



Liquid crystal shutter technology shines new light on page printers

Carl Warren, Western Editor

Impact dot-matrix printer market leader, Epson America Inc. of Torrance, Calif., is betting on liquid crystal shutter (LCS) technology to establish itself in the non-impact page printer market.

The LCS technology is built into the newest Epson model, the GQ 3000, which prints at seven pages per minute (ppm). Prices for OEMs are expected to be less than \$2,000, including the controller. The end-user price for one unit is less than \$5,000.

"Right now we are aiming at the OEM," says Samuel Elias, product manager of Epson's OEM products division. He says that although a number of the units are under evaluation, a full marketing strategy hasn't been set up. "We are looking at the various ways of selling the printer," says Abram Fuks, product support and development manager. "We believe that there are two markets: one for an entire printer, and one for the LCS head mechanism."

A twist on technology

The basic GQ 3000 OEM printer works by depositing toner particles on a charged drum to form characters, which is similar to the way magnetic and laser printers create characters. But rather than using a laser or a charged head to write an image onto the drum, the GQ 3000 does it with a series of staggered liquid crystal matrices. A high-intensity fluorescent lamp beam is guided through a glass tube onto a liquid crystal array. The matrices are shuttered with polarizing plates that determine whether or not a given area on the drum surface will



The desktop Epson GQ 3000 page printer produces seven pages per minute at a cost of about 1.6 cents per page.

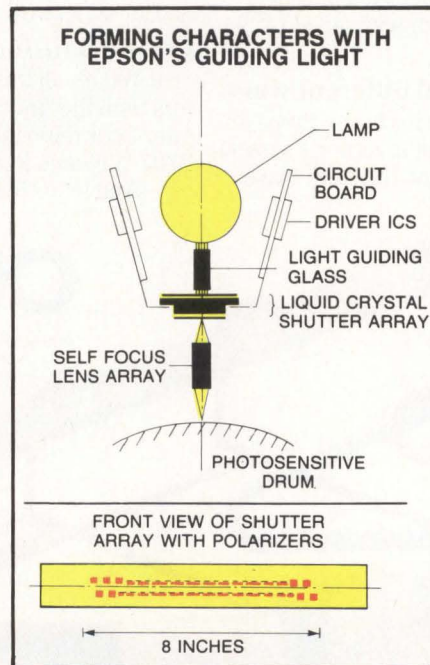

Epson's liquid crystal shutter character-writing technology uses a high-intensity fluorescent lamp beam, which is guided through a glass tube onto a liquid crystal array. Polarizer "shutters" in the array determine how the light will fall onto the drum to form images.

attract and hold a character. According to Victor Klimas, product technical specialist at Epson, the

GQ 3000 is a positive-image, rather than a negative-image, system. "We only deposit material on the charged-character area rather than [on] the background. This, we feel, gives us a better character clarity." No toner need be scraped from non-charged portions of the drum, eliminating the chance of shadows around the characters.

To ensure a ready market for its product, Epson elected to have the GQ 3000 emulate the Xerox 2700 laser printer which, at \$20,000, is one of the more popular low-cost page printers. Klimas explains other emulations are possible, such as Diablo Systems Inc.'s model 630 daisywheel printers. "It depends on what the OEM wants. We can work with them to develop any desired emulation."

Not 'me too'

Canon U.S.A Inc. also has a popular laser page printer that is setting that market's pace for low price. It emulates a daisywheel printer for less than \$5,000. But Epson wants to make sure its product isn't considered a "me-too" effort. "We don't want to be lumped in the Canon mass-market crowd.



**FINALLY. A PRINTER
GOOD ENOUGH TO
WEAR YOUR NAME.**

SIGN HERE.

Datasouth printers *define* high performance. They're benchmarks for the entire matrix printer industry.

Now the whole family of Datasouth printers is available for OEMs.

These are outstanding printers that outperform competitors right out of the box, then outlast them on customer sites. Printers that have earned the right to wear your logo.

The Datasouth sales staff gives you straight answers on the things you care about: private labeling, special colors, custom configurations, drop shipping, special warranty and service provisions, third-party maintenance and OEM pricing.

So call Datasouth toll-free, right now. Arrange to evaluate any of our excellent printers. Then start signing your name on the best printers in the OEM business.

datasouth

H I G H P E R F O R M A N C E O E M P R I N T E R S

Datasouth Computer Corporation
Box 240947 · Charlotte, NC 28224
704/523-8500 · Telex 6843018 DASOU UW

CALL TOLL FREE:

1-800-222-4528

CIRCLE NO. 25 ON INQUIRY CARD

Mini-Micro World

NEWS

That calls for low [price] and short [product] life," Elias says. He notes that Epson's drum should be changed after printing 60,000 pages, but it could print double that number.

But there doesn't appear to be great demand for this kind of printer. Jonathan Dower, vice president of Datek Information Services Inc., Newtonville, Mass., a research firm specializing in printers, notes that the market really hasn't formed. "It's tough to break in with a new technology implementation. Lasers are the dominant force. Currently, page printers command only 1 percent of the entire printer market and OEMs are holding back. It would be unfair, however, to say Epson hasn't a chance. They do—as much as anyone else. As far as technology goes, LCS is as legitimate as anything else."

Competition from many quarters

Even though Epson is keeping an eye on the movements of Canon and other laser printer makers, they will have to consider the impact of other technologies as well. For example, ink-jet technology is receiving a great deal of favor in many quarters, especially for computer-aided design applications and presentation graphics. But Elias claims that is a different area altogether. He says that the GQ 3000 is for applications requiring high-quality, typeset-like printing at a low cost.

The cost of owning one may prove to be a major consideration in whether to buy one. For example, the cost of owning a daisywheel, fully formed character printer, once it's bought, can be as high as 5 cents per page. This figure is based on the cost of ribbons (typically \$5 to \$10), print wheels (\$10 to \$25) and maintenance. "The cost of ownership is often forgotten," asserts Fuks. "The cost of producing one page of printed copy can be very expen-

	Canon LBP-CX	Epson GQ 3000	Ricoh LP-4120	Xerox 2700
Speed (ppm)	8	7	12	12
Resolution (dpi)	240/300	240	300	300
Standard interface	serial video	parallel/serial	serial video	parallel/serial
Unit price (including controller)	<\$5,000 (daisy-wheel emulation) <\$10,000 (bit-map version)	<\$5,000	\$9,950 (controller is \$4,000 more)	\$19,995

sive." Since Epson considers the cost of ownership an important issue, they have been running comparison tests and claim a cost-per-page for the GQ 3000 as low as 1.6 cents. "We figure in all the costs: \$250 for a service call, \$750 for toner, a new drum, parts and service time for a three-month period with 60,000 copies," maintains Klimas.

Printer employs MC68000

The GQ 3000 LCS printer uses Motorola Inc.'s MC68000 microprocessor and has 128K bytes of RAM (expandable to 256K bytes). At press time, the specifications were subject to review by OEMs, so some features may change slightly. For example, production units may come with 256K bytes of RAM. Also available is 64K bytes of ROM containing four character fonts (expandable to 15 fonts either by Epson or OEMs) and a multitasking operating system. The operating

system is responsible for handling all the printer functions, as well as loading various characters and graphics. The LCS is controlled separately by an 8-bit microprocessor.

Currently, the GQ 3000 only permits an 8-inch-wide writing surface because it uses a fluorescent light source. Klimas explains that the light source tends to lose intensity at the ends of the tube, thus the 8-inch restriction. However, future products will use a brighter halogen lamp to permit wider copy.

The GQ 3000 includes an 8-bit Centronics-compatible parallel port and an RS232C serial port. Speed control and protocol characteristics are set via DIP switches located on the interfaces. Additionally, the printer has onboard diagnostics that test all data channels, LCS circuits and paper path controls.

The GQ 3000 is slated for shipment in the first quarter of this year. □

DEC INTRODUCES ITS 'MOST RELIABLE' PRINTER

The new 240-character-per-second Letterprinter 210 dot-matrix printer is the most reliable printer Digital Equipment Corp. has ever manufactured, according to company officials. The \$1,595 unit's printhead uses laminated core technology and requires less electrical current than the company's previous printers, resulting in cooler operation, improved print quality and a claimed printhead life of more than 500 million characters. The model has a Centronics parallel interface option and is compatible with all of DEC's computers, as well as systems from more than a dozen vendors, including IBM Corp. and Apple Computer Inc. It emulates the IBM Graphics Printer and the Epson America Inc. MX-80 printer.



Not long ago, *PC Magazine* called MDBS III "The most complete and flexible data base management system available for microcomputers." That's a powerful statement. But then, MDBS III is an amazingly powerful software package. So powerful, in fact, that it lets you build mainframe-quality application systems on your micro or mini. MDBS III is not for beginners. It's for application developers with large data bases or complex data interrelationships who want to define data base structures in the most natural way—without resorting to redundancy or artificial constructs. It's for professionals who can appreciate its extensive data security and integrity features, transaction logging, ad hoc query and report writing capability and its ability to serve multiple simultaneous users. And if you want the power and the glory that only the world's most advanced data management system can provide, MDBS III is for you. For information on MDBS III and our professional consulting services, write or call Micro Data Base Systems, Inc., MDBS/Application Development Products, 85 West Algonquin Road, Suite 400, Arlington Heights, IL 60005. (800) 323-3629, or (312) 981-9200. **MDBS III. ABSOLUTE POWER.**

WE'LL GIVE YOU THE POWER.

YOU TAKE THE GLORY.

In 1985 There's Only One Softcon.

Sunday, March 31—Wednesday, April 3, 1985 Georgia World Conference Center, Atlanta

If you buy, sell, or develop software, you can't afford to miss Softcon, the International Conference and Trade Fair for Software merchandisers, publishers, users.

In only two years, Softcon has become the 15th largest trade show in America. Proof that software is the fastest growing product in the world. And that Softcon is the premier industry event.

Softcon has 850 exhibiting companies. That's 600 more software companies than the largest hardware and electronics shows. Softcon's 3000 booths will showcase more than 20,000 software products for professional, home, educational, entertainment, office, business, industrial and vertical market applications. Softcon features software for micros, minis and main frames.

Nearly 250 of the world's most respected software authorities will participate in this year's conference program. There will be three separate conferences—one for merchandisers and distributors, one for corporate and institutional users, and one for software industry technical personnel. Each conference will comprise 75 seminars, panel discussions, forums and workshops.

Softcon is a registered trademark of Northeast Expositions, Inc.

To register, just send your check for \$195 for four days of conferences and exhibits, or \$35 for exhibits-only to the address below. Please include your name and address and make checks payable to Softcon.

For a free Softcon brochure, call or write Softcon, c/o Northeast Expositions, 822 Boylston Street, Chestnut Hill, MA 02167. 617-739-2000. Please specify whether you are interested in attending or exhibiting.



The International Conference
and Trade Fair for Software
Publishers, Merchandisers,
and Business Users

Introducing Lear Siegler's 3278 Keyboard Compatibles

Easy to Look at. Easier to Use.

Now you can combine Lear Siegler's exclusive High Touch™ style with the convenience of true IBM 3278 keyboard compatibility.

The ADM 1178 video display terminals offer superior performance and ergonomic design. With standard protocol converters, you can interface with virtually any IBM mainframe to achieve substantial savings in hardware and operator training expense.

The ADM 1178 terminals can handle computer transmissions up to 19,200 baud without handshaking. They feature five video attributes (underlining, blink, blank, bold and reverse video), the IBM extended character set, four cursor modes (block or underline, blinking or steady), and 24 Program Function (PF) keys and two Program Access (PA) keys.

For operator convenience, the ADM 1178 terminals come with a full tilt and swivel monitor that stops positively in any position, an easy-to-read non-glare screen, and a detached, low-profile DIN standard keyboard.

The ADM 1178s are available with a standard 12" green or amber screen and an RS-232C serial printer port. They can be easily modified for OEM applications and are available with such options as 14" green or amber screen, answerback memory, current loop or RS-422 interface, and international character sets.

These Lear Siegler High Touch terminals are made in America—designed, engineered, manufactured and shipped from Anaheim, California. With this total, on-shore capability, and a complete worldwide network of sales and service centers, OEMs as well as end users can be assured of the best local support available in the industry.

Call our ADM 1178 product specialists today for complete information on products and protocol converters.



Small footprint saves desk space.

Green or amber screens, 12" or 14".

Operator information area—separated by a horizontal line.

IBM extended character set.

True 3278 keyboard layout.

3 key rollover.

Adjustable keyboard tilt.

Hooded bezel reduces glare.

Five visual attributes: underlining, blink, blank, bold and reverse video.

Tilt and swivel for operator convenience.

On/off, contrast controls on front of unit.

24 Program Function (PF) keys.

Two Program Access (PA) keys.
Selectable Numeric or PF Keypad



LEAR SIEGLER, INC.
DATA PRODUCTS DIVISION

901 E. Ball Road, Anaheim, CA 92805 (714) 778-3500

IBM is a registered trademark of International Business Machines Corp.

©1984 Lear Siegler, Inc.

Mini-Micro World

NEWS

Sun's diskless engineering workstation lowers the cost of adding network users

Tom Moran, Associate Editor

To lower the overall cost per user of its distributed-network environment, Sun Microsystems Inc., Mountain View, Calif., has extended its product line with the diskless Sun-2/50 workstation. The model 50 is Sun's first desktop product and is designed to complement and share resources with two previous products, the Sun-2/120 and Sun 2/170, which are pedestal and rack-mount configurations, respectively.

According to Jay Puri, marketing manager for Sun, the model 50 will reduce the cost per user of Sun-2 systems to below \$19,000 in OEM quantities. Puri says that figure represents a 30 percent to 35 percent decrease in the cost of adding each user, including amortization of disk and tape storage. Sun expects the retail price of the Sun-2/50

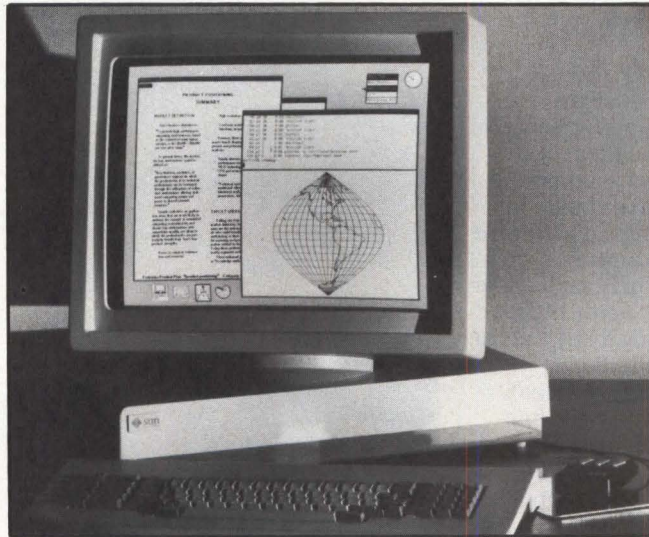

The Sun-2/50 from Sun Microsystems, Mountain View, Calif., shares system-storage devices and eliminates an on-board disk drive.

workstation to be about \$19,900 for one unit, compared to \$16,900 currently for its entry-level workstations. The model 50 was expected to be available 60 days after receipt of order.

All the Sun workstations are based on Motorola Inc.'s 10MHz MC68010 microprocessor, run Berkeley UNIX Version 4.2 and connect to Ethernet via built-in interfaces. As a desktop unit, the model 50 uses only one printed circuit board, eliminating the Multibus found on the 120 and 170.

Other features of the Sun workstations are: 16M bytes of virtual address space per process; up to 4M bytes of RAM; a 1,152-dot-by-900-dot, non-interlaced, bit-mapped monochrome display (optional on the model 170); the SunCore device-independent graphics library; SunWindows window display manager; and C, FORTRAN and Pascal programming languages. The model 120 has a 9-slot card cage with integral disk and tape options, and the model 170 has a 15-slot card cage with options for rack-mounting large-capacity storage devices.

Market to boom as prices fall

David Burdick, senior industry analyst for market research group Dataquest Inc., San Jose, Calif.,

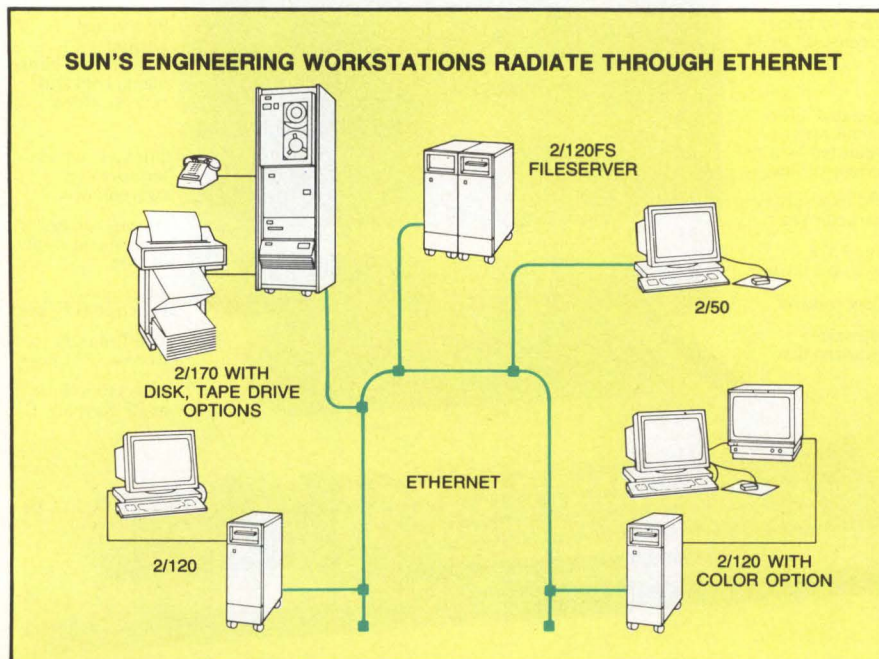

Linked by the Ethernet local area network (color), the Sun-2 family now includes the Sun-2/50, a new diskless node for adding users inexpensively.

Alloy makes your PC multi-user.

Introducing Alloy's PC-SLAVE/16. The multi-user PC strategy that doesn't require additional PCs.

PC-SLAVE/16 transforms your IBM PC into a multi-user, multi-processor system with shared data access and communication between users. All you need is a dumb terminal and a PC-SLAVE/16 board for each user.

And with Alloy's PC-X BUS, you can add up to 31 users. So whether you're adding your secretary or 31 colleagues, Alloy's PC-SLAVE/16 can do it at a much lower cost and with higher performance.

For any system requiring more than one PC, PC-SLAVE/16 is more powerful and less expensive. Each board comes complete with its own 8 MHz, 8088 micro processor and dedicated memory. PC-SLAVE/16 eliminates the need to add costly PCs. And it is ten times faster than LANs (Local Area Networks) at half the cost. Best of all, it's available right now. See PC-SLAVE/16 in action at your local dealer. Or call Alloy today at (617) 875-6100.

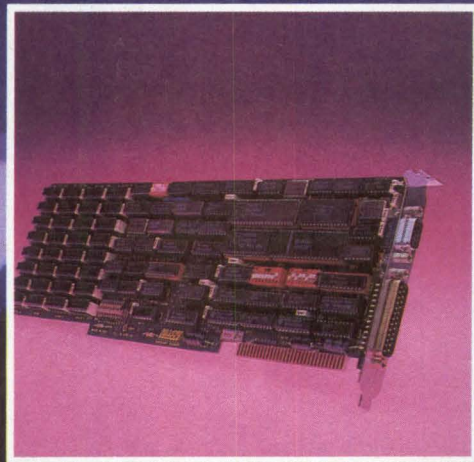

ALLOY

ALLOY
Computer Products, Inc.

Alloy Computer Products, Inc., 100 Pennsylvania Avenue, Framingham, Massachusetts 01701. (617) 875-6100, TWX: 710-346-0394
In Europe: Alloy Computer Products (Europe) Ltd., Cirencester, Gloucestershire, England. Tel: 0285-68709, Tlx: 43340

CIRCLE NO. 29 ON INQUIRY CARD

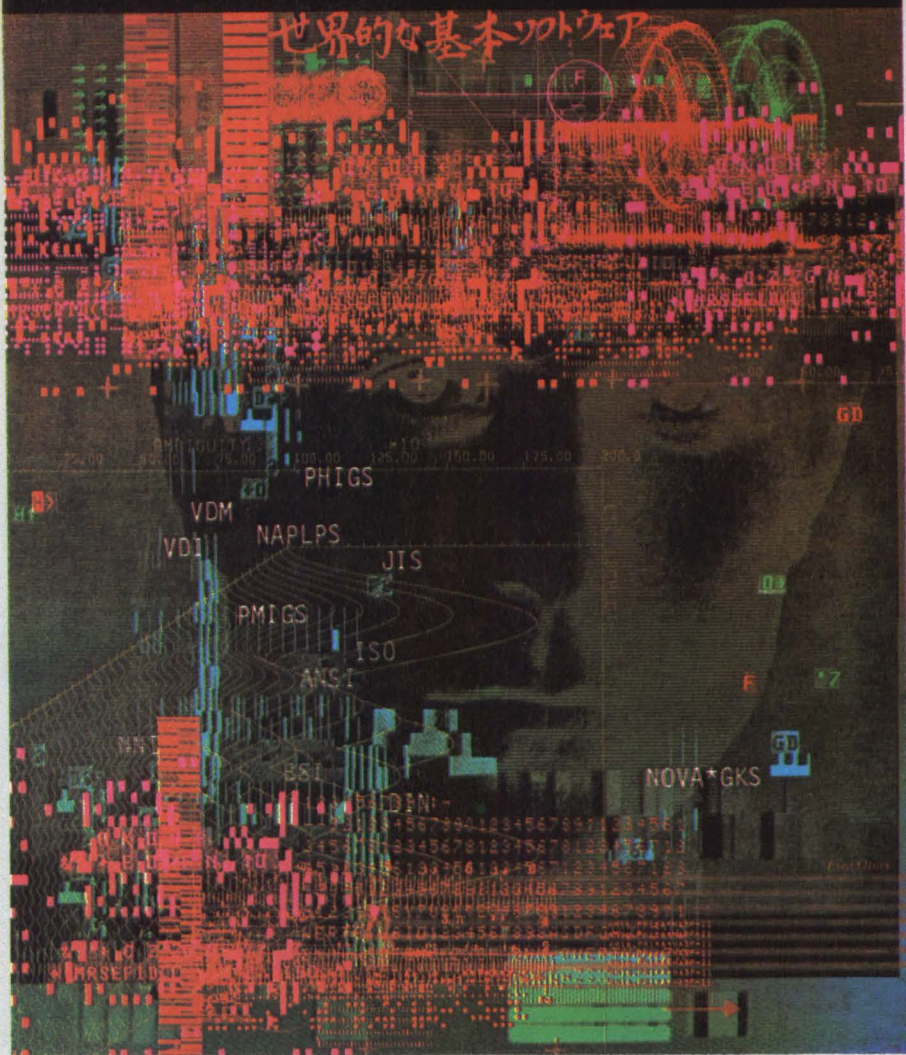

**When the world
of computer graphics
required standards,
the world of standards
acquired NOVA*GKS.™**

Computer graphics takes an unprecedented step into reality with NOVA*GKS™ software from Nova Graphics International.

Years of innovative research make NOVA*GKS today's most advanced, full implementation of the Graphical Kernel System (GKS), the international graphics standard. Because of its unique, distributed architecture, NOVA*GKS allows multiple hardware configurations in host, workstation, and microcomputer environments.

A graphics development tool, NOVA*GKS makes it easier to design and construct graphics applications. In a fraction of the traditional time. In addition, applications using NOVA*GKS are totally device independent. Even portable.

To learn more about NOVA*GKS and its bottom-line competitive advantages, contact us today. We'll show you how NOVA*GKS and the Nova Graphics International support team can put your products on the leading edge of an escalating, worldwide market.



**NOVA GRAPHICS INTERNATIONAL
CORPORATION**

"World Standard Software"

1015 Bee Cave Woods Austin, Texas 78746 USA (512) 327-9300, Telex 767109

CIRCLE NO. 30 ON INQUIRY CARD

Mini-Micro World

NEWS

says Sun's strategy with the model 50 is to take advantage of falling prices in RAM, disks and other components. "It appears that they want to be the low-cost producer and to push the upper limit of price/performance."

Dataquest figures show the engineering workstation market growing at an annual compound rate of 78 percent, faster than any other architecture in the design and manufacturing automation industry. Industry-wide revenues from shipments of engineering-workstation hardware, software and peripherals should skyrocket from \$411 million in 1983 to \$908 million in 1984 and \$7.2 billion in 1988, according to Dataquest figures.

Burdick predicts that as the market grows, the price of an average standalone workstation will decline from \$27,000 in 1983 to \$8,000 or lower by 1988. Factors in that compound annual price drop of 27 percent will include upcoming higher-bandwidth CPUs such as National Semiconductor's NS32032 and Motorola's MC68020, which, when available, will put downward price pressures on the NS16032 and the MC68010. Burdick says increased competition (between Sun, industry leader Apollo Computer Inc. and possible newcomers) will also drive prices down, as will the availability of 256K-bit RAMs.

Burdick sees Sun as a clear number two in the engineering workstation market behind Apollo, of Chelmsford, Mass., which also offers diskless models in its Domain series. "[Sun is] certainly very competitive," Burdick says. "Apollo can't meet all the demand and Sun is positioned to take advantage of that." He expects that Sun and Apollo will be setting the pace for price and performance in the engineering workstation industry. The minimum price for a Domain diskless workstation is \$15,900. That

ENGINEERING WORKSTATIONS: MARKET UP, PRICES DOWN

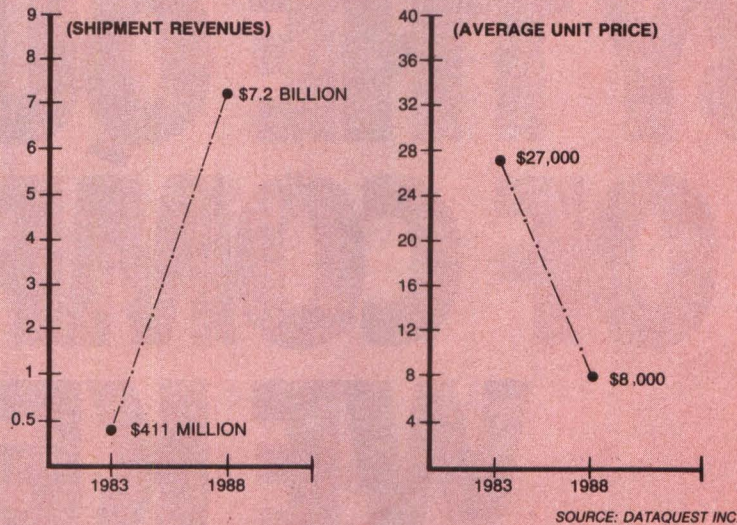

includes a 1,024-dot-by-800-dot monochrome display, the AEGIS operating system, 1M byte of main memory and two asynchronous RS232 ports.

An important difference between Apollo's and Sun's approaches is that Apollo uses its proprietary, distributed operating, multiaccess, interactive network (Domain) architecture, as opposed to Sun's open architecture embracing Ethernet and UNIX. (Apollo does offer a version of UNIX called AUX, which is

priced separately.) An Apollo spokesman points out that Apollo's token-passing ring topology and software architecture permit users to regard all the disks on a network as a subdirectory sitting on its own local-storage disk.

Sun vice president of marketing Carol Bartz cites Apollo as Sun's main competition. Bartz states that Sun's revenues jumped from about \$9 million in 1983 to \$39 million at the end of fiscal 1984. She predicts 1985 revenues of \$100 million. □

MULTIMATE EXTENDS WORD-PROCESSING SOFTWARE

Multimate International Corp., East Hartford, Conn., has introduced version 3.3 of its Multimate Professional word-processing package. Priced at \$495, the new version not only allows file conversion from mainframe systems to microcomputers, but also supports true proportional spacing and ASCII and Teletext file conversion. Additionally, a special cable editor communicates with new printers and takes advantage of special print functions.

DEVICE TESTS DISK DRIVES

For system integrators who need a testing method for disk drives, Computer Programming Services, Glendale, Calif., has developed a series of programs called DISKTEST. The company claims that the programs exercise and test both absolute byte-transfer-rate devices and access times in an operating environment. Currently, versions for the Digital Equipment Corp. PDP-11 and VAX systems are available.

JUDGE US BY THE QUALITY OF COMPANY WE KEEP.

Choose ALAR® thin film media and get more than a superior product. Get a technical partner. Because at Ampex, we're keeping company with the industry's most comprehensive team of professionals in magnetic recording. To provide you with more of the support you need to build today's drives. And plan for tomorrow's.

Specialists in our ALAR Disc Applications Lab. Providing head disc interface analysis. Answering questions. On flyability. On durability. On performance. Creating a correlation program specifically for your requirements. Giving higher yields and less incoming testing.

Our Advanced Technology Division and Media Technology Lab. 150 experts in magnetic recording physics. There to work on cooperative OEM development projects. Making concepts working realities. Preparing you for the future.

Partners. We'll provide the experience of four decades in magnetic recording. More than one million ALAR discs working in over 300,000 systems. So ride on our shoulders. All you have to provide is your company. Ampex Disc Media Operations, **AMPEX**
960 Rincon Circle, San Jose CA 95131 (408) 945-5600, Telex 348464.

Ampex Corporation • One of The Signal Companies 

WE'RE THE HEAVYWEIGHTS IN THIN FILM MEDIA.

ALAR® is a registered trademark of Ampex Corporation. Copyright 1984 Ampex Corporation.

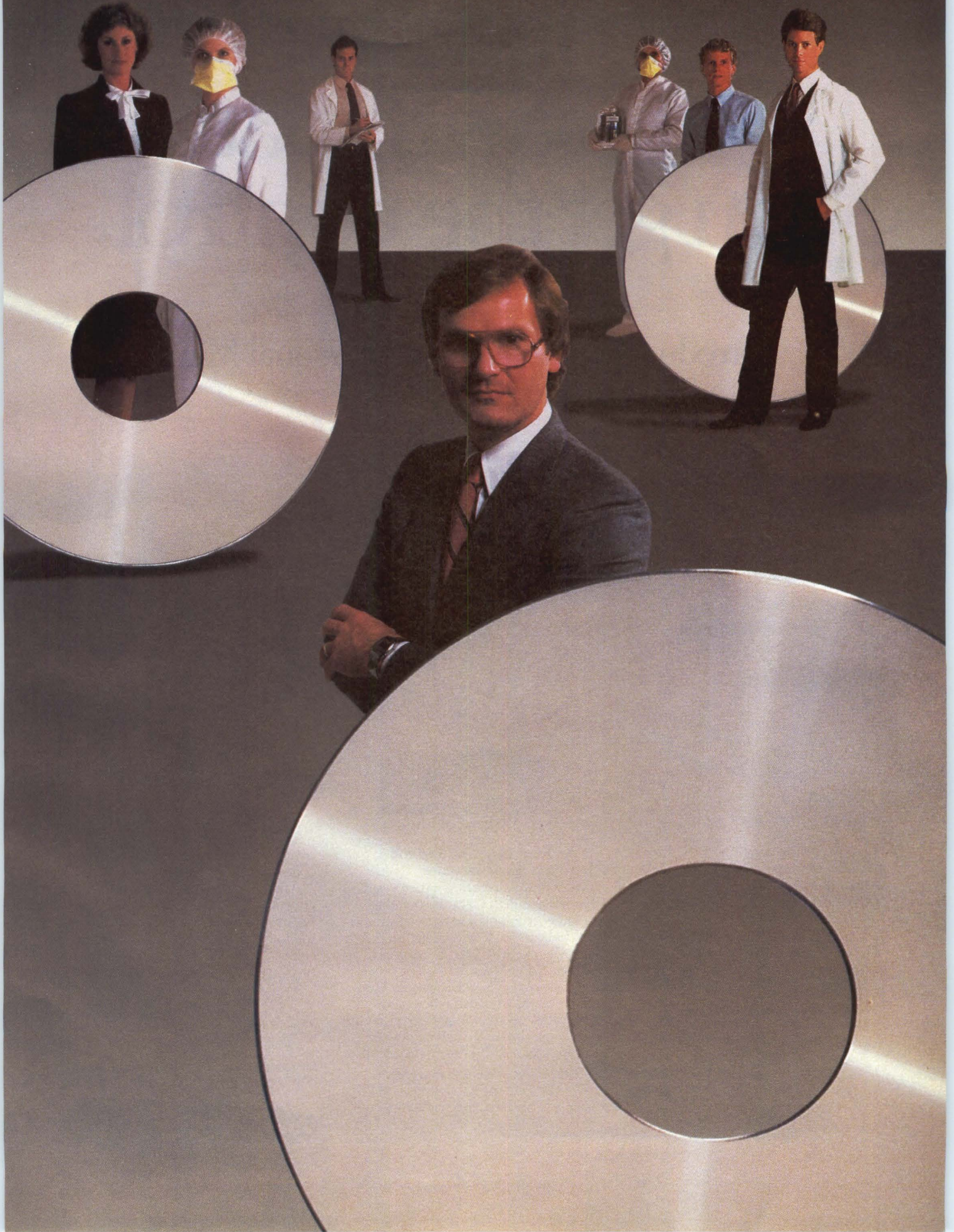

They get a PC growth path. You get the control.

Introducing the TeleVideo Personal Mini.
The growth path for everyone.

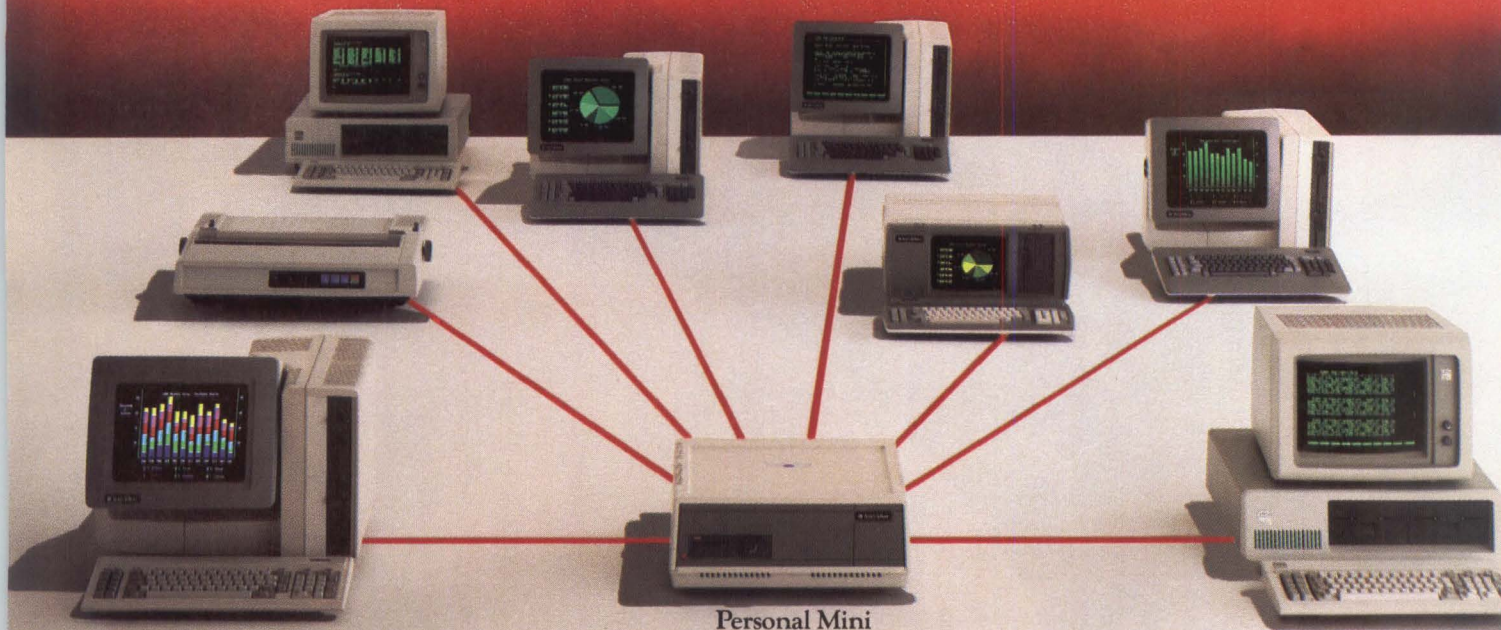

Personal Mini

People in your organization realized they outgrew their personal computers the first time they tried to share information or work together on a task. Standard PCs simply fall short of fulfilling their total business needs. Until now.

Until the TeleVideo® Personal Mini.™ It's the next rational step in your PC growth path. Just plug into it and grow.

Increases power and productivity.

It's the simple way to dramatically increase computing power and group productivity without sacrificing system manageability. It's the low cost way to network IBM®, TeleVideo, and compatible PCs, as well as the new IBM PC AT.

Runs PC, multiuser and mini software.

Its powerful operating system easily supports popular PC software, mini-computer programs and especially multi-user applications development using such languages as RM/COBOL™ or MAI Business Basic.™ Without speed or performance tradeoffs. And with its 3270 emulation, any PC can talk to your mainframe. So your original investments in software, hardware and computer training can only become more useful.

Improves system management.

We also paid special attention to DP concerns. For reliability. System secu-

riety. Total system manageability. And of course, future growth.

The new Personal Mini. The first PC growth plan no one will outgrow. Ever.

Arrange to see it for yourself. Call toll free, 800-521-4897. In California, call 800-821-3774. Ask for operator 10.

Regional Sales Offices: Northwest (408) 745-7760, Southwest (714) 476-0244, Southcentral (214) 258-6776, Midwest (312) 397-5400, Southeast (404) 447-1231, Mid-Atlantic (703) 556-7764, Northeast (617) 890-3282, East (516) 496-4777, Rocky Mountain (408) 745-7760.

IBM is a registered trademark of International Business Machines. RM/COBOL is a trademark of Ryan-McFarland Corporation. MAI Business Basic is a trademark of MAI Basic Four.

The TeleVideo Personal Mini. The first PC compatible multiuser system.



Computers
TeleVideo Systems, Inc.

Mini-Micro World

CORPORATE AND FINANCIAL

GUEST FORUM

The voice for guest experts

High-tech temporary help booms amidst hiring and wage freezes

John J. Davis
Worldwide Computer Services Inc.

Two different problems can have the same solution: professional high-technology temporary employees. For the worker, becoming a "temporary" can add variety to an otherwise dead-end career. And companies can retain temporary senior professionals on specific projects without being restricted by salary and employment freezes. The companies also would not have to carry excess staff members during slow periods.

In a typical scenario, several staff members leave midway through a project, thereby jeopardizing contract or delivery schedules. To solve the problem, employers turn to temporary professionals who can be on site within two weeks, be operative almost immediately and offer very specific work skills. Upon completion of the assignment, the relationship of the employer with the temporary

ends.

The use of such independent "consultants" within the computer industry dates back to the 1960s, when the industry first sought ways to bridge employment gaps during peak activity at a company.

Fueling the interest in consulting are the career crises faced by many engineers and computer professionals: Will their careers continue to progress if they remain with their current employer, or are their current positions really a dead end? Professionals also dislike being pigeon holed or becoming overly qualified in narrow job classifications. And, the potential for a temporary to prevail over salary freezes provides an additional incentive.

The fear of being unemployed is lessened when specialists work through temporary agencies. In some instances, they actually become employees of the temporary agencies. Or they use agencies solely to handle job

John J. Davis is a founder and the president of Worldwide Computer Services Inc., Wayne, N.J., which specializes in temporary, on-site assignments of computer, software and communications professionals.

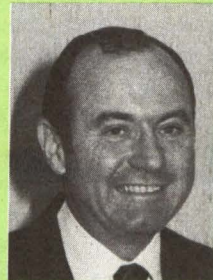

assignments. By "signing on" with an agency, specialists avoid the uncertainties of being a free agent. The typical assignment lasts from six to 18 months.

Depending on the temporary's skills, the employer and the assignment itself, daily rates range from \$250 to \$650. The temporary placement firm receives a negotiated portion of the fee.

Employers also benefit financially even though the daily rate sounds somewhat high. Temporaries, who might earn \$30,000 to \$90,000 a year or more, are not covered by corporate benefit plans that add 30 percent to 40 percent to base salaries. Use of temporaries eliminates additional hiring costs such as employment agency fees or personnel ads in newspapers. And temporaries fill a gap for the three to six months it takes to fill a job following the resignation, firing or promotion of a permanent staff member.

Financings

Los Gatos, Calif., startup company Cohesive Network Corp. recently received \$6 million in its second round of equity funding, bringing its total to \$7.5 million. At press time, the two-year-old company had not yet announced its first product but claimed it would help integrate voice, data, video and other telecommunications products. The lead investors are Sutter Hill Ventures and Bessemer Venture Partners.

Interleaf Inc., a Cambridge,

Mass., developer of office publishing systems, has brought in additional financing of \$5.1 million, for a total of nearly \$8 million. The funding will be used to expand marketing activities. Major investors include Eastman Kodak Co. and Hambrecht & Quist. Interleaf's systems produce, from start to finish, documents containing multiple typefaces and graphics.

Quarterly reports

Despite Intel Corp. president Andrew Grove's comment that he ex-

pects his company's growth rate to slow because of increased industry-wide semiconductor supplies, the Santa Clara, Calif., company posted a third-quarter net income of \$70 million. This was an increase of 118 percent over the third quarter of last year, when net income totalled \$32 million. Share prices moved up from 29 cents to 60 cents, while revenues were up 48 percent, from \$292 million to \$432 million.

Revenues for the first three quarters of this year rose to \$1.2 billion, compared to \$790 million in the

Mini-Micro World

CORPORATE AND FINANCIAL

same period last year. Net income for the three quarters also increased, reaching \$175 million, or \$1.50 per share, as opposed to \$69 million, or 64 cents per share, in the earlier period. Grove adds that system sales were weaker than expected.

With competitors rapidly dropping by the wayside, IBM Corp.'s fortunes continue to grow. Nine-month revenues swelled to \$31.4 billion, compared to \$27.3 billion in the same period a year earlier. Net earnings for the nine months increased to \$4.4 billion, or \$7.22 per share, from \$3.6 billion, or \$5.98 per share in 1983.

Total revenues for the third quarter itself grew to \$10.7 billion, versus \$9.4 billion in the third quarter of 1983. Net earnings for the quarter reached \$1.6 billion, or \$2.60 per share, against \$1.3 billion, or \$2.14 per share, in the third quarter of 1983. □

Contracts

Archive Corp., Costa Mesa, Calif., has been awarded a \$3 million contract to supply ¼-inch streaming tape drives to Metaphor Computer Systems. Metaphor will use the drives as backup devices in its database management system, Metaphor Computer....Culver City, Calif., software vendor Ashton-Tate has contracted to ship more than \$5 million worth of its microcomputer software packages to Tandy Corp. Tandy will distribute Ashton-Tate's Framework integrated software, as well as the dBASE III and Friday! packages, through its Radio Shack store chain....Charles River Data Systems is one of the latest vendors to sign a contract with the People's Republic of China. The Framingham, Mass., supermicrocomputer vendor will deliver 275 of its Universe 68 systems, worth an esti-

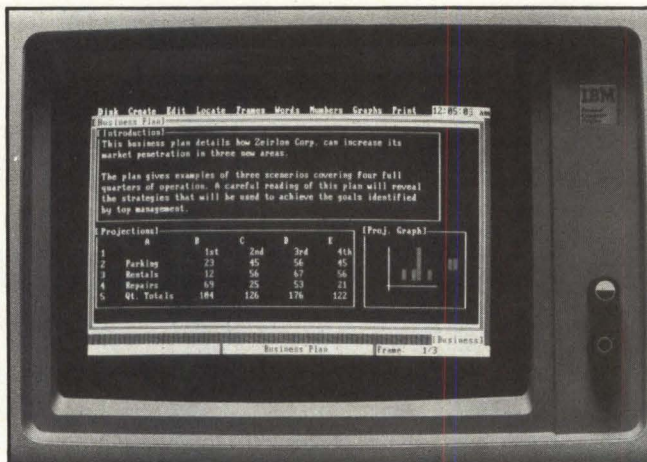

Ashton-Tate will ship more than \$5 million worth of its microcomputer products to Tandy Corp., including the Framework integrated software package.

Waybern Corp. will distribute Citizen America's first printers, including the 80-column, 160 character - per - second MSP-10 dot matrix model (shown), and the 136-column MSP-15.

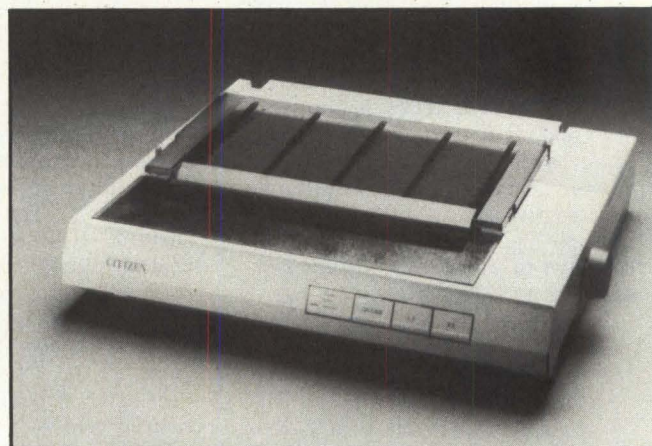

mated \$5 million, to the Tianjin Electronic Computer Factory over an 18-month period. Tianjin will add business and industrial applications software to the systems, which include Charles River's UNIX-like operating system UNOS....Citizen America, Santa Monica, Calif., has chosen Waybern Corp. as one of the first distributors of Citizen's initial line of dot-matrix printers. The \$3 million agreement includes the MSP-10 and MSP-15, 80- and 136-column, 160-character-per-second printers, which are both compatible with Epson America Inc. and IBM Corp. printers....Cullinet Software Inc., Westwood, Mass., has signed a development agreement with Digital Equipment Corp. to integrate Cullinet's Information Database software with DEC's VAX super-

minicomputer systems. The two companies will also cooperate to market existing products and to develop interfaces between VAX systems and IBM mainframe systems....DAVID Systems Inc., Sunnyvale, Calif., and Sharp Corp. have reached an agreement giving Sharp exclusive rights to manufacture and distribute DAVID communication products in Japan. The products from DAVID allow simultaneous transmission of voice, circuit-switched data and high-speed packet data over twisted pair telephone lines....In a \$10 million agreement, Bell Atlantic will market and service the proNET local area networks from Proteon Inc., Natick, Mass. The token-ring network provides 10M-bit-per-second host-to-host connections. □

AVAILABLE NOW FROM
MICRO-TERM

ERGO[®] 301

**GUARANTEED
VT100*
COMPATIBLE
FOR ONLY**

\$745

QUANTITY DISCOUNTS AVAILABLE



Micro-Term has been manufacturing VT100* emulators almost as long as DEC has been manufacturing VT100s. We guarantee that our ERGO 301 will correctly operate your DEC software—ALL of it. If we're wrong, return the unit for a full refund.

- Advanced Video Standard
- Bidirectional Printer Port
- Two Pages of Memory
- Plain English Set-Ups
- User-Programmable Function Keys
- Green Screen with Screen Saver
- Superior 132-Column Clarity
- Full One-Year Warranty

Optional ReGIS and Tektronix 4010 add-on graphics board available now

MICRO-TERM, INC.

Terminals are our only product, and we put more into them.
Call or Write: MICRO-TERM, INC., 512 Rudder Road, Fenton (St. Louis County), Missouri 63026
(314) 343-6515, TWX: 9107601662, MICROTERM, STL.
On-site service available at over 450 locations through Western Union



OEM alert: The new Perkin-Elmer 3205 packs supermini performance into a micro price tag.

Introducing the Perkin-Elmer 3205. Now OEMs and system integrators can provide 32-bit supermini computing power at micro system economics, without making any compromises.

No micro system can approach the per-terminal cost advantages of the Perkin-Elmer 3205 supermini. Or the migration paths. Or offer access to a common database.

No supermini system can touch the Perkin-Elmer 3205 proven price/performance statistics.

Small investment. Big potential.

A basic 3205 costs just \$8,029* and includes one megabyte of memory, eight communications lines, floating point and a lot more. There's even a microprocessor handling just

communications support that has more power than you get in most complete microcomputers.

The 3205 can be expanded to 4 megabytes of memory, 16 communications lines and 1.2 gigabytes of disk storage. And every configuration in the broad 3205 range offers a choice of operating systems: our own Real Time OS/32 or one derived from the UNIX** operating system.

Fully configured value.

50 megabytes of fixed/removable Winchester disk memory, 8 communications ports and a full complement of related capabilities are included in a fully configured 3205 computer for only \$15,469.* That lets you supply powerful computer systems your customers can afford to buy.

The support you need.

Perkin-Elmer has been an OEM supplier for over 15 years. We know how to support you. We have a worldwide service network, powerful, quality software, reliable hardware and the terms and conditions you need.

Mini/Micro/Maximization.

The Perkin-Elmer 3205 gives you the small purchase price of micro systems, and the power, growth potential and common database advantages of supermini systems.

For the complete story, call or write the Perkin-Elmer Corporation, Two Crescent Place, Oceanport, N.J. 07757. **1-800-631-2154.** In N.J., 1-201-870-4712.

*OEM quantity 100, U.S. only.
**UNIX is a trademark of Bell Laboratories.

PERKIN-ELMER

The science and computer company.
Where solutions come first.

CIRCLE NO. 33 ON INQUIRY CARD

Mini-Micro World

INTERNATIONAL

Large Korean companies lead country's technology drive



Charles Hintermeister
Taiwan Correspondent

The 15th Korean Electronics Show gave clear evidence of what observers of the Korean Computer industry have known for some time: A handful of well-funded conglomerates such as Samsung Electronics, the Hyundai Group and Goldstar Electronics have been aggressively developing and promoting their capabilities and products, while the vast majority of Korean computer firms, struggling with low budgets and making little or no investment in research and development, increasingly find themselves locked into producing low-quality, 8-bit, dual-processor systems.

Nowhere was this more evident than in the show displays, which included UNIX-based, 32-bit supermicrocomputers, sleek intelligent terminals, digital switching equipment, optical fiber telecommunication systems and VLSI chips—alongside chintzy electronic trinkets and crude Apple II knock-offs.

The show—held in Seoul, South Korea, October 10th to 15th, as part

After attracting 380 exhibitors and thousands of buyers, the Korean Electronics Show generated an estimated \$750 million in equipment sales.

of the Seoul International Trade Show—was a startling success, its

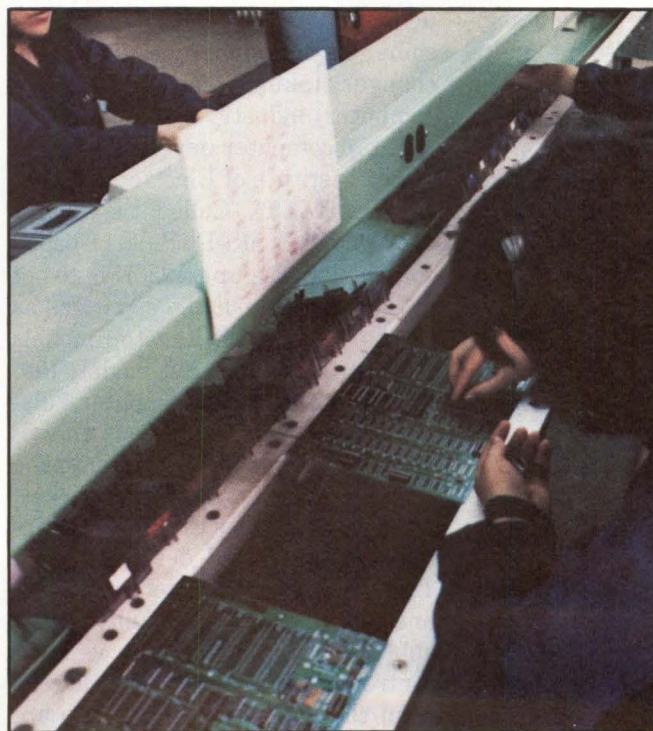

A line worker assembles printed circuit boards for Korea's Trigem Computer Inc., which manufactures IBM PC/XT-compatible computers.

mixed bag of products notwithstanding. About \$190 million worth of business was conducted on just the first day, according to the Electronic Industries Association of Korea, which projected that sales generated by the show would reach \$750 million.

The Taiwan Electronics Show, held directly before the Korean display, produced only \$27 million in orders, although the electronics industries of the two countries are about the same size. Observers speculated that the volume of business done at the Korean show was larger than at the Taiwan show because buyers found it necessary to actually travel to Korea to place orders at the show itself, whereas business with Taiwanese manufacturers can be conducted more easily, via mail and telex.

IBM PC-compatibles compete

As in the recent electronics shows in Hong Kong and Taiwan, many IBM Corp. PC-compatible systems

Mini-Micro World

INTERNATIONAL

were on display. While a number of such computers had suspicious pedigrees, the majority seemed in no immediate danger of incurring a lawsuit by IBM. Free-on-board (f.o.b.) prices of Korean IBM PC/XT-compatible systems tended to be 10 percent to 20 percent cheaper than those available in Taiwan, but of more varying quality.

Trigem Computer Inc. displayed a system billed as "99.9 percent" compatible with the PC/XT. Known as the Trigem 88, the system uses a BIOS developed by Personal Computer Products Inc. of Los Angeles, Calif., according to S.G. Kang, manager of Trigem's overseas business division.

The Trigem 88's standard configuration, which consists of a CPU with 128K bytes of RAM, expandable to 768K bytes, dual floppy disk drives with a total of 1M byte of formatted storage, and an 83-digit keyboard, goes for as little as \$1,000, f.o.b., depending on quantity. Also standard equipment is the "Trigem multivideo card," which offers both monochrome and color graphics support in a single expansion card, and a 128K-byte multi-function card. A 10M-byte hard disk drive may be purchased for an additional \$600. The rear panel of the Trigem 88 features an RS232 communications port and a parallel printer port. Trigem, which last year registered total sales of \$8 million, is actively seeking OEM buyers for the Trigem 88, says S.G. Kang.

Hyundai Electronics Industries Co. Ltd., part of one of Korea's largest conglomerates, the Hyudai Group, displayed for the first time its Super-16 IBM PC/XT-compatible computer and a 10M-byte hard disk drive. The Super-16, said Hwan-Ik Jung, manager of the firm's international sales department, was completely designed in-house, and does not infringe upon

any IBM patents or copyrights.

The Intel 8088-based system offers 256K bytes of RAM, expandable up to 512K bytes on the same board, and two built-in, 320K-byte, 5¼-inch floppy disk drives. Space is provided for two additional floppy drives or two 10M-byte hard drives. The board contains seven I/O slots, and the rear panel sports two RS232 communications ports and one parallel printer port. The system's low-profile keyboard uses 108 membrane-type keys, and includes 10 function keys. The Super-16 offers SNA/SDLC, bisynchronous and asynchronous communications protocols, which enable the system to be used as a local/remote terminal or remote-job entry terminal.

The Super-16 has not yet been marketed outside of Korea, says Jong, adding that Hyundai welcomes OEM business. The f.o.b. price for one standard-configuration CPU and keyboard will be about \$1,500, he says.

Korea makes kneetop computer

One of the more interesting products at the show, and one which in some ways symbolizes the rapid changes taking place in Korea's computer industry, was a 16-bit kneetop computer developed by the Korea Institute of Electronics Technology (KIET). Called the Sprite S-1000, the MS-DOS 2.11-based computer packs up to 256K bytes of RAM, but is about the same size as most popular 8-bit kneetop models (NEC 8102A, Tandy model 100, Epson PX-8). The computer, displayed in prototype form, is an ambitious and promising entry into the booming kneetop-computer market, observers say, but has several annoying, unresolved design defects: The angle of the 80-column-by-16-line LCD display is not fully adjustable and does not feature a contrast control, for instance. In its current form the computer contains no ap-

plication software, but KIET plans to include several popular IBM PC-compatible packages before the machine is released as a commercial product.

KIET, a Korean government-supported research and development organization with a staff of 200 engineers, plans early this year to transfer technology for the Sprite S-1000 to a large, private-sector firm in Korea, according to Jong Soo Shin, one of the KIET engineers who designed the system. The unit will be priced between \$1,500 and \$2,000, f.o.b., he says.

The Iljin Electronic and Industrial Co. Ltd., an OEM manufacturer for Corvus Systems of the United States, displayed a MC-68000-based workstation it is making for Corvus to market under its own name. The "Concept" workstation features 256K bytes of main memory, a 15-inch, high-resolution, bit-mapped display, an onboard Omninet local area network card and up to 45.1M bytes of hard disk storage. It is designed to handle word processing and business graphics, and can double as an intelligent terminal. Iljin also displayed local area networks for IBM PC computers and Apple II computers, each of which carried a suggested retail price of \$600.

Another MC68000-based computer system on display at the show, from Samsung Semiconductor and Telecommunications Co., runs an enhanced version of the UNIX operating system. The multiuser system, called the SSM-16, was developed by Samsung in cooperation with KIET.

Koryo Systems Inc., a subsidiary of the Korea Explosives Group, also introduced a supermicrocomputer at the show. Available in both 16-bit and 32-bit configurations, the KSYS-168 is based on the MC68000 chip family, and can support up to 16 users. The 32-bit version features up to 16M bytes of main mem-

What the salesperson says when you want the leading new price/performance, UNIX*, multi-user supermicro.

To find out, rearrange the letters below, one letter per box, to form five common computer words. Then unscramble the circled letters to see what the salesperson says.

REZO



SEMITURLU



WARTOSEF



TYMEBAGE



CIRVESE

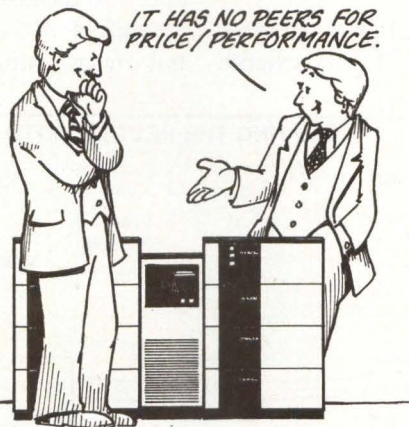

Still playing guessing games about who makes the best price/performance supermicro? Here's a clue.

It's the latest generation of multi-user supermicros, from the company known for the high-performance System 8000 family. Here's another clue. Our new family of three systems provides up to twice the operating speed of its predecessors, with an 11.1 MHz CPU, and a 32 KB cache memory. Plus, it easily supports up to 40 users.

Got the answer? Now get the exciting details! Call our toll-free number (800) 841-2255. Or write: Zilog Systems Division, 1315 Dell Avenue, MS C2-6, Campbell, CA 95008.

*UNIX is a trademark of AT&T Bell Laboratories. Zilog is licensed by AT&T Technologies.

Answer: Zilog Series Two.

Systems Division
Zilog

an affiliate of **EXON** Corporation

Mini-Micro World

INTERNATIONAL

ory, 1.2M bytes of floppy disk memory and a maximum of 1,200M bytes of hard disk memory. Like the Samsung supermicrocomputer, the KSYS-168 was designed and manufactured in Korea, though many of the components were imported.

The presence of the supermicrocomputers surprised many of the buyers present, many of whom had just come from the Taiwan show. The Taiwan computer industry, which is generally regarded as being two or three years ahead of its Korean counterpart, has thus far

not produced a supermicrocomputer. However, two Taiwanese companies, Multitech Industrial Corp. and Mitac Inc., are said to be developing them now.

Korea, home of Asia's second largest electronics industry (Japan is the largest), last year produced \$5.6 billion worth of consumer and industrial electronics goods, 54 percent of which were exported. Computer product manufacturing, according to Korean government statistics, reached \$207 million in 1983, compared to \$47 million in

1982. Major increases in OEM orders by large U.S. firms are expected to substantially increase export figures for this year.

Although Korea's computer industry, like those in Taiwan, Hong Kong and Singapore, strongly encourages OEM business, the country's population of 40 million provides it with a large domestic market. Domestic sales (of both local and imported products) last year accounted for \$300 million of the \$411 million in total computer product sales. □

Cheapernet makes local area networking more affordable

Keith Jones, European Editor

The Ethernet local area network (LAN), a standard LAN scheme

gaining popularity in offices, remains too expensive for some prospective buyers. But two lower-cost "modified Ethernets" that would put networking within reach of

many more users are now under review by committees within the Institute of Electrical and Electronics Engineers (IEEE).

One of the modified Ethernets is the appropriately named Cheapernet. Its bus technology is being defined by IEEE working group

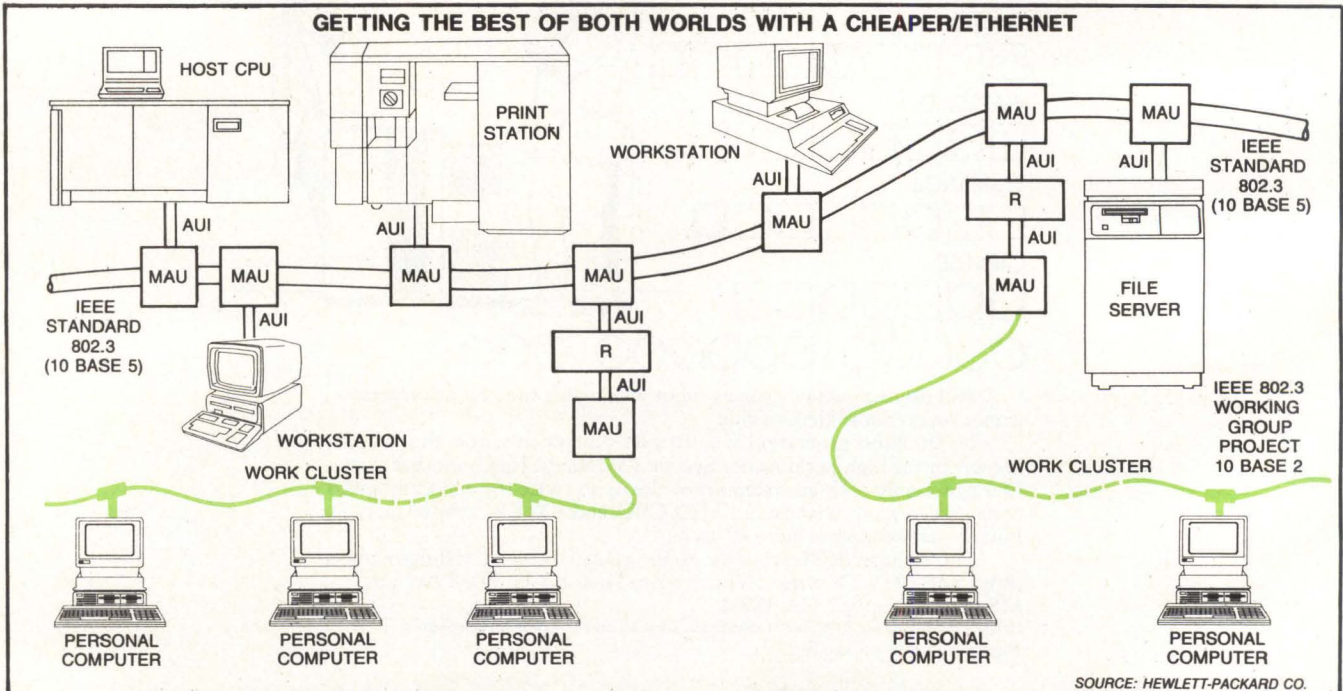

The standard 802.3 CSMA/CD backbone Ethernet network and the proposed standard low-cost Cheapernet network (in color), can be attached to form a hybrid local area network through repeaters (R) and attachment unit interfac-

es (AUI). Unlike Ethernet, Cheapernet does not require external medium attachment units (MAU) housing transceivers. The "10 Base 5" means Ethernet operates at 10M bps on baseband cable and allows 500 meters between nodes.



The UPS manufacturer that satisfies the toughest customers.

Some UPS manufacturers have two standards of quality—the ultra-exacting quality specifications for their government contracts, and the “other” quality they give their commercial customers. But not at GPS.

At General Power Systems, we know that only one customer is tougher than Uncle Sam—you, the OEM. That’s why *all* GPS uninterruptible power supplies, both on-line and standby, are designed, produced, tested and inspected with the same stringent standards applied to our defense products. Components are traceable, reporting is exact, testing is multi-level and burn-in complete.

The result is the highest quality standards in the industry’s most complete line of UPSs—the only UPS products directed specifically to OEM requirements. GPS on-line models span the range from 500VA to 50KVA, while standby units from 100VA to 2KVA are available. Inquire about our full line of options plus OEM customization.

All GPS uninterruptible power supplies have the high reliability, transistor technology pioneered by GPS, plus state-of-the-art operating features. Unusually fast transient response, low output impedance and excellent efficiency characterize the on-line models. Standby units have set the standard with 2ms transition time.

So don’t settle for second rate quality. Buy the UPSs that satisfy the toughest customers—*designed for the OEM by General Power Systems.*

Call or write today for complete information. General Power Systems, 1400 N. Baxter St., Anaheim, CA 92806-1201, (714)956-9321, (800) 854-3469, TELEX 182283.

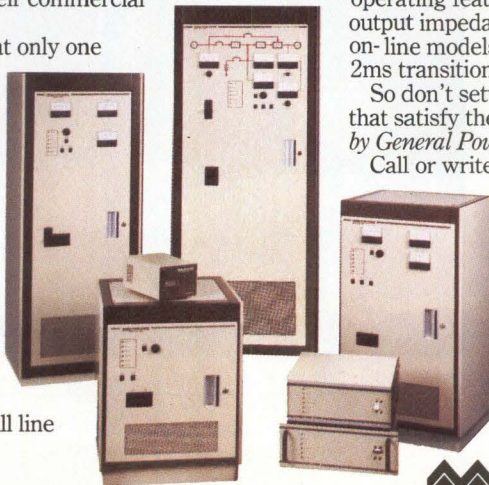

GENERAL POWER SYSTEMS

A Division of ALS Corporation

CIRCLE NO. 35 ON INQUIRY CARD

See us at booth 926.

 Mini/Micro West

TEKTRONIX INTRODUCES THE WORLD'S BROADEST LINE OF 32-BIT GRAPHICS WORKSTATIONS.

Introducing the first workstations whose breadth of options will satisfy the unique needs of every user—yet whose compatibility with hosts, PCs, terminals, and each other will answer the equally demanding needs of every company. From its low-cost personal workstations to its multiple 32-bit, multi-processing engines... from its new graphics displays to its integrated software... from its immediate potential to its long-range value, the new Tek 6000 Family of Intelligent Graphics Workstations is far and away the price/performance leader.

Keep your software, hardware, and host. The workstations' open architecture lowers the cost of developing and porting software. You can use Tek 4000 Family terminals or our all-new window-managed displays. You can specify IBM-PC compatibility. Continue to use your host compute power. And connect with other workstations via the LAN.

Immediate solutions and software tools. Most UNIX-based software is easily ported, as are packages written with GKS and PLOT 10 TCS and IGL. As a result, major third party applications packages are already available, with many more on the way.

In addition, Tek offers a range of superb software tools, including a document processor, project planner, graphics editor and relational DBMS.

Call 1-800-547-1512 today, to learn how you can get everything you've wanted in a workstation: High performance. Host compatibility. More options to start with. And a standard you can grow with. In Oregon, call 1-800-452-1877. Many sales and leasing agreements are available.

Tek Intelligent Graphics Workstations: The standard you can grow with.



Copyright © 1984, Tektronix, Inc. All rights reserved. ZEO-102

4. Tek 4115B terminal
integrated into
workstation.

5

5. Instrument controller
with real-time operating
system.

4

6

6

8

7

6. New window-
managed displays help
deliver the full benefits of
multi-processing.

7. Tek 6200 dual-wide
configuration enables
limitless expansion.

8. Keyboards, displays and
display stands all incor-
porate human engineer-
ing at its best.

UNIX and IBM-PC are trademarks or registered trademarks of, respectively, AT&T Bell Laboratories, Inc., and International Business Machines. 4115B display courtesy of PDA Engineering.

Tektronix
COMMITTED TO EXCELLENCE



New Qantex 7065. A fast printer at a slow price.

No matter how heavy the traffic, our new Qantex 7065 multimode printer will keep your documents flowing smoothly. At a very affordable price.

Use it for data processing, and the 7065 zips along at 300 cps bidirectionally. Both user-defined formats and six-part forms capability are standard.

Switch to word processing and the 7065 delivers near letter quality at 125 cps. Plus features such as proportional spacing, justification, auto-underline and bold.

And as a 65 cps letter quality

printer, it's fast enough and quiet enough to leave the competition in the dust. You get high density, double pass printing in your choice of some 20 fonts.

The 7065 is also a dot addressable graphics printer with resolution to 144 x 144 dots per inch and a full complement of line drawing graphics.

Besides being very fast, the 7065 is very compatible — with IBM, Apple, Lotus 1-2-3 and just about any other personal computer or software on the market. It offers built-in bar code capability. And its 500-million-plus char-

acter print head and industrial quality construction are designed for long, hard use.

To find out how quickly the Qantex 7065 could bring your information processing up to speed, contact Qantex for details or a demo. Qantex, 60 Plant Avenue, Hauppauge, NY 11788. Call toll-free 800-645-5292; in New York State 516-582-6060.

 **north atlantic**
Qantex

CIRCLE NO. 37 ON INQUIRY CARD

Mini-Micro World

INTERNATIONAL

802.3, and may be approved this year. Cheapernet is less expensive than Ethernet, but it employs the same carrier sense multiple access with collision detection (CSMA/CD) topology specified by 802.3.

Another faction within 802.3 is promoting the Starlan, a much more dramatic modification of Ethernet. While Cheapernet retains Ethernet's basic physical bus structure—a coaxial cable running between the workstations—the Starlan's bus is structurally nothing more than two traces on a printed circuit board. The bus is connected to each workstation by unshielded, twisted pair telephone lines, which limit the data rate to 1M bit per second. But Starlan committee chairman Robert Galin notes that CSMA/CD protocols are still used to resolve contention because the protocols are well defined and supported by available components.

Substantial savings available

Cheapernet is about one-fifth the cost of Ethernet (which runs \$1,000 to \$3,000 per workstation node) according to 802.3 chairman Donald Loughry, who is also a project manager at Hewlett-Packard Co.'s Information Networks Division, Cupertino, Calif. Loughry stresses that "Cheapernet is also completely compatible at the protocol level with Ethernet."

Loughry explains that Cheapernet's cost savings derive from the substitution of some expensive Ethernet parts with some much more widely used and cheaper parts. Notably, Ethernet's .4-inch, twin-braided coaxial cable is replaced by the standard RG58 coaxial cable used in products like public address systems. The RG58 still requires a medium attachment unit (MAU) incorporating a transceiver, but not one located outside of the workstation. This obviates the need for expensive shielded boxes and

CCA EMACS. THE MOST POWERFUL, EXTENSIBLE SCREEN EDITOR FOR UNIX AND VAX/VMS.

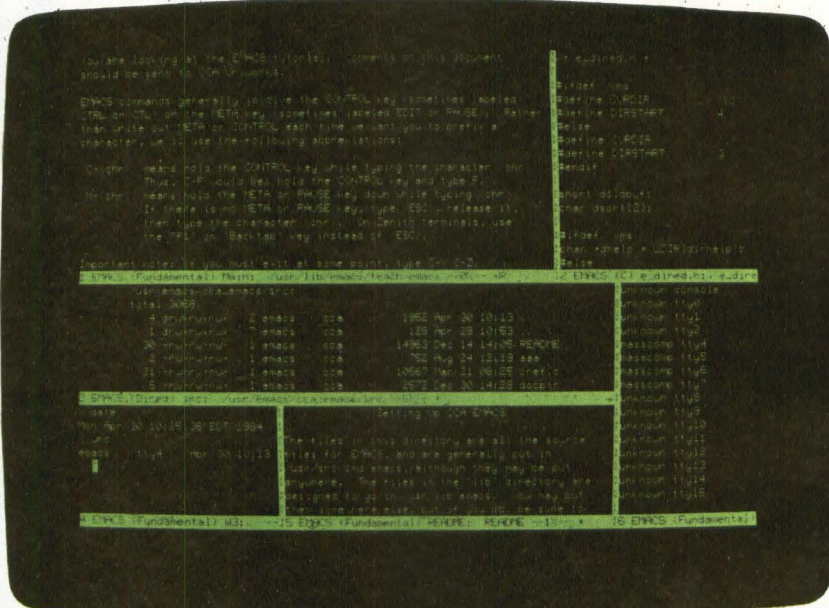

No other system editor gives you the power, speed and functionality of CCA EMACS. Or makes editing so easy. Close to 400 built-in commands let you do any task with only a few keystrokes. Even the kinds of things that are difficult or impossible to do with other editors. And with our Common Lisp-based extension language, Elisp, you can customize CCA EMACS to meet your program needs.

CCA's proprietary display management system provides exceptional performance. Other powerful features include the ability to edit up to 200 files simultaneously and advanced windowing, which enables you to manage concurrent processes and move information from one window to another. All of which makes it easy to revise major software and documentation.

CCA EMACS also has two extensive recovery facilities to protect against system failures.

Any user can quickly utilize all the power of CCA EMACS. Because it's supported by both in-depth printed manuals and a full online documentation package that includes a tutorial.

CCA EMACS runs on Berkeley Unix™ (4.1BSD and 4.2BSD), Bell Unix (System III and System V), Xenix™ and VAX/VMS.™ It requires 500K of address space.

Prices for a license range from \$380 to \$850 for Unix to \$1900 for VMS. Volume discounts and an academic license program are available.

For more information or to get a trial copy, please call our sales staff at 1-800-222-0214. In MA, call (617) 235-2600.

Unix, VAX and VMS and Xenix are trademarks of Bell Laboratories, Digital Equipment Corporation, and Microsoft Corporation respectively. CCA EMACS and Elisp are trademarks of CCA Uniworks, Inc.

CCA Uniworks, Inc.

‡ A Crowntek Company

20 Williams Street, Wellesley, MA 02181

SEE US AT UNIFORM, BOOTH 2165

Up Your AT™

■ Emerald System's new 60MByte 1/4" cartridge tape subsystem is the perfect answer to faster processing of your PC AT's larger, more numerous data files.

Forget about keeping track of expensive floppies. Because this internal upgraded kit has everything you need, including BRU™, Emerald's unique Backup and Restore Utility™.

BRU works as your personal librarian, helping you to retire and track files for archival storage and enabling you to safely and easily transfer files between your Emerald or IBM hard disk and floppies and Emerald's 1/4" tape cartridge.

MORE RELIABLE

Our BRU-equipped tape drive protects your valuable data and helps assure timely access. All data written to tape is checked, and all write errors are corrected automatically.

Even if your AT floppy or disk drive is non-operational, you can still load files directly from tape. Media interchangeability with other machines also running BRU assures you easy access to your valuable data even if your machine is not operating. And our cartridges also allow you to distribute data files that don't fit on floppies.

MORE CONVENIENT

Do multiple volume backup from your IBM or Emerald hard disk or floppies on one data cartridge. And with a utility such as ProKey™, your backup procedure can be fully automated. BRU options invoked from the DOS command line or from a convenient menu gives you these choices:

- Backup an entire physical disk.
- Backup a logical volume.
- Backup entire DOS directories.
- Backup files by name (wild card allowed).
- Backup files by DOS date and time stamp.

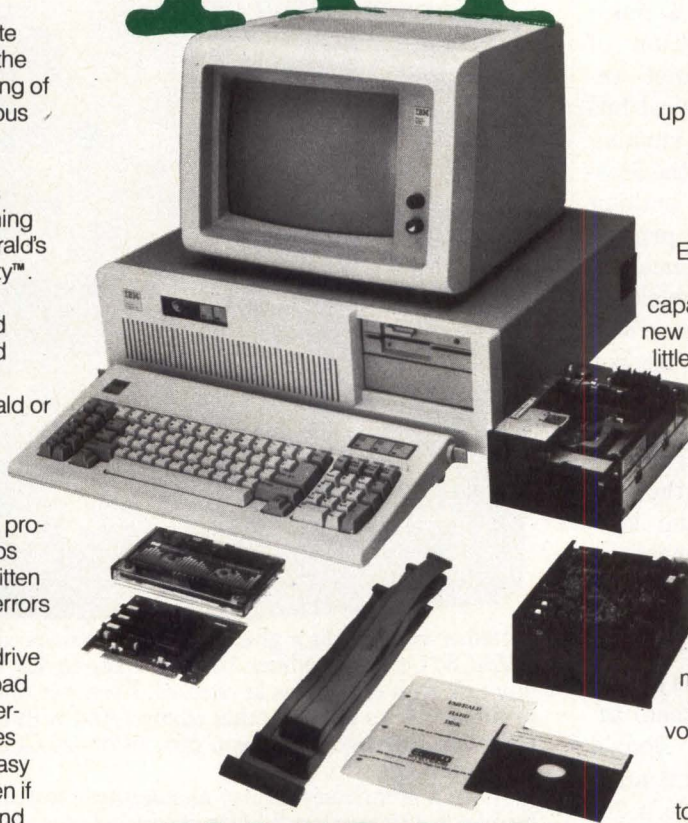

EMERALD

SYSTEMS CORPORATION

Mainframe Storage for Micros

A COMPREHENSIVE SOLUTION — AVAILABLE NOW!

Emerald Systems Corporation. The complete hard disk and tape backup solution for builders of desktop computer systems.

So up your AT, your XT, your PC, or your PC compatible system . . . with Emerald Systems' mainframe storage for micros. Call (619) 270-1994 for more information and the name of the dealer nearest you.

■ And you can forget about file sizes. Emerald's BRU automatically breaks up files that are longer than the tape. Restoring files from tape involves options essentially the reverse of backup.

MORE ECONOMICAL

Emerald's 60 MByte tape cartridge gives you 50 times more storage capacity, yet costs less than 1/5 that of new high-capacity floppies. And for as little as \$65 per MByte you can install our hard disk kit in your PC/AT chassis. Emerald Systems' internal 40, 65, 140, 280 MByte hard disk AT upgrade kit is also 30% faster than IBM's.

And our hard disk cache feature makes retrieval speed of selective files 100 times faster. This hard disk caching feature keeps often-used files available in memory at microspeed access time. And you can partition our disks into 1 to 24 volumes, with up to 240 MBytes per volume.

You may not need 280 MBytes today. But if you need to share disk storage in your LAN or expand your database without being limited by DOS to 32 MBytes, you need Emerald Systems' technology today.

SUPPORTS ALL MAJOR OPERATING SYSTEMS & LANS

Emerald's subsystems support DOS 2.0/2.1/3.0, QNX, PC/IX, UCSDp System, and XENIX (when available). Also, all fully compatible LAN's including 3 COM, PC-NET, X-NET, NOVELL, and IBM's version of SYTEK's LAN (when available).

4901 Morena Blvd.
San Diego, CA 92117
(619) 270-1994

Mini-Micro World

INTERNATIONAL

separate power supplies for each MAU, or the D-type 15-pin connection to each workstation. Instead, the MAU can be located inside the workstation and the only external part, other than the cable itself, is a simple connector. "Ethernet takes some expertise to assemble but Cheapernet can be attached by a secretary," claims Loughry, "So there is also a saving in labor costs."

However, users pay a price for the cheaper cable: lower noise resistance and lower attenuation. Additionally, repeaters are needed every 600 feet on Cheapernet as opposed to every 1,600 feet on Ethernet. And the number of nodes per segment is limited to 30, as opposed to 100. But Loughry believes that users will enjoy the benefits of both technologies by constructing hybrid LANs with Cheapernet branches connected to an Ethernet backbone by repeaters. National Semiconductor Corp. offers a set of three integrated circuits said to support both Ethernet and Cheapernet systems.

If Cheapernet is approved by the IEEE standards board this year, it will then be added to the 802.3 standard. Loughry explains that Cheapernet's official designation is "10 Base 2" under the 802.3 committee's scheme for designating types of LAN. The first two digits are the data rate in megabits per second; the second four letters are an abbreviation of the transmission medium (in this case baseband); and the final digit is the distance between nodes in hundreds of meters. Standard Ethernet is "10 Base 5."

Michael J. O'Rourke, director of international sales at 3Com Corp., Mountain View, Calif., notes that Cheapernet-like hardware has been sold by his company for the past two years under the name of Thin Ethernet and offered as part of 3Com's Etherlink hardware. O'Rourke adds that 3Com has participated in the work on Cheapernet

How To Delight Your Lotus With Mainframe Data

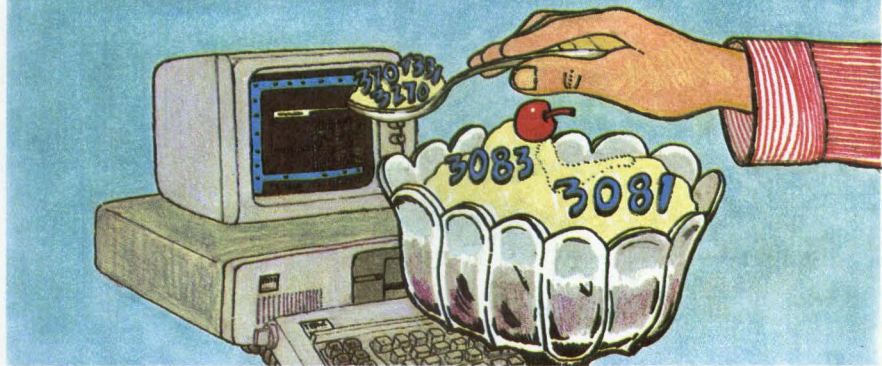

Another Smart Solution From AVATAR

The idea is simple. Make your PC spreadsheet even more powerful by giving it mainframe data. But getting that data out of your mainframe, into your PC and onto your spreadsheet isn't that simple.

Until now, you've had three choices. Transfer entire files from the host and risk choking your PC with data. Not very efficient. Or find the information in printed reports, then reenter and reformat it. Very tedious. And the alternative of asking your DP department to write special host software... well, they're overburdened already. Three choices, no real solution.

Now there's TURBO, the newest micro-to-mainframe link from AVATAR.

TURBO's Data Capture lets you select just the information you need from the mainframe. And use it immediately in any of your PC applications—Lotus, dBASE, you name it. Without rekeying, reformatting, re-anything.

And you can use TURBO's host-assisted File Transfer the way file transfer was meant to be used—for sharing data with other PC users on the 3270 network.

If that isn't enough, TURBO's exclusive Macro Language adds a whole new dimension to your micro-to-mainframe link. Use Macros to automate file transfer and data capture. Better yet, massage host data even before feeding it to your spreadsheet.

So give your PC a TURBO from AVATAR. And delight your Lotus with mainframe data.

AVATAR

The Link That Thinks

Avatar Technologies Inc.
99 South Street
Hopkinton, MA 01748
(617) 435-6872

Allied Computer Group
(414) 961-8808
Computer Communication Connection
(213) 306-5469
Digital Computer Products
(415) 349-5699
Polygon Associates
(314) 576-7709
WA Brown Instruments
(305) 776-4800

International
France/Belgium
ISTA-Imatic
(01) 630 21 46
Sweden
Databolin
(08) 714 00 00

Butler Associates
(617) 964-5270
Data Aids Associates
(713) 353-7728
Innovative Computer Marketing
(803) 288-2422
Portable Computer Systems
(609) 429-6162
XPOINT
(404) 446-2764

Australia/New Zealand
Datatran
(03) 729-2844
Italy
Mactronics
(02) 68 82 141
UK/Ireland
Interlekt Electronics
(0734) 589551

Capital Systems
(703) 892-1150
Data Processing Sciences
(513) 961-0776
Kaltronics Distributing
(312) 291-1220
Servitronics
(313) 273-0036

Canada
Ahearn & Soper
(416) 675-3999
Norway
Norwegian Data Comm
(02) 68 89 83
W. Germany/Austria
Stemmer Elektronik
(089) 80 60 61

All product information is subject to change without notice.

© 1984 Avatar Technologies Inc. Lotus is a registered trademark of Lotus Development Corporation.
dBASE is a trademark of Ashton-Tate, Inc.

CIRCLE NO. 40 ON INQUIRY CARD

Think BEFORE YOUR NEXT PC!

Your PC to Time Sharing System

KT-7/PC

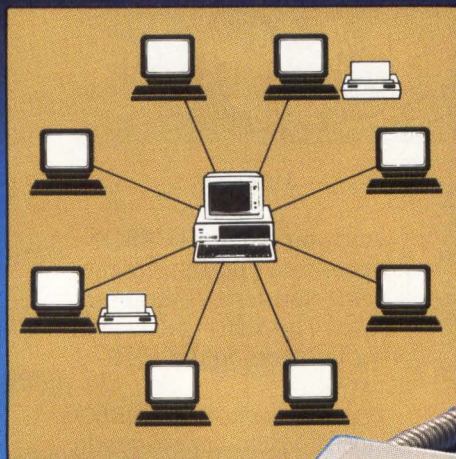

Why buy "ADDITIONAL EXPENSIVE PC'S" just to get additional users!

Kimtron is the only one that enables you to expand your IBM PC, XT, AT or the other PC compatibles to Multi-Tasking and Multi-User system at a fraction of the cost of additional PC's. Only Kimtron can display the screen exactly as your PC monochrome monitor, even for software like Lotus 1-2-3 or Word Star. Plus only Kimtron provides an IBM PC keyboard look-alike.

Operators will not only think and feel the KT-7/PC as if they're using IBM PC, but the KT-7/PC

Kimtron, a 5-year technology leader - we're going places and want you to join the Kimtron family of satisfied users. For more information about our KT-7/PC and your other terminal needs, call the Kimtron Corporation.
(408) 727-1510

NOTE: IBM PC, XT, and AT, Lotus 1-2-3, and Word Star are trade marks of IBM Corporation, Lotus Development Corp., and MicroPro International Corp.

provides many more useful features such as tilt, swivel and height adjustment of monitor, optional amber screen, a dedicated serial printer port for each user at no extra cost, and optional 14 inch screen.

In addition, the KT-7/PC is designed for flexibility so that it can also be used as an industry compatible ASCII terminal.



2225 - I Martin Avenue
Santa Clara, CA 95050
408-727-1510 TWX: 910-338-0237

Kimtron

CIRCLE NO. 41 ON INQUIRY CARD

Mini-Micro World

INTERNATIONAL

within IEEE's 802.3 committee.

Starlan approval slower

Robert Galin, who is strategic planning manager within the peripheral components operation of Intel Corp., Santa Clara, Calif., notes that the Starlan is much further from formal approval by IEEE than Cheapernet. Galin believes that opposition to the Starlan from Cheapernet supporters within 802.3 is politically and economically motivated. But Loughry says that reluctance to the Starlan standard has been the result of incomplete discussions among 802.3 members.

Galín points to the line-up of powerful Starlan supporters, notably AT&T Information Systems. Galín believes that the Starlan is not a direct alternative to Cheapernet because of its dramatically different topology. He also points to its extremely low cost. Starlan committee member Dr. David White, who is the department head for digital networking hardware at Wang Laboratories Inc., Lowell, Mass., suggests an average cost will be only \$50 per workstation, assuming there are about 20 workstations on a hub. These costs do not include installing the actual twisted pair links to the hub, because most offices already have twisted pair bundles with spare pairs. Galín lists other cost savings such as inexpensive twisted pair repeaters and driver and receiver components.

Galín explains that multiple Starlan hubs can be connected in a hierarchy of three levels. In the lowest level, one twisted pair connection in each hub can be linked to a hub in the middle level. One connection on each hub in the middle level can be connected to the highest hub. In the worst case, a transmitted message will need to traverse five hubs before reaching the destination workstation. □

How To Triple The Speed Of Your 3270 Printer

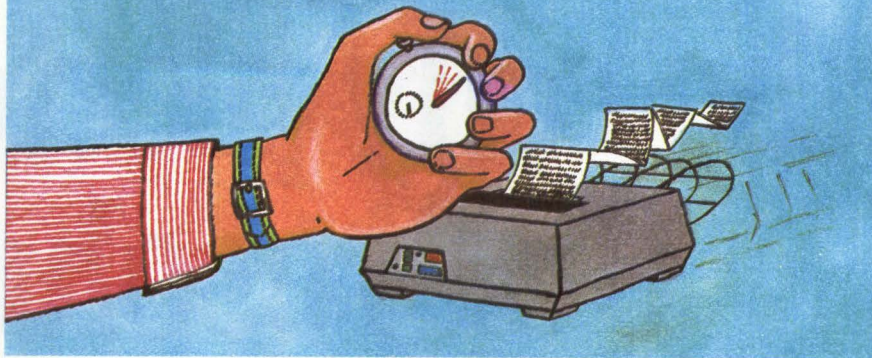

Another Smart Solution From AVATAR

It's a sad sight. Seeing your IBM 3270 printer falling further behind every day. Outpaced by ASCII printers that deliver far greater performance at a much lower cost. ASCII printers that, until now, didn't link to your 3270 system.

Enter AVATAR's PA1500 protocol converter. It lets you attach virtually any ASCII printer directly to your 3270 network with a simple coax connection—including printers that are three times as fast as your IBM printer and cost half as much.

Now you can select the printer that matches your system needs. For greater speed, letter quality printing, better performance. Fast dot matrix or line printers. Bar code or graphics printers. Even the newest ink jet or laser printers can be a part of your 3270 network.

Together, the PA1500 and the printer of your choice give you all the capabilities of your IBM printer...and more.

So get yourself an AVATAR PA1500. And bring your 3270 printer up to speed.

AVATAR

The Link That Thinks

Avatar Technologies Inc.
99 South Street
Hopkinton, MA 01748
(617) 435-6872

Allied Computer Group
(414) 961-8808
Computer Communication Connection
(213) 306-5469
Digital Computer Products
(415) 349-5699
Kaltronics Distributing
(312) 291-1220
Servitronics
(313) 273-0036

International
France/Belgium
ISTA-Imatic
(01) 630 21 46
Sweden
Databolin
(08) 714 00 00

Butler Associates
(617) 964-5270
Data Aids Associates
(713) 353-7728
Epson Great Lakes
(313) 281-2800
Polygon Associates
(314) 576-7709
WA Brown Instruments
(305) 776-4800

Australia/New Zealand
DataTran
(03) 729-2844
Italy
Macronics
(02) 68 82 141
UK/Ireland
Interlekt Electronics
(0734) 589551

Capital Systems
(703) 892-1150
Data Processing Sciences
(513) 961-0776
Innovative Computer Marketing
(803) 288-2422
Portable Computer Systems
(609) 429-6162
XPOINT
(404) 446-2764

Canada
Ahearn & Soper
(416) 675-3999
Norway
Norwegian Data Comm
(02) 68 89 83
W. Germany/Austria
Stemmer Elektronik
(089) 80 60 61

All product information is subject to change without notice.

© 1984 Avatar Technologies Inc. IBM is a registered trademark of International Business Machines Corporation.

CIRCLE NO. 42 ON INQUIRY CARD

CalComp introduces the only plotter with .001" resolution, eight pens and 36" wide plots for under



\$8,500.

The numbers on CalComp's new 1040 Series add up to one great buy. Even better, there are no hidden costs or extras because each 1040 plotter includes a built-in controller interface and host software.

So now every workstation can have its own full-size, full-featured, high-quality plotter.

The 1040 Series has advanced features that make it impressive at any price. For instance, there's a new interchangeable carriage-mounted 8-pen turret that eliminates tedious pen change delays. By using special sensors, it determines pen type, and sets optimal pen force and speed.

User-friendly features such as automatic media loading and sizing allow the user to

IBM and Apple are registered trademarks of, respectively, International Business Machines Corporation and Apple Computer, Inc.

get started quickly, producing A to E size plots. An intelligent control panel has local data manipulation capability and built-in self-diagnostics which further enhance overall productivity.

The 1040 Series family includes both cut-sheet operation for more immediate jobs and continuous roll capability for unattended operation. These flexible products are compatible with any CAD system, including those based on IBM® PC and Apple® computers.

Go by the numbers when you select plotters. For details, contact: CalComp, 2411 W. La Palma Ave., P.O. Box 3250, Anaheim, California 92803. Or call toll-free 1-800-CALCOMP, ext. 156.



CALCOMP
A Sanders Company

“Only the Invitational Computer Conferences bring the latest OEM computer and peripheral products to your front door. You’ll find us there!”

And you’ll find other top OEM manufacturers, such as IBM, Control Data, DEC, Fujitsu, NEC and Seagate, to name a few.

In their 14th year, the “OEM Only” Invitational Computer Conferences bring you, the volume buying decision makers, together with the key suppliers of computer and peripheral products. The ICCs, a series of ten, one-day regional shows are convenient to where you live and work. The social business setting makes it easy for you to meet poten-

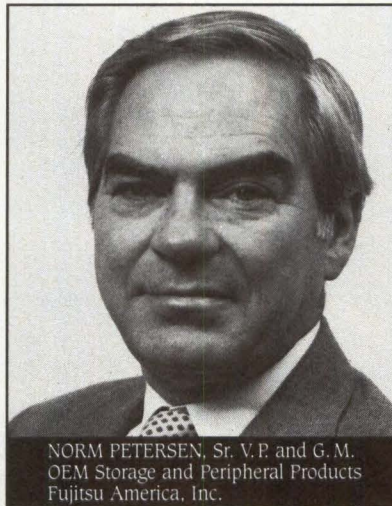

NORM PETERSEN, Sr. V.P. and G.M. OEM Storage and Peripheral Products Fujitsu America, Inc.

tial suppliers one-on-one, and attend high tech seminars of your choice. As an invited guest, there is no cost to you.

Hear what the OEM manufacturers have to say, learn more about their products, and remember, you may attend “by invitation only.”

1984/85 U.S. ICC Locations

Sept. 6, '84	Newton/Boston, MA
Sept. 25, '84	Southfield/Detroit, MI
Oct. 10, '84	Cherry Hill, NJ
Oct. 23, '84	Englewood/Denver, CO
Jan. 8, '85	Irvine, CA
Jan. 29, '85	Houston, TX
Jan. 31, '85	Dallas, TX
Feb. 26, '85	Ft. Lauderdale, FL
Mar. 19, '85	Palo Alto, CA
Apr. 2, '85	Nashua, NH/No. MA

Call your local OEM supplier for your invitation or fill out the coupon and mail to:

B. J. Johnson & Associates, Inc.
3151 Airway Ave., #C-2
Costa Mesa, CA 92626
Phone: (714) 957-0171
Telex: 188747 TAB IRIN



Yes! I need an invitation to your “OEM Only” ICC. The nearest ICC to me is: _____

I buy in volume:

- Computers
- Disk/Tape Drives
- Controllers/ Interfaces
- Terminals/ Graphic Displays
- Software
- Printers
- Memory Boards
- Modems/ Multiplexers
- Power Supplies

Name _____

Title _____

Company/Division _____

Address _____

City _____ State _____ Zip _____

Mail To: B.J. Johnson & Associates, Inc., 3151 Airway Avenue, #C-2, Costa Mesa, CA 92626
Phone: (714) 957-0171 Telex: 188747 TAB IRIN

**TO DISCOVER
THE BEST OEM
PROGRAM IN PRINTERS,
FIRST
TRAVEL TO JAPAN...**



ON US.

Our program begins with the JDL-750, first in a new line of OA printers.

A high resolution serial impact dot matrix printer delivering letter quality and color graphics.

But the product is only half the story. Behind it are two companies with a comprehensive program that makes good sense for the OEM. The JDL-750 is manufactured by Japan Digital Laboratory, an acknowledged leader in OA technology since 1968. From design inception to our consistent manufacturing quality, we deliver value and reliability—on time. Japan Digital Laboratory backs up its commitment to the OEM with unqualified financial strength and a corporate tradition of customer support and service that directly involves 60% of the company's employees.

JDL, Inc. carries on the OEM commitment in the U.S.A. By providing local custom engineering, from proprietary interface and software, to your own logo and colors, we help you develop your OA workstation printer quickly and efficiently. Concurrent testing in the U.S.A. means that our procedures reflect your standards for quality in environmental and life testing, beta tests and agency approvals. And,

we carry on the corporate dedication to service and support in a way that assures you both satisfaction—and profit.

Skeptical? We don't blame you. That's why we want OEM's who meet our qualifications to join us in Japan, free. If you evaluate the JDL-750 and the resources behind it, we know we're going to be your new printer vendor.

So call us or use the coupon below. Then, start packing.



JDL
INCORPORATED

2801 Townsgate Rd., Suite 104
Westlake Village, CA 91361

(805) 495-3451 FAX: (805) 495-3374

© 1984

MINI-MICRO SYSTEMS/January 1985

I'm an OEM looking for a better printer supplier. Tell me how I can qualify for your trip to Japan.

NAME _____

TITLE _____

COMPANY NAME _____

ADDRESS _____

CITY _____ STATE _____ ZIP _____

PHONE (_____) _____

MM 185

CIRCLE NO. 84 ON INQUIRY CARD

87

SIEMENS

The Finishing Touch!

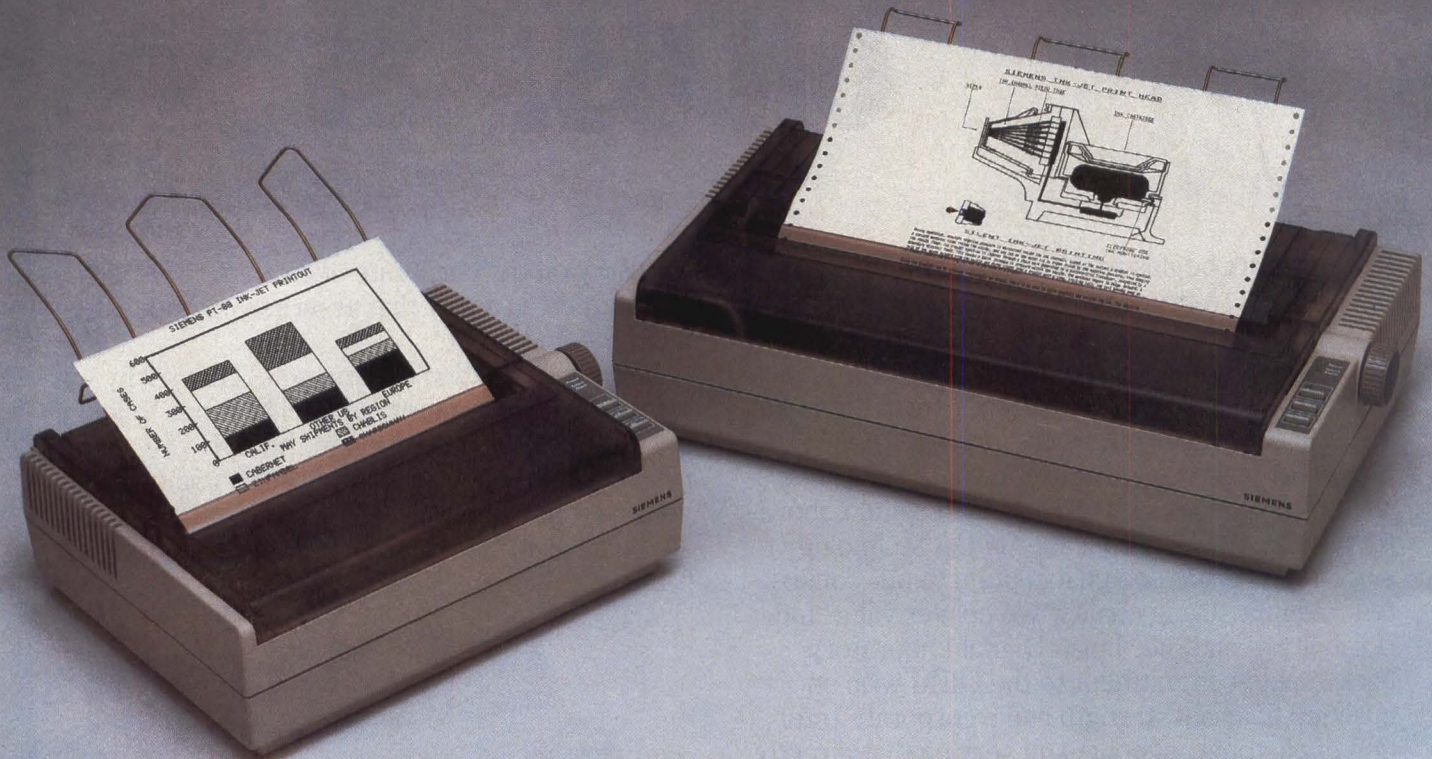

A golden opportunity to include Siemens PT-88/89 printers in your OEM system.

In today's "look-alike, sound-alike" PC systems market, the printer you select for OEM system integration reflects the importance you place on superior performance and long-term reliability. In fact, anything less than a quality printer not only compromises your system's total performance...it undermines customer perception of your system in a highly competitive marketplace.

That's why you owe it to yourself, and the success of your system, to make our incomparable PT-88 ink-jet printer...or the wide-carriage PT-89, part of your OEM system package. Just look at these unique features designed to enhance your system's performance...and give it the all-important "competitive edge":

- Ultra-silent operation (≤ 45 dBa)
- Exceptionally high reliability... the print head is rated in excess of 10 billion characters!
- High speed (150 cps bi-directional) performance
- "Drop-on demand" ink-jet quality printing...crisp, clean, consistent
- IBM-PC, EPSON, and other compatibilities available
- Full graphics capability
- Multiple interfaces
- Friction/traction or roll paper capabilities
- Downloadable character generator
- Siemens quality at no extra cost.

And here's more good news! Siemens PT-88/89 ink-jet printers offer OEMs the cost pricing benefits of high value-added reseller (VAR) margins. And of course, PT-88/89 printers are fully warranted and backed by one of the world's largest technical service/support organizations.

Take advantage of this golden opportunity. Fill out the attached postcard for our detailed information package on the PT-88/89 ink-jet printers. Siemens Communication Systems, Inc., Office Systems Group, 5500 Broken Sound Blvd., Boca Raton, FL 33431 (305) 994-8800 Extension 7608.

Silence is golden...the quiet ink-jet printers from Siemens.

The Interpreter

An analysis of news, issues and trends affecting the computer industry

Scotland battles Ireland for foreign investment

The Scots and the Irish are the class acts in the chase for American and Japanese electronics investment. At the moment, the Scots are ahead

James F. Donohue, Managing Editor

Following Scotland's lead, many European countries in the Common Market are working hard to woo American and Japanese electronics manufacturers. The incentive is straightforward. Companies which manufacture products in Common Market countries can ship to any other Common Market country tariff-free. Annual sales of electronics/computer products in the Common Market are currently valued at about \$27 billion and are expected to hit \$30 billion next year. Tariffs can be significant: 17 percent for semiconductor products, about 13 percent for computers.

The Republic of Ireland is Scotland's principal competition in this game of industrial seduction, but West

Germany, Switzerland and Italy are players, too. Meanwhile, besides Scotland, other parts of the United Kingdom—bedeviled by unemployment rates close to 20 percent—are starting to enter the game. Chief among these is southern Wales and the industrial belt around Birmingham, England.

Nobody is quite as good at the wooing game as are Ireland and Scotland. They're the big-league romancers: the Richard Geres and Robert Redfords. The rest are Woody Allens—clever and resourceful, but suffering deficiencies in raw sex appeal.

West Germany has its own electronics/computer industry and until recently has not pressed hard for foreign investment. Plus, the various German states are on their own when looking for business; there is not

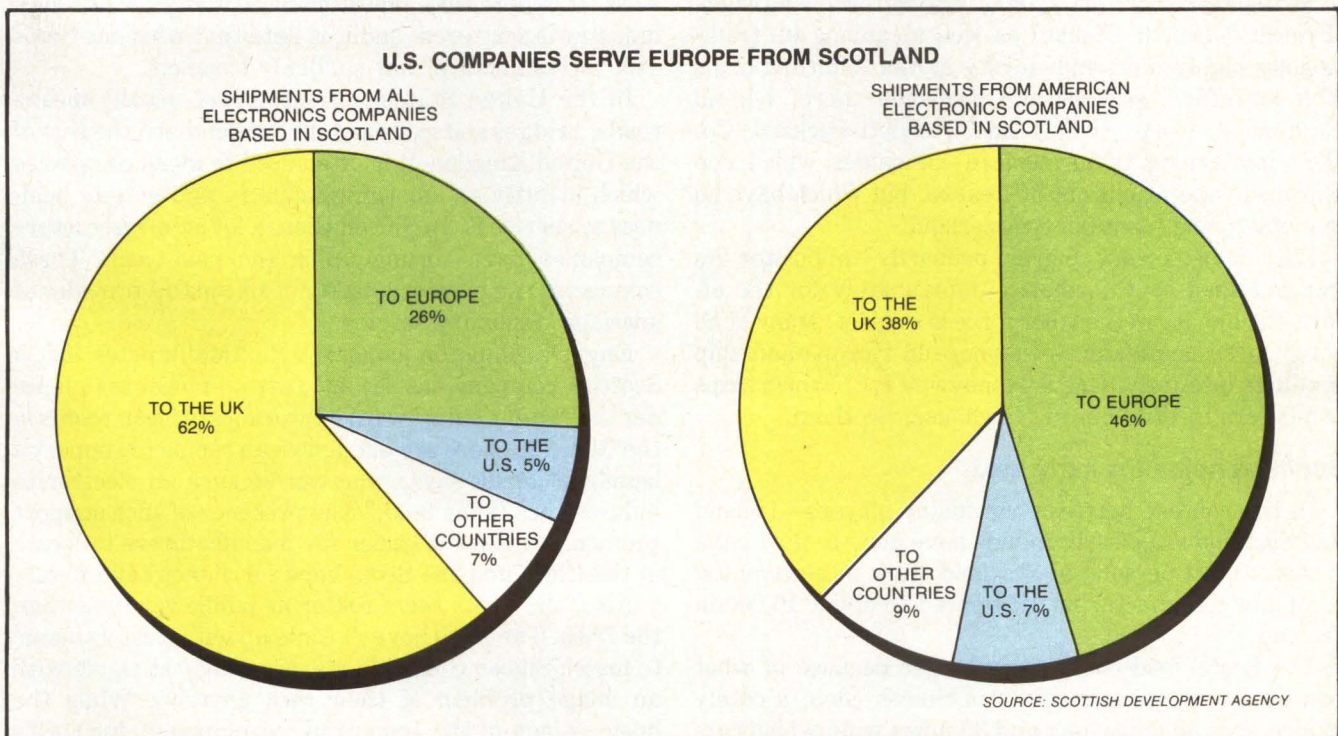

American companies with operations in Scotland ship a third of their products to the United Kingdom and almost half to the rest of Europe, indicating that U.S. companies consider

Scotland an entry point to the Common Market. Non-U.S. companies keep the bulk of their products at home in the UK.

The Interpreter

the same federal coordination as is found in both Scotland and Ireland. Nevertheless, good deals can be made by foreign investors willing to locate in high-unemployment areas like the Ruhr and the Saar coal-mining district and in West Berlin or along the border with East Germany.

West Berlin has suddenly become a serious player. There are unconfirmed reports that West Berlin will cut a very good deal for small (annual sales of less than \$3 million) electronics manufacturers. An American

In the contest between the major players, the early rounds have gone to the Scots.

electronics maker describes an offer from the city as being "virtually 100 percent." He says West Germany offered to give him land, provide a building, equip it and train a labor force—all at no cost to him. And there would be no tax until some time in the next decade. The electronics maker turned down the offer. "That's not a place where I want to do business," he says. "Too risky politically."

Switzerland is a country split among three languages (French, German, Italian) as well as among its traditionally highly-independent city states. Multinationals look for office workers and salesmen there. Digital Equipment Corp. (DEC) and Hewlett-Packard Co. (HP) are among the American companies which run European operations out of Geneva, but which have no manufacturing plants in Switzerland.

Italy is a serious player primarily to bolster its impoverished south, where, unfortunately for the effort, the quality of the labor force is suspect. Many U.S. companies manufacture elsewhere in Europe and ship products into Italy. One is Honeywell Inc., which ships computers to Italy out of Newhouse, Scotland.

Scotland holds the early lead

In the contest between the major players—Ireland and Scotland—the early rounds have gone to the Scots. About 40,000 persons in Scotland work in electronics/computer manufacturing, compared to about 16,000 in Ireland.

The Scots' lead could grow longer because of what has been happening recently in Silicon Glen, a cutely named area 80 miles long and 30 miles wide which cuts in a band across the middle of Scotland. The centerline of the Glen runs in a diagonal from a point north of Edinburgh in the east to a point south of Glasgow in the



west. It is here that almost all of Scotland's electronics industry is scattered, and it is here that what the Scots call "infrastructure" has suddenly bloomed.

In the United States, infrastructure usually means roads, bridges and railroads. In Scotland and the rest of the United Kingdom it is often used to mean companies which identify an emerging industry and go into business to service it. In Silicon Glen, a lot of infrastructure companies have sprung up in the past year. These companies range from a maker of silicon to a provider of specialized laundry service.

English computer journalist Rex Malik notes that a Scottish company has recently set up business to launder the "bunny suits" worn by workers in clean rooms in the Glen. "If there are enough clean rooms to support a laundry," Malik says, "you can be sure an electronics industry has taken hold." The presence of such support companies makes it easier for manufacturers to locate in the Glen, and the Scots hope for a snowball effect.

Also, the Scots seem better at public relations than the Irish. The Irish haven't come up with a catchy name to match Silicon Glen. What's more, they struggle with an image problem of their own creation. While the businessmen of the Industrial Development Authority (IDA) of Ireland try to picture the island as full of industrious workers, the businessmen of the Irish tourism bureau work just as hard to sell the nation as full of

What do these popular micro printers have in common?

Access
Apple
Atari
Burroughs
C.Itoh
Commodore
Coleco
CPT
Cromemco
Digital
Epson
Hewlett Packard
IBM
Integral Data
Leading Edge
NEC
Northstar
Okidata
Radio Shack
Seiko
Sord
Toshiba
Xerox
Zenith Data
Systems

Quality replacement ribbons from Pelikan!

Pelikan 
Franklin, Tennessee 37064

Pelikan offers an outstanding product line as well as a comprehensive dealer support program. For more information call toll free: 800-251-3365 (in Tenn. call collect: 615-790-6171).

The brand names listed are intended only to show the compatibility of the above machines with products manufactured by Pelikan.

CIRCLE NO. 48 ON INQUIRY CARD

OEMs have the right questions

SMS has the right
answers

Introducing the SMS 1000 Model 40 DEC-Compatible Microcomputer System

SMS is listening: You want microcomputer systems that can meet your current needs and can be expanded to handle future requirements. Our new SMS 1000 Model 40 is designed to do just that!

Integrated Architecture

We knew what the end product had to do before we started, so we designed it based upon an integrated foundation module that optimizes performance and flexibility while minimizing complexity. The foundation module includes the Winchester, floppy and tape interfaces; serial communication ports; and the Q-bus interface. And we put it all on one board that doesn't require any backplane space!

Flexible Configurations

This system provides you with the widest choice of peripherals available in any microcomputer on the market. The options include 8 or 5¼ inch floppy drives, up to 140Mb of 5¼ inch Winchester and a streaming tape drive. All this in one 5¼ inch rack mount or floor stand enclosure.

Optimized Performance

The Model 40 allows non-interleaved disk transfers using an enhanced version of DEC's* MSCP storage architecture.

It is offered with fast access Winchesters and either LSI-11/23 or LSI-11/73 processors. So you can optimize your application's performance whether it runs on RT-11, RSX-11M*, RSX-11M-PLUS, RSTS/E*, or TSX-PLUS*.

High Reliability

Dependability is essential to your business. The SMS 1000 Model 40 is designed to provide your users the uptime both you and they dream about. And if things go wrong, the Support Monitor Subsystem is there to help you or your end users get back on the line quickly.

Family of Products

The SMS Model 40 is really a family of products, available in over 150 different configurations—today—with more to come in the near future.

If these are the answers to the questions you are asking, please contact us immediately for more information.



Scientific Micro Systems, Inc.

339 N. Bernardo Avenue
Mountain View, CA 94043
(415) 964-5700 TWX: 910-379-6577

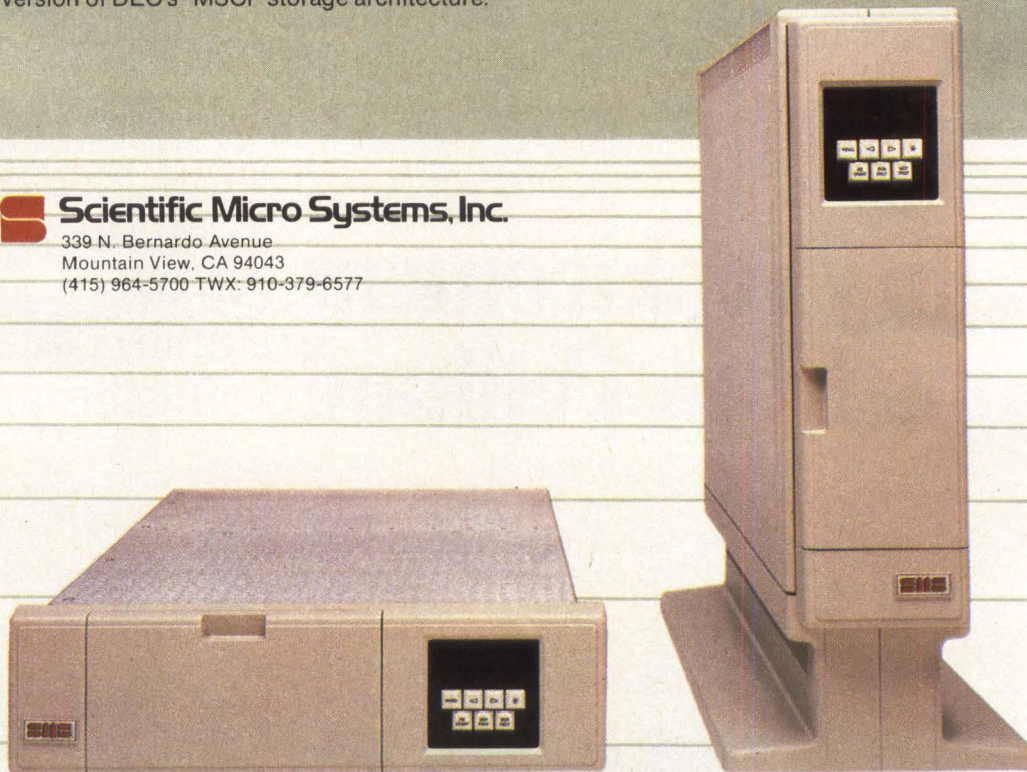

SMS SALES OFFICES: Seattle, WA (206) 883-8303; Boston, MA (617) 246-2540; Atlanta, GA (404) 296-2029; Morton Grove, IL (312) 966-2711; Melrose Park, IL (312) 345-5320; Arlington, TX (817) 429-8527; Philadelphia, PA (215) 860-8626; Greensboro, NC (919) 292-8072; Laguna Hills, CA (714) 643-8046; Mountain View, CA (415) 964-5700.
AUTHORIZED SMS DISTRIBUTORS FOR DEC PRODUCTS: Western—Pnambic Systems, Inc. (206) 282-0199; Quebec Province, Canada—Logicon, Inc. (514) 430-5960.

CIRCLE NO. 47 ON INQUIRY CARD

*DEC, RSX and RSTS are trademarks of Digital Equipment Corporation. *TSX-PLUS is a trademark of S&H Computer.

The Interpreter

quaint folk who wouldn't think of leaving their farms.

"Our tourist industry is too good at getting out those posters of jaunting carts and donkeys," says Nick Ryan, vice president of the IDA.

Terrorism not seen as a factor

American industrialists do not seem put off from opening plants in Ireland because of the continuing acts of terrorism in Northern Ireland. Most of their plants are well south of the border in places like Dublin, Cork and Limerick. "Americans seem to understand that what happens in the North stays there and will not come down into the Republic," Ryan says.

The Scots know the value of a good press in the United States and how to get it. This article comes from a tour of Silicon Glen sponsored late last year for American electronics/computer journalists by the Scottish Development Agency (SDA). *Mini-Micro Systems* sent a reporter on the tour. The SDA paid most of his expenses.

The Irish have many economic weapons. Chief among these is their corporate tax rate, one of the most

forgiving in the world. Irish-based business pays a maximum 10 percent of its taxable income to the state. The rate is guaranteed to the end of the century, and it helps to bring to Ireland the highest rate of return on manufacturing investment in the world, according to the IDA. "If all you're looking for is return on investment," conceded an official of the SDA, "it's true, then. We can't match the Irish."

Ireland's low corporate rate already has driven Scotland—and the rest of the United Kingdom—to do something about the way it taxes business. Corporate rates are falling fast in the UK. They were 50 percent last year, are 45 percent now, will be 40 percent later this year and will drop to 35 percent in 1986. The Scots will show you how to do a bit of sleight of hand to trim the corporate tax by an additional 10 percentage points, bringing it to 25 percent in 1986.

Ireland has a murderous personal income tax, and that takes some of the sunlight out of its tax picture. The Irish are in the 65 percent bracket long before their taxable income hits \$20,000. "We believe the low corporate tax helps us give our people work," explains IDA's

It's tougher to spin off in Silicon Glen

It's called the Silicon Valley effect—that's when workers from one electronics company quit and start another electronics company in competition with the first. The name comes from California's Silicon Valley, where most of the business is a spinoff from somebody else's business.

British entrepreneurs have difficulty working up a Silicon Valley effect. Check around and you'll find only one company mentioned—Rodime Plc. of Glenrothes, Scotland. Paradoxically, the various government-backed development agencies—fat with cash and tax breaks for established companies—are the reason why spinoffs don't do well in the United Kingdom.

Spinoffs don't get much assistance from these quasi-government agencies; instead, they are likely to get discouragement. The agencies are worried about offending the established companies, should they help the upstarts.

Rodime is a case in point. The company began in 1980 when four executives—American Leonard W. Browlow and three Scots—left Burroughs Corp.'s disk drive plant in Glenrothes, north of Edinburgh, and

set up shop nearby to make their own brand of disk drives.

According to W.D. Batchelor, managing director of Rodime and one of the company's three Scottish founders, Rodime got no help from the Scottish Development Agency (SDA),



The Rodime case required caution, says Mike Sandys of the Scottish Development Agency.

the organization charged with setting up companies in Scotland. Burroughs allegedly discouraged the SDA from helping.

Burroughs denies the charge, and so does Mike Sandys, senior project executive of the SDA's electronics division. But Sandys adds, "There's no doubt that we had to play it cautiously."

Eventually, Rodime got help from the Glenrothes Development Council which, despite the presence of Burroughs in the town, provided a manufacturing plant with a clean room for Rodime and accepted delayed rent. Rodime got \$1.5 million from 3i Ventures, a British venture capital company, and launched its line of Winchester drives. Sales of \$28.5 million in 1983 about tripled last year. Rodime employees 500 people in Glenrothes.

Burroughs has since shut down its plant in Glenrothes, throwing 400 persons out of work. The company continues other operations in Scotland.

Was Burroughs' move out of Glenrothes in retaliation for the town helping Rodime? "It's a moot point," says a town official. "But I've heard some people express suspicions about it."

The Interpreter

Ryan. "The high personal tax is how we ask them to pay back the government." In the UK, the rate gets to about 33 percent when annual income reaches \$18,000.

For Americans living in Ireland or the UK, the high personal taxes require creative accounting. American executives often receive big expense accounts to live on while their salaries go into an account at home, or they get free housing, cars and other benefits in lieu of high salaries which would be taxed away.

One American, sent to England to manage his company's manufacturing plant, says he received payment as a consultant for the entire time he was in England. He says that form of payment meant he was not taxed in the UK. How long would England have stood for that arrangement? "Oh, maybe 20 years," he says with a grin. "We've got very good accountants."

Many U.S. computer manufacturers like HP, DEC, Honeywell, Burroughs Corp. and Wang Laboratories Inc. have manufacturing plants in Scotland. Honeywell just celebrated its 21st year of making computers there. But a Japanese electronics company, NEC Corp. of Tokyo, is making most of the news these days. NEC chose the European Solid State Circuits Conference at Scotland's Edinburgh University last year to unveil a 256K-bit dynamic RAM chip that it plans to make at its plant in Livingston in Silicon Glen. At the same time, NEC announced plans for a \$95-million expansion at Livingston and said it will employ 650 workers there in 1987 when annual production of the chips hits six million a month. NEC employs 200 persons at Living-



ston now and turns out 1.5 million chips a month, almost all of them 64K-bit dynamic RAMS.

Technical training is available

The managing director of NEC in Scotland, M. Shiraishi, says the company settled there because "it is easy to recruit educated people. There are many universities in Scotland. We are always asking the professors to send good people to us." About 15 percent of the NEC workforce has technical training beyond high school. The company figures it will need a higher percentage in 1987. Shiraishi forecasts no difficulties in getting them. Scotland has eight universities (Ireland has four), 17 colleges and 12 technical schools.

Yet, the statistics on technical education in Scotland are not entirely rosy. The number of people coming out of the universities and colleges with the equivalent of a bachelor's degree in electrical engineering is not high. The Scots forecast there will be 450 this year, up from 241 in 1976.

These low numbers present a problem to Scottish industrial recruiters. "Technical expertise has not grown as fast as the market," says Manuel Yuen, the American managing director of National Semiconductor (UK) Ltd. "We have difficulty in attracting technical people."

Ireland's IDA publishes a brochure of reprinted ads from the Irish Times in which Scottish-based American companies like Wang and Westinghouse Electric Corp.

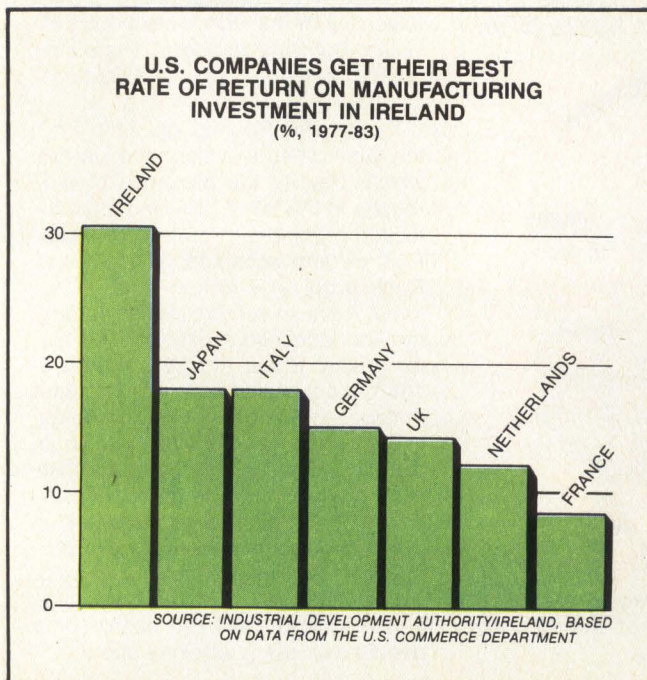



Revolution.

Revelation.

It's a more enlightened approach that combines powerful storage with your compact processing needs.

The Micro VIP[®] (Virtual Information Processor) is a MICRO/PDP-11/23*, 11/73*, or MicroVAX* based system with a Q-bus* backplane—plus a whole lot more.

You get 120 megabytes of formatted hard disk storage with an easy-to-use 100 megabyte tape backup.

And best of all, the Micro VIP gives you the fastest mass storage system in the industry (effective access times under 10 ms. with 512K cache) inspired by U.S. Design's exclusive cache controller technology.

Now you don't have to build your own high performance DEC system. As a tower, or rack-mounted as a disk/tape subsystem the Micro VIP can do the job — at a price that's a revelation too.

So call us for fast access to all the details at 800-368-2811.

*Trademarks of Digital Equipment Corporation.

 **U.S. DESIGN**

5100 Philadelphia Way,
Lanham, Maryland 20706 (301) 577-2880
(800) 368-2811 • TWX 710-826-0417

CIRCLE NO. 49 ON INQUIRY CARD

In a one-to-one comparison, Westrex-One.

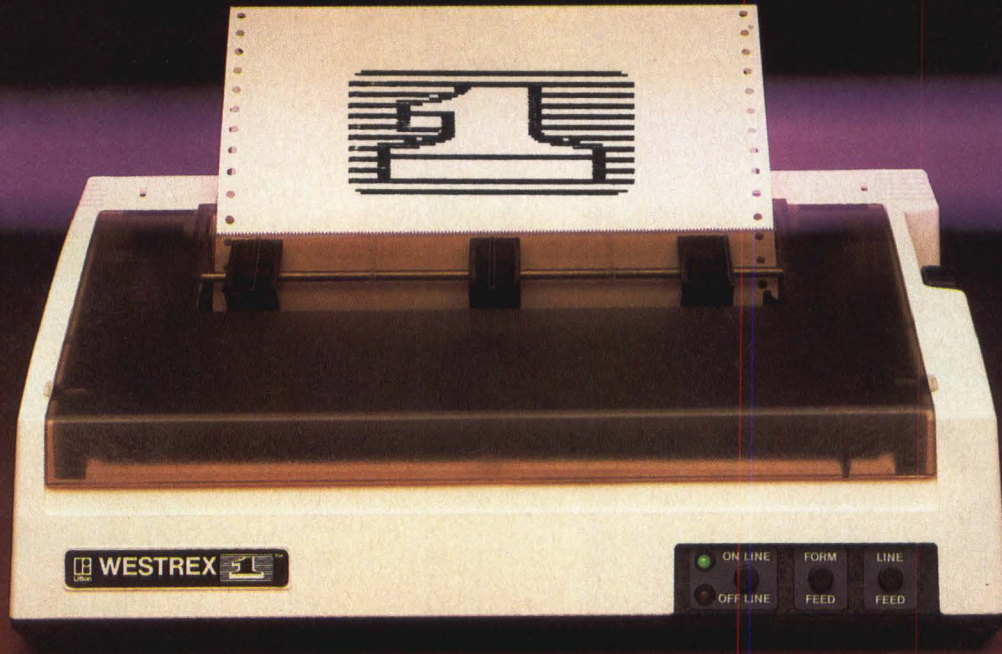

The one printer you can rely on.

Prints in 120 different type fonts.

Elite or Pica, single or multiple pass.

Emphasizes, italicizes, condenses, underscores.

Prints at 145 characters per second.

With RS 232 and Centronics parallel interfaces.

These are actual print samples

Prints in 120 different type fonts.
Elite or Pica, Single or Double pass.

Emphasizes, italicizes, condenses, underscores.

Prints at 145 characters per second.
Available with serial or parallel interface.

Accepts single sheets or continuous forms.
1,000 hour MTBF, 15 minute MTTR.

Extremely small footprint.
Off-the-shelf delivery -
Attractive OEM pricing.
And built-in Litton quality you can count on.

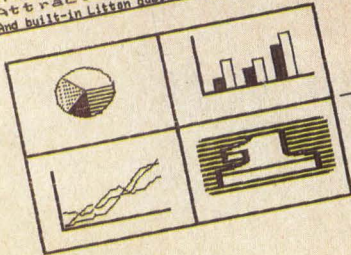

Accepts single sheets or continuous forms.

1,000 hour MTBF,
15 minute MTTR.

And graphics, too.

The new Westrex One. Compare it for yourself.

See the Westrex One in action, and you'll understand why it's far and away the winner in any one-on-one comparison.

Westrex One has the versatility that gives your product extra value. It produces some of the crispest, clearest Dot Matrix printing you can find. Plus a comprehensive variety of type fonts and styles. And the ability to handle intricate graphics. Custom interfaces where required.

Naturally, because it's built and backed by Westrex/Division of Litton, it's a reliable, long lasting product. We kept moving parts to a minimum, so there's less to go wrong.

If you need a printer with Flexibility... Quality... High Performance, the Westrex One is the 1 for you.

Send for free comparative performance matrix and make your own "one-to-one" evaluation. Contact Westrex/Division of Litton OEM Products, 51 Penn Street, Fall River, MA 02724, (617) 676-1016. TELEX: 651490, Please Relay WJNW.



WESTREX OEM PRODUCTS

Litton

CIRCLE NO. 50 ON INQUIRY CARD

The Interpreter

and an Edinburgh recruitment agency are shown hunting in Ireland for technicians and engineers. The brochure is entitled, "The best hi-tech personnel are easy to find...when you know where to look."

The Scottish workforce gets high marks for dependability from managers of multinational companies. Employee turnover is low: 4 percent to 6 percent a year seems to be the average. "You just don't find headhunters all over the place," says Frank Vincze of Circuit-Wise Inc., a circuit board manufacturer in North Haven, Conn., which does work with Prestwick Circuits Ltd. of Ayr, Scotland. Bill Gold, NEC personnel

manager, says the custom in Scotland "is for a person to work with one company for life."

Tamed by high unemployment, the Scottish electronics worker does not readily join unions. Only about a third of multinational companies in Scotland have unions, and these concerns are usually longtime residents. Companies setting up operations for the first time appear to have little difficulty in keeping unions at bay.

National Semiconductor, which recently announced plans to add 1,000 employees at its Greenock, Scotland, wafer plant (there were 1,650 employees last year), is



There are so many clean rooms in Silicon Glen that there's a laundry to wash the "bunny suits" worn in them. The picture was taken at Motorola's plant in East Kilbride, Scotland.

The Irish corporate tax rate is one of the most forgiving in the world, and it's driven Scotland to do something about the way it taxes business.

an example of an American company working without a union. "The unions have made attempts at getting in here," says managing director Yuen. "But the attempts have not been all that serious. What you have to do is see to it that your conditions of employment are such that you do not need a union."

Strong dollar cuts labor costs

Scottish labor works cheaper than American labor, a fact helped by the strength of the dollar against the pound. The British pound was worth only \$1.25 when the electronics writers made their tour. The Irish pound was worth about \$1. Yuen pays his production workers at National Semiconductor 115 pounds a week, or about \$144 at that time. In the past few years, the British pound had been worth twice its current value against the dollar, so the labor-cost advantage in the UK can change dramatically. "However, at this point," Yuen says, "our salary structure is a help" in keeping labor costs down.

Both Scotland and Ireland claim enormous salary advantages over the United States when it comes to paying engineers. Several Scottish industrialists say they pay an engineer who would command a salary of \$60,000 in the United States only about \$20,000 (at the \$1.25 exchange rate).

Industrial consultants in the United States say that, as a rule, labor costs in the UK and Ireland run about 75 percent of U.S. costs. Larry Nye, a management advisor from Acton, Mass., who works primarily with the Irish, says a payroll of \$100,000 in the United States will be about \$75,000 in Ireland.

VME-SMD DISK-TAPE-CONTROLLER

Controls two disk drives
and additional tape
Transferrate up to 16 MHz

User programmable drive
characteristics
SMD/CMD/MMD/LMD-Interface

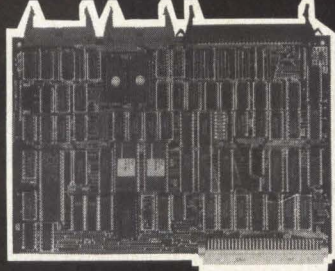

Qic2-Tape-Interface
Unix*-software-driver

No Interleaving!
1 Double Eurocard

*Unix is a trademark of AT&T

DON'T WAIT! IT'S AVAILABLE

Stollmann

Stollmann GmbH
Computer- und Kommunikations-Technik
Max-Brauer-Alle 81
2000 Hamburg 50
W.-Germany
Telefon 0114940-389003-22
Teletex 403226 = stollco
By Telex (17) 403226 +

tor Wanted! Distributor Wa
Qualifikation:
Existing clientele, component
business (if possible VME),
abilities for
qualified support
in Hard- and
Software

CIRCLE NO. 51 ON INQUIRY CARD



High quality low cost data switches

Compare Craig prices. RS232C AB Data Switches —

- Makes most efficient use of costly computer peripherals
- Eliminates redundant hardware, wasted time plugging/unplugging cables • Switches all 24 signals (Pin 1 through)

RS232C EXTENDED DISTANCE DATA CABLES

EDC04 \$11 both ends + .20 per ft.
EDC08 \$12 both ends + .30 per ft.
EDC12 \$12 both ends + .40 per ft.
EDC25 \$16 both ends + .60 per ft.

FREE GENDER MENDER WITH FIRST \$100 ORDER!

To order or request literature,
call toll-free 800-243-5760. In CT: 356-9315

CRAIG
DATA CABLE

652 Glenbrook Road, Stamford, CT 06906

CIRCLE NO. 52 ON INQUIRY CARD

The Interpreter

Managers interviewed by the American electronics writers on their tour of Silicon Glen were universally happy to be in Scotland. Many companies, like NEC, DEC, Honeywell and HP, are planning major expansions. Even Japanese managers consider Scotland a good place to live, despite its strange customs and food. Many, like NEC's Shiraishi, are avid golfers, and Scotland is the Vatican City of the golf religion. The workforce is described as high quality. Several industrialists say unemployed coal miners, thrown out of work by the collapse of what was once a major industry in Scotland, take especially well to training in electronics.

The language is friendly

In the quest for American companies, Ireland and Scotland have the advantage of the English language over the rest of Europe. A company whose homebase management must learn a new language has a problem, and American managers will tell you they'd rather be in Ireland or the UK than in non-English-speaking Europe. The language barrier is demonstrated by NEC's Shiraishi. Although his English is good (he has lived in Scotland for two and a half years), his expression goes blank and his eyes glaze if you speak English to him too quickly.

The local workers of a company whose management speaks another language have a problem, too. Forty Scots working at NEC's plant are studying Japanese on their own time in order to better work with the eight onsite Japanese managers.

American management often chooses either Ireland or Scotland on the basis of whim—the boss likes Irish horses and settles the company in Ireland—or national pride. Finlay MacKenzie, the Scottish managing director of HP's Queensferry Telecommunications Division near Edinburgh, thinks a factor in HP's move to Scotland from Bedford, England, in the early 1960s was that “the managing director was a Scot.”

In favor of Scotland over Ireland, there is the view that the UK is a much bigger market for American companies than is Ireland and that it's better to be in the UK to service it. David Lawrence, an Englishman who is general manager of DEC's plant in Ayr, says DEC, when faced with a need to expand in Europe, chose to open a new plant in Scotland rather than enlarge its existing operation in Galway, Ireland. Says Lawrence, “DEC just decided Ireland was outside the mainstream of Europe.” □

Interest Quotient (Circle One)
High 828 Medium 829 Low 830

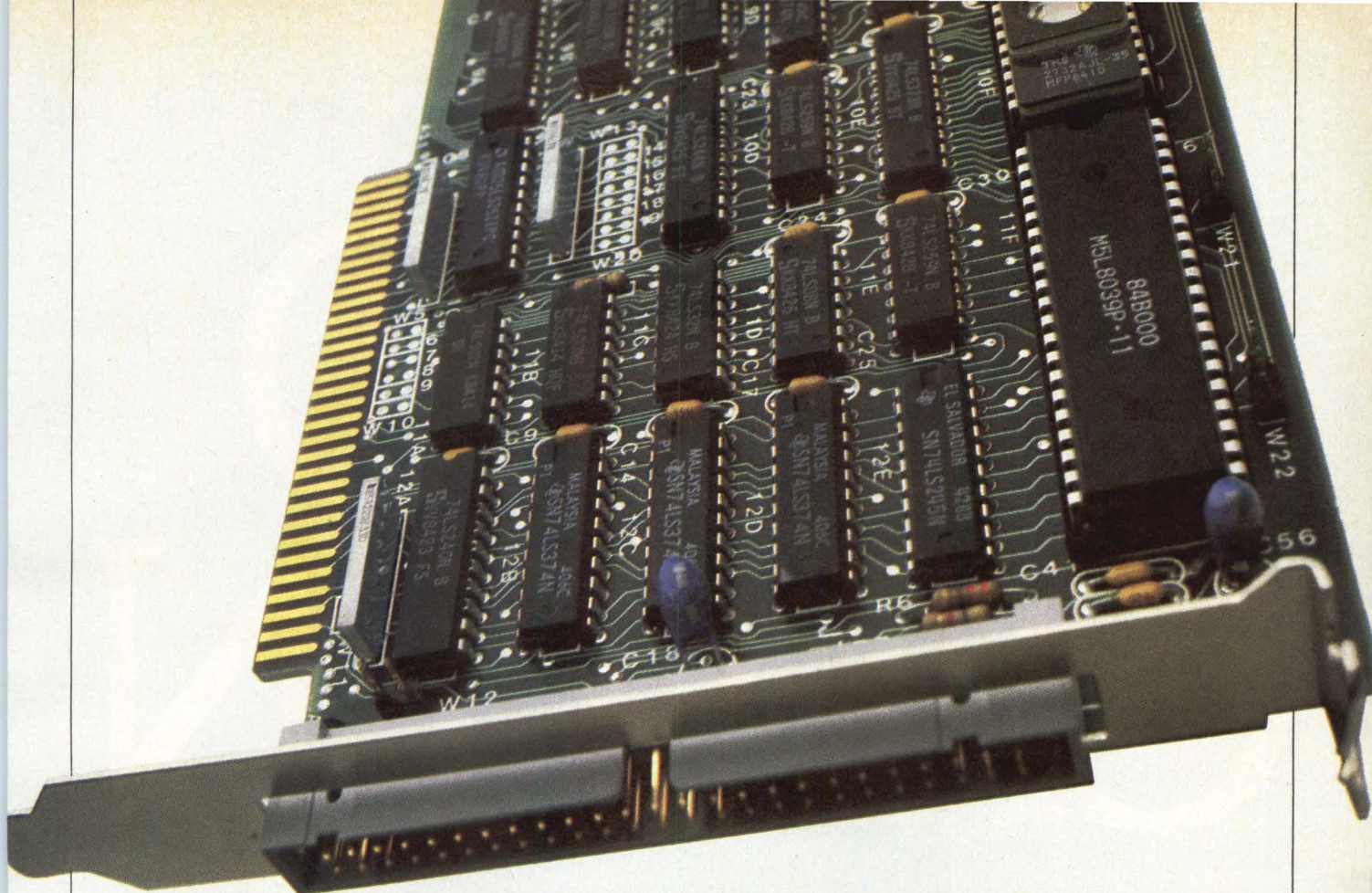

NEED STREAMING TAPE FOR THE PC? SYSGEN DELIVERS.

Install a Sysgen™ SC4500™ tape controller and the basic (non-intelligent) streaming tape drive of your choice.

You've got the fastest, most intelligent, most cost effective back-up system around for the PC, XT, AT™, or PC-workalike.

The same controller that drives Sysgen's top-selling tape back-up systems. Unbundled.

You get a proven, reliable, high performance microprocessor-based single-board controller with QIC-24 data format.

You get data transfer to the tape at rates of up to 3.75 Mbytes per minute.

You get automatic error correction. (Sysgen's high-speed "verify-on-the-fly" technology verifies data accuracy as the controller is writing, so users don't have to wait for the tape to rewind to verify.)

You get fast "image" back-up. And you get intelligent, fast "file-by-file" back-up.

The controller is so intelligent, it turns dumb peripherals into the smartest buy.

Advanced, local-intelligence architecture means you get all this performance with less burden on the system CPU, using less expensive *basic* (non-intelligent) tape drives.

Your system cost and system electronics are minimized. Power requirements are minimized.

Result: greater economics and reliability.

The controller fits any PC-compatible full-length slot. It runs any standard basic drive with DCAS or QIC-36 interface.

It is the most economical way you will find to integrate tape back-up into a PC-class system.

And it is available now.

For more information, including specifications, and the name of your local rep, call Sysgen direct: **(415) 490-6770.**

47853 Warm Springs Blvd.
Fremont, CA. 94539

SYSGEN

I N C O R P O R A T E D

Trademarks: Sysgen, SC4500—Sysgen, Inc.; AT—International Business Machines Corporation.

SOLID CITIZEN.

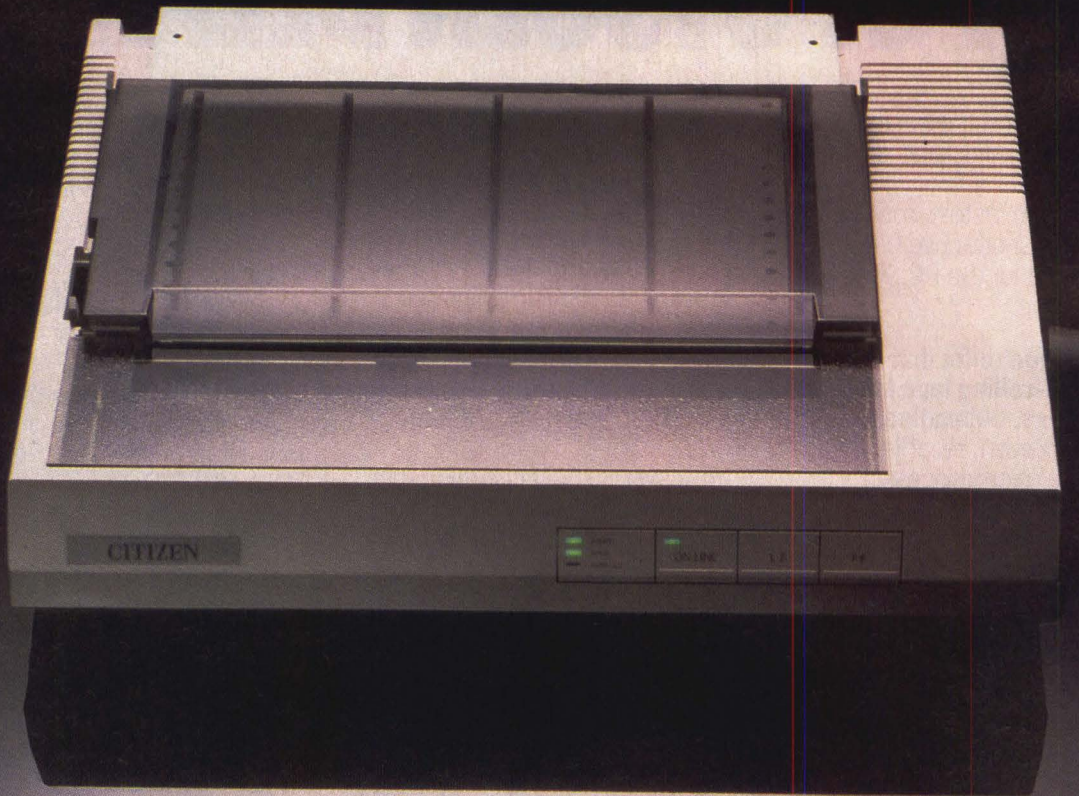

When you're putting together a microcomputer system, you need a printer that's really put together.

Introducing the Citizens. Four new economical dot matrix printers.

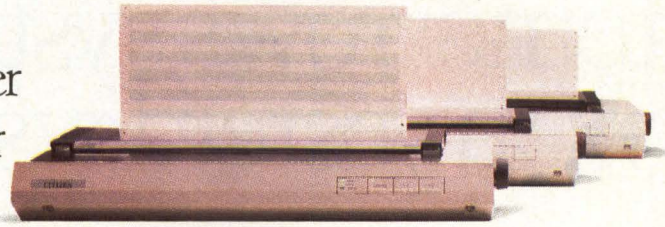

They're designed to be rugged. Dependable. And quiet. Just what you'd expect from a company famous for precision-engineered watches.

Citizen™ printers are IBM® or Epson® compatible, with output speeds of 160 cps (40 cps correspondence-quality) or a speedy 200 cps (50 cps correspondence-quality). That means more flexibility. Plus, all our printers have an easy-to-use push-feed paper loading system. That means happier customers.

The Citizen MSP-10 and 15, and MSP-20 and 25 printers. Because reliability and dependability are just part of being a good Citizen.

For more information, call 1-800-556-1234, Ext. 34. In California, 1-800-441-2345, Ext. 34.

Or write Citizen America Corporation, 2425 Colorado Avenue, Santa Monica, CA 90404.



© 1984 Citizen America Corporation

Citizen and the Citizen logo are trademarks of Citizen America Corporation. IBM is a registered trademark of International Business Machines Corporation. Epson is a registered trademark of Epson Corporation.



You can't build
tomorrow's systems
with yesterday's drives.

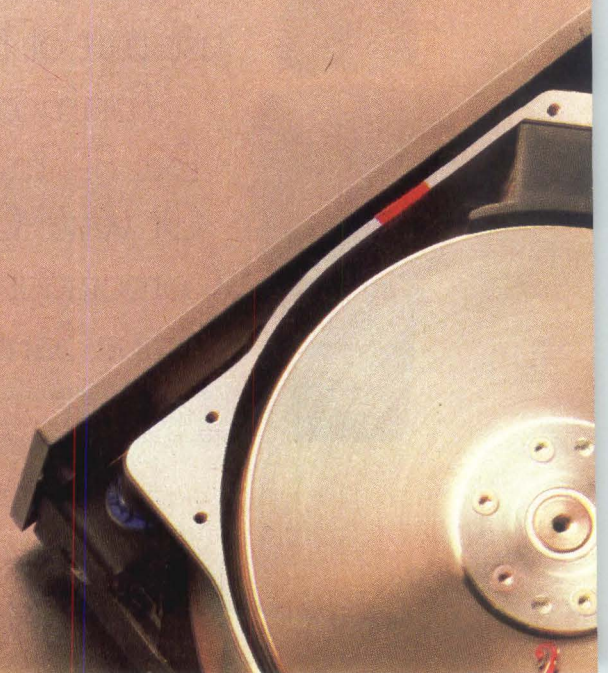

You've seen one small disk drive, you've seen them all, right?
Not exactly. One disk drive stands above all the rest.

It comes from Maxtor.

The company that refuses to produce disk drives merely as good as everybody else. Instead, we set new standards by producing the only 5¼" disk drives worthy of the next generation of supermicros. Winchester with 65 to 380 megabytes of storage. And average access times of less than 30 msec.

And we don't mean prototypes. We mean full production. So, you can build the systems of tomorrow, today. And that can be a big advantage.

For you. Or your competition.

Maxtor Corporation, 150 River Oaks Parkway,
San Jose, California 95134,
(408) 942-1700, TELEX: 171074.
Eastern Regional Sales Office:
(617) 872-8556.
Southwest Regional Sales Office:
(714) 859-3100.

Maxtor

CIRCLE NO. 54 ON INQUIRY CARD



Only from Topaz . . .

Uninterruptible Computer-Grade Power Systems

including Powermaker® Micro UPS



They're in a class by themselves.

Topaz Uninterruptible Power Systems are valued throughout the world for their high reliability, high efficiency and quality construction.

All Topaz Uninterruptible Power Systems deliver pure, continuous computer-grade power, regardless of the condition of the AC power line. Your computer stays on-line during blackouts, brownouts, sags, surges, and power-line noise disturbances. In other words, a Topaz UPS makes power-related computer problems disappear. Period.

Available in micro, mini, and super-mini models, there's a Topaz UPS specifically designed for your equipment.

Find out more about our computer-grade Uninterruptible Power Systems. Call us today at (619) 279-0831, or contact your local Square D distributor.

TOPAZ[®]
Excellence in Computer Power

SQUARE D COMPANY

CIRCLE NO. 55 ON INQUIRY CARD

The Interpreter

Enhancement programs add features to IBM PC operating system, application software

Software packages let existing programs run more smoothly, or do more...some provide multitasking or levels of security, others add pizzazz to graphics

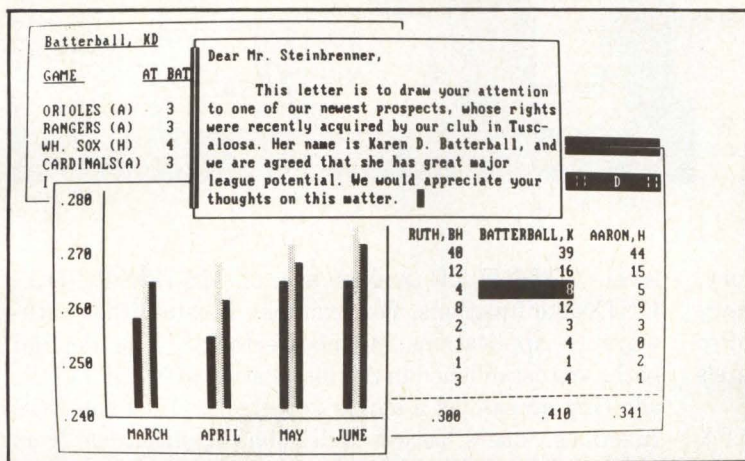

APX Core provides a manager for up to eight windows. When a task is selected to be performed, the window in which it resides moves to the foreground.

Residing in background memory, Borland's Sidekick serves as an extension to other applications by providing typical desktop functions of notepad, calculator and phone dialer.

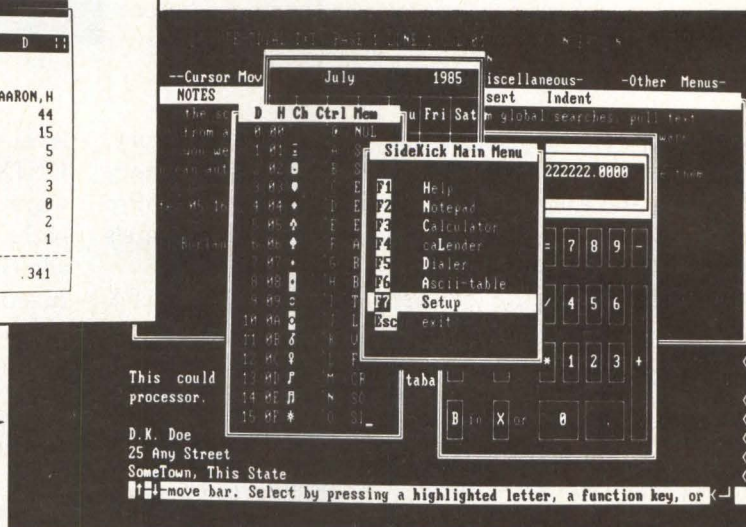

Carl Warren, Western Editor

The latest trend in software for the IBM Corp. Personal Computer (PC) and look-alikes centers on enhancement packages that extend the functions of the operating system or add features to existing applications. These new packages can be grouped into two categories: shell packages and application add-ons.

Shell packages provide an envelope, or sleeve, around the operating system. These envelopes—shells—can exist either in the foreground, i.e., as the dominating part of the operating software, or the background, waiting in queue invisibly; they can also run concurrently. Application add-ons, though, are usually consigned to the background.

One such shell is APX Core, developed by Application Executive Corp., New York, N.Y. This \$95 package provides suspended and time-slice (concurrent) multitasking capability to IBM PCs and compatibles. APX Core does this by dividing memory into segments for use by each application. As a new application is activated, the current one is suspended or moved to the background. Applications are accessed when the user depresses the ALT key on the PC keyboard and touches the number key corresponding to the application block. For example, ALT 3 would switch to the third task in the register queue.

The number of applications supported by APX Core is only limited by the amount of available memory—it requires at least 48K bytes, plus memory over and

The Interpreter

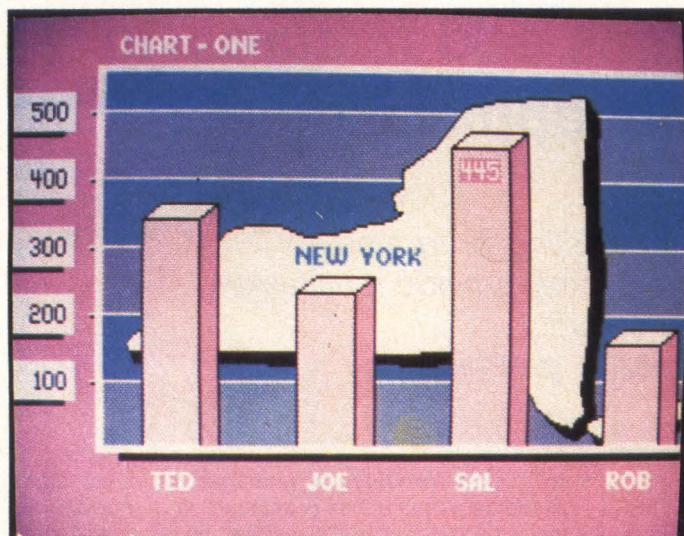

GraFIX Partner lets users spruce up mundane graphics by adding new color textures, type fonts and presentation icons to tell a better visual story.

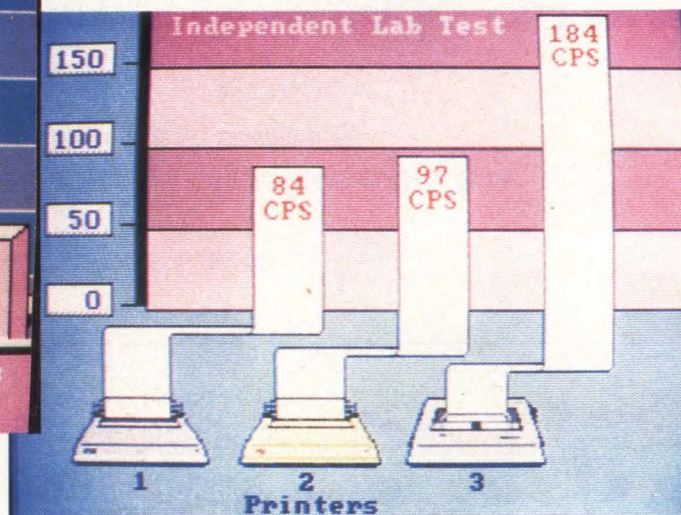

above that, for each application. A 256K-byte memory, for example, can concurrently support two memory divisions and associated applications such as MicroPro International Corp.'s Wordstar and Ashton-Tate's dBase II.

Besides supporting multiple memory tasks, APX Core provides a window manager. An application can be placed in a window that can be moved to any screen location. When a task is selected, the window in which it resides becomes dominant—moves to the foreground. Because the block transfer capability makes APX Core a powerful system tool, data can be transferred task-to-task without special conversions or system utilities.

Establishes password levels

Another package that serves as both a foreground and background shell to the operating system is XTDRIVER. This \$180 package, developed by Chas-Moore Inc., Bakersfield, Calif., provides password file security. Several levels of passwords can be implemented to prevent access to files. Moreover, files can be password-encrypted for further security. However, the company's vice president of marketing, Don Maher, warns that XTDRIVER's password protection is formidable: Lost passwords can mean lost access, especially in the case of encrypted files.

To add further functionality to the operating system and the XTDRIVER package, the authors added Disk Operating System (DOS) functions via menus. Consequently, system functions can be performed without forcing the user back to the operating system command

level. XTDRIVER makes use of MS-DOS/PC-DOS UNIX-like functions. For example, it establishes pathways to applications in subdirectories. The desired paths are established in the installation of XTDRIVER, allowing access via a single key stroke. Like the DOS functions, users access individual applications from menus or by depressing specific, pre-defined function keys. Both APX Core and XTDRIVER are best employed on "larger" PC systems with, say, 620K bytes of user memory, a hard disk, a real-time clock and DOS 2.1.

Background comes forward

Still in the shell category but moving toward application add-ons is the Sidekick package from Borland International, Scotts Valley, Calif. Occupying 20K bytes of background memory until called to the foreground by tapping the CONTROL and ALT keys, Sidekick provides a series of useful applications tied together by a window manager. Company president Phillippe Kahn calls the package a program within a program: "That's why we called it Sidekick. It serves as a partner to any other application in memory."

Sidekick provides a notepad/editor that operates in a similar manner to MicroPro's Wordstar word-processing package, a calculator, an appointment calendar, an ASCII table and an automatic phone dialer. The dialer function uses a built-in "rolodex" from which numbers are plucked for dialing.

As with APX Core, data can be shared between Sidekick's windows. Moreover, information created in

This year Mini-Micro Systems readers will spend almost \$50 billion on Minicomputers and Microcomputers*

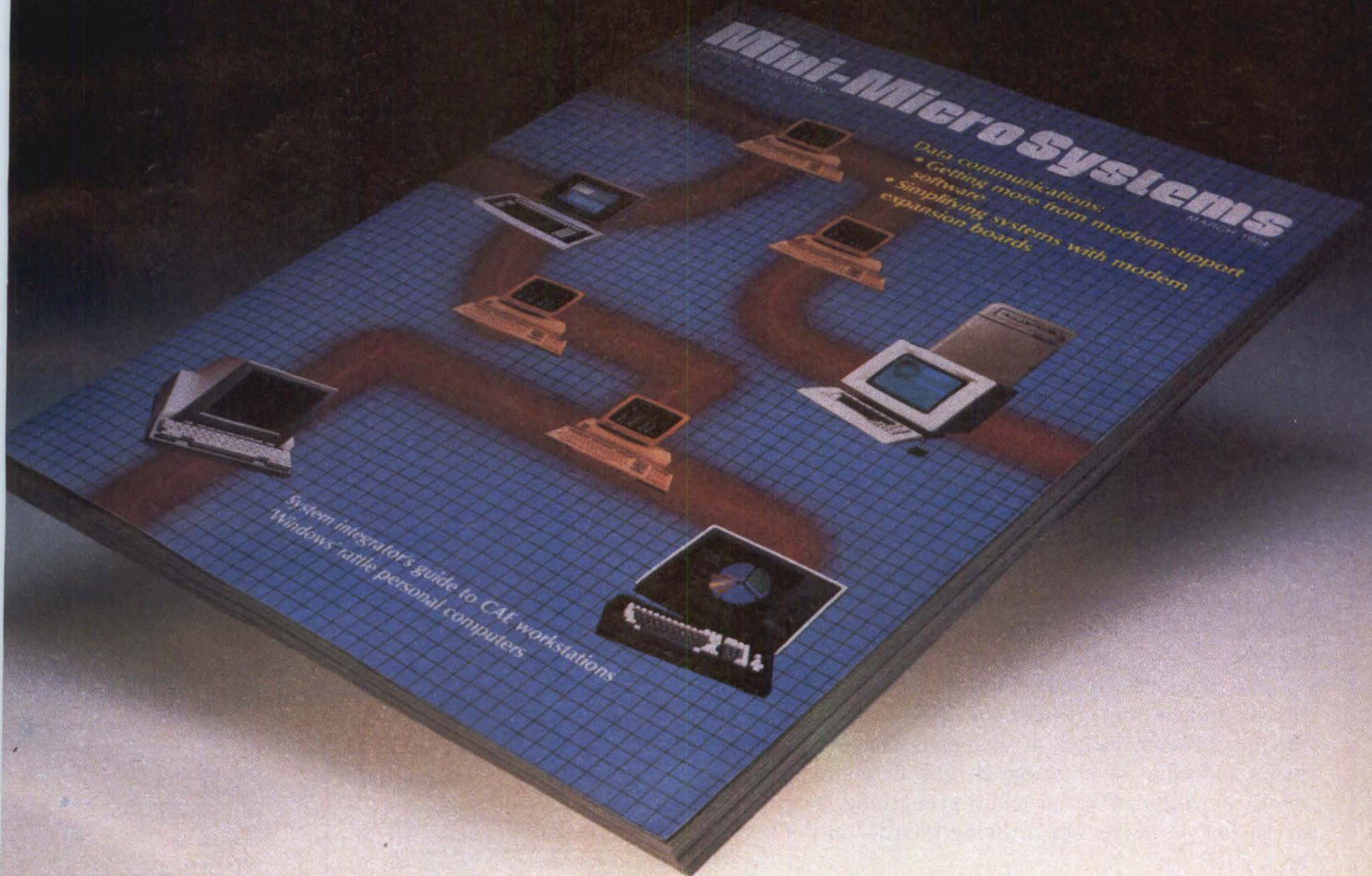

Mini-Micro Systems is the only advertising vehicle to reach the *complete* value-added market for mini-micro computers, peripherals, software, data communication products, supplies and services.

Who are these key prospects? Over 122,000 systems integrators, value-added OEMs, value-added resellers, and value-added users who purchase hardware and software products to configure mini-micro computer systems.

For more information on our market and our magazine, call or write Mini-Micro Systems, 221 Columbus Avenue, Boston, MA 02116 (617) 536-7780.

Mini-Micro Systems

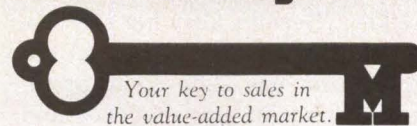

MINI-MICRO SYSTEMS: 221 Columbus Ave., Boston, MA 02116 (617) 536-7780/Chicago: (312) 635-8800/Dallas: (214) 980-0318/ Denver: (303) 388-4511/Los Angeles: (213) 826-5818/Mid-Atlantic: (215) 293-1212; in New York, (212) 724-1790 Orange County: (714) 851-9422/ Northern California & Northwest: (408) 243-8838/Southeast: (404) 955-6500

Cahners Publishing Publishers of 33 specialized business magazines in Building & Construction Electronics & Computers
 Foodservice Manufacturing Health Care

Based on the 13th Annual Mini-Micro Computer Market Report

CIRCLE NO. 56 ON INQUIRY CARD

The Interpreter

Sidekick's notepad is saved in an ASCII format, making it usable by virtually any other application. The package, at \$49.95, may be the most inexpensive windowing product currently available.

Enhancing graphics programs

An innovative package from Brightbill-Roberts & Co. Ltd., Syracuse, N.Y., is GraFIX Partner. This \$149.95 package is designed solely to enhance other applications packages, such as Lotus Development Corp.'s 1-2-3, Ashton-Tate's Framework, Sorcim Corp.'s Supercalc III and other packages that create graphics. The GraFIX Partner uses bit-oriented raster graphics to create charts and type fonts. Although it can also be used to draw designs, GraFIX Partner's main function is to enhance existing graphics. For example, GraFIX Partner can make a chart drawn by Lotus 1-2-3 more exciting by adding to the color mix and integrating different type fonts or specialized overlays.

The GraFIX Partner software not only allows the drawing of dots, lines, boxes and circles but also provides for area filling—painting, copying objects, creating mirror images, zooming and swapping colors. Additionally, unusual color textures can be created, widening the graphics rainbow. Because GraFIX Partner is a raster-oriented product, it can combine pixels—picture bit elements—in a variety of ways to produce new colors or shading effects. In addition, color precedence can be set; by declaring the color association, objects can be made to appear behind or in front of others.

Like Sidekick, GraFIX Partner is written in assembly language and resides in 26K bytes of system memory. When called, it suspends the primary program and takes over. Steve Brightbill, company president, explains, "We provide everything a graphics artist has on his or her drawing board—only it's done on a CRT."

A shortcoming of the package is that, being raster oriented, it doesn't work with plotters. "This is a tool for creating presentation-level graphics," explains Brightbill. "A user will either want to print it on a dot-matrix printer, as part of another document, or make a photographic slide." Besides allowing the creation of a hard copy version of the graphics, the GraFIX Partner package also has slide show provisions. Each slide can be set up in any sequence and timings set for playback on the system CRT. □

Interest Quotient (Circle One)
High 831 Medium 832 Low 833

Let us prove how Cromemco systems can increase your satisfaction with UNIX System V.

Call, or visit, one of our Official System Centers today:

USA	Cromemco, Inc.	INTERNATIONAL
In Arizona:	617 / 938-7010	In Australia:
Artemis Computer 602 / 957-0469	In Michigan:	Minicomp Software & Education 61-1 / 957-6800
Systems Solutions, Inc. 602 / 224-0026	United Microsystems Corporation 313 / 668-6806	Insystems P/L 61-3 / 690-2899
Professional Data Systems, Inc. 602 / 265-6656	Jepsan Group, Inc. 616 / 698-8700	In Canada:
In California:	Automated Business Consultants 313 / 478-0557	Cro-Corp Computer Solutions 403 / 286-8459
Quintec 818 / 889-4819	In New Jersey:	D. E. Systems 613 / 729-5164
American Computer & Communications 415 / 849-0177	Kierulff Electronics 201 / 575-6750	Future Electronics 610 / 421-3251
MCM Enterprises 415 / 327-8080	In New Mexico:	In Costa Rica:
American Computers & Engineers 213 / 477-6751	South West Computer Stores, Inc. 505 / 292-6568	Control Electronico 506 / 23-50-17 / 24-44-44
Kierulff Electronics 213 / 725-0325	In New York:	In England:
Accountability Systems 714 / 639-4570	C.C.S., Inc. 212 / 986-7520	Jarogate Ltd. 44-1 / 671-6321
Excalibur 916 / 972-9252	Trexis, Inc. 914 / 268-5161	In Greece:
Kierulff Electronics 714 / 278-2112	In Ohio:	Algorithm Ltd. 30-1 / 933-8463
Kierulff Electronics 408 / 971-2600	Lucas Office Equipment & Service, Inc. 513 / 433-8484	In Hong Kong:
Cromemco, Inc. 818 / 346-6690	Odyssey Systems, Inc. 216 / 526-9933	Vanda Computer & Equipment 8529 348702-5
In Connecticut:	(ISIS) Innovative Systems/Integrated Software 419 / 531-0220	In Italy:
Datacraft, Inc. 203 / 673-6952		C.N.I.A. 39-51 / 375009 / 359406
In Florida:		In Japan:
Automated Computer Systems 305 / 594-3819		Asahi Glass 81-3 / 218-5848
Computer Centre 813 / 484-1028		In Israel:
Royal Data, Inc. 305 / 267-1960		Information Systems Ltd. 03-775111
In Georgia:		In Mexico:
Cromemco, Inc. 404 / 391-9433		Micromax, S.A./DE C.V. 905 / 687-8886 / 8913 / 905 / 536-5503
Systems Atlanta 404 / 928-0240		In Mid-East:
Kierulff Electronics 404 / 447-5252		Multi Media Video, Inc., CA USA 408 / 727-1733
In Illinois:		National Computer System Karachi 4, Pakistan
Commercial Data Systems 309 / 797-9401		Computer System Marketing System Jeddah 21431, Saudi Arabia
Computerland 312 / 967-1714		In The Netherlands:
Southern Exchange, Inc. 404 / 921-2662		Rocomp B.V. 31-40 / 524055
Alpine Computer Center, Inc. 815 / 229-0200		In Norway:
Cromemco, Inc. 312 / 934-0650		Micro Systems A/S 47-2 / 41-69-76
Alternate Computer Services 312 / 893-1992		In Scotland:
In Indiana:		Micro Centre Complete Micro 44-31 / 556-7354
Memory Bank, Inc. 312 / 891-1064		In Sweden:
219 / 931-0203		Datrolsering Konsult AB 46-8 / 753-3090
Harbourtown Sales 317 / 877-4900		In West Germany:
Microcomputer Specialists, Inc. 219 / 762-8541		Cromemco GmbH 49-6196 / 481606
In Kansas:		Digitronic Computer-systeme GmbH 04103 / 88672 / 73
Tradewind Systems 316 / 624-8111		Cosy-X Computer System GmbH 2173 / 52071 / 72
In Louisiana:		Comicro Deutschland 49-2151 / 795577
Muse Data Technologies 504 / 293-0320		
Standard Systems, Inc. 318 / 625-8613		
In Maryland:		
Dynamic Data Processing 301 / 589-8950		
In Massachusetts:		
Kierulff Electronics 617 / 667-8331		
	In Pennsylvania:	
	Modular System Design 412 / 521-6700	
	In Texas:	
	Kierulff Electronics 214 / 343-2400	
	Gunn Enterprises 713 / 781-6911	
	Procomp 713 / 266-3648	
	Computer Crossroads of America 214 / 231-6108	
	In Virginia:	
	SMS Data Products 703 / 827-0640	
	Business Communications Systems 703 / 344-5563	
	VCA Corporation 703 / 281-4666	
	In Washington:	
	Kierulff Electronics 206 / 575-4420	
	In West Virginia:	
	Systems Support 304 / 766-7762	
	In Wisconsin:	
	Computer World 414 / 733-9547	
	Bay Tech of Wisconsin, Inc. 414 / 846-3038	
	Computer World 414 / 499-9983	



Cromemco®

CROMEMCO COMPUTERS: DESIGNED TO MAKE UNIX SYSTEM V EVEN BETTER...

UNIX System V, the new standard in multi-user microcomputer operating systems, gives you high performance features along with the portability and flexibility of a standard.

Cromemco computers can make UNIX System V even better. Because our systems are designed with UNIX in mind. First of all, we offer UNIX System V with Berkeley enhancements. Then, our hardware uses advanced features like 64K of on-board cache memory and our high speed STDC controller to speed up disk operations—very important with UNIX.

More capability and expandability

We have a high-speed, 68000-based CPU that runs at 10 MHz, coupled with a memory manager that uses demand-paging and scatter loading to work *with* UNIX, not for it.

We provide room for expanding RAM to 16 megabytes—with error detection and correction—for running even the most sophisticated and advanced microcomputer programs. And the power to accommodate up to 16 users—all with plenty of memory.

But we give you even more.

A complete solution

We give you a choice in systems: the System 100 series, expandable up to 4 megabytes of RAM, and the System 300 series, expandable to 16 megabytes. A high speed 50 megabyte hard disk drive is standard on the systems. And you can expand the hard disk capacity up to 1200 megabytes using standard SMD drives. You can add floating point processing. High resolution graphics. Video digitizing and imaging. Communications through

standard protocols. Mainframe interface.

And software support is here to meet your needs. We offer major programming languages, database management systems, communications software, including SNA architecture, X.25 protocol, and Ethernet; even a program to interface to an IBM PC if you need to. And, of course, access to the broad range of standard UNIX applications programs that is growing dramatically every day.

Easy to use.

We also make our systems easier to use, because we install the operating system before we ship your computer. No complicated installation procedures. And the Berkeley enhancements give you the standard UNIX System V operating system, but with the added convenience of these widely acclaimed improvements.

Cromemco's System 100 and System 300 computers: designed to be the highest performance UNIX systems available anywhere.

Just call or visit one of our UNIX System V Official System Centers to see for yourself. They'll also give you a copy of our new publication, "What you should know before you buy a UNIX system." Or contact us directly.

We'll be glad to show you how to get a better UNIX system.

Corporate Headquarters: Cromemco, Inc.,
280 Bernardo Avenue, P.O. Box 7400, Mountain
View, CA 94039. (415) 969-4710. In Europe:

Cromemco
GmbH, 6236
Eschborn 1,
Frankfurter Str.
33-35, P.O. 5267,
Frankfurt Main,
Germany.



UNIX is a trademark of Bell Laboratories.
IBM is a trademark of International Business Machines Corp.

Cromemco[®]

CIRCLE NO. 57 ON INQUIRY CARD



The exceptional flexibility of the ESP 6310 terminal sets it sharply apart from the crowd.

Upgradable to an IBM® PC workstation. Add an ESP 9310 module and your ESP 6310 becomes an IBM PC. You get a loaded terminal and a personal computer on a single footprint. That's unsurpassed present *and* future flexibility.

7 terminals in one. Menu selection of emulators for Televideo 925/910PLUS®, ADDS Regent 25/Viewpoint®, Esprit II, Hazeltine 1500 and Lear Siegler ADM3A®. And we throw in extra features in every mode, including our IBM PC compatibility.

Bridges old and new technologies. Works with either embedded or non-embedded video attributes to save spaces on the screen and hassles in the programming.

Loaded with features. Non-glare 14" screen. An amber display is optional. Tilt & swivel. Line drawing graphics and smooth scroll. 25th status or message line. Low profile DIN keyboard. 22 programmable function keys.

For more about the ESP 6310, the flexible terminal with the unlimited future, call Esprit (Es-pree) toll free at 800-645-4508. In NY State 516-293-5600.

®Registered trademarks: IBM, International Business Machines Corp. Viewpoint and Regent 25, Applied Digital Data Systems. The ADM3A, Lear Siegler, Inc. Televideo 925/910PLUS, Televideo Systems, Inc.



Esprit
Systems, Inc.

PEACE OF MIND TECHNOLOGY
CIRCLE NO. 58 ON INQUIRY CARD

UNIFY CORPORATION

UNIFY CORPORATION

RELATIONAL DATA MANAGEMENT SYSTEM REFERENCE MANUAL

RELATIONAL DATA BASE MANAGEMENT SYSTEM

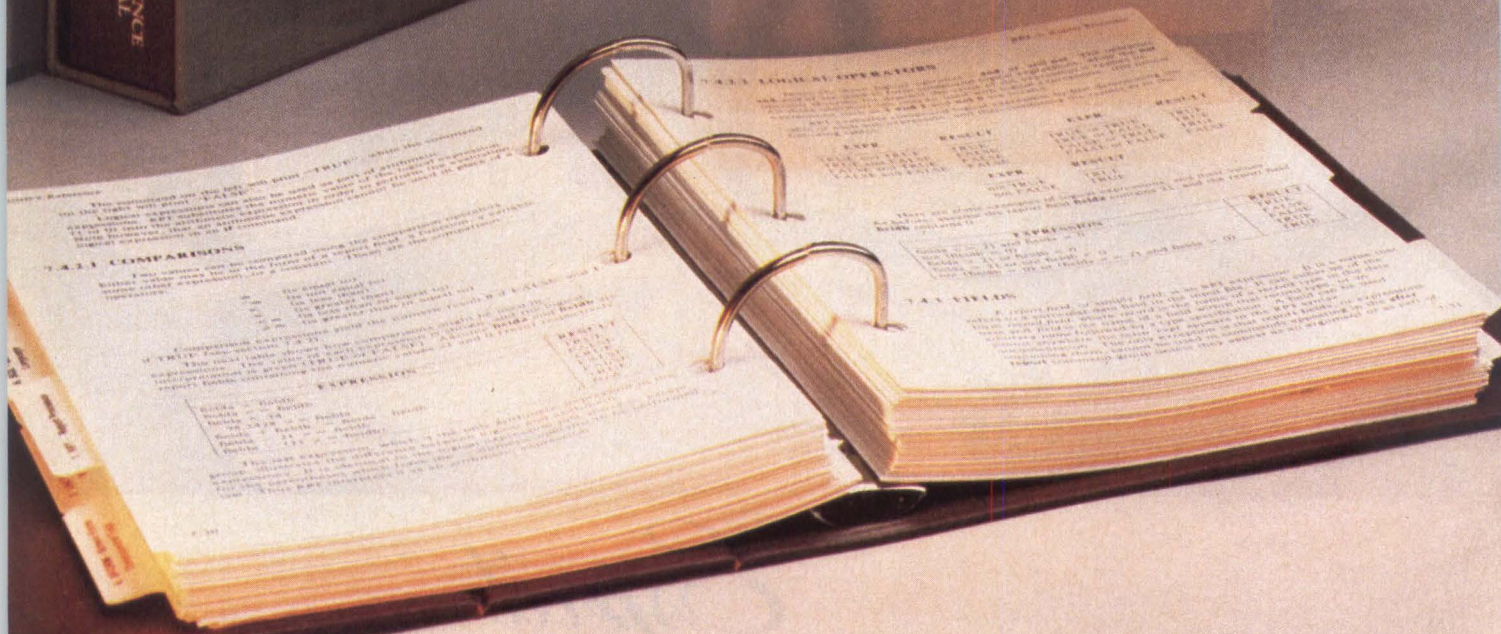

[sysmenu]

1. Schema Maintenance
2. Schema Listing
3. Create Data Base
4. SFDRM Menu
5. ENTER Screen Registration
6. SQL - Query/DML Language
7. SQL Screen Registration
8. Listing Processor

SELECTION: █

UNIFY SYSTEM
17 SEP 1984 - 18:01
System Menu

9. Data Base Test Driver
10. MENUH Screen Menu
11. MENUH Report Menu
12. Reconfigure Data Base
13. Write Data Base Backup
14. Read Data Base Backup
15. Data Base Maintenance Menu

{student}
{INQUIRE}

UNIFY SYSTEM
25 Aug 1985 - 10:45
Student Registration Form

Invoice Number: 458

Last Name: Gordon First Name: Richard

Company: Silicon Design Labs
: 5558 Industrial Hwy
: Basking Ridge NJ 07890
: (201) 555-5488

Student's phone number (if different): (201) 555-5421

Class code (sname): CP0805
Class fee: 995.00
Deposit date: 8/15/85
Payment date: 8/25/85

Subject: C Programming
Class date: 9/1/85
Deposit amount (\$): 100.00
Payment amount (\$): 895.00

{student}
{INQUIRE}

UNIFY SYSTEM
25 Aug 1985 - 10:45
Student Registration Form

Current: 1

REPORT	TO:	SCREEN	PRINT	FILE	FILENAME
1. Student Registration Listing	(x)	()	(x)	-	listing
2. Student Billing	()	()	()	()	()
3. Billing Summary	()	()	()	()	()

REPORT #: 1

UNIFY. THE MIGHTY EASY DBMS.

UNIFY isn't only the fastest and most powerful of all UNIX*-based data base management systems—it's also one of the simplest to use. Which is why some 75 percent of those who see our manuals and buy a DBMS, buy UNIFY.

UNIFY guides the nonprogrammer through data base development with minimal steps, comprehensive menus, on-line HELP, elementary Query By Forms capability, and clear documentation.

UNIFY expedites applications development for users of all skill levels with features like PAINT, for effortless forms design; SQL, the powerful, English-like query language; and a menu-handler that lets you quickly compile screens, queries and reports into menus customized to each user.

And for the skilled programmer, UNIFY offers the most extensive host language interface, for limitless flexibility when you need it.

All of which makes it mighty easy to see why UNIFY has been selected by more computer manufacturers than any other UNIX-based DBMS.

Judge for yourself. Send for our demo kit—disks, tutorial and reference manuals, all for only \$150—that shows you how to build virtually any application. Contact UNIFY, 4000 Kruse Way Place, Lake Oswego, OR 97034, 503/635-6265.

CIRCLE NO. 59 ON INQUIRY CARD



UNIFY®
THE PREFERRED DBMS.

DEC OFFERS EVERYTHING YOU NEED TO BUILD A POWERFUL Q-BUS COMPUTER SYSTEM. EXCEPT THIS.

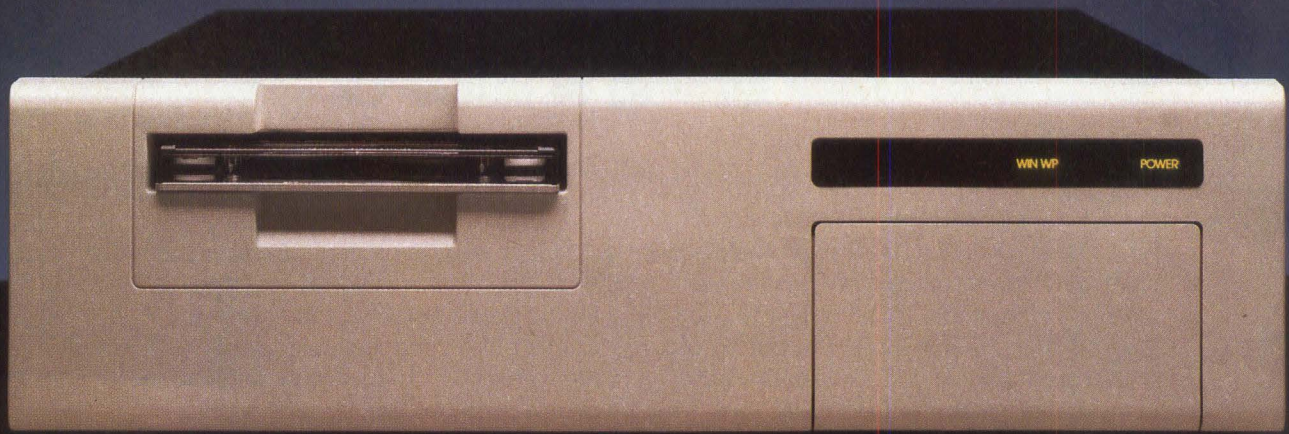

It's called Cyclone.[™] A high-capacity, high-reliability Winchester/tape storage system that's priced to blow your socks off.

For starters, Cyclone's 5¼" Winchester packs formatted capacities from 36 up to 120 megabytes.

So you can use your Q-Bus based system (PDP[®]-11/23, 11/73, MICRO/PDP-11 and MicroVAX[®]) for applications that require large amounts of storage. At the lowest cost per megabyte.

But, of course, we offer more than the highest capacity for the lowest price in DEC-compatible storage.

For instance, Cyclone has faster throughput. And access times are twice as fast as an RL02's.

It's compatible with DEC's Digital Storage Architecture (DSA). And its ¼-inch start/stop tape drive emulates DEC's TSV05/TS11.

For your commercial applications, there's the tabletop StacPac[™]—in addition to the rackmount version that's popular with the industrial and scientific users.

And no matter what kind of system you're building, Cyclone features a comprehensive self-diagnostic system, Customer Service Hotline and Rapid Module Exchange[™] program.

To see what Cyclone can do for your Q-Bus system, call the Qualogy sales office nearest you. And hang on to your socks.

QUALOGY

Formerly Data Systems Design

Eastern Regional Sales: Norwood, MA (617) 769-7620. Southcentral Regional Sales: Dallas, TX (214) 980-4884. Northcentral Regional Sales: Chicago, IL (312) 920-0444. Western Regional Sales: Santa Clara, CA (408) 727-3163. Distributors Worldwide. Corporate Headquarters: 2241 Lundy Avenue, San Jose, CA 95131

[™] Cyclone, StacPac and Rapid Module Exchange are trademarks of Qualogy, Inc. [®] DEC, PDP, and VAX are registered trademarks of Digital Equipment Corporation © 1984 Qualogy, Inc. Literature Hotline: 800-556-1234 ext. 86; in California, 800-441-2345 ext. 86.

CIRCLE NO. 60 ON INQUIRY CARD

The Integrator

Applying integrated systems in industry, engineering and commerce

Network software bridges gap between local area networks

Advanced NetWare provides software 'standard' for 14 major LANs using different topologies

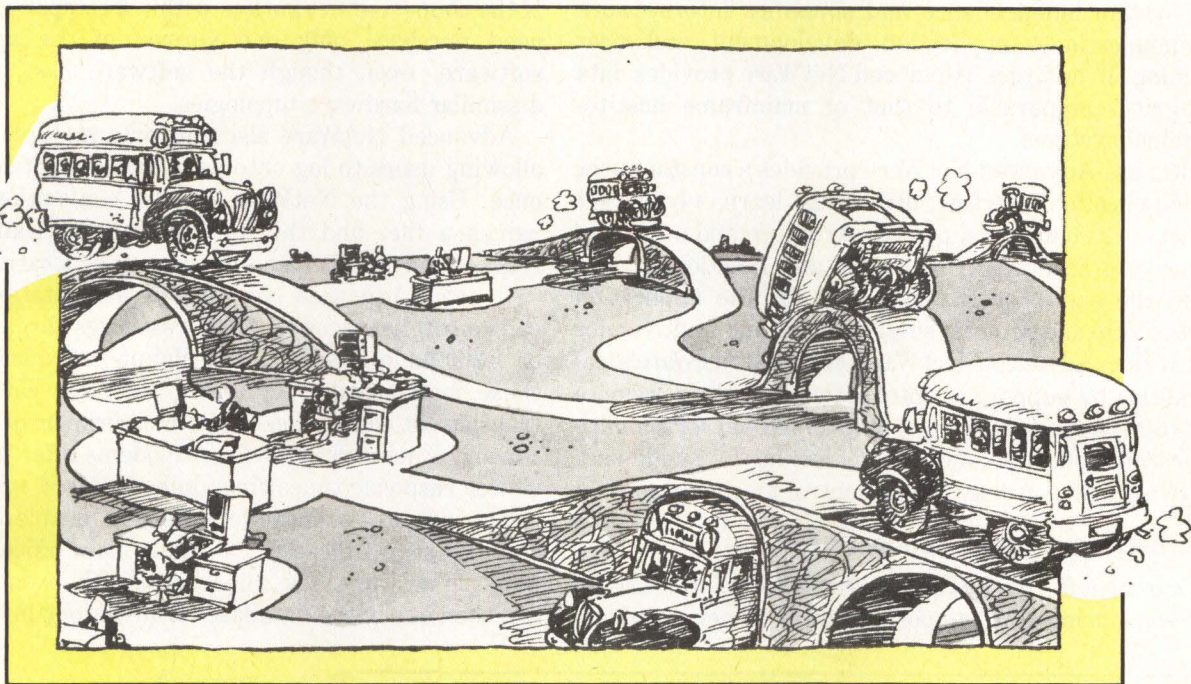

Software bridges provide network-to-network communications in Novell's Advanced NetWare.
An IBM PC bus physically connects the LANs.

Michael Durr, Network Consultant

The first local area networks (LANs) were small peripheral-sharing systems. Companies that wanted to use them could rely on proprietary network software written by each LAN hardware vendor. These programs supported their own LANs, allowing computers in the LANs to communicate and share peripherals.

But LANs have grown—in complexity of architecture and of application—making it more difficult for users to rely on hardware vendors for LAN programs. This is because many large companies now require two or three LAN schemes to meet the demands of their various departments in the most cost-effective manner.

Moreover, multiuser information-sharing has replaced peripheral-sharing as the primary LAN application.

As a result, microcomputer system integrators and users began to wait for a network standard to emerge that would enable them to connect LANs using the same standard hardware topology. Most expected Ethernet, Omnet or another popular LAN to become standard. But, instead of one standard, several protocols—conventions governing message interchange between terminals—have evolved. Each has established its own niche in the market and its own user base.

As an alternative, companies that want to provide information-sharing among departments are now turning to a "standard" software solution, such as Novell Inc.'s NetWare file-server operating system. Novell,

The Integrator

Orem, Utah, has ported NetWare to 18 major LANs for IBM PC/XTs, ATs and compatibles. Its latest release, Advanced NetWare, connects all these LANs. Among them are Corvus Systems Inc.'s Omninet, Standard Microsystems' ARCnet, Gateway Communications Inc.'s G-Net, Novell's S-Net, Proteon Associates Inc.'s proNET, Nestar Systems Inc.'s PLAN 2000, 3Com Corp.'s EtherLink, Orchid Technology's PCnet and Davong Systems Inc.'s MultiLink.

Advanced NetWare connects departmental, or cluster, LANs into company-wide communications systems. It also maintains hardware topology and operating system independence and simplifies internetwork communications, application development and user training. In addition, Advanced NetWare provides data integrity comparable to that of mainframe host-to-terminal systems.

Because Advanced NetWare provides a constant user and application interface, users must learn only one set of network commands, one file structure and one set of security procedures. Commands and functionality remain the same for the user and for the application across local and remote, single-vendor and multivendor networks. Advanced NetWare extends NetWare's capabilities by supporting internetwork bridges, remote PC-to-network execution, value-added servers, multi-user synchronization, default file-locking for single-user software and software usage control mechanisms.

Internetwork bridges connect LANs

One benefit of Advanced NetWare is its use of software bridges to support network-to-network com-

munications. Novell defines software bridges as any NetWare-to-NetWare connection, regardless of what hardware topology the connection uses. Using an IBM PC bus as the physical connection, a user can make an Omninet-to-Ethernet bridge by installing an Omninet board and an Ethernet board in one PC. With the bridge software and NetWare running on both LANs, users can send internetwork communications and use any of the resources on the resulting network as if they were all local.

This scheme allows all of the supported networks to be connected in whatever arrangement a user wishes. If the connected network is within a company, the user need purchase only one version of the application software, even though the software has to run on dissimilar hardware topologies.

Advanced NetWare also supports multiple servers, allowing users to log onto as many as eight servers at once. Using the NetWare naming convention, a user names a file, and the network automatically routes requests with that name to the proper location.

In some Advanced NetWare implementations, users can remotely access all LAN resources through a 300- or 1,200-baud modem and a dial-up telephone line. In these installations, Advanced NetWare can make a transparent connection of two networks or of a remote PC and a network. However, modems offer noticeably slower response times than do hard-wired systems.

The remote internetwork system enables users in satellite sales offices to call their main offices and log onto the network. The salespeople in the remote offices can then query the database for inventory information,

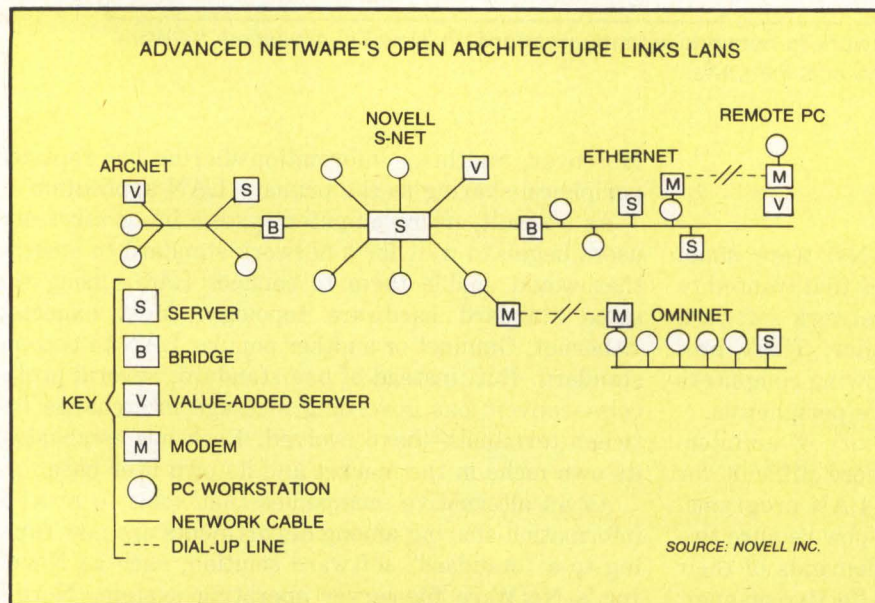

NetWare's open architecture provides an environment in which NetWare overlays all networks for inter-LAN communications.

Why choose a file-server operating system?

Networks can access shared disks via disk servers or file servers. The major differences between the two access methods are:

DISK SERVER	FILE SERVER	DISK SERVER	FILE SERVER	
Management Responsibility				
<p>A disk-server system places the management responsibility on the application software and each PC workstation.</p>	<p>A file-server system, such as Novell Inc.'s NetWare, places the management responsibility on the network operating system.</p>	<p>ever, it does not have any control over storage allocation. Thus, it does not prevent data loss.</p>	<p>is centralized, data loss is not a problem.</p>	
Disk Space Pre-allocation				
Disk Management				
<p>A disk-server approach is "unsynchronized" because each PC tries to manage a directory, a file-allocation table and a disk, with no means of coordinating with other workstations</p>	<p>A file-server approach is "synchronized" because the CPU manages the disk and coordinates, or synchronizes, with other workstations.</p>	<p>Software developers can partially relieve the limitations of disk-server systems by including code to pre-allocate disk space in the application. For example, if a user wanted to write a document, he could pre-allocate 8K bytes for storage. If 8K bytes proved insufficient, the user could return to the file-allocation table and request more space. However, it is difficult to write these disk-management features in application software because developers must write code for each supported local area network.</p>	<p>A file-server system does not require pre-allocation because only one device reads the file-allocation table. This relieves the application software of disk-management chores, freeing it to manage multiuser operations and the application itself.</p>	
Data Integrity				
<p>Because of its inability to coordinate with other workstations, a disk-server system can cause "destructive interaction" between two users' data. For example, if user A and user B were working on the network in the same directory area of a central hard disk, they would both go to the file-allocation table to store their data. The file-allocation table would show the same amount of unused storage space on both users' machines. User A would then store his data, followed by user B, who would store his data in the same area as user A. The result would be destructive interaction—user B's data would destroy user A's data.</p>	<p>Because a file-server system has centralized directory and file management, only one device reads the file-allocation table and allocates space. Hence, it would not tell two users to store their data in the same area, and no data loss would occur.</p>	<p>Because pre-allocation is a multiuser feature, disk servers cannot support single-user software, except when each user has a private disk partition and directory.</p>	<p>A file-server approach supports single-user software. Advanced NetWare also features default file-locking so that users can share single-user files.</p>	
Multiuser/Single-User Support				
Network Security				
<p>In a disk-server network, low-level PC workstation-to-disk system calls manage the shared disk. A user intent on breaking disk-server security would have an open path to the disk. Once there, he could begin to seek security mechanisms and user passwords.</p>				<p>In a file-server network, the workstation makes high-level file system calls to the server. A user at a workstation cannot read the disk directly. The server itself provides the only direct path into the disk area. Because access to the file server is restricted, it is virtually impossible for a user to break the security on a file-server network.</p>
File-Locking				
<p>In a data-server system, locking the files before updating them prevents other users from gaining access to the files. How-</p>	<p>In a file-server system, locking the files before updating them prevents other users from gaining access. Because storage allocation</p>			

The Integrator

enter sales made, make shipping requests and update the database with inventory information. The system also supports file-locking and other multiuser data-integrity features, just as if the access were from a local workstation.

In addition, the Advanced NetWare architecture treats all devices attached to a network as objects that can have user-defined properties. This allows software developers to write value-added servers to run on the operating system. Such value-added servers could include communications servers, database back-end machines and peripheral servers. To date, 100 software developers have written approximately 500 multiuser applications that run on NetWare. Applications on Advanced NetWare can communicate with other workstations or with servers. The applications can also queue requests, and the servers can manage each application's queues. Alternatively, the workstation can manage its own queues.

In operation, value-added servers can manage applications that are impractical for conventional servers. For example, a print server could manage a plotter for the network. Attaching a plotter to a conventional print server would be difficult because a plotter cannot operate continuously; users must constantly change the plotter's pens and paper. But, with Advanced NetWare, developers could write a value-added application that would tell the plotter to beep when it is out of paper or pens. It would also allow many users to spool the plotter.

Software can process tasks simultaneously

Because Novell developed Advanced NetWare specifically for networking, it does not run on top of PC-DOS as other operating systems do. Instead, its network-management software resides between DOS and the disk. Other network operating systems, on the other hand, run on PC-DOS, placing DOS between the network-management software and the disk.

Because it does not run on top of PC-DOS, Advanced NetWare does not incur the bottleneck that typically occurs with other network-management software—the inability to process foreground and background tasks simultaneously. This means that Advanced NetWare can, for example, process disk I/O in the foreground while performing other tasks in the background, such as sorting a cache, hashing a directory or “elevator seeking”—evaluating the location of requested files and retrieving them in the most efficient order.

In addition, Advanced NetWare uses the file-server approach to access shared disks. This method differs from the other available method networks can employ

—the disk-server approach—in the way it manages network files and directories (see “Why choose a file-server operating system?” Page 119). The file-server method places management responsibility on the network operating system. The disk-server method, on the other hand, places responsibility on the application software and each PC workstation.

Moreover, Advanced NetWare provides several layers of software copy-protection and usage-restriction mechanisms. These techniques discourage software piracy and control the number of users that can simultaneously run an application program on a network. For example, a system integrator can mark a software package installed on a NetWare file server as “execute-only.” This means that a user cannot open or use the package's files under program control. Once the file is marked, renaming it will have no effect on its execute-only status. The only way to change the mark would be for the system integrator to erase the file and re-install the package.

Each NetWare file server has a unique serial number, which can be retrieved and checked by an application program running in the NetWare environment. This enables the application programs to query the file server about its identity and to stop execution, should the file server's identity not match the identity the applications are programmed to accept. If the serial number does not match, the file server automatically logs the station off the network—revoking all file-access rights—and returns an error indication to the workstation.

NetWare also includes primitives that allow a package to determine how many stations are using the package at one time. Application software vendors can thus restrict the number of users that can use a single-user or multiuser package simultaneously. Software vendors typically price their packages according to the maximum number of users they support. □

Michael Durr is a network consultant and author of *Networking IBM PCs: A Practical Guide*, published by Que Corp., Indianapolis, and co-author of *Understanding the Law*, published by SRA Publications. Durr received a B.A. in business and technical communications and an M.A. in marketing communications from California State University, Los Angeles.

Interest Quotient (Circle One)
High 834 Medium 835 Low 836

The TI 855 is
the only printer
with letter quality,
draft speed,
graphics,
plug-in font
modules...
all for under
\$1000. (suggested retail price)

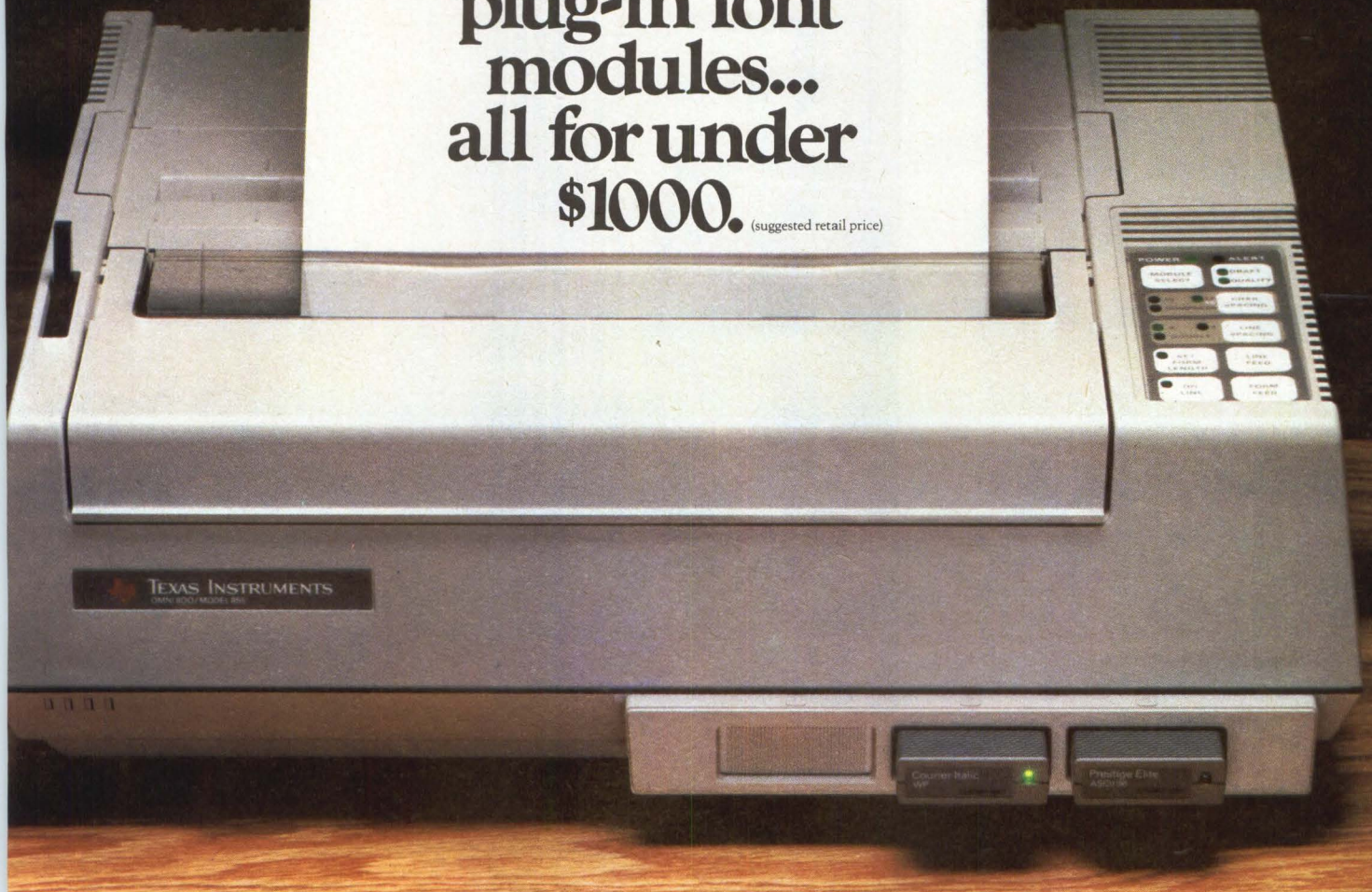

Finally, the printer for all PC needs.

The TI 855 printer. The
printer for all major PC's.
See for yourself today.
Call 1-800-527-3500
for the dealer
nearest you.



**TEXAS
INSTRUMENTS**
Creating useful products
and services for you.

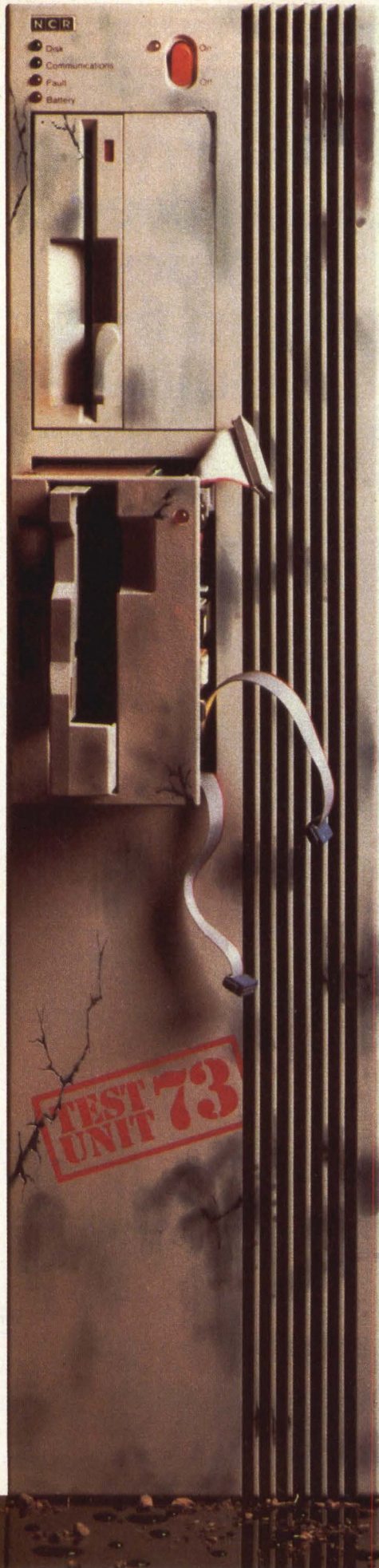

TEST UNIT 73

INTRODUCING TOWER XP. NOW THAT WE'RE THROUGH WITH IT, YOU CAN HAVE IT.

Reliability has been the hallmark of NCR products for over 100 years. But what began as a virtue has, quite frankly, become somewhat of an obsession.

Pick. Pick. Pick.

Before our reliability engineers allow our new Tower systems out the door, they do a little testing.

A little testing.

They burn in 100% of memories, processors and complex VLSI assemblies upon arrival. They burn in the assembled boards. Then, they give the finished unit an extensive burn-in over a wide range of temperatures.

They test the unit against NCR's rigid standards for electromagnetic interference (EMI), radio frequency interference (RFI) and electrostatic discharge (ESD).

And when they're finished performing more QA than any other manufacturer would dream of (an average of over 200 hours per unit), they start

testing features that other manufacturers *only* dream of:

Consistent error-logging.

Extensive in-service and remote diagnostics.

Automatic Power Failure Recovery.

A UNIX™ operating system that virtually never PANICs.

And more.

Tower XP gives your customers the power of a 68010-enhanced CPU, up to 260MB of mass storage, 45MB of ¼" cartridge tape built into the CPU cabinet, industry-standard interfaces and a UNIX of truly commercial reliability.

Tower XP. Now that we're through with it, your customers will never have to settle for anything less.

**TOWER XP.
BUILT FOR SYSTEMS BUILDERS
BY NIT-PICKING FANATICS.**

NCR

OEM Systems Division

CIRCLE NO. 61 ON INQUIRY CARD

NCR Corporation, U.S. Data Processing Group, OEM Systems Division, CSP-1, Dayton, Ohio 45479. Nationwide (800) CALL-NCR. In Ohio (513) 445-2190. In Canada (800) 268-3966.

UNIX is a registered trademark of AT&T.

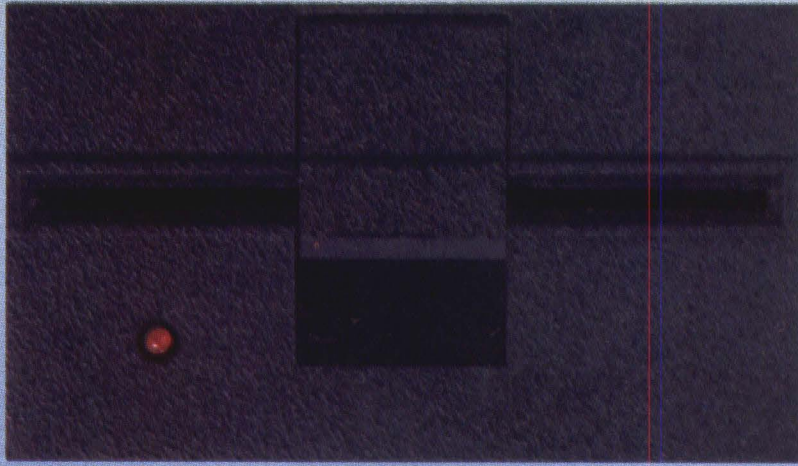

**THE END OF THE
SECONDARY STORAGE SPECTRUM
EVERYONE FORGOT ABOUT
WAS THE MIDDLE.**

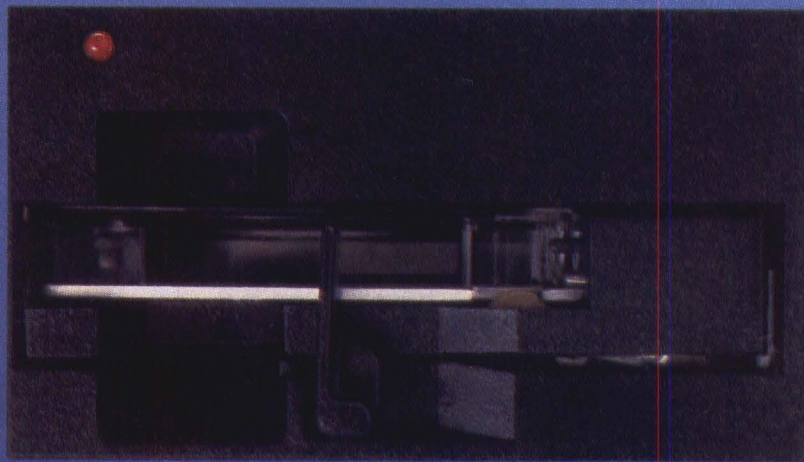

It wasn't long ago that when you wanted to back up a 5¼" Winchester, you only had two choices: floppies or QIC-compatible ¼" tape.

Well, now there's a third choice: Cipher's FloppyTape.™ It gives you the best of both worlds — without the drawbacks of either.

Economical like a floppy.

FloppyTape is the perfect secondary storage device for low-cost systems. It offers a substantially lower cost-per-megabyte than floppies. Yet the actual cost of the drive is only slightly more.

What's more,
FloppyTape
uses a



standard
floppy interface.

And it works perfectly with most regular floppy controllers. So you can share your system's existing floppy controller.

High capacity like a streamer.

Using a standard ¼" tape cartridge, FloppyTape gives you up to 32 megabytes of storage. It eliminates the problems of handling a large number of floppy disks. And FloppyTape is priced well below QIC-compatible ¼" streamers. With QIC, you also need a new host adapter or controller. But you don't with FloppyTape.

If the part of the secondary storage spectrum that's best for your system is the middle, call 800-982-8808. Or write Cipher Data Products, P.O. Box 85509, San Diego, CA 92138.

cipher[®]
data products, inc.

**WE PUT THE BEST IDEAS
INTO STORAGE.**

FloppyTape is a trademark of Cipher Data Products, Inc.

CIRCLE NO. 62 ON INQUIRY CARD

FIVE AGAINST ONE

It Hardly Seems Fair

Five against one is just as unfair in a business environment as it is on a basketball court. IBC's Multi-Star I™ five user business computer—priced as low as a single user personal computer with all of the attributes of a true multi-user system has the full court advantage.

The Multi-Star isn't just another single user personal computer that can be "Networked" to pretend you have multi-user capabilities. It is a true multi-user business system like the high priced multi-user mini-computers of old. And, a low cost "Dumb" CRT terminal is all that you need for each user.

Sophisticated multi-user software with big system features such as record locking, user accounting, privilege levels, and system security provide capabilities well beyond those available on any personal computer.



There are hundreds of multi-user business accounting software applications available right now as well as word processing, spread sheet, and data base software.

The Multi-Star I is the smallest member of the IBC multi-user family. Software compatible systems with up to 16 users and 167 megabytes of hard disk storage are also available.

IBC has been manufacturing high-performance, multi-user micro-computers since 1979.

Their reputation has been built on quality, performance, and reliability. To find out more about the multi-user business systems that is priced like a single user personal computer, please call or write:

IBC

Integrated Business Computers
21621 Nordhoff Street
Chatsworth, CA 91311
(818) 882-9007
Telex No. 215349

FEATURE HIGHLIGHTS

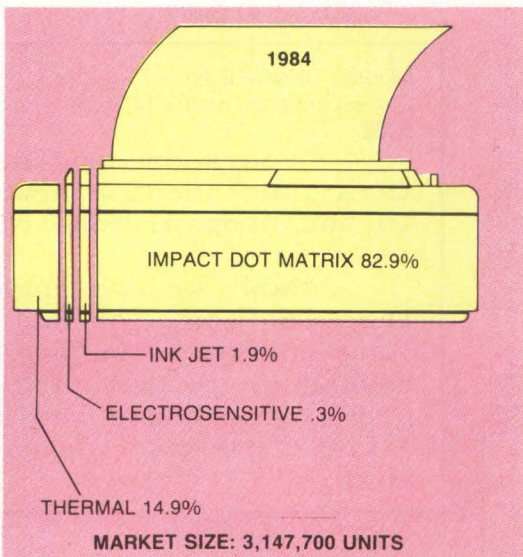

p. 129 Retail reshapes market

PRINTERS: All sectors of the printer market will be affected by the rough-and-tumble price/performance battles now being waged by **retail outlets**. Turn to **p. 129** to see just how retail stores are calling the shots.

Can **daisywheels** survive the onslaught of new printer technologies? Yes, because the office of the future will still require them. To find out why, see **p. 163**.

The choice of a **printer supplier** directly affects system development marketing strategy and, to choose wisely, one must be aware of several practical rules. Turn to **p. 175** for guidelines.

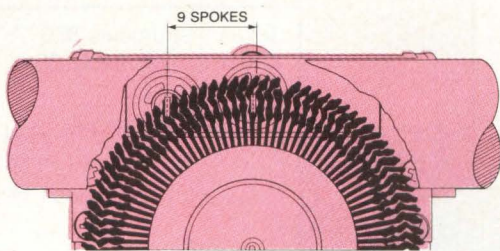

p. 143 Creating artful text

WORD-PROCESSING SOFTWARE: Taking advantage of the display power of the latest computer systems, today's newer, more powerful word-processing programs have gone far beyond simple text editing. Have a look at the newest features and at who offers them, beginning on **p. 143**.

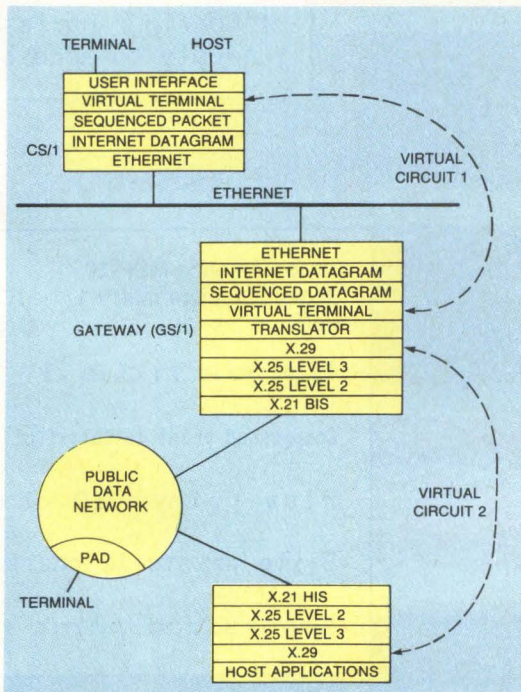

p. 195 Hybrid LANs rewrite rules

8-INCH WINCHESTERS: Despite their lack of glamour, the increasing capacity of 8-inch Winchester disk drives keeps them high on the heap of storage devices. As a result, the demand for 14-inch drives is dwindling and may eventually disappear. For more information and a list of 8-inch drive manufacturers, turn to **p. 185**.

LOCAL AREA NETWORKS: Once characterized by distinct technologies, local area networks (LANs) have become hybrids, mixing media, producing extensive development work in protocols and even influencing application software. See **p. 195** to find out how the LAN industry is being shaped by these new developments.

A portion of Okidata's OKIMATE 20 color selection guide enlarged five times to show "quartertone" printing technique. All boxed copy photographed at actual print size.

Okidata OKIMATE 20
Correspondence matrix 14 x 18
\$268

"Fourscore and seven
this continent a new nat
to the proposition that a

"Now we are engaged
that nation, or any nat
long endure. We are met
have come to dedicate a p
place for those who here
live. It is altogethe
this.

IBM Quietwriter
Letter-quality matrix 40 x 40
\$1,395

☺	☹	♥	♦	♣	♠	•	◼	○	◻	♂	♀	♪	♫	✳
\$	-	↕	↑	↓	→	←	↔	▲	▼		!	"	#	
)	*	+	,	-	.	/	0	1	2	3	4	5	6	7
=	>	?	@	A	B	C	D	E	F	G	H	I	J	K
Q	R	S	T	U	V	W	X	Y	Z	[\]	^	_
e	f	g	h	i	j	k	l	m	n	o	p	q	r	s
y	z	{		}	~		Ç	ü	é	â	ä	à	å	ç
ï	Ä	Å	É	æ	Æ	ô	ö	ò	û	ù	ÿ	Ö	Ü	¢

Texas Instruments 855
Letter-quality matrix 32 x 18
\$935

- * Speed when you need
 - Fast rough drafts
 - Final quality cop
- * No need to switch b
- * Configuring is fast
 - Easy to access par

Star Micronics SB-10
Correspondence mode, 24-element head
\$995

WordStar is a screen-oriented, IBM PC-DOS word processing system specifically designed

Video editing: a portion of the document be reected is always shown on the screen; addit are immediately displayed. Text and comman prompted.

Automatic disk buffering: text is moved be memory without user intervention. Thus, only by disk capacity.

Citizen America MSP-20
Correspondence matrix 17 x 17
\$699

Expanded pr

Compressed print is terrific!

Pica prints 10 charac

Elite prints 12 character

Emphasized print real

ars ago, our
, conceived
men are creat

a great civi
so conceived
a great batt
ion of that f
ve their live
itting and pr

DF output
35CPS
en printers
simple
and switches

nt 100
s per inch!
r inch!
shows up!

Printer manufacturers elbow for shelf space

Retail price competition is reshaping the printer market, directly influencing system integrators and OEMs

Rick Dalrymple, Senior Editor

All sectors of the printer market are bound to be affected by the rough-and-tumble price/performance battles now being waged on the computer store shelf. Product introductions and pricing tactics aimed at the retail market directly impact the system integrator buying 10 to 50 printers a month. Even the OEM buying thousands of printers per month cannot afford to ignore the points along the price/performance curve—now being set by the retail stores instead of the manufacturers.

A few years ago, companies building printers for the “serious” user viewed the retail channel as the place where one went to buy a “toy” printer. Today, the “serious” user is the retail store’s best customer. According to Peter Steiner, director of the Electronic Printer Industry Service at Dataquest Inc., a market research concern based in San Jose, Calif., “A large majority of computer printing requirements can now be met by a printer priced under \$1,000 and the most important distribution channel for these products is retail.”

The sweeping shift to the retail store is clearly due to the enormous popularity of the personal computer. Even engineering and scientific users, who typically have access to both superminicomputer and mainframe computing power, have turned to the personal computer for tasks such as word processing, budgeting and project scheduling. Of course, personal computer users want their own printing capability and now, with

printers so affordable, their sales volume is closely linked to the sales figures of personal computers.

The system integrator, however, should not jump to the conclusion that the under-\$1,000 printer is suitable only for low-duty-cycle applications. Today's 200-character-per-second (cps), 132- to 136-column impact matrix printer is priced under \$1,000 and intended for applications where printing volume often exceeds 2,000 pages per month. Although obviously not in the same league as page and line printers, these products, nevertheless, are well suited to the printing volumes of many multiuser minicomputer and microcomputer systems.

Recognizing that printers sold at retail are reshaping the printer market, Dataproducts Corp., Woodland

Hills, Calif., recently made its move to break into the retail sales channel. For years, Dataproducts has prospered by selling to big OEMs such as Digital Equipment Corp., Burroughs Corp., and IBM Corp. Now the company is turning to the retail sector to participate in those portions of the printer market where both growth and revenue potential are higher.

Another late arrival at the retail store is Citizen America Corp., the Santa Monica, Calif.-based subsidiary of Citizen Watch Co. Ltd., Tokyo. Citizen America is viewed by both U.S. and Japanese competitors as a serious threat. Unlike other competitors with foreign parentage, Citizen America entered the U.S. printer market already armed with an experienced U.S. mar-

Thermal transfer market heats up . . .

This year, thermal-transfer printers are entering the U.S. office in numbers for the first time. Printer-market analysts expect several manufacturers to introduce thermal-transfer products during 1985 but, so far, only three have targeted business users in the United States: Canon U.S.A. Inc., Lake Success, N.Y.; Okidata, Mount Laurel, N.J.; and IBM Corp., Armonk, N.Y.

Industry observers seem divided on how U.S. business will view the offerings. Some feel that they will begin to replace printers based on daisywheel and impact-matrix technologies. Others see thermal-transfer printers being rejected because they require expensive ribbons and "funny" paper. Unlike thermal printers, which create an image by burning a heat-sensitive paper with heated pins, thermal-transfer printheads heat a heat-sensitive ribbon and transfer the "melting" ink onto the paper.

IBM has eliminated the paper objection by employing a proprietary printhead and "resistive ribbon" that can print on the papers commonly used by businesses in the United States and Western Europe.

Unlike the smooth-surface business papers typically found in the Far East, business papers in the United States and Western Europe have a textured surface. Paper manufacturers measure the "coarseness" or "roughness" of a paper in what are called Sheffield points. Coarsely textured papers such as ripple finish or linen have a high Sheffield rating.

"Most U.S. business papers fall be-

tween 140 and 180 Sheffield points," explains Dennis Jacobson, supervisor of product development and technical sales service, Hammermill Paper Co., Erie, Pa. Says Jacobson, "Hammermill has just introduced a line of smooth-finish papers specifically designed for thermal-transfer printers. These papers, rated at 80 Sheffield points, aim at customers who own printers such as the Canon F-60 and [Okidata's] OKIMATE 20. Because the IBM Quietwriter printer

can print on papers rated at 300 Sheffield points or less, almost any paper found in the office will do."

According to Robert Piechnik, Canon's printer division sales manager, "The Canon F-60 will print well on most standard U.S. business papers. However, for best results, we recommend papers that are smoother than high-rag-content bond."

The IBM Quietwriter, Canon F-60 and the OKIMATE 20 carry dramatically different price tags. The sug-



The Okidata OKIMATE 20 color graphics thermal-transfer printer (left) prints on smooth-surface papers and is priced at \$268. The IBM Quietwriter (right) prints on almost all business papers, but only in black and does not offer graphics features. It sells for \$1,395.

keting team, an aggressive product line and the apparent ability to distribute to stores in every key market area in the nation.

Printer-market analysts view the retail side as a game where the price of chips comes high. By stepping into the retail channel, Dataproducts and Citizen America are confronting recently established and formidable competitors. The list includes C. Itoh Digital Products Inc., Epson America, Hewlett-Packard Co. (HP), IBM, Okidata Corp., Star Micronics and Texas Instruments Inc. Like Dataproducts and Citizen America, each of these companies has the financial muscle to participate in an extended retail price/performance war.

Obviously, these manufacturers are not the only

participants in the retail marketplace. However, the consensus among them is that collectively they will be the survivors of the battle over the retail channel and that all other participants will eventually be elbowed off the shelf. Generally, the printer consultants agree. However, each has his own "short and private list" of dark-horse manufacturers poised to move up quickly should any of the leading players stumble.

OEM sales linked to retail

The characteristics that make a manufacturer formidable at retail also make him a major force in the OEM channel. The keys to success in both channels, assuming a competitive product, are low price, high quality

... U.S. market acceptance uncertain

gested retail prices are: \$1,395 for the Quietwriter, \$549 for the F-60 and \$268 for the OKIMATE 20. Print speeds for the OKIMATE 20 are 80 characters per second (cps) in draft mode and 40 cps in letter-quality correspondence mode. For the Canon F-60, print speeds are 80 cps in draft mode and 20 cps in letter-quality mode. The Quietwriter prints only in letter-quality mode at print speeds that range from 40 cps in 10-pitch type to 60 cps in 15-pitch type.

The OKIMATE 20 uses a three-color ribbon and offers dot-addressable graphics, in color, with a maximum resolution of 144 by 144 dots per inch (dpi). Black printing is available by using a black ribbon. The Canon F-60, however, prints one color and can achieve resolutions up to 360 by 180 dpi. Canon printer users may choose from four single-color ribbons and must change the ribbon to print in more than one color. The Quietwriter prints only in black and has no graph-

ics features.

Given these differences, each printer will probably attract different customers. Buyers will find the quiet operation of these thermal-transfer printers appealing. IBM and Okidata describe their noise level as "53 dBA." Canon rates the F-60 at "45 dB." Those customers who are unwilling to use smoother surface papers have one choice—IBM. On the other hand, those customers searching for an inexpensive color printer will find the OKIMATE 20 attractive.

"We are introducing the OKIMATE 20 as a color printer," states Frank Lodge, Okidata's OKIMATE 20 product manager. "Since we expect the OKIMATE 20 to be used in conjunction with either a solid-font or impact matrix printer, we are offering a software switch for the IBM PC that will always direct the color output to the OKIMATE 20 and all other printer output to the standard printer port. Given the low price tags of both the OKIMATE 20 and today's impact matrix printers, the customer can buy both for less than \$1,000."

Marketing executives at Canon have a different view of their thermal-transfer printer. They are positioning the F-60 as a replacement product for both solid-font and matrix printers. Given its 36-by-24 dot matrix layout, Canon's sales force will be claiming that its F-60 is the new versatile printer of the '80s, providing the user with both the character printing quality heretofore found only in daisywheel printers and the versatility previously found only in impact matrix printers.



and on-time delivery. Recognizing this relationship, Epson, Okidata and Star Micronics have stepped up their efforts to land OEM business. In Epson's case the effort has even extended to offering its large OEM customers the services of Epson's design engineers, who will custom-design products to the OEM's specifications. Epson's major OEM product line, however, is the CTM series. It is sold exclusively to OEMs.

Dataproducts, HP, IBM, Texas Instruments and C. Itoh are all, of course, well versed in OEM marketing. Citizen America, however, is the new kid on the block in both the OEM and retail channels. According to Michael Del Vecchio, Citizen's vice president of sales and marketing, "If we can make an impact on the retail customer, the OEM attention will follow." Del Vecchio sees success in the retail store as his first objective. Anticipating that retail success will come soon, the company has already launched a major promotional program aimed at buyers in the OEM channel.

In their zeal to gain a competitive advantage, those manufacturers in pursuit of the retail customer are lowering prices and increasing performance. In this now classic marketing scenario, seen previously in watches, calculators and television sets, the participants on the retail stage create an environment within which the buyer is always discounting the current products in anticipation of the next price cut or new product introduction. Because these same basic products are also being sold in the OEM channel, a price battle at the retail level spills over into the OEM channel as well.

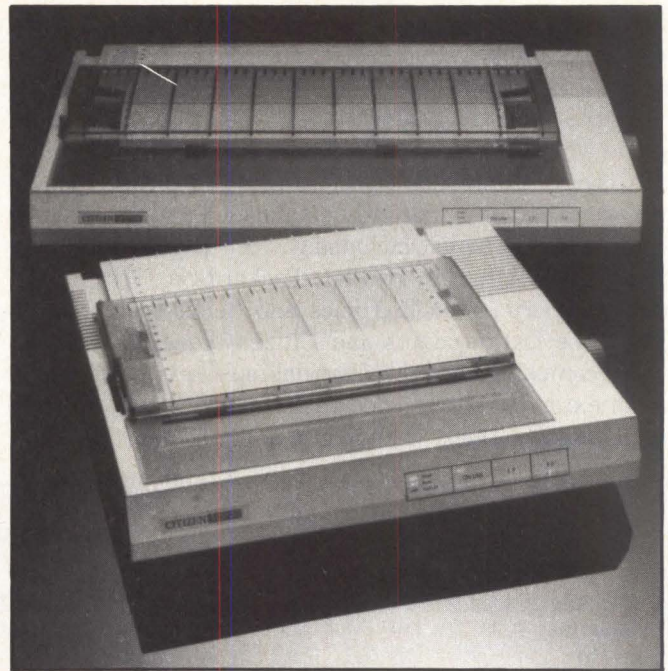

Citizen America's two new 200-cps printers: the 80-column MSP-20, \$699(front), and the 136-column MSP-25, \$949.

This situation is likely to spell trouble for small OEM printer manufacturers, who clearly lack the financial resources to participate in the retail market. Both analysts and industry observers agree that all small OEM manufacturers presently offering impact matrix character printers with print speeds under 200 cps are probably going to feel severe competitive pressure.

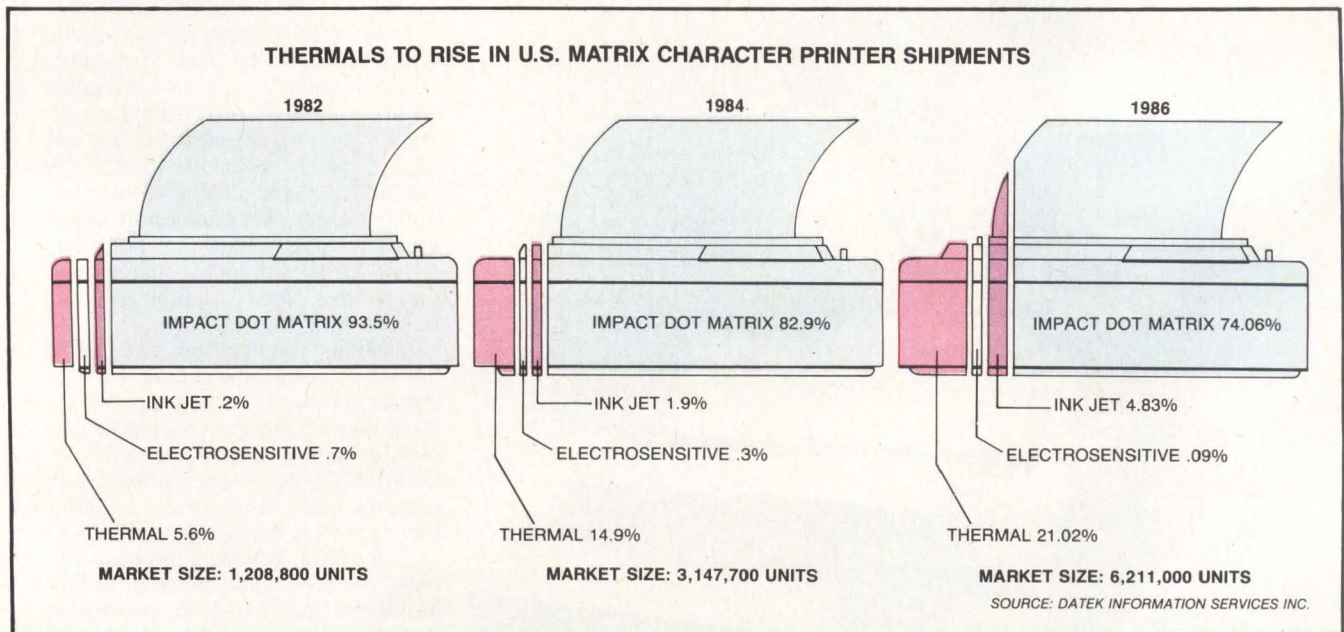

Market figures for thermal printers include shipments of thermal-transfer printers. Datek analysts expect thermal-transfer printers to enjoy the major portion of the thermal category in 1986.

WORDS ARE ONLY WORDS ARE ONLY WORDS

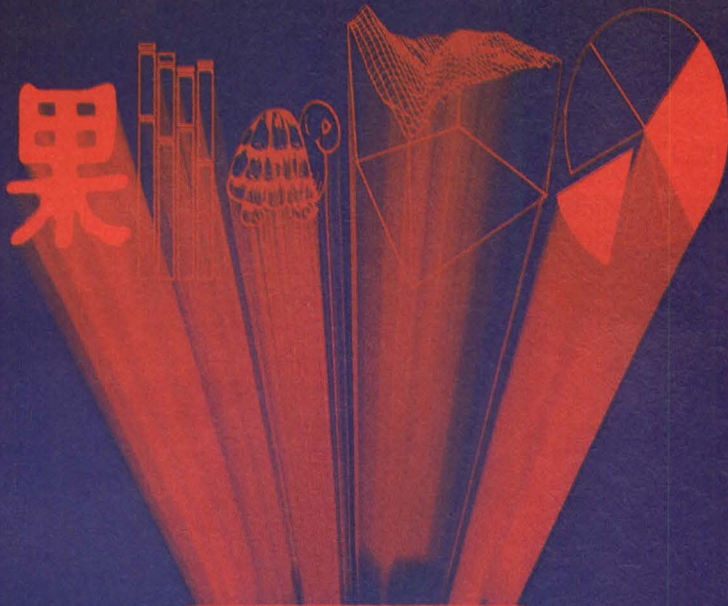

Words Alone Don't Describe The Lasergrafix™ 1200 Printer.

The QMS Lasergrafix 1200 is a breakthrough in electronic page printing. But words alone just don't describe it. Because QMS designed the Lasergrafix 1200 to do so much more than words. With a built in intelligent controller that takes simple print commands through your normal data stream. Built-in applications firm-ware eliminates the need for additional software – and frees your computer's resources for other work.

The difference is graphic – for all your business, scientific and individual printing needs. Create forms that have multiple type-faces and letters up to ten inches high – all on the same line. CAD/CAM. Bit mapped and vector graphics. Pie charts. Bar charts. Even barcodes. At a crisp resolution of 90,000 dots per square inch. With a printing speed of 12 pages per minute.

And, of course, letter quality word processing.

The Lasergrafix 1200 interfaces with just about any computer system. With versatility that lets you take business graphics to the limits of your imagination. Ask for a demonstration. You'll discover that the whisper-quiet performance of the Lasergrafix 1200 speaks softer than words.

And says a whole lot more.

QMS®
QUALITY MICRO SYSTEMS, INC.

P.O. Box 81250 Mobile, AL 36689
Telephone (205)633-4300 Telex RCA 26 6013

WHERE IMAGINATION LEADS

- Send me the Lasergrafix 1200 Information Packet, samples of mixed fonts, graphics and everything else it does.
- Please contact me to arrange a demonstration.

Name: _____ Title: _____

Company: _____

Address: _____

Type of system you are now using: _____

Number of print workstations you are considering: _____

Prime applications for printer: _____

QUALITY MICRO SYSTEMS, INC.
P.O. Box 81250 · Mobile, AL 36689

MM

FOR THE MICROCOMPUTER OEM OR END-USER HEURIKON IS THE CHOICE

Make Heurikon your choice for Multibus™ microcomputers and system components.

For 12 years, Heurikon has supplied thousands of computers to help its customers find economical solutions for their microcomputer applications.

8-BIT MICROCOMPUTERS

MLZ-90A single board microcomputer with nine byte-wide memory sockets for use with RAM or ROM (AM9511 and floppy disk drive controller optional).

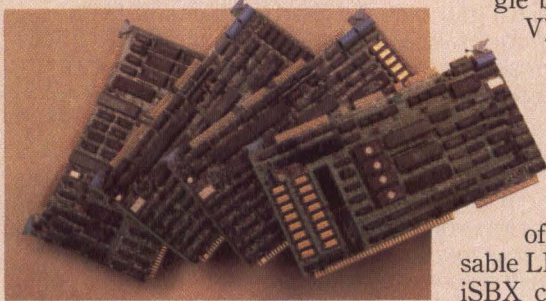

MLZ-91A single board CP/M™ system with on-card floppy disk drive controller, winchester interface, optional AM9511, streamer tape interface, two serial ports, one parallel port, 64K or 128K bytes RAM with parity, two EPROM sockets, and GPIB CONTROLLER.

MLZ-92A single board CP/M™ system with four serial ports on-card, floppy disk drive controller, winchester interface, optional AM9511, Centronics printer interface, 64K or 128K bytes of RAM with parity, and two EPROM sockets.

MLZ-93A single board CP/M™ system with 128K bytes of dual ported RAM, four EPROM sockets, floppy disk drive controller, optional AM9511 and powerful serial port features including SDLC and HDLC protocol support and modem controls.

16-BIT MICROCOMPUTERS



HK68™ powerful and versatile single board UNIX™ (System III or V) or CP/M68K™ system with 68000/68010 CPU (8Mhz or 10Mhz), MMU, quad channel DMA, four serial ports, 128K, 256K, 512K or 1M bytes of on-board RAM with parity, up to 32K bytes of on-board EPROM, user accessible LEDs and dip switches, and two iSBX connectors for I/O expansion. Heurikon can also supply a full line of iSBX I/O expansion modules including quad channel serial port module, floppy disk controller, A/D converter, bubble memory and many more.

GRAPHICS CONTROLLERS

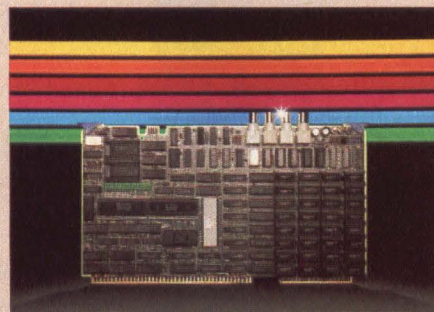

MLZ-VDC intelligent 640 x 480 x 4 color graphics controller based on the NEC 7220 controller chip with on-

board Z-80 CPU, DMA controller, and user definable FIFO interface to Multibus™. Users may display up to 16 colors from a 4K palette. Up to 1024 x 1024 x 3 interlaced also available.

MICROCOMPUTER SYSTEMS

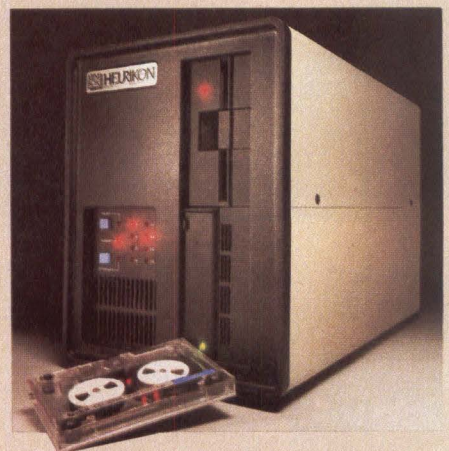

MINIBOX

Heurikon also provides completely integrated UNIX™ development systems with UNIX™ System III or System V including Berkeley enhancements. CP/M-80™, CP/M-68K™, and Regulus™ are also available.

Heurikon UNIX™ systems are available in four, six, and fourteen slot enclosures with 30MB, 65MB, 140MB or 280MB of winchester storage, a megabyte floppy, and optional *interactive* on-line streamer tape drive supporting 1-16 users.

HEURIKON

Microcomputers For Industry

3201 Latham Dr.
Madison, WI 53713
Telex 469532

Z-80 is a trademark of Zilog Corp. Multibus and iSBX are trademarks of Intel Corp. UNIX is a trademark of Bell Lab. CP/M 68000 and CP/M-80 are trademarks of Digital Research. HK68 is a trademark of Heurikon Corp. Regulus is a trademark of Alcyon.

Uniform-See Booth #3301

CIRCLE NO. 65 ON INQUIRY CARD

Call Heurikon Direct

1 800 356-9602

In Wisconsin 1 608 271-8700

Many will have to file under Chapter 11 of the bankruptcy laws, others will be acquired and a few will survive in niches left untouched by higher-volume competitors.

IBM introduces new technology

To get a preview of just how competitive the market for character printers is likely to get, the system integrator need only turn to the latest IBM printer introduction. It appears that IBM's new "Quiet" print-head and "resistive ribbon" technology have removed a major market impediment for thermal-transfer printers. IBM's Quietwriter printer and Selectric Quietwriter 7 typewriter print on most office bond papers. All other thermal-transfer printers require a smooth-surface paper and cannot print on the stationery typically used by businesses in the United States and Western Europe (see "Thermal-transfer printer market heats up. . .," Page 130).

An intriguing aspect of the Quietwriter announcement is the description of IBM's retooled typewriter and printer manufacturing facility in Lexington, Ky. When completed in 1986, IBM will have invested \$350 million to build one of the world's most highly automated manufacturing facilities. Already at work inside the 60-percent-completed plant are IBM model 7535 and 7540 robotic systems controlled by IBM Series/1

processors. According to an IBM spokesman, "The production process has been designed to nearly eliminate the need to keep a parts inventory. Parts not produced in the facility are scheduled for delivery to Lexington 'just in time' for assembly."

The characteristics that make a printer manufacturer a formidable foe at retail also make that manufacturer a major force in the OEM channel.

All the manufacturing steps necessary to produce typewriters and printers will be performed in the facility, including automated parts stamping and welding. When all seven of the plant's automated areas are operational, they will be interconnected by an extensive network of conveyors. As a perspective on the size of the facility, the final assembly area alone includes five miles of conveyor tracks.

Given the massive scale of this manufacturing plant, industry observers expect IBM, over time, to introduce other products based on its proprietary thermal-transfer technology. These products will be priced under \$1,000 and probably feature higher print speeds, color and point-addressable graphics.

How the Japanese see thermal transfer

The still small, but rapidly advancing, personal-computer market is creating a brisk demand for printers in the Japanese domestic market. Currently that means impact matrix printers; however, the dominant position now held by impact-matrix products is being challenged by non-impact printers. In high-duty-cycle applications, the Japanese customer is starting to buy drop-on-demand ink-jet and laser printers. For lower-duty-cycle applications the alternatives are thermal and thermal-transfer printers.

This year, at Japanese trade shows, printer manufacturers will be vigorously promoting thermal-transfer printers. Because the smooth paper required for these printers is standard Japanese business paper, Japanese manufacturers have a home-market incentive to promote these products on a mass-market basis.

Japanese customers have good reason to consider thermal-transfer printers. Unlike countries in the Americas and Europe, which use alphabet-

based languages, countries like Japan and China employ more than 2,000 ideographs in common daily usage. Although a nine-dot square matrix may be acceptable for the draft printing of alphabet characters, it doesn't work for ideographs.

Impact matrix printers produce fuzzy dot patterns that can make an ideograph difficult to read and, unfortunately, solid-font mechanisms such as daisywheels, hammers or golf balls are impractical for so many characters. The result is that Japanese customers are searching for products offering high-resolution character printing along with the versatile printing and graphics features found in matrix printers.

The Japanese printer manufacturers have met these requirements by introducing thermal-transfer printers. Not only are thermal-transfer printers a better product for Japanese users, they are quieter and less expensive than most impact matrix printers.

Several color thermal-transfer prod-

ucts are already on the Japanese market, as are the necessary three-color ribbons. One representative product is the Toshiba TN-5400, which prints one page a minute, making three passes, one for each color, producing a full-color copy with a resolution of 200 dots per inch. The three-color ribbon used with the Toshiba printer will print 160 sheets before replacement is required.

The biggest market for Japanese printer companies is, of course, the export market. Products for export account for approximately 75 percent of the printers manufactured in Japan, hence the emphasis placed on designing products suitable for other markets. The Japan Business Machine Manufacturer's Association is expecting thermal transfer printers in the United States to grow from an estimated 2 percent share now to about 12 percent by the end of 1985.

—Ichiro Kakehashi
Tokyo Correspondent

BYTCOM MODEMS

FOR YOUR PCs
OR DATA TERMINALS



Feature after feature!

- Full Bell 212A compatibility (0-300, 1200 baud) with remote digital loopback and internal self test.
- 16 character security password.
- Designed for use with either "dumb" terminals or PCs.
- Synchronous and Asynchronous transmission modes.
- Internal storage of nine names and numbers to forty characters in length.
- Exclusive ability to "Reboot" your computer.
- User-friendly help menu.
- Rack mountable version available.

Free "SuperScout" Communications Software

This unique \$249 software value allows data file transfer using a sophisticated error checking protocol. It also gives automatic access to COMPUSERVE™, Western Union's EASYLINK™ and 13 other data bases without individual sign-up or monthly minimum fees.

A very broad warranty!

The 212AD is a proved-in-service product whose high reliability allows Bytcom to offer an *Immediate Unit Replacement Warranty* within the first two years of ownership. Details on request.

Contact Bytcom for additional information and name of your nearest distributor.

Software Supplied By
BUSINESS COMPUTER NETWORK
SUPERScout™



BYTCOM

2169 Francisco Blvd. Suite H,
San Rafael, CA 94901

(415) 485-0700 (800) 227-3254 (outside CA).

PRINTERS

Any company planning to compete with IBM should review one of IBM's objectives for the '80s, first stated in its 1981 annual report. "It is our objective," wrote then-IBM chairman John Opel, "to be the most efficient company in our industry. Not only in manufacturing but also in the design, marketing and service of our products." □

Directory of manufacturers

C. Itoh Digital Products

19750 Vermont Ave.
Torrance, Calif. 90402
(800) 348-1984
(for retail distribution)
Circle 763

C. Itoh Electronics Inc.

5301 Beethoven St.
Los Angeles, Calif. 90066
(213) 306-6700
(for OEM customers)
Circle 764

Canon U.S.A.

One Canon Plaza
Lake Success, N.Y. 11042
(516) 488-6700
Circle 765

Citizen America Corp.

2425 Colorado Ave.
Santa Monica, Calif. 90404
(800) 556-1234, Ext. 34
Circle 766

Dataproducts Corp.

6200 Canoga Ave.
Woodland Hills, Calif. 91365
(818) 887-8000
Circle 767

Epson America Inc.

Computer Products Division
2780 Lomita Blvd.
Torrance, Calif. 90505
(213) 539-9140
(for retail distribution)
Circle 768

Epson America Inc.

OEM Products Division
3415 Kashiwa St.
Torrance, Calif. 90505
(213) 533-8277
(for OEM customers)
Circle 769

Hewlett-Packard Co.

P.O. Box C-006
Vancouver, Wash. 98668
(206) 254-8110
Circle 770

IBM Corp.

900 King St.
Rye Brook, N.Y.
(800) 426-2468, Ext. 96/3N
Circle 771

Okidata Corp.

532 Fellowship Road
Mount Laurel, N.J. 08054
(609) 235-2600
Circle 772

Star Micronics Inc.

200 Park Ave.
New York, N.Y. 10166
(212) 986-6770
Circle 773

Texas Instruments Inc.

Peripheral Products
P.O. Box 809063
Dallas, Texas 75380-9063
(800) 527-3500
Circle 774

Interest Quotient (Circle One)
High 837 Medium 838 Low 839

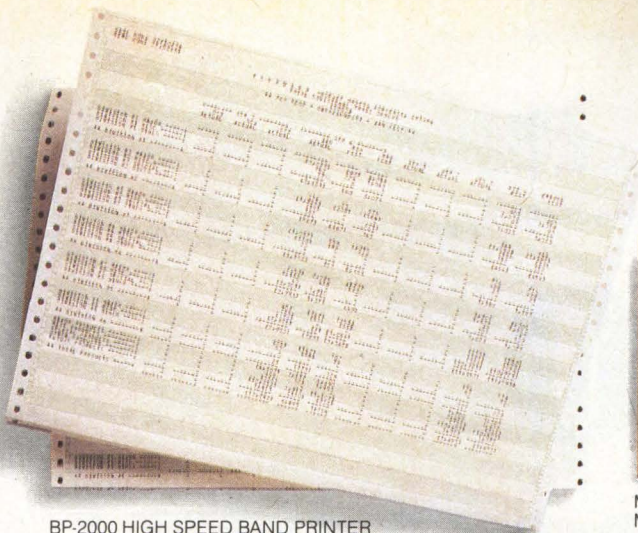

BP-2000 HIGH SPEED BAND PRINTER



M-100L MATRIX PRINTER

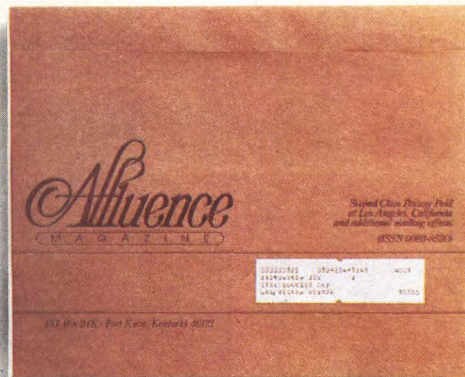

B-600 MEDIUM SPEED BAND PRINTER



8010 MATRIX PRINTER

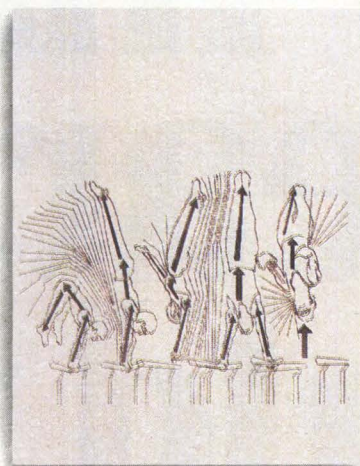

8020 MATRIX PRINTER

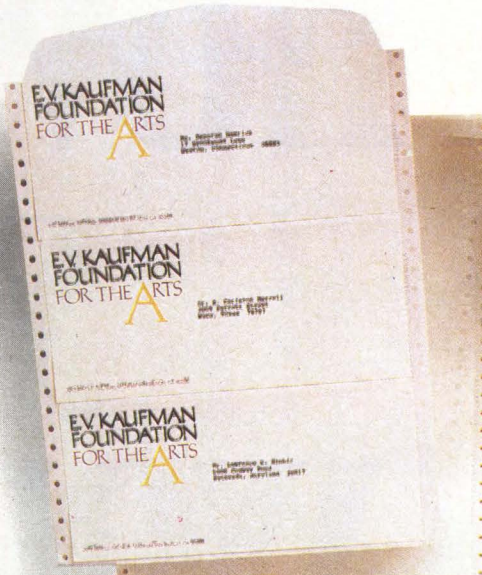

DP-55 DAISYWHEEL PRINTER

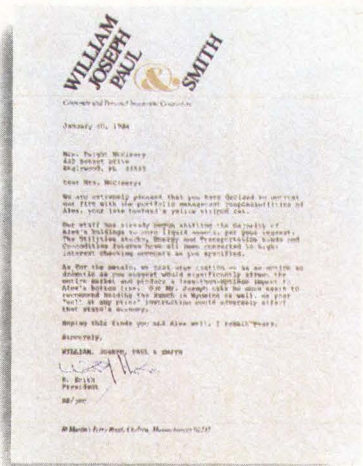

DP-35 DAISYWHEEL PRINTER



8050 MATRIX PRINTER

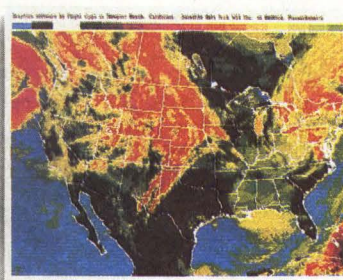

8070 MATRIX PRINTER



M-120 MATRIX PRINTER

...and so on.

CIRCLE NO. 67 ON INQUIRY CARD

DP **Dataproducts printers.**
Nobody puts ideas on paper so many ways.

DATAPRODUCTS CORP., 6200 CANOGA AVE., WOODLAND HILLS, CA 91365. (818) 887-3924. IN EUROPE, 136-138 HIGH ST., EGHAM, SURREY, TW 20 9HL ENGLAND.

**So
how many
years
would you
like to take
off?**

Before you waste any more time, you may want to read about this.

VRTX®. That being the real-time operating system packaged in silicon. From Hunter & Ready.

It's a versatile kernel, efficient I/O system and flexible file manager.

Or to put it another way, it's everything you'd want in a multi-tasking operating system.

But not in the usual all-or-nothing sense of the word.

Fact is, you can use as much — or as little — as you like. And yes, then take as many years off as you like.

A good place to start is the VRTX kernel. Because with it, you can subtract two years from a lengthy design cycle.

Think of it as task management, real-time clock support, dynamic memory allocation, basic I/O, interrupt handling and fast pinpoint timing — all rolled into a neat 4K of memory.

OK, sounds like a lot, but not quite two years? You're right. That doesn't just come from design time. But from what makes VRTX as reliable as a quartz watch.

100,000 manhours of debugging and testing. The stuff nights and weekends can be made of.

Still you'll be happy to know, for all VRTX takes off, there's not much to give up.

Unlike other operating systems, it doesn't lock you into one processor

for life. Or tie you to one type of I/O and file management forever. VRTX is compatible with all major processor families and all standard types of file management and I/O.

And with that choice, we're back to the count.

Meaning if you don't want to spend time on I/O, take off another two years. Since our IOX component works with VRTX to take care of all block, disk and character I/O.

And right along with that goes our FMX file manager. And another two years off. Besides which, FMX includes all the things you'd want in a hierarchical file system. Concurrent file access. Random and sequential access. And compatibility with standard file systems, including none other than PC-DOS.

We could go on. But it's now time for our final summation.

A total of six years if you want it all off (VRTX, IOX and FMX). Two or four years if you'd like a real-time head start.

Or if you'd like to know more before you decide,

write Hunter & Ready, 445 Sherman Avenue, Palo Alto, CA 94306. Or call (415) 326-2950.

There should always be more than one way to buy time.

**HUNTER
♦ READY**

We've taken the hard part out of operating systems.

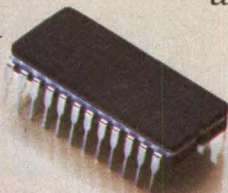

2 Years

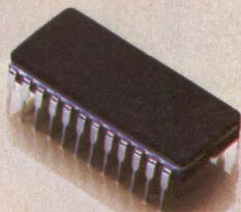

4 Years



6 Years

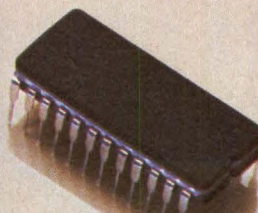

PICK ONE.



COMPAQ[®] is a registered trademark and COMPAQ DESKPRO[™] is a trademark of COMPAQ Computer Corporation. IBM[®] is a registered trademark of International Business Machines Corporation. UNIX[®] is a trademark of AT&T Bell Labs. ©1984 COMPAQ Computer Corporation. All rights reserved.

OR HAVE IT ALL.



Now you don't have to compromise to have it all in a personal computer.

Pick the new COMPAQ DESKPRO™ over the IBM® PC or XT and you get a lot more computer for your investment.

One that runs thousands of the most popular programs right off the shelf—at speeds two to three times faster. One with a dual-mode monitor (amber or green) to display text *and* graphics. One with exclusives like internal tape backup and shock-mounted storage system.

Pick the COMPAQ DESKPRO over the IBM AT and you get comparable performance without sacrificing *any* PC or XT compatibility... *but* for a lot less investment.

And, of course, you can start having it all with your COMPAQ DESKPRO today. It's available now.

In short, COMPAQ DESKPRO is the only personal computer that can grow from a PC to XT to AT level of functionality—easily, affordably, compatibly.

Configure it the way you want: With one or two diskette drives. One or two fixed disk drives. Or new options like a 30M-byte high-performance fixed disk, high-speed 8087-2 co-processor and internal tape backup for either the 10M-byte or 30M-byte fixed disk.

UNIX™-based operating systems? We run them today. PC DOS Version 3.0? That, too. Networking? Can do. Multi-users? No problem. Multi-tasking? Easy. Tape backup? It's inside. High-resolution text and graphics? Standard. Two speeds? Exclusive.

When you pick the COMPAQ DESKPRO, you *do* have it all—from the company that makes the best-selling portable business computer in the world. For a free brochure and the location of your nearest Authorized COMPAQ Dealer call 1-800-231-0900, Operator 2 or Telex 795437 COMPAQCOMP HOU. In Canada, call 416-449-8741.

It simply works better.

COMPAQ
DESKPRO™

Parallel computer. Unparalleled capability.



Introducing the Flex/32 MultiComputer™. A revolutionary parallel computer with performance that's scalable from supermini to supercomputer – a capability for growth beyond the needs of any application.

An entry-level Flex/32™ system starts you out with two 32-bit superminis, 2 megabytes of local memory, 128 kilobytes of common memory and two VMEbus interfaces. That's more power than two stand-alone superminis. But that's just the beginning.

Each Flex/32 MultiComputer cabinet can contain up to twenty supermini CPUs, each with 1 megabyte of RAM and a VMEbus interface, each performing more than one million instructions per second. And since there's no limit to the number of cabinets you can connect, Flex/32 can be configured and reconfigured easily as your applications demand. In fact, Flex/32 is the most change-tolerant system available today.

What's more, since Flex/32 is a Multi-Computer, it can provide true concurrency in processing. Which means it can run many programs at precisely the same instant in time. That's the kind of teamwork you need in large-scale real-time and scientific applications.

The Flex/32 comes with the software tools you'll need to help make the best use of its outstanding processing capabilities. Like our concurrent UNIX™ System V operating systems. And languages like C, our own ConCurrent C™, FORTRAN 77 with ISA extensions, RATFOR and the Flex/32 ConCurrency Simulator. A performance evaluation option is available to enable you to tune run-time performance for optimized applications.

The Flex/32 MultiComputer. The only general-purpose MultiComputer. No other system offers more performance and more capability for growth. So contact us today for more details.

Flexible Computer Corporation

Corporate Office: 1801 Royal Lane, Building 8, Dallas, TX 75229, (214) 869-1234; Eastern Regional Office: 5 Great Valley Parkway, Suite 226, Great Valley Corporate Center, Malvern, PA 19355, (215) 648-3916/7; Western Regional Office: 2250 E. Imperial Hwy., Suite 252, El Segundo, CA 90245, (213) 640-3322.

Flex/32, Flex/32 MultiComputer and ConCurrent C are trademarks of Flexible Computer Corporation. UNIX is a trademark of AT&T Bell Laboratories. © 1984 Flexible Computer Corporation
CIRCLE NO. 70 ON INQUIRY CARD

Word-processing software injects text into pictures

By combining graphics and digitized images and text, word-processing software transforms document processing into an art form

Carl Warren, Western Editor

Word-processing software is helping users create more diversified documents than previously possible.

Taking advantage of the display power of the latest computer systems, these newer, more powerful word-processing programs have gone far beyond simple text editing. They offer such features as multiple windows, integrated spelling dictionaries, graphics and digitized images. Moreover, this latest crop of software displays such character attributes as boldface, underlining, italics, superscript and subscript, and in some cases glyph—for languages such as Hebrew. Graphics and digitized images can be integrated with the text and users can see the “electronic” document much as it will appear on paper. Most software publishers claim this

enhancement is high on users’ wish lists.

Word processing remains a key element of office automation, but Ronni Marshak, associate editor of *The Seybold Report on Professional Computing*, Seybold Publications Inc., Boston, Mass., says it’s being done now on microcomputers, not on dedicated workstations. “Dedicated word-processing workstations didn’t really do a whole lot, other than basic text editing,” she says. “The microcomputer isn’t restricted to one application. It’s a better choice over a dedicated word-processing system. What we are seeing is a trend toward the personal typing unit that has multiple purposes.”

IBM Corp. apparently shares Marshak’s view, because it recently unbundled the Display Writer software from the Display Writer hardware, making it available on the IBM PC series of personal computers.

Serving the singular purpose of a word-processing system, Microsoft’s WORD package employs a tiled-window approach, which displays character attributes on the screen. Word-processing functions are chosen from a menu that is addressed via a mouse cursor.

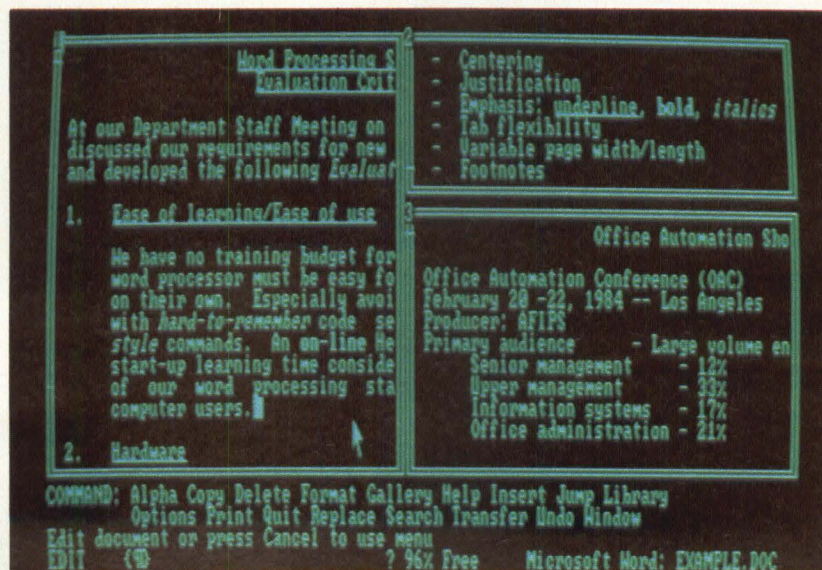

Marshak says this effectively killed the Display Writer hardware as a viable product and established the basis for the personal-workstation trend.

Imposes a style

What system integrators want is word-processing software that is flexible. "All too often, the software developer imposes a single metaphor on the user," says Jean L. Yates, president of Yates Ventures Inc., Palo Alto, Calif. "They either want users to look at the world through a grid, or an outline. People don't necessarily think that way and don't want rules pressed on them. Flexibility in the use of the product is important."

Yates expects a turning away from the traditional multiple-purpose package to single-purpose packages

that permit the combination of functions such as spreadsheets, databases and graphics. Apparently, IBM agrees with her because its newest software strategy calls for separate applications linked via an overseeing supervisor package called TopView. The TopView package allows the combination of a variety of applications in handling information.

One publisher taking this single-purpose approach is Microsoft Corp., Bellevue, Wash. Its \$195 WORD software offers users a full-function word-processing package, employing windows, character display attributes, and an integrated spelling dictionary. The user guides the cursor around the screen with a mouse pointer, which can be used to mark text or to choose specific editing functions.

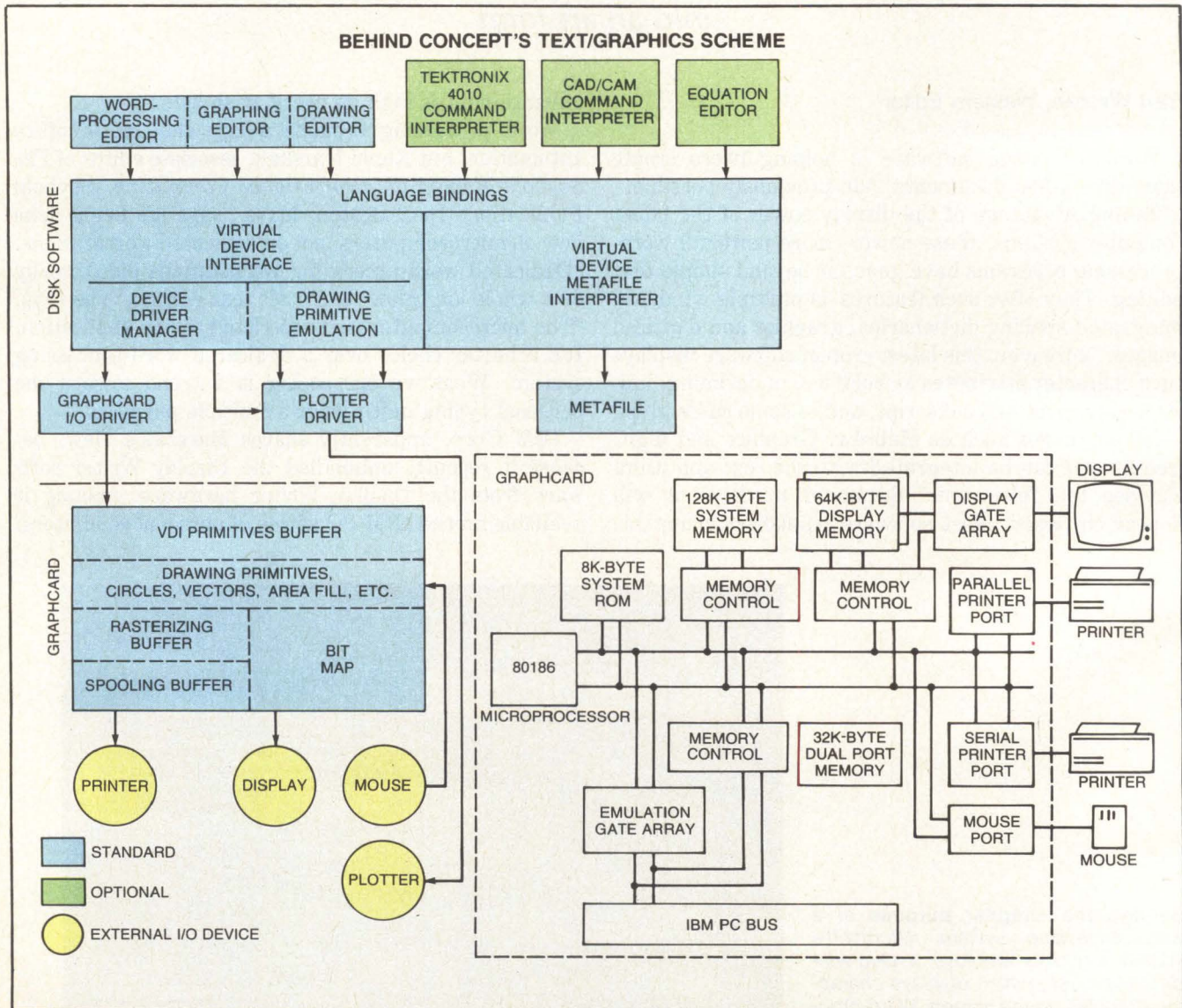

Building on standards, Concept Technologies combines hardware with software to couple text creation with graphics. The entire system relies on the Virtual Device Interface and Virtual Device Metafile proposed graphics standards as the basis of implementing diverse hard-copy and input devices, as well as supporting a variety of graphic images.

4



GOOD REASONS

TO ATTEND



**INFORMATION MANAGEMENT
EXPOSITION & CONFERENCE**



**INFORMATION MANAGEMENT
EXPOSITION & CONFERENCE
FOR SOFTWARE**

O'HARE EXPOSITION CENTER, ROSEMONT, ILL - FEBRUARY 20-22, 1985

- Apple Computer
- AT&T Information
- AT&T Telecommunications
- Ameritech
- Applied Data Research, Inc.
- BRS Software Division
- Boeing Computer Services
- Computer Corporation of America
- Computer Intelligence Corporation
- Comshare, Inc.
- Cullinet Software
- Cyborg, Inc.
- Datapro Research Corp.
- Digital Equipment Corp.

- Dow Jones & Co., Inc.
- Filenet Corp.
- GTE
- Genesys Software Systems, Inc.
- Hewlett-Packard
- Human Edge Software Corp.
- IBM
- Key Software, Inc.
- Leading Edge Products, Inc.
- Lotus Development Corp.
- Management Science America, Inc.
- Mathematica Products Group

- McCormack & Dodge Corp.
- Nixdorf Computer Software Inc.
- On-Line Software International
- Peachtree
- Productive Workspace Inc.
- SPSS, Inc.
- Sysgen
- Signal Technology Inc.
- Southwest Software Services, Inc.
- Statistical Graphics Corp.
- TEC Computer Systems
- Tesseract, Inc.
- Vertex Systems, Inc.
- Xerox Computer Services

For 85 more good reasons: Come to Info/Central and Info/Software, the all-business computer/communications trade shows for end-users who mean business.

For more information, contact: Cahners Exposition Group, 999 Summer Street, P.O. Box 3833, Stamford, CT 06905, Phone: 203-964-8287, Telex: 649400 CAHEX WU STD

Detach and return to Info/Central, Info/Software Media Services Dept., Cahners Exposition Group, 999 Summer St., P.O. Box 3833, Stamford, CT 06905.

Please Send Me _____ qty.
Reduced Rate Registration Forms.

Please Send Me _____ qty.
Full Conference Programs.

B



NAME _____ TITLE _____

COMPANY _____

DIVISION _____

STREET _____

CITY _____ STATE _____ ZIP _____

PHONE () _____

I am interested in exhibiting at the Show.

Call me at () _____

California Serfboard

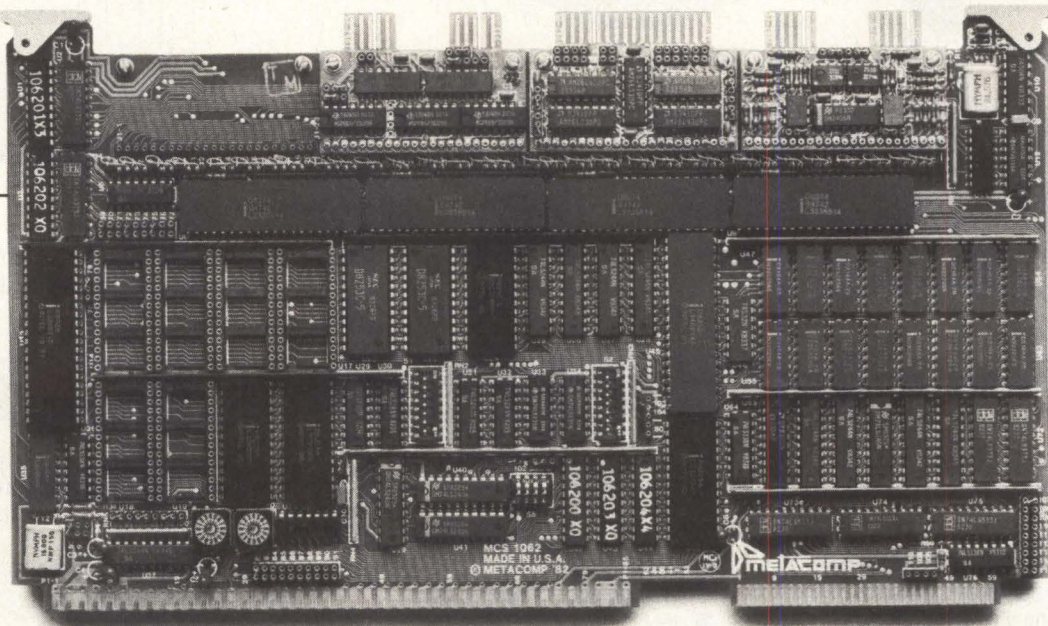

Get eight channels of intelligent slave serial I/O with this new wave Multibus controller

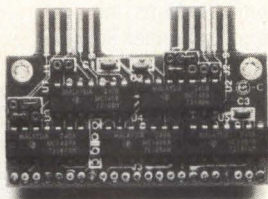

The versatile California Serfboard, MCS-1062, is the first serial I/O controller with eight intelligent slave channels. Plus all the features highlighted below.

That's double the typical capacity in a single cardslot. And the on-board CPU means performance and programmable flexibility that leaves the competition treading water.

Product Highlights:

- Eight individual channels, programmable for ASYNC, SYNC, or BITSYNC.
- Programmable timers for ASYNC data rates to 76.8K Baud.
- Wide range of modular interface adapters available, each field interchangeable. RS-232, RS-422/RS-423 Optical Current Loop, MIL 188-114.

- On-board Intel 8088 CPU. 96K bytes EPROM (using 27128's), 128K bytes RAM.
- Simple "handshake" architecture for user software interface.
- Dual Port RAM. Supports 8 or 16 bit memory accesses, 24 bit Multibus addressing.
- Standard Multibus architecture. One unit load, single card slot, vectored or nonvectored Bus Interrupts.
- Terminal I/O firmware available.

For complete specifications and ordering information, call or write: METACOMP, Inc., 9466 Black Mountain Road, San Diego, California 92126, (619) 578-9840, TWX 910-335-1736 METACOMP SDG. Ask for the hot sheet on the MCS-1062. The California Serfboard.

METACOMP™

MCS-1062 is a trademark of METACOMP, Inc.
Multibus is a trademark of Intel Corp.
© Copyright 1984 METACOMP, Inc., all rights reserved.

THE MULTIBUS BREAKTHROUGH PEOPLE

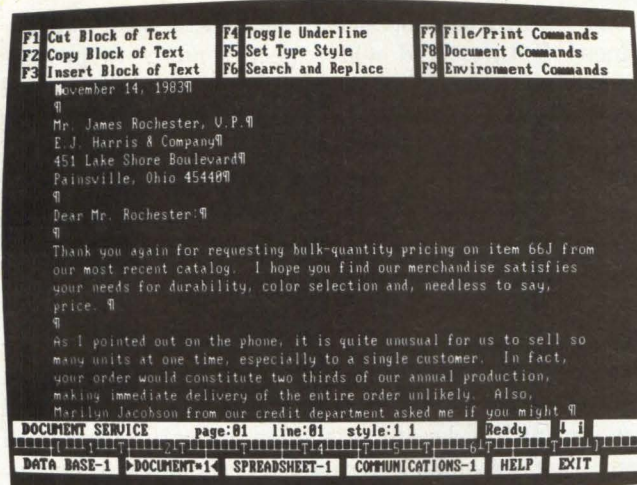

Alpha Software's Electric Desk makes generous use of the IBM PC function keys (F1 to F9) and display characteristics to provide clear text pictures.

Although WORD is primarily a single-purpose package for word processing, it can link into other Microsoft applications, such as Chart and Multiplan, for creating more sophisticated documents.

Unlike other facets of the computer market, word-processing software isn't considered glamorous. Some observers consider it a necessary, but ho-hum, product when stacked against other software. "Word processing is a part of a total system and it's hard to classify it as being spectacular," observes Bonnie Digrius, director of the software microcomputer group for Creative Strategies International, San Jose, Calif. She maintains that about 30 packages sell well, and that they cover the range from singular word-processing packages to integrated offerings. "It's really difficult to cull out the sales of word processing when you have to contend with the integrated software on the market," she notes.

Breaking out sales may be difficult, but clearly the market is changing. MicroPro Corp.'s, (San Rafael, Calif.) WordStar word-processing software, while still considered the number-one selling package, maintains only a marginal lead. "WordStar has the advantage of name recognition," says Yates, "but it is rapidly falling [from favor because] there are better alternatives."

What those alternatives are, however, is subject to debate. For example, Yates believes that growth opportunities for word-processing software are in the UNIX arena. "By being UNIX-compatible, there is the advantage of being able to communicate between machines ranging from mainframes to personal computers. No other operating system offers that far-ranging capability," she insists.

"It's tough to make a sweeping generalization," says Harold Poliskin, of the National Software Testing Labs Inc., Wynnewood, Pa. Poliskin, publisher of NSTL's

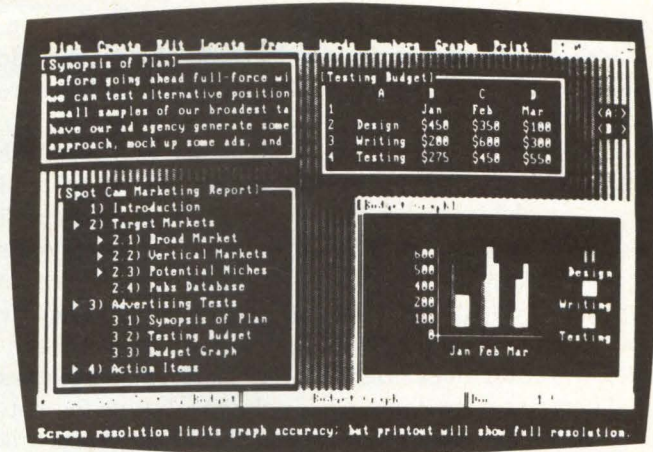

Building documents from ideas is the basis of Ashton-Tate's Framework integrated software. Windows, displaying key character attributes and employing pop-up/down menus, help users integrate the various functions into hard copy.

Software Digest rating newsletter, says, "Not everyone wants the same thing, and virtually every product is different. There is no consistency in word-processing software. I don't have a scientific study to cite, but my impression is that users want simple and powerful products. Price doesn't seem to play a part. We've found that users will pay for what they want."

Another consideration that experts claim to be important is ease of use. Most say that companies don't want to tie their people up learning how to use a package. Seybold's Marshak thinks that ease of use might be the most important feature software developers should aim for.

Making a bid in the ease-of-use category is Alpha Software Corp., Burlington, Mass., with its Electric Desk package. "We're selling an integrated package, but with a singular-task approach. Each application stands on its own," says vice president of product strategy Robert Kutnick. "We don't want the user to fumble around trying to figure out what to do next."

Because word-processing software differs widely in capabilities, choosing the right one can be difficult. Seybold's Marshak suggests an empirical approach: "There are three groups of features users should list when comparing word-processing software: basic functions (need to have); desirable functions (preferable to have); and advanced functions (nice to have)."

The basic group, Marshak says, consists of 11 attributes including: word wrap, whereby the line automatically goes to the next line when the right-hand margin is reached; insert and delete, for adding or removing words; copy and move (also known as cut and paste), to allow word, sentence or paragraph rearrangement; search and replace; line changes; decimal tabs; centering point; automatic indentation; automatic pagination;

system directory access; and paragraph reformation. Marshak says that most products on the market do offer most of these basics; it's the next two levels where differences are the most evident.

For example, the desirable functions of paragraph assembly using repetitive material with "save" and "get" capability and footnoting are important for full word processing. Most higher-level packages offer these. But other functions in this category, such as headers and footers, horizontal scrolling and automatic footnoting, are not included as frequently. For example, WordStar does offer one-line headers and footers and horizontal scrolling to 256 columns, but no footnoting. Although Marshak believes the latter feature is very important, not everyone agrees. James Swanner, president of Wordmovers Inc., Lawndale, Calif., a small systems house, says that it's fine if it's there, but adds that users don't typically ask for it. "We find that users are more interested in being able to print a document that looks as good as a fine-quality typewriter. Everything else is icing on the cake; we don't have users insisting on a lot of bells and whistles," he says.

Marshak, however, contends that with the growing

trend toward sophistication, users will want the advanced features and will expect vendors to provide them. She cites such functions as table of contents and index generation, split-screen capability, macros for storing frequently used keystrokes and text, and calculator-type functions for mathematics and spelling verification. "Users are looking for tools that allow them to handle [material] at the highest possible level. The software is getting there," says Marshak.

In addition to the attributes mentioned, proportional spacing, wherein space steps between words are calculated on letter and word widths, is a growing demand; hard-copy devices are becoming more powerful, and users want to take advantage. In order to create hard copy that resembles typeset representations, manufacturers are developing the proportional capability.

MicroPro was one of the first companies to attempt implementing proportional spacing in Wordstar and, as a consequence, built-in rudimentary forms of proportional spacing tables. Unfortunately, the expected output fell far short on quality. Therefore, Writing Consultants, Fairport, N.Y., took on the task of developing the necessary look-up tables for properly handling

Dedicated word processing market declines

The market for dedicated word-processing systems is rapidly declining, as indicated by studies performed by Yates Ventures Inc., Palo Alto, Calif. According to vice president of research, John Kiefer, word processing is headed for a multipurpose world.

"The market has shifted from 58 percent in 1979 for dedicated word-processing systems to about 12 percent today," says Kiefer. He notes

that currently 65 percent of all personal computers sold come equipped with word-processing software. "The question is," he says, "is it used for word processing?" Kiefer thinks that in most cases it is. "Everyone writes something at sometime," says Kiefer. But he declined to estimate the total number of personal computers being used primarily for word processing. Still, Kiefer says that today 48 percent of all microcomputers (8-bit and

16-bit) are employed in some word-processing function.

Kiefer predicts that by 1989, dedicated systems will be a thing of the past. "By then it will be a 100-percent universe made up of 16-bit or 32-bit microcomputers. I would expect 85 percent of available users will have word-processing, but that, more than likely, it won't be the sole function because it's clear that the marketplace wants to do multiple tasks."

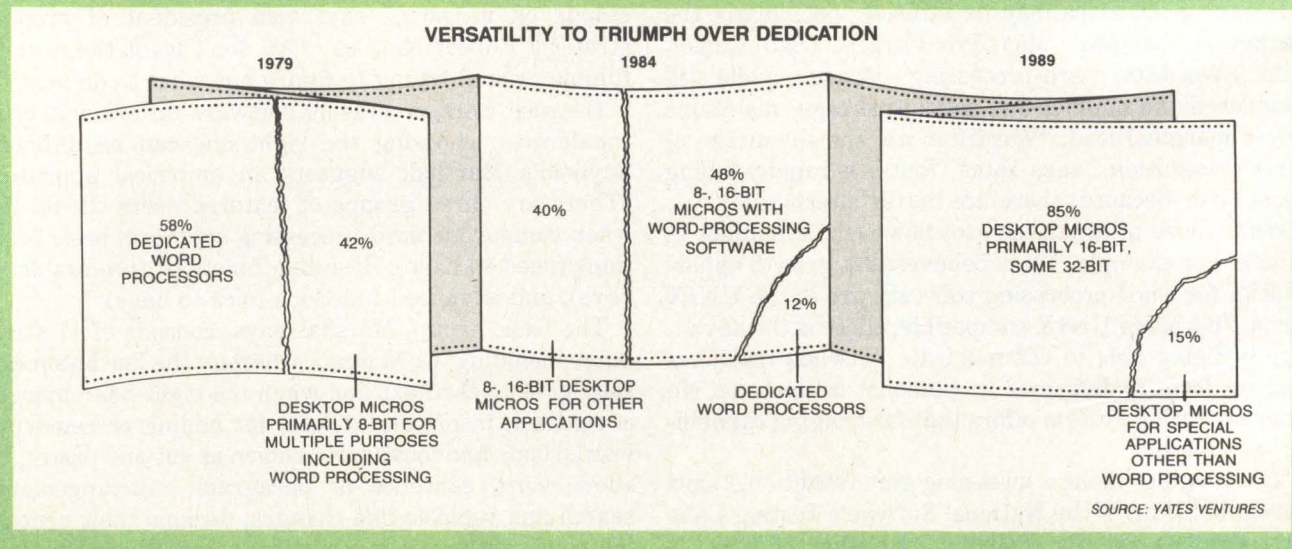

A
MINICOMPUTER
NETWORK
CAN INCREASE
YOUR
PRODUCTIVITY.

OR YOUR
PHONE BILLS.

Most companies experience the same thing when they start tying remote terminals to their minicomputer.

Much higher phone bills.

But now there's an inexpensive solution to that costly problem: The new Codex 6002 Intelligent Network Processor.

This low-cost multiplexer will save you money even if you're using as few as two terminals. The 6002 boosts operating efficiency, reduces the number of needed lines and protects data from errors due to line disturbances. And it can handle any mix of up to 16 asynchronous "terminals", including graphics terminals, word processors and personal computers from virtually any manufacturer.

Plus, only with the 6002 can you add asynchronous equipment without worrying if your multiplexer is compatible or not. So not only will it save you money now, but also later as your network grows and grows.

The Codex 6002 Intelligent Network Processor. It's just one of our many products that enable minicomputer users to develop and efficiently manage a growing network.

To learn more about the 6002, call 1-800-821-7700, ext. 892. Or write: Codex Corporation, Dept. 707-92, 20 Cabot Boulevard, Mansfield, MA 02048.

codex

MOTOROLA INC.
Information Systems Group



proportional spacing for WordStar documents. The result is a \$75 package called ProportionalStar. "We carefully analyzed what it takes to achieve true proportional spacing with a wide range of printer types. The exercise isn't trivial because specialized drives had to be created that would work within WordStar. We found that proportional spacing and multicolumn printing were the two biggest shortcomings of WordStar, and now for most word-processing software," states publisher Mike Weiner.

Meets perceived needs

With the perceived needs of users in mind, software publishers began lining up an impressive array of available word-processing software.

Among the newer approaches is that being taken by Syntactics Corp., Santa Clara, Calif., with the CrystalWriter package. According to chairman of the board and company president Erwin Morton, CrystalWriter can't be characterized as another word-processing package. He insists that it is a document-management system. "The office isn't built around spreadsheets or databases. It is, however, built around documents," he asserts, "These documents can be spreadsheets, letters, or names and addresses and graphs. What people

want to do is meld these documents into a usable order such as a report."

To achieve these goals, Crystalwriter, priced at \$2,500, provides users with a menu-driven system that allows the incorporation of foreign files from databases and spreadsheets. Moreover, the package is specifically designed for the UNIX environment. Morton maintains that UNIX provides the ideal environment for handling multiple users and tasks. "Because our whole metaphor of the office is based on a filing cabinet, we decided that UNIX was the only environment that provided enough drawers and file folders," claims Morton.

Another innovative approach to multifunction word processing is the Word Image Processing System (WIPS) Model 800 developed by Datacopy Corp., Mountain View, Calif. The system, which is priced under \$10,000, consists of WIPS software that combines images, text and printing for various dot-matrix and laser printers. For example, the Model 680 graphic scanner uses an integrated electronic digitizing mechanism that allows images of 1728-dot-by-2846-dot resolution to be captured with as many as 256 shades of gray. Model 680 connects to an IBM PC/XT personal computer via the Model 110 Image processing interface. The entire system serves as a front-end peripheral to the

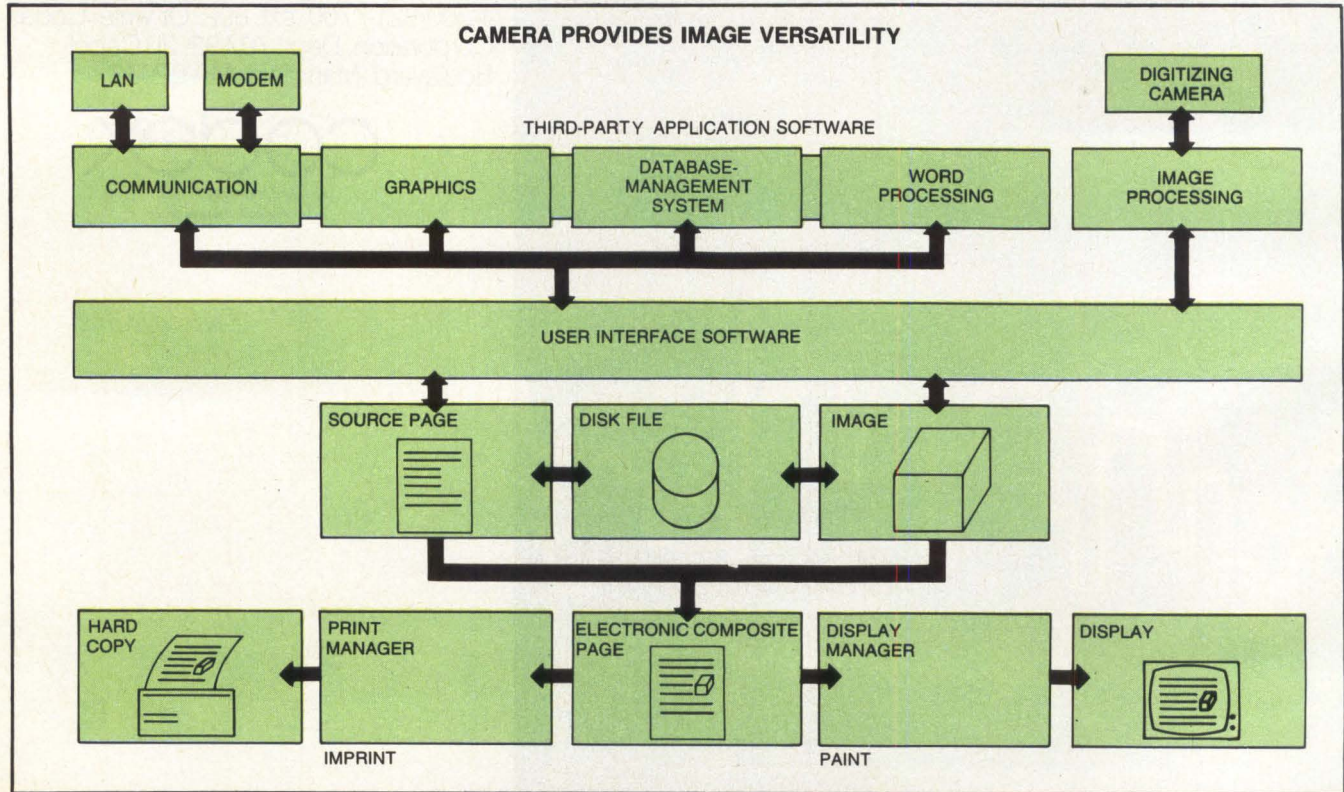

Datacopy's word-imaging processing system couples a digitizing camera and an IBM PC to produce information other than computer-generated graphics. The system takes a snapshot of the image, compresses it and melds it to the text

with word-processing software, databases and other graphics. It also allows the image and total document to be transmitted like a facsimile document.

REPRESENTATIVE WORD PROCESSING PACKAGES

PUBLISHER/ PRODUCT	BASIC FUNCTIONS need to have										DESIRABLE FUNCTIONS preferable to have					ADVANCED FUNCTIONS nice to have							
	Word-wrap	Insert-delete	Copy and move (cut and paste)	Search and replace	Ability to change ruler line	Decimal tabs	Centering point	Indent	Automatic pagination	Ability to access directory	Paragraph reform	Paragraph assembly (folder plate)	Screen print attributes (underline, bold, ital, super)	Headers, footers, page no.	Horizontal scrolling	Automatic footnoting	Table of contents and index generation	Split screen and/or windows	Keystroke — macros and text	Spelling verification	Math features calculation style	Mallmerge	Proportional spacing
ALPHA SOFTWARE CORP. Electric Desk integrated package Price: \$345 MS/PC-DOS	•	•	•	•	•	•	•	•	•	•	•	•	•	•	•	•	•	•	•	•	•	•	•
ASHTON-TATE Framework integrated package Price: \$695 MS/PC-DOS	•	•	•	•	•	•	•	•	•	•	•	•	•	•	•	•	•	•	•	•	•	•	•
CONCEPT TECHNOLOGIES INC. Concept 100 combination hardware add-in and software Price: \$2,195 MS/PC-DOS	•	•	•	•	•	•	•	•	•	•	•	•	•	•	•	•	•	•	•	•	•	•	•
LIFETREE SOFTWARE INC. Volkwriter Deluxe word processing only Price: \$295 MS/PC-DOS	•	•	•	•	•	•	•	•	•	•	•	•	•	•	•	•	•	•	•	•	•	•	•
LOTUS DEVELOPMENT CORP. Symphony integrated package Price: \$695 MS/PC-DOS	•	•	•	•	•	•	•	•	•	•	•	•	•	•	•	•	•	•	•	•	•	•	•
MICROPRO INTERNATIONAL CORP. Word Star word processing only Price: \$495 MS/PC-DOS	•	•	•	•	•	•	•	•	•	•	•	•	•	•	•	•	•	•	•	•	•	•	•
MICROSOFT CORP. Word word processing Price: \$195 MS/PC-DOS	•	•	•	•	•	•	•	•	•	•	•	•	•	•	•	•	•	•	•	•	•	•	•
MULTIMATE INTERNATIONAL CORP. Multimate word processing Price: \$495 MS/PC-DOS	•	•	•	•	•	•	•	•	•	•	•	•	•	•	•	•	•	•	•	•	•	•	•
NEWSTAR SOFTWARE INC. New word word processing Price: \$249 MS/PC-DOS	•	•	•	•	•	•	•	•	•	•	•	•	•	•	•	•	•	•	•	•	•	•	•
OFFICE SOLUTIONS INC. Office Writer word processing Price: \$375 MS/PC-DOS	•	•	•	•	•	•	•	•	•	•	•	•	•	•	•	•	•	•	•	•	•	•	•
THE SOFTWARE GROUP Enable integrated Price: \$695 MS/PC-DOS	•	•	•	•	•	•	•	•	•	•	•	•	•	•	•	•	•	•	•	•	•	•	•
SYNTACTICS CORP. Crystal Writer document processor Price: \$2,500 UNIX	•	•	•	•	•	•	•	•	•	•	•	•	•	•	•	•	•	•	•	•	•	•	•
UNISOURCE SOFTWARE CORP. The First Word word processing Price: (license) VENIX	•	•	•	•	•	•	•	•	•	•	•	•	•	•	•	•	•	•	•	•	•	•	•
XYQUEST INC. Xywrite word processing Price: \$395 MS/PC-DOS	•	•	•	•	•	•	•	•	•	•	•	•	•	•	•	•	•	•	•	•	•	•	•

Only Microware's OS-9 Operating System Covers the Entire 68000 Spectrum

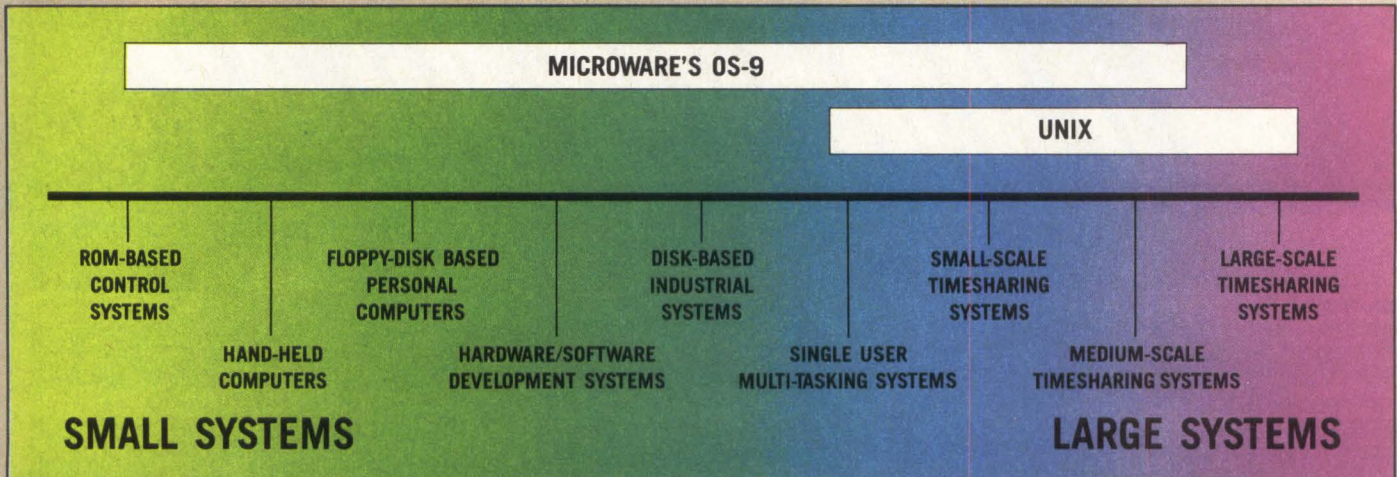

Is complicated software and expensive hardware keeping you back from Unix? Look into OS-9, the operating system from Microware that gives 68000 systems a Unix-style environment with much less overhead and complexity.

OS-9 is versatile, inexpensive, and delivers outstanding performance on any size system. The OS-9 executive is much smaller and far more efficient than Unix because it's written in fast, compact assembly language, making it ideal for critical real-time applications. OS-9 can run on a broad range of 8 to 32 bit systems based on the 68000 or 6809 family MPUs from ROM-based industrial controllers up to large multiuser systems.

OS-9'S OUTSTANDING C COMPILER IS YOUR BRIDGE TO UNIX

Microware's C compiler technology is another OS-9 advantage. The compiler produces extremely fast, compact, and ROMable code. You can easily develop and port system or application software back and forth to standard Unix systems. Cross-compiler versions for

VAX and PDP-11 make coordinated Unix/OS-9 software development a pleasure.

SUPPORT FOR MODULAR SOFTWARE — AN OS-9 EXCLUSIVE

Comprehensive support for modular software puts OS-9 a generation ahead of other operating systems. It multiplies programmer productivity and memory efficiency. Application software can be built from individually testable software modules including standard "library" modules. The modular structure lets you customize and reconfigure OS-9 for specific hardware easily and quickly.

A SYSTEM WITH A PROVEN TRACK RECORD

Once an underground classic, OS-9 is now a solid hit. Since 1980 OS-9 has been ported to over a hundred 6809 and 68000

systems under license to some of the biggest names in the business. OS-9 has been imbedded in numerous consumer, industrial, and OEM products, and is supported by many independent software suppliers.

Key OS-9 Features At A Glance

- Compact (16K) ROMable executive written in assembly language
- User "shell" and complete utility set written in C
- C-source code level compatibility with Unix
- Full Multitasking/multiuser capabilities
- Modular design - extremely easy to adapt, modify, or expand
- Unix-type tree structured file system
- Rugged "crash-proof" file structure with record locking
- Works well with floppy disk or ROM-based systems
- Uses hardware or software memory management
- High performance C, Pascal, Basic and Cobol compilers

microware[®]
OS-9[™]

MICROWARE SYSTEMS CORPORATION
1866 NW 114th Street
Des Moines, Iowa 50322
Phone 515-224-1929
Telex 910-520-2535

Microware Japan, Ltd
3-8-9 Baraki, Ichikawa City
Chiba 272-01, Japan
Phone 0473(28)4493
Telex 299-3122

OS-9 is a trademark of Microware and Motorola. Unix is a trademark of Bell Labs.

CIRCLE NO. 73 ON INQUIRY CARD

PC for capturing images. According to vice president of marketing and planning, James P. McNaull, the WIPS goes beyond combining images with text. He explains that because the image is in digital form, it can also be sent electronically to other sites. "It's the next level up in information processing," he says.

Because the combination of graphics with text is becoming increasingly attractive to users, a number of approaches are being taken. Concept Technologies Inc., Portland, Ore., for example, has developed a \$2,195 combined hardware and software system for the IBM PC that permits the coupling of high-level graphics with text. Called the Concept 100, the package uses an Intel 80186-based intelligent graphics subsystem board that plugs into the PC. The subsystem emulates the IBM monochrome and color display adapters and supports a 50-Hz, non-interlaced display with a 720-dot-by-352-dot resolution.

The word-processing function provides a broad range of capabilities including full-screen attributes of bold facing, underlining and italics. And the system can be used with a mouse input device. The graphics functions are similar to the Tektronix Inc.'s PLOT 10 graphics;

users can draw images, or download them from a host computer. To ensure the package's ability to interface with a host of output devices, including the company's own laser printer, the Virtual Device Interface (VDI) proposed graphics standard has been adopted. Like the other packages, the developers claim that data for the document can be combined from other foreign sources such as databases and spreadsheets.

Taking the singular-purpose approach even further is Xywrite from Xyquest Inc., Bedford, Mass. This package was developed for manipulating words and controlling ink on paper. Therefore, besides handling hyphenation and justification, as well as providing multicolumn capability, Xywrite provides device drivers for matching to a variety of printers, including laser printers.

Besides supporting a wide range of hardcopy devices, Xywrite 3.0 is available in a multilingual version, thus allowing the editing of glyph-oriented languages, such as Hebrew. Although the software is priced at \$395, users who want multilingual capability will need to invest in Quadram Corp.'s, (Atlanta) QuadVue display board at \$450.

The previously mentioned packages do offer a num-

Directory of manufacturers

Alpha Software Corp.
30 B St.
Burlington, Mass. 01803
(617) 229-2924
Circle 775

Ashton-Tate
10150 West Jefferson Blvd.
Culver City, Calif. 91230
(213) 204-5570
Circle 776

Concept Technologies Inc.
P.O. Box 5277
Portland, Ore. 97208
(503) 684-3314
Circle 777

Datacopy Corp.
1215 Terra Bella Ave.
Mountain View, Calif. 94043
(415) 965-7900
Circle 778

Lifetree Software Inc.
Suite 315
411 Pacific St.
Monterey, Calif. 93940
(408) 373-4718
Circle 779

Lotus Development Corp.
161 First St.

Cambridge, Mass. 02142
(617) 492-7171
Circle 780

MicroPro International Corp.
33 San Pablo Ave.
San Rafael, Calif. 94903
(415) 499-1200
Circle 781

Microsoft Corp.
Suite 200
10700 Northrup Way
Bellevue, Wash. 98004
(206) 828-8080
Circle 782

Multimate International Corp.
52 Oakland Ave. North
East Hartford, Conn. 06108
(203) 522-2116
Circle 783

Newstar Software Inc.
1601 Oak Park Blvd.
Pleasant Hill, Calif. 94523
(415) 932-2278
Circle 784

Office Solutions Inc.
5708 Odana Road
Madison, Wis. 53719
(800) 228-0747

(608) 274-5047
Circle 785

The Software Group
Northway Ten Executive Park
Ballston Lake, N.Y. 12019
(518) 877-8600
Circle 786

Syntactics Corp.
Suite 145
3333 Bowers Ave.
Santa Clara, Calif. 55051
(408) 727-6400
Circle 787

UniSource Software Corp.
71 Bent St.
Cambridge, Mass. 02141
(617) 491-1264
Circle 788

Writing Consultants
11 Creek Bend Drive
Fairport, N.Y. 14450
(800) 828-6293
(716) 377-0130
Circle 789

Xyquest Inc.
119 The Great Road
Bedford, Mass. 01730
(617) 275-4439
Circle 790

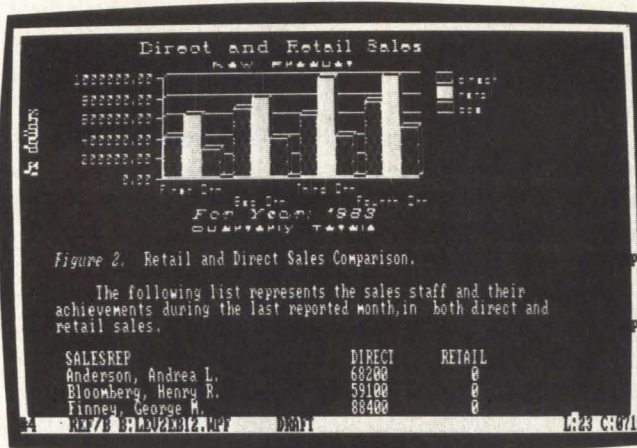

The Enable integrated package lets users slip in graphs, spreadsheet data and text, plus use a variety of fonts for customizing documents on the screen and for hard-copy output.

ber of attributes, but none currently provide the multiple path (access to sub-directories) permitted in IBM's PC-DOS. However, most industry analysts claim that it is coming. One company with an implementation that does provide at least one level of path access is Multimate International Corp., East Hartford, Conn. The Multimate Professional word processor, priced at \$495, supports DOS paths and allows file conversion from mainframes to microcomputers. In addition, mailmerge, spelling dictionary and character display attributes are all basic features of the package. Although Multimate does not currently support footnoting, the company is planning on implementing it in future versions.

Multimate is also paying special attention to user interfaces. According to director of communications Mary Page, a printer cable editor has been added to ease interfacing tasks with special printers. "The newer printers offer specialized features, and users want to take advantage of them. The cable editor allows the proper match-up," says Page.

Not a word processor, but a new generation of idea processor, is KAMAS, developed by Compusophic Systems, Aloha, Ore. According to the company, the package allows users to organize their thoughts in outline fashion. The outline is then translated to a word-processing package to create the final document. The company clearly states that their product can't and shouldn't be confused with word processing.

Can integrated packages stack up?

Publishers of integrated packages are expecting to garner a fair share of the word-processing market. For example, both Lotus Development Corp., Cambridge, Mass., and Ashton-Tate, Culver City, Calif., have

taken similar yet diverse approaches to providing word processing in integrated packages. Both are priced at \$695 and combine graphics, spreadsheets, communications and text processing in a window-oriented package. However, the similarities end there. Lotus, with the Symphony product, creates a metaphor of a grid and provides general word processing. In contrast, Ashton-Tate's Framework uses as a metaphor the basis of idea processing through outlines. Moreover, Ashton-Tate word processing is more fully featured than Lotus' and provides the ability to handle text and attributes.

Although neither product can be classified as a full-fledged word processor, each can claim full document processing. Thus, database information can be combined with graphics or spreadsheets, and the results put on paper.

Similarly, The Software Group's, Ballston Lake, N.Y., Enable package combines all the features of an integrated package plus word processing without, however, proportional spacing or footnoting. Enable treats each of its function as a separate module. Like Framework and Symphony, Enable is also priced at \$695.

In the meantime, MicroPro, according to industry sources, is developing a major integrated package, based on a word-processing code, named Ivan. Reportedly, Ivan is written in C-language, making it possible to port the package to a variety of machines and operating systems. In addition, Ivan is not expected to bear any resemblance to WordStar. MicroPro officials could not be reached for comment.

Finally, Alpha Software Corp.'s, Burlington, Mass. Electric Desk, priced at \$345, offers task-dependent modules. Electric Desk, like others, also allows the combination of graphics and spreadsheets, as well as databases. The company contends that speed and ease of use are the product's hallmarks, and that switching tasks is possible without losing the context of the overall picture.

Even though most of the integrated packages aren't as glutted with features as standalone word processors, virtually all allow mailmerge and background printing. How they stack up against the standalone word-processing software in the marketplace is subject to conjecture, because sales success depends on the users' needs.

What is apparent, however, is that the technology for creative documentation through word-processing software is beginning to capture the imagination of users and the energies of package makers. The verdict of the marketplace should depend less on price than on how well makers meet users' expectations. □

Interest Quotient (Circle One)
High 840 Medium 841 Low 842

“The question no longer is how
Fujitsu drives compare to the other guy’s,
it’s how *theirs* compare to *ours*!”

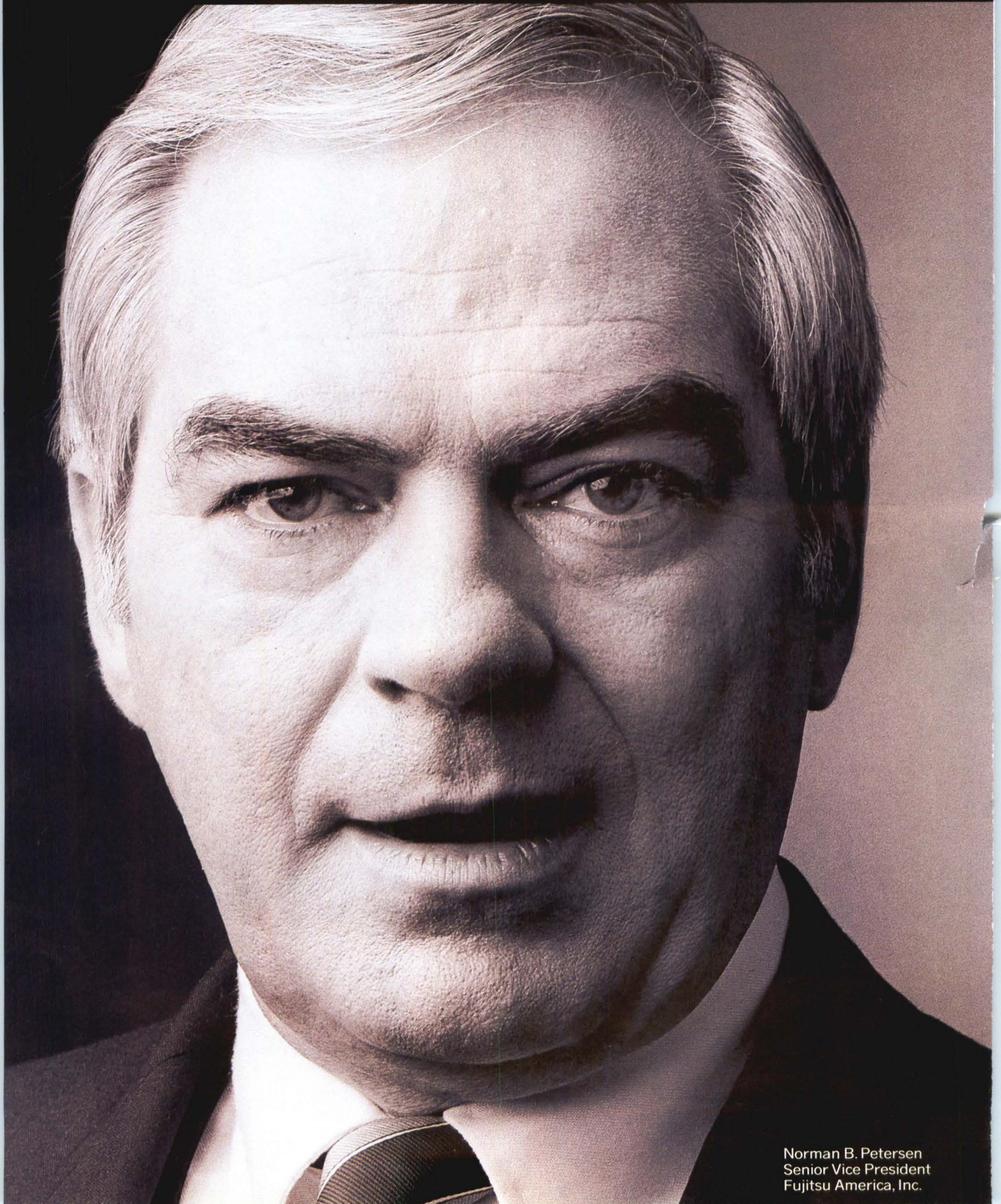

Norman B. Petersen
Senior Vice President
Fujitsu America, Inc.



“In 10¹/₂” drives, the big news is a new high-capacity Eagle with a 2.4 MB/sec. SMD interface.”

Fujitsu has done it again.

With the introduction of the new 689 megabyte Eagle, we've set still another standard for disk drive performance—2.4 megabyte-per-second data transfer. We did it by increasing track capacity using proven RLL (Run Length Limited) encoding methods. And we used the same high-speed SMD-compatible interface as we did in our new 336 megabyte 8” drive.

The new Eagle features the same head, media and actuator technology as previous designs. Which means you can take advantage of this new performance standard without sacrificing any of Fujitsu's world-proven reliability.

Both the new Eagle and the new 8” drive have the same track capacity and can attach to a common controller. Off-the-shelf controllers are readily available for both drives.

So if you already have designed-in our 474 megabyte Eagle, you have nothing



MODEL	M2351	M2361
CAPACITY (MB) Unformatted	474	689
AVERAGE POSITIONING TIME (msec)	18	18
TRANSFER RATE (KB/sec)	1859	2458
INTERFACE	SMD	SMD
POSITIONING METHOD	Rotary Voice Coil	Rotary Voice Coil

to worry about. Because the new 689 megabyte Eagle will slip into your design like a hand into a glove! And give you more storage, higher performance, and a lower cost per megabyte.

But whichever Eagle you choose, you still get fast data access and the same dedication to quality that has made Fujitsu America one of today's leading OEM disk drive suppliers.

Call Fujitsu America at (408) 946-8777 for more information. And be sure to ask about our new start/stop and streaming tape drive systems. Because we believe the best disk drives deserve the best backup systems.

Fujitsu Storage Products. Maximum Performance. Maximum Quality.

FUJITSU AMERICA, INC.

FUJITSU

From 5¼" disk drives to high-performance, low-cost tape systems, Fujitsu America has the data storage systems you need. And they're available today.

Since 1978, Fujitsu America has grown rapidly to become one of the leading OEM suppliers of disk storage products in North America.

A key reason for this success has been our uncommon devotion to quality. Quality that pays off in maximum reliability for the ultimate user.

The quality has remained a Fujitsu hallmark as we have expanded our product line over the years to reflect continued advancements in data storage technology. Advancements that not only increased performance and capacity, but also helped to reduce overall data storage costs.

Today, Fujitsu America is proud to announce further evidence of our commitment to meeting the data storage requirements of our North American customers.

We're giving you more products to choose from.

First, we've expanded our product line once again. Now you can choose Fujitsu rigid disks from 14" down to 5¼", with capacities from 689 megabytes to 13 megabytes, and the highest performance in the industry. And we now offer high-performance, low-cost streaming and start/stop tape drive systems as well.

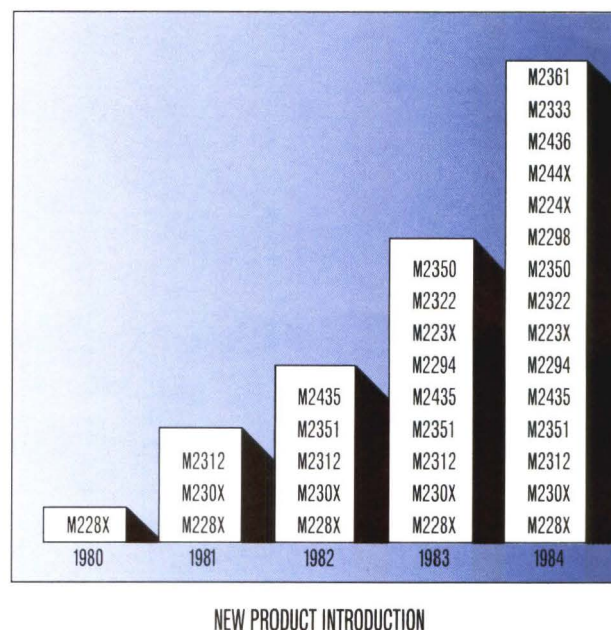

And we've boosted delivery capacity to meet today's needs, today.

Secondly, we've increased our delivery capabilities substantially.

For example, two automated manufacturing plants with over a million square feet are now devoted exclusively to Eagle (10½"), 8" and 14" disk drive production. A new plant with 220,000 square feet is dedicated to 5¼" manufacturing. Also, a new U.S. distribution center and a product reconfiguration facility both have recently been completed to help us better serve our OEM customers.

In addition, yet another disk drive manufacturing plant is now under way in

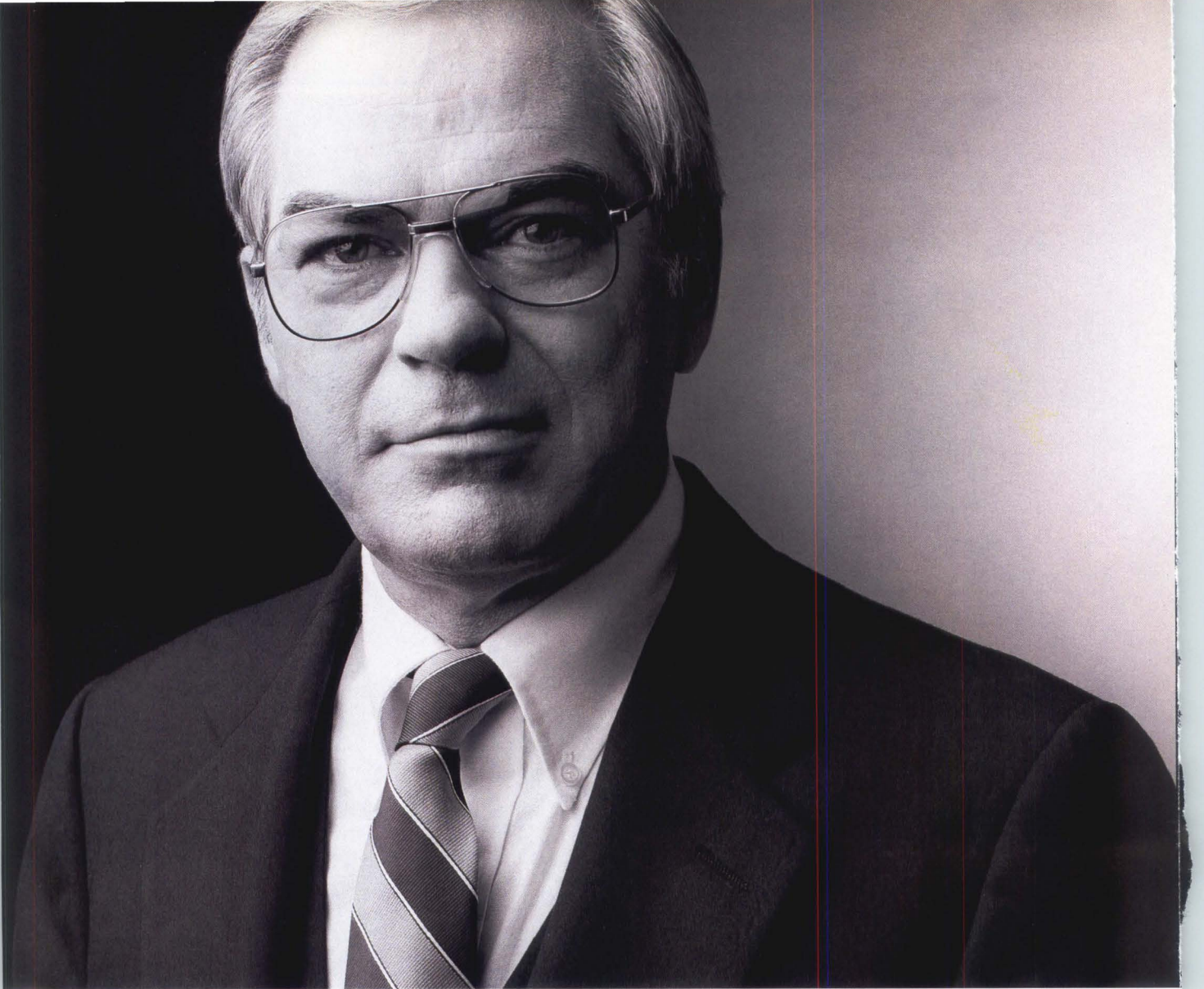

“Fujitsu’s 14” disk drives offer you the lowest cost per megabyte available anywhere.”

Fujitsu America not only gives you maximum performance and reliability in data storage products, we also continue to provide you with the lowest cost of ownership.

Take our 14” disk drives, for example. Our initial product, introduced in 1980, provided 168 megabytes of storage. Then we introduced the 336 megabyte model, which provided double the capacity and set new industry standards for quality, performance and cost per megabyte of storage.

Today, there’s a new leader in 14” disk drives — Fujitsu’s 671 megabyte model. Not only does it give you double the capacity yet again, it also gives you the faster data transfer rate of the Fujitsu Eagle—1.86 megabytes per second!

Furthermore, you get this higher capacity and performance in the same form factor as the previous model, making it easy to integrate into your current system design.



MODEL	M2284	M2294	M2298
CAPACITY (MB) Unformatted	168	336	671
AVERAGE POSITIONING TIME (msec)	27	27	27
TRANSFER RATE (KB/sec)	1012	1012	1859
INTERFACE	SMD	SMD	SMD
POSITIONING METHOD	Rotary Voice Coil	Rotary Voice Coil	Rotary Voice Coil

Best of all, this new drive offers you the lowest cost per megabyte of any disk drive available today.

And speaking of availability, the new 671 megabyte model is available, today, in production quantities. With the same field-proven 20,000-hour MTBF reliability that has helped make Fujitsu America one of today’s leading OEM disk drive suppliers.

For more information, call (408) 946-8777. And ask about our new streamer and start/stop tape drive systems, too. Because when you buy the best disk drives, you deserve the best backup systems.

Fujitsu Storage Products. Maximum Performance. Maximum Quality.

FUJITSU AMERICA, INC.

FUJITSU

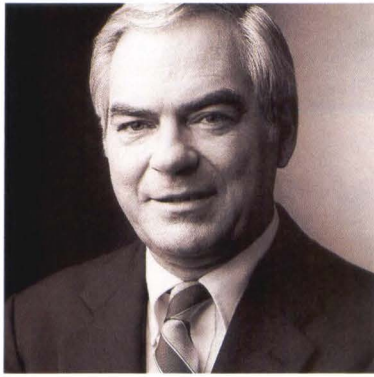

“Because now, no other storage products supplier can match Fujitsu America in all the key parameters. Performance. Quality. Depth of product line. And delivery.”

Portland, Oregon, which will add significantly to our production capacity in 1985.

The bottom line is that we can now deliver a greater selection of data storage products than ever before, and we can deliver them in volume. Today.

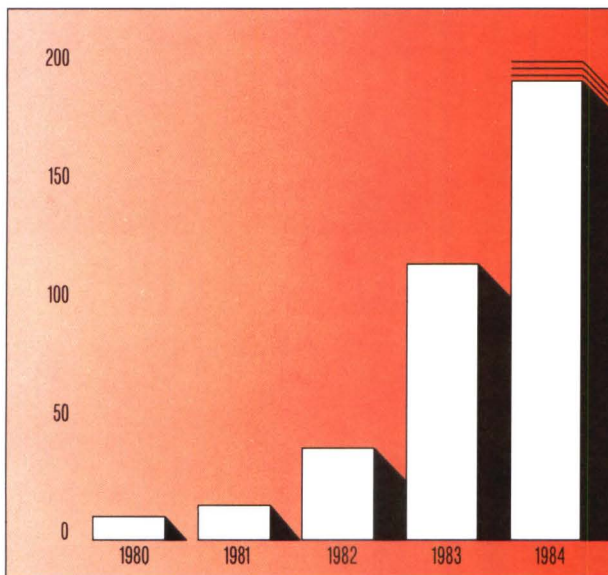

SALES GROWTH CHART

The continuing Fujitsu investment in reliability.

And every Fujitsu drive we deliver will continue to reflect our demonstrated commitment to maximum quality and maximum performance. The Fujitsu commitment to quality is rooted in the very core of the way we do business, and is one of the primary

reasons why we manufacture virtually every component of every drive ourselves.

It's also the reason why the very first task of every Fujitsu assembly worker is to QA the work that has gone on before. A very simple step, but one that pays enormous dividends in the care and pride with which every part is manufactured and assembled.

Fujitsu facilities themselves also reflect our investment in quality. Highly efficient clean room filtration systems, for example, are designed to eliminate air-borne particles as tiny as three microns. And the extensive use of robotics in the assembly process further enhances consistent product reliability.

Additionally, every component and completed drive goes through an extensive power-on burn-in. This helps reduce early-life failures and boost reliability. And because of the high reliability of these drives as proven in actual field experience, Fujitsu has recently doubled the MTBF specification for all our rigid disk drives to 20,000 power-on hours.

These are just a few of the many ways in which Fujitsu America is working to serve the industry better. We have led the way with new standards of quality, performance and reliability. And we are continuing to invest in people and facilities to provide still more product choices, along with faster product deliveries, and high quality product service.

So when you think of mass data storage, think of Fujitsu America first.



“At last there’s a high-performance 5¼” disk drive with Fujitsu quality. From Fujitsu, of course.”

Finally there’s a 5¼” disk drive that offers you the kind of high-performance features and quality components generally found only in larger, more expensive drives.

It’s from Fujitsu, of course. We worked very hard to perfect this drive, so we could offer you a product that is competitive in price, yet still superior in quality.

So we designed it with proven technology, using standard ferrite heads and oxide recording media.

Then we proved it in the field. And today, based on actual operating experience, we now back all our 5¼” drives with a specified MTBF of more than 20,000 power-on hours.

So you can design them into your system with complete confidence.

You’ll get a top-notch performer, too. With from 31 to 86 megabytes of capacity, 33 millisecond average positioning time, and a 625 kilobyte-per-second transfer rate!

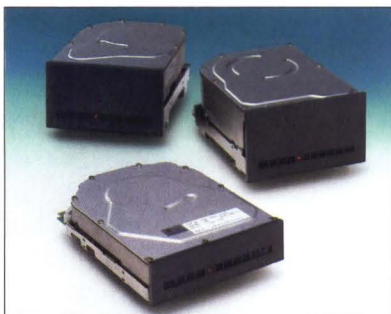

MODEL	M2241	M2242	M2243
CAPACITY (MB) Unformatted	31	55	86
AVERAGE POSITIONING TIME (msec)	33	33	33
TRANSFER RATE (KB/sec)	625	625	625
INTERFACE	ST506/ SA4000	ST506/ SA4000	ST506/ SA4000
POSITIONING METHOD	Rotary Voice Coil	Rotary Voice Coil	Rotary Voice Coil

We also offer a full line of stepper-motor, standard performance 5¼” drives. With capacities from 13.3 to 26 megabytes. Plus half-high models with 6.6 and 13.3 megabyte capacities.

To assure you prompt delivery, we have just completed a new plant, adding 220,000 square feet to our 5¼” manufacturing capability.

So give us a call today, at (408) 946-8777. We’re Fujitsu America... your one-stop, full-line disk drive supplier. We’ve got the sizes and the capacities. We’ve got the performance. We’ve got field-proven reliability.

And we can deliver.
Fujitsu Storage Products. Maximum Performance. Maximum Quality.

FUJITSU AMERICA, INC.





“The 8” disk drive contest is over. Fujitsu just doubled the capacity and the transfer rate.”

Your best choice in 8” disk drives just got twice as good. Because we took our popular 168 megabyte model and doubled both its capacity (to 336 megabytes) and its transfer rate (to 2.4 megabytes per second). And we did it in the same form factor, using RLL (Run Length Limited) encoding methods and an SMD-compatible interface.

Which means you can now get twice the capacity from a drive with proven technology. It also means you can readily integrate this new maximum-performance drive into your current system design.

This drive is just what you need to help satisfy those complex, multi-user applications requiring fast access and huge amounts of data. You can stack up to four of these drives together in a 19” rack, and thereby provide a total of 1.3 gigabytes of storage, with an average positioning time of 20 milliseconds. Now that’s performance!

You also get compatibility with our



MODEL	M2322	M2333
CAPACITY (MB) Unformatted	168	336
AVERAGE POSITIONING TIME (msec)	20	20
TRANSFER RATE (KB/sec)	1229	2458
INTERFACE	SMD	SMD
POSITIONING METHOD	Rotary Voice Coil	Rotary Voice Coil

new 689 megabyte Eagle. They have the same track capacity, the same high-speed SMD interface, and can attach to a common controller. Off-the-shelf controllers are readily available for both drives.

But best of all, you get Fujitsu’s dedication to maximum quality. And it’s our quality which has helped establish Fujitsu America as one of today’s leading OEM disk drive suppliers.

Get the full story. Call Fujitsu America today, at (408) 946-8777. We’ll show you why the performance contest is over in 8” disk drives.

Fujitsu Storage Products. Maximum Performance. Maximum Quality.

FUJITSU AMERICA, INC.





“And finally, Fujitsu introduces two tape drive systems with world-proven reliability.”

Fujitsu America is proud to announce two “new” tape drive systems that out-perform anything in their class. The high-performance M244X GCR streamer, and the 200-ips M2436 start/stop system.

They’re “new” only in the sense that they are just now being introduced to the North American OEM market. But we’ve already proved them in Fujitsu computer systems around the world.

Both are extremely reliable, and have earned the highest MTBF ratings in the industry.

And both are available today.

Our family of low-cost GCR streaming tape drives are performance-matched with our Eagle disk drives to provide the best data storage combinations going. And we have two models, offering a choice of either 100 or 75 ips, to match your price/performance and system requirements.

Then there’s the start/stop system which offers state-of-the-art performance



MODEL	TAPE SPEED		RECORDING DENSITY (bpi)	RECORDING METHOD	DATA TRANSFER (Max KB/Sec)
	STREAM (ips)	START/STOP (ips)			
M2442	100	12.5	6250/1600	GCR/PE	625
M2444	75	25	6250/1600	GCR/PE	465
M2436	n/a	200	6250/1600	GCR/PE	1250

and versatility. It’ll search through your files at 200 ips, transferring data at 1.25 megabytes per second! And it offers many additional big-system features like auto tape loading and sophisticated self-diagnostics.

To get the full story on the complete line of Fujitsu data storage products, just call (408) 946-8777. Or write Fujitsu America, Inc., Storage Products Division, 3055 Orchard Drive, San Jose, CA 95134.

Fujitsu Storage Products. Maximum Performance. Maximum Quality.

FUJITSU AMERICA, INC.

FUJITSU

Will the networked office save the daisywheel?

Despite new and exotic printer technologies, office work in the future may still revolve around the good, ol' daisywheel

Don Dempsey, Xerox Corp.

Dot matrix, thermal transfer and laser printers are all far faster than daisywheel printers. But does that spell the demise of the traditional standard of the computer printer business? Not if daisywheels can meet the technological demands of the networked office environment. While it's true that the old, noisy, stand-alone impact word processor is beginning to give way to faster and fancier printers—each of which have their own disadvantages—daisywheels remain unsurpassed for letter-quality printing.

The schematics of the future office have already been determined. Most large- and medium-sized businesses have already laid plans to become networked environments. Offices will consist of several personal computer workstations, both local and remote, perhaps using a single high-speed printer for hard copy output. With the technology available today, this is the most economical, efficient and logical way to design an office. It also, of course, puts a tremendous strain on that single printer—and greatly affects the future of the printer industry, which must somehow produce machines of the necessary speed, quality and reliability.

Traditionally, only dot-matrix printers have been reasonably priced and fast enough to handle the workload of multiple workstations. However, their inability to achieve solid-font printing prevents them from handling many professional-level jobs. And, while non-impact technologies such as thermal transfer and laser printers have been able to produce both the speed and

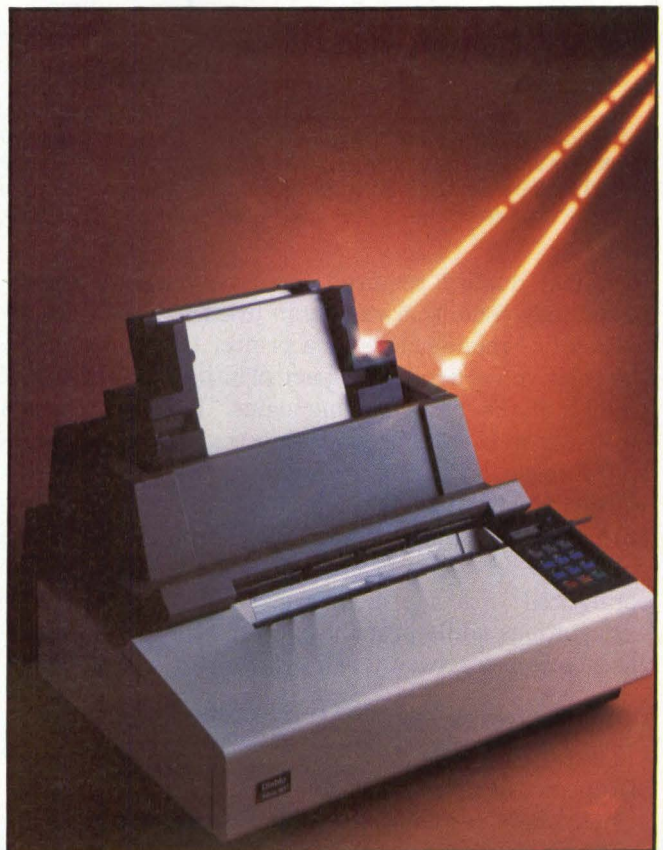

The Series 80IF daisywheel printer from Diablo System Inc. is part of a new generation of daisywheels finding a secure niche in the networked office environment. It features dual-hammer design, a wedge capture system and print-on-the-fly capability.

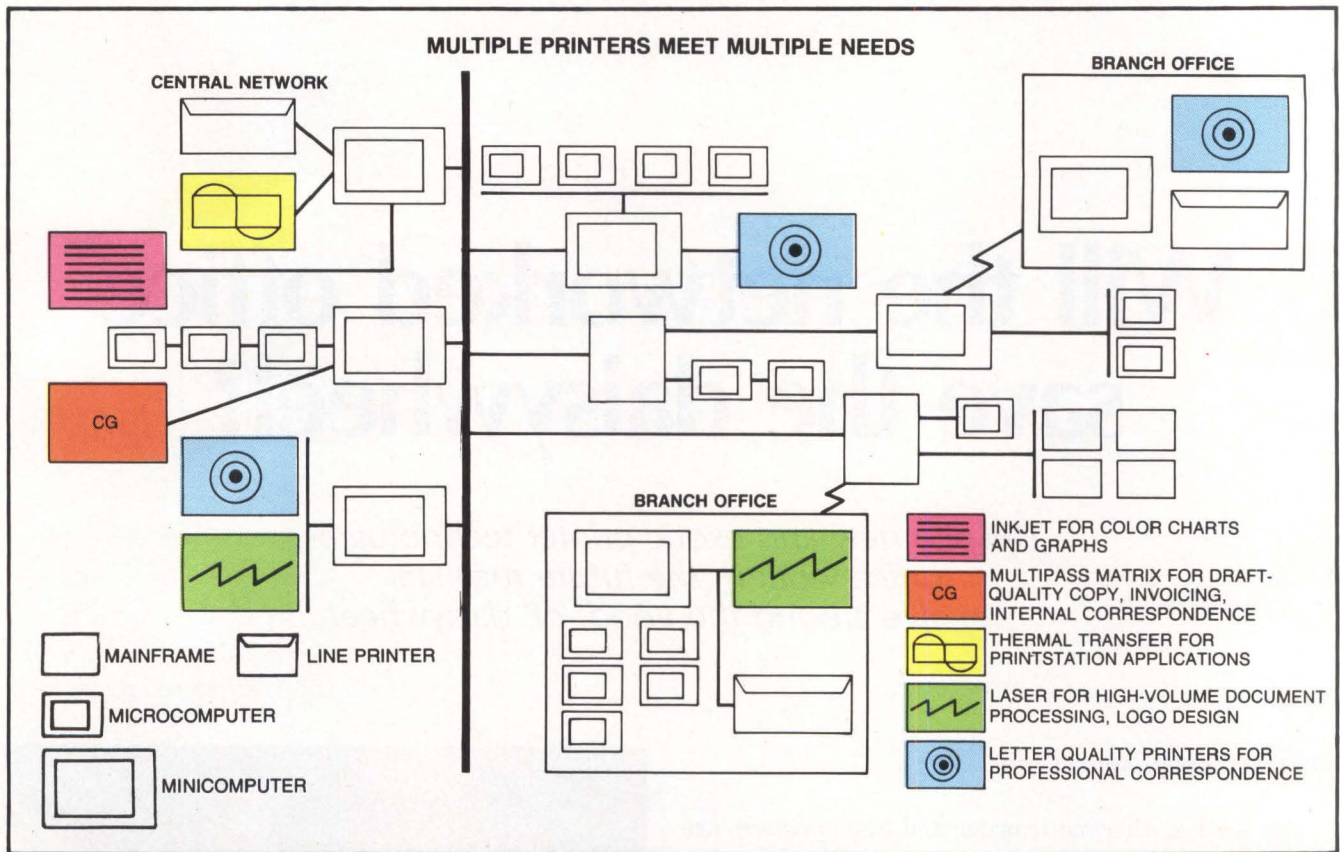

The ideal office would contain a number of printer types to meet the various needs of a networked environment. These would include high-speed, dot-matrix printers for draft copy, thermal transfer printers for integrated text and graphics,

color ink-jet printers for color graphics, laser printers for high-volume document processing and letter-quality printers for professional correspondence.

the print quality required for a networked environment, they come at a very high price.

Clearly, what's needed is a printer that can combine the relative economy of impact printing with the print quality of the newer technologies. The best method currently available for achieving that blend is a high-speed daisywheel printer specifically designed for networked applications. One such printer is the Series 80IF, from Diablo Systems Inc., Fremont, Calif., a subsidiary of Xerox Corp. The Series 80IF, when configured with a print server, can handle up to 16 workstations while providing letter-quality print at 80 characters per second (cps).

Printers draw outlines of future offices

The ideal office of the future might combine a number of types of printer to meet varying business needs:

- A high-speed dot matrix printer at 150 cps for draft-quality copy, invoicing and internal correspondence
- Thermal transfer machines for producing high-quality integrated text and graphics, at speeds up to 6 lines per minute (lpm)

Whether the document is a memo to the boss, a letter to a prospective client or a long-overdue report, the ability to put text and graphics on one highly impressive page with one relatively inexpensive device is essential.

- Color ink-jet printers for visually interesting graphs and charts
- Laser printers for processing high-volume documents and logo designs at very high speeds, i.e., 12 pages per minute
- Letter-quality printers for professional correspondence—high-quality documents to be sent outside the company, or to higher levels within the company.

It is in this last category that high-speed daisywheel printers fit particularly well. Whether the document is a memo to the boss, a letter to a prospective client or a

Going out for a drive? Travel light.



Now you don't have to go out of your way to find a complete line of fast, accurate floppy disc drive diagnostic and alignment tools.

Dysan makes them all. And they're all so compact they fit in a briefcase.

Which makes them perfect for field service.

Or (without the briefcase) for your test bench.

For instance, our Digital Diagnostic Diskette (DDD™) with appropriate software lets you zip through digital tests like head positioner linearity. Head radial alignment. Diskette centering. Head azimuth alignment. Index timing. All in just minutes.

And you get the results right on the screen of the machine you're testing.

Our Interrogator™ is a DDD packaged with menu-driven software and instructions that simplify drive tests on the IBM® PC and XT, Zenith Z/H 100 Series, Osborne® 1 (and more to come).

The hand-held Performance and Alignment Tester (PAT-2+™) and the DDD enable you to step through a

complete series of drive diagnostic tests. Plus performance tests like read/write data handling capabilities and rigorous head positioner testing.

Or you can use the PAT-2+ as a drive exerciser with our Analog Alignment Diskette (AAD™) and an oscilloscope for precision drive alignment.

Dysan's drive diagnostic and alignment tools.

Whether you go out for a drive or just walk over to the test bench, take them along.

For more information or to place an order, call toll free, 800-551-9000.

Dysan Corporation, 5201 Patrick Henry Drive, P.O. Box 58053, Santa Clara, CA 95050, (408) 988-3472.

Dysan®

**Somebody has to be better
than everybody else.**

Dysan is a registered trademark, DDD, Interrogator, PAT-2+, and AAD are trademarks of Dysan Corporation. IBM and Osborne are registered trademarks of International Business Machines Corporation and Osborne Computer Corporation, respectively.

© 1984 Dysan Corporation

CIRCLE NO. 74 ON INQUIRY CARD

COMDEX WINTER HAS SOFTWARE FOR THE IT HARDWARE ... HARDWARE ALL FOR THE SOFTWARE.

**COMDEX brings you
the whole computer industry under one roof
—hardware, software and everything else you need
to improve the profitability
of your business.**

COMDEX™/WINTER '85

**March 21 - 24, 1985
Anaheim Convention Center
Anaheim, California**



Presented by **THE INTERFACE GROUP, Inc.**, world's leading producer of computer conferences and expositions including The Nationwide COMPUTER SHOWCASE EXPOS, COMDEX/Winter, COMDEX/Spring, COMDEX/Fall, COMDEX/Europe, COMDEX in JAPAN, INTERFACE, FEDERAL DP EXPO & CONFERENCE and THE BYTE COMPUTER SHOWS.
300 First Avenue, Needham, MA 02194 • (617) 449-6600

Since the networked office environment is, to date, far from standardized, the printer must have "plug and play" compatibility with most host systems on the market.

long overdue report, the ability to put text and simple business graphics on one impressive page with one relatively inexpensive device is essential.

The daisywheel printer that fits well in a networked environment has a number of unique characteristics. One is high flexibility. Since the networked office environment is, to date, far from standardized, the printer must have "plug and play" compatibility with most host systems on the market. Moreover, it must be easily transported from one node in the network to another. The Series 80IF, for example, can function not only in central or local area networks, but also connects with remote (branch office) stations. It also has an All Purpose Interface (API) which combines the RS232C,

Centronics and IEEE 488 interfaces.

In addition, it has an integrated—rather than optional—dual-bin-sheet paper feeder for faster throughput and increased efficiency. By incorporating the paper path into the printer mechanism, the printer improves feed-and-eject times while reducing the cost of intelligent paper handling accessories. A bidirectional tractor with optional bottom feed is available for continuous forms processing. The integrated dual-bin sheet feeder provides forward-collated, or "security" (face down) output as a standard feature. Other options include an envelope feeder and adjustable paper trays. The microprocessor control that drives the printer also provides double-precision vertical and horizontal control of the paper and feeder system.

A daisywheel in a networked office should also have a closed-loop stepper motor, because the feedback system of that type of motor allows for more precise monitoring of the system than possible with an open-loop motor. A closed-loop stepper's ability to identify the actual position of the rotor at any time makes it possible to precisely determine the correct time to advance the stator magnet, assuring maximum torque

Closed stepper motors lock in precision

Where an open-loop stepper motor simply moves the rotor forward in regular steps, a closed stepper motor can stop and start the rotor by changing the polarity of its stator magnets.

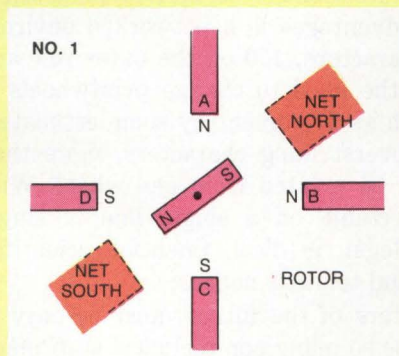

For example, in Number 1, the south end of the rotor magnet is centered between A and B. Assuming A, B, C and D are magnets of equal strength, the net magnetic field vector of these four stator magnets (shown as dotted lines) lies between A and B (net North pole) and C and D (net South pole). The magnitude of the net magnetic field, being the vector sum of those of the individual magnets, is V^2 times that of the individual magnets.

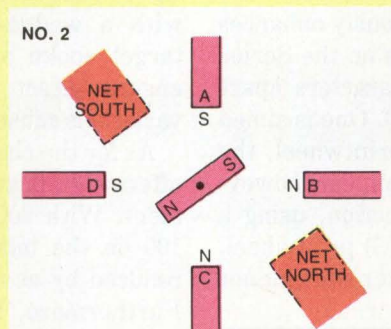

Were the polarity of magnets A and C reversed suddenly, creating the situation shown in Number 2, the net magnetic field would be shifted to the

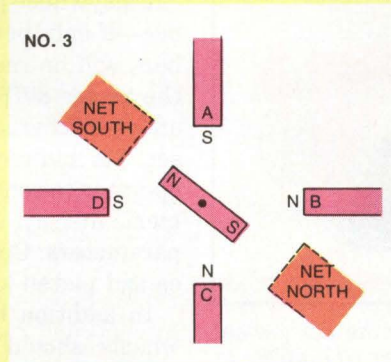

locations shown: "one step" clockwise. The rotor magnet would see a force which would align it with the new magnetic field; in fact, the rotational torque created is at its maximum when the rotor is one step away from the stator's net field location.

The rotor will then move clockwise to eliminate this torque, i.e., it will "follow" the effective rotation of the stator field. The rotation torque goes to zero when the rotor gets to the position in Number 3, but the rotating magnet has maintained velocity at this time.

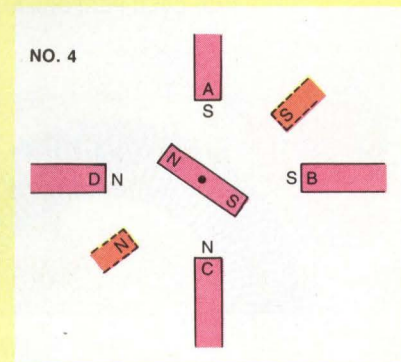

When magnets B and D reverse their polarity, the situation is that of Number 4.

Careful timing of the carriage, printwheel, ribbon and hammer allow a character to be printed without the carriage coming to a complete stop.

and acceleration and minimum time to move a given number of steps (see "Closed stepper motors lock in precision," Page 167).

The Series 80IF, in fact, has the ability to "print on the fly." Careful timing of the carriage, printwheel, ribbon and hammer allows a character to be printed without the carriage coming to a complete stop. The printwheel motor seeks the appropriate letter, the ribbon motor steps—or advances—the ribbon, and the carriage remains in motion. Just before the carriage moves to the desired position, the hammer fires. By the time the printwheel spoke hits the paper, the carriage has reached the print position. After the printwheel releases the hammer, the cycle resumes.

Hammers and characters strike a balance

Dual-hammer construction is another important feature of daisywheels in the networked environment. The ability to print two characters simultaneously enhances both speed and reliability. The hammers on the Series 80IF, for example, are spaced nine characters apart (counting the character under a hammer). One is aimed at the outer row of characters on the printwheel, the other at the inner row. Both characters appear, however, on the same printline. This construction, using a double-row, extended-character-set (ECS) printwheel, makes all characters available with neither shifting nor

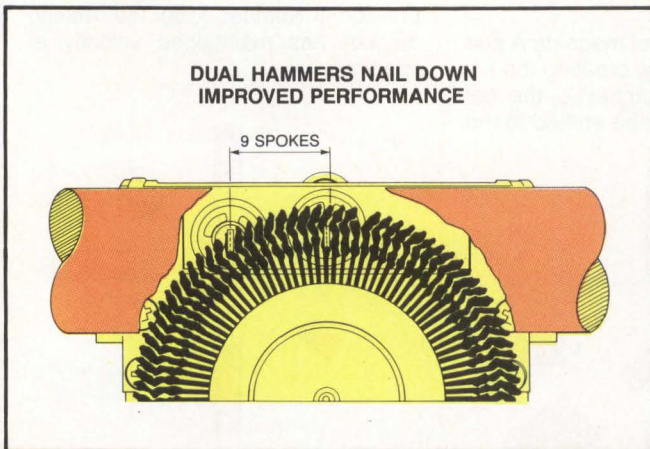

Dual-hammer construction is important for the daisywheel printer operating in a networked environment. The ability to print two characters simultaneously enhances both speed and reliability.

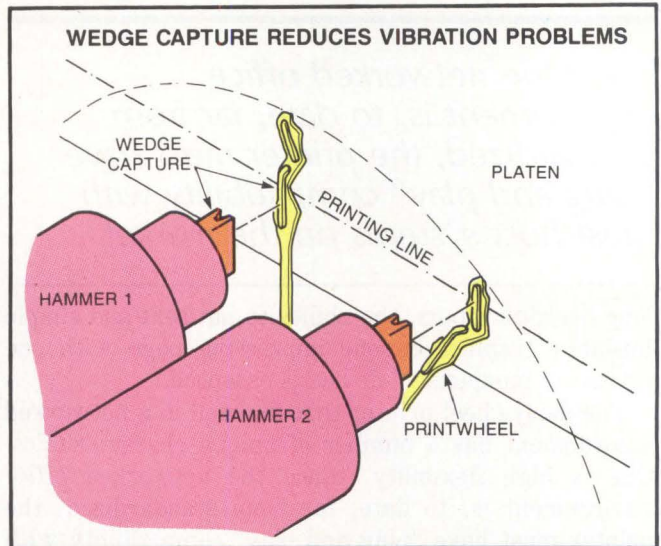

Wedge capture design ensures exact positioning and eliminates minute variations caused by wheel motion. The tip of each hammer is equipped with a wedge-shaped depression which captures the target spoke of the printwheel and steadies it during strikes.

carriage motion, which can both slow printing and cause wear on the machine.

The printer also makes use of "wedge capture design." This means the tip of each hammer is equipped with a wedge-shaped depression that captures the target spoke of the printwheel during strikes. This ensures exact positioning and eliminates the minute variations caused by the wheel's motion or by vibration.

As for the characters themselves, an ECS printwheel offers significant advantages in a networked environment. With 200 characters, 100 on the outer row and 100 on the inner, the need to change printwheels is reduced by as much as 60 percent by some estimates. Furthermore, by overstriking characters, more than 400 characters can be printed from one wheel. With multiple fonts selectable on a single line, a single printer can meet legal, medical, financial, scientific, foreign-character and teletext needs.

Daisywheel printers of the future must be easy to use—if only because so many non-technical staff members will be required to work with them. To this end, the Series 80IF uses a push-button control panel with an eight-character (or optional 16-character) display set. Its bidirectional communication allows a remote operator to send nonprintable messages to the alphanumeric display, detect error messages and set printing parameters. Conventional DIP switches, rotary switches and platen knobs can therefore be eliminated.

In addition to being easy to load, cartridge printwheels should be automatically identifiable by the printer itself. For example, the bottom of each printwheel cassette can be marked with bar code that

DEC, DG, PE, TI, HP, MULTI-BUS USERS

GD CONTROL DATA YOU'VE BEEN WAITING FOR US!

Faced with growing storage requirements that your present system can't handle? Or a need for more sophisticated applications that can't be done with your OEM's limited selection of hardware? Your growth and success should reward you, not clean out your bank account. And rewards are in store for you at California Computer Group.

Take a look at our economical fixed drive and backup systems that offer you more freedom and greater potential than you ever thought possible with your present system, whether it's a DEC, DG, PE, TI, or multi-bus computer.



HP or multibus computer, we'll provide the interface for your system.

AFFORDABLE STREAMING TAPE DRIVES? YES!

Keystone 92185/92180/92181 Tape Transports.

California Computer Group brings you the new Keystone high-performance streamers at up to 70% savings over comparable subsystems! The Keystone 92185 reads and writes in both the phase-encoded (PE) and group coded recording (GCR) formats.

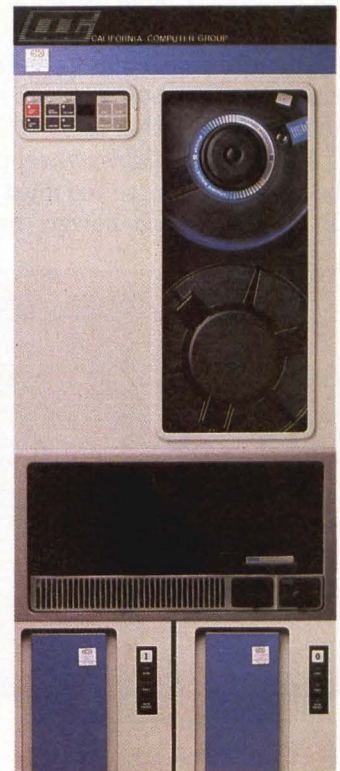

JUST THE RIGHT MATCH FOR YOUR MINI.

Control Data 9715 Fixed Storage Drive 9710 Removable Storage Drive.

CDC's 9715 provides up to 516 Mbytes of storage in a 9-inch fixed drive, with data transfer rates as fast as 1.8 Mbytes/sec. — all packed into a rack-mountable, sealed module. Or, mount two 9715s side by side for a total of more than one gigabyte of memory, accessible in just 20 ms.



You can back it all up with CDC's amazing 9710 front-loading removable storage drive, which gives you over 80 Mbytes of unformatted storage in a convenient removable data pack.

Control Data's 9715/9710 drives for your mini-computer — a winning combination!

MORE POWER TO YOU — AND YOUR DATABASE.

Control Data XMD 9771 Fixed Drive

The XMD 9771's extensive use of thin film head technology brings up to 825 Mbytes of rugged, reliable fixed-disk storage to your data-intensive applications. The rack-mountable 9771 is fast, too, with an average access time of only 16 ms and data transfer rates to 1.8 Mbytes/sec.

Whether it's a DEC, DG, TI, PE,



With it, you can store up to 180 Mbytes on a single reel of tape and back up your fixed drive storage five times faster than conventional streaming tape drives.

Easy to thread and gentle on tape, the entire family of low-cost Keystone streamers are compatible with a wide range of minicomputers.

WAIT NO LONGER.

Let our configuration experts show you how to make a good system even better. We'll help you get the most from your minicomputer — with peripherals and subsystems that are both affordable and 100% compatible with the equipment you're using now. And we'll be there every step of the way, with assistance

in installation, maintenance, and continuing first-rate service. Now — Are you ready for the best your money can buy?

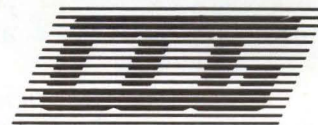

California Computer Group
Making A Good System Better.
3303 Harbor Blvd., Suite G-10
Costa Mesa, CA 92626

(800) 854-7488 ... Nationwide
(800) 232-1661 ... California
(714) 966-1661 ... Corporate

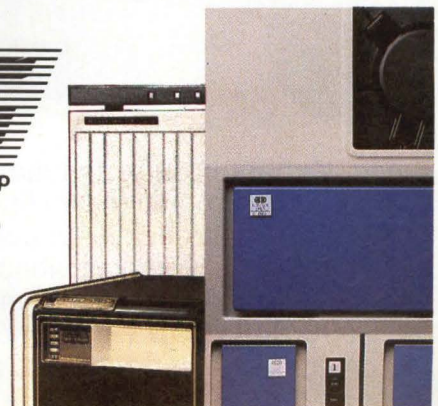

DEC, DG, HP, TI, PE are registered trademarks of Minicomputer Manufacturers.
CDC, 9715, XMD 9771 and the Control Data logo are trademarks of Control Data Corporation.

conveys the type styles directly to the printer's micro-processor. In addition, daisywheels of the future should be pleasantly quiet to work with, operating no louder than approximately 58 dB.

It's also important to be able to expand the buffer size to 1.5K or 64K bytes of memory, allowing the user to move on to other tasks while a document is printing.

Finally, if the daisywheel printers of the future must be user friendly, so too must they be "owner friendly." To compete with newer, but costlier, laser and jet-

spray printers, daisywheels must be not only economical to buy, but also economical to own. To this end the Series 80IF has an integrated sheet feeder, eliminating the need to purchase a separate one. In addition, its mean time between failure (MTBF) of 4,000 hours represents a significant achievement, considering the MTBF for most integrated sheet-feeder systems is only half that. Further, the dual-bin feeder is extremely reliable, averaging only one jam every 1,500 sheets.

In short, daisywheel printers are far from obsolete. Indeed, daisywheel printers with dual hammers, wedge-capture capability, closed stepper motors and print-on-the-fly ability may dictate the future of the industry.

Spec summary

- **Model:** Series 80IF
- **Company:** Diablo Systems Inc., 901 Page Ave., P.O. Box 5030, Fremont, Calif. 94537
- **Print speed:** 80 characters per second (AAA standard)
- **Interface:** All Purpose Interface (API), compatible with RS232C, Centronics and IEEE 488
- **Noise level:** 58 dB
- **Weight:** 80 pounds
- **Size:** 18.17 inches (or 12.74 inches without paper tray) by 23.82 inches by 21.17 inches
- **Cost:** \$3,495

Don Dempsey, acting vice president of OEM marketing and sales at Xerox Corp., has been with the company since 1968. He also spent five years in marketing and sales with IBM Corp. Dempsey has a B.A. in mathematics/physics from St. Peter's College, Jersey City, N.J., and an M.A. in mathematics from the University of Detroit.

Interest Quotient (Circle One)
High 843 Medium 844 Low 845

WE'RE LOOKING FOR OEM/VAR PARTNERS WHOSE DETERMINATION TO SUCCEED MATCHES OURS.

Here's our card. We're New Channels, a division of Cincom Systems. And we're looking for qualified OEM's and VAR's interested in partnering with one of the world's most successful independent software vendors.

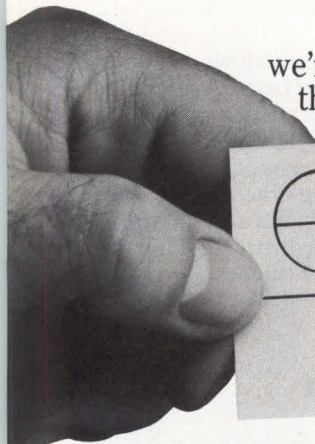

A partnership with Cincom means access to proven products. Like TOTAL®, the industry's most reliable DBMS which is portable across more than 50 different mainframe and minicomputer systems. And MANTIS™, our powerful 4th Generation Application Development System that enables you to build applications faster, more efficiently and with more quality than any other system.

A partnership with Cincom means attractive pricing policies designed specifically to help you both build your application and maximize its sales potential once it has been introduced to the market.

We provide the technology and the software industry expertise. We back up our commitment with unparalleled support for you and your customers.

If you're serious about an OEM/VAR venture, Call Bret Schultze, Marketing Manager for New Channels today at 1-800-543-3010 for additional information. It could be the beginning of a productive and profitable partnership.





When You Ask For A Custom Printer, We'll Do More Than Change The Logo.

Some people think swapping logos and cabinet colors is customizing.

Not C. Itoh.

Ask us to modify one of our standard printers and we'll not only change the outside: your logo, custom defined colors (two-tone if you like), tinted carriage cover, custom tear bar, serial number & ID tags, etc. But we'll also provide an almost endless array of custom features to the inside, including custom command sets, buffers, custom character or graphic sets, graphic dot density, superscripts & subscripts, interfacing, downloading

wheel and impact sequences . . . the list keeps growing.

And so has our product line, which now includes a full spectrum of Daisy and Dot Matrix printers in a wide variety of speeds, sizes and capabilities. Each loaded with the years-ahead features others charge extra for. Each available in large OEM quantities. And each backed by our full warranty and complete support organization.

It all adds up to a total commitment to the OEM market. Something C. Itoh started more than a decade ago. It's just one

reason why our roster of OEM customers includes some of the world's largest companies.

So contact us if you need a printer. And if you want it customized, don't worry, we'll do more than change the logo. Call or write C. Itoh Electronics at 5301 Beethoven Street, Los Angeles, CA 90066, Tel. (213) 306-6700, Telex WU 65-2451 ANS B. CIE LSA, Twx 910-343-7446 ANS B. CI ELEC LSA, Facsimile (213) 390-1188.



C. Itoh Electronics, Inc.

There Are Only Two Things New Tested Pairs

The Testing.

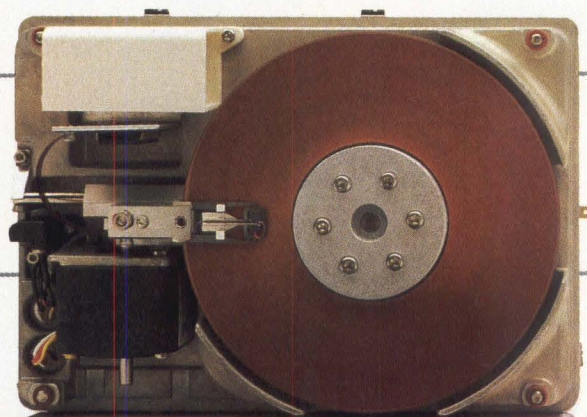

OEMs face major problems trying to decide which hard disk drives to build into their microcomputer systems. What with the wide range of drives, and so many hidden costs associated with evaluation, testing and integration, the process

becomes a time-consuming and costly hassle.

But there's a way out—from the company that's helped solve OEM disk controller integration problems more often and over a longer period of time than anybody in the business. That company is Xebec.

From standard-setting to vertical integration, from heavy investment in computer-aided design to the total commitment to the most automated manufacturing technologies, Xebec has demonstrated its leadership position in supplying microcomputer storage solutions.

Tested Pairs. The Guaranteed Match.

With its new tested pairs program, Xebec solves a major industry problem: post-delivery drive failure when interfaced to the controller. Having to do "after



the fact" drive testing for many of our OEM customers, we have decided to offer a "before the fact" program. We'll guarantee quality and reliability by assuring a match between our zero defect controllers and a choice of drives in different capacities and form factors.

It's simple. Tell us which drives you're considering and we'll test them on Xebec-designed equipment against the most rigorous standards in the industry. Standards we at Xebec have set. Then we'll tell you which of our controllers is the best match for that drive—or we'll customize a controller for you—and accelerate your time to market.

The Edge In Controller Technology.

Xebec controllers are well known as the best in the industry. Their single-board designs incorporate MOS microprocessors and the latest standard cell and surface mount IC technology. Compatible with standard interfaces, our controllers have set the pace with sophisticated data separation, advanced error detection and correction, hard-fault isolation, a high-level

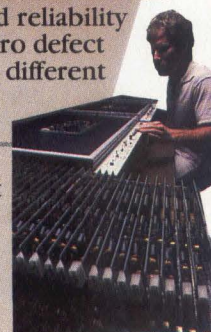

CORPORATE HEADQUARTERS
2055 Gateway Place, Suite 600
San Jose, California 95110 U.S.A.
(408) 287-2700

That Distinguish Xebec's Storage Solutions.

And The Pairing.

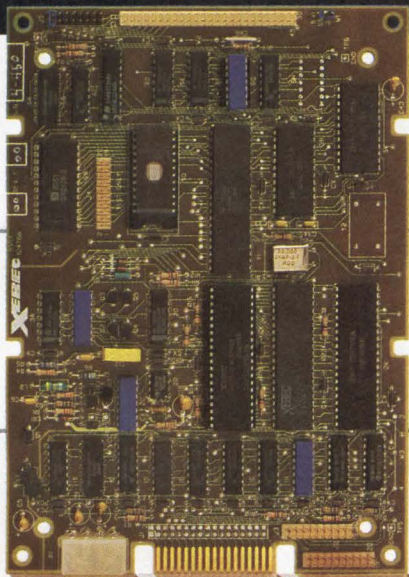

command set and other performance and reliability features.

Now these superior controllers can be paired with high-quality, Xebec-qualified drives. And you save time and money on evaluation engineering, incoming inspection, and service—while gaining a single-source, single purchase order solution to disk drive integration.

The Front Line Of Drive Testing.

We were recently asked to design and build a disk drive tester for one of the world's largest OEMs. We'll be using that tester to analyze disk drive performance for you. Full environmental testing, including shock and vibration. Full functional testing at elevated temperatures, with read/write tests at marginalized voltages. Careful calculation of hard and soft bit error rates. Complete checking of FCC and other agency emission standards. We'll make sure any drive meets its stated specifications and performance and quality claims.



How Xebec Does It. And Why.

Xebec can offer its tested pairs service to OEMs because of our commitment to quality. Zero defect quality symbolized by our "Xero D" signature and demonstrated by our superior computer-aided design, manufacturing and testing. Our talented people. Our experience. That's *how* we can provide high-quality products for prices no more than products that deliver a lot less.



Why offer our tested pairs? Why originate a new concept in quality? Enlightened self-interest. Because if we don't, someone else will. Frankly, we want to continue to enjoy the benefits of our leadership position as much as our customers do.

Call Xebec today. Pair up with one of our representatives to find out more about how Xebec tested pairs can benefit you.

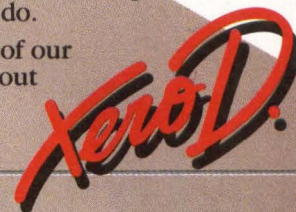

SALES, INTERNATIONAL,
Belgium
32-02-762-9494
England
44-734-693511
Italy
39-6-350201

SALES, U.S.A.
Sunnyvale, CA (408) 733-4200
Irvine, CA (714) 851-1437
Atlanta, GA (404) 457-9872
Boston, MA (617) 740-1707
Dallas, TX (214) 361-0687
Baltimore, MD (301) 992-7377
Federal (301) 621-3010
Chicago, IL (312) 931-1420

U.S.A. AND CANADA DISTRIBUTORS
Kierulff
Hamilton-Avnet
Avnet Electronics
Hamilton Electro Sales

XEBEC
The Quality Investment

CIRCLE NO. 79 ON INQUIRY CARD

Sell someone a Genicom 3000, and it may be some time before you hear from them again.

Genicom 3000 printer reliability can keep a customer happy for years.

From offices to factories across the country—hour after hour, day after day—Genicom 3000 printers have been proving their quality and reliability under even the toughest conditions for years.

The result has been a large number of very satisfied customers, which means a large number of satisfied OEM's. But durability is only part of the Genicom 3000 printer advantage.

The Genicom 3000 family of printers offers multi-model flexibility combined with single design simplicity to give OEM's real dollar savings with price/performance matching for every customer. Parts

commonality. Easier servicing. Single source supply. Plus you can select speeds from 180-500 cps draft/EDP, 45-100 cps NLQ, single or multi-

mode printing, automatic sheet feeders, document inserters, multi-color printing and graphics, plus more. There's such a diversity of models, features and options, you can choose just the right printer and you don't have to pay for things you don't need.

See how long you can keep your customers satisfied...with the long lasting, field proven printers that have earned the respect of OEM's nationwide—the Genicom 3000 family.

GENICOM

The New Printer Company.

Genicom Corporation, One General Electric Drive, Waynesboro, VA 22980 In Virginia, call 1-703-949-1170

For the solution to your printing needs call
TOLL FREE 1-800-437-7468



CIRCLE NO. 80 ON INQUIRY CARD

How to choose a printer supplier

New technologies and a market shift from minicomputers to microcomputers are forcing OEMs and system integrators to re-evaluate peripherals strategies and supplier relationships

Lex Pietraszkiewicz, Epson America Inc.

An OEM's choice of peripherals and peripherals supplier unavoidably affects system development and marketing strategy. Because the peripherals supplier is so important to the OEM's success, the procedure of evaluating and selecting this partner should not be given short shrift. And, even after the OEM selects the supplier, there are practical rules for a profitable relationship. An OEM may not utilize all the capabilities of a given supplier, but those services germane to the OEM's business should be carefully scrutinized.

An OEM or system integrator who develops and markets computer systems to end users through retail outlets, value-added retailers or through a direct sales force must take a fresh look at peripherals strategy, particularly at what is required from a supplier. A number of factors are accelerating the need for an effective strategy and supplier re-evaluation.

The shift in market emphasis from minicomputers to microcomputers, for example, has radically altered the

OEM's competitive situation. This shift decreases the OEM's control over product planning, if he utilizes non-proprietary architectures, processors or operating systems, because of the increased competition fostered by non-proprietary approaches. The shift also places greater emphasis on the OEM's peripherals strategies—such as for printers—because, in the microcomputer world, printers usually represent 25 percent to 40 percent of a system's price. The OEM must also rely more on retail distribution to compensate for the ever-increasing cost of direct sales. Finally, the OEM must depend on third-party software to sell hardware systems for specific applications; when minicomputers reigned, OEMs and manufacturers relied more heavily on their own software to sell hardware.

New technology also has a major impact on the OEM's peripherals strategy—especially insofar as it involves printers. New products often span various application markets and fall within competing price/performance ranges, forcing the OEM to constantly re-evaluate marketing strategies.

SUPPLIER'S OEM SUPPORT PROGRAM TYPICALLY COMPRISES FOUR GROUPS

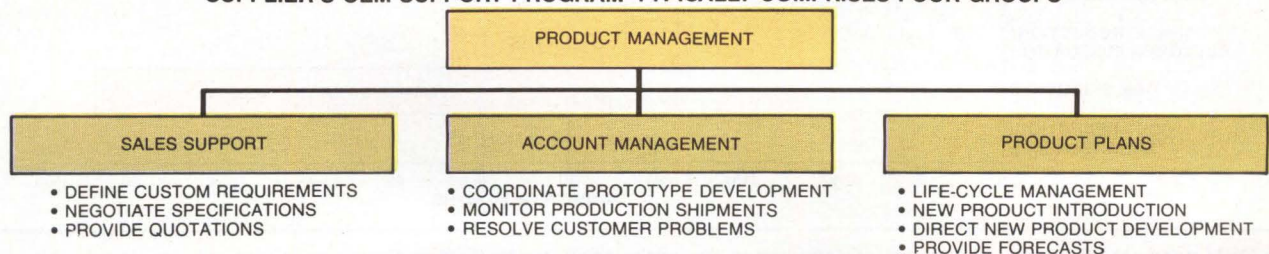

The OEM's own peripheral-equipment needs add to the hurdles. If the OEM is a high-volume manufacturer with emphasis on retail sales, attractive volume discounts are important. If the OEM offers an innovative, proprietary system where product differentiation is crucial, a supplier that can respond to unique requirements is more important than are volume discounts.

The OEM's choice of a printer supplier will also be affected by the OEM's method of distribution. Dependence upon third-party sales organizations, for instance, can increase the risk of printer substitutions at the point of sale. The printer supplier's willingness to stand by the OEM's product differentiation and pricing strategies is essential to minimizing such a risk.

What is an 'ideal' supplier?

The most common OEM/supplier relationships are these: The supplier is a "hardware supplier", providing the OEM with a standard off-the-shelf printer; the supplier is a "custom designer", providing a unique or modified-standard printer; or, the supplier is a "partner" in the proprietary design of a new printer technology, and shares research and development costs.

Ideally, a supplier should provide a variety of *services*, including pre-sale, ongoing engineering and marketing consultation and *support*—warranty, service, training, spare parts and documentation. Asking two basic questions about the prospective supplier can usually get the evaluation procedure off to a good start. Can the supplier provide printers that will produce acceptable profit margins as well as the required performance? Can the supplier provide printers that can be easily distinguished from printers sold off-the-shelf through retail channels?

The supplier's level of commitment to the OEM market should be an OEM's pre-eminent concern. Does

the supplier also deal directly with retailers and end users? If so, the prospective supplier may also be a competitor, distributing the same printer to the OEM's potential customers, and possibly offering the same features and performance at a lower price. However, there is something to be said for dealing with a supplier involved in both the OEM and retailing business: that OEM is more likely to appreciate the benefits of mass production, proven technology, reliability and market acceptance.

Can the supplier provide printers that can be easily distinguished from printers sold off-the-shelf through retail channels?

Although the OEM and supplier might share a common manufacturing facility, it is essential that the OEM products group have its own engineering and support staffs. Such human resources enable the OEM group to provide the product differentiation essential to price protection and competitive strategy. If the supplier can provide custom design, rather than just a specialized nameplate, the OEM can be confident of protection against product duplication in the marketplace.

If truly committed to the OEM market, the supplier will have performed extensive market research. Getting the benefit of this effort will help the OEM define and specify printer requirements. The OEM should know the criteria on which the target market's price/performance or cost/features criteria is based, as well as other buyer concerns such as reliability and service. In addition, the OEM needs to know the impact of competing technology, and if new technology can be

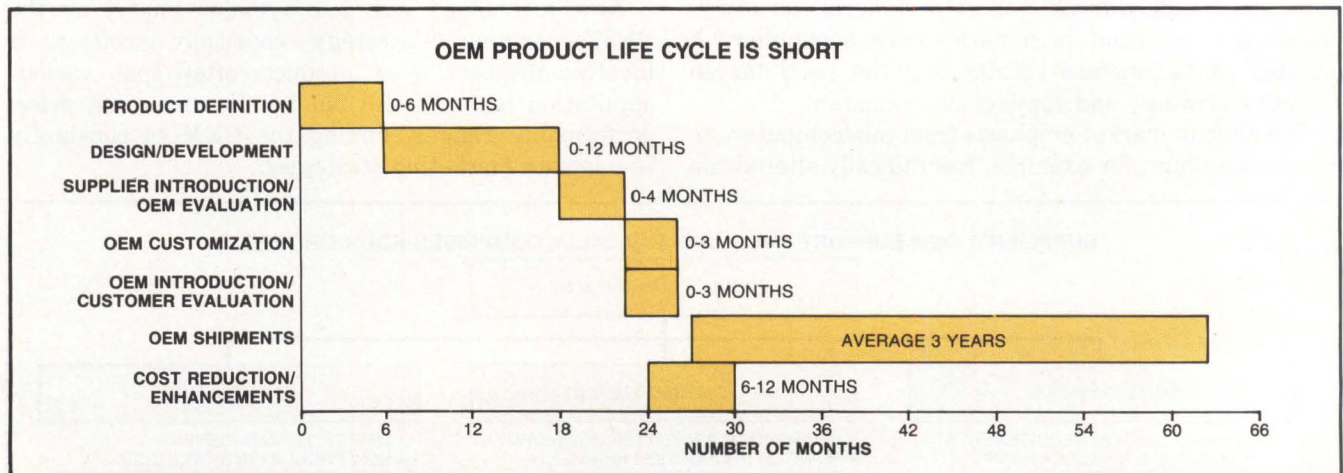

An OEM product life cycle, from product definition to discontinuation, typically lasts five years. OEM shipments take place for about three of those years, making a supplier's commitment to long-range planning vital.

utilized to enhance its own printers throughout the projected delivery commitment. Both parties must agree on later substitution of newer products. Market research can also help the OEM in setting inventory levels for finished products and spares.

Plan for product life spans

An important part of an OEM/supplier relationship is long-range planning. For example, a printer normally has a salable life span of three years, but emerging, competitive technology may severely shorten that period. It's disheartening to see a well-executed product design and marketing strategy torpedoed in mid-life by new technology or a lower-priced, similar product. The OEM's supplier should be in a position to recommend product life spans and to signal probable changeover points. In addition, the supplier should be able to offer information that will help the OEM phase out stock and introduce in new products without having to resort to fire sales or year-end write-offs.

The OEM should also assess the supplier's ability to monitor market developments. An OEM's customers could pass up one printer in favor of another that's available off the shelf, perhaps for less money and with more—or at least equal—performance and features.

OEM volume governs printer choice

To a large extent, the OEM's sales volume governs the freedom of printer selection. If volume is less than 500 units per year, OEM investment in printer development will be negligible. In this case, the OEM would select a standard printer and negotiate the best possible volume discount. If sales volume is 1,000 to 2,500 units per year, the OEM can probably afford minor modifications or customization. If sales volume is high enough—say, 5,000 units per year or more—the OEM may want to commit to the development of a custom printer. This ensures an exclusive product.

The OEM should be aware that printer suppliers that provide a broad range of products have necessarily committed substantial resources to the product line and must be manufacturing in volume. The supplier most likely sells a portion of that volume through retail distribution channels. Thus, the chances of the OEM's customers finding the system printer in a retail outlet are fairly good, unless the OEM has performed minor modifications.

Interface requirements often represent an OEM's strategy to discourage customers from substituting off-the-shelf printers for the OEM's system printer. Thus, the ability of the supplier to furnish the required interface is important. However, cost considerations may force the low-volume OEM to accept a standard interface.

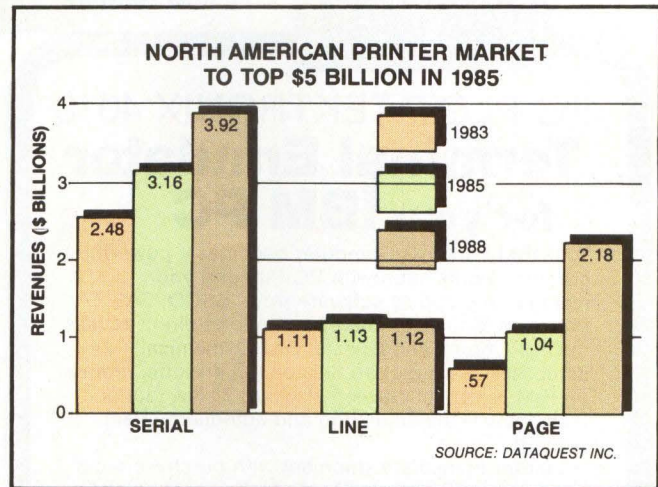

The OEM should assess the supplier's ability to present a variety of hardware options, including cabinet design and appearance, location and function of operator controls, and power-supply configurations. The ability to provide a universal power supply is critical because it can simplify and perhaps eliminate the problems encountered in forecasting separately for international and domestic markets.

The choice of other printer features is a direct function of the OEM's application. The OEM should investigate the ability of the supplier to furnish the right mix of features without special design and development costs.

Check the supplier's support services

An OEM who has dealt with a peripherals supplier has already had a number of good or bad experiences with the business side of the relationship and should be well armed to assess the basics of the final agreement. These basics include warranty provisions, service, drop shipments, local engineering support and account management responsibility.

Most suppliers offer a 30-day warranty on printers. Others, with substantial production experience and installed product bases, are able to offer more. For example, Epson America Inc., offers a one-year warranty.

Service options range from the supplier's in-house departments to third-party service arrangements. If the supplier offers third-party service, there should be provisions for training the third-party maintenance technicians, and for providing them with necessary engineering and service documentation.

When the OEM and supplier agree on custom printer specifications, there is always the possibility that some mechanism, such as firmware or package design, has already been patented by another OEM or manufacturer. In such cases, the supplier should do a patent

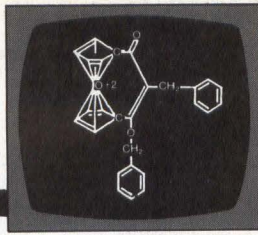

The Graphics Link
between your
IBM PC and your
Computer Network

PC-PLOT TEKTRONIX 4010 Terminal Emulator for your IBM PC

Your IBM Personal Computer becomes a powerful graphics workstation with PC-Plot and your mainframe graphics software from ISSCO, SAS, Precision Visuals, or Tektronix. Allows direct access to CAS OnLine and Questel DARC chemical databases. Save picture files on PC diskette, redraw on IBM printer or Hewlett-Packard 7470A plotter. Includes VT-100 emulation and autodial modem support.

Call for immediate shipment with purchase order number or VISA/MasterCard number or send check.

Call or write for complete technical brochure.

\$95 plus \$3 shipping
For information call:
800-633-2252
ext 260



2152 E. DUBLIN GRANVILLE RD. SUITE 205
COLUMBUS, OHIO 43229 614-882-4786

CIRCLE NO. 81 ON INQUIRY CARD

TERMINALS FROM TRANSNET

PURCHASE PLAN • 12-24 MONTH FULL OWNERSHIP PLAN • 36 MONTH LEASE PLAN

Authorized Distributors — Carry the COMPLETE lines of:			MONTHLY RATES			
			Purchase	FULL Ownership		Lease
				12 mo.	24 mo.	36 mo.
DEC 	LA50	Personal Printer	\$ 650.	\$ 65.	\$ 35.	\$ 25.
	LA120KSR	DECwriter III	2295.	220.	125.	85.
	VT101	CRT Terminal	1195.	115.	65.	45.
	VT102	CRT Terminal	1425.	140.	75.	50.
	VT220	CRT Terminal	1150.	110.	65.	45.
TI 	TI820KSR	Terminal Pkg.	1995.	190.	105.	75.
	TI850	Printer w/Tractor	575.	55.	30.	20.
	TI855	Dual Mode Printer	895.	85.	50.	30.
	TI855	Dual Mode Printer	895.	85.	50.	30.
TELE-VIDEO 	TV914	Tilt/Swivel CRT	615.	60.	35.	20.
	TV950	CRT Terminal	1075.	105.	60.	40.
	TV970	Tilt CRT Terminal	1195.	115.	65.	45.
NORTHERN TELECOM	NT6K90	Displayphone plus	1395.	135.	75.	50.
	NT6K00	Displayphone	1095.	105.	60.	40.
	NT6K55	Modem 212/A	525.	50.	30.	20.
C ITOH	CIT101	Video Terminal	1095.	105.	60.	40.
	CIT414A	Graphics Terminal	1395.	135.	75.	50.
	CIT500	W/P Terminal	1995.	190.	105.	70.
	CIT600	Line Printer	5595.	540.	300.	200.

ON SITE TECHNICAL SUPPORT & SERVICE

PERSONAL COMPUTER SYSTEMS

Visit our computer stores in Union and Ocean, NJ
AUTHORIZED RETAIL DEALER

APPLE® Ie, IIc, MAC, III and LISA — DEC RAINBOW — TI PROFESSIONAL

SUPPLIES — FREE CATALOG — CALL

DEC is a registered trademark of the Digital Equipment Corporation.

APPLE is a registered trademark of Apple Computer Inc.



TRANSNET CORPORATION

1945 ROUTE 22 — UNION, NJ 07083

In NJ (201) 688-7800 • (800) 526-4965 • TWX 710-985-5485

CIRCLE NO. 82 ON INQUIRY CARD

PRINTERS

search. Suppliers have been known to intentionally leave patent identification clauses out of contracts, and such "oversights" could lead to a lawsuit against the OEM. Some suppliers provide patent-search services for their printers, as well as for the OEM's entire system.

The supplier's level of commitment to the OEM market should be an OEM's pre-eminent concern.

If the OEM works with a supplier whose manufacturing facilities are offshore, it's crucial for the supplier to maintain full-service offices in the United States. Those should include a staff of application engineers, product managers, planners, hardware designers and technicians and service and support personnel. The facility should also be able to produce prototypes of custom-designed printers for pre-manufacturing evaluation.

All these factors provide a good indication of the supplier's commitment to the OEM market. Whatever mix of services and capabilities a supplier offers, the prudent OEM will not overlook the evidence of the supplier's dedication to the OEM market. The attractions of the retail market are strong, and a supplier with limited resources and unlimited ambitions may provide only lip service to OEM customers. □

Lex Pietraszkiewicz is manager of product marketing, printer products, for Epson America Inc.'s OEM Products Division. Previously with Okidata Corp., Scientific-Atlanta Inc. and Simmons Precision Products Inc., he has been involved with the product management of computer peripherals and accessories for several years.

Interest Quotient (Circle One)
High 846 Medium 847 Low 848

LOOKING AHEAD IN MMS

Be sure to watch for these editorial highlights in coming issues of Mini-Micro Systems:

- The February issue will spotlight disk and tape drives and controllers.
- The premier issue of MMS' Communications Digest will appear February 15.
- Portable computers and PC compatibles will be profiled in the March issue.
- Minis and UPSs will hold center stage in the April issue.

INTRODUCING LARGE-DISK PERFORMANCE IN DRIVES HALF THE SIZE

MODEL 9715 FSD. With 160, 340 or 515 Mbytes in a sealed module, you get the same capacity, speed and performance as the CDC® Mini Module Drive (MMD) in a unit one-half the size.

MODEL 9710 RSD. With 80 Mbytes in removable data packs for unlimited storage. Has the same capacity, speed and performance as a CDC Storage Module Drive (SMD) in a unit one-half the size.

**TOLL FREE
HOTLINE**
1-800-828-8001
EXT. 82
IN MINNESOTA
(612) 921-4400

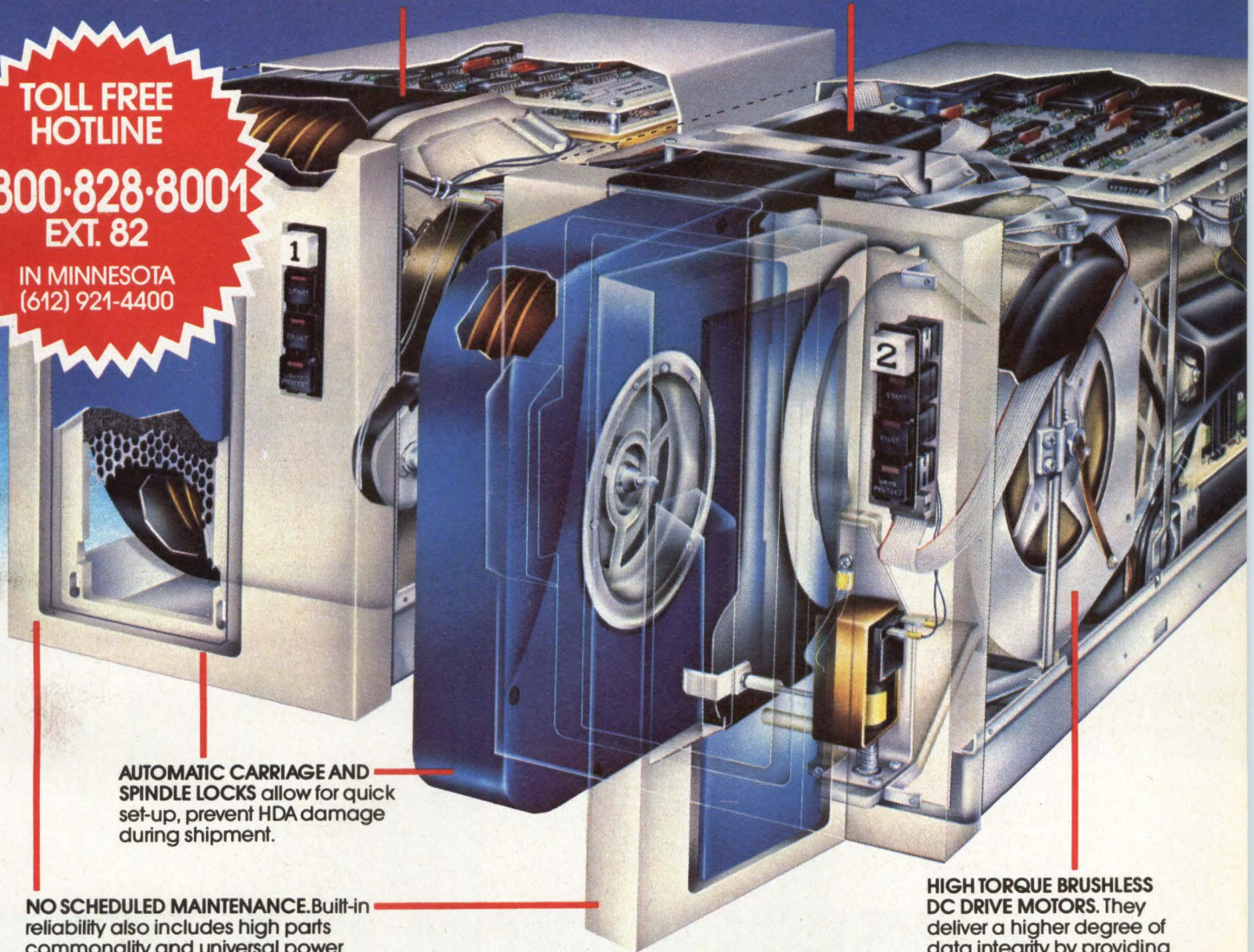

AUTOMATIC CARRIAGE AND SPINDLE LOCKS allow for quick set-up, prevent HDA damage during shipment.

NO SCHEDULED MAINTENANCE. Built-in reliability also includes high parts commonality and universal power supply (100-240V, 50/60 Hz) for easy installation worldwide.

BOTH MEET FCC, UL, CSA, VDE STANDARDS FOR A STAND-ALONE UNIT.

HIGH TORQUE BRUSHLESS DC DRIVE MOTORS. They deliver a higher degree of data integrity by providing rapid disk acceleration with minimum head drag. (Both models)

T H E F S D™ / R S D™ S E R I E S

Both 9710 and 9715 Drives use LSI circuitry for all read and write, fault, transmitter/receiver functions and a μ P for servo control, for full performance in half the space. For more data call your local Control Data OEM Sales Representative or write: OEM Product Sales, HQW08X, Control Data Corporation, P.O. Box 0, Minneapolis, MN 55440. Also available through your Arrow and Kierulff Distributor.

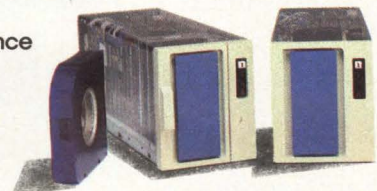

GD CONTROL DATA



UNIX™ SYSTEM V. FROM AT&T. SELLING

When you start with products based on UNIX System V from AT&T, you can end up closing the sale. And opening up new markets.

It's another reason why good business decisions are based on UNIX System V from AT&T.

More and more of your customers will be demanding multi-user and multi-tasking systems. The benefits of UNIX System V—portability, reliability, flexibility—make it the ideal software

system for this lucrative market.

In addition, AT&T will support UNIX System V with the service, training, and documentation resellers need to prosper.

More choices, more opportunities

UNIX System V is virtually hardware independent. So you'll be able to configure systems using equipment from a variety of vendors.

You can use the flexibility of UNIX System V as a real selling

point to customers who want to add hardware that is compatible with the machines they already have.

And over the long term, UNIX System V offers continuing opportunities to upgrade and expand your customers' systems. End-user flexibility translates into market opportunity for the reseller.

Software that sells

UNIX System V offers another sales opportunity in

SYSTEM V

FROM THE START.

an area of tremendous potential—customized software.

You'll be able to sell software for a wider range of configurations. You'll have more software to offer, too. Your programmers can concentrate on developing new packages instead of rewriting old ones.

For more information on this sales tool from AT&T, send in the coupon for a copy of our free booklet, "Why Good Business Decisions are Based on UNIX System V."

**UNIX System V. From AT&T.
From now on,
consider it standard.**

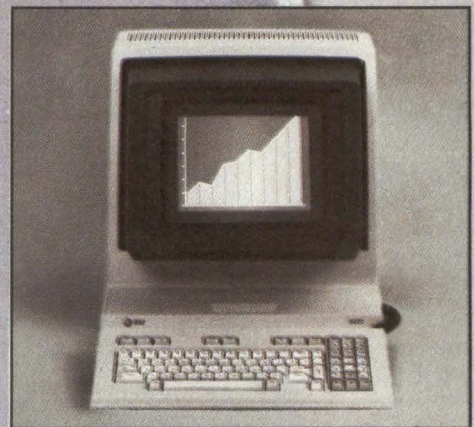

MS-0100-CA

Please send the free booklet "Why Good Business Decisions are Based on UNIX™ System V."

Mail to: AT&T, P.O. Box 967,
Madison Square Station,
New York, NY 10159

Name _____

Title _____

Company _____

Address _____

City _____ State _____ Zip _____

My business category (check one):

OEM/VAR Software House
 MIS/DP Mgt. General Business Mgt.

Other _____
UNIX System Licensee Yes No Don't know

Now, terminal bored at a reasonable cost.

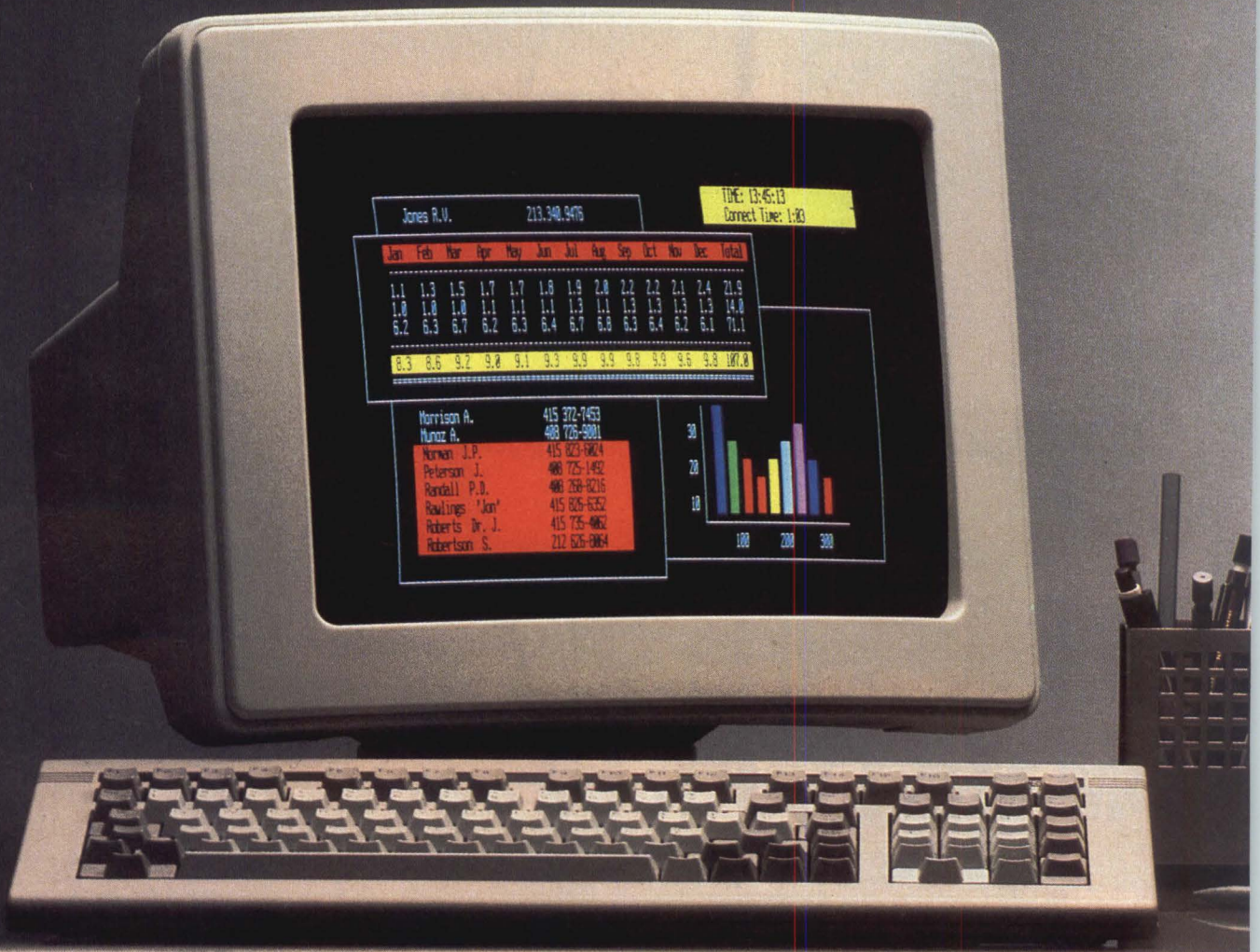

om can be cured

Even in alphanumeric displays, color can mean important gains in productivity. The use of color can bring any application to life.

And now, the new WY-350 ends terminal boredom inside and out. It has all the features that have made the WY-50 a worldwide best-seller: tilt/swivel screen; 132 column format; adjustable, low-profile keyboard. In fact, the WY-350 *is* the WY-50, plus a slightly larger screen, and 64 crisp, clear colors. So, like the WY-50, it's fully software and hardware compatible with most computer systems.

The WY-350 is an exciting, colorful performer at an unbeatable price. For more information about our complete line of products, call the regional office nearest you: Northeast (201) 725-5054; Southeast (305) 862-2221; Midwest (313) 471-1565; Southwest (818) 340-2013; Northwest (408) 559-5911.

WYSE
| | | |

Wyse Technology, 3040 N. First Street, San Jose, CA 95134.

CIRCLE NO. 85 ON INQUIRY CARD



Pictorial depicts the inside story of the 234M-byte, embedded-servo, Mercury Series 8-inch Winchester disk drives manufactured by Northern Telecom Corp., Ann Arbor, Mich.

High-capacity 8-inch Winchester aim to overtake 14-inch market

Pushed by 5¼-inch Winchesters, 8-inch drives are breaking past the 160M-byte barrier, supplanting 14-inch models in newer system designs

Carl Warren, Western Editor

Despite their lack of glamour, the increasing capacity of 8-inch Winchester disk drives keeps them high on the heap of storage devices. As a result of being pushed from the low-end by 5¼-inch drives, 8-inch models have grown in capacity from Shugart Corp.'s popular 10M-byte SA-1000 to models ranging from 160M bytes to above 500M bytes. Industry watchers such as James Porter of Disk/Trend Inc., Los Altos, Calif., and Dennis D. Waid of Peripheral Research Corp., Santa Barbara, Calif., see 8-inch capacities expanding into the gigabyte range as storage needs continue to expand.

As 8-inch drive capacities expand, the market for 14-inch drives dwindles and may, say some observers, eventually disappear. According to Porter, the benchmark is the 84M-byte Fujitsu Ltd. 2312 drive that sports a 23-msec average access time. "This drive, which became available in April 1981, offered manufacturers of supermicrocomputers and low-end minicomputers a viable alternative to 14-inch drives," Porter says. As with 5¼-inch implementations, space is an important issue. Therefore, high-performance 8-inch drives offer a reasonable alternative to 14-inch drives in a smaller footprint.

What's more, available technology is still used to increase the capabilities of 8-inch drives. Drive manufacturers have a wide range of media and transducers [read/write heads] and a variety of interfaces from which to choose. "System OEMs have a long list of good alternatives," says Porter, "It's more of a matter of choosing the proper design-in window. Right now there are drives ranging from 16M bytes to over 500M bytes.

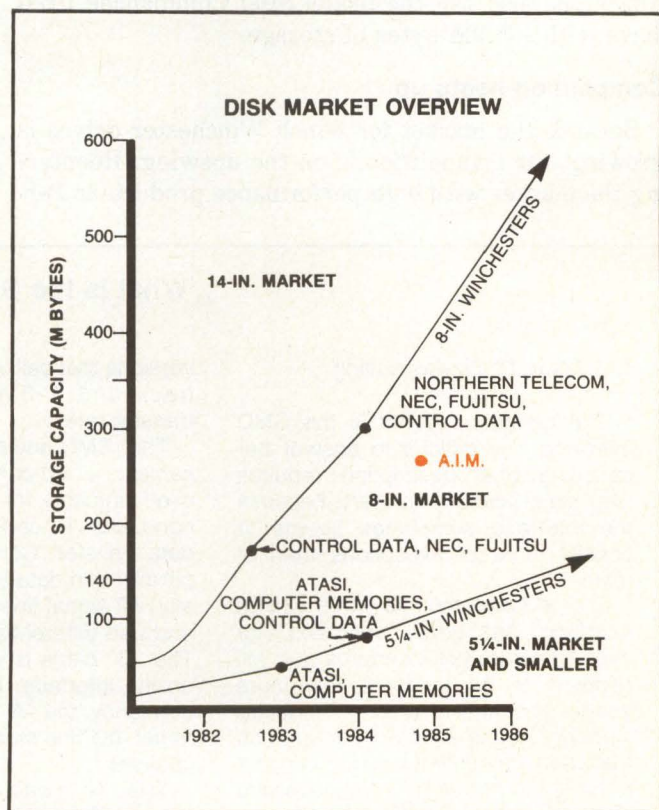

Eight-inch drives are moving up fast on 14-inch markets, and most 5¼-inch drives are stabilizing around the 140M-byte range. But newcomers such as Applied Information Memories slip over into the high-performance arena in a 5¼-inch package.

The OEM only has to determine the specific application requirements."

The system OEM does have an impressive shopping list from which to make a selection. For example, Control Data Corp. (CDC), Minneapolis, Minn., offers the FSD series of sub-14-inch drives that employ 9-inch platters and range in capacity from 160M bytes to 340M bytes. A 516M-byte version is expected soon. These drives have established the performance pace for the entire class of sub-14-inch drives.

Priam Corp., San Jose, Calif., is outstripping its sales of 14-inch products with a series of 8-inch drives. This family ranges in capacity from 35M bytes for the model 3450 to 500M bytes for the model 808. Another contender for a piece of the 8-inch, high-performance pie is Kennedy Co., Monrovia, Calif. The Kennedy model 73160 drive fits the low end, with 165.9M bytes of unformatted capacity and a swift 20-msec average access time.

Amcodyne Inc., Longmont, Colo., is also enjoying success with a series of 8-inch drives. The Amcodyne Arapahoe 7110 cartridge drive has 26.6M bytes of removable storage. To meet higher capacity needs, Amcodyne also has the model 8160 Commanche fixed drive with 165.9M bytes of storage.

Competition heats up

Because the market for 8-inch Winchester drives is growing, the competition is on the upswing. Reentering the market with high-performance products is Per-

tec Peripheral Corp., Chatsworth, Calif., with the DX series. In the past, Pertec had fallen on hard times with a number of ill-fated designs. But vice president of marketing James Youngblood asserts the company is back in contention. Pertec is tracking the industry closely and is slipping into the storage-module-device (SMD) arena with a full family of drives that range in capacity from 180M bytes to 300M bytes. "We discovered that we had entered the market too late with too little. By the time we had working 8-inch designs, 5¼-inch drives were encroaching on existing 8-inch performance. The market we thought was there vanished and forced us to reevaluate the market and our product strategy," Youngblood explains.

While in the redevelopment phase, Pertec discovered that the market was highly segmented. Manufacturers of 5¼-inch drives served the lower half of the market; CDC had the higher-end [14-inch] domain, but was vulnerable where price/performance requirements could be met with 8-inch designs. Essentially, the market is seeking drives that offer 14-inch performance in smaller sizes, with equal transfer rates and access times, according to both Youngblood and Porter.

It appears that the low end of the 8-inch performance bracket is about 160M bytes; the top end is 300M bytes and improving. Megavault Corp., Woodland Hills, Calif., is readying the models MV-300 and MV-660—331.8M bytes and 660.4M bytes respectively—for the

What is the SMD interface?

Dal Allan, ENDL Consulting

The question, "What is the SMD interface?" is difficult to answer because a brief description requires over-simplification, in part because the interface sometimes seems to consist more of exceptions than of rules.

The storage module drive (SMD) interface has been criticized for over 10 years, yet it endures and will continue to do so for a few more years. The interface is an industry standard, but is adaptable enough so that users have been able to change it to meet the needs of rapidly evolving disk technology.

In its early stages, the SMD interface specified 20,160 bytes per track and a 1.2M-byte-per-second transfer rate. More recently, manufacturers have introduced versions that handle 40,480-byte-per-track data transfers at 2.4M bytes per second, as well as

versions that call for 50,400 bytes per track and a 3M-byte-per-second transfer rate.

The SMD interface requires two cables: a 60-conductor "A" cable used primarily for control, and a 26-conductor "B" cable used primarily for data transfer. Control takes place in parallel and data transfer occurs serially. All signal lines are unidirectional and use differential drivers/receivers. The "B" cable is radial to every disk on the interface. In systems with redundancy, the "A" cable may also be radial, but it is more commonly daisy-chained.

The "A" cable contains three buses: Selection (4 signals), BUS OUT (10 signals) and BUS IN (8 signals). The contents of the buses are interpreted according to the setting of one of seven tags. (The standard SMD has only tags 0-3, but extensions have defined tags 4-6.) Tag 5 is a doubly defined signal that is the

Selection Bus Bit 3 when tag 0 is not set. Tag 6 is the gated product of tag 4 and tag 5. The tag definitions are:

- Tag 0 and selection bus—Device Selection
- Tag 1 and BUS OUT—Set Cylinder Address and Initiate Seek
- Tag 2 and BUS OUT—Set Head Address and Cylinder Address
- Tag 3 and BUS OUT—Data Transfer or Control Function
- Tag 4 and BUS IN—Report Current Sector Address
- Tag 5 and BUS IN—Report Extended Status (this information tends to vary widely by vendor)
- Tag 6 and BUS IN—Report Access Status and Device Type Status (this also varies widely by vendor)

During the setting of tags 0-3, the contents of BUS IN are always available to advise of drive status conditions.

The "B" cable consists of seven inbound and two outbound signals.

first and second quarters of 1985. Megavault, like Pertec, anticipates the industry will buy more 8-inch, high-performance Winchester.

The Mercury series of drives from Northern Telecom Inc.'s Memory Systems Division, Ann Arbor, Mich., sport capacities from 71.8 to 378.6M bytes. According to Ray Kavlick, vice president and general manager of the Memory System Division, tough design problems were solved in developing the product. "We aren't pushing the areal density, so we don't push the interface bandwidth. About 2.2M bytes is the maximum boundary of acceptable bandwidth. We went to great lengths to stay within the boundaries of SMD without sacrificing performance." There are various ways to increase areal [tracks per inch (tpi) times bits per inch (bpi)] density. One is to increase the tpi and bpi together. But increasing the bpi speeds up the transfer rate. Another method is to increase the tpi and hold the bpi steady. Currently, most drives hold bpi at about 10,000 bpi and 900 to 1,000 tpi to maintain SMD compatibility.

SCSI predicted

Virtually all the 8-inch manufacturers adhere to the SMD interface. The interface requires a 1.8M-byte transfer rate (see "What is the SMD interface?" below). Even though adherence to SMD is considered important for high-performance drives, none of the

manufacturers is ignoring other interfaces.

For example, Northern Telecom's disk product manager, Ken Nisbet, points out that the Small Computer System Interface (SCSI) is now in the SMD area of performance and offers a viable alternative to various system approaches. "But as capacities go up, the transfer rate has to keep going up," Nisbet explains. "In a very short time 15 MHz will be the requirement and that's when IPI-2 [Intelligent Peripheral Interface] will come into play. We are making provisions to handle it as well," he says.

All the manufacturers agree that SCSI is coming. Controller manufacturers are developing host adapters to meet the expected demand. "The whole disk strategy is going to change," says Kavlick. "It is driven by local area networks and multiuser systems. System integrators aren't going to be burdened by primitive disks. As capacities go up, so will the intelligence and transfer rates."

Servoing included

Because the newer 8-inch drives are able to handle so much data and retrieve it quickly, sophisticated tracking (servoing) systems are included in the drive. Two methods are used by drive makers: dedicated surface and embedded. Both offer advantages to users and to manufacturers.

In embedded servo systems, for example, the elec-

Two of the inbound signals—Index and Sector Mark—duplicate those available on the "A" cable BUS IN. It is possible to configure drives to provide these signals on cable "A," "B" or both. Some controllers continuously monitor the Index and Sector Mark signals on the "B" cable of each drive, because it is radial. This requires a lot of logic, but enables the controller to maximize performance because it knows where each drive is positioned by cylinder and sector at all times.

The Unit Selected signal confirms device selection. If it occurs on two "B" cables, this indicates false selection or an improperly configured system. The Seek End signal must be interpreted according to BUS IN on the "A" cable to determine if the seek completed successfully.

Of the five signals used for data transfer, two are paired as Read Data and Read Clock, and two as Write Data and Write Clock. The fifth is the Servo Clock, which is generated by the drive and echoed back to the disks

as Write Clock by the controller. Thus the disk controls data timing because it is responsible for clock generation.

Data is transferred in a non-return-to-zero (NRZ) format and is integrated with its corresponding clock to produce valid data. Thus a byte consisting of three zeros followed by four ones and a zero would require processing two data transitions and eight clock pulses.

The controller uses Read Gate and Write Gate on BUS OUT (during tag 3) to toggle when data is to be read or written by the disk. There is a critical timing relationship during all stages of data transfer because of the need for the controller to perform gap management. The timing between disk and controller is critical because not only must the data be clocked but also the phase-locked oscillator (PLO) synchronization, sync-byte recognition, write splicing, and start/end or record tolerances must all be handled.

Many companies have added enhancements to the SMD interface

since its introduction in the early 1970s by Control Data Corp. The sum of the most popular enhancements and the standard SMD is referred to as the SMD-E interface. The probable successor to SMD—the intelligent peripheral interface (IPI)—incorporates the enhancements found in SMD-E. The device-level implementation of IPI is a higher-performance alternative to SMD. Because it takes a long time for manufacturers to change hardware interface models—and an even longer time to replace existing software interfaces—the replacement of SMD by IPI will be a gradual development.

Dal Allan is the founder of ENDL Consulting, Saratoga, Calif. He is also vice chairman of the American National Standards Committee X3T9.3, which is responsible for peripheral device interfaces.

tronic pulses that keep the read/write transducers properly positioned over the data are written on each data surface. With this method, the servo data is continually read with each seek by a read/write transducer. This servo (positioning) information comprises an identification burst and an address mark with a cyclical redundancy check (CRC). The same is basically true for dedicated surface servos except that the positioning information is written on a single surface that uses a read/write transducer to follow the servo information and feed it back to the positioning electronics that guide all the transducers on the head assembly.

Detractors of dedicated servo systems point out they take up an entire data surface and don't take into account movement of the head assembly due to shock or aging. On the other hand, they note that embedded

servos always cause the transducers to follow regardless of changes in the drive chassis or media. But embedded servoing doesn't come free. It uses only portions of each data surface (typically less than 2 percent), but it does determine fixed-sector (data area) sizes. These sector sizes can range from 256 bytes to 1,024 bytes. Some system integrators say that they prefer to choose the size, rather than work in fixed limits.

The method of servoing may end up as a non-issue along with the sector sizes, however. Pertec's vice president of engineering, Hossein M. Moghadam, explains that the company chose to use a dedicated servo primarily to ensure absolute adherence to SMD requirements. But he does admit, "A lot of system OEMs question dedicated servos since they can be forced

One can increase areal density by increasing tracks per inch (tpi) and bits per inch (bpi) together, but increasing bpi speeds up the transfer rate. The tpi can be increased while holding the bpi steady. Most drives maintain SMD compatibility by holding bpi at about 10,000 and tpi at 900 to 1,000.

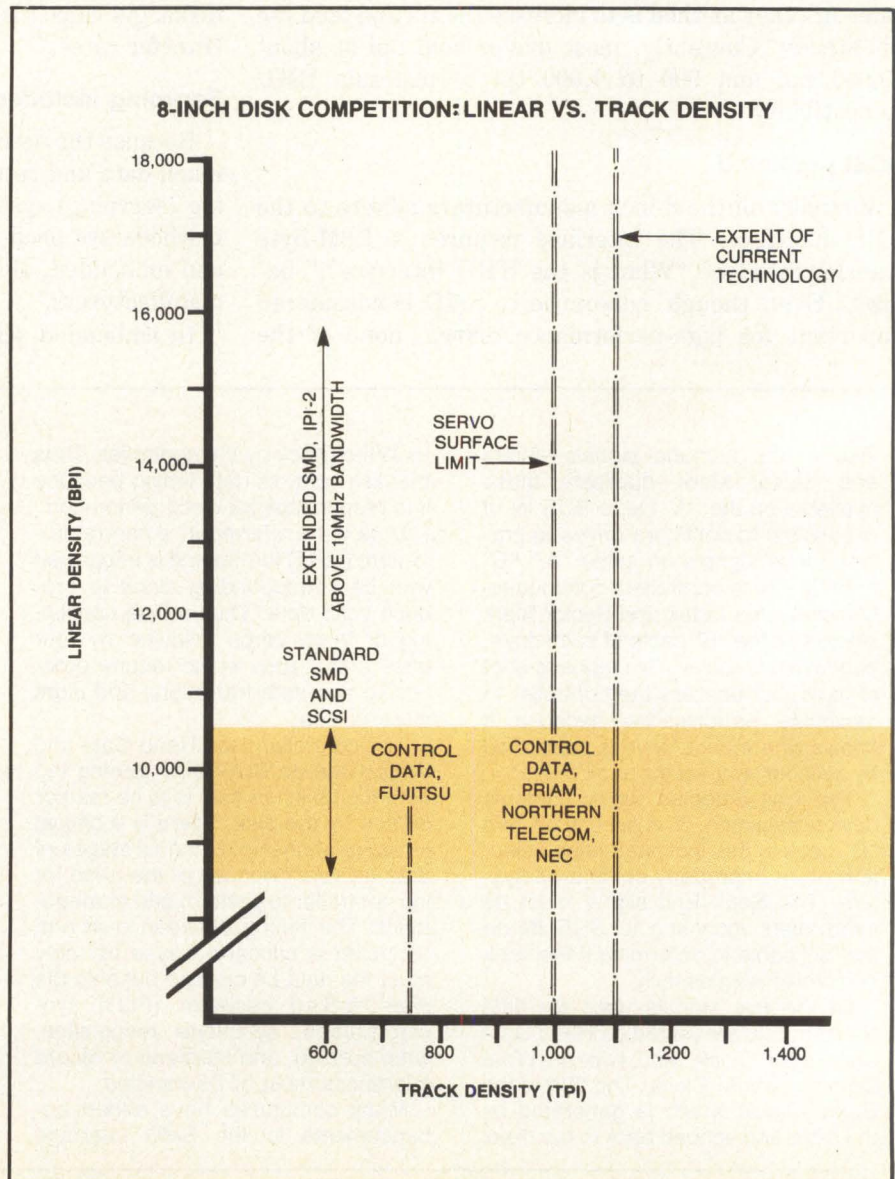

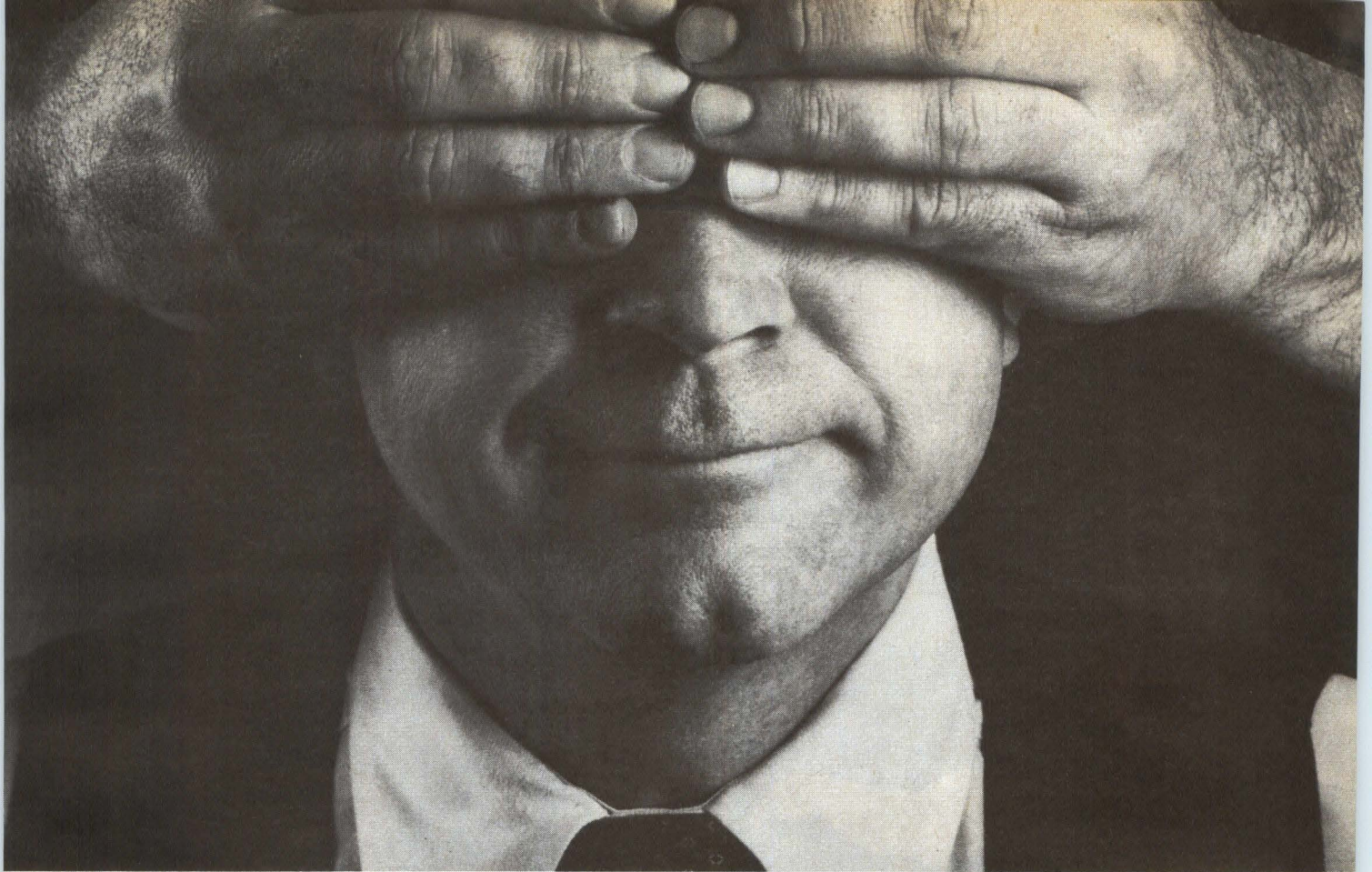

The only reason you're not using Pioneer's disk drive tester already.

If you still haven't seen the Pioneer hard disk drive tester in action, it's time to take a look. And judge for yourself.

Beginning with the price tag, every aspect of the Pioneer Qualifier™ is designed to meet your requirements for pocketbook *and* performance.

It's the only tester to interface with any and all SMD drives.

It's the only one with a hefty 20-megabit per second capability. Even at triple the price.

It's the only one that can read and transfer Fujitsu's error map right into your computer. In seconds.

It's the only one that will format to your custom specs. And it does it at one megabyte per second. Over five times faster than by computer.

It pinpoints your errors to a specific media sector. And separates the correctable from the uncorrectable. So you can detect and log either set.

Have you ever seen a tester that does all that?

And also checks the address mark capability of your drive? And isolates

intermittents in the output? And works with embedded servos? And can be multiplexed to test four drives at once?

The Pioneer Qualifier does all those things. And easily, at that.

It's almost turnkey. It's totally programmable through the simplified keyboard. And you can input a custom set of drive characteristics with no EPROMS to modify or boards to change.

Plus, there's even a standard RS232 port for remote operation, data print-out, uploading and downloading.

Call Pioneer for a demonstration today. It's an eye opener.

Pioneer Research, 1745 Berkeley St., Santa Monica, CA 90404.
(800) 233-1745
(outside California).
(800) 848-1745 (in California). Rep opportunities available.



 **Pioneer Research**

Qualifier is a registered trademark.

CIRCLE NO. 86 ON INQUIRY CARD

THE
ASIAN
COMPUTER
MARKET
IS
EXPLODING



ANNOUNCING
COMDEX™
IN JAPAN '85

March 26-28, 1985
Harumi Exhibition Center
Tokyo, Japan

COMDEX in JAPAN '85 is the *only*
computer exhibition organized exclusively
for Asian Independent Sales Organizations (ISOs) and
the producers of computer and related products from around the world.

Do business with professionals who can recognize the profit potential of what you offer.
Do business with professionals who can best present your products to their end-user customers.
Do business with professionals who know and understand local, regional, and national differences.

For more information call (617) 449-6600.
Or write Exhibit Sales, COMDEX in JAPAN, 300 First Avenue, Needham, MA 02194.

Presented by



World's leading producer of computer conferences and expositions including: COMDEX/Winter, COMDEX/Spring, COMDEX/Fall, COMDEX/Europe, COMDEX in JAPAN, INTERFACE, FEDERAL DP EXPO & CONFERENCE, The Nationwide COMPUTER SHOWCASE EXPOS & THE BYTE COMPUTER SHOWS

300 First Avenue, Needham, Massachusetts, USA 02194 • (617) 449-6600 • TELEX-951176 • TWX-710-325-1888

In Europe: Rivierstaete, Amsteldijk 166, P.O. Box 7000, 1007 MA, Amsterdam, The Netherlands • Telephone 31-20-460201 • TELEX-12358NL

In Japan: Kashiwabara Bldg. 2F 1-3-3, Kyobashi, Chuo-Ku, Tokyo 104 • Tel. 03-271-0246 • FAX 03-271-0248 • TELEX 25845 SIMPLE

off-track due to shock. We are aware of that possibility and, if we sense an off-track indication, we turn the write gate off so we don't overwrite adjacent tracks."

Most drives using dedicated servos turn off the write gate when an off-track event is sensed. But Northern Telecom's Nisbet insists that isn't sufficient. "Embedded methods let the transducers always follow the tracks. Shock is only part of the problem. Drives age and the characteristics can change, thus causing transducers to go off-track. An embedded design always forces the transducers on track."

Nisbet adds that the forced fixed-sector sizes of embedded servos designs is not important. "All the system integrator wants is a drive that can be plugged in and that will operate. He really only sees the interface connector. As SCSI becomes more popular, everything becomes transparent." Both Nisbet and Youngblood agree that users tend to buy drives of this class based on performance, not price.

The forthcoming IPI-2 interface also promises transparent operation, and newer, speedier—and intelligent—versions of SMD are isolating the user from the internals of the drive. "It is rapidly becoming a plug-and-go business," says Chris Karzag, director of marketing research for controller manufacturer Spectra Logic Corp., Sunnyvale, Calif. Raymond C. Freeman, president of Freeman Associates, Santa Barbara, Calif., a consultant on data storage technology and markets, concurs. "The ideal is to isolate both ends of the system from each other as far as how they operate. That's why developing standardized interfacing methods such as SCSI, IPI-2, ESDI and the QIC techniques are so important: They put the burden on the individual devices so the system OEM can plug them together in a standardized way."

Markets acquire new shapes

Clearly, the Winchester disk drive markets are taking on new shapes. Sub-4-inch drives are pushing the low end of the 5¼-inch drives, which are in turn pushing 8-inch drives. The high-end, 14-inch market, however, appears to be dwindling as system OEMs demand more in smaller packages.

It appears that manufacturers of 8-inch SMD-compatible Winchesters have little to fear from 5¼-inch products. But that may not last. Already, Applied Information Memories (A.I.M.), Milpitas, Calif., has developed the Dart, a 250M-byte, SMD/SCSI, 5¼-inch drive whose performance stacks up to any of the 8-inch models. "This isn't just a shot in the dark," says vice president of engineering William Glover. "The Dart is everything an 8-inch drive [is]...just better packaged."

A.I.M. officials claim that the Dart displays all the characteristics of larger SMD drives, including an

18-msec access time. Glover says the small size gives the added benefits of better shock immunity and lower power consumption as well. Disk Trend's Porter thinks A.I.M. has a solid design, but notes it is only good if it can be manufactured.

The high performance of 8- and 5¼-inch SMD drives doesn't come cheaply. Typically, drives range from \$2,500 range for the A.I.M. Dart SQ to as much as \$8,000 for drives in the class of the Megavault 600M-byte model.

All of the manufacturers agree that, above 160M bytes, the question becomes one of cost per megabyte. "The greater the performance," says Pertec's Youngblood, "the more it costs. But the cost/performance ratio does decline. Unlike the low-end [5¼-inch] business, this end is immune to price erosion." □

Directory of manufacturers

Amcodyne Inc.
1301 So. Sunset St.
Longmont, Colo. 80501
(303) 772-2601
Circle 792

Applied Information Memories
776 Sycamore Drive
Milpitas, Calif. 95035
(408) 263-9321
Circle 793

Control Data Corp.
OEM Product Sales
P.O. Box O
Minneapolis, Minn. 55440
(612) 853-8100
Circle 794

Fujitsu America Inc.
3055 Orchard Drive
San Jose, Calif. 95134
(408) 946-8777
Circle 795

Kennedy Co.
1600 Shamrock Ave.
Monrovia, Calif. 91016
(818) 357-8831
Circle 796

Megavault
6431 Independence Ave.
Woodland Hills, Calif. 91367
(213) 884-7300
Circle 797

Northern Telecom Inc.
Memory Systems Div.
100 Phoenix Drive
P.O. Box D
Ann Arbor, Mich. 48106
(313) 973-4600
Circle 798

Priam Corp.
20 West Montague Expwy.
San Jose, Calif. 95134
(408) 946-4600
Circle 799

Shugart Corp.
475 Oakmead Pkwy.
Sunnyvale, Calif. 94086
(408) 733-0100
Circle 800

Interest Quotient (Circle One)
High 849 Medium 850 Low 851

At IBM, you're not limited to
a daisy wheel printer,

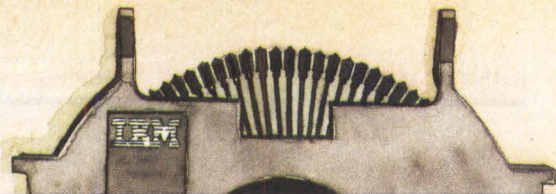

or an ink jet,

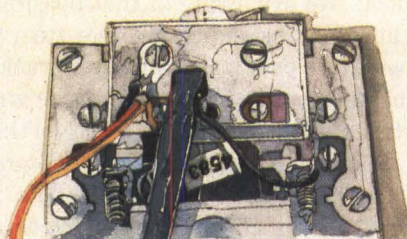

or a color ink jet,

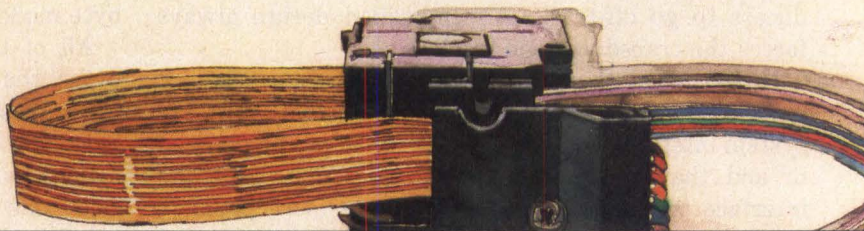

or a thermal,

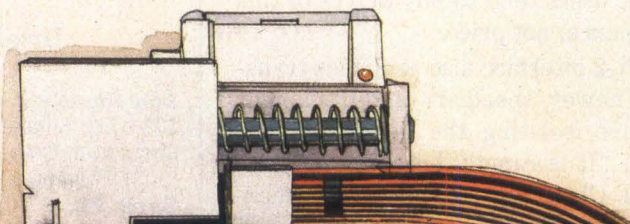

or a laser,



or a Selectric[®],



or a band,



or an electro-erosion,

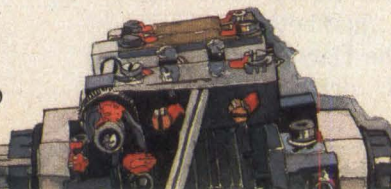

or a dot matrix,

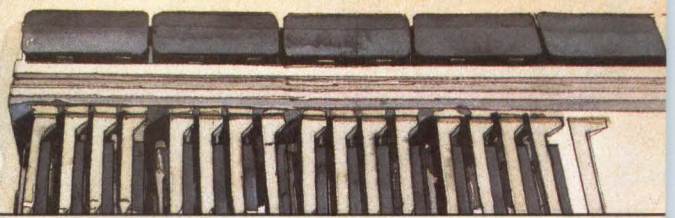

or a color dot matrix,

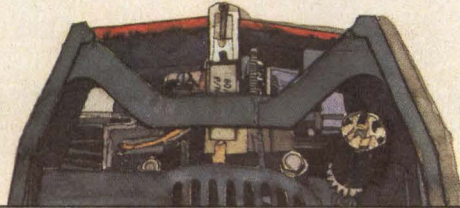

or a train printer,

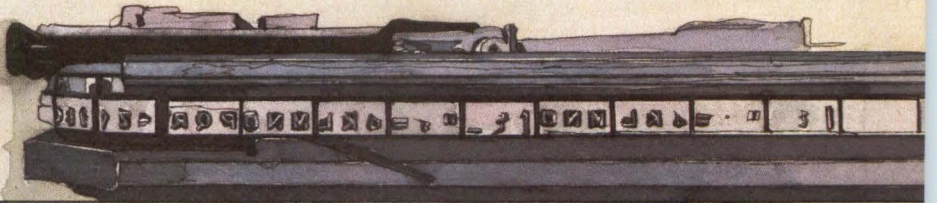

or even a plotter. Because we alone
give you the choice of all of them.



What does this mean for you?
Simply that our range of choices
lets you choose the printer that best
suits your needs.

IBM makes more than 70
different printer models, from
personal computer printers to
printers for our large computers.

We offer you an infinite choice
of printing styles. From data
printouts to IBM letter-quality
printing. Color. Graphics.
Electronic forms. And illustrations.

You can have print so perfect
it's almost indistinguishable from
offset printing.

There's also a choice of speeds
—from desk-top printers measured
in characters per second to
printers fast enough to count in
pages per second.

When computers first were
joined with printers, IBM was

there. We built the first chain
printers, train printers and laser
printers. And in the process, IBM
developed something else: a
reputation for reliability.

At IBM, our range of print
technologies and printers, our
reliability and our service all serve
a single purpose: To make your
printing as effective as your
processing. To give your work the
finishing touch.

For free literature on our
printers, call 1 800 IBM-
2468, Ext. 96/3N.



IBM PRINTERS

*The
Finishing
Touch*

CIRCLE NO. 88 ON INQUIRY CARD



Our Low-Cost Voice Data Entry Peripheral Could Double Your Computer System's Productivity

Verbox voice data entry has improved the speed and accuracy of data entry operations for companies across the country. We're helping firms in material handling, inventory control, inspection, test and other applications save thousands of dollars in time and labor costs, often resulting in productivity gains of 100% and more. Now *you* can offer this proven technology in a new, low-cost voice data entry peripheral—the Verbox Series 4000 Voice Recognizer.

Integrating seamlessly with your own system, the Series 4000 Voice Recognizer adds simultaneous voice input to keyboard data entry for virtually any mainframe, mini, micro or personal computer. It loads voice patterns and applications vocabularies

directly from your host system, or from its own reusable CMOS voice cartridges. Users simply drop their own cartridges into the Series 4000 Voice Recognizer console and it instantly responds to verbal commands despite accent, dialect, or interference from loud background noise.

Simple software tools let you create custom vocabularies.

With our Series 4000 Voice Planner™ software, you can program vocabularies for any customer application. Voice Planner software runs on IBM® PC, PC compatible, and DEC VAX™ systems, and is readily adaptable to other computing environments.

True continuous speech recognition: the key to your success.

With Verbox, the user inputs data in a natural voice, so there's no risk of fatigue or irritation caused by the staccato diction that other products require. And while others may claim it, only Verbox's patented continuous speech recognition achieves this natural man/machine interface without sacrificing accuracy or vocabulary size.

For details on the Series 4000 or our OEM/VAR programs, call toll-free 1-800-343-4458. In Mass., call (617) 275-5160. Or write on company letterhead and ask for a free video tape of voice applications. Verbox, Two Oak Park, Bedford, MA 01730.

Verbox

A DIVISION OF EXON ENTERPRISES

Voice Planner is a trademark of Verbox. IBM is a registered trademark of International Business Machines Corp. VAX is a trademark of Digital Equipment Corp.

CIRCLE NO. 89 ON INQUIRY CARD

Hybrid technologies rewrite the rules for local area networks

*The LAN industry is being shaped by new applications,
new and refined transmission media
and old software shortages*

Judith Estrin, Bridge Communications Inc.

The current state of the local area network (LAN) arena is perhaps best characterized by the blending of once-distinct technologies—a necessary development for increasingly complex applications linking large, medium and small computers, terminals and other devices. Specifically, the need to integrate personal computers into the corporate environment has led to merging back-end, general-purpose and personal computer networks.

One result is that media not previously used together are being mixed in “hybrid” networks. Another result is extensive work in protocols development. Standardization efforts, which began at the lowest protocol levels, have slowly moved up to the higher layers, with a

number of standards being defined, as opposed to the single standard once expected to emerge. Finally, LANs are influencing development even at the application software level, where special features must be designed in to run applications in shared environments.

Applications include three types

LAN technology has become a key element in data communications systems and distributed computing systems. LANs today are being used as highly effective distributed data switches interconnecting personal computers, terminals and peripherals to groups of multivendor, host-computer systems. In addition, LANs are being used as the bus in distributed computing systems interconnecting mainframes to disk storage and workstations, or personal computers to file, print

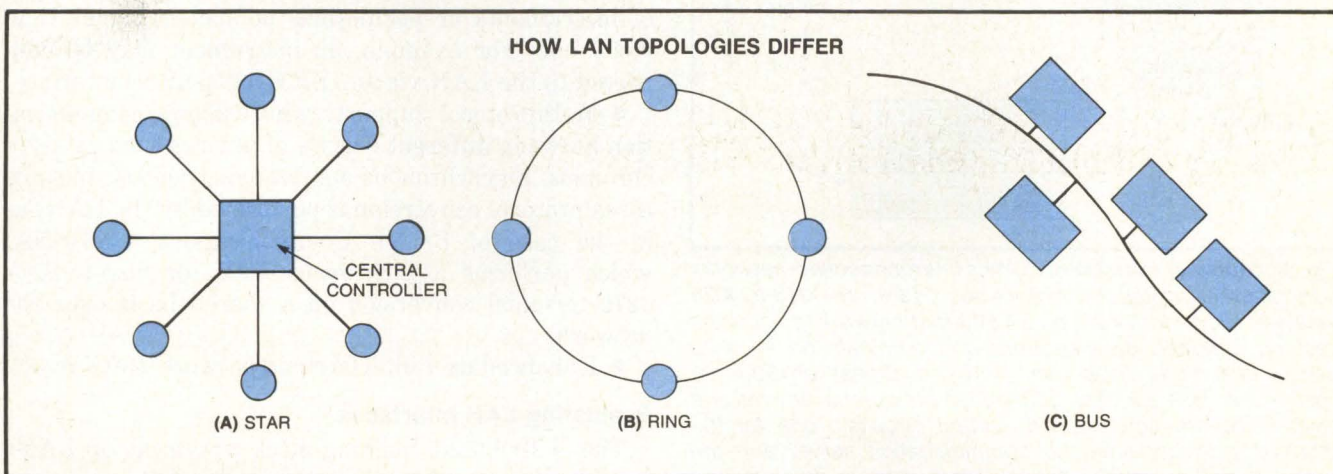

Fig. 1. The three major LAN topologies currently in use are star, ring, and bus. Star (A) depends on a central controller, which simplifies network management but increases the chances that a single fault will silence the entire system. Ring

(B) provides distribution of intelligence and can use point-to-point connections to run at very high speeds. Bus (C) has the ring's advantages of distributed intelligence and is often easier to install and configure.

and mail servers.

All applications primarily involve the back-end, general-purpose and personal computer networks. Back-end networks provide high-speed file-transfer and shared storage among large mainframes and minicomputers—typically within a small geographic area such as a computer room. Network Systems Corp.'s Hyperchannel, the best known, is a multivendor back-end network with interfaces to most of the common mainframe and minicomputers, including those produced by IBM Corp., Central Data Corp., Sperry Corp., Digital Equipment Corp. (DEC) and Data General Corp. Another single-vendor, back-end network is DEC's cluster system, which provides high-speed transfer and disk sharing among VAX computers. Because these applica-

tions are better defined in scope than those of general-purpose networks, this segment has been relatively unaffected by standardization.

The major thrust in back-end networks has been to provide faster datalink speeds. Current products are in the 10M-bits-per-second (bps) range, and several companies have announced projects aimed at the 200M-bps range. Network Systems, for example, is planning a fiber optic-based back-end network with a 275M-bps data rate. The type of media used in back-end networks is typically either baseband coaxial cable or fiber-optic cable. Fiber optics eventually will dominate in this segment due to its inherently greater bandwidth.

General-purpose networks are being used primarily in two areas. The first is as a distributed data switch, where the LAN is used as a data highway providing connectivity via packet-switched virtual circuits among terminals, minicomputers, peripherals, microcomputers and mainframes. These systems provide communication between hundreds or even thousands of devices within buildings or across campuses. Examples are Bridge Communications Inc.'s Ethernet-based Communications Servers, Ungermann-Bass Inc.'s Net/One and Sytek Inc.'s LocalNet System. Each of these consists of a packet-switching computer in a small enclosure with both a network connection and two to 32 serial I/O ports. They act as cluster controllers to their networks.

LAN-based data switches provide all the features of a classical data Private Branch Exchange (PBX), plus enhanced functionality. Among the enhancements are:

- Speed intermix (or speed matching), which provides the capability to communicate between devices running at different speeds. For example, a 9,600-bps terminal can communicate with a 19.2K-bps host port and a 300-bps modem without changing speeds.
- Higher-speed interfaces, which allow attachment of instruments or peripherals at speeds higher than 9,600 bps. For example, an instrument may be connected to the LAN via an IEEE-488 parallel interface.
- Multiprotocol support, which allows communication between different classes of devices such as asynchronous, bisynchronous and bit-synchronous. In some cases protocol conversion is performed by the LAN, as in the case of Bridge Communications' CS/1-SNA, which performs asynchronous TTY terminal-to-SNA 3270 terminal conversion on a shared basis over the network.
- Enhanced user interface and network software.

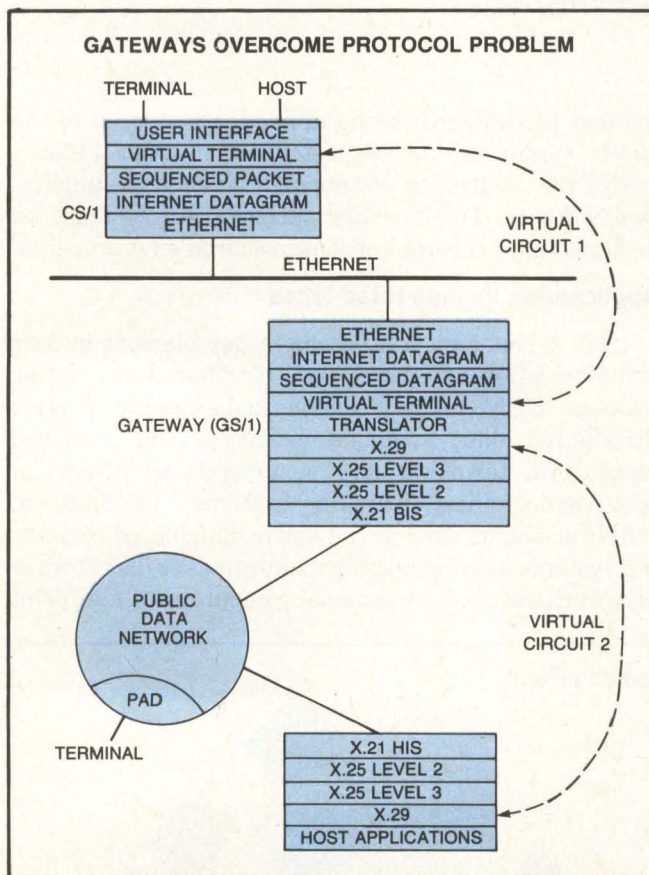
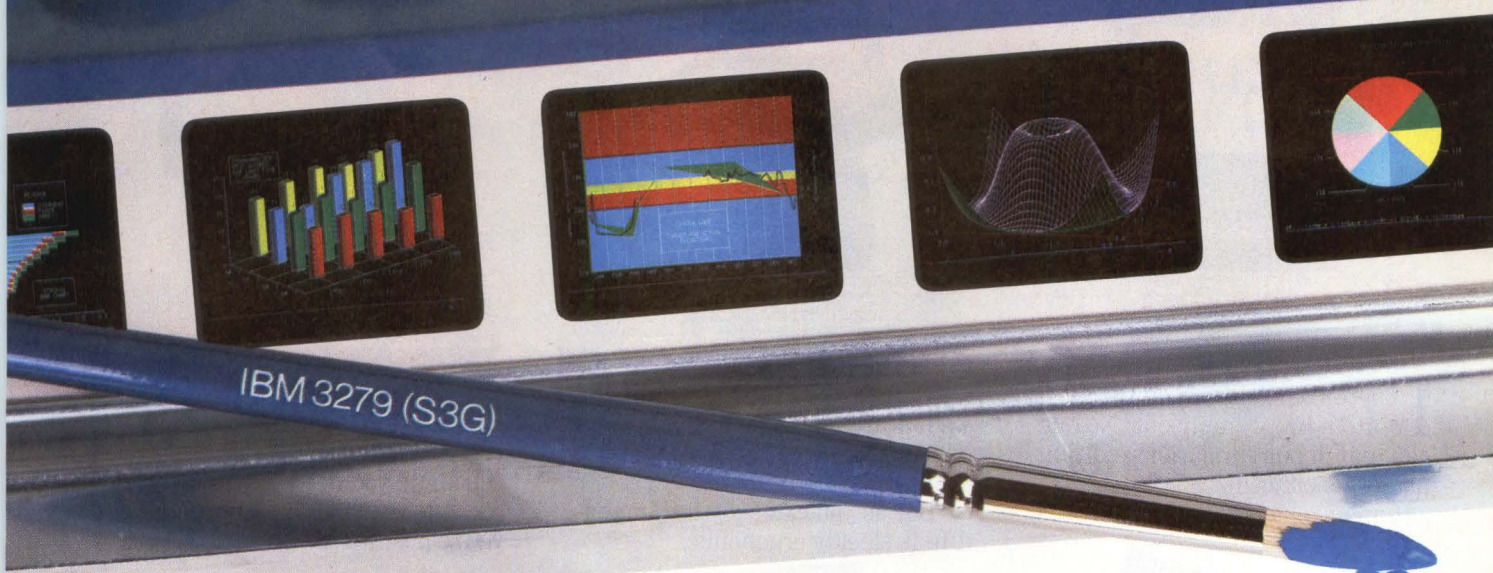

Fig. 2. Gateway translation allows interconnecting networks with different protocol architectures. Here, an XNS-to-X.25 gateway allows terminals on an Ethernet network to access a host on a public data network and terminals on an X.25 packet assembler/dissembler (PAD) to access an Ethernet host. In this case, for each connection between a terminal and host, there are actually two "virtual circuits": one for the Ethernet side between the communication server and the gateway, and one on the X.25 side between the gateway and the host or PAD. The gateway is responsible for receiving data from one circuit and transmitting it over the second, as well as for mapping and making parameter changes from one circuit to the other.

Evaluating LAN interfaces

The distributed building-block approach of LANs provides increased flexibility and reliability over centralized switches. If a single LAN controller fails, it impacts only the devices connected to it.

There are several key factors in the evaluation of



Forte puts mainframe graphics on your PC

Get mainframe graphics right at your desk. With the ForteGraph™ Emulator.

Just add it to the Forte PJ™ communications adaptor. Without using an extra slot. You're ready to roll with a single PC keystroke.

With a compatible monitor, you'll get true 3279 model S3G emulation. From color quality and screen print speed, right down to pixel resolutions.

Dip into a palette of software, like GDDM¹, SAS/GRAPH[®] and ISSCO's TELLAGRAF.™ Create pie and bar charts, histograms and conceptual drawings. Or paint up a storm with your own custom-designed characters.

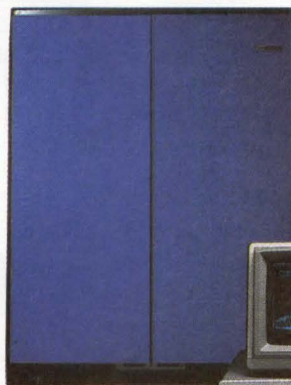

Even foreign language fonts and scientific notations can be used.

ForteGraph is entirely soft-loaded. So you can send, receive and store files while host sessions remain untouched. You can even save your mainframe graphics on your own diskettes.

And print copies right in your office.

Installation?

It's a snap.

Because ForteGraph requires no host hardware or software modifications.

Graphic smarts from Forte. Colorful. Creative. Easy to use. And ready for you now.



THE FORCE IN MICRO TO MAINFRAME COMMUNICATIONS



2205 Fortune Drive, San Jose, CA 95131 (408) 945-9111 Telex 275973 TOLL-FREE HOTLINE (800) 233-3278

©1984 Forte Data Systems. ¹GDDM is a product of International Business Machines. SAS/GRAPH is a registered trademark of SAS Institute, Inc. TELLAGRAF is a trademark of Integrated Software Systems Corporation. IBM is a registered trademark of International Business Machines.

CIRCLE NO. 90 ON INQUIRY CARD

18 Reasons We're Uniquely



1 There's our position on the bottom line. Simply put: No one can match our emulations, editing and ergonomics for \$549. Can anyone better this price?



2 Only at the expense of features. Often it's obvious where they've cut corners: With a pug-ugly box. But as you can see, the Ampex 210 is sleekly ergonomic.



3 We human-engineered the Ampex 210 with a full 14" screen that tilts and swivels to just the angle you need. So it's comfortable to use, no matter how you're positioned.



7 As well as the local editing and block mode transfer capacities you need to speed work flow.



8 Plus 16 resident emulations you can switch at the touch of a key. Including the TeleVideo 910, 910+, 912, 920 or 925*..



9 The Lear Siegler ADM 3, ADM 3A, 3A+ or ADM 5*..



13 What's more, we'll add more. In OEM quantities, we'll customize our 210's appearance, personality and programming so it's perfectly suited to your needs.



14 And if you need a more powerful terminal with even more features, consider the next step up in our family of terminals: the Ampex 230.



15 We back every Ampex terminal with a six month warranty and a worldwide service network.

Positioned to Meet Your Needs.



4 We also equipped it with a low-profile, Selectric-style, adjustable-slope keyboard for easy typing.



5 And with a soothing, flicker-free amber screen for easy reading. (If you prefer, you can have the option of green at no extra cost.)



6 But ergonomics are just the beginning. The Ampex 210 is as beautifully engineered inside as outside. With line graphics and a bidirectional printer port as standard features.



10 The Esprit (Hazeltine) 1400, 1410 or 1500*..



11 ADDS Regent 20, 25 and Viewpoint*..



12 And Qume's QVT 102*.



16 How can we pack all that into the Ampex 210 for just \$549? We're in a position to be competitive. We can take advantage of over 25 years of video, computer peripheral and offshore manufacturing experience.



17 So if you need a well-designed, full-featured terminal, call us at 800 621-0292. Or 800 821-9473 in California. We'll show you how you can be very comfortably situated for just \$549.

AMPEX

18 The Ampex 210 is from the Computer Products Division of Ampex Corporation. One of The Signal Companies 

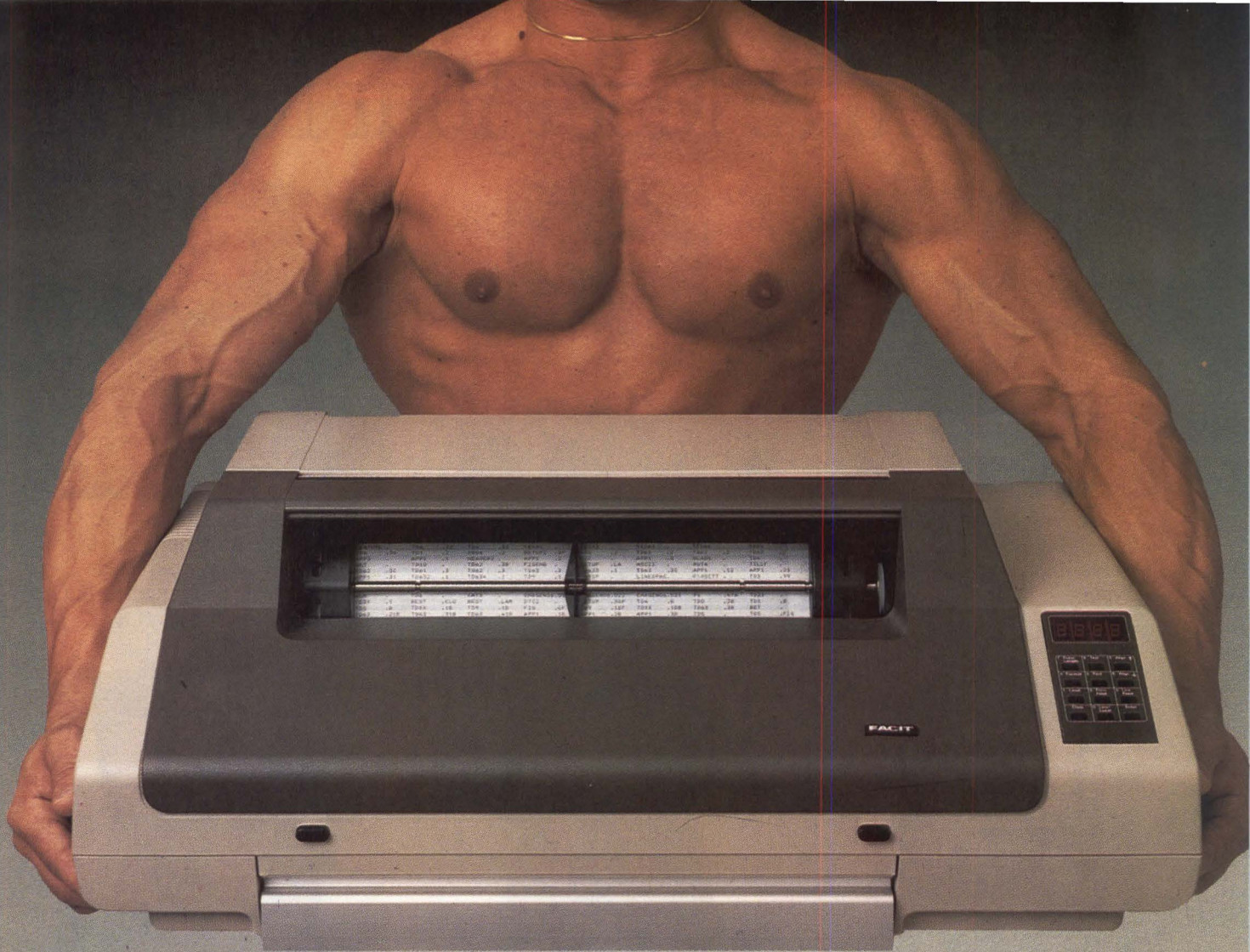

ADD SOME MUSCLE TO YOUR SYSTEM POWER

You'll immediately notice the difference with the Facit 4570 Matrix Printer.

Just try to lift it! Its 92 lbs (42 kg) speaks for its ruggedness. Built for professional heavy-duty operations round the clock. Featuring Facit's unique Stored Force Flexhammer Printhead with all-perfect, non-deteriorating printouts throughout its average 1,000,000,000 character service life!

Facit 4570 has all the essential qualities that define it as your central printer with large-volume printouts. As well as the handling of printouts from several wordprocessing workstations. At a speed of 250 CPS draft

or 80 CPS NLQ printing.

Integrated in your word and dataprocessing systems, its software intelligence and printing capability will convince you of its competitive edge.

Italic, bold and elongated characters with 16 different fonts, monospaced or proportional, are easily selected from the keypad or host computer. Equipped with Facit's Cut

Sheet Feeder, the Facit 4570 can be manually or automatically fed from two magazines.

So when performance and reliability are vital parts of your system building, Facit 4570

Matrix Printer will add more muscle to your own product.

Printer
Perfect ✓

FACIT

Head Office: Facit AB, S-172 91 Sundbyberg, Sweden. Phone: (8) 764 30 00. USA: Facit Inc. P.O. Box 334, Merrimack, NH 03054. Phone: (603) 424-8000

AUSTRALIA: EAI Electronics Associates Pty Ltd., 427-3322. AUSTRIA: Ericsson Information Systems GmbH, 0222-43 95 01. BELGIUM: Ericsson S.A., 02-243 82 11. CANADA: Facit Canada Inc., 416-821-9400. CYPRUS: LBM (Lillytos) Ltd. DENMARK: Facit A/S, 02-92 24 00. FINLAND: OY Facit, 90-770 01. FRANCE: Facit S.A., 1-780 7117. GREAT BRITAIN: Facit, 0634-40 17 21. GREECE: Computer Application Co., Ltd., 01-671 97 22. HONG KONG: Gilman & Co. Ltd., 5-790 95 55. ICELAND: Gisli J. Johnsen HF, 354-17 31 11. INDIA: Forbes Forbes Campbell & Co. Ltd., 22-26 80 81. IRELAND: Memory Ireland Computers Ltd., 1-98 97 33. ITALY: Facit Data Products S.p.A., 0039-63 63 31. JAPAN: Electrolux (Japan) Ltd., 03-479-3411. THE NETHERLANDS: Ericsson Information Systems BV, 03480-709 11. NEW ZEALAND: McLean Information Technology Ltd., 501-801, 501-219. NORWAY: Ericsson Information Systems A/S, 02-35 58 20. PORTUGAL: Regisconta Sarl, 1-56 00 91. SINGAPORE: Far East Office Eqpts Pte Ltd., 745 82 88. SPAIN: Facit, 91-457 11 11. SWEDEN: Ericsson Information Systems Sverige AB, 08-29 00 20. SWITZERLAND: Ericsson Information Systems AG, 01-391 97 11. USA: Facit Inc., 603-424-8000. WEST GERMANY: Ericsson Information Systems GmbH, 0211-79 93 31.

CIRCLE NO. 91 ON INQUIRY CARD

LAN-based communication systems. The LAN interfaces (Communications Servers or Network Interface Units) must provide standard interfaces to a variety of devices. Ideally these interfaces should be such that the devices being connected to the network need not be modified. The LAN interface is responsible for putting data in packets and transmitting it. Performance of the LAN interface is critical in providing the necessary response time in screen-oriented applications where each character must be transferred over the network and echoed from the host. So as not to restrict future hardware choices, it is important to choose a system based on industry standards. For example, the cable used should allow other equipment to coexist with the current "data-PBX" LAN equipment.

General-purpose network technologies such as Ethernet are also used as backbones or system buses for distributed computer systems. Examples include CAD/CAM systems such as those made by Daisy Systems Corp., Sunnyvale, Calif., or Valid Logic Systems

Inc., which use Ethernet to interconnect their workstations and file servers; and Xerox Corp.'s Network System products, which uses Ethernet to interconnect Star workstations to file, print, mail and communications servers. In this type of application, the LAN must provide high performance for both file transfer and transaction processing.

Personal computer networks are similar to back-end networks except that they support small microcomputers as opposed to mainframes. Personal computer networks typically interconnect a small number (in the tens) of personal computers and provide a mechanism to share disks and printers among them. Examples are 3Com Corp.'s EtherSeries, Corvus Systems Inc.'s Omnet and IBM's new personal computer network. Personal computer networks range in speed from 1M to 10M bps and usually are department-level in scope. Their key feature, however, is high-level software that allows sharing of resources.

The integration of these networks is being achieved

Integrated networks provide unique benefits

There are several reasons for integrating different network types into a single system. Network installations typically serve multiple applications, and different network technologies are often appropriate for various applications. In addition, the choice of system (computer, workstation, etc.) vendor may dictate a network type should that vendor use a proprietary network scheme.

The diverse networks can be integrated into a large heterogeneous system. In the example, a back-end, high-speed network allows mainframe computers to share data with each other. General-purpose networks interconnect terminals, minicomputers and microcomputers with the mainframes. Personal computer networks generally let a small number of personal computers share resources.

The difficulty of integration derives from the degree of difference between the networks. In cases where the networks use standard media and protocols, off-the-shelf gateway products can often be used. If no such products can be used, integrators look for products that attach to both networks as a gateway. For example, in the absence of a Hyperchannel-to-Ethernet gateway, a VAX is used for which there exists an interface to each network. Similarly, an IBM PC might be used as a gateway from Ethernet to a personal computer network.

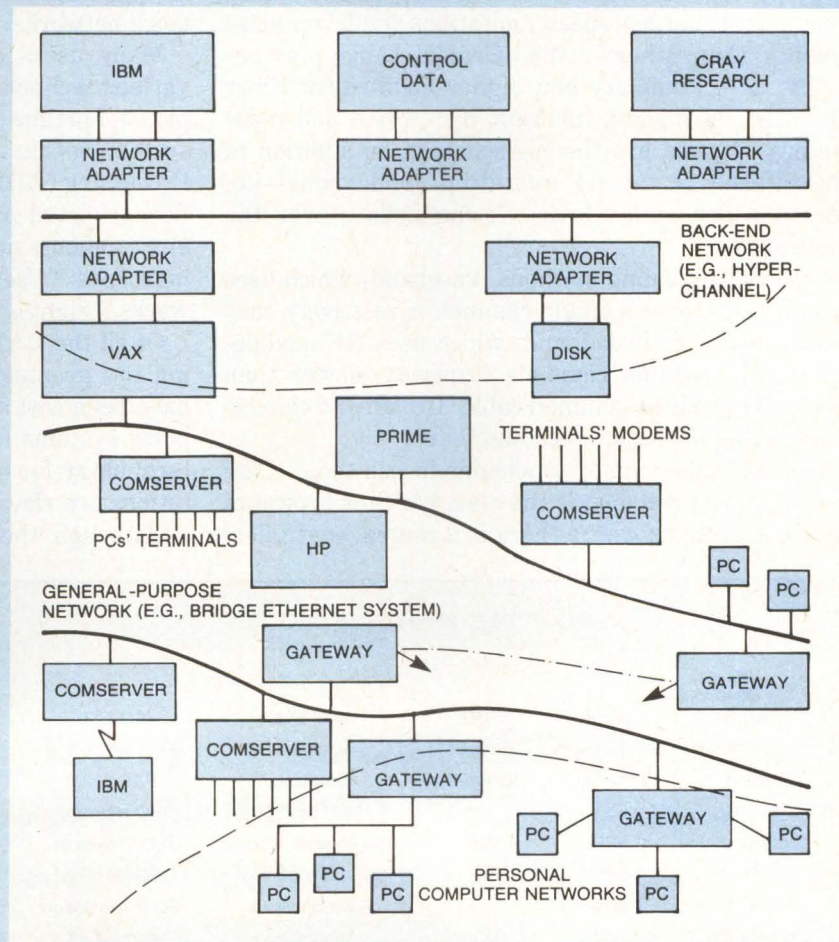

by means of gateways between different environments and agreements between different companies to provide compatibility between their products (e.g., 3Com's EtherSeries personal computer network and Bridge Communications' Ethernet System Products' general-purpose network).

Media becomes central to LAN construction

For several years after LANs were first introduced, vendors and customers focused on the media, signaling, topology and media access. These four parameters together describe LAN technology—the method used to transmit packets between stations. Much energy was spent discussing the benefits of baseband versus broadband, coaxial cable versus twisted pair cable versus fiber optics, CSMA/CD versus token, and bus versus ring. As the market and products have matured, it has become clear that there is no one perfect LAN technology, but that different media, signaling, access methods and topologies are appropriate for different applications and environments.

Twisted pair, coaxial and fiber-optic cable are three commonly used media. Twisted pair typically is the lowest in cost, but has speed limitations and lower noise immunity than other media. Coaxial cable provides greater noise immunity and higher bandwidth. Fiber optics has the highest inherent bandwidth and noise immunity. It also has the highest cost, in addition to being difficult to tap for multidrop applications—i.e., those in which many devices communicate over the same cable.

Of the two signaling methods, baseband, which uses digital impulse over a single channel, is relatively easy to install and use. Broadband, which uses RF modulation, allows multiple channels (typically slower than baseband) to share a common cable. Broadband can use a single cable for data, voice and video.

There are three major topologies in use today. The oldest and most common is the star, which is typical of most PBX systems where there is a central controller.

Although it simplifies network management, the star's central control also provides a single point of failure. A ring topology provides distribution and has the advantage of utilizing point-to-point connections that can be run at higher speeds and utilize almost any medium. A bus topology also provides distribution and is often simpler to install and configure than the ring. (Fig. 1)

In systems with no central controller, an access method is required to arbitrate the medium. The two common methods are CSMA/CD (Carrier Sense Multiple Access with Collision Detection) and token passing. In a CSMA/CD system all stations listen to the network. If it is free to do so, any station may transmit. If two stations begin to transmit simultaneously (i.e., a collision), they both back off and try again after a random period of time. CSMA/CD is simple and usually economical. It is ideal for bursty environments such as those characterized by heavy terminal-to-host or workstation-to-server interaction. In a token-passing system a "token" is passed from station to station in a specified order. Token passing, while having the advantage of being deterministic (i.e., the maximum delay can be calculated), also has the longer delays associated with large networks.

Many users are beginning to mix and match the various technologies into a hybrid network. For example, a Fortune 1000 company might use a baseband system within the engineering and Electronic Data Processing (EDP) areas, fiber-optic cable on the factory floor, twisted pair (from a PBX) in selected corporate environments and CATV coaxial to interconnect buildings (see "Users blend technology for hybrid networks," right).

Of all the LAN technologies, fiber optics is undergoing the greatest change. The key limitations of fiber have been cost and the ability to use it only in point-to-point systems due to the lack of adequate "tapping" technology for multidrop applications. Both these limitations are slowly being overcome.

Although the medium is important when deciding

ISO PROVIDES PROTOCOL MODEL					
ISO OSI model	XNS	DOD	IBM SNA	ISO STD	
1 Physical	Ethernet	Ethernet	Control	IEEE 802.3, 4, 5	
2 DataLink	Ethernet	Ethernet	DataLink	IEEE 802.2	
3 Network	IDP	IP	Path Control	ISO Network	
4 Transport	SPP	SPP	Transmission Control	ISO Transport	
5 Session	SPP	TCP	DataFlow Control	ISO Session	
6 Presentation	Courier	Telnet	FMD Services	ISO Presentation	
7 Application	Application	Application	Application	Application	

Fig. 3. The International Standards Organization reference model describes network protocols so that vendors can meaningfully define their own protocols. Although all the above protocol architectures implement "layering" in some fashion, none exactly follows the ISO model (except for the ISO protocols themselves). The model, however, does make it easier for vendors to build inter-system compatibility into their products and to define the functionality of those products to their users.

how to wire a building or campus, the key features and benefits gained from a LAN come from high-level protocols. Whereas the LAN technology (i.e., low-level protocols) provides a mechanism to move data packets from one station to another, the high-level protocols establish the communication "session" and provide the flow control that allows devices to communicate effectively over the network. The protocol architecture used dictates such factors as whether or not local networks can be interconnected into a network system spanning longer distances or serving multiple applications. The protocol implementation and the hardware it runs on determine actual end-to-end throughput (Fig. 2).

The International Standards Organization (ISO) has produced a methodology for specifying protocols for packet-switching networks (of which LANs are one type). This methodology, called the Open Systems Interconnect (OSI) reference model, is divided into seven protocol levels. Most protocol architectures in

use today can be described in terms of those levels.

There has been significant work in the standards regarding media, signaling and access method—the first two layers of the seven-layer ISO Open Systems Interconnect (OSI) reference model. For instance, the IEEE project 802 has produced a standard or draft standard for each of the key technologies:

- 802.3 CSMA/CD, bus, baseband (broadband in progress), coaxial
- 802.4 token, bus, broadband, coaxial
- 802.5 token, ring, baseband, coaxial and fiber.

The European Computer Manufacturers Association (ECMA) and ISO are addressing these same areas with standards compatible with those of the IEEE project 802.

Several protocol architectures have emerged as formal and de facto standards: ISO protocols, Department of Defense (DOD) TCP/IP protocols, Xerox Network System (XNS) protocols, IBM System Network Archi-

Users blend technology for hybrid networks

Hybrid networks, like the one shown here, might use baseband coaxial cable within a building, CATV coaxial between buildings, fiber-optic cable on the factory floor and twisted pair for certain corporate functions.

When the same high-level protocol set is used throughout the system, as in the given example, the gateways that interconnect the different media simply need to route datagram packets between the network types. If Terminal A is sending data to Host A, an "end-to-end" connection is established between ComServer 1 and ComServer 2. Each individual packet is routed from ComServer 1 through Gateway 1 and Gateway 2 to ComServer 2. Similarly, if Terminal B connects to Host A, individual packets of the connection are routed through Gateway 3 and Gateway 2. The Xerox Network System (XNS) protocol architecture is an example of a network architecture which supports transparent inter-network routing of packets through its Internetwork Datagram Protocol (IDP) and Routing Information Protocol (RIP).

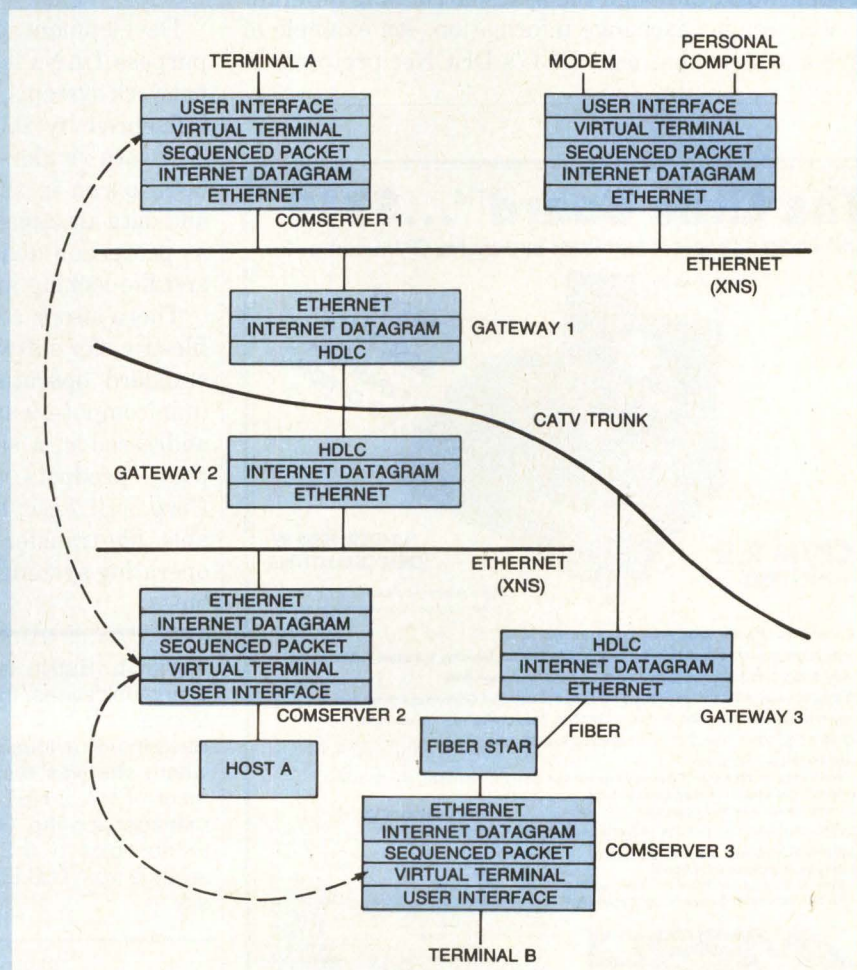

ecture (SNA) protocols, and DEC's DECNet protocols. The ISO, in addition to its reference model, is working on a set of protocol standards for each level, with help from the National Bureau of Standards (NBS) and ECMA. The DOD's TCP/IP protocols have been in use for several years in the ARPAnet community. TCP/IP is also the protocol architecture used in most UNIX-based scientific and engineering computer systems.

Xerox has defined a set of protocols called XNS-ITP (Internet Transport Protocols) as part of its Network Systems offering. These protocols have been adopted as a de facto standard for many office and EDP network products. Because of their influence on the computer industry, IBM's SNA and DEC's DECNet protocols also have become de facto standards. Although protocol architectures are most often linked to a particular network technology (e.g., IBM SNA to token ring, Xerox XNS to Ethernet), each is layered so that it may be used on any technology (Fig. 3).

Multiple protocol architectures may coexist on a single network, although the systems running different protocols cannot exchange information. An example of this is a system that uses DEC's DECNet protocols to

transfer files between VAX computers on Ethernet and also uses Bridge Communications' XNS-Ethernet-based Communications Servers to connect terminals to the VAXs. The Ethernet packet format includes a protocol-type field that allows these protocols to coexist and not interfere with each other.

Advances in chip technology—for example, the advent of VLSI and gate arrays—have made a significant impact on the cost of implementing protocol layers 1 and 2. More than six vendors currently offer or will soon offer chip sets that implement the entire physical and data-link layers for Ethernet. Similar chip sets are under development for other networks such as the token ring. These two-chip sets replace components that formerly used up an entire board. The higher-level protocols (layers 3 through 7) have not been affected by these advances because they are typically implemented in software. Faster microprocessors and 256K dynamic RAMS, however, are helping to bring down the cost of network interfaces without sacrificing performance.

Applications software shortage plagues LANs

Development of application software for general-purpose LANs lags behind that for personal computer network systems, where developers are beginning to be influenced by the emergence of distributed systems. Software vendors are being forced to adapt their products to run in shared environments. When programs and data are accessible by multiple users, features such as protection and security, shared access, and record- and file-locking are required.

There also is a lack of high-performance multivendor file-transfer software, partly because of the shortage of standard operating systems among large computers (minicomputers and mainframes). The problem is being addressed in a simple way by asynchronous point-to-point products such as Communications Research Corp.'s BLAST. BLAST is an asynchronous-based reliable file-transfer protocol that runs under multiple operating systems and transfers files between different hosts. □

Judith L. Estrin is vice president of engineering at Bridge Communications Inc., Mountain View, Calif. Before joining Bridge, she held a technical marketing post at Ungermann-Bass Inc. Previously, she had spent four years with Zilog Inc., where she was responsible for initial definition and development of the Z-NET local area network, and later served as manager for the General Systems engineering group. Ms. Estrin holds a B.S. degree in mathematics and computer science from U.C.L.A., and an M.S.E.E. from Stanford University.

Interest Quotient (Circle One)
High 852 Medium 853 Low 854

The Little Board™ ... \$349*
The world's simplest and least expensive CP/M computer



NEW SCSI/PLUS™ EXPANSION I/O OPTION

CP/M 2.2 INCLUDED

***UNDER \$200 IN OEM QUANTITIES**

Z80A is a registered trademark of Zilog, Inc.
CP/M is a registered trademark of Digital Research.

- 4 MHz Z80A CPU, 64K RAM, Z80A CTC, 2732 Boot ROM
- Mini/Micro Floppy controller (1-4 Drives, Single/Double Density, 1-2 sided, 40/80 track)
- Only 5.75 x 7.75 inches, mounts directly to a 5 1/4" floppy drive
- 2 RS232C Serial Ports (75-9600 baud & 75-38,400 baud), 1 Centronics Printer Port
- Power Requirement: +5VDC at .75A; +12VDC at .05A/On-board -12V converter
- CP/M 2.2 BDOS • ZCPR3 CCP • Enhanced AMPRO BIOS
- AMPRO UTILITIES included:
 - read/write to more than 2 dozen other formats (Kaypro, Televideo, IBM CP/M86....)
 - format disks for more than a dozen other computers
 - menu-based system customization
- BIOS and Utilities Source Code Available
- SCSI/PLUS Adapter:
 - Mounts directly to Little Board
 - Slave I/O board control • Full ANSC X3T9.2
 - 16 bidirectional I/O lines • \$99/Quantity 1

DISTRIBUTORS

Argentina-Factorial, S.A.	1-41-0018
Australia-ASP Microcomputers	613-500-0628
Belgium-Centre Electronique Lempereur	041-93-45-41
Canada-Electronic Sales Assoc.	(604) 986-5447
Denmark-Danbit	03-66-90-90
England-Quant Systems	01-534-3158
Finland-Symmetric OY	358-0-585-392
France-Aleln Lequeux	1-525-6960
Israel-Alpha Terminals	03-491595
Spain-Xenios Informatica	3-593-0892
Sweden-AB AKTA	08-54-20-20
USA: Digital Distributors (CA)	408-423-1556
Peripheral Business Systems (WA)	206-823-6661
Dorado Business Systems (NY/NJ)	609-459-9243

AMPRO COMPUTERS, INCORPORATED
67 East Evelyn Ave. • Mountain View, CA 94041 • (415) 962-0230 • TELEX 4940302

CIRCLE NO. 92 ON INQUIRY CARD

TeleVideo corrects the VT220 key mistakes.

The new TeleVideo® 922 shares but one feature with the VT220®: DEC®-compatibility. The similarity ends there.

1. Take our keyboard, for example. The RETURN key is within direct, easy reach. But VT220 users must stretch over an additional key to hit RETURN. Or have the hands of a concert pianist.



DEC VT220

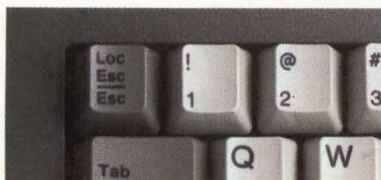

Here's ours.

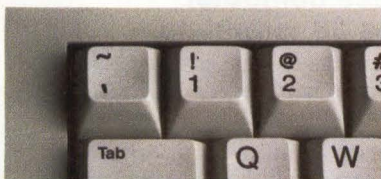

Where's the VT220 ESCAPE key?

That's a true accounting keypad, complete with a Clear Entry, Double Zero and a TAB key. Not merely the numeric keys you get with the VT220.

2. Our ESCAPE key is located above the TAB key, right where you'd expect to find it.

Theirs isn't. In fact, you have to go hunt for the VT220 ESCAPE key halfway across the row of function keys.

3. Take a look below at the 922 keyboard.

4. Our SHIFT key is exactly where it should be, so it does exactly what it should do—shift. Their SHIFT key is shoved over by the < and > key to create lots of < and > on the CRT. Of course with a little practice, you could re-learn their keyboard. But why, now that you've seen our 922?

Moving The Shift Key Is A Mistake.

922 Display Screen.

<oving <he <hift Key <s A <istake.

VT220 Display Screen.

5. And after we built a better keyboard, we built a better terminal. With exceptional reliability. Quality. Advanced ergonomics. Everything you'd expect from the industry ANSI leader.

The new 922 is available now and priced to move now. And it's backed by a worldwide sales and support network.

6. Here are 5 more advantages to the 922.

	TeleVideo 922	DEC VT220
Programmable Function Keys	15 (30 with shift)	15 (shifted only)
True Accountant Keypad	YES	NO
Plug-in Graphics Upgrade Option	YES	NO
Full Tilt & Swivel	YES	NO
Enhanced ANSI Mode	YES	NO

DEC VT220 are registered trademarks of Digital Equipment Corporation.



800-538-8725.
In California, call 408-745-7760.

The TeleVideo® 922
TeleVideo Systems, Inc.

CIRCLE NO. 31 ON INQUIRY CARD

New Products

SYSTEMS



Portable computer features built-in interfaces

- 256K bytes of RAM
- 600-by-400-dot resolution screen
- 8088 microprocessor

The 16-inch-by-9-inch-by-20-inch, one-piece Sperry portable computer features one parallel port and one serial port. With a minimum of 256K bytes of RAM, the main system board furnishes graphics, memory and floppy diskette controllers. Utilizing an Intel 8088, 4.77-MHz microprocessor, the system is available in three models. Model SP2 contains two 360K-byte, 5¼-inch floppy disk drives; Model SP1 contains one drive and Model SPX contains one floppy disk drive and one 10M-byte fixed disk drive. All three models provide an 84-key keyboard; a 9-inch, monochrome screen with a 600-dot-by-400-dot density; an MS-DOS 2.11 operating system and GW BASIC software. By adding a color board, the system can display graphics on a Sperry, IBM or IBM-compatible monitor. Models SP1 and SP2 offer four expansion slots; Model SPX offers three slots. From \$2,685 to \$4,985. **Sperry Corp. Computer Systems**, P.O. Box 500, Blue Bell, Pa. 19424, (215) 542-4213/2504.

Circle No 300

Workstation incorporates high-resolution display

- 19-inch color display
- 1,664-by-1,248-pixel resolution
- Processes 1.2 MIPS

The Saberstation, an interactive CAE/CAD workstation, features a 19-inch color video display with a flicker-free 60-Hz refresh rate, 180-MHz video rate and 1,664-pixel-by-1,248-pixel resolution. The workstations' application processor uses the National Semiconductor NS32032 that supports a de-

mand-paged virtual memory and a floating-point coprocessor. Running at 10 MHz, it processes 1.2 million instructions per second. The system also offers local area network/Ethernet support, has two 40M-byte disk drives on separate disk controllers and a streaming tape for backup. The graphics subsystem employs a proprietary DMA controller and bus topology with a 20M-byte-per-second data-transfer rate. Berkeley UNIX Version 4.2 comes standard. \$40,000. **Saber Technology Corp.**, 2381 Bering Drive, San Jose, Calif. 95131, (408) 945-9600.

Circle No 301

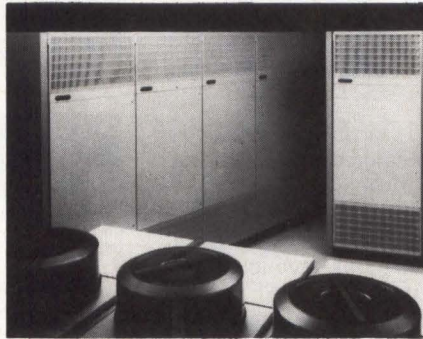

Computer suits on-line transaction-processing

- 80M-byte-per-second bus
- 128K bytes of cache memory
- 2½ to 50 MIPS

Suited for on-line transaction processing, the Sequoia 32-bit multiprocessor system is compatible with Berkeley UNIX Version 4.2 and System V operating systems. The computer's architecture interconnects as many as 64 processor elements through dual system buses; processing capability ranges from 2½ million instructions per second (MIPS) to 50 MIPS. Main memory can be expanded from 4M bytes to 256M bytes. I/O capacity is expandable from two to 96 channels; each channel supports as many as 16 controllers. Each controller, in turn, supports as many as four disk and tape drives or 16 terminals, printers and other peripherals. Automatic load balancing assigns tasks to the first available processor. As many as 128 memory and I/O elements can be interconnected in combinations through 80M-byte-per-second buses. \$290,000 for 2½-MIPS system. **Sequoia Systems Inc.**, Metropolitan Corporate Center, Marlborough, Mass. 01752, (617) 480-0800.

Circle No 302

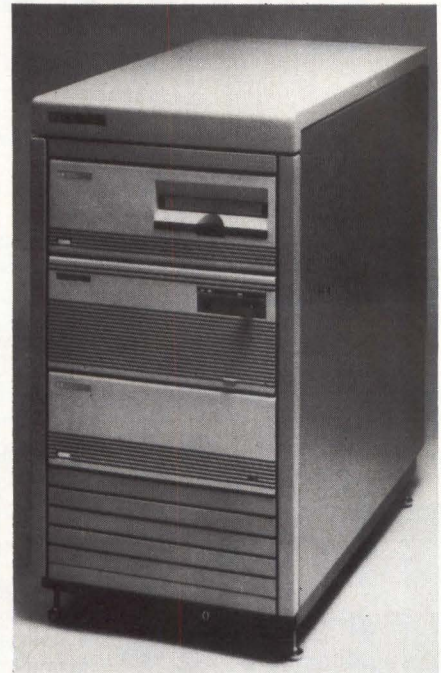

Business computer handles 28 terminals

- 512K bytes of main memory
- 55M-byte hard disk
- HP 3000-compatible

The Series 37 office computer offers the feature set of the company's HP 3000 and runs identical software. It communicates with larger computer systems, or with smaller personal computers. The system comes with 512K bytes of main memory, a 55M-byte disk with a 30-msec average seek time, cartridge tape backup, systems console, IMAGE database and office cabinet. It supports 28 terminals, 2M bytes of main memory and 2,400M bytes of disk. The processing unit measures 6.14 inches by 12.8 inches by 15.75 inches. \$19,950 for basic system. **Hewlett-Packard Co.**, 3000 Hanover St., Palo Alto, Calif. 94304.

Circle No 303

System offers 150 peripheral combinations

- 250W switching power supply
- 8-slot quad-width card cage
- Emulates DEC floppy, hard disks

The configurability of the VQ-11 computer system serves system integrators as a "standard" box to match the application. With suitable controllers, DEC RX02 floppies and RL02 hard disk

WINCHESTER, FLOPPY AND TAPE All on one board

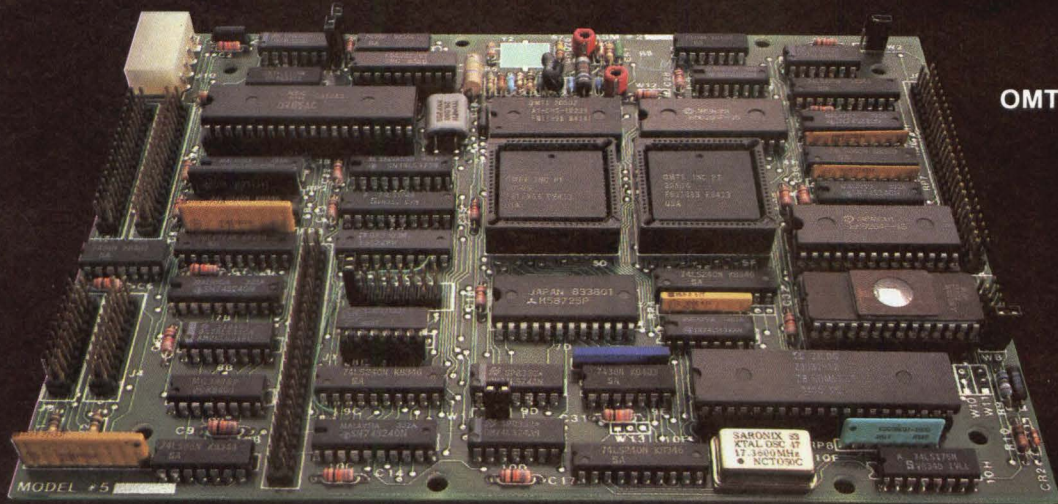

OMTI 5400

Our OMTI 5400 SCSI (SASI) controller offers Winchester, floppy and tape support all on a single 5 1/4" footprint PC board. By using our proprietary VLSI chip technology, we were able to squeeze all these functions onto a board size that most controller companies are still using for single function controllers. This means increased capability and improved cost-effectiveness in your application.

As a forward-looking OEM, you want multifunction SCSI (SASI) data controllers that meet your needs today and can meet the challenges of future developments in peripheral device technology. As you would expect, we've applied our new technology to meet these challenges in a whole family of SCSI (SASI) data controllers, the OMTI Series 5000.

UNBEATABLE FLEXIBILITY

Our OMTI Series 5000 family of SCSI (SASI) controllers supports industry standard ST506/412 5 1/4" fixed and removable Winchester disks, 5 1/4" and 8" floppy disks and QIC-02 compatible streaming tape. Each controller is SCSI (SASI) compatible to protect your software from change as you add next generation disk and tape technologies. And they are all second-sourced to guarantee availability.

HIGH PERFORMANCE

The Series 5000 controllers provide consecutive sector, non-interleaved data transfer and multisector buffering between host and peripherals. In addition, our data buffer supports simultaneous transfers between Winchester and streaming tape for fast image backup operation. No other manufacturer offers you performance like this!

EASY TO USE

Our high-level SCSI (SASI) command set off-loads your host CPU. Only one command is required to completely backup or restore Winchester data to and from tape, all without host intervention. Separate host-initiated commands allow selective file backup and restore. A sophisticated 32-bit ECC and automatic error retry means that reliable data is always available to the host. Finally, automatic Winchester flaw management handling prevents disk defects from corrupting your system.

To learn more about the OMTI Series 5000 data controllers, please contact us for additional information.

OMTI 5100
Winchester



OMTI 5300
Winchester
plus Tape

OMTI 5200
Winchester plus Floppy

OMTI
A Subsidiary of
Scientific Micro Systems, Inc.

339 N. Bernardo Avenue, Mountain View, CA 94043 (415) 964-5700

SALES OFFICES: Seattle, WA (206) 883-8303; Boston, MA (617) 246-2540; Atlanta, GA (404) 296-2029; Morton Grove, IL (312) 966-2711; Melrose Park, IL (312) 345-5320; Arlington, TX (817) 429-8527; Laguna Hills, CA (714) 643-8046; Greensboro, NC (919) 292-8072; Mountain View, CA (415) 964-5700; Philadelphia, PA (215) 860-8626.

DISTRIBUTORS: United States-Arrow Electronics, Inc. (516) 694-6800; Canada-Allan Crawford Associates Ltd. (416) 678-1500; International-Prima International (408) 732-4620.

CIRCLE NO. 93 ON INQUIRY CARD

IF POWER FAILS, DATASAVER® TAKES OVER!

PROTECTION - saves data during power failures.
 - saves hardware from overvoltage transients.

PORTABILITY - allows mobile or extended holdup time using auxiliary 12 volt battery.

FEATURES - internal battery provides 5 min. + operating time - AC line conditioning
 - audible and visual alarms, interrupt signal - compact, desktop styling
 - no installation required.

200 WATT - \$495 / **90 WATT** - \$350
 For special applications and product information, call 805-541-4160.

Instant power order line
805-541-4161



CUESTA SYSTEMS, INC.
 3440 Roberto Court, San Luis Obispo, California 93401

INSTANT AC POWER



CIRCLE NO. 94 ON INQUIRY CARD

Products

SYSTEMS

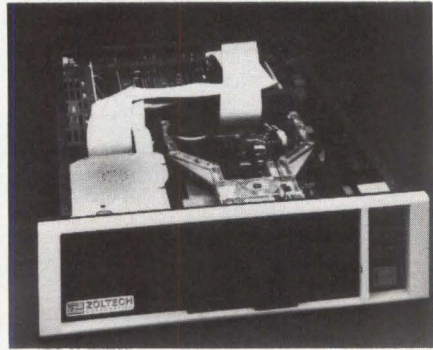

drives may be emulated, with self-contained hardware. The modular package consists of a 250W switching power supply, an eight-slot quad-width Q-bus card cage and a modular frame that accepts over 150 combinations of floppies, Winchester and tape drives. The Q-bus card cage accommodates CPUs from PDP-11/21s to 11/23s or PDP-11/73s as well as controllers and several megabytes of system memory. Graphics and FFT cards and analog interfaces are available. \$7,620. **Zoltech Corp.**, 7023 Valjean Ave., Van Nuys, Calif. 91406, (818) 780-1800.

Circle No 304

Why Trade-UPGRADE!

Why Spend a Fortune for an 11/44 or VAX?

Get the performance benefits of an 11/73 by using Able's Microverter Plus. At the same time, you can hang on to your investment in UNIBUS* peripherals! You benefit because

- With MICROVERTER PLUS, you can use 18-bit UNIBUS DMA devices with up to 4 mb of Q-Bus memory
- MICROVERTER PLUS is compatible with PDP-11/73, LSI-11/23, and -11/23+ processors
- MICROVERTER PLUS is software transparent to RSTS/E, RSX-11, UNIX,** and DSM*
- MICROVERTER PLUS can help increase your communication capability
- All at a fraction of the cost of a new system

UPGRADE with a MICROVERTER PLUS from ABLE. Call us toll-free at 800/332-2253 (outside California), or 800/225-3332 (inside California)

ABLE COMPUTER, 3080 Airway Ave., Costa Mesa CA 92626
 (714) 979-7030, TWX 910 595-1729, TELEX 668307



*PDP, UNIBUS and DSM (DEC System M.U.M.P.S.) are trademarks of Digital Equipment Corporation. ** UNIX is a trademark of AT&T.

CIRCLE NO. 95 ON INQUIRY CARD

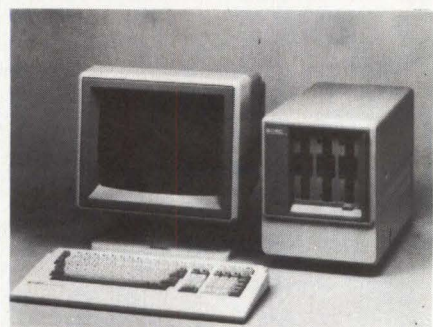

16-bit computer emulates IBM terminal

- Standard VME bus
- Multiple operating systems
- 8086 processor

The single-user and multiuser, desktop, 16-bit M343SX computer suits measurement, database-access and office-processing requirements and acts as a communications terminal. IBM 3270 emulation allows operation under the 3270/SNA/SDLC protocol. With 512K bytes of memory, the computer runs on the proprietary RMDOS operating system and PIPS electronic spreadsheet. Smaller systems may use the UCSD-P system, MS-DOS version 2.0 and the concurrent CCP-M 3.1 operating systems. Utilizing an 8086 processor, the system operates at 5 MHz; an 8087 coprocessor



A FIRST FOR THE SOFTWARE INDUSTRY

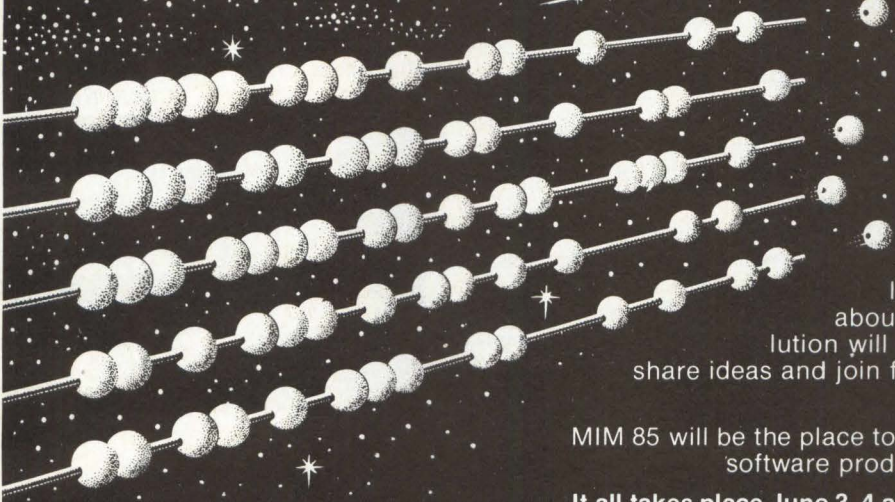

For the first time ever, anywhere, the collective genius that has brought about the worldwide software revolution will come together to sell product, share ideas and join forces in the international software marketplace.

MIM 85 will be the place to be for the world community of software producers, distributors and buyers.

It all takes place June 3, 4 and 5, 1985 in Montreal, Canada.

The first international software marketplace

Never have so many representatives from so many countries come together in one location. No less than 42 countries will be present to buy and sell, to meet software producers, publishers and distributors on an international level.

The first international software import/export conference

Never have so many experts in the field come together to offer advice. Internationally renowned specialists in import/export software marketing will lecture on software importing/exporting, producers rights internationally and state-of-the-art technology.



Montreal International Software Market

Tel.: (514) 288-8811
Telex: 055-62495



Montreal International Software Market

300, Leo-Pariseau, suite 1919
P.O. Box 1119, Station La Cite
Montreal, Quebec, Canada
H2W 2P4
A-001-USA-MM-2

Please send me more information on MIM 85, in English , in French .
I intend to attend as a participant , an exhibitor .

Name _____ Title _____

Company _____

Address _____ City _____

Country _____ Postal Code _____

Telephone _____ Telex _____

I am a software producer , buyer , distributor , manufacturer .

Types of product _____

Please print

SPOTLIGHT #6

WDOFF IN A SERIES

8-CHANNEL FERRITE HEAD READ/WRITE CIRCUITS

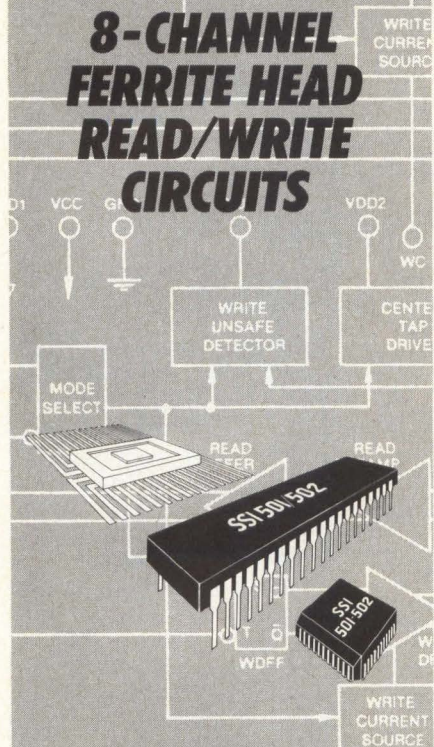

The SSI 501/502 devices are the newest bipolar disk drive integrated circuits designed for use in high capacity, high-performance ferrite-head drives. They provide a low noise read path, write current control, and data protection circuitry for up to eight channels.

The devices operate off standard +5V and +12V power supplies, feature a

programmable write current source, and they may be easily multiplexed for larger systems. Control signals are TTL compatible, and both devices have a "write unsafe detection" feature. The SSI 502 differs from the SSI 501 simply by having internal damping resistors. The units are offered in a 40-pin ceramic or plastic DIP, a 32-lead Flat Pack, or a 44-lead Quad plastic package.

For more information on these latest products in a complete line of read/write IC's and related data path, support logic, and motor control IC's for rigid and floppy disk and tape drives, contact: **Silicon Systems**, 14351 Myford Road, Tustin, CA 92680. (714) 731-7110 Ext. 575.

silicon systems™
INNOVATORS IN INTEGRATION

CIRCLE NO. 97 ON INQUIRY CARD

New Products

SYSTEMS

for floating-point operations is optional. Main memory is expandable from the standard 256K bytes to 6M bytes. The built-in VME bus allows hardware additions and exchanges. A 12-inch amber screen is standard; the optional 14-inch screen displays 16 colors out of 4,096. The system comes with a low-profile, 109-key keyboard with 21 function keys. \$3,690. **Sord Computer of America Inc.**, 723 W. 7th St., Los Angeles, Calif. 90017, (213) 622-0244.

Circle No 305

System furnishes 3-D displays

- 60-Hz non-interlaced refresh
- 1,280-by-1,024-bit resolution
- 16-bit depth buffer

Providing local manipulation and realistic shaded display of three-dimensional objects, the Model One/380 graphics system produces color images at 1 to 3 μ sec per pixel. A 1M-byte local Display List memory comes standard, and is expandable to 4M bytes. Flicker-free resolution is 1,280 by 1,024 by 24 bits of image memory at 60 Hz. A 32-bit, 10M-FLOP floating-point processor performs 3-D coordinate transformations and light-model calculations, smooth shading and hidden surface removal. The system generates vector-defined text in vertical and horizontal formats from 8 to 256 pixels and manages multiple local-scrolling alphanumeric windows. Key features include a local debugger, command stream translator, macro programming, local command interpreter, a DMA port and four serial ports at 19.2K baud. The system includes a tower enclosure, 19-inch monitor, keyboard, data tablet and mouse. \$41,500. Delivery is 120 days ARO. **Raster Technologies Inc.**, 9 Executive Park Drive, North Billerica, Mass. 01862, (617) 667-8900.

Circle No 306

Portable computer is PC compatible

- 16-color graphics
- 9-inch color monitor
- 256K-byte RAM

The IBM PC-compatible MBC 775 portable color computer runs on the MS-DOS 2.11 operating system and GW BASIC. The unit employs an 8088 CPU and furnishes 256K bytes of RAM expandable to 640K bytes; two 360K-byte,

5¼-inch floppy disk drives and a 9-inch color monitor. An 80-column-by-25-row character format or 40-column-by-25-row format in double-size mode is standard. The system offers 16 color graphic capabilities; resolution is 640 by 200 pixels in color mode or 320 by 200 pixels in black-and-white mode. Key features include an 84-key detachable keyboard, Centronics parallel port and two expansion slots that accept IBM compatible add-on boards and bundled software. \$2,599. **Sanyo Business Systems Corp.**, 51 Joseph St., P.O. Box 387, Moonachie, N.J. 07074-1098, (201) 440-9300.

Circle No 307



Symbolic processor handles AI applications

- 32-bit NuBus
- 128K-byte virtual address
- 1,024-by-808-pixel display

Suited for the development and delivery of artificial-intelligence-based applications, the Explorer System single-user symbolic processing computer furnishes a processor, a user interface and a software development environment. It contains a writable control store, a tagged architecture for run-time data typing, hardware-assisted memory management, a 128K-byte virtual address space and a 32-bit NuBus architecture with a 37½M-byte-per-second transfer rate. Key components include an SCSI bus interface; a 112M-byte Winchester disk drive with a 30-msec average access time; a 60M-byte, ¼-inch streaming cartridge tape subsystem with a 90K-byte-per-second transfer rate and 2M bytes of main memory. Features include a 1,024-by-808-pixel, 17-inch landscape display; optical mouse and low-profile keyboard. The system comes with a programming environment that includes the LISP language. Prices start at \$52,500. **Texas Instruments Inc.** P.O. Box 809063, Dallas, Texas 75380-9063, (800) 527-3500.

Circle No 308

1985 FAR EAST COMPUTER TECHNOLOGY TOURS

**Two Business and Computer Technology Tours for
Manufacturers/Distributors/Reps/Retailers/Buyers/Marketing Executives**

March Computer Technology Tour

Date: March 22 to April 6, 1985

Visit: Japan, Korea, Taiwan and Hong Kong

Attend Trade Shows and Exhibitions:

- Japan COMDEX Exhibition
- Japan Science and Technology EXPO
- Hong Kong Infotech Show

May Computer Technology Tour

Date: May 19 to June 2, 1985

Visit: Japan, Korea, Taiwan and Hong Kong

Attend Trade Shows and Exhibitions:

- Japan Micro Computer Show
- Japan Business Show
- Japan Science and Technology EXPO

Program Highlights

- Half day seminar in each country
- Business meetings with computer companies in Korea, Taiwan and Hong Kong
- Visit computer showrooms
- Visit factories
- City and shopping tours
- First class hotel accommodations
- Direct flights to Japan from San Francisco, Los Angeles, Seattle, Chicago and New York via Pan Am, Northwest Orient or Japan Airlines
- Optional tours to China, Thailand and Singapore

Price

- \$2668 from the West Coast, \$2925 from Chicago and \$2,945 from New York based on double occupancy. Price includes airfare, hotel accommodations, daily American breakfast, four dinners, transportation to/from show grounds and airport/hotel transfers, and all business programs as outlined above.

For further information or a detailed brochure, please return coupon or call:

March Computer Tour

May Computer Tour

Name: _____

Company: _____

Address: _____

City: _____ State: _____ Zip: _____

Telephone: _____

Robert Chang
Computer Technology Tours
COMMERCE TOURS INT'L, INC.
870 Market Street, Suite 708
San Francisco, CA 94102
(415) 433-3072
(800) 845-4485 Outside California
(800) 321-7271 in California

New Products

DISK/TAPE

High-capacity disk drive suits portable systems

The Microscience International Corp. HH-325 3½-inch Winchester disk drive is designed for office, factory and military environments where size, weight and power are considerations. The drive stores 20M bytes (formatted) on thin-film media and transfers data at 5M bytes per second. Average access time is 80 msec. Requiring only 9W of power, the drive can run from the microcomputer system's supply. A proprietary closed-loop, servo-positioning system steps the heads to the center of the data track, despite hysteresis or mechanical wear and thermal expansion of the motor.

Using just one printed circuit board, the HH-325 eliminates interconnections via LSI circuitry, which in turn reduces heat dissipation. Noise is reduced by employing a PLL-controlled, brushless, DC spindle motor. A linear actuator-band stepper motor system maintains accurate movement under stress conditions by placing the single-band section at the rear of the carriage/head assembly. An onboard microprocessor per-

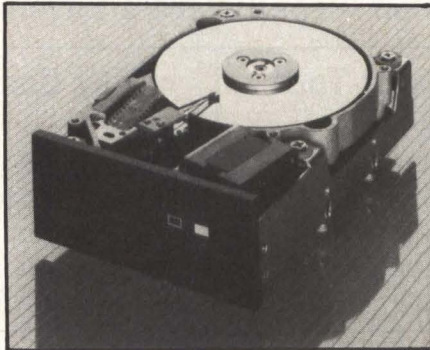

The HH-325, a 3½-inch, half-height Winchester disk drive, holds 20M bytes and uses a closed-loop servo positioning system and plated media.

forms continuous drive checks during powerup and operation. A front-panel LED provides status reports and error messages. The drive weighs 2¼ pounds and measures 1.62 inches by 4 inches by 5¾ inches. Approximately \$900. **Microscience International**, 575 E. Middlefield Road, Mountain View, Calif. 94043, (415) 494-9111.

Circle No 309

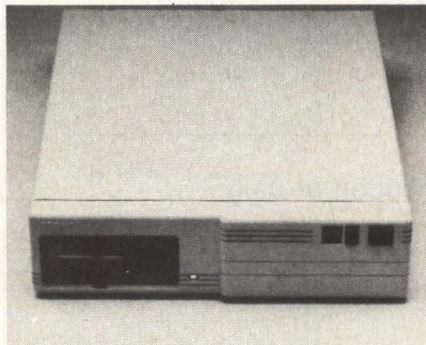

Tape subsystem backs up 20M-byte hard disk

- Employs ¼-inch tape
- Streams at 25 seconds per megabyte
- Compatible with HP computers

The Sponge, a ¼-inch tape subsystem storing 20M bytes, provides a low-cost backup solution without requiring a computer or an extra software driver. It backs up HP or Bering hard disks below 100M bytes in capacity at a streaming rate of 25 seconds per megabyte. In backup mode, the subsystem becomes

the active controller of the HP-IB bus. Supporting four types of HP disk emulations, it runs like a hard disk and includes a 64K-byte cache memory. The 4.2-by-15½-by-17½-inch unit features a ½-msec average access time (in cache). \$2,380. **Bering Industries Inc.**, 1400 Fulton Place, Fremont, Calif. 94539, (415) 651-3300.

Circle No 310

Tape transport runs in dual mode

- 45 ips in start/stop mode
- 100 ips in streaming mode
- 160K-bps transfer rate

The Model 9600 ½-inch, reel-to-reel tape transport automatically threads tape under microprocessor control and operates in start/stop mode at 45 ips for file-management operations or streaming mode at 100 ips for high-speed disk backup. Start/stop time is 8.3 msec at 45 ips with a 0.6-inch interrecord gap. Rewind is 200 ips. In both modes, the nine-track,

read-after-write transport achieves an 800- or 1,600-cpi data density using Non-Return-to-Zero Inverted (NRZI) or phase-encoding (PE) techniques. Data transfer rate is 160K bps in PE and 80 bps in NRZI at 100 ips. Packaged as a drawer-mounted transport, the unit measures 8¾ inches by 17 inches by 22 inches and weighs 70 pounds. \$3,400, 500-unit quantity. **Kennedy Co.**, 1600 Shamrock Ave, Monrovia, Calif. 91016, (818) 357-8831.

Circle No 311



Tape backup systems work with IBM PC-AT

- 27M-byte or 60M-byte capacity
- 90K-byte-per-second transfer rate
- IBM DOS 3.0 compatible

The AT-Filesafe Tape half-height, internal backup models for the IBM PC-AT offer capacities of 27M bytes (four tracks) and 60M bytes (nine tracks). The FSTI27-AT and the FSTI60-AT are compatible with the IBM DOS 3.0 and with networks supported on the PC-AT such as the 3COM Ether Series, Novell, Orchid PCnet and Nestar. At a 90K-byte-per-second transfer rate, the tape units back up an PC-AT 20M-byte hard disk in streamer mode in less than ten minutes and can restore files. Tape speed is 90 ips. Model FSTI27-AT, \$1,595; model FSTI60-AT, \$1,695. **Mountain Computer Inc.**, 300 El Pueblo Road, Scotts Valley, Calif. 95066, (408) 438-6650.

Circle No 312

Cartridge subsystem stores 67M bytes

- MFM recording method
- Reads, writes at 2M bytes per minute
- Records at 10K bpi

The model UT9000 ¼-inch cartridge

Mini-Micro Systems

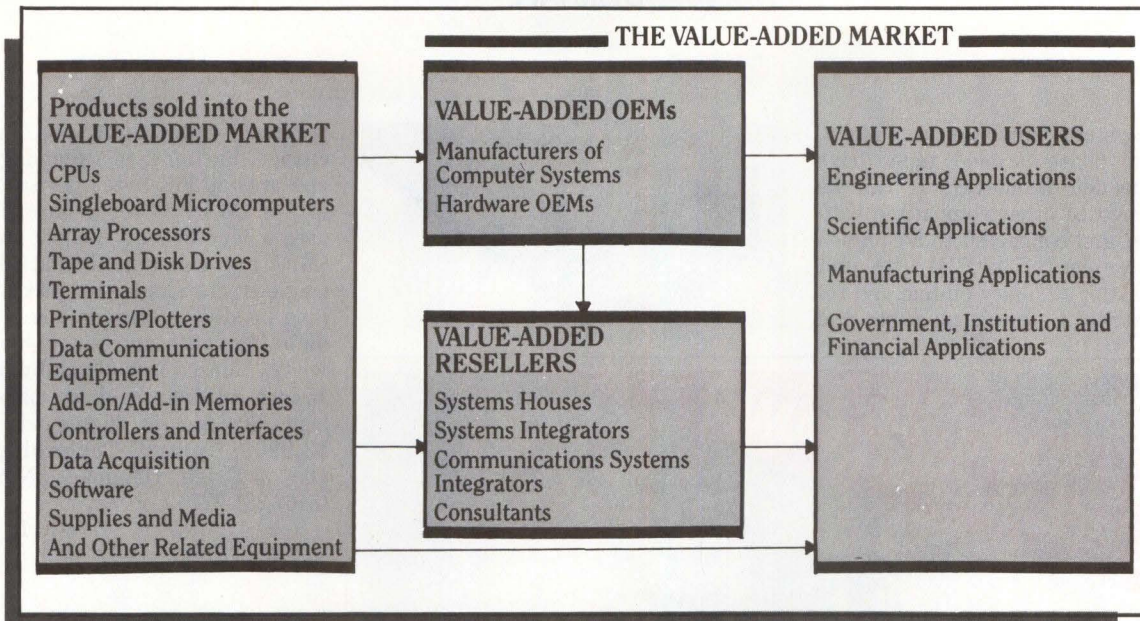

Over 112,000 computer professionals receive *Mini-Micro Systems* each month.

Because of their extensive computer product knowledge and appreciation of how systems elements function together, these readers are uniquely qualified to add value to your product. That makes them very valuable to you.

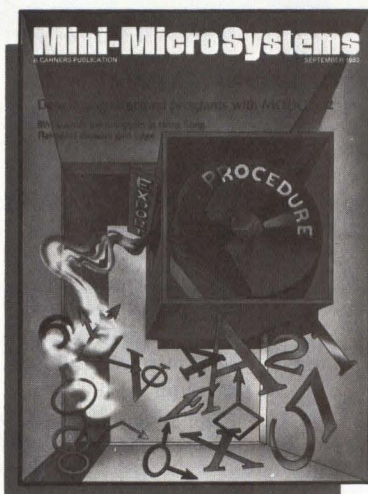
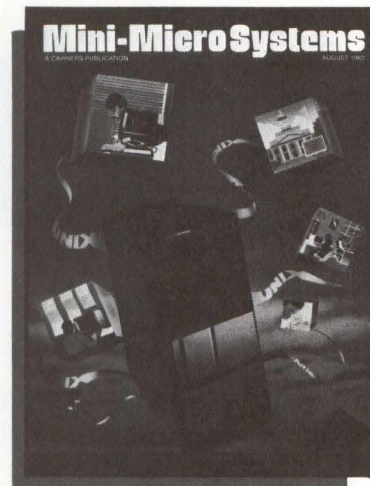

The

term value-added distinguishes *Mini-Micro Systems'* audience as those OEMs, resellers and sophisticated users who add value by integrating hardware and/or software into the mini-micro based systems they configure or enhance.

Mini-Micro Systems

The only computer publication covering the complete value-added market.

Boston (617) 536-7780/Chicago (312) 635-8800/Dallas (214) 980-0318/Denver (303) 388-4511/Los Angeles (213) 826-5818/Mid-Atlantic Southeast (215) 293-1212/Orange County (714) 851-9422/San Francisco (408) 243-8838

Cahners Publishing Publishers of 30 specialized business magazines in Building & Construction
 Electronics & Computers Foodservice Manufacturing Health Care

New Products

DISK/TAPE

tape subsystem emulates a ½-inch, nine-track, phase-encoded tape drive with embedded formatter. It can be daisy-chained to other compatible half-inch drives and connected to a common host-adaptor card. The 67M-byte unit serves backup, auxiliary on-line and removable archival storage purposes and

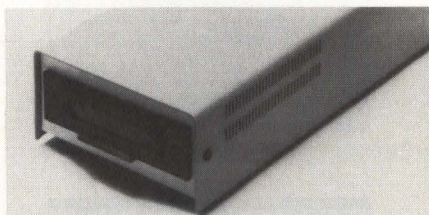

performs data logging and data interchange functions. In streaming mode, it operates at 35K bytes per second at 60 ips, or 2M bytes per minute. The drive uses a Modified Frequency Modulation (MFM) recording method at 10K bpi. A single-track, single-gap precision stepping head with straddle erase provides data integrity and single-block overwrite. Housed in a 9-inch-by-5-inch-by-15-inch cabinet, the drive loads and unloads 600 feet in 80 seconds (90 ips). \$2,990. **Upland Technologies**, 80 Davids Drive, Hauppauge, N.Y. 11788, (516) 231-0770.

Circle No 313



Standard Format... Interchangeability Guaranteed!

It's easy to see why OEMs are getting excited about The Mainstreamer!

- At \$1850*, the price is right!
- At 57% smaller than Cipher, the size is right!
- At 53% lighter than Cipher, the weight is right!

The times demand smaller, lighter, more cost-competitive OEM designs. And the Mainstreamer is right for the times.

- Storage of up to 136M bytes per reel.
- Transfer rates of 20K to 160K bytes/second.
- 800 bpi NRZI, 1600 and 3200 bpi PE.
- Cipher/Pertec interface.
- Internal diagnostics.
- Mounting options: door, drawer or table top.

The IBEX Mainstreamer. It's simple, reliable and quiet. It's right for your systems of the future, because it's *Right for the Times*.

Call, TWX or write today for the rest of the story.

*OEM quantities, 1600 bpi PE format, domestic prices.

IBEX

Right for the Times

IBEX COMPUTER CORPORATION
20741 Marilla Street
Chatsworth, CA 91311
(818) 709-8100
TWX 910-493-2071

IBEX COMPUTER CORPORATION
Eastern Regional Office:
2 Industrial Way
Salem, NH 03079
(603) 893-7036, 893-7037



Tape subsystem offers two recording modes

- Features Group Code Recording
- Stores 140M bytes on one reel
- Backs up DEC VAX systems

The TU81, a Group Code Recording (GCR) streaming tape subsystem, suits applications such as disk backup, data archiving and data recording. The subsystem features 6,250-bpi and 1,600-bpi industry-standard recording, GCR and Phase Encoding on a 9-track magnetic tape. Designed for backing up DEC's Unibus VAX superminicomputers, the unit offers a streaming mode at 75- and 25-ips speeds and a start/stop recording mode at 25 ips. It stores 140M bytes on a 2,400-foot reel and allows the mounting of a disk in the tape cabinet. The tape drive uses the Digital Storage Architecture protocol, which permits prefetching commands from the CPU. \$25,500. **Digital Equipment Corp.**, 146 Main St., Maynard, Mass. 01754, (617) 897-5111.

Circle No 314

CIRCLE NO. 100 ON INQUIRY CARD

Our multi-mode HERMES printers shake hands with all kinds of computers. Even some you've never heard of.



And for your IBM-PC™, we have created the fully compatible multi-mode HERMES PC-PRINTER 1.

Troquet Advertteam

Fully compatible with your IBM-PC™, tested with Easywriter™, Multiplan™, Lotus 1-2-3™ and other software packages, the HERMES PC-PRINTER 1 allows you to convert your personal computer to a heavy duty professional system. IBM-PC™ users who only pick the best will also appreciate:

Its speed. Bi-directional, shortest path printing. 200 cps Data, 100 cps Near Letter Quality (single pass).

Its resolution. Finest print quality available on a matrix printer. So good you can even print signatures. Bit mapping graphics in single, double and triple density modes.

Its quality. Swiss high quality construction. Very high reliability for heavy duty use.

Its versatility. Choice of printing styles with the complete IBM™ character set tables (226 chars.). Wide range of automatic sheet-feeders with 1 or 2 bins + envelopes, single document inserter, roll-holder and tractor.

Its ease of use. Plug'n play installation. Plug it in, switch it on yourself.



HERMES®
The impressive printers

Made by HERMES PRECISA INTERNATIONAL, CH-1401 Yverdon, Switzerland
HERMES printers are distributed in Austria, Canada, Cyprus, Finland, France, Greece, Jordan, Kuwait, Lebanon, Saudi Arabia, South Africa, Spain, Sweden, Switzerland, United Kingdom, USA, West Germany.

CIRCLE NO. 101 ON INQUIRY CARD



To receive a sample of the finest quality matrix print-out and additional information on the HERMES PC-PRINTER 1, please return the coupon below.

Please send me more documentation about your PC-PRINTER 1.

Name Title

Company

Street City

State Zip Phone ()

Send to: HERMES PRODUCTS, Inc. - Printer Division
1900 Lower Road, LINDEN, NJ 07036, (201) 574 0300

While others are simply making promises about high-capacity storage peripherals, we're actually making deliveries.

Being able to promise OEM's a 234MB, 8-inch Winchester Disk or a 100MB, 1/4-inch Tape Drive is one thing.
Being able to deliver on that promise has always been something else.

Now, we can do both. Send us your order, and we can send you our Mercury* 234MB Disk Drive that features embedded servo technology, a choice of SMD or SCSI interfaces, and average access times as low as 20 ms. Our disk drive also offers microprocessor control, assuring you of fail-safe operation.

Or tell us you want the highest capacity 1/4-inch streamer available and we'll ship you the Flashback* 100MB Tape Drive. It has QIC-2 interface and QIC-24 or 11 interchangeability.

With either drive, you get the same outstanding reputation for design simplicity, data integrity and reliability that comes with Memory Systems' 16 years of design and manufacturing experience. But maybe most importantly, you'll get the drives themselves. For more information, or to order an evaluation unit, call 1-800-521-3278, Telex #810-223-6011.



234 MB

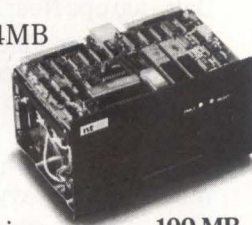

100 MB



The Mercury 234MB Disk Drive and Flashback 100MB Tape Drive. These high-capacity storage peripherals are available today.

New Products

TERMINALS



Data terminals transmit at 9,600 bps

- Three data speeds
- 15-inch screen
- Eight-page memory

The 8000 series of standalone data terminals provides one EIA RS232 port and one Centronics printer port and emulates other protocols via backpack

module and keycaps. Each ergonomic terminal has an anti-glare, flicker-free 15-inch screen, a front-mounted on/off switch, brightness control and keyboard with palm rest. Model 8015S uses Bell 8A1 protocol to send and receive asynchronous data at 1,800 bps and synchronous data at 4,800 bps. Providing multiple format storage, the unit offers eight pages of memory with cursor selectable page numbers, line and column position. Time and data are inserted on the screen by depressing one key. Model 8220S uses Univac protocol for synchronous transmission to 9,600 bps. Reverse video, low intensity, underline, blink and blank functions and bidirectional scrolling are provided. \$2,550, both models. **Racal-Milgo**, 8600 N.W. 41st St., Miami, Fla. 33166, (305) 592-8600.

Circle No 315

ANSI-based terminal works with UNIX

- Transfer speeds to 19.2K bps
- 38 function keys

- 80-or-132-cpl formats

Compatible with the UNIX operating system and the DEC VT102 and DEC VT52 terminals, the Teletype 5425 ANSI 3.64-based terminal suits editing, programming and data processing applications. The 12-inch, diagonal white, green or amber screen features full-screen windowing, scroll mode and horizontal split screen. The display has a 78-line memory with 80 cpl or a 54-line memory with 132 cpl in a 7-by-9-dot or 5-by-7-dot-matrix format. The detached tilt-adjustable keyboard has 38 downloadable function keys. Data transfer speeds can reach 19.2K bps. Other features include ASCII code with vertical parity generation and detection options, auto answer, audible alarm, self-diagnostic test routines, 2,000-character line buffer, EIA RS232C modem interface and a buffered EIA RS232C printer port. Weighing 32 pounds, the unit measures 15¼ by 16¾ by 13¼ inches. \$1,400. **AT&T Teletype Corp.**, 5555 Touhy Ave., Skokie, Ill. 60007, (312) 982-3189.

Circle No 316

There is a band printer with an MTBF of up to 6000 hours.

What more do you need to know?

Call: 1-800-626-4686

Fujitsu Printers
Maximum Quality. Maximum Value.

FUJITSU

CIRCLE NO. 103 ON INQUIRY CARD

New Products

PRINTERS

Desktop printer replaces TI model 850

- 35 cps, letter-quality mode
- 9-by-9-inch dot matrix
- ASCII 96-character set

The PLCQ55 dot-matrix printer features letter-quality printing capabilities plus raster and mosaic graphics. Suited

for correspondence, drafts and graphics, the lightweight desktop printer prints 150 cps in draft-quality mode and 35 cps in letter-quality mode. Offering an ASCII 96-character set, the bidirectional printer operates in a 9-inch-by-9-inch dot-matrix and 32-inch-by-18-inch, double-pass dot-matrix format. Word-processing capabilities include three

user-selectable font modules, Epson-compatible escape sequences and Qume- and Diablo-standard data processing. Raster graphics permit horizontal dot densities of 60, 72, 120 and 144 dpi and vertical dot densities of 72 and 144 dpi with an 8-bit vertical input. Mosaic graphics consist of a 64-character set. Serial transmission rates range from 300 baud to 9,600 baud. \$765, OEM quantities. **Plessey Peripheral Systems Inc., Distributor Products Division**, 15542 Mosher Ave., Tustin, Calif. 92680, (714) 731-2440.

Circle No 317

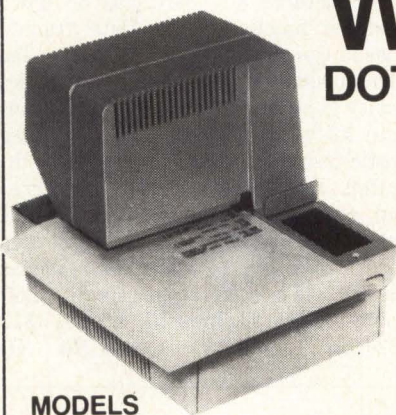

**MODELS
8400/8410**

WESTREX DOT MATRIX PRINTERS

**NEW!
STAND-ALONE,
150 CPS
SLIP/DOCUMENT
PRINTERS**

**8000
SERIES**

Model 8400 and Model 8410 are new, packaged, stand-alone, alphanumeric, bidirectional, flat bed, Slip/Document dot matrix printers. They print up to 40 columns at 12 characters per inch at 3 lines per second. Both models provide side or front form insertion; top and bottom-of-form sensors and adjustable Slip/Document Stop. The print head employs a 7-needle vertical array that permits selection of fonts and characters (5 × 7, double width, etc). The character set is fully alphanumeric under software control. The 100% duty cycle print head life is rated at 100 million characters.

Model 8400 and Model 8410 are complete with control and drive electronics. Serial RS-232C or TTY and parallel interfaces are available. Both units can provide multiple print lines and carbon or pressure sensitive copy.

Model 8410 additionally features a stepping motor paper drive system which permits variable and programmable forward/reverse line spacing for applications requiring line selection and or unique form indexing.

QUANTITY DISCOUNTS AVAILABLE.



For full details, write or call us

WESTREX OEM PRODUCTS

51 Penn Street, Fall River, MA 02724. (617) 676-1016 TELEX: 651490 Relay WNJV
IN FRANCE — WESTREX OEM PRODUCTS, 103-105 Rue de Tocqueville,
750 Paris, France 01-766-322-70 TELEX: 610148
IN SWEDEN — WESTREX OEM PRODUCTS, Box 3503, S-17203 Sundbyberg,
Sweden 46 8 + 981100 TELEX: 12139

CIRCLE NO. 104 ON INQUIRY CARD

Low-cost ink-jet generates 150 cps

- eight character sets
- 5- to 17-cpi, programmable pitch
- 9-by-9 dot matrix

The Model TDP 8800 ink-jet, matrix printer offers eight character sets including international, USASCII and English. Its bidirectional print speed is 150 cps; print rate is 100 lpm based on a 60-character line with 10 cpi. Character fonts are built within a 9-by-9 dot matrix with provisions for descenders and underscoring. A 165-character data buffer, expanded print, programmable pitch (5 to 17 cpi), proportional spacing and horizontal and vertical tabulation are standard. A paper-feed system accepts fanfold, roll and single sheets. A replaceable ink cartridge yields an average of 5 million characters. Raster scan and bit-image graphics output, an expandable receive buffer of as much as 4K bytes and a loadable character generator are optional. \$895. **Tandberg Data Inc.**, P.O. Box 99, Labriola Court, Armonk, N.Y. 10504, (914) 273-6400.

Circle No 318

Ink-jet printer features 45 font styles

- 176 cps in draft mode
- 88 cps in letter-quality mode
- Eight standard print sizes

Ensuring reliable operation, the SQ-2000 non-clogging, drop-on-demand, letter-quality ink-jet printer initiates a 10-second cleaning cycle when shut off or turned on. In draft mode, the unit prints 176 cps with a 15-by-17-dpi resolution; in letter-quality mode, 88 cps with a 37-by-17-dpi resolution. Also featured are nine bit-image graphic modes

with densities from 60 to 240 dpi. The printer provides 45 standard font styles and 96 ASCII, 96 italic, 32 international and 128 downloadable user-selected characters. Manual friction-feed and eight print sizes, including elite, proportional and proportional super/subscript, are standard. Column width is 13.6 inches. \$2,500. Delivery is 90 to 120 days ARO. **Epson America Inc., OEM Products Division**, 23600 Telo Ave., Torrance, Calif. 90505, (213) 534-4500.

Circle No 319

columns with adjustable sprocket feed tractors. Machine configuration is via menu-driven program commands. The printer also offers correspondence-quality printing at 350 cps and two dot-addressable graphics modes: 50-by-90 dpi for high speed output or 100-by-69 dpi for higher resolution copies. Paper feed is from the front or bottom of the case; the control panel features membrane switches and LED indicator lights. \$1,595. **Output Technology Corp.**, 606 110th Ave. N.E., Bellevue, Wash. 98004, (206) 453-9794.

Circle No 320

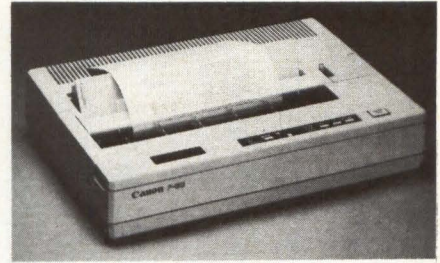

letter-quality text appears in a 28-by-24 dot-matrix format; in draft mode, a 9-by-24 dot-matrix format. Graphics are formed at 360 dpi. The unit prints on transparencies, or on thermal paper 11.7 inches wide, with a maximum of 110 cpl in standard mode; 55 cpl in enlarged mode and 188 cpl in condensed mode. Print speeds vary from 20 to 80 cps. An interchangeable cartridge provides seven typestyle options. An 8-bit Centronics parallel interface comes standard. The typewriter-size printer runs at a 45-dB noise level. \$545. **Canon U.S.A. Inc., Printer Division**, One Canon Plaza, Lake Success, N.Y. 11042, (516) 488-6700.

Circle No 321

Matrix printer operates at 700 cps

- 350-cps correspondence-quality
- 136-column carriage width
- Dot-addressable graphics

Meeting high-volume output needs of data-processing environments, the OT-700 prints matrix characters at 700 cps. Furnishing nine foreign character sets, the printer's carriage width is 136

Thermal-transfer printer operates quietly

- 360-dpi graphics
- 36-by-24 dot-matrix format
- 20- to 80-cps print speed

In 36-by-24 dot-matrix format, the F-60 thermal-transfer printer produces letter-quality text and graphics. Near-

There is a band printer which sets new standards in price/performance.

What more do you need to know?

Call: 1-800-626-4686
Fujitsu Printers
Maximum Quality. Maximum Value.

FUJITSU

CIRCLE NO. 105 ON INQUIRY CARD

New Products

DATACOMM

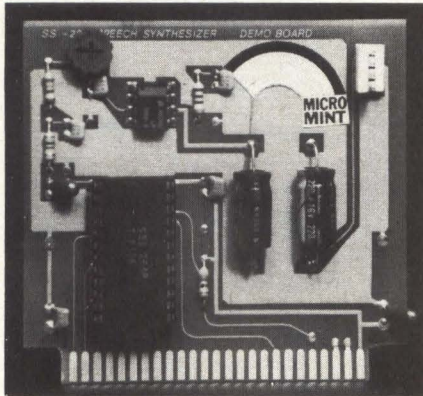

Synthesizer interfaces with Apple computers

- 50- to 70-bps data rates
- 4,096 pitch variations
- Five 8-bit internal registers

Based on the SSI 263 integrated circuit from Silicon Systems Inc. (SSI), the Sweet Talker II speech synthesizer can be configured for various levels of intelligibility. Intonation, inflection and filtration are user-controlled, and 64 phoneme values, each with four different duration settings, are set on the five 8-bit internal registers. Intended for the Apple II+ or Apple IIe, the unit provides analog output for music, sound effects and continuous speech with 4,096 pitch variations and at data rates of 50 to 70 bps. The synthesizer is compatible with voice software intended for SCI 263-based Apple products. Measuring 3 inches by 3¼ inches, the unit features three control inputs for address mapping with several buses, four handshaking modes, eight articulation rates, 16 speed settings and 16 amplitude levels. \$104. **Micromint Inc.**, 561 Willow Ave., Cedarhurst, N.Y. 11516, (516) 374-6793. **Circle No 322**

Protocol converter links ASCII devices, IBM host

- Supports 100 asynchronous terminals
- Supports 19.2K baud rates
- Eight port configurations

Suited for computer facilities with numerous remote sites that employ only one or two IBM 3270 terminals per site, the MC 800 protocol converter allows 24 asynchronous ASCII devices to communicate with an IBM or equivalent host computer. Using either SNA/SDLC or BSC protocols, the converter appears to the host computer as an IBM 3274 or

3276 communications controller with IBM 3278/3279 terminals attached. The unit features full screen mapping; data displayed on the terminal is the same as that on the IBM. Available in port configurations of five, seven, eight, nine, 12, 16, 20 and 24 ASCII ports, the converter supports over 100 different types of asynchronous terminals, teleprinter devices and personal computers. It is user configurable to support standard asynchronous baud rates of 19.2K baud. \$3,600, 5-port unit. **Innovative Electronics Inc.**, 4714 N.W. 165th St., Miami, Fla. 33014, (800) 327-3955. **Circle No 323**

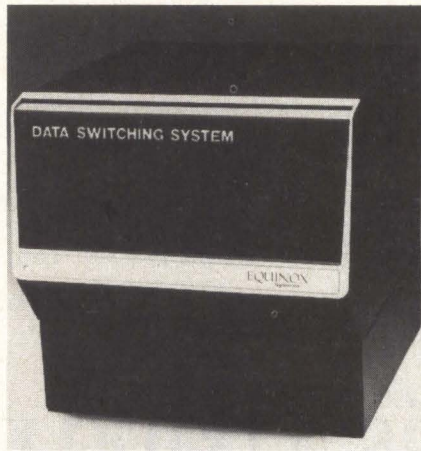

Data PBX links computers, terminals

- 360-line capacity
- Expandable to 1,320 lines
- Connects 24 to 1,320 computer ports and terminals

Less than one-sixth the size and one-seventh the weight of conventional port selectors, the Data PBX (Private Branch Exchange) employs programmed array logic. It provides user-controlled switching among computers, port contention and access control and network management. At 9,600 bps, from 24 to 1,320 asynchronous computer ports and terminals can be connected simultaneously. The system uses standard telephone PBX-type connectors and cabling for easy installation. Modular in construction, the basic central unit has a 360-line capacity, is expandable to 1,320 lines and occupies 17½ inches in rack height. Each line board handles 24 lines, which can be individually configured as terminals or ports. \$8,800. **Equinox Systems**, 12041 S.W. 144th St., Miami, Fla. 33186, (305) 255-3500. **Circle No 324**



Modem provides error-free transmission

- 2,400-bps data transfer rate
- ARQ error recovery
- Automatic adaptive equalizer

The 2,400-bps, full-duplex CDS 224 modem with ARQ (Automatic Request for Repetition) error correction, doubles the data throughput of 1,200-bps modems, providing error-free data transmission over telephone lines. It automatically adapts if a remote modem is not similarly equipped with ARQ or is a Bell-212 type. The ARQ feature utilizes a bit-synchronous protocol to transfer binary files. The modem's automatic adaptive equalizer feature compensates for telephone line interference. Diagnostics include Loop 2 (Digital Self Test) and Loop 3 (Analog Self Test) and an internal test pattern generator and checker. Features include an automatic answer or an originate and/or manual answer mode. The modem comes in rack-mount and tabletop models. \$1,295. **Concord Data Systems Inc.**, 303 Bear Hill Road, Waltham, Mass. 02154, (617) 890-1349. **Circle No 325**

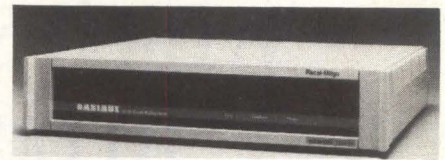

Multiplexer cuts synchronous line costs

- Half- or full-duplex operation
- 1,200- to 3,200-bps data rates
- EIA RS232C and CCITT V.35 interfaces

The Omnimux TDM56 time division multiplexer reduces synchronous line costs by dividing wideband DDS circuits into low-speed channels for economical data transfer. It supports standard synchronous protocols and operates in either half- or full-duplex mode. To increase channel capacity of megabit multiplexers, eight low-speed channels can be combined over a single synchronous channel. Data rates from 1,200 to 3,200 bps are individually set for each channel. The standard EIA RS232C and

CCITT V.35 interfaces support aggregate link speeds from 9,600 bps to 7,200 bps. All parameters are entered via DIP switches. Remote channel parameters are down-line loaded from the local multiplexer. \$3,200. **Racal-Milgo**, 8600 N.W. 41st St., Miami, Fla. 33166, (305) 592-8600. **Circle No 326**

Data compression unit doubles transfer rate

- Transfers data over 1,200-, 2,400- or 4,800-bps telephone lines
- Employs X.25 protocol
- ASCII or EBCDIC character set

The Accelerator Series 21 asynchronous data compression unit doubles data transfer rates over 1,200-, 2,400- or 4,800-bps point-to-point telephone lines while providing error-free transmission and data security. It can be employed with dial or dedicated lines, in multiplexed configurations and transparently, where there is no complementary device. The unit is installed between

modem and terminal at each end of a circuit. A modified X.25 protocol uses CRC-based logic to ensure the detection or transmission errors. A four-digit Network Security Code assigns each Accelerator on a host's network. Either EIA or In Band flow control is supported. Modems can be asynchronous or synchronous, fixed rate or autobaud; ASCII or EBCDIC character sets; data transmission, character or block mode. Starts at \$695. **Telebyte Corp.**, 215 Oak St., Natick, Mass. 01760, (617) 653-3995. **Circle No 327**

Modem board plugs into IBM PC or XT

- CCITT V.29 and V.27 ter interfaces
- Synchronous, half-duplex mode
- 9,600-bps data transfer rate

The FAXT-96 modem board plugs into an IBM PC or XT adapter slot and provides data transfers at 9,600 bps over dial-up telephone lines. It features

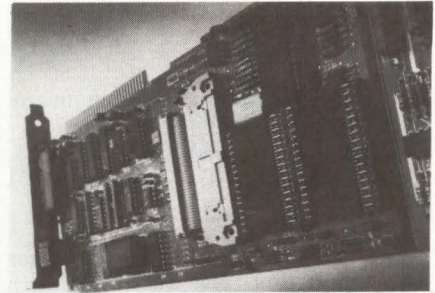

auto dial, auto answer and fallback speeds of 7,200, 4,800 and 2,400 bps. Bundled with a software package, the board connects to the telephone line by modular jack and to a serial adapter card with included cables. The synchronous, half-duplex modem works with a two-wire, dial-up, switched network and conforms to the CCITT V.29 and V.27 ter standards. When two FAXT-96 modems are used in an end-to-end link, they automatically test the circuit and select the best transmission speed. \$1,995. **Gamma Technology Inc.**, 2452 Embarcadero Way, Palo Alto, Calif. 94303, (415) 856-7421. **Circle No 328**

There is a band printer that operates at an acoustic noise level of 55dBA.

What more do you need to know?

Call: 1-800-626-4686
Fujitsu Printers
Maximum Quality. Maximum Value.

FUJITSU

CIRCLE NO. 106 ON INQUIRY CARD

New Products

SOFTWARE

Packages suit Toshiba printers

- Works on IBM-compatible microcomputers
- 10 different type styles
- Downloads to the Toshiba P1351 printers

Three font disk software packages with 10 different type styles work with IBM and IBM-compatible microcomputers and download into Toshiba P1351 dot-matrix printers. The Toshiba Font Disk offers the Toshiba Original for serif print in proportional spacing, the Letter Gothic for a standard typewritten appearance and the Bold Face Italic. The disk includes American English, British, German, French, Swedish and Norwegian characters. The Fonts America disk features three type faces in serif, sans serif and stylized fonts — Micro 1, Italic 1 and Italic 2. Greentree Software offers four fonts; Courier (IBM extended) and IBM PC (IBM extended elite), and Graph 10 and 12 (elite) for

graphics shapes. Toshiba Font Disk, \$49.95; Fonts America, \$49.50; Greentree Software, \$34.95. **Toshiba America Inc.**, Information Systems Division, 2441 Michelle Drive, Tustin, Calif. 92680, (714) 730-5000. **Circle No 329**

Graphics tools package implements GKS standard

- Supports 80 graphics peripherals
- Contains 190 subroutines
- Features on-line debugging

The GK-2000, available for the DEC VAX, most UNIX CPUs and IBM mainframes, meets and exceeds the GKS (Graphical Kernel System) standard. The graphics tools package is compatible with Precision Visuals' device-intelligent drivers and supports 80 graphics output devices. With 190 user-callable subroutines, the package develops 2D applications that are independent of an output device. Included are GKS-standard features plus 2D image manipula-

tion, support for 11 concurrent device drivers, 24 stroke-precision fonts, 256 line types, graphics input devices, extended error processing, on-line debugging, pause function and file-name control. Starts at \$4,500. **Precision Visuals**, 6260 Lookout Road, Boulder, Colo. 80301, (303) 530-9000.

Circle No 330

Graphics package displays 16 colors

- Five pull-down menus
- Mouse-driven
- Thirty backgrounds

The PC Paintbrush enhances and prints graphics and text created by programs such as Wordstar, SuperCalc 3 and Lotus 1-2-3 using 14 tools, five pull-down menus and 30 backgrounds. The mouse-driven program runs on seven color cards, one with 720-by-704 resolution for four colors and one with 640-by-400 resolution for 16 colors. For display on a monochrome monitor, each of the 30 backgrounds is transformed into black and white texture. Six available text fonts can be manipulated in seven styles and sizes from 9 to 72 points. The program determines the height, width and margin for printing, and prints either a selected portion or a full image. The package requires an IBM PC or PC-compatible, 192K bytes of RAM, and MS-DOS 2.0. \$139. **International Microcomputer Software Inc.**, 633 Fifth Ave., San Rafael, Calif. 94901, (415) 454-7101.

Circle No 331

Entry system reduces programming time

- Automatic syntax checking
- Edits IBM PC Pascal and C
- Structure manipulation

The Entry System for Programs (ESP), a language-oriented editor for IBM PC Pascal and C users, helps programmers learn Pascal and C. The program entry environment combines the text-manipulation function of a general purpose editor with the syntax checking function of a compiler. The system operates on individual language structures; it is context-sensitive and creates program structures with one keystroke. Programs are automatically formatted. Three methods of input—stream mode, abbreviation mode and expand/view

If you think all port expanders are equal... HERE'S THE SWITCH!

No more scraps to see who gets to use the printer first. No more tangles with cables everytime you want to connect to peripherals. No more jostling heavy equipment around the office.

WOULDN'T YOU RATHER SWITCH THAN FIGHT?

Portal allows you to quickly and easily introduce a comprehensive switching system that will handle terminals, printers, modems, CPUs and other RS232 compatible devices. Up to 32 ports can handle 16 simultaneous connections.

SAVING TIME AND MONEY—NOW THAT'S A SWITCH

Portal gives you network capabilities at a fraction of the cost. With features such as hunt group (acts much like a multi-line telephone that will ensure the user gets through to an open node) and wait queues that will automatically notify user once the requested peripheral is available. There's more good news and features. Call or write today for complete details.

PORTAL
ENFIN RESOURCES INC.

150 Metcalfe St.
Suite 102B, Ottawa
Ontario K2P 1P1
613-230-1759



“All you need to know
is how much
Fujitsu has improved
band printer technology.”

Norman B. Petersen
Senior Vice President
Fujitsu America, Inc.

Consider that our M304X series band printers are extremely reliable. Easy to use and service. And so quiet they don't have to be banished to an inaccessible corner in the computer room.

Take a look at the details—like a state-of-the-art operator control panel. One of the most compact band printer designs available. And 77% parts commonality among all the printers.

Think about Fujitsu's 30 years of experience as one of the world's leading electronics companies.

What more do you need to know? Our prices and specifications. To get those, and to see the M304X family of band printers, **contact Fujitsu at 3055 Orchard Drive, San Jose, CA 95134. Or give us a call at 1-800-626-4686.**



MODEL	LPM (64 char. set)	MTBF (HRS)	SIZE (H x W x D)	NOISE (dBA)
M3040	300	6,000	41.7 x 26.8 x 35.4	55
M3041	600	6,000	41.7 x 26.8 x 35.4	55
M3042	900	4,000	41.7 x 26.8 x 35.4	55
M3043	1200	4,000	41.7 x 26.8 x 37.8	55

Fujitsu Printers
Maximum Quality. Maximum Value.



New Products

SOFTWARE

mode—work simultaneously. The environment offers automatic creation of program structures, crash resistance, structure manipulation and on-line help. Required are an IBM PC, XT and other IBM PC-compatible or MS-DOS computers with 192K bytes of RAM, an 80-column display, one disk drive and a language compiler. Pascal only, \$249; C only, \$349; Pascal and C, \$399. **Belle-soft Inc.**, 2820 Northup Way, Bellevue Wash. 98004, (206) 828-7282.

Circle No 332

and mainframe computers through asynchronous ports over telephone lines, satellites or local-area networks. Using a multibuffering technique and a full-duplex line, transmission efficiency is improved 80 percent with a selective retransmission function. The system uses an RS232C serial port and communicates with an asynchronous modem at 4,800 bps; direct connection enables a 9,600-bps transmission rate. \$250. **Anderson Jacobson**, 521 Charcot Ave., San Jose, Calif. 95131, (408) 945-9030.

Circle No 333

PC-DOS operating system allowing communications access while using other programs. It accesses information services, bulletin boards, electronic mail systems and other computers, and emulates keyboard and display functions of 24 terminals, supporting conversational and block modes. Operating at 9,600 baud, the program allows a personal computer to hardwire locally to a host computer for high-speed operation, or remotely through manual or auto-dial modems. Written in assembly language, it provides management of multiple serial and parallel ports for communications. The package includes support for the XMODEM protocol and auto-dial modems and modem cards, a menu-driven format, a built-in phone book, character protocol for text files with user-defined parameters, built-in disk and file utilities, patch utilities and a 24-hour online update service and bulletin board system. \$295. **Softronics**, Suite 10, 3639 New Getwell, Memphis, Tenn. 38118, (901) 683-6850.

Circle No 334

File-transfer program links 70 files

- 4,800-bps data transmission rate
- Employs RS232C serial port
- Transfers spreadsheet models

The asynchronous file transfer software, BLAST, permits computers with incompatible operating systems to transfer and exchange data. The program links more than 70 different models of microcomputers, minicomputers

Software serves dual purposes

- Emulates 24 terminals
- Operates at 9,600 baud
- Accesses information services

Softerm PC, a communications manager and terminal emulation program for the IBM PC, functions as a stand-alone program or as an extension to the



HIGH PERFORMANCE, VERSATILITY, VIVID COLOR, CRISP IMAGE TOEI COLOR DISPLAYS FTC/CDM - SERIES.

TOEI, experienced Display Monitor specialists, offer a wide selection of Color CRT Displays. You can choose from our versatile standard models or OEM versions to meet your exacting requirements.

•Housed in lightweight, impact-resistant Cabinet. •Hi-Contrast (Black Face), Hi-Brightness CRT displays a crisp, sharp image. •Limitless colors can be displayed through Analog Input.

FTC-12" Series



CDM-14" Series

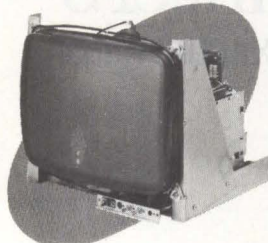

Versions CRT Size	RGB Version	NTSC Version	PAL Version	NTSC & RGB Version	PAL&RGB Version	IBM PC Compatible only
12" (CRT Pitch)	FTC-1208-R (0.28mm Dot trio)	FTC-1201-N (0.47mm Stripe)	FTC-1201-P (0.47mm Stripe)	FTC-1201-NR (0.47mm Stripe)	FTC-1201-PR (0.47mm Stripe)	FTC-1208-F (0.28mm Dot trio)
	FTC-1203-R (0.38mm Dot trio)	FTC-1200-N (0.63mm Stripe)	FTC-1200-P (0.63mm Stripe)			FTC-1203-F (0.38mm Dot trio)
	FTC-1201-R (0.47mm Stripe)					
14" (CRT Pitch)	FTC-1455H-R (0.31mm Dot trio)	FTC-1410H-N (0.52mm Stripe)	FTC-1410H-P (0.52mm Stripe)	FTC-1410H-NR (0.52mm Stripe)	FTC-1410H-PR (0.52mm Stripe)	FTC-1455H-F (0.31mm Dot trio)
	FTC-1428H-R (0.39mm Dot trio)	FTC-1416-N (0.64mm Stripe)	FTC-1416-P (0.64mm Stripe)			FTC-1428H-F (0.39mm Dot trio)
	FTC-1423H-R (0.42mm Dot trio)					
Applications	IBM PC·PC jr Apple IIc, IIe* RGB TTL & Analog	IBM PC·PC jr, Apple IIc· IIe, Commodore C-64				IBM PC with card

*with RGB card FTC-1203-R, FTC-1203-F "Non-Glare"

CDM Series (Unit for OEM)

Model	CRT Size	CRT Pitch
CDM-1208-R	12"	0.28mm Dot trio
CDM-1203-R	12"	0.38mm Dot trio
CDM-1201-R	12"	0.47mm Stripe
CDM-1455H-R	14"	0.31mm Dot trio
CDM-1428H-R	14"	0.39mm Dot trio
CDM-1423H-R	14"	0.42mm Stripe
CDM-1410H-R	14"	0.52mm Stripe

•OEM versions include Color 6"-26" in addition to the above, Monochrome 3"-26", CRT Pitch 0.64mm - 0.21mm, Horizontal frequency less than 64kHz, Non-glare to meet your requirements.

•Green/Orange CRT Displays are also available. (Included IBM PC Compatible.) CRT size: 9" or 12".

•We are looking for reliable and established distributor worldwide.

TOEI ELECTRONICS (MFG) CO., LTD.

Kanda Cent Bldg, 2-4, Yushima 1-chome Bunkyo-ku, 113 Tokyo JAPAN
Tel. (03) 257-1131 Telex. 0222-2555 TOEICO J FAX (03) 258-3560

IBM PC is a Trademark of IBM Corp. Apple IIc, IIe are Trademarks of Apple Computer Inc.
Commodore C-64 is a Trademark of Commodore Business Machine Inc.

New Products

SUBASSEMBLIES

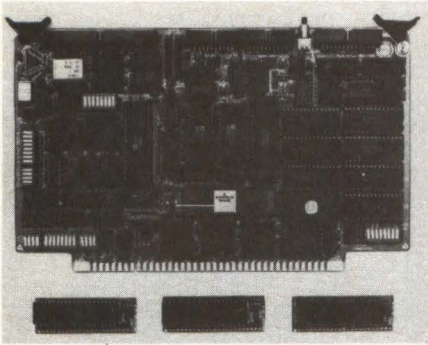

Single-board computer offers 16-, 8-bit CPU

- 65K bytes of memory
- 20 I/O ports
- 6 inches by 9¾ inches

The 6-inch-by-9¾-inch GMS6507 single-board computer provides either a 68008 16-bit microprocessor with 8- and 10-MHz operation or an 8-bit 6809, Z80, 6502 or 9900 CPU with 1 or 2 MHz. The module offers two RS232C ports with 15 programmable baud rates; two parallel printer ports; a GPIB or IEEE-488 controller/talker/listener port; and 20 bidirectional and buffered I/O lines capable of driving 30 mA. A 65K-byte, on-board, static CMOS memory eliminates the need for additional external memory. The memory section provides eight byte-wide sockets, which accept 16K-byte or 64K-byte static RAM or ROM/EPROM devices. Each device, or the entire memory, may be disabled under software control to allow bootstrapping. Priority-level interrupt logic eases programming. \$685. **General Micro Systems Inc.**, 1320 Chaffey Court, Ontario, Calif. 91762, (714) 621-7532.

Circle No 335

Package integrates text and graphics

- Utilizes an Intel 80186 coprocessor
- 720-pixel-by-352-pixel graphic resolution
- IBM PC/XT compatible

Requiring an IBM PC with hard disk or an IBM PC/XT, the Concept 100 document processing system consists of an Intel 80186-based intelligent graphics subsystem, a graphics editor, a Mouse Systems mouse and a set of basic fonts. Capabilities include word processing, system documentation, data-driven chart making, zoom and pan, crosshatching, color output and creation

of block diagrams, circles, polygons, graphs, maps and text with diagrams. The subsystem board increases resolution for ANSI Graphic Kernel System (GKS) applications using the Virtual Device Interface (VDI). It supports a 720-pixel-by-352-pixel, 25-row-by-80-column monochrome graphics display and concurrent graphics printing. Serial and parallel printer ports are provided. \$2,195. **Concept Technologies Inc.**, P.O. Box 5277, Portland, Ore. 97208, (503) 684-3314.

Circle No 336

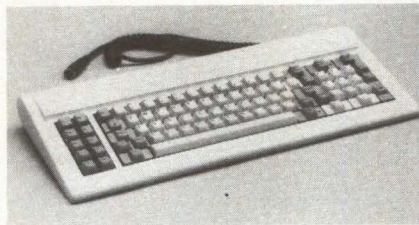

Keyboards plug into IBM PC

- ASCII compatible
- DIN standards
- 30-character buffer

The PC-84 keyboard plugs directly into an IBM PC or system emulating the IBM PC. The PC-83 model features the IBM (international) keyboard configuration. The PC-84A and PC-83A keyboards provide 300-baud TTL ASCII output and are identical to the IBM keyboard style. A passive contact system common to all models isolates the contact force from the actuation force. All meet ergonomic (DIN) standards and feature a 30-character buffer, sublimation-printed keycaps and a keyswitch life of 100 million cycles. \$57.19, quantity 10,000. **NMB/Hi-Tek Corp.**, 7274 Lampson Ave., Garden Grove, Calif. 92641, (714) 898-9511.

Circle No 337

Controller contains 128K-byte cache RAM

- 5¼-inch form factor
- Expandable to 16M bytes
- 1M-byte average data rate

The PM-3010 single-board disk controller with an integral 128K-byte cache RAM can be expanded to 16M bytes. The controller uses a true sector caching algorithm, whereby 128,000 sectors are individually stored in cache with an access time under 400 µs, and a one-page,

one-sector architecture. The 5¼-inch, form-factor board controls four ST506, SA1000 or SMD Winchester drives plus four floppy drives. An SCSI interface links the controller to the host computer and accommodates an average data rate of 1M byte per second. \$740, OEM quantities. **Distributed Processing Technology**, 132 Candace Drive, Maitland, Fla. 32751, (305) 830-5522. Circle No 338

Printer controller features universal interface

- Serial or parallel port
- MC68000 microprocessor
- Handles 8 ppm to 60 ppm

The Pixel 300 intelligent laser printer controller uses an MC68000 L10 processor to accept data from the host computer or word processor through an RS232 or parallel port. It interfaces with word-processing systems and host computers and features a VME bus-based architecture. Type fonts can be downloaded. The controller system provides expandable fixed fonts, pixel address and text, forms and graphics merge and is configurable to three levels of performance: 8-ppm to 15-ppm machines, 18-ppm to 60-ppm machines and graphics capability offering a 4,000-character, full-page bit map at 0.6 seconds. \$3,000, OEM quantities. **Electronic Machine Corp.**, #500, 417 South Hill St., Los Angeles, Calif. 90013-1169, (213) 687-9681.

Circle No 339

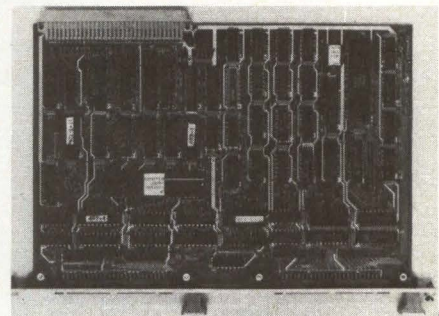

Board links VME bus, disk drives

- DMA controller
- Two RS232 serial ports
- 64K-byte transfers

The IoVME402 bus master interfaces the VME bus to 9-track tape drives, an SCSI interface, dual RS232 I/O ports and vectored interrupts. The interface

New Products

SUBASSEMBLIES

features an AM9516-based dual channel Direct Memory Access (DMA) controller, which performs 24-bit addresses, 16-bit transfer counts, 8- or 16-bit data transfers, byte-to-word funneling and end-of-process conditions. The controller transfers 64K bytes in one operation. The 9-track interface consists of a formatter control, command and status

ports, and a double-buffered read/write data port. The SCSI/SASI interface allows communication to Winchester and floppy disks. Data is transferred between the host and the SCSI controller in either DMA or programmed I/O mode. The two asynchronous RS232 communications ports use the Signetics 2681-40 DUART device, which features

programmable baud rates for each channel and a 16-bit timer/counter. An interrupter circuit prioritizes interrupt requests from the SCSI, 9-track tape, serial I/O interfaces and DMA controller. \$1,850. **Io Inc.**, Suite 105, 1806 W. Grant Road, Tucson, Ariz. 85745, (602) 792-0969. **Circle No 340**



SONEX kills printer noise beautifully.

Hard walls reflecting printer chatter? Thick, rich, lush carpeting might cut much of the noise, but SONEX acoustical foam will absorb four times as much noise at about the same cost. The anechoic wedge surface looks good, and its open-cell structure absorbs, deflects, scatters and de-energizes sound energy. It will silence annoying disk drive and fan hum, or kill noise from collators, shredders, copiers...anything noisy. Call us at 612/521-3555 or write us at 3800 Washington Avenue North, Minneapolis, MN 55412

illbruck/usa
techniques with foams

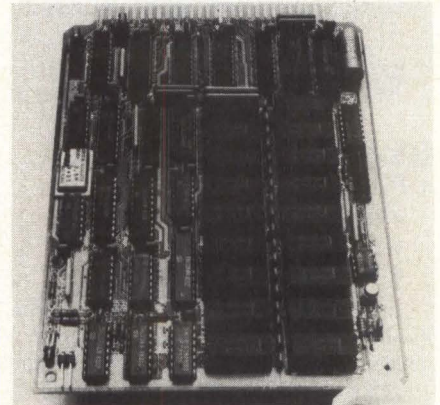

DRAM card operates without wait states

- Compatible with 8088, 8085A CPUs
- Dual 4-bit decoder
- 64K bytes to 512K bytes of memory

The Model 7712 DRAM card eliminates software overhead caused by wait states during RAM refresh and missing RAM refresh during hardware resets. Compatible with 8088 5-MHz and 8085A 6¼-MHz CPU cards, it features memory expansion from 64K bytes to 512K bytes in four densities: 64K bytes or 128K bytes populated with 64K by 1 DRAMs and 256K or 512K bytes with 256K by 1 DRAMs. Onboard refresh circuitry enables transparent refresh of DRAMs during push-button resets, extended wait periods, DMA transfers and normal MPU operations without software overhead or hardware degradation. The controller circuitry eliminates wait states during read or write access and automatically initiates refresh during DMA operations; the three refresh modes are asynchronous, synchronous and forced refresh. The parity-detection circuit activates an interrupt in the event of a parity error. An onboard dual 4-bit decoder allows the card to use the full 20-bit address from a 8088 CPU, or it can be latched to steer data to the 64K-byte memory block during a 16-bit DMA address transfer. From \$490 to \$1,750. **Pro-Log Corp.**, 2411 Garden Road, Monterey, Calif. 93940, (408) 372-4593. **Circle No 341**

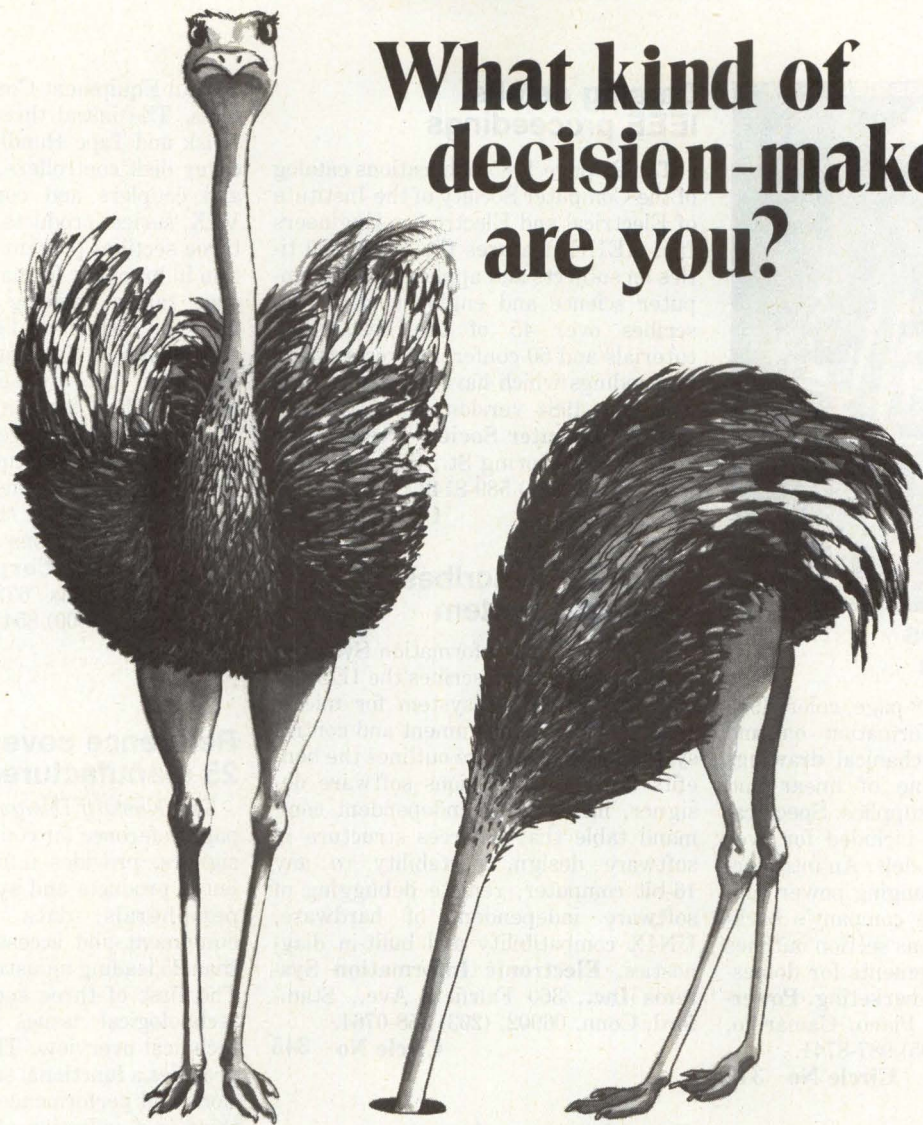

What kind of decision-maker are you?

It's a rare bird that will boldly stand up and look at problems right in the eye.

But when it comes to problems as complex as communications systems, information systems, or integrated office systems, you need more than just stout-hearted resolve. You need the facts.

That's why if you're responsible for influencing or specifying your organization's office systems integration purchases, you should attend The 13th Annual INTERFACE '85 Conference & Exposition.

You can learn the facts at INTERFACE. INTERFACE is presented for people who are expected to confront and solve issues like local area networking. Desktop systems integration. Networking. Specialized carrier systems. These, and related issues, are examined from both technical & senior management perspectives at INTERFACE.

The prestigious Conference has

sessions conducted by expert industry leaders. There are sessions that will help untangle the problems you face, then suggest practical solutions that you can use to fulfill your day to day responsibilities and help you plan for the future.

Also at INTERFACE will be more than 300 exhibits with the latest products. Talk with exhibitors about your specific problems and needs. They'll be happy to tell you how they can help you. That's why they're there.

If you don't have the facts to confront your communications problems, you might as well have your head in the sand. Attend the 13th Annual INTERFACE '85 Conference & Exposition.

For more information about attending The 13th Annual INTERFACE '85 Conference & Exposition, call (617) 449-6600. Or write The 13th Annual INTERFACE '85 Conference & Exposition, 300 First Avenue, Needham, MA 02194.

INTERFACE '85

MARCH 4-7, 1985 ATLANTA, GEORGIA

Co-Sponsored by **BusinessWeek** and **Data Communications**



Presented by **THE INTERFACE GROUP, Inc.**, world's leading producer of computer conferences and expositions including INTERFACE, FEDERAL DP EXPO, COMDEX/Winter, COMDEX/Spring, COMDEX/Fall, COMDEX/Europe, COMDEX in JAPAN, the nationwide COMPUTER SHOWCASE EXPOs and The BYTE Computer Shows.
300 First Avenue, Needham, MA 02194 • (617) 449-6600

New Products

LITERATURE

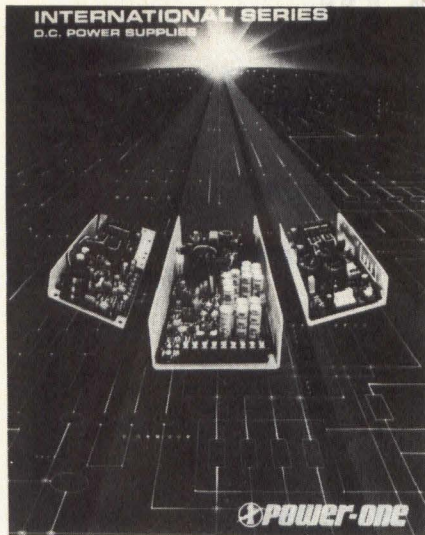

Catalog outlines power supplies

The "Power-One" 28-page, color, 1985 catalog provides information on and photographs and mechanical drawings of the company's line of linear and switching DC power supplies. Specifications and prices are included for over 200 "off-the-shelf" models. An introduction discusses the changing power supply industry and the company's background and applications section outlines safety agency requirements for domestic and international marketing. **Power-One Inc.**, 740 Calle Plano, Camarillo, Calif. 93010-8583, (805) 987-8741.

Circle No 342

Catalog lists DEC Q-bus components

The 1984 "Microcomponents Product Catalog" for system designers, integrators and engineers lists the 16-bit processors, modules, chips, peripheral equipment and software that make up DEC's Q-bus family of products. The 45-page catalog describes operational capabilities and applications of the Micro PDP-11 computer; LSI-11/73, LSI-11/23-PLUS and LSI-11/23 central processors; Falcon and Falcon-PLUS single-board computers; and J11 and T11 chip-level microprocessors. Included are memory management and floating point options; add-on memory modules; and multifunction, communication, network and I/O interfaces. Q-bus-compatible storage devices are also discussed. **Digital Equipment Corp.**, 146 Main St., Maynard, Mass. 01754, (617) 897-5111.

Circle No 343

Catalog details IEEE proceedings

The 24-page 1985 publications catalog of the Computer Society of the Institute of Electrical and Electronics Engineers Inc. (IEEE) features the latest 200 titles on subjects and applications in computer science and engineering. It describes over 45 of the best-selling tutorials and 60 conference records and proceedings which have been published since the 1984 version of the catalog. **IEEE Computer Society Press**, Suite 300PR, 1109 Spring St., Silver Spring, Md, 20910, (301) 589-8142.

Circle No 344

Brochure describes operating system

The Electronic Information Systems' 12-page brochure describes the IES-110 real-time operating system for micro-processor-based instrument and control systems. The brochure outlines the benefits for the applications software designer, including an independent command table that enforces structure in software design, portability to any 16-bit computer, remote debugging of software independent of hardware, UNIX compatibility and built-in diagnostics. **Electronic Information Systems Inc.**, 360 Fairfield Ave., Stamford, Conn. 06902, (203) 358-0764.

Circle No 345

Booklet examines protocol conversion

The booklet "Timeplex Technical Backgrounders: Protocols And Protocol Conversion" examines protocols and discusses the utilization of protocol conversion within the data communications network. Topics covered include SNA and protocol converters, the differences between protocols, and protocols for new information services. Diagrams are provided. **Timeplex Inc.**, 400 Chestnut Ridge Road, Woodcliff Lake, N.J. 07675, (201) 930-4600. Circle No 346

Handbooks contain integration information

Two illustrated handbooks provide hardware, software and systems integration information for connecting Emulex Corp. mass storage and data communications peripheral products to

Digital Equipment Corp. computer systems. The initial three sections of the "Disk and Tape Handbook," 264 pages, cover disk controllers, tape controllers and couplers and controllers for the VAX series products. The remaining three sections present product information in brochure format and cross-reference tables showing compatibility of tape and disk controllers with non-captive drives, giving application and performance data by specific make and model. "The Communications Products Handbook," 120 pages, explains data communications multiplexing processes, covers communications products and offers information on the STATCON series communications subsystems. \$5 each. **Emulex Corp.**, 3545 Harbor Blvd., P.O. Box 6725, Costa Mesa, Calif. 92626, (800) 854-7112.

Circle No 347

Reference covers 25 manufacturers

The *Kierulff Designer's Guide*, a 350-page reference for computer system designers, provides information on computer products and systems, software, peripherals, data communications equipment and accessories from more than 25 leading industry manufacturers. The first of three sections details the technological issues associated with technical overview. The second section provides a functional survey of specifications and performance features and the third is a collection of data sheets and photographs on each manufacturer's product lines. \$75. **Kierulff Electronics Inc.**, 2585 Commerce Way, Los Angeles, Calif. 90040, (213) 725-0325.

Circle No 348

Report discusses CAD/CAM technology

A 110-page report, "Computer-Aided Manufacturing" by Siltran Digital examines the changes required to implement CAD/CAM technology and pinpoints the key issues and trends for the computer system vendor and manufacturer. Issues include system and software selection, sculptured surfaces, laser machining, process control, the use of networks, robotic systems, robotic programming and planning the system. \$450. **Siltran Digital**, 2250 Monterey Road, Atascadero, Calif. 93422, (805) 466-3209. Circle No 349

Classified Ads

**This Publication
is available in
Microform.**

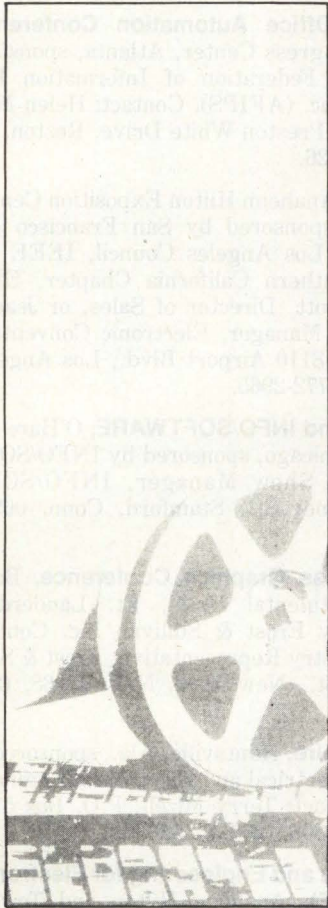

University Microfilms International

Please send additional information
for _____
Name _____
Institution _____
Street _____
City _____
State _____ Zip _____

300 North Zeeb Road
Dept. P.R.
Ann Arbor, Mi. 48106

hardware

**HEWLETT
PACKARD**
Desktop CAD/CAM
Computer
Systems 

**SAVINGS ON ALL
SERIES 200/500
WORK STATIONS**

9836S 9000 Non-HP memory
9020S 9826A and peripherals

CALL OR WRITE FOR DISCOUNT PRICES

**graphia
systems center**
Box 23051 Portland, OR 97223 USA
503-246-0202
International Sales Telex 360-143

CIRCLE NO. 225 ON INQUIRY CARD

inventions wanted

**Inventors, Entrepreneurs,
Product Promoters**

wanted to display concepts at
national technology trade show

Call: 1-800-528-6050 X831

CIRCLE NO. 226 ON INQUIRY CARD

Small ads do
attract attention.
Next time, why not read
your ad here?

Call 617/536-7780

software

D-M-DRIVER
DISK in MEMORY for 11-M
Call 415-420-9579

Proto Systems 1238 Josephine St.
Berkeley, California
94703

CIRCLE NO. 227 ON INQUIRY CARD

Copy Deadline:

Space reservations and
advertising copy must
be received by the 10th
of the month preceding
the issue date. Camera-
ready mechanicals
must be received by the
15th of the month pre-
ceding the issue date.
For example, to appear
in the February issue,
copy must be received
by January 10; mechan-
icals by January 15.

 **Linda Lovett
(617)536-7780**

CLASSIFIED ADVERTISING ORDER FORM

Mini-Micro Systems classifieds reach more mini-micro people

Rates: \$90.00 per column inch (non-commissionable)

6x program earns 5% discount; 12x program earns 10% discount.

There is no charge for typesetting classified listings. Plan approximately 50 average words to a column inch, 8 lines of approximately 38 characters per line (3 inch maximum). Please send clean typewritten (double-spaced) copy.

Category: The following categories are available; be sure to specify the category you wish to be listed under: Business Opportunities, New Literature, Selling, Buying, Trading, Seminars, Services, Software, Supplies & Accessories. (Other categories may be employed at our discretion.)

Run this ad in _____ (number issues) Reader Inquiry No. YES NO
Ad size 1 col. wide by _____ inches deep Under _____ (category)
Check enclosed for \$ _____ (Pre-paid orders only)

Signature _____
Name _____ Title _____
Company _____ Telephone No. _____
Address _____
City _____ State _____ Zip _____

REGIONAL SALES OFFICES

BOSTON

Robert K. Singer
National Sales Manager
Norma E. Lindahl
Assistant To The National
Sales Manager

John J. Fahey
Regional Manager
Katie Kress
Sales Coordinator
221 Columbus Ave.
Boston, MA 02116
(617) 536-7780

PHILADELPHIA

Stephen B. Donohue
Regional Manager
1873 Route 70, Suite 302
Cherry Hill, NJ 08003
(609) 751-0170

ATLANTA

Larry Pullman
Regional Manager
6540 Powers Ferry Rd.,
Suite 170
Atlanta, GA 30339
(404) 955-6500

CHICAGO

Robert D. Wentz
Regional Manager
Marianne Majerus
Sales Coordinator
Cahners Plaza
1350 E. Touhy Ave.
P.O. Box 5080
Des Plaines, IL 60018
(312) 635-8800

DALLAS

Don Ward, Regional Manager
13740 Midway Suite 515
Dallas, TX 75234
(214) 980-0318

DENVER

John Huff
Regional Manager
270 St. Paul St.
Denver, CO 80206
(303) 388-4511

LOS ANGELES

Len Ganz
Regional Manager
12233 West Olympic Blvd.
Suite 236
Los Angeles, CA 90064
(213) 826-5818

ORANGE COUNTY

Debra Huisken
Regional Manager
2041 Business Center Dr.
Suite 109
Irvine, CA 92715
(714) 851-9422

SAN FRANCISCO

Frank Barbagallo
Regional Manager
Rick Jamison
Regional Manager
Janet Ryan
Regional Manager
Sherman Building, Suite 100
3031 Tisch Way
San Jose, CA 95128
(408) 243-8838

AUSTRIA

Elan Marketing Group
Neutor g. 2
P.O. Box 84
1010 Vienna, Austria
Tel: 43-222-663012 or -638461

BENELUX

Elan Marketing Group
Boschdijk 199B
5612 HB Eindhoven
The Netherlands
Tel: 32-40-455724

ISRAEL

Elan Marketing Group
13 Haifa St., P.O. Box 33439
Tel Aviv, Israel
Tel: 972-3-252967 or -268020
Telex: 341667

JAPAN

Tomoyuki Inatsuki
General Manager
Trade Media Japan Inc.
R. 212 Azabu Heights
1-5-10 Roppongi Minato-ku,
106, Japan
Tel: (03) 587-0581

TAIWAN

Mr. Donald H. Shapiro
Trade Winds, 2nd Floor
132 Hsin Yi Road, Sec. 2
Taipei, Taiwan

UNITED KINGDOM

Elan Marketing Group
5th Floor, Suite 10
Chesham House
136 Regent St.
London W1R 5FA
Tel: 437-6900
Telex: 267653

SWEDEN

Elan Marketing Group
Humlegardsgatan Nr. 5
11446 Stockholm, Sweden
Tel: 46-8-677243 or -676243

WEST GERMANY

Elan Marketing Group
Sudring 53
7240 Norb/Neckar, West Germany
Tel: 49-7451-7828

Mini-Micro Marketplace

Norma Lindahl
221 Columbus Ave.
Boston, MA 02116
(617) 536-7780

Direct-Response Postcards

Carol Anderson
221 Columbus Ave.
Boston, MA 02116
(617) 536-7780

Career Opportunities

Peggy Gordon
Recruitment Advertising Manager
P.O. Box 10277
8 Stamford Forum
Stamford, CT 06904
(203) 328-2550

Cahners Magazine Division

J.A. Sheehan, President
William Platt
Executive Vice President
T.M. McDermott, Vice President
Electronics/Computer Group
Tom Dellamaria, VP/Production
Ira Siegel, VP/Research

Promotion Staff

Susan Rapaport
Marketing Communications Director
Mary Gregory
Promotion Manager
Liz Phillips
Promotion Assistant

Circulation

Denver, CO:
(303) 388-4511
Sherri Gronli
Group Manager

Calendar

FEBRUARY

4-6 OAC '85, 1985 Office Automation Conference, Georgia World Congress Center, Atlanta, sponsored by the American Federation of Information Processing Societies Inc. (AFIPS). Contact: Helen Mugnier, AFIPS, 1899 Preston White Drive, Reston, Va. 22091, (703) 620-8926.

5-7 Mini/Micro West, Anaheim Hilton Exposition Center, Anaheim, Calif., sponsored by San Francisco Bay Area Council and Los Angeles Council, IEEE and Northern and Southern California Chapter, ERA. Contact: Tim Parrott, Director of Sales, or Jeannie Oldendorph, Sales Manager, Electronic Conventions Management Inc., 8110 Airport Blvd., Los Angeles, Calif. 90045, (213) 772-2965.

20-22 INFO/CENTRAL and INFO/SOFTWARE, O'Hare Exposition Center, Chicago, sponsored by INFO/SOFTWARE. Contact: Show Manager, INFO/SOFTWARE, 999 Summer St., Stamford, Conn. 06905, (203) 964-0000.

20-23 Computer Business Graphics Conference, Bonaventure InterContinental Hotel, Ft. Lauderdale, Fla., sponsored by Frost & Sullivan Inc. Contact: Carol Every, Industry Representative, Frost & Sullivan, 106 Fulton St., New York, N.Y. 10038, (212) 233-1080.

22-23 IEEE Computer Faire, Huntsville, Ala., sponsored by The Institute of Electrical and Electronics Engineers Inc. (IEEE). Contact: Terry Mizell, P.O. Box 5188, Huntsville, Ala. 35805, (205) 532-2036.

26-28 Automated Design and Engineering for Electronics Exposition (ADEE), Anaheim Hilton and Towers, Anaheim, Calif., sponsored by Cahners Exposition Group. Contact: Michael Indovina, Cahners Exposition Group, Cahners Plaza, 1350 Touhy Ave., P.O. Box 5060, Des Plaines, Ill. 60018, (312) 299-9311.

MARCH

4-7 FOSE Software '85 Conference and Exposition, Washington, D.C. Convention Center, sponsored by National Trade Productions Inc. Contact: Rosalind Boesch, National Trade Productions, Suite 400, 2111 Eisenhower Ave., Alexandria, Va. 22314, (800) 638-8510 or (703) 683-8500.

18-20 Intercontinental Computer and Telecommunications Conference, COMTEL '85, INFOMART, Dallas, sponsored by Hamman, Crume and Co. Contact: COMTEL '85, Director of Communications, International Computer & Telecommunications Conference, 5080 Spectrum Drive, Suite 707E, Box 17, Dallas, Texas 75248, (214) 631-6482, or Ed Warren, Hamman, Crume and Co., Suite 208, 1230 River Bend, Dallas, Texas 75247, (214) 637-4526.

Calendar

- 25-28 IEEE Infocom '85**, Washington, sponsored by the Technical Committees for Computer Communications of the Societies. Contact: Tom Stack, Program Chairman, IEEE Infocom '85, P.O. Box 639, Silver Spring, Md. 20901, (301) 589-8142.
- 26-28 European Information Technology and Office Automation Exhibition (INFO)**, Olympia, London, sponsored by B.E.D Exhibitions Ltd. Contact: Sandra Paul, British Information Services, 845 Third Ave., New York, N.Y., 10022, (212) 752-8400.
- 26-28 COMDEX-in-Japan**, Harumi Exhibition Center, Tokyo, produced by The Interface Group Inc. Contact: Peter B. Young (U.S.A.) or T. Shinohara (Japan), The Interface Group Inc., 300 First Ave., Needham, Mass. 02194, (617) 449-6600 or (800) 325-3330; in Japan: Kashiwabara Bldg. 2F, 1-3-3, Kyobashi, Chuo-Ku, Tokyo 104, Japan, 03-271-0246.
- 27-30 PBC Show '85/Infotech '85**, Hong Kong Exhibition Centre, organized by Hong Kong Exhibition Services Ltd. Contact: Overseas Exhibition Services Ltd., 11 Manchester Square, London, W1 M 5AB, England, 01-486-1951.
- 28-29 Minnesota Joint Computer Conference (MJCC)**, Radisson South Hotel, Bloomington, Minn., sponsored by the Association of Systems Management (ASM), the Association of Computing Machines (ACM) and the Data Processing Management Association (DPMA). Contact: Mick Williams, c/o Standard Iron, 4990 N. County Road 18, New Hope, Minn. 55428, (612) 533-1110.
- 31-(3) SOFTCON**, Georgia World Congress Center, Atlanta, sponsored by Northeast Expositions. Contact: Northeast Expositions, 822 Boylston St., Chestnut Hill, Mass. 02167, (617) 739-2000.

APRIL

- 2-4 1985 IEEE Microprocessor Forum: "Pathways to Design Productivity,"** Bally Park Place Casino Hotel, Atlantic City, N.J., sponsored by the Philadelphia Electric Co. Contact: Gerald W. Gordon, Philadelphia Electric Co., 2301 Market St., N3-1, Philadelphia, Pa. 19101, (215) 841-4676.
- 14-18 Computer Graphics '85**, Dallas Convention Center, Dallas, sponsored by National Computer Graphics Association. Contact: Christine Radiske or Sheila Donoghue, National Computer Graphics Association, Suite 601, 8401 Arlington Blvd., Fairfax, Va. 22031, (703) 698-9600.
- 18-19 Network Management/Technical Control Show**, Marriott Copley Place, Boston, sponsored by CW/Conference Management Group. Contact: Judie McDaid, National Sales Director, Box 880, 375 Cochituate Road, Framingham, Mass. 01701, (617) 879-0700 or (800) 225-4698.

Add IBM Format-Compatible Magnetic Tape To Any RS-232 Port With The IBEX STC-100

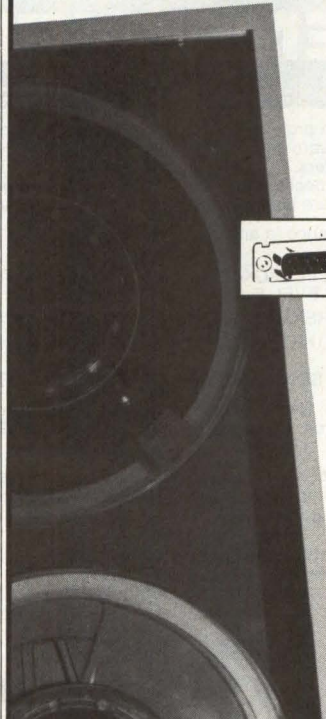

Plug-In 1/2" mag.
tape drives to any
mini or micro computer
Full read/write capability
Data logging
Call-detail recording

Write, phone or TWX
for information

IBEX

IBEX COMPUTER CORP.

20741 Marilla Street,
Chatsworth, CA 91311
(818) 709-8100
TWX 910-493-2071

CIRCLE NO. 112 ON INQUIRY CARD

Wondering Where To Turn Next?

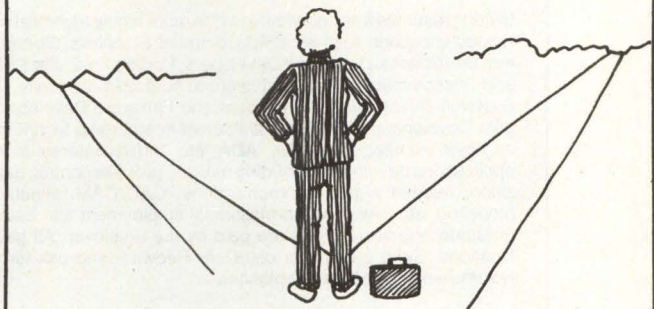

Turn To Mini-MicroSystems

Career Opportunities Section

CIRCLE NO. 113 ON INQUIRY CARD

Career Opportunities/Recruitment Advertising

SOFTWARE ENGINEERS

Discover a whole new dimension in professional growth at Computer Horizons Corp. Learn why we are among the top 15 software services firms in the country with a client list that includes numerous Fortune 500 leaders. Currently, state-of-the-art projects include development of software modifications to meet specific client applications, as well as developing solutions to client problems relating to software computer design, evaluation and analysis.

If your background includes experience in any of the following areas, we definitely have the opportunity for you.

HARDWARE: DEC, HEWLETT PACKARD, INTEL 8080, IBM PC, TANDEM, DATA GENERAL, HONEYWELL LEVEL 6

SOFTWARE: UNIX*, VAX, RSX, DPL, GRAPHICS, CAD/CAM, DPS, TPS, DEC NET

LANGUAGES: "C", SHELL, KERNAL, PASCAL, FORTRAN, TAL, ANY REAL TIME ASSEMBLERS

COMMUNICATIONS: X.25, SDLC, SNA/NCP, FAULT TOLERANCES

Opportunities exist in our offices in: New Jersey, Delaware, New York, Chicago, Washington, D.C., Virginia, Miami, Orlando, Detroit, Cincinnati, Denver, Houston, San Francisco and Los Angeles.

Our excellent salaries are above industry average with a superior benefits package including health and dental insurance, unlimited tuition refund, relocation assistance and much, much more.

Please call or send your resume to:

Tammy Knauer
National Recruiting Director
In New York Call (212) 371-9600
Outside of New York Call (800) 847-4097



COMPUTER HORIZONS CORP.

747 Third Avenue, Department MM1 - 2
New York, N.Y. 10017

An Equal Opportunity Employer M/F
* UNIX is a trademark product of Bell Labs

CIRCLE NO. 241 ON INQUIRY CARD

System Developers 800-231-5920

Inviting resumes from individuals in the more highly technical computer related vocations such as: PHD Computer Scientists, Operating System Developers, Data Base Developers, Porting Specialists, Networks and Telecommunications, Architecture, Artificial Intelligence, Graphics Systems Developers, Microcoders and Firmware Developers, Compiler Development, etc. Special interest in emerging technology such as novel architecture, UNIX, ADA, etc. Similar interest in scientific applications developers including military, process control, data acquisition, telemetry and communications, CAD/CAM, simulation and modeling, etc.—we are a professional employment firm managed by graduate engineers. Fees are paid by the employer. All geographic locations. Send resume or call D. A. Redwine and ask for our free resume workbook & career planner.



Scientific Placement, Inc.

P.O. Box 19949 CW, Dept. MMS 2 Houston, TX 77224 713/496-6100

UNIX is a trademark of Bell Labs

CIRCLE NO. 242 ON INQUIRY CARD

ENGINEERS

Choice positions available in New England and Nationwide. If you earn \$25,000 or more we have a more rewarding job for you.

**Networking • Communications
ATE Engineers • Tools & Utilities SW
Real-Time SW • Memory Design**

All fees & expenses paid. Call or send resume to:

LARSEN PERSONNEL
1492 Highland Avenue
Needham, MA 02192
(617) 449-3840

Serving the high tech industries.

ELECTRONIC ENGINEERS SOUTHEAST

Openings for design engineers of circuits, computers, logic, signal, communications, testing, ATE, systems, and controls. Professional confidential service. Fee paid by employer. Send resume to:

Ted McCulloch
McCulloch & Co.
P.O. 10211
Greenville, SC 29603

Computer Consultants Corner

TKC

• THE KEENAN CORPORATION

FCC 15J WE WROTE THE BOOK

"Digital Design for Interference Specifications"

• FCC/VDE & Static Retrofit and Testing
• "Front End" Design Guidance

R. Kenneth Keenan, Ph.D.

8609 66th Street North Pinellas Park, FL 33565
(813) 544-2594

UNIX

System V Consultants

A professional team, with specialties in
• Applications in the C Programming Language
• UNIX Internals and Device Drivers
• Telecommunications
Contact: Marty Poulsen

PROTOCON INCORPORATED
140 Statesir Place
Red Bank, New Jersey 07701
(201) 747-8974

6800/68000 Experts

• Microprocessor hardware and software design • Industrial control specialists • Hierarchical software design methodology • Complete prototype facilities

CLIENTS INCLUDE: Sohio • Elgar • Schlumberger • Motorola • Gulf Oil • Carborundum • Renal Systems



Computer System Associates

7564 Trade St., San Diego, CA 92121 (619) 566-3911

More and more advertisers of minicomputers, microcomputers, CRT terminals, printers, disk drives, memories, modems, distributed data processing systems, etc., are consistently turning to **MINI-MICRO SYSTEMS**. Call Peggy Gordon at **203-328-2550**.

Get results with

Mini-Micro Systems

CAREER OPPORTUNITY SECTION...

When you advertise in **Mini-Micro Systems**, you can be sure of reaching only the people you are trying to recruit. Every reader is a potential employee. We reach the highest percentage of all significant personnel in our industry. You'll find us not only effective, but a more economical magazine.

for space reservation
contact:

Peggy Gordon
203-328-2550

Advertisers Index

Able Computer	208	Emulex Corp.	36-37	Market	209
Alloy Computer Products .	61	Enfin Resources Inc.	222	NCR Corp.	122-123
Ampex Corp., Computer Products Div.	198-199	Epson America, Inc.	C3	NEC Business Systems . .	E8
Ampex Corp., Disc Media Operation	64-65	Esprit Systems	112-113	Northern Telecom	216
Ampro	204	Facit Data Products	200	Nova Graphics International Corp.	62
Apple Computer Inc.	12-13	Flexible Computer	142	OEMTek	51-53
AT&T Technologies, Inc.	180-181	Forte Data Systems	197	OMTI (subsidiary of Scientific Micro Systems)	207
Avatar Technology	81, 83	Fujitsu America Inc.	155-162, 217, 219, 221, 223	Pelikan	93
BASF	E4-E5	General Power	75	Peachtree Software	18
Bytcom	136	Genicom	174	Perkin-Elmer Corp.	70
C. Itoh Electronics	171	Gould Inc., Computer Systems Div.	5	Pioneer Research	189
Cahners Exposition Group	145	Hermes Precisa Int'l	215	Qantex (Div. of North Atlantic Inc.)	78
CalComp	84	Heurikon Corp.	134	Quality Micro Systems . .	133
California Computer Group	169	Human Designed Systems Inc. (HDS)	43	Qualogy Inc.	116
Carroll Touch Technology .	10	Hunter & Ready	138-139	Scientific Micro Systems . .	94
CCA Uniworks Inc.	79	IBC/Integrated Business Computers	126	Shugart Corp.	8-9
CIE Terminals	14, 21	Ibex Computers Corp.	214, 231	Siemens Corp.	88-90
Cincom Systems	170	IBM Corp.	192-193	Silicon Systems	210
Cipher Data Products, Inc.	124-125	Illbruck/USA	226	Softcon	58
Citizen America	102-103	Infotron Systems Corp.	1	Stollman	100
Codex Corp.	149	Intercontinental Micro	22	Sysgen Inc.	101
Commerce Tours	211	Interface Group.	166, 190, 227	Systech	17
Compaq Computer Corp.	140-141	Intermec Inc.	48	Tandon Corp.	6-7
Compupro	25	Invitational Computer Conferences	85	Tektronix Inc.	38, 76-77
Control Data Corp.— OEM	179	Iomega Corp.	44-45	TeleVideo Systems Inc.	66, 205
Craig Data Cable	100	ITT Information Systems	47	Texas Instruments Inc.	121
Cromemco Inc.	110-111	JDL	86-87	Toei Electronics	224
CTS Corp.-Datacomm Products	4, 40	Keytronic	30	Topaz Electronics Div.	106
Cuesta Systems Inc.	208	Kimtron	82	TransNet Corp.	178
CXI	26-27	Lear Siegler Inc.	59	Unify Corp.	114-115
Dataproducts	137	Maxtor Corp.	104-105	U.S. Design Corp.	97
Dataram	C2	Metacomp	146	Verbex	194
Datasouth Computer Corp.	55	Micom Systems Inc.	C4	Westrex OEM Products	98, 218
Digital Equipment Corp.	28-29	Micro Data Base Systems .	57	Wyse Technology	182-183
Dysan Corp.	165	Microplot Systems	178	Xebec	172-173
Emerald Systems	80	Micro-Term	69	Zilog Inc.	73
		Microware	152	See P. 229 for Classified Advertisers	
		Mini-Micro Systems .	109, 213	See P. 232-233 for Career Opportunity Advertisers	
		Montreal International Software	231	See P. 237-238 for Mini-Micro Marketplace	

This index is provided as an additional service. The publisher does not assume any liability for errors or omissions.

Market Track

Sharon Hassell
Assistant Editor

Shipments surge in disk drive industry

With the production of half-height 5¼-inch disk drives increasing steadily, full-height versions with capacities lower than 30M bytes will experience peak shipments this year reaching 1.562 million, according to a recent report by Disk/Trend Inc., Los Altos, Calif. The report on rigid and flexible disk drives also predicts that 3½-inch drives will lead other small, fixed-media drives in worldwide shipments by 1987, accounting for 54 percent of the total market.

Drives expected this year from IBM Corp., such as a double-density version of the 3380, a new 5¼-inch drive for small, multiuser systems and a 3½-inch drive for single-user personal computers, will jolt the previously stable disk drive industry, the report states.

Other report highlights include a prediction that the total worldwide shipment of high-end OEM 5¼-inch Winchester drives will jump from 41,200 units shipped in 1983 to a projected total of 647,000 in 1987.

The share of worldwide OEM unit shipments held by U.S. manufacturers is expected to drop from 80.9 percent in 1983 to 62 percent in 1987. James Porter, author of the report, attributes this decrease to the inability of U.S. manufacturers to stay competitive with Japanese manufacturers.

Better design boosts attachment industry

Users' desire to upgrade their display terminals to more intelligent devices is expected to trigger a 30 percent increase in shipments of personal computer attachments in the next two years. According to a market study by Advanced Resource Development (ARD), Medfield, Mass., shipments will reach 13,000 by 1987.

ARD defines personal computer attachments as microcomputer intelligence and storage devices that hook up to non-intelligent display terminals, converting them to workstations. Most are boxes housing a CPU and a disk drive, with cabling to link the box to a terminal's communications port.

The attachments offer design improvements ranging from PC compatibility to concurrent operation as a terminal and a personal computer. According to the study, the design improvements are the major force behind the market's expected growth.

Large companies such as Digital Equipment Corp. (DEC) and IBM Corp. originally offered attachments with their terminals. However, when the attachments failed to catch on due to

design problems and lack of publicity, DEC and IBM abandoned the market, says Mary Owen, author of the study. This exodus allowed smaller companies, such as Solaris Computer Corp., Personal Micro Computers Inc., Morrow Designs Inc. and Paradise Systems Inc. to create a niche.

According to Owen, the attachments will be sold on an OEM basis to terminal manufacturers, who will market them as their own products.

VAR market shifts distribution channels

Microcomputer manufacturers, reacting to retail market saturation and increased direct sales from major vendors, will increasingly use the value-added market to distinguish their systems, according to a study by Venture Development Corp. (VDC), Wellesley, Mass.

The study predicts that the number of personal computers and supermicrocomputers shipped through OEM and value added reseller (VAR) channels will represent 15.3 percent of the total units shipped by 1989. This is an increase from 11.3 percent of the total shipped last year.

Distribution channels will gravitate toward low-end, minimal-support dealers or toward high-end, problem-solving VARs. This trend, according to Sharon Berman Kern, computer division project director at VDC, will bury computer specialty stores, which sell off-the-shelf personal computers and small business systems, because these stores lack the vertical-market expertise required to support and service specialized end users.

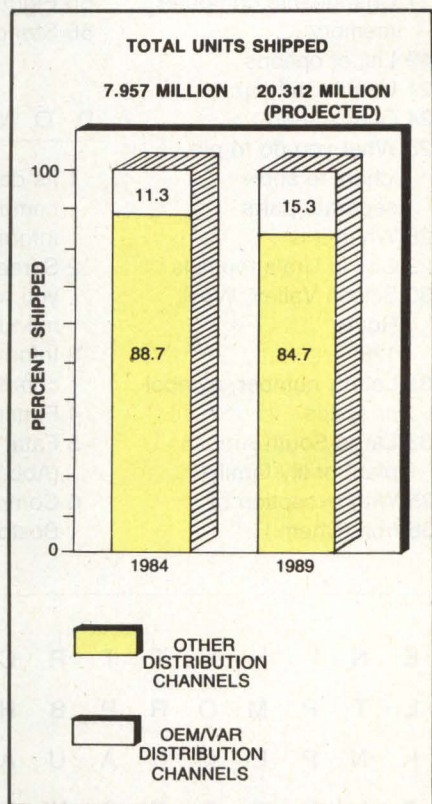

NEXT MONTH IN MMS

Mini-Micro Systems presents its premier Communications Digest issue this February 15.

The exploding market for communications equipment and software has created a need for comprehensive evaluation, selection and purchasing information. The Communications Digest will answer that need in these key areas:

- Modems
- Local area networks
- Multiplexers/concentrators
- Network and communications software/electronic mail
- Network terminals
- Directory of manufacturers

Artful Intelligence

A C R O S S

- 1 Microcomputer's heart
- 3 Graphic function
- 7 Storage for information unit
- 10 Land of Opportunity State (Abb.)
- 11 Network terminal
- 12 Logical operation
- 13 Permanent computer memory
- 15 Afterthought in letter
- 17 Changeable computer memory
- 19 List of options
- 21 Unable to hear
- 24 Dual screen
- 25 What you do to pie chart to show separate parts
- 28 When it is
- 29 City in Urals foothills
- 30 Silicon Valley, West; Route 128, _____
- 31 Letter, number, symbol or space
- 33 Large South African plant of lily family
- 35 With exception of
- 36 Iron (Chem.)

- 37 Computer bed data
- 39 Business data processing language
- 42 Talk in loud, wild way
- 43 Assyrian god of war
- 44 Common command
- 46 Integrated circuit
- 47 Texas college (Abb.)
- 49 Exist
- 51 Direct and table access = _____ ed
- 53 At the time that
- 54 Recording medium
- 55 Eight bits
- 56 Strings in music (Abb.)

D O W N

- 1 Its dashboard now gives computer-controlled information
- 2 Screen message tells you to select option form menu
- 3 Information fed into computer
- 4 Function
- 5 Fatal excess of narcotic (Abb.)
- 6 Compass direction of Boston from NYC

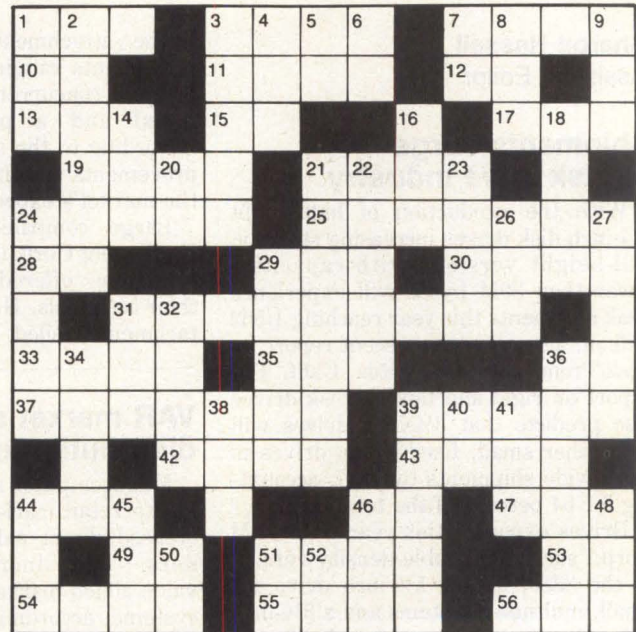

- 7 Prefix meaning "together"
- 8 Lose precision
- 9 Moon vehicle (Abb.)
- 14 Pure honey
- 16 Need plotter to produce
- 18 (.)'s
- 20 Nickel (Chem.)
- 21 Preset value for variable
- 22 Highly accurate
- 23 Run away from unpleasantness
- 24 Days of youth and inexperience
- 26 Blade for rowing boat
- 27 Her name means "noble"
- 29 City characteristic
- 31 Minor part worker plays in computer industry
- 32 Person legally entitled to inherit
- 34 High speed printer
- 36 Instruct computer to set up document for printing
- 38 Multiterminal screen-handling facility
- 39 Storage place
- 40 Bone
- 41 Wires connecting different sections of computer
- 44 String in tennis rackets
- 45 Communications software lets you _____ into databases
- 46 Suffix meaning "a person skilled in"
- 48 Function
- 50 Yours truly
- 51 Backfield football position (Abb.)
- 52 What those in favor say

E N I N E T T R C U E S V
 L T P M O R P B H R N L P
 I N P E M L A U A K E E C
 F L L O R C S W R G S X M
 D O R A K I D H A O L I K
 A K R U I R P U C L N P D
 C I P M A C G H T T A O R
 A L P H A N U M E R I C A
 X O N E A T B R R R M P O
 I B I L I B F A S O A D B
 N Y M B I A L M D O A L Y
 U T D O C U M E N T R E E
 W E N E R D M S A P A C K

- | | |
|---------------------|--------------------|
| Alphanumeric Backup | Interface Keyboard |
| Baud | Kilo |
| Bit | Kilobyte |
| Bug | Language |
| Byte | Menu |
| CPU | Modem |
| Character | Net |
| CAD | Pack |
| CRT | Peripheral |
| Cursor | Pitch |
| Data | Pixels |
| Disk | Prompt |
| Document | RAM |
| File | ROM |
| Format | Scroll |
| Hardware | UNIX |
| I/O | |

Mini-Micro MARKETPLACE

Products and services for the value-added market.

READERS: Please circle reader service numbers for additional information.

YOU KEEP THE QUALITY IN, WHEN YOU PUT A SHOCKWATCH ON!

The Shockwatch® Label is revolutionizing the way hi-tech shippers control the quality of shipments. This inexpensive and precision impact device is the basis of a shipping system that controls the quality of handling after the product leaves your dock. Abusive handling turns this device a bright red, warning your customer to inspect for possible damage. If you control quality inside your plant, why not control it after it leaves.

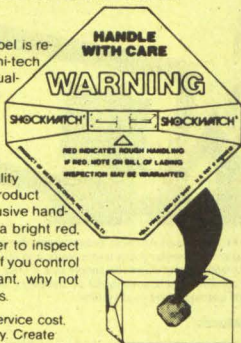

- Reduce damage, service cost, returns, dead inventory. Create customer goodwill & protect the quality product you manufacture.

Call 1-800-527-9497 for application information & a list of our Fortune 500 customers.
MEDIA RECOVERY, INC.
1435 Round Table Drive, Dallas, Texas 75247

CIRCLE NO. 200 ON INQUIRY CARD

Z80 MADE E—Z

EZT, the most POWERFUL Z80* software debug tool available today for CP/M* systems features:

- Assembly Language Input.
- Disassembler.
- Direct Instruction Execution.
- Trace with Traps.
- Up to Seven Breakpoints.
- Search Mode.
- On Line Calculator.
- Binary, Octal, Decimal, Hex, ASCII.

\$44.95 includes complete 100 kbyte source program on diskette. Visa, MC, P.O. or personal checks accepted.

TAYLOR MICRO TECHNOLOGY
1800 Mariposa Lane
Fullerton, CA 92633
(714) 773-4882

* registered trademarks of Zilog and Digital Research.

CIRCLE NO. 201 ON INQUIRY CARD

ZX-5000™ EXTENDED RANGE™ SURGE SUPPRESSORS

The ZX-5000 Extended Range series surge suppressors provide the most advanced protection available on the market today against spikes, surges and noise disturbances.



SUTTON DESIGNS INC.
COMPUTER SECURITY DIVISION
300 North Tioga · Ithaca, NY 14850
607-277-4301

CIRCLE NO. 202 ON INQUIRY CARD

PIN GRID ARRAY & DIP SOCKETS



10 Mupac Drive, Brockton, MA 02401
Tel (617) 588-6110 TWX (710) 345-8458

CIRCLE NO. 203 ON INQUIRY CARD

THE RSX/VMS SPECIALISTS



THE LSI-11/73 BASED CM-300/Q22 COMPUTER SYSTEMS WITH RSX-11M+ SUPPORTING SUPERVISOR-MODE LIBRARIES AND SEPARATE I AND D SPACE

THE MICRO-VAX I BRINGS VAX POWER AND HIGH PERFORMANCE TO THE Q-BUS

CM-300/Q22 computer systems are configured with DEC's NEW LSI-11/73 CPU, giving these systems 11/70 PERFORMANCE AT LSI-11 PRICES. CM-300/Q22 systems can be configured with up to 1200MB of fixed Winchester disk, up to 4MB of main memory and up to 64 terminals. System back-up is provided by an industry standard 9 track 1/2" 1600 BPI tape drive. Optional software packages include accounting software, mailing list, FORTRAN 77, FMS-11, BASIC +2 and DATATRIEVE. An LSI-11/73 based 300MB system including RSX-11M+ license, media and documentation, with a VT220 terminal may be purchased for under \$23,000.

MICRO/VAX I computer systems can be configured with up to 4MB of main memory, up to 31MB of fixed disk and up to 5 terminals. Prices start at \$13,730.

Call A.C.S. and let us configure a hardware/software solution for your specific problems.

ADVANCED COMPUTER SYSTEMS, Inc.
250 Prospect Street
Waltham, Massachusetts 02154
617-894-3278

CIRCLE NO. 204 ON INQUIRY CARD

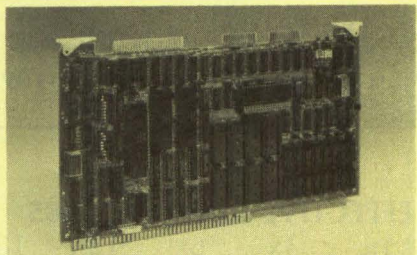

10 MHz Z8000™ PERFORMANCE

In addition to 10 MHz, the NEW MBx8000 SBC features a single width SBX connector for adding standard expansion modules, such as the SBSxFDC Floppy Controller. MBx8000 maintains all the capabilities of its predecessor, the MB8000: Z8001/Z8002 CPU 4/6/10 MHz; 32K/128K/512K DRAM; up to 48K static RAM or EEPROM; up to 128K EPROM; 2 RS-232 ports; 40 parallel I/O lines; six 16-bit counter-timers; etc. Z8000™ Zilog. SINGLE BOARD SOLUTIONS, 7669 Rainbow Drive, Cupertino, CA 95104. (408) 253-0181

CIRCLE NO. 205 ON INQUIRY CARD

ENCLOSURE PRODUCTS

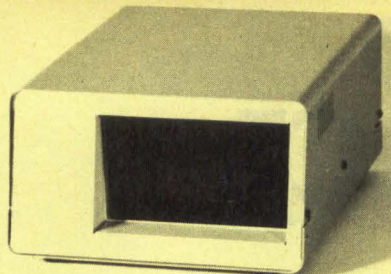

- Floppy and Hard Disk Drive Enclosures for all Major Micros.
- Xebec Controllers Optional
- Custom Design Available
- Class 'B' Certification Support Can Be Provided
- Call For Pricing and Catalog

Microware, Inc.

41711 Joy Road • Canton, MI 48187
(313) 459-3557

CIRCLE NO. 206 ON INQUIRY CARD

If you are a serious software developer, shopping for software development tools, call or write today for more information. **800-551-5554** in CA call **(408) 733-2919**

TARGET MICROPROCESSORS

8086/80186, 8096, 8080/8085, 8051, 8048, and others.

HOST MINI'S

DEC VAX, PDP-11, DG MV-Series Eclipse, Apollo, UNIX Systems, and others.

HOST PC'S

IBM PC, Data General/ONE, HP 150, COMPAQ, Columbia, DEC Rainbow, and other Compatibles.

SOFTWARE TOOLS

C Compilers, Pascal Compilers, Assemblers, Simulators, Linking Loaders, Librarians, Conversion/Download, Communications, and VT-100 Emulator.

for Serious Software Developers

MICROTEC RESEARCH

3930 Freedom Circle, Suite 101, Santa Clara, CA 95054
Mailing Address: P.O. Box 60337, Sunnyvale, CA 95088
(408) 733-2919 Telex (ITT) 4990808

CIRCLE NO. 207 ON INQUIRY CARD

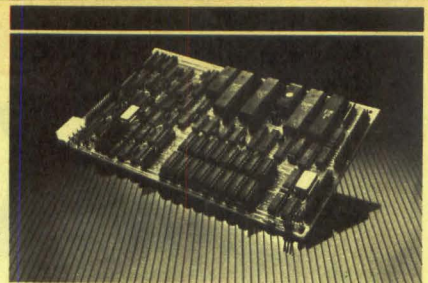

POWER THAT GOES ANYWHERE!

Single Board Computer

- FAST** — 6MHz Z80B* CPU
POWERFUL — 64K to 256K RAM, 2K to 64K ROM
— 5¼" and 8" Floppy Controller, SASI
— 2 RS-232, Centronics Port
FLEXIBLE — 50-pin I/O Expansion Bus.
SMALL — 5¼" x 10"

Davidige

DAVIDIGE CORPORATION
292 East Highway 246
P.O. Box 1869
Buellton, CA 93427

(805) 688-9598

*Z80 is a registered trademark of Zilog

CIRCLE NO. 208 ON INQUIRY CARD

Hot Air up to 700°C

electronically adjustable for Plastics Welding of pipes, sheets and foils. For shrinking and bending, soldering, drying, degerminating and gluing.

**Ask for free brochure
EX 543**



Brian R. White Co. Inc., 313 Henry Station Road, Ukiah, CA 95482 Telephone: (707) 462-9795, TWX 510-743-2052

Brian R. White Co. Inc., 1 Industrial Way West Bldg. E, Eatontown NJ 07724 Telephone: (201) 544-1212, TWX 888 307

CIRCLE NO. 209 ON INQUIRY CARD

Micromate

"the terminal converter"

128K
with
Bundled
Software

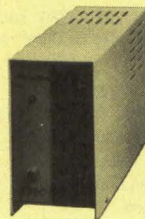

Lowest
priced
Business
Computer

You already have half of your next personal computer if you own a terminal. Just add our MicroMate to run thousands of CP/M software programs and still keep the same mainframe connection.

Personal Micro Computers, Inc.

275 Santa Ana Court, Sunnyvale, CA 94086
(408) 737-8444

CIRCLE NO. 210 ON INQUIRY CARD

SAM...Prevents Computer

MELTDOWN

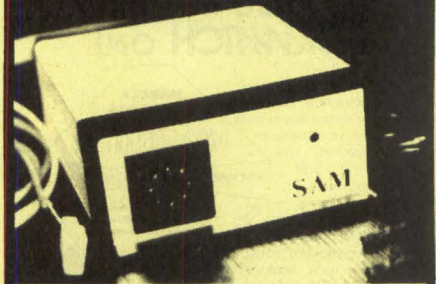

SAM, The Smart Ambient Temperature Monitor/Power Controller... measures computer room temperature and lets your computer know too! Automatic power-down is a simple task if your mini-computer gets too hot for comfort. There's no threat of computer damage or loss of data with SAM watching over your system.

Features:

- Utilizes a powerful single-chip micro
- Dual Solid State Temperature Sensors
- Controls Popular Mini-Computer Power Distribution Panels
- Standard RS-232 Interface
- Built-in Audible Warning Alarm
- Switch Selectable Baud Rates: 300, 1200, 4800, and 9600
- Auto Hi/Low Temperature Storage
- Compact Size: 2½" x 5½" x 7"
- Metal Case
- One Year Warranty

Computer - 101 W. 31 ST., N.Y., N.Y. 10001 (212) 947-5533

CIRCLE NO. 211 ON INQUIRY CARD

ORDER FORM

Advertise in the **MINI-MICRO MARKETPLACE**

Please run my advertisement in the following issues

EFFECTIVE JANUARY 1985

1x	3x	6x	12x	18x
\$660	\$595	\$575	\$560	\$545
	24x	48x		
	\$525	\$505		

MATERIALS

1. Glossy photo with 50-75 words. We will typeset your ad at no charge.
2. Camera ready artwork.
3. Film negatives: right reading emulsion side down.

AD SIZE: 2¼" x 3⅙"

COMPANY

ADDRESS

CITY

STATE

ZIP

TELEPHONE

SIGNATURE

Space reservation by the first week of the month preceding issue date.

- Materials enclosed Materials to come Please send information

Send to: Norma Lindahl, **MINI-MICRO SYSTEMS**
221 Columbus Ave.
Boston, MA 02116

15% Agency commission to accredited agencies. Please specify agency.



There's an Epsonomic answer to your printer needs.

Our new OEM printer is part of it.

Epsonomics means more than designing a printer exclusively for the OEM. Though we'll never market our CTM series through retail.

But Epsonomics means more. More than offering a printer with a unique custom case. More than Epson® reliability. Though that has become a byword in the printer world.

Epsonomics means even more than technical superiority and advanced performance. Though the CTM F-series of 160 cps printers boasts an increased line speed and data transfer rate that yields 20% greater throughput. And the universal power supply accommodates 100, 120, 220, and 240 volt inputs to match your domestic and international needs and simplify purchasing decisions.

Epsonomics means designing products that will increase the saleability of your products, lower their after-sale service costs and provide the OEM protection against similar products marketed through the retail channel. It means on time delivery to minimize your inventory costs. It means making that extra effort to help you grow so we can grow with you.

Epsonomics. Our new CTM F-series of OEM printers is only part of it. So are our LCDs, floppy drives and printer mechanisms, and the integrated technology behind them. The main part is that we do business so you can provide cost effective products to your customers.

Find out how Epsonomics can help you achieve an aggressive competitive posture in your marketplace. Call or write us today.

EPSON®
OEM

EPSON AMERICA, INC.
OEM Products Division
Peripherals Group
3415 Kashiwa Street, Torrance,
CA 90505 (213) 533-8277
TELEX: 664277



*The top lines for
your bottom line*

SW Region (714) 250-0111 • NW Region (408) 970-9977 • SE Region (404) 956-1934 • NE Region (617) 245-8007 • Central Region (815) 338-5810
© Registered trademark of the Epson Corporation.

CIRCLE NO. 114 ON INQUIRY CARD

Our IBM Protocol Converter is not the same under the skin!

Up to 16 channels.
Down to \$353 per channel.



For protocol conversion without tears,
think MICOM.

MICOM[®]

MICOM Systems, Inc. • 20151 Nordhoff Street • Chatsworth, CA 91311 • Telephone (805) 583-8600 • TWX 910/494-4910
Regional Sales/Service • Atlanta, GA • (404) 435-2999 • Boston, MA • (617) 527-4010 • Chicago, IL • (312) 964-0551
Dallas, TX • (214) 258-0774 • San Francisco • (415) 327-0890 • St. Louis, MO • (314) 576-7626 • Teaneck, NJ • (201) 836-4000
MICOM-Borer Ltd. • Reading RG20JT, England • (0734) 866801 • MICOM Europe • Newbury RG13IJU, England • (0635) 832441

For literature please call: (800) "MICOM U.S."

M4003

CIRCLE NO. 115 ON INQUIRY CARD