

Mini-Micro Systems

A CAHNERS PUBLICATION

SEPTEMBER 1984

Line printers:
The impact of
higher quality, lower costs

Will software standards
be possible?

Disk controller
boosts system
performance



They're walking in our footprints but they can't fill our shoes

Kennedy's Model 73160 Winchester Disk Drive walks tall with specifications the competition can't match.

Specifications such as:

- Full SMD compatibility (including media format and signal timing)
- 20 msec average seek times.
- Only two DC voltages are required (+5V and +24V)
- Only 96 W average power dissipation

- Model 73160 may be obtained with SMD, ANSI or Pico interface.

- And all this comes in a package the same size as an 8' floppy disk drive.

Call or write for complete details

KENNEDY

An Allegheny International Company

1600 Shamrock Ave., Monrovia, CA 91016

(818) 357-8831 • ITT TELEX 472-0116 KENNEDY



KENNEDY • QUALITY • COUNT ON IT

CIRCLE NO. 1 ON INQUIRY CARD

More and more. For less and less.

Hewlett-Packard introduces the HP 2392A.

When you get this new HP display terminal, suddenly you'll be running applications

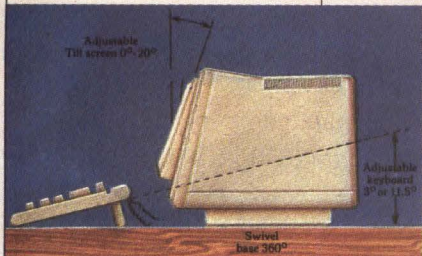

with less effort. In less space. For less money. And with more confidence, having HP's reliability and quality to count on.

Less effort.

The first thing that will impress you is how easily everything fits into place. Integral tilt and swivel make screen and keyboard adjustments easier. Power and brightness controls are right up front, at your fingertips.

Working becomes more pleasant, thanks to the non-glare, high-resolution screen and well defined, smooth scrolling characters. Up to four pages can be stored in display memory, with up to four more pages available as an option.

And all that happens on a 12-inch display that only takes up about one square foot of your desk.

More helpful.

With eight non-volatile, programmable function keys, it will take you less time to enter complex or repetitive commands. A handy terminal status line tells you what mode you're working in. And

17 national language keyboards are available to make work easier for everybody, just about everywhere.

You get more speed, too. You'll communicate

with your computer at up to 19,200 bps in block, line or character mode. So your information will get around in less time. It's also easy for you to get hard copy, since our terminal has an optional printer port you can install yourself.

If you're an ANSI user, you've also got more going for you. The HP 2392A has ANSI capabilities making it an ideal terminal for your DEC system.

More reliable.

HP engineered the HP 2392A using state-of-the-art VLSI



technology to minimize component count and increase reliability.

But, if you do need support services, just pick up the phone. A worldwide network of HP sales and service offices is staffed by qualified engineers ready to help you.

Less money.

With all these features, you'd expect to pay more than \$1,295* for our new display terminal. But that's all we're asking. So why settle for less?

To get more information, call your local HP sales office listed in the white pages. Or get in touch with Terry East-

ham, Hewlett-Packard, Dept. 008199, 8020 Foothills Blvd., Roseville, CA 95678. Phone (916) 786-8000. In Europe, contact



Michael Zandwijken, Hewlett-Packard, Dept. 008199, P.O. Box 529, 1180 AM Amstelveen, The Netherlands.

Productivity. Not promises.
hp HEWLETT PACKARD

Mini-Micro Systems



p. 163 Interphase Corp. presents the Storer disk controller. Art direction by Ron Carl, photography by Ellen Schuster. Graphics workstation courtesy of Silicon Graphics. Winchester drive courtesy of Maxtor Corp.

MINI-MICRO WORLD News

- 31 Wyse unveils 64-color alphanumeric terminal
- 32 AT&T grabs at MS-DOS market share
- 34 Software vendor taps riches of 1-2-3
- 35 High-speed Delphax S6000 impels ion printing into new channels
- 38 Gould UNIX supermini reaches 10 MIPS
- 43 Heard on the Hill: Anatomy of a computer sting
- 45 Congress questions price of DOD hospital computer network
- 46 Half-height 25M-byte Winchester suits mid-range system architectures
- 50 Active-matrix technology improves liquid crystal displays
- 54 Ungermann-Bass stretches network connection options
- 58 Plain-vanilla data-interchange standard proposed for UNIX applications
- 62 Teletype adds 200-cps dot-matrix printer
- 70 Database manager eases OEM application-development tasks
- 72 Grid links products to IBM, expands portable line, cuts prices

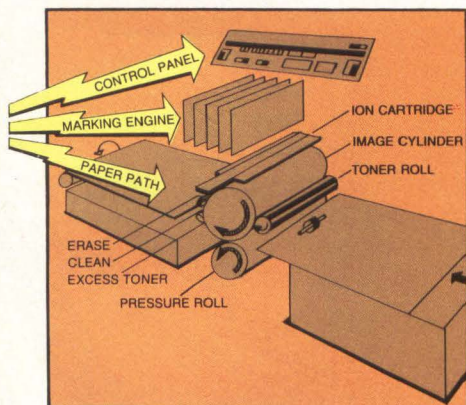

p. 35 Ion deposition is reliable

Corporate and Financial

- 77 Franklin's success sours after Apple lawsuit
- 78 Corporate and financial briefs

International

- 81 Taiwan's PC-compatible makers stumble following problems with IBM copyrights
- 87 Japan's stance on software copyright causes international rebuke
- 89 Price pressures drive U.S. companies to seek Far East manufacturing
- 96 Pacific Perspective: Japanese manufacturers expand, diversify to meet semiconductor demand

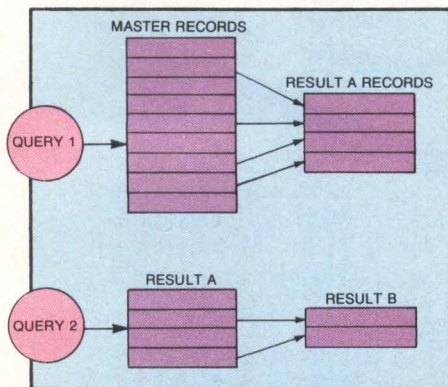

p. 127 AI speeds software development

INTERPRETER

- 99 Relational DBMS vendors girded for ascent of multiuser microcomputer market
- 111 Will 1984 be the year of the LAN?

INTEGRATOR

- 127 Artificial intelligence techniques speed software development
- 143 Diagnostic diskettes suit system integrators but can leave users confused
- 151 Graphics system rejects keyboard in favor of simple controls

FEATURES

- 161 **Feature Highlights**
- 163 **UNIX-optimized controller supports intermixed tape, floppy, Winchester drives** . . . device reduces rotational latency and increases peripheral performance
- 175 **Line printer leaders lower prices, improve reliability** . . . the impact vs. non-impact battle rages on
- 187 **Impact line printer table**
- 202 **Market considerations hinder search for software standards** . . . proponents and opponents face off
- 215 **Large software package ports from a 32-bit to a 16-bit machine** . . . memory management proves the most difficult problem
- 225 **Intelligent I/O board extends S-100 systems to 16 terminals** . . . Macrotech's ADIT provides intelligent processing for S-100 based systems
- 235 **Simplicity is key goal in applications development** . . . mature development methods help develop complex applications
- 249 **Law column: Can copyrights protect all forms of software?**

DEPARTMENTS

- | | |
|---------------------|----------------------------|
| 4 Editorial Staff | 280 Calendar |
| 11 Editorial | 283 Classified Advertising |
| 15 Breakpoints | 284 Career Opportunities |
| 255 Guest Viewpoint | 288 Index to Advertisers |
| 257 New Products | 289 Mini-Micro Marketplace |

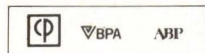

MINI-MICRO SYSTEMS (ISSN 0364-9342) is published monthly (with additional issues in spring, summer and fall) by Cahners Publishing Company, Division of Reed Holdings, Inc., 221 Columbus Avenue, Boston, MA 02116. Norman L. Cahners, Chairman; Saul Goldweitz, President and Chief Executive Officer; Ronald G. Segel, Executive Vice President and Chief Operating Officer. MINI-MICRO SYSTEMS is published by the Cahners Magazine Division: J. A. Sheehan, President; William Platt, Executive Vice President. Circulation records are maintained at Cahners Publishing Co., 270 St. Paul St., Denver, CO 80206. Second class postage paid at Denver, CO 80202 and additional mailing offices. Postmaster: Send address changes to MINI-MICRO SYSTEMS, 270 St. Paul St., Denver, CO 80206. MINI-MICRO SYSTEMS is circulated without charge by name and title to U.S. and Western Europe based corporate and technical management, systems engineers, and other personnel who meet qualification procedures. Available to others at the rate of \$55.00 per year in the U.S.; \$60.00 in Canada and Mexico; \$75 surface mail in all other countries; \$120 foreign air mail (16 issues). Special DIGEST issues, \$15.00. Single issues \$4.00 in the U.S.; \$5.00 in Canada and Mexico; \$6.00 in all other countries.

© 1984 by Cahners Publishing Company, Division of Reed Holdings, Inc. All rights reserved.

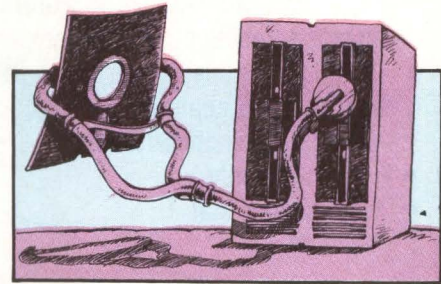

p. 143 . Are diagnostic diskettes too exotic?

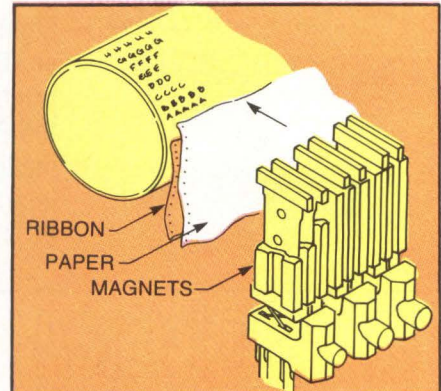

p. 175 Line-printer battle rages on

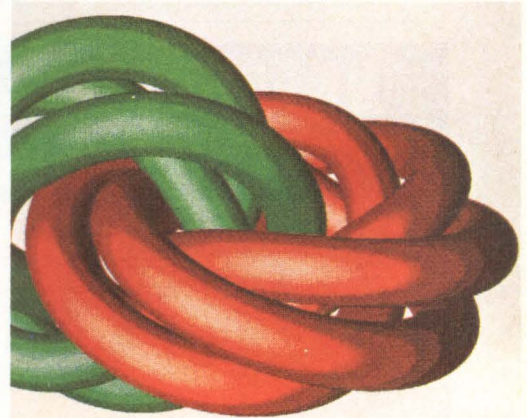

p. 202 . Moving towards software standards

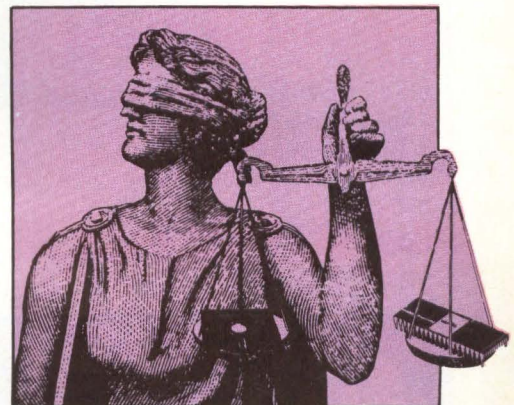

p. 249 Broadening copyright protection

THE INDOOR MULTIPLEXER

- Eight channel capacity
- No modem needed: up to 2000 ft. distance between multiplexers
- Completely transparent, up to 9600 bps for each channel
- No option switches to set
- 2 Year warranty
- Free 30-day trial

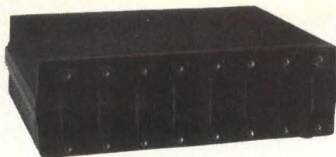

\$495

THE PC MUX

\$395

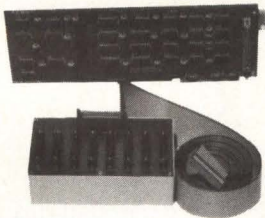

Eight terminals can be connected to an IBM PC using the PC MUX. One printed circuit board mounts inside the PC. An external interconnect module with eight RS-232 connectors interface directly with terminals, other PC's or other serial devices.

SOLANA electronics
(619) 481-6384

CIRCLE NO. 5 ON INQUIRY CARD

UNFORGETTABLE MEMORIES MULTIBUS — QBUS

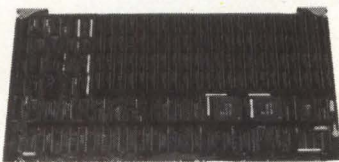

MULTIBUS MEMORY 512KB TO 2MB EDC

- Error Detecting and Correcting (EDC)
- Faster Access Times

SINGLE QTY. PRICE

	Without/EDC	W/EDC
512KB	895.00	1495.00
2MB	3595.00	4595.00

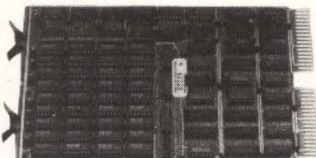

Q-BUS MEMORY 256KB TO 4MB

- Battery Backup Mode
- Block Mode DMA, ECC or Parity
- Works with LSI-11, J-11, MicroVAX

SINGLE QTY. PRICE

1MB	1695.00
256KB	525.00



"OFFERING QUALITY WITH AFFORDABLE PRICING"



Chrislin Industries, Inc.

31352 Via Colinas • Westlake Village, CA 91362 • 818-991-2254
TWX 910-494-1253 (CHRISLIN WKVG)

J-11, LSI-11, MicroVAX, Q-BUS are trademarks of Digital Equipment Corporation. MULTIBUS is a trademark of Intel Corporation.

CIRCLE NO. 6 ON INQUIRY CARD

STAFF

Vice President/Publisher
S. Henry Sacks

Editor-in-Chief
George V. Kotelly

Managing Editor
James F. Donohue

Assistant Managing Editor
Bruce J. MacDonald

Senior Western Editor: **Jerry Borrell**
San Jose, (408) 296-0868
Senior Editor: **Sarah Glazer**
Senior Editor: **Paul Sniger**
Senior Editor: **Lori Valigra**
Senior Projects Editor: **Rick Dalrymple**

Western Editor: **Carl Warren**,
Los Angeles, (213)826-5818
Associate Editor/Research:
Adrienne DeLeonardo
Associate Editor: **Frances T. Granville**
Associate Editor: **Lynn Haber**
Associate Editor: **Tom Moran**,
San Jose, (408)296-0868
Associate Editor: **David Simpson**
Associate Editor: **Marjorie Stenzler-Centonze**,
New York, (516)595-2737
Associate Editor: **Michael Tucker**
Associate Editor: **Jesse Victor**
Assistant Editor: **David Bright**
Assistant Editor/New Products: **Eileen Milauskas**
Assistant Editor/Research: **Megan Nields**

Contributing Editors:

London: **Keith Jones**, (011-441-661-3040)
Data Communications: **Walter A. Levy**
Computer Architecture: **Efrem Mallach**
Office Automation: **John Murphy**
Frankfurt: **Maureen O'Gara**
Artificial Intelligence: **Steven Roberts**
Washington, D.C.: **Stephen J. Shaw**,
(202)387-8666

Editorial Production

Senior Copy Editor: **Arsene C. Davignon**
Production Editor: **Mary Anne Weeks**
Copy Editor: **Gregory Solman**
Word Processing: **Kathleen Ewing**
Administrative Assistant: **Frances C. Michalski**

Editorial Services

Sharon Hassell, Robin Sheehan

Assistant to the Publisher: **Linda L. Lovett**

Executive Editor,

Cahners Computer Publications:
Alan R. Kaplan

Art Staff

Art Director: **Vicki Blake**
Assistant Art Director: **Cynthia McManus**
Artist: **Anne Tregay**

Director of Art Dept.: **Norm Graf**

Production Staff

VP Production: **Wayne Hulitzky**
Supervisor: **William Tomaselli**
Production Manager: **Nancy Norton**
Composition: **Diane Malone**

Editorial Offices

Boston: 221 Columbus Ave., Boston, MA 02116.
(617)536-7780. **Irvine:** 2041 Business Center Dr.,
Suite 109, Irvine, CA 92715. **Los Angeles:** 12233 W.
Olympic Blvd., Los Angeles, CA 90064. **San Jose:**
3031 Tisch Way, San Jose, CA 95128. **New York:**
33 Arcadia Dr., Dix Hills, NY 11746. **London:** Busi-
ness Press International, Quadrant House, The
Quadrant, Sutton, Surrey, SM2 5AS, England.

Reprints of Mini-Micro Systems articles are avail-
able on a custom printing basis at reasonable prices
in quantities of 500 or more. For an exact quote, con-
tact Art Lehmann, Cahners Reprint Service, Cahners
Plaza, 1350 E. Touhy Ave., Box 5080, Des Plaines,
IL 60018. Phone (312)635-8800.

We've drawn the line on computer price/performance.

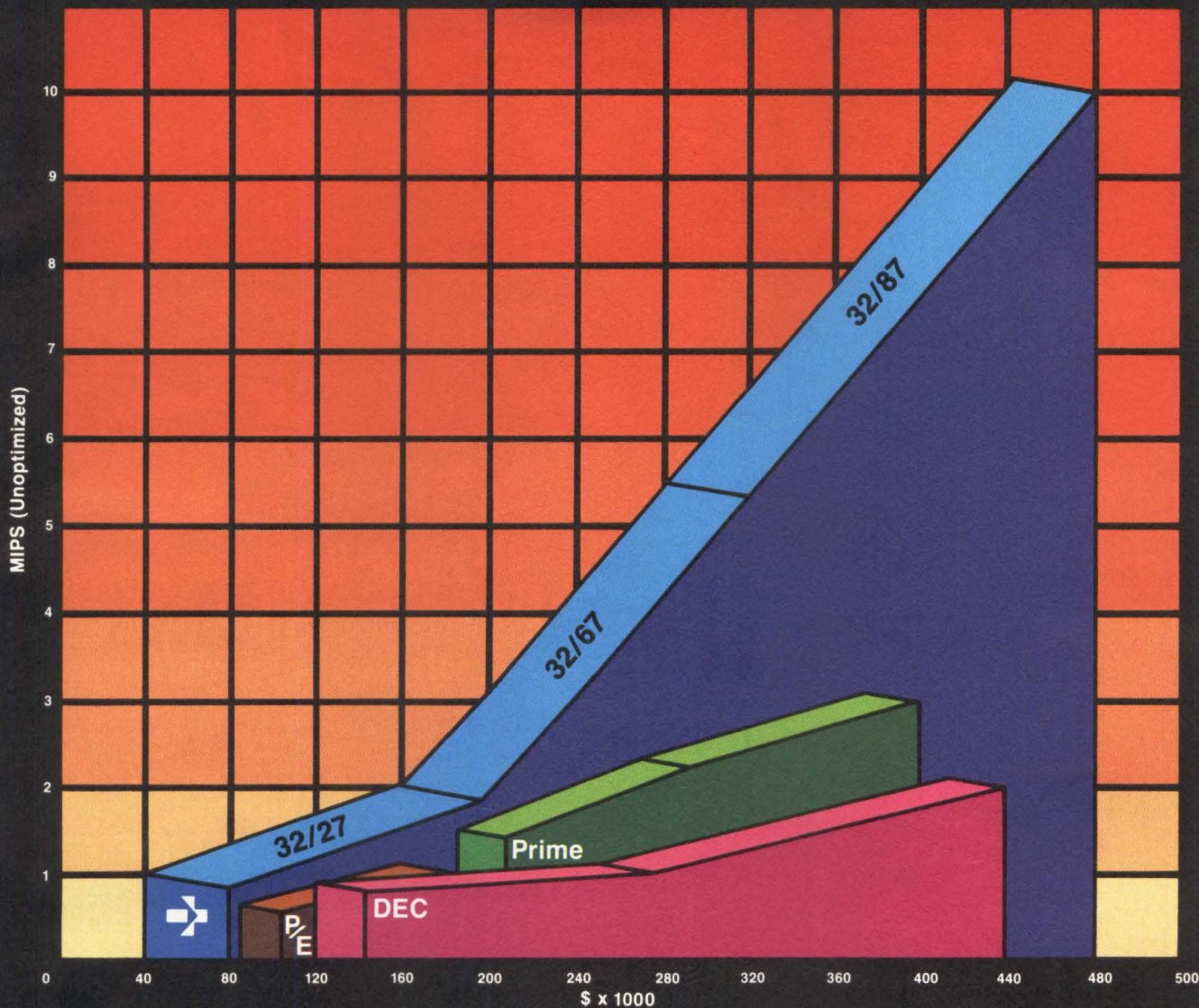

Gould has set new supermini-computer performance standards with its CONCEPT/32™ family of 32-bit machines. The cost-effective, wide-ranging capabilities of Gould minicomputers make Gould Computer Systems the dominant source for the compute power you need, at a price you can afford.

The competition just doesn't tow the line in either price or performance. Whatever the requirement. The Gould CONCEPT/32 family offers the widest range of superior performance while

keeping the price in line. Our low-end CONCEPT 32/27 incorporates high density packaging for lower cost. The mid-range 32/67 combines a minimal footprint and cost with superior computational power. For heavy duty scientific and engineering applications, the Gould CONCEPT 32/8780 offers mainframe performance at a fraction of the cost. And if you're worried about where your application falls on the line, don't be. Upward compatibility and software transportability allow you to move up our line as far as you need to go.

Gould has drawn a new price/performance line. One that shows it takes more than 32-bits to make a supermini. A line the competition can't cross. Call or write for more information.

Gould Inc., Computer Systems Division

High Performance Systems Operation
6901 West Sunrise Boulevard
Ft. Lauderdale, Florida 33313
1-800-327-9716

All chart data from published competitive information.
™ CONCEPT/32 is a trademark of Gould Inc.

CIRCLE NO. 7 ON INQUIRY CARD



GOULD
Electronics

68000-based Just tell us

68000-based systems to fit your application.

Right from the pages of our catalog, we can deliver 68000-based super-micro systems to match virtually any application.

Including yours.

Here's how.

Built on the IEEE-696 (S-100) bus, Cromemco systems offer up to 21 board slots. And a family of 35 boards — CPU, memory and specialized I/O — to fill the slots any way you choose.

At the heart of each system is our 68000/Z-80 dual processor. Backed by as much as 16 Mb of error-correcting RAM. Full multi-tasking capability. I/O to handle up to 16 terminals.

And that's just the beginning.

You can select single or dual floppies, 5¼" or 8". A 50 Mb 5¼" Winchester hard disk. And a nine-track tape drive.

We can accommodate your taste for the exotic, too. With boards like our SMD interface that supports up to 1200 Mb of disk storage. A fast floating-point processor. A color graphics interface. A TV camera digitizer. An IEEE-488 bus interface. Communications. And more.

Intelligent workstations.

Then, if you're designing a dis-

tributed processing system, you'll want to take a look at our C-10 personal computer. The Z-80-based C-10 can serve our 68000-based systems as a powerful intelligent workstation in a distributed processing mode. Or as an independent personal computer with its own floppy storage.

High-level languages and applications software.

That brings us to software. It starts with CROMIX®, our UNIX™-like operating system that you're free to tailor to your application.

CROMIX can execute both 68000- and Z-80-based programs. So right along with your 68000-based packages, your system will accommodate a wide selection of CP/M® software written for the Z-80.

And our high-level language support is second to none. From a 68000 Macro Assembler. To 68000 FORTRAN 77, PASCAL, GSA-certified high-level COBOL, C and BASIC.

Cromemco means business. Your business.

You see, when we say, "Just tell us what you need," we're not kidding. You won't find another family of

systems. what you need.

68000-based microcomputers that can fit your needs as exactly as ours.

So if you're in the business of providing specialized computing solutions, you really should be doing business with Cromemco.

For a copy of our Systems Catalog, contact Cromemco, Inc., 280 Bernardo Avenue, P.O. Box 7400, Mountain View, CA 94039. (415)964-7400.

In Europe: Cromemco GmbH, 6236 Eschborn 1, Frankfurter Str. 33-35, P.O. 5267, Frankfurt Main, Germany or Cromemco Ltd., The Cambridge House, 178-182 Upper Richmond Rd., Putney, London SW15 England.

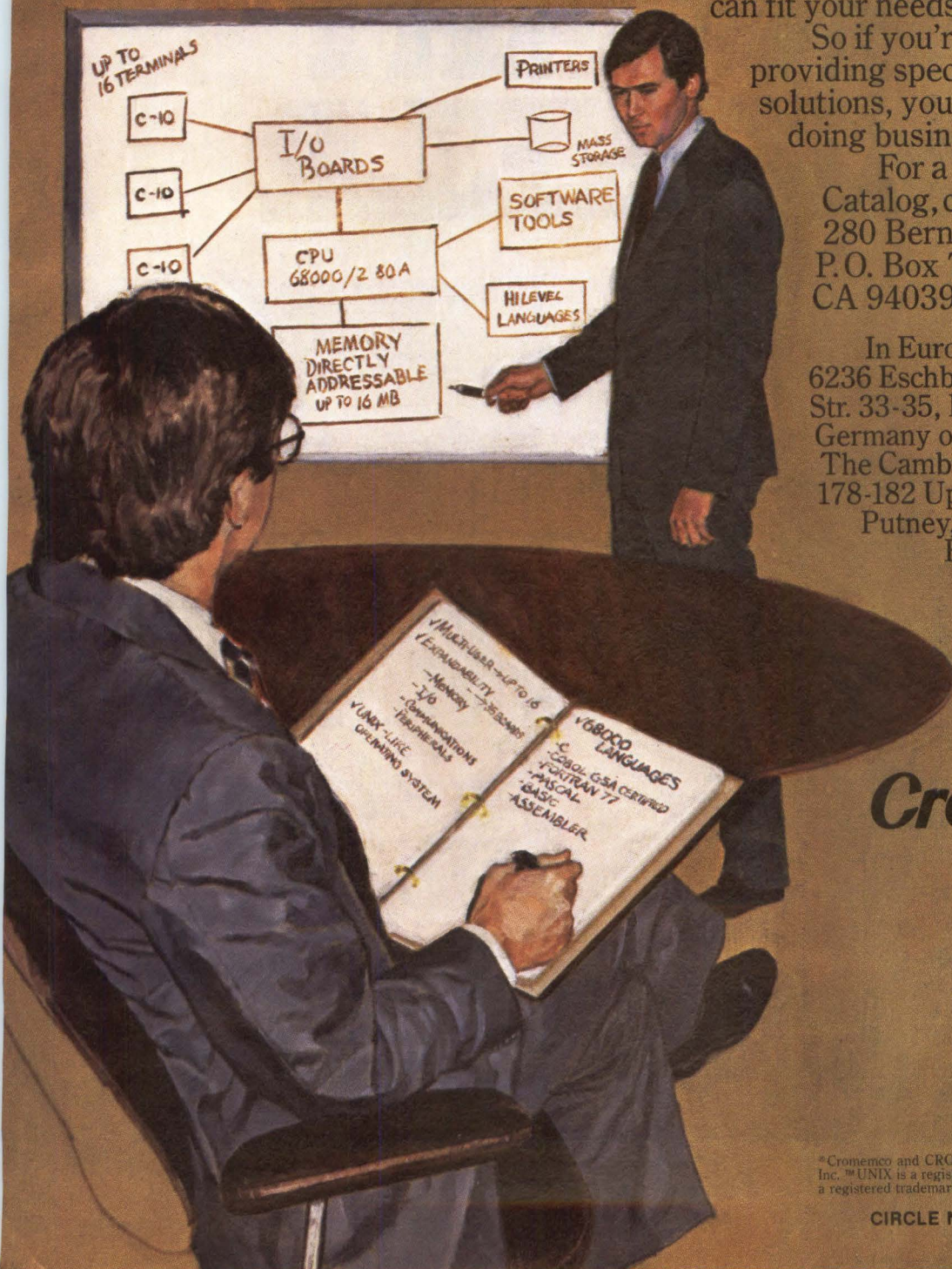

Cromemco®

*Cromemco and CROMIX are registered trademarks of Cromemco, Inc.™ UNIX is a registered trademark of Bell Laboratories. *CP/M is a registered trademark of Digital Research. ©1983, Cromemco, Inc.

CIRCLE NO. 8 ON INQUIRY CARD

IF YOUR BUSINESS IS SHRINKING, SHUGART CAN HELP.

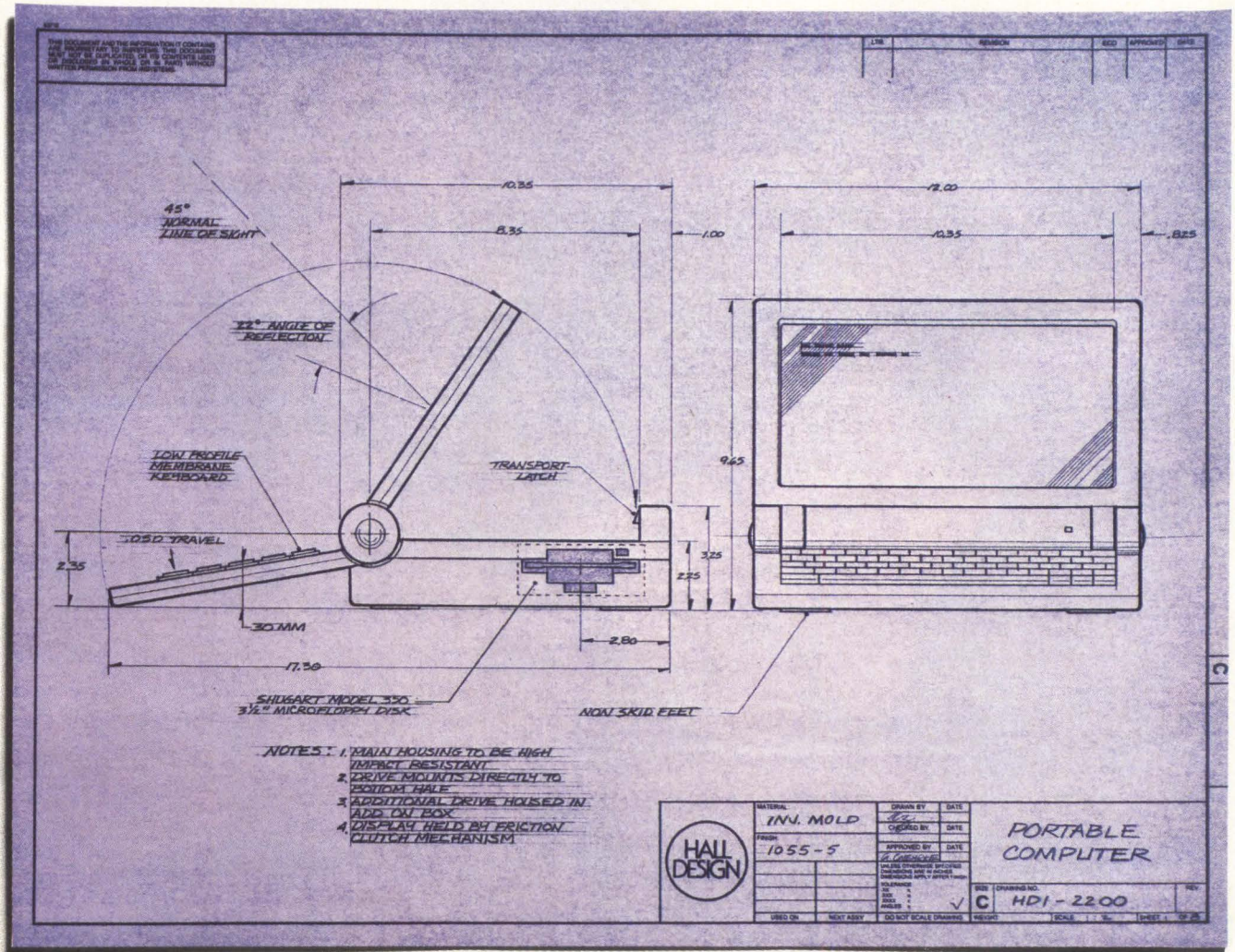

These days, computer designers everywhere face a problem of massive proportions: How do you cram a desktop computer into a briefcase?

Sound familiar? If so, there's a family of 3.5" single and double-sided microfloppy disk drives you should meet. The Shugart 300 and 350, respectively.

The perfect drive solution for a full-featured portable.

Tiny enough to fit easily into your smallest design. Yet with a 6 millisecond average access time, a capacity up to 1 megabyte and Minifloppy™ compatibility, your portable computer could easily run the same software as someone else's desktop.

And keep it running for quite some time.

Shugart drives are so reliable, you can count on an MTBF of 10,000 power on hours. One reason we're projecting delivery of over 100,000 microfloppy drives this year.

At just over a pound apiece, you could even use two. And still call your portable computer portable.

There's just one thing to remember. You should always check the activity light on a Shugart microfloppy. They're so quiet, there's no other way to tell if they're running.

What more could a shrinking

business need? A couple of other small things. Industry standard 3.5" microcartridges, to be exact. Their track densities offer a more than generous upgrade path. But more important, considering where they could end up, they come equipped with a hard shell plastic media cartridge. And an automatic head access shutter. Sure protection from all kinds of catastrophes. Stick them in your pocket. Throw them in your purse. Bang them around in your briefcase. They'll survive.

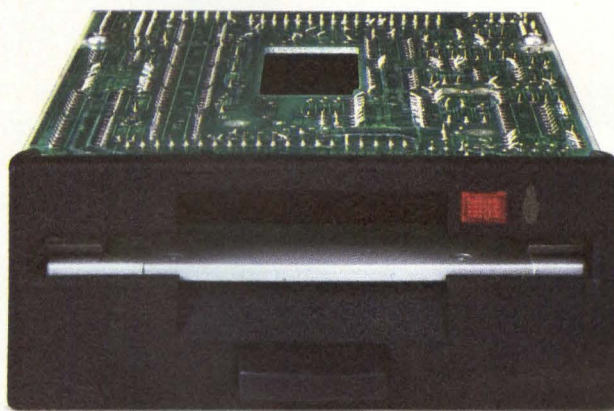

The 3.5" Shugart Microfloppy. Smaller than actual size, but not much.

Sound interesting? Call your local Shugart sales office. We'll do a private microfloppy workshop right in your office. But do it soon. The more your business shrinks, the more Shugart can help.

Shugart

Right from the start.

Milpitas, CA (408) 263-2600, Costa Mesa, CA (714) 979-1935, Thousand Oaks, CA (805) 496-5388, Rochester, NY (716) 235-7190, Minneapolis, MN (612) 546-4411, Richardson, TX (214) 234-3568, Framingham, MA (617) 879-1700, Saddle Brook, NJ (201) 368-8445, Smyrna, GA (404) 436-0953, Markham, ONT (416) 475-2655, Paris, France (3) 946-42-66, Munich, West Germany (089) 786-021, London, U.K. (44) 4862-27272, Wanchai, Hong Kong (852) 5-733307. © 1984 Shugart Corporation
Hamilton/Avnet, authorized distributor

50,000 DRIVES DELIVERED

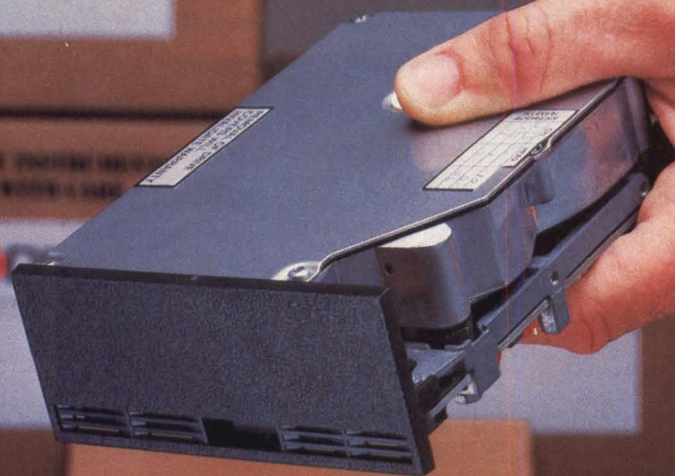

WE'VE BEEN DELIVERING 3 1/2" WINCHESTER DISK DRIVES FOR OVER A YEAR.

Rodime has been setting a new standard in Winchester disk drive storage for more than a year. Its 3 1/2" drive with 5 and 10 megabytes of formatted storage has become the industry leader for sub 4" Winchester disk drives. Rodime has now delivered tens of thousands!

The proven compact drive and proven quantity supplier

With thousands of its 3 1/2" Winchester drives in operation today Rodime has further demonstrated its reputation for reliability, a major design consideration for its 3 1/2" drive, and quality. It has a rugged design with high resistance to shock, an important consideration for portability and for vibration prone environments. Using advanced large-scale integration, the entire electronics for the drive are on a single compact board and there are no adjustments or select-on-test components.

New design horizons

The compact size of Rodime's drive suddenly puts large-scale storage into areas never considered before. The 350 series is one-fourth the volume of a 5 1/4" Winchester drive. And the 250 series, which includes



mounting brackets and a face plate, fits into the same space as a half-height 5 1/4" Winchester offering even further shock and vibration isolation. Now, system designers have a new level of flexibility. One area that has received attention is use with portable computers. Several major portable computer manufacturers have already incorporated Rodime 3 1/2" Winchester disk drives into

their products. There are other equally exciting areas such as desk top computer systems, intelligent terminals, point-of-sale terminals, industrial controllers, telecommunications systems, navigation and guidance systems, and portable instrumentation. In fact, the list of potential uses is only limited by the imagination of the system designer.

A tradition of excellence

In a few short years, Rodime has established itself as a major force within the Winchester disk drive industry. Rodime is one of the few manufacturers that are delivering 5 1/4" Winchester drives with a broad range of capabilities up to 54 megabytes. And is the only manufacturer delivering high-performance 3 1/2" Winchester drives in production quantities.

For the compact 3 1/2" Winchester disk or other 5 1/4" Winchester requirements, look to Rodime. Rodime delivers.

RODIME

Western Sales Office: (714) 770-3085 • Eastern Sales Office: (512) 453-5135

Distributors: San Jose, CA (408) 946-8000 • Tustin, CA (714) 730-8000 • San Diego, CA (619) 279-5200, 453-9005 • Chatsworth, CA (818) 700-1000 • Tempe, AZ (602) 244-0900 • Englewood, CO (303) 790-4500
Redmond, WA (206) 881-0850 • Addison, TX (214) 733-4300 • Austin, TX (512) 835-0220 • Sugarland, TX (713) 240-2255 • Burlington, MA (617) 272-9400 • Hauppauge, NY (516) 273-1660 • Fairfield, NJ (201) 227-7960 • Horsham, PA (215) 443-5150 • Columbia, MD (301) 964-0040 • Tulsa, OK (918) 644-8812

CIRCLE NO. 10 ON INQUIRY CARD

©1984 Rodime, Inc.



UNIX falls short of standard status

Despite zealous press, public relation and advertising efforts, UNIX will not become the de facto industry-standard operating system, technically speaking, for 16- and 32-bit microcomputer-based multi-user operating systems. It does not possess all the key features that an operating system requires to handle today's advanced computer architectures and technologies. However, on the plus side, UNIX is a powerful operating system, has achieved success in the computer marketplace and has the backing of AT&T. On the debit side, though, its shortcomings have hampered widespread implementations because UNIX doesn't solve all of the computer industry's software problems.

And what are these UNIX deficiencies? International Data Corp., a Framingham, Mass.-based market research company, documents them all in their recent research memorandum entitled "Whither UNIX?" First, UNIX is simply not user-friendly. Its command structure and system administration functions are terse and complex, especially to unsophisticated users, and, therefore, hard to learn. Several software companies have built packages with a more user-friendly shell around UNIX, but this patchwork approach restricts functions and reduces overall efficiency.

Another deficiency: UNIX runs slowly and inefficiently on small single- and multiuser computer systems. In addition, it has no record files, no index files and no file-locking. Moreover, it has no security capability and is subject to system crashes. Even more negative, though, no single UNIX standard exists. In fact, more than a dozen AT&T and University of California at Berkeley UNIX versions are available, and few are identical to, or compatible with, one another. For instance, take your pick from Version III, Version V, the University of California at Berkeley 4.1 and 4.2 BSD versions, and the commercial Idris, VENIX and XENIX adaptations. And further clouding the scene is the fact that even within the same version, variants coexist, such as for I/O handling, system commands and functional supersets. Indeed, these variants also diminish software portability and compatibility.

Still another deficiency centers on the lack of available applications software for UNIX-based systems. In fact, the limited supply of UNIX-based software has hindered universal acceptance. Other factors have also impeded approval. For example, UNIX software is minicomputer-derived and drastically outmoded. Developed years ago in an academic environment and targeted at software development, UNIX doesn't contain the important microcomputer-software features needed today. These features include multiple-application program and database management, network communications, machine independence, real-time support, multitasking, memory protection, security, virtual storage, windowing and bit-mapped graphics. Such features can be fixed, modified, patched and enhanced into UNIX, but they would not result in an optimized, fully integrated operating system.

If not UNIX, then what? System integrators still want the desirable features of UNIX, such as C language, directory structure, pipes and programmer's workbench. Fortunately, forward-thinking software companies have anticipated present and future operating requirements. They have produced integrated operating systems that provide multiple coordinated software services. And such systems are application-adaptable and modifiable to avoid obsolescence. For example, Digital Research Inc., Pacific Grove, Calif., offers Concurrent DOS; Multi Solution Inc., Lawrenceville, N.J., provides S1; Microsoft Corp., Bellevue, Wash., supplies XENIX; and other companies have comparable offerings.

UNIX brought the importance of operating-system software into prominence. It has served its purpose. Let's now benefit from the experience and move on to the newer, more capable and fully integrated operating-system solutions—the same way industry moved from the 8-bit CP/M world to the 16-bit MS/DOS arena. The marketplace has accepted UNIX, but not as the single standard. Indeed, the marketplace will accept many other operating systems as well. Sensible integrators will employ the one that meets application requirements and not the one rated as the de facto standard.

A handwritten signature in cursive script that reads "George V. Kotelly".

George V. Kotelly
Editor in Chief



UNIX™ System V from AT&T can help you close a sale, as well as open up new markets.

It's another reason why good business decisions are based on UNIX System V from AT&T.

More and more of your customers will be demanding multi-user and multi-tasking systems. The benefits of UNIX System V—portability, reliability, flexibility—make it the ideal software system for this lucrative market.

In addition, AT&T will support UNIX System V with the service, training, and documentation resellers need to prosper.

More choices, more opportunities

UNIX System V is virtually hardware independent. So you'll be able to configure systems using equipment from a variety of vendors.

You can use the flexibility of UNIX System V as a real selling

point to customers who want to add hardware that is compatible with the machines they already have.

And over the long term, UNIX System V offers continuing opportunities to upgrade and expand your customers' systems. End-user flexibility translates into market opportunity for the reseller.

Software that sells

UNIX System V offers

SYSTEM V

another real sales opportunity in the area of customized software.

You'll be able to sell software for a wider range of configurations. You'll have more software to offer, too. Your programmers can concentrate on developing new packages instead of rewriting old ones.

For more information, send in the coupon for a copy of our free booklet, "Why Good Business Decisions are Based on UNIX System V."

UNIX System V. From AT&T. From now on, consider it standard.

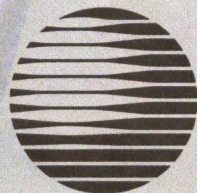

AT&T

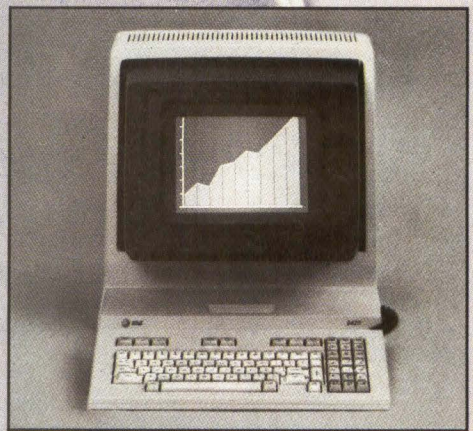

MS0900CA

Please send the free booklet "Why Good Business Decisions are Based on UNIX™ System V."

Mail to: AT&T, P.O. Box 967,
Madison Square Station,
New York, NY 10159

Name _____

Title _____

Company _____

Address _____

City _____ State _____ Zip _____

My business category (check one):

OEM/VAR Software House
 MIS/DP Mgt. General Business Mgt.

Other _____
UNIX System Licensee Yes No Don't know



We've got DEC's[®] number, plus a lot more.

We've really done another number on DEC. We've added in more features and more reliability than their 220 offers, all without adding to the cost. Fact is, our

CIT220+ costs even less than the DEC VT220. Yet, it has all of DEC's features, *plus*: Four additional enhanced menus. Enhancement set-ups for Display, General, Auxiliary Port and Keyboard.

Plus: A bi-directional Auxiliary Port, not just uni-directional like DEC's. So with the CIT220+, you can have the flexibility of adding either a second host or a printer.

Plus: Not just smooth scroll like DEC's, but variable speed smooth scroll for fast or slow review.

Plus: Two more LEDs than you'll find on the DEC keyboard—one for online, the other for shift lock. We give you more usable cable length, too, and a better keyboard elevating mechanism.

Plus: An on/off switch on the front of our monitor (DEC's is on the back), along with an on/off light indicator at eye level for better visibility.

That's the CIT220+, the one with all the pluses. Including a lower price. So now that we've got DEC's number, you'll most likely want ours. It's (714) 660-1421. Or call toll free 1-800-854-5959. In California, call 1-800-432-3687. Or write CIE Terminals, 2505 McCabe Way, Irvine, CA 92714.

CIE TERMINALS
A CITECH ELECTRONICS COMPANY

® DEC is a Registered Trademark of Digital Equipment Corp.
© 1984 CIE Terminals

CIRCLE NO. 11 ON INQUIRY CARD

Breakpoints

IEEE FORMS WORKING GROUPS FOR NUBUS and MULTIBUS II STANDARDS

IEEE will have four committees working on 32-bit bus standards. In addition to IEEE P896 Futurebus and IEEE P1014 VMEbus groups, the Microprocessor Standards Committee of the IEEE is requesting two new "P" numbers in order to establish working groups that will derive 32-bit bus standard specifications from the NuBus and MultiBus II. Both new working groups are scheduled to hold organizational meetings during this month's Midcon trade show in Dallas, Texas. Paul Borrill, chairman of the P896 committee, will serve as interim chairman of the Multibus II working group. George White, Texas Instruments Inc.'s NuBus development manager, will serve as interim chairman of the NuBus standard working group.—R.

Dalrymple

NETWORK SYSTEMS CORP. READIES FIBER OPTIC NETWORK

Networking pioneer Network Systems Corp., Brooklyn Park, Minn., plans to complete its prototype Datapipe fiber-optic network by the end of the year. Datapipe is said to operate at 275M bits per second and is designed to join other networks with fiber optic cable. It will interface with the company's primary network product, Hyperchannel, as well as with other vendors' products, including Ethernet LANs.—M. Stenzler-Centonze

JMI DEVELOPS NSC 32000 CROSS COMPILERS

By the first quarter of 1985, JMI Software Consultants Inc., Spring House, Pa., plans to have C, Pascal and BASIC cross compilers available to move source code from applications developed on several hosts to National Semiconductor Corp.'s NSC 32000 systems. The hosts are Digital Equipment Corp.'s VAX superminicomputers running VMS, IBM Corp.'s Personal Computers running PC-DOS, and IBM's 370 and 4300 mainframes running VM. The C cross compiler comprises both a native code generator for the host system and a code generator for the NSC 32000. The C cross compiler is based on Whitesmiths Ltd. program. Also in the works are native compilers for NSC 32000-based systems.—D. Bright

NEW HP 3000 MINICOMPUTER IS PRICED UNDER \$20,000

Early this month Hewlett-Packard Co. planned to introduce the smallest, lowest-priced member of its HP 3000 minicomputer family. The Series 37 Office Computer, which is priced less than \$20,000, is said to be software-compatible with all other HP 3000s. The user-installable Series 37 is desktop-high and supports seven terminals; with an I/O extension board it can support 28 terminals. The minimum configuration includes 512K bytes of memory, a 55M-byte Winchester disk drive, a 67M-cartridge tape drive, seven terminal ports, a console, the MPE V/E operating system and a database-management system. Availability is scheduled for next month.—D. Bright

DATABASE MANAGEMENT SOFTWARE CAN BE ACTIVATED BY VOICE ON IBM'S PC

A voice-activated database-management system for IBM Corp.'s Personal Computer is being readied by Supersoft Inc., Champaign, Ill. Marketing director Stephen Hagler cannot quote an availability date or price, but he notes that one piece of the system, the voice recognition board from Tecmar Inc., Cleveland, is already available with Supersoft Scratchpad spreadsheet

Breakpoints

software for \$995. The Dax Plus database-management software is already available for the IBM PC without the Tecmar board. Dax Plus was developed by Derwent Data Systems Ltd., Sunderland, England. Hagler says Texas Instruments Inc., Austin, Texas, will offer Dax Plus for use with its Professional computer and with TI's Speech Command voice recognition system.—K. Jones

BRIDGE PREPARES ETHERNET COMMUNICATIONS SERVER

Bridge Communications, Mountain View, Calif., is expected to introduce this month the CS/1-SNA Ethernet communications server. The server will combine protocol conversion to the IBM SNA environment with local network connections and services, enabling ASCII terminals to function as IBM 3278 terminals. Each CS/1-SNA server will handle as many as 24 terminals. The CS/1-SNA is expected to be priced at \$13,000 per unit plus a \$1,000 annual software fee for updates and maintenance.—M. Stenzler-Centonze

PRIMAGES TO INTRODUCE 100 CPS DAISY WHEEL PRINTER

Primages Inc., Bohemia, N.Y., is developing a daisy wheel printer that could run as fast as 100 characters per second (cps). (The top speed of most daisy wheel printers is currently 90 cps.) The new printer, which is slated for introduction at Comdex in November in Las Vegas, will have a very competitive price, according to president Anthony Mauro. The company presently makes the \$1,695 Primage I, which prints 45 cps, and the new printer will use the same open-loop stepper motor that the earlier model uses. Mauro says the special damping method added to the stepper enables quality printing at high speed.—D. Bright

ZAISAN UNVEILS INTEGRATED VOICE / DATA PC-COMPATIBLE WORKSTATION

Zaisan Inc., Houston, Texas, is expected to ship an IBM PC-compatible personal computer with an integrated autodial/answer telephone this month. The ES.3 system has voice and data capability, a 360K-byte floppy disk drive and 128K bytes of RAM. Price is \$2,595. A \$3,295 version has two disk drives and 256K bytes of RAM.—T. Moran

SAGE INTRODUCES MC68000-BASED SUPERMICROCOMPUTER FAMILY

Sage Computer, Reno, Nev., which is changing its name to Stride Micro, is unveiling a family of MC68000-based multiuser supermicrocomputers. The Stride 420, 440 and 460 all contain a Centronics-compatible printer port and a Corvus Omninet LAN interface. The 420 has four serial ports and a 640K-byte floppy disk drive. The 440 has 16 serial ports, one floppy drive and a 10M-byte Winchester drive with 15M-byte and 33M-byte options. The 460 supports as many as 22 serial ports and four Winchester drives. Its total available disk capacity is 448M bytes. Scheduled for availability this month, the basic systems without terminals will be priced at \$2,900 for a 420, \$5,900 for a 440 with a 10M-byte Winchester drive, and \$8,900 for a 460 with a 15M-byte Winchester drive.—T. Moran

TAIWAN COMPANIES ARE DEVELOPING IBM PC LOCAL AREA NETWORKS

One of the first Taiwanese-designed local area networks (LANs) for the IBM PC was recently introduced by R.P.T. Intergroups International Ltd., which

OUR MULTIBUS CONTROLLERS ALREADY SPEAK YOUR LANGUAGE.

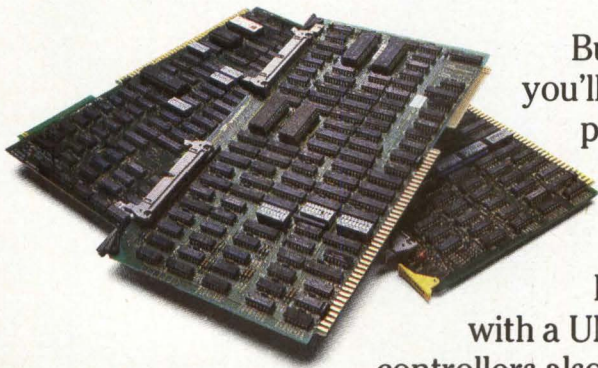

Buy anybody else's multibus* controllers and you'll probably spend a lot of time and money programming them to communicate with your system.

Buy ours and you can start talking right away.

Every Systech multibus controller comes with a UNIX Device Driver.** And because our controllers also contain a self-test program, you can install and check them out without CPU support or software development.

Systech engineers have considerable experience with the Motorola 68000 microprocessor, various hardware technologies and the UNIX operating system. This experience plus our software support ensures easy integration of our controllers into your systems.

We also ensure quality and reliability by subjecting our finished products to extreme variations of temperature and voltage in our environmental test chambers.

And we back our products with extensive technical documentation, a 12-month warranty and the best customer service program in the industry.

Applications of our multibus controllers include printer controllers, tape controllers and multi-channel communication controllers for multibus-based computer systems. For details, please contact Alan Remen, Vice President of Sales, at: Systech, 6465 Nancy Ridge Drive, San Diego, CA 92121; (619) 453-8970.

You'll find that we speak your language, too.

systech

*Multibus is a trademark of Intel Corp. **UNIX is a trademark of Bell Labs. Available to licensed users.

We've Earned The Right To Be #1 By Being First So Often

When it comes to being FIRST with technology-leading products, **Advanced Digital** wears its #1 button with pride. We were **FIRST** to introduce an 8-Bit, single board S-100 computer... We were **FIRST** to introduce a 6MHz, 128KByte single board computer... We were **FIRST** to introduce a 6MHz, 128KByte Slave Processor board. And our record for being FIRST continues with...

- The introduction of SUPER EIGHT – an 8MHz master with Winchester and Floppy disk controller on one board.
- The introduction of SUPER SLAVE II – A dual slave processor that will support two users under TurboDOS.
- The introduction of our new SUPER 186 – the **FIRST** 16-Bit, single board S-100 computer that performs at twice the speed of older technologies. Loaded with features such as on-board floppy disk controller and up to 1MByte of RAM, the SUPER 186 is designed to function as a bus Slave or Master. Advanced Digital's SUPER 186 permits you to take advantage of vast libraries of sophisticated applications software.

Advanced Digital boards are IEEE 696 compatible, run under a variety of operating systems such as CP/M 2.2,* CP/M 3.0, Concurrent CP/M, MP/M,* OASIS,* and TurboDOS*

(Top row L to R: Super Slave 128, HDC-1001, Super Slave 64, Bottom row L to R: Super Quad, Super 186, Super Six)

and are available with CPU speeds of 4, 6, or 8MHz. On-board memory capacities range from 64KBytes to 1 MByte.

When it comes to selecting your S-100 boards, go with Advanced Digital – The Company that earned the right to be #1.

See your local computer dealer or contact Advanced Digital today... We'll help you become #1.

 **ADVANCED
DIGITAL
CORPORATION**

Leading the Microcomputer Technology

Advanced Digital

5432 Production Drive, Huntington Beach, CA 92649
Tel. (714) 891-4004 • Telex 183210 ADVANCED HTBH

In Europe:

Advanced Digital U.K. Ltd.

27 Princess St., Hanover Square
London W1R8NQ • United Kingdom
409-0077 • 409-3351 Telex 265840 FINEST

CIRCLE NO. 13 ON INQUIRY CARD

See us at Booth #4745 Comdex, Nov. 14-18, 1984

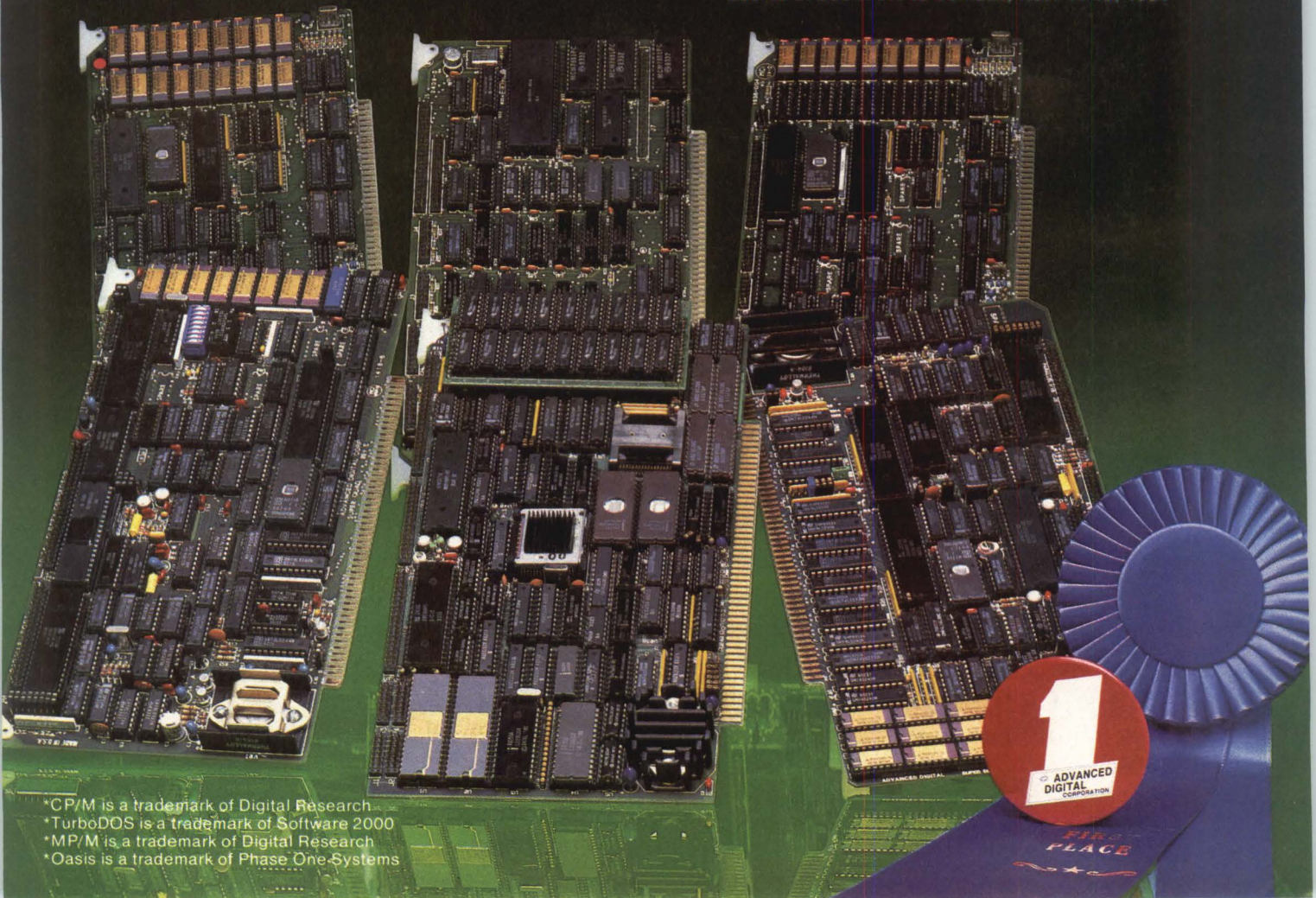

*CP/M is a trademark of Digital Research.
*TurboDOS is a trademark of Software 2000
*MP/M is a trademark of Digital Research
*Oasis is a trademark of Phase One Systems

Breakpoints

also represents National Advanced Systems and Wang Laboratories Inc. in Taiwan. Known as Trans-Net, the LAN supports 64 IBM PC or compatible systems when in operation, says Ken Kao, the managing director of R.P.T.'s computer department. Other specifications include hard-disk sharing, CSMA/CD protocol, printer-spooling files, distributed bus topology and a data rate of one megabit per second. Trans-Net can operate under PC-DOS and MS-DOS, and requires a minimum of 128K bytes of RAM per connected system. The LAN uses RS422 twisted-pair wires. R.P.T. is negotiating with prospective distributors in the United States and Europe, Kao says. The suggested retail price for Trans-Net is \$495 per node. IBM PC LANs from seven other Taiwanese firms are expected to be available by early next year. The seven firms, which include AOC International, Mitac Inc., Multitech Industrial Corp., Shinlee Corp. and Tatung Co., are now jointly developing the LAN in cooperation with Taiwan's government-supported Electronics Research and Service Organization.—C. Hintermeister

IBM SHOWS ARTIFICIAL INTELLIGENCE PRODUCTS

Signalling its determination to be as major a player in artificial intelligence (AI) as in all other areas of computer technology, IBM Corp. recently unveiled several AI research projects and a new product at the National Conference on Artificial Intelligence, Austin, Texas. The product, LISP/VM, a version of the widely-used AI language, is designed for time-sharing users of System/370 computers. IBM also exhibited Paris Scientific Center (PSC) Prolog for the same machines. An experimental shell system, PRISM, incorporates a set of procedures that can be used to construct a variety of expert systems that mirror the way experts solve problems. An experimental PC-based program, HANDY, permits the design of highly interactive AI user interfaces that include windows, color animation, graphics and speech synthesis.—J. Victor

SORCIM ORCHESTRATES MOVE AGAINST SYMPHONY

Sorcim/IUS Corp., San Jose, Calif., is expected to introduce this month an integrated software product positioned against Lotus Development Corp.'s Symphony. The Symphony software package combines word-processing, communications, database-management, spreadsheet and graphics functions with a window management system.—M. Stenzler-Centonze

STARTUP SELLS CUSTOM IBM PC CONFIGURATIONS TO OEMS

OEMTEK Inc., San Jose, Calif., hopes to grab a share of the IBM PC-compatible market by selling only to OEMs. The new company, which provides custom configurations, manufactures a range of modular PC products from keyboards and monitors to XT workstations and distributed database file servers supporting as many as 100 users. The workstations use the Intel Corp. 8088 chip; the file servers use the 8086 and 80826 chips. The offerings include low-profile modules, standard-sized modules, and both IBM-identical keyboards and enhanced keyboards.—D. Bright

Breakpoints

TECH FILES: A QUICK LOOK AT INDUSTRY DEVELOPMENTS

PRINTER FILES: Concept Technologies Inc., Portland, Ore., is preparing to unveil this month a \$7,995 laser printer based on Canon U.S.A. Inc.'s print engine. The new printer is designed to work with the company's Concept 100 publishing system that integrates word processing with graphics capability. The printer runs at 8 pages per minute and has 300-dot-by-300-dot-per-inch resolution. It uses plain paper or transparencies, has bit-mapped memory and is compatible with Tektronix Inc. 4014 and Diablo Systems Inc. 630 products. A manual switch allows up to four users.—C. Warren

Dataproducts Corp., Woodland Hills, Calif., plans to introduce its first non-impact printer next month—a table-top, 24 page-per-minute laser printer with 300-dot-by-300-dot-per-inch resolution. The printer is based on a Toshiba Corp. print engine, to which Dataproducts has exclusive rights. Dataproducts-built controllers are optional. The printer's OEM price ranges from \$7,000 to \$12,000.—D. Bright

Taking a different approach to multi-color dot-matrix printing is **CAL-ABCO**, Woodland Hills, Calif., with an as-yet-unnamed 180 character-per-second, 132-column dot-matrix printer. The price is expected to be less than \$1,200. To be introduced as early as December, the printer uses a proprietary ink-pad system with eight color pads. The printer can thus print multiple colors without either multiple passes or shifting ribbon zones. Moreover, the printer, which is being shown to selected OEMs, is able to print IBM PC color graphics without reducing speed.—C. Warren

MICRO FILES: Digital Equipment Corp., Maynard, Mass., is expected to introduce this month the PRO 380, an upgrade of the company's PRO 350 microcomputer. The PRO 380 will use a faster, higher performance PDP-11-type microprocessor.—T. Moran

SOFTWARE FILES: Lantech Inc., Dallas, Tex., is offering its uNETix UNIX-like operating system for the IBM PC and compatibles as a \$399 developers' tool kit. The kit includes a choice of either the VI full-screen Berkeley editor, or the Rand Institute editor, which is an enhanced version of the VI. In addition, the package comes with the standard ED line editor, the VTTY terminal emulator and a window manager. The kit's integration facility allows movement of source code segments from larger machines to the IBM PC and back again. Lattice C, available for \$200, produces either PC-DOS- or uNETix-compatible code.—C. Warren

Microsoft Corp., Bellevue, Wash., which has made a major commitment to support Apple Computer Inc.'s Macintosh microcomputer, is readying Microsoft Word for the Macintosh. November availability is planned. The word processing program joins MultiPlan, MultiBasic and Microsoft Chart, which are already available.—M. Stenzler-Centonze

LINE PRINTER COMPARISON CHART

STANDARD FEATURES	CIE TERMINALS CI-300	CIE TERMINALS CI-600	DATAPRODUCTS B-300/600	PRINTRONIX P-300/600
LOWEST PRICE	X	X		
L Q PRINTING	X	X	X	
COMPRESSED PRINT	X	X		
GRAPHICS RESOLUTION				
60 x 72	X	X		X
120 x 72	X	X		X
200 x 144	X	X		
200 x 288		X		
BOLDFACE PRINTING	X	X		
SLANTED PRINTING	X	X		
CHAR. ENLARGEMENT	X	X		
INT'L CHARACTERS	X	X		

This printout proves we out-print the competition.

The chart above tells a telling story about our CI-300 and CI-600 Matrix Line Printers. Feature for feature, they out-print Dataproducts® and Printronix®—and at a lower cost. Our printers can accommodate many types of applications and computer systems. They provide both multimode

printing and graphics plotting. Graphics resolution on the CI-300 and CI-600 printers is the highest available on a line printer in their speed class, with excellent graphics quality for business, scientific and

barcode applications. Barcode applications are easily developed with optional graphics card.

Interfacing is not a problem either. RS232-C Serial, Centronics® and Dataproducts Parallel, and IBM-compatible interfaces accommodate most types of computer systems.

The printers' sturdy design and small number of moving parts make them extremely dependable, and easy to maintain as well.

The CI-300 and CI-600 are the Matrix Line Printers with the versatility built in. And they're available immediately. To find out more, just write or call CIE Terminals, 2505 McCabe Way, Irvine, CA 92714. (714) 660-1421.

Call toll-free 1-800-854-5959.

In California, call toll-free 1-800-432-3687.

CIE TERMINALS
A CITECH ELECTRONICS COMPANY



®Dataproducts is a registered trademark of Dataproducts Corp.
Printronix is a registered trademark of Printronix Corp.
Centronics is a registered trademark of Centronix Data Computer Corp.
©1984 CIE Terminals.

CIRCLE NO. 14 ON INQUIRY CARD



“We sell IBC computers because it’s the best way to attain a low cost, high performance multi-user system.”

Roger Scaggs
President, APS Systems, Inc.
Dallas, Texas

“APS is the nation’s leading supplier of medical office management systems, serving over 1,000 practices in 30 states.

Most of our customers require more than a single-user desk top system. They need a good, fast multi-user computer without a minicomputer price tag.

We looked at many of the so-called low-cost “Supermicros” running UNIX™ but decided to continue selling **IBC-OASIS™** computers. UNIX requires a lot of horsepower to run well, and the low cost UNIX systems did not have the performance to do our customers job to our satisfaction.

APS sells high performance systems based on the OASIS multi-user operating system. OASIS provides all the features that you find on a good minicomputer multi-user operating system. OASIS is user friendly and performs very well on low cost multi-user systems.

At APS, we have selected **IBC** for our customers, because they provide a computer that allows us to efficiently run up to 16 users with our OASIS software.

Do you want a multi-user system which has hundreds of applications already available? Do you want to sell user friendly, low cost, multi-user computers that outperform the low end UNIX systems? Then I suggest you contact **IBC** immediately.”

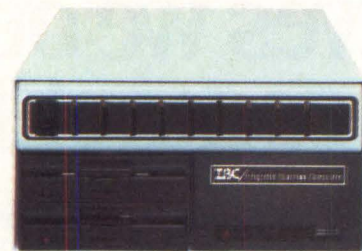

IBC/Integrated Business Computers is the leader in multi-user technology. To find out more about the company, its products and support, please call or write:

OUTSIDE THE USA

IBC/Integrated Business Computers

21621 Nordhoff Street
Chatsworth, CA 91311
(818) 882-9007 Telex No: 215349

WITHIN THE USA

IBC/ DISTRIBUTION

1140 36th Street, Suite 212
Ogden, Utah 84403
(801) 621-2294

UNIX is a trademark of Bell Laboratories
OASIS is a trademark of Phase One Systems

Circle 191 for END USERS

Circle 192 for DEALERS

Breakpoints

Oracle Corp., Menlo Park, Calif., scheduled a late August introduction of its Oracle relational database management system for the IBM Corp. PC-XT, Texas Instruments Inc. Professional, and Digital Equipment Corp. Rainbow computers. The first microcomputer version of Oracle, including Oracle Link software for transferring data files between microcomputers and mainframes, will be priced at about \$1,000 (minimum six orders) for each computer's version.—T. Moran

On-Line Software International Inc. and **ITT Corp.** have announced a licensing agreement under which ITT's European affiliates now have exclusive rights to market On-Line's IBM-compatible micro-and-mainframe software in Europe.—M. Stenzler-Centonze

The \$149.95 Grafix Partner from **Brightbill Roberts & Co. Ltd.**, Syracuse, N.Y., for the IBM PC and compatibles, is designed to work with such popular software packages as Lotus Development Corp.'s 1-2-3 and Ashton-Tate's Framework without requiring extra memory. Grafix Partner allows any graphics function to be enhanced with color and special fonts. It also works with any input device such as joysticks, bit pads or light pens. The package can also drive any dot-matrix printer, according to the company. The Grafix Partner function is called by simultaneously depressing three keys. Deliveries are expected this month.—C. Warren

COMMUNICATIONS FILES: **Linkware Corp.**, Waltham, Mass., this month plans to add VAX/VMS and IBM/MVS support to its Linkware: Information Server software. The "virtual server" currently connects IBM PCs and other personal computers to the VM operating system on IBM mainframes. It features selective file access, security, auditing and DIF transformations. The company, which is backed by Ungermann-Bass Inc., a local area network leader, is readying an Apple Macintosh version for first-quarter availability. Price for microcomputer modules is \$350 and less, depending on quantity. For host machines the price is \$15,000.—D. Bright

RANDOM DISK FILES: Using both the Enhanced Small Disk Interface (ESDI) capability for tape drives and the Small Computer System Interface (SCSI) to provide host computer independence, the newest family of controllers from **Electronic Processors Inc.**, Englewood, Colo., gives system integrators a range of tape and disk subsystems. The EPI-3, expected to be about \$650 in volume quantities, is a ½-inch tape-only controller that supports streaming with a 128K-byte buffer. For mid-range applications, the 1450 EPI-2 is a combination controller that can support four 5¼-inch Winchester drives, four ½-inch tape drives, four ¼-inch tape drives, or any combination thereof. The EPI-1 low-end tape controller for personal computers is in the \$250 range. Prototypes of EPI-2 and EPI-3 are available now. Production is scheduled for November.—C. Warren

NOTES FROM OVERSEAS: Britain's largest computer maker, **ICL Plc.**, reportedly became the target of a serious takeover bid early last month by fellow British giant, Standard Telephone and Cable (STC). STC's initial offer was a stock exchange deal worth about \$450 million, and that may be increased. The surprise

Breakpoints

merger move immediately received the apparent blessing of ITT Corp., STC's one-time sole owner, and now 35-percent shareholder. ITT already is said to be interested in taking a 29.9 percent share of the merged companies, should the deal come to fruition.—M. O'Gara

The export value of floppy disk drives shipped from Taiwan this year is running at least six times ahead of the 1983 pace. Floppy disk drives have become a favored peripheral product for medium- and small-scale companies, who want to establish a good reputation with OEM suppliers as a step toward later offering one-board computers and other products. Mitac Inc. and other companies are expanding their production capacity, as are some of the bigger manufacturers, like the Tatung Co. and the Teco Electric and Machinery Co.—I. Kakehashi

Not to be outdone by the lustrous IBM-CES-Merrill Lynch videotext alliance, **AT&T** has lined up British videotext pioneer Aregon International to co-develop and co-market its videotext product. The new 10-year pact calls for AT&T to supply its Sceptre terminals and Aregon to supply an Americanized version of its IVS-3 software. AT&T International gets the exclusive rights to sell it abroad under a royalty arrangement with Aregon worth about \$3 million. The new software, called IVS-5, supports eight to 500 users and incorporates messaging facilities. The videotext system will use Digital Equipment Corp. VAX-11/750, /780, /785, or MicroVAX minicomputers as front-end processors.—M. O'Gara

IBM U.K. has finally nailed down a long-rumored alliance with Britain's public telephone authority, British Telecom, that is considered by rivals as dangerous. Competitors also view the coupling as crucial to Big Blue's strategy for dominance of Britain's telecommunications market. The pair plan to establish a joint venture, run by an IBM-appointed chief executive, to provide a national data network management service based on IBM's Systems Network Architecture (SNA). A particular sore point among competitors is the possibility of IBM's proprietary SNA becoming a standard. The British government already has pledged to promote a network standard from the International Standards Organization.—M. O'Gara

Signs are the 8-inch floppy is on its way to becoming passé. The **Japan Electronic Industry Development Association** (JEIDA) has found that a half-million 8-inch drives were shipped by Japanese makers in the fiscal year that ended in March, while 1 million 5¼-inch drives and 50,000 of the newer 3-inch, 3¼-inch and 3½-inch drives were shipped in the same period. Demand for 8-inch drives probably will reach a peak of 600,000 in the fiscal year 1985, being surpassed then by 5¼-inch models, which will then settle into a steady 20 percent annual growth by fiscal year 1988. That means that 2 million 5¼-inch drives would be shipped in the next fiscal year, and 2.5 million in the fiscal year 1988. At the same time, 3-inch and 3½-inch drives will grow to 1.1 million units in fiscal year 1985 and 3 million by 1988.—I. Kakehashi

HERE TODAY HERE TOMORROW

Reliability.

The essential ingredient that OEMs and systems integrators need for today and tomorrow. Without it, you can't generate business.

Which is why CompuPro's System 816™ answers your needs.

Survival of the Fittest.

This micro is The Essential Computer. It not only outperforms the competition, but also operates in extreme environments for virtually an unlimited number of applications.

Just one look at our specs and you know the System 816 will be around for a long, long time. And because the System 816 is structured on the IEEE 696/S-100 bus you can select the appropriate components, independently, in any combination. Even use boards for graphics and other unique applications.

One of the Strongest Warranties.

And since only the strong survive, we housed

the System 816 in a rugged metal enclosure . . . and backed it with one of the industry's longest warranty coverages: From 12 to 24 months.

To find out more about how the System 816 outlasts and outperforms anybody else, call (415) 786-0909 and ask for an OEM/systems integrator application package and our 1984 catalog.

You'll find CompuPro will be just as essential tomorrow as we are today.

CompuPro®

A GODBOUT COMPANY

3506 Breakwater Court, Hayward, CA 94545

System 816 and The Essential Computer are trademarks of CompuPro. System 816 front panel design shown is available from Full Service CompuPro System Centers only. ©1984 CompuPro

CIRCLE NO. 15 ON INQUIRY CARD

The Essential Computer™



CITIZENS
FOR WORKING
WITHIN
THE SYSTEM.

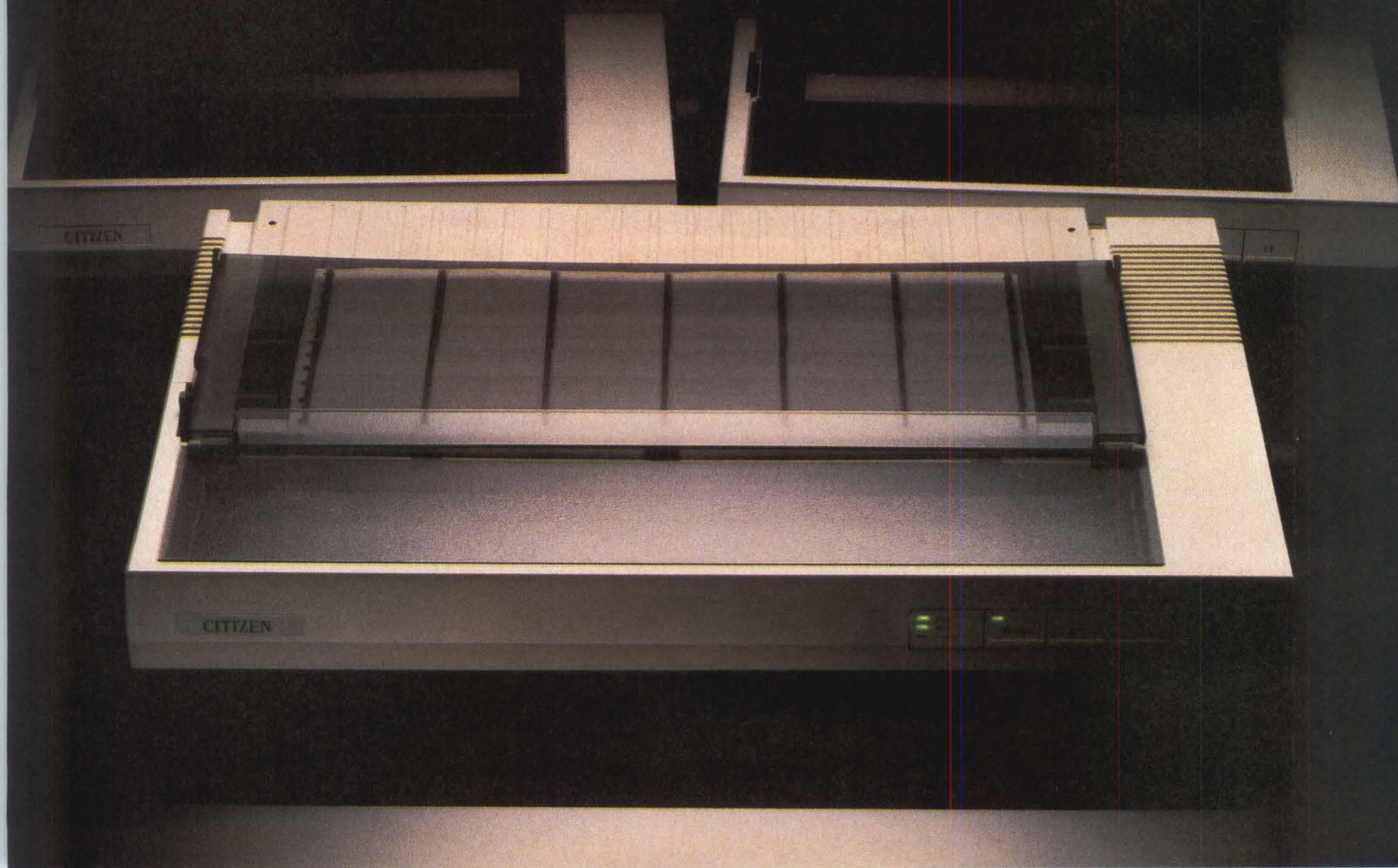

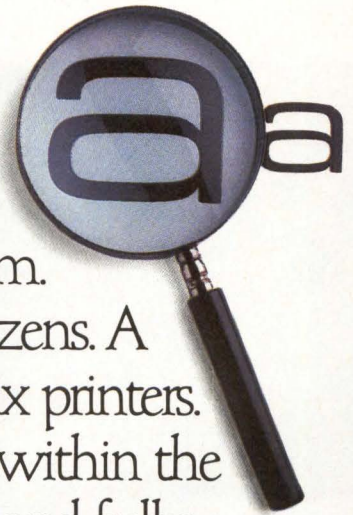
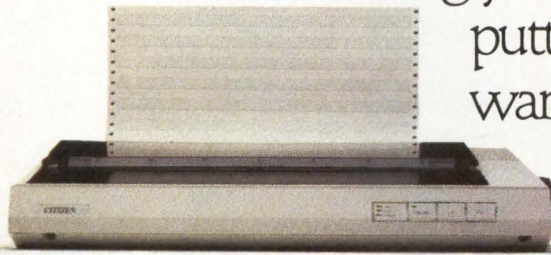

The last thing you need when you're putting together a hardware package is a printer that bucks the system.

Introducing the Citizens. A whole new line of economical dot matrix printers.

Citizens know how to work within the system. They're rugged, reliable, and fully IBM[®]- or Epson[®]-compatible. They deliver output speeds of 160 cps, or 40 cps correspondence-quality. Quietly and accurately. Just what you'd expect from a company famous for precision-engineered watches. Plus, our unique push-feed paper loading system makes loading easy. And customers happy.



Citizen[™] printers. Because every system works better when there's at least one responsible Citizen.

For more information, call 1-800-556-1234, Ext. 34. In California, 1-800-441-2345, Ext. 34.

Or write Citizen America Corporation, 2501 Colorado Avenue, Santa Monica, CA 90404.



© 1984 Citizen America Corporation. Citizen is a trademark of Citizen America Corporation. IBM is a registered trademark of International Business Machines Corporation. Epson is a registered trademark of Epson America, Inc.

THOMAS EDISON DIDN'T
HE JUST MA

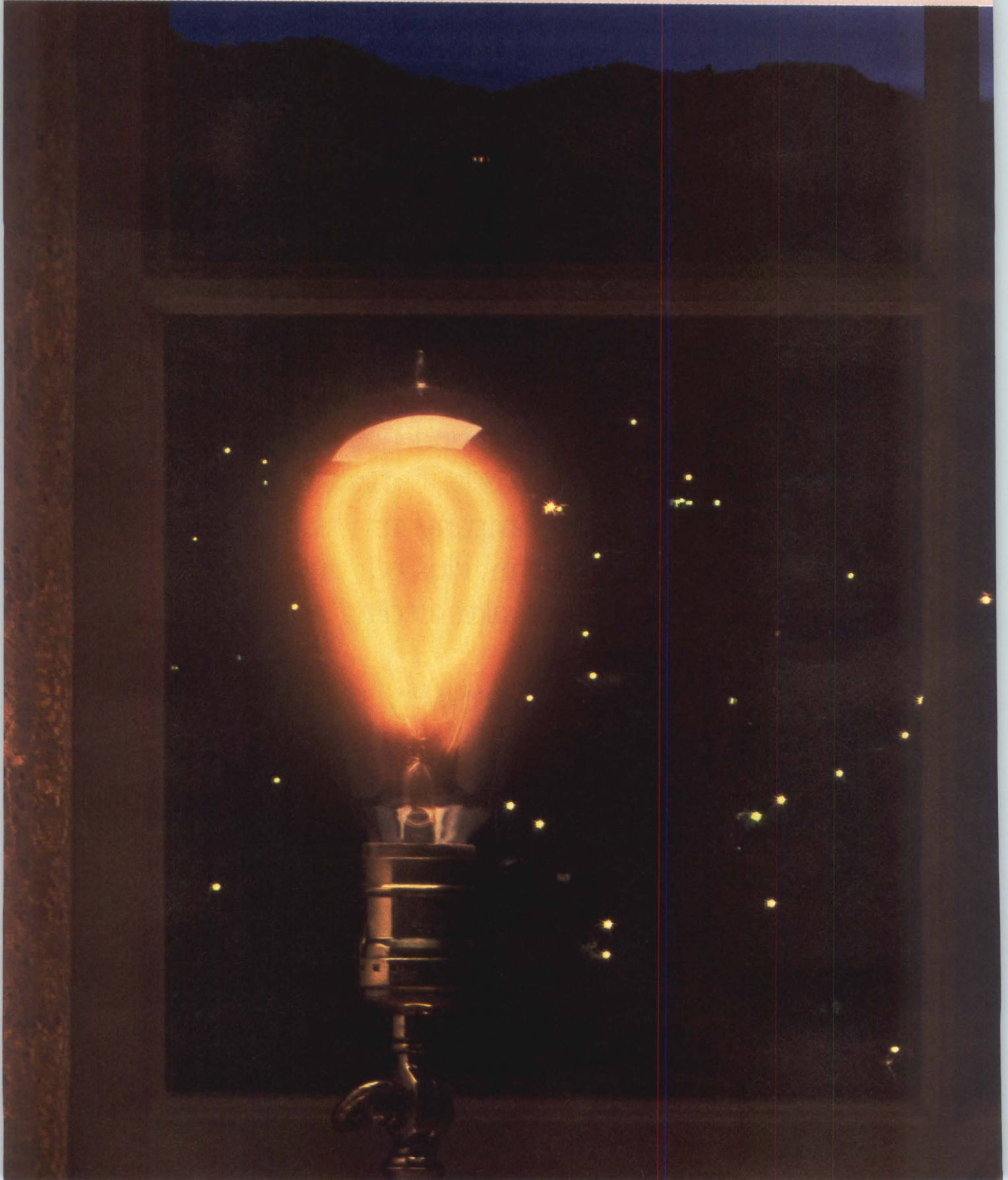

INVENT THE LIGHT BULB. DE IT WORK.

Fifty years before Edison, people were taking the air out of glass tubes, sending in current and hoping the filament would glow.

But in 1879, Edison attacked the bigger problem of how to distribute the electricity. So that by developing the power grid first, he was able to determine the precise combination of carbon rod, vacuum, voltage and current that his lamp would demand.

At Priam, we build our disc drives with a similar focus—on your system's requirements, and on your production schedule. It's a commitment that has made us the leading U.S. manufacturer of high-performance, high-quality 8" voice-coil Winchesters—from 35 to 500MB. A commitment we're now making to our new 86MB 5¼" drives as well. It's why we provide total, industry-standard interface support, including ST412, ANSI, SMD, SCSI, IPI-3, and our own Priam interfaces. And it's why we've just opened a new, automated production facility, one of the largest and most modern in the OEM world.

Priam. For high-performance disc drives, check with us first. We'll make sure it works.



JUST THE RIGHT DISTANCE FROM
THE LEADING EDGE.

20 West Montague Expwy., San Jose, CA 95134 (408) 946-4600
Boston (617) 444-3973; U.K. (44) 734-884-788

SPECIAL OFFER!

TWO FREE

StorageMaster™

flexible diskettes with every box of ten.

Buy the specially-marked boxes of Control Data's new StorageMaster brand 5¼-in. double sided, double density diskettes and get 2 extra floppies free during our special limited time offer. That's 12 disks—20% more—in every box, while supplies last.

So plan to stock-up now on StorageMaster brand diskettes. Ask for them at your local computer store or call your local authorized Control Data Business Products distributor.

1244-00
CONTROL DATA
DOUBLE SIDE
SINGLE/DOUBLE DENSITY
SOFT SECTOR
35 / 40 TRACK

1244-00
CONTROL DATA
DOUBLE SIDE
SINGLE/DOUBLE DENSITY
SOFT SECTOR
35 / 40 TRACK

1244-00
CONTROL DATA
DOUBLE SIDE
SINGLE/DOUBLE DENSITY
SOFT SECTOR
35 / 40 TRACK

1244-00
CONTROL DATA
DOUBLE SIDE
SINGLE/DOUBLE DENSITY
SOFT SECTOR
35 / 40 TRACK

1244-00
CONTROL DATA
DOUBLE SIDE
SINGLE/DOUBLE DENSITY
SOFT SECTOR
35 / 40 TRACK

1244-00
CONTROL DATA
DOUBLE SIDE
SINGLE/DOUBLE DENSITY
SOFT SECTOR
35 / 40 TRACK

1244-00
CONTROL DATA
DOUBLE SIDE
SINGLE/DOUBLE DENSITY
SOFT SECTOR

1244-00
CONTROL DATA
DOUBLE SIDE
SINGLE/DOUBLE DENSITY
SOFT SECTOR
35 / 40 TRACK

1244-00
CONTROL DATA
DOUBLE SIDE
SINGLE/DOUBLE DENSITY
SOFT SECTOR
35 / 40 TRACK

CONTROL DATA
StorageMaster
Media
Premium Series
5.25-inch Flexible Disks

CONTROL DATA
StorageMaster
Media
Premium Series
5.25-inch Flexible Disks

StorageMaster™

CONTROL DATA

Premium Series
5.25-inch Flexible Disks

100% Certified
5-Year Warranty

Get 12
Control Data
Flexible Disks
20% More In This Box.

2 FREE DISKS

Give him a call...or call toll-free and we'll help you find the nearest source.
1-800/328-6207 (In Minnesota call 1-612/835-8065).

CONTROL DATA

Mini-Micro World

NEWS

Wyse unveils 64-color alphanumeric terminal

Tom Moran, Associate Editor

Wyse Technology, San Jose, Calif., is unveiling the WY-350, a 64-color, 80- or 132-column alphanumeric terminal with a retail price of \$1,295. Its price equals that of the eight-color WY-300, which the WY-350 is expected to supersede.

The WY-350 has a 15-inch, tilt-and-swivel screen that displays either 80 or 132 columns by 24 lines plus a status line and function-key labeling line. The 128 ASCII characters are displayed in a 7- by 13-dot matrix in a 10- by 13-dot cell. Although 64 colors are available, black must be either the foreground or background color for each individual character. The 16 pre-defined, color-scheme palettes can be interchanged by the user at any time except during setup. All terminal parameters are configured using soft-screen setup. The user can also create additional color schemes while in setup mode.

The detached keyboard of the WY-350 can be tilted either at the DIN-standard angle or at the same angle as an IBM Selectric typewriter. The keyboard includes 101 keys, including a numeric keypad and 16 function keys that can be shifted to provide 32 functions.

Two asynchronous RS232C serial ports, a modem port capable of up to 38.4K bits-per-second (bps) transmission speeds, and a 19.2K bps printer port are included. The WY-350 offers block and conversational modes in either half- or full-duplex, and is compatible with the WY-50, Lear Siegler ADM-31, ADDS Viewpoint, Hazeltine 1500, and TVI 910, 920, and 925. The terminal weighs 25 pounds and the display console measures 13½ inches high by 14 inches wide by 15

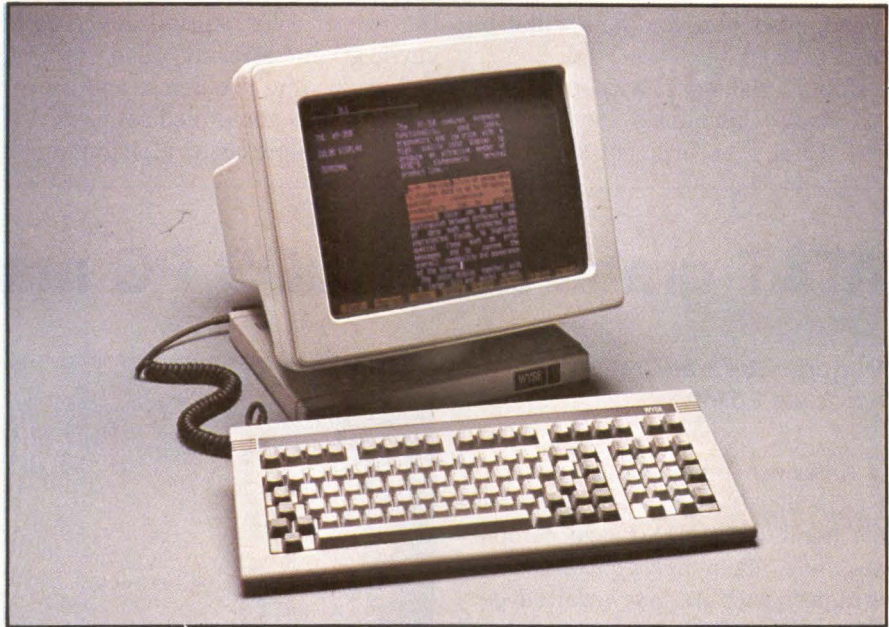

Wyse Technology's WY-350 64-color alphanumeric terminal has a 15-inch screen that displays 80 or 132 columns of text. The \$1,295 terminal will initially be aimed at applications in which highlighting of information is critical.

inches deep. Wyse predicts the WY-350 will be available in production volumes in November or December.

Some industry observers predict that color alphanumeric terminals will become standard. Others doubt there is great demand for color outside of graphics applications. "Some people will [demand] a color terminal, and others will think that it is not worth [the price]," says Lionel Martin, Wyse's director of marketing for terminals. "We feel, provided that the price premium is not outrageous, that people would rather have [displays] in color."

Sufficient software is lacking

Alphanumeric terminals currently lack enough application software to really exploit their capabilities. According to Martin, "It is a chicken-and-egg situation. As [the industry] produces fairly inexpensive color alphanumeric displays, more

and more people will write their applications taking color into account. Once that happens, a lot of possibilities [will] open." Martin adds that Wyse already is talking to software developers about packages that might use a color display.

Other manufacturers currently making color alphanumeric terminals include Applied Digital Data Systems Inc. (ADDS), Hauppauge, N.Y.; Esprit Systems Inc.'s Hazeltine Terminals Division, Melville, N.Y.; Intecolor Corp., Norcross, Ga.; and IBM Corp.

George Chao, president of Liberty Electronics, USA, San Francisco, Calif., agrees with Martin that software support is essential to color alphanumeric, and adds that the cost premium over monochrome will also play a part. "For ASCII color terminals over \$900 there could be a problem. The cost-premium issue also applies to hard copy." Chao points out that present color,

Mini-Micro World

NEWS

alphanumeric software is limited to mapping different video attributes to default to different colors. "Eventually, color will be a standard. The question is when, and how will it be implemented."

Robert Sanekoff, vice president for display terminals for the San Jose, Calif., research concern Data-

quest Inc., is not as convinced of the ultimate success of color alphanumeric terminals. "There are certain applications that lend themselves to the use of color, specifically credit verification, aircraft, and other, weight-loading problems, and there are probably some medical uses. In the general-purpose, alphanumeric

world, color will have a limited market because there is limited applications software and limited total systems support in the way of low-cost, color printers and plotters." Sanekoff does not expect color terminals to exceed 20 percent penetration of the alphanumeric terminal market in the next five years. □

AT&T grabs at MS-DOS PC market share

Marjorie Stenzler-Centonze
Associate Editor

American Telephone & Telegraph Co., which recently announced its 3B family of UNIX-based computers, has taken a step toward the ordinary with its long-awaited personal computer introduction: an IBM PC-compatible model.

AT&T is making available through major computer retail chains its Personal Computer 6300, an IBM look-alike based on the MS-DOS operating system. At \$2,750 without the MS-DOS and \$2,810 with it, PC 6300 runs about 5 percent below the cost of the IBM PC. In addition, the company announced a local area network, (LAN) called Information Systems Network, designed to link AT&T PCs to more powerful computers. It is scheduled to be available in January, which would beat IBM to market with a similar network by about two years.

A typical configuration of the PC 6300 features, along with the MS-DOS, an Intel 8086 processor (faster than the IBM PC's 8088), 128K bytes of RAM, dual 5¼-inch floppy disk drives, a monochrome monitor, parallel and serial I/O ports, color graphics interface, higher-resolution graphics, and seven expansion slots. A 10M-byte



Charles Marshall, chairman of AT&T Information Systems, says AT&T wants to be the broadest and best supplier of personal computers in the market.

hard disk drive version with 256K bytes of RAM sells for \$4,985.

The PC 6300 is being manufactured for AT&T by Olivetti SpA, in which AT&T has a 25 percent interest. Olivetti is handling European sales.

Not 'just another clone'

But most industry analysts say there's not much difference between the products. "The AT&T PC is just another dreary clone of the IBM PC," Kenneth G. Bosomworth, president of the consulting company International Resource Development Inc. (IRD), Norwalk, Conn., says. "As far as the user, IBM or even Apple Computer Inc. [are concerned], there [will be] little impact

AT&T goes after independent software vendors . . .

In an effort to stimulate software development for its UNIX System V-based 3B computer family, AT&T is initiating an independent software vendor support program.

The program features separate but similar efforts by AT&T Technologies Inc. and AT&T Information Systems to support software development through formal training sessions and a 25-percent discount on computer systems. AT&T is offering a variety of software publishing options and refer-

ence catalog publishing.

Jack Scanlon, vice president of AT&T Technologies' Computer Systems Division, says UNIX represents an opportunity for independent software vendors to become hardware-independent. "UNIX allows [them] to write to an operating system rather than to a specific box," Scanlon remarks.

Scanlon claims vendor interest in AT&T's programs is strong, and expects the number of UNIX System V

felt from the AT&T announcement. The real impact will be felt by other clone makers like Compaq Computer Corp. and Columbia Data Systems Inc.," because AT&T is such a large company.

Some industry observers speculated during the last few months that AT&T's PC would be based on the UNIX operating system. Frank Vigilante, division president for product management and development at AT&T, explains his company's choice. "We decided on an

MS-DOS box because of the enormous software available that is just not available on UNIX," he says.

Users of the PC 6300 can take advantage of a vast assortment of available software running on MS-DOS. And, by using AT&T's PC Interface for the 3B computers, users can gain access to the UNIX operating system as well, Vigilante points out. The PC Interface links AT&T's 3B2 microcomputers to personal computers, enabling users to move files between UNIX-based

machines and MS-DOS-based machines. The only connection supported now is in an Ethernet LAN. In the Ethernet, the PC Interface requires AT&T's 3BNET network interface in a 3B2 computer and 3Com Corp.'s Ethernet interface board in the PC 6300. RS232 connections should be available late next year.

MS-DOS: The smart choice

Jean Yates, president of Yates Ventures, a Los Altos, Calif. market research company, says AT&T made a wise decision to go with MS-DOS. "If AT&T had announced a UNIX-based system they would have very little applications software for the single-user PC market," Yates says. There will be MS-DOS systems wherever AT&T goes to sell into large accounts, she adds. "They [the accounts] may as well have the machines be AT&T, MS-DOS-based systems with links, interfaces and networks...rather than have all of them be IBM systems," hooking into IBM mainframes, she says.

Yates says a UNIX-based, single-user, single-tasking system doesn't make sense when MS-DOS is the standard. What makes better sense, she says, is a UNIX-based Western Electric WE32000-based or Motorola MC68000-based workstation that operates in either a single-user or network configuration with multi-tasking and multiple windows, and has a telephone. "That's what I expect [will be] the system that's under development for AT&T by Convergent Technologies," Yates says, adding that it would cost more than the PC.

AT&T signed an OEM agreement earlier this year with Convergent, Santa Clara, Calif., under which Convergent will design and manufacture a proprietary line of products for AT&T.

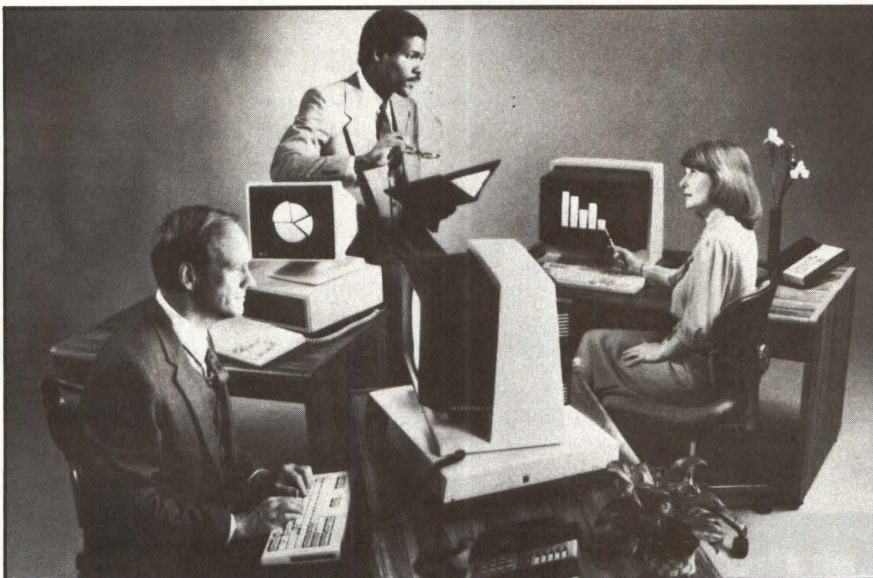

The Personal Computer 6300 operates with AT&T's 3B UNIX-based computer family through the company's PC Interface.

... but is it slowing things down?

packages to triple by the end of this year from the 300 packages available in 1983. Conferences are being held throughout the country to accelerate interest in the software development program, he says.

While the industry awaits System V software, some people question the practicality of AT&T's separate efforts. AT&T Information Systems, which sells to end users, and AT&T Technologies, which sells to value-added resellers and OEMs, are required to

maintain separate marketing programs under terms of the AT&T divestiture.

Jean Yates, president of Yates Ventures, a Los Altos, Calif. research company, says these requirements are slowing things down. "Vendors are dealing with two parts of AT&T, contracting with them for two sets of requirements, two pricing schedules and two distribution schedules and the efforts are not necessarily meshing."

Meanwhile, the AT&T network is drawing a good deal of attention from potential users and competitive vendors. "The network is interesting because it is so similar to IBM's concept," IRD's Bosomworth states. IBM recently announced a LAN to be based on token ring architecture. The network, however, is planned for two to three years from now. "For once, AT&T has been able to implement something faster than IBM can."

While the network differs on the architectural level from the one proposed by IBM, users will notice many similarities, Bosomworth explains. The AT&T network and the proposed IBM version are similar in physical configuration and both require twisted pair cables, making them simpler and less expensive to install in existing buildings. "What the user ends up seeing in both AT&T and IBM networks is a back-plane configuration in which all of the printed circuit card interfaces are in a central equipment cabinet," Bosomworth says.

The way data is handled internally within those two printed circuit card interfaces is different, he points out. "In IBM's case, a chip is used to implement the token-passing network. In the case of AT&T, there's an existing printed circuit card that is a discrete component device that is used to implement the network. It is not a token-passing network."

One of the major problems, according to Bosomworth, is still insufficient support for the creation of a network. "Users still see a lack of large-scale filing systems they can hook into and a lack of mainframe software to respond to a local network situation," he says. "You can tie a mainframe into a local network with no trouble at all, but to actually make it do something useful is a whole different story." □

Software vendor taps riches of 1-2-3

Carl Warren, Western Editor

Because some application programs are rich in features, they have become ideal environments for development of other applications. DSS Development Inc., Bloomfield, Conn., took advantage of Lotus Development Corp.'s popular 1-2-3 integrated package and created 52 OptionWare business applications based on it.

"We have done more than make templates. We have defined sets of macro [commands] within the constraints of 1-2-3 that allow us to manipulate data and set user boundaries," says DSS President Ian A.R. Boyd. "Templates are simply guidelines to perform a task. We provide a full interactive environment for the user."

DSS may be the only application provider taking such a thorough tack. Most others are building sets

of pre-defined templates without extending the focus or using the full power of the 1-2-3 environment. Louis Barnett, president of consulting company Metalogic Corp., Rancho Palos Verdes, Calif., likens the DSS approach to building applications in a high-level language. "In reality it doesn't make much difference what the language or environment is. It is more important to maximize [a product's] use, whether it's BASIC, a data base manager, or the C language."

Language defines 1-2-3 basics

DSS' goal, according to Boyd, was to remove users from the basic 1-2-3 environment and put them into another application environment. This meant all functions in the new application had to be defined. DSS created a language to define the basic 1-2-3 functions with a set of macro commands combined with instruc-

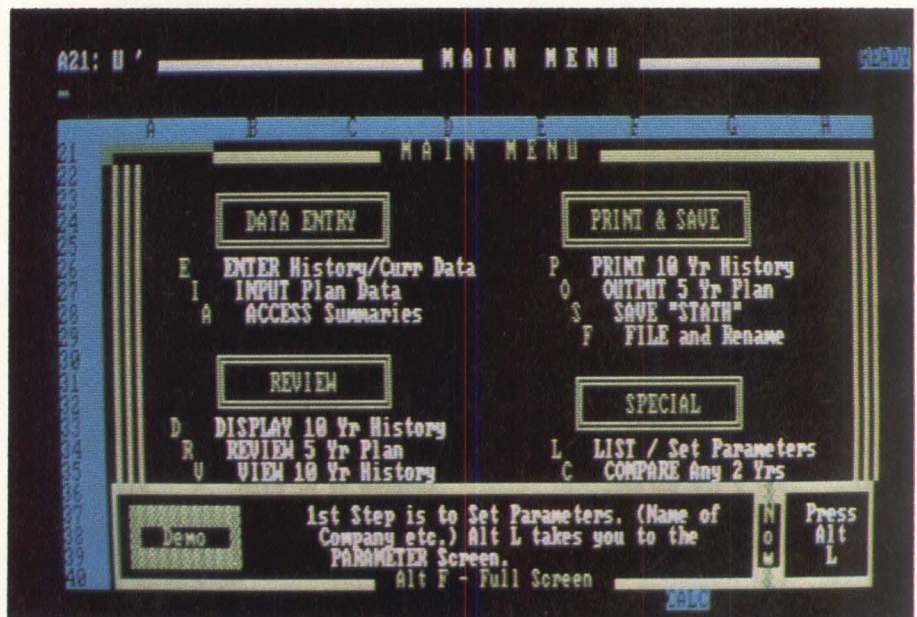

Employing a macro-command language made up of the basic functions found in Lotus 1-2-3, DSS created 52 specialized application programs that extend 1-2-3's functions.

tions. Each macro command defines specific actions to be taken by an application task. For example, in an asset-management application, the instructions define program actions such as inventory control and fixed asset. Included in DSS' macro-command language are entry forms with graphics for each application.

The OptionWare business programs are priced at \$130 each. DSS may develop a similar base for

Ashton-Tate's recently-introduced Framework integrated software. "We don't really see a need to try to create competitive integrated packages. We feel that [those packages] are providing a more useful user environment, and are making it easy for software writers to create applications within that context," explains Boyd.

Toward this end, Lotus and Ashton-Tate made provisions for

software writers to take advantage of the internal functions of their products. Some observers contend that integrated software packages are establishing new operating system philosophies and may eventually supplant operating systems for most single-user microcomputers. Metalogic's Barnett speculates this may foreshadow an entirely new approach to creating application software. □

High-speed Delphax S6000 impels ion printing into new channels

Tom Moran, Associate Editor

Printer engine supplier Delphax Systems of Westwood, Mass., has introduced its first complete product, the S6000 60-page-per-minute (ppm) intelligent printer. Designed for high-volume applications calling for 100,000 to more than 1.5 million printed copies per month, the S6000 incorporates Delphax's model 2460 ion-deposition print engine and sells for between \$60,000 and \$80,000, depending on configuration.

The most striking advantage of ion-deposition over laser-xerography technology is reliability, claims Gary Sharpe, president and chief executive officer of Delphax. He says the soft photoconductive drums used in laser-xerographic printers tend to retain toner, resulting in a low toner-transfer rate. In the Delphax process, however, toner is attracted to charged particles projected onto the surface of a hard dielectric drum. The drum presses directly against the paper, fusing the toner to the paper. This avoids any need for the heated fusing roller or the radiant heat source used in laser xerography, while increasing the amount of toner trans-

ferred from the drum to the paper. Laser printers are more complicated than ion-deposition products, and require more energy.

According to Edward Webster, president of Datek Information Services Inc., a Waltham, Mass., printer information company, the print quality and pressure fusing of ion deposition have both been improved with the new product. "It [the printed characters] had a shiny image that a lot of users didn't like, but now Delphax has textured rollers and new toners that improve the appearance quite a bit. The print quality is not as good as a lot of laser printers, but it does have an edge on price and speed, and it may have an edge in reliability."

The Delphax S6000 uses a Digital Equipment Corp. LSI-11 processor and is fitted with four available card slots for options. It prints standard line-printer formats on cut-sheet letter-size paper with a resolution of 240 by 240 dots per inch. The S6000 offers portrait and landscape printing, can change print size or type within a page, and is compatible with both IBM 3211 and Dataproducts Corp. interfaces. OEMs can add additional buffers, a disk drive,

or a job-request control unit if desired. Other options include up to four electronic forms overlays, job separation capabilities and additional type fonts and sizes. Delphax estimates the mean time between failures to be 300,000 pages.

Complete printer to help sales

Sharpe says Delphax decided to offer a complete system because integrators of the print engine, although important, are not the major potential market for its products. "The prime marketplace is among the mainframe and minicomputer companies because [printers] are sold as parts of their systems. [Their] main interest is to get to market quickly with a complete product that's ready to plug and play. We have not found that there is a widespread interest in buying just the mechanism [in that market]."

Peter Steiner, vice president and director of the Electronic Printer Industry Service with the market research company, Dataquest Inc., San Jose, Calif., echoes Sharpe's statement that Delphax will strengthen its position by introducing a complete product. "[The

Announcing MicroNet™

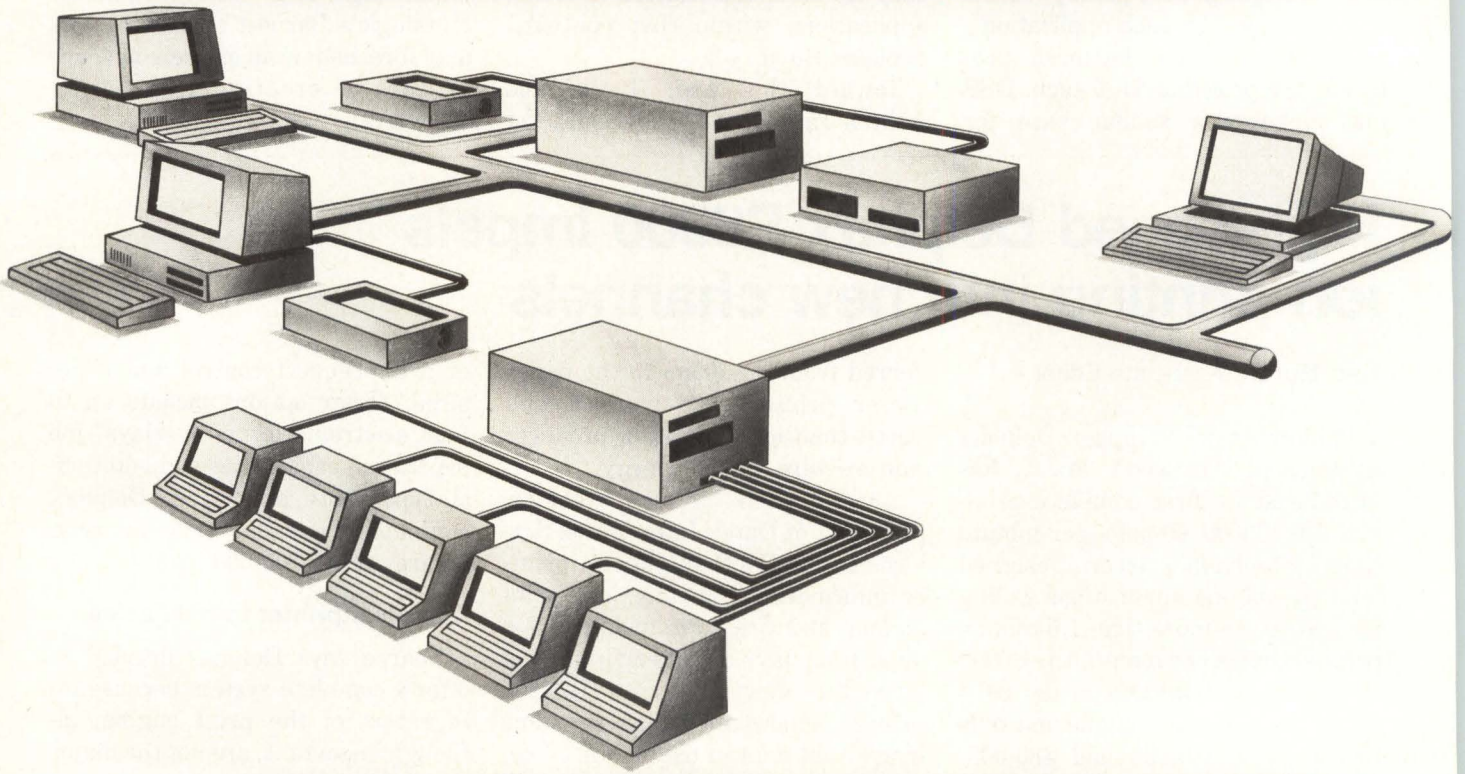

COMPLEX MICRO NETWORKS MADE SIMPLE

Imagine IBM PCs™ or compatibles, intelligent workstations and S-100 Bus structured networks, all linked together into a local area network.

Impossible?

Not with Intercontinental's MicroNet.™

Best of all, we're shipping today.

The key is a unique hardware and software approach to local area networks.

PCs and S-100 Bus systems are integrated with a simple plug-in board and co-axial cable. MicroNet uses the TurboDOS™ operating system to provide CP/M,™ CP/M 86,™ MS-DOS,™ PC-DOS™ compatibility.

Intercontinental's WS80X workstation processor allows you to convert almost any dumb terminal into a desk top computer with networking capability.

You get the flexibility of using both 8-bit and 16-bit processors on the same network, at prices that finally make Micro Computer networks cost effective.

With up to 4000 possible users and simple network expansion, you can configure your MicroNet almost any way you like—and still get the advantages of shared peripherals, true file and record locking, automatic print spooling, and a host of other benefits.

MicroNet comes from the technology leader in the S-100 world. Our masters, slave processors and memory products have introduced advanced features like Direct Memory Access and Memory Management to micro environments.

Call, write or circle the bingo number below, we'd like to tell you more about MicroNet, the Micro Computer network solution.



MicroNet is a Trademark of Intercontinental Micro Systems.
IBM-PC is a Trademark of IBM International Business Machines

4015 Leaverton Ct., Anaheim, CA 92807, (714) 630-0964, TELEX: 821375 SUPPORT UD

CIRCLE NO. 18 ON INQUIRY CARD

Mini-Micro World

NEWS

S6000] does broaden their product line and should open up some new markets to them. It should be especially interesting to smaller OEMs and to turnkey operations. It is considerably cheaper and there aren't many machines in that [speed and price] range. That could be an advantage."

Meanwhile, Delphax's OEM business has received several boosts. Delphax recently signed a two-year, \$3 million agreement for Royal Business Machines Inc., Windsor, Conn. to distribute the S6000 to mainframe and large minicomputer installations as the Royal 8800. A three-year, \$6 million contract calls

for I.E.R., Paris, to distribute the S6000 and the 2460 print engine in France. A third contract permits C. Itoh Electronics to build a low-cost desktop office printer designed by Delphax. The 30-page-per-minute device is expected to be priced less than \$10,000 and to be available in the third quarter of 1985. □

Laser, ion technologies both improving

The main competition for laser xerographic technology comes from ion-deposition and magnetic printing technology. At the National Computer Conference in Las Vegas, Nev., in July, Cynthia Peripheral Corp. announced its MP 6050 perpendicular magnetic printer. Cynthia said evaluation units of the 50 page per minute (ppm) printer would be available in the fourth quarter for \$15,000.

President Edward Webster of Datek Information Services Inc., of Waltham, Mass., estimates that domestic shipments of non-impact page print-

ers rated from 44 ppm to 100 ppm will grow from 325 units in 1983 to 2,800 units in 1986. He says Delphax Systems' new 56000 printer and the Siemens Corp.'s ND3 laser printer are the main competitors in this class.

Webster says that next year will be very important to the success of non-laser page printers. "They will either make it or fade away. Ion deposition appears to be making it." He says that funding from Canada Development Corp., Vancouver, B.C., a joint-venture partner in Delphax along with Dennison Manufacturing Co., Fram-

ingham, Mass., which provided technology, should help give Delphax the staying power necessary to develop a different technology, if necessary.

But Dataquest's Steiner points out that the cost of laser printers is coming down and improvements in their liability are being made. "The introduction of the amorphous silicon drum by Canon [U.S.A. Inc.] will take away some of the advantages that the [ion deposition] technology may have had before. [The silicon drum] is a very hard drum that's supposed to last the life of the machine."

DELPHAX'S S6000 PRINTS 60 PPM

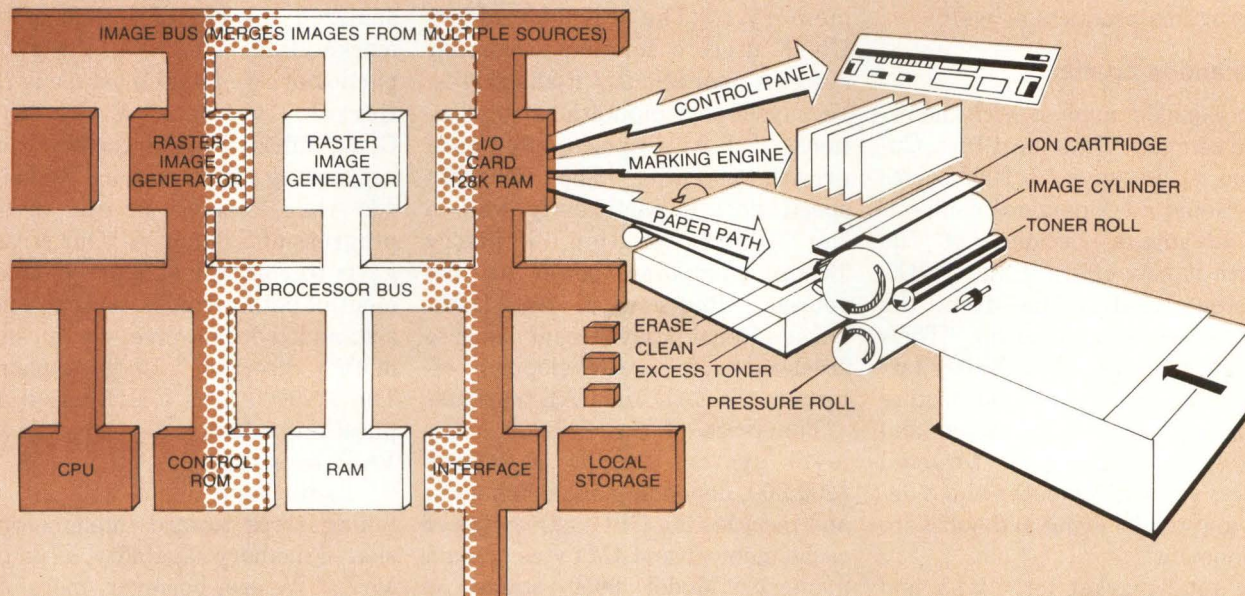

The Delphax ion-deposition print process eliminates heat-fusing and toner-recycling, making the system simpler than laser printers. Toner is fixed onto the paper between the pressure roll and the hard dielectric image cylinder.

Gould UNIX supermini reaches 10 MIPS

Marjorie Stenzler-Centonze
Associate Editor

Gould Inc.'s Computer Systems Division, Fort Lauderdale, Fla., recently unveiled the PowerNode 9000 super-minicomputer, completing the company's evolution from an industrial to a totally electronics orientation. Concurrent with the PowerNode 9000 introduction, Gould sold its battery division, its last non-electronic business unit.

The PN9000 comes in three models which offer several times the speed of Digital Equipment Corp.'s VAX 11/780, according to G.E. Rodts, vice president of marketing and sales for the division. The PN9000 completes Gould's UNIX-based PowerSeries family of computers at the high end. "Our strategy is to complement our strong position in the real-time, scientific, 32-bit marketplace," Rodts says. Gould will continue to address that business and will pursue the UNIX-based systems market with distributed systems products as well.

Applications crucial

Jim Renalds, analyst with the research company Dataquest Inc., Cupertino, Calif., says the 9000 series gives Gould a tremendous competitive advantage because of the breadth it now offers in its UNIX-consistent product line from the PS1000 desktop unit on up. "Their strategic planning is really on target," he states. "The crucial factors will be applications software and their sales approach to targeted markets such as computer-aided design, and engineering and software development."

The total market for UNIX and UNIX-like systems was \$1.1 billion in 1982, according to the research company Frost & Sullivan of New

Gould officials say the new PN9000 supermini competes more on mainframe turf than with mini-computers because of its speed, which can reach 10 MIPS.

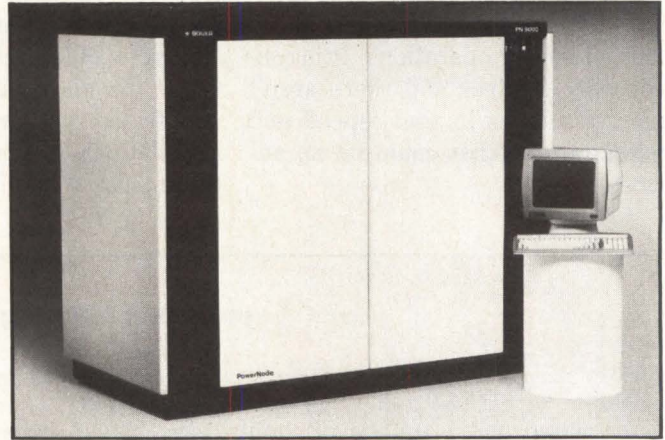

York, and is expected to climb to \$5.1 billion by 1985.

Rodts says the PN9000 32-bit virtual memory processor opens new market opportunities for Gould because of its speed, which ranges from 4.5 million instructions per second (MIPS) to 10 MIPS, and its 16M-bytes of virtual memory. (Although DEC's top-end VAX systems' raw speed is much slower, just under 2 MIPS, all VAX machines support 4G bytes of virtual memory.) "The PN9000 offers UNIX users a solution to current systems' limitations," Rodts states. He says high computational applications, such as graphics, offer good growth potential. The PN9000's speed suits it particularly well to the film-automation industry "where computer power is devoured," Rodts says. But Dataquest's Renalds says Gould needs to accelerate software development efforts in the CAD and CAE markets.

The price of the PN9000 entry level system begins at about \$200,000, depending on peripherals, and includes the CPU, 32K bytes of cache memory and 4M bytes of main memory. Model 9050 starts at \$230,000. The most powerful system, the PN9080, begins at \$310,000 and includes a second processor

called the Internal Processing Unit. The IPU operates in parallel with the CPU and boosts performance by close to 80 percent without a proportional increase in price, Rodts says. The 9080, when fully configured, can have a total of 128K bytes of cache memory.

The PN9000 series utilizes Gould's UTX/32 operating system, which is based on the Berkeley 4.2 UNIX extension, with additional features from System V. "After we analyzed the use of UNIX in the marketplace, with VAX users in particular, we found most using the Berkeley version," Rodts says. Gould officials believe the best market strategy is to support Berkeley 4.2 while keeping an eye on the progress of System V. "Our strategy is to continue supportive treatment of both versions, so that when a standard does evolve, we can shift in that direction," Rodts explains. The PN9000 runs UNIX-based applications software developed on the VAX, he says.

Rodts says Gould will also be taking steps toward implementing shared memory capability, as on the VAX. "We are, however, more of a competitor to some mainframes than to VAX because our speed is so great," he adds. □

^{new} The **CONCEPT AVT+** In a word: capability.



THE CONCEPT AVT+ DISPLAY TERMINAL

ANSI standard conformance, DEC software compatibility, eight pages of memory, 80/132 columns, windowing, multiple computer connections...and a full range of practical ergonomic features. Capabilities which enable all terminal users to maximize their productivity and explore their creativity. Only from Human Designed Systems.

Introducing the new *concept* AVT+ display terminal from Human Designed Systems. Simply the smartest interactive display terminal available today. And at a very competitive price.

It starts with ANSI standard (X3.64-1979) conformance and DEC software compatibility, and incorporates superior human design features, advanced functionality and highest quality construction. A commitment to quality that is reflected in each of the individual components.

The *concept* AVT+ keyboard is ergonomically designed for optimum operator comfort, incorporating a VT100-style numeric pad for DEC software compatibility. And it builds on those human design features with a range of capabilities that make the *concept* AVT+ an ideal choice for smart terminal users.

The *concept* AVT+ offers up to eight pages of display memory that eliminates unnecessary

*Quantity one DEC and VT are trademarks of Digital Equipment Corporation.

\$1295*

hardcopy printouts and provides a powerful tool for applications requiring multiple formats and storage of large volumes of text; non-volatile memory that enables users to permanently configure a terminal for their needs or applications; windowing that allows users to create individual displays within display memory; programmable function keys which transmit data and/or execute terminal commands; up to three additional communications ports for connection to other peripherals and computers; flexible user networking and functionality for use in a wide range of different applications, including multiple computer connections; and much more.

The new *concept* AVT+. More to offer at its price for terminal users than any other terminal available today.

human designed systems, inc.

3440 Market Street, Philadelphia, PA 19104

215-382-5000

CIRCLE NO. 19 ON INQUIRY CARD

Human Designed Systems. We're redefining terminal performance.

Atlanta — (404) 391-9763; Boston — (617) 449-6446; Chicago — (312) 825-2960; Dallas — (214) 437-1888; Delaware — Infocon: (302) 239-2942; Denver — (303) 469-1953; Detroit — (313) 434-2729; Hawaii — Gray Associates: (808) 261-3751; Houston — (713) 952-1403; Los Angeles — (213) 410-9454; Northern New Jersey — Infocon: (201) 624-1372; New York City Area — Infocon: (212) 689-8833; New York State — Naco Electronics: Rochester: (716) 223-4490; Syracuse: (315) 699-2651; San Francisco — (415) 692-4184; Washington, DC — International Systems Marketing: (301) 279-5775; Argentina — Itron SA: (01) 774-9369; Australia — Computer Clarity Pty. Ltd.: (02) 241 3385; Belgium — BELCOMP: 091-31 52 22; Canada — CAIL Systems: Toronto: (416) 362-1063; Denmark — ADCOM Data Aps: 1-19 44 66; Finland — Valtamatic Oy: 0-742 011; France — Walton: (1) 226.06.90; Japan — Ampere: 03 (365) 0825; Portugal — Soc. Com. Crocker, Dellatorce Co. Ltd.: 1-6801 41; Singapore — DTS: Singapore: 33-88-566; South Africa — Psitec (Pty.) Ltd.: (11) 836-9181; Switzerland — Mitek ag: 01/461 22 52; United Kingdom — Shandell Systems Ltd.: 2407-2027; Venezuela — H. Blohm SA: 2 541.21.22; West Germany — COMKO Computersystemges. mbH: 221-48 30 51. INTERNATIONAL DISTRIBUTORSHIP INQUIRIES INVITED.

EMULEX COMMUNICA HOW TO PLEASE ALL THE



New! CS02 allows LSI-11 through 11/23 PLUS and MICRO/PDP-11 systems to handle up to 16 lines on one board! Emulates DEC DHV11.

New! CS32 Series — Single-board controller is totally transparent to DEC DMF-32. Can handle up to 128 lines, *all* modem controlled.

New! Statcon Series 32 — Up to 256 local and/or remote lines on a single hex-sized controller. Totally software transparent to VAX-11 CPUs.

CS01 — A DH11 emulation for LSI-11 through 11/23 PLUS Series computers. Handles 8 to 64 asynchronous lines per controller. Replaces DEC DLV11 and DZV11.

No matter what type of DEC you're using, Emulex will make you happy. For LSI-11, PDP-11 and VAX-11 systems, we offer more than 17 transparent controllers emulating DHV11, DH11, DZ11, DV11, and DMF-32. All deliver improved line-handling capabilities, in a smaller package, at lower costs.

TWO NEW HIGH-PERFORMANCE MULTIPLEXERS.

FOR QBUS SYSTEMS:

Our new CS02 multiplexer is a good example of the kind of performance that only

Emulex delivers. It allows LSI-11 through 11/23 PLUS and MICRO/PDP-11 systems to handle 16 lines — eight lines more than DEC's DHV11. The CS02 fits into existing space within the DEC system. It saves that valuable board slot, and power too, for those expanded system applications.

FOR VAX SYSTEMS:

VAX users will appreciate our new CS32. Totally transparent to DEC's DMF-32, this single-board controller can handle many more

lines — up to 128. All modem controlled. (With DEC, only two out of every eight lines have modem control.)

If your VAX system needs even more power, our field-upgradable Statcon 32 Series is the answer. It allows your system to grow to 256 remote and local lines, still operating off a single controller.

LESS BACKPLANE SLOTS.

Since Emulex packs so much more capability onto each board, fewer boards are needed. For example,

ATIONS CONTROLLERS: DEC USERS ALL THE TIME.



CS11 Series – DH11, DV11 and DMF-32 emulations for PDP-11 and VAX-11 CPUs. Handles 8 to 64 asynchronous lines.

Statcon Series 11 – Transparent remote statistical concentrators for PDP-11 and VAX-11 CPUs. Up to 64 local and/or remote lines on a single Unibus SPC slot.

CS21 Series – DH11, DZ11 and DMF-32 emulations for PDP-11 and VAX-11. Up to 16 lines per controller.

Statcon Series 21 – Up to 32 remote and/or local lines on a single hex-sized Unibus controller. Transparent to PDP-11 and VAX-11 CPUs.

take a 64-line DH11 emulation. Emulex does it on one board. DEC takes 36. The only thing more impressive than the savings in rack space will be the savings in price.

NO GROWING PAINS.

Emulex makes upgrading simple. As your system grows, just change PROM sets. For instance, DH to DMF costs just \$350. In addition, Emulex's advanced microprocessor architecture is consistent throughout the product line. Just think

of the inventory savings. For that matter, think of the dollar savings, too.

THE PRICE IS RIGHT.

Here's a typical example. A DEC DMF-32 controller lists at \$3,995 per eight lines, with expansion chassis costing \$3,500 or more. Compare that to Emulex's CS32/F at \$5,000 for the first 16 lines and \$3,200 for each additional 16 lines. At 128 lines, you suddenly have a savings of about \$36,520 and a lot of extra slots to boot.

Now that ought to be enough to keep a DEC user happy. And Emulex can do the same for you. Call toll-free: (800) 854-7112. In California: (714) 662-5600. Or write Emulex Corporation, 3545 Harbor Blvd., P.O. Box 6725, Costa Mesa, CA 92626.



The genuine alternative.

If Your Network Goes Down When A Switch Processor Fails, You're Not Using Our Switch!

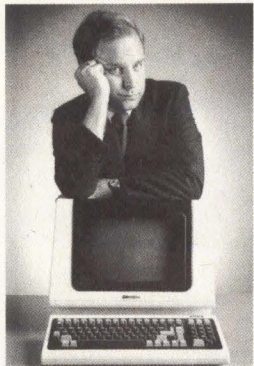

Processor failures are a fact of electronics life, and one of the measures of a switch is how well it deals with it. With some switches it's very simple. The system goes down.

But not with CommPonents. Each line card carries its own microprocessor. At worst you lose four ports on that card, and the rest of your system continues to function. To completely restore the system, just replace that card.

That's just one reason why CommPonents and its multiple processors supports DEC, Data General, Hewlett Packard, Prime, Amdahl, Tandem and NCR computer systems better than the other switches. There are other reasons.

Like virtually unlimited port expandability. Your network can begin small and grow as large as you need it. Without compromise.

Or speed. CommPonents doesn't keep your computer or

your terminals waiting. The processors support full data rates on all ports. RS232 up to 19,200 bps and V.35 to 256,000 bps.

Or functionality. Do things you never expected a switch to do. Like multiplexing. Like alternate

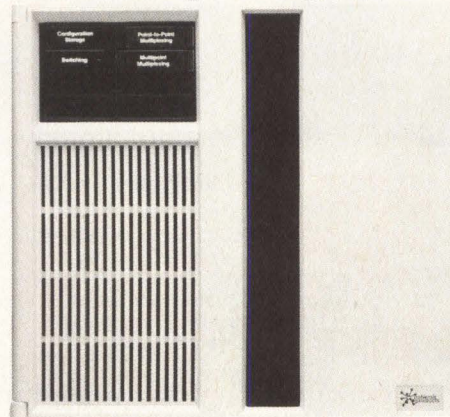

routing. Like flow control. And like multiple switches tied together as a network. Virtually

everything about CommPonents is different.

More than that, it's better. It's the switch that can support your system in the manner that you would like to become accustomed to.

Ask us about CommPonents. We'll be glad to tell you why it's the faster, more functional and reliable switch for you.

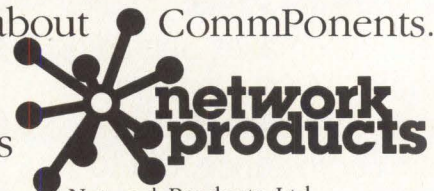

Network Products, Ltd.
387 Sykes Road
Slough, Berkshire SL14SJ
United Kingdom (0753) 821 898
Telex 848461

Network Products, Inc.
Research Triangle Park, NC 27709
919/549-8210 Telex 802855

COMMPOONENTS

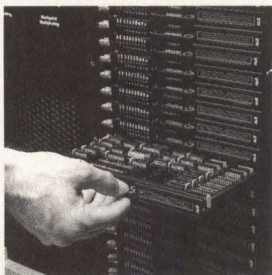

CIRCLE NO. 21 ON INQUIRY CARD



HEARD ON THE HILL

Anatomy of a computer sting

Stephen J. Shaw
Washington Editor

Life in the computer business doesn't often resemble an episode of "The FBI", but for a time earlier this year a Boston software executive found himself playing a role that could have been lifted from a script of that old television series.

David Rozewski is the marketing manager for Intersystems Corp., a system-integration company that incorporates the MUMPS operating system into minicomputers and peripheral hardware, for medical applications. Intersystems is a contractor for the Veterans Administration's Decentralized Hospital Computer Program (DHCP). It most recently integrated a variety of MUMPS-based applications packages to run on a PDP-11/24 minicomputer for the DHCP system.

Last October, Rozewski attended a conference in Baltimore sponsored by a medical-records society. While taking a look at the exhibits he noticed that the Department of Defense had a booth promoting its Tri-Services Medical Information System (TRIMIS), an ambitious project to provide 169 military hospitals with computer support for clinical laboratory functions, pharmacy activities, patient-scheduling and admission/transfer/discharge processing.

Rozewski knew that a request-for-proposals (RFP) was being prepared by the TRIMIS program staff for procurement of hardware and software that could total upwards of \$250 million, and Intersystems was very interested in bidding on at least a portion of the project. A key question was whether the RFP would specify MUMPS as the operating system. Rozewski reasoned that because of Intersystems' experience with the

DHCP, it would have a possibly decisive edge in competing for the DOD contract, if MUMPS were required.

Rozewski went to the TRIMIS booth, where he met Edward Thomas, a TRIMIS procurement officer. After explaining his interest in TRIMIS, Rozewski arranged to meet Thomas for lunch in Washington, D.C. to talk over how DOD planned to handle the procurement.

Thomas brought along another person, Arthur Hill, whom he introduced as a friend. Rozewski says he later learned that Hill was a middle-level executive with the Mobil Oil Corp. When the introductions were completed, the Intersystems marketing manager quickly got down to the business at hand.

Was TRIMIS going to a MUMPS-based system, Rozewski asked. He said Thomas did not reply directly, but told him that, if he wanted the information, the TRIMIS official expected a "favor" in return. Rozewski later said he was too surprised to say anything.

Thomas, he said, pressed the point. "What's this contract worth to you?" he asked, according to Rozewski's reconstruction of the conversation. Rozewski stalled, saying that he needed to check with his company.

Upon his return to Boston, Rozewski discussed the situation with his boss. He related that Thomas' companion, Hill, had told Rozewski that Thomas was "the main man" in formulating the upcoming RFP. A TRIMIS spokesman confirmed that, indeed, Thomas was involved in writing the RFP, but the spokesman said Thomas was only one of several procurement officers working on the project and that Thomas' role involved "messaging" the system's functional requirements that were being developed by the staffs of the

DOD hospitals. Regardless of Thomas' role, Rozewski and his superiors at Intersystems decided the situation was too serious to ignore.

The company contacted the U.S. attorney in Baltimore, where the initial contact between Thomas and Rozewski had taken place. The Federal Bureau of Investigation was quickly brought in, and a computer "sting" was devised.

Rozewski was asked by the FBI to meet again with Thomas and Hill, this time wearing a tape recorder to document any bribe attempts. Rozewski refused, saying he was not comfortable playing such an undercover role. The FBI and Intersystems then agreed to have an FBI agent pose as an Intersystems employee and meet with the two men.

According to Rozewski, Thomas and Hill fell easily into the FBI trap. "They didn't even question whether the agent was really who he said he was," commented Rozewski. "Not too bright."

Subsequent meetings between the phony Intersystems representative and the two men were videotaped and recorded. In exchange for advance information on the TRIMIS RFP, and a promise to slant the RFP specifications in favor of Intersystems, Thomas and Hill asked for \$60,000 in cash and 1 percent of the contract award, if Intersystems should be the successful bidder. Rozewski estimated the total payoff would have been approximately \$670,000.

The FBI reported it arrested both men at a Bethesda, Md. hotel after an initial payoff was made. Thomas pleaded guilty to bribery and conspiracy charges. Hill was convicted on a charge of conspiring to commit bribery. Both men are currently awaiting sentencing.

At Last! A Communications Processor For DEC Computers That You Can Program

The Simpact ICP1600 Intelligent Communications Processor can off-load your host system because it's versatile enough to handle the toughest communications tasks and is code compatible with VAX and PDP-11s.

Use your host system utilities and our software toolkit to create your custom protocols, or let our communications specialists help you develop them. X.25 software is available from Simpact now, and more standard packages are on the way.

For under \$5,000, the ICP1600 is the most cost-effective communications processor available today.

256 Kbytes on-board memory to store downloaded programs and buffer data

High-speed DMA transfers with host processor

Eight programmable, serial communications ports (expandable to 20) support multiple asynchronous and synchronous protocols at speeds up to 612 Kbaud

15 Kbytes PROM contains Boot Loader, Self-Test routines and Debugging firmware

DEC MICRO/T-11 processor engine executes the PDP-11 instruction set

Single hex-size card plugs into any UNIBUS slot*

*Q-Bus version available soon.

DEC, PDP, MICRO/T-11, UNIBUS and VAX are trademarks of Digital Equipment Corporation

Discuss your requirements with us. Call today: (619)565-1865, ext. 246 or write to:

simpact
ASSOCIATES, INC.

5520 Ruffin Road
San Diego, California 92123

CIRCLE NO. 22 ON INQUIRY CARD

Congress questions cost of DOD hospital computer network

Stephen J. Shaw
Washington Editor

Congress is raising its eyebrows at the expensive \$397 million price tag for the Department of Defense's Tri-Services Medical Information System (TRIMIS). TRIMIS will link 120 military hospitals in a sophisticated computer network.

Critics of the system say that the DOD could learn from the Veterans Administration, which is completing a two-year, \$62 million project to implement a similar medical information network providing computer support to 169 VA hospitals. A \$250 million request for proposals (RFP) had been expected to be authorized for TRIMIS by the DOD early this summer. But two requests for review of the program, coupled with the criminal conviction of TRIMIS program executive Edward Thomas for attempted bribery in relation to the RFP, have placed a hold on the funding.

In a letter to Secretary of Defense Caspar W. Weinberger, Rep. G.V. "Sonny" Montgomery (D.-Miss.), chairman of the House Committee on Veterans Affairs and a member of the powerful House Armed Services Committee, asked why the DOD has not taken advantage of the VA's experience in developing its Decentralized Hospital Computer Program (DHCP). Montgomery asked for a review of the TRIMIS costs and urged Weinberger to keep in mind a 1982 law, which Montgomery sponsored, mandating that VA and DOD medical resources be shared whenever feasible.

Montgomery specifically questioned why the DOD has not in-

cluded in its plans the use of 75 software applications packages that the VA developed internally for the DHCP system and that would be available for free.

"I have been a strong supporter of DOD initiatives brought before the House Armed Services Committee and the Congress, as they are the results of effective planning and good judgement," Montgomery wrote. "It does not appear that this TRIMIS decision reflects those same good qualities."

The House Appropriations Committee also has asked the DOD to review and provide justification of the costs of the hospital program, according to a TRIMIS official who asked not to be identified.

The same official, however, defended the program against charges that it is too expensive compared to its VA counterpart. TRIMIS, he explained, will support more applications than the DHCP and has more functional requirements incorporated into its design, including one specifying that TRIMIS interface with several non-DOD medical information networks.

Responding to Montgomery's criticism about ignoring the 75 VA-developed software packages, the TRIMIS spokesman said that no decision has been made yet regarding their use by the DOD. He notes that the DHCP system employs the MUMPS medical operating-system language which was specified in the VA RFP. MUMPS will not be specified in the TRIMIS RFP and the decision on which computers and operating system to employ will be left up to the bidding companies, he said.

Roger Cooper, VA director of

medical information resources notes, "The base-level functions of the two systems are the same." Both medical information systems are intended to provide data-processing support for various operational functions through centralized databases. Operational functions of both TRIMIS and DHCP include: patient registration, admission, discharge and transfer, clinic scheduling, pharmacy record-keeping, and clinical laboratory results-reporting.

However, in addition to those applications, TRIMIS is expected to also support other medical-records databases, programs for radiology support, nursing and other health-care scheduling, and clinical dietetics. The network is also being designed with interface requirements not found in the VA system. These include communications with a DOD health-care-eligibility system for military retirees and dependents, and a uniform charting-of-accounts system that allocates hospital personnel work loads and resources.

Comparative costs disputed

The TRIMIS official disputes the cost estimates used by Montgomery in comparing the two hospital systems. The \$62 million figure, he says, includes initial equipment purchase but not the significantly higher life-cycle costs. In addition, he charges, it provides for only a single year of equipment maintenance, and does not reflect software development costs that were absorbed internally by the VA.

On the other hand, TRIMIS' \$397 million price tag represents its total life-cycle cost, including maintenance; its greater, more expensive

Mini-Micro World

NEWS

functionality; and the development of software application packages commercially instead of through internal DOD resources.

According to a VA document that details the automatic data-processing plan for fiscal years 1984-89 for the Department of Medicine and Surgery, which is responsible for implementing DHCP, the total life-cycle cost of the DHCP system including the quoted \$62 million is projected to reach \$204 million. This includes maintenance, equipment,

software, operating supplies and training. Comparison of the two systems' life-cycle costs reveals a gap of \$193 million, significantly less than the \$335 million difference as outlined in Montgomery's letter to Weinberger.

When asked if Montgomery's criticism of the TRIMIS network and its costs were valid, the VA's Cooper responded, "It's a tough call. The VA software, in particular, does not contain enough functionality for DOD."

Cooper says DOD hospitals handle more dependents and outpatients, with accompanying requirements for more extensive record-keeping and file transfer. VA hospitals provide care for less mobile and generally less healthy patients. He doubts, however, that the DOD is trying to incorporate too many applications into the TRIMIS system. "When do you stop adding requirements to your wish list?" he asks. □

Half-height 25M-byte Winchester suits mid-range system architectures

Carl Warren, Western Editor

The market for more storage on mid-range microcomputer system architectures is prompting disk-drive manufacturers such as Cogito Systems, San Jose, Calif., to boost capacities beyond 10M bytes on new models.

Cogito has introduced the model PT925, half-height 25.52M-byte (unformatted) drive, into its existing series of 6.38M-byte to 12.76M-byte, half-height drives.

The PT925 drive has two platters, 527 tracks-per-inch (2,448 tracks) and 11,150 bits-per-inch. It is plug-compatible with systems using the

ST412 controller, and is priced at \$625 in quantities of 10,000. Evaluation units are planned this month with production quantities scheduled for November.

According to Cogito's vice president of marketing, Andrew Roman, there is a trend in mid-range architectures toward higher capacities in smaller packages. "Operating system software [e.g., UNIX] is pushing the storage requirement. For example, at least 6M bytes to 7M bytes of disk storage is required for UNIX. This leaves very little [room] for applications and data."

Drive can take a punch

Since Cogito and other manufacturers of similar drives, such as Microscience International Corp., Mountain View, Calif., are aiming at the transportable, desktop system market (MMS July, Page 52), the drives have to be rugged enough to withstand handling without damage to the data surface.

To ensure data integrity, the PT925's head/disk assembly has a three-axis shock mount. In addition,



Measuring 1.6-inches high and packing 25.52M bytes of unformatted storage on two platters, the Cogito PT925 Winchester drive is plug-compatible with systems using ST412 controllers.



High Capacity and Removable Data Storage

The Hard Facts About Our 3.3 Disk Drive.

When you consider the hard facts, Kodak's new 3.3 megabyte 5¼" flexible disk drive is an easy solution to today's microcomputer needs. It not only challenges the capacity of Winchester's, it also outmatches them in performance. The 3.3 Drive is removable, too. So you're not limited to how it can be used. And what makes the drive even harder to pass up is that Kodak incorporated only proven technologies in its manufacture...and that means incredible reliability.

In fact, everywhere you look it's easy to see the quality you've come to expect from Kodak. Like 3 millisecond track to track speed...a 192 tpi double-sided record format...a proprietary servo system for remarkably precise read/write head positioning. The 3.3 Drive even features software-controllable microprocessor reading of 48 and 96 tpi diskettes. And to ensure easy operation, there's no preventive maintenance required.

So look at the hard facts and you'll have to agree: Kodak's new drive is the superior choice for a high-capacity floppy upgrade or a back-up for Winchester-based systems.

The 3.3 flexible 5¼" drive. Another easy solution from DTC to help you manage information.

Call or write Data Technology Corporation today for technical and sales information on the new KODAK 3.3 Drive.



Data Technology Corporation

2775 Northwestern Parkway
Santa Clara, CA 95051
Telephone: (408) 496-0434
TWX: 910-338-2044

Eastern Regional Sales
15 Wiggins Avenue
Bedford, MA 01730
Telephone: (617) 275-4044

*Kodak is a registered trademark of Eastman Kodak Company.



KODAK

3.3

CIRCLE NO. 23 ON INQUIRY CARD

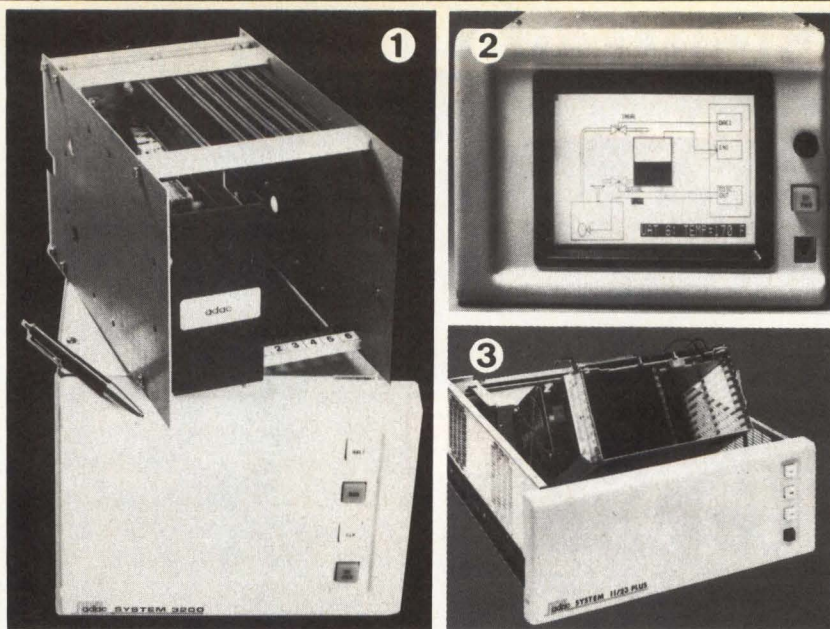

Q-Bus enclosures, systems and rack mount CRT's improve performance and reliability.

These recent additions to ADAC's broad line of Q-Bus compatible products offer unsurpassed flexibility in system configuration.

① ULTRA COMPACT Q-BUS ENCLOSURE • Ideal for remote data acquisition and systems integration applications. . . . Model 3200BPS combines a 6 slot backplane and a 10 amp plug-in power supply in only 6" x 6¼" x 10" of space. . . . Perfect chassis for the DEC FALCON or FALCON-PLUS as well as 11/73.

② UNIQUE RACK-MOUNTABLE CRT DISPLAY/TERMINAL • This compact, rack-mountable unit is VT-100 compatible. . . . It is an excellent choice as the operator display within a system. . . . An optional plug-in keyboard is available. . . . Also offered with 640 x 240 pixel bit-mapped graphics.

③ INDUSTRY'S LARGEST Q-BUS ENCLOSURE • System 1200 holds 22 half-quad or 11 full-quad cards with up to 40 amps of +5v power. . . . Ideal for 11/23 plus or 11/73 processors. . . . Features fan-failure sensor and overtemperature detection. . . . Also available including the DEC processor of your choice and RT-11 or RSX-11M software. . . . Fully supports ADAC's memory and I/O modules, as well as those of other Q-BUS vendors.

ADAC offers the world's widest selection of Q-BUS system components.



U.S.A. Headquarters: 70 Tower Office Park • Woburn, MA 01801
Tel. (617) 935-6668 • Tlx. 951802

U.K. Headquarters: P.O. Box 42, Epsom KT18 7SP • Surrey, England
Tel. 3727-42577 • Tlx. 918179

a mechanical brake stops the spindle rotation in six seconds so the read/write head can be moved into a safe zone should a disk problem occur. Moreover, the drives use thin-film media, which is typically less prone to damage.

Access speed is not an issue

The PT925 employs a rack and pinion, open loop actuator and has an average access time of 75 msec. Although the drive can't stack up against faster closed-loop servo designs, Roman insists that isn't an issue. "The important issue [in this market] is, can the drive ensure data integrity and remain cost-productive?"

Roman contends that speed is more important in multi-user systems than single-user systems. Moreover, he says the system integrator is the one who affects the overall operation of the drive. "What the system integrator needs to do is employ a controller and operating system that will allow caching—full- or multiple-track buffering—to achieve the greatest throughput. If speed and super-high capacity is what they need, then another type of drive is needed, and they can expect to pay a high price for it," says Roman.

Market to expand

Jim Parker's 1983 Disk/Trend report, published in Mountain View, Calif., indicates that the market for half-height 5¼-inch Winchester will explode from 72,000 units shipped in 1983 to more than 2 million by 1986. What could eat at some of this growth, however, is 3½-inch 20M-byte Winchester drives encroaching on the same market. Currently, only one manufacturer, Microcomputer Memories Inc., Van Nuys, Calif., has a 25M-byte 3½-inch Winchester that it is preparing to ship late this year. □

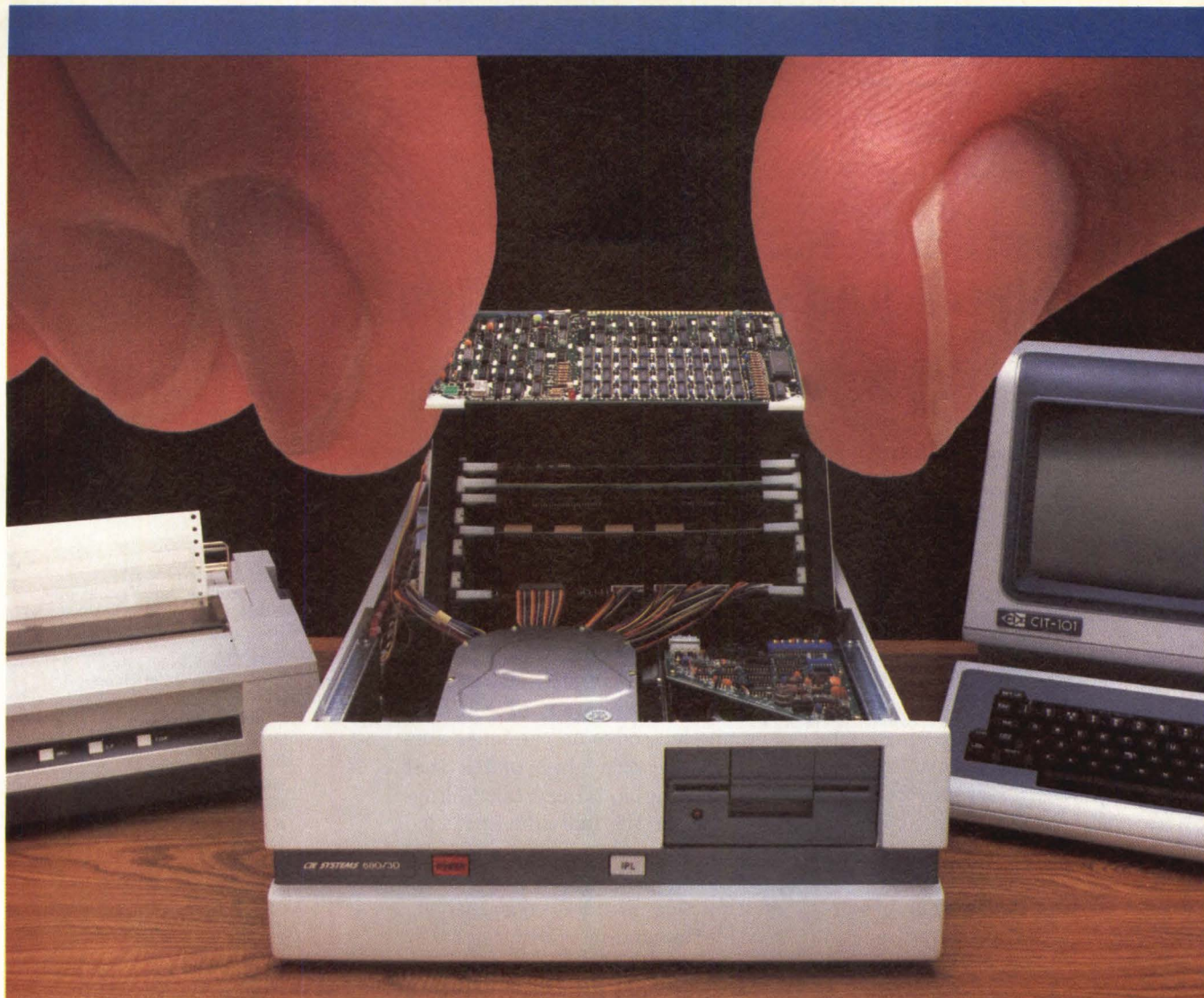

Our giant commitment to OEMs

BOARDS TO SYSTEMS. YOU NAME IT.

CIE Systems is committed to being your source for the very latest in micros and all that goes with them.

The micros are the CIES 680™ Business Computers with the advanced 32/16-bit 68000 micro-processor and Intel's Multibus™ architecture. So from boards to systems, you can easily configure your product line for virtually any business.

There are four 680 models. The 680/30 (shown above), 680/20 (on the right), 680/35 and the 680/40.

The 680/30 and 680/35 will accommodate up to eight interactive users. The 680/20 expands to four users. And the 680/40 expands to as many as 16 users.

Disk capacities range from 10 to 300 Mbytes, memory from 256K to one Mbyte.

Operating systems include REGULUS™ and CNIX™ (both UNIX™ compatible), as well as RM/COS™.

Language processors include BASIC, FORTRAN, COBOL and PASCAL.

Applications offered are general accounting, financial worksheet and word processing, as well as a wide range of vertical applications.

And you can include PRO-IV™, the applications processor that allows you to develop applications in one-tenth the time or modify applications in one-hundredth

the time it normally takes.

Boards up to complete CIES 680 systems. Our name or your name on them. That's an ongoing commitment to OEMs from CIE Systems, the company backed by the third largest trading company in the world with well over \$60 billion in sales.

Just call or write CIE Systems, Inc., 2515 McCabe Way, Irvine, CA 92713-6579. Call toll free 1-800-854-5959. In California, call 1-800-432-3687.



CIE SYSTEMS
A CITOH ELECTRONICS COMPANY

TM CIES 680 is a Trademark of CIE Systems, Inc.
Multibus is a Trademark of Intel Corporation.
REGULUS is a Trademark of Aleyon Corporation.
CNIX is a Trademark of CIE Systems, Inc.
UNIX is a Trademark of Bell Laboratories.
RM/COS is a Trademark of Ryan-McFarland Corporation.
PRO-IV is a Trademark of Data Technical Analysts, Inc.

© CIE SYSTEMS, INC. 1984

Mini-Micro World

NEWS

Active-matrix technology improves liquid crystal displays

Tom Moran, Associate Editor

One of the first commercial devices to use active-matrix technology—touted as the solution to the size and performance limitations of liquid crystal and other flat-panel displays—is being introduced by Panelvision Corp., Pittsburgh, Pa. The company is using the technology in a roughly 4- by 5-inch liquid crystal display (LCD) unit called the MiniGraphic.

Active-matrix addressing integrates a semiconductor, thin-film transistor and storage capacitor with each picture element (pixel). The pixels each act as their own memory cell for the duration of the frame period. Panelvision predicts that active-matrix addressing will solve the traditional problem of individually wiring thousands of pixels

and will produce flat-panel displays with the size and resolution of CRTs.

The company says it can apply active-matrix addressing to any of the many electro-optical flat-panel display technologies. Active-matrix circuitry functions as a dynamic random access memory (DRAM), but because it only surrounds the pixels, it is much less dense than a DRAM. Traditional multiplexed LCDs have a matrix of row and column electrodes on the inner surfaces of the two glass plates that surround the liquid crystal. Voltages applied to the individual row and column electrodes activate the appropriate pixels. This time-division multiplexing is done consecutively row-by-row and is therefore slower than the DRAM-type function inherent in active-matrix technol-



PANELVISION CORP.
introduces the
multi-purpose
MINIGRAPHIC
flat panel display—
the first commercial
implementation of the
"active matrix"
addressing principle.

The MiniGraphic display system from Panelvision uses active-matrix semiconductor circuits to address its 24,576 picture elements. The high-contrast, large-viewing-angle device is said to offer greater flexibility than previous liquid crystal displays.

Symbol Regional Offices

Charles G. Furedy
2110 Newmarket Parkway
Suite 211
Marietta, GA 30067
404-955-0454

Dan Gallagher
1101 Lakeland Avenue
Bohemia, NY 11716
516-563-2400

Richard A. Mathews
1720 E. Garry Avenue
Suite 110
Santa Ana, CA 92705
714-556-3825

Gary Ritz
2401 Plum Grove Road
Suite 220
Palatine, IL 60067
312-397-4990

John Shipley
8320 Old Courthouse Road
Tysons Corners-Suite 402
Vienna, VA 22180
703-790-8430

Distributors

Ahearn & Soper, Inc.
100 Woodbine Downs Boulevard
Rexdale, Ontario, Canada M9 W5 S6
416-675-3999
John Fedak

Bermuda Business Machines
P.O. Box 459
Hamilton 5, Bermuda
809-295-4672
Travis Collins

Compunetics, Inc.
2500 Rochester Court
Troy, MI 48084
313-524-9010
Danny Ballas

Data Entry Alternatives, Inc.
2010 Algonquin Road-Suite 209
Schaumburg, IL 60195
312-397-2060
George Bergstrom

Denco-Data Equipment Corp.
25 Skippack Pike
Ambler, PA 19002
215-542-9876
Charles Osisek

Gentry Associates
7665 Currency Drive
Orlando, FL 32809
305-859-7450
Robert Theodore

J & J Associates
225 East Street
Winchester, MA 01890
617-729-5770
Jack McDonough

Kraft Technologies, Inc.
8 Prince Street
Rochester, NY 14607
716-442-1760
James Kraft

Technical Concepts Corp.
1200 South Sherman-Suite 100
Richardson, TX 75081
214-783-9330
Arthur Chavoya

Telscan Systems, Inc.
3001 Redhill Avenue
Esplanade 5-Suite 208
Costa Mesa, CA 92626
714-556-3949
Sandy Stroich

symbol
TECHNOLOGIES, INC.

MINI-MICRO SYSTEMS/September 1984

Want to eliminate your wand problems?



The answer is automatic laser scanning now made easy with LASERLINK. Now FREE* until November 1, 1984.



Of course, you'll need the world's leading hand-held laser scanner to take advantage of LASERLINK's capabilities. That's why the input end of LASERLINK hooks up exclusively to Symbol Technologies' LS-7000—the go-anywhere laser scanner that eliminates the wand and the problems that go with it. With an LS-7000 at the head of your bar code system, you'll achieve accurate reads in the blink of an eye and be able to scan bar codes that are less than picture perfect.

You've known it all along. The weakest link in your bar code system is at its business end. The lightpen or wand which does the actual reading is a low-tech performer, working only as fast as an operator's hand—when it works at all. Until now, if your high-tech system was dedicated to lightpen technology, you were stuck with the low-tech slow-poke.

Today, there's LASERLINK, a palm-sized interface that plugs into your system's wand port, and you're ready for automatic laser scanning. The result: An operator can fly through bar codes at scans per second rather than at scans per minute. And you can kiss lightpen letdowns goodbye.

What's more, if you order an LS-7000 within the next few months, you'll get a LASERLINK for free. For larger orders quantity discounts will apply, which means you can upgrade a network of bar code systems with LASERLINK at a very productive price.

This offer is limited to LS-7000s ordered before November 1, 1984, so get in touch with your Symbol distributor or salesperson today. He will demonstrate how LASERLINK and the LS-7000 will unlock the limits of bar code technology. Or contact:

symbol
TECHNOLOGIES, INC.

1101 Lakeland Avenue
Bohemia, New York 11716
516 563-2400

*with the purchase of an LS-7000.

One billion byte supermicro. Just think of the possibilities.

Introducing the new, expandable Dual 83/500. A UNIX*-based, 68000-driven supermicro so capable, you'd swear it was a mainframe.

The system already comes with 500 megabytes of Winchester storage. And our patent-pending high-speed SMD disk controller for fast access to data.

But you can increase memory to a massive one billion bytes just by adding a twin drive.

Or take an already sizeable two megabytes of RAM and expand it to six.

Or even double user capacity from 8 to 16. The hardware is already in place.

When it comes to value, no supermicro system offers you more than the 83/500. Because along with the computer, you get a 9-track, 1600 BPI phase-encod-



ed tape drive for reliable disk backup and quick file transfers to other systems.

There's a convenient one megabyte double-sided/double-density floppy disk drive that protects individual files.

And the industry standard UniPlus+™ implementation of AT&T's UNIX System V with

Berkeley enhancements. Plus a multi-user license.

All at no extra cost.

And while you're speedily going about processing your data, we're protecting your investment. For free. With a comprehensive 12-month warranty. And a nationwide service network that protects your system whether it's in or out of warranty.

See the system that's redefining the supermicro. The value-packed Dual 83/500. Call or write Dual Systems Corporation, 2530 San Pablo Avenue, Berkeley, CA 94702, (415) 549-3854

At just \$65,940 base price, its possibilities are endless.

*UNIX is a trademark of AT&T Bell Labs.

™UniPlus+ is a trademark of UniSoft Corp.

There's only one

DUAL

CIRCLE NO. 27 ON INQUIRY CARD

Mini-Micro World

NEWS

ogy. A problem with the technology may lie in the product's manufacturing yield. A small defect in a semiconductor wafer can make the wafer partly or completely useless. Since semiconductor fabrication techniques will be used to make large active-matrix devices, they may be prone to production problems. An early version of the MiniGraphic system had a number of dead pixels because of the fabrication technique, which gave the effect of a scrolling stadium scoreboard with a few bulbs burned out. However, Panelvision sources expect such yield problems to be soluble.

Display has high contrast

Two problems with LCDs have been their small viewing angle and low contrast, especially in poor lighting conditions. The MiniGraphic's 90 degree viewing angle and 8:1 contrast ratio are twice those of traditional LCDs. The device's 24,576 pixels form up to 512 characters in a 5- by 7-dot character matrix. The MiniGraphic measures 5¼ inches wide by 4 inches high by ½ inch deep and weighs 8 ounces. The active display area is 3.84 inches by 2.56 inches with 16 rows of 32 characters. The display supports full graphics and has a refresh rate of 60 Hz.

Because of the MiniGraphic's small size, Panelvision expects OEMs and system integrators to use the MiniGraphic in applications such as automated teller machines, aircraft instrumentation, and electronic cash registers. The graphics ability of the MiniGraphic display could also be applied to oscilloscopes, medical instruments, and process-control panels.

A second, transreflective version of the MiniGraphic will be available with an optional electroluminescent lamp for outlining the display in darkness. In transreflective mode the

contrast ratio of the LCD is reduced to 6:1.

The MiniGraphic display alone is priced at \$750 for a single unit, and the MiniGraphic system with a controller is priced at \$1,475. Panelvision will offer discounts for volume purchases. When attached to the back of the MiniGraphic, the printed circuit board controller adds ½ an inch to its depth. The controller can be located away from the LCD screen, if thinness of the display is critical.

The controller includes an RS232 serial port, a Centronics-compatible parallel port and inputs for direct memory access. It supports seven data communications rates from 150 baud to 9600 baud. Panelvision planned to ship the MiniGraphic and the MiniGraphic system with controller beginning in August.

Enhancements to follow

A second Panelvision product will be the PV 2000, which will display 25 lines by 80 columns on an active area 8 inches by 5 inches. Prototypes are scheduled for the fourth quarter of 1984, with production quantities expected in late 1985. The larger PV 2000 is intended for small systems and portable computers, and is expected to have over 250,000 pixels and 400-line resolution. Future possibilities for active-matrix technology include gray

scaling, color devices, and the integration of controllers directly into the semiconductor circuitry of the display.

According to T. Peter Brody, vice chairman and director of technology at Panelvision, "Active-matrix addressing solves the critical interconnection problem. It enhances the performance of liquid crystals and other display materials to a point where they can rival a CRT."

Brody, who founded Panelvision in 1980, formerly headed active-matrix development at the Westinghouse R&D laboratories. Panelvision has obtained exclusive licenses to patented Westinghouse technology and has raised \$11 million from venture-capital sources.

Sandy Gant, analyst for research concern InfoCorp, Cupertino, Calif. says that Panelvision's active-matrix addressing is an approach with potential. "The clarity of the display was better than [previous LCDs]. It will be interesting to see the larger display. They were announcing an addressing capability that happened to be linked with LCD technology. I'm sure they have a bright future. [The MiniGraphic] is an improvement on LCDs and it will help LCDs as a technology." Arthur D. Little, Cambridge, Mass., estimates that the market for flat-panel displays could reach \$2 billion within a few years. □

INTEL DEVELOPS 256K-BIT CHMOS DYNAMIC RAMS

Intel Corp. has introduced its first 256K-bit dynamic RAMs that use the company's high-performance metal-oxide semiconductor (CHMOS) technology. The 51C256H is optimized for high-bandwidth applications such as graphics displays and has a 120-nanosecond access time and a Ripplemode cycle time of 65 nanoseconds. (Ripplemode allows the single access of up to 512 bits within a single row.) The 51C256L targets low-power applications such as portable computers. It requires a total data retention current of 230 microamperes. The 51C256HL provides a combination of both low power and high performance. All three products are pin-compatible with Intel's recently introduced 64K-bit CHMOS dynamic RAMs.

Mini-Micro World

NEWS

Ungermann-Bass stretches network connection options

Marjorie Stenzler-Centozze
Associate Editor

Ungermann-Bass, Inc., Santa Clara Calif., has expanded its options on the Net/One local area network (LAN) with a modestly priced interface controller designed to offer system integrators added flexibility in connecting personal computers.

The Personal Computer Network Interface Controller (NIC), a \$595 plug-in board, links the Net/One LAN to IBM PCs and PC-compatible microcomputers. The NIC is intended for use in PC workstations as is Ungermann-Bass's own Personal Network Interface Unit (NIU), introduced earlier this year for \$1,095.

The NIU is a processor-based interface that executes network communications protocols under control of an Intel 80186 microprocessor. The NIU has 128K bytes of memory and a high-speed interface across the PC bus. All networking protocols run in that memory.

Choosing connection options

From an operator's standpoint, the differences in using a personal computer with the NIC rather than the NIU would not be apparent, says James F. Jordan, vice president and general manager at Unger-

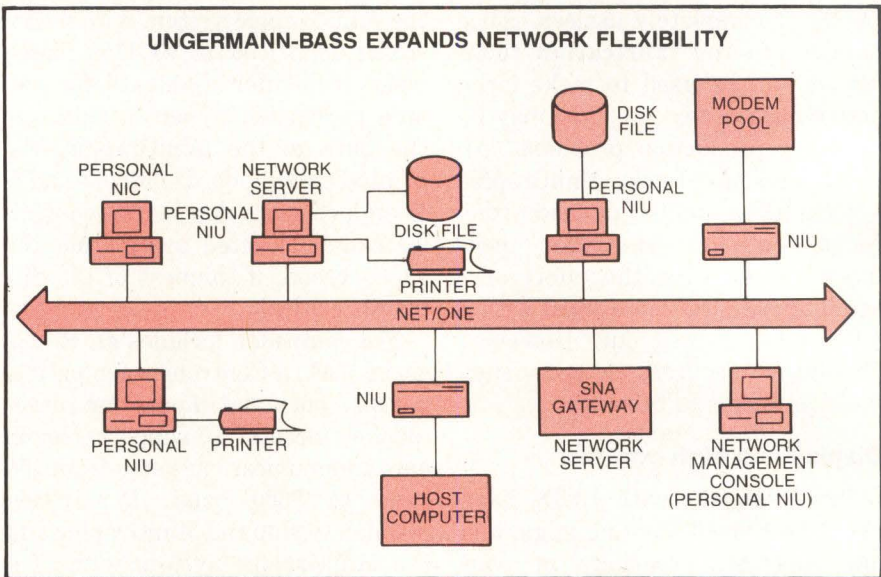

The Personal Network Interface Controller (NIC) and the Personal Network Interface Unit (NIU) from Ungermann-Bass enable IBM PCs and PC-compatible micro-computers to attach to the company's Net/One local-area network.

mann-Bass. He notes that the networking protocols and software that run on the board in the NIU, run in the PC with the network controller. "However, the NIC puts more processing burden on the PC itself, so it's not going to deliver as high [a] performance as the NIU," Jordan says.

Typically, he says, NIUs would be used in personal computers functioning as disk or print server stations, while the Personal NICs would be used in those computers employed as workstations. With this combination, the system integrator has the option of using smart boards or unintelligent boards at different

prices, Jordan points out. "System integrators can mix, match and build systems as traffic and performance require," he states. "Systems can be built around the application rather than trying to fit the application to 'non-smart' boards, for instance, and working around that."

Jordan expects the market for network interface options to expand as the installed base of LANs continues to grow. The installed base of LANs currently is 15,900 worldwide, according to the research company International Data Corp., Framingham, Mass. The number of LANs installed is expected to reach 100,000 by 1988, the company predicts.

Choosing cable and software

Both the NIU and the NIC support all Net/One media, including standard Ethernet, 10M-bps thin-coated baseband, 5M-bps broadband or 10M-bps fiber optic cable, and can be used with Net/One Personal Connection software such as

LOCAL AREA NETWORK GROWTH BOOMS
(WORLDWIDE SYSTEM COMPONENT VALUE, \$M)

	1981	1982	1983	1984	1985	1986	1987	1988	CAGR* 1988
Initial value	\$247	\$440	\$689	\$985	\$1,324	\$1,839	\$2,494	\$3,359	37.3%
Add-on value	30	62	120	187	266	358	497	673	41.2%
Service and support	50	102	189	321	496	765	1,132	1,642	54.1%
Total value	\$327	\$604	\$998	\$1,493	\$2,086	\$2,962	\$4,123	\$5,674	41.6%

*Compound annual growth rate

Source: InfoCorp

Silent/Scribe[®]

Go Quietly.



In these modern times, you have to go all out to stay ahead of the competition. And going with our up-to-date Silent/Scribe printers can help keep you there; because Silent/Scribe quietly goes about your business reports, letters, charts and graphs, while you quietly go about your business.

Unruffled. Undisturbed. And assured that the letter you signed on the first day of the month and the final monthly report will both have

the same crisp high-quality look.

All Silent/Scribe printers feature snap-in long life ribbon cartridges, easy-to-use controls, and Logic/Card[®] interfacing to fit virtually any computer.

And they come in a variety of models to fit your specific needs and budget.

Call us today and discover how going quietly can quickly get you ahead.

Outside California: (800) 4-ANADEx
In California: (800) 792-9992

© Copyright 1984 Anadex, Inc.



Anadex ... When you know printers.

ANADEx, INC. • 1001 Flynn Road • Camarillo, CA 93010 • Tel: (805) 987-9660 • TWX: 910-494-2761
ANADEx, LTD. • Weaver House, Station Road • Hook, Basingstoke, Hants RG27 9JY, England • Tel: Hook (025672) 3401 • Telex: 858762 ANADEx G

CIRCLE NO. 28 ON INQUIRY CARD

We make computers that design what you make.

We're Apollo Computer, the fastest growing professional workstation company in the world. And for some very good reasons.

We introduced a new standard in the computer industry.

In 1981, we introduced the next step in the evolution of the computer. With the logical successor to time sharing: DOMAIN[®] processing.

DOMAIN processing puts on the desk of every technical professional exactly what they need to design and develop new products. Dedicated 32-bit workstations with the compute power of a mainframe. Closely-integrated, bit-mapped graphics. And a high speed local area network that shares information and resources. The result is a fully integrated, dynamic environment that lets your technical professionals produce better, more innovative new products in considerably less time. With considerably lower development costs.

From left to right
application software from:
Mentor Graphics Corp.,
Interleaf,
Auto-Trol,
Swanson Analysis
Systems, Inc.,
Racal-Redac,
Automated Impact,
GE/CAE International,
ORACLE Corp.
and GE Calma Co.

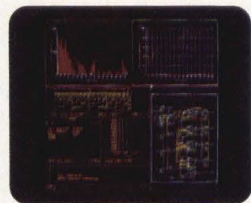

Logic design
simulation.

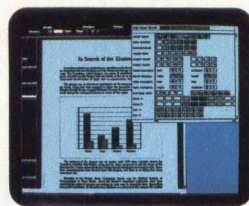

Documentation
with
integrated
graphics and
text.

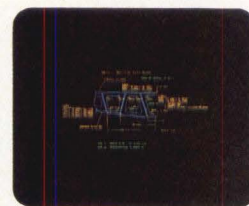

Finite
element
analysis of
gear cluster.

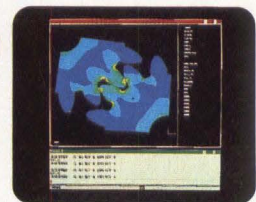

Design
drawing of a
bulkhead.



We have a family of compatible workstations.

Today, we have an unprecedented range of DOMAIN workstations to meet whatever design and development needs you may have. From our high performance VAX™ 780-class DN660 (color) and DN460 (monochromatic) for applications like finite element analysis and solids modeling, to our midrange DN550 for applications like integrated circuit and printed circuit board design. To our low cost DN300 series for applications like software engineering and technical illustration. And all of our DOMAIN family of workstations are completely compatible.

We have nearly 300 technical applications packages.

To stay competitive today, you have to look beyond automating individual tasks. So we allow you to automate the entire development process. With nearly 300 of the most powerful and prestigious third party applications packages available today.

If you'd like to know how we can help boost your technical professionals' productivity and shorten your product development cycle, you have only to ask. Write or call Marketing Communications, Department A1, Apollo Computer, 330 Billerica Road, Chelmsford, Massachusetts 01824 (617) 256-6600 Ext. 4497.

DOMAIN® is a registered trademark of Apollo Computer.
VAX™ is a trademark of Digital Equipment Corp.
ORACLE® is a registered trademark of ORACLE Corp.
© Apollo Computer, Inc. 1984.

apollo

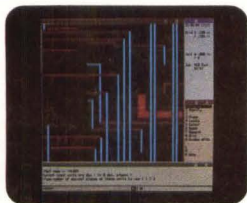

Printed circuit board layout.

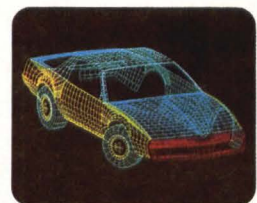

3D surface model.



Exploded solid model of an automobile.



Relational database management system.

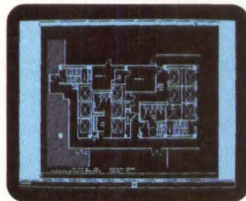

Space plan of a facility.

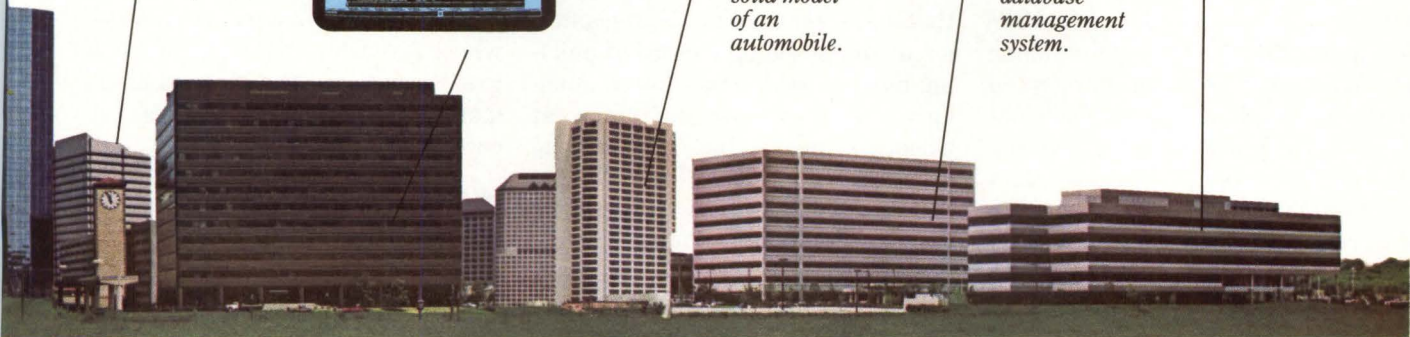

Diskshare, Printshare and Mailshare.

Personal computers configured with either the Personal NIC or NIU can use Diskshare to access files and application programs from shared hard disks on the network.

Mailshare software enables network users to send letters, messages and files over the network and Printshare permits shared access to printers.

The NIC will be sold by the Ungermann-Bass direct-sales force to

major financial institutions and Fortune 500-type companies. The majority of sales will be to OEMs and system integrators who need to put together multiple microcomputer systems, Jordan says. □

Plain-vanilla data-interchange standard proposed for UNIX applications

Stephen J. Shaw
Washington Editor

Four software-development companies have banded together to push for a standard data-interchange format for UNIX-based application packages. The group, known as Independent Software Information Standards (ISIS), released a draft of the proposed standard, also known as ISIS, for industry review at the spring Comdex computer conference in Atlanta.

The proposed ISIS standard seeks to achieve an industry consensus on "read" and "write" files, definitions of command languages and access programs. The goal is to incorporate common headers into all application packages and allow data to be passed between separate programs and users. Although ISIS would provide less file-interchange capability than found in integrated packages, such as Lotus Development Corp.'s 1-2-3, its advantage lies in its ability to exchange data between software programs from different developers by adding common headers.

"ISIS is essentially an intermediate file that allows the user to get data in or out of a program," says Steve Thomas, marketing communications director at Software Ex-

press Inc., one of the four founding members of the ISIS group. "For instance," Thomas says, "if you're working on a general ledger file and need to get data out of a spreadsheet program, you can do it."

According to Thomas, the proposed ISIS standard would be simple for software companies to incorporate into their UNIX application software. Only the three pages of C language programming need to be written into a program, he says.

ISIS ideal for UNIX

The ISIS format is well-suited to the UNIX operating system environment, say industry analysts. UNIX-based computer systems are designed for multiple users who share software files and databases that are added as needed. "ISIS reflects the basic idea of UNIX, [in] that a system need not be monolithic but composed of a series of building blocks," says Brian Boyce, managing analyst for software at Gnostic Concepts Inc., a consulting organization in Menlo Park, Calif.

Boyce sees ISIS as evolving from the data-interchange format (DIF) that allows a degree of data interchange on CP/M operating systems. Under the DIF format, one program, such as a spreadsheet, could write the information and another package, such as a database manag-

er, could read it. Because of the differences in the nature of database files, relational databases in a UNIX environment usually use a relational database model, while CP/M-based systems most commonly use a hierarchical database model. For this reason, ISIS is more complex than DIF, "but not much more," comments Boyce.

Besides Software Express, the other three ISIS consortium founders include Access Technology Inc., South Natick, Mass., Quadratron Corp., Encino, Calif., and Unify Corp., Sacramento, Calif. The four are integrating ISIS compatibility into their own software packages and expect other developers to quickly follow suit. The ISIS standard is currently under review by the UNIX/Usr/group—an association of UNIX users, software developers and equipment suppliers—whose favorable endorsement would greatly increase the chances of the standard's gaining widespread acceptance.

M/A-Com chooses ISIS programs

The efforts of the ISIS founders to create a uniform data exchange format for UNIX software received a boost in May when M/A-Com Sigma Data (MSD) Inc. selected ISIS-compatible programs from all four companies to be packaged by

ELECTRONICS MAKES US BEST

NO OTHER CUT-SHEET FEEDER COMPARES TO THE ZIYAD® Z-300.

Compare the Ziyad® Z-300 Intelligent Paper Processor™ to all other cut-sheet feeders and the difference is obvious.

They are mechanical.

The Ziyad Z-300 is electronic.

In fact, the Z-300 is the only cut-sheet and envelope feeder that electronically captures both name and address from typed letterhead and automatically delivers a typed envelope collated with your letter.

This single feature, alone, makes mechanical sheet feeders obsolete.



paper sizes...including envelopes. When oversized documents have to be printed, a simple touch of a button lets the operator tilt the Z-300 back from your printer.

The Ziyad Z-300 is the only dual-bin, cut-sheet and envelope feeder that has this capability.

ELECTRONICS MEANS RELIABILITY

We stand on proven performance. With integrated electronics the Ziyad Z-300 can boast an incredible MTBF of 6,000 hours. That's more than three years of continuous operation. And, that's why more than 100,000 Ziyad products will be sold this year.

In an age of electronics, don't compromise your electronic word processing system with a mechanical sheet feeder. Add the essential electronic option—the Ziyad Z-300 Intelligent Paper Processor.™

Put our technical hardware and software support team to work for you. Call Ziyad today, and let us show you how easy it is to integrate the Ziyad Z-300 into your next office automation system.

For more information on how Ziyad productivity can work for you, call or write Sue Turner 201-627-7600.

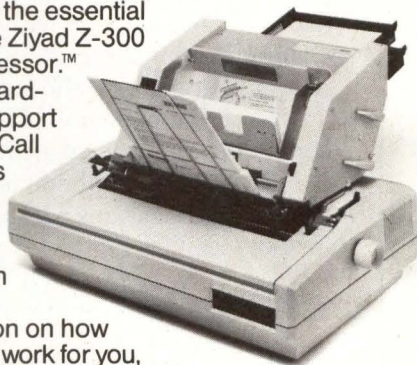

WHY CHOOSE ELECTRONICS?

Precision. Accuracy. Reliability.

All are important in guaranteeing increased office productivity. The Z-300 has integrated three electronic sensors, drive motors, and a tiny PROM chip. This tiny chip acts as a nerve center for the sensors and motors constantly monitoring paper and envelope flow. Both paper and envelope are properly aligned and fed consistently each and every time.

If the paper or envelope trays are empty, or if a misfeed should occur, the Z-300 electronically stops the printer from printing on the platen... immediately. It memorizes typing position, and can automatically alert the operator with an audible and visual signal... whether nearby, in the next room, or on the next floor!

MORE FOR YOU—MORE FOR THE OPERATOR

The Z-300 is easy to operate. It attaches simply to most printers, making it the essential cut-sheet and envelope feeder option to more than 22 of the world's leading manufacturers of word processing equipment. The Z-300 offers various trays to accommodate a variety of

ZIYAD

Ziyad, Inc., 100 Ford Road, Denville, NJ 07834 USA
Telephone (201) 627-7600

Chairman of the boards

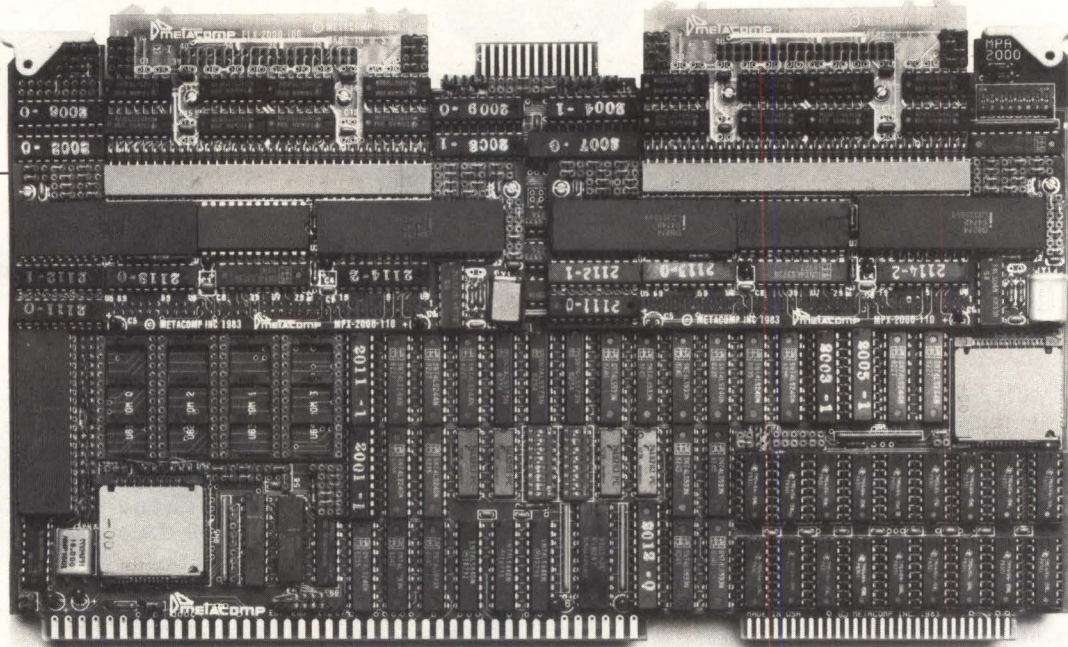

The first true Multibus single-board computer

The MPA-2000 is highly qualified for the top slot. It's the first to offer the iAPX-186 CPU. The first to offer 512KB of dynamic RAM. And, the first with architecture that allows plug-in modules with multiple DMA channel support.

That makes it the first CPU and I/O processor that combines: data processing, data communications, local area networking, disk I/O and similar peripheral functions. Standard data communications packages available include; CCITT-1980 X.25, IBM-3270 SNA (LU 1, 2 & 3), SDLC, HDLC (LAPB) and IBM-3270 BISYNC. Operating system portations include; PC-DOS, iRMX-86, VRTX/86 and MTOS-86. In all, it has the performance and capability to replace 2, 3 or 4 board members in most applications.

With that outstanding resume, it's easy to see how the MPA-2000 became the unchallenged Chairman of the Boards.

For complete specifications and ordering information, call or write METACOMP, Inc., 9466 Black Mountain Road, San Diego, California 92126, (619) 578-9840. TWX 910-335-1736 METACOMP SDG.

Ask for the resume of the Chairman of the Boards.

METACOMP™

The MPA-2000 is a trademark of METACOMP, Inc., Multibus, and iRMX-86 are trademarks of Intel Corp., PC-DOS is a trademark of IBM Corp., MTOS-86 is a trademark of Industrial Programming, Inc. VRTX/86 is a trademark of Hunter and Ready, Inc.
© Copyright 1984 METACOMP, Inc. All rights reserved.

THE MULTIBUS BREAKTHROUGH PEOPLE

Mini-Micro World

NEWS

MSD into the AT&T 3B computer series. AT&T signed an OEM agreement with MSD to market computer systems based on 3B hardware to the federal government. It marks one of the first such accords AT&T has reached with a value-added reseller for its new computer family.

Software application packages that MSD has made available for distribution with the 3B line include Quadratron's complete office automation series, Unify's relational database system, Access Technology's Supercomp 20 and 20/20, and the APGEN series of application generators and accounting applications from Software Express.

MSD, however, is careful to point out that the packages were not chosen because of their data-exchange

capabilities under the ISIS approach, but rather because they are good programs, suitable to the type of federal customers MSD is pursuing. During negotiations with AT&T, neither party raised the subject of ISIS, recounts Michael Abramowitz, MSD vice president for systems marketing. He notes that other UNIX-based applications packages that MSD is making available on the 3B computers include programs that do not conform to the ISIS format, including The Santa Cruz Operation Inc.'s adaptation of Microsoft Corp.'s Multiplan and the MIMIX and PC WORKS communications packages from Touchstone Inc.

Nevertheless, Abramowitz says there is a "definite need" for a data exchange standard for UNIX sys-

tems, and that the ISIS proposal could be beneficial to an end user in an office environment by consolidating databases for multiple applications. "The ISIS group has approached this area properly," the MSD executive says. "There will be some standard established."

ISIS still not widely accepted

The ISIS draft has not met with immediate widespread acceptance. One software developer says it will take a year or more and require the strong endorsement of a major hardware manufacturer for ISIS to come under serious consideration by the 100-odd companies estimated to be working on UNIX applications. Another says that ISIS could suffer from the "not-invented-here" syndrome that will delay acceptance of

HALF INCH TAPE BACK-UP ON YOUR Q BUS. \$3995.



Featuring:

- TS-11* Emulation replacing DEC TSV05*
- 22-Bit addressing support, optional.
- Start/Stop or Streaming Operation.
- 1600 bpi density for up to 69 Mbytes capacity.
- 25/100 ips for up to 160 Kbs data rate.
- Up to 4 drives per controller.
- Price \$3995, quantity one.

Also available:

- TS-11 Emulation on Unibus*, replacing DEC TU80*
- Conventional start/stop 1/2" tape sub-systems for DEC, Data General and HP Computers.
- 1/4" start/stop cartridge tape systems for Q Bus*, Multibus**, S-100 and RS232.

*Trademarks of Digital Equipment

**Trademark of Intel Corporation



DIGI-DATA
CORPORATION
® . . . First In Value

Digi-Data Corporation
8580 Dorsey Run Road
Jessup, MD 20794
Tel. (301) 498-0200
Telex 87-580

In Europe Contact:

Digi-Data Ltd.
Kings House
18 King Street
Maidenhead, Berkshire
England SL6 1EF
Tel. 0628 29555-6
Telex 847720

Mini-Micro World

NEWS

the ISIS standard by most software companies.

Other software developers, however, are keeping their eyes on what happens with the proposed standard and are preparing versions of their packages with the ISIS headers in case ISIS finds acceptance as a de facto industry standard. These companies include Data Resources Inc. and The Santa Cruz Operation.

Gnostic's Boyce predicts that ISIS will gain enough momentum by 1985 to change the "not-invented-here" syndrome to the "me-too" syndrome.

ISIS is an inclusive standard, not an exclusive one," Boyce says. "It's generic enough, sensibly drawn, and so beautifully vanilla that it will run on any UNIX variation." □

Teletype adds 200-cps dot-matrix printers

David Bright, Assistant Editor

AT&T has followed up the spring announcement of its 3B computer line with several related products, including dot-matrix printers. The company's Teletype Corp. subsidiary, a longtime supplier of terminals and printers, recently announced the 5300 family, intended to compete with Digital Equipment Corp.'s LA120.

The popular LA120 is noted for its reliability. But Teletype marketing vice president Daniel Printz stresses the new units' own reliability, plus their speed, flexibility and

features. He expects half of the new products' sales will be to AT&T for integration with the 3B series. The rest will go to other OEMs and distributors.

Each of the two models in the 5300 line operates bidirectionally, producing draft-quality copy at speeds up to 200 characters per second (cps). DEC's LA120 produces draft quality at 180 cps.

The compact model 5310 uses a 9-inch platen, and the model 5320 uses a 15-inch platen. All other components of the two printers are interchangeable, including the ribbon cartridges. Teletype's nine-wire

9600bps MODEM \$97.*

The MADZAR Z9600® series of short haul modems are a cost effective way to get your asynchronous data down the hall or down the street at rates from 75 to 9600 bps. The MADZAR Z9600® series out performs any other brand in its price range and it's available in a rack mount version that packs 16 short haul modems in only 5-1/4 inches of rack space.

Try a pair of our MADZAR Z9600® series short haul modems for 30 days on credit approval. Then decide. Be particular. Buy the best and join the ranks of our growing list of customers like General Electric, NASA, Aerojet Strategic and General Dynamics to name just a few.

Want more information? Call or write us now for a brochure and complete pricing. (We have generous discounts for quantity buyers).



MADZAR CORPORATION
37490 Glenmoor Drive
Fremont, CA 94536-9990
415/794-7400
*100 Unit Price

CIRCLE NO. 33 ON INQUIRY CARD

USE LIGHT TO COMMUNICATE FIBER OPTIC MODEM



- 16 Data channels at 19.2 Kbps variable to 6 channels at 64 Kbps.
- BER of 10E-9 good to 3 miles.
- Local and Remote Alarms
- Low System Cost

Ask also for Fiber Optic Modem at T1 rate and other products.

CALIFORNIA DATA LINK, INC.
45 Granada Court, Portola Valley, CA 94025
Tel: (415) 851-3459

CIRCLE NO. 34 ON INQUIRY CARD

MINI-MICRO SYSTEMS/September 1984

PICTURE PERFECT PRODUCTIVITY

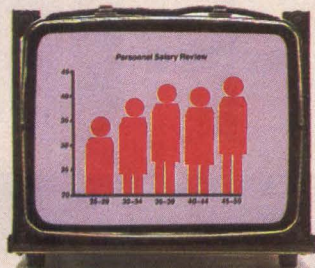

Administration



Order Entry

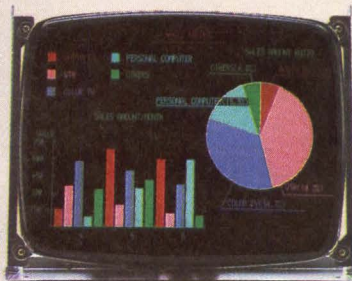

Marketing and Sales

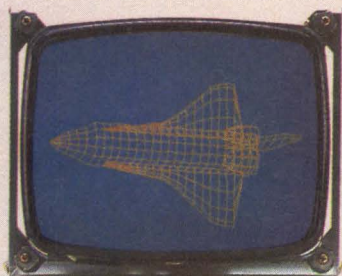

Engineering



Finance

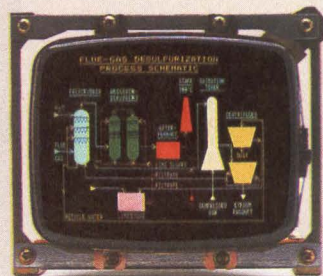

Q.A. and Statistics

MIS Monitors from Mitsubishi

Mitsubishi monitors take excellent care of business at every level from clerical to top management. Our extensive product line includes both color and monochrome models, with high and medium resolution. In any size you need, with exceptional strength in 12", 14" and 16" models. Customs, too.

With all this selection, it's easy for you to performance-match our monitor to your MIS requirements. For superb business graphics, we'll deliver super-high contrast monitors with an extended range of true, vibrant colors and a very dense black. For number-crunching tasks, select a high-efficiency monitor with special anti-reflective coating, reducing operator fatigue even after extended periods of viewing. Choose economical monochrome units to staff up an entire order entry department. And use our precision, high fidelity monitors for demanding CAD/CAM applications.

Just pick the features, then let us show you how Mitsubishi monitors can give your system a better image at the best possible price.

For complete technical specifications or MIS applications information, contact Mitsubishi today.

Write or call: Mitsubishi Electronics America, Inc., Industrial Electronics Division, 991 Knox St., Torrance, CA 90502. Telephone: (213) 515-3993. In the East, call (617) 938-1220; in the Central area, call (312) 298-9223.



**MITSUBISHI
ELECTRONICS**
ADVANCED AND EVER ADVANCING

VMEbus + UN

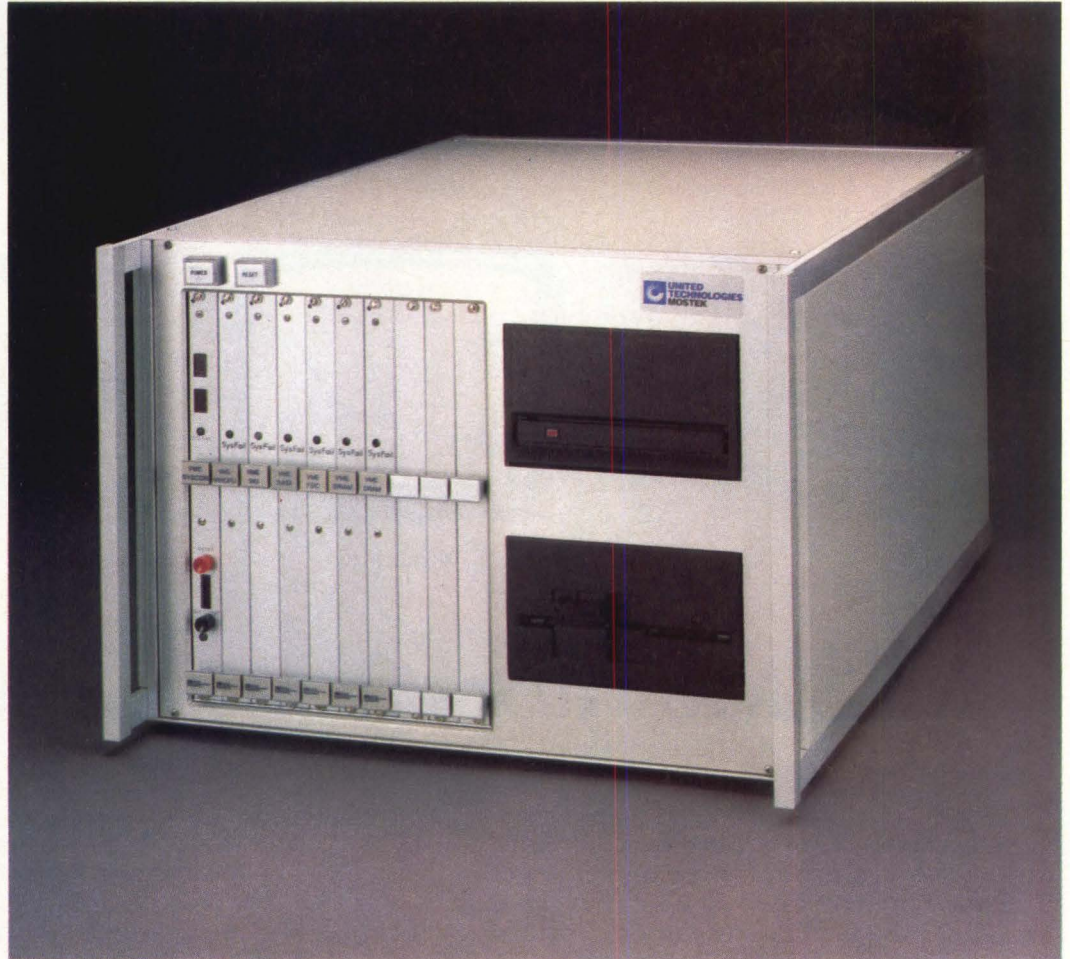

UNIX™ + MOSTEK

Add the above together, and what do you get? The Mostek Matrix 68K™. It combines a multi-user, 16-bit microcomputer system based on the VMEbus architecture—plus a UNIX operating system. The result is a powerful and cost-effective tool for system integrators.

The Matrix 68K is also a high performance tool. It's modular. Structured. Flexible. And easily expandable for future application requirements. What's more, it can lower your development costs, and get your product to the market faster.

This new system in its base configuration features 640KB of expandable main memory, a 36MB Winchester disk, 1MB of floppy disk storage, serial RS-232 interfaces for five users, a standard parallel printer interface, and three open slots for expansion.

The heart of the system is the VME-MMCPU board with its 16-bit processor. The VMEbus-based modular board designs meet today's 16-bit needs. And permit fast, easy reconfiguration for 32-bit applications in the future. So, you won't have to develop another architecture as more powerful hardware becomes available.

The flexibility of VMEbus architecture is further enhanced by the powerful UniPlus +™ operating system (UNIX System III with Berkley enhancements). It provides you with a flexible, expandable operating system that's well suited to program development, text preparation, and general purpose processing. Its supported languages include "C," Fortran, and Pascal.

Another big plus is Mostek's ongoing development of new cards for the VMEbus: a one megabyte DRAM, SMD disk controller, and Intelligent I/O boards will soon be available. With the reconfiguration software package, UNIX can easily be expanded to use these and many more VMEbus boards.

With the Matrix 68K, you get high performance. Full VMEbus compatibility. Transportable software. Flexibility. And unusual value. Because it's all you need today. And tomorrow.

Get in on VMEbus + UNIX + all the future applications. Contact Mostek, 1215 W. Crosby Road, MS2205, Carrollton, Texas 75006, (214) 466-8801. In Europe, (32) 02/762.18.80. In Japan, 03/496-4221. In the Far East (Hong Kong), 5-681157.

UNIX is a trademark of Bell Laboratories. UniPlus + is a trademark of UniSoft Systems. UniPlus + is derived from UNIX System II under license from AT&T. Matrix 68K is a registered trademark of Mostek Corp.



CIRCLE NO. 36 ON INQUIRY CARD

Mini-Micro World

NEWS

AT&T announces UNIX network interfaces

AT&T has announced the first three UNIX System V network interfaces in its new COMMKIT network and communications software. The packages support the company's 3B computer line and other minicomputers running UNIX System V.

The synchronous terminal interface enables ASCII and EBCDIC terminals to communicate with UNIX System V

minicomputers, while the Ethernet interface supports Digital Equipment Corp. VAX minicomputers in an Ethernet local-area network (LAN). The Ethernet interface provides batch file transfer, remote command execution, communications with other Ethernet-compatible machines and user-level compatibility with 3BNET, which is supported on the 3B line. The price

for either interface is \$5,000.

The HYPERchannel interface provides the software connection between 3B20 computers or other UNIX System V minicomputers and the HYPERchannel LAN from Network Systems Corp. The price is \$10,000. All three products should be available in the fall.

print head has a life of 100 million characters, says Printz. The 5310 weighs 15 pounds; the 5320 weighs 21 pounds. Teletype's 5310 and 5320 and DEC's LA120 all handle com-

munications speeds up to 9,600 baud. An integral modem is optional on the Teletype printers but not on the LA120.

The 5310 and 5320 become print-

ing terminals with the addition of the optional, low-profile, detached keyboards. The 5320's keyboard has a built-in keypad. Setup is performed via eight pressure-sensitive buttons and a 4-character liquid-crystal display (LCD) on the front of the printers. The 300- to 1,200-bit-per-second modem performs auto-dial, auto-log-on and auto-answer, displaying the status on the LCD. Users can select line-buffer sizes of 256 bytes, 1K byte or 2K bytes.

Friction-feed platens are standard on both printers, with a pin-feed platen optional on the 5310. The 5310 has a "last-form-tear-off" feature that saves paper; it is unnecessary to feed an empty form through the printer between documents.

The printers contain three Intel 8051-based circuit boards: a controller, a print card and a board for the LCD. Users can replace the boards themselves by tipping the printers forward and removing four screws.

Printz says the maximum noise level on the printers is 74 decibels when producing high-resolution graphics. Fifteen character sets, including APL, Securities Industry, Finnish and Italian, are standard. The printers have three graphics modes: bit-mapped, business and Videotex with the mosaic element set. List prices range from \$1,300 to \$1,987 for the 5310 and from \$1,775 to \$2,463 for the 5320. □

TELETYPE CORP. 5300 FAMILY TAKES ON DEC LA120

	5310	5320	LA120
Print speed cps	200, bidirectional	200, bidirectional	180, bidirectional
Characters per inch	8 settings: 5-16.7	8 settings: 5-16.7	8 settings: 5-16.5
Character matrix size	7 x 9	7 x 9	7 x 7
Form width (in.)	3-9.5	3-15	3-14.9
Paper type	single sheet, roll, fanfold	single sheet, roll, fanfold	fanfold
No. of forms printed	6	6	6
Interfaces	RS232C	RS232C	RS232C, RS423
Integral modem?	\$500 option	\$500 option	no
Line buffer (bytes)	2K	2K	1K (optional 4K)
Weight (with keyboard) (lbs.)	15	21	102
Price (\$)	1,300	1,775	2,420
Price with keyboard (\$)	1,492	1,984	2,800



AT&T subsidiary Teletype plans to sell its new 5310 (right) and 5320 dot-matrix printers to AT&T and other OEMs and distributors.

Excellence Found

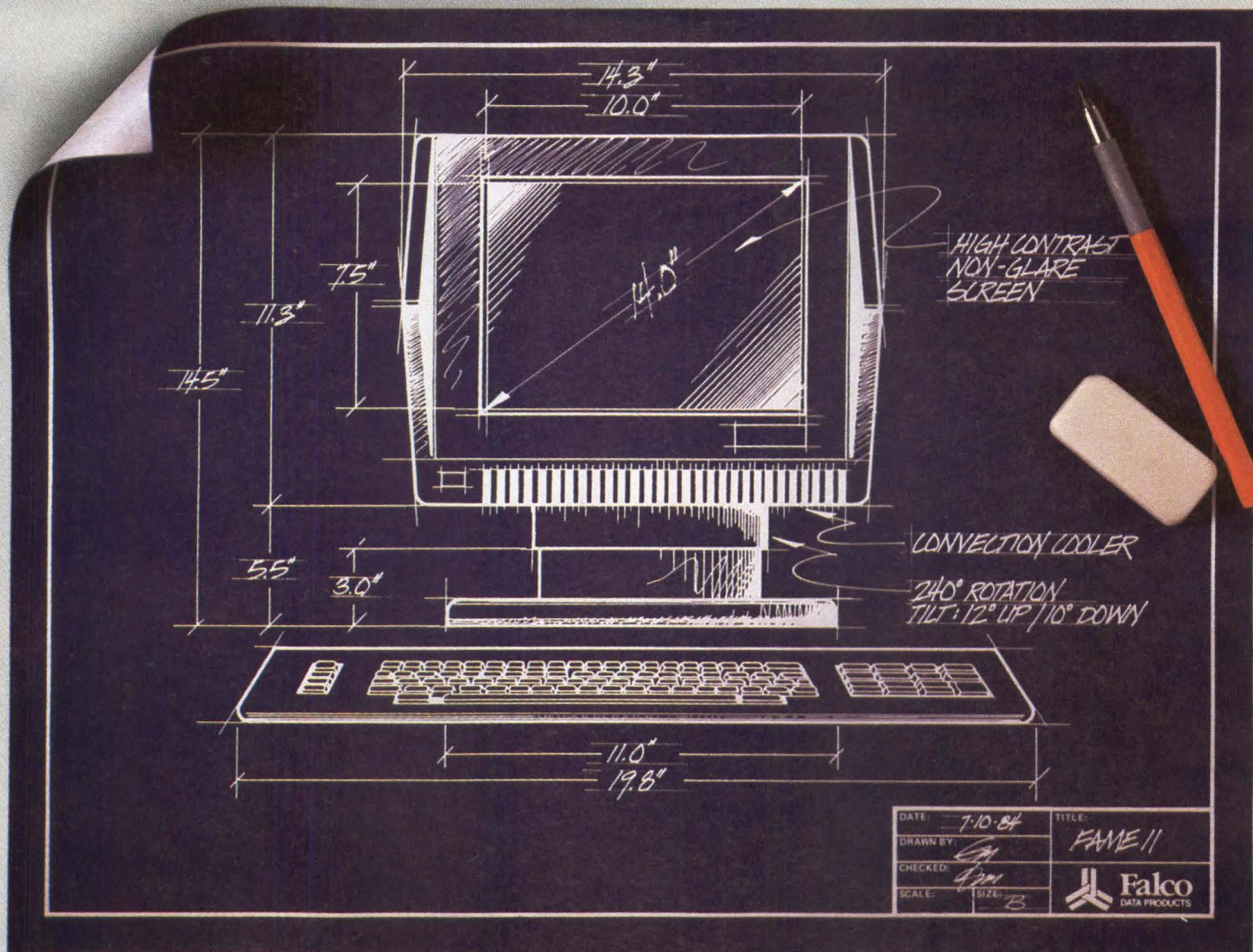

FAME II's advanced features make it the perfect multi-purpose terminal.

- VT100 compatible (ANSI 3.64) and VT52 mode with 80/132 columns
- TVI 925 mode with 2 pages of memory
- 24 or 25 lines plus status and user line
- 50 non-volatile programmable function keys with 900-character storage (77 per key)
- Two independently configurable communications ports
- Block and monitor modes
- Transparent print
- Soft extension port

- Screen saver (protects screen from burned-in shadows)
- Full page or single line soft screen set-up
- Buffered printer port
- Standard line character graphics plus 64 mosaic characters

Whether you choose our top-of-the-line FAME 100, or our low-cost FAME III, you get a lot more terminal for a lot less money.

For more information call toll free:

800-538-5383 800-835-8765
 (within California) (outside California)

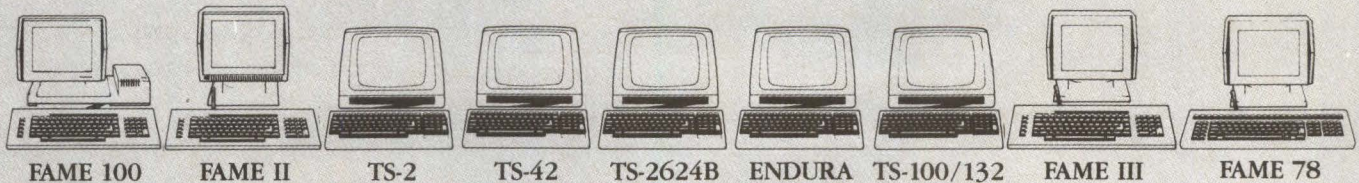

FALCO DATA PRODUCTS

WESTERN REGIONAL OFFICE
 1286 Lawrence Station Road
 Sunnyvale, CA 94089
 (408) 745-7123

SOUTHERN REGIONAL OFFICE
 2091 Business Center Drive
 Suite 100
 Irvine, CA 92715
 (714) 476-3111

CENTRAL REGIONAL OFFICE
 9801 West Higgins Road
 Suite 220
 Rosemont, Illinois 60018
 (312) 823-5340

EASTERN REGIONAL OFFICE
 855 Valley Road
 Suite 1000
 Clifton, New Jersey 07013
 (201) 472-2801

CIRCLE NO. 37 ON INQUIRY CARD

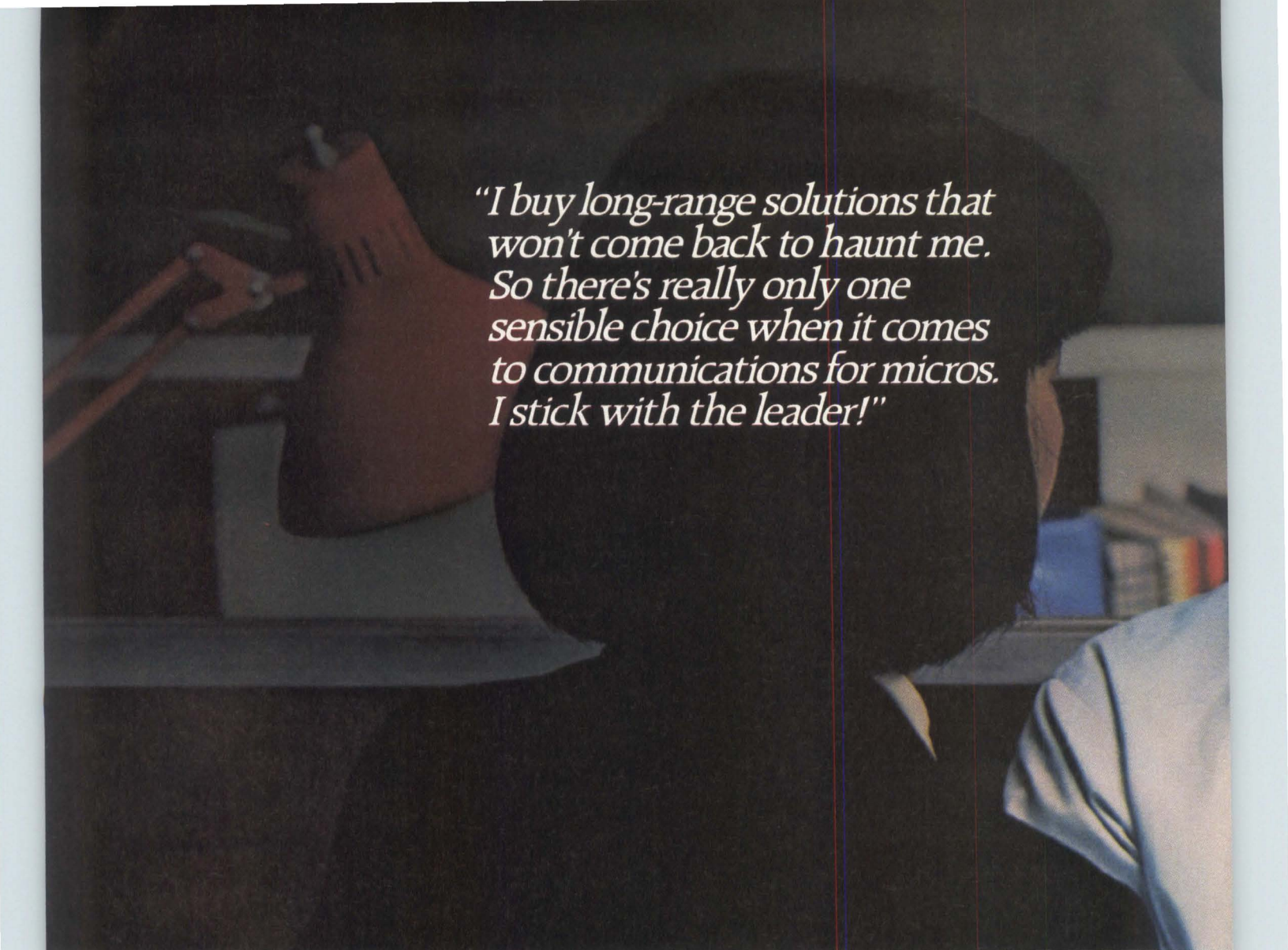

"I buy long-range solutions that won't come back to haunt me. So there's really only one sensible choice when it comes to communications for micros. I stick with the leader!"

Hayes. Leading the way with quality telecomputing systems for the personal computers that businesses use most.

If you're in the business of configuring computer systems for businesses, you know the importance of quality and reliability.

That's one good reason to trust the telecomputing leader. Hayes Smartmodems (300, 1200 and the 1200B board modem for the IBM® PC and compatibles) have an unsurpassed record of reliability. And when Smartmodem is combined with Hayes Smartcom II® software, you have the most complete and dependable telecomputing system available!

Smartcom II is flexible. Use it as is or customize it for particular applications. Smartcom II makes telecomputing simple for beginners, with sophisticated programming options for you.

Now Smartcom II does even more to streamline business communications.

More connection capabilities. Our new Smartcom II is available for more

than 16 personal computers (with more to come). Now the DEC Rainbow in purchasing can swap data with the HP 150 in accounting. While the IBM PC in sales gets updates from the TI in the southeastern office. Quickly and easily, Smartcom to Smartcom. And with no handholding from you.

XMODEM protocol. In addition to the Hayes Verification protocol, Smartcom II includes the XMODEM protocol, for error-free transmission to even more micros, as well as to mainframes at the information services.

Terminal emulation. Smartcom II emulates the DEC VT100 and VT52 terminals, opening the door to a vast installed base of DEC minicomputers.

Voice to data communications. With Smartcom II, users can easily switch from voice to data transmission (and back again), all in the same



phone call. This saves the user time and the company money.

Unattended operation. Smartcom II can increase the efficiency of corporate communications, by receiving and sending data unattended. It can receive messages on disk or hard copy. And Smartcom II also lets users "batch" up to 25 communication sequences, and will automatically transmit them later. This convenient feature can cut long-distance costs considerably, since data can be sent when phone rates are lowest.

Follow the leader! If you're involved with linking micros or setting standards for configurations, let Hayes provide the definitive connection. With our feature-rich, direct-connect modems. Easy-to-use, menu-driven software. Concise documentation. And a customer service organization that is second to none!

Smartcom II

Available for: IBM PC and compatibles, plus HP 150, DEC Rainbow 100, Texas Instruments Professional and Portable Computers and Wang Professional.*

- Hayes Verification and XMODEM protocols
- Records and executes up to 25 communication sequences for unattended transmission
- Emulates DEC VT100 and VT52 terminals
- Prints data while recording on disk
- Stores telephone numbers and communication parameters
- Defines and stores log-on sequences and 25 remote system commands
- 128K memory
- Voice/data communications.

Smartmodem

- Smartmodem 300™ (300 bps), Smartmodem 1200™ (up to 1200 bps) and Smartmodem 1200B™ (plug-in board modem for the IBM PC)
- Direct connect
- Auto answer, dial and disconnect
- Full or half duplex
- Automatic speed selection (1200 modem)
- Built-in speaker
- Two-year limited warranty.

For additional information see your Hayes authorized dealer or call us direct.
Hayes Microcomputer Products, Inc.
 5923 Peachtree Industrial Blvd.,
 Norcross, Georgia 30092. 404/441-1617.



Hayes

Smartcom II is a registered trademark and Smartmodem 300, Smartmodem 1200 and Smartmodem 1200B are trademarks of Hayes Microcomputer Products, Inc. *Trademarks of International Business Machines Corp., Digital Equipment Corporation, Hewlett-Packard, Texas Instruments and Wang Laboratories, Inc. ©1984 Hayes Microcomputer Products, Inc.

CIRCLE NO. 38 ON INQUIRY CARD

Database manager eases OEM application-development tasks

Carl Warren, Western Editor

Aimed at OEMs and system integrators, the Probase database-management system (DBMS), developed by Probase Group, Redondo Beach, Calif., is a full-feature relational database manager for both 8- and 16-bit computer environments.

Even with microprocessor constraints, relational database systems provide users with a number of functions. Probase—available for systems using Digital Research Inc.'s CP/M-80 or CP/M-86, IBM Corp.'s PC-DOS or Microsoft Corp.'s MS-DOS operating systems—can support up to 16 million bytes per file on 16-bit systems and 1 million bytes on 8-bit systems. Although these files are larger than most microcomputer systems can accommodate, Probase supports large files across multiple diskettes.

Generators are the key

Probase's application generators are key product elements, says Probase president Curt Luce. Luce points to three optional aids for program developers: QUICK GEN, REPORT GEN and MENU GEN.

The screen-oriented QUICK GEN generates data-entry and display programs. Formats are laid out as if they were on a piece of paper. Field sizes and the proper entry format are selected by developers. Unlike other products, such as generators for Ashton-Tate's dBASE II and III database managers, QUICK GEN permits setting the order for entering each field. To maximize flexibility of the generated screens and data dictionary definitions, dynamically created tables can be edited to fine-tune the application. "Once the application is generated,



Probase Group's president, Curt Luce, is waiting to see what AT&T's impact on the software industry will be. He's taken a conservative approach in making the Probase database-management software more portable by using the C language.

the user can then further enhance the system by using the supporting development language," says Steve Bostwick, president of Query Computing Systems Inc., Torrance, Calif. "In addition, a master creation file can be kept for use when the database-entry system has to be changed. The operator needs only the final results."

REPORT GEN and MENU GEN are used in the same manner as QUICK GEN but serve special purposes. One of the major problems with database-management systems, according to both Luce and Bostwick, is their inflexibility in creating reports. Therefore, REPORT GEN lets users design a report by moving the fields around on the screen as in creating the database. "Virtually any form design desired can be created," claims Luce.

The MENU GEN links many defined databases and functions. For example, many menus can be nested—one calls the other, and each defines a different set of functions.

Networking available but . . .

Due to the increasing emphasis on multiuser capability in networks,

the Probase Group offers Probase Net, which is compatible with 3Com Corp.'s Ethernet local-area network. The Probase software allows as many as 100 users on the network and—like Ashton-Tate's—provides record-locking to ensure proper updating and security of files.

A back door to portability

Software portability is a major industry issue, and Luce is taking a back-door approach. "Right now, we have Probase written in machine-dependent code. However, the application definitions and databases are portable. Plus, due to the flexible command language, users can quickly create a utility to port foreign files to operate under Probase or back to [operate under] another product such as MicroPro International Corp.'s Wordstar. We consider this to be solving one of the major problems in portability." In addition, Probase comes with utilities that handle file translation, thus saving the integrator's time.

But Luce isn't forsaking the portability of the product either. Probase is exploring the optimum method of providing processor-independent code so that Probase can be ported to any processor. "We will soon have a version of Probase written in C. The question is, however: Is it the optimum language for the long haul? We think there may be other options. A great deal depends on AT&T's influence on the overall market.

The Probase system including the three generators sells for \$390; Probase P without the generators sells for \$180; the program generators alone sell for \$210; and Probase Net lists for \$540. Probase R, a run-time-only version, sells for \$90. □

Printers as versatile as the people who use them.

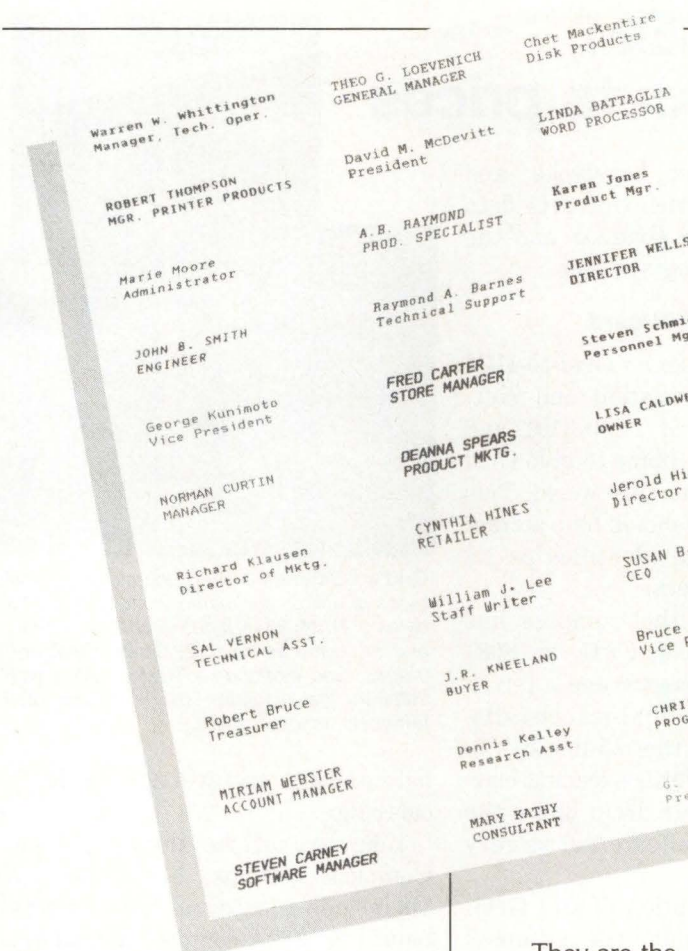

including OCR-A and -B, bar codes, dot addressable graphics, forms, and logos. You can even extend your print horizontally or vertically to produce super-high or super-wide characters as well as non-alphanumeric symbols.

If you'd like, we'll design a special font for you and deliver it in less than a month.

For added versatility you even have complete color capabilities with certain units.

The GP300 printers are some of the quietest in the industry today. We've engineered them to operate at 51 dB or less. You won't have to shut down your office when you start printing.

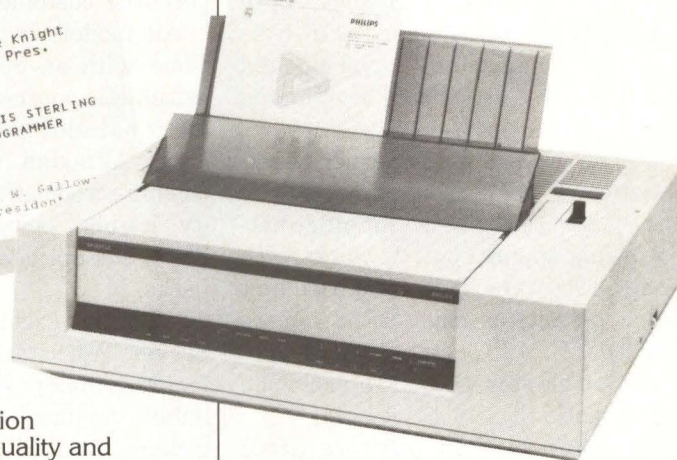

The Philips GP300 printer family was designed for people who want a printer that will handle nearly all of their applications — at a price they can afford.

The GP300 printers provide high speed for DP use, high quality for word processing, and a broad range of print characters for telecommunications.

They are the first true multi-speed, multifunction integrated letter-quality and graphics printers available.

The GP300 product line features Philips' proprietary and field-proven 18-needle print head. It produces single-pass dot resolutions up to 18x50 in text and up to

144x144 dots/inch for graphics. All at speeds up to 300 cps.

You can use the printer interface to load any of the 95 character sets

Depending on your application, you can choose from a complete line of paper handling devices including platen, tractor, or front feed as well as automatic single sheet handlers.

If you're looking for a printer that is quiet, versatile, fast, dependable, and economical, find out more about the new industry standard today. Call or write for complete information on the Philips GP300 printer family.



Philips Peripherals, Inc.
385 Oyster Point Boulevard, Unit 12
South San Francisco, CA 94080
(415) 952-3000

CIRCLE NO. 39 ON INQUIRY CARD



PHILIPS

Mini-Micro World

NEWS

Grid links products to IBM, expands portable line, cuts prices

Tom Moran, Associate Editor

Grid Systems Corp., Mountain View, Calif., has expanded its family of Compass portable computers. It also has linked its products to the IBM Corp. environment via networking, MS-DOS compatibility and software for terminal emulation and data-file conversion.

Grid introduced its new version, Compass II, in two models: the 256K-byte 1121 at \$6,795 and the 512K-byte 1129 at \$7,995. Both have four sockets for 128K-byte ROM cartridges that can be plugged in by users. Grid should be shipping the 10-pound portables.

A new \$3,450 GridServer workstation is a bare-bones version of the Compass designed for office networking applications. It works with the GridServer, a desktop base unit that permits as many as 58 remote or local IBM PCs and Compasses to share disk storage and to exchange information.

Three new Grid software products are GridAccess, a telephone-management program for Compasses; GridRecord/GridPlayback, which replicates long command se-

quences with one keystroke; and GridTransfer, which converts data files between the Grid-OS and the MS-DOS operating systems.

Grid plays the IBM card

MS-DOS support, Grid-to-IBM PC data-file translation and software emulation of IBM 3101 and 3270 terminals combine to give Grid users access to the IBM world. This product strategy should help attract those whom Grid identifies as its potential customers.

All models in the Compass line come with an 8086 CPU, an 8087 arithmetic coprocessor and a 6-inch diagonal electroluminescent display. Although the 25-line-by-80-column screen affords excellent clarity, its high power drain limits the life of the optional external battery packs.

With the exception of the GridServer Workstation, the Compass family members sport 384K bytes of bubble memory. The Compass IIs include the four ROM sockets and one 128K-byte ROM pack with system utilities. ROM cartridges will start at \$225. MS-DOS, the Grid word processor, and the Grid termi-



Grid's Compass II offers as much as 1.4M bytes of solid-state memory, including 512K bytes of RAM, 384K bytes of bubble memory and as many as four 128K-byte ROM cartridges. Grid is offering a ROM cartridge with software that emulates IBM 3101 and 3270 terminals, among others.

nal emulator are available on ROM cartridge.

Like two of the three previous Compass systems, both Compass IIs include an integral 300- to 1,200-baud Bell 212A-compatible modem.

Portable stores 1.4M bytes

Starting with 512K bytes of RAM and 384K bytes of bubble memory, the Compass II 1129's on-board memory can be expanded to 1.4M bytes using four 128K-byte ROM packs. Grid claims the Compass II has at least twice the memory of competing briefcase portables.

In bringing out its new family, Grid also dropped the prices on its existing models by 23 percent to 30 percent. The 256K-byte Compass 1100 was \$5,995 and is now \$4,250. The Compass 1101 with 256K bytes of RAM and 384K bytes of bubble memory, was \$6,795 and now sells for \$4,995. The 512K-byte Compass 1109, which topped the line at \$7,995, now sells for \$6,195. It also has 384K bytes of bubble mem-

GRID EXPANDS PRODUCT FAMILY, ADDS ROM SLOTS TO HIGH END

Model	EL display 8086 8087	RAM memory (K bytes)	384K-byte bubble memory	512K-byte ROM slots	1200/300 baud modem	Price (\$)
GRiDServer Workstation 1705	•	256				3,450
Compass 1100	•	256	•			4,250
Compass 1101	•	256	•		•	4,995
Compass 1109	•	512	•		•	6,195
Compass II 1121*	•	256	•	•	•	6,795
Compass II 1129*	•	512	•	•	•	7,995
Tempest 1107	•	512	•	•		12,495

*includes one 128K-byte ROM pack with system utilities

Source: Grid Systems Corp.

The MTX512 opens up to endless OEM possibilities.

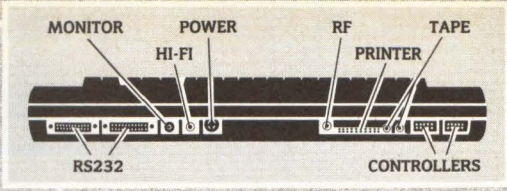

Until now, micros meant limitations. In hardware. In performance. And in OEM applications. But the new Z-80A based MTX512 micro computer opens up a whole new world of applications for OEMs. Because it gives you power and flexibility no micro has ever given you before. Especially when you consider the base price—under \$600 retail.

A designer's dream

The MTX512 will surprise you with its standard features. 16 color high resolution graphics. 8 simultaneous windows. Cartridge ports for up to 4MB ROM, pageable in 32KB increments. An uncommitted parallel port. Centronics parallel printer port. Monitor, RF, hi-fi and cassette ports. Plus 104KB of memory—including 64KB user RAM—expandable to 512KB through user-transparent memory segmentation. But don't stop there. The MTX512's open architecture lets you customize to your own needs. Internal expansion slots let you add twin RS232C ports, plus your own custom boards. Optional floppy, hard disk or silicon disk drives provide storage up to 160 MB. You can even connect up to 256 units together in our Oxford Ring—Local Area Network (LAN).

Simplify your development with interacting languages.

Developing software couldn't be more simple. Embedded in ROM are MTX BASIC and MTX GRAPHICS, incorporating LOGO-type commands. MTX NODDY, a simple 11 command text language. Symbolic ASSEMBLER/DISASSEMBLER. And a front panel debugging tool. All 5 can be used interactively and coherently, giving you unprecedented flexibility.

Add disk drives, and the MTX512 runs CP/M* allowing you to choose from the world's largest library of software.

Quality components for added reliability.

When you use computers in your applications, assurance in quality and performance is essential. The MTX512 is designed around proven components, like the Zilog Z80A (running at

4 MHz) and the TI 9928 video processor. All housed in an anodized aluminum case, which not only provides extraordinary durability, but heat dissipation and RF protection as well.

The MTX512's applications are as expansive as your imagination.

Contact us today for more information.
USA: Memotech Corporation, 99 Cabot Street, Needham, MA 02194 617-449-6614
Europe: Memotech Limited, Station Lane, Witney, Oxon. OX8 6BX, England.

MEMOTECH

CIRCLE NO. 40 ON INQUIRY CARD



*CP/M is a registered trademark of Digital Research Inc.



NOW THOUSANDS OF CALIFORNIA OEM'S AND SYSTEMS INTEGRATORS FOCUS ON JUST ONE SHOW.

And so can you...on Mini/Micro West.

Mini/Micro West is the one West Coast event that focuses entirely on computer design needs. That means you, as an exhibitor, can deal face to face with the prime concentration of OEM's, systems integrators and software developers.

Having their own event recognizes the importance of the California OEM market today. For you, it presents a unique opportunity to zero in on California OEM's face to face—in an environment undiluted by other interests.

Sponsored by California regional units of IEEE and the Electronic Representatives Association

So if you're after California OEM's and systems integrators, be at Mini/Micro West. For complete information, call toll-free: 800-421-6816. In California, 800-262-4208.

*The Anaheim Hilton Exposition Center,
February 5-7, 1985.*



Mini/Micro West
FOCUSING ON THE OEM

LOTUS 123[®]

Lotus 123[®] and Dataproducts new 8050 and 8070 printers are the best combination for any business assignment.



Everyone's talking about the best software package on the market, the Lotus 123.

Dataproducts wants you to go one step further with their 8050 and 8070 printers.

These versatile printers translate the wealth of information generated by the Lotus 123 into charts, graphs and text.

They deliver a full page of text quality print in nothing flat while their sheet feeder automatically prevents loading hassles. And the 8050 and 8070 use pin feed or plain paper and have the brains to fill every appropriate

line with crisp, sharp copy, even if they have to proportionally space to do it.

And the 8050

and 8070 printers have dual speed capability for correspondence quality output for word processing applications, and high speed output for draft or spreadsheets.

The Dataproducts 8050 and 8070 printers. And the Lotus 123. There's no better combination on the market. For more information go 1234 to your nearest computer store and ask about our 8050 and 8070 printers, or call Dataproducts, 818-887-8000.



Dataproducts computer printers

Nobody puts ideas on paper so many ways. Dataproducts Corporation, 6200 Canoga Avenue, Woodland Hills, CA 91365.

123 and Lotus are trademarks of Lotus Development Corporation.

CIRCLE NO. 42 ON INQUIRY CARD

NOTHING ELSE STACKS UP TO IT.

The IOMEGA Alpha 10H Half High: More Performance, Reliability, Versatility— And Virtually Unlimited Capacity.



Take the measure of IOMEGA's new Alpha 10H. Not just the low-profile, half-high physical dimensions, but its true OEM height—a height measured in performance, versatility,

convenience, cost-efficiency, dependability and deliverability.

New Heights In The Measure Of Reliability And Performance.

Thanks to IOMEGA's revolutionary cartridge technology, OEMs can integrate a mass storage solution into their systems that easily surpasses traditional Winchester or even Winchester cartridge alternatives. In access time (35 ms average). In transfer rates (1.13 Mb/sec). In day-in/day-out dependability.

Capacity, Convenience, And Low Cost-Per-Megabyte: Taking The Measure Even Higher.

One of the best measures of the Alpha 10H's true OEM height is in the versatility it allows you to design into your system. Our highly reliable, easily transportable and absolutely interchangeable 10-megabyte cartridges mean the sky's the limit on system capacity in applications as diverse as system control and monitoring, office information and word processing, and industrial instrumentation, among others. So is convenience. Be it loading large and complex data bases, or the rapid, reliable backup of system data, the Alpha 10H simply cannot be topped. Lastly, in low cost per megabyte, no storage device, fixed or floppy, stacks up.

Do Your Own Measuring. Call Today.

The IOMEGA Alpha 10H half high is available, right now. For more information on how this superb new IOMEGA offering measures up to the competition, give us a call.

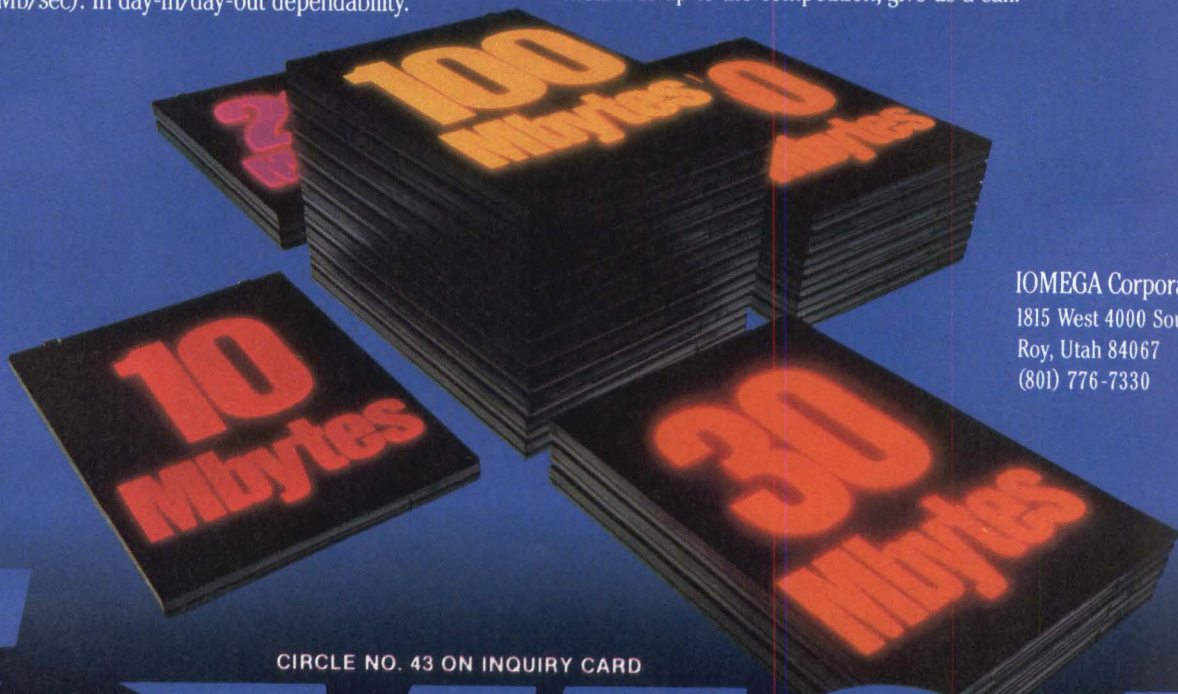

IOMEGA Corporation
1815 West 4000 South
Roy, Utah 84067
(801) 776-7330

CIRCLE NO. 43 ON INQUIRY CARD

IOMEGA™

Mini-Micro World

CORPORATE AND FINANCIAL

Franklin's success sours after Apple lawsuit

David Bright, Assistant Editor

Franklin Computer Corp., once a highly prosperous Apple-compatible vendor, is now faced with the possibility of closing. Following a wave of top management resignations, massive layoffs and production delays on its new portable microcomputer, the 3-year-old Pennsauken, N.J., company filed in late June for federal bankruptcy protection under Chapter 11.

Until very recently, the company appeared to be growing at a healthy pace. In its fiscal year ended in March, Franklin said it sold 70,000 Ace computer systems, causing revenues to jump to \$71 million, from \$28 million the previous year. At one time the company boasted more than 1,500 dealers. And former president Avram Miller, previously manager of Digital Equipment Corp.'s Professional computer program, had bigger plans for the company. Miller had recruited several top engineers from IBM Corp., DEC and other industry leaders to build the CX portable computer, which runs Apple II software as well as MS-DOS and CP/M. After Franklin had settled out of court an 18-month-long legal battle with Apple Computer Inc. last January, its future seemed assured.

Apple had claimed that Franklin illegally copied the Apple operating system, which resides in ROM. Franklin agreed to develop its own operating system, which is split between ROM and disk memory. In return, Apple gave Franklin a grace period of three months to make the changeover.

At that time, Franklin co-founder and chairman Barry Borden called the settlement (for \$2.5 million) "wonderful." "This will work out



Franklin Computer Corp.'s 27-lb. CX computer is the first portable to run Apple II software, MS-DOS and CP/M. However, Franklin is strapped for funds and may not be able to produce the CX in quantity.

fine for both companies," he said. Borden has since left the company.

Apple lawsuit drained Franklin

But Franklin's recent troubles may stem from that long fight with Apple. "They just didn't bounce back from the Apple lawsuit," sums up a source close to the company. For one thing, Franklin's investment in the new operating system called for in the settlement was "substantial," as Borden put it. To make matters worse, Franklin was late shipping computers with the new system.

Meanwhile, Franklin was also readying the CX portable for a May introduction. Then, in early April, Miller resigned, saying his long-range professional goals could not be fulfilled at Franklin. "My real interest was in developing a large, broadly-based company engaged in microcomputer applications beyond the personal computer industry," he said. About the same time, the company laid off 70 of its approximately 500 employees.

Most of Miller's management team has since resigned, including William Sydnes, operations vice

president; Varam Erdekian, manufacturing vice president; and Eugene Sherman, marketing vice president. After further resignations and layoffs, the company finally let go 160 of 275 employees remaining at the time of the Chapter 11 filing. Co-founder Joel Shusterman, who had resigned in February, returned three months later as acting president.

Still hoping to recover

Shusterman and new chairman Morton David still hope to save Franklin. The company's "loyal" dealers and the fact that Franklin makes the only legal Apple-compatible portable are stressed by Shusterman as strong points. In a statement announcing the bankruptcy filing, David said the company was negotiating to be acquired.

But analyst Alan Hirsch of Data-pro Research Corp. says Franklin's efforts are not going to be good enough. In his opinion, "only Apple can introduce an Apple II portable and get away with it." Apple can easily quash any Apple-compatible competition by decreasing its prices, he explained. Furthermore,

Mini-Micro World

CORPORATE AND FINANCIAL

...and Osborne is reborn

Tom Moran, Associate Editor

As Franklin was filing for bankruptcy protection, the Osborne Computer Corp. received court approval for its own reorganization plan. After an official, 60-day waiting period, Osborne expected to be healthy by early this month.

The once successful innovator of the transportable computer is moving from its 112,000-square-foot Hayward, Calif., facility to a 24,000-square-foot building in Fremont, Calif. Under the reorganization plan, Osborne becomes a new company. Its creditors receive \$15.5 million and 20 percent of the new company's stock. Controller Mike Anthofer says Osborne's \$15.5 million debt already has been reduced to less than \$9 million, and will be paid off within 15 months. At one point, the company even auctioned off furniture and equipment, netting \$1.1 million for its creditors.

Osborne will contract its manufacturing to third parties who will provide it with systems packaged for vertical markets. The company plans to sell half of its products overseas, says vice president of operations Chodi McReynolds.

Even as the bankruptcy protection proceeded, Osborne's products continued to be popular in Europe. Towards the end of reorganization, 80 percent of the company's sales were in overseas markets. Osborne currently has approximately 60 domestic dealers and will continue looking for major account sales in vertical markets, says McReynolds.

Osborne president Ronald J. Brown stresses the company's commitment to portable and transportable computers. But its IBM-compatible portable is not a significant factor in the recovery plan, he adds. Osborne has signed an OEM arrangement with Vadem of Milpitas, Calif., for Vadem's 9-lb. MS-DOS portable with built-in modem, 5¼-inch disk drive and LCD screen. Brown says Osborne will sell the Vadem machine overseas after adding value in the form of communications products.

Former chairman Adam Osborne and former president Robert Jaunich remain on the board of directors, but neither is involved in the company's day-to-day operations. Adam Osborne has begun a software publishing concern and Jaunich is working as a consultant to venture capitalists.

Hirsch says, the Apple II base is eroding. Franklin is trying to "scrape the crumbs off the market, but those crumbs are dwindling." He added that he also feels Franklin suffers from poor management.

Egil Juliussen of the market researcher, Future Computing Inc., Richardson, Texas, claims "the market is there" for another Apple-compatible portable. The problem with Franklin is that it grew too fast and lacks a "top-notch management team," he says. He further suggests that the management shuffle was the result of a power struggle.

Another problem at Franklin is one that plagues many other small computer companies: money. Miller's vision was apparently bigger than his company's bankroll. Franklin might have been able to absorb

the \$2.5 million payment to Apple, but there were other, related costs, such as legal fees for the long litigation process, development costs for the new portable and for the new operating system, and losses resulting from the late shipment of the operating system. The expense of bringing Miller and his associates to the company, and construction of a new building, added to Franklin's monetary troubles.

The company had accumulated \$6 million in venture capital and had planned a stock offering to get more cash. But it delayed the initial offering, Miller said last fall, because of the impending introductions of the IBM PCjr and the Apple Macintosh.

Upon rejoining Franklin, Shusterman conceded that the financial bind caused by withholding the stock offering, combined with

the pressure of developing new products, had "produced a very anxious environment" at Franklin.

Product manager Gwen Lurie remains optimistic about the CX portable. She claims Franklin's "high assets" put it in better stead than most Chapter 11 companies. But those assets may not be high enough. Reportedly, Franklin even had trouble getting the bankruptcy protection press release out to the media. The company's public relations outfit refused to send it out because Franklin was behind in payments, according to an agency employee.

Franklin's initial CX shipments were delayed from June to late August due to "parts shortages," but Lurie says that may actually be "a blessing" because it allows more time to fully test the machine. However, continued delays will give Apple more operating time to staturate the market with its IIc portable.

If Franklin finds a way to produce the CX in quantity, it must also hang onto its dealer network, which has fluctuated between 900 and 1500 outlets. William Peer, president of one such dealership, Lane Business Systems, Morris Plains, N.J., says he plans to stay with Franklin, if it can produce. But he admits the situation is "up in the air," noting the company had not even notified him about late shipments. □

Wet Ink

Archive Corp., Costa Mesa, Calif., recently signed several companies to contracts for its ¼-inch, streaming cartridge tape drives. Altos Computer Systems Inc. will buy \$6 million worth of Archive's 60M-byte drives over two years, while Media Distributing Inc. is committed to purchasing \$5.5 million worth of drives. Point 4 Data

UNIX[®] IS A DINOSAUR CP/M[®] & MS-DOS[™] ARE TOYS

MULTI SOLUTIONS PRESENTS

THE WORLD'S FIRST 4th GENERATION OPERATING SYSTEM

A SERIOUS
OPERATING
SYSTEM

S1[™]

FOR TODAY
AND
TOMORROW

- PORTABLE
- MODULAR
- MULTIUSER
- MULTITASKING
- MULTI PROCESSING
- PARALLEL PROCESSING
- 64 CHARACTER NAMES
- 3 COMMAND PROCESSORS
- REAL TIME
- NETWORKING
- DISTRIBUTED PROCESSING
- HIERARCHICAL DIRECTORIES
- KEYED FILES
- ISAM
- VSAM
- B-tree
- RECORD LOCKING
- UNIX SOURCE COMPATIBLE
- WINDOWING
- BIT MAPPED DISPLAYS
- FULL SCREEN MANAGEMENT
- FULL SCREEN EDITING
- FULL MEMORY MANAGEMENT
- VIRTUAL MEMORY
- SEMAPHORES & LOCKS
- EXTENSIVE UTILITIES
- AND MUCH, MUCH MORE

S1 IS THE ONLY OPERATING SYSTEM WORTHY OF THE TITLE:
“THE NEXT WORLD STANDARD.”

ONLY S1 DOES IT ALL.

NO OTHER OPERATING SYSTEM
COMES CLOSE. CUTS DEVELOPMENT
TIME FROM MAN YEARS TO MAN MONTHS.

Please send for additional information.

IN TIME, ONLY THE BEST WILL SURVIVE: S1



Multi Solutions, Inc.
123 Franklin Corner Rd.
Lawrenceville, N.J. 08648
609-896-4100 Telex: 821073

*Reg. Trademarks: CP/M of Digital Research; Unix of Bell Laboratories Trademarks: MS-DOS of Microsoft, Inc.
CIRCLE NO. 44 ON INQUIRY CARD

Mini-Micro World

CORPORATE AND FINANCIAL

Corp. and Maynard Electronics Inc. will buy \$3.3 million and \$3 million worth, respectively....**Language Processors Inc.**, Waltham, Mass., landed two contracts for its LPI-COBOL compiler. In a \$4.5 million, five-year deal, NCR Corp. will offer the compiler with its Tower MC68000-based computer. Plexus Computers signed to purchase \$3 million worth of the compilers over five years....In a \$4 million, 18-month agreement, Data Phase Corp. agreed to purchase approximately 60 Parallel 300 fault-tolerant computer systems from **Parallel Computers Inc.**, Santa Cruz, Calif. Data Phase will add its library information software and resell the systems to libraries....MDS Quantel Inc. and **Printek Inc.**, Benton Harbor, Mich., signed a multi-year

agreement for MDS Quantel to purchase at least \$3 million worth of Printek 930 printers. MDS Quantel also acquired manufacturing rights to the 930. The printers will be used with MDS Quantel's office workstations....**Shugart Corp.**, Sunnyvale, Calif., recently picked up two contracts for its half-height 5¼-inch minifloppy disk drives. Mindset Corp. will use the 500K-byte drives in its new IBM PC-compatible computer, optimized for graphics. And Zenith Data Systems will incorporate the drives in its new Z-100 PC series of IBM-compatible desktop and portable computers. The Mindset agreement is for \$8 million; the Zenith, for \$3 million....**Western Digital Corp.**, Irvine, Calif., will supply TeleVideo Systems Inc. with \$5 million worth of Winchester and

floppy disk drive controllers. The controllers will be used in TeleVideo's multi-user and personal computers. Western Digital has been supplying TeleVideo with controllers since 1981.

Quarterly report

For the 12 weeks ended June 2, **Data General Corp.** reported that revenues surged to \$277.1 million from \$188.7 million for the same period a year earlier. Earnings increased to \$19.6 million, or 74 cents per share, from \$4.3 million, or 18 cents per share a year previously. For the 36 weeks ended June 2, revenues reached \$745.1 million, compared to \$557.1 million for the same period a year ago. Net income for the 36 weeks rose to \$41.2 million from \$12.5 million. □



HIGH PERFORMANCE, VERSATILITY, VIVID COLOR, CRISP IMAGE TOEI COLOR DISPLAYS FTC/CDM - SERIES.

TOEI, experienced Display Monitor specialists, offer a wide selection of Color CRT Displays. You can choose from our versatile standard models or OEM versions to meet your exacting requirements.

FTC-12" Series

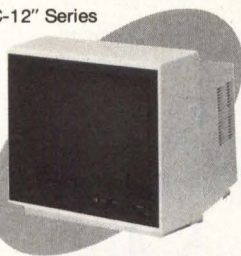

CDM-14" Series

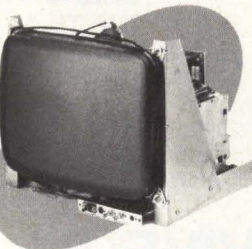

FTC Series (Housed in lightweight, impact-resistant Cabinet)

Versions CRT Size	RGB Version	NTSC Version	PAL Version	NTSC & RGB Version	PAL&RGB Version	IBM PC Compatible only
12" (CRT Pitch)	FTC-1201-R* (0.47mm Stripe)	FTC-1200-N (0.64mm Stripe)	FTC-1200-P (0.64mm Stripe)	FTC-1201-NR (0.47mm Stripe)	FTC-1201-PR (0.47mm Stripe)	FTC-1203-I* (0.38mm Dot trio)
	FTC-1203-R* (0.38mm Dot trio)		FTC-1201-N (0.47mm Stripe)			FTC-1201-P (0.47mm Dot trio)
	FTC-1208-R* (0.28mm Dot trio)	FTC-1410H-N (0.52mm Stripe)	FTC-1410H-P (0.52mm Stripe)			FTC-1410H-NR (0.52mm Stripe)
FTC-1423H-R (0.42mm Stripe)	FTC-1416-N (0.64mm Stripe)		FTC-1416-P (0.64mm Stripe)	FTC-1455H-I (0.31mm Dot trio)		
FTC-1435H-R (0.39mm Dot trio)						
14" (CRT Pitch)	FTC-1455H-R (0.31mm Dot trio)					

Application/NTSC·PAL (Commodore·Apple II, Ile), RGM (IBM PC·Apple II, Ile, III·RGB TTL & Analog)

*FTC-1201-R, 1208-R: Applying for FCC Standard (Class B). *through Interface-Module

*FTC-1203-R: Acquired FCC Standard (Class B). FTC-1203-R, 1203-I: Non-Glare

CDM Series (Unit for OEM)

Model	CRT Size	CRT Pitch
CDM-1208	12"	0.28mm Dot trio
CDM-1203	12"	0.38mm Dot trio
CDM-1201	12"	0.47mm Stripe
CDM-1455H-R	14"	0.31mm Dot trio
CDM-1435H-R	14"	0.39mm Dot trio
CDM-1423H-R	14"	0.42mm Stripe
CDM-1410H-R	14"	0.52mm Stripe

- Green/Orange CRT Displays are also available. (Included IBM Compatible.) CRT size: 9" or 12". Horizontal frequency: 15.75-64kHz. [15.75kHz version: acquired FCC Standard (Class B).]
- Conform to UL Standard.
- Special made products: Select Horizontal Frequency within 31-40kHz (Color), 24-64kHz (Monochrome). Models display providing with more than 640x400-dot-resolution are also available.
- We are looking for reliable and established distributor worldwide.

TOEI ELECTRONICS (MFG) CO., LTD.

[Japanese Name: Toei Tsusho Co., Ltd.]

Kanda Cent Bldg., 2-4, Yushima 1-chome Bunkyo-ku, 113 Tokyo JAPAN
Tel. (03) 257-1131 Telex. 0222-2555 TOEICO J FAX (03) 258-3560

IBM PC is a Trademark of IBM Corp. Apple II, Ile, III are Trademarks of Apple Computer Inc.
Commodore is a Trademark of Commodore Business Machine Inc.

Mini-Micro World

INTERNATIONAL

Taiwan's PC-compatible makers stumble following problems with IBM copyrights

Charles Hintermeister
Taiwan Correspondent

The enthusiasm and optimism with which Taiwanese computer makers entered the IBM PC-compatible market last year appears to be dwindling. Victims of strong local and international competition, Taiwanese companies are also being forced to contend with their own underdeveloped distribution channels, a recent IBM PC price cut and an underlying fear of continuing legal difficulties with their products.

Taiwanese computer companies had once set their sights on a PC-compatible market that promised a bonanza for all—one which would lift the island's young computer industry out of the legal morass and economic dead end of Apple II counterfeiting. Now, they have largely abandoned the idea of entering the U.S. market using their own brand names, and are increasingly counting themselves lucky to land OEM deals. Taiwanese makers who displayed PC-compatible systems at



Stan Shih, chairman of Multitech Industrial Corp, says IBM's price cuts will benefit Taiwan's computer industry, because more U.S. manufacturers will seek offshore manufacturing sites.

the July National Computer Conference in Las Vegas, Nev., say they were there looking primarily for OEM buyers in the United States.

IBM challenges Taiwan's BIOS

The manufacture of 16-bit PC-compatibles in Taiwan began last year with a development project

sponsored by the Electronics Research Service Organization (ERSO), an arm of the government-run Industrial Technology Research Institute. Nine companies each paid as much as \$150,000 for rights to manufacture and distribute their own versions of the PC-compatible machine that ERSO designed. A number of other Taiwanese companies came up with their own designs.

The ERSO prototype was independently designed, ERSO assured the nine firms, and would not likely lead to a legal conflict with IBM. But, although it appeared that ERSO went to considerable lengths to design a basic input/output system (BIOS) that did not violate IBM's copyrights, IBM reportedly wrote to Taiwanese manufacturers and government officials in April that it had not succeeded. Several shipments of Taiwanese-made 16-bit PC clones were detained at U.S. Customs, and Taiwan's Ministry of Economic Affairs threatened to impose a ban on the export of such

When compatibility becomes counterfeiting

When IBM accuses PC clone makers of copyright infringement, the charge generally involves copying the basic input/output system (BIOS), which plays a crucial role in determining the degree of compatibility with software written for the IBM PC. It was with this in mind that Taiwan's Electronics Research and Service Organization (ERSO) designed the BIOS for its IBM PC-compatible system, says Chia-Chi Chin, manager of ERSO's System Design Technology Group.

"The ERSO BIOS was independently developed," declares Chin, "and does not violate IBM copyrights." Chin, who played a leading

role in ERSO's IBM PC-compatible development project, says the project took about one year to complete and involved 11 ERSO engineers. "If we had wanted to simply copy the IBM PC," he said, "we could have done it in a few weeks at considerably less expense. Instead, we developed our own independently."

IBM appears to disagree. Chin admits that ERSO used published IBM material relating to the PC, a step which IBM Taiwan Corp. general manager Barry B. Lennon deplored. Not only should ERSO not have used IBM PC documents, says Lennon, they should not have had anyone on their development team who had more

than a passing familiarity with the IBM PC. Only in this way, he says, could ERSO have assured itself of coming up with a truly independently developed product.

When ERSO officials met with IBM attorneys in April, says Chin, they discussed only the principles of what constitutes copyright infringement, and did not enter into technical details. The changes that ERSO subsequently made in the BIOS, he says, were carried out entirely by ERSO engineers without IBM's involvement. Consulting firm Arthur D. Little Inc., Cambridge, Mass., acted as a bridge in discussions between ERSO and IBM, Chin says.

Mini-Micro World

INTERNATIONAL

systems until the problem was resolved. Though the threat was never carried out, many companies complied with a request from both IBM and the Ministry to temporarily slow, or halt, exports.

IBM attorneys visited ERSO headquarters in Taiwan's Hsinchu Science-based Industrial Park in April. Although what passed between the attorneys and ERSO was largely kept secret, local news reports indicated that a review of records and documents pertinent to the development process convinced IBM that ERSO's prototype did indeed violate IBM copyrights on the PC's BIOS. The attorneys reportedly agreed, however, that the similarities between the two BIOSs were "minor and unintentional." ERSO carried out some necessary changes, apparently with the help of foreign legal and technical advisors, and IBM is said to have written ERSO in May that it no longer considered ERSO's BIOS to be in violation of its copyrights.

Worries persist

The incident threw a serious scare into Taiwanese PC-compatible makers, many of whom used to make Apple II look-alikes until legal problems led them to stop. Shipments have since resumed and, for the most part, are passing U.S. Customs. But delays in getting products into the United States, coupled with IBM's recent price cuts for the PC of 18 percent to 23 percent, have made U.S. marketing efforts even tougher for the Taiwanese concerns.

The price advantage held by Taiwanese computer makers has been seriously reduced by IBM's price cuts. As lower price had been Taiwan's major—perhaps only—advantage, many Taiwanese 16-bit system makers are considering getting out of the market. Selling to OEMs is not enough, they say. "Even though

we have our own office in the United States," explained Michael Conley of Multitech Industrial Corp., "we realized some time ago that we don't have the ability to effectively market our MPF-PC there." Multitech, a large Taiwanese computer manufacturer, recently signed an OEM agreement with Applied Digital Data Systems (ADDS), Hauppauge, N.Y., under which Multitech's MPF-PC will be exclusively marketed in the United States under the ADDS' PC-1 model name.

OEM sales are difficult, too

Tim Juan, a marketing specialist at Mitac Inc., Taupei, Taiwan, takes Conley's pessimism one step further, saying that not only are Taiwanese makers unable to penetrate the 16-bit PC market in the United States, but that prospects for OEM sales look dim as well. The reason, he says, is that since the IBM PC price cut, U.S. OEM buyers have been offering to buy systems for around \$800 free on board (FOB), meaning OEMs would then own the systems. That would enable the Taiwanese to send the product to the United States for about \$1,000. Taiwanese manufacturers, however, says Juan, are generally unable to deliver 16-bit systems for so little.

As evidence of the local industry's dim view of the future of the IBM PC clones, Juan said that negotiations between Intel Corp. and the Taiwanese government for rights to manufacture the 8088 microprocessor in Taiwan have been abandoned.

Other industry observers have suggested that the negotiations were dropped simply because the persistent, serious shortage of 8088 chips in Taiwan has largely eased.

Juan and others at Mitac believe that the product life of 16-bit IBM PC-compatible systems is limited, and that far-sighted Taiwanese firms are now preparing to act as OEM manufacturers for the coming wave of 32-bit systems. Mitac shocked the industry last year by declining to participate in the ERSO development project, choosing instead to make its own PC-compatible system.

Multitech's chairman, Stan Shih, still anticipates opportunities for Taiwanese companies in the PC-compatible business. While agreeing that most Taiwanese computer firms—his own included—had been overly optimistic about their ability to distribute their own products in the United States, he believes the IBM price cut will, in the long run, benefit Taiwan's computer industry. "The price cut," he says, "will cause a serious shake-out among U.S. manufacturers of IBM PC-compatible systems, and will force increasing numbers of them to seek offshore manufacturing sites. A number of those sites will undoubtedly be in Taiwan." U.S. manufacturers have always held a strong lead in technology and product design, he says, but have lost their edge in production, thus obliging them to increasingly seek out overseas manufacturers. □

POSTAL SERVICE'S ECOM MAIL SYSTEM ORDERED SOLD

The Postal Service Board of Governors has ordered the U.S. Postal Service to sell its ECOM computerized mail system. The decision came after months of criticism from government agencies and private companies that ECOM was stifling the development of the commercial electronic mail market by charging prices that were far below service costs, and illegally subsidizing the difference with revenues from first-class mail service. All ECOM equipment must be sold or leased to private companies, according to the board ruling. The board's decision came after it rejected a proposal that called for a price hike of ECOM letters from \$.26 to \$.39.

SAMSON™



NOTHING GIVES UNIX* MORE MUSCLE THAN SGS' NEW SAMSON™.

Want to unlock more of the capabilities of UNIX? Want the best UNIX-based cost-per-megabyte system in the industry? Then you want the power of Samson.

Backed by more than a quarter of a century of technological strength, SGS' 32/16-bit multi-user, multi-task, virtual memory Samson packs large-mainframe power in a compact, rack-mountable cabinet. Standard features include a 70MB Winchester disk with the only 67MB formatted cartridge back-up warranted for interchangeability, plus the strength to support up to 34 ports.

Multibus* compatible, dual-bus, dual-port memory, 10-slot chassis.

Samson is more than muscle. It is designed for speed, flexibility and expandability. System architecture is based on industry-standard Multibus, enhanced by SGS' new P2 dual-bus structure (SAM-BUS™).

Samson permits the main processor to converse with memory, while allowing the other intelligent Multibus controllers direct access to memory (DMA) via the Multibus (P1) connector. Each bus can address the system's full 16MB range. The result is exceptionally high-speed

operation and significantly improved throughput without the need for cache memory architecture.

32/16-bit Intelligent Serial I/O Controller.

Samson's Intelligent I/O incorporates the same 32/16-bit microprocessor strength as the master CPU. The microprocessor allows software originally handled by the CPU, to be executed directly by the I/O firmware, further increasing overall system speed and throughput. This, coupled with the compatibility of the powerful Z8030* Serial Controller, make the I/O extremely flexible.

Powerful system- oriented software.

Total in-house expertise allows SGS to be system oriented — not just hardware or software. In fact, SGS is one of the few hardware vendors to port the full version of UNIX and to develop its own programs.

One SGS package, M.E.N.U.™, guides users through UNIX and the wide range of other powerful user-friendly programs available on Samson. These include a sophisticated word processor, electronic spreadsheet, TELEX PLUS™ (a package for automatically sending and receiving telex messages), IBM 3780*, APPGEN*, Ethernet*, UNIFY*, RM/COBOL*, SMC-BASIC and "C".

Meets today's demanding OEM and user needs, tomorrow's challenges.

Samson incorporates the most commonly used OEM "standards" including UNIX, MULTIBUS AND ETHERNET. Compatibility with an exceptionally wide range of products means OEM's can negotiate with numerous manufacturers for the best available peripheral values.

In fact, both OEM's and end users can count on increased UNIX performance now and in the future because SGS has unlocked the strength of Samson.

Get all the powerful facts on SAMSON — the historical breakthrough. Call Jim Sullivan: 602/867-6245. Or write SGS Semiconductor Corporation, 1000 East Bell Road, Phoenix, Arizona 85022.

Call today 602/867-6245



Technology and Service

*UNIX is a trademark of Bell Laboratories

*RM/COBOL is a trademark of Ryan-McFarland Corp.

*APPGEN is a trademark of Software Express

*IBM 3780 is a trademark of Int'l. Business Machines

*Z8000 is a trademark of Zilog, Inc.

*Telex is a trademark of Western Union

*Multibus is a registered trademark of Intel Corporation

*Ethernet is a trademark of Xerox Corporation

*UNIFY is a trademark of UNIFY Corporation

*TELEX PLUS, M.E.N.U., SAM-BUS and SAMSON

are trademarks of SGS Semiconductor Corporation

CIRCLE NO. 46 ON INQUIRY CARD

WHEN IT COMES TO WINCHESTERS, WE RUN CIRCLES AROUND THE COMPETITION.

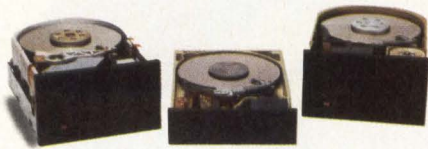

Tandon's made so many improvements in Winchesterst that the rest of the drive industry is dizzy just trying to keep up.

We build a wide range of drives. Open-loop and high performance closed-loop models. In both full and half-height versions ranging from 12.8 to 36.2MB unformatted capacities.

All are available in high quantities now, because Tandon's been ramping up capacities at a pace like never before. And we've kept up the pace of improving Winchester performance as well, so the most advanced technology is ready when you need it.

As far as our current line is concerned, the low-cost TM500 line has become the most reliable full-height 12.8 and 19.1MB drives you can get. The

new TM252 half-height 12.8MB surpasses the industry's most critical specifications. And our TM703 has been increased to 36.2MB to make it the ideal high capacity drive for desktop business systems.

Another part of our success revolves around our highly automated plated media plant in Northern California. Its buttoned-down efficiency and technological sophistication guarantee higher quality and higher volume production than ever.

What's more, our proprietary plated media is used in all our Winchesterst, no matter what the capacity. It's more durable, more reliable. And it has six times more storage capacity than oxide media. At less than half the cost.

In fact, it's so good, other drive manufacturers are buying their plated media from us.

So all around, Tandon Winchesterst have more capacity in less space at less cost.

And that's a pretty good circle to run around in.

Tandon

THE DRIVING FORCE BEHIND THE SMALL COMPUTER INDUSTRY.

Tandon Corporation, 20320 Prairie, Chatsworth, CA 91311. (818) 993-6644, TWX: 910-494-1721, Telex: 194794. Regional Sales Offices: Boston (603) 888-8612 • New York (201) 851-2322 • Atlanta (404) 934-0620 • Chicago (312) 530-7401 • Dallas (214) 423-6260 • Irvine (714) 669-9622 • Santa Clara (408) 727-4545 • Kelsterback/Frankfurt, West Germany 6107-2091, Telex: 411547 • Reading/London, England (0734) 664-676, Telex: 848411. Distributors: Hall-Mark, Kierulff, Schweber.

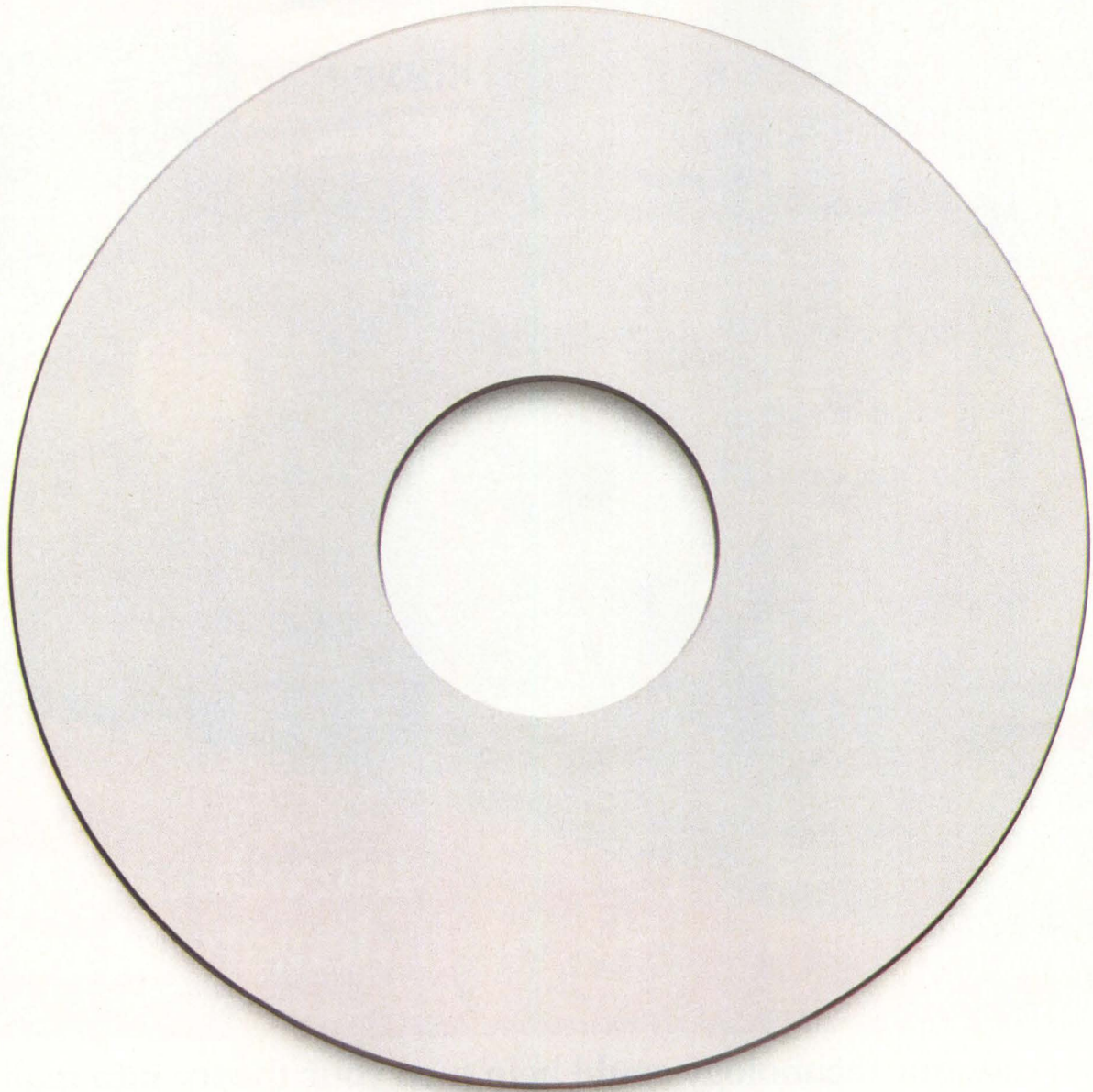

CIRCLE NO. 47 ON INQUIRY CARD

You're challenging the
limits of 5¼" drives.
And so are we.



Introducing the
5¼" high-density Maxell.

Tomorrow, our technology could help turn your theory into reality.

Where will new drive capabilities come from? Your vision. And our ability to envision the disks they demand.

When a new high-density 5¼" flexible drive went on the drawing board at YE Data, we went to work on a disk that matched its unprecedented 2,000,000 byte capacity. Compressing our oxide layer to a mere one micron, we achieved a 15,000 BPI recording density at 600 oersted resolution. And made a remarkable theory a reality.

What's next? You tell us. In the meantime, we'll be making 8", 5¼" and micro floppy disks that lead the industry in error-free performance and durability. Disks made to specifications so exacting, the only standard is our own. The Gold Standard.

maxell®
IT'S WORTH IT.



Maxell Corporation of America, 60 Oxford Drive, Moonachie, N.J. 07074 201-440-8020

CIRCLE NO. 48 ON INQUIRY CARD

Mini-Micro World

INTERNATIONAL

Japan's stance on software copyright causes international rebuke

George Black

Contributing Correspondent

Any hopes for an early solution to the international dilemma over software copyright protection seem to have dwindled. Japan is at odds with the rest of the world on the issue.

The Japanese maintain that current copyright law is unlikely to provide adequate protection. Japan's Ministry of International Trade and Industry (MITI) early this year had proposed a bill to improve protection by requiring Western software vendors to deal by license through Japanese hardware manufacturers. But the bill included provisions to cut the period covered by a copyright from 50 years to 15 years. One of the bill's many Western critics, Dr. Douglas Eyeions, spokesman for the European Computing Services Association (ECSA), London, notes that

obligating software vendors to sell through Japanese hardware manufacturers would be particularly intimidating to IBM. The U.S. view, which is broadly backed by most other nations, is that copyright law has worked well in the past and does not need changing.

The Agency for Cultural Works blocked the bill when it was debated in the Diet, the Japanese Parliament. The Agency controls such legislation, but a battle with MITI over the rights to introduce similar legislation continues.

The U.S. argument has been summed up by Sen. Frank R. Lautenberg, D-N.J., who was a co-founder of the computing service company Automatic Data Processing, Roseland, N.J. He says, "The MITI proposals would weaken consensus, encourage other nations to follow Japan's example and invite international retaliation." Terry R. Lautenbach, a vice president in IBM Corp's Information Systems Group, says that any nation that does not enact a suitable copyright law will be taking a divergent course from the rest of the world. The MITI legislative proposals on software, including systems software, would be disastrous for IBM, says Lautenbach, who argues that IBM is entitled to all the profits of its own research and risk-taking.

The 15 nations composing ECSA stand firmly behind the United States and IBM. According to ECSA's Eyeions, this is not only a Japan/United States issue, it is a Japan/rest-of-the-world issue.

Some Europeans fear that Japan is inviting piracy by claiming its existing law is inadequate to prevent it, says Eyeions.

The Japanese are particularly

worried about the state of copyright laws in neighboring Far East countries. China, for instance, does not recognize copyrights, and China is Japan's biggest potential market. However, Yang Chao Shu, director of the Chinese government software center at Beijing, says China is reviewing the need to come into line with the rest of the world on copyright matters.

The president of the Japan Software Industry Association, Kazuro Fujimoto, asserts that no international consensus exists about software protection. Faced with angry protests by the Americans, the Japanese have tried to appear flexible. Zentarō Kitagawa, law professor at Kyoto University, emphasizes that Japan thinks the matter needs further study before any conclusion is reached.

The software protection issue came to a head at the World Computing Services Industry Congress

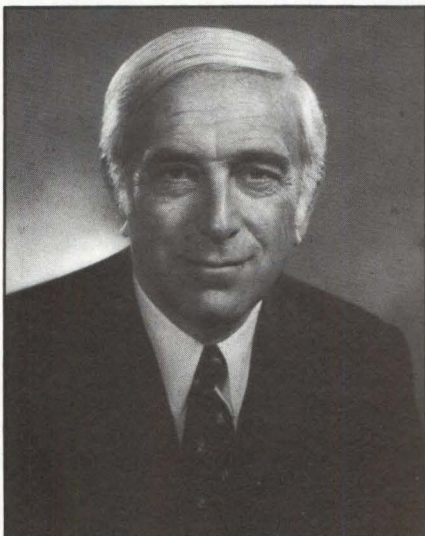

Sen. Frank R. Lautenberg says dissenting software protection schemes proposed by Japan would weaken consensus, encourage other nations to follow Japan's example and invite international retaliation.



Dr. Douglas Eyeions, spokesman for the European Computing Services Association, notes that making Western software vendors sell products through Japanese hardware manufacturers would particularly intimidate IBM.

Mini-Micro World

INTERNATIONAL

held in Tokyo in June. Especially vehement during the session was John Maguire, president of the American software house, Software AG. He asked why a 1982 recommendation by the Japan Software Industry Association (JSIA) to MITI to adhere to the copyright formula has been ignored. Kitagawa responded that a difference of opinion had since arisen between JSIA and MITI.

The copyright issue could take years to sort out. The United

States, strongly influenced by IBM's situation, is unlikely to yield. According to IBM sources, the company takes the matter very seriously. Contracts offered to IBM employees who write programs for the Personal Computer stipulate a 70-year copyright.

Eyeions' statement of unity in Europe reflects policy, rather than actuality. In his own country, Britain, no case has been brought to court to test the law. So far, cases have been settled out of court,

which is less expensive. And, Lautenberg warns, Japan's neighbors may follow its example. Korea has yet to accede to either the Berne Copyright Convention of 1886 or the Universal Copyright Convention of 1952, and Korea's small software business has begun to grow at a phenomenal pace. □

George Black is the software editor of *Computer Weekly*, based in London.

Shrink wrap licensing binds software pirates

Keith Jones, European Editor

A novel way of preventing unauthorized duplication of software, called shrink wrap licensing, is being pioneered in California and Louisiana. Shrink wrap licensing establishes a software license as soon as a user breaks open the package in which a piece of software is contained. The license would theoretically be a contract prohibiting copying, modifying, selling or renting—and possibly, reverse engineering—of the software.

W. Krag Brotby, chairman and founder of Vault Corp., a Westlake Village, Calif., vendor of software protection products, says his company has worked closely with legislators in California and Louisiana on shrink wrap bills. Brotby says that shrink wrap licensing, added to existing state contract laws, will be more easy to enforce than federal copyright legislation. A problem with copyright, Brotby adds, is that software often can be rewritten to avoid copyright infringement, while providing the same functionality. He notes that a shrink wrap contract between maker and user can include the prohibition of such reverse engineering.

Brotby traveled to Europe, Australia and the Far East earlier this year to promote both the shrink wrap concept and his own company's products, which he describes as "not impregnable" and needing backup by legislation.

With a shrink wrap license, the user becomes a licensee of the software publisher the moment he or she

opens the package, provided there is contract legislation affirming the legality of the agreement inside the package. Brotby cites the preliminary draft of a Software License Enforcement bill introduced to the California legislature by Assemblyman Gray Davis, D-Los Angeles. The bill says a license will be enforceable "provided that a written legend is affixed to, or packaged with, a copy of computer software in such a manner that the legend is clearly and conspicuously visible upon a cursory examination of the copy...and provided that the legend states clearly that (1) any use of the copy of the computer software will

constitute acceptance of the terms of the accompanying license agreement and/or states that (2) any opening of the package, envelope or container in which the copy of the computer software is contained will constitute acceptance of the terms of an accompanying license agreement." It goes on to state that any user who does not agree with the license can return the unused, unopened copy of the software program to the party from whom it was acquired, within a reasonable period, for a full refund.

Brotby describes the software protection situation in Europe as "a shambles" because of the lack of legislation. A new pressure group in Britain called the Federation Against Software Theft has been set up to extend the criminal penalties of the Copyright Act to computer software. FAST members include the British operations of IBM Corp., Digital Equipment Corp., Digital Research Inc., and Microsoft Corp.

On behalf of FAST, a member of Parliament is promoting a bill that would provide a fine of up to \$3,000 for each illegal copy made, and up to two years in prison. These penalties already apply to records, films and video recordings. One member of FAST's management group, Roger Tuckett, a senior commercial lawyer with DEC Ltd., Reading, England, estimates that DEC in Britain loses \$15 million each year in licensing fees through unauthorized copying and usage. FAST estimates that overall software theft in Britain totals up to \$250 million a year in lost revenue.

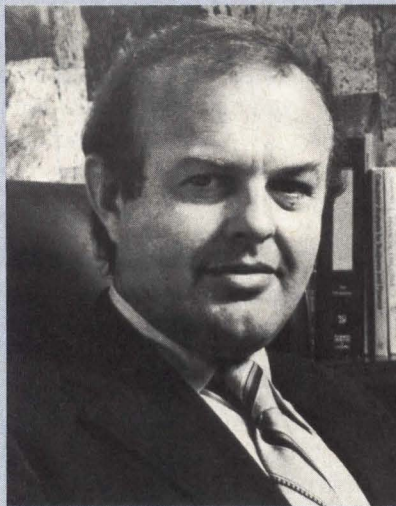

W. Krag Brotby, chairman of the software protection company Vault Corp., is promoting shrink wrap protection in the United States, Europe, Australia, and the Far East.

Price pressures drive U.S. companies to seek Far East manufacturing

Lori Valigra, Senior Editor

The falling prices of products such as terminals and personal computers in America have forced some competitors out of the market, and others out of the country.

The thought of Far East manufacturing may conjure up images of tiny sweat shops filled with hand laborers. But producers in the Orient are coming into their own, offering automated facilities and test capabilities. They can successfully backstop U.S. companies buckling under price pressures by offering relief from stateside labor rates, and by having product assembly and production situated close to major component sources.

So far, U.S. companies have approached Far East manufacturing in three main ways: they set up plants for their own products, they subcontract work for their own designs, or they purchase products designed and made by Far East companies.

Digital Equipment Corp. (DEC) set up Far East plants as long ago as 1972. Others, such as ITT Corp., moved to the Far East more recently. ITT's Qume Corp. subsidiary makes printers and disk drives in Taiwan, while the ITT Information Systems unit signed Far East subcontractors to make its Xtra, an IBM PC-compatible microcomputer. Applied Digital Data Systems Inc. (ADDS) early this year became the exclusive U.S. distributor for a Taiwanese company's PC-compatible. The approach each company takes is based largely on a company's resources and time-to-market issues.

DEC has vast resources

In Taiwan, Hong Kong and Singapore, DEC owns about 500,000 square feet of space—to be almost doubled by 1986—and employs 4,000 people. The Taiwanese plant produces terminals in high volumes, and the Hong Kong and Singapore

plants meet all of DEC's needs worldwide for semiconductor memories.

The 100,000-square-foot DEC facility in Taoyuan, Taiwan, is 45 minutes by car south of Taipei, the capital city. It is an equal distance from the Hsinchu Science-based Industrial Park, the site of many U.S. manufacturing plants such as those of Wang Laboratories Inc. and Qume. Taoyuan's rural location is far from competitors, which keeps job-hopping to a minimum, says Richard H. Yen, vice president and director of DEC's Far East engineering and manufacturing locations. Yen explains that DEC initially chose Taoyuan to be near an RCA Corp. plant. When RCA withdrew from the computer industry in the early 1970's, DEC purchased RCA's core-memory-building equipment, hired its personnel, and started making its own core memory.

DEC began manufacturing terminals five years ago in Taiwan. The Taoyuan facility is devoted to high-volume products such as the VT220 terminal and personal computer displays. VT100 production has been shifted to the United States, and the successor VT220 product has taken its place on the line in Taiwan. Yen proudly points out that the VT220 was the first product designed for DEC in Taiwan. "In the United States, manufacturing plants seldom have design capabilities," Yen explains. Manufacturing capacity for the VT220 product is 200,000 terminals annually, but the line is just now being ramped up. Yen says DEC is the 14th largest exporter in terms of dollar volume in Taiwan. RCA is the largest.

Low labor rates and tax relief

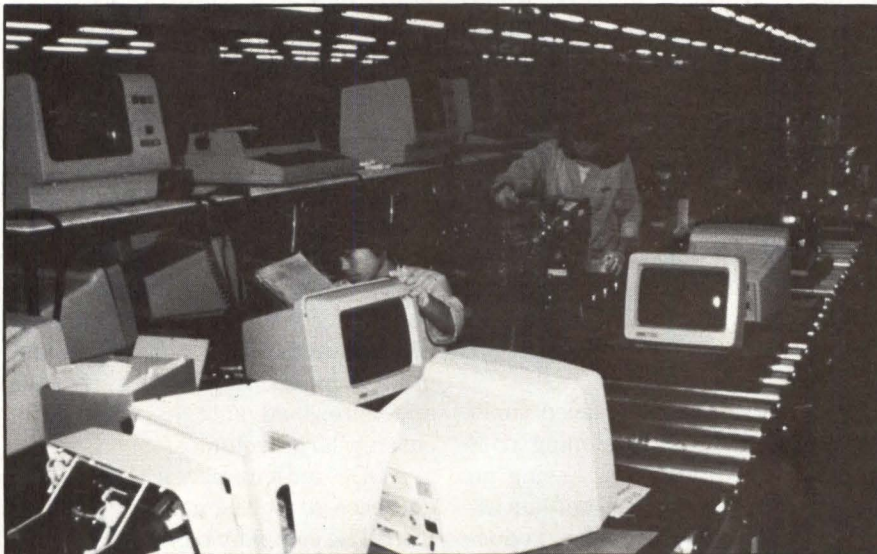

DEC's Taiwan plant has 100,000 square feet of manufacturing space. The company is now ramping up production of its VT220 terminal there.

Mini-Micro World

INTERNATIONAL

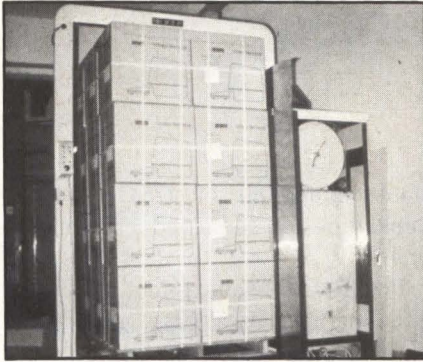

DEC ships its terminals and personal computer monitors from Taiwan to the United States in containers. About 1,000 cartonned terminals fit in each container (above). The containers are then shipped to Long Beach, Calif., on vessels such as the one shown (right), a 20-day process, and then moved on trucks to DEC's New Mexico facility.



programs enable low-cost manufacture in the Far East. Of DEC's 1,000 Taoyuan employees, 700 are direct laborers working on production lines. Yen says those employees typically earn less than \$1 per hour, compared with about \$3.50-per-hour rates in the United States.

Tax relief also is a point in favor for Far East manufacturing. DEC has bonded factories, allowing it to import raw materials and re-export them as finished goods within one year, paying duty only on scrap parts. Additionally, Taiwan's government allows a five-year tax deferral for each product line produced by a company.

Special considerations

Yen explains that DEC is careful to observe local work practices such as the 48-hour-work-week. But where many Taiwanese companies are open six days a week, DEC employees work 48 hours in six days one week, and 48 hours in five days the alternating week. DEC organizes outings for its employees each year, a common Taiwanese practice. And, the company hires local managers, as well as workers. Yen notes he is the only employee at Taoyuan

from the United States.

The most obvious consideration at DEC's Hong Kong plant, called DEC House, is real estate, or lack of it. Hong Kong is strikingly vertical, with barely enough room to stretch your arms between the numerous high-rises. The company's Hong Kong facility is located in the colony's mainland New Territories, where property is slightly less expensive.

DEC House has 13 floors, divided by a large bank of elevators. Manufacturing is confined to boards, memory systems, power supplies, and other products not requiring heavy factory automation. Different work is performed on each floor in about 14,000 square feet of space. Employees move large carts of assemblies from floor to floor in the huge elevators, so catching an elevator is a prized art at DEC House.

Time-to-market issues

Both ITT and ADDS faced time-to-market issues in developing IBM PC-compatible products. Facing an already crowded market and anticipating IBM's recent price reductions on its PC, the companies chose Asian manufacturing sites for their

products.

ITT took its PC-compatible design to Taiwan's Multitech Industrial Corp. and Mitac Inc. to be built. Though Multitech also builds its own PC-compatible product, for which it has signed an exclusive North American distributor agreement with ADDS, ITT is not worried about its design being copied. Counterfeit computers have been notorious in Taiwan, particularly Apple II-type computers. "You must pick the right partner [in order] to protect the design," says Thomas N. Payne, president of ITT Information Systems, Tempe, Ariz. "It [copying] is no more a danger in Taiwan than anywhere else."

Payne says ITT's product has little labor content in it, so labor rates are not ITT's real savings. "The real factor is materials costs," he says, explaining that Taiwan is close to many sources of semiconductors and other components, which gives cost and access advantages when purchasing large volumes.

ADDS' anticipation of IBM's price decrease drew the company to Taiwan. The company based its product plans on its ability to undercut IBM's lower prices, says ADDS

Get the VAX[®] Performance DEC[®] Dreams About.

Fortunately, you don't have to dream. Because the VAX performance you demand is shipping now from Cambridge Digital. You get the quality and dependability of a VAX processor, enhanced with state of the art components from recognized leaders like National Semiconductor, Fujitsu, Cipher, and Emulex. For the entire VAX line, you get performance simply not available from DEC. Each system is assembled and tested, then loaded with your choice of VMS, UNIX System/V or Berkeley UNIX 4.2 operating systems and applications. DEC maintenance is available. Call TOLL FREE for a price on your dream configuration.



**FREE
CATALOG**

800-343-5504

In Mass: 617-491-2700

In NY: 516-935-5111

CIRCLE NO. 49 ON INQUIRY CARD

*UNIX is a trademark of AT&T Technologies, Inc.

*DEC, VAX, VMS are trademarks of Digital Equipment Corporation.

digital VAX 11/750

**Cambridge
Digital**

DIVISION OF COMPUMART

The Edge in Value-Added DEC[®] Systems

Dept. 7401, P.O. Box 568, 65 Bent St., Cambridge, MA 02139

Telex: 92-1401/COMPUMART CAM

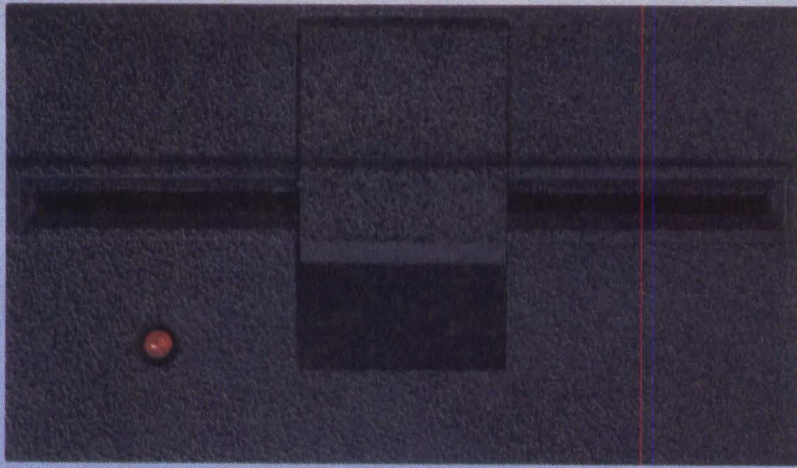

**THE END OF THE
SECONDARY STORAGE SPECTRUM
EVERYONE FORGOT ABOUT
WAS THE MIDDLE.**

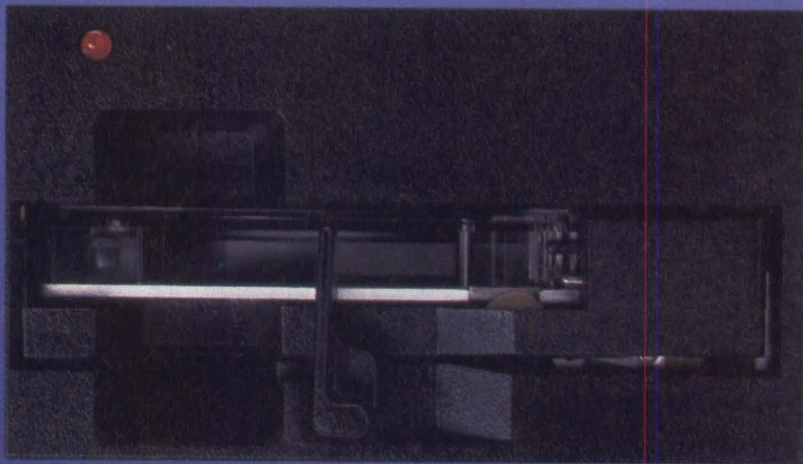

It wasn't long ago that when you wanted to back up a 5¼" Winchester, you only had two choices: floppies or QIC-compatible ¼" tape.

Well, now there's a third choice: Cipher's FloppyTape.™ It gives you the best of both worlds — without the drawbacks of either.

Economical like a floppy.

FloppyTape is the perfect secondary storage device for low-cost systems. It offers a substantially lower cost-per-megabyte than floppies. Yet the actual cost of the drive is only slightly more.

What's more, FloppyTape uses a



standard floppy interface.

And it works perfectly with most regular floppy controllers. So you can share your system's existing floppy controller.

High capacity like a streamer.

Using a standard ¼" tape cartridge, FloppyTape gives you up to 32 megabytes of storage. It eliminates the problems of handling a large number of floppy disks. And FloppyTape is priced well below QIC-compatible ¼" streamers. With QIC, you also need a new host adapter or controller. But you don't with FloppyTape.

If the part of the secondary storage spectrum that's best for your system is the middle, call 800-982-8808. Or write Cipher Data Products, P.O. Box 85509, San Diego, CA 92138.

cipher
data products, inc.

**WE PUT THE BEST IDEAS
INTO STORAGE.**

See us at COMDEX, Booth #4127 in Las Vegas

FloppyTape is a trademark of Cipher Data Products, Inc.

CIRCLE NO. 50 ON INQUIRY CARD

ONLY ONE COMPANY CAN IMPROVE THE TELEVIDEO 925.

It's TeleVideo®. Introducing the new 925E.

Every 925 imitation on the market today lacks something only we could give the 925E: total 925 compatibility. Since TeleVideo created the 925 standard, no imitation has truly emulated it. At any price.

One glance at the 925E instantly reveals our latest ergonomic thinking. A new DIN keyboard delivers the unmistakable feel of quality. A full tilt and swivel non-glare CRT cuts eye strain. But its most attractive feature is a price/performance advantage. Unmatched by any competitor.

After we enhanced its appearance, we improved its performance with a buffered printer port, five additional function keys and optional graphics upgrade. It's all neatly packed in a smaller, lighter case to take up less workspace but put out more work.

So if you want total 925 compatibility, the best service, best availability and best price, don't settle for less than the original. TeleVideo's new 925E.

Call toll free for a TeleVideo Sales Office near you: 800-538-8725. In California, call 408-745-7760.

TeleVideo® Terminals
• TeleVideo Systems, Inc.

CIRCLE NO. 51 ON INQUIRY CARD

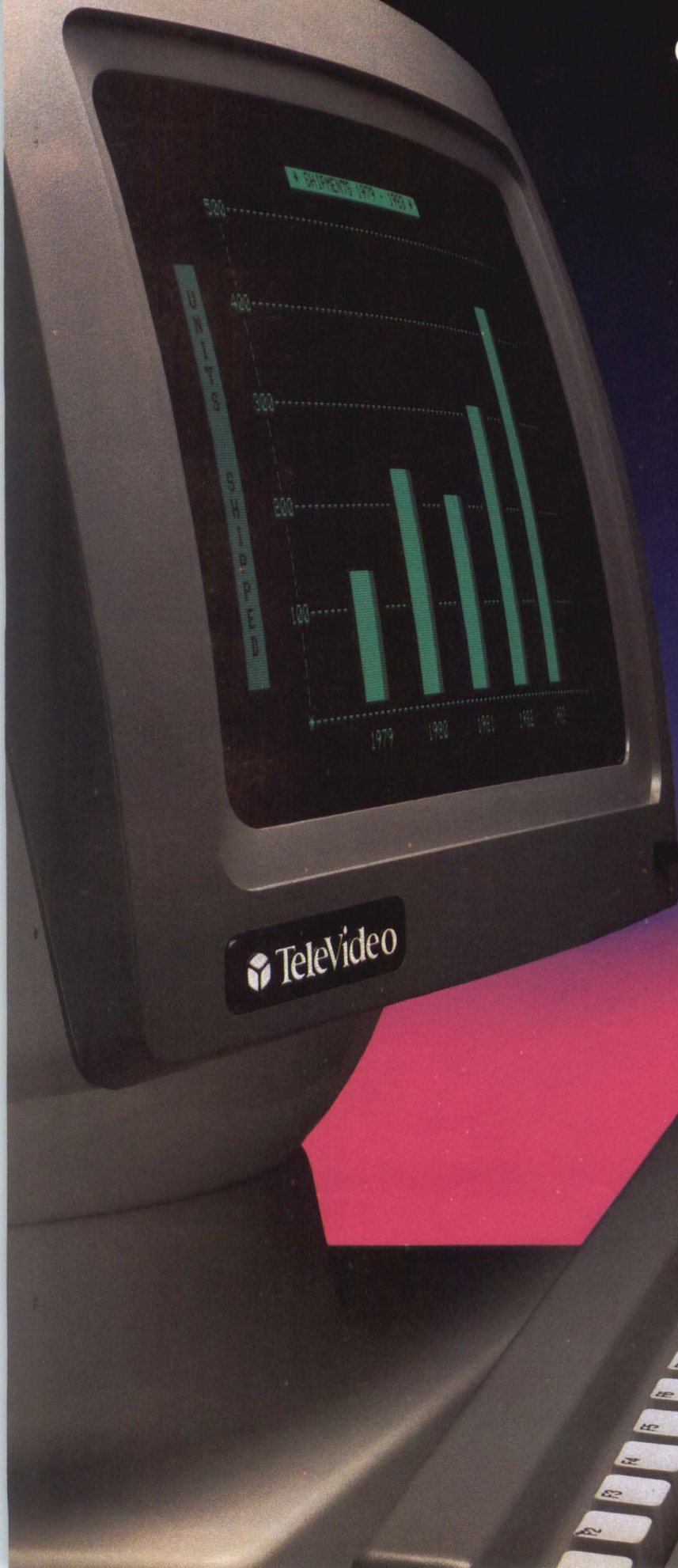

Mini-Micro World

INTERNATIONAL

president David G. Laws. He won't disclose what type of cost savings ADDS has gleaned from its link with Multitech, because that would reveal ADDS' ability to reduce prices even further in competitive situations. Laws says Multitech was chosen as a vendor because of its product quality. "We went only to Multitech. We were impressed with them as a vendor, with their technical capability, and with the financial arrangements," he says.

An idea of the cost savings to be had was given by James R. Hung, director of Shinlee Corp.'s foreign trade department. Shinlee manufactures a PC-compatible that is distributed through Articulate Computers Inc., Costa Mesa, Calif., an agent for Shinlee's Synco marketing group in Taiwan. Shinlee charges Articulate about \$1,000 for the machine, which Articulate in turn sells for two to two-and-one-half times that price.

Unexpected snags met

ADDS had to delay its product introduction about one month, until the end of July, because of unforeseen problems. About 700 Multitech machines were seized and held by U.S. customs officials in Seattle, Wash., in April on grounds of copyright infringement. The alleged infringement was of the basic input/output system (BIOS), with which U.S. mimic makers also had problems. Laws says ADDS would not have purchased the machines had it suspected the problem. But Multitech has since been able to ship 10 units incorporating a new BIOS to the United States, and ADDS showed the product at the National Computer Conference.

Multitech expects a significant growth in its PC-compatible product activities. The company increased its production capacity from 3,600 square feet to 45,000 square

feet over the past three years. It has separate lines for the ADDS and ITT products.

The ADDS contract is worth as much as \$15 million to Multitech, says Michael J. Conley, marketing

specialist in Multitech's international marketing division. He says the ITT contract will pull in substantial revenues as well, because Multitech expects to deliver 30,000 units to ITT this year. □

LASER DISKS TO PROLIFERATE

Last year, the emerging optical storage market was only \$1 million. But that market will grow to \$40 million this year and to \$90 million next year, according to an International Data Corp. study. The growth curve is then expected to head almost straight up, with the market reaching \$8.7 billion by 1990. In contrast, the bubble-memory market will peak at \$450 million in 1987, predicts IDC. For archiving, optical disks have a longer shelf life than magnetic disks, while also providing faster access time. IDC says that it is very unlikely that optical storage devices will replace floppy disk drives or Winchester disk drives.

COMMERCE DEPT. PROBES HONG KONG MARKET LOSS

The U.S. Department of Commerce has concluded that delays in obtaining export licenses for digital telephone switching and other equipment did not cause a boycott of U.S. companies by a Hong Kong telecommunications company. Cable and Wireless Systems (CWS) of Hong Kong decided in May to end what it called its "traditional reliance" on American electronic equipment in favor of products from European and Japanese companies. The Department of Commerce examined export license requests from Harris Corp., Emerson Electric Co., and Racal Export Corp. and concluded that, despite delays of up to eight months for export license approval, this was not a factor in CWS's decision. The Commerce Department analysis did not offer an alternate explanation for the loss of U.S. sales.

U.S. HIGH-TECH TRADE SURPLUS FALLS

The traditional U.S. trade surplus for electronic and information-technology products fell precipitously in 1983 and threatens to disappear this year, according to Department of Commerce statistics. Exports of these products totaled \$26.8 billion in 1983, while imports were valued at \$26.7 billion, producing a positive trade balance of \$100 million. For 1982 and 1981, the export trade balances stood at \$3.5 billion and \$4.8 billion, respectively. Exports in 1982 totalled \$24.9 billion and imports \$21.4 billion. In 1981, \$24 billion worth of goods were exported and \$19.2 billion imported.

INFORMATION AGE INSTITUTE SHUTTERED

The Information Age Institute, founded in February to sponsor a variety of research projects in computer and information technology, has been shut down after failing to enroll any companies as members. The Institute had been started by the Computer and Business Equipment Manufacturers Association and the National Electrical Manufacturers Association to study and provide industry guidance in such areas as health aspects of extended video display terminal use, computer security and privacy, productivity of workers in information industries and job displacement due to office automation.

PACIFIC PERSPECTIVE

Japanese manufacturers expand, diversify to meet semiconductor demand

Ichiro Kakehashi
Tokyo Correspondent

Japan's semiconductor makers do not expect the shortages for key devices that have prevailed since mid-1983 to abate before the year-end. As a result, they have accelerated their capital investments in this fiscal year to expand capacity.

The continuing supply-demand imbalance has brought into the picture several companies that are better-known for other things. Makers of audio and video equipment, cameras and watches—even automobiles—are making semiconductors or getting ready to.

Osamu Ohtake, research manager at the Tokyo office of Dataquest Inc., the Cupertino, Calif., computer industry market research company, said that the capacity is being raised fastest to meet the accelerated demand for memory devices. This is an area in which Japanese manufacturers have the biggest sales advantage—70 percent to 80 percent of world demand.

The growth, Ohtake said, is coming at the expense of American and European competitors. This is because the market for semiconductors and integrated circuits (IC) estimated at \$18.8 billion worldwide last year, goes beyond memory parts. Japanese manufacturers are steadily raising their share across the product range, producing 37 percent of all ICs made last year, up from 34 percent in 1982.

In the fiscal year that ended in March 1983, Japan's nine largest semiconductor makers invested about \$1.02 billion in capital expansion. In the fiscal year that ended last March, the investment in new plant and equipment jumped to nearly \$1.75 billion for the top nine companies. In the current fiscal year, according to spokesmen for each of the companies,

the anticipated investment is more than \$2.55 billion. Some analysts in Japan say that estimate is conservative. That figure represents only the semiconductor-related spending plans of NEC Corp., Hitachi Ltd., Toshiba Corp., Fujitsu Ltd., Matsushita Electronics Corp., Mitsubishi Electric Corp., Tokyo Sanyo Electric Co., Oki Electric Industry Co. and Sharp Corp.

If the investments of other manufacturers—among them Ricoh Co., Sony Corp., Seiko Electronics Industry Co., Nippon Gakki, Nippon Denso, and newcomers like Fuji-Xerox—are added to the spending plans of foreign-owned and joint-venture companies like Nippon Motorola Seizo, Texas Instruments Japan and the new Fairchild Japan operations, the total investment this year in Japan is nearer to \$3 billion.

Pioneer Electronics and Clarion Co. are among the audio-oriented companies that are adding a new factor to the complex semiconductor equation. Clarion's semiconductor facility in Tohoku is to raise capacity to about 40,000 to 50,000 devices a month by fall.

That is the kind of capability that analysts who watch Japan's semiconductor industry say makes the supply-and-demand ratio tricky. There are other factors.

Olympus Optical, which established its first semiconductor research facility in 1981, is now making some of its own custom ICs, as is Canon, with 440 employees in its Component Development Center. But competitors see the Olympus capability as the tip of an iceberg. The companies that have been concentrating on a narrow product range have found in the past recession that diversification is wise from the standpoints of both profit and technological development for future growth.

Among the biggest semiconductor makers, NEC, which is second only to Motorola in production, is expected to spend nearly \$510.6 million in this fiscal year on new plant and equipment. The company would not give details of its semiconductor spending plans, but most of the investment is expected to be directed to the Kyushu NEC diffusion facility—its seventh—now under construction, and to establishing two new affiliates and expanding its Yamagata subsidiary's production capacity.

NEC's semiconductor output grew an estimated 26 percent in the last fiscal year, to \$1.574 billion, and it expects an output of around \$2.04 billion in the current fiscal year that ends next March. Its production of 64K dynamic RAMs is now 7.4 million chips a month, which is expected to be raised to 10 million a month by the year-end.

Microprocessor production is also growing fast; already at 12 million devices a month, NEC's Micro Processor unit (MPU) output is to be raised to 17 million units a month by early next year.

Hitachi Ltd., now Japan's largest consolidated electronics company and one of the four largest companies in Japan, surpassed Texas Instruments Inc. last year as the largest producer of memories.

That represented about one-third of all Hitachi-built ICs last year, but the total was far above the forecast of \$1.29 billion projected at the beginning of the last fiscal year. At \$1.44 billion, the total value represented an increase of about 35 percent from the previous fiscal year, with output this year expected to be worth at least \$1.83 billion. To do that, Hitachi will invest \$468 million in new plants and equipment this year, with about \$374 million to parent-company capacity and the rest to affiliates.



We seek VARs that have a mighty future.

IBM is looking for companies with real potential, those with a solid foundation for growth.

We want firms that have first-class application solutions that run on IBM products. Companies that hope to become IBM Value Added Remarketers.

It isn't easy to qualify; but if you do, IBM has much to offer.

For starters, IBM VARs can apply for some of our most competitive products: IBM 4300 systems, System/36, Series/1, System/38, the IBM Personal Computer and the System 9000 family.

Then IBM can add strength to your marketing efforts. We can, for instance, help with product literature, direct mail and business show support. IBM also has a wide range of professional classes for VARs. And thanks to an online referencing system used by IBM's own sales force, we can refer prospects with special needs to VARs with unique solutions.

For more information on qualifying as an IBM VAR, simply send in the coupon below or call 1 800 IBM-VARS, Ext. 96.

If you think you're destined for greater things, plant the first seed now.



Larry Humphreys
IBM Distribution Channels
P.O. Box 76477
Atlanta, GA 30358

96/9-84

Please send me your free booklet, "Looking for Leaders."

Name _____ Title _____

Company _____

Address _____

City _____ State _____ Zip _____

Phone _____ Product Interest _____

BEAT OUR BENCHMARK.

GET THIS WATCH.

Take the Plexus Challenge.

Everybody in the UNIX-based supermicro business talks performance.

Only Plexus dares to prove it... with the Plexus Challenge:

Show us a UNIX-based supermicro that can beat Plexus — running any recognized benchmark (or even your own application code*) — and we'll present you with this elegant Heuer chronograph valued at \$485.00.

How do we dare make this offer? Simple: our multiprocessor architecture and highly-tuned version of UNIX leave the single-CPU competition in the dust. Multibus architecture and intelligent I/O processors let you expand modularly from

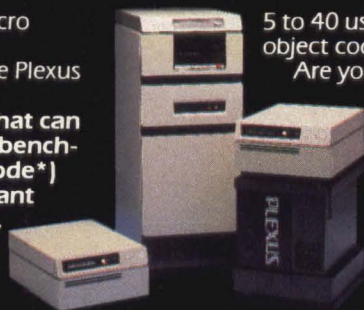

5 to 40 users — without changing a single byte of object code.

Are you thinking "Fine, but I really don't need all that performance"? Well, some of our customers tried other hardware first. They used to think the same thing.

Challenge details: This offer is extended to bona fide OEM's, value-added resellers, and volume end-users in the multiuser commercial UNIX systems market. Limit one award per company. Offer expires Jan. 31, 1985 unless withdrawn earlier. For complete rules and participation information, call (800) 556-1234 Ext. 560 (in Calif. (800) 441-2345 Ext. 560)

PLEXUS

Supermicros built for speed.

Plexus Computers Inc., 3833 North First Street, San Jose, CA 95134

*Subject to prior approval © 1984. UNIX is a trademark of AT&T Bell Laboratories. Multibus is a trademark of Intel Corp.

The Interpreter

An analysis of news, issues and trends affecting the computer industry

Relational DBMS vendors prepare for ascent of multiuser microcomputer market

To fit a growing market, vendors compress minicomputer database-management systems, add muscle to personal-computer packages.

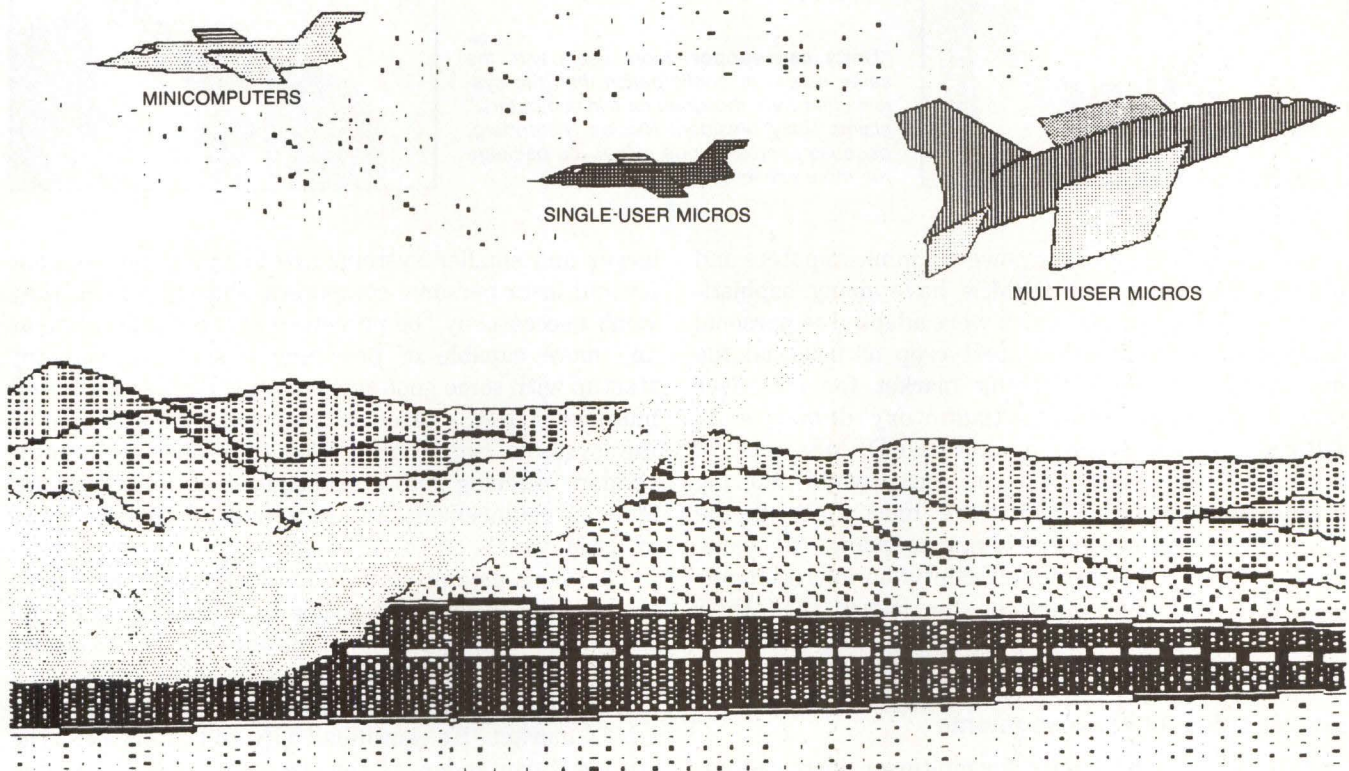

Illustration by Anne Tregay

"This [DBMSs for multiuser microcomputer] market is certainly going to be taking off next year," predicts analyst Ann Morley of International Data Corp.

Sarah Glazer, Senior Editor

One of the computer's earliest appeals was the promise of instant access to huge bodies of information. Pioneers predicted that computers would answer—in mere seconds—the questions that routinely sent clerks pawing through file cabinets and trudging through libraries. Sadly enough, the first methods of organizing computer databases were cumbersome and difficult to use. But now the dream of instant answers has come closer than ever to reality with the development of relational database-management systems (DBMSs).

In contrast to earlier database managers, relational DBMSs don't require that users know how the database is organized before they can extract information. From the user's point of view, finding information is somewhat like using a library card catalog that contains several cross-referenced listings for every book. A relational DBMS indexes key portions, or fields, within each record, allowing the system to answer questions about data in those fields without having to manipulate entire records. And, rather than having to search the whole database for an answer, the software need examine only the relevant index.

The Interpreter



◀ *"In the microcomputer environment, you are forced to make compromises," says Harvey Jeane, vice president of product development for Ashton-Tate. "As operating systems take partnership in making things happen, you will have more power."*

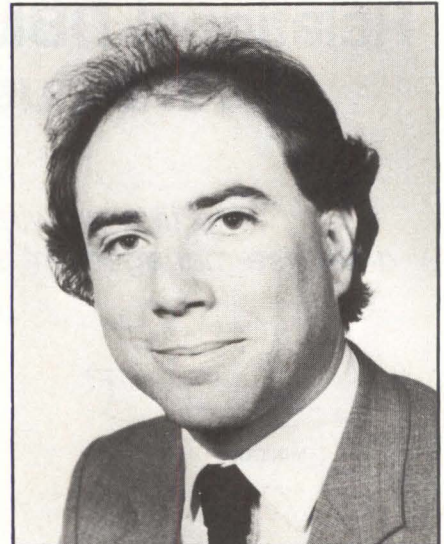

▶ *"Unify can support more users with the same hardware configuration than the systems that were designed for minicomputers," claims Unify president Nicolas Nierenberg, because compact code makes the package run more efficiently.*

Originally developed for powerful minicomputers and mainframes, relational DBMSs have many sophisticated features, some of which were adapted to personal computers to create the latest crop of personal file managers. But the emerging market for multiuser microcomputers puts contradictory demands on DBMSs. Certain features of multiuser DBMSs must, of necessity, be complex. For instance, while allowing simultaneous searches, software must prevent the chaos caused by two users trying to change the same record at once. Yet, to run efficiently on microcomputers, these packages must be far leaner than their powerful—but memory-hogging—counterparts designed for faster-processing minis and mainframes.

Market splits into two segments

Only a handful of DBMSs for multiuser microcomputers have existed for more than a year. Most of these, such as Informix from Relational Database Systems Inc. and Unify from Unify Corp., were written for the UNIX operating system. DBMSs developed for multiuser personal computers running MS-DOS and other personal-computer operating systems are virtually all newcomers. "It's a wide-open marketplace," says Ann Morley, senior software consultant for research company International Data Corp., Framingham, Mass.

Morley predicts that the DBMS market for multiuser personal computers, typically supporting two to eight users, will "certainly be taking off next year." She estimates that the market will zoom in either 1985 or 1986, depending on how soon hardware advances take place. But Morley declines to forecast market leaders. Although companies with popular packages for both

larger and smaller systems are bringing out versions for multiuser personal computers, she argues that they won't necessarily "be perceived in the marketplace as any more capable of providing a solution than any startup with some good technology." Prices for current multiuser DBMSs based on personal computer operating systems range from \$400 to \$1,200, with some vendors offering less expensive, run-time versions. Memory requirements range from 256K to 384K bytes of RAM.

The more established UNIX-dominated segment of the market consists of packages aimed at more powerful computers that typically support eight to 32 users, according to analyst Deck Hazen of Yates Ventures, a Los Angeles research company that specializes in the UNIX market. He classifies Unify and Informix as the strongest contenders in this category. Gaining ground are Oracle from Oracle Corp., Sequitur from Pacific Software Manufacturing Co. and Ingres from Relational Technology Inc., he says.

Price and memory requirements in the UNIX-dominated segment vary more widely than for personal computers. Prices, which start at more than \$1,000, vary according to developers' options. Memory requirements depend on hardware configurations, but can be as little as 256K bytes of RAM. Most vendors report that 0.5M byte of RAM is usually required.

Ensuring data integrity

A key feature that differentiates multiuser DBMSs from single-user packages is record-locking—software that keeps two or more users from changing the same record simultaneously. Ideally, a DBMS should lock as



U.S. Congress

M.I.T.

Nº 10
Downing St.

Those who know, pick Pacific

However it's defined, quality has a way of being recognized.

For some of our customers, it might be product versatility. Two years ago we began making a 68000-based 16/32 bit CPU board that could operate with or without the popular UNIX operating system, depending on whether the customer had system- or real-time needs.

For others, performance is important. We designed a memory management unit that protects multiuser programs with no wait states. That's when we discovered that performance and versatility become interconnected.

For instance, Congress needed some method of debugging the networking system currently used by the Members'

staffs. We packaged our CPU board with the necessary peripherals, and from this computer system we discovered even more applications. Our board now helps the U.S. Geological Survey analyze minor quakes from the Atlantic seafloor, while across the ocean the Prime Minister's Office uses the same product to edit correspondence.

To increase performance even further we later designed a feature known as "dual porting". This allows two or more processors to work together in tandem. Like a bicycle pedaled-by-two, the speed is impressive. So too is its versatility. M.I.T. uses our new "D" board to study astronomy; General Electric uses it to control a robot for welding jet turbines.

Versatility and performance aside, we like to think that our list of "Who's

Who" is most attracted to us by our unique brand of personal service. Pacific sales representatives provide pre-sales consultation and we pride ourselves on our post-sales service and support . . . no matter who you are.

For additional information, contact
Sherrell Harper
Pacific Microcomputers, Inc.
160 Chesterfield Drive
Cardiff, California 92007
(619) 436-8649

PACIFIC
MICROCOMPUTERS, INC.
Quality Across the Board

CIRCLE NO. 143 ON INQUIRY CARD

Voice Data Entry: Improving the Productivity of People and the Equipment They Use

If you're using skilled labor or trained professionals to collect, control or enter data by hand, you may be wasting time and money. Even bar code scanners and keyboard-controlled equipment may not maximize the return on your investment in your workforce and the expensive equipment they use. Such systems can constrain the speed and accuracy of your workers by demanding their complete attention or the use of both hands and eyes.

Voice data entry can change this. Once the dream of productivity experts, Verbex has made voice data entry a practical, field-proven technology that can improve productivity by 100% or more and cut thousands of dollars in labor, time and equipment costs.

Here's how some of our customers are benefiting:

At one of the nation's largest commercial airlines, Verbex voice data entry systems have doubled the speed of baggage handling and reduced routing errors.

At a major manufacturing firm, Verbex voice data entry systems have increased the speed of inventory processing, generated real-time inventory records and established a system



for simultaneous damaged goods inspection.

At the headquarters of a leading overnight delivery service, Verbex voice data entry systems have shown how to cut labor costs and improve throughput by allowing workers to handle up to 75% more packages while entering data at the same time.

These are only a few of the areas where Verbex voice data entry systems can improve productivity. Other applications include test and inspection, back office processing, financial transactions, or wherever hands and eyes are busy.

Next generation technology that anyone can master.

Verbex voice data entry systems are easy to learn and easy to use. Wearing a simple microphone headset, workers

speak directly to a computer in a natural voice—without unnatural diction or staccato pauses. Verbex systems are field-proven 99% + accurate regardless of user speech patterns, accent, dialect or interference from background talking or industrial noise.

Turnkey applications solutions set Verbex apart.

The technology behind our data entry systems is only part of what has put Verbex at the cutting edge of practical speech recognition product development. We are also applications leaders. Our turnkey and OEM products are designed to meet the requirements of your application and to integrate into your operation with little or no disruption. With the help of our specialists, or using our Speech Applications Development System (SPADS™), you can design a custom vocabulary using terminology generic to your industry, your application or your firm.

If you could profit from greater throughput, fewer errors, reduced labor costs and a faster return on your investments, call us TOLL FREE at 1-800-343-4458. In Massachusetts, call (617) 275-5160. Or write: Verbex, Two Oak Park, Bedford, MA 01730.

CIRCLE NO. 52 ON INQUIRY CARD

Verbex

A DIVISION OF EXXON ENTERPRISES

See us at AUTOFACT 6, October 2-4, 1984, Anaheim Convention Center, Booth #238

The Interpreter

little of the database as possible while an update takes place, to keep from inconveniencing other users. But such deftness depends on software complexity, which, in turn, can slow a system down.

Many DBMSs designed for only a few users lock an entire file of records during every update. One such example is R:base 6000 from Microrim Inc., Bellevue, Wash., a package designed for clustered terminals and local area networks (LANs). It runs under MS-DOS or Convergent Technologies Inc.'s CTOS operating system. R:base 6000 automatically locks a relation-level file while any record within it is updated. Other users won't mind, "if it doesn't take too long," argues Microrim chairman and chief executive officer Wayne Erickson, R:base's developer.

Multuser versions of Ashton-Tate's dBase II and dBase III also lock at the file level, says Harvey Jeane, vice president of product development for the Glendale, Calif., software publisher. For the multuser ver-

sion of MS-DOS-based dBase III, which Jeane expects to be on the market this fall, "we're working mainly with LAN [vendors]," he reports. "We provide file-locking, and they provide the hardware."

Slightly more sophisticated is Mag/base from Mag Software Inc., Canoga Park, Calif., a DBMS that runs under the MP/M-86 and Concurrent CP/M-86 operating systems. According to Greg Scott, company president, Mag/base automatically implements record-level locks that leave all of a file—except the record being changed—available for other users to update. This feature facilitates operation of the package by as many as 16 users.

All the UNIX-based DBMSs lock at the record level, even though UNIX System V itself doesn't yet include record-locking. Roger Sippl, president and founder of Relational Database Systems Inc., Palo Alto, Calif., predicts that AT&T won't release record-locking for System V before the year-end at the earliest.

Looking at structures: B-trees vs. hashing

The diagram illustrates two methods of organizing relational DBMSs. On the left, a B-tree index structure is shown for salaries. The root node contains keys 12,000 and 21,000. It points to three internal nodes: [8,000, -], [14,000, 15,000], and [40,000, -]. These internal nodes point to leaf nodes containing actual salary values: [6,000, -], [10,000, 11,000, -], [13,000, -], [17,000, 17,500, -], [31,000, 35,000, -], and [75,000, -]. This structure is labeled "B-TREE INDEX OF SALARIES".

On the right, a hashed index structure is shown. It consists of a vertical column of 14 slots. The top 10 slots contain the following salary values: 24,000, 16,000, 18,000, 22,000, 45,000, 9,000, 75,000, 13,000, 15,000, and 43,000. The bottom 4 slots are empty. This structure is labeled "HASHED INDEX OF SALARIES".

Of the two methods of organizing relational DBMSs, hashing is considered very fast for exact matches, while B-trees are faster for finding a range of values.

Most relational database-management systems (DBMSs) use one of two organizational structures: binary trees—called B-trees—or hashing. "Both are shortcuts" to locating certain kinds of data within stored records, explains analyst Deck Hazen of research company Yates Ventures, Los Angeles. He points out, however, that all DBMS organizing structures add overhead to the packages as well.

Both methods have staunch adherents. Although many experts claim that hashing can be a faster method of finding data, others note that it slows down drastically, should maintenance become slack.

For hashing, developers build tables for each attribute of a record, which contain pointers indicating the records' locations. "Hashing is very fast when you're looking for one exact match," says Ish Rosenblit, a database specialist for the Coca-Cola Co., Atlanta.

B-trees are structures like inverted trees that organize attributes sequentially, Rosenblit explains. A piece of data having a value between two others at the "branch level" can be found by following a pointer to the "leaf level."

"With B-trees, a search key is always a sort key," says Robert Sippl, president of Relational Database Systems Inc., Palo Alto, Calif. When looking for a range of values, B-tree organization prevents a separate search for each piece of data, because each piece in a sequence is beside or points to its successor.

Sippl claims that B-trees are easier to maintain because they can grow dynamically. If additions of data make a tree unbalanced, software can rebalance it, allowing it to occupy memory space efficiently. For hashing, space for an entire index must be allocated in advance, he says, forcing the programmer to anticipate future needs for space. If space runs out, search efficiency is greatly impaired.

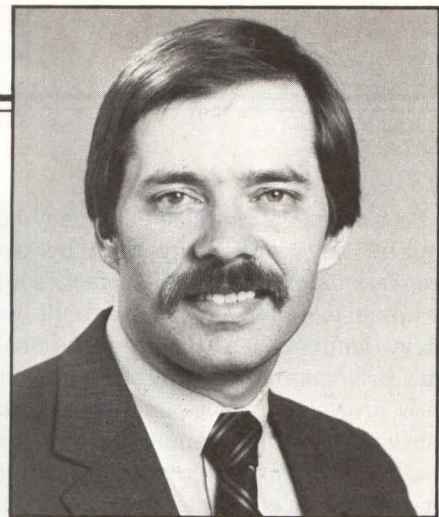
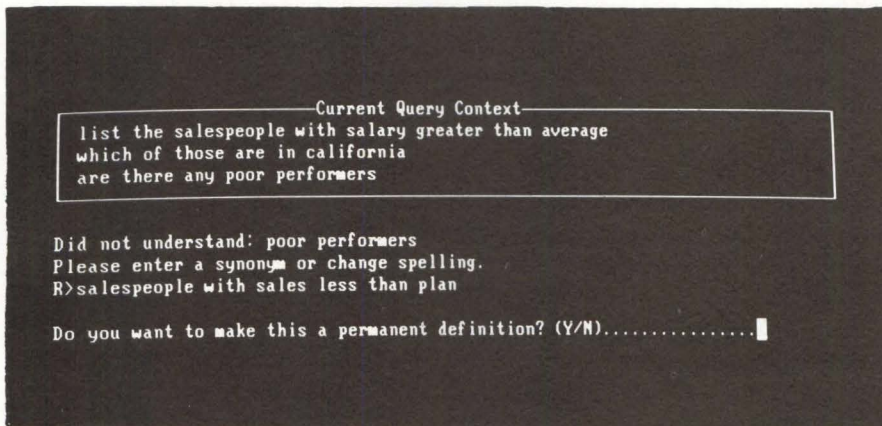

"Menu-based systems are easy to use but inflexible, while command-based systems are flexible but hard to use," comments Microrim chairman and chief executive officer Wayne Erickson about differences between DBMSs oriented toward end users as opposed to program developers.

Microrim's Clout natural-language processor lets a novice user query a database without regard to formal structure of the requests.

Keeping failures from contaminating data

But for powerful database packages, record-locking is not enough; it should be only the tip of the data-integrity iceberg, contends Joseph Alsop, president of Data Language Corp., Billerica, Mass., developer of Progress, a UNIX-based DBMS. "Many users have large databases that contain vital information, and a system must be able to preserve data integrity through all types of failures," he explains. "An organization can't afford to lose records like inventory." Progress' recovery capability, says Alsop, includes "before-imaging and rollback," that prevent losing data despite power outages and other such system failures.

Some other DBMSs use different recovery methods. For example, Informix allows users to provide some or all files with transaction audit trails that—in case of failure—can work with recovery routines to reconstruct data. Oracle has an automatic rollback feature that reacts to system failure by returning the database to an earlier, uncontaminated state. Users would then have to re-enter only the most recent transactions. Ingres also provides full recovery in case of failure, with features that include rollback and roll-forward capabilities.

However, a few databases in the high-end segment lack recovery capability. Unify Corp., Sacramento, Calif., is still developing such features for Unify, according to president Nicolas Nierenberg. "Now we have only rebuild capabilities," he admits. Although Unify is waiting for the anticipated enhancements of UNIX System V, Nierenberg expects recovery features to be available by mid-1985.

Recovery features may overburden the lean programs of the less powerful, personal-computer-oriented DBMSs. "To support rollback, the overhead would be too much for an 8086 to handle," reasons Microrim's

Erickson. "It would slow the system down too much." Therefore, R:base 6000's recovery features consist simply of a "reload" command. "You salvage what you can," Erickson says.

Ashton-Tate's Jeane agrees that recovery adds unacceptable overhead to an 8086-based computer. "But," he counters, "with new processors like the 68010 and the 80286, all the overhead required for recovery still doesn't make operation too slow." Jeane reveals that future dBase versions will include recovery capability.

Should a package suit users or developers?

Higher-end DBMSs are designed to be used by programmers, Jeane contends, while low-end packages are more often geared toward end users. "We go after the doctor or the lawyer," he says, even though he acknowledges that "dBase II is perceived as difficult to learn," earning a reputation for requiring a skilled programmer to set up many applications. Jeane claims that developers of dBase III took this criticism to heart and made the new package far easier to use.

While high-end products are often chock-full of sophisticated application-development tools aimed at programmers, many also have features that make them accessible to end users. These include query languages (simple, English-like programming languages that allow non-programmers to make "ad hoc queries" of a database) and report-writers (prepared screen formats that users can easily customize to generate reports from the answers to their queries).

Unify's query language, SEQUEL, is forms-based and integrated with its report-writer, says Nierenberg. This lets a user's questions appear on a screen in the same format as the eventual report. Most other DBMS report-writers are not integrated, he claims, forcing a user to format reports separately.

The Interpreter

Programmers can also use query languages to build applications more easily than by using conventional programming languages. In fact, some packages' program-development tools are built entirely around a query language. Although Relational Technology allows programmers to augment applications for Ingres with procedural programming languages, these conventional languages must go through the query language. "We don't let a programmer call the database directly," explains sales manager Chris Dozier. "The query language automates the calls."

"A relational, nonprocedural language is not powerful enough to build full-blown applications," argues Data Language's Alsop. Progress uses a "fourth-generation language to build applications and retrieve data," he says, describing it as very different from query languages. He claims it can take the place of using both procedural languages and query languages to develop programs.

Even some of the low-end DBMSs have easy-to-use database languages. Microrim has Clout, which it describes as "a natural-language processor" that employs artificial-intelligence techniques to allow end users with

no programming experience to use the database. "A mainframe database has an administrator to help end users," comments Microrim's Erickson. Clout lets a user ask questions of the database without having to worry about correct syntax, for example. He says that untrained programmers could use Clout to build applications but admits that it would be cumbersome. The language processor is intended, instead, for ad hoc queries.

Reconciling the very different needs of end users and program developers is an avowed goal of most DBMS vendors. But most of them acknowledge that making their packages useful to both kinds of users will require two sets of features. As technology advances, the contradictions increase, Ashton-Tate's Jeane notes. "Users will have access to awesome power, but the user who can afford these products is less sophisticated than ever." □

Interest Quotient (Circle One)
High 801 Medium 802 Low 803

Make it snappy.



When a printed page has to represent your whole company, it'd better look sharp. Our DP-35 and DP-55 daisywheels rival the finest office typewriters for crisp clean impressions. And they zip along at just about a page a minute. Call your printer distributor. Or contact Dataproducts at (213) 887-3924, 6200 Canoga Avenue, Woodland Hills, CA 91365. In Europe, 136-138 High Street, Egham, Surrey, TW 20 9HL England.

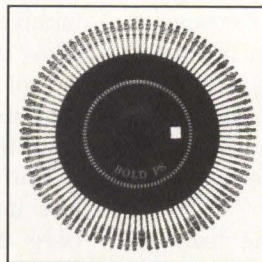

Dataproducts Daisywheel Printers

CIRCLE NO. 53 ON INQUIRY CARD

THE MOST

Information on availability, price, applications, and compatibility of software packages and the systems they run on. *The Software Catalog* is the definitive resource.

Indexed by: software vendor; computer system; operating system; programming language, microprocessor; application; and keyword.

Over 30,000 packages

"Just about everyone who is going to be buying software for his computer will want a copy of this dream book to thumb through." *New York Times*, 12/20/83

"The 800-page volume for microcomputers sits atop my desk and is used frequently." *Interface Age*, September 1983

"Before even talking to the salesman spend some time with *The Software Catalog: Microcomputers*." *Forbes*, July 4, 1983

THE SOFTWARE CATALOG

1984 editions:

Microcomputers \$75.00

Minicomputers \$115.00

Science and Engineering Edition \$29.00

Let us tell you more about *The Software Catalog*. Please call or write.

Elsevier/International Software Database™

52 Vanderbilt Avenue, New York, New York 10017. Call toll free 1-800-223-2115, or in New York State call 1-212-867-9040, ext. 307.

NH105

CIRCLE NO. 54 ON INQUIRY CARD

UNIFY FINISHES FIRST.



UNIX
DATA BASE
MANAGEMENT
SYSTEM

In one independent competition after another, UNIFY has proved itself the fastest UNIX data base management system. No wonder it's been selected by more computer manufacturers than all other UNIX data bases combined.

UNIFY speeds you through development and expedites program execution with some of the fastest and most powerful utilities of all, including:

Fully menu-driven design.

Built-in optimizers that select the fastest of four data access methods.

Industry standard IBM SQL query language, fully integrated to our own powerful report writer, for easy access

by your end-users.

Ninety subroutines for advanced program development... the most complete package of its kind.

Horsepower for the long run.

Unlike other data bases, UNIFY won't slow down under the weight of additional data or multiple users. It won't fall behind in the future either, because it's built with the power to support new features as they come on-board.

Judge for yourself. Send for our 300-page tutorial and 500-page reference manual—yours for only \$95. Together they show you how to build virtually any application. To order, contact UNIFY, Dept. MMS-9, 9570 S.W. Barbur Blvd., Portland, Oregon 97219, 503-245-6585.

UNIFY®
THE PREFERRED UNIX DBMS.

CIRCLE NO. 55 ON INQUIRY CARD

UNIX is a trademark of Bell Laboratories. UNIFY is a trademark of Unify Corporation. Copyright © 1984, Unify Corporation, Portland, Oregon 97219.

Gould... Innovation and Quality in UNIX-based Systems

The Firebreathers from Gould blast the competition into oblivion.



* UNIX is a trademark of AT&T Bell Laboratories

™ PowerNode and PowerSeries
are trademarks of Gould Inc.

™ VAX is a trademark of Digital Equipment Corp.

With blazing performance.

Great leaps in raw performance are rare in the computer world. Usually, changes occur in increments of half-a-MIP or so. Now real Firebreathers roar into the arena, quadrupling the best the competition has to offer.

With scorching speed.

These creatures don't run a little faster. Running real production code supplied by VAX™ users, our PowerNode™ 9000 benchmarks at 4.5 times faster than the VAX 11/780... at a comparable price! Even our second-in-line

PowerNode 6000 runs 1.5 times faster. But with all this power and speed, the PN6000 has a dainty footprint... 60% less than the VAX 11/780.

With sizzling simplicity.

Even the hottest firebreather won't fly if it's hard to run. Ours are UNIX*-based, so ease of use and compatibility become part of the power. Plus we offer the "Compatibility Suite", application software packages which are consistent across our entire Gould PowerSeries™ product line... the widest range of UNIX-based systems in the world.

More than a myth.

We know these claims sound outrageous. Make us prove them. Give us your benchmarks and production code. We'll show you numbers that surpass all expectations. Call 305-797-5459 for a test flight on the Firebreathers. Main-frame performance disguised as a supermini. The scorching performance you expect from Gould.

Gould Inc.,
Computer Systems Division
Distributed Systems Operation
6901 West Sunrise Boulevard
Ft. Lauderdale, FL 33313

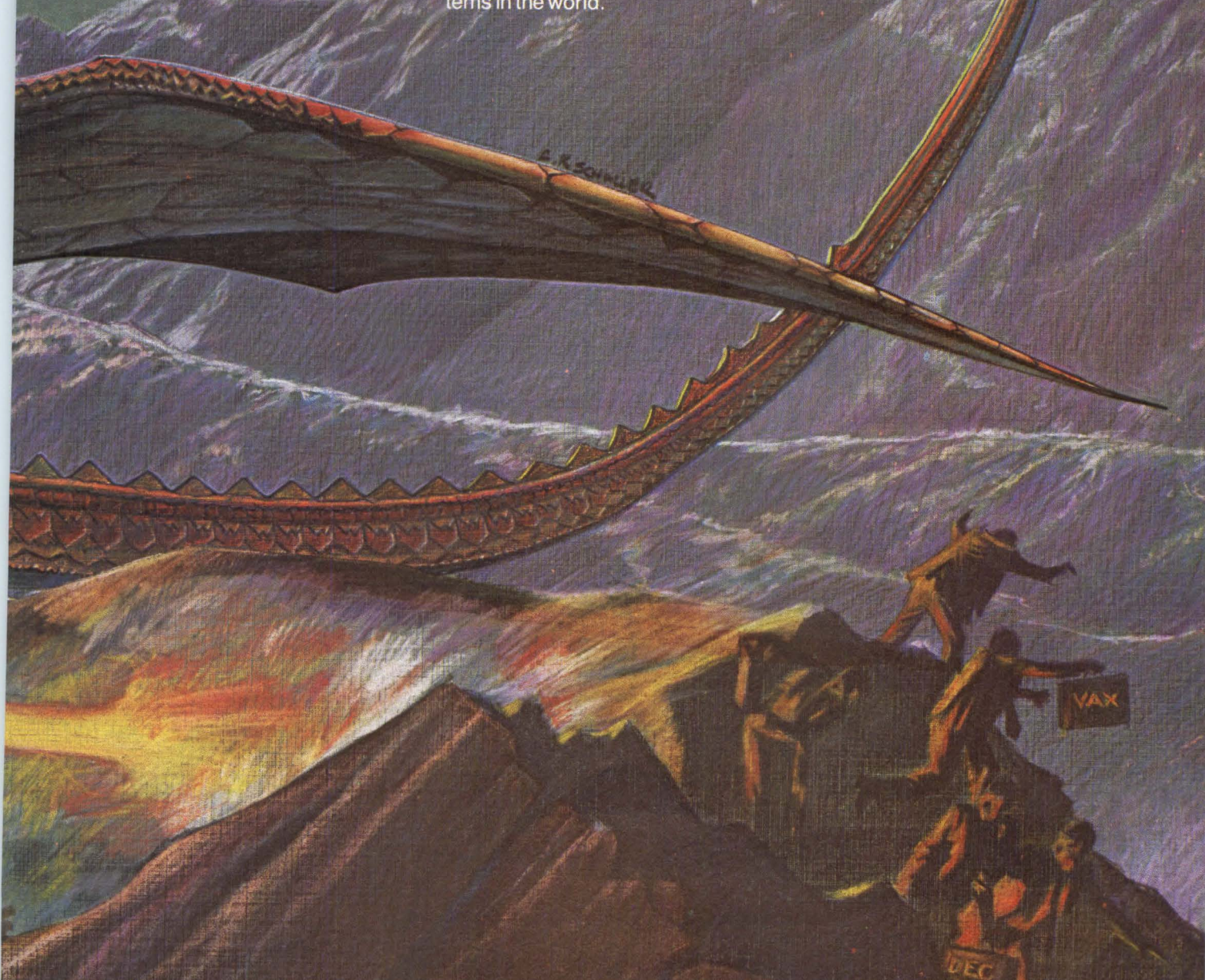

CIRCLE NO. 56 ON INQUIRY CARD



GOULD
Electronics

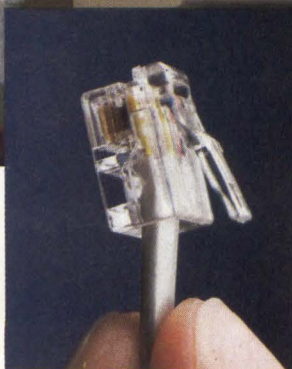
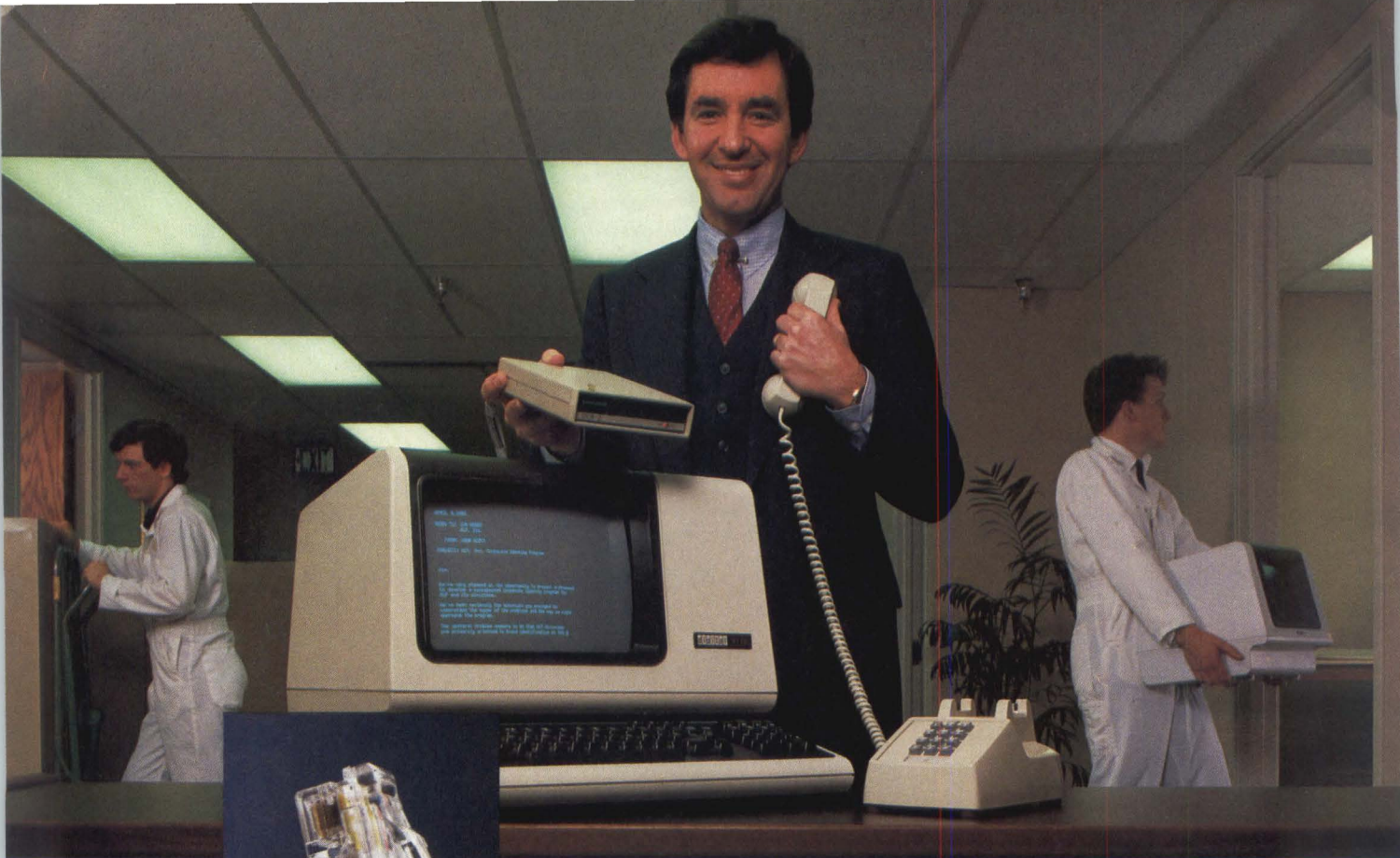

“Today we installed 27 terminals but not a foot of data cable. We’re using Teltone’s DCS-2 instead.”

There’s only one thing you can count on these days. If anything can change, it will. And sooner than you think.

That may be why companies worldwide have purchased more than 40,000 channels of our DCS-2 Data Carrier System. They’ve learned that DCS-2 can cut the cost of adding or moving terminals by using existing PABX wire to carry both voice and data traffic—simultaneously.

With DCS-2, a PABX (or Centrex) becomes a common communications network. From then on, making a computer hookup is as easy as plugging in a phone. Up to 9600 bps of dedicated-channel, full-duplex data can be transmitted or received by any RS-232C terminal in your system. But the data won’t interrupt phone service.

At a time when drilling one hole for cable can cost \$100 or more, the Data Carrier System is a smart choice economically. Logistically, it can make your next move faster and far less troublesome. Like the one you’ll probably be making next week?

For fast information call 1-800-227-3800 (Ext. 1122) or write Teltone Corp., PO Box 657, Kirkland, WA 98033. In Canada call (416) 475-0837 or write Teltone Ltd., 183 Amber St., Markham, Ontario L3R 3B4.

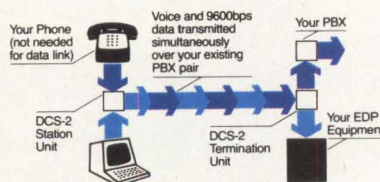

TELSTONE

See us at TCA in San Diego, September 18-20, Booth G.

FCC Part 68 registered. For users of DEC, Prime, Data General, Tandem, IBM Series/1, H-P and other asynchronous computers.

CIRCLE NO. 57 ON INQUIRY CARD

The Interpreter

Will 1984 be the year of the LAN?

Not unless network vendors find the right marketing strategy will they get a chance to sell a local-area network with every PC

Mary Jo Foley, Contributing Correspondent

The market for personal-computer local-area networks (PC LANs), potentially the largest and most lucrative segment of the LAN market, has yet to materialize. Although the PC has become an indispensable tool in thousands of offices, networks linking them are few in number. The LAN market floundered for a host of reasons—chiefly the unresolved debate about standards, IBM Corp.'s failure to take the networking plunge and a scarcity of networking software. Market players and watchers first predicted that 1982 would be the year of the PC LAN. At the end of that year, they updated their forecasts to 1983. Now they claim that the market will take off this year.

But, this year, evidence exists to back up the predictions. Although most OEMs have so far remained casual observers of LANs, many are now signing contracts with network suppliers involving products that will support the OEMs' computers and peripherals. Customers are also finally leaving the sidelines to purchase PC networks, both singly and in high volumes.

Unless LAN vendors begin to exploit all available marketing channels, however, shipments will again fall short of market predictions. Most suppliers sell PC LANs directly to end users or through a few OEMs—channels that may be too limited to accommodate the anticipated rush. This year, according to research concern Future Computing Inc., Richardson, Texas, LAN suppliers in the United States will ship 19,000 networks worth \$156 million for interconnecting PCs and related peripherals. By 1988, vendors will ship 166,000 PC LANs worth \$1.58 billion, Future Computing predicts. At these rates, shipments each year will increase 72 percent, while their dollar volume will grow 78 percent annually.

Selling through OEMs has proved an effective way to distribute general-purpose LANs that link all types of computers—not just PCs—and their related peripherals. Vendors such as 3Com Corp. and Sytek Inc., both

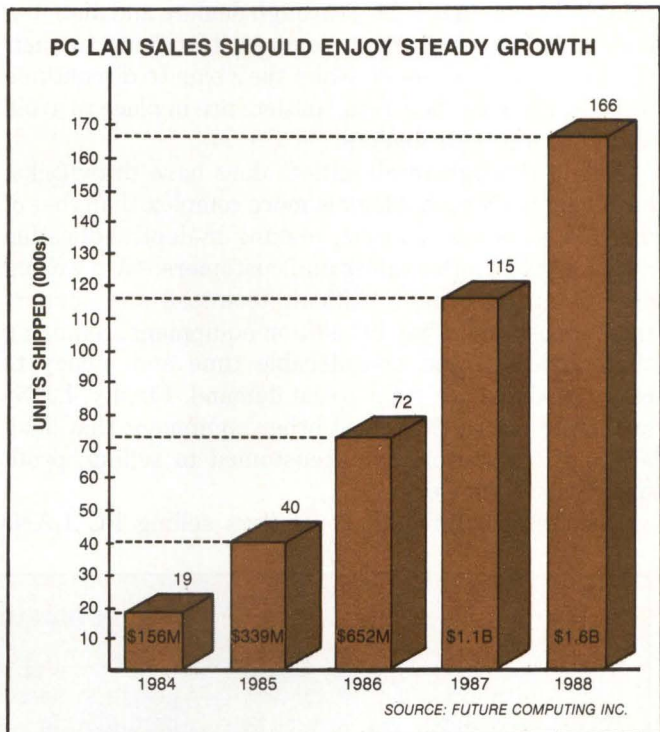

Sales of PC LANs will finally take off this year, increasing steadily through 1988, predicts research company Future Computing. The figures do not include LANs used to connect intelligent terminals and their peripherals. They include only the hardware and software necessary to connect personal computers and their peripherals.

of Mountain View, Calif., have successfully sold their general-purpose LANs through OEMs, but most PC LAN vendors are only now building their OEM sales forces. But it takes capital and time, however, to build manufacturing capacity to meet OEM contracts. It's also possible that an OEM might decide to manufacture its own LANs or to sign a contract with another LAN supplier.

Direct sales, another proven market channel for PC LANs, also has limitations. With direct sales forces that rarely exceed 30 people, most network vendors will be unable to meet an expanding demand. "How can

The Interpreter

a little, 50-person company make a sales call on AT&T?" asks one vendor. "We wouldn't know where to begin."

Some vendors try retail sales

To address their marketing problems, an increasing number of PC LAN vendors are adopting a new distribution strategy—retail sales. They reason that customers will prefer to use retail outlets as one-stop shopping centers for all PC equipment, including LANs. Backing up this thinking is the experience of at least one company: Corvus Systems Inc., San Jose, Calif. Corvus sold all its Omninet LANs through dealers and distributors until last year. Most vendors, testifying to their faith in the new channel, claim they plan to discontinue direct sales once their retail outlets are in place to avoid undercutting their dealers.

Selling through retail outlets does have drawbacks, however. LAN technology is more complex than that of most PCs and peripherals, making in-depth education necessary for both dealers and customers. Networking devices are also more difficult to install and support than almost any other PC add-on equipment, requiring that dealers invest considerable time and money to carry products not yet in great demand. Finally, LANs are lower-priced than most other equipment that dealers and distributors are accustomed to selling; profit margins are smaller.

Despite the difficulties, retailers selling PC LANs

generally report positive results. For example, Micro D, a Fountain Valley, Calif., distributor, has sold Corvus' Omninet for two years and is "looking at a few other PC LANs," according to company president Lorraine Mecca. The PC LAN "is not a product every chain store can carry," she contends. "Most LANs don't have on-board file-locking systems," the software that ensures data integrity by allowing only one user at a time to operate on a file. This shortcoming of most LANs "prevents distributors from being able to recommend [PC LANs] right off the shelf," she says. Micro D also distributes Corvus Winchester-disk systems, PCs and other products. "Corvus as a whole is among our top 20 vendors," Mecca says. Although specialized retailers were the first to carry PC LANs, national retail chains such as the Businessland, ComputerLand and Entré Computer stores have started to handle them.

Until recently, "there has been insufficient focus on the benefits PC LANs can provide, and too much on the technology," comments Anthony Morris, president of New York computer dealer Morris Decision Systems. Morris has carried Nestar Systems Inc.'s PLAN series since 1981 and 3Com's Etherseries since early 1983. The company also carried Corvus' Omninet and Orchid Technology's PCnet, but has "migrated away" from what he describes as less powerful, low-end LANs. Overall, Morris reports "increased momentum" in the

IBM: competitor or customer?

IBM Corp. has traditionally made its presence known in the network market by its absence. Its lack of networking announcements until late last year kept industry watchers guessing and potential customers from making any moves, for fear of risking incompatibility with IBM.

By mid-1984, IBM had made three announcements concerning local-area networks (LANs). Last December, it announced a token-passing, general-purpose ring network. In mid-February, it announced Clusternet, a low-end baseband network for connecting PCs, PC XT's, PCjr's and portable PCs. And in early May, in what was considered its biggest "non-announcement," IBM conceded that its general-purpose office LAN would not be unveiled for two to three years and that those wishing to prepare for it should install twisted-pair copper wiring in their buildings.

But none of these products is expected to become the network standard that the computer industry expected IBM to unleash into the LAN market. Increasingly, industry insiders are toying with the idea that IBM may wind up adopting a multinetting strategy. With such a strategy, IBM might both manufacture its own networks and sell those from several other suppliers, predicts Kim Myhre, an analyst with International Data Corp., Framingham, Mass.

So far, IBM has given no clues concerning its direction in the PC-networking area, outside of Clusternet, which "is almost not a LAN at all," according to one analyst. But whether it becomes a manufacturer, a reseller or both, IBM will have a huge impact on the PC-network market. The company has by far the largest installed base of personal computers, so its endorsement—or lack thereof—could

make or break any of the independents.

Myhre predicts that "something like Corvus [Systems Inc.'s] Omninet could be IBM's solution for the PC LAN environment." Indeed, IBM and Corvus last year negotiated a three-year, \$70 million contract with the West Virginia public school system for IBM PCs networked with Omninet and Corvus drives. But IBM also could introduce a low-end broadband product, Myhre says, as the company reportedly is negotiating a deal for Localnet hardware and/or software with Sytek Inc.

Perhaps Corvus' manager of OEM sales, John Houghton, puts it best, confiding: "Trying to understand IBM's networking strategy is like trying to nail Jell-O to a wall. The eventual goal is distributed processing on micros, but it is getting there via a curved path."

_____NET
(fill in blank)



Multiple Choice Made Easy.

Confused about which Local Network to choose? You're not alone. In today's personal computer environment, new LANs seem to pop up daily, adding even more choices. And more questions.

Questions about performance. Price. Security. Expandability. And software availability. It isn't hard to see that multiple choice has become multiple guess.

We Provide The Answer. At Novell, we offer a unique new approach. An approach which answers the multiple choice question. We've taken our field-tested network operating system and made it work on all of today's LANs. ARCnet. Ethernet. OMNINET. proNET. PCnet. G-NET. Even tomorrow's Anynet.

We call it NetWare.™

NetWare is designed to bring the user and software supplier together for maximum performance, security and functionality. No matter which LAN hardware you choose.

Software, Software And More Software. Because each LAN is different, today's leading software companies view NetWare as the single unifying answer to the multiple choice question. Many have become NetWare "Do It Once and For All" affiliates, adapting their software for application in multiuser NetWare environments.

Quickly. Easily. Uniformly. And only once for all LANs.

Novell Means Service. To serve the LAN market better, we've initiated a series of benchmark tests on all the major LAN configurations—both with the supplier's native operating system and with NetWare. The results are available now.

Interested? Give us a call to order your copy of the "LAN Benchmark Report." It's free. We'll also try to answer any questions you might have about personal computer networking. Call us at 1-800-LANKIND.

**NetWare. Dedicated to serve
all LANKind.**



Novell Inc.

1170 N. Industrial Park Dr.
Orem, Utah 84057
801 226-8202

ULTRA-RE

R - AT&T 3B20D SUPER MINICOMPUTER - AT&T 31

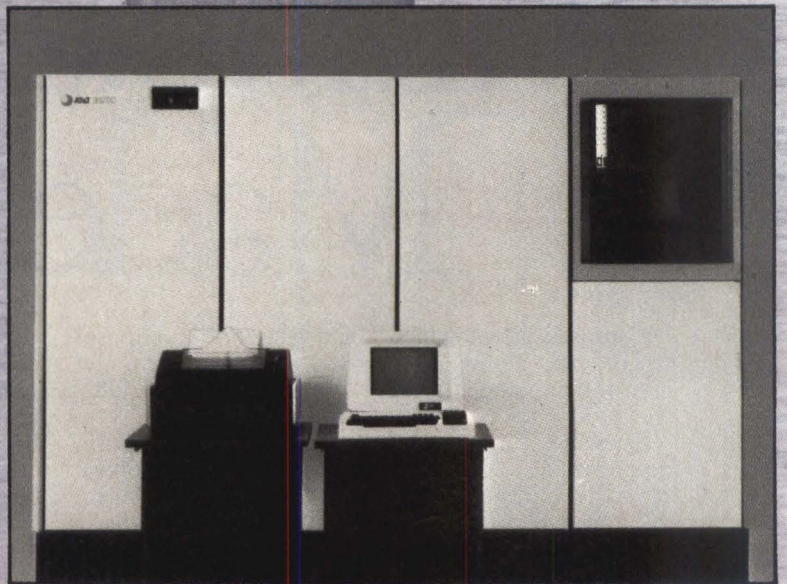

LIABILITY

3B20D SUPER MINICOMPUTER - AT&T 3B20D SUPER

Power. Performance. Profits.

In every way, the 3B20D from AT&T is in a class by itself. We designed this 32-bit super minicomputer to give new meaning to the concept of ultra-high reliability.

To set new standards for uptime.

To break new ground with our enhanced UNIX™ Operating System - UNIX RTR—that offers your customers maximum real time and time-sharing advantages.

And to give you the technically advanced machine you need to realize the full business potential of the lucrative multi-tasking and multi-user market.

A NEW BEST SELLER

The 3B20D will prove essential for industries whose business depends on the absolute reliability of their computer systems. Companies with reservation systems, such as airlines or hotels. Or those with command and control systems,

on-line banking or financial systems.

To deliver on its promise of unfailing performance, the 3B20D from AT&T continues computation during diagnosis, hardware faults, and hardware and software updates. The result is downtime that can be measured in minutes-per-year.

Other benefits include a crash-proof file system, and a host of features that prevent memory failure and reduce programmer error.

YOU CAN COUNT ON THE 3B2 AND 3B5, TOO

For complete systems solutions, your customers will welcome the other members of the 3B family of computers. Especially because they're based on UNIX System V.

Our 3B2/300 is a powerful 32-bit supermicro that's perfect for situations where a number of people require desk-top computers. It can support up to 18 users at individual

workstations—all sharing peripherals and data.

Our 3B5/100 and 3B5/200 can accommodate up to sixty users, without sacrificing response time. You'll find these super minicomputers powerful tools for a variety of applications—software development, office systems and CAD/CAM.

For all the members of the 3B family of computers, AT&T pledges a full program of service and support, including a comprehensive and flexible program for OEMs and VARs.

That and the unsurpassed research and development capability of our own AT&T Bell Laboratories make an unbeatable combination. Machines that won't let your customers down, coupled with support that won't let you down.

Only from AT&T.

If you'd like more information about AT&T Computers, call 1-800-833-9333 or use our international telex number (210-209).

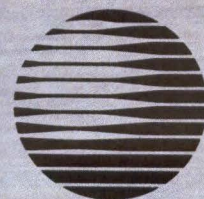

AT&T

TELEX®

Telex Shamrock 9250 has everything you want in a GCR tape subsystem. Right down to your favorite color.



It's the color of the money you stand to save with the new Telex Shamrock 9250. The most affordable GCR subsystem in its class.

Telex engineers have been making advancements in GCR technology for over a decade. The Shamrock 9250 is the biggest breakthrough yet. It gives you the faster access and throughput, greater storage efficiency and higher data reliability you look for in a full performance GCR subsystem. And it does so with the kind of cost efficiency other tape drives just cannot match.

The savings start right up front. The unit price of the Telex Shamrock 9250 is half that of previous GCR subsystems. Its compact design frees up valuable space. And with the assistance of Telex Engineering experts, your interface development will be fast



and efficient.

Down the road, the savings continue to add up. Cost of ownership of the Telex Shamrock is truly attractive. There are no planned service calls because the 9250 requires no preventive maintenance. Self-calibrating capability eliminates the need for scheduled adjustments. When service is required, the resident diagnostics hold costs to a minimum. Lower power consumption (typically 100 milliwatt) of the 9250 gate arrays increases reliability and keeps energy costs in line.

There are more reasons why the Shamrock 9250 is today's best value in full GCR performance. For the rest of the story, call your nearest Telex OEM Sales Office or our OEM Marketing Department at 918-627-1111. And let us show you how good you'll look in Telex Shamrock green.

CIRCLE NO. 59 ON INQUIRY CARD

TELEX® SHAMROCK  The innovation continues . . .

Telex Computer Products, Inc., Terminals/Peripherals/OEM Products
6422 East 41st Street, Tulsa, OK 74135 (918) 627-1111 Regional Offices: Amherst, NH (603) 673-9272/Garden Grove, CA
(714) 898-9833/Houston, TX (713) 497-6770 International: (214) 931-8511/telex: 730612 TLXINTL ADDI

The Interpreter



Rick Browne/Picture Group

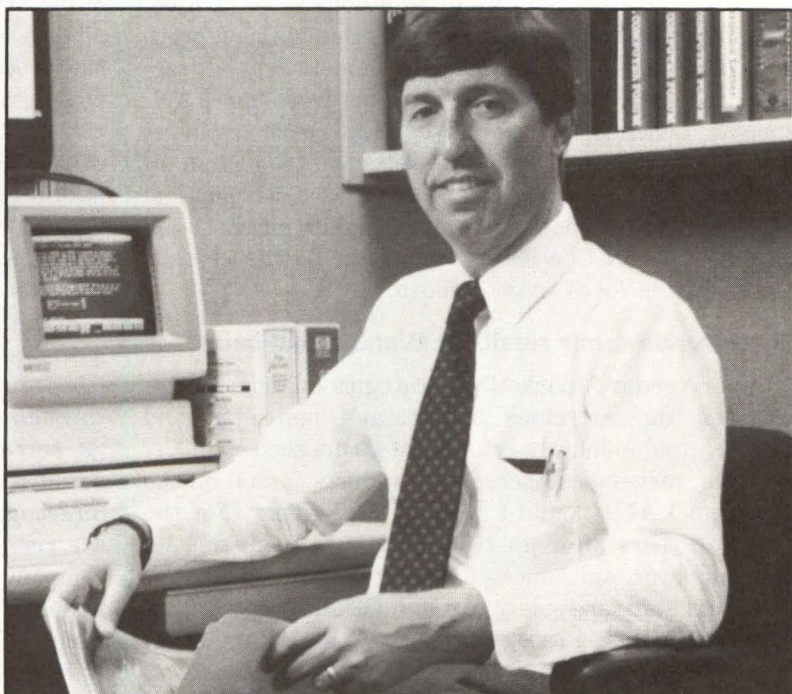

"Our products will be purchased where PCs are bought," says 3Com president William Krause of the company's decision to add retail sales to its successful OEM marketing strategy.

Nestar's marketing plan skirts the dealer/distributor channel, relying instead on selling through OEMs, value-added resellers and its own direct sales force, says vice president of marketing Peter Hertan.

dealership's LAN sales, even though he characterizes the typical PC LAN installation as small.

No single strategy dominates

At least one supplier—Nestar Systems Inc., Palo Alto, Calif.—has ruled out the dealer/distributor channel altogether. "We're not catering to low-cost items that go through dealers," says vice president of marketing Peter Hertan. Instead, Nestar sells its PLAN 3000 and 4000 networks through a 12-person direct-sales force and a few value-added resellers. Its series 2000, introduced last December, is sold through OEMs. Computer manufacturers may opt to sell PLAN 2000 either "as our brand or theirs," Hertan reports. Eagle Computer Inc., Nestar's first OEM, sells PLAN 2000 as Eaglenet Link.

Hertan says that Nestar will announce five other IBM-compatible OEMs this year and that the company expects OEM sales to represent 20 percent of this year's anticipated \$20 million in revenues. Almost 85 percent of Nestar's stock belongs to London's Rank Organization, which also jointly markets Xerox Corp. products sold outside of the United States.

Corvus is pursuing a different course. Until last year,

the Corvus national sales division handled LANs, selling half to retail dealers and half to distributors. This year, 15 percent of the company's business will come from OEM sales, says John Houghton, manager of the two-person OEM sales division. By late February, Corvus had signed on 32 OEMs, including Canon USA Inc., Fujitsu America Inc., IBM, NEC Inc. and Olivetti & Co. Moving into a new marketing channel isn't easy, notes Robert Clark, head of the Corvus national sales division: "It's costly in marketing terms to bring an OEM on-board—it could take from a year to 18 months." Retail sales are easier, he says, especially since a third-party maintenance organization handles 30 percent of Corvus' service responsibility.

Corvus sells its storage systems and PCs through the same dealer/distributor/OEM channels. Although sales for the nine months ending Feb. 21 were \$39.9 million, up from \$33.1 million for the same period last year, net income declined drastically, from a profit of \$3.1 million for the nine months ending in 1983 to a loss of \$1.3 million for the nine months ending this year. A Corvus spokesperson insists the poor showing did not result from distribution changes but instead stemmed from problems in getting new products out the door.

The Interpreter

Analyst David Lawrence of Montgomery Securities, San Francisco, agrees with Corvus that its new products caused company income to plummet. A good fraction of Corvus business used to come from non-LAN-specific Winchester disk drives, Lawrence explains. But he points out that the recent introduction of Omninet LAN drives has changed that proportion: "The company is putting a much higher emphasis on LANs." Despite the losses it caused, Lawrence calls the change in focus "a good move."

Some vendors mix retail, OEM and direct sales

Other vendors' marketing strategies fall somewhere between the extremes of Nestar's non-retail and Corvus' predominantly retail slants. One such company is 3Com, maker of Etherseries products, based on the Ethernet LAN standard pioneered by Xerox. For the first two years after its 1979 founding, 3Com sold its minicomputer and microcomputer networking hardware and software solely through OEMs.

Through this strategy, it acquired a number of impressive customers, including Hewlett-Packard Co., Texas Instruments Inc. and Zenith Data Systems.

3Com president William Krause reports that "although all the details still aren't worked out," the company is in the process of adding AT&T Technologies Inc. to its OEM stable. 3Com will provide AT&T with the transceiver—the device that connects a computer to a LAN cable—for AT&T's recently announced Ethernet-compatible 3B Net. Although 3B Net was designed primarily for large computers, AT&T's PC Interface, a plug-in card announced in conjunction with the network, allows PCs to access the network.

3Com, which went public in March, is adding retail stores and value-added resellers to its list of outlets. Consequently, its sales mix is roughly 55 percent through OEMs, 25 percent through retail outlets, and 20 percent through direct sales, Krause says. As a result of its retail addition, the company is eliminating direct sales, he notes. Despite this prohibition, sales are rising; for the three quarters ending Feb. 29, the company announced \$10.8 million in sales, up from \$4.8 million for the full year ending May 31, 1983. The company's new premise, Krause says, is for its products to be "purchased where PCs are bought."

"PC LANs need to parallel the way PCs are sold," agrees Kenneth Biba, vice president of Sytek Inc.'s six-month-old PC division. The division will manufacture and sell LocalNet/PC, a product that, if available by year-end, will be the first broadband PC LAN. PC LANs have traditionally transmitted data using baseband technology, which has low-cost, low-performance characteristics that are ideally suited to PC interconnection.

Sytek sells its general-purpose LAN, LocalNet, directly to Fortune 1,000 companies and on a limited basis through OEMs and retail outlets, Biba says. Sales for Sytek, 51 percent of which is owned by General Instrument Corp., reached more than \$30 million last year, he reports.

For its PC network, Biba explains, the company will stress high-end retail outlets. "For some time, our OEM business will dominate [within the PC division], but this will shrink," he predicts. "There are many types of PCs, and Sytek wants to be a diversified supplier." However, Sytek is reportedly in the throes of negotiating a deal for LocalNet/PC hardware and/or software with the biggest OEM of all—IBM. □

Mary Jo Foley is an associate editor of *Electronic Business* magazine, in which this article originally appeared.

**SUPER
LOW
PRICES!**

HIGH QUALITY LOW COST CABLES WITHIN 24 HOURS

**CALL TOLL FREE 800-243-5760
in CT 203-356-9315**



EXTENDED DISTANCE DATA CABLES

EDC04 \$11 both ends + 20¢ per ft.
or 1000 ft. reels \$93
EDC08 \$12 both ends + 30¢ per ft.
or 1000 ft. reels \$149
EDC12 \$12 both ends + 40¢ per ft.
or 1000 ft. reels \$215
EDC25 \$16 both ends + 60¢ per ft.
or 1000 ft. reels \$384

**ASK FOR
OUR NEW
20-PAGE
CATALOG!**



CRAIG DATA CABLE CO.
652 GLENBROOK ROAD
STAMFORD, CT 06906

CIRCLE NO. 60 ON INQUIRY CARD

**Interest Quotient (Circle One)
High 804 Medium 805 Low 806**

Two New Freedoms for DEC.

Video Display



VT-220 compatible Freedom 220: \$795

Straight-out, the Freedom™ 220 Video Display Terminal gives you what you need in the DEC world: VT-220, VT-100 and VT-52 compatibility.

And then some.

Like room for a full-sized add-on PC board (OEMs, take note). A low-profile, professional 106-key keyboard that includes four program function keys as well as several programmable, non-volatile function keys. You also get a crisp resolution, non-glare screen. With +15° and -5° tilt. And 70° swivel. All in a 25-line by 80-column display with smooth scrolling. You also get panning for 25-line x 132-column applications. An amber screen is your option.

What isn't available is a down-loadable character set. Ours is fixed.

What you do get. And what you don't. Just \$795.

Voice/Data



VT-220 compatible Freedom 222: \$1395

List all those products available today that offer VT-220 compatible terminal capabilities, full data communications, and full telephony features.

You'll discover there is only one.

The Freedom™ 222 Remote Information Station.

Based on the Freedom 220 Video Display Terminal, the Freedom 222 is VT-220, VT-100 and VT-52 software-compatible and features an integral Bell 212A-compatible modem. You also get sophisticated, hardworking "smart" telephone features like a 25-entry directory and an automatic dialer.

The Freedom 222 is the only product available anywhere today with voice and VT-220 data capabilities for your DEC system. It's a powerful terminal. With powerful data communications. And powerful telephony features. At \$1395, that's a powerful lot.

 **LIBERTY**

We make terminals.

Liberty Electronics, 625 Third Street
San Francisco, California 94107
Telephone (415) 543-7000. Telex 470 439

© 1984 Liberty Electronics

VT-52, VT-100, VT-220 and DEC are trademarks of Digital Equipment Corporation.

CIRCLE NO. 61 ON INQUIRY CARD

NINE WAYS MORE MONEY AS

It's finally happened... your opportunity to be in the right place at the right time.

Consider: Over the next five years the market for business computers is estimated to be more than \$300 billion. That's *billion* with a "b." And that's not counting add-ons and aftermarket sales.

And that means hundreds of thousands of businesses are looking for computers *right now*... but that's not all. They're also looking for consulting, applications, training, supplies and ongoing support. They're looking for a reliable computer company—but they're also looking for someone who knows their business.

And, that means if you're a Digital Commercial OEM, they'll be looking for you.

Why Digital?

Because Digital is one of the world's leaders in the computer reseller market. *More OEMs work with Digital than with any other computer company.* In fact, Digital is the second largest computer company in the world, with over \$4 billion in revenue in 1983 alone.

And no one does more than Digital to help Commercial OEMs get their slice of the pie. Here are just some of the ways we can help you be more successful:

1. Sell the widest range of compatible computers in the world.

Here is proof that Digital is the computer company that "thinks OEM": We have created the broadest range of compatible computer systems in the industry. Computers that have proven themselves in the Commercial OEM channel—and in the marketplace—for over 20 years.

Our range extends from our award-winning PCs (we have three families), through our family of PDP-11 systems, which has been a mainstay of the Digital OEM marketplace for more than a decade, on through our complete VAX family, famous for setting the standard in 32-bit computing.

Our commitment to compatibility means you'll get more mileage out of your software applications. You'll spend less time rewriting programs, more time selling the ones you've got. And you'll be able to sell the same appli-

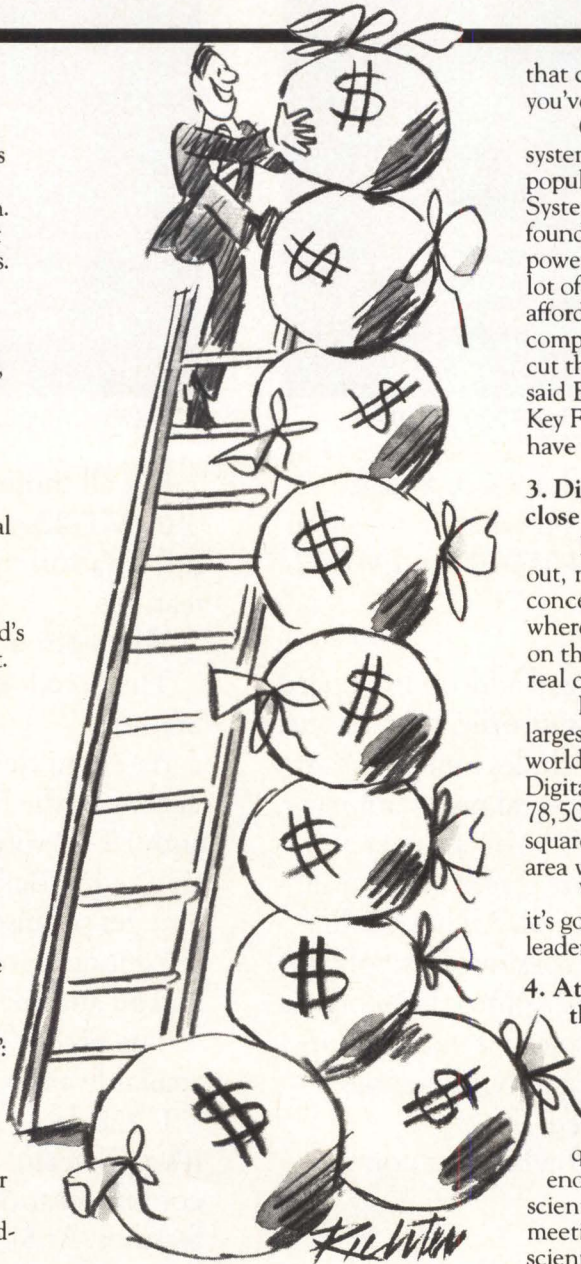

cation to a wide variety of businesses, both small and large. In short, you get maximum protection of your investment in software applications.

2. Open up whole new markets practically overnight.

How would you like to discover a whole new market for your application almost overnight? Digital makes this possible—with a broad range of computers

that can enable you to reach customers you've never been able to reach before.

One example is the MicroPDP-11 system, the latest in a whole history of popular PDP-11 computers. Key Financial Systems, a Digital OEM in New Jersey, found that the MicroPDP-11 put high-power data processing within reach of a lot of trust companies who couldn't afford it before. This opened up a completely new market for them. "It cut the cost of hardware in half for us," said Bill Brinsfield, Vice President of Key Financial Systems, "and we didn't have to touch our software."

3. Digital's reputation can help you close more sales.

In today's computer market shake-out, more and more end users are concerned about reliability. That's where Digital's credentials as a company on the Fortune 100 list can give you a real competitive edge.

In addition to being the second largest computer company and the world's leader in minicomputers, Digital can also boast of more than 78,500 employees and 8 million square feet of manufacturing area worldwide.

When the competition gets fierce, it's good to know you're running with a leader.

4. Attract more customers—and keep them happier—with Digital's high-quality computers.

At Digital we know that the opposite of quality is customer frustration, so we impose our own quality standards—standards tough enough to satisfy the most demanding scientific and technical applications. By meeting the rigorous requirements of scientific environments, Digital has earned an industry-wide reputation for outstanding quality.

And that hasn't happened by accident. We test all our computers for thousands of hours, in a variety of demanding, real life situations. And we are the only major company to give a limited, 1-year on-site warranty on our personal computers.

So you can look forward to more sales—and fewer "unpleasant surprises" after the sale.

YOU CAN MAKE A DIGITAL OEM.

5. Digital's service and support programs can help customers feel more comfortable buying from you.

Digital has a service network of more than 18,000 personnel in 43 countries on 5 continents, as well as carry-in centers, and a fleet of fully equipped mobile units in major cities throughout the

your customers. But we also have special programs just for Commercial OEMs, such as the Commercial Business Orientation Seminar (CBOS). CBOS gives you everything you need to know about planning and running your business.

Because the more you know, the more you'll sell.

other OEMs. And Digital symposiums give you first-hand information on products and product services.

9. Find hidden customers with Digital's Market Mapping, Lead Matching, and Business Review Programs.

Many of Digital's programs are designed to ensure that when you jump into Digital's Commercial OEM program you'll have a soft landing. Here are some examples:

Through the Market Mapping and Business Review Programs, Digital will thoroughly analyze your market and help locate new opportunities for you.

The Lead Matching program matches prospective customers (anywhere in the U.S.) with the Commercial OEM who has just the right package.

And all this is just the beginning. Because Digital has many other ways to help boost your profits. Like special incentive programs. The Authorized Distributor Program. Advertising and lead generation programs. And more.

There's really nothing else like it in the industry... and there never has been. That's because only Digital has pioneered the OEM business for the past 20 years. Only Digital has the largest share of the OEM market. Only Digital.

Wouldn't you like to make more money, and command a larger piece of the action as a Digital OEM? Isn't this the time and the place for you?

Write today for more information, or mail in the attached card. You have nothing to lose, and many great opportunities to gain.

Write to:

Digital Equipment Corporation
BB 22, 909 Third Avenue
New York, NY 10022

digitalTM

copyright © Digital Equipment Corporation 1984
PDP, VAX, and MicroPDP-II are trademarks of
Digital Equipment Corporation.

"Our Commercial OEMs have specialized experience and knowledge in various markets that we do not have. Their expertise and entrepreneurial spirit have contributed greatly to our success."

*Ward MacKenzie, Vice President, OEM Group
Digital Equipment Corporation*

U.S., Canada, and Western Europe.

We even offer remote diagnosis of computer problems by telephone, plus a Telephone Support Service which puts you in touch, instantly, with someone who understands your computer.

It's a complete blanket of service that can make any customer feel a lot more comfortable about buying from you.

6. Our outstanding educational system and training programs can help you increase your effectiveness—and your sales!

At even the most basic level Digital's educational services mean increased revenue for you.

Our Profit Express program, for example, makes it possible for you to buy Digital's training courses and products at a substantial discount. (You can resell these courses to customers at a profit, or use them to train your own people.)

We have 27 training centers offering more than 300 courses, including lab courses, audiovisual courses, computer-based instruction, and even our own library of textbooks.

These courses are for you and for

7. Get the inside track on your competition with Digital's information programs.

To help you know more, and know just the right things, Digital will keep you supplied with our product information, marketing information, technological news, and more.

We've even set up an On-Line Communications Program designed to provide you with critical business information. This information will include lists of applications that Commercial OEMs have made available for resale, as well as up-to-date product and marketing information.

Priceless information—for the price of a phone call!

8. Seminars, trade shows, and symposiums help you sell more effectively.

At Digital we'll never just drop our computers on your doorstep and wait for you to sell them. Quite the contrary. We support you all the way... and we do a lot of this support in person, face to face.

For example, there's the Executive Seminar, a forum for the exchange of ideas with Digital management and

Become a Digital OEM and watch what happens.

CIRCLE NO. 62 ON INQUIRY CARD

HOW TO STRETCH A PC TO CREATE NEW MARKETS.

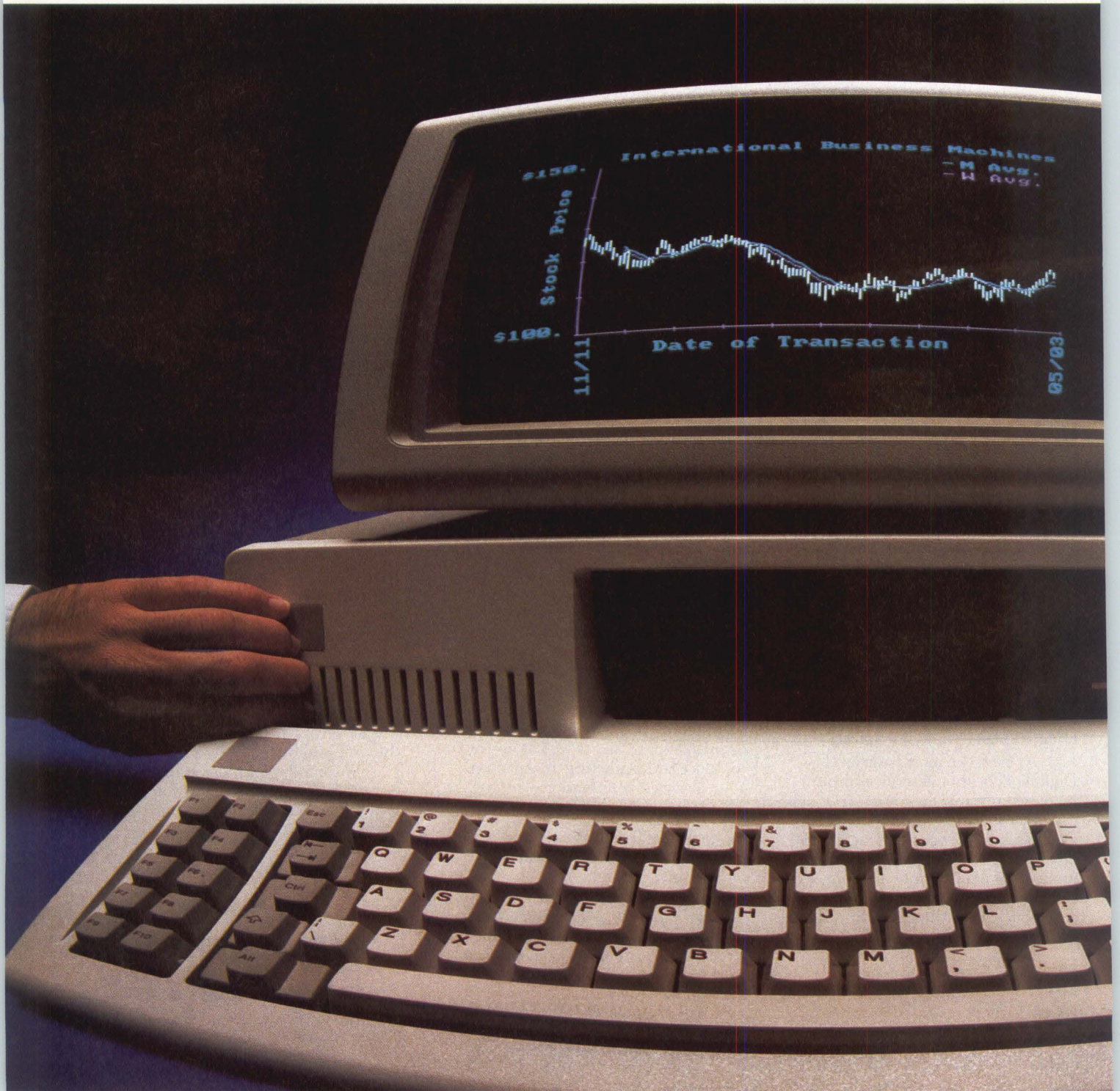

OR EXPAND EXISTING ONES.

When is a PC not a PC? When you turn it into a personal data base cruncher. Or a personal graphics workstation. A personal image processor. Even a personal signal processor.

You can do all that and more with the Marinc board pictured below. It's your key to unlocking new opportunities and new markets.

Power to the PC.

We've put array processor technology to work to supercharge the PC. Suddenly a spectrum of applications that were beyond that PC's capabilities are wide-open possibilities.

If your strength is software, the Marinc array processor gives you incredible performance improvements. Even the most complex spreadsheets can ripple faster than you can say 1-2-3. Enormous data bases can search, sort and report in the blink of a cursor. And high speed arithmetic calculations which slow a standard PC down to a crawl are performed in split seconds.

If you're a systems integrator, VAR or OEM looking for a competitive advantage, a PC with a Marinc array processor is a natural line extension, enabling you to offer a cost-effective "personal" version of your best-selling product.

The Race Is to the Swift.

The Marinc array processor is especially flexible and easy to program. So you can get to market quickly. Which, after all, is the name of the game.

We could fill pages with pertinent performance specs on our PC-compatible array processor. So we did. We've put together an 8-page brochure that will stretch your imagination. And just might open a world of opportunity. Write for a copy. Marinc Computer Products, 3878 Ruffin Rd., San Diego, CA 92123. Or call 1-800-421-4807, in CA (619) 268-4814.

Marinc array processors include a 24-bit floating point board with optional IEEE-754 compatibility and a 16-bit integer-only board for maximum price/performance.

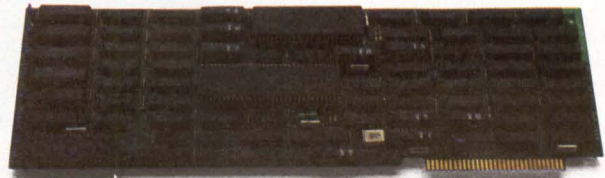

/// MARINCO

CIRCLE NO. 63 ON INQUIRY CARD

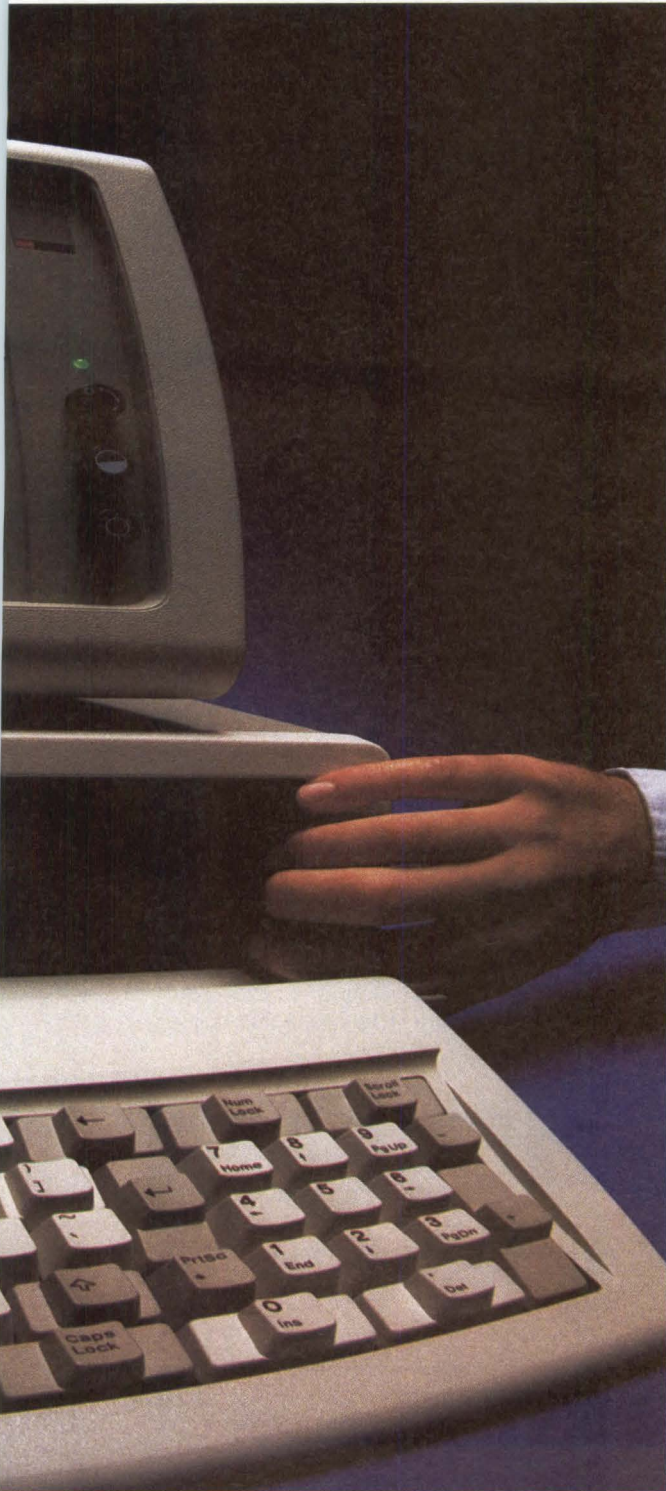

NEW FROM MICRO-TERM



ERGO[®] 201 WITH PLOT-10 GRAPHICS

The ERGO 201 with Plot-10 Graphics is a unique user-programmable terminal with total Tektronix 4010 compatibility. In addition to the many standard emulations available on the unit, the ERGO 201 also has a custom mode, which allows the operator to define the terminal's control codes and escape sequences and then save the designations in non-volatile memory. The ERGO 201 is also available without graphics for only \$795 list price.

EMULATES: Televideo 925 • DEC VT 52 • Micro-Term ACT 5A • Lear Siegler ADM 3A • ADDS and Hazeltine (most environments) • Custom mode (Define your own.)

STANDARD FEATURES: Custom mode • 16 function keys (host-definable or user-programmable to provide 48 functions) • 25th status line (five-mode operation) • Bidirectional printer port • Five video attributes • Keyboard LEDs • Full one-year warranty. ERGO 201 is also available with amber screen, current loop and alternate character generator and second page of memory.

\$1395

Quantity Discounts Available

Terminals are our only product, and we put more into them.
Call or Write: MICRO-TERM, INC., 512 Rudder Road, Fenton (St. Louis County), Missouri 63026
(314) 343-6515, TWX: 9107601662, MICROTERM, STL.

On-site service available at over 450 locations through Western Union

VT 52, Espirit II, ADDS Viewpoint, Televideo 925 and ADM 3A are Registered Trademarks.

CIRCLE NO. 64 ON INQUIRY CARD

The Integrator

Applying integrated systems in industry, engineering and commerce

Artificial intelligence techniques speed software development

Using expert systems tools to customize commercial COBOL package saves time, will make future modification easier

Bernard P. Wess Jr., Information Architects Inc.

Expert systems, which use principles of artificial intelligence (AI) to structure bodies of information, now exist primarily for sophisticated applications in science and engineering. But those AI concepts can also help system integrators develop and maintain commercial data-processing systems. These tools can reduce

the time needed to customize and later modify a software package and also improve software's usefulness by making it more closely reflect the human decision-making process.

Information Architects Inc., Needham Heights, Mass., recently used expert systems technology to develop a customized, transaction-processing package for a distribution company. The foundation was a

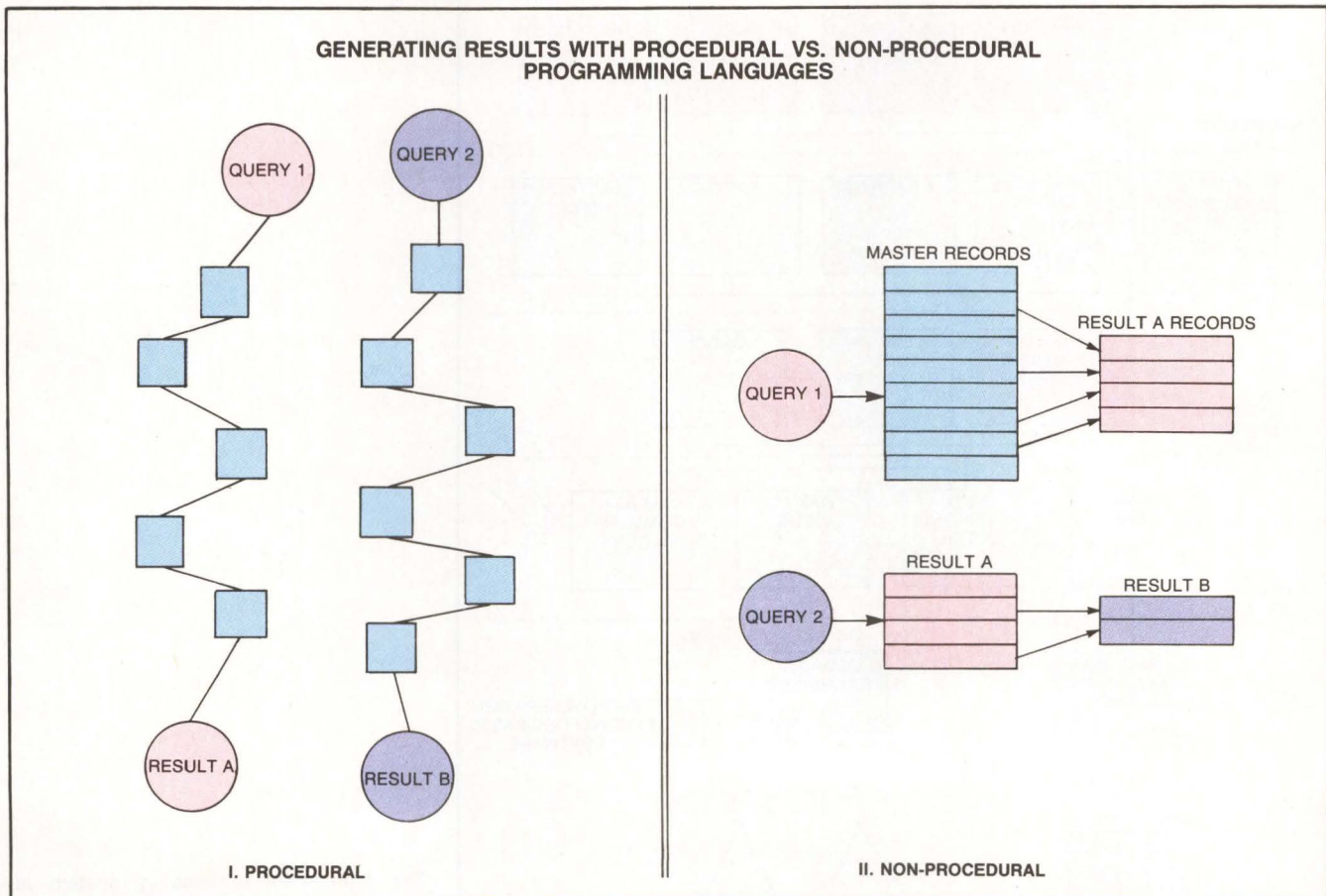

I. Procedural programming languages produce a structure of step-by-step instructions to generate results. Even if result B is included in result A, a common situation in database accessing, the two queries initiate independent instruction paths to their results.

II. Non-procedural languages access table-structured information. Here, software derives result B from records already retrieved to generate result A.

The Integrator

standard, commercial package written in COBOL, a programming language well-suited to business applications. Rather than writing all the custom software in COBOL, however, Information Architects wrote portions in the AI programming language Prolog.

The software designers had found they could program some of the customer's business procedures—especially evolving ones—far more easily by using Prolog and AI concepts than by using COBOL and conventional development approaches. They wound up using a combination of languages and development approaches, matching each with a compatible business procedure.

Software spans five generations

The past 35 years has seen the emergence of five generations of software development methods—all still used. The first two generations concern processing data. First-generation software, written in machine language, deals with individual units of data, while second-generation software, written in high-level programming languages such as COBOL, handles data organized into records. The programming languages used are *procedural*, consisting of step-by-step instructions, such as "if/then/else," "do while" and "perform."

Third-generation software, also written in high-level, procedural languages, is oriented toward databases.

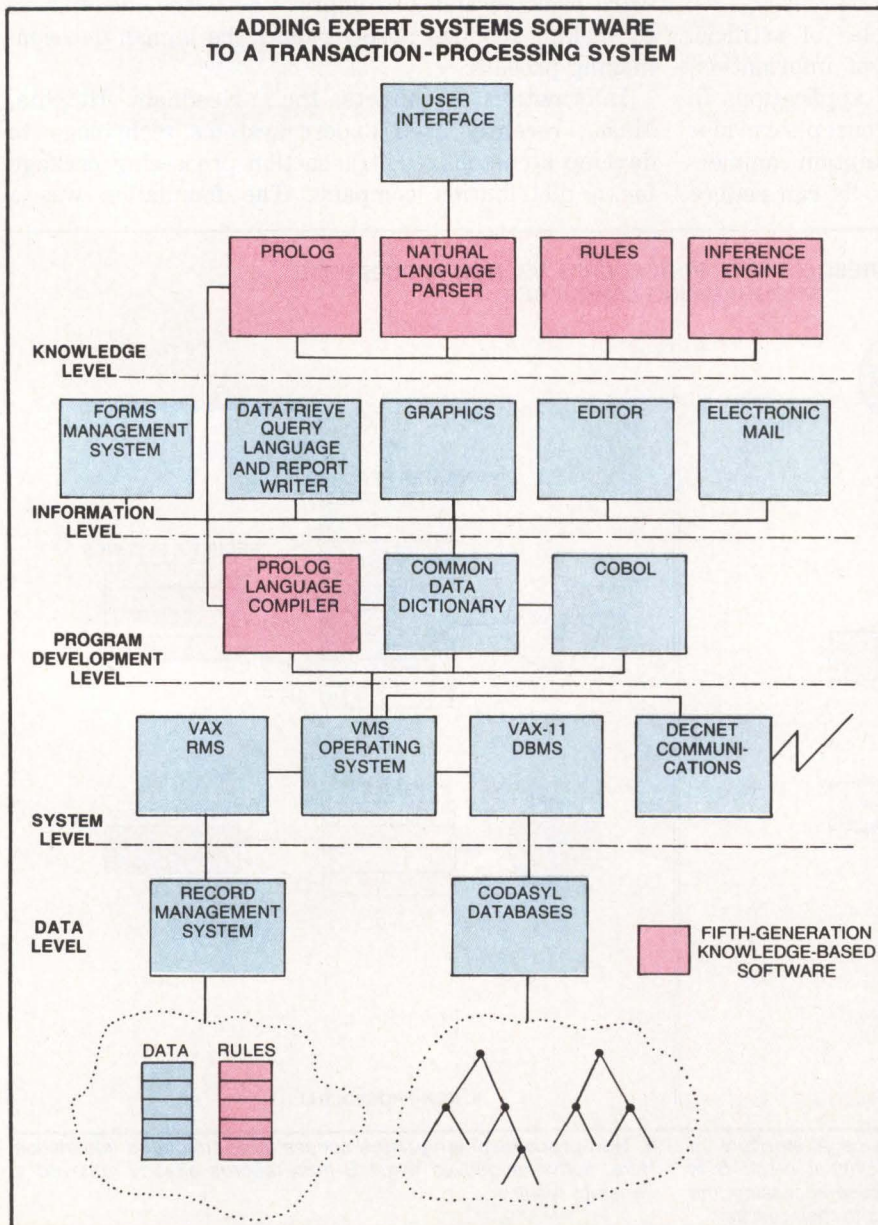

The transaction-processing system includes five levels of software. On top of a four-level COBOL-based foundation package, Information Architects added a fifth level containing knowledge-based expert systems software.

**A \$14 BILLION*
MARKET
AWAITS YOU...**

*Source: U.S. Dept. of Commerce

The Integrator

In these programs, the structure of the database itself imparts information in addition to that contained within individual records.

Fourth-generation software uses *non-procedural* languages and is oriented toward information contained in a database-management system (DBMS). Non-procedural languages, such as Nomad and Query By Example, allow users who are not trained programmers to access table-structured data simply by stating requests. A transaction-processing system created by using fourth-generation methodology has four levels: data in a database, system software (including the operating system and the DBMS), program-development software (including high-level languages) and information software (including tools such as forms managers, graphics interfaces and query languages to present information easily).

Fifth-generation software, which encompasses many branches of AI, adds the knowledge level to the four-level model above. This level includes logical rules, entered by the application developer, about the facts stored at the data level. Using an inference engine, the system can generate answers to queries by inferring relationships between the rules and relevant facts. To express such rules, new programming languages were developed, including LISP, Themis and Prolog. The knowledge level might also include a natural language parser and rules about syntax and semantics, to make querying the system easy.

AI features make programs more flexible

In planning payroll budgets in a commercial transaction-processing system, for example, the data, information and knowledge levels all come into play. Employees' hourly pay rates, stored at the data level, are facts. Software at the information level can create 18-month payroll projections for each department by retrieving facts from the data level and processing them into a display or report.

Software at the knowledge level can generate one or more logical results in response to a query such as, "Do our payroll projections exceed 110 percent of our previous year, and, if so, what department budgets should be cut and by how much?" Knowledge-level software produces one or more alternative results through inferences from relevant facts (pay rates and department sizes) and rules (company policy and managers' experience).

Of course, in all companies, such facts and rules change. But while procedural languages like COBOL can effectively access large, simply organized data structures, they can't easily manage the rules of human

decision-making. When programmers use conventional languages—even non-procedural ones—to program decision-making processes, the code is usually complex and difficult to change.

An AI language gives programmers a convenient tool for expressing rules in machine-readable form. Information Architects used a version of the expert systems language Prolog, developed by the University of Sussex, Brighton, England, which has a built-in inference engine, editors, a symbolic (source language) debugger and interfaces to other programming languages.

The software designers found that they could program some of the customer's business procedures—especially evolving ones—far more easily by using Prolog and AI concepts than by using COBOL and conventional development approaches.

The inference engine is a formal mathematical proofing algorithm that permits a system to understand a knowledge-level query and then generate logical results from facts in the database and from rules written in Prolog. To do this, the inference engine must be able to recognize patterns, compare statements and create complex data structures such as syllogisms and B-trees.

An inference engine can detect conflicts between a new rule and existing rules as soon as the new rule is written—an ability beyond the scope of conventional programming approaches and languages. If available facts and rules don't provide enough information to answer a query, the system asks the user qualifying questions in an attempt to clarify alternatives.

Expert systems methods simplify changes

Information Architects' client company needed generic business applications, such as general ledger; applications specific to the distribution field, such as order entry; and unique applications, such as managing a customer-service application. Furthermore, the company wanted to implement the system over a nationwide network.

To save time, the developers decided to buy a foundation package and customize or add software as needed. They estimated they could use 70 percent to 80 percent of most commercially available packages without

ABOARD AFIPS-ASIA'85...

Demand is strong...the computer market is growing rapidly...expanding to over \$14 billion* in the next 5 years. AFIPS-ASIA '85 is your opportunity to secure your presence in Japan, Taiwan, Hong Kong, and Singapore.

AFIPS-ASIA '85 will take your products and expertise to thousands of international computer buyers in six key ports along the Pacific Rim. As an AFIPS-ASIA '85 exhibitor you will display your computer hardware, software, and related products in the ship's large, specially designed exhibit halls, with the unique advantage of only one set-up.

For more information about AFIPS-ASIA '85, complete the coupon below and mail to: Exhibit Sales, AFIPS-ASIA '85, 1899 Preston White Dr., Reston, VA 22091; or call us at (703) 620-8935.



*Source: U.S. Dept. of Commerce



—m.v. World Wide Expo

Yes, I'm interested
in finding out more about
AFIPS-ASIA'85!

- Send me additional information. Have one of your representatives call me.

MAIL COUPON TO:
AFIPS-ASIA '85, 1899 Preston White Dr., Reston, VA 22091

NAME _____
TITLE _____
COMPANY _____
ADDRESS _____
CITY/STATE/ZIP _____
PHONE _____

AFIPS-ASIA'85

February 14 through March 2, 1985



SPONSORED BY
American Federation of Information
Processing Societies, Inc.

CIRCLE NO. 65 ON INQUIRY CARD

IT WILL GROW ON YOU.

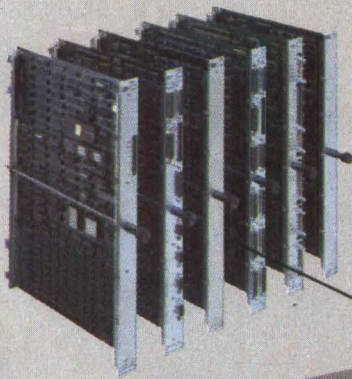

CONFIGURABLE ACCORDING TO USER NEEDS. As many as six processors can be installed in each enclosure. CPU-intensive jobs utilize multiple Applications Processors. Systems with heavy disk usage can distribute this load among several File Processors. The number of user ports can be increased by adding more I/O Processors.

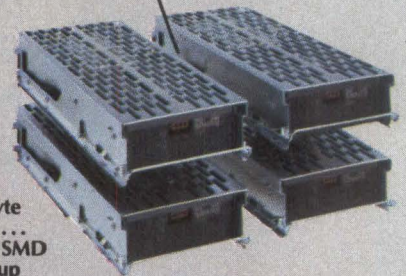
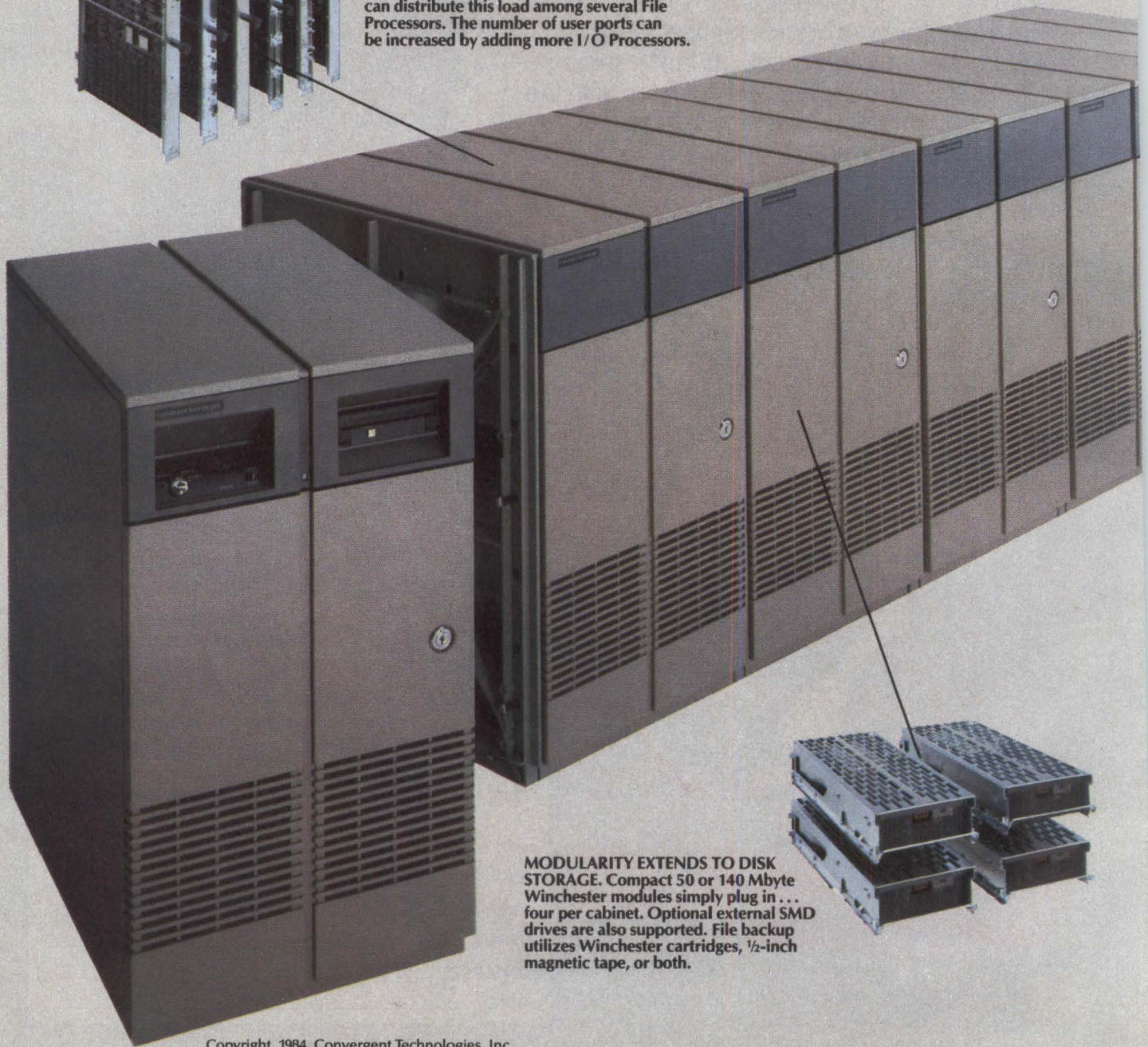

MODULARITY EXTENDS TO DISK STORAGE. Compact 50 or 140 Mbyte Winchester modules simply plug in . . . four per cabinet. Optional external SMD drives are also supported. File backup utilizes Winchester cartridges, 1/2-inch magnetic tape, or both.

MegaFrame™. Now OEMs can offer a high-performance UNIX™-based system that can't run out of performance.

OEMs can now deal cost-effectively with the problems encountered when user applications produce computing demands that outstrip the capabilities of conventional systems.

Convergent Technologies' MegaFrame is a revolutionary new UNIX-based super-minicomputer—so innovative in its architecture that it represents the ultimate in multiuser systems design. It grows exponentially from a system offering minicomputer-level performance to an enormously powerful engine serving as many as 128 users with 36 parallel processors, 24 megabytes of RAM and gigabytes of disk storage.

No other system can match the MegaFrame's potential for field expansion. It enables manufacturers and systems builders to keep pace with today's requirements for more and more computing services... but *not* at the cost of discarding hardware or performing expensive CPU upgrades.

MegaFrame's architectural breakthrough. Dependence on traditional single-CPU shared-logic architecture is the root of systems bottlenecks.

Convergent's response: a novel system utilizing *multiple* specialized processors to distribute workloads for optimum performance—even if user needs are unpredictable or subject to rapid change.

MegaFrame's virtual memory Applications Processors each have a 32-bit CPU, up to 4 Mbytes of RAM and run a demand-paged version of UNIX System V. Up to 16 of them can operate in parallel.

The File Processors effectively function as back-end machines providing DBMS, ISAM and other disk-related services. Up to six File Processors each with four disks can operate in parallel.

Terminal and Cluster Processors can also be added—the latter serving front-end communications needs. They off-load communications from the other processors by running protocols such as SNA and X25 networks.

MegaFrame's daisy-chained cabinets offer total expansion potential of up to 36 slots. OEMs configure the system needed for specific applications simply by adding the correct number/combination of processors.

Flexibility in applications development. Inclusion of one or more Applications Processors allows running UNIX System V. All standard UNIX tools are provided, along with COBOL, FORTRAN-77, BASIC interpreter and compiler, plus Pascal.

The "least-cost solution" to serving a wide range of UNIX-systems needs, MegaFrame has won acceptance from OEMs in the U.S. and abroad. The uniqueness of its modular design, its versatility in providing upgrade-path options and its price/performance advantages give it market-share potential of outstanding dimensions.

The system that will grow on you starts at a very attractive price: about \$20,000 for a system that effectively supports 16 users. Send now for a comprehensive Information Package including reprints of magazine articles. It explains how MegaFrame's growth potential can impact favorably on your plans for growth in the UNIX market.

Convergent Technologies, Data Systems Division, 3055 Patrick Henry Drive, Santa Clara, CA 95050. Phone: 408/980-0850. Telex: 176-825.

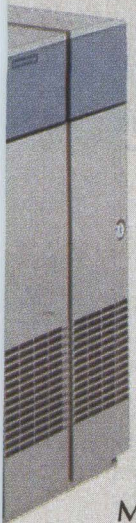

MiniFrame™: the entry-level multiuser UNIX system.

Starting at under \$5,000 for a single-user system, Convergent's MiniFrame offers outstanding capabilities for small to medium sized organizations running large UNIX-based applications. Utilizing an MC68010 microprocessor operating at 10Mhz, with no wait states, it provides impressive CPU speed—comparable to VAX™-11/750 running the AIM™ Benchmark. MiniFrame features virtual memory management, with demand-paged implementation of UNIX System V. It runs as many as eight terminals, with up to 50 Mbytes of integral mass storage. MiniFrame and MegaFrame are object-code compatible, allowing OEMs to offer a *complete family* of systems unrivaled in price/performance characteristics.



MiniFrame and MegaFrame are trademarks of Convergent Technologies, Inc. UNIX is a trademark of Bell Telephone Laboratories, Inc., VAX is a trademark of Digital Equipment Corp.

Convergent Technologies

Where great ideas come together

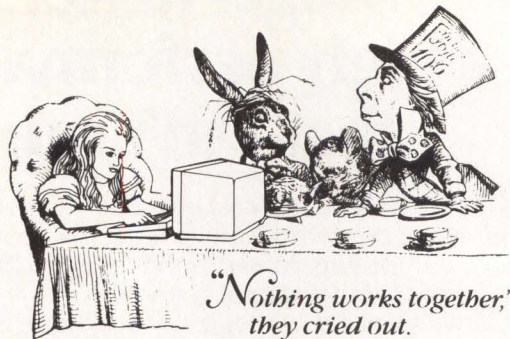

*"Nothing works together,"
they cried out.*

"It will now," said Alis.

With Alis™ everything works together. Text, spreadsheets, drawings, business graphics and database information work together in a single, always editable document.

Alis combines the advantages of integrated PC applications with the information-sharing benefits of communications-based OA systems. It offers the most advanced total office solution ever.

Alis makes it easy for people to work together. It provides integrated electronic mail, calendar and meeting scheduling, and revolutionary Automatic Office Assistants™ to aid management information monitoring and decision making.

Written in "C," Alis is initially available on UNIX* to large OEMs. It's destined to bring sanity to the mad tea party world of office automation.

*UNIX is a trademark of Bell Laboratories. Applix, Alis, and Automatic Office Assistants are trademarks of Applix, Inc.

Alis™

The next-generation office software system from APPLIX

Finally, some answers in Wonderland.

APPLIX, INC. 302 TURNPIKE ROAD, SOUTHBORO, MASSACHUSETTS 01772 (617) 481-4721

The Integrator

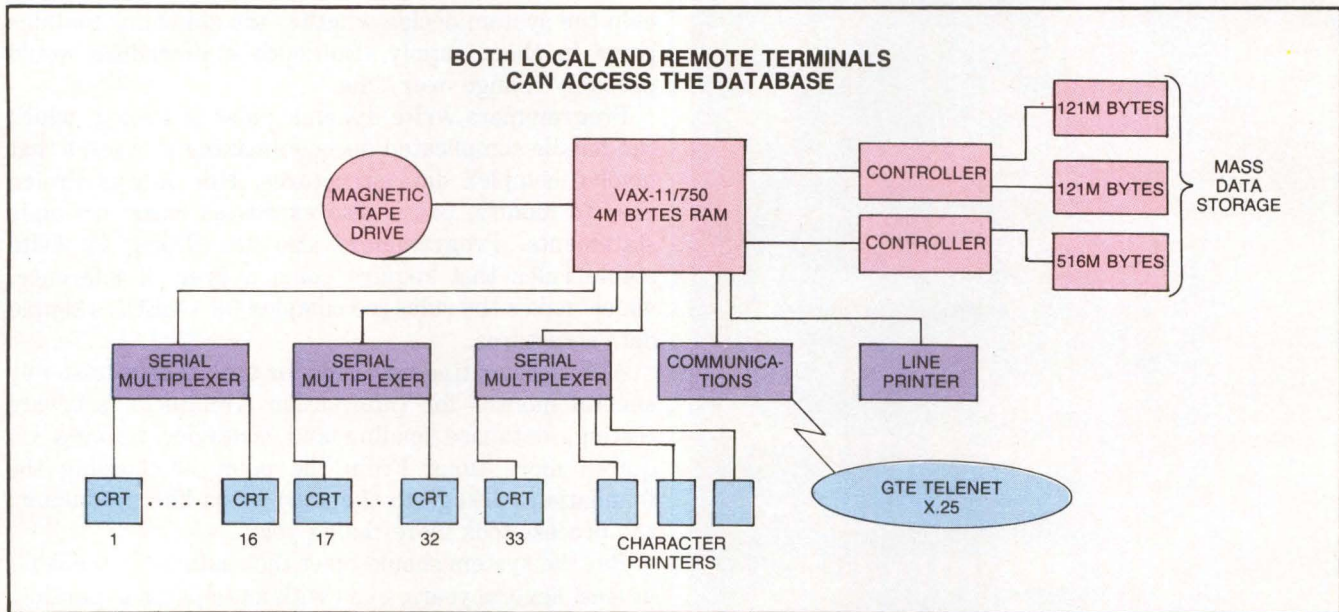

The computer system that runs the distribution company's transaction-processing package can support 33 terminals locally and others scattered nationwide, linked via a public network.

changes. The developers looked for certain features: general business modules written in COBOL for real-time transaction processing; thorough documentation; and built-in application development tools such as audit trails, journal files and a screen generator. They also wanted a package that could interface with accounting files and had a query language/report writer. Finally, they wanted the software house that supported the package to provide source code.

After reviewing 15 possible choices, Information Architects selected Xerox Computer Services' PRAXA package, which has 100,000 lines of COBOL code and occupies 10M bytes of mass memory. The package runs on Digital Equipment Corp.'s VAX computers, letting developers use the X.25 packet-switching protocols contained in DECnet communication software to build networking around GTE Telenet's public packet-switched network.

Programmers used three programming languages to develop the custom software: COBOL, Datatrieve (DEC's database query language and report generator) and Prolog. They decided which language to use after determining whether a particular business procedure was governed by stable, unstable or dynamic rules. This represents a technique developed to build expert systems.

Stable rules include government regulations, and cast-in-concrete policies like, "Don't accept a shipment unless it is labeled with the number of an outstanding purchase order." Stable rules with simple data struc-

tures, including those the distribution company might add in the future, are written in COBOL.

Unstable rules often arise from temporary or uncertain solutions to problems. For example, an occasional shipment may be received without a purchase order, logged into the system and then returned. The materials manager may even decide to violate a stable rule on purpose, as when an unlabeled shipment is immediately needed in production. Establishing an unstable rule to cover such emergencies, the manager could require the receiving clerk to enter an unlabeled shipment's bill of lading in the computer system, verify its quantity and then decide—on an individual basis—how to proceed. Unstable rules will eventually be converted to either stable or dynamic rules.

Programmers write unstable rules in Datatrieve, an easy-to-use query language that can simulate human decision-making in procedures that have simple data structures. Producing the same results as COBOL code, Datatrieve is far easier to modify. Therefore, Information Architects specified that the customer's maintenance programmers should write, if possible, all new stable rules in Datatrieve first. After fine-tuning the software, they can convert the stable rules from Datatrieve to COBOL code, which runs more efficiently.

Dynamic rules are firm, but expected to change as company needs and policies change. For example, a dynamic rule for unlabeled shipments might require the clerk to check an inventory database of part numbers to

The Integrator



LMC's 32-Bit Virtual Memory MegaMicro Is The-State-Of-The-Art UNIX Microcomputer

LMC's 32-bit MegaMicro provides mainframe or super-minicomputer performance at prices competitive with today's far less powerful 8- and 16-bit microcomputers. This is made possible by use of the next generation of logic chips—the National Semiconductor 16000-series. LMC MegaMicros incorporate: the NS16032 central processing unit which has true 32-bit internal logic and internal data path configured on the IEEE 796 multibus; demand-paged virtual memory implemented in hardware; and hardware 64-bit double-precision floating-point arithmetic.

The LMC MegaMicro is supplied with HCR's UNITY* which is a full implementation of UNIX** and includes the Berkeley 4.1 enhancements to take advantage of demand-paged virtual memory. Also included are C and FORTRAN. Typical multi-user systems with 33 megs. of fast (30 ms. average access time) winchester disk storage, a half meg. of RAM, virtual memory, hardware floating-point arithmetic, UNIX, C, and FORTRAN 77 are available for \$20,000 (and even less with quantity or OEM discounts).

* UNITY is a Trademark of Human Computing Resources.

**UNIX is a Trademark of Bell Laboratories.

LMC MegaMicros *The Logical Alternative™*

LMC

The Logical MicroComputer Company

4200 W. Diversey, Chicago, IL 60639 (312) 282.9667



A member of The Marmon Group of companies

CIRCLE NO. 68 ON INQUIRY CARD

help the system decide whether the shipment contains parts in short supply. But such a procedure would probably change over time.

Programmers write dynamic rules in Prolog, which can handle complicated decision-making processes that involve complex data structures. Not only is Prolog easy to modify, but it also expresses rules in simple statements. Programmers also use Prolog to write stable rules that require some degree of inference, which makes the rules too complex for COBOL's simple data structures.

Although writing new code for the package took only several months for Information Architects, software testing, database loading and customer training required more time. From the point of choosing the foundation package to the start of on-line production, the process took more than a year.

But the system should meet the customer's needs for at least several years, even with anticipated expansion. The company can upgrade its host processor to a larger VAX machine or can increase capacity through networking several VAXs. And modifying software will be simpler than for most conventional packages because of the flexibility of Prolog and expert systems methodology. □

Bernard P. Wess Jr. is president of Information Architects Inc., Needham Heights, Mass.

Interest Quotient (Circle One)
High 807 Medium 808 Low 809

NEXT MONTH IN MMS

Mini-Micro Systems' October issue focuses on software utilities and mass storage memories for small systems.

Other topics will include:

- stretched-surface recording
- a flexible PC/XT DBMS
- microcomputer graphics

LOOKING AHEAD IN MMS

The Fall issue of Mini-Micro Systems' Peripherals Digest is due in mid November. This comprehensive reference guide will cover the following topics:

- disk drives (up to 5 ¼-inch)
- disk subsystems
- cartridge tape drives (up to ¼-inch)
- alphanumeric terminals
- serial printers

A directory of manufacturers will also be included.

**YOU CAN'T
PREDICT
THE FUTURE.**

**BUT
YOU CAN BE
PREPARED
FOR IT.**

WITH INFORMIX AND File-it!

THE FIRST DATABASE SOFTWARE FAMILY
FOR UNIX AND MS-DOS.

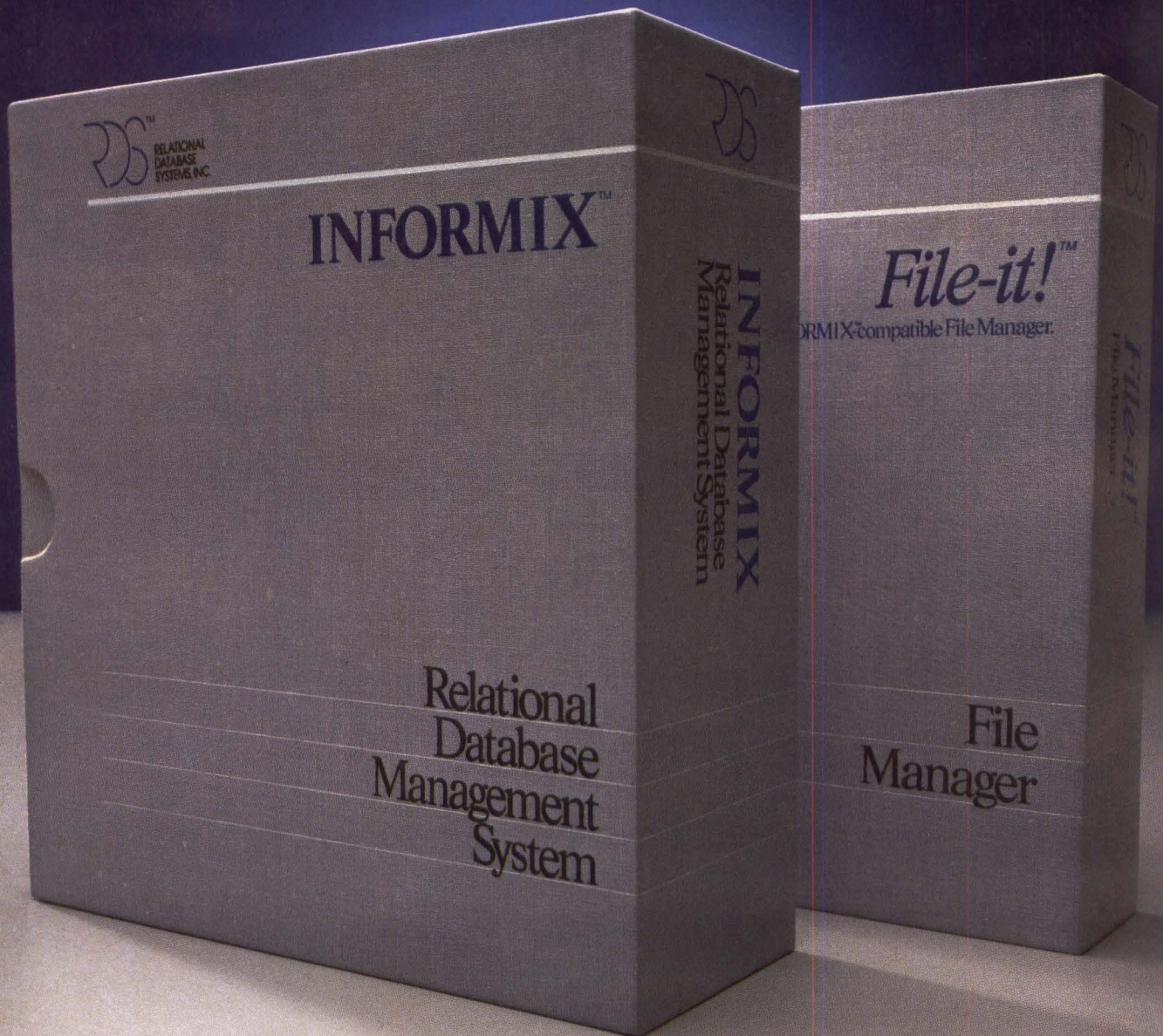

Now OEMs and systems integrators can sleep better at night. Because one company has taken the worry out of buying the right software.

RDS.

The company that produces a family of database software designed to take on the future.

Incompatibility is a thing of the past.

INFORMIX[®] and File-it![™] are compatible with UNIX,[™] MS[™]-DOS, PC-DOS,[™] and PC/IX systems (over 60 micros and minis* at last count).

INFORMIX is a true relational database system designed to take full advantage of the power of UNIX. It includes the most widely used report writer on the market.

Then there's File-it! The first easy-to-use UNIX file manager. Together, they have the flexibility to accommodate novices and experts alike.

INFORMIX and File-it! are fully integrated. Users can upgrade from File-it! to INFORMIX or access data from one program or the other without re-entering data, retraining employees or reprogramming.

Applications can also be moved from MS-DOS to UNIX and vice versa without having to rewrite the application.

Simplify program development.

RDS offers C-ISAM,[™] the de facto standard ISAM for UNIX. It's a library of C subroutines with a B⁺-Tree based access method that stores, retrieves and modifies data from indexed files. It's embedded in INFORMIX and File-it! Or is available as a standalone product.

Software good enough for AT&T.

AT&T, inventor of UNIX, has co-labeled INFORMIX, File-it! and C-ISAM to run on their full AT&T 3B Computer line (from micros to minis).

Hewlett-Packard, Altos, Zilog, Siemens, Cromemco, Perkin-Elmer, Sydis and General Automation have selected RDS as well.

In fact, INFORMIX has an installed base of over 6,000 copies. And RDS has sold over 35,000 licenses for all their products to date.

But before you make up your mind, check the facts one more time.

There's only one database software family that's UNIX-, PC-DOS-, MS-DOS- and PC/IX-based. It runs on more than 60 systems. And it's ideal for both novice and expert.

Now it doesn't matter where the future's headed. You're already there.

*RDS products are available for the following systems:

Altos 586, 986, 8600, 68000	Hewlett-Packard 9000
Apollo DN300	Series 200, 9000 Series 500
AT&T 3B2, 3B5, 3B20,	IBM PC, PC-XT
AT&T Personal Computer	Intel System 86/330
BBN C machine (all models)	Masscomp NC 500
Bunker Ramo Aladdin 20	Momentum Hawk 32
Charles River Data Systems	NCR Tower
Universe 68	Onyx C8002, C8002A
Convergent Technologies	Perkin-Elmer 3210, 3220,
Miniframe and Megaframe	3240, 3250
Corvus Systems Uniplex	Pixel 100/AP, 80 Supermicro
Cromemco System 1	Plexus P/25, P/35, P/40, P/60
DEC 11/23, 11/34, 11/44, 11/60,	Pyramid Technologies 90x
11/70, VAX 11/730, 11/750,	Radio Shack Model 16
11/780	SCI Systems IN/ix
Dual Systems System 83	Wicat System 150WS, 160,
ERG Mini System (all models)	200
Fortune 32:16	Zentec 2020
Forward Technology 320	Zilog System 8000
General Automation Zebra	(all models).
(all models)	

Demos of INFORMIX and File-it! are available. Demonstration software and complete manuals included.



2471 East Bayshore Road, Suite 600, Palo Alto, California 94303
(415) 424-1300 TELEX 467687

INFORMIX is a registered trademark of Relational Database Systems, Inc. RDS, File-it! and C-ISAM are trademarks of Relational Database Systems, Inc. UNIX is a trademark of AT&T Bell Laboratories. MS is a trademark of Microsoft and PC-DOS is a trademark of International Business Machines.

CIRCLE NO. 69 ON INQUIRY CARD

Start/Stop And Stream.

INTRODUCING

DOUBLE DRIVE™

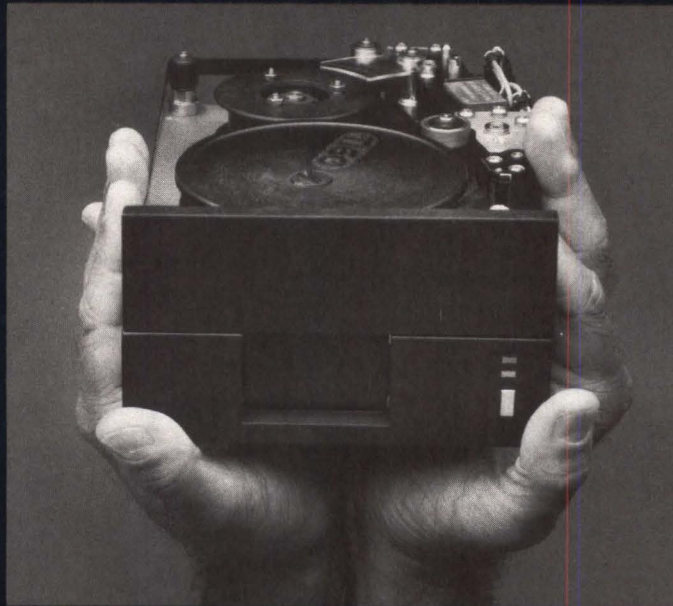

Series 50 Drive. High Performance. High Capacity.

If you've been pondering whether you need a streaming tape drive to back up your Winchester, or a start/stop tape drive, or maybe both, we have good news. You no longer have to decide.

Because now there's a drive with the capabilities of both. Rosscomp's Double Drive.

It saves you the agony of decision. And an incredible amount of money at the same time.

There Are Two Sides To Our Story

When our engineers set out to design the Double Drive, they too had a decision to make. Quarter-inch tape? Or half-inch tape? But then they found that, even by pushing quarter-inch technology to its absolute limit, they wouldn't be able to give us the capabilities we wanted.

So half-inch became the only choice. That also meant they could assure us of something else we demanded. Reliability. For instance, they could design-in the industry's highest quality read/write half-inch heads. Meanwhile, they could make the system stream at unbeatable speeds.

And do practically everything a large start/stop machine can do for a fraction of the cost.

Side One

One of the fruits of their labors is, you get a Winchester backup that does something no other can. It scoops 190 MBytes of data onto standard half-inch tape that's housed on our Back-Pac™ four inch self-threading reel. (Which costs less than a cartridge.)



The Back-Pac™ self-threading reel stores 190 MB on 1/2" tape. Costs less than 1/4" cartridges.

That translates into the lowest cost per byte of any tape drive, anywhere. And it streams at a blazing 90 ips standard.

In fact, the Double Drive's electronic speed and capacity are matched by only one thing we know of. Its mechanical reliability.

That comes from its having the simplest and most dependable tape-handling method yet devised.

Threading is automatic. The tape travels a path of proven design, kept on course by both



spring-loaded and ball-bearing guides. Tension control is equally precise.

A single capstan motor drives both supply and takeup reels with one belt, while



Simple, dependable automatic tape threading.

an advanced controlling device maintains identical tension between them. So you experience very little ISV.

As well as lower power dissipation. The motor uses less than 15W.

Spring loaded and ball bearing tape guides.



Side Two

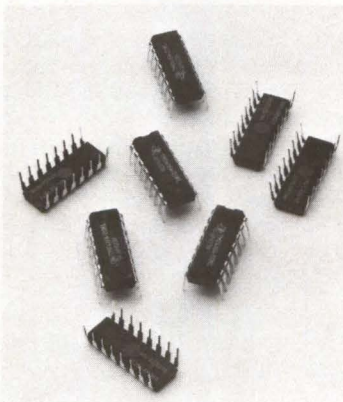

64 KB cache memory in its interface makes it look like a start/stop drive.

For your selective file-search and backup jobs, the Double Drive acts as a start/stop unit. Because it has 64 KBytes of cache memory right in its interface.

That means no time loss. An optimized I/O. And apparent real-time operation for every user.

Plus more efficient use of your tape, covering a full 95% of it.

Online, it gives ample secondary storage for files during

restructuring and in hierarchical memory management schemes.

Now, if the Double Drive sounds like it might be just what you need, here's more good news. It will fit your system.

Series 80 to right. Series 50 below.



Or rather, one of our Double Drives will. Our Series 80 fits an 8" envelope, our Series 50 a 5 1/4" envelope.

They'll each hold 190 MBytes of data, stored on 24 serpentine tracks.

Both are available with standard industry interfaces. So one of them is right for you.

Which means there's no painful decision to make. Just put the Double Drive to work. Doing double duty.

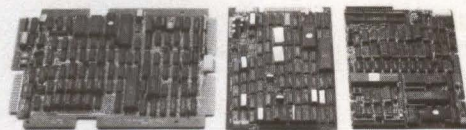

Available formatters include QIC-02, SCSI and 9-track.

NASDAQ-RCOM

1695 MacArthur Blvd., Costa Mesa, California 92626 · Call (714) 540-9393

ROSSCOMP®

The way with tape.

CIRCLE NO. 70 ON INQUIRY CARD

OEMs have the right questions

SMS has the right answers

Introducing the SMS 1000 Model 40 DEC-Compatible Microcomputer System

SMS has been listening: You want microcomputer systems that can meet your current needs and can be expanded to handle future requirements. Our new SMS 1000 Model 40 is designed to do just that!

Foundation Module

We knew what the end product had to do before we started, so we designed it based upon an integrated foundation architecture that optimizes performance and flexibility. The foundation module interfaces to Winchester, floppy and tape peripherals; serial communication ports; and the Q-bus backplane. It also includes a sophisticated Support Monitor Subsystem which makes the system easy to use and maintain. And we put it all on one board that doesn't require any backplane space!

Compatibility

The SMS 1000 Model 40 contains a Q-bus backplane and emulates the DU handler/device driver. All LSI-11 software will operate with no modifications.

Flexibility

This system provides you with the widest choice of peripherals available in any microcomputer on the market. The options include 8 or 5¼ inch floppy drives, up to 140 Mb of 5¼ inch Winchester and a soon-to-be-released streaming tape drive. All this in one 5¼ inch rack mount or floor stand enclosure.

Performance

The Model 40 allows non-interleaved disk transfers using an enhanced version of DEC's* MSCP storage architecture. It is offered with fast access Winchester disk drives and either LSI-11/23 or LSI-11/73 processors. So you can optimize your application software performance whether it runs on RT-11, RSX-11M*, RSX-11M-PLUS, RSTS/E*, or TSX-PLUS*.

Reliability

High reliability is essential to your business. The SMS 1000 Model 40 is designed to provide your users the uptime both you and they dream about. And if things go wrong, the Support Monitor Subsystem is there to help you or your end users get back on the line quickly. The system was designed to minimize parts count and maximize access to all components. This allows replacement of any failed component in less than 5 minutes!

Family of products

The SMS 1000 Model 40 is really a family of products, available in over 150 different configurations—today—with more to come in the near future.

If these are the answers to the questions you are asking, please contact us immediately for more information.

SMS Scientific Micro Systems, Inc.

777 East Middlefield Road
Mountain View, CA 94043
(415)964-5700
TWX: 910-379-6577

CIRCLE NO. 71 ON INQUIRY CARD



SMS SALES OFFICES: Seattle, WA (206)883-8303; Boston, MA (617)246-2540; Atlanta, GA (404)296-2029; Morton Grove, IL (312)966-2711; Melrose Park, IL (312)345-5320; Arlington, TX (817)429-8527; Laguna Hills, CA (714)643-8046. **AUTHORIZED SMS DISTRIBUTORS FOR DEC PRODUCTS:** Midwest—First Computer Corporation (312)920-1050; Western—Pnambic Systems, Inc. (206)282-0199; Quebec Province, Canada—Logicon, Inc. (514)430-5960.

*DEC, RSX and RSTS are trademarks of Digital Equipment Corporation. *TSX-PLUS is a trademark of S&H Computer.

The Integrator

Diagnostic diskettes suit system integrators but can leave users confused

Exotic tool may prove too sophisticated for most end users

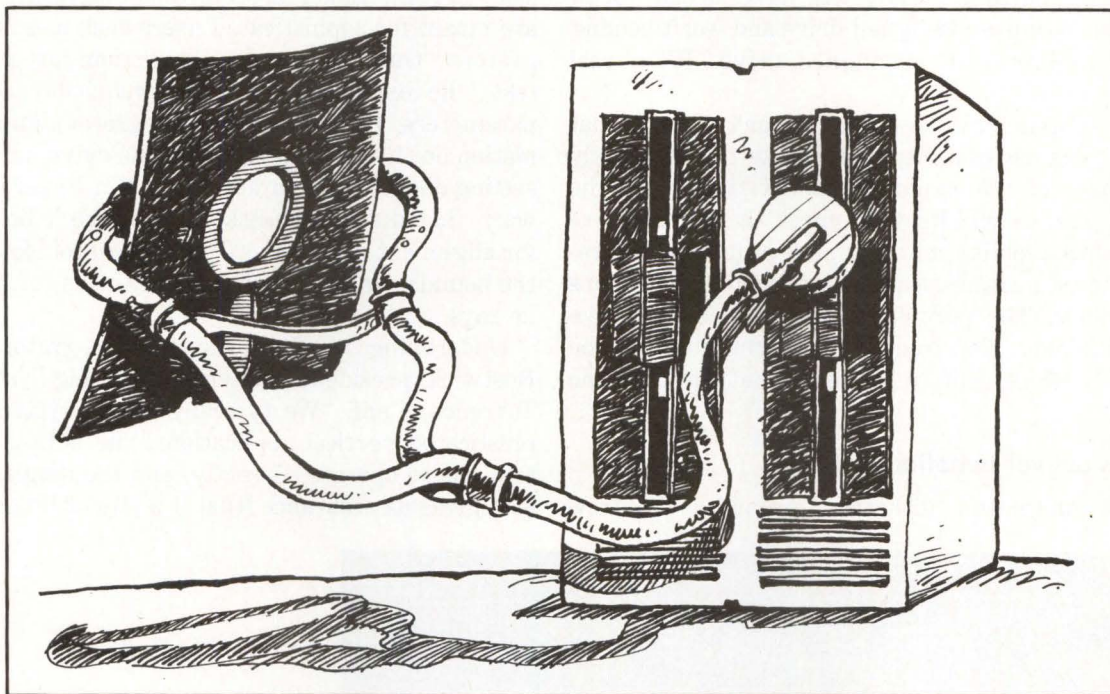

Illustration by Jon McIntosh

Diagnostic diskettes can detect problems in a flexible disk drive by reporting detailed information about its internal operation.

Carl Warren, Western Editor

Diagnostic diskettes—designed to report detailed information about the internal operation of flexible disk drives—are becoming recognized troubleshooting tools. By pinpointing problems, they allow for timely corrective action. But while the exotic diskettes promise important benefits for equipment manufacturers and system integrators, they may be too sophisticated to help the average end user.

Currently, three California-based companies—Dymek Corp. in San Jose, Dysan Corp. in Santa Clara, and Verbatim Corp. in Sunnyvale—make the diskettes for a variety of systems, most often those using 5¼-inch disk drives. The devices provide information about

characteristics of a drive's alignment that can affect interchange. If the alignments of two drives are too dissimilar, neither will be able to read data written by the other. Diagnostic diskettes simulate typical operation of a drive and measure rotational speed, clamping, noise tolerance, read/write functions, track alignment, erase-cross-talk, and positioner accuracy.

Dymek's Recording Interchange Diagnostic Diskette (RID) identifies problems that can prevent the interchange of diskettes from one system to another. According to Duane Meulners, company president and chief executive officer, the RID's purpose is to provide the user with insurance. "We consider the RID to be an extension of users' application libraries. By periodically using the RID, they can be assured of being able to

The Integrator

recover data," he says.

Verbatim's Disk Drive Analyzer offers similar capabilities. Like the Dymek product, Verbatim's diskette picks up inaccuracies in the alignment and overall operation of the flexible disk drive and warns a user that a drive needs corrective action.

For a typical end user, corrective action consists of seeking out a qualified service technician. However, getting the drive properly aligned may cause new problems for the user, insists Mycroft Labs Inc.'s Vice President of Operations, Bruce Justham. "More than likely, end users will use the diagnostic diskette at the wrong time," he says. "They will have already been writing data using a misaligned drive and won't be able to read the data with an aligned drive. It's a real Catch-22."

Dymek's Meulners, however, doesn't expect that problem. "The use of a diagnostic diskette will quickly become part of the standard use of the drive," he predicts. "A user will know to check the drive before using it, thus avoiding misalignment problems." Moreover, Meulners argues that post-alignment problems will be minor. The purpose of the devices is to give users confidence that recorded information will be recoverable 80 percent to 90 percent of the time, he notes.

Diskettes deliver benefits to OEMs

Despite diagnostic diskettes' promises, Andrew

Czernek, director of marketing for Zenith Data Systems Corp., Glenview, Ill., doesn't think they will fare well in the consumer market. "End users aren't really attuned to understanding the technical ramifications of a device," he says. "More than likely, if they use the diagnostic diskettes, they will tend to misinterpret the information or use the diskette at the wrong time." System integrators and resellers will benefit most from using the diskettes, Czernek contends. "They can make sure that the drives are operating properly before they put them in the end user's hands."

Brad Baker, general manager of Dysan's C.E. division, agrees. Baker asserts that diagnostic diskettes are meant for sophisticated users such as system integrators. "Our diskette gives more than just a 'go/no-go' test," he explains. "We can dynamically adjust the parameters, thus giving the integrator detailed information on the characteristics of the drive, allowing the setting of operating parameters." But Baker is quick to warn that diagnostic diskettes shouldn't be mistaken for alignment diskettes. "This type of tool lets you find the boundaries, and alignment diskettes set the focus," he says.

Underlining benefits for system integrators is Steve Bostwick, president of Query Computing Systems Inc., Torrance, Calif. "We typically create systems for sophisticated vertical applications," he notes. "The system has to operate correctly, and the diagnostic diskette gives us assurance [that it is] by letting us quickly

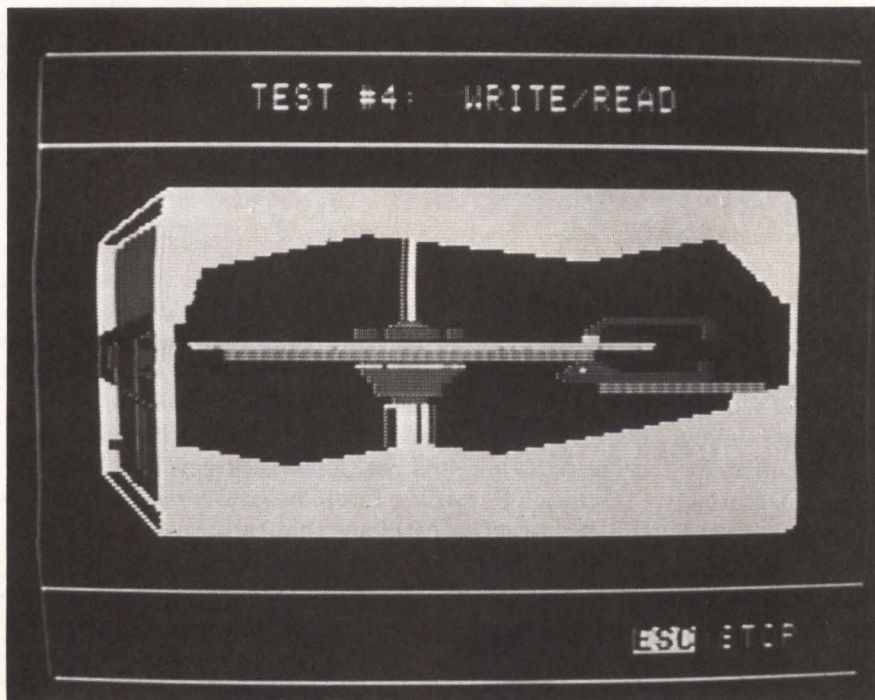

Using graphics to display a diagnostic test in operation, Verbatim's disk drive analyzer diskette checks the accuracy of a flexible disk drive.

You can't build tomorrow's systems with yesterday's drives.

You've seen one small disk drive, you've seen them all, right? Not exactly. One disk drive stands above all the rest.

It comes from Maxtor.

The company that refuses to produce disk drives merely as good as everybody else. Instead, we set new standards by producing the only 5¼" disk drives worthy of the next generation of supermicros. Winchester's with 65 to 380 megabytes of storage. And average access times of less than 30 msec.

And we don't mean prototypes. We mean full production. So, you can build the systems of tomorrow, today. And that can be a big advantage.

For you. Or your competition.

Maxtor Corporation, 150 River Oaks Parkway,
San Jose, California 95134,
(408) 942-1700, TELEX: 171074.
Eastern Regional Sales Office:
(617) 872-8556.
Southwest Regional Sales Office:
(714) 859-3100.

Maxtor

CIRCLE NO. 72 ON INQUIRY CARD



Add IBM Format-Compatible Magnetic Tape To Any RS-232 Port With The IBEX STC-100



Plug-In 1/2" mag.
tape drives to any
mini or micro computer
Full read/write capability
Data logging
Call-detail recording

Write, phone or TWX
for information

IBEX

IBEX COMPUTER CORP.

20741 Marilla Street,
Chatsworth, CA 91311
(818) 709-8100
TWX 910-493-2071

CIRCLE NO. 73 ON INQUIRY CARD

the Black Jack™

A NEW PORTABLE
MODULAR JACK FOR MODEMS

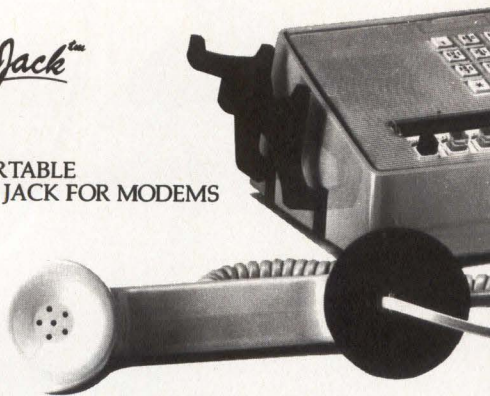

Have you ever been dealt out of telecommunications in hotels, offices and other places on the road? Why gamble on finding a telephone jack that will accept your modem. Deal yourself a winning hand with the Black Jack.

Simply unscrew the mouthpiece together with the microphone and carefully set them to one side. Attach the Black Jack on the handset, insert your RJ11C direct connect line cord from your modem and you're ready for action. You may now dial direct from your computer if your modem has Touch Tone® dialing.

If not, simply dial from the telephone itself. When your telecommunications are complete, snap off the Black Jack and replace the mouthpiece.

Suggested Retail Price: \$49.95.

For enduser orders contact: 1-800-227-3800 Ext. 245.

For dealer inquiries and
OEM information contact: **the micropipheral corporation**

Patent pending.

™the Black Jack is a trademark of The Micropipheral Corporation. (206) 881-7544

2565 - 152nd Avenue NE, Redmond, WA 98052

CIRCLE NO. 74 ON INQUIRY CARD

The Integrator

find faults before we ship."

Reporting methods differ

Although the three manufacturers' diagnostic diskettes work in a similar manner, their reporting methods differ. For example, Dymek's device uses a menu-driven system to guide the user, reporting a "go" or "no-go" after each test. Verbatim's diskette uses a similar technique but, in addition, has graphics that show the test in operation.

The Dysan diskette also incorporates graphics during tests that display the drive's operating margins. This information is extremely helpful, comments James Swanner, president of Wordmovers Inc., Lawndale, Calif., a systems house specializing in desktop systems. He emphasizes that misaligned disk drives cause major problems because "they go out of alignment over a period of time and newly aligned drives can't read the old data diskettes." Displaying margins help determine a system's operating boundaries, so old data can be recovered before realignment, Swanner explains.

'I think a typical end user would end up being more confused than assisted.'

Not a large consumer market

David Pava, president of Byte Industries Inc., Hayward, Calif., is one of those who feel that, although the devices are useful for computer sellers, they are inappropriate for most end users. "I don't see them being used early enough to be of benefit. I don't see retailers clamoring to have them on their shelves," he says. Query Computing Systems' Bostwick agrees: "I think a typical end user would end up being more confused than assisted."

Wordmovers' Swanner agrees that resellers will find the diskettes most useful. "Right now," he says, "we have them in the store for our use." He also reports that he has convinced members of a Kaypro user's group to buy a diagnostic diskette. "The members bring their systems in and we check them out. If necessary, we can perform the alignment," he says. But utilizing the devices is beyond most end users' capabilities, Swanner maintains. He warns that "the diagnostic diskettes are only good if you know what they are telling you." □

Interest Quotient (Circle One)
High 810 Medium 811 Low 812

NOW-GCR AND PE STREAMERS THAT REALLY DRIVE DOWN THE COST OF OWNERSHIP.

CHOICE OF DENSITIES: The 92181 runs at 25 ips start/stop and 100 ips streaming with ANSI Standard 1600 bpi, Phase-encoded (PE) format. The 92185 runs at 25 ips and 75 ips streaming with ANSI Standard 6250 bpi, Group Coded (GCR) format; 25 ips start/stop and 75 ips streaming with PE format.



**TOLL FREE
HOTLINE**
1-800-828-8001
EXT. 82
IN MINNESOTA
(612) 921-4400

EASY TO OPERATE: touch sensitive switches and LED indicators with decimal readouts. Tape threading guides allow simple, fast loading.

MAINTAINABILITY MEANS RELIABILITY. Keystone tape units need no field adjustments of any kind. No scheduled preventive maintenance either.

AIR BEARINGS give better tape control, cut media stress and wear caused by spring-loaded guides and rollers. Tape rides on a cushion of air.

GCR TAPE PATH. Unique, patented tape path (only 13"), solid-state tension sensing, and μ P-controlled servos for precise high-density tape motion control.

SIMPLE MECHANICAL DESIGN. No tension arms, vacuum columns, capstan motors or guide rollers.

T H E K E Y S T O N E TM S E R I E S

We designed the Keystone Series with built-in diagnostics and maintenance features that make it simple to operate, easy to service, low in life-cycle costs. For more information, call your local Control Data OEM Sales Representative or write: OEM Product Sales, MNB04A, Control Data Corporation, P.O. Box 0, Minneapolis, MN 55440.

CD CONTROL DATA



A smart terminal smart on a desk.



should look

The WY-50 is one ASCII terminal that makes economic sense without offending your aesthetic sense. At \$695, it looks as smart to the people who pay for it as it does to the people who use it. No wonder it's now among the best-selling terminals in the world.

Like all our display products, the WY-50 combines an unusually small footprint with a very generous 14" diagonal display. The non-glare screen tilts, swivels, and displays a full 132-column format. The low-profile keyboard adjusts, too, for perfect fit and feel.

The WY-50 offers full software and hardware compatibility with most computer systems. And at \$695, its price/performance is unbeatable. More intelligence inside and out.

For more information about our complete line of products, write or call Wyse Technology, 3040 N. First Street, San Jose, CA 95134, (408) 946-3075. Outside of California 800-421-1058.

To find out where you can see the WY-50 demonstrated, call the regional office nearest you.

WYSE
| | | |

Regional Offices: Northeast (201) 725-5054; Southeast (305) 862-2221; Midwest (313) 471-1565; Southwest (213) 340-2013; Northwest (408) 559-5911.

CIRCLE NO. 75 ON INQUIRY CARD

Stop tying up 90% of your time solving 10% of the problem.

Where does the time go in creating a technical document or manual?

In a word — art. It occupies about 10% of the finished product. But it consumes 90% of the effort.

Introducing the Qubix WorkSurface.™

Now there's a better way. The Qubix WorkSurface.

Using the latest in CAD technology, the WorkSurface lets you interactively and simultaneously create both art and text on screen. Using the actual type styles. In their actual point size — from 4.5 point. The comprehensive batch and interactive composition and pagination software produces completed pages.

So what you see on screen is exactly what you'll see in print.



Up, down, all around. The WorkSurface electronically adjusts to how you like to work.

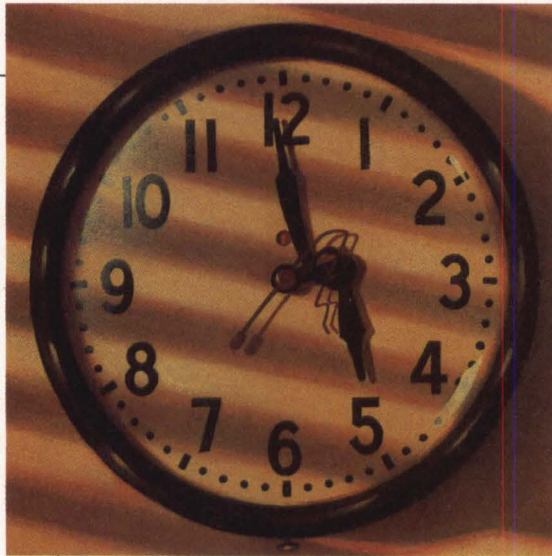

Now, once is always enough.

Any art elements you create can be stored in the system's memory. So commonly used elements need only be drawn once — and then recalled for use whenever and wherever needed. In any size you choose. And in combination with any other elements.

It uses a language you already know. English.

For all its sophistication, the WorkSurface is very easy to use.

Menus, in plain English, are displayed on the screen at all times. Select a command. And the system responds.

Making changes won't put you through changes.

With any document, there are always changes. And changing art has always been the most difficult. It might take hours. It might take days.

With the WorkSurface, it takes seconds. Simply display the appropriate page. Then, using the digitizing pen, draw the changes directly on the screen. That's all.

You can create illustrations from scratch in 1/4th the time. And make revisions in 1/10th the time. In fact, in little over a year, you'll save enough in time to pay for the system.

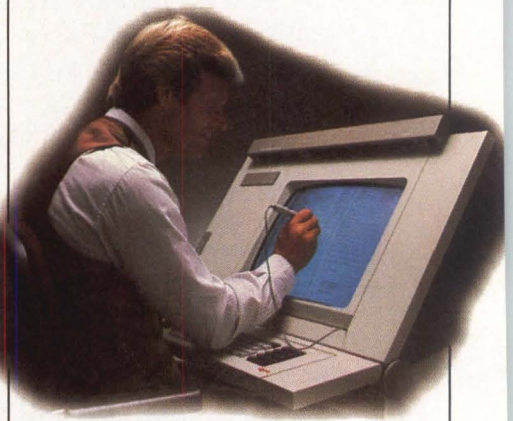

Draw your conclusions. Instantly. Redesign a page and evaluate several different layouts in seconds. Not hours.

For complete details and to arrange a demonstration, call us now at (408) 370-9229.

We'll show you how to do in a minute what used to take ten.

QUBIX
18835 Cox Avenue
Saratoga, CA 95070
(408) 370-9229

CIRCLE NO. 76 ON INQUIRY CARD

The Integrator

Graphics system rejects keyboard in favor of simple controls

Developed for artists, graphics software directs easy-to-use input devices to manipulate images precisely without typing

Sarah Glazer, Senior Editor

Paradoxically, the more advanced computers become, the less training users need to operate them. Directing machines that have powerful capabilities is now within the grasp of users who can't program at all and, in some cases, may even have trouble finding their way around a keyboard. But giving such users access to a computer isn't easy. A designer or system integrator

must analyze how people work with traditional tools and then devise a way for the computer to harness human skills and help unleash creativity.

Designing a powerful graphics system that could be used by people who may have no previous computer experience but extremely exacting requirements—artists—was the goal of Lightspeed Computers Inc., Boston. Trained to plan and work visually, most artists find a keyboard an intolerable intrusion between their

The range of colors that can be created on the screen is almost infinite, as these works by Nathan Felde illustrate. The artist chooses color completely through controls shown on the screen. No keyboarding is needed.

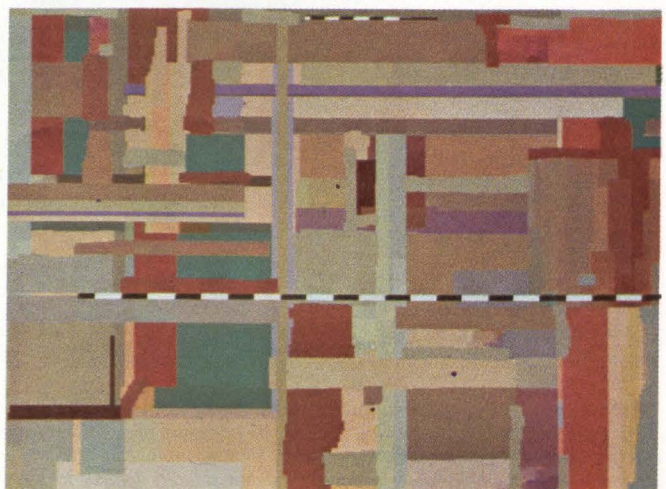
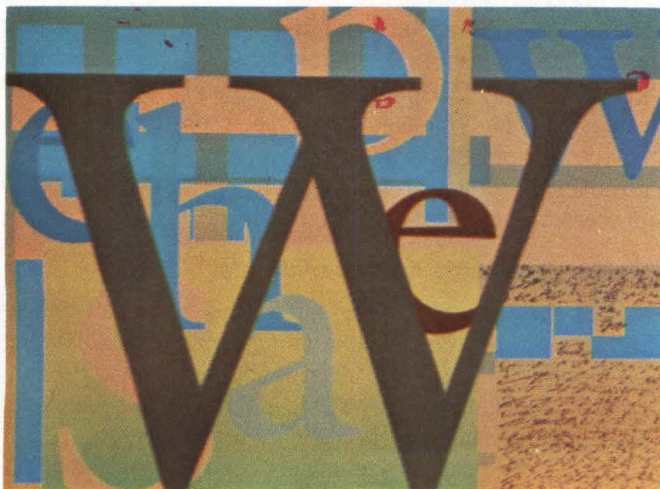
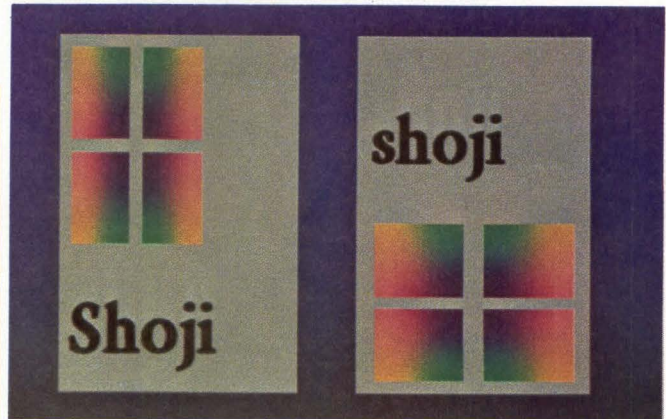

The Integrator

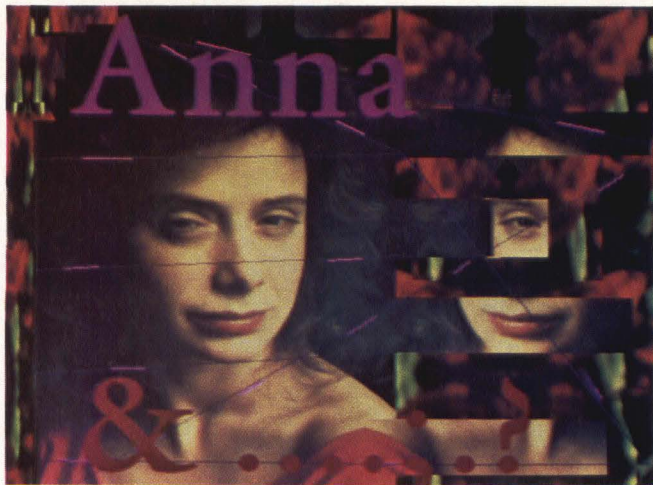

Francis Olschafskie

After feeding photographic images into the system with a digitizing camera, the artist can manipulate the contents of a CRT screen with a variety of techniques. It's so easy to alter an image drastically that the system includes a mechanism that makes it easy to save screen contents frequently, either for printing or reference.

hands and the graphics display, making alternative input devices a must. Yet, while needing input devices that are easy to use, artists also require a highly sensitive system with sophisticated capabilities.

Lightspeed's four founders, who met while studying in the Massachusetts Institute of Technology's graphics department, are attuned to artists' special needs and familiar with conventional computer graphics equipment. They pool training in engineering, computer programming and fine arts and have all been involved in creating their own artwork using computers. This led them to design a system to enhance visual decision making. "Artists think visually," says Francis Olschafskie, one of Lightspeed's founders. They need to define colors and shapes without having to use words or other codes.

To strengthen visual control and minimize reliance on verbal commands, a digitizing tablet and a mouse, rather than a keyboard, control the display. The keyboard is unnecessary even to activate the system's main menu, which consists of one-word program titles on colored areas, or "buttons," on the screen. Using the stylus on a digitizing tablet, the artist guides a cursor to one of the buttons and presses the tablet to activate that program's sub-menu.

Pressing one corner of the mouse (Lightspeed calls it a flipper box) switches the display to a second window, where the artist can create a work or can view a montage of small versions of previously recorded screens, much like a contact sheet of photographic images. The box also activates a straight-edge feature; pressing one corner makes the cursor move vertically, while pressing another makes it move horizontally.

The artist can also introduce images into the display by using a video camera connected to a high-resolution digitizer. After scanning photographs or 3-D objects, the digitizer converts the image into digital signals that the artist can feed into the display and manipulate by using other features of the system. To make the high-resolution CRT display respond quickly to motions of the stylus and mouse, Lightspeed produces its own custom graphics boards. The company also chose to use an MC68000 microprocessor as its CPU because of its processing speed, notes Olschafskie.

Software reflects human methods

"All the options in our software deal with applications in an artist's life, like using an airbrush or using oil-painting techniques," Olschafskie explains. He contends that relating graphics capabilities to techniques the artist already uses is the system's key strength. For example, the process of choosing colors, a portion of the "paint" program, follows as closely as possible the way

Choose Precision Visuals graphics software and you're in the best company.

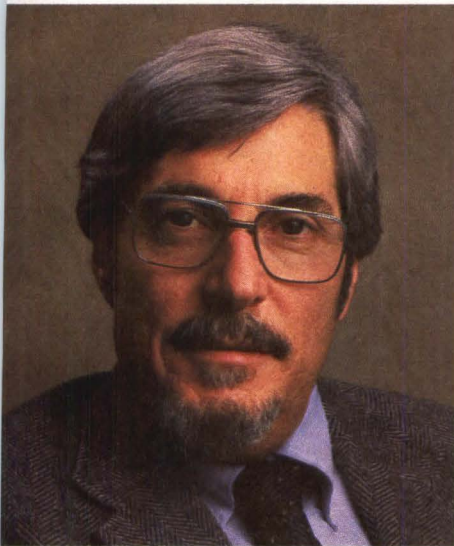

"DI-3000® graphics software will meet the needs of a total enterprise."

Phil Goss
Honeywell

Precision Visuals' graphics software tools are today's standard for over 800 organizations, large and small. Here's why. Graphics programmers are saving hundreds of hours by using the appropriate Precision Visuals software tools for the project. They choose from our integrated family of graphics packages based on the commercially acclaimed DI-3000® subroutine library or the GKS implementation, GK-2000.™ With full support for most computers—IBM, DEC, CDC, PRIME, Honeywell, Data General, Cray, Apollo, and many UNIX-based systems*—and over 80 popular graphics peripherals, their investment in our software is secure . . . today and tomorrow. Look into Precision Visuals and see why.



"Precision Visuals' documentation is a model for the industry."

Dr. James D. Foley, President
Computer Graphics Consultants, Inc.

Here's someone who knows how a good manual should look. Dr. Foley, Professor of Electrical Engineering and Computer Science at George Washington University, is co-author of *Fundamentals of Interactive Computer Graphics*. According to Dr. Foley, our DI-3000® manual is "ideal for people with little or no graphics experience." Our example-intensive documentation includes a quick reference guide for the experienced graphics programmer and step-by-step tutorials that quickly turn beginners into productive graphics programmers.

It's not surprising that many customers were sold on our graphics tools just by looking at our documentation. Ask to see a copy for yourself.

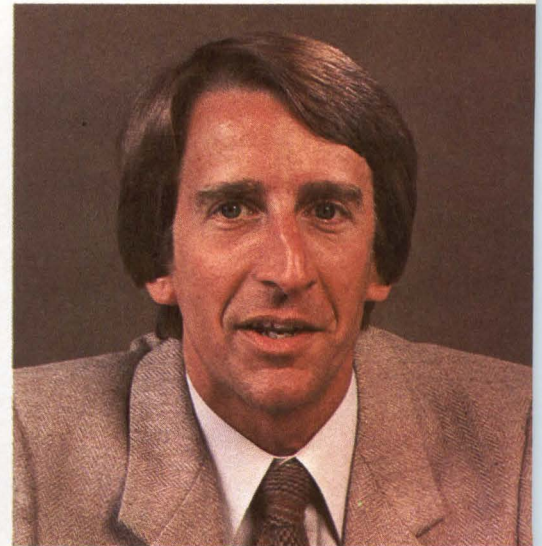

"It's not just the package that's important. It's the people behind it."

David Campbell
INCYTE, Fairchild/A Schlumberger Co.

What adds even more value to our versatile graphics tools is the support you get from our people at Precision Visuals. Graphics software specialists staff a Help Line for quick answers to keep you on schedule; national training programs, for the novice to the advanced graphics programmer, help get your applications operating on time and within budget; active international and regional user groups that exchange creative and productive ideas; plus thoroughly tested products and documentation designed to meet your needs today and in the future.

Don't you think it's time to choose Precision Visuals? Call us today at 303/530-9000.



Precision Visuals

6260 Lookout Road / Boulder, Colorado 80301
303/530-9000
TELEX 45-0364 / TWX 910-940-2500

Presentation Graphics

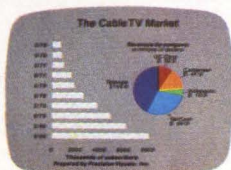

Enhanced Contouring

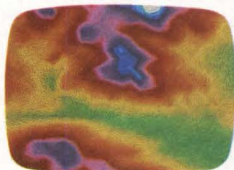

VLSI Design

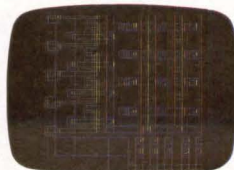

Solids Modeling



Process Control

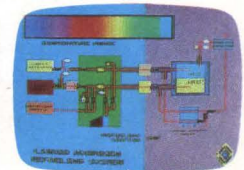

*UNIX is a trademark of BELL Laboratories, Inc.

CURRENT SCALE = 2.03 END(0), RESET(1) OR SCALE UP(2)

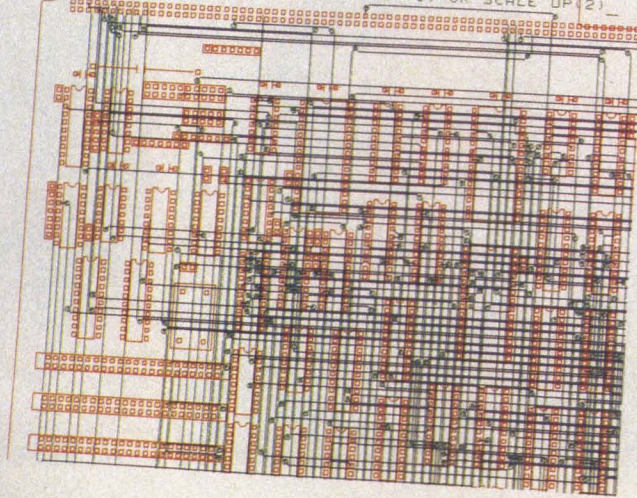

- * PROBLEM AREA
- * MTBF
- * COST TO REPAIR

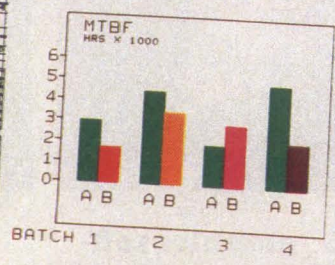

CPU BOARD FAILURE ANALYSIS

Read The Fine Print.



Letters. Numbers.
Charts. Graphs.
Fine curved or
straight lines.
Engineering
drawings and
presentation

materials. On paper or film.
The CH 5201 puts high quality color hard copy in your hands.

With amazing consistency. Ask for 100 copies and the last one looks as good as the first. No wash-out. And no color deviations. Lines remain parallel. Curves look like curves. And details don't turn into blobs. Whether you're using plain paper or transparency film.

There are no long waits, either. Because

the 5201 is fast. In the time it takes most other copiers to produce a sheet, the 5201 can produce a stack! Its built-in frame buffer captures the image and lets you make up to 99 copies. Without operator attendance. Plus, it frees your terminal. Which frees you from wasting a lot of time.

Finally, the 5201 is a system manager's delight. Our Adaptable Video Interface (AVIF) accepts a wide variety of video inputs, making interface a breeze.

For a demonstration of this rather inexpensive miracle contact your Seiko Instruments representative, or us at 1623 Buckeye Drive, Milpitas, CA 95035, (408) 943-9100.

You'll be amazed at how easy and inexpensive it is to read the fine print.



© 1984 Seiko Instruments U.S.A., Inc., Graphic Devices & Systems Division.

The Integrator

an artist would mix colors using oil paints. At one side of the screen, a palette appears that has a spectrum of high-intensity colors and a "gray scale," a stripe that shows intensities of gray from white to black.

Using the cursor like the tip of a brush, the artist touches colors or shades of gray and brings them to a section of the palette reserved for color mixing. Here, the artist can mix as many as four colors and shades of gray as one would on a palette and can create as subtle a range of color as is possible with paint. Again, as with oil paint, the artist can also mix colors or grays directly on the image on the screen. Olschafskie claims that this mixing technique gives artists the infinite range of color they are accustomed to using. In contrast, most computer graphics systems, even those that offer over 100 colors, emphasize high-intensity hues, leaving the artist who wants to use pastels or subtle shading at a loss, he says.

The other main component of the paint program is choosing "brushes," which define the size and shape of an area of color (a group of pixels) an artist activates by moving a stylus across a digitizing tablet. Choices consist of rectangle, circle and smear brushes.

The rectangle brush produces a series of overlapping rectangles (a familiar computer graphics technique) that follow the path an artist traces on the tablet. The circle brush similarly produces overlapping circles, which gives the path of color a soft edge. The smear brush differs from the other two in that the artist can't use it to apply color. Instead, it defines a path in which already displayed colors are averaged or, in artist's terms, "smeared." Made up of overlapping circles, the smear brush has soft rather than jagged edges.

The artist chooses the width of a path of pixels, or the brush's size, from a size scale displayed at one edge of the screen. The artist can pick any width ranging from a mere point to about 1 inch and chooses visually, simply by moving the cursor to any position on the scale. In addition to size, each brush, except a smear brush, has a transparency level. The artist can apply opaque color or can lighten a color's density to an almost-transparent film. Once again, the artist chooses visually, from a continuous transparency scale on an edge of the screen.

The circle and smear brushes relate closely to traditional fine-art techniques, Olschafskie asserts. The circle brush produces an effect like that of an airbrush, a conventional piece of artist's equipment that produces a very controlled paint spray. Using the smear brush resembles a number of conventional techniques: smearing wet oil paints on a canvas to blend colors and soften edges, rubbing pastels together on paper to blend them and rubbing a charcoal drawing to produce shading.

Other features of the system produce results similar to effects a photographer can create in a darkroom. The artist can "flip" an image to make its mirror image, create "negative" images—not unlike photographic negatives—and superimpose grids or other patterns over an image. However, some features have no counterparts in the fine-arts world. For example, the system can define an area on a screen and repeat it. By creating a path of repeated images, the artist can effectively use a part of the screen as a brush.

Unleashing creativity

Another goal of the designers was to make it easy to save images. "Because you can alter an image so dramatically and so quickly, it's important that people can get back to where they were," Olschafskie explains. The artist can dump screens in 35 seconds, storing them on a floppy disk or in a temporary buffer that can hold several screens and display them in a contact-sheet-like format.

For hard copy, Lightspeed chose a photographic film recorder, operated by a foot pedal, that can produce 35mm slides or transparencies and negatives in others sizes. In Olschafskie's view, photographic hard-copy devices give a wider range of color than plotters and electrostatic copiers produce.

Although some artists use the system to create final products, others use it merely as a study tool. "With the computer, you can change your image so quickly, it makes you use your creativity," Olschafskie reasons. "You can't just settle for something that's not quite right." He argues that the computer can be an especially powerful tool for letting artists study their work and learn what's possible more easily than by producing traditional studies.

To make computer graphics more available to artists—few of whom could afford to buy a system—Lightspeed rents its equipment and studios on an hourly basis. Before renting equipment, an artist must go through a training session that takes at least 4 hours. But, even for those with no previous contact with computers, Olschafskie insists, training takes no more than 10 hours.

Because the company developed its software to enable users to control all functions without a keyboard, artists can quickly learn to use sophisticated features with a minimum of effort. And the founders of Lightspeed believe that making a system easy to operate is one of the most important steps in making computers available to many potential users. □

Interest Quotient (Circle One)
High 813 Medium 814 Low 815

ON THE FIRST WE CREATED

Ethernet Activity ●

Packet Received ●

Data Received ●

Boot State ●

Self Test ●

Reset ●

Power ●



Communications Server / 1

DAY, MAN.™

When Bridge Communications first opened for business, we took a good look at what the computer age was creating.

We saw computers that couldn't talk to other computers. LANs that couldn't link up with other networks. Data PBXs so slow they could stop an entire organization in its tracks.

And we said, "Let there be MAN."

MAN: The Multiple Area Network.

MAN is more than just another LAN or Data PBX. Much more.

It's a highly intelligent, high performance communications system designed from Day One to link multiple devices, multiple networks, and multiple locations.

MAN can link all kinds of devices from multiple vendors to Ethernet. And Ethernets to other Ethernets, remote nets, X.25 public nets, and SNA.

Computers, printers, terminals, personal computers, and mainframes all become one transparent system with MAN.

The MAN who has everything.

Our Terminal Servers, Host Servers, and Gateways have the capacity to serve even the most demanding user. And they can grow to meet the needs of the largest organizations.

MAN systems use multiple 68000 microprocessors to move information faster and easier than any other network. There's no single failure point, and our expansion capability beats all other LANs or Data PBXs.

People who really need and depend on powerful communications systems have already gotten their MAN. People like Honeywell, Motorola, GTE, U.C.L.A., The U.S. Forest Service, and NASA.

Call 415-969-4400 or write Bridge Communications, Inc., 1345 Shorebird Way, Mt. View, CA 94043, and get the story of MAN.

It's the Genesis of a whole new way of networking.

BRIDGE 
COMMUNICATIONS

The Multiple Area Network

CIRCLE NO. 79 ON INQUIRY CARD

NCR

Disk

Communications

Fault

Battery

On

Off

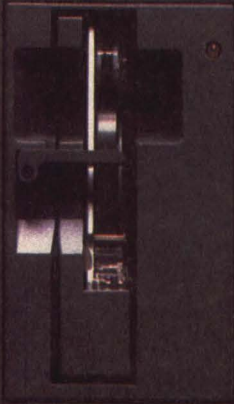

TOWER 1632. THE SHAPE'S THE SAME, BUT IT'S GOT AN ENTIRELY NEW DIMENSION.

The most memorable shape in the computer industry just became even more unforgettable.

You might think it would be hard to improve on the computer that took the OEM world by storm only a short year ago, but we've done just that.

First, we added two 46MB, 5 $\frac{1}{4}$ " Winchester to bring total storage capacity to 92MB (unformatted) in a single Tower unit.

Then we added a $\frac{1}{4}$ " streaming tape for faster, more convenient back-up. The tape's 45MB capacity allows you to dump the entire contents of a Winchester on one tape cartridge.

Of course, this enhanced Tower still offers the UNIX*-based Tower Operating System for maximum software compatibility and flexibility. And unsurpassed interfacing capacity. And the NCR name. Your guarantee of support. Now and in the future.

And it all still comes in that famous box. You know. The one that towers over the minicomputer.

Call us at 1-800-222-1235 to learn more about the Tower's exciting new dimension.

*UNIX is a trademark of Bell Laboratories.

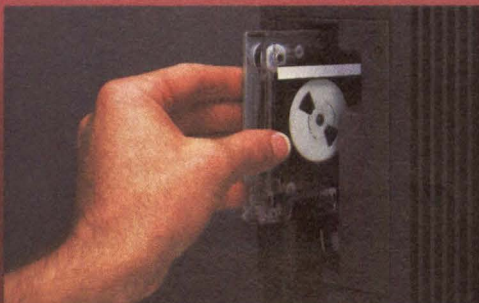

BUILT FOR SYSTEMS BUILDERS.
TOWER 1632.

NCR

OEM Systems Division

NCR Corporation, World Headquarters, OEM Systems Division, Dayton, Ohio 45479. Nationwide (800) 222-1235. In Ohio (513) 445-2380. In Canada (800) 268-3966.

CIRCLE NO. 80 ON INQUIRY CARD

TWENTY-FIVE YEARS AGO CALCOMP PIONEERED THE MOVEMENT TOWARDS INNOVATIVE GRAPHICS PRODUCTS.

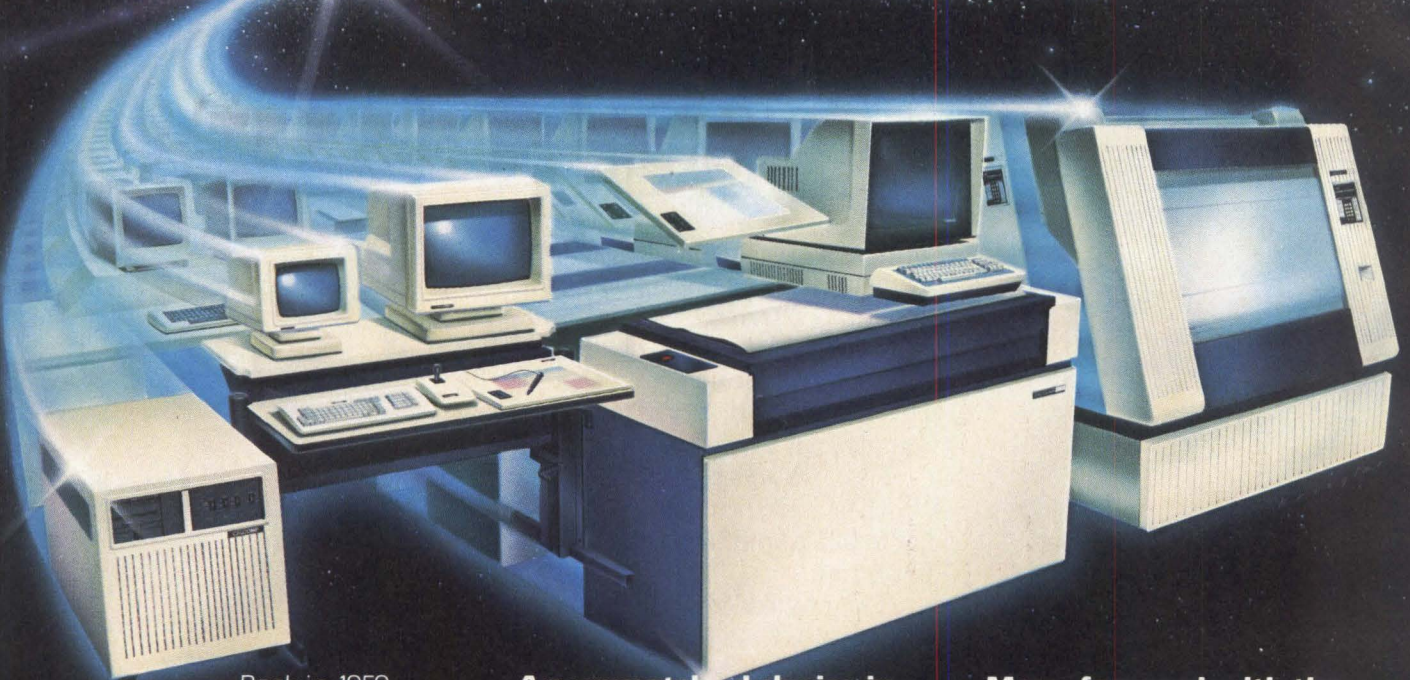

Back in 1959 when computer graphics was barely a concept, CalComp pioneered the first computer-driven plotter. Since then we've had one successful product after another, and the momentum has never been greater than it is now.

Versatile DUAL-MODE™ pen plotters fill out the line.

To offer you the broadest line of plotters in the industry, we've introduced a new generation of intelligent, microprocessor-based DUAL-MODE™ pen plotters. They give you the versatility to run unattended, continuous roll batch jobs, as well as drawings on cut-sheet or pre-printed forms.

The fastest electrostatic plotters in the industry.

CalComp offers a complete line of electrostatic plotters. With the fastest paper travel speeds in the industry, you get fast finished-quality plots at an affordable price.

An unmatched choice in precision digitizers.

Known for accuracy and reliability, CalComp digitizers range from a small 11-inch (2794mm) square to tablets as large as 44 x 60 inches (11176 x 1524mm), with advanced features such as rear projection and micro-processor control.

Powerful new CAD systems.

The new CalComp System 25 interactive CAD system is designed to meet your most demanding design and drafting needs. Configured as a small stand-alone system or a large multi-station network, System 25 delivers the most complete solutions quickly and cost-effectively.

Displays draw on local intelligence.

We've also enhanced our display family with a valuable option that lets you use the intelligence of your terminal for developing customized graphic applications.

Move forward with the leader.

CalComp will introduce a wide array of state-of-the-art products this year. Our 25th anniversary year. That's the kind of momentum that has made CalComp the leading supplier of computer graphics equipment, with the most complete product line in the industry.

You'll find CalComp plotters, displays, digitizers and CAD systems in every corner of the world, supported by a comprehensive sales and service network.

As you can see, the momentum is growing every day.

CALCOMP, 2411 West La Palma Avenue, P.O. Box 3250, Anaheim, CA 92803.

In continental U.S., except California, call (800) 556-1234, ext. 156. In California call (800) 441-2345, ext. 156.

CALCOMP

A Sanders Company

THE MOMENTUM IS GROWING

CIRCLE NO. 81 ON INQUIRY CARD

FEATURE HIGHLIGHTS

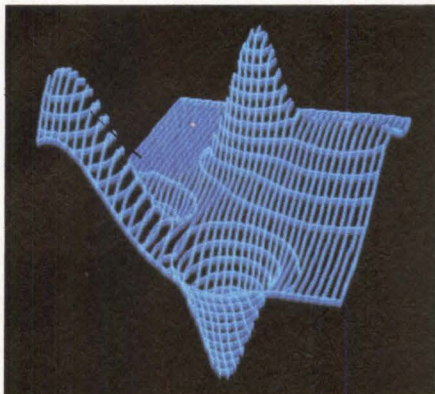

SOFTWARE: While most of the industry advocates **software standards**, proponents and opponents stand nose-to-nose in a battle of conflicting objectives. Some manufacturers cite the need to be different to ensure their market share. Others will accept standards only if those standards guarantee that hardware will be available to support their offerings. See **p. 202** for more information.

Hardware manufacturers, software resellers and end users are demanding more functionality from application and operating software. To meet this challenge, software developers are employing structured specification designs using **software tools** such as programmed logic trees, automatic application code generators, optimized compilers and linkers for code generation and software/hardware debuggers. Turn to **p. 235** for the whole story.

System integrators attempting to **transport large software packages** from one hardware environment to another can benefit from companies such as Digital Innovations Pvt. Ltd., which has ported National Semiconductor Corp.'s NSX16 development tools from a 32-bit DEC VAX supermini running VMS to a 16-bit PDP-11 mini running RSX-11. To find out how they did it, consult **p. 215**.

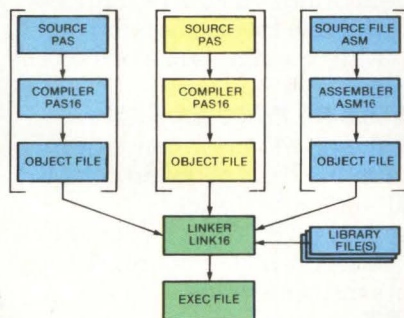
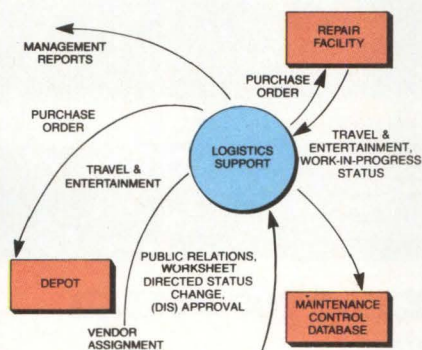

CONTROLLERS: Microcomputer peripherals have proved to be a major bottleneck in system performance, especially in disk-intensive UNIX environments. The need for higher performance devices has produced a new generation of disk drives, which in turn has required higher performance disk controllers. Interphase Corp. has developed the Storager, which increases performance through reduced rotational latency, virtual buffering and disk caching. More details appear on **p. 163**.

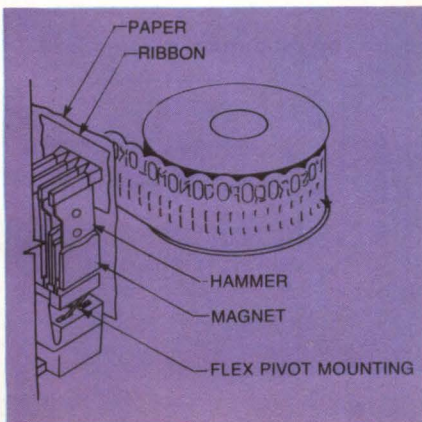

LINE PRINTERS: Impact or non-impact? Impact printers continue to dominate the line-printer industry despite a promised market revolution in non-impact machines. For more information, see **p. 175** and peruse the **impact line printer table** on **p. 187**.

COMMUNICATIONS: An intelligent I/O board permits more users to run programs simultaneously from a single host without decreasing throughput. Macrotech International Corp.'s ADIT I/O board, detailed on **p. 225**, provides intelligent processing for S-100 based systems and supports up to 16 terminals, printers, modems or other serial devices.

DATA GENERAL'S MV/10000. LESS MONEY THAN DEC'S VAX 11/780 AT TWICE THE SPEED.



DATA GENERAL



DEC

DATA GENERAL'S MV/FAMILY—TOP PERFORMANCE, NOT TOP DOLLAR

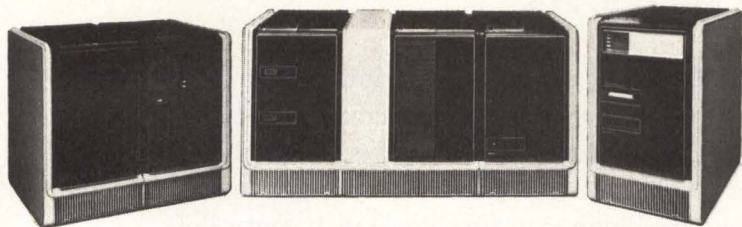

Forget VAX.™

Data General's ECLIPSE® MV/Family of 32-bit computers brings you the best price/performance available for engineering applications—while running some of the best electronics engineering software.

TWICE AS FAST AS VAX

Consider the price/performance graph shown below. On the basis of dollar-per-MIP,

Data General's MV/10000™ gives you twice the performance of the VAX 11/780—at a lower price.*

Now compare the MV/8000®II to the VAX 11/780. Same performance. But the MV/8000II is half the price. The same holds true when you compare the MV/4000® to the VAX 11/750. And our recently announced OEM MV/8000 C offers almost twice the performance of the VAX 11/750. But it's the same price.

RUNS THE MOST WIDELY-USED SOFTWARE

You can run all of the best software on our ECLIPSE MV Series, including TEGAS™, NCA/DVS™, MicroSet-86®, ECAD's DRACULA, and Mentor's CADISYS®.

Data General keeps you a generation ahead with comprehensive service plans and industry standard software development environments.

For further information, write Data General Corporation, M.S. F134, 4400 Computer Drive, Westboro, MA 01580.

*Compared to the VAX 11/785, our MV/10000 offers 40% better performance for two-thirds the price.

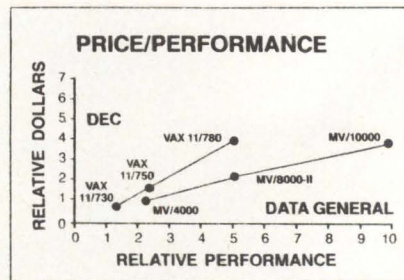

Copyright 1984 Data General Corporation, Westboro MA. ECLIPSE, ECLIPSE MV/4000 and ECLIPSE MV/8000 are registered trademarks, and ECLIPSE MV/10000 is a trademark of Data General. DEC and VAX are trademarks of Digital Equipment Corp. Prices based on Data General and DEC price lists and other publicly available information as of Jan. 1984. TEGAS is a trademark of Calma Co. MicroSet-86 is a registered trademark of First Systems Corp. CADISYS is a registered trademark of California Automatic Design.

Data General
a Generation ahead.

CIRCLE NO. 82 ON INQUIRY CARD

MINI-MICRO SYSTEMS/September 1984

UNIX-optimized controller supports intermixed tape, floppy, Winchester drives

Working with Multibus systems and major disk interfaces—including ESDI, ST506 and ST412—controller uses multitasking architecture with virtual buffering and disk caching to reduce rotational latency and increase peripheral performance in disk-intensive applications

A. Edward Turner, Interphase Corp.

While CPU power is increasing rapidly, microcomputer peripherals are becoming the bottlenecks that system integrators must confront in seeking greater overall system performance. This situation is particularly true in disk-intensive UNIX environments. The need for higher-performance, higher-capacity storage devices has led to a new generation of 5¼-inch Winchester disk drives that have faster interfaces and storage capacities in excess of 300M bytes. This, in turn, has led to the need for higher-performance disk controllers that take advantage of the new drive and interface capabilities.

Interphase Corp.'s answer is the Storager disk controller, which works with Multibus-based systems and supports all major 5¼-inch disk interfaces. A multitasking architecture increases performance by reducing rotational latency. Other architectural features—such as “virtual buffering” and disk caching—boost the performance level of 5¼-inch disks to that of 8-inch storage module device (SMD)-type disks. The controller board supports two 5¼-inch Winchester drives, four ¼-inch tape drives using either quarter-inch cartridge (QIC)-02, or Archive Corp. interfaces and two floppy disks intermixed in any two of three formats—3½-, 5¼- or 8-inch.

The Storager employs a multitasking, virtual buffering architecture. This scheme reduces data-transfer delays resulting from disk rotational latency and pro-

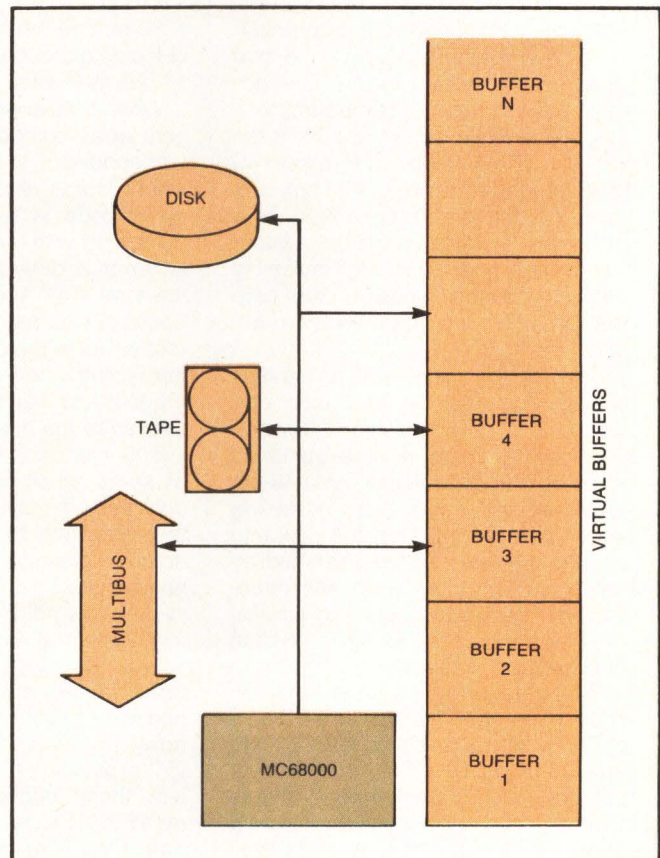

MC68000 microprocessor manages the pool of virtual buffers and regulates activity on the controller. It allocates and de-allocates buffers as they are accessed or released by the disk, tape or Multibus.

vides simultaneous disk and bus transfers as well as concurrent disk and tape operations.

Two bipolar-state machines manage the data streams. The direct memory access (DMA)-control state machine manages data movement between the controller and the Multibus; the buffer control state machine manages data movement between the controller and its peripheral devices. The two state machines operate independently to allow simultaneous data movement between the controller and the bus and between the controller and its peripherals.

A Motorola MC68000 microprocessor regulates activity on the Storager controller. It breaks up commands, sets up data transfer operations and manages the pool of virtual buffers that support a variety of activities on the controller. The Storager has 16K bytes of on-board memory that can be treated as a series of sector buffers. Any of three devices—disk, tape or Multibus—can access the individual buffers. The 68000 dynamically allocates and de-allocates buffers as they are re-

quested or released by the various devices. Because each device has a seemingly endless supply of buffers, this design eliminates data overrun and underrun problems inherent in first-in-first-out (FIFO)-based systems. The multitasking architecture and the pool of buffers assist in reducing rotational latency.

A traditional controller, upon receiving a multi-sector request from the operating system, waits to read and transfer data until it encounters the first of the

Two bipolar state machines manage the data streams.

requested sectors. This delay accounts for an average rotational latency of half a track, or eight milliseconds of additional access time. For example, if the request is for a full track of data, a traditional controller takes an average of a revolution-and-a-half to accomplish the transfer. In comparison, the Storager begins reading as

Custom gate arrays decrease component count

Jointly developed by Interphase Corp. and Signetics Corp., the two custom gate arrays in the Storager reduce the number of components on the board while increasing its functionality. The gate arrays eliminate 45 to 50 integrated circuits (ICs) typically found on this kind of controller. As a result, the Storager offers the system integrator a board with high reliability and low cost. In addition, the gate arrays perform on-board error correction.

One of the gate arrays handles serializer/deserializer and error-correcting code (ECC) functions. Typically, these functions require up to 20 ICs. The chip is packaged on a 48-pin leadless chip carrier, and converts serial data coming from the disk into parallel data that can be handled by the controller. In the opposite direction, the gate array converts parallel data from the controller to serial data to be written to the disk.

The gate array includes a cyclic code generator that produces 16-bit cyclic redundancy check (CRC) code and 32-bit ECC. CRC code detects but does not correct errors, and is typically used on floppy disks and as a check on header fields on hard disks. In contrast, ECC, which is generally used on data fields, detects errors and allows for correction. ECC generates

a 32-bit checksum, which is capable of locating and correcting errors up to 11 bits in length.

When data is written to the disk, the gate array computes the cyclic code and appends it to the data. In reverse, when data is read from the disk, the cyclic code is read, computed and compared with what was just read. If an error is detected, the ECC generates an error syndrome that the on-board 68000 processor uses to correct errors in the data. In other words, the Storager performs error correction on-board so that only correct data is passed to the host.

This approach is in contrast to that of some other controllers that pass only the error syndrome to the host, thus requiring the host to make the actual correction. Not only does this necessitate host intervention, but the system integrator must write software for the host to handle the correction.

The Storager's other custom gate array handles encoding/decoding and phase-lock-loop functions. The gate array is arranged in a 24-pin dual in-line package (DIP). In other controllers, these functions typically require up to 30 ICs. As with the other gate array, this chip frees more space on the board for other ICs.

The Storager's encoding/decoding chip handles a variety of functions,

including:

- Conversion of non-return-to-zero (NRZ) data to frequency modulation (FM) or modified frequency modulation (MFM) encoded data. This function converts digital data into a form that can be written on the magnetic media of the disk. Single-density floppies typically use the FM data format, and double-density floppies and hard disks typically use the MFM data format.

- Conversion of FM or MFM encoded data to NRZ data. This involves converting the analog data read from the disk to digital data.

- Address mark detection and generation for soft-sectored disks.

- Write precompensation with external delay line. Because precompensation varies with different drive manufacturers, the Storager allows the precompensation cylinder number to be programmed on a per-drive basis.

- Receive clock regeneration, commonly known as "data separation," which separates the clock and data signals.

- Phase comparator portion of the phase-lock-loop circuitry. This function assists in isolating clock and data signals.

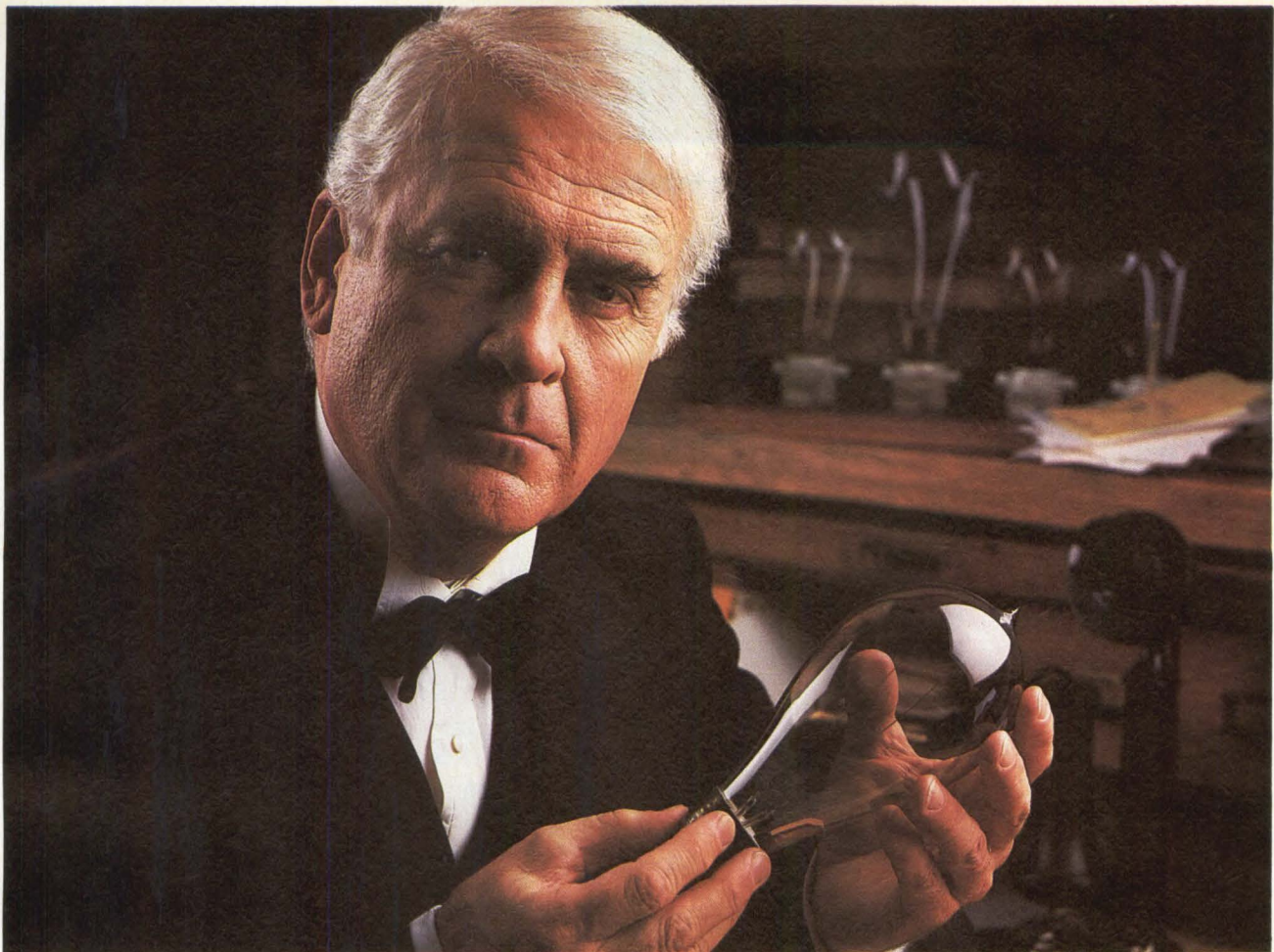

Zetaco's latest inventions make 86 disk and tape drives Data General BMC compatible.

Zetaco's BMX-1 disk drive controller and BMX-2 mag tape coupler give the user of Data General's high-speed BMC (Burst Multiplexor Channel) full compatibility with the newest high-speed, high-capacity, non-DG drives.

These two bright ideas let you choose virtually any high performance SMD-type disk drive or 1/2" tape drive to run on the BMC or Data Channel on DG's newest Eclipse or MV Series mini.

Each BMX-1 supports up to 4 SMD-interfaced hard disk drives. Each BMX-2 supports up

to 8 streaming or start/stop tape drives.

Zetaco's full emulation of DG's 60XX and 61XX series disk and 6026 and 4307 tape subsystems means no software patching is required. E² PROMs eliminate switches, making drive configurations and functions selectable via downline loaded software. And Zetaco's exclusive

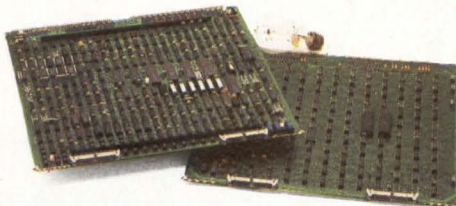

backplane cable design is plug-and-go compatible with DG's FCC and non-FCC compliant chassis.

Discover the BMX Series from Zetaco, 6850 Shady Oak Road, Eden Prairie, MN 55344, (612) 941-9480. Telex 290975. European Headquarters: 9 High Street, Tring, Hertfordshire, HP23 5AB, England. (044282) 7011. Telex 827557. ZETACO G.

ZETACO

Controller Division, Custom Systems Inc.

CIRCLE NO. 83 ON INQUIRY CARD

Lear Siegler's New ADM 220

DEC VT 220™ Compatibility.

More performance with High Touch™ Style.

DEC compatibility. Ergonomic styling. Standard features that include advanced editing, 15 programmable function keys, DEC VT220 keyboard layout, and user-friendly set-up. All these—and more—are combined in Lear Siegler's ADM 220 video display terminal.

The ADM 220 is engineered for use with Digital Equipment Corporation and ANSI X3.64 compatible systems. It is compatible with the DEC VT220, as well as the VT100™ and VT52.™ Add Lear Siegler's superior styling and ergonomics and you have a VDT that offers maximum operator comfort and efficiency.

Lear Siegler's High Touch style includes a full tilt and swivel monitor that stops positively in any position. The low-profile, DIN standard keyboard includes a built-in tilt adjustment. Set-up is easy with parameter menus displayed in English, French or German.

The ADM 220 provides four non-embedded visual attributes (blink, bold, underline and reverse video), 80 or 132 column x 24 line display (plus 25th status line), split screen, double high/double wide line attributes, and vertical or horizontal scrolling.

The ADM 220's unique 3-level function keys give you 15 fixed functions and 15 programmable functions. An

added feature (not available on DEC's VT220) is the addition of 15 programmable, non-volatile functions.

A 12-inch green or amber screen is standard and 14-inch displays are optionally available.

For complete information, call your regional sales office: Anaheim, 714/774-1010; Atlanta, 404/971-9781; Boston, 617/456-8228; Chicago, 312/279-7710; Houston, 713/780-2585; New York, 516/549-6941; Philadelphia, 215/245-4080; San Francisco, 415/828-6941. Or call 800/532-7373 for a distributor near you.



LEAR SIEGLER, INC.
DATA PRODUCTS DIVISION

901 E. Ball Road, Anaheim, CA 92805
714/774-1010

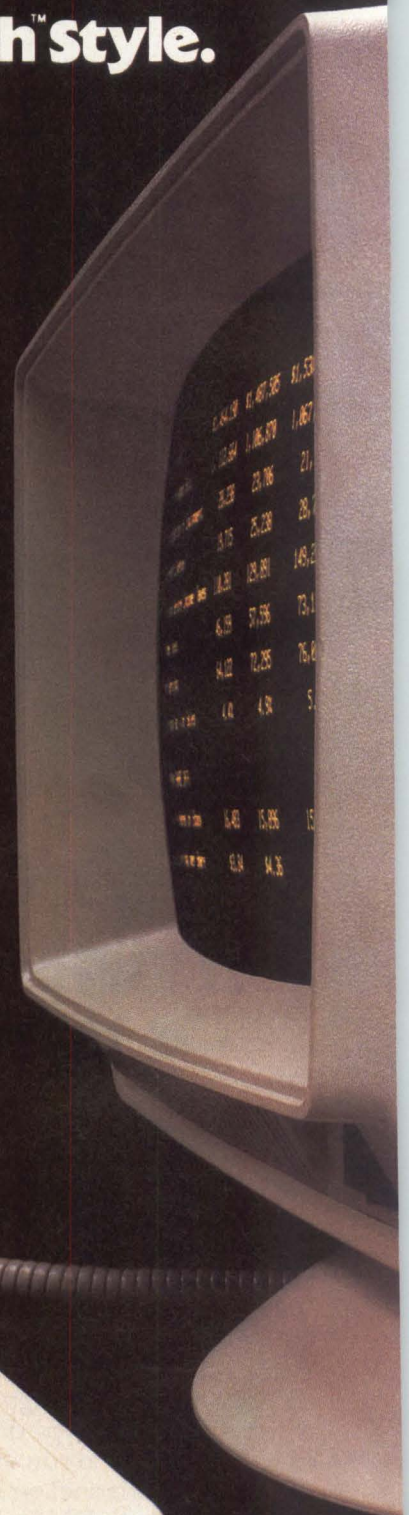

CIRCLE NO. 84 ON INQUIRY CARD

soon as the head lands on the track and begins transferring data as soon as it encounters any of the requested sectors.

Because it does not have to wait for the disk to rotate to the beginning of the requested string, the Storerger never takes more than a single revolution to transfer an entire track of data. For example, if the operating system requests sectors 0-7 and the head lands at sector 4, the Storerger immediately begins reading and transferring data. The controller first places sectors 4-7 in the correct location in the system memory and then reads and transfers sectors 0-3. This technique reduces rotational latency in direct proportion to the size of the request and eliminates latency for reads of one track or more.

Caching optimizes controller for UNIX applications

Intelligent caching can greatly improve overall system throughput in disk-intensive applications. Tests have shown throughput improvements averaging greater than 40 percent compared to a traditional 1:1 interleaving scheme without caching.

The controller accesses requested information from the disk and, while awaiting further instructions, continues to fill the cache with subsequent data from the disk. When the controller has completed a read opera-

tion and transferred the requested data, if there are no other requests in its queue, it will continue to read the next sequential data until it has filled all available buffers. Thus, if sequential data requests from the operating system are for logically contiguous sectors, as is frequently the case in file-oriented transactions, these requests can be satisfied directly from the cache

Spec summary

- **Company:** Interphase Corp.
- **Model:** Storerger
- **Interfaces:** enhanced small disk interface(ESDI), ST506 or ST412HP hard-disk interfaces; floppy interface; QIC-02 or Archive tape interfaces
- **CPU:** Motorola 68000
- **Unit initialization block concept:** software control of disk, parameters, gap sizes, stepping rates, etc.
- **DMA rate:** 3M bytes per second
- **Component count:** 115 integrated circuits
- **Sector size:** 128 to 2,048 bytes
- **Hard disk support:** two
- **Tape support:** four
- **Floppy disk support:** two (single-sided/single-density, double-sided/double-density; 3½-, 5¼-, 8-inch)
- **Data buffer:** virtual buffer (buffer pool for all units allows sector first-in-first-out operation, caching, zero latency read and write and streaming-tape operation.)

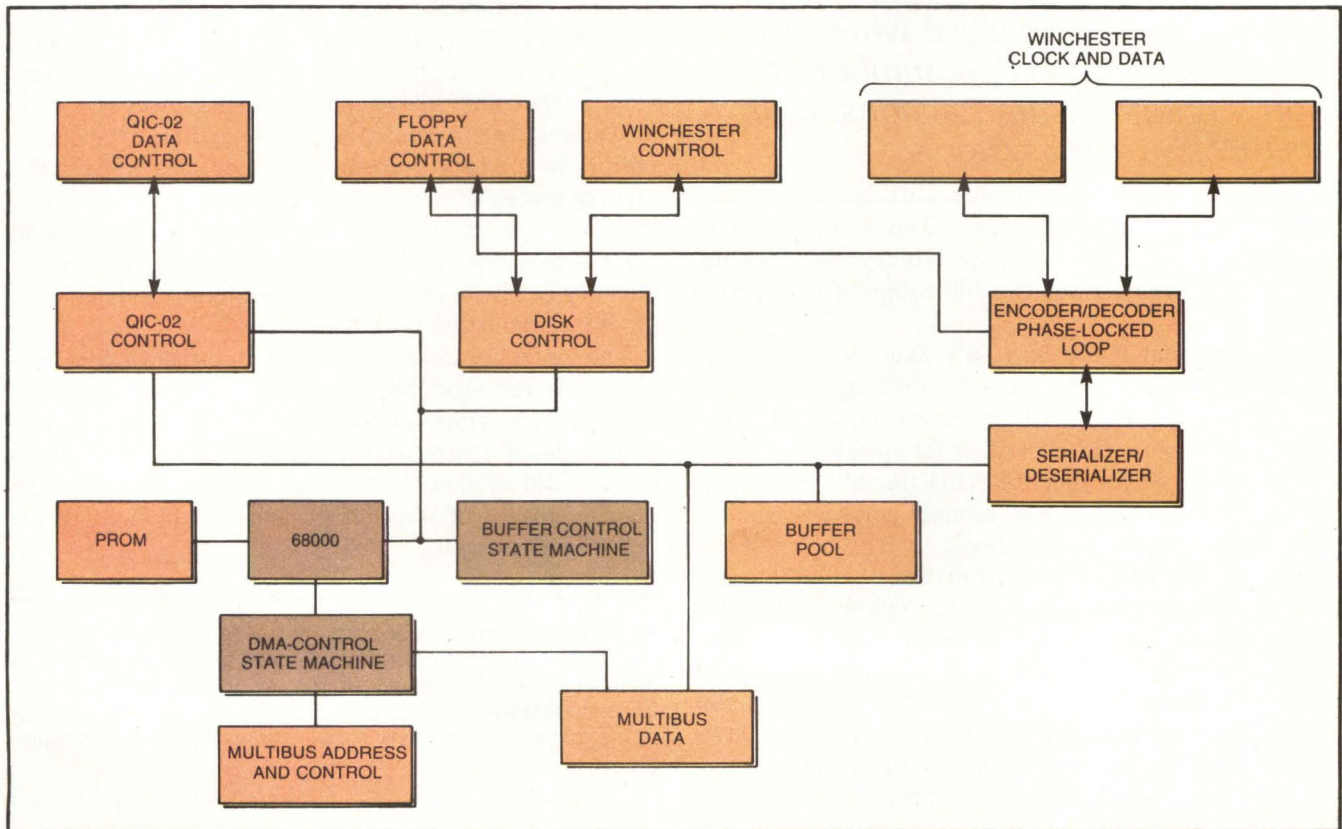

The architecture of the Storerger disk controller includes an MC68000 microprocessor that regulates activity on the controller and two bipolar state machines. The DMA-control state machine man-

ages data flow between the controller and the Multibus. The buffer-control state machine manages data flow between the controller and peripherals.

ESDI interface extends ST506 capabilities

In November 1983, a committee of disk and controller manufacturers completed specifications for the enhanced small-device interface (ESDI). The specifications provided for the connection of disk and tape drives to a single controller. The new interface was targeted at high-performance 5¼-inch Winchester.

The ESDI interface differs from the industry-standard ST506 interface primarily in speed and flexibility. ESDI supports transfer rates of 10M bytes per second and faster, whereas the ST506 is limited to 5M bytes per second. It places the data separator on

the drive rather than on the controller. This method improves performance because the data separator, which is an analog device, can be optimized for the characteristics of the specific disk drive.

Data gets transmitted between the drive and the controller in the non-return-to-zero (NRZ) format. Because NRZ data require a separate clocking signal, the interface specification is not limited to a single-disk transfer rate, and can accommodate higher transfer rates as the need arises. Data transmission between the disk and controller is more reliable and less

subject to error using the NRZ format.

An ESDI connection comprises two cables: a control cable that is daisy-chained from drive to drive, and a series of radial data cables that connect the controller with each disk drive. The ESDI also supports two methods of head positioning. In step mode, step and direction lines are used with no facility for reporting configuration or status information, as in the ST506 interface. The preferred method of operation is serial mode, in which the interface communicates command data, configuration and status information on the control cable.

without accessing the disk.

Caching proves most effective when disk activity involves a large number of short, contiguous transactions, as is the case with most UNIX-based systems. As transaction size increases, caching becomes less important and reduced rotational latency becomes more important. For transactions of a track or more, rota-

Caching is most effective when disk activity involves a large number of short, contiguous transactions, as in most UNIX-based systems.

tional latency will go to zero. The combination of caching and reduced rotational latency provides improved disk response for the full range of transaction sizes.

Many optional features of the Storager are under software control. For example, the Storager has a unit initialization block (UIB) that allows the system integrator to configure the controller for specific disk types and operating environments. This flexibility lets system integrators configure around software choices rather than hardware limitations.

To support a wide variety of drives, system integrators can program the controller to work with all methods of sector addressing, including hard sectoring, address mark and byte clock. The controller also supports all methods of head positioning — serial cylinder selection and stepper pulses — and has software control of step rates to take advantage of drives supporting buffered steps. Sector sizes are programmable from 128 to 2048 bytes.

The major interfaces for 5¼-inch drives are the industry-standard ST506, the enhanced small-device

interface (ESDI) and the ST412HP, which is a 10-MHz version of the ST506. Using an on-board data separator, system integrators can mix ST506 and ESDI drives or ST412HP and ESDI drives with the same controller. This capability provides easy migration from existing ST506 drives to new, high-performance drives.

The controller board uses two custom large-scale integration (LSI) circuits: the data separator (encoder, decoder, and phase-locked loop) and the serializer/deserializer. The LSI circuits are implemented in gate arrays. The Storager supports streaming and start/stop modes and allows simultaneous disk and tape operations. In streaming mode, the controller allocates buffers to the tape drive in a manner that ensures the tape operates at maximum speed. It can do off-line mirror-image backups and restores without the use of system memory. File-oriented transfers using system memory can be done concurrent with, and independent of, Winchester disk activity.

The controller can handle two floppy disks in 3½-, 5¼- or 8-inch formats. Most controllers cannot intermix sizes. Single sided/single density and double sided/double density are software selectable. Disk formats can be IBM 3740 or System 34. All caching and performance features of Winchester disk control apply to the floppy disk as well. □

A. Edward Turner is vice president of Interphase Corp., Dallas. Turner joined Interphase in 1983 after several years as technical marketing manager for the Information Networks Division of Hewlett-Packard Co. Before that, he was manager of the telecommunications support group for Procter & Gamble Co.

Interest Quotient (Circle One)
High 816 Medium 817 Low 818

Get a VAX free with ABLE's ATTACH.* Here's how:

If you were to configure a four CPU network for terminal support, you'd dedicate virtually one entire CPU to Local Area Network overhead. That's because LANs require as much as one quarter of a computer's processing power for network management.

Productivity Vs Overhead

ATTACH frees up VAX overhead. Because ATTACH gains a VAX through software transparency, *bypassing* the need for network overhead.

Terminal Network System

ATTACH is a multi-host terminal network system for DEC UNIBUS computers. Offering virtual data switch capabilities, ATTACH permits users to initiate a request to access any one of the host computers in the network. Security is assured through user access class definition.

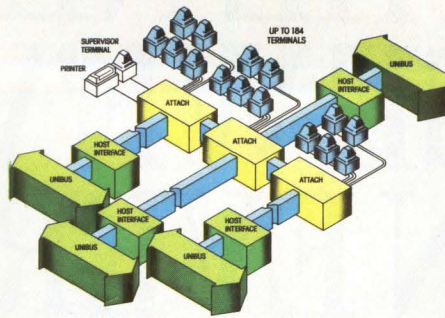

ATTACH networking makes sound investment sense with outstanding features and benefits like "hot swap" modules, redundant configurations and *fiber optic* security. An ATTACH network can support any number of terminal clusters

-1,000 and more, just for starters.

The Choice Is Obvious

To put it into simple terms, you have two options—a LAN that costs one whole VAX for operating overhead, or ATTACH—it gives you a VAX, free.

Be money and computer-wise. *Let ATTACH free your VAX (or PDP).

Send in the certificate today. Better yet, contact an ABLE Computer representative near you, or call toll-free at 800-332-2253.

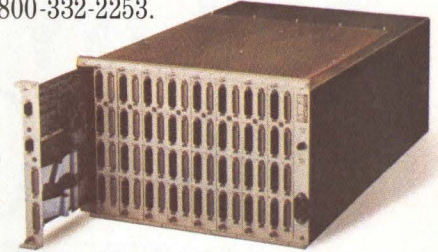

The communication specialists

ABLE COMPUTER, 1732 Reynolds Avenue, Irvine, California 92714. In the Irvine area: (714) 979-7030. Or, TWX: 910-595-1729.

Buy ATTACH And get a VAX Free*

SEND TODAY

CERTIFICATE

Yes, I want to free one of my UNIBUS computers with ABLE's ATTACH.

NAME _____	PHONE () _____
TITLE _____	
COMPANY _____	My network will consist of approximately:
ADDRESS _____	(NUMBER) _____ VAX-11/ _____
CITY _____	(NUMBER) _____ PDP-11/ _____
STATE _____ ZIP _____	(NUMBER) _____ Terminals _____

ABLE COMPUTER, The communication specialists 1732 Reynolds Avenue, Irvine, CA 92714

ANA4830

ATTACH is Patent Pending. DEC, PDP and VAX are trademarks of Digital Equipment Corporation.

CIRCLE NO. 85 ON INQUIRY CARD

ON THE NEXT PAGE WE'VE SHOWN EVERYONE WHO MATCHES AMPEX'S EDITING, EMULATION AND ERGONOMICS FOR ONLY \$549.

That's right. No one.
Not TeleVideo,[®] not ADDS,[®] not
Lear Siegler.[®]

Not surprising. Because the
Ampex 210 isn't just a conversational
terminal at a stripped-down price.

It's loaded.

With editing and other
features you'd expect only on
more expensive terminals.

With 14 popular, non-volatile emulations
you can switch at the touch of a key.

And with ergonomics like a low-profile,
Selectric-type[®] keyboard for easy typing.

A large 14" tilt-and-swivel screen for easy
reading. And amber or green at no extra cost.

How can we sell all that for \$549,



or even less in quantity? Then back
everything with nationwide service
and a full six-month warranty?

By taking advantage of
something none of our competitors
can match—our 30 years of video,
computer peripheral and manu-
facturing expertise.

So call Ampex

Computer Products Division
toll free at 800 621-0292. 800 821-9473 in
California. Ask us to detail everything we pack
into our \$549 terminal.

Then go out and compare us to the
competition. But don't be surprised
if you can't
find any.

AMPEX

Ampex Corporation • One of The Signal Companies

TeleVideo, ADDS, Lear Siegler and Selectric are registered trademarks of TeleVideo Systems Inc; Applied Digital Data Systems Inc; Lear Siegler Inc. and IBM.

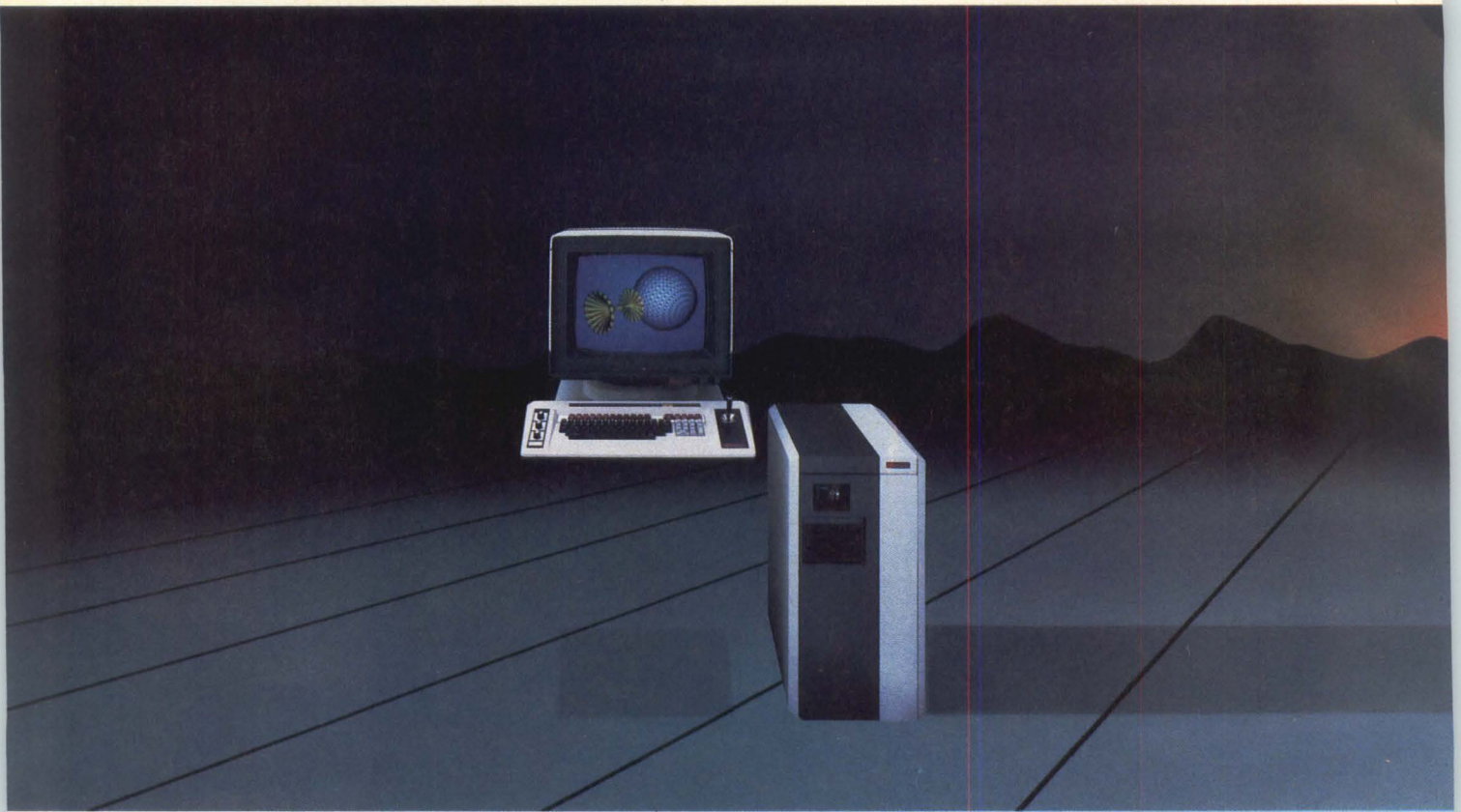

Merlin. The Result of and a Pinch of

More than 15 centuries ago, Merlin—the world's greatest sorcerer—took magic truly beyond state-of-the-art. He not only made the impossible possible—he made it easy.

The same way Megatek is doing today. In computer graphics.

We've taken tomorrow's technological magic to produce graphics miracles today. In other words, what Merlin did for his world, Megatek can do for yours now. The Merlin™ 9200 to be exact.

The most completely interactive, high-performance, high-resolution graphics rendering system yet created. Advanced graphics capabilities combined with high reliability and the first intelligent approach to graphics database management and system networking.

The Merlin 9200 offers graphics capabilities that virtually leave the leading edge of technology behind. Translucents and opaque solids, for example. Flat, Gouraud or Phong shading. X, Y and Z axis clipping of objects. Depth cueing. Perspective. Surface texturing, patterning and meshes. And a unique, proprietary Pixel Phaser™ that gives ultra-sharp 3056x2304 virtual screen addressability. Plus, 64 or 256 or 4096 colors from a palette of 16.7 million.

And behold the system-supported miracles Merlin creates.

Communications. A database editor. Local task processing and display.



1500 Years of R&D Megateknology.

Print, set-up and configuration managers. Peripheral devices including color hardcopy output, a graphics tablet and full-function keyboard with joystick and valuator dials.

Plus, Merlin's hierarchical database allows graphics and non-graphics information integration in up to 4 megabytes of dedicated memory. You can create or modify screen graphics while automatically changing the system's database. You can even store and recall data from either the host or, thanks to an optional Ethernet® interface, from other networked Merlins. Sheer wizardry.

Then there's VT-100™ emulation, hardware diagnostics, status checking, error recovery and a configurable error routing capability.

Merlin 9200 from Megatek. The ultimate high-performance graphics solution that takes you far beyond state-of-the-art. Thanks to Megateknology.™

Pure and simple graphics magic—1500 years in the making, but well worth the wait.

See us at AUTOFACT, Booth 515, October 2-4.

World Headquarters, 9645 Scranton Road, San Diego, CA 92121
619/455-5590, In CA, 800/824-4489, In USA, 800/854-1975, TWX: 910-337-1270

Merlin, Megateknology and Pixel Phaser are trademarks of Megatek Corporation. Ethernet is a registered trademark of Xerox Corporation. VT-100 is a trademark of Digital Equipment Corporation.

Merlin

 **MEGATEK
CORPORATION**
A UNITED TELECOM COMPANY
Making History out of State-of-the-Art



THE PRINTER TO PICK WHEN THE PACE QUICKENS.

It's happening all over the value-added world.

Your multi-user customers are getting hit with a ton of increased throughput requirements and they need more printer speed. A lot more.

They're also looking for more professional-looking presentations so they need better print quality. A lot better.

Where can you find the best of both worlds for them? And at the same time find some margins that'll look real good to you?

With Okidata's Pacemark 2350 and 2410 dot matrix printers.

Take throughput. The 2350 and 2410 can quickly get your customers out of the waiting game to where they're *really* cranking it out.

But wait. Cranking *what* out, you may ask? A single, restrictive printing mode? No way. The 2410 can give your customers DP, draft, and correspondence quality that truly rivals the daisy-wheel. And with flexibility, too: up to 5 pages per minute.

And the 2350 and 2410 can both print at up to 350 cps. While producing 120 to 420 lines a minute for them. With bidirectional printing and short line seeking logic. And both high speed and vertical slew.

SYSTEMS COMPATIBILITY. SOFTWARE COMPATIBILITY.

The 2350 and 2410 use industry standard interfaces making them hardware compatible with most mini and microsystems on the market today. In addition, they are supported on the menus of most of the important software being offered to microsystem users.

You also get an outstanding graphics capability with 144 x 144 dots per inch resolution.

Two color printing for highlighting. Down line loadable font sets for flexibility. Subscripts and superscripts so your scientific and technical usage won't bog down. Six-part forms handling. The capability to print 132 columns on

eight-inch paper using 17.1 characters per inch to save paper costs and make output easier to handle.

And—so that your customers can depend on getting all that good stuff, all the time—a mean time between failure of 2200 hours. A mean time to repair of only 30 minutes. An average print-head life of 200,000,000 characters.

No doubt about it, the quicker the pace at your customers' place, the more you need Pacemark from our place. For more information, call toll free 1-800-OKIDATA. In New Jersey, 609-235-2600. Or write OKIDATA, Mt. Laurel, NJ 08054.

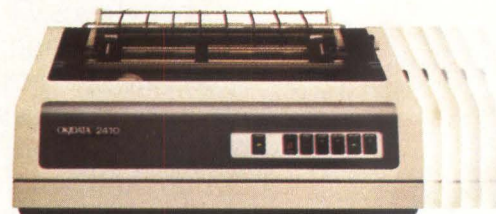

OKIDATA
an OKI AMERICA company

We're keeping pace with your business.

CIRCLE NO. 88 ON INQUIRY CARD

Line printer leaders lower prices, improve reliability

Although non-impact printers threaten the low and high ends, the 300- to 2000-lpm market remains the domain of impact line printers, particularly band printers and emerging dot-matrix units

David Simpson, Associate Editor

As it has for the past few years, controversy in the line-printer industry continues to center on the impact vs. non-impact debate. Impact line printing is a mature industry, leading some analysts and manufacturers to believe that the time is ripe for non-impact

technologies. Nevertheless, the much-touted non-impact line-printer revolution is still in its early stages.

Non-impact printing, however, is beginning to capture low-end market share with high-speed thermal and ink-jet printers and is threatening the high-end market with non-impact page printers using laser-xerographic and ion-deposition techniques. Currently, the

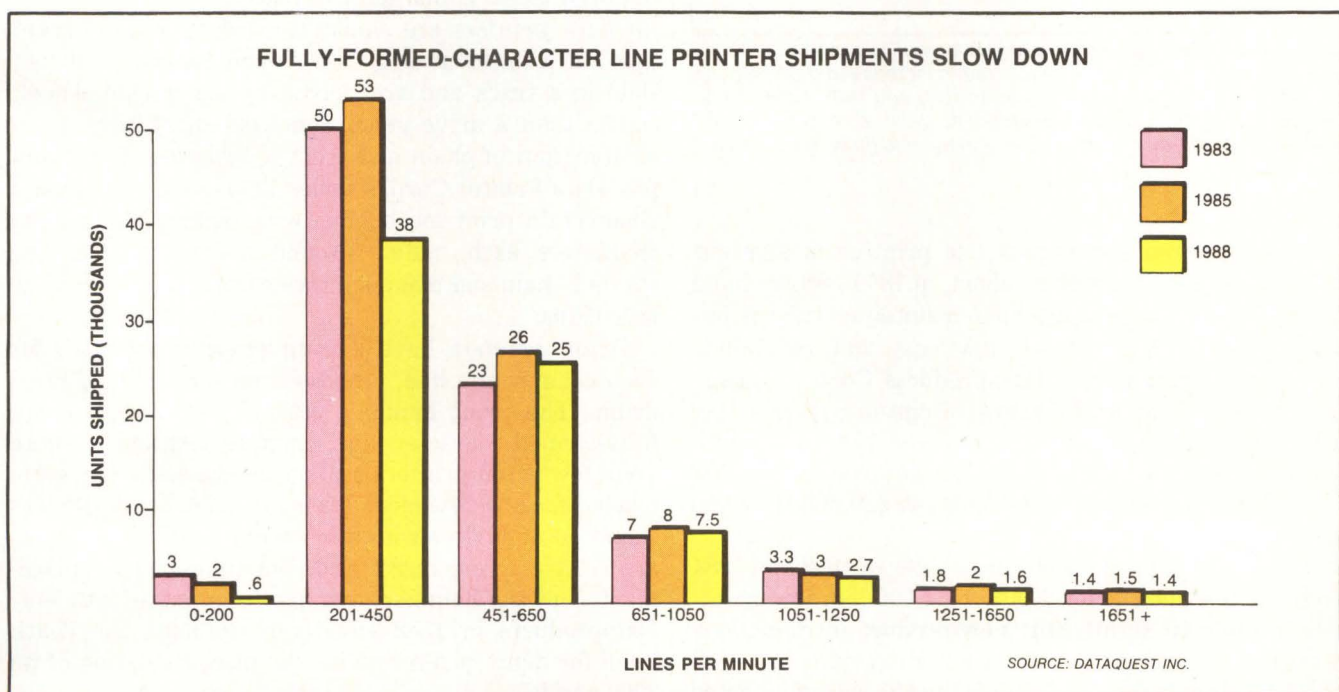

The market for line printers that produce fully-formed characters is expected to decline slightly between 1983 and 1987 due to competition from other technologies, particularly impact dot-matrix.

300- to 2000- line-per-minute (lpm) market is dominated by impact printers. Band printers rule this market, but impact dot-matrix units are gaining popularity. OEMs have more than 80 products from which to choose. To facilitate buying decisions, some impact line-printer manufacturers are eschewing technological innovations in favor of improved reliability, added features and lower prices.

Band technology dominates impact printers

Band printers incorporate a horizontally rotating steel or plastic band with embossed characters. A bank of print hammers strikes the paper and ribbon against the characters as they rotate into position. The print mechanism usually contains a full line of print hammers.

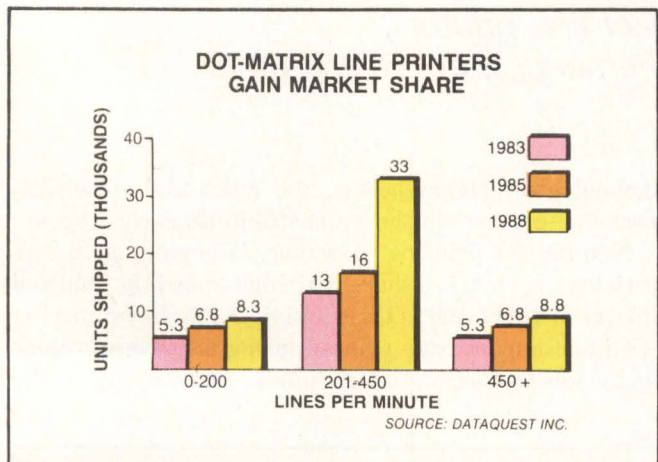

Shipments of dot-matrix, line printers operating between 201 and 450 lines per minute (lpm) are expected to increase at a 27-percent, compound annual growth rate between 1983 and 1988. Units operating at under 200 lpm are expected to grow at 7 percent, and over-450-lpm, dot-matrix printers are expected to grow at a 9-percent rate.

Over 60 percent of impact line printers in a recent MMS survey (see product chart, p.187) employ band technology. Band printers have maintained their popularity due to high speed, low cost and reliability. Centronics Data Corp., Dataproducts Corp., Storage Technology Corp. and Synergy Printer Systems Inc. are among companies offering over-1500-lmp units. Average prices are \$8000 for a 300-lpm printer, \$11,000 for 600 lpm, \$17,000 for 1,000 lpm and \$20,000 for 1,500 lpm.

The rise in superminicomputer sales in 1983 and 1984 spurred the market for 1,000- to 2,000-lpm line printers, leading to significant, new-product introductions from market leaders. Centronics, for example, unveiled the 1,800-lpm E-Series Model III in the second quarter of this year, and Dataproducts began shipments of its

2,000-lpm BP-2000 late last year. Centronics and Data-products are the front-runners in the impact-line-printer market.

Other significant new printers include Cynthia Peripheral Corp.'s 1,200-lpm PR1200 and 1,500-lpm PR1500, Centronics' 400-lpm Linewriter 400 and 800-lpm Linewriter 800, IBM Co.'s 2,000-lpm 4245 and 3,600-lpm 4248 (the fastest impact printer on the market) and Teletype Corp.'s 300-lpm T-300. Teletype's T-300 uses belt technology, the other printers employ belt printers except that they use a belt with character slugs, instead of a band with embossed characters.

Japanese manufacturers made a strong showing in 1984 with Fujitsu Ltd.'s Jupiter M3000 series, ranging from 390 lpm to 1,300 lpm, and Hitachi Ltd.'s UP series, which goes from 470 lpm to 2,000 lpm. The printers will be marketed in the United States by Fujitsu America Inc. and Hitachi America Ltd., respectively. Fujitsu's introductions are indicative of the move away from technological innovation and toward improved reliability and lower cost. Mean-time-between-failure (MTBF) specifications for the M3040 and M3041 are 4,000 hours; the faster M3042 and M3043 claim a 6,000-hour MTBF.

Train printers push unconnected character slugs along a looped horizontal track. As with belt and band printers, hammers strike the ribbon and paper against the character slugs. Train printers have multiple sets of characters so that a full revolution of the track is never required to set a character in place.

Chain printers are similar to train printers except that the character slugs are linked together, do not slide in a track and are driven by a sprocket wheel, rather than a drive gear. Some manufacturers use a combination of chain and train techniques. For example, Data Printer Corp.'s series 1200 line printers use a ChainTrain print mechanism with eight links of eight characters each, pulled around a rail. Most of the current chain and train printers were introduced in the late 1970s.

Drum printers have a complete character set for each column in a line, embossed on a cylindrical steel drum. The print hammer action is similar to other fully-formed-character line printers. Although there are a few drum printers still on the market, they seem headed for obsolescence. Their precision is usually less than that of devices with other technologies, the drums are relatively expensive and sometimes need replacement, and the hammers require frequent adjustment. Dataproducts in 1982 effectively sounded the death knell for drum printers with the discontinuation of its 2200 series.

Perhaps the most significant recent technological

It Works Hard for Your Money

In considering Daisy M45 as your next printer look beyond the striking European styling. Look at its value-packed quality and performance. You'll be impressed.

Daisy M45 advanced daisywheel printers deliver true bi-directional printing at an incredible speed of 45 characters per second. You get crisp letter-quality output from printwheels interchangeable in a wide variety of type styles.

Daisy's M45 is compatible with all computer systems. Mini and micro. You get a choice of eight different interchangeable interface modules for the hardware/software combination you choose — no need to be concerned about compatibility.

And it's quiet. Very quiet. Daisy's designers scored a breakthrough with a minimum of moving parts — 35% fewer than other conventional daisywheels. Considerable research went into its automatically controlled "long-life", impact hammer. Plus it uses Daisy's "multistrike" cartridge to further optimize ribbon life.

Daisy M45 has earned a great deal of respect throughout the world — not only as a reliable and durable office printer — but also one sensibly priced with more features for your money. Like programmable carriage motion. Pitch and proportional spacing. 5760 points per square inch plotting resolution — and many operator controls and indicators built-in.

Extensive office use in every major country in the world has proven Daisy's enviable record of dependability.

Call today or send coupon for more details.

The World's Finest Printers



Daisy Systems Holland

Daisy Systems Holland BV, Nieuweweg 279, P.O. Box 125,
6600 AC Wijchen, The Netherlands, 31-(8894)-18170, Telex 48281

CIRCLE NO. 89 ON INQUIRY CARD

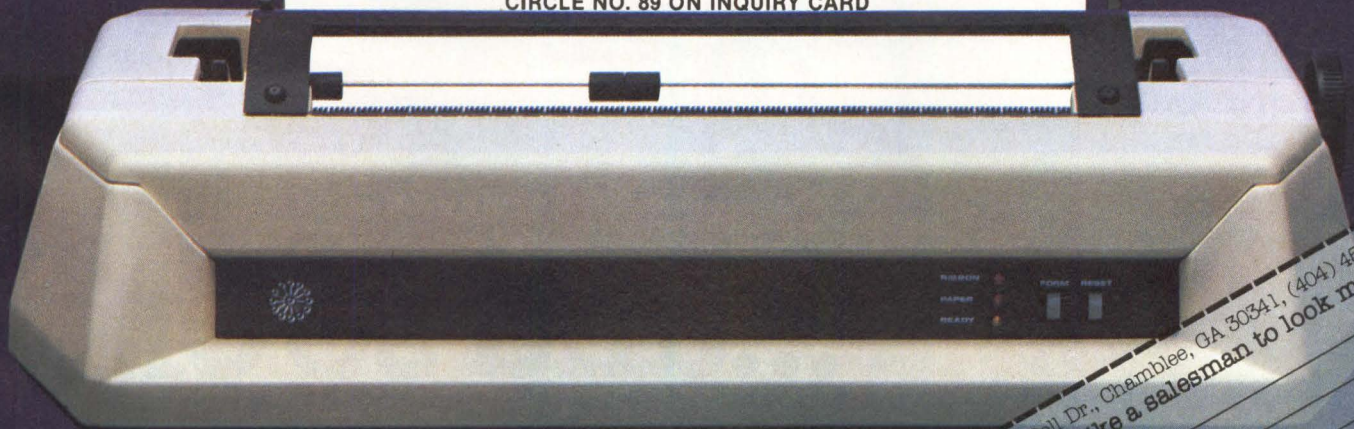

Mail to: Daisy Systems 4646 Bell Dr., Chamblee, GA 30341, (404) 451-0257
 Send info now I'd like a salesman to look me up
Name _____
Company _____
Address _____
City _____ State/Zip _____
Call 1-(800) 44 DAISY

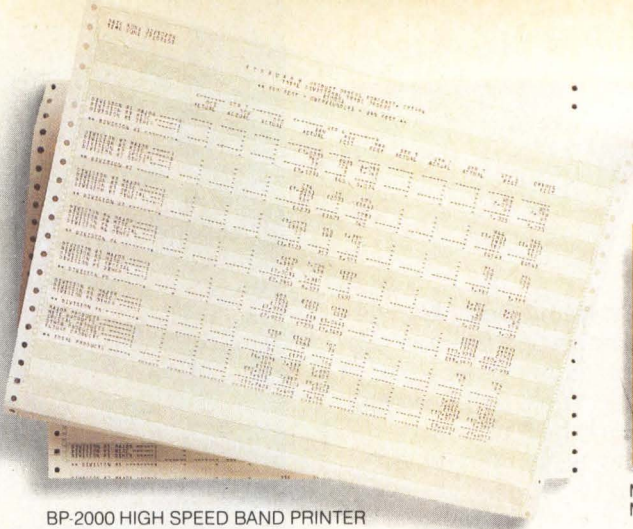

BP-2000 HIGH SPEED BAND PRINTER



M-100L MATRIX PRINTER

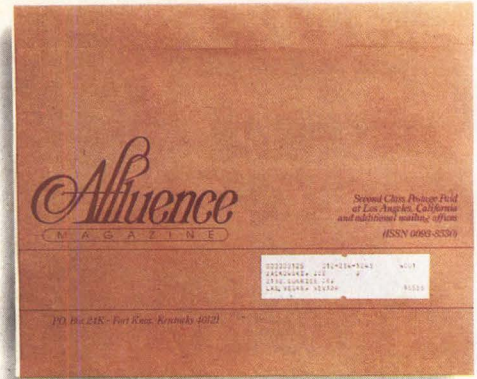

B-600 MEDIUM SPEED BAND PRINTER

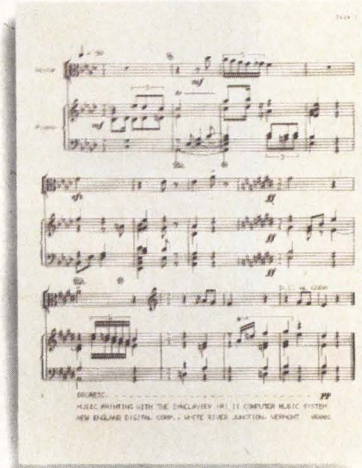

8010 MATRIX PRINTER

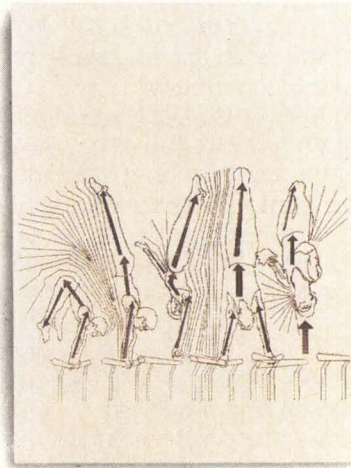

8020 MATRIX PRINTER

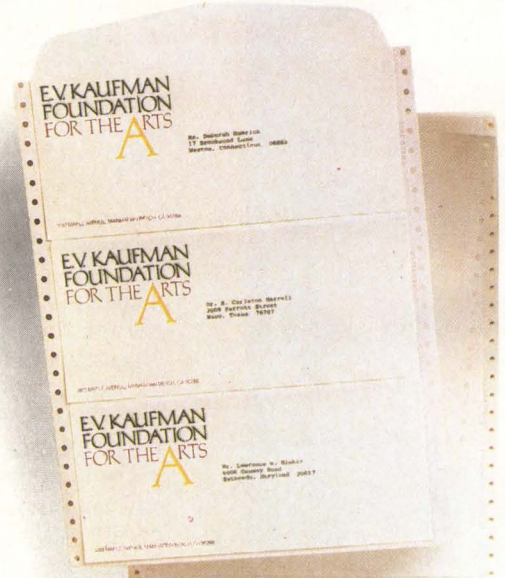

DP-55 DAISYWHEEL PRINTER

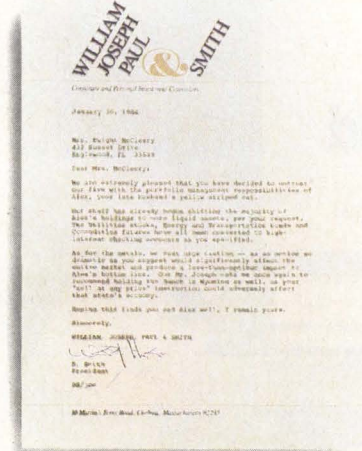

DP-35 DAISYWHEEL PRINTER



8050 MATRIX PRINTER

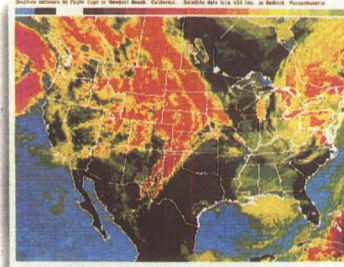

8070 MATRIX PRINTER



M-120 MATRIX PRINTER

...and so on.



Dataproducts printers. Nobody puts ideas on paper so many ways.

DATAPRODUCTS CORP., 6200 CANOGA AVE., WOODLAND HILLS, CA 91365. (818) 887-3924. IN EUROPE, 136-138 HIGH ST., EGHAM, SURREY, TW 20 9HL ENGLAND
CIRCLE NO. 90 ON INQUIRY CARD

innovation in fully-formed-character line printers came from the market leader, Centronics. The 400-lpm Linewriter 400, introduced in mid-1983, and the recently introduced 800-lpm Linewriter 800, both employ a linear, free-flight hammer technology. The use of a linear hammer—as opposed to an arcing, or pivoting, mechanism—virtually eliminates character clipping (the absence of part or all of a character). According to director of marketing Bob Barbary, linear hammers improve print quality by providing a true sandwiching between paper, ribbon and character.

Centronics is also concentrating on reliability. MTBF specs for the Linewriter 400 and 800 are 2,860 and 2,200 hours, respectively. Barbary adds that the print-

ers require no preventive maintenance. One way that manufacturers are improving reliability is via the increased use of LSI chips, which reduces the number of mechanical parts.

In lieu of technological innovations, some manufacturers of fully-formed-character line printers are concentrating on lowering prices. One example is Data-products' recently introduced BP-2000, a 2,000-lpm band printer. "The BP-2000," says product manager Gary Berthelson, "is priced in accordance with the throughput increase over the BP-1500, as opposed to pricing in accordance with market niche." IBM's 2,000-lpm printer, he adds, is priced around \$65,000; the BP-2000 costs \$30,000. Dataproducts is also working on

REVIEWING LINE PRINTER TECHNOLOGIES

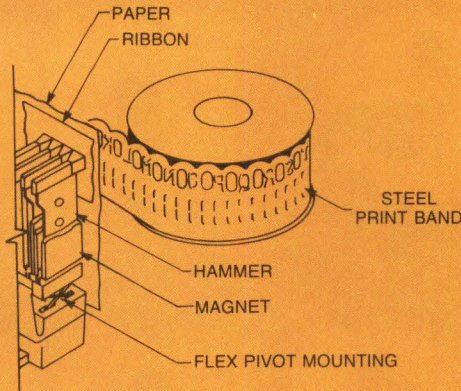

Band and belt printers employ either of two horizontally rotating devices: a steel or plastic band with embossed characters, or a belt with character slugs. As a character moves into position, a print hammer is actuated, impacting the paper against the ribbon and the character.

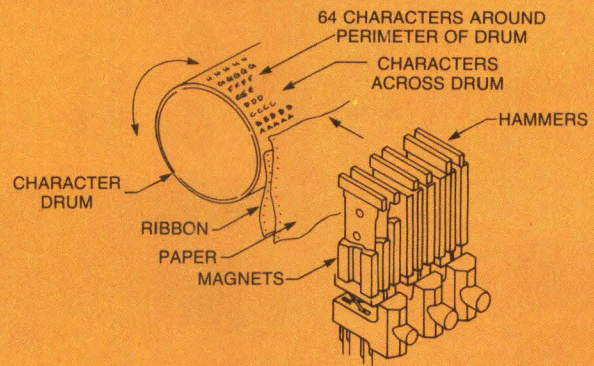

Drum printers have a complete character set for each column in a line, embossed on a cylindrical steel drum. Images are transferred to the paper when hammers strike the paper and the inked ribbon, which are sandwiched between the drum and a bank of hammers—one for each column.

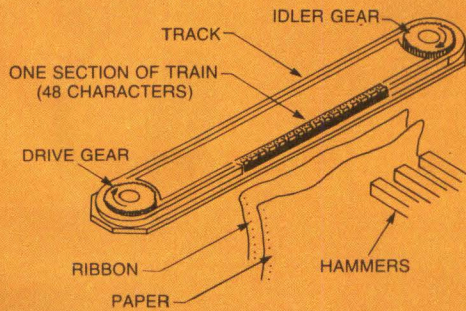

Train printers have embossed character slugs that are pushed along a horizontal track by a pair of gear drivers, past hammers that strike the paper and inked ribbon. Typically, multiple sets of characters are in the track; therefore, only a fraction of a revolution is required to set a character in front of a column.

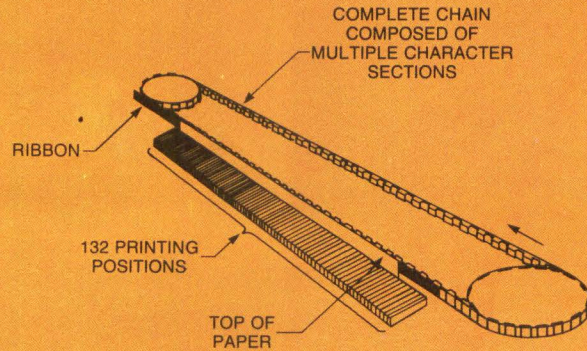

Chain printers operate on a principle similar to that of train printers, with the following differences: Slugs on a chain printer are linked together, do not slide in a track, and are driven by a sprocket wheel, rather than a drive gear.

**Our 8
customers
are no
demand
less of**

99
ers
w
ing
us.

Our 5¼" drives are now very much in demand by the same customers who keep our 8" drives at the top of the charts. Since our 8" customers include the biggest, toughest OEMs in the world, we think it's noteworthy that our existing customers have given our smaller drives such a big reception.

So big, in fact, that we now make more medium-capacity Winchester disk drives than anybody.

If you've been thinking of us as the people who make the most reliable 8" Winchesters on the market, great. But in the future, we hope you'll think less of us, as well.

5¼" drives, from 20 to 40 megabytes.
8" drives, from 10 to 85 megabytes.

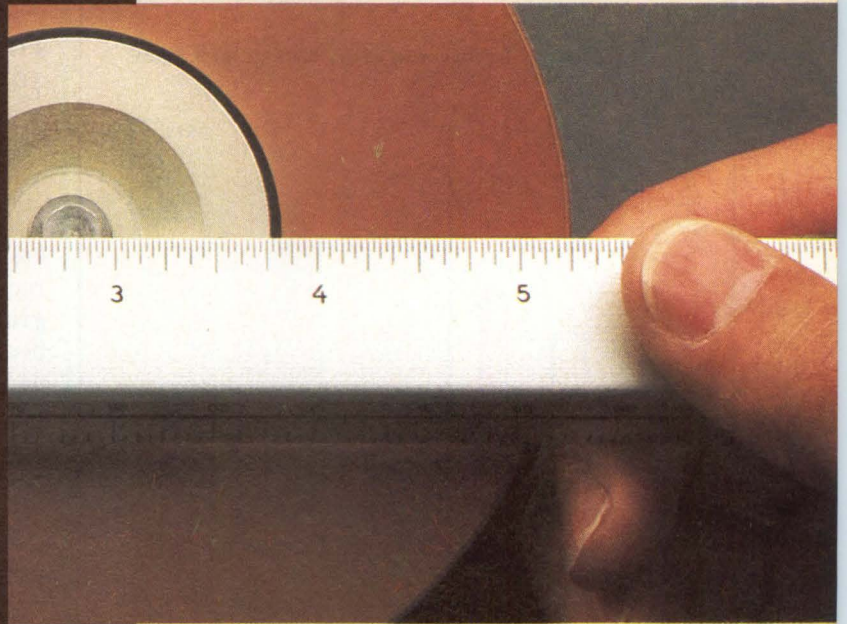

Quantum Corporation, 1804
McCarthy Boulevard, Milpitas, CA 95035,
(408) 262-1100, TWX 910-338-2203.
Eastern Regional Sales Office: Salem, NH
(603) 893-2672. Western Regional Sales
Office: Santa Clara, CA (408) 980-8555.
European Sales Office: Frankfurt, West
Germany 069-666-6167.

QUANTUM

Quantum products are distributed in the United States
by Arrow Electronics, Inc.

CIRCLE NO. 91 ON INQUIRY CARD

new print-hammer technologies to increase speed and reliability.

The line printer market is experiencing slow going at the low end because of competition from high-speed, impact and non-impact, serial-matrix units and at the high end because of competition from page printers. Yet some analysts expect the market to undergo steady—if somewhat modest—growth over the next few years. For example, Datek Information Services Inc., a Newton, Mass., consulting and publishing company specializing in printer market research, expects shipments of fully-formed-character line printers to go from 86,800 units in 1983 to 104,000 in 1986. Revenues are expected to rise from \$1.15 billion in 1983 to \$1.4 billion in 1986. Analysts agree that the greatest growth in the impact line printer market will come from impact dot-matrix units.

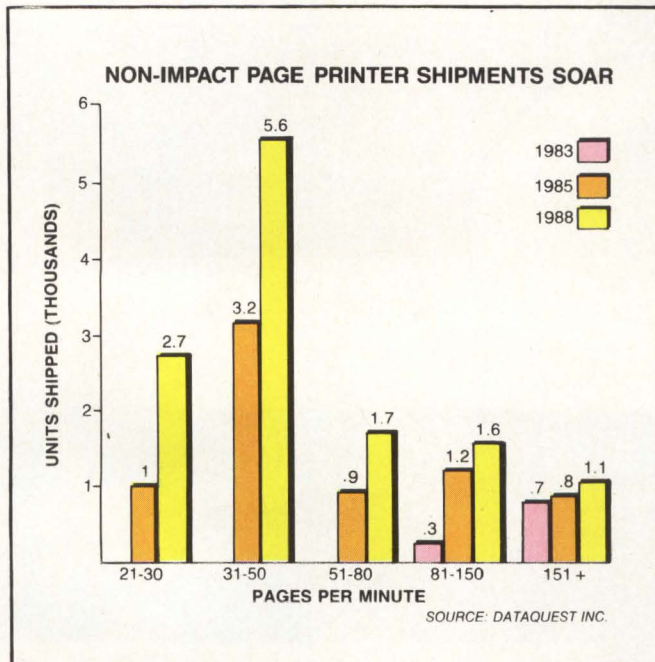

Non-impact page printers that use plain paper are expected to exhibit dramatic growth in the 21-150 pages-per-minute range between 1983 and 1988. Faster page printers are expected to exhibit modest growth.

Impact-matrix printers enter low end

Serial, dot-matrix printer speeds have been increasing rapidly in the past few years, enabling them to compete at the low end of the line printer market. This shift has given rise to dot-matrix line-printers, a classification that is often based more on speed than on line-printing technology. These new printers are entering the 300-lpm range, and some are pushing 600 and 900 lpm.

Matrix printers offer a variety of advantages over fully-formed-character line printers, including graphics and color capabilities. Line printer applications have had little need for color in the past, but graphics are becoming an increasingly desired feature. Graphics are important in applications such as forms generation, bar coding and computer aided design/computer-aided manufacturing (CAD/CAM). Expanding the need for graphics, system integrators are adding decision-support software to minicomputer-based systems.

Another advantage of impact, dot-matrix line printers is low cost. Genicom Corp., Hewlett-Packard Co., Printronix Inc., Trilog Inc. and Synergy offer 300-lpm printers for around \$5,000. Genicom, Mannesmann-Tally Inc., Printronix and Synergy offer 600-lpm units for less than \$8,000. Hewlett-Packard also boasts the fastest matrix line printer: the 900-lpm 2566A, due out this fall.

The rise in superminicomputer sales in 1983/84 spurred the market for 1,000 to 2,000-lpm line printers.

There are also drawbacks: Impact-matrix line printers do not produce fully-formed characters, and they require sophisticated software, especially for color and graphics. Also, price-to-speed ratios may be misleading because these printers can operate at various speeds, depending on the application requirements. For example, Genicom's 4410 operates at 75 lpm in correspondence-quality mode, 240 lpm in near-letter-quality mode and 300 lpm in draft mode.

Datek expects an annual growth rate of 25 percent in the dot-matrix line-printer market over the next few years, compared to about 10 percent annual growth for the total line-printer market. Sixty percent of these units will be aimed at the low-end market: around 300 lpm. Datek expects unit shipments to increase from 31,000 in 1983 to 55,000 in 1986 and revenues to grow from \$318 million in 1983 to \$515 million in 1986.

Printronix leads independent manufacturers of impact-matrix line printers, and last year strengthened its market position by acquiring Data Printer, a leading manufacturer of band and chain printers. Mannesmann-Tally, another leader in the dot-matrix field, recently announced the 660-lpm MT-660, a markedly high-speed dot-matrix unit that should challenge other manufacturers to keep pace.

The primary competition for fully-formed-character printers at the low end of the line market is the impact dot-matrix printer, but non-impact serial printers show

Tally Technology Works Great On Paper.

No other 600 LPM line printer is engineered like a Tally. So nothing else performs like a Tally. Or prints like a Tally.

- ▶ The proof's on paper.
- ▶ Everything from high volume report printing to high resolution graphics. And a quality, fully formed look for correspondence.
- ▶ All in one machine. All the result of Tally technology. Like the MT660's innovative hammer bank and linear "shuttle" system that perfectly positions every impression and prints with uniform impact.

- ▶ There's also more than enough resident intelligence and paper handling versatility to make programming shortcuts easy. For operator convenience, status reports are illuminated on a scrolling display. And it's quiet enough—at 60 dBa—to go almost unnoticed.
- ▶ Precision printing at its reliable and repeatable best. From Mannesmann Tally.
- ▶ For more information on the world's most advanced, most productive line printers call now: (206) 251-5524.

**MANNESMANN
TALLY**

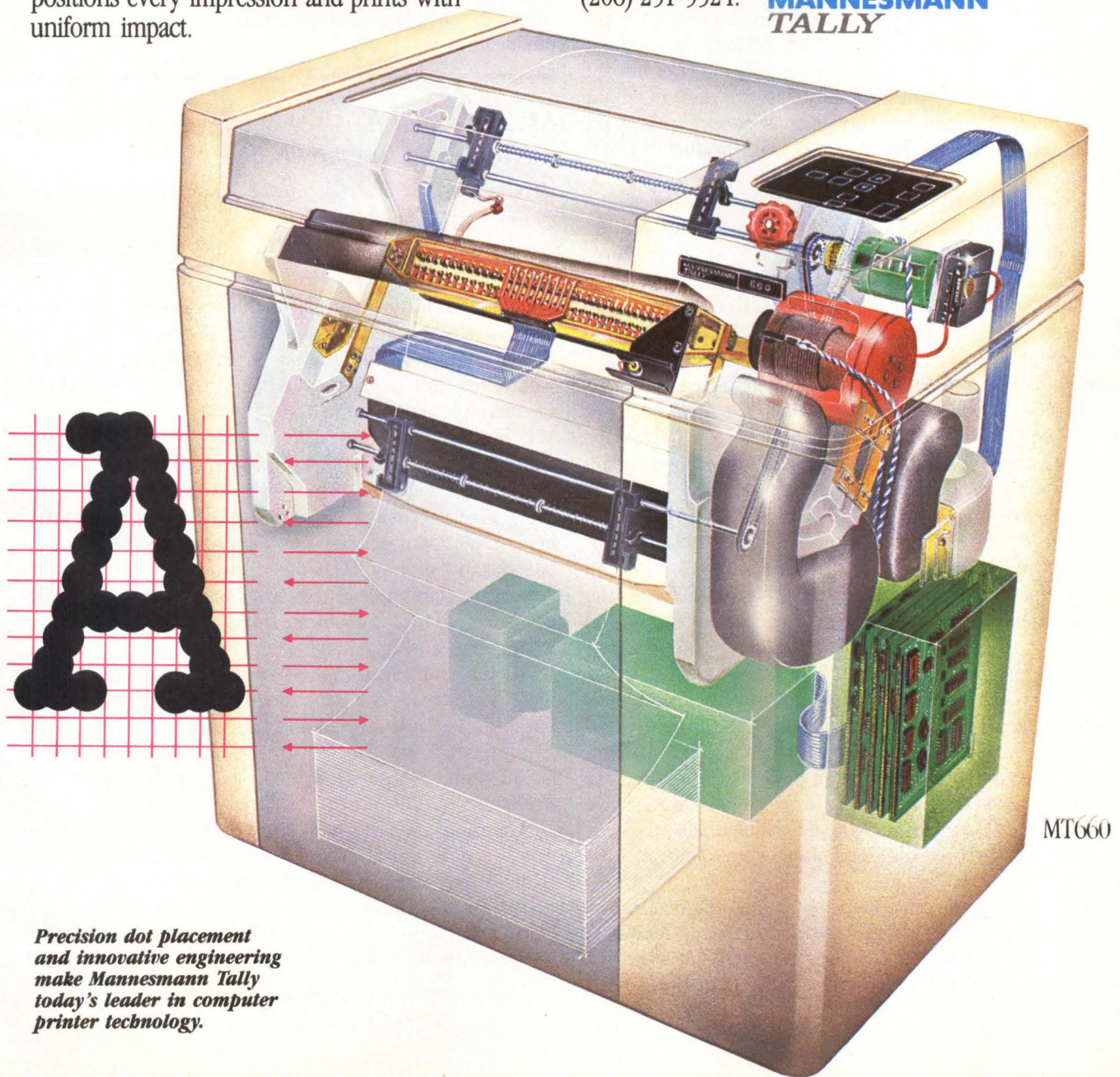

*Precision dot placement
and innovative engineering
make Mannesmann Tally
today's leader in computer
printer technology.*

promise of getting to 300 lpm within the next few years. Most analysts, including Dataquest's Dean Scott, agree that at present there are no non-impact serial technologies that compete in the line-printer arena.

Thermal or thermal transfer, electrostatic and ink-jet technologies are most often predicted to affect the line-printer market at the low end. Over-100-characters per second (cps) thermal printers are available from Alphacom Inc., B-G Instruments Inc., Computer Devices Inc. and Computer Transceiver Systems Inc. And Hewlett-Packard and Siemens Communications Systems Inc. offer over-150-cps ink-jet printers, but these speeds are far below those of line printers. Non-impact technologies are also experiencing slow acceptance because of high costs, interface problems, lack of software and relatively low reliability. In addition, they cannot simultaneously print multiple copies. "Non-impact printers will start digging into our market in about three to five years in applications where multipart forms are not required," says Dataproducts' Bertelson.

Non-impact printers have had more success at the high end of the line-printer market. These units—called page printers—use technologies such as laser xerographic and ion deposition. Page printers typically operate from 6 to 150 pages per minute (ppm).

When IBM introduced the 20,000-lpm model 3800 laser printer in 1975, many industry observers thought that this signaled the end of impact line printers. But IBM soon introduced advanced impact line printers (such as the 4245 and 4248) putting those expectations to rest. Other manufacturers have developed laser-based, line or page printers.

At the low end, Canon U.S.A. Inc.'s 8-ppm LBP-CX was one of the first to compete directly with impact printers, both serial—and to a lesser extent—low-end line printers. Introduced in 1983, the LBP-CX uses the disposable cartridge technology incorporated by Canon in the PC-10 and PC-20 copiers. Relative to line printers, one problem with the LBP-CX—as with other non-impact printers—is its low duty-cycle. Datek's director of research Jonathan Gower says, "The controversy is over application, not technology. There is not a duty-cycle equivalence between impact and non-impact printers. Low-end non-impacts have low duty-cycle capabilities." Canon officials maintain that the LBP-CX is targeted more at high-end daisywheel than at low-end line printers.

A more recent introduction in the low-end laser-printing market is Fujitsu America's desktop M3071A. The printer is targeted at OEMs and prints at either 16 or 20 ppm. A barebones unit costs \$5,620; those with options, \$8,380.

Lending credence to low-end non-impact page print-

ing—and representing a major move by an established impact line printer manufacturer—Dataproducts is working on a 24-ppm printer based on a laser diode and a selenium photoreceptor drum. The printer is to be a joint effort of Dataproducts and Toshiba Ltd. in which Toshiba will contribute its non-impact print-engine technology and manufacturing capabilities and Dataproducts will add interfaces, applications software and marketing expertise. This new product, scheduled for release at the Comdex Fall show, (Nov. 12-16, Las Vegas, Nev.) places Dataproducts in competition with non-impact laser printers from Canon and Xerox, Corp. particularly the Xerox 2700. Analysts see the move as a shortcut into the non-impact technology that is destined to cut into Dataproducts' impact line-printer business.

Matrix printers offer a variety of advantages over fully-formed-character line printers, including graphics and color capabilities.

High-end laser printers include General Optronics Corp.'s 2,600-lpm Holloscan 28, Siemens' 21,000-lpm ND3 and Xerox's 18,000-lpm 9700. These printers are well above line-printer speeds and costs. (IBM's 3800, for example, costs more than \$300,000.)

Other page-printer technologies include magneto-graphic (Cynthia Peripheral), thermal (Diablo Systems Inc.), electrostatic (Honeywell Information Systems Inc.), electroerosion (IBM) and ion deposition. A number of companies offer ion-deposition page printers based on Delphax Systems' print engine, including American Computer Hardware Corp., Anser Technology, Imagen Inc., Paradyne Corp., Renaissance Marketing Inc. and Symbolics Inc.

At this year's National Computer Conference (NCC), Delphax introduced its own ion-deposition printer based on the company's 2460 print engine and a Digital Equipment Corp. LSI-II processor. The S6000 prints at 60 ppm. End-user prices range from \$60,000 to \$70,000.

Affecting only the very high end of the line printer market, non-impact page printers are expected to jump from 5,200 units shipped in 1983 to 72,500 in 1986, according to Datek's projections. Revenues are expected to climb from \$298 million in 1983 to about \$1 billion in 1986. □

Interest Quotient (Circle One)
High 819 Medium 820 Low 821

HIGH PERFORMANCE

FULLY INSTRUMENTED DASHBOARD

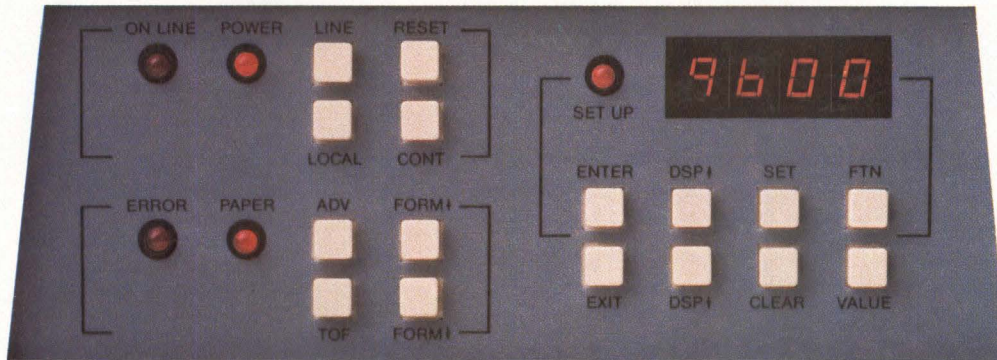

It's easy to drive a Datasouth high performance printer. Just look at the dashboard. Everything you need to know or do is right there, ready to go.

JUST TURN THE KEY

With a few simple keystrokes, you can program up to 50 different features in just seconds. Settings are retained in a non-volatile memory that keeps them safe on power-down. No other printer is more willing, in more ways, to perform the commands of its computer or its user.

WATCH THE ROAD

Every Datasouth printer has a 4-digit LED readout that displays all the features and settings that other printers leave to your imagination. So you can make changes and check settings with little more than the push of a key and the glance of an eye. With a Datasouth, it's easy to see what's going on, any time you want.

ENJOY BETTER HANDLING

Front panel controls eliminate the need for dipswitches, jumpers and other primitive devices. You manipulate all your parameters quickly, right on the front of the printer. So you can make the most of a most capable printer. You can program forms control, make fine adjustments down to 1/48" increments, select handshaking protocols and activate a variety of capabilities. Then you can watch your

Datasouth perform with the kind of high-speed precision that leaves some pretty hot competitors in the dust.

RIGHT FOR ANY DISCERNING DRIVER

Just about any computer can drive a Datasouth printer and put its foot to the floor. A Datasouth will communicate at up to 9600 baud through standard serial and parallel interfaces, with a 2K buffer.

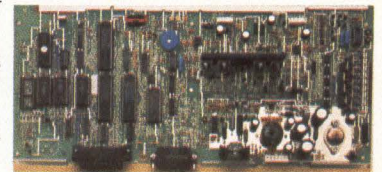

TAKE YOUR CHOICE

Datasouth reliability comes in two high performance models. The DS180 is a legendary workhorse that delivers crisp data quality printing at 180 CPS. The new multimode DS220 cruises at 220 CPS for high speed data printing and at 40 CPS for letter quality word processing. Both models print precision dot-addressable graphics.

If you have a high performance printing need, Datasouth has a high performance printer to fill it.

DRIVE ONE TO WORK TODAY

Both the DS180 and the DS220 are on display at more dealer showrooms every day, including one near you. So go take a hard look at the kind of hard copy you get from high performance Datasouth printers.

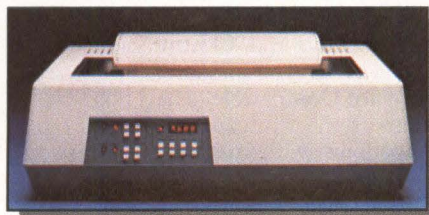

datasouth

H I G H P E R F O R M A N C E M A T R I X P R I N T E R S

Find Datasouth Printers At
Participating **ComputerLand**® Stores
And Other Fine Dealers.

AVAILABLE NATIONWIDE
THROUGH OUR NETWORK OF
SALES AND SERVICE DISTRIBUTORS
CALL TOLL FREE:
1-800-222-4528
CIRCLE NO. 93 ON INQUIRY CARD

Datasouth Computer Corporation
Box 240947 • Charlotte, NC 28224
704/523-8500 • Telex 6843018 DASOU UW

Both letter-quality and draft hard copy

Fastest document throughput in its class

Both friction and tractor paper feed

Industry standard serial and parallel interfaces.

Better, more versatile operator controls

TI reliability

Compatibility with third-party and proprietary software

Better, more durable easy-access font modules

Introducing the TI 855 microprinter. No other printer says better so many ways.

Feature for feature, no other microprinter can match the versatility, compatibility, reliability and productivity of the OMNI 800* Model 855 microprinter. Here's why.

Two Printers In One. With the TI 855 you get the speed of dot matrix draft copy. Plus the precise clarity of the most advanced matrix technology for letter-quality print. It's two printers in one — at one low price.

A Great Family Name. Texas Instruments is known for providing the world with the industry standard for printers — the TI 810. TI builds the same reliability into every 800 series microprinter. Both the 855 and the data processing Model 850 are part of the expanding TI line of high-performance, low-cost microprinters.

Hardware Compatible. The TI 855 microprinter is compatible with all major PC hardware. And it provides both serial RS232C subset and "Centronics-type" parallel as standard interfaces.

Software Compatible. The TI 855 uses industry standard escape sequences for compatibility with virtually all third-party software. And for those with proprietary software needs, a model is available with ANSI standard escape sequences.

Tough Font Modules For Quick Character Change. Three font modules can be inserted into the front of the printer at one time, and are accessed individually. Each contains both draft- and letter-quality character sets. They're easier to use, more reliable and more durable than traditional metal or plastic daisy wheels.

More Productivity Than Any Other Microprinter. The 855 offers both friction and tractor paper feed, to handle all types of word and data processing applications. A quick-change snap-in cartridge ribbon. Raster and mosaic graphics. And intelligent printing which maximizes document throughput — regardless of format.

Get the printer that makes for better information systems. For more information visit your nearest TI authorized dealer or write Texas Instruments Incorporated, P.O. Box 402430, Dept. DPF-00000, Dallas, TX 75240. Or call toll-free: 1-800-527-3500.



TEXAS INSTRUMENTS

Creating useful products and services for you.

291380-R

IMPACT LINE PRINTERS

Company Model	Print method	Print speed	Characters/line	Forms width (inches)	Interfaces (protocols)	Price (\$)	Notes, features, options	Circle no.
BURROUGHS CORP.								
Burroughs Pl. Detroit, MI 48232 (313) 972-7000								
B9246-6, 12/13, 20	band, train	650, 1250, 2000	132			14,700; 42,500; 69,300		775
B9249-375	chain	375/500	132			14,700		
CENTRONICS DATA COMPUTER CORP.								
1 Wall St. Hudson, NH 03051 (603) 883-0111								
E-Series Model I, II, III	band	1130, 1440, 1800	48-128	4-16	Dataproducts		towel ribbon; opt. acoustic cabinet, noise level less than 60 dBa	776
Linewriter 400, 800	band	400, 800	48-128	4-18	RS232C, RS422, RS423, Dataproducts, Centronics (19.2K bps, X-on/X-off, DTR, ETX/ACK)	4,885; 6,595 (in small OEM quantities)	block graphics; opt. 62 or 55 dBa acoustic cabinets	
CYNTHIA PERIPHERALS CORP. (A BULL PERIPHERIQUE COMPANY)								
766 San Aleso Ave. Sunnyvale, CA 94086 (408) 745-0855								
PR1200, 1500	band	1200, 1500	136	4-19	Dataproducts	16,000; 18,000	self-test, re-inking ribbon, static eliminator; opt. paper stacker, acoustical cabinet	777
DATA PRINTER CORP. (Subsidiary of Printronix)								
99 Middlesex St. Malden, MA 02148 (617) 321-2400								
1200, 1210, 1260	chain	1200, 1000, 600	132	3.5-17.5	Dataprinter, Dataproducts, Centronics, RS232C, CDC	19,390; 16,673; 11,210	8- or 12-channel VFU, self-test diagnostics, four forms tractors, "quietized" cabinet	
DP600, 750, 1000, 1200	band	600, 750, 1000, 1200	132	3.5-17.5	Dataprinter, Dataproducts, Centronics, RS232C, CDC	9,385; 7,855; 10,875; 13,350	8- or 12-channel VFU, self-test diagnostics, universal power supply, EVFU, DAVFU, "quietized" cabinet; 1000 and 1200 include paper pullers	
3101, 3121	band	1000, 1200	132			10,875; 13,350		
3601, 3751	band	600, 750	132			7,855; 9,385		
BT1500	band	1500	132			19,500		
DATAPPOINT CORP.								
9725 Datapoint Dr. San Antonio, TX 78284 (512) 699-7000								
9257, 9258	band	300, 600	132	4-16	serial, parallel	8,500(Q1), 7,225(Q100); 11,950(Q1), 10,150(Q100)	pedestal cabinet; opt. acoustic cabinet	779
DATAPRODUCTS CORP.								
6200 Canoga Ave. Woodland Hills, CA 91365 (818) 887-3924								
B-300, 600, 1000	band	300, 600, 1000	132, 136	3-16	Dataproducts, RS232C, Centronics (19.2K bps, X-on/X- off, ETX/ACK, ACK/NAK, DTR)	6,800; 8,600; 12,800	self-test, diagnostic status display, static elim- inator; opt. 60 dBa acoustic cabinet, universal power supply, Dataproducts parallel interface	780
BP-1500, 2000	band	1500, 2000	132, 136	3.5-18.75	Dataproducts, RS232C, current loop (19.2K bps)	23,000; 30,000	universal power supply, four forms tractors, vertical format unit, self-test, diagnostic status display	
DECISION DATA COMPUTER CORP.								
100 Witmer Rd. Horsham, PA 19044 (215) 674-3300								
6610, 6665, 6680	drum	1000, 650, 800	132			17,600; 13,600; 15,200	power paper puller, sound-proof cabinet	781

IMPACT LINE PRINTERS

Company Model	Print method	Print speed	Characters/line	Forms width (inches)	Interfaces (protocols)	Price (\$)	Notes, features, options	Circle no.
6703-25	impact matrix	300	132			6,188	coarse/fine, vertical/horizontal adjustment	
6807, 6811, 6814	band	700, 1100, 1400	132			12,100; 17,000; 23,000	vertical/horizontal adjustment, forms motion sensor, front/rear operation panel	
DIGITAL EQUIPMENT CORP. 146 Main St. Maynard, MA 01654 (617) 897-5111								782
LP 25, 26, 27	band	215-1200	132, 196	3-16				
FUJITSU AMERICA INC. 3055 Orchard Dr. San Jose, CA 95134 (408) 946-8777								783
M304X Series	band	300, 600, 900, 1200	132, 136	3-17	RS232C, Centronics, Dataproducts (150-9.6K bps)		built-in acoustic cabinet; opt. power stacker, custom interface	
GENERAL BUSINESS TECHNOLOGY INC. 1891 McGaw Ave. Irvine, CA 92714 (714) 261-1891								784
3220LP, 3230LP, 3240LP	band	720, 1130, 1440	132, 198	4-16.75	IBM S/34, S/36, S/38	11,500; 16,995; 19,995	self-test, acoustic cabinet; opt. line counter, power paper stacker	
GENICOM CORP. One General Electric Drive Waynesboro, VA 22980 (703) 949-1170								785
310, 340, 510	belt	240, 340, 425	132	3-15	Centronics; opt. RS232C, current loop (9.6K bps, X-on/X-off)	4,170(Q1), 3,336(Q100); 4,835(Q1); 3,868(Q100); 6,080(Q1), 4,864(Q100)	opt. dual sheet feeder	
4410	impact matrix	75, 240, 300	132, 158, 175	3-16.54	RS232C, RS449, Centronics, Dataproducts, current loop (19.2K bps, X-on/X-off)	5,500(Q1); 4,400(Q100)	bit-mapped mosaic graphics, 12-channel VFU, 20-ips paper slew, dual tractors	
4440	impact matrix	150, 465, 600	132, 158, 175, programmable	3-16.54	RS232C, RS449, Centronics, Dataproducts, current loop (19.2K bps, X-on/X-off)	7,500(Q1); 6,000(Q100)	bit-mapped mosaic graphics, 12-channel VFU, 20-ips paper slew, dual tractors	
HARRIS CORP. COMPUTER SYSTEMS DIV. 2101 W. Cypress Creek Rd. Ft. Lauderdale, FL 33309-1892 (305) 974-1700								786
4240	chain	1000	132, 136	3.5-19.5		29,900	controller, EVFU, electronic paper width adjustment	
4250, 4260	chain	730, 1200	132, 136	3.5-19.5		30,900; 39,900	controller, EVFU, electronic paper width adjustment	
4270	chain	900	132, 136	3.5-19.5		40,900	controller, EVFU, electronic paper width adjustment	
4326, 4336, 4356	band	300, 600, 1200	132	3-16		11,900; 16,900; 28,900	controller, EVFU, dual bands, dual speed	
HONEYWELL INFORMATION SYSTEMS INC. 200 Smith St. Waltham, MA 02154 (617) 895-6000								787
9619/9620	belt	900, 1200	136	4-19	RS232C, Honeywell OAS, DPS6	26,000; 33,000		
9626/9627	band	300, 600	132, 136	3-15	RS232C, Honeywell OAS, DPS6	11,500; 14,450		

HIGH PRINTING QUALITY

VS.

TOTAL FORMAT FLEXIBILITY

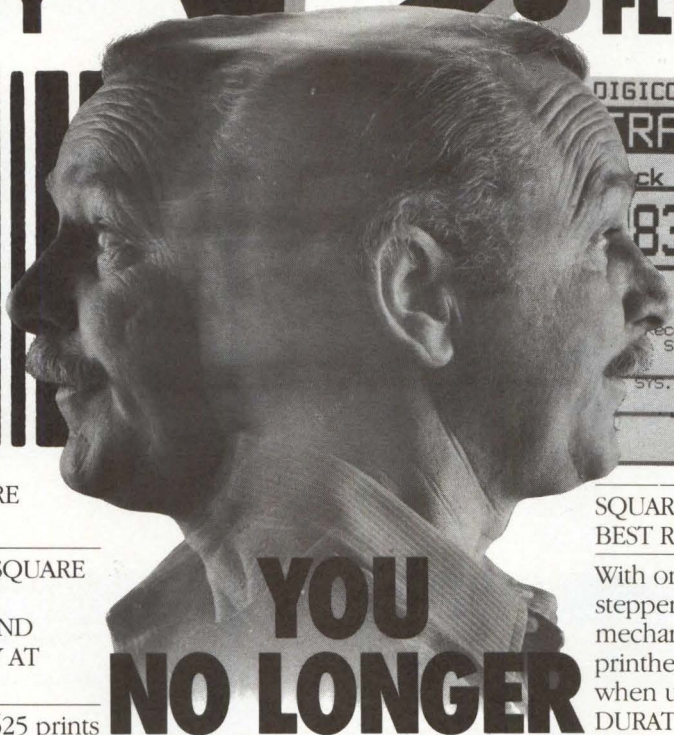

INTERMEC introduces SQUARE MATRIX label printing.

WITH THE NEW INTERMEC SQUARE MATRIX PRINTER YOU GET SUPERIOR PRINT QUALITY AND TOTAL FORMAT FLEXIBILITY AT DOT MATRIX PRICES.

The new SQUARE MATRIX 8625 prints bar code and human readable text from a series of tight fitting squares. These squares virtually eliminate the gaps, ragged edges and grayness so common to dot matrix printing. Since the 8625 SQUARE MATRIX is a thermal printer, variations in image density are eliminated giving you superior printing quality with every label. The result: The SQUARE MATRIX 8625 gives you bar code labels with optimum scanning performance plus maximum print format flexibility.

ONE UNLIMITED FORMAT, SQUARE MATRIX 8625 DOES THE WORK OF 10 PRINTERS.

The 8625 gives you the ability to print multiple bar codes in up to 10 different formats: two are pre-programmed and eight are user programmable.

SQUARE MATRIX 8625 PRINTS ANYTHING, ANYWHERE, ANY SIZE.

Print any height label up to 3 1/4" high. Bar code height can vary up to the full height of the label. Three different text fonts, special graphics, lines, boxes and logos can be printed in any direction or magnification any place on the label.

For Literature, Circle Number 193.

For Demonstration, Circle Number 194.

YOU NO LONGER HAVE TO CHOOSE.

SQUARE MATRIX 8625 PRINTS THE MAJOR BAR CODES.

CODE 39, CODE 93, Interleaved 2 of 5, 2 of 5, CODE 11, and Codabar, all with high density capability, are pre-programmed within the 8625. Even UPC/EAN is printed in most popular densities.

USER FRIENDLY PROMPTING MAKES SQUARE MATRIX LABEL FORMATS EASY TO DEVELOP.

Anybody can do it. Just plug it in and the user friendly prompting menu allows even untrained personnel to design custom formats quickly. Using standard interfaces, the 8625 operates with most mini computers and CRT terminals.

THE SQUARE MATRIX 8625 PRINTS LABELS ON DEMAND.

The 8625 delivers single labels as needed or in batches in straight through or spooled form with no paper waste.

SQUARE MATRIX PRINTERS OFFER BEST RELIABILITY.

With only one active moving part, a stepper motor, the 8625 eliminates mechanical trouble spots. The 8625's printhead is warranted up to five years when using INTERMEC's quality DURATHERM™ label stock.

SMALL SIZE, SMALL PRICE, UNLIMITED FLEXIBILITY AND QUALITY MAKE SQUARE MATRIX THE LOGICAL CHOICE.

The compact 8625 takes very little space at a work station and even less from your budget. To find out more, contact INTERMEC Corporation, 4405 Russell Road, P.O. Box 360602, Lynnwood, WA 98036-9702. Call 206/743-7036. TELEX: U.S. 152447, Int'l (ITT) 4740080.

 **INTERMEC®**

The industrial bar code experts.



IMPACT LINE PRINTERS

Company Model	Print method	Print speed	Characters/line	Forms width (inches)	Interfaces (protocols)	Price (\$)	Notes, features, options	Circle no.
HEWLETT-PACKARD CO. (BOISE DIV.) 11311 Chinden Blvd. P.O. Box 15 Boise, ID 83707 (208) 323-6000								788
HP2563A	impact matrix	300	66, 132, 220	3-16.7	RS232C, RS422, HP-IB, HP Multipoint, Centronics, Dataproducts (300-19.2K bps, X-on/X-off, ETX/ACK, ENQ/ACK)	5,700(Q1); 3,876(Q100)	raster graphics, programmable 16-channel VFC, self-test; opt. cabinet, stand, sound cover, passive stacker	
HP2565A	impact matrix	600	66, 132, 220	3-18	RS232C, RS422A, HP-IB, Centronics, parallel (300-19.2K bps, X-on/X-off, ETX/ACK, ENQ/ACK)	18,500(Q1); 12,025(Q100)	raster graphics, programmable 16-channel VFC, self-test; opt. bar codes, passive paper stacker	
HP2566A	impact matrix	900	66, 132, 220	3-18	RS232C, RS422A, HP-IB, Centronics, parallel (300-19.2K bps, X-on/X-off, ETX/ACK, ENQ/ACK)	21,500(Q1); 13,975(Q100)	raster graphics, programmable 16-channel VFC, self-test; opt. bar codes, passive paper stacker	
ITT COURIER TERMINAL SYSTEMS INC. 1515 W. 14th St. Tempe, AZ 82581 (602) 894-7000								789
6260, 6230	band	600, 300	132	15.5-22	Centronics parallel (up to 1.5M bps)	13,550; 11,350	self-test diagnostics, LED indicator	
9341, 9342	band	300, 600	132	15.5-22	Centronics parallel (up to 1.5M bps)	11,350; 13,550	self-test diagnostics, LED indicator	
MANNESMAN TALLY INC. 8301 S. 180th St. Kent, WA 98032 (206) 251-5500								790
MT-660	impact matrix	660	66, 132, 198	4-16	Dataproducts, Centronics; opt. RS232C, RS422, current loop (4.8-150K bps)	7,995	plot mode graphics, self-test, 60 dBA noise level; opt. block characters, static eliminator, universal power supply	
MILTOPE CORP. 1770 Walt Whitman Rd. Melville, NY 11747 (516) 420-0200								791
HSP 3609-212A	impact matrix	600	80, 132	9.325	RS232C, parallel, MIL-STD-188C, Rolm, Norden, Honeywell, IBM, NTDS (9600 bps)	20,000	meets military specs; line addressable graphics	
LP 3036	impact matrix	300	36, 60	4.25	RS232C, parallel, MIL-STD-188C, Rolm, Norden, Honeywell, IBM, NTDS (9600 bps)	7,500	meets military specs	
PRINTER SYSTEMS CORP. 9055 Comprint Ct. Suite 200 Gaithersburg, MD 20877 (301) 258-5060								792
B-300, B-600	band	300, 600	132	3-16	RS232C, Centronics, Dataproducts (50-19.2K bps)		int'l character sets available; opt. pedestal and paper shelf	
B-1000, B-1500	band	1025, 1500	80, 132	3-16	RS232C, Centronics, Dataproducts (50-19.2K bps)		opt. tape controller and/or direct access 12-channel VFU	
PRINTRONIX INC. 17500 Cartwright Rd. P.O. Box 19559 Irvine, CA 92713 (714) 863-1900								793
DataPrinter 1200 Series	drum	600-1200	132	3.5-19.5	parallel, serial, TTL, DPC S-1003 Universal (X-on/X-off, ETX/ACK)	11,210-19,390	12-channel VFU, forms-length selector, static eliminator, parity check, acoustic cabinet, I/O interface, paper puller	
DataPrinter 3000 Series	band	600-1200	132	3.5-17.5	RS232C, DataPrinter, Dataproducts, Centronics, Control Data (X-on/X-off, ETX/ACK)	7,855-13,350	EVFU, acoustic cabinet, forms-length selector, parity check	

Although our HERMES 615 multi-mode printer comes in a plain black and white casing it prints text and graphics beautifully in 8 colors.

Pencils may draw in colors, but they are slow, inaccurate and their points keep breaking. Professionals choose the HERMES 615 color printer: it produces text and graphics in black, red, blue, yellow and in green, orange, violet and brown too with no rainbow fringes. Much better than this pale offset copy.

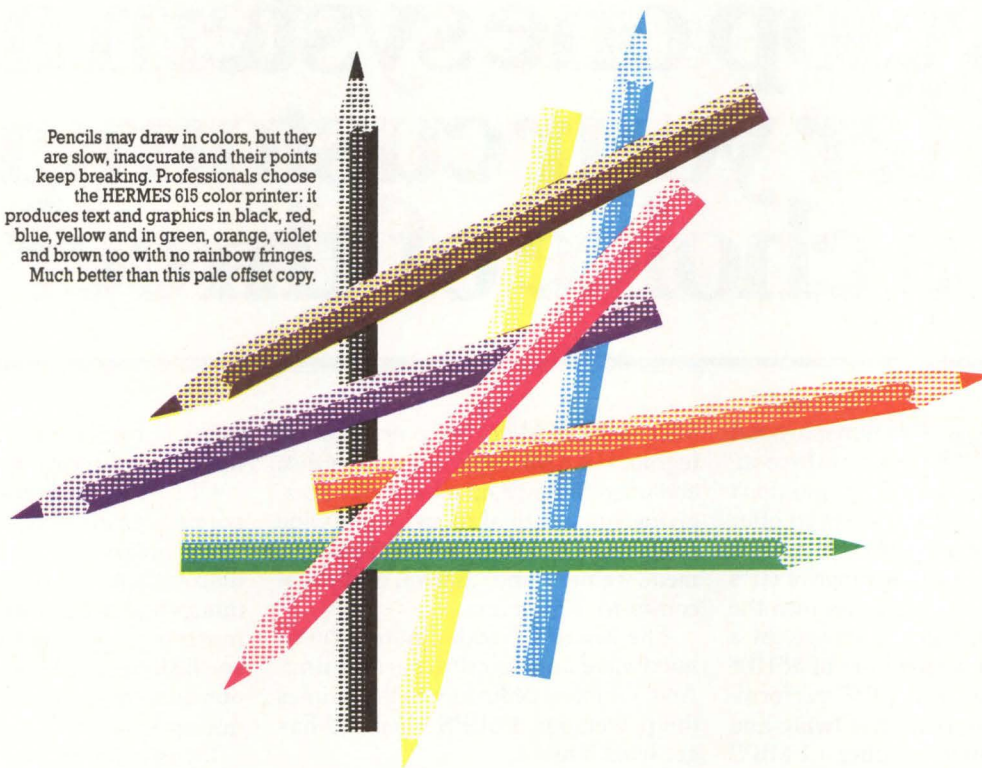

Printing and graphics in 8 colors are just two of the numerous outstanding features of the HERMES 615. Professionals who only pick the best will also appreciate:

Its speed. Bi-directional, shortest path printing. 400/480 cps Data, 100/120 cps Near Letter Quality (single pass).

Its resolution. Finest print quality available on a matrix printer. So good you can even print signatures. Bit mapped graphics in single and double density modes, 6 dot densities in each mode. A circle on the screen means a circle on the paper too!

Its quality. Swiss high quality construction. Quality that lasts - thanks to its exclusive «moving-ruby» head.

Its versatility. Wide range of attractive characters sets in 16 national versions, as well as math symbols, bar codes and Teletex. Dual ports, parallel (Centronics™/Epson™ compatible) and serial (RS-232C/RS-422) interfaces. DIABLO™ 630 emulation optional.



HERMES®

The impressive printers

Made by HERMES PRECISA INTERNATIONAL, CH-1401 Yverdon

HERMES distributors:

ME, NH, VT, CT, MA, RI:	S & S Electronics, Inc.,	(617) 458 4100
TX, AR, OK, LA:	US DATA Associates, Inc.,	(214) 680 9700
MD, DE, VA, DC, PA, S.NJ:	MESA TECHNOLOGY Corp.,	(301) 948 4350
NY State, NY City, N.NJ:	TMA LOGON,	(201) 646 9222
Upstate NY:	NACO ELECTRONICS Corp.,	(315) 699 2651
MI, OH, KY, WV, W.PA:	LOWRY and Associates, Inc.,	(313) 229 7200
FL, GA, TN, AL, MS, NC, SC:	GENTRY ASSOCIATES, Inc.,	(305) 889 7450
CO, UT, ID, MT, NM, AZ:	PAR Associates,	(303) 371 4140

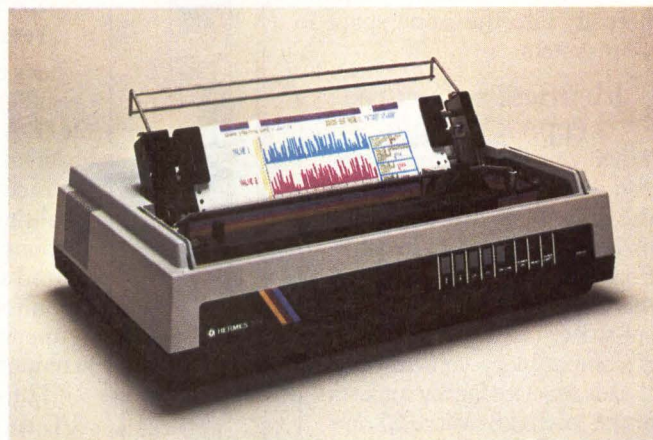

Troquet Adverteam

To receive a sample of the finest quality matrix print-out and additional information on the HERMES 615 please return the coupon below.

I want to know more about your printers.

Name _____ Title _____
 Company _____
 Street _____ City _____
 State _____ Zip _____ Phone () _____

Send to: HERMES PRODUCTS, Inc.
 Printer Division
 1900 Lower Road, LINDEN, NJ 07036, (201) 574 0300

CIRCLE NO. 94 ON INQUIRY CARD

How can you develop one system and offer your customers a choice of three?

Simple. Develop it around HP's new three-in-one microsystem. That way, you don't have to redesign your system to offer your customers a range of performance. Because the entire power range of HP's new A-Series computers fits into the same small, convenient package. At a slimmed-down starting price of \$6110*

So you can offer 1 MIPS performance. Or floating point hardware and microprogramming in either a 1 MIPS or 3 MIPS computer. Whichever one your customer chooses, you can fit it easily into the same space in your system.

Identical software keeps it simple.

When you change processors, you don't have to go back to the drawing board with your programs. Because, in addition to compatible hardware, these computers run identical software. That's the best kind of compatibility you can buy.

Our A-Series family consists of the Micro 26, Micro 27 and

Micro 29. The Micro 26 comes with integrated 14.6 Mb mini-Winchester disc and microfloppy. And it has 8 I/O slots, giving you plenty of room for our wide selection of I/O cards for instruments, measurement and control, and data-comm, to name a few.

The Micro 27 adds floating point hardware and microprogramming. And, for jobs needing up to three times the power, our 3 MIPS Micro 29 has got what it takes.

Our brand new operating system really performs.

That's one secret of our success. The new, full-function RTE-A real-time operating system provides the performance you need for your real-time automation applications. Ranging from dedicated machine control to monitoring instruments to supervising a network of computers.

This power, speed and I/O capacity also make our

A-Series systems ideal for multi-user, multi-tasking environments.

Of course, these compact new computers are part of our newly expanded OEM program. This includes higher discounts and credits, extended warranties and free training. So you'll make more when you get to market. And you'll also get there faster with our new operating system and newly packaged microsystems.

If you'd like micro, mini or maxi performance in one micro package, call your local HP sales office listed in the white pages of your phone book. Ask for a technical computer representative. Or write for more information to: Hewlett-Packard, Attn. Greg Gillen, Dept. 08171, 11000 Wolfe Road, Cupertino, CA 95014. In Europe, write to Henk van Lammeren, Hewlett-Packard, Dept. 08171, P.O. Box 529, 1180 AM Amstelveen, The Netherlands.

*A600+ microsystem component, 128Kb memory, box, Winchester disc.

Prices are U.S.A. list in OEM quantities of 100 and include integrated peripherals, one interface card, RTE-A and 512Kb of memory for Micro 26 and Micro 27. Micro 29 includes 768Kb of memory.

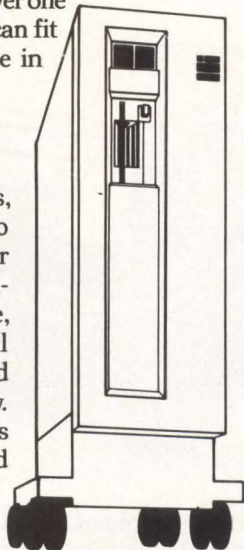

Our new microsystems also come in this floor-mount or bench-top models.

 **HEWLETT
PACKARD**

Micro:

1 MIPS for
\$7445

Maxi:

3 MIPS, plus floating
point hardware and
microprogramming, for
\$16,650

Mini:

1 MIPS, plus floating
point hardware and
microprogramming, for
\$13,140



Whatever the level of performance you pick, it fits in this little 7" x 19" x 25.5" package.

FACIT



PRINTERS

There is a Facit Printer to satisfy virtually all printout requirements. From putting your Personal Computer on low cost printing terms, to the most professional heavy duty application with printers that put four-colour dots anywhere on paper.

Facit Matrix Printers, Daisy Wheel Printers and Graphic Flexhammer Printers offer intelligent solutions to any of your printing problems.

Just state your printing speed, print width, single sheet, fanfold or paper roll handling, letter quality, font and graphic print demands and Facit Printers will handle the rest.

So when comparing printers, think professionally. Contact Facit – we'll introduce you to a whole family of Quality Printers.

FACIT

Head office: P.O. Box 54, S-172 22 Sundbyberg, Sweden. Phone: (8) 28 27 20.
USA: 235 Main Dunstable Road, P.O. Box 828, Nashua, N.H. 03061.
Phone: (603) 883-4157.

CIRCLE NO. 96 ON INQUIRY CARD

IMPACT LINE PRINTERS

Company Model	Print method	Print speed	Characters/line	Forms width (inches)	Interfaces (protocols)	Price (\$)	Notes/features/options	Circle no.
P300, P300XQ	impact matrix	300, 400	132	3-16	Centronics, Dataproducts, RS232C, current loop (X-on/X-off, ETX/ACK, DTR)	5,400; 6,450	bar codes, business graphics, double-high chars.; opt. multi-mode capability, intelligent graphics	
P600, P600XQ	impact matrix	600, 800	132	3-16	Centronics, Dataproducts, RS232C, current loop (X-on/X-off, ETX/ACK, DTR)	7,500; 8,550	bar codes, business graphics, double-high chars.; opt. multi-mode capability, intelligent graphics	
RACAL-MILGO INC. COMPUTER PRODUCTS DIV.								794
6250 N.W. 27th Way Ft. Lauderdale, FL 33309 (305) 979-4000								
4295	impact matrix	300	132	4-15.8	Centronics (IBM, Bell 8AI, Univac)	3,599	self-test, 2 buffers, bidirectional printing	
SOUTHERN SYSTEMS INC.								795
2841 Cypress Creek Rd. Ft. Lauderdale, FL 33309 (305) 979-1000								
BP1500, BP2000	band	1500, 2000	132	3.5-18.75	serial, parallel, DEC, DG, Perkin-Elmer, TI, HP, Prime, Gould, IBM, Burroughs (up to 19.2K bps, X-on/X-off, ENQ/ACK)	18,000 (BP2000)		
QT 300, 600, 1000, 1200	band	300, 600, 1000, 1200	132	4-16.75	serial, parallel (up to 19.2K bps, IBM 2780/3780, Univac MTR, Honeywell VIP 7700)	7,000; 10,000; 15,000; 17,000	IBM compatible, bar codes, bit-mapped graphics, quiet cabinet	
STORAGE TECHNOLOGY CORP. (DOCUMENTATION)								796
2270 S. 88th St. Louisville, CO 80028 (303) 673-4066								
impact 3000	band	3000	132	18.75			automated elevator stacker, line counter, VFU, DAVFU	
Univ. 1000	band	1600	132	18.75	Dataproducts	13,775	automated elevator stacker, line counter, VFU, DAVFU	
SYNERGY PRINTER SYSTEMS INC.								797
4020 Fabian Way Palo Alto, CA 94303 (415) 493-8181								
CB1200, 1800	band	1200, 1800	132, 136	4-16.75	Dataproducts, Centronics, RS232C, HP-IB (19.2K bps, X-on/X-off, ETX/ACK, ENQ/ACK, IBM 2780/3780, Burroughs)	16,950(Q1), 12,950(Q100); 21,950(Q1), 16,950(Q100)	12-channel DVFU, acoustic cabinet; DEC, Wang, IBM, DG, HP compatible	
LW400, 800	band	400, 800	132, 136, 198, 204	4-15	Dataproducts, Centronics, RS232C, HP-IB (19.2K bps, X-on/X-off, ETX/ACK, ENQ/ACK, IBM 2780/3780, Burroughs)	5,950(Q1), 4,495(Q100); 7,950(Q1), 5,995(Q100)	12-channel DVFU, acoustic cabinet; DEC, Wang, IBM, DG, HP compatible	
C1300, 1600	impact matrix	300, 600	136, 160, 182, 227	3.5-16	RS232C, Centronics, DPC (19.2K bps, X-on/X-off, ETX/ACK, ENQ/ACK, IBM 2780/3780, Burroughs)	4,495(Q1), 3,495(Q100); 5,995(Q1), 4,695(Q100)	12-channel DFVU, bit-mapped graphics, bar codes; DEC, Wang, IBM, DG, HP compatible	
TELETYPE CORP.								798
5555 Touhy Ave. Skokie, IL 60077 (312) 982-2000								
40	belt	300	80, 132			3,262	input buffer	
4540	belt	300	80, 132			5,595	input buffer	
T-300	belt	300	132		serial, parallel	4,400	self diagnostics	

IMPACT LINE PRINTERS

Company Model	Print method	Print speed	Characters/line	Forms width (inches)	Interfaces (protocols)	Price (\$)	Notes, features, options	Circle no.
TRILOG INC.								
17391 Murphy Ave. Irvine, CA 92714 (714) 863-3033								
C60 Colorplot	impact matrix	300	132, 220	4-16	Centronics, Dataproducts; opt. RS232C (110-9600 bps, X-on/X-off)	11,500	256-color printing, bit-mapped graphics	799
TIP 150, 300, 301	impact matrix	38-150; 78-300	132, 178, 200	4-16	RS232C, Centronics; opt. Dataproducts (110-19.2K bps, X-on/X-off, DTR)	3,900; 4,900; 5,900	static eliminator, compressed printing; opt. bar codes and bit-mapped graphics	
TIP 302 Colorplot II	impact matrix	78-300	132, 178, 220	4-16	RS232C, Centronics; opt. Dataproducts (110-19.2K bps, X-on/X-off)	6,900	256-color printing, bit-mapped graphics, nonstop printing	
WANG LABORATORIES INC.								
1 Industrial Ave. Lowell, MA 01851 (617) 459-5000								
5573, 5574, 5575	band	300, 600, 1100	132	16	proprietary	9,500; 13,250; 29,500	tractor feed, interchangeable bands, remote model available	800

Printer sharing systems for multiple computers and printers.

Add MultiSpool - the hardware spooler that's truly flexible.

Now, thanks to MultiSpool, there's no more need to buy individual spoolers, no more wasted computer time or memory. With its enormous memory-sharing power, this dynamic six-port switching device not only lets you network any combination of computers and printers; it also provides the spooling function within that network.

With its 60K of buffer memory, controlled by 4K of memory management firmware, MultiSpool can orchestrate up to five computers or



five printers simultaneously. Only this degree of flexibility can meet the ever-changing port-expansion needs of today's multiuser environment.

Note, too, that MultiSpool mixes four serial and two Centronics-compatible ports. It also handles X-on, X-off protocols and DTR. So, with the unit's dipswitch, you can configure each port to accommodate either a computer or printer; and you can define the discipline of that port.

Best of all, MultiSpool sells for just \$1,295 - even less if you don't need all six ports. And that, we're sure, is music to your ears.

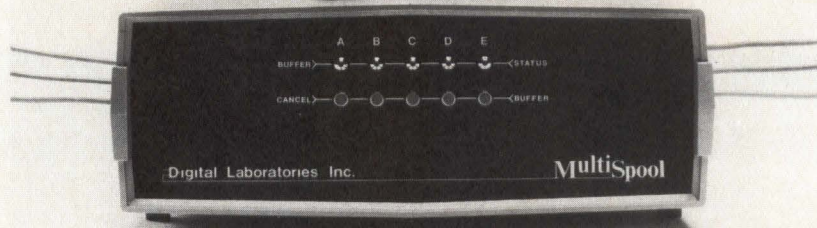

Digital Laboratories Inc.

600 Pleasant Street, Watertown, MA 02172. (617) 924-1680

Shrinking, Soldering, De-soldering and Thermoplastic welding

*from 20-600°C with adjustable
Leister-Hot-Air Tools.*

De-soldering of a CB.

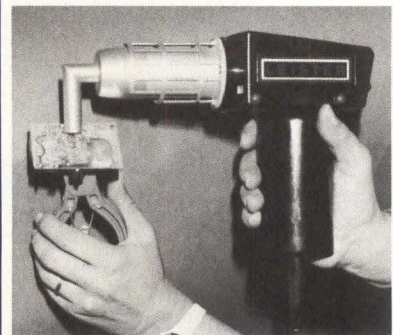

Ask for free brochure EX 404

Brian R. White Co. Inc., 313
Henry Station Rd., Ukiah, CA
95482, Tel. (707) 462-9795,
TWX 888303

East Coast Office, 1 Industrial
Way West Bldg. E, Eatontown
NJ 07724, Tel. (201) 544-1212,
TWX 888307

CIRCLE NO. 97 ON INQUIRY CARD

CIRCLE NO. 98 ON INQUIRY CARD

The only line printer easier to maintain than ours.

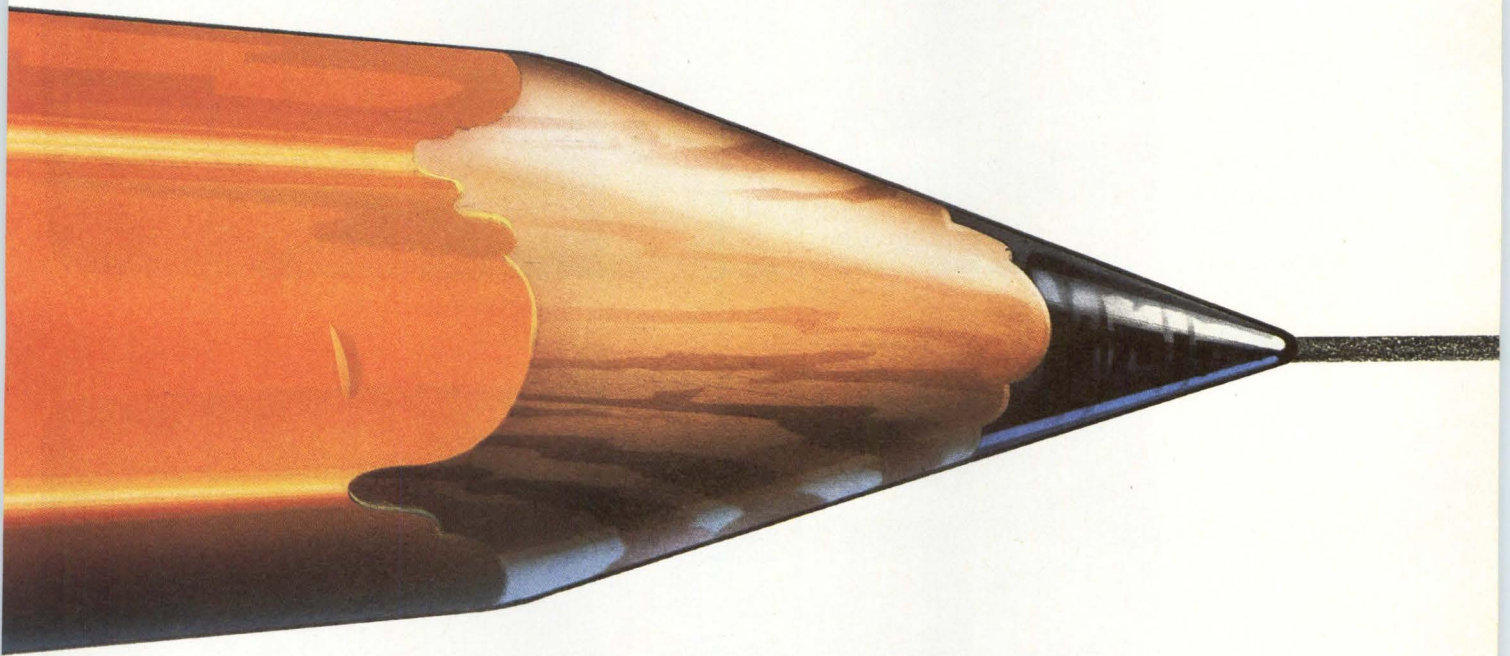

At Centronics, we combine the most advanced technology available with 20 years of experience to build the world's most reliable line printers. So that you don't have to worry about maintenance.

Take our Linewriters at 400 and 800 lpm. They deliver print quality better than any line printer on the market, at noise levels below 55 dB(A). Yet they're so reliable that with no preventive maintenance whatsoever, they run for 18 months

without service. Something no other line printer can do.

For heavy duty applications, our E-Series line printers can print three times faster. Up to 2400 lpm. And they too require less maintenance than any printer in their category. So they're perfect for your most demanding needs.

Pick up a pencil and write us. We'll show you that if you're looking for line printers, you have to look at Centronics.



CENTRONICS®

An affiliate of Control Data Corporation

When was the last time you looked at us.

Centronics Data Computer Corp., Dept. A, One Wall Street, Hudson, NH 03051. Tel. (603) 883-0111.

CIRCLE NO. 99 ON INQUIRY CARD

An average terminal gets this far in 1.4 seconds. You'll twiddle your thumbs for 14 seconds before it's finished.

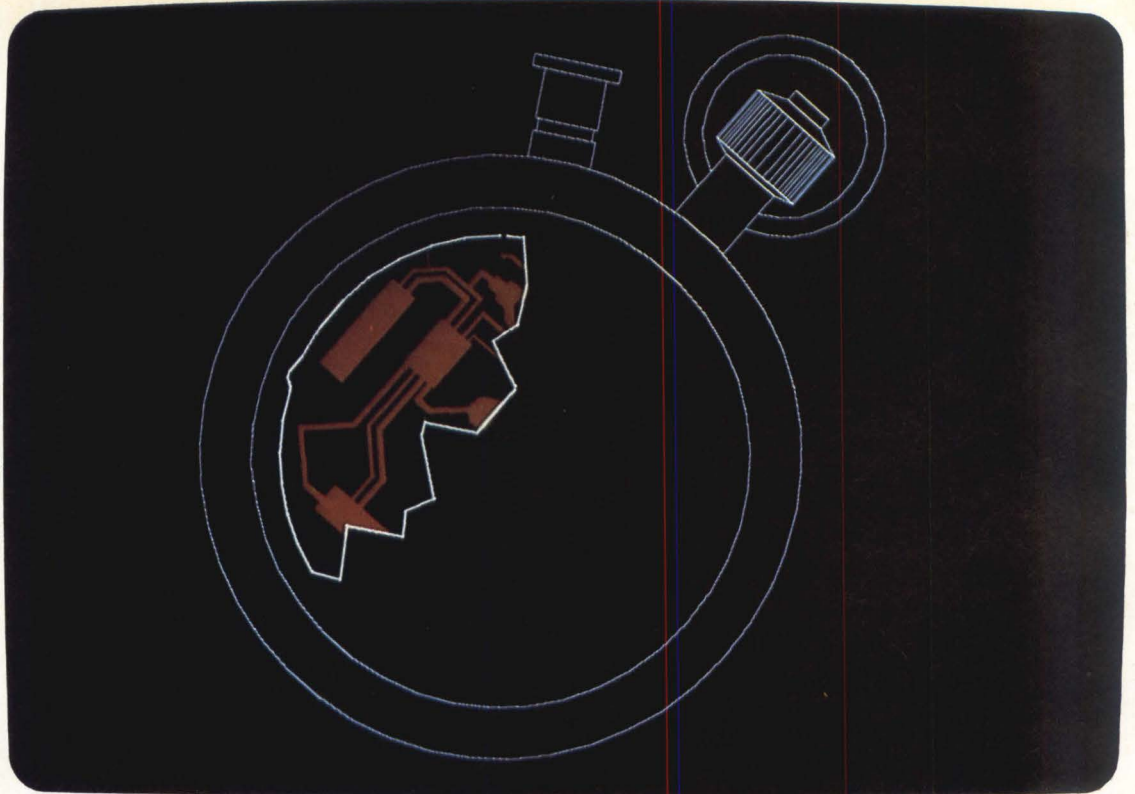

New HiSCAN terminals complete the entire drawing in just over one second.

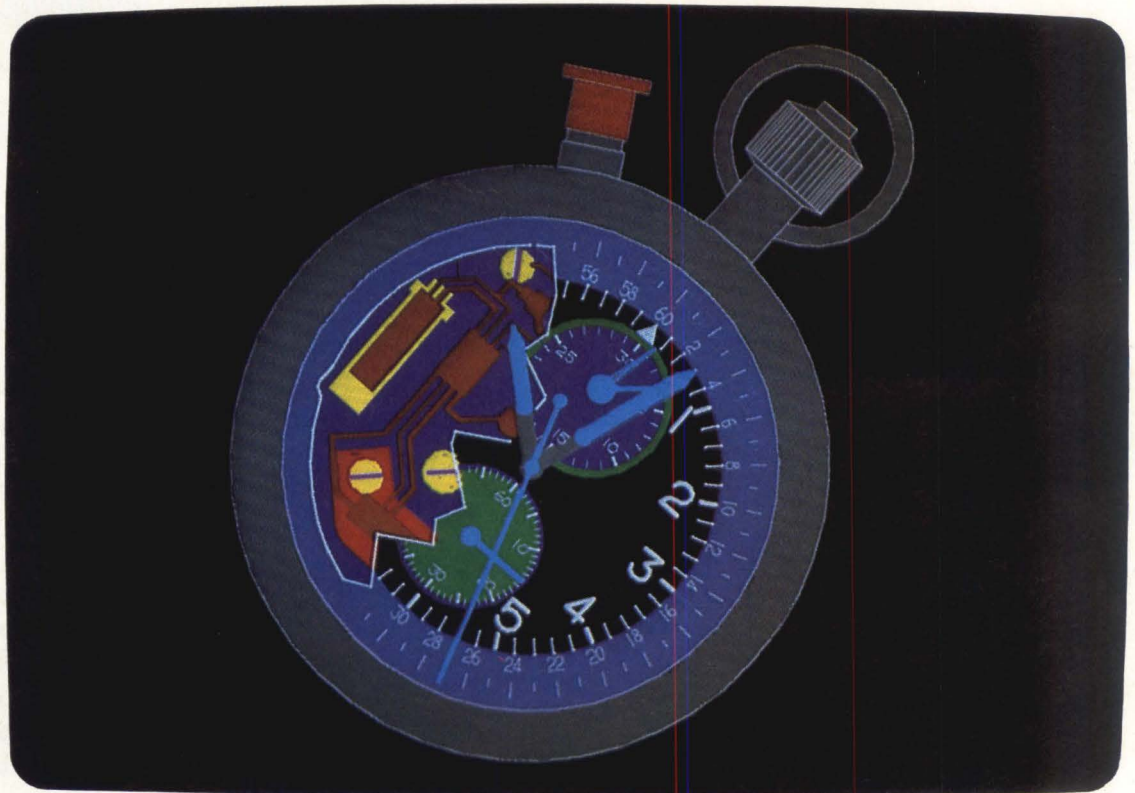

Graphics terminals with ten times the drawing speed. \$2,195 Monochrome, \$2,995 Color

Stop watch courtesy of Heuer Electronic Corp.

'One, one thousand...

Our new graphics co-processor technology gives you a faster draw than anything under \$10,000. It's ten times as fast as others in its price range. A hundred times as fast as the slowest terminals.

You get superior resolution, too: 800 x 600 monochrome, 800 x 300 color. The monochrome terminal displays four gray levels. The color terminal displays 16 colors (out of 64 choices). Plus fifteen programmable,

non-volatile function keys. Simple menus. Superior ergonomics.

You don't sacrifice a thing for superior graphics. The alphanumeric quality equals the best text terminals. The display is not interlaced (not running at half speed), so there's no smearing or ghosting when you scroll. You can even choose an 80- and 132-column display to get a full spreadsheet on the screen.

HiSCAN™ graphics terminals have full DEC VT220 and TEK® 4010/4014 compatibility. Plus your choice of DEC ReGIS, TEK 4027 or TEK 4105 compatibility at no extra cost. They're cable-ready for light pens, mice, digitizing tablets and inkjet printers.

They're designed to help you be more productive and creative. Because they work almost as fast as you think. So now you can play "what-if" with graphics.

You have to get your hands on a HiSCAN graphics terminal to believe it. And that's easy. We'll even arrange a 30-day trial at no risk. Just send the coupon.

done!"



**New
HiSCAN Terminals**
From the people
who brought you Retro-Graphics®

MMS 9/84

- Send complete information
- I want a 30-day trial with no risk. Call me about my compatibility requirements.

NAME _____ TITLE _____
COMPANY _____ PHONE _____
ADDRESS _____
CITY _____ STATE _____ ZIP _____

Mail to: Digital Engineering, 630 Bercut Drive, Sacramento, CA 95814

**DIGITAL
ENGINEERING**
630 Bercut Drive, Sacramento, CA 95814
Phone (916) 447-7600 Telex 910-367-2009

CIRCLE NO. 100 ON INQUIRY CARD

“Whatever you need to keep your computer system running right, I deliver.”

Dan Hankild

“IBM systems, DEC systems or Control Data systems—whatever you need to keep your system up and running, Control Data will be there—with a full line of services.

More than 2,800 customer engineers, like me, maintain whatever needs to be maintained, even on mixed-vendor environments. Our service is responsive, flexible; backed by a national network of parts warehouses; and a Central Support Center full of hardware and software support experts.

One more thing: Control Data has a 26-year track record, and with all that experience, you can depend on us. I wouldn't have it any other way—believe me. Call Control Data Engineering Services. We deliver.”

1-800-828-8001 ext. 58.
In Minnesota 612/921-4400
ext. 58. Outside the U.S. call
your local office.

CIRCLE NO. 101 ON INQUIRY CARD

GD CONTROL DATA

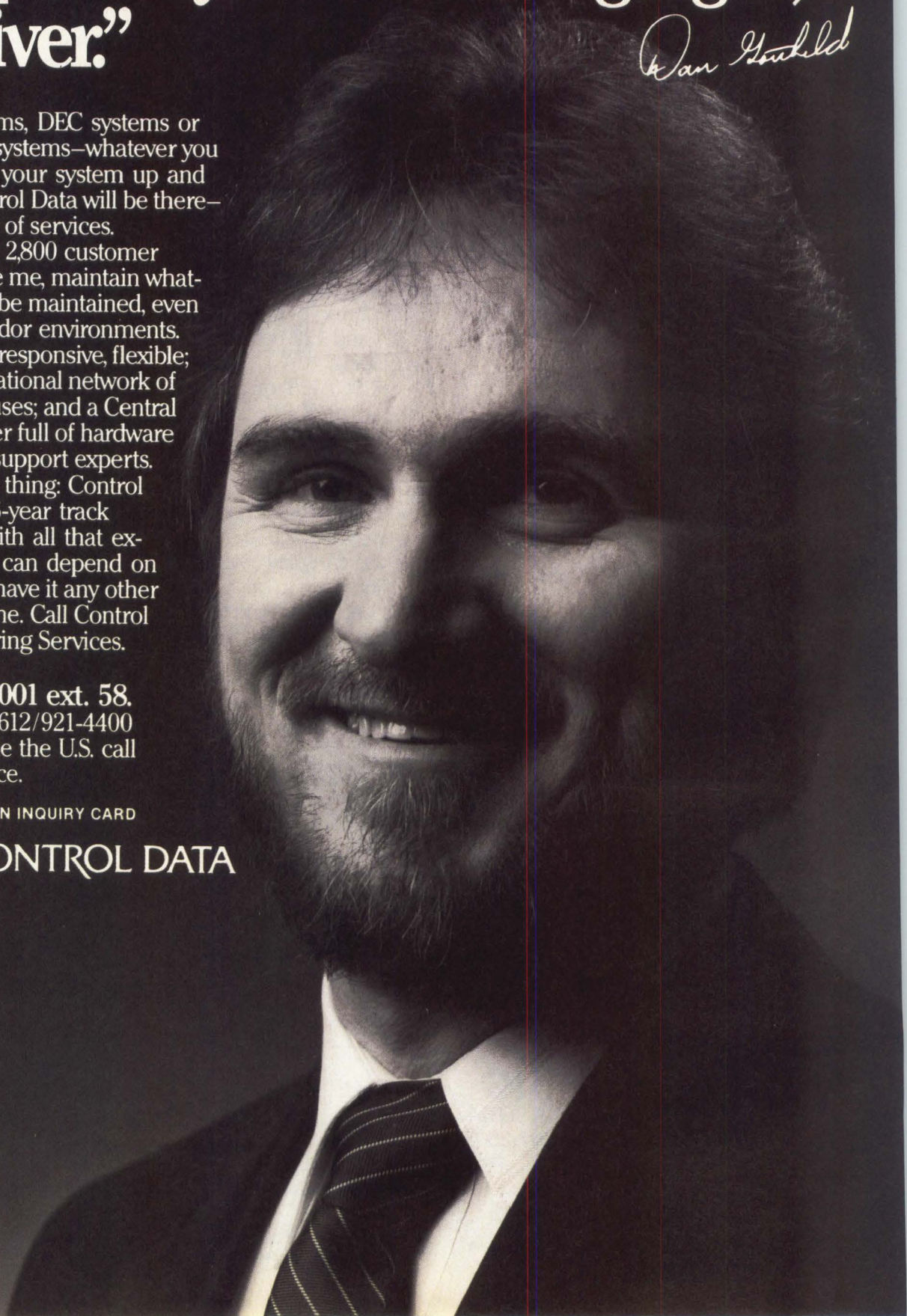

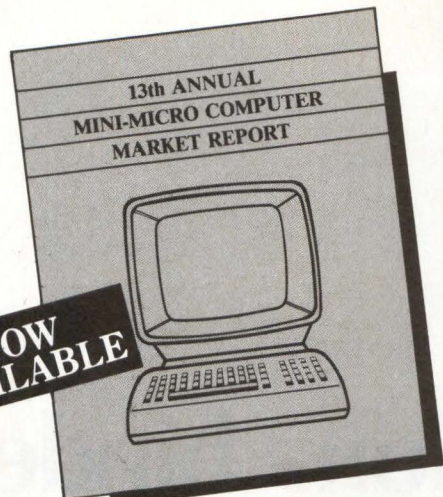

NOW AVAILABLE

Key in on Your Hot Prospects

with Mini-MicroSystems 13th Annual Mini-Micro Computer Market Report

This year Mini-Micro Systems readers will spend \$50 billion on minicomputers, microcomputers, peripherals, software and supplies. The 13th annual Mini-Micro Computer Market Report outlines 8,511 sites (buying centers) representative of the explosive value-added market. Data is available in the following formats:

MAGNETIC TAPE OF COMPLETE DATABASE

For those marketers who wish to receive all the information and be able to generate their own analysis, the complete database is available on magnetic tape. Data includes:

- 1983 Expenditures for minicomputers, microcomputers, peripherals, and software.
- 1984 Estimated Expenditures for minicomputers, microcomputers, peripherals, and software.
- Geographical Regions
- Type of Organization
- Minicomputers/Microcomputers purchased in 1983 and those installed in prior years:
 - Vendor name and model number
 - Units acquired
 - Major applications
- Minicomputers/Microcomputers planned 1984 purchases:
 - Vendor name and model number
 - Units planned to be acquired
 - Major applications
 - Sites planning to change major vendor
 - Fail-safe computer operations
 - Electronic office functions

- Boston (617) 536-7780
- Chicago (312) 635-8800
- Dallas (214) 980-0318
- Denver (303) 388-4511
- Los Angeles (213) 826-5818
- Mid-Atlantic (215) 293-1212
- in New York (212) 724-1790
- Orange County (714) 851-9422
- Northern California & Northwest (408) 243-8838
- Southeast (404) 955-6500

Phi Cahners Publishing: Publishers of 33 specialized magazines in Building & Construction, Electronics & Computers, Foodservice, Manufacturing, Healthcare

Mini-MicroSystems

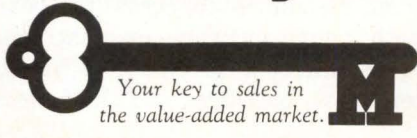

PRESELECTED LISTS AND MAILING LABELS

All selections are available as a listing or as cheshire or pressure sensitive labels. Cross tabulations of categories are also available.

Site Selection	Site Count
■ Total sites surveyed.....	8,511
■ Sites by planned 1984 expenditure levels	
\$50,000-99,999.....	4,829
\$100,000-249,999.....	3,582
\$250,000-499,999.....	2,218
\$500,000 or more.....	1,403
■ Sites planning to install integrated electronic office functions in 1984.....	1,642
■ HOT PROSPECTS... Sites planning to change major vendors in 1984.....	1,085
■ Value-added OEMs and third parties.....	3,110
■ Value-added user sites.....	4,813

13th ANNUAL MINI-MICRO COMPUTER MARKET REPORT

All data is available in a 200-plus page bound report for \$495. In addition to an executive summary, the report's tables include:

- 1983 Unit expenditures
- Type of Organization
- Geographical Regions
- Current Computer Vendors
- 1984 plans for:
 - switching vendors
 - unit expenditures
 - fail-safe computer operations
 - electronic office functions

For more information on prices, list selections, and the MINI-MICRO SYSTEMS Market Report, fill out and send the coupon below.

Mini-MicroSystems

Please send _____ copies of the 13th Annual MINI-MICRO COMPUTER MARKET REPORT to the address below. (Please make checks payable to Mini-Micro Systems. \$495.00/report.)

Please send more information on...

_____ The complete Mini-Micro Computer Market Database _____ Preselected lists and mailing labels

_____ The 13th Annual Mini-Micro Computer Market Database

Name _____

Title _____

Company _____

Address _____

City _____ State _____ Zip _____

Telephone (____) _____

MINI-MICRO SYSTEMS COMPUTER MARKET REPORT, 221 Columbus Avenue, Boston, MA 02116

CIRCLE NO. 102 ON INQUIRY CARD

Market considerations hinder search for software standards

Acceptable sets of standards promise to end interchange problems through portability, longer software life

Carl Warren, Western Editor

Software standards are stumbling forward even as conformity and flexibility issues throw up roadblocks. But, while most of the industry says it wants standards, proponents and system and software manufacturers stand nose-to-nose in a battle of conflicting objectives.

Though standards promise to eliminate confusion of interchange, display methods and integration of foreign devices into systems, software manufacturers often advocate particular standards only out of self-interest. They want standards that will guarantee that more hardware will be available to support their offerings. By the same token, hardware manufacturers want to ensure that support will be available from a variety of sources—the goal of all, of course, being to grab more of the market share.

Regardless of supporters' motives, it seems clear that standards benefit the end user by making it possible to better match software and hardware to meet a given objective.

Three ways to set standards

Basically, there are three ways of setting standards:

- Market force, which leads to a de facto standard. A dominant manufacturer establishes a methodology and

forces others to follow suit in order to enjoy market share.

- Simple evolution. Typical examples are UNIX for operating systems—just now becoming prominent for multiuser system—and Smalltalk, LISP and Prolog for artificial intelligence. This type of standard evolves as a product first, carves a niche in a small market and later expands as manufacturers perceive its value.

- Established by committee, such as those of the American National Standards Institute (ANSI), or the Institute of Electrical and Electronics Engineers (IEEE). Some standards committees aren't formal but are coalitions of manufacturers banded together to establish a working relationship and to develop a market. One example of this is the Independent Software Information Standard (ISIS) group, formed to provide a standard method of interchanging information between different software environments.

Regardless of the method used to establish a standard, the expected result is order from chaos.

A critical look at standards

Even with a great deal of emphasis on standards, there are pockets of resistance to across-the-board standardization, with many software manufacturers citing the need to be different to ensure a healthy market share. Peter Shaw, president and chief execu-

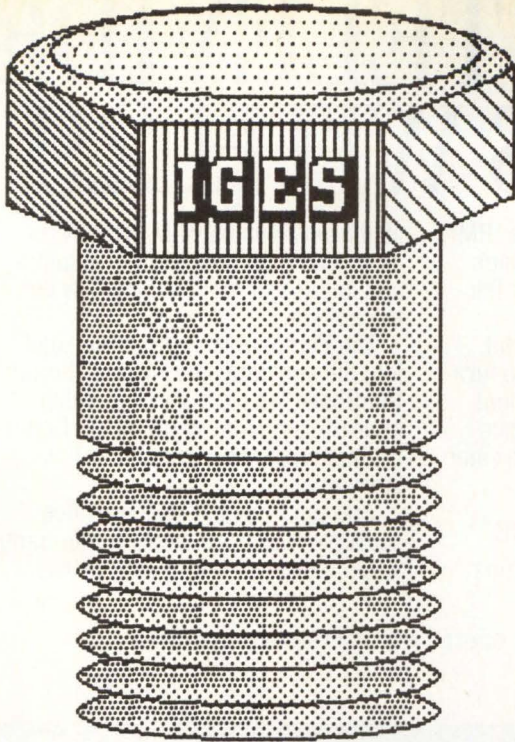

Illustration by Anne Tregay

A mix of software standards solves compatability issues for specific tasks, but inconsistencies exist from standard to standard, creating system interchange problems.

Tools for designers serve specific needs

An alphabet soup of graphic standards purport to provide designers with an array of tools with which to work:

(a) **The Initial Graphics Exchange Standard (IGES)** is an American National Standard Institute (ANSI) standard for transporting Computer Aided Design (CAD) and Computer Aided Manufacturing (CAM) data within and between systems; (b) **The Graphical Kernel System (GKS)** is an ANSI standard that defines two-dimensional objects; (c) **The Programmers Hierarchical Interface to Graphics (PHIGS)** is a developing standard, similar in concept to GKS, for dynamic systems; (d) **The Virtual Device Interface (VDI)** is a two-way protocol which takes place at the lowest level of device independence; (e) **The Virtual Device Metafile (VDM)** represents a standard file format for 2-D graphics data; (f) **The North American Presentation Level Protocol Syntax (NAPLPS)** defines

the methods of presentation and storage for Videotex graphics.

Notice that IGES is highest and in between the applications and the object databases. The other standards

serve special functions, like device handling, as they progress down the structure.

Thus, each standard is designed to serve a specific need in the system.

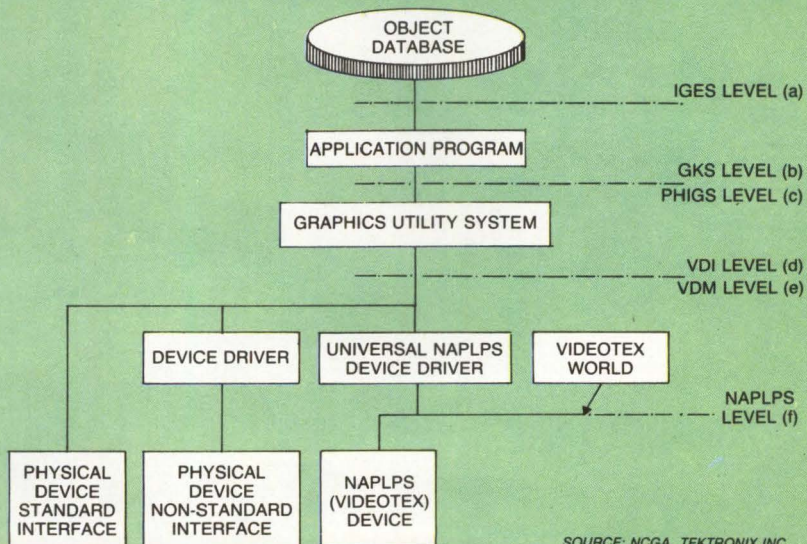

SOURCE: NCGA, TEKTRONIX INC.

THE TELEVIDEO COMES WITH 2.9 MI

They're all the people who use IBM® PCs and PC compatibles. Each one's a potential customer for the new TeleVideo® Personal Mini™.

This is simply the most powerful, economical and profitable way to turn stand alone PCs into efficient multi-user networks. Systems that let people work on the same file simultaneously.

RUNS IBM PC SOFTWARE.

The TeleVideo Personal Mini runs

all the most popular IBM PC software, as well as hundreds of minicomputer and multi-user applications now on the market.

The Personal Mini provides excellent file and data sharing and, through InfoShare™, an exclusive TeleVideo operating system, workers get better utilization of expensive hard disk storage.

And the Personal Mini provides the highest performance—performance without degradation—regardless of



CIRCLE NO. 103 ON INQUIRY CARD

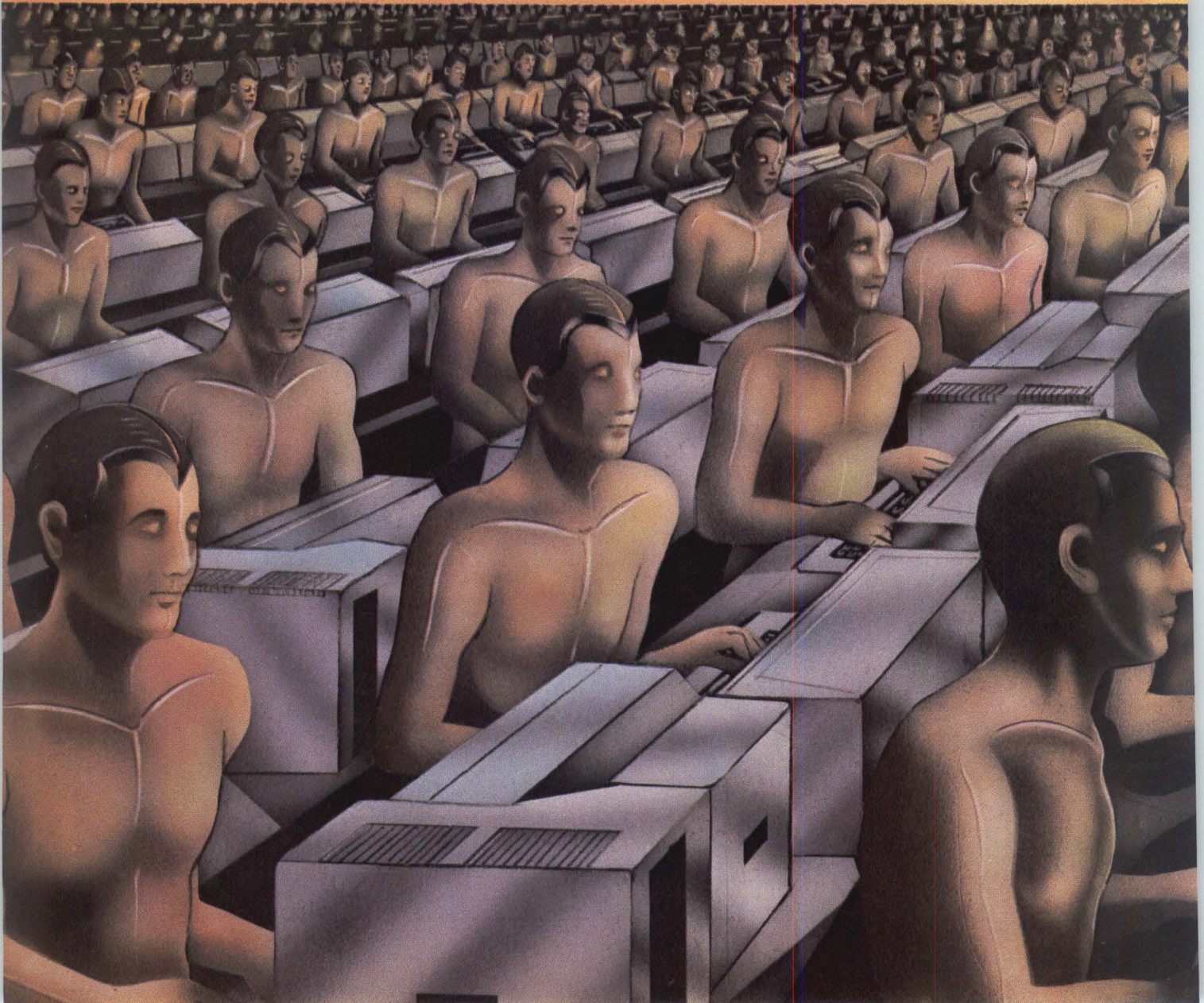

PERSONAL MILLION CUSTOMERS.

how many workstations are being served. It also enables workstations to share expensive peripherals like plotters and printers.

AS EASY FOR YOU AS IT IS FOR THEM.

Not only is the Personal Mini incredibly easy to use, it installs easily. And we supply everything you need to get the system up and running or expand it. So there's no need to coordinate components from more than one vendor.

The Personal Mini is even easy on data processing budgets. The TeleVideo line of expansion products allows the system to grow without sacrificing any PC investment. And TeleVideo workstations can be easily added for substantially less than an IBM PC.

In fact, the Personal Mini networks the entire TeleVideo compatible line—PC, XT and portable computers—as well as IBM. And it does so with plug-in simplicity, for under \$100 per node.

THE CUSTOMERS ARE BUILT IN.

It's never been easier to identify a target audience. Because the Personal Mini makes the IBM PC installed base your customer base.

Call TeleVideo toll free at 800-538-8725. In California, call 408-745-7760.

Regional Sales Offices: Northwest (408) 745-7760, Southwest (714) 476-0244, Southcentral (214) 258-6776, Midwest (312) 397-5400, Southeast (404) 447-1231, Mid-Atlantic (703) 556-7764, Northeast (617) 890-3282, East (516) 496-4777, Rocky Mountain (408) 745-7760
IBM is a registered trademark of International Business Machines

THE TELEVIDEO PERSONAL MINI.
THE FIRST PC COMPATIBLE MULTI-USER SYSTEM.

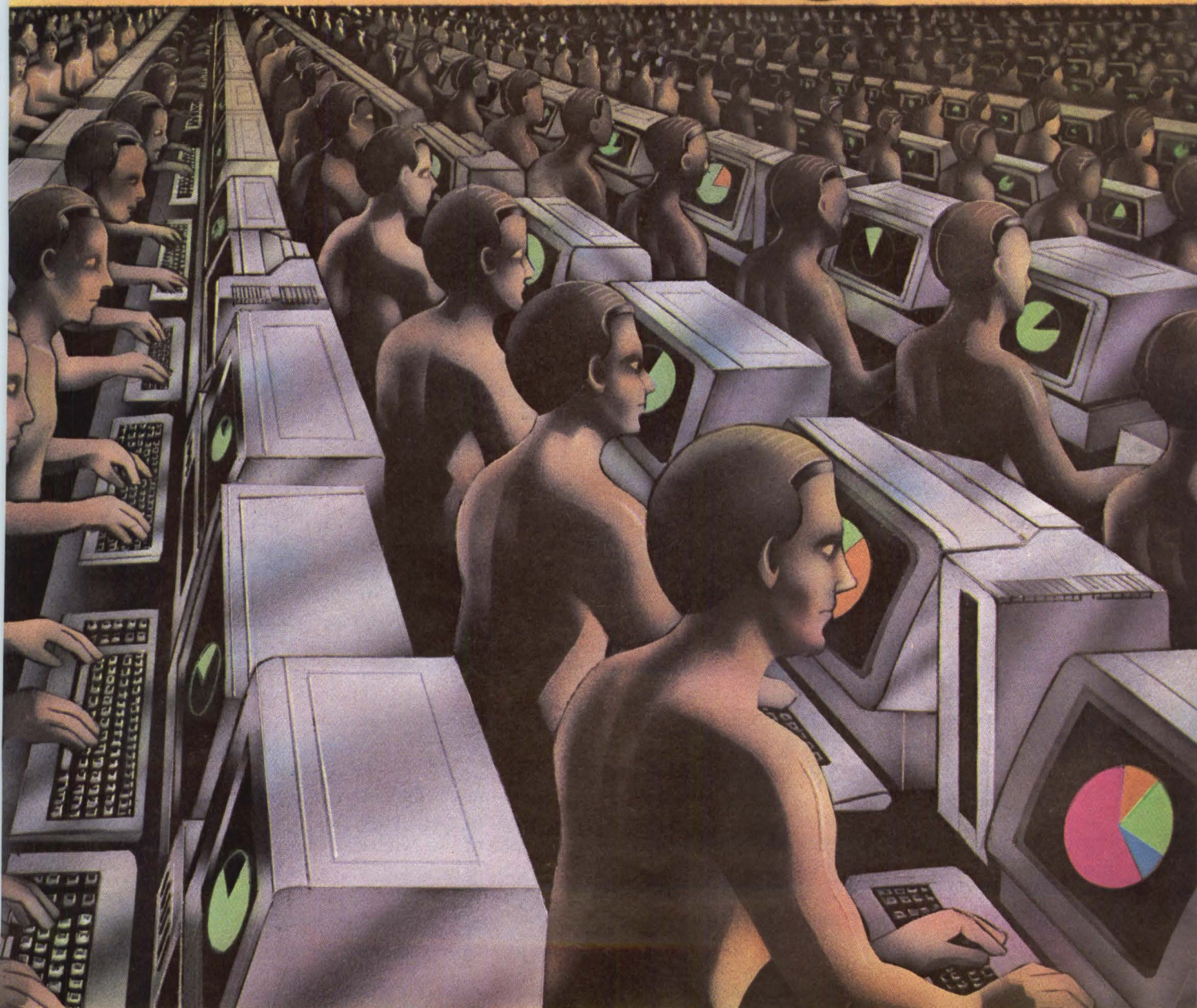

UNIX Application Software Sales

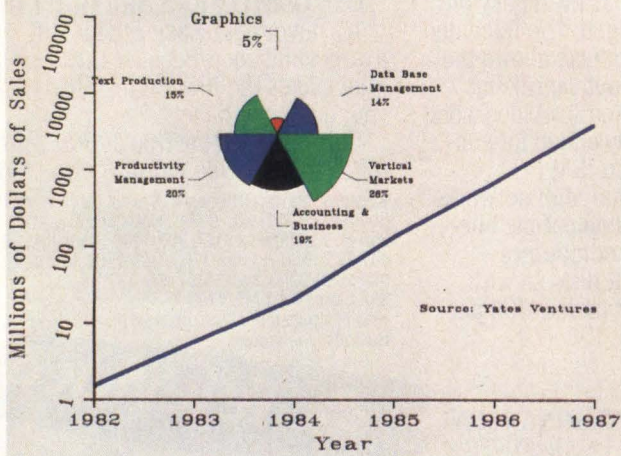

The Graphical Kernel System (GKS) provides a standard interface for high-level business graphics. (Courtesy of Visual Engineering Inc., Palo Alto, Calif.)

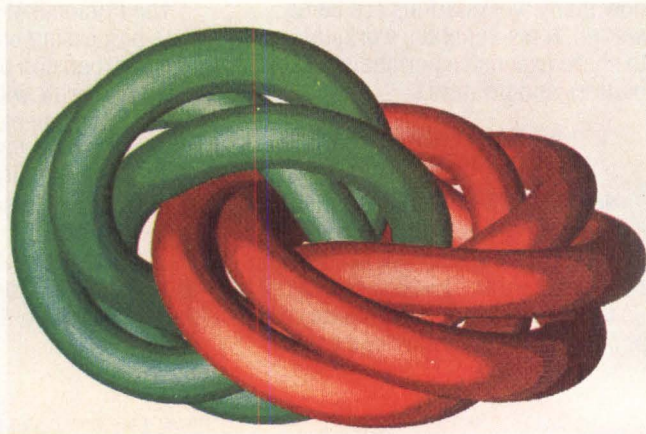

By coordinating the basics of a standard while exploiting the features of the graphics-output device, sophisticated results are possible—including 3-D perspective from 2-D devices. (Courtesy of Uniras Inc., Burlington, Mass.)

tive officer of Syte Technology Inc., San Diego, stresses that adherence to standards often hinders design, and adds that, while they can't be ignored, standards do not work to the advantage of "fast-paced, technology-mature" companies.

Though Shaw's candor may appear to indicate that Syte intends to avoid standardization, such is not the case. Syte, like many companies competing in an increasingly difficult market, does adhere to standards, but only when it suits a company purpose. President Edwin P. Berlin Jr. of Cubicomp Corp., Berkeley, Calif., says that he, too, will adhere to standards, given certain conditions. "If someone had data files written on a machine using the Graphical Kernel System (GKS) file structure, we'll provide a utility to translate that information. But we aren't going to make files compatible to run on a competitor's machine—there is no percentage in it for us."

The hesitancy of manufacturers to leap on the standards bandwagon gives rise to important questions. Will efforts to standardize be foiled because manufacturers won't cooperate? Will there be an ultimate tribunal, consisting of end users, that will force the issue? There are really no clear-cut answers, but differing opinions abound, centering on which standards are under discussion and what market segments are being addressed.

End users, whether they are independent integrators or Fortune 5000 companies integrating a system into their infrastructure, often have the wrong idea about standards. Typically, they believe that adherence to a standard implies they must be followed to the

letter. With communications this seems to be the case, but generalized systems—either for business, or graphics—require a more flexible approach.

One software company built on standards is Precision Visuals Inc., Boulder, Colo. "We've hung our hat on standards since 1979," explains James R. Warner, company president. "But that doesn't mean we ignore the performance issues and burden the system with a by-the-book-standards implementation."

Warner believes that standards are necessary and, if nothing else, teach a specific way of handling graphics. Moreover, he maintains that people get steeped in extensions. "Typically, you find that only 10 percent of the implementation follows the standard. The other 90 percent is made-up extensions to perform functions the way the end user expects them. We continually get customers coming to us for extensions, and often it starts directly with the hardware manufacturer six to 12 months before they introduce the hardware. What they want is something that represents a standard approach but still maximizes the performance capabilities of the system."

With hardware technology rapidly leap-frogging, it becomes difficult for standards to keep up. And virtually everyone agrees that standards aren't meant to be a panacea.

One staunch defender of standards is Dr. Peter R. Bono of Ship Analytics Inc., North Stonington, Conn., chairman of the American National Standards Committee X3H3 on computer graphics. "Standards represent a codification of current practice. As such, they lag and always will. What standards have done for the graphics

In microcomputers today, UniSoft sets the standard.

AT&T has recently been advertising that their UNIX™ operating system will be the standard OS for microcomputers. That's true. But if you want AT&T's UNIX software on micros today, talk to UniSoft Systems.

UniSoft has been delivering AT&T's UNIX adapted for 68000-based microcomputers for two years. More than 75 different computer systems run the UniSoft software, UniPlus+.™ At each Bell release level, all these systems are object code compatible. This means that applications software developed on any UniPlus+ system will work on any other. This is where software portability pays off.

UniSoft enhances Bell's vanilla UNIX with the best features from the Berkeley BSD research version of the UNIX operating system. IP/TCP networking, record and file locking, and virtual memory from UniSoft turn UNIX into a commercial product. All this added value is still Bell-compatible.

Don't wait six months to get System V running on your hardware. UniSoft's customers can ship it now.

If you're building or selling a 68000-based UNIX system, your operating system should come from UniSoft Systems, the UNIX experts.

UniSoft
S Y S T E M S

THE BERKELEY PORT AUTHORITY

*UNIX is a trademark of Bell Laboratories

739 Allston Way, Berkeley, CA 94710 • (415) 644-1230
TWX II 910 336-2145 • UUCP ucbvax!unisoft!unisoft

CIRCLE NO. 104 ON INQUIRY CARD

DELTA'S MAPPED OUT A WAY TO HANDLE YOUR TOP PRIORITY SHIPMENTS



Delta Air Express guarantees shipment to over 10,000 communities in more than 90 cities — on the flight you specify.

Few shipments are too large and none are too small. If your shipment does not get on the flight specified, rates will be adjusted to that of regular air freight. Local pick-up and delivery available.

Delta can ship anywhere in the U.S. or the world, via interline connections. Delta Air Express rates compare favorably with other air express services.

Also ask about Delta DASH®—same-day delivery on packages up to 70

pounds. And Delta 3-D™ Air Freight—40% off regular freight rates on high-density shipments.

For details, call the Delta Marketing Office in the city nearest you.

DELTA
The airline run by professionals



DELTA AIR CARGO. READY ALL-AROUND

industry is give us a common vocabulary—we all now talk the same language and can understand each other.”

Bono contends that, besides providing a common vocabulary, standards open up wider markets for companies and benefit end users who are nervous about getting locked into one company, rather than being able to find solutions from multiple vendors. He points to Graphic Software Systems Inc., (GSS) Wilsonville, Ore., which has developed a software approach around the GKS and Virtual Device Interface. “They see it as a market opportunity, not a hindrance,” Bono says. “However, manufacturers of turnkey systems who are offering unique solutions to their customer base may be worried—standards would tend to erode their market.”

Thomas B. Clarkson III, president of GSS, says, “Standards provide us with a set of rules to follow. They don’t inhibit our creativity, however. We go to great lengths to maximize the performance of the devices by using device-dependent drivers.”

Bono and Clarkson point out that the decision to be device-dependent requires a tradeoff between portability and the full use of the machine environment. “Device independence gives you portability; device dependence lets you exploit the device,” says Bono.

Although it’s a give-and-take situation, no one is forcing anyone in the industry to use standards. They exist as a tool and can be used, modified or ignored. In some cases, standards are used to a point, and device dependence takes over to exploit the device.

Precision Visual’s Warner cautions that hardware manufacturers should consider the impact of the total system, not simply try to shove standards in ROM for the sake of having done it. “The software people are in the business of solving the matching problems and maximizing the system,” asserts Warner. He says that what is done often entails picking the appropriate standard—if one exists—to handle the task at hand. “Sometimes a standard isn’t appropriate,” he says.

No easy answers

Clearly, there are no clear answers to the chaos surrounding graphics standards. It appears that, on the one hand, there are solid reasons to base the entire implementation on standards; on the other hand, modification is a must. Brian Rosen, vice president of engineering for PERQ Systems Corp., Pittsburgh, Penn., emphasizes that standards provide a comfort level for users. “The first contact we have with a customer is to satisfy a check list. On that list is what standards we support. Once we get past that, we can concentrate on solving the problem with the proper solution—and that solution has a foundation in standards.”

Rosen believes that standards are promulgated by the diversity in software vendors. “A vast majority of the software being written today is by third-party vendors, and because of this, standards are being forced.” Rick Stuckey, partner in technical services for Arthur Anderson & Co., Chicago, agrees with Rosen. “We have a policy that dictates that some things require creativity and mundane functions don’t. We don’t encourage the reinventing of the wheel. So standards prevent that.”

Even though standards may offer a lot, Syte’s Shaw may be right on target in claiming they are only for technically poor companies. For example, dominant manufacturers such as IBM can establish de facto standards through sheer market force. “Take for example the IBM-PC,” says Stuckey. “It has a method of using the screen for graphics, and they have essentially locked it up so everyone has to do it differently. It is a standard and one that has to be dealt with. Therefore, software writers can decide to support the IBM approach and everyone else. Should Microsoft MS-

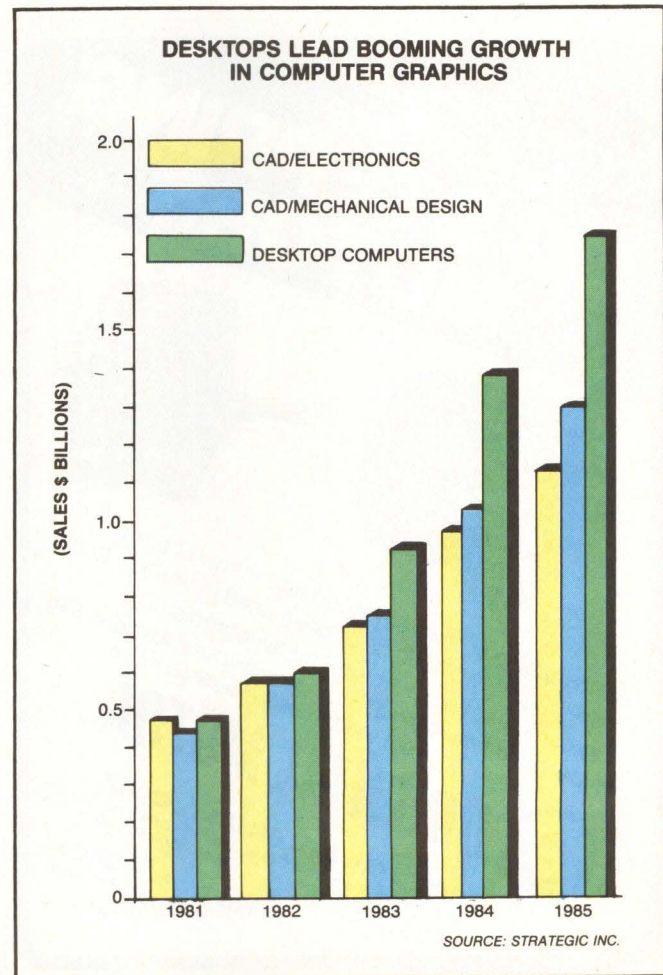

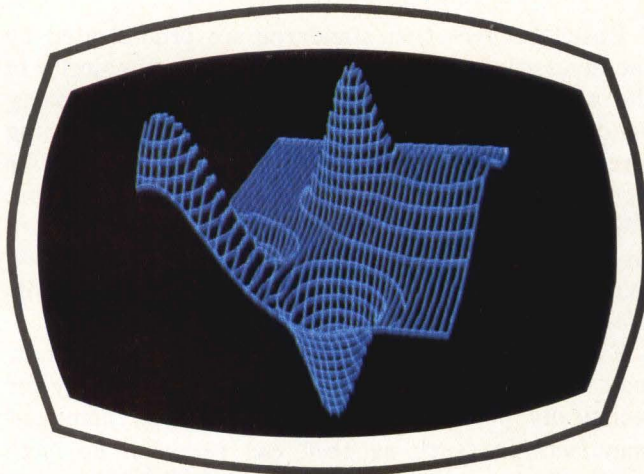

Using the SIGGRAPH CORE standard as the basis, with machine-independent subroutines and device-dependent device drivers, sophisticated graphics can be achieved. (Courtesy of Precision Visuals.)

Windows concept catch on, it means only two versions of the same software will need to exist for all practical purposes—that's basically what standards are all about: increasing markets and portability."

Applications set the standard

No matter what anyone says, the applications—solutions to real-world problems—set the standards. In many cases, such as those built around software tools from companies like GSS, Microsoft Corp. and Precision Visual, the basis is a standard. But, with a growing emphasis on graphics, many non-standard approaches will also be used. "Good standards promote creativity, rather than inhibit it. They prevent individuals from wasting time on mundane tasks," concludes Arthur Anderson's Stuckey.

Bono agrees and says there is no question that standards use more machine resources and do affect performance. "However," he says, "they also provide developers with a quick method of prototyping and creating a working base for the software. Once the basic design is done and is working, the performance-sensitive parts can be rewritten to optimally use the device."

Is certification a problem?

Currently, there is no process of certification of products that claims compatibility to a standard. The reason? "Our legal system isn't set up to handle it," says Bono. "Who's going to stand up and say someone's product violates any given standard? I'm not, and I don't think anyone else will." Bono explains that the self-certification process is used in the United States. For government contracts, however, there are guidelines that have to be met. "Right now the National Bureau of Standards is establishing certification methodology for GKS implementations when dealing with the government—but that's the only time it may be important," explains Bono.

No one loses

Despite the widespread disorder in graphic software standards, it appears that no one really loses. Manufacturers who follow standards are benefitting from a common vocabulary but are still free to optimize designs to meet specific goals, and end users aren't forced to throw out a software investment with an upgrade in hardware—they merely rewrite the device-dependent portions. Confusion exists in the definitions and choosing what standard to use for what application. Charles J. Simon, president of Vectron Graphic Systems Inc., Santa Clara, Calif., sums it up, "We create systems to solve our problems and we take the best approach that promises the widest market." □

Interest Quotient (Circle One)
High 822 Medium 823 Low 824

**From 2-Phase
to 5-Phase
DC STEPPING
MOTORS**

DC stepping motors designed and manufactured by "ORIENTAL MOTOR" have been used in various fields to control speed, position and synchronism.

2-Phase Hybrid Type: 0.9°/1.8° Mounting Size: 2.3"sq/3.4"sq
0.9°/1.8°/3.6° Mounting Size: 1.7"sq

ORIENTAL MOTOR®

Tokyo, Japan
ORIENTAL MOTOR U.S.A. CORP.
 LOS ANGELES OFFICE: 213-515-2264 NEW YORK OFFICE: 201-992-0480
 CHICAGO OFFICE: 312-577-0310 SAN JOSE OFFICE: 408-988-2655
 BOSTON OFFICE: 617-568-8514

Visit our booths at MIDCON,
NORTHCON and
WESCON

CIRCLE NO. 105 ON INQUIRY CARD

Take it along for the drive.

The floppy disc drive, that is. There's a world of floppy drives out there. All begging for quick, thorough testing.

They're in the field. On the QA test bench. And even back in engineering.

Wherever they are, our new programmable Performance and Alignment Tester, PAT-2+,™ is ready to run them through their paces.

In conjunction with our Digital Diagnostic Diskette,™ the PAT-2+ performs over 30 vital drive tests.

Things like head radial alignment. Head positioner linearity. Head azimuth alignment. Diskette centering. Index timing. Read/write data handling tests. And it

can function as an exerciser.

You can even program and memorize (in non-volatile memory) data rates and drive parameters. So you can meet the challenge of the new high density drives.

The PAT-2+ tests virtually any standard interface 5¼" 8" or microfloppy drive. And adaptors will be available soon for non-standard interface drives.

All this comes in an inexpensive, accurate instrument you can hold in the palm of your hand.

An easy-to-use instrument that plugs right into the drive interface. And, in most cases, eliminates major disassembly of the computer under test.

Just the kind of innovative instrument you'd expect from Dysan. The leader in quality media and diagnostic tools.

The PAT-2+.

Next time you go for a drive test, take one along.

For more information or to place an order, call toll free (800) 551-9000.

Dysan Corporation, 5201 Patrick Henry Drive, Santa Clara, CA 95050, (408) 988-3472.

Dysan is a registered trademark, Digital Diagnostic Diskette and PAT-2+ are trademarks of Dysan Corporation. Copyright 1984, Dysan Corporation.

Dysan.®

CIRCLE NO. 106 ON INQUIRY CARD

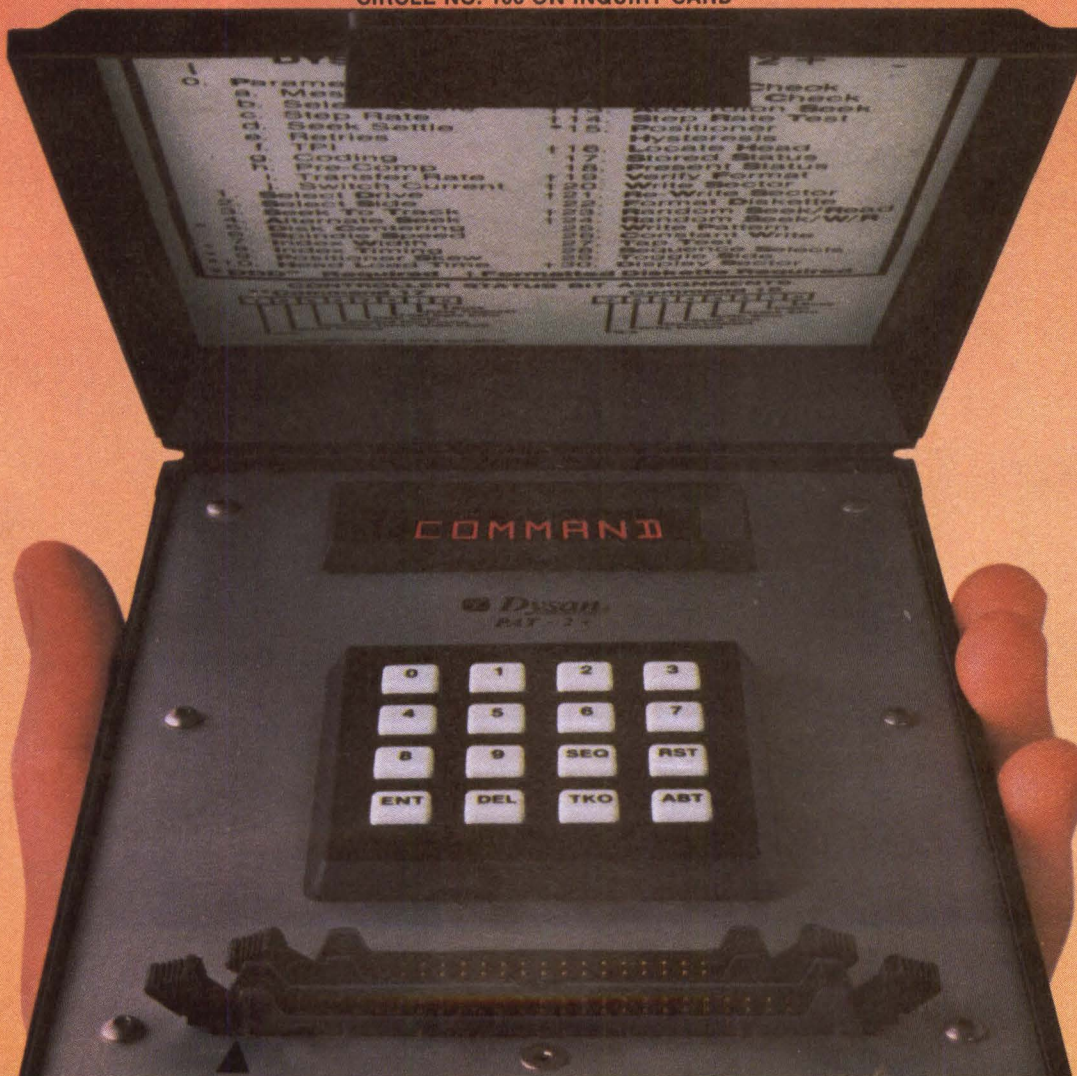

THE BETTER CONTROLLERS

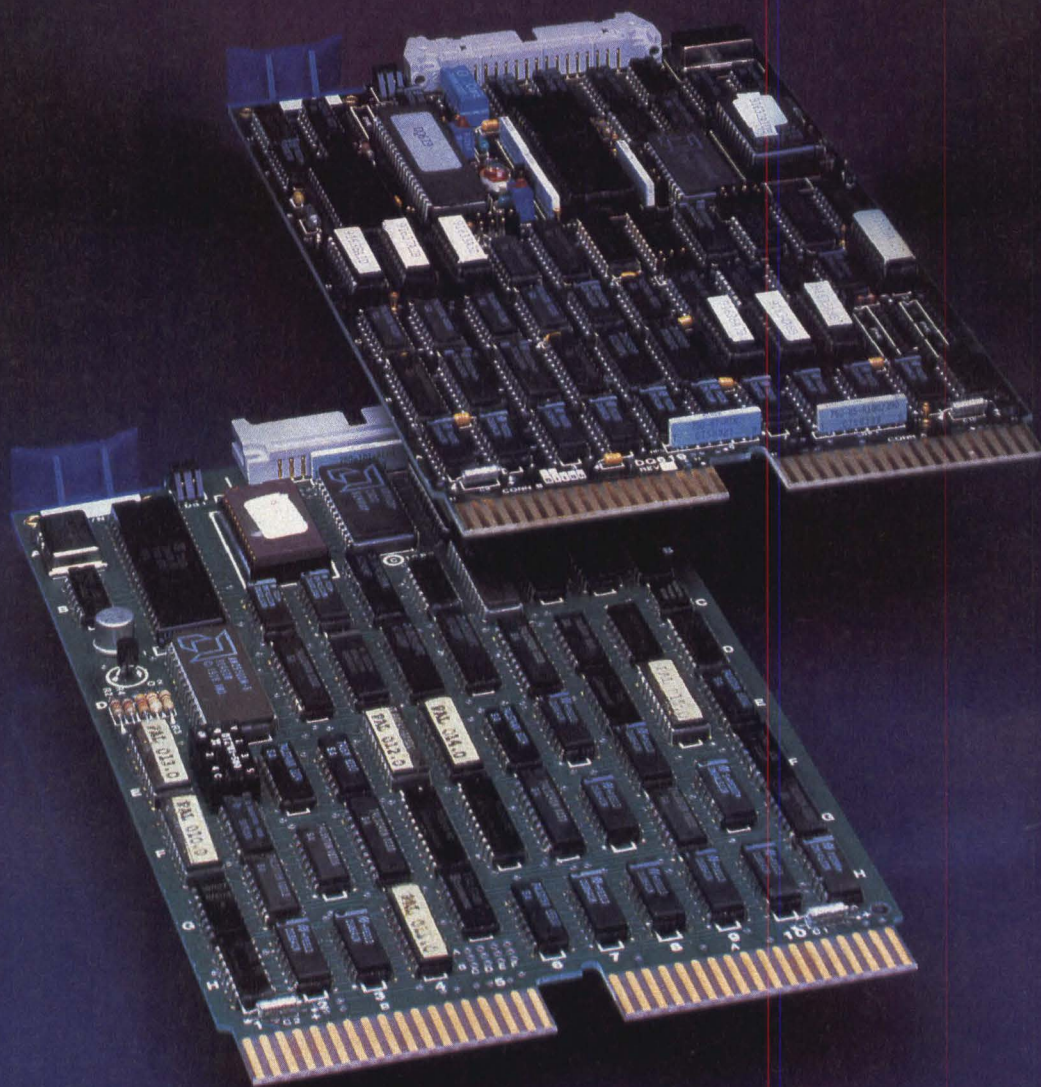

AND FOR GOOD REASONS.

NO OTHER 5¼" OR 8" FLOPPY CONTROLLERS MATCH THEM.

First, they're both low cost. Yet they employ powerful control and interface electronics for full emulation and operating system compatibility. All completely self-contained on a single dual height PCB. The DQ619 controls the 5¼", SA450 I/O floppy and the Model DQ419 is for the 8", SA850 I/O floppy.

Next, they share standard features you'll need

- complete DEC RX02 emulation
- RT-11, RSX-11 and RSTS compatibility
- and 22-bit addressing for up to 4-megabyte memory access.

And they both include an exclusive feature that extends both media life and drive reliability. It's a DC motor control and associated electronics that unloads the read/write heads and turns off the drive motor following access periods beyond 15 seconds.

There are numerous other features to make your life with a floppy easier, like on-board diagnostics, full sector data buffer, media present monitor, 4-level interrupt that's jumper selectable, on-board bootstrap loader and write precompensation.

Write or call to discover for yourself all the features and benefits these better controllers have to offer.

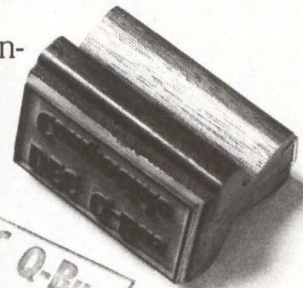

DEC Q-Bus
Compatible



DISTRIBUTED LOGIC CORPORATION

12800 Garden Grove Blvd. ■ Garden Grove, CA 92643 ■ (714) 534-8950 ■ TLX 681399
64-A White Street ■ Red Bank, NJ 07701 ■ (201) 530-0044
12 Temple Square ■ Aylesbury, Buckinghamshire, England HP 20 2QL ■ 44 (0296) 84101 ■ TLX 837038

One small step for Digilog. One giant leap for data comm test.



New family of automatic protocol analyzers interpret and isolate the error source for you.

Meet the New Digilog 200, 400, 600, and 800 . . . four revolutionary diagnostic analyzers that can actually describe in plain English what is happening on your data lines.

They decode and interpret the protocol for you. Isolate faults automatically. Exactly. Even statistically analyze data line performance.

Digilog 200 automates data comm testing

Digilog 200 sets up automatically. Decodes protocols automatically. Analyzes protocols automatically. Tests devices automatically. And identifies the faults automatically. You get EE PROM packs for program or data storage, remote

control, typewriter-like keyboard, full programming, menu driven traps and triggers, CRT, help screens, six BERT tests, interface breakout, printer output, etc.

Digilog 400 and 600 for greater sophistication

Here the emphasis shifts toward versatility, power and higher speed . . . up to 72K bits/second.

You get more programming power, bigger CRTs, built-in 3 1/2" micro disks, soft function keys, graphics, protocol simulation plus all the features of the 200.

Digilog 800, the new technology

Use the world's first protocol/performance analyzer to conquer the toughest data comm problems. Debug software programs.

Improve your network.

The Digilog 800 offers you fully selective and bit image recording, full protocol simulation, automatic protocol analysis through level 3 (X.25, SNA, etc.), and speeds to 256K bits/second.

You also get on-line color graphics, internal 10 megabyte disk with selective logging and comprehensive statistical analysis with reports.

Digilog is out in front

Want to see what the new generation of Digilog analyzers can do for you? Call now for a demonstration (215) 628-4530.

DIGILOG INC., 1370 Welsh Road
Montgomeryville, PA 18936

DIGILOG[®]
NETWORK CONTROL DIVISION

Transport software packages from 32-bit to 16-bit machines

A VAX-to PDP-11 case study shows system integrators how to accommodate differences in operating systems, compilers, machine-word sizes and memory management

Madhu Mehta, Digital Innovations Pvt. Ltd.

System integrators attempting to transport large software packages from one hardware environment to another can benefit from the experience of companies that have completed such a task. One such company is Digital Innovations Pvt. Ltd., Vadodara, India, which has ported National Semiconductor Corp.'s NSX16 development tools from a 32-bit Digital Equipment Corp. VAX supermini running VMS to a 16-bit PDP-11 minicomputer running RSX-11. Digital Innovations completed the port, including quality-assurance testing, in approximately 8,000 man hours. Memory overlays allowed the company to reduce the memory requirement of the NSX16 package from more than 400K bytes on the VAX to 145K bytes on the PDP-11.

The purpose of Digital Innovations' port was to make the NSX16 software tools available to PDP-11 users

The NSX16 cross-software package includes the PAS16 Pascal cross compiler and the ASM16 cross assembler to generate code for NS16000-based systems. LINK16 links object files and library routines into an executable file. Users can then employ the BIN16 utility, which prepares the file for programmable read-only memory (PROM) generation. Users can debug the code using the DBG16 utility and then can down-load it to target systems such as National's DB16000 development board. The NSX16 package operates with the VMS, RSX-11 or Starplex II operating system and is available from Softrade International, Pleasantville, N.Y.

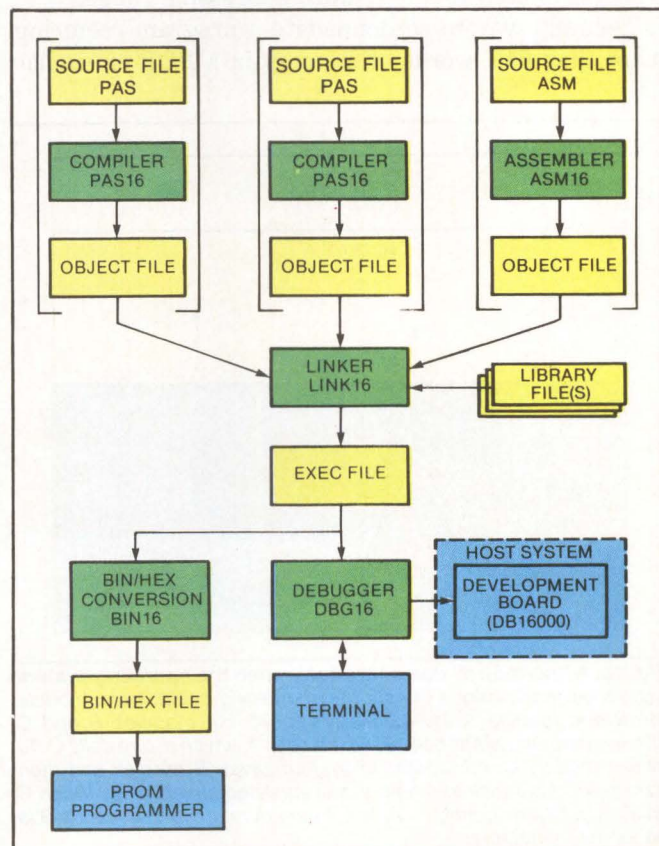

who wish to create application programs for NS16000-based target systems such as National's DB16000 development board. Project managers for the porting effort established guidelines to ensure that programmers could revise the PDP-11 code to coincide with future enhancements to the VAX version. Three of the most important guidelines are:

- To preserve the original program structure, making necessary changes on a statement-to-statement rather than a module level. This preservation reduces the amount of converted code and facilitates its identification.
- To preserve the original program algorithms, thus reducing the likelihood of subtle bugs caused by inconsistent logic.
- To design the target package as a whole. For example, the package might include an assembler and a linker. If the assembler recognizes only 350 external symbols per program, there is no point in having the linker support more than 350 symbols per object file.

Null procedures facilitate overlay swapping

Memory management is perhaps the most difficult problem in porting a large program. To move code from the VAX to the PDP-11, Digital Innovations had to adapt software written for the VAX's demand-paged virtual memory to the PDP-11's segmented memory, which is limited to a 64K-word addressing range.

The only way to accommodate a program requiring more than 64K words of memory in a PDP or similar

computer environment is to overlay some program modules. To overlay a module, the operating system temporarily replaces that module with a module of the same size or smaller. When the program subsequently requires the original module, the operating system transfers the module from the disk to memory.

In primitive implementations of overlaying, the operating system does not save a module on disk before overlaying it. In such an environment, the system can restore a module's *original* state, which resides on disk, but not a module's latest state. Although a module's code generally does not change during program execution, its local data *does* change, so a program must be carefully designed to avoid losing data during overlaying.

The RSX-11 operating system used by Digital Innovations supports a sophisticated overlaying method called swapping. In swapping, the operating system saves on disk the current state of an overlaid module, so local data have the correct values when the operating system restores the module in memory. RSX-11 automatically handles the transfer of overlays between memory and disk using the system's auto-loading mechanism.

Swapping does not solve all problems associated with overlays, however. In chains of subroutine calls, a procedure might be unable to return to its caller because the caller has been "swapped out" (Fig. 1a). Digital Innovations solved this problem by using "null procedures," which do not perform any operations.

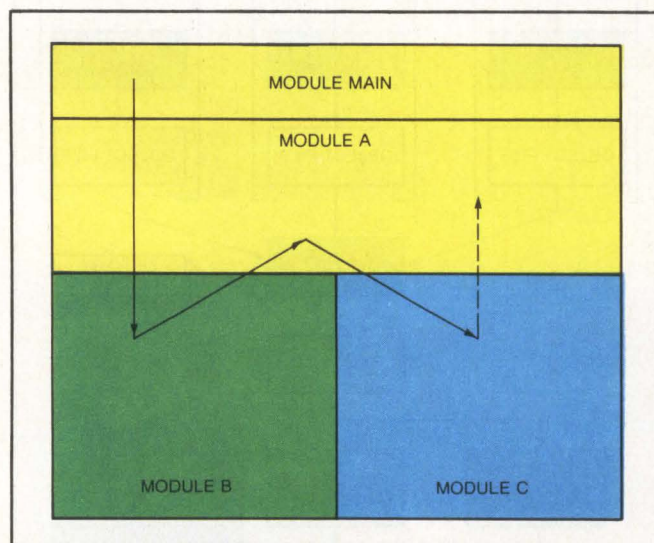

Fig. 1a. A "no-return" dilemma arises when the operating system swaps out a module in the middle of a calling chain. Here, module MAIN and module A are memory-resident, but modules B and C share an overlay. MAIN calls B, which calls A, which in turn calls C. To invoke module C, the operating system saves B on disk and then transfers C from disk to memory previously occupied by B. When C finishes, it returns control to A, but A cannot return to B because B is no longer in memory.

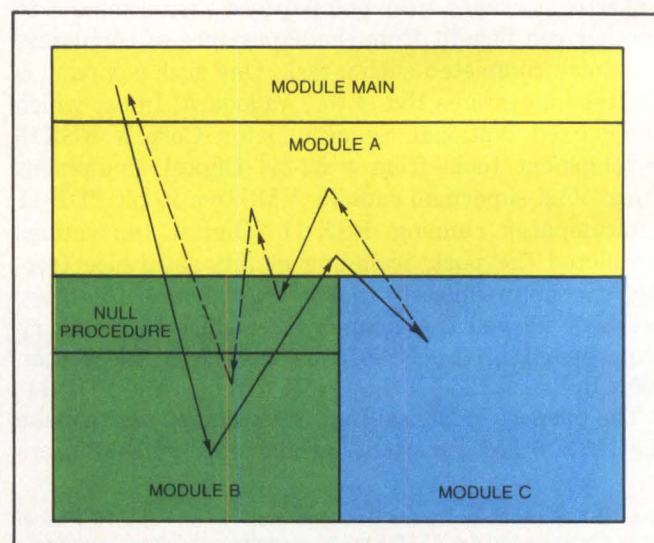
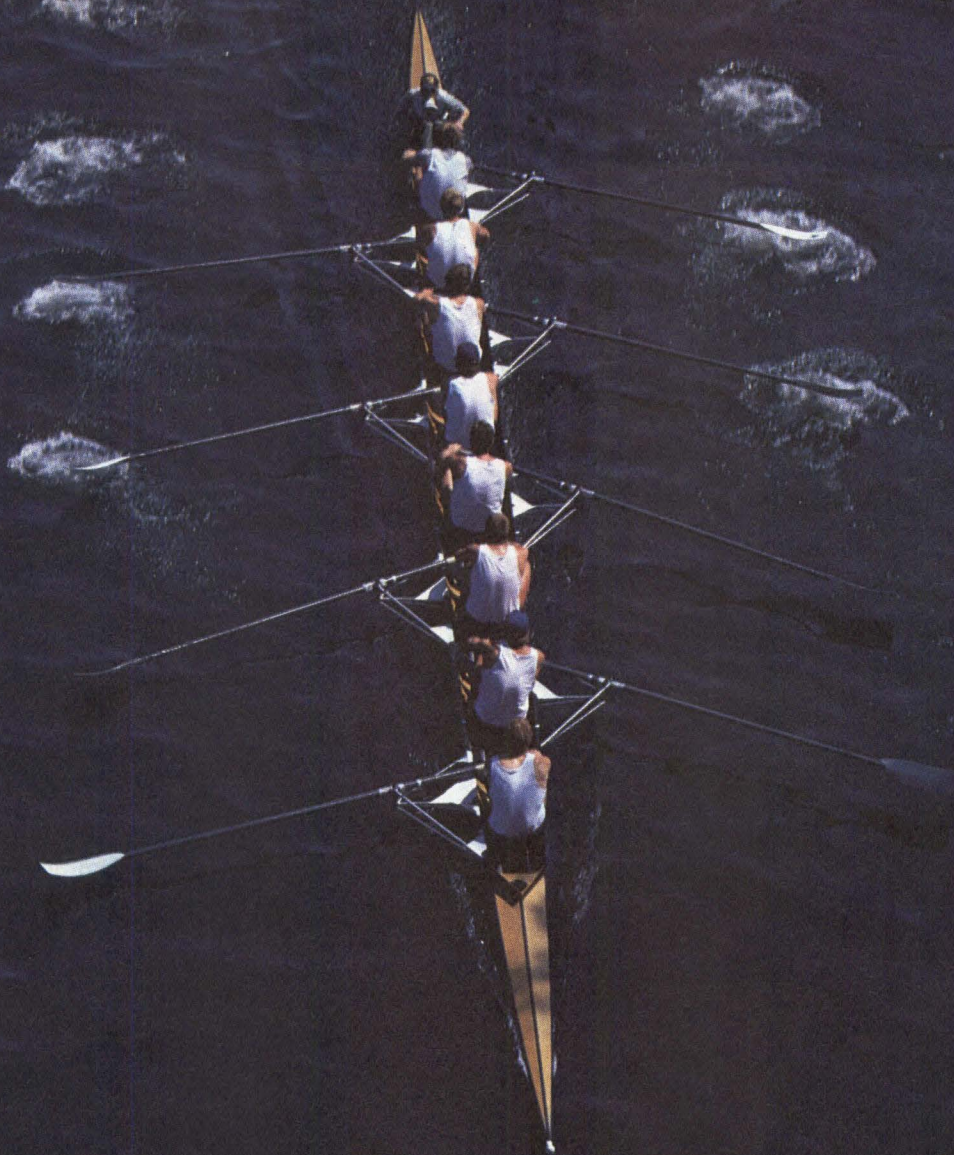

Fig. 1b. A null procedure solves the no-return dilemma. The calling chain remains the same except that module A calls the null procedure after completing all of its operations. Because the null procedure resides in the same overlay as module B, the call to the null procedure causes the operating system to reinstate B in memory. The null procedure itself performs no operations, so it immediately returns to its caller, module A. Now, module A can return to its caller, B, which completes the chain by returning to MAIN.



HOW WELL YOU MOVE IS DIRECTLY PROPORTIONAL
TO HOW MANY OARS YOU HAVE IN THE WATER.

YOU NEED A BROAD PRODUCT LINE TO PULL AHEAD.

We Give You A Choice Of Seven.

Designing information systems for all different kinds of businesses demands flexibility. Lots of it.

And you just can't have flexibility without choice.

Which is primarily why Okidata gives you the broadest line of OEM printers to choose from.

Seven models in all, with responding speeds from 120 to 350 characters per second... unlimited compatibility... up to three different print modes... black and white or color. And on and on. All the options you need to match the printer to the application, not the application to the printer.

A Broad Line Is Only The Beginning.

But Okidata's flexibility doesn't stop there. In fact, you've only rippled the surface. There's a highly qualified technical staff to quickly make the alterations that meet your special OEM requirements. There's software applications assistance, hands-on training support, a nationwide network of service people, and parts already stocked, already in-place, that can get to your place real fast.

An Invitation To Pull Together.

And Win. If you're putting together systems for all different kinds of businesses, it might make sense to choose the printer that pulls for you in

all the important directions. The one that already knows the way. Call us at 1-800-OKIDATA. Or write Okidata, Mt. Laurel, NJ 08054.



OKIDATA
an OKI AMERICA company

CIRCLE NO. 109 ON INQUIRY CARD

Pascal-2™

PROVING GROUNDS

Pascal-2 Performs in Implementation of the Vision System for Robots at GMF Robotics.

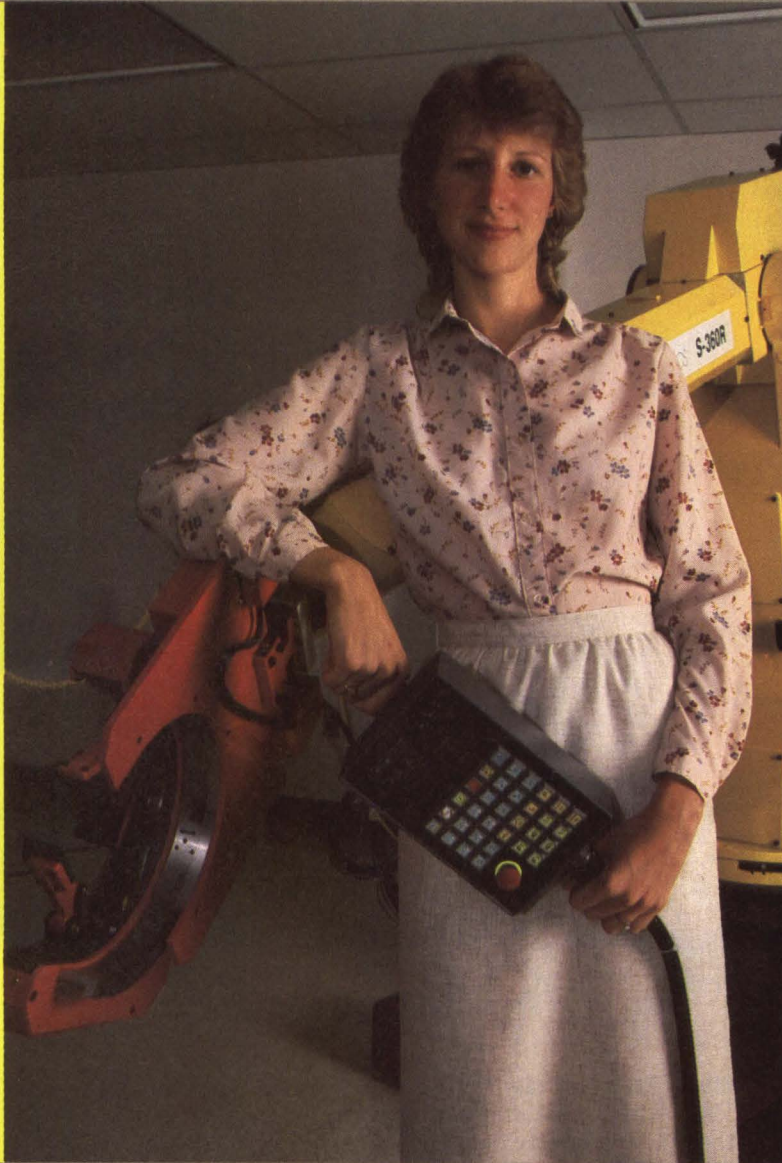

“Our hardware is very sophisticated and our process complex. We need machine access at bit level and the ability to access fixed addresses. Execution speed is critical to our process.”

Cindy Bronsky
Research Software Analyst
GMF Robotics
Troy, Michigan

Cindy Bronsky is using Pascal-2 as the implementation language for new products. The current project, a vision system, enables robots to react to changes in the environment. By eliminating hard tooling, robots with vision systems will have the flexibility necessary to orient, assemble, and inspect parts in the manufacturing process.

Why is Pascal-2 Ms. Bronsky's choice in software? "Compile time error detection. Conformant array parameter passing. The CASE 'OTHERWISE' clause. External subroutine compilation. Conformance to ISO standards. Pascal-2 documentation and customer telephone support."

To see how Pascal-2 meets your application needs, call

1-800-874-8501.

Oregon Software

2340 S.W. Canyon Road
Portland, Oregon 97201
(503) 226-7760

The Pascal-2 system is available on Digital's PDP, VAX and Professional Computer systems running on the RSTS, RT-11, RSX and Unix Operating Systems.

Digital, PDP, VAX, RSTS, RT-11 and RSX are trademarks of Digital Equipment Corporation. Unix is a trademark of Bell Laboratories. Pascal-2 is a trademark of Oregon Software.

CIRCLE NO. 110 ON INQUIRY CARD

NSX16 element	No. of lines	No. of procedures	Memory occupied without overlay (bytes)	No. of segments overlaid	Overlay size (bytes)
LINK16	9,188	97	53,344	6	20,432
PAS16	41,787	415	140,540	34	21,256
DGB16	18,130	202	109,676	26	26,156
ASM16	7,463	132	47,260	7	27,748
BIN16	3,538	11	30,708	1	30,708
LIB16	5,580	100	51,120	7	17,644

Heavy use of memory overlays reduces the total memory requirement of the six NSX16 components from 433K to 145K bytes.

Instead, they cause the operating system to reload the desired overlay so that program execution can continue (Fig. 1b).

In RSX-11, programmers can improve software performance by using memory-resident, rather than disk-resident, overlays. If more than 64K words of physical memory are available, RSX-11 permits over-

In chains of subroutine calls, a procedure might be unable to return to its caller because the caller has been 'swapped out.'

lays to reside in memory even when they are swapped out. The system loads these overlays by simply changing a software pointer to the address of the desired overlay.

Managing the overlays in the target NSX16 package was particularly difficult because the code is written in Pascal. The Pascal run-time library occupies an average of 22K bytes, even when overlaid. Pascal programs also rely heavily on stack operations, requiring large stack spaces averaging 15K to 20K bytes that cannot be overlaid. Global data also is difficult to split in overlays. Because of these constraints, the PDP-11 version of the NSX 16 package is heavily overlaid (above). For example, the PAS16 component requires 140,540 bytes of program space without overlays, but Digital Innovations squeezed it into only 21,256 bytes.

Variant records accommodate new word size

The VAX performs arithmetic on 32-bit quantities, whereas the PDP-11 performs arithmetic on 16-bit quantities. Digital Innovations accommodated this architectural difference by constructing a library of double-word (32-bit) arithmetic functions for the PDP-11 to implement the NSX16 package. Digital

Innovations created 14 such functions to perform all necessary arithmetic operations. One function, for example, converts a 16-bit integer to an equivalent 32-bit integer. These functions declare a 32-bit Pascal variant record that can be viewed as a Boolean variable; a floating-point variable; or an array of bits, bytes or words.

Unfortunately, the double-word functions to implement 32-bit arithmetic require changes to the program's source code. Moreover, what was once a simple arithmetic expression can become complex as function calls substitute for arithmetic operators.

When porting a program from one machine to another, the porting team often has to rewrite the source code in a different programming language or in a different version of the same language.

The NSX16 porting team accommodated differences between two dialects of Pascal. The original NSX16 package is written in Digital Equipment Corp.'s VAX Pascal, but the team wrote the target package in Oregon Software Inc.'s Pascal-2. The two versions of Pascal differ in several ways:

- VAX Pascal compiles procedures separately by recognizing a keyword called MODULES. Pascal-2 uses a compilation switch to perform separate compilation.
- VAX Pascal provides a pre-defined procedure called OPEN that opens a VAX/VMS file with specified characteristics. Pascal-2 provides additional parameters in pre-defined procedures RESET and REWRITE, which open a file and prepare it for I/O.
- In VAX Pascal, a FOR loop control variable can be declared at an outer level and used in an inner level. In Pascal-2, a FOR loop control variable must be declared in the level at which it is used.

In addition, Pascal-2 lacks some features of VAX Pascal. For example, Pascal-2 does not support dynamic array parameters and does not allow nested comments. Consequently, VAX Pascal has the pre-defined function UPPER, which returns the upper bound of an array parameter, whereas Pascal-2 does not. To accommodate differences between the two versions of Pascal and between VMS and RSX-11, Digital Innovations developed 23 Pascal-2 functions and three Pascal-2/Macro interfaces to replace VMS system and library utilities. □

Madhu Mehta is co-founder and managing director of Digital Innovations Pvt. Ltd., Vadodara, India. He received M.S. and Ph.D. degrees in electrical engineering and previously worked for eight years at GTE Corp., Chicago.

Interest Quotient (Circle One)
High 825 Medium 826 Low 827

Computer dreams.

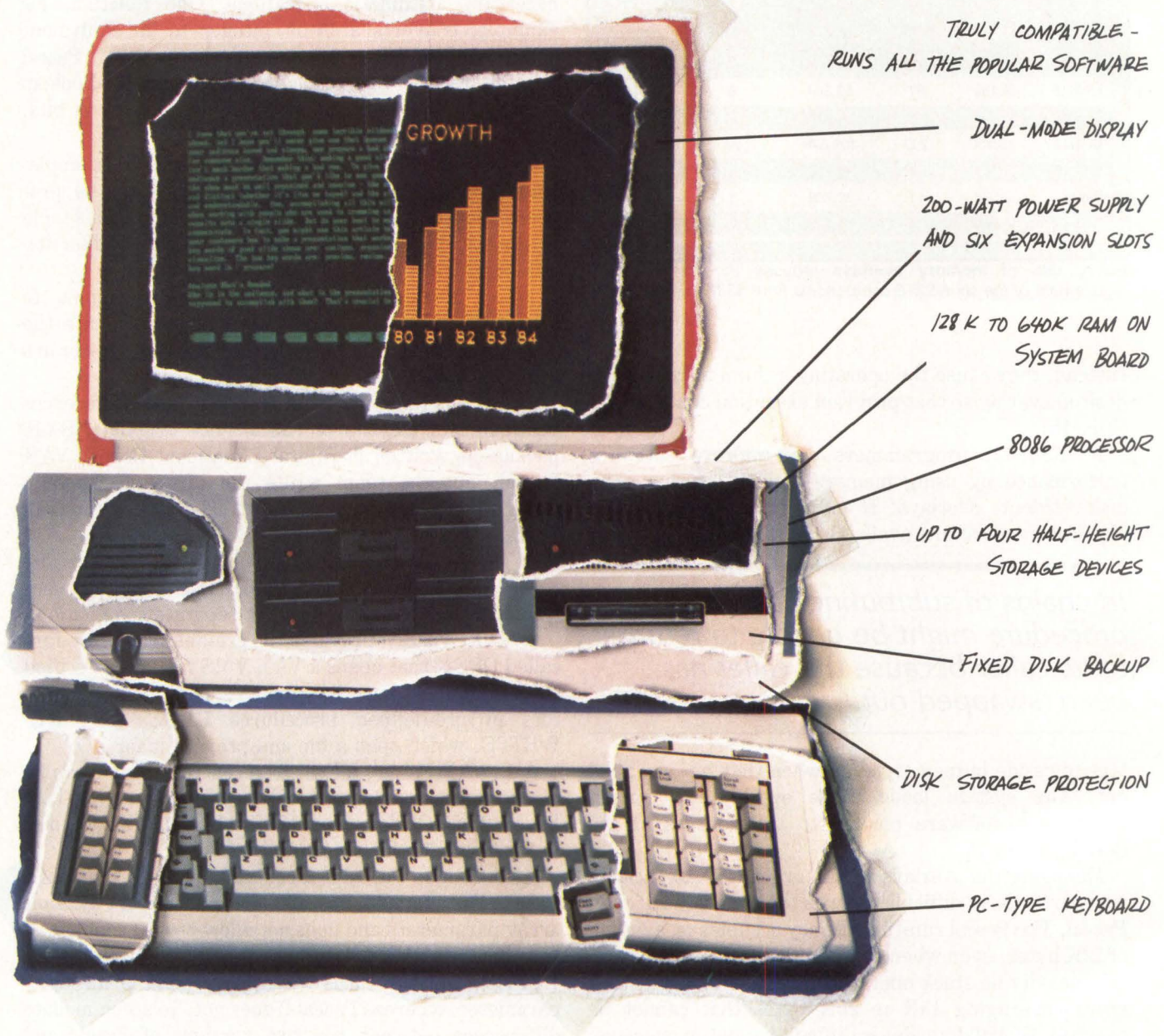

TRULY COMPATIBLE -
RUNS ALL THE POPULAR SOFTWARE

DUAL-MODE DISPLAY

200-WATT POWER SUPPLY
AND SIX EXPANSION SLOTS

128 K TO 640K RAM ON
SYSTEM BOARD

8086 PROCESSOR

UP TO FOUR HALF-HEIGHT
STORAGE DEVICES

FIXED DISK BACKUP

DISK STORAGE PROTECTION

PC-TYPE KEYBOARD

Introducing the new COMPAQ DESKPRO.[™] COMPAQ combined the best features of the best desktop computers. And then added exclusives you won't find on others. Today they're together in *one* personal computer. The COMPAQ DESKPRO.

The COMPAQ DESKPRO is the most expandable desktop you can buy. It can grow as you grow, with up to six available expansion slots and four storage devices, including a unique fixed disk drive backup—all *inside the computer instead of out*, saving your desk from clutter.

It's the most rugged desktop, too, because it's the only desktop with a shock-mounted mass storage compartment to help keep disk drives in alignment and help protect you from losing data, downtime, and dollars.

It's also the most compatible desktop, giving you true hardware and software compatibility with the industry's most popular personal computers. The COMPAQ DESKPRO runs thousands of programs written for the IBM[®] PC and XT right off the shelf. Which brings us to the next point.

Dream computer.

The industry leader in compatibility

Text and graphics on one screen, not two.

Power and space for almost unlimited expansion.

Add up to 640K of memory on system board and save expansion slots.

Runs software 2X to 3X faster.

*10MB fixed disk drive
10MB fixed disk backup
Two diskette drives*

Exclusive tape backup helps protect data.

Unique shock mounting helps protect your data and hardware investment.

Familiar layout enhanced with LED's on caps and num-lock keys.



The COMPAQ DESKPRO is the fastest truly compatible desktop you can buy. It's two to three times faster than the industry standard. That saves time now. And in the future, as software becomes more sophisticated and integrated, it will save you even more time as well as protect your personal computer investment.

But there's more. We gave the COMPAQ DESKPRO one other feature not found on any other machine. You can choose between an amber or green dual-mode monitor that displays high-resolution text *and* graphics with equal

brilliance, saving you the cost and clutter of a second monitor.

See the Dream Computer. Then pinch yourself. It's for real.

For the location of the nearest Authorized COMPAQ Computer Dealer, or for a free brochure, call 1-800-231-0900, Operator 5 or Telex #795437 COMPAQCOMP HOU.

The New

COMPAQ

DESKPRO™

It simply works better.

HOW TO CHOOSE A DISK DRIVE, PART II:

Computers designed for the office environment are in for a shock!



Here's a shocking fact: when someone sets a computer down on a desk, the disk drive inside can be subjected to a pulse shock as high as 30 g's. Obviously, if the disk drive (or any other component in your system) can't handle that kind of shock, your system runs the

risk of breaking down under rather ordinary conditions—like every time there's an office shuffle and people move their computers. What follows is some technical information on how we handle the problem in our high performance 5¼-inch Winchester disk drives.

Shock and vibration: twin problems

Shock, and the closely related problem of vibration, have come under intense study at ATASI Corporation, and for good reason: both can cause loss of data. A severe pulse shock can cause a

AN ENVIRONMENTAL IMPACT REPORT.

drive's head to "slap" against the disk, removing a "divot" of oxide material, along with the data written there. Severe vibration can cause the head to overshoot or undershoot a track, so that the head can't find the data it's seeking. In addition, vibration can fatigue components over time, and perhaps lead to premature failure.

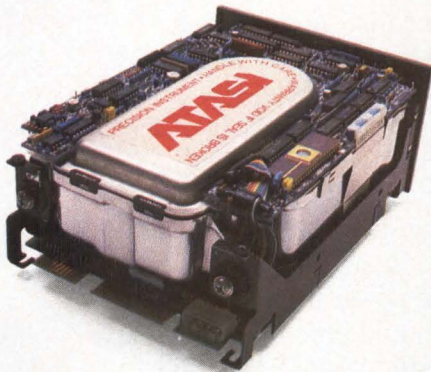

ATASI's 46 Mbyte, 5 1/4-inch Winchester disk drives are available in production quantities immediately.

Double shock isolation

In order to sustain high shock loads, the ATASI design incorporates a unique dual system for shock and vibration isolation. Like most disk drives, ATASI drives have isolators between the frame and the head/disk assembly bowl. In addition, ATASI's proprietary design includes elastomere isolators inside the bowl, between the bowl and baseplate on which the head/disk assembly is mounted. A foam pad with high damping properties, also located between the baseplate and the bowl, further protects the head/disk assembly from vibration.

The grommets ATASI uses for isolators are far from ordinary. To handle both pulse shocks and vibration effectively—to avoid a declining spring rate with displacement while maintaining adequate damping properties—ATASI tested 330 different options before

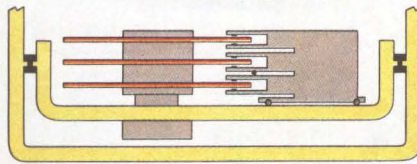

Most disk drives only have shock and vibration grommets (black) between the frame and the bowl.

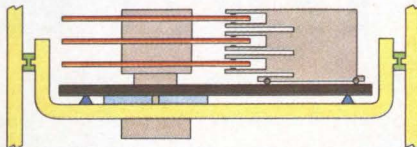

ATASI's proprietary design also includes isolators (blue) between the bowl and baseplate.

making a choice. These tests involved the use of a laboratory shaker as well as computer models.

ATASI's double isolation system more than protects its drives—and the data they store—from the shocks of the office environment.

Beyond the shock/vibration problem

Shock and vibration engineering is only one of a number of ways ATASI achieves such a high level of data integrity. ATASI drives also feature dedicated "landing zones." Upon powerdown—intentional or emergency—the back e.m.f. of the motor is used to position the carriage over data-free landing zones. A carriage lock then me-

chanically holds the carriage in place, protecting the data field from any head contact.

The ATASI White Paper

At ATASI, we are proud of the quality we build into every drive we make, and we encourage clients to test our products rigorously. To help, we have prepared a White Paper on shock and vibration for systems integrators. It discusses test methods and the interpretation of test data in detail.

If you are a systems integrator, contact ATASI Corporation now to receive your ATASI White Paper. Corporate headquarters: 2075 Zanker Road, San Jose, CA 95131, (408) 995-0335; Eastern region: (617) 890-3890; Southwest region: (714) 432-0757.



PERFORMANCE SPECIFICATIONS

MODEL NO.	3033	3046
CAPACITY	33 MB	46 MB
ACCESS TIME (AVG.)	30 ms	30 ms
DATA RATE	5 Mbits	5 Mbits
INTERFACE	ST 506	ST 506

Available in high volume today.

MODEL NO.	3065	3075
CAPACITY	65 MB	75 MB
ACCESS TIME (AVG.)	24 ms	24 ms
DATA RATE	5 Mbits	5 Mbits
INTERFACE	ST 506	ST 506

Available second quarter, 1984.

© 1983 ATASI Corporation

SOLVE YOUR SNA 3270 TESTING PROBLEMS BEFORE THEY HAPPEN.



(Without SNAtrace)

SNAtrace™ from Tekelec, Inc. It's one in a series of understandable, powerful protocol analysis software packages now available for our Chameleon Protocol Test System.

Eliminate protocol charts and guesswork from your testing repertoire. Instead, add an easy-to-use, intelligent interpretation of IBM's SNA/SDLC 3270 protocol—which includes not only the Link and Transmission Header, but also the Request/Response Header and Request/Response Unit.

Even more SNA 3270 software power from Tekelec lets you emulate an IBM host and front end processor. It's as easy as hooking up the Chameleon via standard RS232 cable to

your 3274 type cluster controller. A few keystrokes, and you're testing all six layers of SNA 3270 protocol compliance.

Solve your testing and network problems before they happen. Complete Chameleon multi-protocol test systems for X.25, SNA/SDLC, Bisync and Async development and support start at around \$18,000. If you'd like more information or a demonstration in your area, call us at **(213) 829-7305**.



Where testing comes first.

```

BLU FROM DTE  TIME 00:00:06.86  LENGTH=47

LINK HEADER = C1 00

ADDR = C1 CONTROL = INFORMATION N(S) = 0 N(R) = 0 P/F BIT = 0

TRANSMISSION HEADER = 2D 00 02 01 04 89
FID TYPE 2  ONLY SEGMENT EXPEDITED FLOW
DAF = 02  OAF = 01  SNF = 0489

REQUEST HEADER = 6B 80 00
SC F1 ONLY RU
DR11 = 1  DR21 = 0  ERI = 0  DEFINITE RESPONSE REQUESTED
RESPONSE BYPASSES TC QUEUES
CODE 0

RU LENGTH = 36

0000 31 01 03 03 B1 90 30 80 00 00 88 F8 00 00 02 00
0010 00 00 00 00 00 00 00 02 00 00 07 E3 E2 D6 F0
0020 F0 F4 F0 00
BIND — NONNEGOTIABLE
FM USAGE — PRIMARY LU PROTOCOLS FOR FM DATA
FM PROFILE = 03  TS PROFILE = 03
FM DATA USAGE (PLU) = B1  FM DATA USAGE (SLU) = 90
FM USAGE COMMON LU PROFILES = 3080
PACING SLU TO PLU = 00  PACING NCP TO SLU = 00
MAX RU FROM SLU = 88  MAX RU FROM PLU = F8
PACING PLU SEND COUNT = 00  PACING PLU RECEIVE COUNT = 00  LU TYPE = 02
PS VALUE CHARACTERISTICS = 00 00 00 00 00 00 00 00 02 00
CRYPTO OPTIONS = 00  CRYPTO ENCPH. MODE07
CRYPTO KEY: —

0000 E3 E2 D6 F0 F0 F4 F0 00
    
```

Tekelec, Inc.
2932 Wilshire Blvd.
Santa Monica, CA 90403
Telex: 182077
TWX: 910 343 6962

For European Inquiries:
Tekelec-Airtronic
Rue Carle Vernet
92310 Sevres France
(33) (1) 534.75.35
Telex: Teklec 204552 F

Intelligent I/O board extends S-100 systems to 16 terminals

Z80B-based board combines eight dual-channel serial communications controllers and resident operating system to bring 'front-end processing' to S-100-based microcomputers

Mike Pelkey, Macrotech International Corp.

Non-intelligent I/O boards must continually communicate on a character-by-character basis with a host to access files and application software. In small systems with, say, four users, a non-intelligent board does not noticeably restrict the host's operating speed. The greater the number of users, however, the greater the need for on-board intelligence and functions such as message-level communications, direct memory access (DMA) and dynamic allocation of on-board memory. An intelligent I/O board permits more users to run pro-

grams simultaneously from a single host without decreasing throughput. Macrotech International Corp.'s ADIT I/O board provides intelligent processing for S-100 based systems and supports up to 16 terminals, printers, modems or other serial devices.

DMA and on-board OS offload host processing

Because host operating systems usually perform I/O communications on a character-by-character basis, the host spends much time converting message levels to character levels. While the ADIT board has commands that allow operating systems to continue this approach,

The ADIT intelligent I/O board extends S-100 systems to as many as 16 terminals, modems or printers. While the ADIT board can enhance any multiuser operating-system environment, its on-board software specifically supports protocols for UNIX, AMOS or Digital Research Inc. (DRI) -based operating systems.

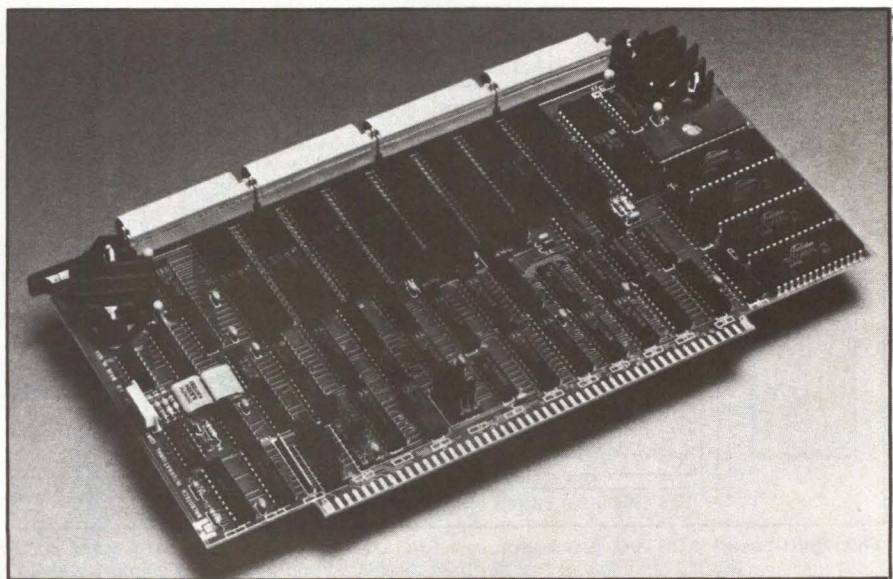

it also includes message-level commands. Because the ADIT can communicate with the host at the character or message level, it reduces the host's message-to-character conversion times.

Consider an output operation in which the host wants to send 32K bytes of data to a printer. The host operating system would normally check status throughout the transaction by pointing to each character in its memory, reading it, and sending it to the printer. In an ADIT-equipped system, the I/O board accepts the output command and address of the data and directly copies into its memory the information from the host while the host performs its regular application processing. This process is transparent to the host. After copying the information, the board performs the full output and informs the host when the command has been completed.

A number of firmware-implemented functions aid in offloading host processing. For example, on-board jumpers furnish a default channel configuration that can be dynamically reconfigured by commands from the host. Because of the jumpers, the board can initialize all lines without assistance from the host if all lines have the same setup. That would usually be the case if all lines are connected to terminals operating at the same baud rate. If the line setups are not the same, the host would have to reset, or reconfigure, the lines. The ADIT board accomplishes this dynamic reconfiguration via host commands.

Input commands can use one of three input-editing

protocols—Digital Research Inc.'s MP/M-86 or Concurrent CP/M, Alpha Micro Systems' AMOS or American Telephone & Telegraph Co.'s UNIX. Alternatively, the input commands can use one of four user-downloaded protocols. When input commands are in effect, the ADIT operating system (AOS) holds the incoming characters and responds to the terminal-editing control codes until an end-of-line character is received. A user can edit the input before the host is aware of any input from the terminal. The host receives the entire line through a DMA transfer to host memory.

The ADIT board implements DMA in accordance with IEEE-696 standards, using 24-bit addressing. The I/O channels can transfer data directly to and from host memory without tying up the host CPU. When the ADIT board uses DMA, it controls the transaction by issuing strobes, control signals and data to read or write in host memory.

Controlling the bus

In a DMA transfer, the ADIT first requests the host CPU to relinquish control of the bus. When the host acknowledges the request, the I/O board places the desired address on the bus. When writing into host memory, it also places the data byte on the bus. The board returns control of the bus to the host after the transfer is completed.

The AOS multitasking, real-time operating system resides in 8K bytes of ROM. All 16 channels have access to 16K or 32K bytes of RAM, which are divided into

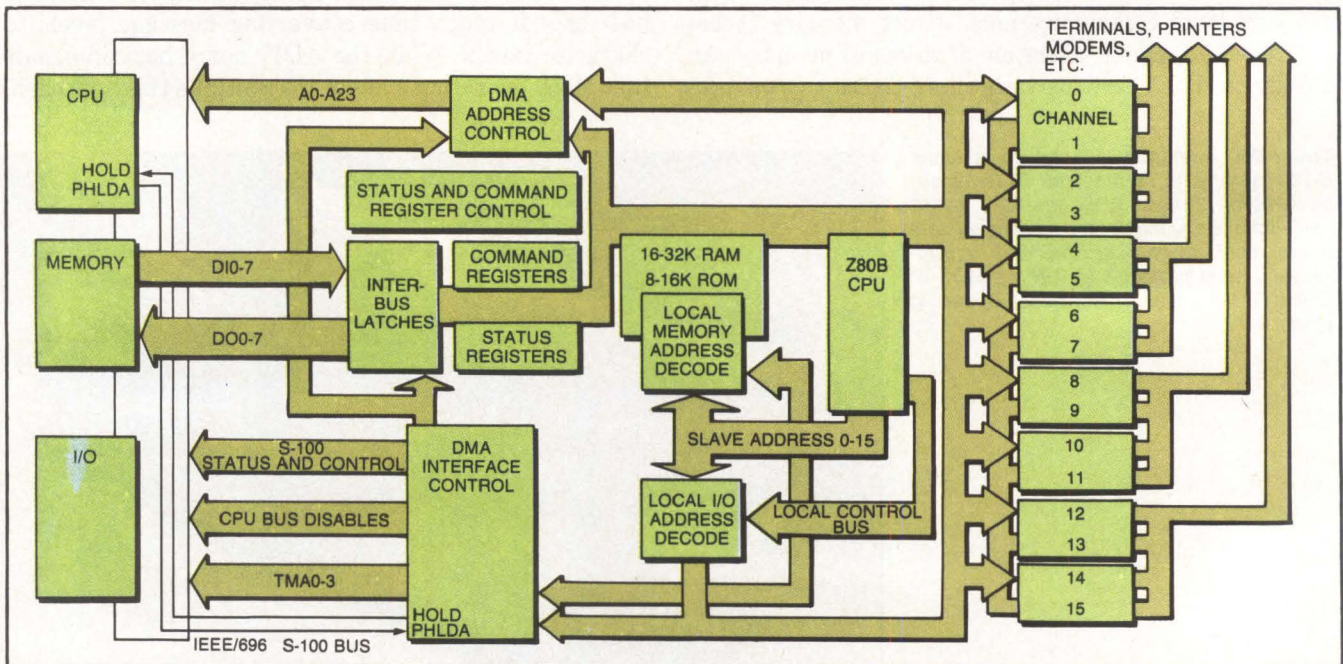

The Z80B-based ADIT I/O processor has 16K to 32K bytes of on-board RAM and 8K to 16K bytes of ROM. The board uses 24-bit DMA that enables I/O channels to transfer data directly to and from host memory without tying up the host CPU.

WORK FAST. BUT WORK SMART.

You've got to work fast to get ahead in the systems and sub-systems business. But you'll just spin your wheels if you don't also work smart.

That's why disk drive vendor selection is so important. And VERTEX is the smart choice.

We work fast. In our first full year of production we will deliver over 30,000 30MB, 50MB and 70MB V100 5¼" Winchesters. That's because the V100 was designed intelligently with a low parts count, simple assembly procedure and "off the shelf" components. This design approach provides greater manufactureability, but it also means higher reliability and margins.

Our new V185 85MB 5¼" Winchester is an extension of this design philosophy. The V185 family is based upon our V100 family. By increasing the number of tracks and track density, and maintaining the ST412 interface (with 5Mbit/second transfer rate) we've maintained our four-platter, eight-head configuration. So you get lower cost and higher reliability.*

And since few changes were made to upgrade the V100 family to the V185, we'll be able to get up the high volume production ramp faster.

Speaking of fast... the V185 also has a 30msec average access time (including settling) and a microprocessor interface that starts head arm movement at the first seek pulse.

Every VERTEX drive is backed by the best Winchester engineering and manufacturing team in the business. So get your system and sub-system plans going now. Call us at (408) 942-0606. Or write VERTEX, 2150 Bering Drive, San Jose, CA 95131.

It's the smart decision.

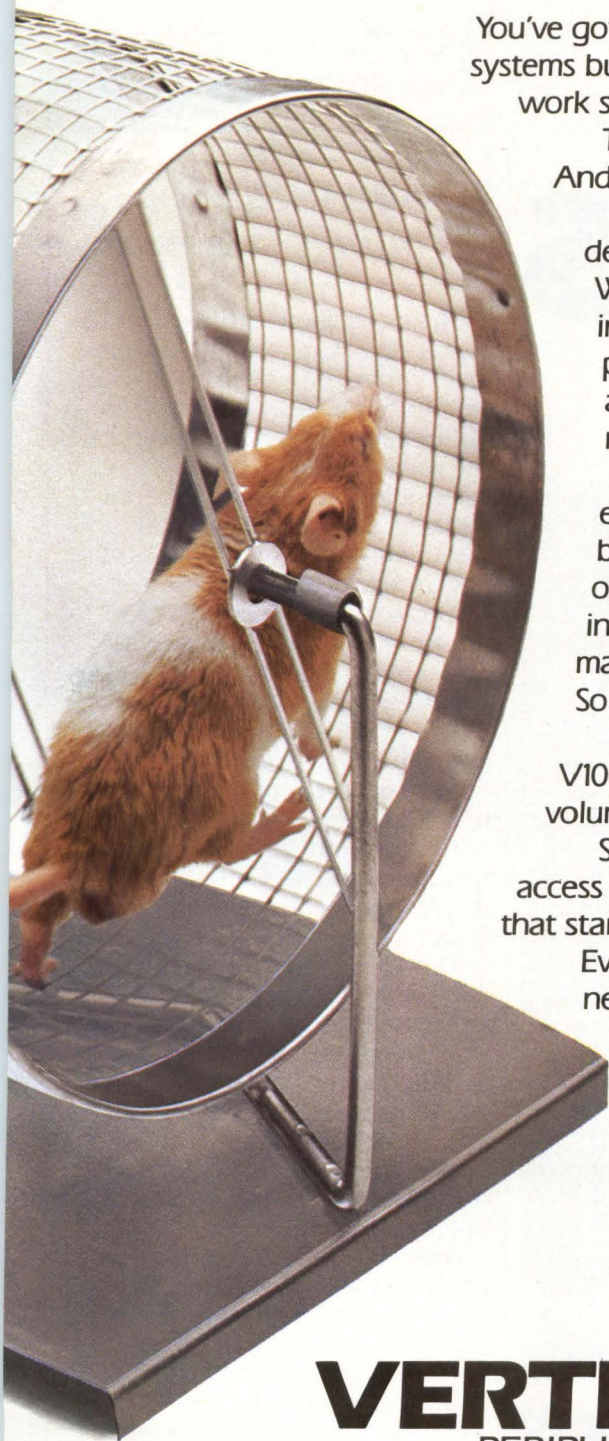

VERTEX
PERIPHERALS

You Can Plan On Us...

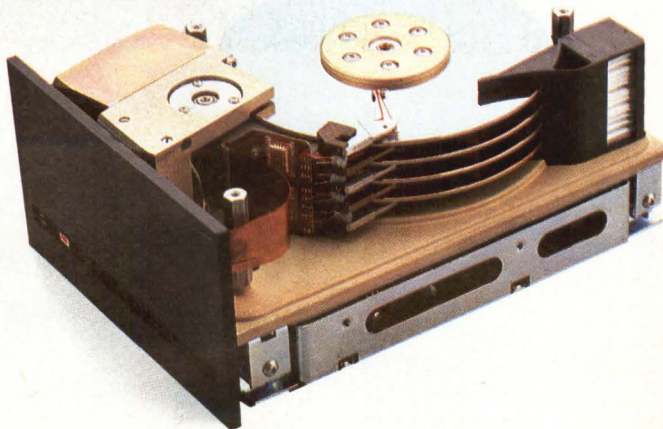

CIRCLE NO. 112 ON INQUIRY CARD

AT LAST! ALL 32 CHANNELS AT 9600



With 32 busy terminals, I ask a lot of my stat mux. ComDesign's TC-500A delivers.

228

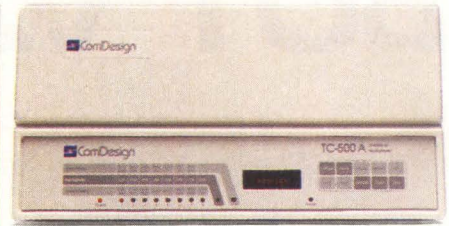

TC-500A: The performance you need.

The days when statistical multiplexers could almost, but not quite meet your needs . . . are past. The TC-500A from ComDesign is the difference between Almost and All the Way.

Deciding factors for a superior stat mux are the ability to handle very heavy loads without loss of data integrity or degradation of response times. Most statistical multiplexers perform adequately under light loads, but will fail when you need high volume performance.

The TC-500A can handle an aggregate input of up to 307,200 bps with 32 channels operating at 9600 bps. It provides error correction, network monitoring and diagnostics, and achieves exceptionally fast response times even under heavy loads.

The TC-500A is available with 4800 or 9600 bps integral modems and synchronous capability. Additional channel capacity can be installed in the field to allow convenient network expansion. ComDesign's unique modular firmware scheme provides easy access to available options and the latest operating software.

Bring *YOUR* data communications network up to speed with the power and flexibility of the TC-500A. To find out more, call ComDesign toll-free (800) 235-6935 or in California (800) 368-8092. TWX 910-334-1189.

 **ComDesign**

Leaders in Data Communications

751 South Kellogg Avenue
Goleta, California 93117
(805) 964-9852

discrete 32-byte packets. Each packet contains 4 bytes of chain-pointer information and 28 bytes of data-storage space. If a message is longer than 28 characters, the AOS links additional packets.

Spec summary

- **Company:** Macrotech International Corp.
- **Model:** ADIT board
- **Command ports:** number of ports: five, address width: 8 bits, address selection: any 8-byte boundary, data width: 8 bits
- **Direct-memory-access channel:** address width: 24 bits, data width: 8 bits
- **On-board processor:** CPU: 6-MHz Z80B, no wait states; ROM: 200 nsec., 8K or 16K bytes; RAM: 150 nsec., 16K or 32K bytes
- **Serial communications controllers:** speed: 6-MHz, master clock: 4.9152 MHz, number of channels: four, eight, 12 or 16
- **Transmission speeds:** synchronous: 1.23M bits per second (bps), asynchronous: 38.4K bps
- **Power consumption (+8V only):** four channels: 2.8A, eight channels: 3.2A, 12 channels: 3.6A, 16 channels: 3.9A
- **Price:** Four models from \$1,075 to \$2,125 in single-unit quantities, OEM and quantity pricing available

After the board transfers a group of 28 characters over a channel, it returns the empty packet to a pool of available packets. Each channel needing memory space obtains these packets from a pool. At any given instant, one of the 16 channels might not need memory or might need thousands of bytes of memory. The AOS dynamically allocates memory to the channels. This process is transparent to the host and to the user.

Balancing the load

The ADIT board uses closed-loop feedback techniques and dynamic allocation of on-board memory to maintain control during heavy usage. When the board is handling communications on multiple channels, some channels will be doing output from the host while others will be active on input. If the capacity is nearing saturation, the AOS slows down output-character handling by allocating less of the available memory to the output channels, while preventing data loss. However, the system must process input data as it occurs to prevent data loss or overrun conditions. The AOS maintains sufficient memory packets for input use so that input is not slowed and data is not lost. The AOS dynamically adjusts memory allocation as needed in the real-time environment to prevent data loss.

The host initiates I/O processing by issuing an immediate

command through the port interface. Four transfer commands institute the lowest level of interface transfer. These commands are single-character commands, as opposed to commands associated with extended processing. Using only the single-character commands, the host can communicate with the ADIT board with minimal change to the host operating-system I/O drivers. Most of the board's commands, however, are associated with extended processing that uses DMA. To use the extended commands fully, a programmer must make sophisticated modifications to the host operating system I/O drivers.

The host initiates extended commands by issuing an immediate command that includes a 24-bit address of the extended-command control block. The AOS interleaves commands that might not be processed immediately with commands on the other channels. The host determines completion of extended commands by polling for current status or by use of the interrupt system.

PALs and six-layer architecture concentrate logic

The ADIT is a six-layer, 5-by-10-inch printed-circuit board. Programmed-array-logic (PAL) integrated circuits contribute to logic concentration. All decoding and creation of output terms and subterms can be implemented on PALs, eliminating the need for separate chips. PALs communicate with the bus via tri-state and open-collector output structures in addition to normal totem-pole-type output structures. Further reducing the size of the board, the use of static RAM eliminates the need for additional refresh circuitry.

The Z80B-based ADIT board contains eight 8530 serial communications controllers with two channels on each controller. Each pair of 8530s connects to a single 34-pin ribbon connector that has four panel cards, each providing the cable connection for a single channel. In a fully implemented, 16-channel ADIT board, there are four ribbons with four channels each. Cards are available for RS232C, RS422 and RS423 line protocols. □

Mike Pelkey is executive vice president of Macrotech International Corp., Chatsworth, Calif. A founder of Macrotech, where he oversees all engineering functions, Pelkey has had extensive experience in designing S-100 systems. Before launching Macrotech, he was with International Micro Machines (IMM) Inc., a research and development company that he founded in 1975. At IMM, Pelkey was instrumental in the development of a multiprocessor-based cash-accounting network marketed by Unilever Ltd., a British subsidiary of Lever Brothers Inc. Pelkey developed S-100 products manufactured by Base 2 Inc.

Interest Quotient (Circle One)
 High 828 Medium 829 Low 830

Between Your System Micros Are Two Lines

Our Controller Line.

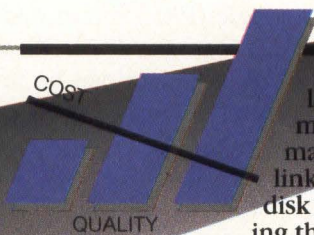
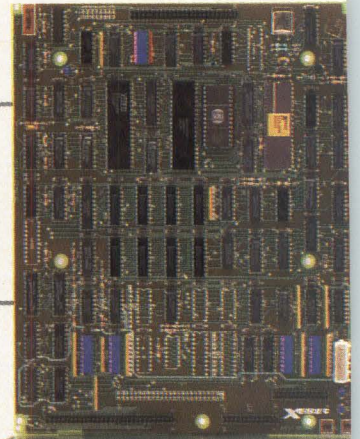
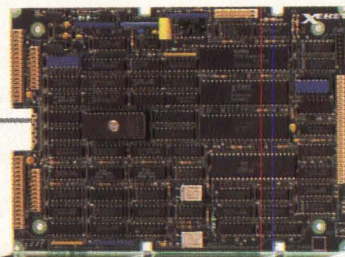

Smoothly and efficiently linking today's diversity of micros and disk drives is a major headache for OEMs. That link, of course, is made by a disk drive controller, and choosing the right one means walking a fine line between getting the performance and reliability you want and the amount of money you want to spend to get it.

Xebec is that fine line, featuring the most popular across-the-board offering of disk drive controllers in the industry—and backed with more expertise in solving disk drive integration problems than anybody else. Period.

More Choices. Fewer Decisions.

One mark of leadership is Xebec's wide array of disk drive controller products—designed, built and tested to match more microcomputers with more disk drive types. Off-the-shelf controllers for all the best-known standard drives. Controllers for 5¼-inch drives and for 3½-inch drives. For the growing number of half-height Winchesters. For fixed drive and floppy drive combinations. For fixed and removable combinations. And custom controllers that solve special integration problems.

Each is at the top of its class, providing high performance in the most demanding applications. Xebec's easy-to-integrate, single-board designs are based on reliable MOS microprocessors, integrated with the latest standard cell and surface mount IC solutions. A long list of performance and reliability features include, among others, sophisticated data separation, advanced error detection and correction, hard-fault isolation, and a high-level command set.

Because the Xebec controller line offers more and better solutions, you have to make fewer decisions. You'll spend less time comparing specifications, and less time trying to think up ways to work around some less-than-perfect match-ups between drive and controller. Less time on in-house testing and post-sales service. Less time sharpening your cost-cutting pencil.

Tested Pairs: Another Standard-Setting Solution.

Problem: Because our controllers perform so well, and so reliably, it's not always easy to find a disk drive that measures up to our high standards.

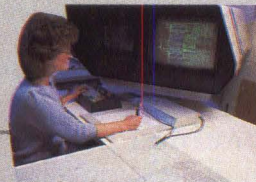

CORPORATE HEADQUARTERS
2055 Gateway Place, Suite 600
San Jose, California 95110 U.S.A.
(408) 287-2700

And Your System Disk Drive, To Consider.

Your Bottom Line.

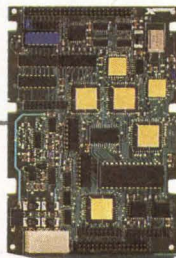
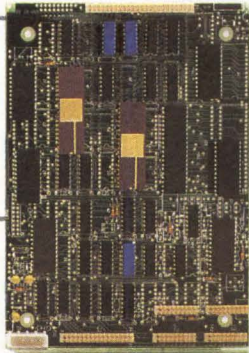
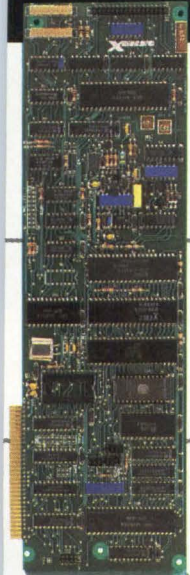

Solution: Xebec's tested pairs program that tests and matches drives and Xebec controllers, guaranteeing that they'll work in tandem, using Xebec-designed test equipment and Xebec-defined tough test standards. Available now in a range of capacities and configurations, tested pairs will help you cut down on evaluation and incoming inspection with a single-source, single purchase order solution you can trust.

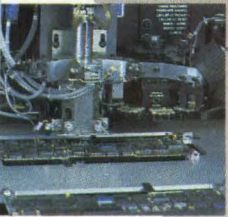

Our Bottom Line. And Yours.

Our "Xero D" signature defines the bottom line: zero-defect quality, companywide.

To make that happen, we've equipped our design engineers with the latest CAD/CAM facilities and equipment to make sure the quality is built in from the start. Test engineers have put together an imposing battery of test devices including a sophisticated drive tester used in our tested pairs program. We've made a multi-million dollar commitment to automated manufacturing.

These quality investments pay off on your bottom line. And in savings you make in up-front design, evaluation, inspection and no-hassle integration. In high-volume, high-quality products delivered on time. Most important, perhaps, you get to market faster, with added value that will keep you there longer.

So call Xebec now. Ask about our controller line. And we'll have a Xebec representative get right down to the bottom line with you.

Xero D.

SALES, INTERNATIONAL
Belgium
32-02-762-9494
England
44-734-693511
Italy
39-6-350201

SALES, U.S.A.
Sunnyvale, CA (408) 733-4200
Irvine, CA (714) 851-1437
Atlanta, GA (404) 457-9872
Boston, MA (617) 740-1707
Dallas, TX (214) 361-0687
Baltimore, MD (301) 992-7377
Federal (301) 621-3010
Chicago, IL (312) 931-1420

U.S.A. AND CANADA DISTRIBUTORS
Kierulff
Hamilton-Avnet
Avnet Electronics
Hamilton Electro Sales

XEBEC
*The Zero Defect
Company*

CIRCLE NO. 114 ON INQUIRY CARD

**DEC OFFERS EVERYTHING
YOU NEED TO BUILD A POWERFUL
Q-BUS COMPUTER SYSTEM.**

EXCEPT THIS.



It's called Cyclone.™ A high-capacity, high-reliability Winchester/tape storage system that's priced to help you blow the socks off your competition.

For starters, Cyclone's 5-1/4" Winchester packs formatted capacities from 36 up to 120 megabytes.

So you can sell your Q-Bus based systems (PDP®-11/23, 11/73, MICRO/PDP-11 and MicroVAX) into applications that require large amounts of storage. While providing the lowest cost per megabyte.

But, of course, we couldn't just offer you the highest capacity for the lowest price.

Rather, Cyclone is just what you'd expect from the leader in DEC®-compatible storage.

For instance, its controller

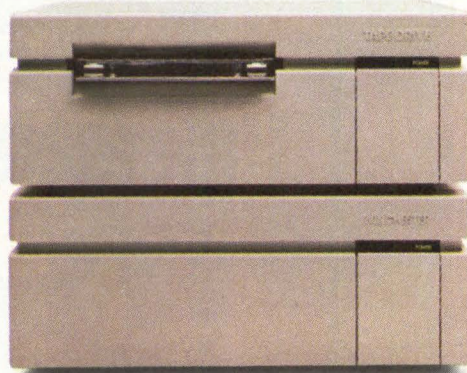

Our attractive StacPac version can be expanded to include a 6-slot backplane module.

takes data off the Winchester at non-interleaved speeds. So your system provides faster throughput.

And Cyclone's access times are twice as fast as a DEC RL02's.

When it comes to integration, Cyclone won't slow you down one bit. It's compatible with DEC's Digital Storage Architecture (DSA), so you don't have to make a single software patch.

Even the 1/4" tape cartridge

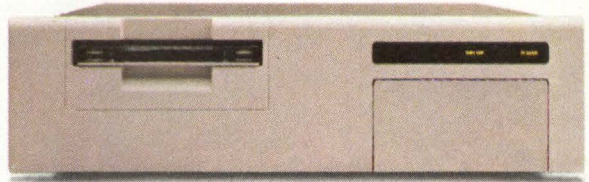

The ever-popular rackmount model gives you tape and disk storage in one unit.

system is software compatible. It emulates DEC's TSV05/TS-11 so you can run your DEC utilities like BRU, PIP, and SAVRES. Plus it puts a day's work on a single 1/4" tape cartridge. Instead of a supply room full of floppies.

Cyclone's good looks also make you look good. For your commercial customers, it's available in our tabletop StacPac™ version. And for scientific or industrial environments, Cyclone is rackmountable.

Finally, Cyclone features HyperDiagnostics™, the industry's most comprehensive self-diagnostic system. So troubleshooting's a breeze. And our Customer Service Hotline and Rapid Module Exchange program make it easy for you to keep your customers in business.

To see what Cyclone can do for your Q-Bus system, call the Qualogy sales office nearest you. And watch the competition's socks fly.

QUALOGY

Formerly Data Systems Design

Eastern Regional Sales: Norwood, MA (617) 769-7620. Southcentral Regional Sales: Dallas, TX (214) 980-4884. Northcentral Regional Sales: Chicago, IL (312) 920-0444. Western Regional Sales: Santa Clara, CA (408) 727-3163. Distributors Worldwide. Corporate Headquarters: 2241 Lundy Avenue, San Jose, CA 95131

™Cyclone, StacPac, Rapid Module Exchange and HyperDiagnostics are trademarks of Qualogy, Inc. *DEC, PDP and MicroVAX are registered trademarks of Digital Equipment Corporation. © 1984 Qualogy, Inc.

CIRCLE NO. 115 ON INQUIRY CARD

233

Dear Ma:

Good news! Racal-Vadic has immediate delivery on 212A modems.



**Ma Bell,
% Heaven**

Get this, Ma. Racal-Vadic's entire line of 212A-compatible 0 to 300 and 1200 bps full-duplex modems is available for immediate delivery.

212A Super-Mart

Racal-Vadic is a veritable 212A super-mart. They offer the industry's most complete line of dual and triple low-profile desk-top modems. Remote-terminal users can choose from 0 to 300 through 1200 bps modems including the economical, fully featured VA212LC, the sophisticated VA212PA auto-dial, or the VA3451 triple modem.

Rack-Mounted Modems for Computer Sites

Racal-Vadic lets you choose from a wide variety of 0 to 300 and 1200 bps full-duplex modem cards (switched network or leased line) to fill your central-computer and remote-multiplexer site needs: the new VA212PAR with built-in auto dialer and the VA3467 and VA3481 triple modems. These compact plug-in cards fit in a 16-slot rack-mount chassis featuring its own powerful displays and diagnostics.

Deal with Experts

Racal-Vadic's nationwide network of reps and distributors are data communications experts. They'll help you select the right modems or multiplexers, assist with installation, and be there when you need them. They're backed-up by Racal-Vadic's toll-free on-line diagnostic centers. One phone call puts you in touch with this free service.

Hey Ma... If you need a 212A modem NOW — call Racal-Vadic.

Your independent thinking son,

Alexander Graham Jr.

Product Information Circle No. 190.

Gone, but not forgotten.



Racal-Vadic

1525 McCarthy Boulevard, Milpitas, CA 95035
Tel: (408) 946-2227 • TWX: 910-339-9297

RACAL

Phone (800) 543-3000, Operator 507
For Free Ma Bell "Rest in Peace"
Poster Circle No. 189.

Simplicity is key goal in applications development

Structured analysis, processing logic trees, compilers, debuggers, operating-system extensions, kits from vendors—software development tools get more sophisticated. But the goal is to make them easier to use.

Carl Warren, Western Editor

Software developers face increased demand for more functionality from applications and operating software. In response, they are employing structured specification designs using variations on programmed logic trees, automatic application code generators, optimized compilers and linkers for code generation and software/hardware debuggers.

In addition, many developers rely on multitiered testing, such as evaluating the application concept, developing the user interface, and alpha and beta product testing.

Because the newest generation of applications is extremely complex, software developers are using mature methods to create the foundation specifications that define program operations. Metalogic Corp., Rancho Palos Verdes, Calif., favors the structured-analysis method to create foundation specifications. According to Metalogic president Lewis Barnett, systems are so complex that they must be broken down into component parts to ensure that all elements are addressed. "However," says Barnett, "care must be taken not to lose sight of the big picture—a major feature of structured analysis."

The structured-analysis method (Fig. 1) is a primary development tool used to create functional specifications. It can be used to define the elements of a complex system such as a maintenance-control system. In the structured-analysis method, the scope of the project is defined as a series of functions without losing the overall purpose. Furthermore, each function is defined with in and out information paths.

Structured analysis defines tasks as functions of other tasks. For example, data elements can be defined as functions of bigger elements (Fig. 2). This method allows the examination of a problem from two or three different angles, thus determining the overall flow

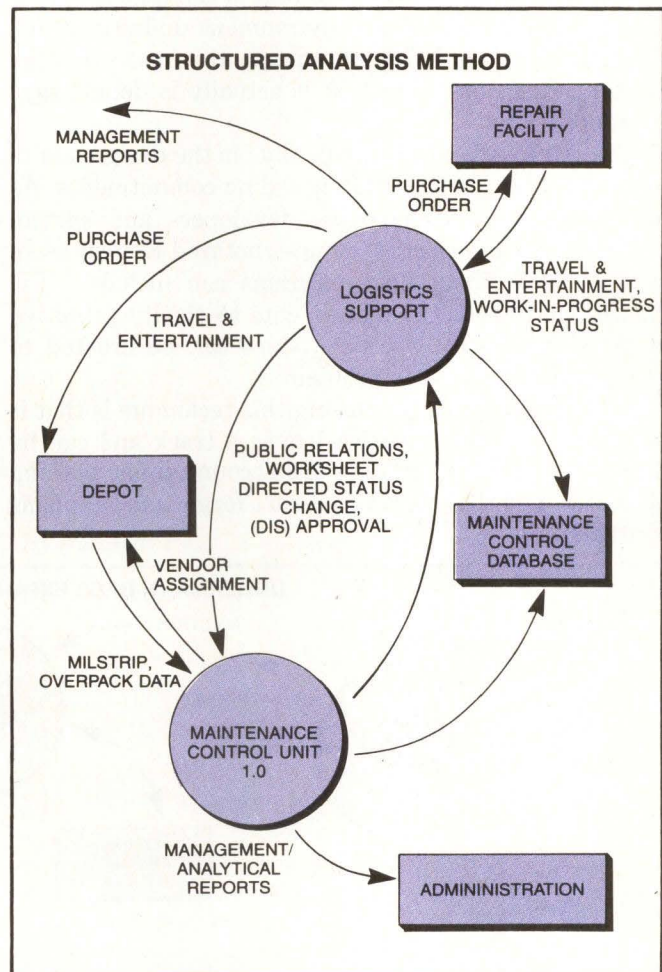

Fig. 1. A context diagram establishes a project's working environment and working boundaries. Each input donates an output to the next major element. The diagram shows all the major elements for a maintenance-control system.

between each process, as well as what should be in the data store or files.

Further structured analysis is important because it deals with outside entities to an internal process. For example, system integrators can identify where inputs originate and where outputs terminate (Fig. 3). Metalogic's Barnett explains that it establishes the context of the operation.

Barnett points out that by using structured analysis, system integrators aren't burdened with the actual data structure until it's absolutely necessary. "You break each part down into its constituent parts, then refine it to the primitive process. This is a process of hierarchical decomposition—you decompose the problem to the smallest element."

There are rules to follow, however. Specifically, structured analysis requires the conservation of data flow(s). Therefore, any set of flows (inputs and outputs) must be accounted for at the lowest levels. When using this method, the context diagram is the highest level, and it sets the system's environment definitions and boundaries. "You define graphically the function of the system. You don't care how it actually is done," says Barnett.

The purpose is to remain flexible in the design and to make decisions before making coding commitments. As the concept is decomposed, developers and system integrators can resort to using structured English as an add-on tool. Thus, flow diagrams can include "IF," "FOR" and "WHILE" statements to clarify primitive actions. Moreover, decision tables can be created to further decompose the problem.

"A major advantage of using this technique is that it is auditable. Each function leaves a track and can be traced—inputs and outputs are accounted for; nothing gets lost, and the overall goal isn't forgotten," explains Barnett.

To speed the creation of supporting data dictionaries and to keep track of decision tables and flows, Barnett employs the Informix relational database-management system from Relational Database Systems Inc., Palo Alto, Calif. By automating the bookkeeping functions, Barnett speeds documentation and uses data dictionaries in coding. "Basically, I use a full range of development tools. On the one hand, I have structured analysis as a thought-guide tool, and on the other, a database manager to keep the books in order, maximizing my skills. This is a system approach to creating systems."

Coding requires structure

Another important thought tool, used by application and system software developers, is the processing logic tree (PLT), developed by Dr. Randall Jensen of Hughes Aircraft Co., for handling complex software projects. The PLT technique employs standard flowcharting symbols, thus eliminating the requirement for users to learn new symbols. PLTs resemble structured analysis in that the big picture concept is never lost. The PLTs represent "step-wise refinements"—starting with a gross concept and refining and expanding it. The PLTs lend themselves to final refinement into code. Moreover, PLTs are inherently structured, thus eliminating "GO TO" statements.

Another important aspect of using PLTs is that they avoid the "double-think" problem, which until now has been rampant in the software industry. This problem arises when software developers put the lowest-level portions of the program first, then refer back to them. Employing a structured step-wise methodology bypasses this pitfall. What's more, programs written

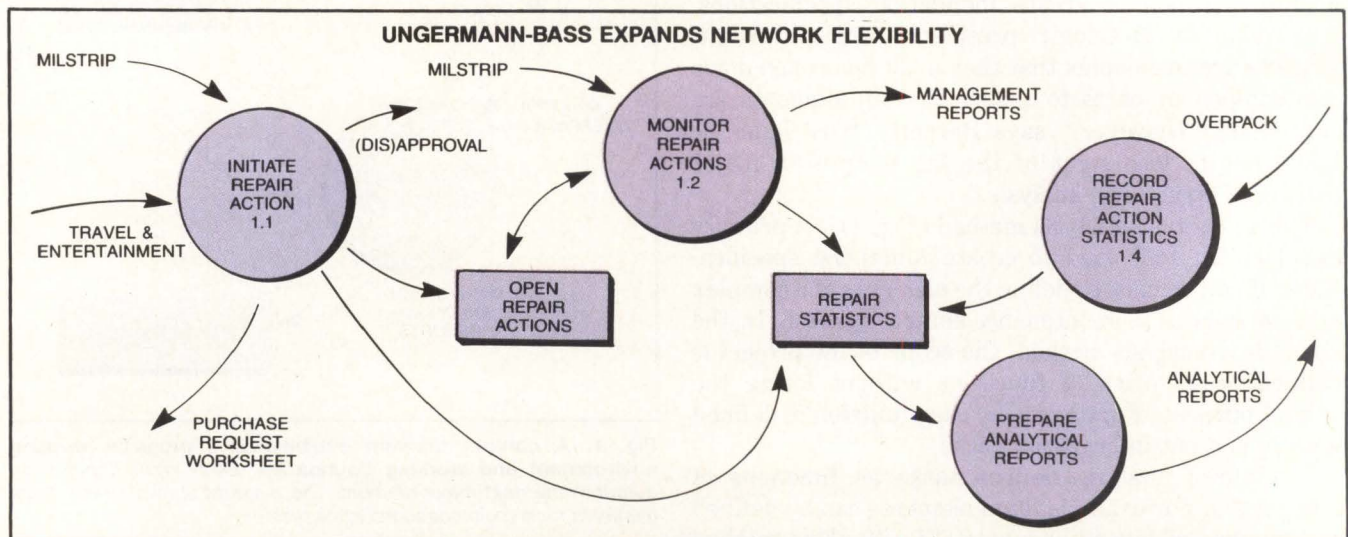

Fig. 2. Data elements are defined as functions of bigger elements. The maintenance-control unit comprises multiple functions with numerous inputs.

Gould . . . Innovation and Quality in Software

CELEBRATE!

New UNIX™-based software tools bring projects in on time, within budget.

Get your hands on our UNIX tool kit. Take out the Gould Software Division 4.2 UNIX with System V enhancements. You'll know it. It has a fast file system, automated system configuration, interactive debugging, and a Source Code Control System that compresses files for more efficient disk storage.

Then grab The Newcastle Connection, an ingenious tool that lets you create a distributed UNIX file system in a LAN by uniting heterogeneous UNIX versions and hardware environments.

Next, try the Unicellerator™, a high efficiency, user transparent tool that dramatically increases productivity under UNIX by offloading CPU intensive jobs from the host. The Unicellerator is available to *all* users of a system simultaneously.

The kit also contains a Cross Development System for developing and interactively debugging C language programs under UNIX that will run on Motorola® and Intel® microprocessors. The heart of the system is a C lan-

guage compiler that generates compact, efficient code that reduces code space by 20-40% and increases performance by an equal amount. For programmers who want to develop Macintosh™ applications in C under UNIX, our Macintosh Cross Development System will do it four times faster than Apple®'s Lisa™-based environment.

Our UNIX tools are available individually or as a complete, well-integrated set. The sooner you get your hands on them, the faster you'll finish your development projects. And that's worth a toast any time. Contact Gould Software Division, 1101 East University Avenue, Urbana, Illinois, 61801. (800) 952-8888 or (217) 384-8500.

UNIX is a trademark of Bell Laboratories
Apple is a registered trademark of Apple Computer, Inc.
Motorola is a registered trademark of Motorola, Inc.
Intel is a registered trademark of Intel Corporation
Lisa is a trademark of Apple Computer, Inc.
Macintosh is a trademark licensed to Apple Computer, Inc.

CIRCLE NO. 117 ON INQUIRY CARD

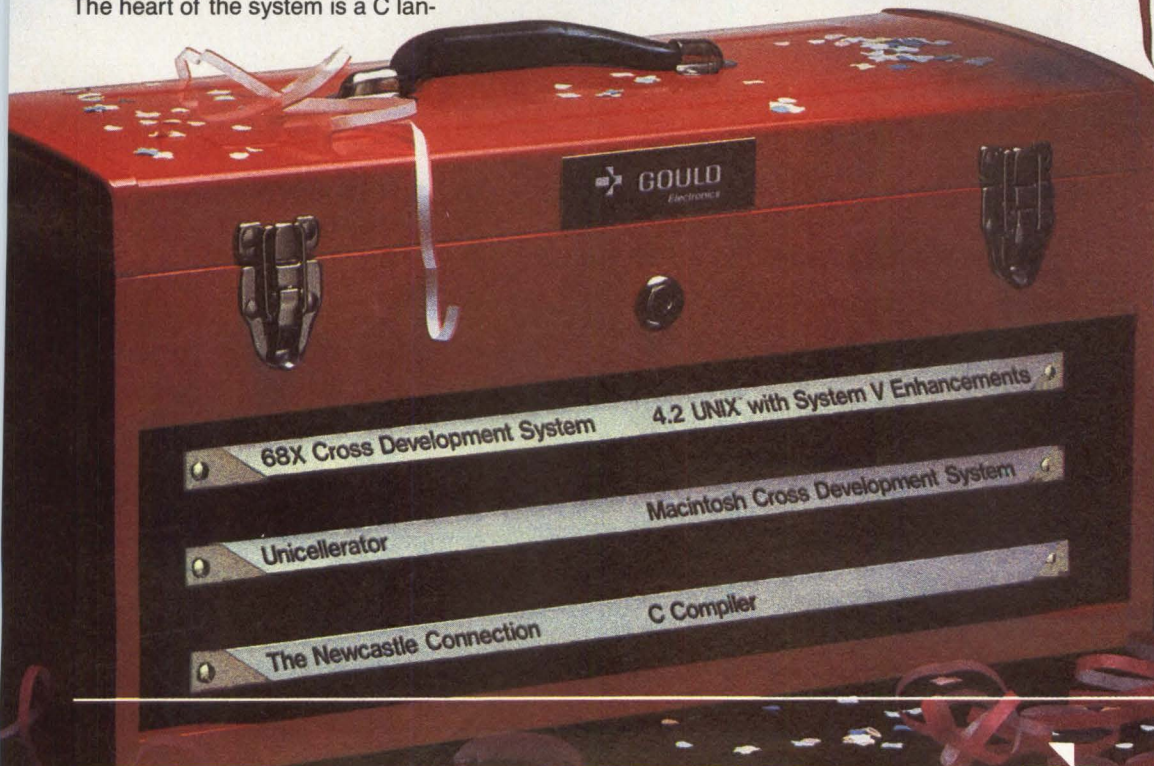

GOULD
Electronics



**If you have one of these,
Infotron can have you
communicating data
in just 48 hours.**

**Modems and stat
muxes, to go.**

Infotron offers a complete line. And now, with our unique distributor warehousing program, we can have any of them on your doorstep within 48 hours of your call. 48 hours, max. Just say the word.

Full system flexibility.

Infotron modems combine advanced features and inherent reliability.



Our statistical multiplexers handle from 4 to 32 channels in a range of models—with full provision for expansion.

All with the same high quality that earns us top marks in performance and reliability from our present users.

Add competitive pricing, and we start making real sense.

Then add our 48-hour delivery,

and we're awfully hard to beat.

1-800-345-4636

**To find out more.
Your Infotron distributor.**

There are Infotron distributors nationwide, ready to give you more information, provide equipment and offer expert advice on the best way to meet your needs. For the name of the distributor near you, dial toll-free 1-800-345-4636 and ask for ISO. Or write Infotron Independent Sales Organization, 9 North Olney Avenue, Cherry Hill, NJ 08003.

**Infotron. First in
performance and reliability.**



CIRCLE NO. 118 ON INQUIRY CARD

from the top down make maintenance easy.

One company that is using this method for development is Query Computing Systems Inc., Torrance, Calif. "Our users typically require a complete set of documentation to provide proper maintenance of the code," says Query president Steve Bostwick.

According to Bostwick, the goal of the structured step-wise method is to bring mainframe techniques to microcomputers. "Microcomputer programs are harder to create. The tools aren't there. You have to build them and be aware of the limitations imposed by the microprocessor and the system architecture."

Query and other developers use "conceptual tools." Included in that category are PLTs and reference manuals to coordinate the work and to set programmer standards. The documentation required includes the design specification, which is created using structured analysis, the as-coded maintenance specification with flow diagrams in the form of PLTs and a users manual.

For large projects, many developers first create the users manual and then code to it. The PLTs, developed in concert with the users manual, serve as a map. For example, to create a search function (Fig. 4), the operation is defined as a series of step-wise operations,

or elements. Each element is defined in terms of operation with cause-and-effect relationships defined, giving the programmer directives on how to and what to code.

These created functions become part of a utility library that Query's Bostwick explains is the same as capital equipment is to a programming shop.

Because Query relies heavily on PLTs in its development work, the company has automated the process in much the same manner as Metalogic has for structured analysis. However, Query has added an extra benefit. "The creation of PLTs can be time-consuming and often cumbersome. Therefore, we use a database of the functions and employ a plotter to perform the actual drafting," notes Query's chief engineer Steve Cook. Besides automating the drafting, Query gains additional benefits because the company need only update the database; the computer redraws the PLT. In addition, the plotter output is used in the specification documentation.

Although it would seem that it takes a master programmer to use the tools, Query's Bostwick insists that isn't the case. "If the personnel who are going to do the programming are capable of writing a decent essay

Fig. 3. A system's inputs and outputs, when defined by structured analysis, become auditable and have clearly structured links to every system level.

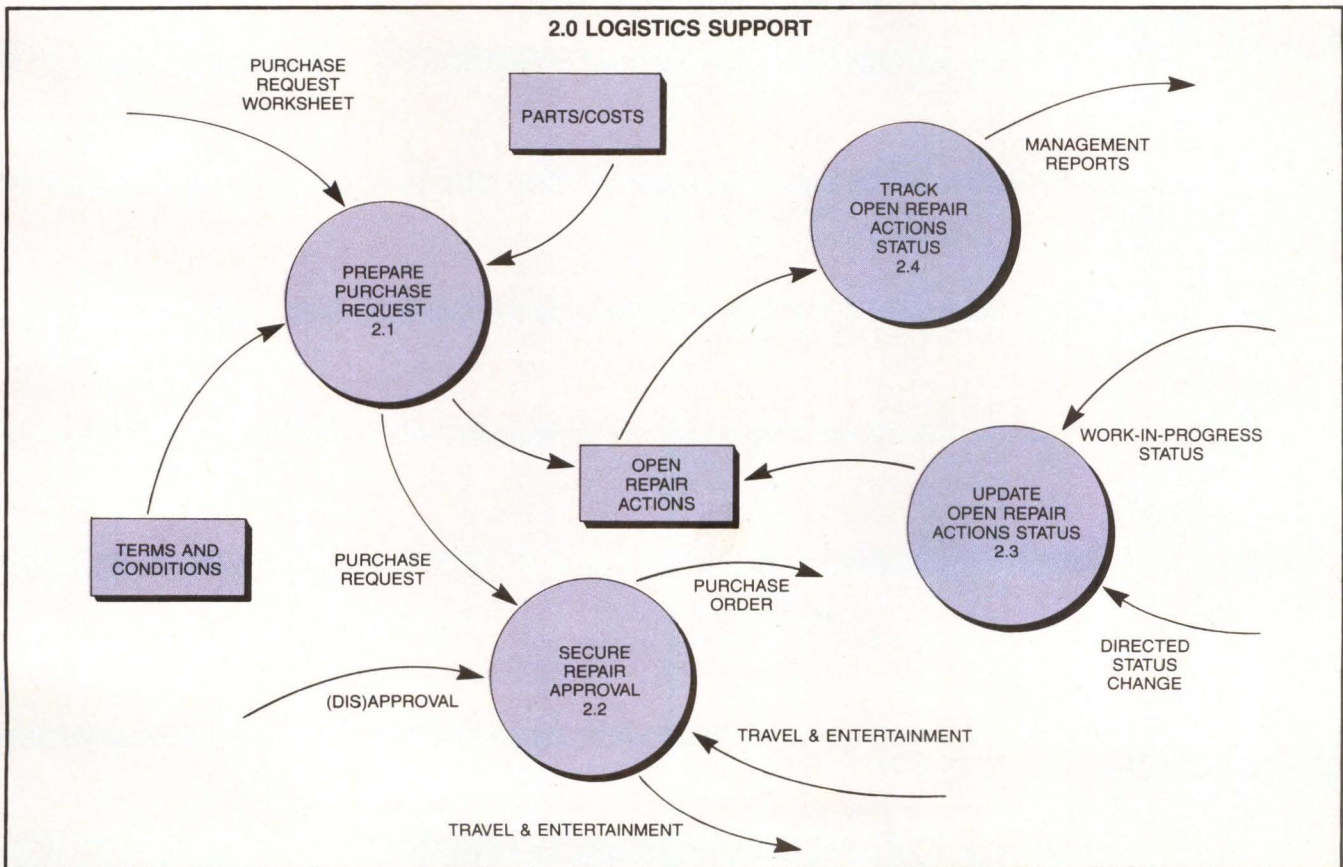

UDS Modems—

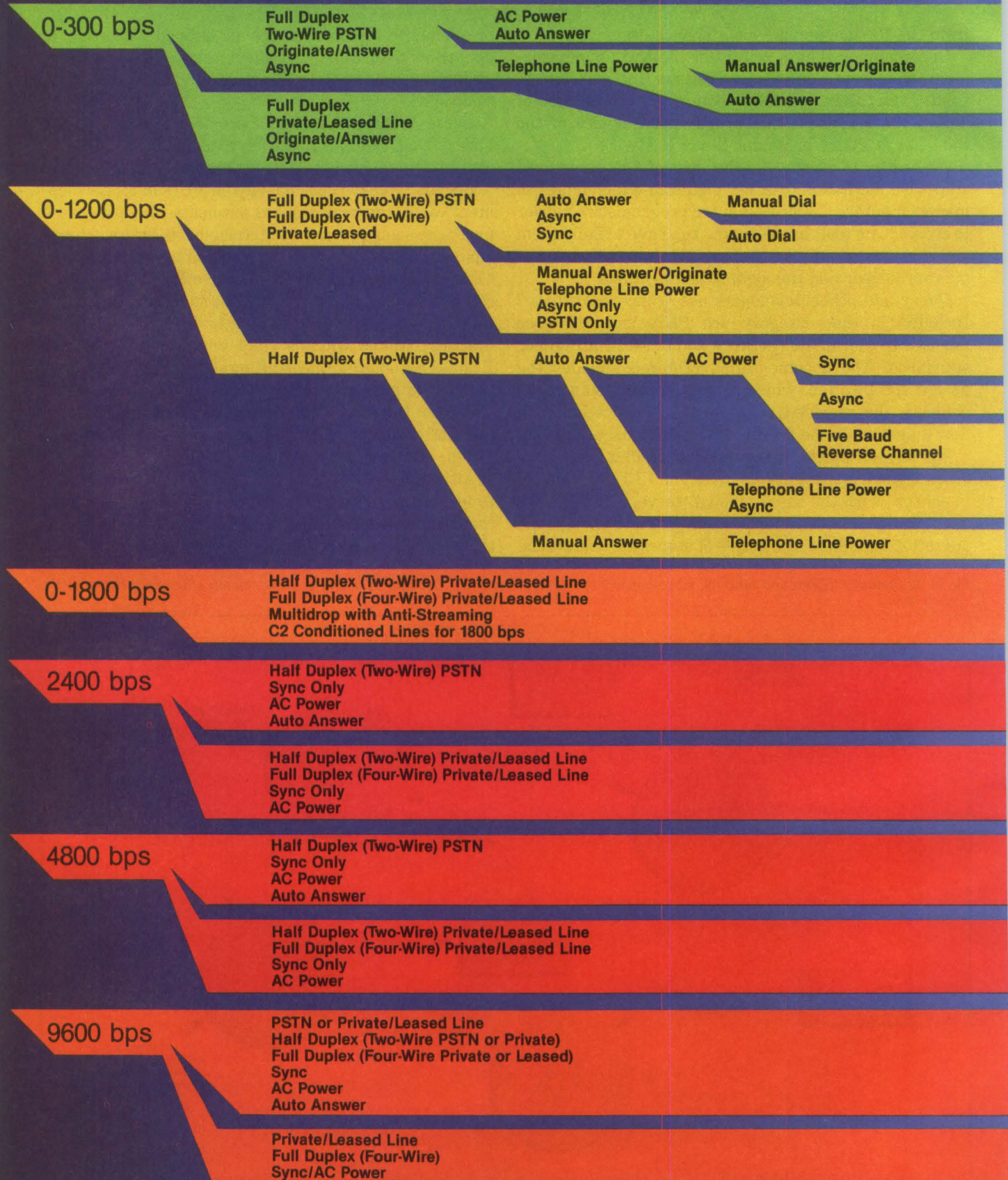

GLOSSARY: **Private/Leased Line:** A line that is not dialed, also termed a dedicated line.
Telephone Line: A dial-up line on the public phone network. Also termed PSTN—Public Switched Telephone Network (formerly called DDD).

Easy to Buy,

Advantageous to Own



103J

103 LP 0/A

103J LP

108

212A

212A/D

212 LP

202S/SS

202S

202S/5

202S LP

202 LP

202T

201C

201B

208A/B

208A/B

9600A/B

9600

If you have decided on the speed for your data communications system, the decision tree at left will make it easy for you to select the proper UDS modem. Start with the speed, make decisions such as synchronous/asynchronous, full-duplex/half-duplex or dial-up/dedicated lines, and you'll be led to the right decision!

The decision tree *doesn't* show you the ownership advantages inherent in your choice of a UDS modem. They include competitive prices, one of the industry's best reliability records and a history of exceptionally helpful customer support.

Easy specification and ownership advantages make Universal Data Systems the logical choice as your modem supplier. For additional specifications and price quotation, contact Universal Data Systems, 5000 Bradford Drive, Huntsville, AL 35805. Telephone 205/837-8100; TWX 810-725-2100. **Inquiry Hotline: 800/633-2252, ext. 352.**



 Universal Data Systems

 **MOTOROLA INC.**
Information Systems Group

UDS Modems are offered nationally by leading distributors. Call the nearest UDS office for distributor listings in your area.
DISTRICT OFFICES: Atlanta, GA, 404/998-2715 • Bellevue, WA 206/455-4429
Blue Bell, PA 215/643-2336 • Boston, MA, 617/875-8868 • Columbus, OH, 614/895-3025 • Englewood, CO, 303/694-6043 • Glenview, IL, 312/998-8180 • Houston, TX, 713/988-5506 • Huntsville, AL, 205/837-8100 • Mountain View, CA, 415/969-3323
Old Bridge, NJ, 201/251-9090 • Richardson, TX, 214/680-0002 • Silver Spring, MD, 301/587-0166 • Tampa, FL, 813/684-0615 • Tustin, CA, 714/669-8001

CIRCLE NO. 119 ON INQUIRY CARD

Created by Dayner/Hall, Inc. Winter Park, Florida

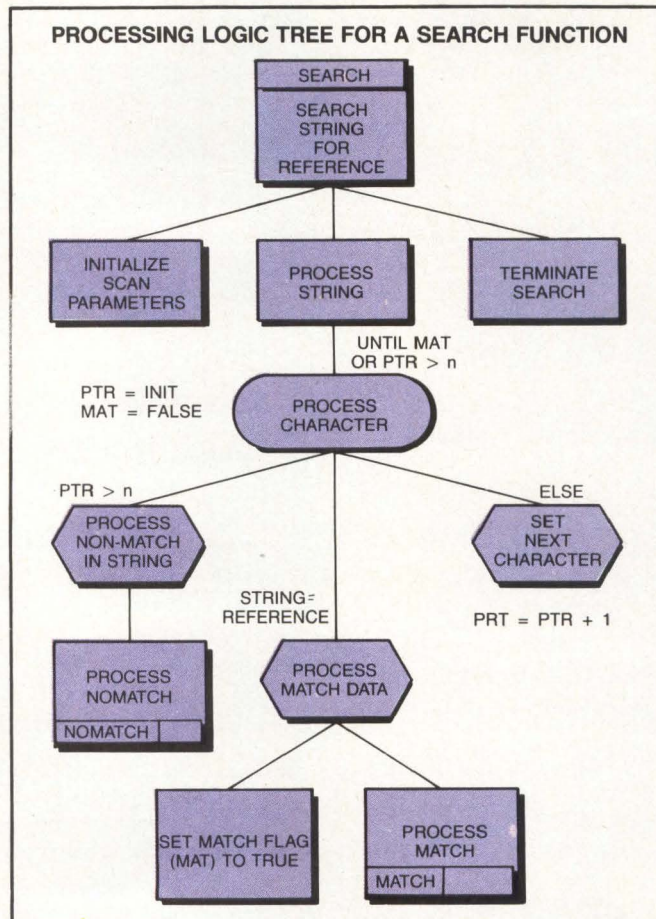

Fig. 4. Using standard flowcharting symbols and step-wise refinements, PLT's permit the decomposing of complex processes into straightforward "byte-sized" parcels. PLT notation permits the indication of subroutines, indexing and counters.

and are provided with the proper tools to do so, they can create a decent program. The trick is to give them the proper tools, guidelines and motivation—the fallout is the program.”

Once the specification for a software product is created, developers and integrators turn to sophisticated software and hardware tools to create the application.

Some developers shy away from commercial tools, insisting they are too restrictive. Typically, tracers and automated documentation products don't take into account all the parameters the developer is concerned with, thus giving rise to in-house-created tools such as those used by Metalogic and Query.

But even though some developers are wary, all agree that a number of commercial tools, including compilers, linkers and debuggers, are important to ease development tasks. According to Jeff Harbers, associate manager, productivity software group for Microsoft Corp., Bellevue, Wash., optimized compilers, linkers and debuggers are musts for developers. “We are

primarily a C house and as such have created special versions to develop our products. In concert with this, we employ software-tool experts to maintain the tools.”

Although Microsoft has developed specialized in-house tools, it also offers developers a range of products, including Windows, which the company terms an “operating-system extension.” To assist developers in the use of Windows, Microsoft is providing a tool kit that comprises Windows and a C and Pascal compiler for \$795. The company plans to ship the tool kit this month to qualified developers.

Other tools exist too

Microsoft isn't the only software vendor offering tools. For example, system integrators can develop applications for dBase II from a wide range of available application generators. These programs, serving as front ends, permit the generation of screen formats and ultimately the database structure without requiring an in-depth understanding of how the dBase II application-development language works.

Another popular package is Quickcode from Fox & Geller Inc., Teaneck, N.J. Priced at \$295, Quickcode lets integrators create an application and command files and provides hooks to export data to Micropro International Corp.'s WordStar word-processing package. Another similar product is the \$195 Autocode developed by Stemmos Ltd., San Francisco. This application generator works much like Quickcode and furnishes field numbering on the screen layout. In addition, the dProgrammer product from Sensible Designs Corp., San Diego, looks like Autocode and has the same price. It, too, speeds the generation of dBase applications.

Although speedy compilers and code generators are important aspects of application development, tools that locate problems are equally important. Typically, most developers and integrators employ a variety of debugging aides to locate problems and make patches. Probably the leader in software debugging aids is Digital Research Inc., Pacific Grove, Calif., which recently introduced the DR Assembler Plus tools. The tools include an assembler, a linker, a debugger, a librarian and a cross-reference utility. The \$200 package operates with the CP/M family, PC-DOS or MS-DOS.

Offering a similar approach to debugging is the Mylstar Symbolic Debugging Program created by Mylstar Electronics Inc., Northlake, Ill. This \$120 package provides full macro command functions and trace, breakpoint and debugging facilities. Like many other software tools, it operates in the MS-DOS and PC-DOS environments.

Because both systems and software are becoming more complex, software tool manufacturers require innovative approaches. For example, the \$2,495 PC

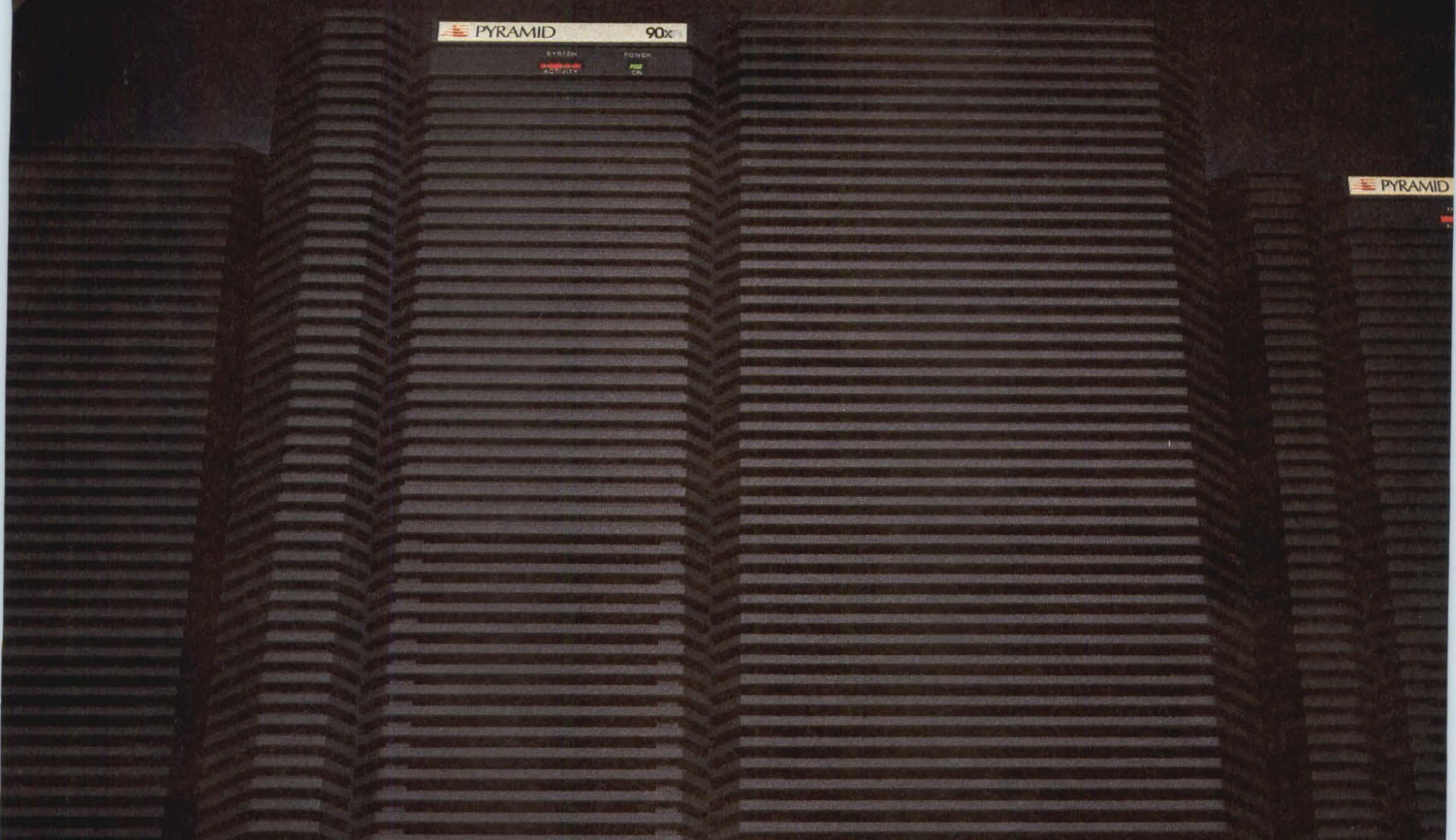

IF IT WEREN'T FOR UNIX WE NEVER COULD HAVE BUILT THE PYRAMIDS

Ordinary computers, yes. But not a Pyramid Technology 90x.

After all, here's a supermini not just capable of running UNIX™, but born to run it. And run it up to four times faster than the most popular UNIX host. For a lot less money.

The secrets of this Pyramid are a thorough understanding of UNIX, a few fundamentals of RISC (Reduced Instruction Set Computer) theory, more registers than 30 VAXs, and a 32-bit proprietary architecture that outperforms a roomful of micros.

All combined to speed up UNIX just where it likes to slow down.

For example, gone are 85% of performance-robbing memory references. The endless parameter shuffling of yesterday's technology has been replaced with a hardware register window. Even context switching takes less than one percent of the CPU's time.

It's amazing what hardware architects can do, given the chance. It's almost as startling as what our software wizards did.

They crafted OSx, a dual port of Berkeley's 4.2 BSD and Bell's System V. Because you can switch environments at will, no UNIX port offers more capabilities. With absolutely no loss

of compatibility.

Well, almost.

We do admit to one feature not compatible with other UNIX systems. Our single-source support.

One telephone number instantly connects you to both hardware and software experts. In-house pros, who spend their energy pointing you towards solutions. Not pointing fingers at each other.

So no matter how you see your requirements shaping up, contact Pyramid Technology, 1295 Charleston Road, Mountain View, California 94043. Or call (415) 965-7200.

Because when it comes to running UNIX, a Pyramid looks good from any angle.

 **PYRAMID
TECHNOLOGY**

Probe debugging system developed by Atron Corp., Saratoga, Calif., contains a microprocessor-based board that plugs into an IBM PC expansion slot and an outboard control for resetting or stopping the system. Included with the package is a sophisticated debugging program that permits memory examination and system operation monitoring in an interactive mode. Atron has extended the system and offers an add-on \$100 logic probe, allowing the monitoring of signals external to the PC Probe and the system. A \$395 software module provides performance and timing analysis of user programs. According to Gary Carleton, Atron's director of software, "It's important that developers recognize the necessity of employing sophisticated tools to create complex programs. Before, the technology really wasn't available to allow the creation of these tools. We can provide dynamic tools, rather than static ones, that allow the programmer to take real-time snapshots of a program's operation."

Taking an integrated approach

Taking an almost integrated approach to development tools is Phoenix Software Associates Ltd., Norwood, Mass. Designed for use with 8088/86-based systems running PC/MS-DOS and CP/M-86, the company's four programming tools include a full-screen text editor, a dynamic debugger, an object-module linkage editor and a library manager. The \$225 P-MATE86 full-screen, single-keystroke editor supports as many

as 10 auxiliary disk buffers that speed editing functions and encompasses an extensive macro-language for developing macroinstructions that handle frequently used operations. The \$245 P-FIX86 symbolic debugger has a windowed full-screen display and in-line assembler and permits breakpoint insertion. This package also works in tandem with the \$345 P-LINK86, which includes the \$125 P-LIB86. Phoenix's tools can use the outputs from Microsoft and Digital Research products.

Software-development tools are getting more sophisticated but easier to use. To meet future needs of software developers and system integrators, however, software manufacturers such as Digital Research and Microsoft are simplifying the development task even more by taking an open-system approach. At an independent software vendors seminar held by Microsoft last February, Microsoft president Jon Shirley emphasized that an open-system approach is required so that developers and system integrators can take maximum advantage of the hardware and operating-system environments. The trend is toward divorcing applications from hardware and operating-system dependency, thus clearing the path for the creation of easily transportable applications. □

Interest Quotient (Circle One)
High 831 Medium 832 Low 833

For more information

For additional information about the products and services mentioned, contact the companies directly or circle the appropriate reader service number.

Thought Tools

Metalogic Corp.
4235 Miralest Drive
Palos Verdes, Calif. 90274
(213) 519-7013

Circle No 764

Query Computing Systems Inc.
2707 Toledo St., Suite 603
Torrance, Calif. 90503
(213) 320-0561

Circle No 765

**Database Managers/
Code Generators**

Relational Database Systems Inc.
2471 E. Bayshore Road, Suite 600
Palo Alto, Calif. 94303
(415) 424-1300

Circle No 766

Fox & Geller Inc.

604 Market St.
Elmwood Park, N.J. 07407
(201) 794-8883

Circle No 767

Sensible Designs

5244 Edge Park Way
San Diego, Calif. 92024
(619) 268-0123

Circle No 768

Stemmos Ltd.

666 Howard St.
San Francisco, Calif. 94105
(415) 777-3800

Circle No 769

Windowing Tool Kits

Microsoft Corp.
10700 Northup Way
Bellevue, Wash. 98004
(206) 454-8080

Circle No 770

**Debuggers and Programming
Aids**

Atron Corp.
20665 Fourth St.
Saratoga, Calif. 95070
(408) 741-5000

Circle No 771

Digital Research Inc.
P.O. Box 579
Pacific Grove, Calif. 93950
(408) 649-3896

Circle No 772

Mylstar Electronics Inc.
165 W. Lake St.
Northlake, Ill. 60164
(312) 562-7400

Circle No 773

Phoenix Software Associates Ltd.
1420 Providence Highway, Suite 260
Norwood, Mass. 02062
(617) 769-7020

Circle No 774

NOW THE ONLY DIAL ERROR YOU CAN MAKE IS TO STAY AT 1200 BPS.

Announcing Codex's 2230 Series dial modems.

Now you can get 2400 bps productivity with the reliability you expect at 1200 bps.

Codex's 2230 Series full duplex modems accomplish this through the industry's only proven, second generation design. A design that combines powerful automatic and fixed equalization, delivering leased-line performance over any dial network.

The 2230 Series lets you operate at both 2400 bps and 1200 bps, allowing for faster screen fills and file transfers, reducing computer port needs, and drastically reducing line charges.

There's even a model with programmable auto call. So you can send data unattended at night when rates go down.

Each 2230 Series model is fully Bell 212 compatible. Each accommodates all communications protocols and meets the CCITT international 2400 bps dial standard. You can integrate Codex 2230's into your network gradually or all at once, without putting your system in turmoil.

Then, there's Codex's worldwide service and support organization, ready to answer any question or solve any problem.

Plus very attractive options to buy or lease.

To get the complete story on Codex's advanced 2230 Series dial modems, dial **1-800-821-7700**, ext. 881. Or write: Codex Corporation, Dept. 707-81, 20 Cabot Boulevard, Mansfield, MA 02048.

codex

 **MOTOROLA INC.**
Information Systems Group



**In September, see us at the Federal
Computer Conference and TCA.**

© 1984 Codex Corporation.

What do you like
better about the VISUAL 2000 ...
its power or its versatility?

Personally,
I like its price!

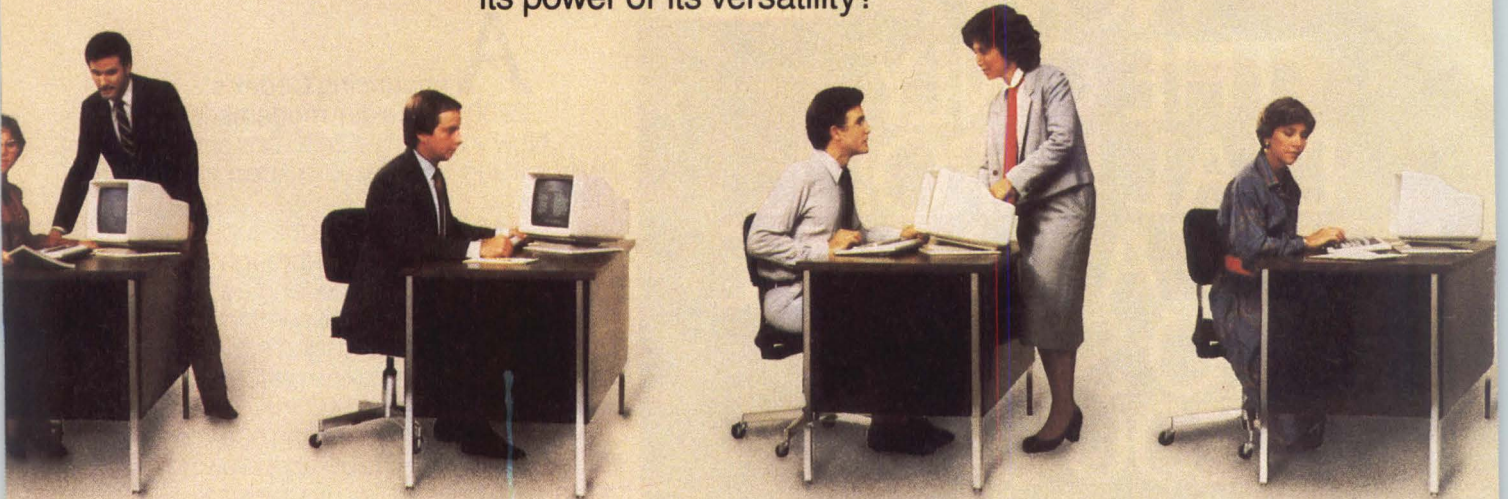

Never has a UNIX-based multi-user system given so much to so many for so little.

Introducing the VISUAL 2000

The VISUAL 2000 is the full-featured system with the power and flexibility to support multiple users in real business applications at a surprisingly low cost per station. It can be used with inexpensive video terminals. Or as a database manager or file server for a cluster of intelligent workstations or PCs, including both the IBM® PC and VISUAL's own lightweight, portable, totally IBM PC compatible COMMUTER. In all applications it offers greater performance, more flexibility, and lower cost than any other system in its class.

Powerful Intel 286 processor

The Intel 286 is today's chip of choice for UNIX™-based systems. Only the Intel 286 has on-chip memory management, an instruction set optimized for multi-tasking, and the optional 287 numeric co-processor to speed up floating point by a factor of 10.

What do these features mean to the VISUAL 2000 end user? Faster response time, more users supported, and lower system cost!

Cost-effective one-board design

A basic advantage of the VISUAL 2000 is its one-board base-level design. A single high-density board includes the 286 CPU, 512KB-2MB of RAM, controllers for Winchester, floppy, and streaming tape, an intelligent communications processor, six RS-232 ports, and a parallel printer port. Even a real-time clock with battery backup. One-board design means higher performance, lower cost, and greater reliability than comparable multi-board implementations.

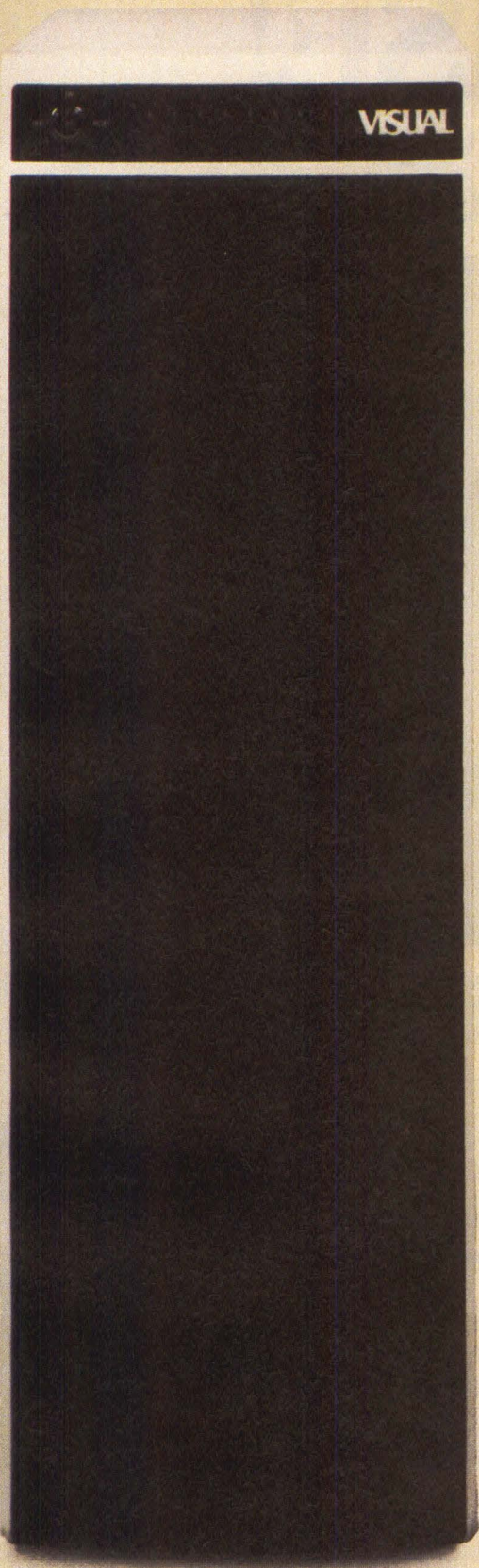

Configurability and Expandability: VISUAL gives you more

The VISUAL 2000 spans a much wider range of configurability and expandability than other systems in its price class. Up to 16 independent users. 6 megabytes of RAM. 4 Winchester. Floppy. And streaming tape for simple, reliable disk backup. All in a small stand-up enclosure which looks right at home next to a desk.

And if a fully expanded VISUAL 2000 isn't enough, you can connect up to 254 VISUAL 2000s, PCs, and workstations in a local area network.

Extensive system software simplifies system integration

The VISUAL 2000 runs XENIX, Microsoft's popular, enhanced version of UNIX, derived from UNIX under license from AT&T, and designed to be faster, more secure, and easier to use in business applications.

And VISUAL has worked hard to simplify the system integrator's job, by providing all the tools needed to deliver end-user applications with a minimum of effort.

Languages such as C, SMC BASIC, RM/COBOL, TOM BASIC, SOFTBOL, and MicroFocus Level II COBOL, to provide instant compatibility with hundreds of proven business application programs.

Other system-building tools, like the INFORMIX database management system and RealWorld modular accounting system.

And productivity software, such as the 20/20 integrated spreadsheet and XED office-grade word processor.

The Bottom Line

High performance. Superior flexibility. Extensive software. And low cost... VISUAL 2000 systems start at under \$10,000, suggested list. No one gives you more in a UNIX-based multi-user system.

Whether you're an OEM, system house, distributor, or end-user, call today for further information on the VISUAL 2000 and see for yourself!



VISUAL See for yourself®

Visual Technology Incorporated
540 Main Street, Tewksbury, MA 01876
Telephone (617) 851-5000. Telex 951-539

- REGIONAL OFFICES:**
- Northwest: (415) 490-1482
 - Southwest: (213) 534-0200
 - North Central: (513) 435-7044
 - South Central: (214) 255-8538
 - Northeast: (201) 528-8633
 - Southeast: (301) 924-5330

CIRCLE NO. 120 ON INQUIRY CARD

SURPRISE!

Now, designing in bar code capability is fast and easy with HP's new decoder IC and wands.

HP offers a variety of bar code solutions.

OEM's who want to help meet the needs of end-user customers are adding bar code reading capabilities to their products. And HP offers you a one-supplier solution to make these new designs fast and easy. Our new decoder IC and digital wands, as a product set, offer a complete component solution for bar code reading. Or, the wands are available separately. And HP can fill your orders now.

HP's new decoder IC simplifies designs.

HP's new decoder IC can save you considerable time and money in bar code software development. Both parallel and serial ASCII interfaces are available, so the IC is easy to use with most common microprocessors. It fits easily onto your PC board. There's no need

to develop your own decoding software, or use up time on your host microprocessor. And since the IC performs the functions of the typical decoding box, you eliminate that piece of equipment altogether.

Moreover, the new decoder IC gives you decoding capability for standard industrial and commercial

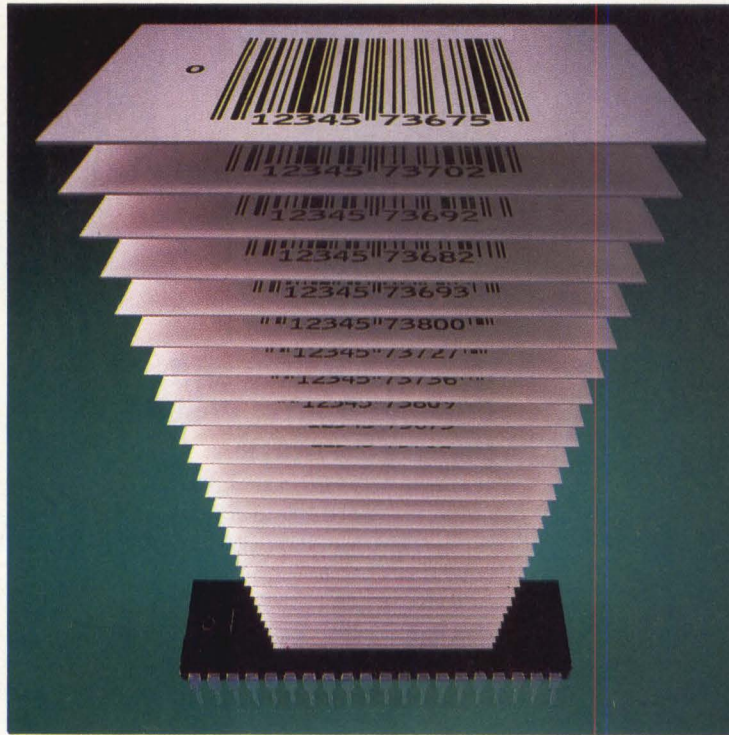

bar codes — the 3-of-9, Interleaved 2-of-5, UPC, EAN and JAN codes — all on a single chip. And it's been optimized to use with either our new HBCS-2000 or HBCS-4000 series wands. The decoder IC and a wand are available together in the HBCR-1000 series Component Bar Code Readers.

HP's new sapphire tip wands feature rugged construction.

HP's two new digital wands are designed for high performance bar code scanning in both industrial and commercial applications. They feature tough, replaceable sapphire ball tips, rugged construction, a variety of resolutions and a standard digital TTL interface. Each wand can be used at scanning angles up to 45 degrees for improved reading performance.

For your heavy industrial and LOGMARS applications, select from the new HBCS-4000 series sealed metal wands.

And for commercial or light industrial uses, choose from the HBCS-2000 series polycarbonate-cased wands.

For pricing and delivery, contact your local Hewlett-Packard authorized components distributor. In the U.S., call Hall-Mark, Hamilton/Avnet, Pioneer Standard, Schweber, or the Wyle Distribution Group. In Canada, call Hamilton/Avnet or Zentronics, Ltd. For more information, call your local HP sales office listed in the telephone directory white

pages and ask for the Components Department.



HP: The right choices for bar code solutions.



Can copyrights protect all forms of software?

Apple vs. Franklin decision broadens copyright protection for computer programs

L.J. Kutten, Attorney at Law

The U.S. legal system has not protected computer software as well as computer hardware and other high-technology products. Although patent law and trade-secret statutes adequately protect computers and peripherals against misappropriation and unauthorized use, most software cannot be patented. Until recently, copyright protection for all forms of software other than source code, including object code in ROM (or on floppy disk) and computer operating systems, was ambiguous at best. But last fall's decision of the 3rd U.S. Circuit Court of Appeals in *Apple Computer Inc. vs. Franklin Computer Corp.* goes a long way toward providing computer software the protection it needs. Barring a review by the U.S. Supreme Court, it definitively extends copyright protection to all forms of software.

Protecting player-piano rolls

The controversy over copyright protection for computer software has its origins in the 1909 Copyright Act. In enacting the statute, the U.S. Congress wrote into law the Supreme Court's decision in *White-Smith Music Publishing vs. Apollo Co.* In the case, White-Smith sued for copyright violation because Apollo had



Collage by Anne Tregay

produced player-piano rolls for its machines of two popular musical compositions owned by White-Smith. The Supreme Court ruled that Apollo had not violated the copyright because the piano rolls were not in a form that could be read or interpreted by themselves and hence were not a copy of the underlying musical composition. For a work or document to be protected by copyright under the 1909 Act, a person had to be able to read or understand it. Expressed in terms of today's technology, a flowchart or source code could be copyrighted under the 1909 law, but a program stored in ROM or expressed as object code could not.

With the proliferation of computer technology, Congress passed the 1976 Copyright Act. A significant

advance over the 1909 law, it furnishes copyright protection to original works "fixed in any tangible medium of expression [e.g., a floppy disk] from which they can be perceived, reproduced or otherwise communicated either directly or with the aid of a machine." This statute covers works physically embodied in any stable form that a person or a machine can read, including punched cards and magnetic tape. In 1980, Congress amended the 1976 Act by adding computer programs to the category of material that can be copyrighted.

Under the 1909 or 1976 Copyright Act, copyright protection extends to computer programs written on paper or recorded by some other visibly perceivable method. But the two acts leave other important legal questions unanswered, including:

- Can a software developer copyright a computer program if the program is not visibly perceivable?
- Can the developer copyright object code in addition to source code?
- Can an operating system be copyrighted?
- Can a program embodied in a ROM chip be copyrighted? At what point does a program embodied in ROM become part of the machine? If a program in ROM is a machine part, is it a "utilitarian object" and thus not eligible for copyright protection?

Apple vs. Franklin defines the issues

With these legal issues unclarified, Franklin Computer Corp., Cherry Hill, N.J., aimed to capture a substantial niche in the microcomputer market by selling its "Apple-compatible" Ace 1000 microcomputer for a lower price than Apple Computer Inc., Cupertino, Calif., sold its Apple II. To be compatible, the Ace 1000 had to run nearly all 15,000 Apple II application programs. Instead of developing its own operating system, Franklin copied all 14 Apple II operating-system programs embodied in ROM or floppy disk, including the Autostart ROM, Applesoft, DOS 3.3 and Apple 13-sector boot ROM.

Franklin had considered writing its own operating-system programs. But according to vice president of engineering David McWherter, this course was unfeasible because there were "just too many entry points in relationship to the number of instructions in the program." Without 100 percent compatibility in the entry points, Franklin could not ensure 100 percent compatibility between its computer and Apple application programs.

Apple sued Franklin in the federal District Court of Eastern Pennsylvania, alleging copyright infringement, patent infringement, unfair competition and misappropriation. Apple based its claim for copyright protection on four major points:

- A computer's operating system is a form of

expression and not an idea or process, which cannot be copyrighted.

- Object code is a form of expression and a work of authorship, whether stored in ROM or on a floppy disk.
- A ROM is a tangible medium of expression.
- In enacting copyright legislation, Congress intended to protect all computer programs as literary works, no matter what their form.

Apple requested a temporary injunction prohibiting Franklin from "using, copying, selling or infringing" Apple's copyrights. Franklin admitted to the court that it had copied Apple's programs. But it denied Apple's claims, arguing that the company's copyright registrations were invalid and unenforceable because the programs were ineligible for copyright protection.

The District Court denied Apple's request for an

In 1980, Congress amended the 1976 Copyright Act by specifically adding computer programs to the category of copyrightable materials.

injunction, asserting that the programs' eligibility for copyright protection was in question and that Apple had failed to show it had a reasonable probability of winning the case on its merits. Apple appealed the decision, and after six months of deliberation, the Court of Appeals overruled the lower court.

In overruling the District Court, the Court of Appeals specifically stated that:

- object code can be copyrighted,
- a computer program embedded in ROM can be copyrighted, and
- an operating system is subject to copyright.

The Court of Appeals rejected the argument that object code, unlike source code, cannot be copyrighted. In an earlier case, *Williams Electronics Inc. vs. Artic International Inc.*, the court had ruled that "the copyrightability of computer programs is firmly established after the 1980 amendments to the Copyright Act." Under the 1976 Copyright Act, a work must be an original work of authorship fixed in a tangible medium of expression. Although the law, the court said, "does not expressly list computer programs as works of authorship, the legislative history suggests that programs were considered copyrightable as literary works."

For example, with the 1980 amendments to the Copyright Act, Congress defined a computer program as "sets of statements or instructions to be used directly or indirectly in a computer in order to bring about a certain result." Because object code is the only instruction a computer can run directly, Congress must

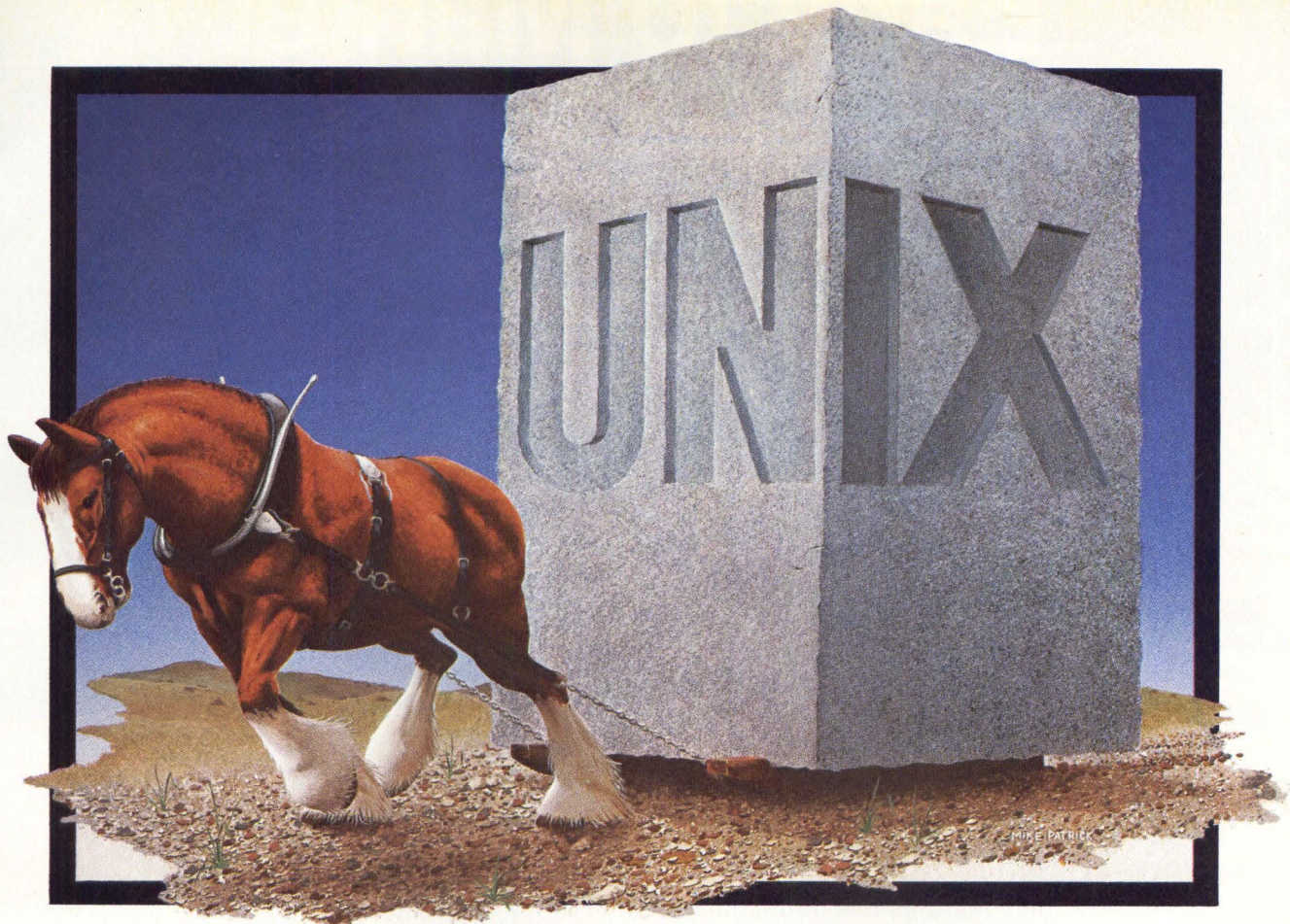

UNIX™ HORSEPOWER!

There are a lot of UNIX based systems on the market today claiming to be "SUPERMICROS". But do they really have what it takes to run multi-user UNIX well? The IBC ENSIGN™ does and here's why:

FAST MEMORY: No computer running at **any** clock speed can run faster than it's overall memory design. The ENSIGN has up to 8MB of 120nsec memory with dual bit error correction. With IBC's proprietary memory management, **all** of this memory runs with no wait states as fast as the 68000 CPU will go. Compare this to other systems running only small cache memories at full speed. Other multiple user systems cannot load all their programs into a small cache memory. Their systems slow down considerably under a heavy multi-user load.

INTELLIGENT SERIAL I/O CONTROLLER: Even the fastest CPU will slow down when it's trying to handle interruptions from multiple on-line users. The ENSIGN provides slave serial I/O CPU's **and** FIFO buffering for both input and output. The result is the ENSIGN's ability to support up to 32 users, with heavy serial I/O demand, while leaving the main 68000 CPU free to run with little serial I/O overhead.

INTELLIGENT DISK CONTROLLER AND HIGH PERFORMANCE DISK DRIVES: The ENSIGN has a slave CPU to handle all disk operations, **plus** 16K of disk buffering. IBC's proprietary disk DMA allows high speed data transfer to main memory without slowing down the main CPU. Further, the ENSIGN

supports SMD type 8" hard disks with much faster seek times and transfer rates than 5¼" hard disks usually found in personal desk top computers.

THE RESULTS: The IBC ENSIGN runs multi-user UNIX at performance levels not attainable by other supermicros.

Call IBC and get a copy of IBC's multi-user benchmarks—benchmarks that test 8 users running large CPU programs, with heavy disk I/O **and** heavy serial I/O simultaneously. You'll find that nothing can compare to the ENSIGN.



If you want to run multi-user UNIX on a high performance system with up to 32 users, 8MB memory, and over 1,000MB disk storage, see the IBC ENSIGN.

Outside The USA

IBC / Integrated Business Computers

21621 Nordhoff Street
 Chatsworth, CA 91311
 (818) 882-9007
 Telex No. 215349

Within The USA

IBC / DISTRIBUTION

1140 36th Street Suite 212
 Ogden, Utah 84403
 (801) 621-2294

UNIX is a trademark of Bell Laboratories

Early to Market

... Through Building Block Technology



Memory System Modules

Our Series 90 Family features five of the most comprehensive memory products available — up to 128 megabytes in a single chassis — each extensively tested for reliability and engineered to fit your unique application requirements, exactly. That means that you don't have to give up a single design objective to get all the advantages of an off-the-shelf system. Like low cost. And faster time to market.

Guarantee Against Obsolescence

In today's market of compressed product life cycles, it is imperative that your product remain the leader for as long as possible. That's a problem which Zitel turns into opportunity. Because the Series 90 Family accepts new memory component technologies as they become available.

Broad-Based Applications

For unfriendly operating conditions, we offer ideal add-on for mobile and impact-susceptible environments normally associated with defense and geophysical applications. And there's main memory add-on, intelligent memory, disk replacement and disk cache.

In fact, Zitel products are an integral part of systems throughout the computer, medical, simulation, communications, industrial automation and environmental control industries, to name but a few.

Low cost, proven reliability and the flexibility of our building block modules. When it comes to implementing your next memory system for early market entry, think Zitel.

We'd like to bring you there . . . on time.

Please send me more information on the following Zitel Products:

- Multibus® Memory MMS 9/84
 Series 90 Family of Bulk Memory Custom Microcomputer Cards
 VME/Versabus™ Interface Special Interface Custom Memory Cards
 Other _____

My application is _____

Name _____ Title _____

Company _____ Phone (____) _____

Division _____

Address _____

City, State _____ Zip _____

zitel®

Zitel Corporation

Attn: Applications Manager
399 W. Trimble Road
San Jose, California 95131
408/946-9600

Zitel International

53 Blvd. de Waterloo, bte 2
1000 Brussels, Belgium
32-2-513-3565

CIRCLE NO. 122 ON INQUIRY CARD

Multibus is a registered trademark of Intel Corp. Versabus is a trademark of Motorola Inc.

have meant to protect object code, the court said. Furthermore, the court noted, under copyright law, "the category of 'literary works'...is not confined to literature in the nature of Hemingway's *For Whom the Bell Tolls*." It also encompasses expression in numbers or other symbols. "Thus, a computer program, whether in object code or source code is a 'literary work' and is protected from unauthorized copying."

Finally, the court considered the question of whether object code must be perceivable or intelligible to people to be eligible for copyright—the distinction first raised in the *White-Smith* case. In this respect, the fact that people cannot read a program directly has no bearing

Can a program embodied in a ROM chip be copyrighted? At what point does the program become part of the machine?

on the case, the court ruled. The distinction raised by *White-Smith*, the court said, was specifically rejected by the 1976 Copyright Act, which protects works in any tangible means of expression "from which they can be perceived, reproduced or otherwise communicated" either directly or *with the aid of a machine*.

The court spent little time on discussing copyright protection for computer programs embedded in ROM. The media on which a work is stored, the court stated, does not affect whether the work is eligible for copyright protection: "The medium is not the message." A program meets the 1976 Copyright Act's requirement that a work be fixed in a tangible means of expression "through the embodiment of the expression in the ROM." That a program is etched on a ROM, the court asserted, does not make it a machine or part of a machine and thus ineligible for copyright protection.

Franklin had argued that an operating system is not subject to copyright because it is merely a "process," "system" or "method of operation" and because it is a purely "utilitarian work." In regard to the first argument, an earlier Supreme Court case (*Baker vs. Selden*) held that a "process," "system" or "method of operation" cannot be copyrighted. A book's copyright did not give its author the exclusive right to use a system described in the book. The appeals court, however, rejected Franklin's argument. "A process is no more involved [in this case]," it said, "because the instructions in an operating system program may be used to activate the operation of the computer than it would be if instructions were written in ordinary English in a manual which described the necessary steps to activate an intricate complicated machine."

The decision of the Court of Appeals, in effect, denies that an operating system is an idea—an important distinction in copyright law. A form of expression can be copyrighted; the idea behind it cannot. Thus copyright does not protect the "process," "system" or "method of operation" in the operating system. It protects only Apple's *expression* of the "system" involved. Franklin could have developed its own expression or version of the Apple operating system without violating copyright law.

The court dealt with another interesting point of law. If there exists only *one* possible expression of a "process," "system" or "method of operation," the expression is a purely "utilitarian work" and cannot be protected by copyright. Therefore, if it were impossible to write a compatible operating system that could run most Apple II application programs, Franklin could legally copy part or all of the Apple operating system. The court rejected this argument by noting that the district court had "made no findings" deciding whether some or all of Apple's operating system represented the only way to express the underlying ideas. In effect, copyright protects Apple's expression of its operating system unless Franklin can prove there is no other way to express the ideas behind it.

The court also noted that Congress had made no distinction between application programs and operating systems when it added computer programs to the Copyright Act. In addition, the Court cited several lower court cases that upheld copyrights involving operating systems. Ultimately, the court asserted, "both types of programs instruct the computer to do something. Therefore, it would make no difference for purposes of section 102(b) [of the Copyright Act] whether these instructions tell the computer to help prepare an income tax return (the task of an application program) or to translate a high-level language program from source code into its binary-language object-code form (the task of an operating system program such as Applesoft)...There is, therefore, no reason to afford any less copyright protection to the instructions in an operating system program than to the instructions in an application program." □

© 1984 by L.J. Kutten

L.J. Kutten received the Juris Doctor degree from Washington University, St. Louis, Mo. A member of the Missouri and Illinois Bar Associations, he is in private practice, specializing in all aspects of computer and high-technology law. Kutten is the author of *Computer Buyer's Protection Guide*.

Interest Quotient (Circle One)
High 834 Medium 835 Low 836



SOME PEOPLE PAY TOO MUCH FOR COLOR GRAPHICS WORKSTATIONS. BUT SOME PEOPLE GET THE NEW COLORWARE™ SYSTEM 23.

Now you can market a complete DEC™
-compatible turnkey color graphics system for
even the most price-sensitive vertical markets.

Because now there's the Colorware System
23 family. With system configurations
under \$25,000. It's the lowest cost family of
high resolution stand-alone systems around.

But that's not the only reason these new
LSI 11/23™-based workstations will make you
look brilliant and your competitors look silly.

There is simply no faster way to get to
market with a complete new turnkey color
graphics solution. Whether you have a stand-
alone application or you're operating remotely
in a host environment, you only need to
port the software from your mainframe or
mini, and you're ready to ship.

For more information
and detailed specs, call 800/
538-1730 or 408/733-3555
(in CA), and ask for Market-
ing at ext. 255. Or write to
AED, Inc., 440 Potrero
Avenue, Sunnyvale, CA
94086.

The alternatives all simply cost way too
much. But with the DEC compatibility, high
price/performance and low cost of our new
Colorware System 23 family, you're looking
good.



Colorware is a trademark of AED, Inc.
DEC and LSI 11/23 are trademarks of
Digital Equipment Corporation.
© 1984 AED, Inc. All Rights Reserved.

AED COLORWARE

CIRCLE NO. 123 ON INQUIRY CARD

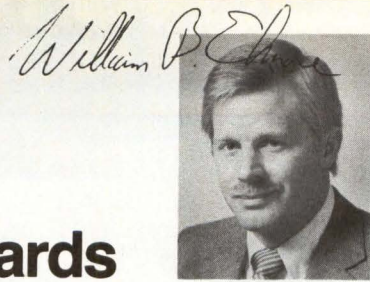

William B. Elmore, is president of Visual Engineering, San Jose, Calif. He holds an M.B.A. degree from Stanford University and B.S.E.E. and M.S.E.E. degrees from Purdue University.

UNIX and GKS standards create opportunities for graphics

William Elmore, Visual Engineering

Two important computer industry standards — UNIX for operating systems and the Graphical Kernel System (GKS) for graphics — are making it possible to run the same programs on different computer systems. This will create large markets for both hardware and software graphics products. There's already a huge demand for computer graphics software in business, scientific and technical fields, and 1984 will see just the beginning of explosive growth in this broadly-based market.

According to a report by Strategic Inc., San Jose, Calif., of the 31 million people who could make good use of computer graphics, fewer than 1.5 million will actually start putting them to work in 1984. Why the delay?

Until recently, software developers concentrated on programs for word processing, spreadsheets and databases, relegating graphics to the back burner. Graphics programs were difficult to write — and expensive to produce. Most had limited portability and were aimed at a narrow market. Moreover, many vendors viewed graphics merely as an additional application, not a feature. But, today, our perception has changed. Graphics capabilities are recognized as features. And features sell products. Ironically, in their scramble to include graphics as a value-added feature, vendors could find themselves caught in a strange contradiction: Although creating graphics software from scratch can help a company set itself apart from its competitors, this approach can be costly and self-defeating. By adhering to standards, software developers are still able to create a unique product line and their packages can run on a larger number of machines.

Standardization clearly affects the software developer's bottom line. For example, established standards increase the pool of applications programmers. Standards avoid the need for constantly re-inventing the wheel

in an attempt to train people in esoteric operating systems and languages. In addition, standards simplify programming and reduce development time. This reduced development time translates into lower costs in adapting existing software to new generations of processors. What's more, standards can also release the creativity of applications programmers by letting them focus on the applications. More important, vendors can rapidly bring to market a variety of programs that stimulate sales of computer systems to graphics-hungry end users.

Standards offer a strong package of benefits to end users, too, by increasing the availability of reasonably priced, presentation quality graphics. Because sophisticated users don't want to be locked into a particular system, portability is a big issue — and this is one area where UNIX excels. Its flexibility facilitates the use of a wide range of peripherals from many manufacturers.

In addition, UNIX is easy to use on computers of all sizes from mainframes to personal computers and suits networked single- and multi-user systems — the wave of the future.

UNIX also facilitates the portability of graphics applications through its ability to network with other UNIX machines. Another major strength of UNIX is its ability to access data quickly from other sources, including database, word-processing and spreadsheet packages.

The acceptance of UNIX as a standard operating system by major computer manufacturers, and of GKS as the standard graphics language, will bring mainframe-like graphics capabilities to small computers. It will also open up new opportunities for OEMs and system integrators.

GKS, a software standard for two-dimensional computer graphics, allows graphics software to operate independently of the computer type and of the graphics output and input device types. Graphics output can

easily be redirected to laser printers, pen plotters, photographic output devices or to color or monochrome graphics terminals. GKS provides the needed functions for a majority of applications with a minimum number of commands. And GKS is the official standard in Europe and has been adopted by the International Standards Organization (ISO). In the United States, the American National Standards Institute (ANSI) has endorsed a proposal for adopting GKS as the American national standard. American computer software companies now use GKS for two reasons: to sell graphics software in Europe — and to support a workable solution for standards.

The lack of good software previously served as a deterrent to the use of graphics. Today, new graphics programs provide tools for programmers and end users. By increasing user productivity, these new programs make the creation of graphics more cost-effective on all levels of expertise.

UNIX has been the operating system of choice for many engineers and there is a huge marketplace for graphics in technical applications. In addition, UNIX is rapidly becoming used for business applications. Thus, we'll see an increasing demand for graphics in both areas.

The graphics explosion is bringing new programs to the market but OEMs and system integrators must be selective in their choice. Any discussion of graphics software must focus on the levels and complexity of graphics software and on the sophistication of users. Graphics functions for systems and applications programmers differ significantly from those for business end users who need to create graphics easily and quickly. Programs utilizing the GKS standard, written in C for the UNIX environment satisfy the most important needs of today's users in creating presentation-quality graphics — ease of use, portability and cost-effectiveness.

IMAGEN'S NEW 8/300.

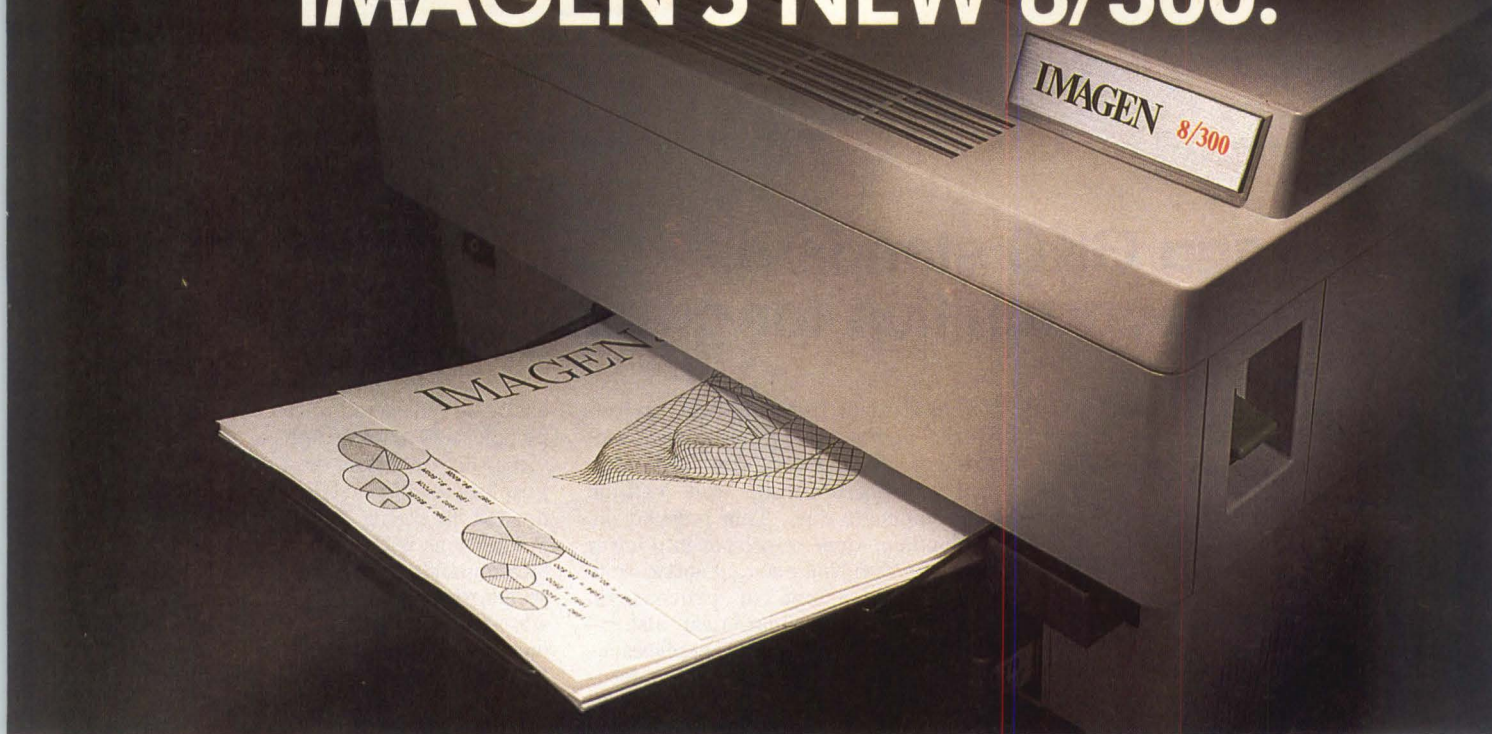

A New Definition for Laser Printing . . . Affordable.

Our 8/300 sets exciting new levels of performance and value for electronic page printing systems.

In the office, type font flexibility and the ability to easily merge text and graphics allows the 8/300 to produce high quality reports, documents, letters, and even transparencies. In data processing, the 8/300 delivers higher quality output than line printers, at comparable speeds. For graphic arts applications, the 8/300 functions as a proofing device for typesetting and provides final output for demand publishing. In an engineering environment, the 8/300 delivers exceptional plotting capabilities, and produces high quality output from intelligent workstations.

Text, graphics, plotting, font flexibility—for any

application, Imagen's 8/300 provides a high quality, affordable alternative to traditional printing methods.

Operating at 8 pages per minute, with a resolution of 300 dots per inch, the 8/300 prints on a variety of papers, including your letterhead. The alternate feed facility allows printing odd sizes too. From business cards, to envelopes, to legal size—or any size in between.

The 8/300 delivers all this in a compact, desk-top size, small enough to put just about anywhere—and quiet enough to operate anywhere you put it.

Take a closer look at the 8/300. For less than \$10,000 it can open up a whole new world of printing possibilities for you.

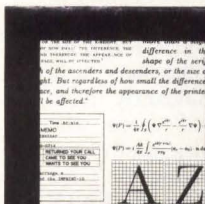

PRINTING

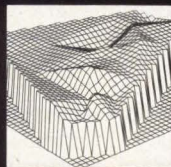

PLOTTING

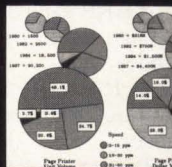

GRAPHING



AND MORE

IMAGEN™

IMAGEN Corporation
2660 Marine Way
Mountain View, CA 94043
(415) 960-0714

THE INTELLIGENT WAY TO PRINT

New Products

SYSTEMS

Fault-tolerant computer aids on-line transaction applications

The Reliant Computer, a distributed multiprocessing system, offers a fault-tolerant architecture. The architecture consists of multiple application processors, dual data buses, dual file processors, dual disk controllers, mirrored disks, and dual power supplies contained in a cabinet the size of a standard two-drawer office file. The application processors handle all communications between users and the system; the file processors govern internal data transfers and the system printers. The twin data buses, file processors and disk subsystems operate in parallel, performing real-time mirror images of each system operation.

The product's distributed design dedicates independent 8- or 16-bit micro-processor-based boards to running specific application programs. Each Intel 8086-based board has as much as 512K bytes of on-board RAM, a tri-ported "mailbox" for communications with both data buses and four RS232 ports that connect to displays, printers and other I/O devices.

The Systems Activity Monitor (SAM) checks all modules in the system for actual or impending failures. When SAM senses a problem, the diagnostic program shuts down the defective component while the system continues to run; if an application processor goes down, that processor board and its attached devices are temporarily disabled.

The computer, including the SAM diagnostic program, operates under con-

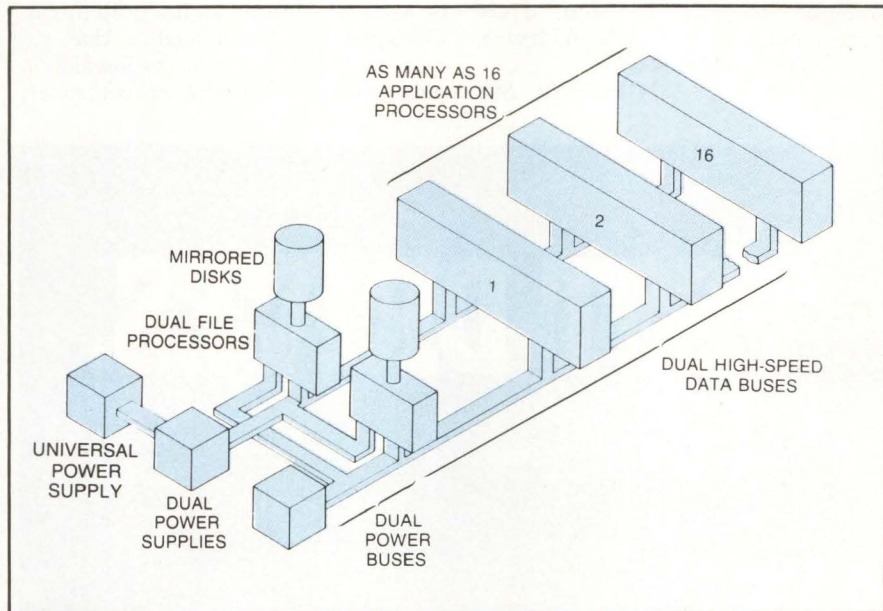

NoHalt Computers' fault-tolerant Reliant computer system has an internal architecture that replicates crucial system components. If a power supply fails, the other power supply keeps the system running. If a disk drive, disk controller or file processor fails, the system runs on the mirrored information copied in the alternate file subsystem. Should a data bus fail, communications between application processors and the disk subsystem continue unaffected on the other data bus.

trol of the company's proprietary NH DOS operating system, which supports file locking for concurrent file sharing, error correction and file security levels. Other NH DOS functions include spooling, despooling and automatic program loading. A multitask dispatcher allocates processing power among the competing processes.

A basic configuration, including one 16-bit application processor, mirrored system components with twin 20M-byte Winchester disk drives, NH DOS and utilities, sells for \$25,570. **NoHalt Computers**, 1750 New Highway, Farmingdale, N.Y. 11735, (516) 225-2121.

Circle No 300

Portable computer includes modem

The RoadRunner portable computer measures 3 by 11 by 8 inches and weighs 5 pounds. Powered by an 8-hour-rated removable, rechargeable battery, the unit uses an NSC800 microprocessor and removable 8K- and 16K-byte cartridges for data storage. It includes a parallel printer and RS232C communications interfaces as well as a built-in 300-baud, auto-dial, auto-answer modem. The computer runs CP/M-compatible software and provides a built-in text editor, a phone directory, a name/address list, a daily schedule and remote

communications programs. The 73-key keyboard includes 18 function keys. The display provides 8 lines of 80 characters and 480-by-64-dot resolution graphics. \$2,015. **Micro Office Systems Technology Inc.**, 35 Kings Highway East, Fairfield, Conn. 06430, (203) 367-2525.

Circle No 301

Computer system uses DEC LSI-11/73 processor

Based on the DEC KDJ11-AA LSI-11/73 processor, the model 8650 computer system features a 41.6M-byte fixed/

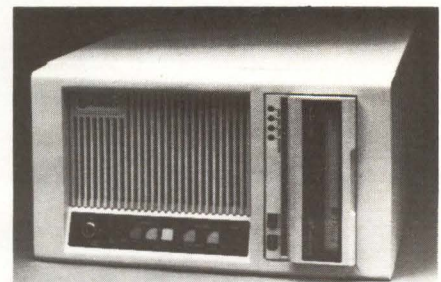

removable Whitney-technology hard disk drive (20.8M bytes fixed, 20.8M bytes removable, formatted) and 256K bytes of RAM, expandable to 4M bytes. It also includes six RS232C ports. The

New Products

SYSTEMS

system runs most DEC LSI-11 and PDP-11 operating systems and software with little or no modification. \$17,950. **Plessey Peripheral Systems Inc., Computer Systems Division, 17466 Daimler Ave., P.O. Box 19616, Irvine, Calif. 92714, (714) 540-9945.**

Circle No 302

Microcomputer system is DEC-compatible

The SMS 1000 model 40, a DEC LSI-11 Q-bus-compatible microcomputer system, features an integrated, single-board foundation module that requires no backplane slot. The foundation module includes a peripheral controller,

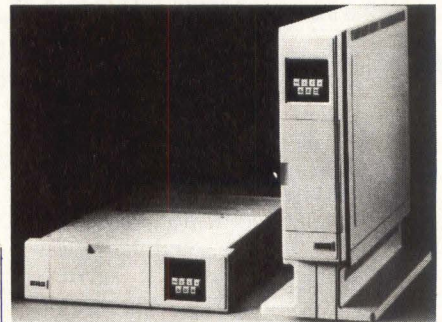

two serial ports, backplane circuitry and a support monitor subsystem that contains system analysis, system utilities and diagnostics software. Model 40 uses LSI-11/23 or LSI-11/73 CPUs with as much as 2.5M bytes of main memory. Single or dual 5¼-inch Winchester disk drives with capacities ranging from 12M to 70M bytes each, one 8-inch, 1.2M-byte floppy disk drive or single or dual 5¼-inch, 800K-byte floppy disk drives and a 21M-byte cartridge-tape drive are available. Model 40 supports RT-11, RSX-11M, RSX-11M-Plus, RSTS/E, UNIX and TSX-Plus operating systems. The product comes in floor- or rack-mount versions. Prices start at \$5,800 (50 units). **Scientific Micro Systems Inc., 777 E. Middlefield Road, Mountain View, Calif. 94043, (415) 964-5700.**

Circle No 303

Multiprocessor computer runs Concurrent CP/M-86

The single-user, dual-processor Poly 8/16 computer features a two-board set that includes an 8-bit Z80 processor with 64K bytes of RAM running CP/M-80 on the system master card plus a 16-bit 80186 processor with 256K bytes of RAM running Concurrent CP/M-86 on the slave board. The computer can support as many as four users by adding 80186 slave boards. The version of Concurrent CP/M-86 supplied offers multitasking built-in windows and PC-DOS compatibility. The basic system includes the master and slave boards, a five-slot S-100 motherboard, one 5¼-inch, 800K-byte floppy disk drive, four RS232C/RS422 ports, two parallel ports, a monochrome display terminal and operating system and GSX graphics extension software. Prices start at \$4,495. **PolyMorphic Systems, 5330 Debbie Lane, Santa Barbara, Calif. 93111, (805) 967-0468.**

Circle No 304

TEST DRIVES.



Put Applied Data's PT-350 portable floppy drive tester through its paces and you'll find that it's the most thorough and economical drive tester on the market today.

Small, but powerful, the PT-350 offers capabilities comparable to larger systems with a higher sticker price. With a single command, up to 30 successive tests can be initiated and as many as 10 user-defined test strings can be stored in the 2K-bytes of CMOS static RAM with a battery back-up.

You'll enjoy the easy handling and high performance of the PT-350, which is capable of testing all drives from 3" to 8" and utilizes Dysan's Digital Diagnostics (DDD) for verifying drive alignment.

The PT-350 comes complete with a 40 character/2 line display, carrying handle, storage area for 5 cables with options available for built-in printer and 2 serial ports. No other drive tester offers all these features.

Other products available from ADC: Winchester disk drive tester, diskette duplication equipment, Trans/Media conversion system and media certifier.

Prompt delivery of your new PT-350 if you order today.

ADC APPLIED DATA COMMUNICATIONS

14272 Chambers Rd. • Tustin, CA 92680 • (714) 731-9000

CIRCLE NO. 125 ON INQUIRY CARD

A Complete Graphics Department For Just \$2295



Realize day-in and day-out solid performance from a quiet and capable desktop plotter. It's true. For only \$2295* the Houston Instrument HIPLØT™ DMP-29 will provide you with world-class multi-color hard copy graphics, and deliver a level of quality and performance that you would expect in a plotter costing three times as much.

It's a hard worker. The DMP-29 goes about its job with amazing speed and precision. Unbeatable resolution and repeatability are yours in both 8½" x 11" and 11" x 17" formats, and 8-pen capability assures you of fast attention-free flexibility when multi-color output is required. High pen speed combined with an addressable resolution of 0.001" assures fast, accurate and stepless traces.

It's friendly. You can call 21 different functions directly from the front-panel membrane keyboard. It's tolerant too. The DMP-29 will modestly protect itself from user errors, as when attempting to place a pen in an already occupied stall.

And it's smart. An extensive set of firmware routines makes life easier for the user. A small sampling of the built-in talent inherent in the DMP-29 includes character generation, circle, arc and ellipse synthesis, line type variations, viewport/windowing, clipping and scaling.

For the name, address and phone number of your nearest representative, write Houston Instrument, P.O. Box 15720, Austin, TX 78761. Phone 512-835-0900, or 800-531-5205 if outside Texas. In Europe contact Houston Instrument Belgium NV., Rochesterlaan 6, 8240 Gistel, Belgium. Tel 059-27-74-45, tlx 846-81399.

**houston
instrument**



* U.S. Domestic price only
™ Trademark of Houston Instrument

CIRCLE NO. 128 ON INQUIRY CARD

4P005D

Protection
For . . .
RS232,
Modems,
20ma Loops,
etc.



MCG Data Line Protectors stop "transients" from causing downtime and costly equipment failure.

High voltage transients, caused by lightning, by switching surges, relays, solenoids, and heavy machinery, etc. can be coupled into data lines directly. High voltage transients cause immediate and cumulative damage to semiconductor junctions that results in equipment failure. A direct lightning strike even many miles away can do serious damage.

MCG Data Line Protectors keep these transients from reaching your equipment. They interface between the equipment and the data line, and provide a sophisticated blend of high speed (less than 5 nanoseconds) and brute force protection.

MCG Data Line Protectors can be used with coaxial cable, single or twisted pairs, and will protect RS-232, -422, and -423, 20ma loops, and modems.

Best of all, MCG protectors offer cost effective insurance against "downtime" that cannot be obtained in a service agreement.

To request our complete DLP catalog, contact Bill Purcell at (516) 586-5125, or at the address below.

MCG

ELECTRONICS, INC.
12 BURT DRIVE
DEER PARK, NEW YORK 11729
(516) 586-5125 • TELEX 645518
Protection you can depend on

CIRCLE NO. 126 ON INQUIRY CARD

New Products

SYSTEMS

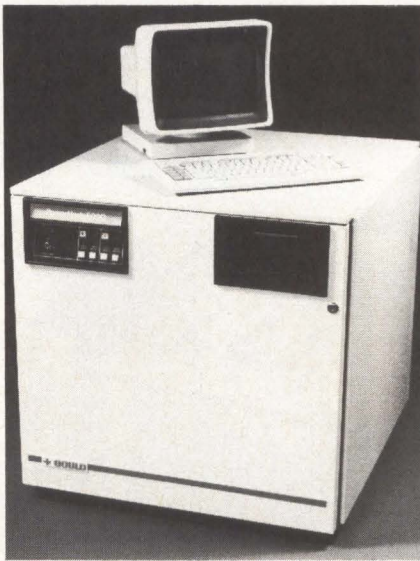

Workstation supports two users

The dual-user Workstation 500 system accommodates two 19-inch raster graphics displays—either two 1,024-by-1,024-dot resolution monochrome units, twin 832-by-600-dot resolution color units or a color/monochrome pair. Each display has a dedicated 68000 graphics processor with a 128K-byte program store. Each graphics processor contains a software library of graphics primitives for plotting 2-D graphs; drawing polygons, circles and arcs; and scrolling, zooming and panning images. The workstation incorporates dual 10-MHz microprocessors (68010 and 68000), a 4K-byte cache, a 1,024-element translation buffer and a 1,024-entry I/O map. A 50M-byte Winchester disk drive with a 5¼-



inch floppy disk drive or a ¼-inch cartridge-tape drive provides mass-storage capabilities. The workstation uses a real-time, virtual-memory, UNIX-based operating system that provides multitasking, memory-locked processes, guaranteed process priorities, contiguous files and high-speed pipes. A system with a CPU, 1M byte of ECC memory, real-time UNIX with C and FORTRAN and dual monochrome displays sells for \$11,370 (100 units). **Masscomp**, 1 Technology Park, Westford, Mass. 01886, (617) 692-6200.

Circle No 306

Graphics workstations boast mini capabilities

The GW/8000 and GW/10000 graphics workstations are packaged engineering graphics systems based on the mid-range and high-end Eclipse MV/8000 II and MV/10000 minicomputers. The systems integrate two monitors—a 19-inch color graphics display featuring 1,280-by-1,024-dot resolution and a Dasher D460 alphanumeric monitor—in one workstation. Each system includes a CPU, dual monitors in an integrated

Computers provide network support

The 32-bit, UNIX-based PowerNode 6000 virtual-memory computer system serves as a computational node in a LAN or as a standalone processor with multiple terminals. The computer comes in three configurations—models PN6030, PN6050 and PN6080—that differ in packaging and expansion capabilities. Each model includes a 32-bit virtual-memory processor. A 32-bit internal-processing unit is optional on model PN6050 and standard on model PN6080. All models include 2M bytes of main memory and 32K bytes of dual cache memory per processor. Memory can be expanded to 6M bytes for model PN6030 and 16M bytes for model PN6080. The computers are built around the company's SELbus synchronous bus with a 26.7M-byte-per-second transfer rate. Model PN6030 is packaged in a 30-inch-high cabinet and includes an 80M-byte Winchester subsystem and a removable 60M-byte cartridge-tape subsystem. Models PN6050 and PN6080 are packaged in 71-inch-high cabinets. The PowerNode 6000 series runs the UTX/32 operating system, which is based on the Berkeley 4.2 version of UNIX with selected Bell System V features. The computers support C, FORTRAN 77, ISC Pascal and RM COBOL programming languages. Prices start at \$80,000 for the PN6030 and \$150,000 for the PN6080. **Gould Inc., Computer Systems Division**, 6901 W. Sunrise Blvd., Fort Lauderdale, Fla. 33313, (305) 587-2900.

Circle No 305



housing, the GDC/1000 graphics controller, the GKS Level 2B programmer's graphics interface and the AOS/VS operating system. The workstations suit solids modeling, seismic analysis and geophysical image-processing applications. Prices start at \$160,500 for the single-user GW/8000 system with 354M-byte non-removable disk and tape drives. A fully configured, four-user GW/10000 system, including the 354M-byte disk drive and a cartridge-tape drive, sells for \$345,000. **Data General Corp.**, 4400 Computer Drive, Westboro, Mass. 01580, (617) 366-8911. **Circle No 307**

Office minicomputer supports 64 users

Packaged in two desk-height cabinets, the Prime 2550 minicomputer contains a two-board CPU with custom gate arrays and supports 64 interactive users. The machine features quad floating-point capability and hardware decimal arithmetic. It runs on the PRIMOS operating system. Priced at \$99,500, the standard system package includes a 32-bit CPU, 2M-byte main memory, 16K-byte cache memory, 315M bytes of rigid disk storage, a 1,600-/3,200-bpi streaming-tape drive, a PST100 console and a diagnostic processor. **Prime Computer Inc.**, Prime Park, Natick, Mass. 01760, (617) 655-8000. **Circle No 308**

Pick-based micros are expandable

The Sunshine series of microcomputers features a 10-slot S-100 bus chassis and a Motorola 68000 CPU. The computers use the Pick or XENIX operating systems. Offerings in the series begin with an entry-level, four-user system having 256K bytes of memory and 5M bytes fixed/5M bytes removable Winchester disk storage. The top-of-the-

range product features 4M bytes of internal memory, 280M bytes of disk drive capacity, the ability to handle 32 users, a 1/2-inch tape drive controller and a parallel printer port. Prices start at \$9,995. **Climax Computer Corp.**, 3605 W. MacArthur Blvd., Suite 702, Santa Ana, Calif. 92704, (714) 545-8357.

Circle No 309

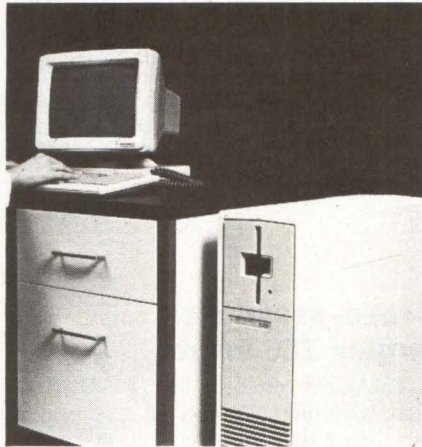

UNIX-based computer features windows

Based on the Motorola 68010 microprocessor, the 6000 series computer systems run under a UNIX-derived operating system with the Uniview common user interface. Uniview provides menus and help screens and allows windowing of eight tasks simultaneously, copying and moving information between windows and direct access to UNIX commands. For application development, COBOL, BASIC, Pascal, SIBOL and C programming languages are available. Communications software for the 6000 series includes 2780/3780 bisynchronous (BSC) remote job entry, 3770 SNA remote-job entry, 3270 BSC interactive communications and 3270 SNA interactive communications. Model 6300, with two workstations, 20M bytes of disk storage, 1M byte of memory, the UNIX operating system, a 68010 CPU and a character printer sells for \$15,181. Model 6600, with eight workstations, 74M bytes of disk storage, 1.5M bytes of memory, a character printer and a line printer, the UNIX operating system and a 68010 CPU sells for \$70,650. **Four-Phase Systems**, 10700 N. DeAnza Blvd., Cupertino, Calif. 95014, (408) 255-0900.

Circle No 310

UNITRONIX distributes DIGITAL computers

As a member of Digital Equipment Corporation's network of independent computer distributors, Unitronix can define your needs and help you choose the right Digital computer system for your company. Best of all, Unitronix provides fast delivery of your Digital computer from our multi-million dollar inventory.

Powerful systems using these CPUs . . . tailored to your needs

- | | |
|--------------|--------------|
| ■ Micro 11 | ■ MICROVAX I |
| ■ PDP-11/23+ | ■ VAX 11/725 |
| ■ PDP-11/24 | ■ VAX 11/730 |
| ■ PDP-11/44 | ■ VAX 11/750 |
| ■ PDP-11/73 | ■ VAX 11/782 |

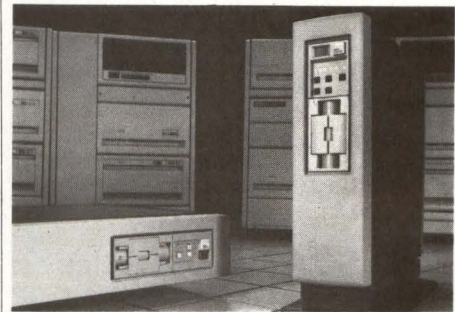

COMPLETE DATA SYSTEMS

with Unitronix-developed standard, customized and custom applications software

CALL TODAY . . .
FOR LATEST PRICING, DELIVERY
AND LEASE OR RENTAL INFO
(201) 231-9400

UNITRONIX CORPORATION

AUTHORIZED
digital
COMPUTER DISTRIBUTOR

50 County Line Road
Somerville, NJ 08876
(201) 231-9400 ■ TELEX: 833184

CIRCLE NO. 127 ON INQUIRY CARD

New Products

SOFTWARE

C library contains 200 functions

The Greenleaf Functions C library, a programmer-productivity tool for the IBM PC and IBM PC-compatible microcomputers, holds more than 200 functions and routines and supports Computer Innovations C86, Microsoft C or Lattice C compilers. It includes more than 32 DOS functions for DOS 2.0 and 1.1, 23 video- and screen-control functions, more than 60 string functions, five color-graphics functions, 44 graphics-printer functions, six keyboard functions, nine time and date functions, RS232 asynchronous communications functions and four software-diagnostics functions. The package also contains a 200-page manual with examples of each function, demonstration programs with source code and a reference card. \$175 with assembler and complete source code in C. **Greenleaf Software Inc.**, 2101 Hickory Drive, Carrollton, Texas 75006, (214) 446-8641.

Circle No 311

Package provides data-analysis capabilities

The Statpro statistics and graphics database workstation is a series of integrated statistics, graphics and data-management programs. Statpro turns Apple's Lisa 2 computer into a professional research and management workstation. The database component allows users to enter, edit, manipulate, transform, store, copy and print data. The statistics component contains statistical procedures grouped into descriptive, regression, analysis of variance, time series and multivariate modules. The graphics component provides standard graphing functions, including scatter, triangle, regression and box plots as well as pie charts and histograms. \$1,995. **Wadsworth Professional Software Inc.**, Statler Office Building, 20 Park Plaza, Boston, Mass. 02116, (617) 423-0420, (800) 322-2208.

Circle No 312

Compiler family runs on 68000-based UNIX systems

This six-member family of high-level language compilers allows users to mix subprograms written in different languages into one program. The compilers, for COBOL, RPG-II, Pascal, C,

PL/I and BASIC, run on computers that use the Motorola MC68000 microprocessor and the UNIX operating system. They use the company's Component Architecture, a modular software architecture that combines front-end, optimizer, code-generator, run-time-library and high-level-debugger processors into a compiler. The compilers use ISAM to handle data files; programs written in one language can address and use files written in another language. The compilers sell for \$50,000 each to hardware OEMs, plus royalties based on system size. Single copies with run-time license distribution rights are available. **Language Processors Inc.**, 400-1 Totten Pond Road, Waltham, Mass. 02154, (617) 890-1155.

Circle No 313

Cross-assembler targets Z80 micro

XMACZ80 enables any PC-DOS or MS-DOS microcomputer system to serve as a development station for the Zilog Z80 microprocessor. This software system includes a relocating macroassembler, a linking loader, an absolute macroassembler, a text editor, a cross-reference generator, a hex file converter and offloading facilities. The relocating macroassembler features full macro and conditional assembly and can chain a series of source files during one assembly. The two-pass linking loader produces an absolute Intel hex file. The absolute macroassembler handles projects that do not require the relocation feature. A user-configurable down-loader offloads programs developed under XMACZ80 to the target processor for test. \$250. **Alley Ashley**, 395 Sierra Madre Villa, Pasadena, Calif. 91107, (818) 793-5748.

Circle No 314

Floating-point library runs on 68000 micros

The 68000 FPAC/DPAC floating-point library is a set of subroutines that processes floating-point numbers in the proposed KCS IEEE single- and double-precision formats. In addition to standard arithmetic operations and integer-to-floating-point conversion routines, the library includes functions to compute sine, cosine, tangent, arc-

tangent, square root, common logarithm, natural logarithm, exponentiation and floating-point-number-to-integer power. It also contains ASCII-to-floating-point and floating-point-to-ASCII conversion routines. The re-entrant package performs basic single-precision operations at approximately 12,000 FLOPS on an 8-MHz 68000 microprocessor. Double-precision basic operations run at approximately 5,000 FLOPS. Single-precision 68000 FPAC: \$750; double-precision 68000 DPAC: \$1,250. **U.S. Software**, 5470 N.W. Innisbrook Place, Portland, Ore. 97229, (503) 645-5043.

Circle No 315

Utility transfers files between computers

The IBM PC's file-transfer system (FTS) utility program provides bidirectional file transfers between PCs and mainframes running OS/VS2 TSO. FTS runs under version 1.1 or later of PC-DOS and requires the IRMA decision-support interface printed-circuit board. The board furnishes the communication link to the host mainframe via a 3270 control unit. FTS supports files containing character data only. It supports PC files consisting of ASCII graphics characters and the following ASCII control characters: horizontal tab, line feed, form feed, carriage return and control Z. \$295. **Mackensen Distributed Systems**, 3323 Pearl St., Santa Monica, Calif. 90405, (213) 452-5520.

Circle No 316

Tool transports programs from RSTS/E to VAX/VMS

The BIO series of external callable routines emulates the RSTS/E disk file I/O environment on the VAX/VMS operating system and aids transportation of application programs for the RSTS/E operating system to the VAX/VMS operating system without converting to RMS files and without major programming logic conversion. It also allows RSTS/E software to continue to perform multiblock I/O transfers with full file sharing and block locking. \$500 to \$3,000. **Park Software Inc.**, P.O. Box 202 Northgate Station, Seattle, Wash. 98125, (206) 284-4025.

Circle No 317



Subject: Engineering for maximum performance.

Quantum Software Systems Ltd. bring you QNX — The Ultimate Operating System. The design of QNX allows you to take advantage of an IBM-PC or similar micro-computers in ways that are only possible on large mini and mainframe computers.

Unlike other UNIX™ type systems QNX was engineered for the 86/8088 architecture. All of QNX's features were designed into the operating system right from the beginning. As a Real-Time Multi-Tasking O/S, QNX will support up to 48 tasks executing simultaneously. It is also a Multi-User O/S with a Time-Sharing Environment supporting up to 17 users, with a security conscious Message-Passing Protocol ideally suited for Local Area Networks. We will shortly be announcing a true (not just a file server) distributed Local Area Network version of QNX.

To minimize memory requirements we allow Shared Code and Shared Libraries. Disk access is accelerated by Disk Caching. To improve productivity we give you Multiple Windows. For those of you who wish to add new devices, you simply mount a Device Driver. Our operating system is compact (64K).

QNX is fast; benchmarked to be 20 times faster than other popular UNIX™ systems. On a 5 Mhz 8088, task switching is done in under 1.3 msec interrupt latency and kernel call overhead is under 50 usec.

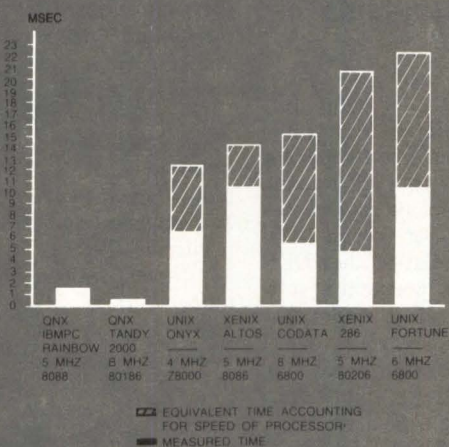

The QNX file system is highly optimized with minimum floppy disk access and is tolerant of power failure. It is a Hierarchical Directory system with 16 character file/directory names. There are NO limits on number of files, or number of directories. The file system has a

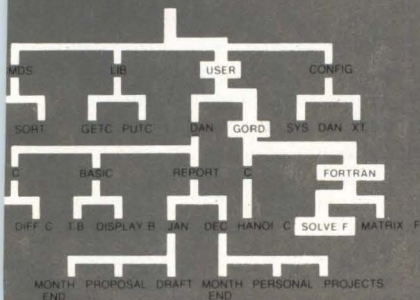

minimum File Allocation Unit of 512 bytes regardless of disk size with a directory overhead of less than 2%. Up to 40 files can be opened simultaneously. The QNX Multi-User file security includes read/write/append/execute/modify file permissions, and read/create/

block/modify directory permissions. 256 Groups of up to 256 users in each group are possible. QNX files can grow automatically and need not be contiguous.

The Intertask communications include message passing, non-blocking signals, and asynchronous exceptions. Messages are passed at the rate of 3 usec/byte on a 5 Mhz 8088 and may consist of up to 64K bytes. Partial I/O of messages is permitted and message forwarding is supported. Priority task scheduling will allow up to 16 priorities and 48 simultaneous tasks. Messages may be sent between tasks on different nodes in the local area network version of QNX.

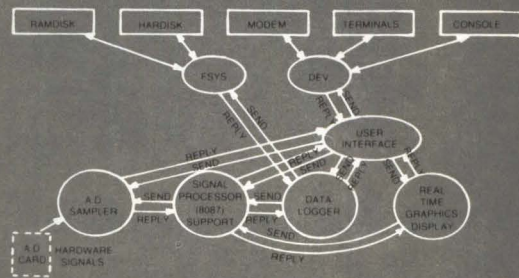

Asynchronous Communications are completely interrupt driven with up to 16 serial (RS232) devices supported. Input/output Flow Control is supported for XON/XOFF and DTR/CTS hardware. Loss of carrier can generate a High Level Exception. Line Editing is a programmable option on any terminal and terminal independence is made simple with a "TERMCAP" type database.

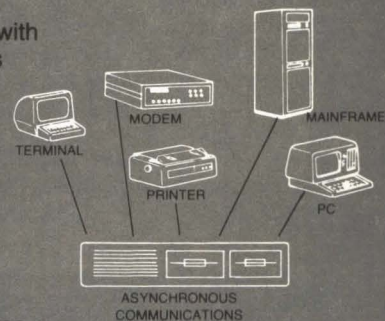

Other Quantum Software product development tools include a "C" Compiler, a Full Screen Editor, an 8086 Assembler, a Fortran Compiler, a Basic Compiler, a Qbol (Dibol) Compiler, and Graphics and Math libraries with complete 8087 support.

Minimum hardware required is an IBM-PC or compatible with 128K RAM, single 320K floppy drive, and display/keyboard (or terminal). Maximum requirements are 880K RAM, 8087 math co-processor, 8 disk drives (floppy, hard or ramdisk), 2 parallel printers and 16 RS232 devices (terminals, modems, printers).

QUANTUM SOFTWARE SYSTEMS LTD.
Moodie Drive, HiTech Park
215 Stafford Rd., Unit 104
Ottawa, Canada K2H 9C1
(613) 726-1893



CIRCLE NO. 129 ON INQUIRY CARD

PRICE LIST

QNX 1.20 WITH "C" COMPILER	QBOL COMPILER	\$595
QNX 2.00 WITH "C" COMPILER (2 NODES)	QMENU	\$150
BASIC COMPILER	BTREE	\$150
"C" COMPILER	QSPELL	\$199
	QDOC	\$300
	TED/TERMCAP	\$ 50

AUTHORIZED DISTRIBUTORS

CANADA:	QUANTUM SOFTWARE SYSTEMS	(613) 726-1893
	PERIPHERALS PLUS INC.	(514) 364-5554
	KANATEK MICRO	(613) 726-1907
USA:	MICRO MANAGERS OF TEXAS INC.	(512) 341-9544
EUROPE:	XMIT A G (SWITZERLAND)	(41) 57-331966
SOUTH AMERICA:	ANALYSIS SISTEMAS PLANEJAMENTO	
	E ORGANIZAC (BRAZIL)	(11) 280-5930

New Products

DISK/TAPE

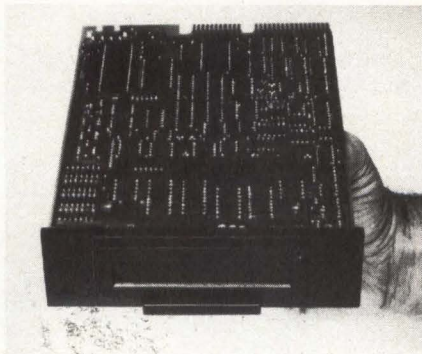

Micro cartridge-tape drives store 10M bytes

The model 110 and 210 tape drives pack 10M bytes of formatted data on DC-100A-sized cartridges to meet Winchester disk backup needs. The 110 comes in a half-height, 5¼-inch form factor; the 210, a 3½-inch form factor. They incorporate a host interface that is hardware-compatible with SA450 minifloppy controllers. Both products read and write data at 39 ips and transfer data at 250,000 bps. Recording density is 6,400 bpi on eight tracks. \$300 (500 units). **Irwin Magnetics**, 2311 Green Road, Ann Arbor, Mich. 48105, (313) 996-3300. **Circle No 318**

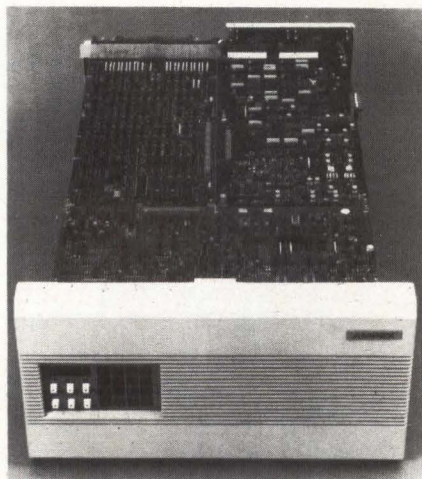

Winchester stores at \$10 per megabyte

The Centaurus family of 14-inch Winchester disk drives provides 330M, 660M or 825M bytes of unformatted rack-mountable storage capacity. All three models offer average access times of less than 25 msec. using a linear voice-coil actuator in a closed-loop, dedicated-servo system. Incorporating an SMD interface with dual-port capabili-

ties, the drives support 1.859M-byte-per-second data transfers. The products use RLL 2,7 encoding and have track capacities of 40,320 bytes per track. The units support densities of 960 tpi and 12,500 bpi. Model 825: \$8,250 (OEM quantities). **Ampex Computer Products Division**, 401 Broadway, Redwood City, Calif. 94063, (408) 725-2017.

Circle No 319

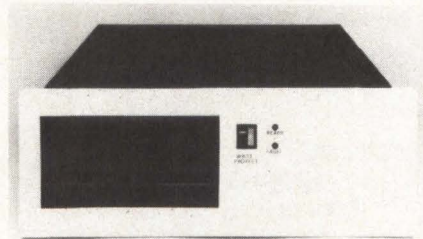

Winchester subsystems store 140M bytes

The CI-1340-WF Winchester subsystems for DEC LSI-11 microcomputer-based systems store 42M, 70M or 140M bytes, using a 22-bit DMA controller for the Winchester disk drive. The rigid disk drive has a 20-msec. average access time and a 1.2M-byte-per-second data-transfer rate. It emulates the DEC RK06 and RK07 drives, permitting software-transparent operation under the RSTS-E, RSX11M, RSX11M+, RT11 and UNIX operating systems. All subsystems contain a 2M-byte, dual floppy disk drive or streaming-tape drive backup. Prices are \$6,995, \$7,195 and \$8,195 for the 42M-, 70M- and 140M-byte models, respectively. **Chrislin Industries Inc.**, 31352 Via Colinas, Westlake Village, Calif. 91362, (818) 991-2254.

Circle No 320

Memory subsystem is Q-bus-compatible

The model 81QB-4 mass-storage subsystem provides 41.6M bytes of formatted storage capacity for DEC LSI-11 Q-bus systems. The subsystem includes two of the vendor's model 8520 fixed/removable, 8-inch disk drives, an SASI controller, a Q-bus host adapter and a shielded interface cable. The package emulates as many as four RL02 14-inch disk drives and is software-compatible with operating systems and diagnostics for the RL01/02, including RSX11M, RSTS and UNIX. Model 81QB-2 contains one fixed/removable disk drive and stores 20.8M bytes. Model 81QB-4:

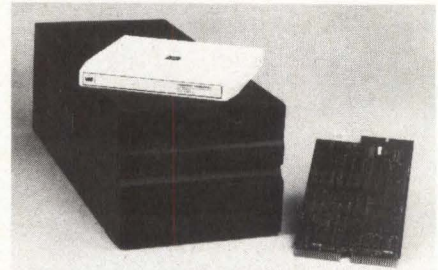

\$11,020 (100 units); model 81QB-2: \$6,420 (100 units). **Vermont Research Corp.**, Precision Park, North Springfield, Vt. 05150, (802) 886-2256.

Circle No 321

Half-height minifloppy packs 1.6M bytes

The double-sided model 475 half-height, 5¼-inch floppy disk drive features an unformatted capacity of 1.6M bytes, a 500K-bit-per-second data-transfer rate and a 91-msec. average access time. The 96-tpi unit can read data written on 48-tpi, 5¼-inch diskettes. Recording density is 9,646 bpi. A brushless, direct-drive DC spindle motor revolves the spindle at 360 rpm. A stepper-motor/band-actuator system positions the read/write head. Other key specifications include power requirements of 12.5W, operating, and 3.6W, standby, and an MTBF rating of 10,000 power-on hours. Less than \$200 in OEM quantities. **Shugart Corp.**, 475 Oakmead Parkway, Sunnyvale, Calif. 94086, (408) 737-4355. **Circle No 322**

Subsystems add 40M bytes to LSI-11s

The CI-820 Winchester subsystems for DEC LSI-11 microcomputer-based systems are available with formatted capacities of 10M, 20M and 40M bytes. All subsystems contain a 2M-byte dual-diskette-drive or streaming-tape backup. One 22-bit dual-DMA controller handles floppy and Winchester disks. The drives access data in 40 msec. (average) and transfer data at 625K bytes per second. They emulate RLO1, RLO2, RX02 and RX03 drives, permitting software-transparent operation under RSTS-E, RSX-11M, RSX-11M+, RT11 and UNIX operating systems. \$4,495, \$4,995 and \$5,995 for the 10M-, 20M- and 40M-byte versions, respectively. **Chrislin Industries Inc.**, 31352 Via Colinas, Westlake Village, Calif. 91362, (818) 991-2254. **Circle No 323**

More than A Memory A Commitment To Quality

Every department, every person in our organization is dedicated to one goal—to deliver the finest in disk memories.

At Century Data Systems, we see quality as a pervasive, company-wide attitude. And our customers share this perspective.

Leading OEMs continue to rely on Century Data Systems disk memories for superb reliability, year after year. That's the real payoff from our total approach to quality.

At Century Data Systems, quality is much more than a memory. It's a living company commitment. And it can work to your advantage. Write or call for specifics.

 **Century Data Systems**
A Xerox Company

Marketing Communications
1270 N. Kraemer Boulevard
Anaheim, California 92806
(714) 999-2660

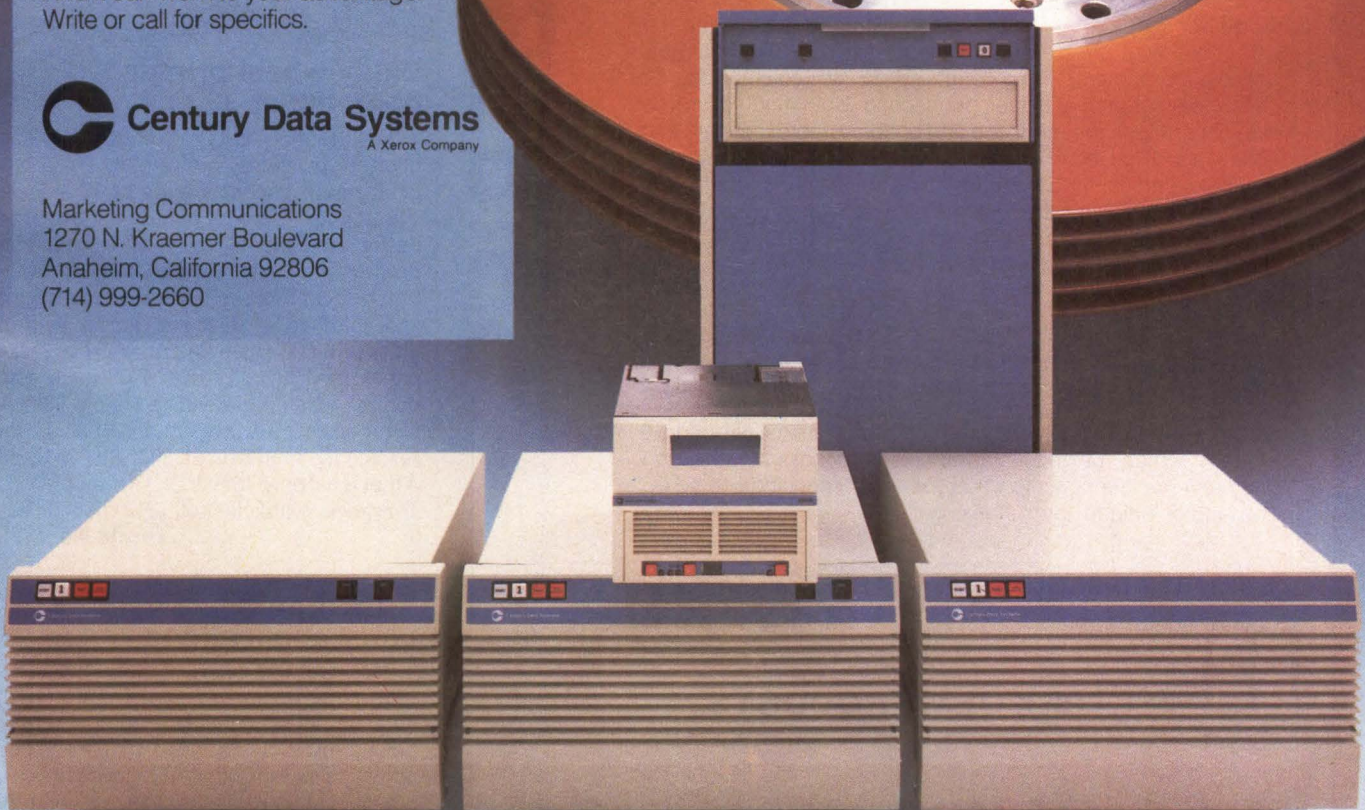

CIRCLE NO. 130 ON INQUIRY CARD

New Products

PRINTERS

Printers employ 125-character daisy wheels

The 500 series daisy-wheel printers operate at a 50-dBa noise level and have Centronics and RS232 interfaces. The transportable model 5025 prints at 25 cps; the 5040 and 5055 desktop models

print at 40 and 55 cps, respectively. The printers can print 132-column forms for spreadsheet applications using 125-character daisy wheels. The print wheels for the models 5040 and 5055 are interchangeable. External software controls allow the printing of as many as

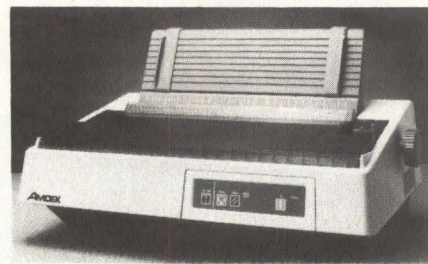

309 Teletex characters. Model 5025: \$799; model 5040: \$1,675; model 5055: \$1,990. **Amdek Corp.**, 2201 Lively Blvd. Elk Grove, Ill. 60007, (312) 364-1180. **Circle No 324**

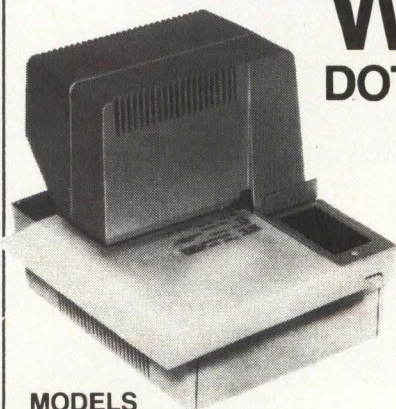

**MODELS
8400/8410**

WESTREX DOT MATRIX PRINTERS

**NEW!
STAND-ALONE,
150 CPS
SLIP/DOCUMENT
PRINTERS**

**8000
SERIES**

Model 8400 and Model 8410 are new, packaged, stand-alone, alphanumeric, bi-directional, flat bed, Slip/Document dot matrix printers. They print up to 40 columns at 12 characters per inch at 3 lines per second. Both models provide side or front form insertion; top and bottom-of-form sensors and adjustable Slip/Document Stop. The print head employs a 7-needle vertical array that permits selection of fonts and characters (5 x 7, double width, etc). The character set is fully alphanumeric under software control. The 100% duty cycle print head life is rated at 100 million characters.

Model 8400 and Model 8410 are complete with control and drive electronics. Serial RS-232C or TTY and parallel interfaces are available. Both units can provide multiple print lines and carbon or pressure sensitive copy.

Model 8410 additionally features a stepping motor paper drive system which permits variable and programmable forward reverse line spacing for applications requiring line selection and or unique form indexing.

QUANTITY DISCOUNTS AVAILABLE.



For full details, write or call us

WESTREX OEM PRODUCTS

51 Penn Street, Fall River, MA 02724. (617) 676-1016 TELEX: 1651490 Relay WNJW
IN FRANCE — WESTREX OEM PRODUCTS, 103-105 Rue de Tocqueville,
750 Paris, France 01-766-322-70 TELEX: 610148
IN SWEDEN — WESTREX OEM PRODUCTS, Box 3503, S-17203 Sundbyberg,
Sweden 46 8 + 981100 TELEX: 12139

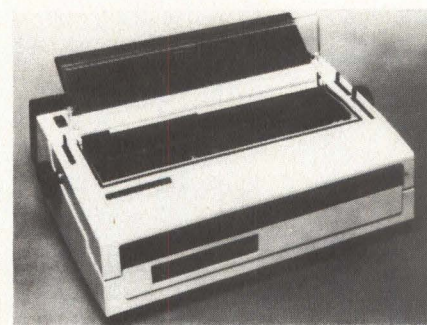

Daisy-wheel printer operates at 36 cps

The model EXP 770 daisy-wheel printer provides bidirectional, 36-cps printing on paper as wide as 17 inches. The standard model contains a 2K-byte buffer, expandable to 48K bytes. The product supports word-processing functions including subscript, superscript and boldface. It features carrier feed in units of 0.0083 inch and forward/reverse paper feed in units of 0.0208 inch. The printer also emulates the Diablo 630. A Centronics interface or an RS232C interface is standard. \$1,295. **Silver-Reed America Inc.**, 19600 S. Vermont Ave., Torrance, Calif. 90502, (213) 516-7008.

Circle No 325

Printer suits color applications

The Gultron color printer produces hard copy in seven colors from a CRT, CPU or video monitor. Using a triple-pass thermal-transfer process, the printer can reproduce video images on non-thermal Z-fold paper or acetate film. Model CP-80V is RS170 compatible and accepts RGB signals with or without separate sync. It prints a full page (640 by 480 dots) in 45 seconds. Model

CIRCLE NO. 131 ON INQUIRY CARD

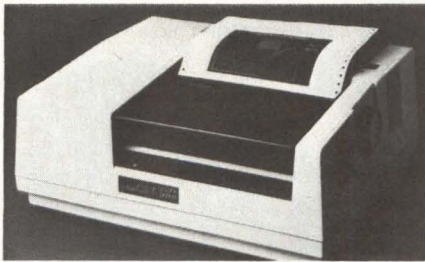

CP-80C is 8-bit parallel and Centronics-compatible. It accepts text and graphics directly from a CPU. The data-input code consists of 192 characters; the character configuration is a 7-by-11-dot matrix. \$4,950. **Gulton Industries Inc., Graphic Instruments Division**, Gulton Industrial Park, East Greenwich, R.I. 02818, (800) 343-7929. **Circle No 326**



Dot-matrix printer uses 24-pin technology

Featuring a 24-pin print head, the P1340 dot-matrix printer provides letter-quality output, high-speed drafts and graphics in one pass. In letter-quality mode, the 80-column unit prints at 54 cps. It produces draft-quality documents at 144 cps and graphics with 180-by-180-dpi density. Additional features include software-selectable multiple fonts, pitches, line spacing, condensed print and proportional spacing. Qume Sprint 5 emulation is standard. The unit handles letter sheets or continuous forms from 4½ to 10 inches wide. In compressed print mode, the printer furnishes a 132-column format on letter-head-sized sheets. Friction-roller paper feed and a built-in forms tractor are also standard. The printer connects to microcomputers and word processors via a Centronics-compatible interface. \$995. **Toshiba America Inc., Information Systems Division**, 2441 Michelle Drive, Tustin, Calif. 92680, (714) 730-5000.

Circle No 327

INTRODUCING THE CTS 212AH MODEM

Discover in nine minutes
what it's taken ninety years
to develop;
Reliability.



CTS Technological Reliability

The high speed, digital signal processor in our 212AH modem was originally engineered for very complex, custom modem systems. We now have applied this advanced technology to a standard Bell 212A compatible product. You get clear, error free transmission despite varying phone line conditions. Other features include auto dial/answer, remote digital loopback, full duplex 300 bps and 1200 bps asynchronous operation and 1200 bps synchronous operation. In a few minutes you'll discover our modem has all the bells and whistles you could ask for. Yet, at a surprisingly low price.

CTS Field Reliability

We warranty our 212AH modem for two years, and we demand our distributors service and support your needs immediately. Once in the field, our modems operate with all data terminals, more than 100 types of computers and are Hayes compatible.

CTS Brand Reliability

In 1896 CTS began manufacturing hand cranked, wooden, wall mounted telephones. Today, we offer the sophisticated 212AH modem. It's taken us almost ninety years of hard work, intensive research and innovative products to develop a reputation for reliability. Take nine minutes, examine our 212AH modem, and find out for yourself.

CTS®

DATA COMM Products Division

131 West St.

Danbury, CT 06810

203-743-3681

New to the industry since 1896.

New Products

PRINTERS

Matrix line printer runs at 400 lpm

The Dasher GPS dot-matrix line printer operates at 400 lpm. The printer feeds paper as fast as 10 ips and features high-speed space skip when more than five spaces appear between characters.

The unit's programmable functions include character set and pitch, form setting, horizontal and vertical tab settings, underscore, memo-quality print and alternate character sizes. The product prints as many as 136 cpl when printing at 10 cpi. The printer has 11 resident character sets including U.S.,

WHILE EVERYONE WAS TALKING ABOUT OPTICAL DISK TECHNOLOGY, ALCATEL THOMSON GIGADISC WAS DELIVERING.

Gigadisc, the new laser memory system developed for low-cost storage of large quantities of data, has proven itself in field applications worldwide already.

If you require a high capacity random access memory which includes non-erasable removable media with excellent archival properties, Gigadisc is the right product for you. To maintain the lead in today's competitive market, you need the Gigadisc to deliver an attractive system offering low-cost on-line and lower cost off-line storage.

Features like one Gigabyte per side capacity, random data retrieval, SCSI interface and a field proven design make Gigadisc one of the most appealing laser optical memory products available today.

Call us before you write the specifications for your next system. Distributor inquiries welcome.

Alcatel Thomson Gigadisc
210 Avenue I, Suite D
Redondo Beach, CA 90277
(213) 543-5537



GIGADISC

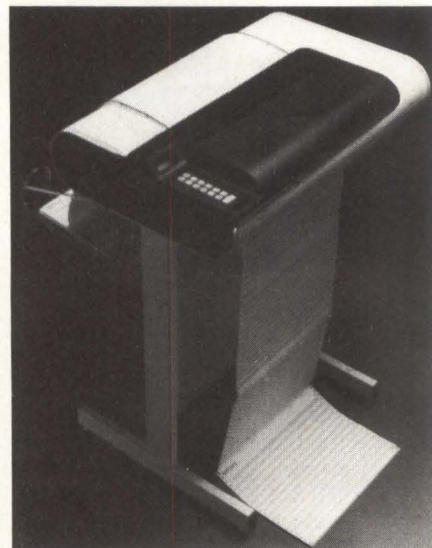
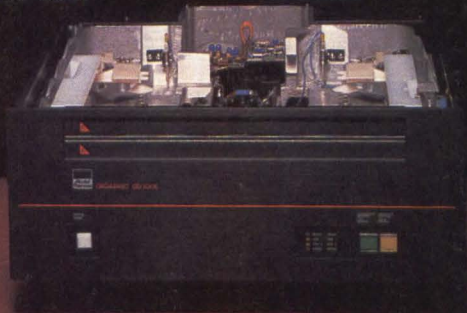

U.K., French, German, Swedish/Finnish, Danish/Norwegian, Spanish, Swiss, kana/ASCII, kana/Japanese and DG multilingual. Serial interface version: \$2,995, parallel interface version: \$2,950. **Data General Corp.**, 4400 Computer Dr., Westboro, Mass. 01581, (617) 366-8911.

Circle No 328

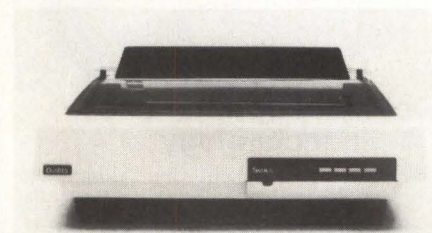

Daisy-wheel printer offers universal interface

The Series 36 daisy-wheel printer prints Shannon text at 28 cps. The device uses drop-in, 98-character plastic print wheels that are available in 18 languages and 19 fonts. The printer features automatic print-wheel recognition and can print as many as 132 columns in 10 pitch. The unit handles one-to five-part forms as wide as 15.2 inches. It offers a variety of interfaces through an all-purpose interface, including RS232C, IEEE-488 and Centronics. The interface is selected by using the appropriate host/printer cable. A 12-bit parallel interface is also available. A 1,280-character buffer is standard. \$1,595. **Diablo Systems Inc.**, 901 Page Ave., P.O. Box 5030, Fremont, Calif. 94537, (415) 498-7000. **Circle No 329**

New Products

TERMINALS



HP terminal has ergonomic features

Featuring a green screen and an ergonomically improved design, the HP 2392A display terminal performs many of the functions of the HP 2622A block-mode data-entry terminal which it supersedes. The new terminal suits data-entry, program-development and data-inquiry applications on HP host systems. ANSI-standard compatibility is available at no extra cost. Furnishing a 12-inch diagonal display, the product occupies approximately one cubic foot of desk space. It incorporates an integrated tilt-and-swivel mechanism. Characters are formed with a 9- by 14-dot cell. Smooth scrolling enables users to read through as many as four pages of text without pause. The unit offers 17 different keyboard language options for international use. Other features include local-editing keys and a 64-character line-drawing set. Communication with host systems occurs via a combined RS232C/HP 422 port. \$1,295. Delivery is approximately six weeks ARO. **Hewlett-Packard Co.**, 1820 Embarcadero Road, Palo Alto, Calif. 94303.

Circle No 330

Dual-personality terminal combines Tek, DEC traits

The CIT-414a monochrome graphics terminal combines Tektronix 4010/4014 terminal emulation and terminal DEC traits. Priced at \$1,495, this 4010/4014 alternative provides a flicker-free 640-by 480-dot resolution display with a 4,096-by-4,096 addressable plot area. Its Tektronix personality offers variable line types, vector/point/incremental plotting, and, using standard 4014 com-

mands, four character sizes. A keyboard-controlled, eight-direction crosshair cursor enhances compatibility with the Tektronix GIN mode. The product's native graphics mode provides line, circle, arc and box generation capabilities. In ANSI mode, features include DEC editors EDT, KED and TICO,

tutorial setup mode and reverse video. Other standards include a printer port for LA100, C. Itoh 8510 and Epson MX-80 compatibility, a detachable keyboard and a non-reflecting screen. **CIE Terminals Inc.**, 2505 McCabe Way, Irvine, Calif. 92714, (714) 660-1421.

Circle No 331

GCR

Take a minute... let's talk about the benefits of GCR (group-coded recording) tape subsystems.

Today's disk drives offer faster transfer rates and larger storage capacities than ever before, placing stringent demands on the tape subsystems used to back them up.

A high density GCR tape subsystem is your logical choice for high performance backup.

Let's Talk Benefits

GCR packs data at 6250 bits per inch—a standard tape reel holds up to

YOUR BACKUP REMEDY

180 megabytes of data! That translates into fewer tape mounts and rewinds, reducing operator involvement... and that's a saver. GCR also provides an outstanding improvement in read/write reliability. Time that was previously spent in retries and error recovery can now be used for computing. That's another saver!

Let's Talk Affordability

Until now, many thought GCR technology was out of their budget. Not anymore! At CCG - California Computer Group, our GCR subsystems start as low as **\$10,500**

Let's Talk Choice

You can't make the right choice unless you have a choice. And CCG helps you choose the right GCR subsystem for your DEC, DG, HP, PE and TI systems. Whether it's a Kennedy 9400, a CDC 92185 "Keystone" or a STC 2920 "Avalanche"

Let's Talk Expertise

At CCG, we're not just selling hardware... we're sharing knowledge. Our configuration specialists examine your needs, then help you determine the right GCR subsystem for your application.

And CCG's been around—our clients include Lockheed, USC, TRW, Citibank, Mobil Oil, University of Chicago... even Notre Dame.

Let's Talk Teamwork

CCG works with you every step of the way... from your first call until your systems are up and running. And whenever you need us, we're only a phone call away.

Let's Talk

There's so much more to talk about. Call us—we'll show you how CCG can put GCR to work for you!

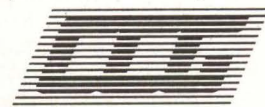

California Computer Group, Inc.

Making A Good System Better.
3303 Harbor Blvd., Suite G-10
Costa Mesa, CA 92626

(800) 854-7488 - Nationwide
(800) 232-1661 - California
(714) 966-1661 - Corporate

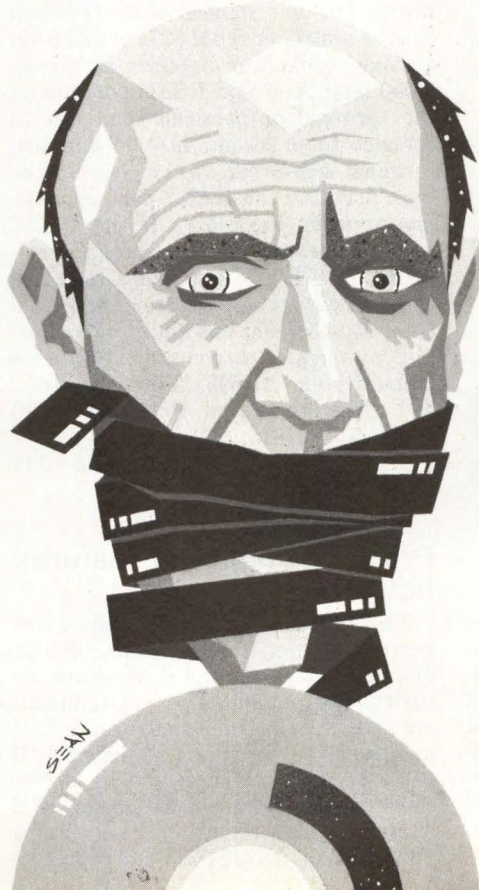

CIRCLE NO. 134 ON INQUIRY CARD

New Products

DATACOMM



Product combines modem with telephone

The Tel-A-Modem integrates an intelligent modem device into a two-line desk-type telephone. The product is compatible with all RS232C terminals and computers. Telephone features include audiovisual phone status, hold function for both lines, last-number automatic re-dial, nine-number memory automatic dialer and individual volume controls for ring signals and line monitor. Modem features include 300- and 1,200-baud data-transmission rates, full-duplex operating mode, automatic answer, automatic selection of baud rate and answer/originate tone, tone or pulse dialing and programmable signal interchange. Five LEDs provide modem status information. \$695.95. **Code-A-Phone Corp.**, 16261 S.E. 130th Ave., Clackamas, Ore. 97015, (503) 655-8940.

Circle No 332

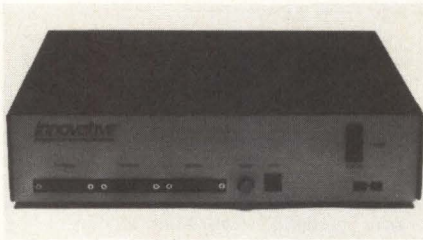

Device performs as async ASCII host

The MC-80/602 communications processor converts a general KSR device or an asynchronous ASCII host into a full-function IBM 3277-1, 3277-2 or 3278-2 terminal communicating with the IBM host using the EBCDIC binary synchronous communications protocol. The device supports IBM 3277/3278 virtual screen sizes of 480, 960 and 1,920 characters. It also supports all IBM 3277/

3278 screen-formatting capabilities including auto-tabbing and protected or unprotected alphanumeric, numeric and non-display fields. The unit provides as much as 16K bytes of ROM, 16K bytes of RAM and one serial communications port. \$1,650. **Innovative Electronics Inc.**, 4714 N.W. 165th St., Miami, Fla. 33014, (305) 624-1644 or (800) 327-3955.

Circle No 333

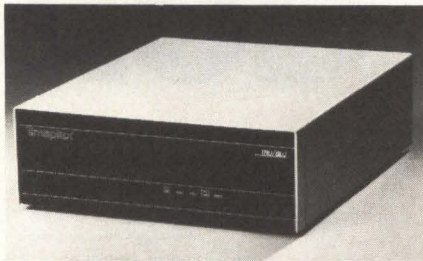

Protocol converter allows IBM 3278 emulation

The TRU/BLU 78 protocol converter permits an ASCII terminal or personal computer to substitute for IBM 3278 synchronous terminals in SNA networks. The unit connects to the terminal cluster controller (IBM 3274 or 3276) via a coaxial cable over distances as long as 5,000 feet. A second RS232 port allows the terminal or personal computer to connect to a second host. From one terminal, a user can switch between the coax port and the RS232 port, increasing network flexibility. If the RS232 port connects to a second host via modems, TRU/BLU 78 supports such features as password protection, autobaud from 300 to 9,600 bps and programmable automatic disconnect. Setup is menu-driven. \$1,695. **Timeplex Inc.**, 400 Chestnut Ridge Road, Woodcliff Lake, N.J. 07675, (201) 930-4600.

Circle No 334

Protocol converter features help screens

The PA1000E universal protocol converter features help screens, dial-up disconnect and multilevel password security. The unit allows personal computers and ASCII terminals to access IBM mainframe environments and ASCII hosts locally or remotely. The device connects via coaxial cable to an IBM 3274/76 cluster controller supporting IBM BSC or SNA/SDLC environments

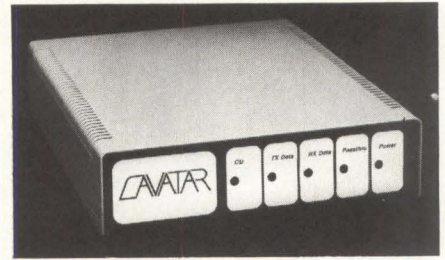

and through an auxiliary RS232C port to ASCII devices, including a printer or modem for connection to an asynchronous host, public information or time-sharing service. ROM-based help screens are available for personal computers such as the IBM PC running 3101 emulation software, the DEC Rainbow running VT100 emulation software and Apple's Macintosh running MacTerm and terminals such as the DEC VT100 and IBM 3101. An optional terminal-emulation software package, Compass, provides IBM 3278-2 and DEC VT100 emulation for MS-DOS-based microcomputers. \$1,095 for the PA1000E, \$100 for Compass. **Avatar Technologies Inc.**, 99 South St., Hopkinton, Mass. 01748, (617) 435-6872.

Circle No 335

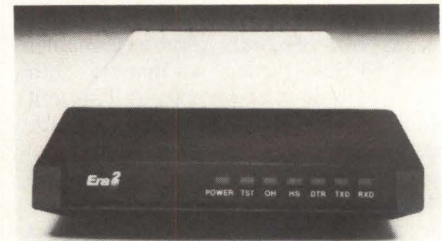

Modem provides error-free datacomm

The Era 2 SX/1200 standalone 1,200-baud modem implements the MNP machine-independent, error-correcting protocol. MNP detects transmission errors between Era 2 modems caused by line interference or low-quality telephone connections and retransmits lost or incorrectly received data. The product is Bell 212A-compatible, supports RS232 devices and can be rack-mounted. It can store as many as nine telephone numbers of 36 digits each, with battery backup. Prices start at \$599. **Microcom Inc.**, 1400A Providence Highway, Norwood, Mass. 02062, (617) 762-9310.

Circle No 336

White Collar Worker.

Blue Collar Worker.

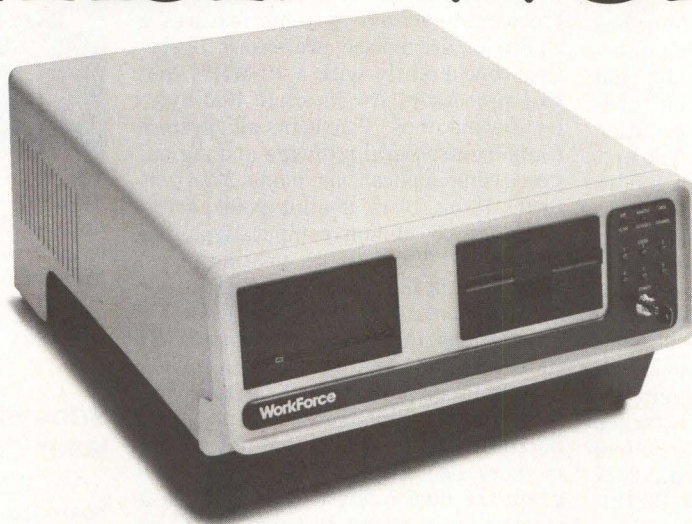

Introducing WorkForce™

A 68000-based multi-user system
that makes one incredible worker.

In the factory. Or the office.

Because it's built to take on rugged
environments, or not-so-rugged envi-
ronments, 24 hours a day — every day.

Weekends. Holidays. No days off.

It handles up to 16 different work-
stations. It's expandable up to 2.4
gigabytes of rotating memory. It fea-
tures a parallel printer port and
real-time calendar clock. And it's
backed by an established nationwide
service network.

Which just goes to show: good help
really isn't hard to find.

If you know
where to look.

WorkForce™

Good help isn't hard to find.

WorkForce, c/o Digital Datacom, Inc.,
27721 South La Paz Road, Laguna Niguel, CA 92677 (714) 831-8470.

New Products

SUBASSEMBLIES

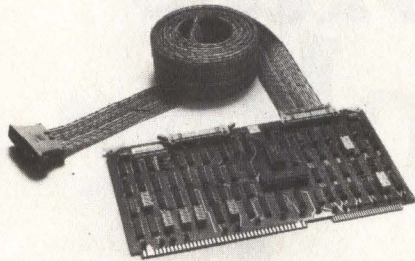

Versatec plotters connect to Multibus computers

The model 10071-5 interface connects Versatec printer/plotters to Multibus computer systems. The product's interface registers provide 8-, 16-, 20- and 24-bit address decode with inhibit capability, I/O or memory-mapped operation and 8- or 16-bit register access. The unit supports all Multibus interrupt modes and furnishes 8- and 16-bit DMA transfers with switch-selectable byte ordering in 16-bit mode at rates as high as 400K bytes per second. Other switch-selectable options include CBRQ/drive capability, parallel or serial bus priority and single-transfer or block-mode bus arbitration. The interface delivers on-board diagnostics without an attached printer/plotter. \$2,000, including 25-foot cable and manual. **IKON Corp.**, 2617 Western Ave., Seattle, Wash. 98121, (206) 624-3410.

Circle No 337

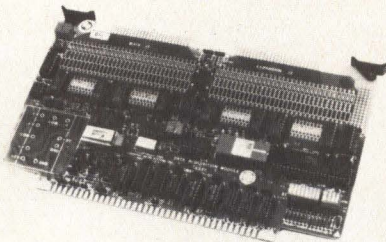

Module performs 12-bit A/D conversions

The model GMS6520 EXORbus data-acquisition module provides 12-bit A/D conversions of 64 input channels and software programmability. It furnishes two banks each of 16 differential or 32 single-ended inputs. A programmed differential gain amplifier has gains of 1, 2, 5 and 10 and multipliers of 1, 4 and 10. Each channel can be software-programmed for single-ended or differential operation to full-scale voltage for

unipolar or bipolar inputs. Full-scale inputs are 0V to 5V, 0V to 10V, $\pm 5V$, $\pm 10V$, $\pm 2.5V$, $\pm 10.24V$ or $\pm 5.12V$. \$680. **General Micro Systems Inc.**, 1320 Chaffey Court, Ontario, Calif. 91762, (714) 621-7532.

Circle No 338

Array processors feature dual processors

The Zip 3200 series of software-programmable array processors for microcomputer-based systems features a choice of arithmetic processors operating concurrently with a 10-MIPS control processor. An internal 40M-byte-per-second bus connects all system components. Serving image and signal-processing applications, model 3216 performs 16-bit (block floating-point) arithmetic at 20 million computations per second and 32-bit (block floating-point) arithmetic at 5 million computations per second. Serving graphics and scientific applications, model 3232 performs 32-bit (floating-point) arithmetic at 10 million computations per second. The basic configuration is implemented on a three-board Multibus card set and has a main memory size of 128K bytes. Users program the dual internal processors in a single-source program using Zip/C, a programmable language that employs a C-like syntax. \$8,000 and \$10,000 for the Zip 3216 and Zip 3232, respectively. **Mercury Computer Systems Inc.**, Wannalancit Technology Center, 600 Suffolk St., Lowell, Mass. 01854, (617) 458-3100.

Circle No 339

3-D digitizer has on-board intelligence

The Perceptor electromechanical digitizer can acquire 3-D points at the rate of seven x, y and z coordinates per second and send them over an RS232 interface to computers that accept serial inputs. The product consists of a precision-machined digitizing arm attached to a frame that is mounted on a ground aluminum reference plate. A Z80A-based circuit board enclosed in a metal housing beneath the reference plate performs the electrical data-acquisition functions. Applications include interactive 3-D CAD, contour analysis of objects that fit within the unit's work

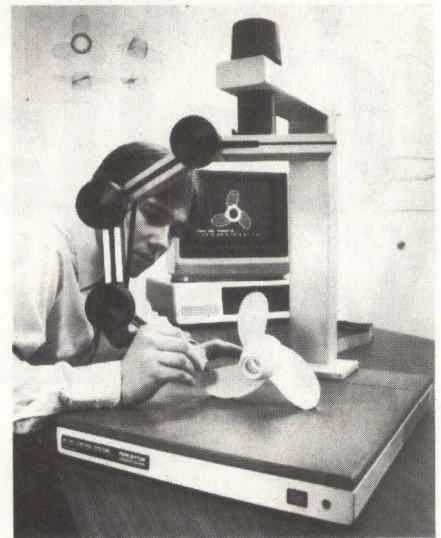

volume, medical applications and field mapping of various information by fixing specific sensors to the device's pointer tip. Contact the company for price. **Micro Control Systems Inc.**, 27 Hartford Turnpike, Vernon, Conn. 06066, (203) 647-0220.

Circle No 340

Subsystem combines laser-disk video, graphics

The V:Link 1000 video-disk controller board package for the IBM PC and look-alikes consists of a plug-in board and associated software. The package generates computer graphics, passes control commands to video-disk players and reads digitally encoded data, such as frame numbers, from the video disk. Users can generate graphics that cover a screen or overlay graphics on video. Users can also move animated images around the screen in real-time with a standard input device such as a tablet. Mapped into eight contiguous 8088 I/O addresses, the board contains a graphics processor, a disk player communications processor and a data-decoding processor. The graphics processor provides 256-by-192-pixel resolution, 16 colors, including transparent, and 33 graphics planes. Software includes a library of control subroutines callable from BASIC, Pascal and C; a graphics-definition package that provides facilities for interactively defining graphics, animation and text; and a BASIC language-development system. \$1,150. **Visage Inc.**, 12 Michigan Drive, Natick, Mass. 01760, (617) 655-1503.

Circle No 341

Zilog now gives users of the System 8000 the kind of choice the big three cereal companies have given breakfast eaters for years.

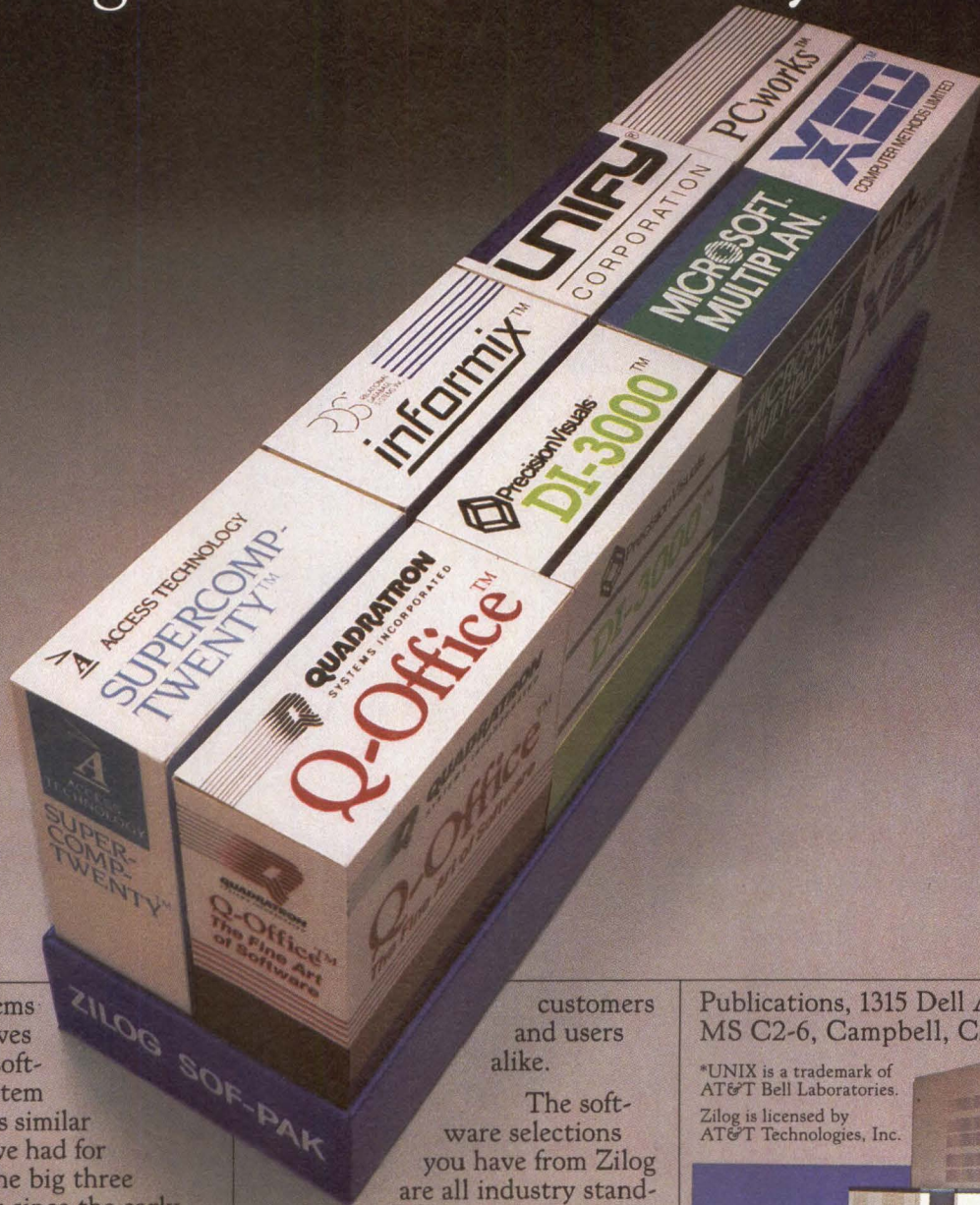

Zilog Systems Division now gives you a choice in software for the System 8000 supermicros similar to the kind you've had for breakfast from the big three cereal companies since the early 1960's. You get to select the software you need when you need it. It's an easy and practical way to satisfy individual tastes.

We give you a choice of the best software you can buy. All from a single source.

We give you a choice of the best software applications packages you can buy. All from a single source. It's efficient, convenient and it saves you money. While satisfying the individual needs of

customers and users alike.

The software selections you have from Zilog are all industry standard packages. Your customers will recognize them instantly. What's more, Zilog provides complete software support. So you don't waste energy seeking vendors for help if and when you need it.

Get a taste of what it's like to run the most satisfying menu of software on the best high-performance UNIX* multi-user supermicros ever built—the System 8000. Call Zilog Systems Division at (800) 841-2255. Or write: Zilog Systems Division, Corporate

Publications, 1315 Dell Avenue, MS C2-6, Campbell, CA 95008.

*UNIX is a trademark of AT&T Bell Laboratories. Zilog is licensed by AT&T Technologies, Inc.



Systems Division
Zilog

an affiliate of EXON Corporation

This year Mini-Micro Systems readers will spend almost \$50 billion on Minicomputers and Microcomputers*

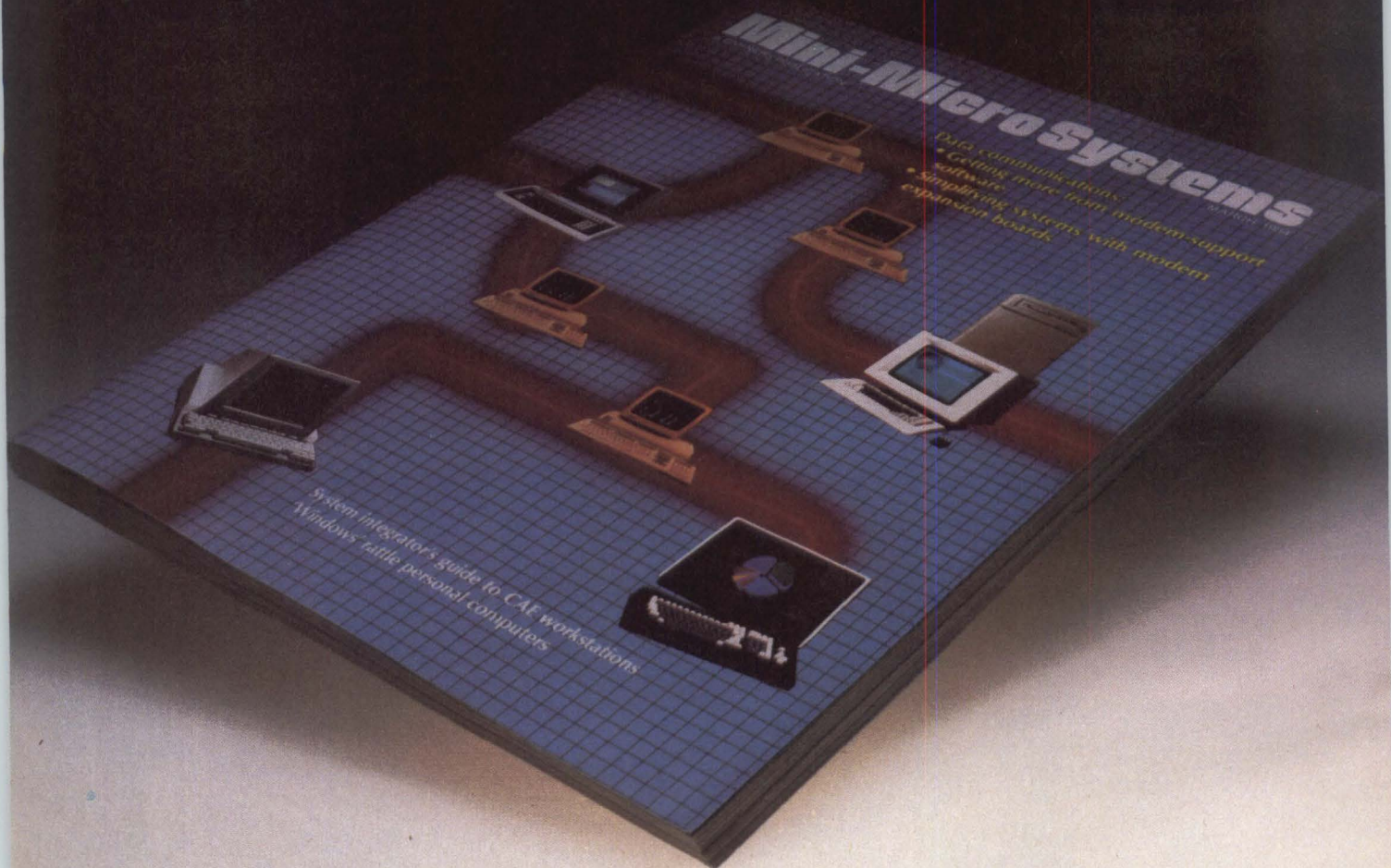

Mini-Micro Systems is the only advertising vehicle to reach the *complete* value-added market for mini-micro computers, peripherals, software, data communication products, supplies and services.

Who are these key prospects? Over 122,000 systems integrators, value-added OEMs, value-added resellers, and value-added users who purchase hardware and software products to configure mini-micro computer systems.

For more information on our market and our magazine, call or write Mini-Micro Systems, 221 Columbus Avenue, Boston, MA 02116 (617) 536-7780.

Mini-Micro Systems

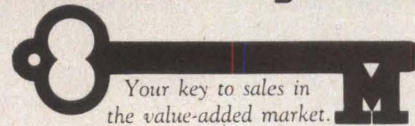

MINI-MICRO SYSTEMS: 221 Columbus Ave., Boston, MA 02116 (617) 536-7780/Chicago: (312) 635-8800/Dallas: (214) 980-0318/ Denver: (303) 388-4511/Los Angeles: (213) 826-5818/Mid-Atlantic: (215) 293-1212; in New York, (212) 724-1790 Orange County: (714) 851-9422/ Northern California & Northwest: (408) 243-8838/Southeast: (404) 955-6500

Cahners Publishing Publishers of 33 specialized business magazines in Building & Construction Electronics & Computers
 Foodservice Manufacturing Health Care

Based on the 13th Annual Mini-Micro Computer Market Report

CIRCLE NO. 137 ON INQUIRY CARD

FINALLY, PUT YOUR FINGER ON ALL THE INFORMATION YOU NEED...

1985 TRADESHOW WEEK DATA BOOK

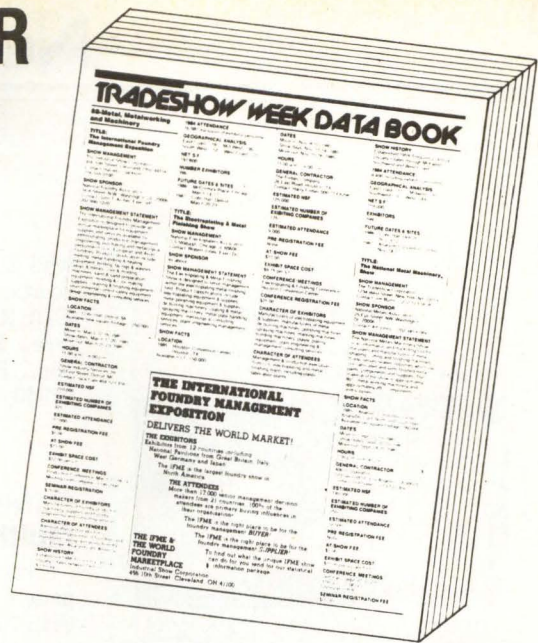

A Long-Needed Reference Source To All Key U.S. Tradeshows

There has been a lack in our industry...a lack of accessible, organized information - An information gap which can only be filled by complicated cross checking of numerous sources and resources, by time consuming legwork and busywork.

Now we've done something about it. We're doing all that information gathering for you to provide specific, useable, applicable statistical and marketing information on 5,000 current tradeshows. It's the long-needed reference guide to a far-reaching industry, the reference guide which finally supplies, in one volume, a compendium of crucial data not previously available anywhere.

Information Is Access. Access To The Right Show At The Right Time In The Right Place.

You'll benefit from features like:

- Reporting Form: A sample of the form used to gather statistics, plus the policy used in validating the report form.
- Index to Tradeshows: Alphabetical index to all tradeshows listed in the Directory with key to their classifications.
- Prime Listing Section: The basic listings of all shows organized by industry with a cross-reference by SIC classification.
- Chronological Listing
- Geographical Listing
- Tradeshow Industry Associations: Listing of all tradeshow industry associations and their functions.
- Multiple Tradeshow Management Organizations: Boldface paid listing section for management organizations who produce tradeshows.

The Industry Said, "We Need This Book."

The **TRADESHOW WEEK DATA BOOK** is designed to facilitate tradeshow planning for every sector of the industry. **CORPORATE EXHIBIT MANAGERS** will find the **TRADESHOW WEEK DATA BOOK** an essential research tool for planning effective tradeshow participation. **EXPOSITION MANAGERS** will be able to put standardized format information about their shows into the hands of corporate management. **TRADESHOW CONTRACTORS** and **HOTEL SALES EXECUTIVES** will find the Directory the most effective source of sales leads in the industry. **CONVENTION BUREAU** and **EXHIBIT HALL MANAGERS** will be better equipped to make logical decisions about potential clients. **ADVERTISING AGENCIES** will be able to make intelligent show participation recommendations. **ASSOCIATION EXECUTIVES** and **EXHIBIT DESIGNERS** and **PRODUCERS** will reach a much wider universe of corporate management and potential exhibitors, significantly expanding corporate tradeshow participation.

THE TRADESHOW WEEK DATA BOOK Is A Tool For Profit

If you're in the business of using information for profit, put the most informative book in the industry at your fingertips. Order your copies today at the special prepublication price of only \$150.

THE TRADESHOW WEEK DATA BOOK - you'll wonder how you ever worked without it.

Order now and save \$25
—Pre publication price
only \$150
—regular price \$175

- The statistics on 5000 tradeshows
- All shows arranged according to industry
- All shows listed chronologically and geographically
- Published by Tradeshow Week in cooperation with the Trade Show Bureau

YES. We're interested in basing our business decisions on the best available information. Please put **THE 1985 TRADESHOW WEEK DATA BOOK** at our fingertips.

Company Name _____
 Address _____
 City, State _____ Zip _____
 Ordered by _____
 Title _____
 # of copies _____ at \$150. Total enclosed in check or money order \$ _____

Tradeshow Week Inc., Suite #236, 12233 W. Olympic Blvd., Los Angeles, CA 90064

New Products

LITERATURE



Digitizer Information

From Summagraphics, manufacturer of the digitizer line preferred worldwide—
The MM™ Series Digitizers

Once again Summagraphics has anticipated the digitizer needs of contemporary graphics systems builders. The MM Series digitizers are designed to offer builders of today's laser and graphics workstation maximum performance at minimum cost. The MM Series performs all corner steering, mouse pointing and graphics tasks, with the added flexibility of a built-in mouse. This unique combination of functions is unmatched by any other digitizer product currently available.

The latest addition to Summagraphics' comprehensive digitizer line features an available, diamond-studded 9" x 11" (182 x 278mm), and 11.7" x 11.7" (101 x 101mm) digitizer mouse cursor for mouse-like cursor steering, a four button cursor for high accuracy tracing, or a mouse stylus for drawing, or a mouse pointing and mouse pointing.

These units incorporate new technology that provides 1000 points of resolution per inch of active area.

All MM Series digitizers come in a compact, slim, lightweight package with all accessories contained on a single printed circuit card. You can select from either a three button cursor for mouse-like cursor steering, a four button cursor for high accuracy tracing, or a mouse stylus for drawing, or a mouse pointing and mouse pointing.

Summagraphics
CORPORATION

Brochure describes MM series of digitizers

This four-page brochure describes the company's MM series of digitizers. It features technical data, interface options, physical data, accessories and photographs of the products in use. **Summagraphics Corp.**, 777 State St. Extension, P.O. Box 781, Fairfield, Conn. 06430, (203) 384-1344.

Circle No 342

Guide covers video data acquisition

Written for engineers who want to configure a video data-acquisition system, this four-page product-selection/designer's guide introduces the company's PC-Eye Capture System. The guide covers text capture, pseudo-color, camera considerations, lenses, speed, hard copy, accessories, system configuration and specifications. **Chorus Data Systems Inc.**, P.O. Box 810, Hollis, N.H. 03049, (603) 465-7100.

Circle No 343

Catalog lists datacomm products

This data-communications products catalog describes the company's line of switches for data terminals, printers, computer ports, modems, multiplexers, concentrators and front-end processors. The catalog also details null modems, data cables and modem/terminal interface testers. The publication includes a

wall chart that describes the pin/signal relationship at the industry-standard EIA RS232 data-communications interface. **Electro Standards Laboratory Inc.**, P.O. Box 9144, Providence, R.I. 02940, (401) 943-1164.

Circle No 344

Catalog covers Multibus products

This 248-page catalog details the company's Multibus product line of more than 70 products, including single-board computers, memory modules, I/O extenders and analog and peripheral controllers. The catalog includes brief descriptions of the IEEE 796 bus (Multibus) and the IEEE P959 bus (iSBX) specifications. **Symbicon Associates Inc.**, 89 Route 101A, Amherst, N.H. 03031, (603) 673-8898.

Circle No 345

Guide aids LAN planning

"How to Stay Calm When Your Company's Getting Wired," an easy-to-read guide to LAN planning, defines the three primary LAN technologies: baseband, broadband and PBX. The guide identifies and discusses 13 basic planning criteria covering topics such as areas served, interconnections, topology (star, bus or tree), adaptability (ease of changing service), resource sharing, security, adherence to network standards and mixed services (voice, video and data). **Sytek Marketing**, 1225 Charleston Road, Mountain View, Calif. 94043, (415) 966-7330.

Circle No 346

Technical manual specifies STD-bus products

The STD-bus technical manual and product catalog contain specifications and data sheets on the company's STD bus product line. The product catalog covers memory and I/O cards, motherboards, card racks, utility cards, prototyping aids and power supplies. Each data sheet covers features; operational, electrical, environmental and mechanical specifications; functional capabilities; options; and ordering information. **Pro-Log Corp.**, 2411 Garden Road, Monterey, Calif. 93940, (408) 372-4593.

Circle No 347

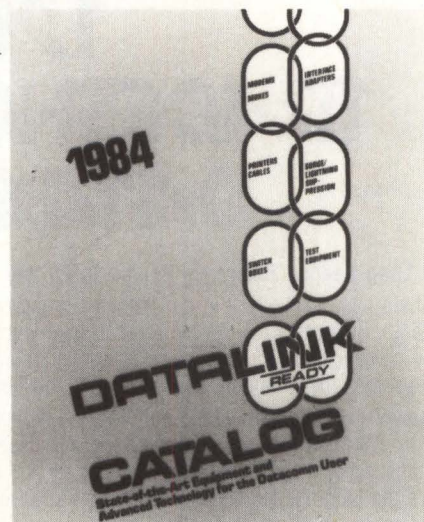

1984

TELEPHONE MODEMS
TELETYPE TERMINALS
TELETYPE PRINTERS
TELETYPE MOUNTING AND REPRODUCTION
TELETYPE SOFTWARE

DATALINK READY

CATALOG

Specialist in Art, Engineering and Advanced Technology for the Datacom User

Communications catalog lists 1,000 products

This 160-page catalog lists more than 1,000 data-communications products including modems, multiplexers, interface adapters, loop converters, surge suppressors, cables and accessories. The publication includes a section on telecommunications references and standards. **Datalink Ready Inc.**, P.O. Box 2169, Melbourne, Fla. 32902, (305) 676-0500.

Circle No 348

Literature outlines VMEbus modules

This six-page color brochure describes the company's VMEbus-compatible product line, including a UNIX-based development system, single-board microcomputers, I/O cards, memory cards and disk and graphics controllers. **DY-4 Systems Inc.**, 1475 S. Bascom Ave., Suite 200, Campbell, Calif. 95008, (408) 377-9822.

Circle No 349

Brochure details Pick-based computers

This six-page color brochure describes the Sabre family of multiuser, multitasking computers that support the Pick operating system. The brochure highlights the Pick operating system, the company's System Builder application generator and hardware specifications. **Pertec Computer Corp.**, Mail Station 71-81, 17112 Armstrong Ave., Irvine, Calif. 92714, (714) 660-0488.

Circle No 350

The Big Apple Hosts The World's Largest End-User Business Computer & Communications Show

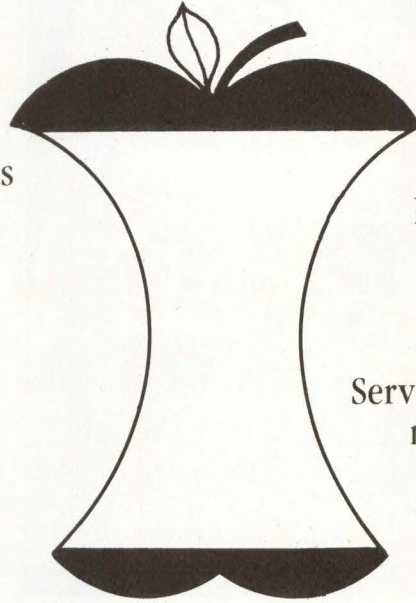

Personal Business Computers
Minicomputers
Mainframe Computers
Computer Peripherals
Work Stations/Computer
Support Furnishings
Data Communications
Voice Communications
Software

Word Processing/Records
Retention & Retrieval Systems
Electronic Mail
Microfilm Equipment
Duplicating/Copy Systems
Services (education/training, facilities
management, consulting, etc.)
Computer Supplies

Plan now to join over 40,000 corporate executives and MIS/DP professionals as they explore the world's largest exhibition of business computer systems.

SEE INFO/SOFTWARE...A SHOW WITHIN A SHOW.

The Eleventh International
**INFORMATION MANAGEMENT
EXPOSITION & CONFERENCE**

New York Coliseum • October 1-4, 1984



We will rush you information about
attending the Show & Conference—or
about exhibiting at INFO 84; all you have
to do is phone INFO 84 at this
special number:
203/964-8287.

New Products

LITERATURE

Handbook covers software design, use

Edited by Charles R. Vick and C.V. Ramamoorthy, the *Handbook of Software Engineering* shows how to apply software engineering tools and techniques at each stage of software development. The 720-page handbook, which contains 285 illustrations, explains simulation modeling, data design, operating systems, management of software development, software testing technology, database management and system evaluation. It discusses strategies for hardware/software trade-offs, performance measurements, fault-tolerance techniques and formal verification procedures. \$62.50. **Van Nostrand Reinhold**, 135 W. 50th St., New York, N.Y. 10020, (212) 265-8700.

Circle No 351

Volumes cover microcomputer interfacing

The Micro-Match two-product service covers planning, installing and interfacing of microcomputers. The first product, *Blueprints*, includes ready-to-use interface diagrams and step-by-step interface instructions for implementing a working interface between microcomputers, CRTs, modems, printers, plotters and special input/output devices. *Blueprints* contains pin-to-pin cable designs, switch-setting diagrams, jumper configurations, device specifications and interface notes for hundreds of device pairs. The second product, *Access Forum*, assists data-processing professionals in integrating microcomputer technology into computer environments. The products are updated quarterly. \$690 per year. **Command Computer Corp.**, P.O. Box 5096, Philadelphia, Pa. 19111, (215) 745-5555.

Circle No 352

Graphics software user's guide provides tutorials

The revised and expanded, 500-page users' guide for the DI-3000 graphics software tools package contains a detailed, step-by-step tutorial that presents the basic concepts of device-independent graphics; more than 200 illustrations, including color plates de-

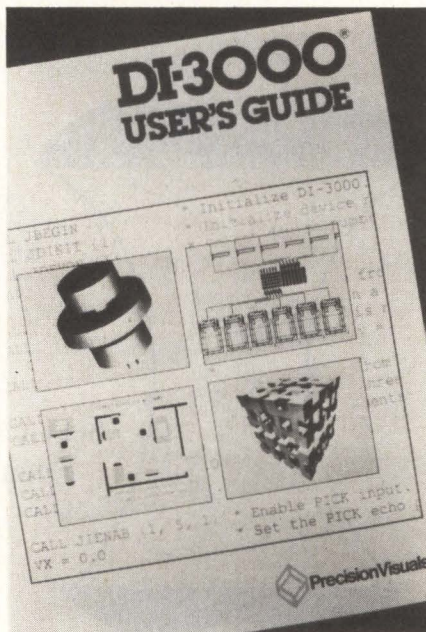

cribing DI-3000's hue/saturation/lightness color capabilities; a reference section; more than 100 partial programs that illustrate commonly used graphics functions; and nine annotated programs that can be used as prototypes for basic business graphs, slide generation and 3-D modeling applications. \$35. **Precision Visuals**, 6250 Lookout Road, Boulder, Colo. 80301, (303) 530-9000.

Circle No 353

Directory details 400 UNIX packages

The second edition of the *UNIX Applications Software Directory* lists almost 400 software packages in 27 categories. Each listing provides the package's price and hardware requirements and its supplier's name, address and telephone number. The directory also includes a cross-reference matrix, in which software is listed by major function and application. \$50. **Onager Publishing**, 6451 Standridge Court, San Jose, Calif. 95123, (408) 225-3541.

Circle No 354

Report outlines software distribution

The 180-page "Microcomputer Software Distribution" report focuses on evolving distribution patterns and strat-

egies for microcomputer software from 1983 through 1990. According to the report, retail outlets and direct responses accounted for 78 percent of all microcomputer software distributed in 1983. The study predicts that, as these two channels decline in importance, computer and software franchises will become the primary channel for the rest of the decade. The report also forecasts software sales by type of outlet through 1990. \$985. **Find/SVP, Information Products Division**, 500 Fifth Ave., New York, N.Y. 10110, (212) 354-2424.

Circle No 355

EIA directory lists member organizations

The 60th anniversary edition of the *EIA Trade Directory and Membership List* lists the Electronic Industries Association's members, associates, affiliates, corporate locations, division locations, telephone numbers, top-level management personnel, products manufactured and corporate trade names. It also records the EIA's board of governors, association committee organizations and the officers and staff of EIA's groups, divisions, departments, councils and panels. \$25 for EIA members, \$50 for non-members. **Electronic Industries Association**, 2001 Eye St., N.W., Washington, D.C. 20006, (202) 457-4980.

Circle No 356

Study examines artificial intelligence

The two-volume "Artificial Intelligence—A New Tool for Industry and Business" shows how AI will affect product manufacturing, research, teaching and training workers, computer programming, business management and decision making. Volume 1 discusses AI technology and its applications and includes a market analysis and forecast for each application. Volume 2 presents the AI programs of U.S. universities. This volume summarizes ongoing projects, lists available research reports and presents contacts for more information. \$485. **Technical Insights Inc.**, P.O. Box 1304, Fort Lee, N.J. 07024, (201) 944-6204.

Circle No 357

“Only the Invitational Computer Conferences bring the latest OEM computer and peripheral products to your front door. You’ll find us there!”

And you’ll find other top OEM manufacturers, such as IBM, Control Data, DEC, Fujitsu, NEC and Seagate, to name a few.

In their 14th year, the “OEM Only” Invitational Computer Conferences bring you, the volume buying decision makers, together with the key suppliers of computer and peripheral products. The ICCs, a series of ten, one-day regional shows are convenient to where you live and work. The social business setting makes it easy for you to meet poten-

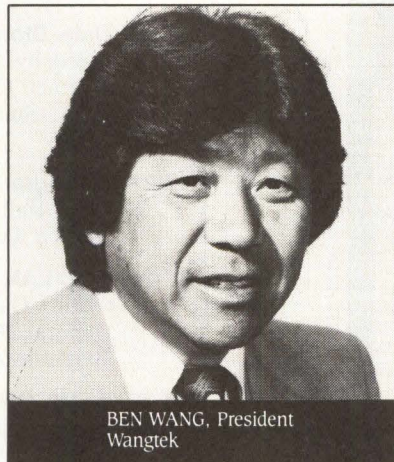

BEN WANG, President Wangtek

tial suppliers one-on-one, and attend high tech seminars of your choice. As an invited guest, there is no cost to you.

Hear what the OEM manufacturers have to say, learn more about their products, and remember, you may attend “by invitation only.”

1984/85 U.S. ICC Locations

Sept. 6, '84	Newton/Boston, MA
Sept. 25, '84	Southfield/Detroit, MI
Oct. 10, '84	Cherry Hill, NJ
Oct. 23, '84	Englewood/Denver, CO
Jan. 8, '85	Irvine, CA
Jan. 29, '85	Houston, TX
Jan. 31, '85	Dallas, TX
Feb. 26, '85	Ft. Lauderdale, FL
Mar. 19, '85	Palo Alto, CA
Apr. 2, '85	Nashua, NH/No. MA

Call your local OEM supplier for your invitation or fill out the coupon and mail to:

B. J. Johnson & Associates, Inc.
 3151 Airway Ave., #C-2
 Costa Mesa, CA 92626
 Phone: (714) 957-0171
 Telex: 188747 TAB IRIN



Yes! I need an invitation to your “OEM Only” ICC. The nearest ICC to me is: _____

I buy in volume:

- Computers
- Disk/Tape Drives
- Controllers / Interfaces
- Terminals / Graphic Displays
- Software
- Printers
- Memory Boards
- Modems / Multiplexers
- Power Supplies

Name _____

Title _____

Company/Division _____

Address _____

City _____ State _____ Zip _____

Mail To: B. J. Johnson & Associates, Inc., 3151 Airway Avenue, #C-2, Costa Mesa, CA 92626
 Phone: (714) 957-0171 Telex: 188747 TAB IRIN

ATRON Announces A State-of- the-Art Software Debugging Tool



FOR THE MULTIBUS®

- **DEBUG 86/88/87 BASED BOARDS**
- **HARDWARE BREAK-POINTS**
 - finds problems like memory overwrites
- **REAL TIME TRACE**
 - answers the question "How did I get here"
- **SYMBOLIC DEBUGGING**
 - no more hex addresses
- **MEMORY MAPPING**
 - test code before blowing proms
- **COMPATIBLE WITH INTEL OBJECT MODULE FORMATS**
 - simplifies language compatibility
- **8 CHANNEL LOGIC ANALYZER**
 - trace and trap external signals
- **MACRO COMMANDS**
 - create your own commands
- **PERFORMANCE ANALYZER**
 - execution histograms
- **PROGRAM PATCHING**
 - on line symbolic assembler

*If you're developing
MULTIBUS® based systems
you need MBUS PROBE
86/88. Call us today.*

MULTIBUS is a registered trademark of Intel Corp.



THE DEBUGGER COMPANY
20665 FOURTH STREET
SARATOGA, CA 95070
(408) 741-5900

Calendar

SEPTEMBER

- 17-19 "Industrial Robots" Course**, Center for Robotics Research of the University of Cincinnati, Cincinnati, sponsored by the University of Cincinnati. Contact: Susan Lyons, Mechanical and Industrial Engineering Department Mail Location 72, University of Cincinnati, Cincinnati, Ohio 45221, (513) 475-4387 or (513) 475-2738.
- 17-19 Data Storage '84**, Fairmount Hotel, Denver, sponsored by Disk/Trend Inc. and Freeman Associates. Contact: Cartlidge & Associates Inc., 4030 Moorpark Ave., Suite 205, San Jose, Calif. 95117, (408) 554-6644.
- 17-21 C Programming Workshop**, San Diego, sponsored by Plum Hall Inc. Contact: Joan Hall, Plum Hall Inc., 1 Spruce Ave., Cardiff, N.J. 08232, (609) 927-3770.
- 17-24 FOC/LAN '84**, Las Vegas, Nev., sponsored by Information Gatekeepers Inc. Contact: Michael O'Bryant, General Manager, Information Gatekeepers Inc., 138 Brighton Ave., Boston, Mass. 01234, (617) 787-1776.
- 18-20 SEMICON/East '84**, Boston, sponsored by Semiconductor Equipment and Materials Institute Inc. Contact: Mary Beth Kern, Semiconductor Equipment and Materials Institute, 625 Ellis St., Suite 212, Mountain View, Calif. 94043, (415) 964-5111.
- 18-20 Federal Computer Conference**, Washington Convention Center, Washington, sponsored by National Council for Education on Information Strategies. Contact: (617) 358-5301.
- 18-21 "Implementing Local-Area Networks" Course**, San Diego, sponsored by Integrated Computer Systems, 6305 Arizona Place, P.O. Box 45405, Los Angeles, Calif. 90045, (213) 417-8888, (800) 352-8251 or (800) 421-8166.
- 19-20 Factory Systems Seminar**, New York, sponsored by The Yankee Group. Contact: Lisa Caruso, Seminar Director, The Yankee Group, 89 Broad St., Boston, Mass. 02110, (617) 542-0100. Also to be held Sept. 26-27 in San Francisco.
- 19-28 35th International Exhibition of Data Processing, Teleprocessing, Communication, Office Procedures and Office Systems (SICOB)**, CNIT, La Defense, Paris, sponsored by International Trade Exhibitions in France Inc. Contact: Pierre Wagner or Claire Bring, International Trade Exhibitions in France, 8 West 40th St., New York, N.Y. 10018, (212) 869-1720.
- 20-21 "Intelligent Robots" Course**, Center for Robotics Research of the University of Cincinnati, Cincinnati, sponsored by the University of Cincinnati. Contact: Susan Lyons, Mechanical and Industrial Engineering Department, Mail Location 72, University of Cincinnati, Cincinnati, Ohio 45221, (513) 475-4387 or (513) 475-2738.

Gould... Innovation and Quality in Image Processing

The Best Software Package in Image Processing Today.



If you want the best image processor, get the best software.

From the day Gould's Library of Image processing Software (LIPS) is installed with your IP8500, you'll have an interactive system with help files, command sequence files, discrete image directories, and full interactive control of all hardware components. You can begin filtering or Fast Fourier Transform (FFT) operations immediately on our sample files, or capture and load your own images from an RS170 camera or our new Real-Time Digital Disk. Look-Up Table manipulation is precise, convenient, and fully interactive, including storage and retrieval.

LIPS is the "package deal" to meet your imaging needs.

LIPS also provides interactive software for measurement of pixels, lines, or regions of any image. Once you've analyzed your images, call a filter of any size or shape from the LIPS kernel database and execute it entirely on our four-channel Digital Video Processor at video rates. Or do spatial modifications such as rotation, translation, or warping. All interactively, all starting installation day. That's the difference between Gould software and any other package in the industry.

LIPS Version 3.0 and LIPS Plus

To assist LANDSAT, specialized classification, and recognition applications, Gould proudly announces LIPS Plus with the following features:

- **Filters:** Median, Wallis (Local Area Adaptive Histogram Equalization), Sobel, kernel of any size, block average filters, Roberts, Prewitt, Laplacian, FFT.
- **Topological Operations:** Thinning, exoskeleton, thick, hollow, fill, cut tail, raster-to-vector, vector-to-raster.
- **Statistics:** Histogram, mean value, standard deviation, variance, covariance, matrix, scattergram for training set generation and edit.
- **Classification:** Bayesian maximum likelihood, parallelepiped, Parzen window, Mahalanobis, minimum distance, Fisher discriminant, principal components, RGB to IHS transforms.

LIPS version 3.0 features the following highlights:

- Convenient system operation and image database management.
- Real-time inputs from camera or digital disk (up to 3200 images).
- Flexible radiometric operations for intensity display and modification (up to 16-bit look-up table).
- Thorough measurement and analysis—spatial and radiometric quantification. Near real-time histogramming.
- Powerful filters and transforms for mathematical data alteration.
- Geometric operations—changing the spatial relationship of data. Warp hardware will perform a 2nd order geometric transform of up to 4K×4K images (8, 12 and 16-bits) using cubic convolution resampling. Typical warp time for 512×512, 8-bit, 4×4 cubic convolution resampling is 1 second.
- Artistic and graphic functions—embellish, rearrange, create images. Auxiliary Graphics Processor: 800,000 points/second.
- Support—training, installation, software subscription.

Write or Call and let us tell you what else is new at Gould Imaging and Graphics Division.

Gould Inc., Imaging and Graphics Division,
1870 Lundy Avenue, San Jose, CA 95131,
(408) 263-7155, TWX (910) 338-7656,
Eastern: (516) 736-3440, Southwest:
(214) 458-0052, Western: (408) 263-7155,
European: (089) 769-5037, Telex: 05-29-628
mod-d.

IMAGE CAPTIONS

Top:

- Left back corner: 2-D FFT processed in 2 minutes with LIPS Plus.
- Four 1024² medical images: multimodality, split screen display.
- Face: CT scans in 3-D modeling, plastic surgery at Mallinckrodt.
- Mountains: LIPS assists fast graphics hardware and large memory matrices with GKS-based Auxiliary Graphics Processor. Courtesy S.A.I.
- Pseudo-colored flowers: shows LUT manipulations. Note graphic load display plus intensity reference scale.
- Same 1024² flowers: shows color cut and paste in 1 frame time.
- Jars and pens: Synthetic image like #4, courtesy Pacific Data Images. Photo by Jim Weil.

Bottom:

- Two corners: LIPS driver supports 1024² LANDSAT imagery, courtesy NASA-Ames Research.
- Top bas relief: Matrix filter, the basis of classification and recognition. LIPS allows kernels of any shape and size and executes at video rates.
- Histogram: line or pixel analysis under LIPS.
- Spheres: fast Z-buffer merge, courtesy Rensselaer.
- Cake and strawberries: 1024² looks good enough to eat.
- Bottom: mesh algorithm, courtesy Lunar & Planetary.
- Weather satellite: shows graphics overlay, courtesy MacDonald Dettwiler.

CIRCLE NO. 142 ON INQUIRY CARD



GOULD
Electronics

BOSTON

Robert K. Singer
National Sales Manager
Norma E. Lindahl
Assistant To The National
Sales Manager
John J. Fahey
Regional Manager
Katie Kress
Sales Coordinator
221 Columbus Ave.
Boston, MA 02116
(617) 536-7780

PHILADELPHIA

Stephen B. Donohue
Regional Manager
1837 Route 70, Suite 302
Cherry Hill, NJ 08003
(609) 751-0170

ATLANTA

Larry Pullman
Regional Manager
6445 Powers Ferry Rd.,
Ste. 140
Atlanta, GA 30339
(404) 955-6500

CHICAGO

Robert D. Wentz
Regional Manager
Marianne Majerus
Sales Coordinator
Cahners Plaza
1350 E. Touhy Ave.
P.O. Box 5080
Des Plaines, IL 60018
(312) 635-8800

DALLAS

Don Ward, Regional Manager
13740 Midway Suite 515
Dallas, TX 75234
(214) 980-0318

DENVER

John Huff
Regional Manager
270 St. Paul St.
Denver, CO 80206
(303) 388-4511

LOS ANGELES

Len Ganz
Regional Manager
12233 West Olympic Blvd.
Los Angeles, CA 90064
(213) 826-5818

ORANGE COUNTY

Debra Huisken
Regional Manager
2041 Business Center Dr.
Suite 109
Irvine, CA 92715
(714) 851-9422

SAN FRANCISCO

Frank Barbagallo
Regional Manager
Rick Jamison
Regional Manager
Janet Ryan
Regional Manager
Laura Obradovic
Sales Coordinator
Sherman Building, Suite 1000
3031 Tisch Way
San Jose, CA 95128
(408) 243-8838

AUSTRIA

Elan Marketing Group
Neutor g. 2
P.O. Box 84
1010 Vienna, Austria
Tel: 43-222-663012 or -638461

BENELUX

Elan Marketing Group
Boschdijk 199B
5612 HB Eindhoven
The Netherlands
Tel: 32-40-455724

ISRAEL

Elan Marketing Group
13 Haifa St., P.O. Box 33439
Tel Aviv, Israel
Tel: 972-3-252967 or -268020
Telex: 341667

JAPAN

Tomoyuki Inatsuki
General Manager
Trade Media Japan Inc.
R. 212 Azabu Heights
1-5-10 Roppongi Minato-ku,
106, Japan
Tel: (03) 587-0581

TAIWAN

Mr. Donald H. Shapiro
Trade Winds, 2nd Floor
132 Hsin Yi Road, Sec. 2
Taipei, Taiwan

UNITED KINGDOM

Elan Marketing Group
5th Floor, Suite 10
Chesham House
136 Regent St.
London W1R 5FA
Tel: 437-6900
Telex: 26153

SWEDEN

Elan Marketing Group
Humlegardsgatan Nr. 5
11446 Stockholm, Sweden
Tel: 46-8-677243 or -676243

WEST GERMANY

Elan Marketing Group
Sudring 53
7240 Norb/Neckar, West Germany
Tel: 49-7451-7828

Mini-Micro Marketplace

Norma Lindahl
221 Columbus Ave.
Boston, MA 02116
(617) 536-7780

Direct-Response Postcards

Carol Anderson
221 Columbus Ave.
Boston, MA 02116
(617) 536-7780

Career Opportunities

Peggy Gordon
Recruitment Advertising Manager
P.O. Box 10277
8 Stamford Forum
Stamford, CT 06904
(203) 328-2550

Cahners Magazine Division

J.A. Sheehan, President
William Platt
Executive Vice President
Tom Dellamaria, VP/Product
Ira Siegel, VP/Research

Promotion Staff

Susan Rapaport
Marketing Communications Director
Wendy Whittemore
Promotion Coordinator
Mary Gregory
Promotion Coordinator
Liz Phillips
Promotion Assistant

Circulation

Denver, CO:
(303) 388-4511
Sherri Gronli
Group Manager

Calendar

24-25 World Conference on Ergonomics in Computer Systems, Los Angeles, produced by World Conference on Ergonomics in Computer Systems. Contact: Robert W. Bailey, Ph.D., Computer Psychology Inc., 54 E. Main St., P.O. Box 16, Mendham, N.J. 07945, (201) 543-9009. Also to be held on Sept. 25-26 in Dallas, Sept. 26-27 in Chicago, Sept. 27-28 in New York, Oct. 1-2 in London, Oct. 3-4 in Dusseldorf, West Germany, and Oct. 4-5 in Helsinki, Finland.

24-26 PCEXPO, Anaheim Convention Center, Anaheim, Calif., sponsored by PCEXPO Shows. Contact: Steven Gross, PCEXPO Shows, 333 Sylvan Ave., Englewood Cliffs, N.J. 07632, (201) 569-8542.

25 Invitational Computer Conference, Southfield/Detroit. Also Oct. 10 in Cherry Hill, N.J. and Oct. 23 in Englewood/Denver, Colo. Contact: Susan Fitzgerald, conference manager C-2, 3151 Airway Ave. Costa Mesa, Calif. 92626, (714) 957-0171.

25-27 International Industrial Controls Conference & Exposition (IIC '84), Philadelphia Civic Center, Philadelphia, organized by Tower Conference Management Co. Contact: Lowell B. Koppel, General Program Chairman, Tower Conference Management Co., 331 Wesley St., Wheaton, Ill 60187, (312) 668-8100.

26-27 Ottawa Computer & Office Automation Show, Lansdowne Park, Ottawa, organized by Industrial Trade Shows. Contact: Robert Grainger or Peter McLean, Show Managers, or James K. Mahon, Group Show Manager, Industrial Trade Shows, 20 Butterick Road, Toronto, Ontario M8W 3Z8, (416) 252-7791.

OCTOBER

1-4 INFO: Information Management Exposition and Conference, New York Coliseum, New York, sponsored by Clapp & Poliak, a Cahners Exposition Group. Contact: INFO, Cahners Exposition Group, 999 Summer St., P.O. Box 3833, Stamford, Conn. 06905, (203) 964-0000.

1-4 "Make the Right Connections," NATA's 1984 Convention and Exhibition Showcase, Sheraton Washington Hotel, Washington D.C., sponsored by North American Telecommunications Association. Contact: Karen Palermo, NATA, Suite 550, 2000 M St., N.W., Washington, D.C. 20036, (202) 296-9800.

2-4 Northcon '84 High-Technology Electronics Exhibition and Convention, Seattle, produced by Electronic Conventions Inc. Contact: Nancy Hogan or Kent Keller, Electronic Conventions Inc., 8110 Airport Blvd., Los Angeles, Calif. 90045, (213) 772-2965.

2-4 Mini/Micro Northwest '84 Computer Conference and Exhibition, Seattle, produced by Electronic Conventions Inc. Contact: Nancy Hogan or Kent Keller, Electronic Conventions Inc., 8110 Airport Blvd., Los Angeles, Calif. 90045, (213) 772-2965.

Classified Ads

hardware

**HEWLETT
PACKARD**
Desktop CAD/CAM
Computer
Systems



**SAVINGS ON ALL
SERIES 200/500
WORK STATIONS**

9836S 9000 Non-HP memory
9020S 9826A and peripherals
CALL OR WRITE FOR DISCOUNT PRICES

**graphia
systems center**

Box 23051 Portland, OR 97223 USA
503-246-0202
International Sales Telex 360-143

CIRCLE NO. 225 ON INQUIRY CARD

This space should be
working for you.
For details call:



Linda Lovett
(617)536-7780

software

MicroPERT®
Project Management
for Tektronix, IBM PC, XT
For information, call or write
SHEPPARD SOFTWARE COMPANY
4750 Clough Creek Rd.
Redding, CA 96002
(916) 222-1553

CIRCLE NO. 226 ON INQUIRY CARD

IBM-PC - PLOT-10
PC-PLOT-III is an intelligent emulation of
the Tektronix Model 4010 graphics ter-
minal which runs on the IBM-PC. The
program allows display and creation of
picture files when connected to a host
computer running PLOT-10 (tm) or
compatible software. The user may save
picture data files on a local diskette as
they are received from the host. The
program also includes local printer con-
trol, and a serial line debug mode. Utility
programs included allow the drawing of
a local picture data file on the screen,
plotting it on a HP Model 7470A pen
plotter, printing on a local printer, and
scaling. VISA, MasterCard, checks,
PO's accepted. \$95.00

MicroPlot Systems Co.
2151 East Dublin-Granville Rd.
Suite 205
Columbus, OH 43229
614-882-4786

CIRCLE NO. 227 ON INQUIRY CARD

This space should be
working for you.
For details call:
Linda Lovett
(617)536-7780

custom equipment

EQUIPMENT
(To your spec's)
HARDWARE/SOFTWARE
[call/write Pres. ABACI INC]
201-263-8649; 201-263-0417
Parsippany, N.J.—Dagsboro, Del.
07054-0136 19939-0232
[25 Yrs. Electronics Dev.]

CIRCLE NO. 228 ON INQUIRY CARD

inventions wanted

**Inventors, Entrepreneurs,
Product Promoters**
wanted to display concepts at
national technology trade show.
Call: 1-800-528-6050 X831

CIRCLE NO. 229 ON INQUIRY CARD

Copy Deadline:

Space reservations and
advertising copy must
be received by the 10th
of the month preceding
the issue date. Camera-
ready mechanicals
must be received by the
15th of the month pre-
ceding the issue date.
For example, to appear
in the February issue,
copy must be received
by January 10; mechan-
icals by January 15.



Linda Lovett
(617)536-7780

CLASSIFIED ADVERTISING ORDER FORM

Mini-Micro Systems classifieds reach more mini-micro people

Rates: \$80.00 per column inch (non-commissionable)

6x program earns 5% discount; 12x program earns 10% discount.

There is no charge for typesetting classified listings. Plan approximately 50 average words to a column inch, 8 lines of approximately 38 characters per line (3 inch maximum). Please send clean typewritten (double-spaced) copy.

Category: The following categories are available; be sure to specify the category you wish to be listed under: Business Opportunities, New Literature, Selling, Buying, Trading, Seminars, Services, Software, Supplies & Accessories. (Other categories may be employed at our discretion.)

Run this ad in _____ (number issues) Reader Inquiry No. YES NO
Ad size 1 col. wide by _____ inches deep Under _____ (category)
Check enclosed for \$ _____ (Pre-paid orders only)

Signature _____

Name _____ Title _____

Company _____ Telephone No. _____

Address _____

City _____ State _____ Zip _____

MAIL TO: Linda L. Lovett, Classified Advertising, Mini-Micro Systems,
221 Columbus Ave., Boston, MA 02116

Career Opportunities/Recruitment Advertising

Rates

	Page	3/4	1/2	1/3	1/4	Col. Inch
1x	\$3,990	\$3,140	\$2,145	\$1,605	\$1,075	\$110
3x	3,885	3,025	2,060	1,550	1,015	100
6x	3,765	2,935	1,995	1,490	985	95
9x	3,655	2,845	1,935	1,445	955	90
12x	3,530	2,755	1,880	1,430	930	85
15x	3,425	2,675	1,820	1,385	900	80
18x	3,295	2,565	1,750	1,370	870	75
24x	3,235	2,520	1,720	1,310	850	70

Circulation

Over 122,000 technically sophisticated professionals in computer operations/systems management, data communications, engineering management, systems engineering/integrators, educators and systems programming specialists.

Recruitment
Hot Line
(203) 328-2550

Call your ad in—
we'll set the type
at no charge.

Mail Film to:

Peggy Gordon
Recruitment Manager

CAHNERS PUBLISHING CO.
8 Stamford Forum
P.O. Box 10277
Stamford, CT 06904

Microcomputer Systems at Advanced Micro Devices

Our Microcomputer Systems team (MCS) grew 50% last year. We plan to grow another 60% this year by taking the lead in high-performance multibus products and software for Computation, Communication, Instrumentation and OEMs.

MCS products stress leading-edge technology by using AMD's proprietary ICs. Work with state-of-the-art products like our 80186-based Communications Controller with UNIX front-end software... our megabyte memory board... 10-Mhz 8086 CPU, or intelligent storage controller. Or bring new products to market, including an Ethernet controller with networking software, a 16mb ECC memory subsystem, and a 32-bit floating point array processor board with firmware.

Communications Software Managers

Supervise a group of hardware and software communications engineers writing and porting computer communications software onto microcomputer boards. Contribute to product definition and planning, and provide technical

leadership. Requires BSEE/CS and 5 years computer communications software experience with mini or micro software development and applications.

Senior Software Engineers

Participate in the development, installation and evaluation of computer communications software products. Utilize VAX and UNIX tools to develop communications protocol and local area network software. Requires BSEE/CS and 3 years computer communications software experience. Prefer familiarity with C, UNIX, local area networks and/or communications protocols.

Product Marketing Engineers

Interface daily with Field Sales and customers to develop product strategies and sales tactics, extending MCS product line leadership for both existing and new products. Requires BSEE/CS with at least 2 years experience in technical marketing.

*AMD offers an outstanding benefits package, including cash profit sharing, salary investment and various stock programs. Call **Barry Greenberg weekdays at (800) 538-8450, ext. 3034 TOLL FREE**. Or send your resume to **Advanced Micro Devices, Dept. MM-984, MS-57, 901 Thompson Place, P.O. Box 3453, Sunnyvale, California 94088**. An equal opportunity employer. Principals only, please.*



CIRCLE NO. 241 ON INQUIRY CARD

Computer Consultants Corner

TKC

• THE KEENAN CORPORATION

FCC 15J WE WROTE THE BOOK

"Digital Design for Interference Specifications"

- FCC/VDE & Static Retrofit and Testing
- "Front End" Design Guidance

R. Kenneth Keenan, Ph.D.

8609 66th Street North Pinellas Park, FL 33565
(813) 544-2594

CIRCLE NO. 242

6800/68000 Experts

- Microprocessor hardware and software design
- Industrial control specialists
- Hierarchical software design methodology
- Complete prototype facilities

CLIENTS INCLUDE: Sohio • Elgar • Schlumberger • Motorola • Gulf Oil • Carborundum • Renal Systems



Computer System Associates

7564 Trade St., San Diego, CA 92121 (619) 566-3911

CIRCLE NO. 243

UNIX

System V Consultants

- A professional team, with specialties in
- Applications in the C Programming Language
 - UNIX Internals and Device Drivers
 - Telecommunications

Contact: Marty Poulsen

PROTOCON INCORPORATED

140 Statesir Place
Red Bank, New Jersey 07701
(201) 747-8974

CIRCLE NO. 244

DATA PROCESSING POSITIONS

\$25-\$70,000+

East Coast - Midwest - West Coast - Southeast - Southwest

- Directors of D.P. • D.P. Managers
- Project Leaders • Systems Analysts
- Programmer • Analysts • Software Programmers • IBM, DEC, Univac, Honeywell • Mfg., Banking, Insurance, Telecommunications.

Please send resume & location Preference to P.B. Darrah, (402) 330-2814.

RELIABLE "COMPUTERS"

11318 Davenport Street
Omaha, Nebraska 68154

ENGINEERS

Choice positions available in New England and Nationwide. If you earn \$25,000 or more we have a more rewarding job for you.

Networking • Communications
ATE Engineers • Tools & Utilities SW
Real-Time SW • Memory Design

All fees & expenses paid. Call or send resume to:

LARSEN PERSONNEL
1492 Highland Avenue
Needham, MA 02192
(617) 449-3840

Serving the high tech industries.

ELECTRONIC ENGINEERS SOUTHEAST

Openings for design engineers of circuits, computers, logic, signal, communications, testing, ATE, systems, and controls. Professional confidential service. Fee paid by employer. Send resume to:

Ted McCulloch
McCulloch & Co.
P.O. 10211
Greenville, SC 29603

A small ad here will attract a lot of attention. For more information please call (203) 328-2550

EMPLOYMENT SERVICE FOR PROGRAMMERS AND ANALYSTS

National Openings With Client Companies and Through Affiliated Agencies

Scientific and commercial applications • Software development and systems programming • Telecommunications • Control systems • Computer engineering • Computer marketing and support.

Call or send resume or rough notes of objectives, salary, location restrictions, education and experience (including computers, models, operating systems and languages) to either one of our locations. Our client companies pay all of our fees. We guide; you decide.

RSVP SERVICES, Dept. MM
Suite 700, One Cherry Hill Mall
Cherry Hill, New Jersey 08002
(609) 667-4488

RSVP SERVICES, Dept. MM
Suite 211, Dublin Hall
1777 Walton Road
Blue Bell, Penna. 19422
(215) 629-0595

From outside New Jersey, call toll-free 800-222-0153

RSVP SERVICES

Employment Agents for Computer Professionals

CIRCLE NO. 245 ON INQUIRY CARD

ENGINEERS ... it's time to invest in your future!

Printronix, an Orange County-based firm, designs, manufactures and markets a full spectrum of printers for use with mini-computers, micro-computers and other computer systems. Marketed worldwide through a network of distributors and OEM's, our printers provide conventional alphanumeric printing as well as full plotting and graphics capabilities.

The Printronix commitment to produce quality printers engineered for reliability, durability and performance has contributed to the phenomenal growth of our company over the past several years, AND we're still growing! Because 1984 promises to be yet another year of growth and success, we need to expand the depth of our Engineering Department. The following opportunities are currently available:

ELECTRICAL ENGINEERS

A BSEE is required as well as experience in design and analysis of analog and digital circuitry.

MECHANICAL ENGINEERS

This position requires a BSME plus experience in high speed mechanisms.

SOFTWARE ENGINEERS

A BS in Physics, Engineering, or Computer Science is required plus experience in top-down design and structured development.

Our benefits include a company-paid group insurance package which provides all Printronix employees with immediate eligibility for medical/dental and group life insurance plans. In addition, we offer vision care, long-term disability, an employee stock purchase plan, educational assistance including 100% reimbursement for approved courses and Friday afternoons off.

For immediate consideration on these and other career opportunities at Printronix, please forward your resume including salary history and requirements to the Human Resources Department, Printronix, 17500 Cartwright Road, Dept. M-46, Irvine, CA 92714.

PRINTRONIX

We are an equal opportunity employer m/f.

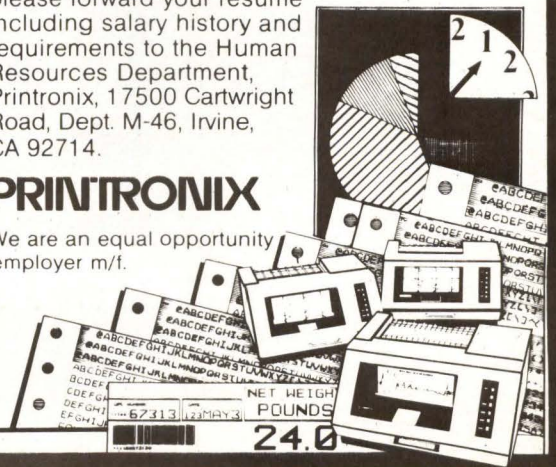

CIRCLE NO. 246 ON INQUIRY CARD

How much do computing salaries vary by geography?

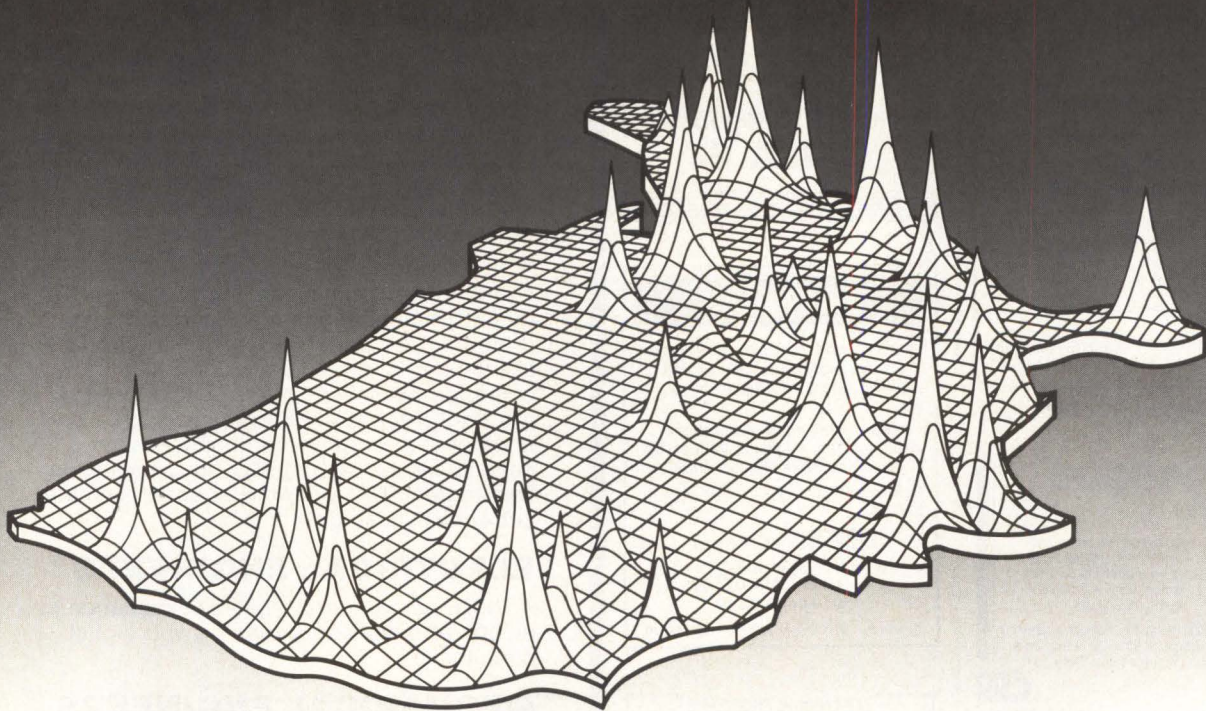

Find out in our new Survey of 55 areas. It's free!

If you haven't explored salary ranges lately, you'll find that compensation varies enormously by different areas.

Peaks, plateaus and valleys

In our new 1984 Local Metropolitan Computer Salary Survey you'll see how salaries differ by as much as 10, 20 or even 30% from coast to coast.

The new Survey reviews 55 major metropolitan areas and 56 different computer position titles throughout North America.

So whether you are interested in learning what your peers are making—or you are evaluating salary levels for people you plan to hire—our new Survey will give you the most timely, accurate and thorough information available.

Call for your free copy

There's no cost or obligation. Call the Source Edp office nearest you, and we'll mail a copy to you in complete confidence. If you're unable to call, write, **Source Edp, Department MM3, P.O. Box 7100, Mountain View, California 94039.**

1984 Local Metropolitan Computer Salary Survey

source edp
Personnel Services

United States:	Georgia	Minnesota	Ohio	Dallas
Alabama	Atlanta/Downtown 404/588-9350	Minneapolis	Akron 216/535-1150	Central 214/954-1100
Birmingham 205/322-8745	Atlanta/North 404/953-0200	West 612/544-3600	Cincinnati 513/769-5080	North 214/387-1600
Arizona	Illinois	Downtown 612/332-6460	Cleveland 216/771-2070	Fort Worth 817/338-9300
Phoenix 602/279-1010	Chicago/E. Loop 312/861-0770	St. Paul 612/227-6100	Columbus 614/224-0660	Houston
Tucson 602/792-0375	Chicago/W. Loop 312/346-1280	Missouri	Dayton 513/461-4660	Downtown 713/751-0100
California	Oak Brook 312/986-0422	Kansas City 816/474-3393	Toledo 419/242-2601	Galleria/Post Oak 713/439-0550
Northern	Rolling Meadows 312/392-0244	Clayton 314/862-3800	Oklahoma	San Antonio 512/342-9898
Mountain View 415/969-4910	Indiana	St. Louis 314/576-4444	Oklahoma City 405/722-7410	Utah
Sacramento 916/446-3470	Fort Wayne 219/432-7333	Nebraska	Tulsa 918/599-7700	Salt Lake City 801/966-3900
San Francisco 415/434-2410	Indianapolis 317/631-2900	Omaha 402/346-0709	Oregon	Virginia
Walnut Creek 415/945-1910	Iowa	Nashua 603/880-4047	Portland 503/223-6160	McLean 703/790-5610
Southern	Des Moines 515/243-0191	New Jersey	Pennsylvania	Washington
Fullerton 714/738-1313	Kansas	Cherry Hill 609/482-2600	King of Prussia 215/265-7250	Seattle 206/454-6400
Irvine 714/833-1730	Overland Park 913/888-8885	Edison 201/494-2800	Philadelphia 215/665-1717	Spokane 509/838-7877
Los Angeles/	Wichita 316/688-1621	Morristown 201/267-3222	Pittsburgh 412/261-6540	Wisconsin
Downtown 213/688-0041	Kentucky	Paramus 201/845-3900	Rhode Island	Green Bay 414/432-1184
Los Angeles/	Louisville 502/581-9900	Princeton 609/452-7277	Providence 401/751-0065	Madison 608/251-0104
South Bay 213/540-7500	Louisiana	Somerset 201/469-9444	South Carolina	Milwaukee 414/277-0345
Los Angeles/West 213/203-8111	Baton Rouge 504/924-7183	Somerville 201/526-9658	Columbia 803/256-7446	Canada:
San Diego 619/231-1900	New Orleans 504/561-6000	New Mexico	Greenville 803/271-7044	Ontario
San Fernando Valley 818/781-4800	Maryland	Albuquerque 505/247-4270	Tennessee	Toronto
Colorado	Baltimore 301/727-4050	New York	Nashville 615/256-0625	Don Mills 416/425-5730
Denver 303/773-3700	Baltimore 301/441-8700	Albany 518/482-2035	Texas	Downtown 416/865-1125
Connecticut	Towson 301/321-7044	Buffalo 716/835-9630	Austin 512/479-0720	Mississauga 416/848-3344
Danbury 203-797-0590	Massachusetts	New York City	Canada:	
Hartford 203/522-6590	Boston 617/482-7613	Grand Central 212/557-8611	Ontario	
New Haven 203/787-4595	Burlington 617/273-5160	Penn Station 212/736-7445	Toronto	
Stamford 203/967-4888	Springfield 413/739-4083	Wall Street 212/962-8000	Don Mills 416/425-5730	
Stratford 203/375-7240	Wellesley 617/237-3120	Rochester 716/263-2670	Downtown 416/865-1125	
Waterbury 203/574-5633	Michigan	Syosset, L.I. 516/364-0900	Mississauga 416/848-3344	
District of Columbia	Detroit 313/259-7607	Syracuse 315/422-2411		
Washington D.C. 202/293-9255	Grand Rapids 616/459-6539	White Plains 914/694-4400		
Florida	Lansing 517/484-4561	North Carolina		
Fort Lauderdale 305/491-0145	Southfield 313/352-6520	Charlotte 704/552-5577		
Jacksonville 904/356-1820	Troy 313/362-0070	Greensboro 919/379-1155		
Miami 305/624-3536		Raleigh 919/847-7605		
		Winston-Salem 919/724-0630		

source edp[®]
Personnel Services

The world's largest placement firm devoted exclusively to the computer profession. Client companies assume our charges.

Career Opportunities/Recruitment Advertising

RESUME FORWARDING SERVICE

To have your resume forwarded on to the company of your choice, simply write in the box at the right the name of the company that interests you.

Forward my brief resume to:

(Never more than 3 companies, please)

Complete the following brief resume and mail to: Peggy Gordon

MINI-MICRO SYSTEMS
P.O. Box 10277
8 Stamford Forum
Stamford, CT 06904

(Please type, or print using all caps in dark ink.)

1.

Last Name _____ First _____ Middle Initial _____

Home Address (Street, City, State, Zip) _____

Home Phone (Area Code) _____ Other (Area Code) _____

2. *EDUCATION INFORMATION:* Schools Attended

Name _____ Location: _____ Degree: _____

Name _____ Location: _____ Degree: _____

3. *EMPLOYMENT INFORMATION:*

Name & Address of Present Employer (Will not be contacted) _____

Position (Please give brief description of your title and current job assignment) _____

Length of time with current employer _____

4. Are you willing to relocate? _____

What are your geographical preferences? _____

5. Please Check One:
U.S. Citizen _____ Permanent Resident _____ Student Visa _____

6. Foreign Language
Read _____ Write _____ Speak _____

7. Please indicate current salary _____

*Please Sign Here

Date

*Your signature will authorize us to forward the above information on to the company of your choice, in the strictest confidence. Your current employer will not be contacted.

9-84

Advertisers Index

Able Computer	169	Digital Laboratories, Inc.	196	Olivetti	E7
ADAC Corp.	48	Dilog (Distributed Logic Corp.)	212-213	Oregon Software	218
Advanced Digital Corp.	18	Dual Systems	52	Oriental Motor USA	210
Advanced Electronic Design (AED)	254	Dysan Corp.	211	Pacific Microcomputers	101
Alcatel/Thomson Gigadisc	268	Electronic Conventions	74	Philips Peripherals	71
American Federation of Information Processing Societies, Inc. (AFIPS)	129, 131	Elsevier Science Publishing Co.	106	Plexus Computers	98
Amplex Corp., Computer Products Div.	170-171	Emulex Corp.	40-41	Precision Visual	153
Anadex Inc.	55	Epson America, Inc.	C3	Priam	28-92
Apollo Computers	56-57	Facit Inc.	194	Pyramid Technology	243
Applied Data Communications	258	Falco Data Products	67	Qualogy Inc.	232-233
Applix Inc.	134	Gould Inc., Computer Systems Div.	5, 108-109	Quantum Corp.	180-181
Atasi Corp.	222-223	Gould Inc., Imaging Div.	281	Quantum Software	263
Atron	280	Gould Inc., Software Div.	237	Qubix	150
AT&T Technologies, Inc.	12-13, 114-115	Hayes Microcomputer Products	68-69	Racal-Vadic Inc.	234
Bridge Communications	156-157	Hermes Precisa Intl.	191	RDS-Relational Database Systems	137-139
C. Itoh Electronics	E3	Hewlett-Packard	1, 192-193, 248	Rodime	10
Cahners Exposition Group	277	Houston Instrument Div. of Bausch & Lomb	259	Rosscorp Corp.	140-141
CalComp	160	Human Designed Systems Inc. (HDS)	39	Scientific Micro Systems	142
California Computer Group	269	IBC/Integrated Business Computers	22, 251	Seiko Instruments USA	154
California Data Link	62	Ibex Computer	146	SGS Systems Div.	83
Cambridge Digital Systems (Div. of Compumart)	91	IBM Corp.	97	Shugart Corp.	8-9
Centronics Data Computer Corp.	197	Imagen Corp.	256	Simpact Assoc. Inc.	44
Century Data Systems (a Xerox Co.)	265	Infotron Systems Corp.	238	Solana Electronics	4
Chrislin Industries, Inc.	4	Intercontinental Micro	36	Symbol Technology	50-51
CIE Systems	49	Intermec Inc.	189	Systech	17
CIE Terminals	14, 21	Invitational Computer Conferences	279	Tandon Corp.	84-85
Cipher Data Products, Inc.	92-93	Iomega Corp.	76	Tekelec	224
Citizen America	26-27	Karl Leister	196	TeleVideo Systems Inc.	94, 204-205
Codex Corp.	245	Kennedy Co.	C2	Telex Computer Products Inc.	116
ComDesign	228	Lear Siegler Inc.	166	Teltone Corp.	110
Compaq Computer Corp.	220-221	Liberty Electronics USA	119	Texas Instruments Inc.	186
CompuPro	25	Logical Microcomputer	136	Toei Electronics	80
Control Data Corp.—Business Prod. Group	20	Madzar Corp.	62	Tradeshow Week Inc.	275
Control Data Corp.—Eng. Services	200	Mannesmann Tally	183	Unify Corp.	107
Control Data Corp.—OEM	147	Marinco Computer Products	124-125	Unisoft Systems	207
Convergent Technologies	132-133	Maxell Computer Products Div.	86	Unitronix	261
Craig Data Cable	118	Maxtor Corp.	145	Universal Data Systems Inc.	240-241
Cromemco Inc.	6-7	MCG Electronics	260	Verbex	102-103
CTS Corp.—Datacomm Products	267	Megatek Corp.	172-173	Vertex Peripherals	227
Daisy Systems	177	Memotech	73	Visual Technology Inc.	246-247
Danish Data Electronics	E8-E9	Metacomp	60	West Computer	E4
Data General Corp.	162	Micom Systems Inc.	C4	Westrex OEM Products	266
Dataproducts	75, 106, 178	Micro Peripherals Corp.	146	Wyse Technology	148-149
Datasouth Computer Corp.	185	Micro-Term	126	Xebec	230-231
Data Technology Corp. (DTC)	47	Mini-Micro Systems	E10, 201, 274	Zetaco Div. of Custom Systems	165
Delta Airlines	208	Mitsubishi Electronic America	63	Zilog Inc.	273
Digi-Data Corp.	61	Mostek Corp.	64-65	Zitel	252
Digilog Business Systems (DBS)	214	Multi Solutions	79	Ziyad	59
Digital Datacom Inc.	271	NCR Corp.	158-159		
Digital Engineering	198-199	Network Products	42		
Digital Equipment Corp.	120-123	Novell Data Systems	113		
		Okidata Corp.	174, 217		

See P. 283 for Classified Advertisers
 See P. 284-287 for Career Opportunity Advertisers
 See P. 289-290 for Mini-Micro Marketplace

*Please note any page number with an E preceding it will appear in the Foreign edition only.

This index is provided as an additional service. The publisher does not assume any liability for errors or omissions.

Mini-Micro MARKETPLACE

Products and services for the value-added market.

READERS: Please circle reader service numbers for additional information.

Keep Your Computer New With PC-CARE™

PC-CARE is the complete menu-driven system of hardware diagnostics. It analyzes performance levels of Winchester and floppy disk drives, video display, RAM memory, video memory, ROM character generator and keyboard. Includes (1) Diagnostic Diskette (1) PC-CARE Program Diskette (1) Users Manual.

Let PC-CARE keep your computer new, insure the performance of your computer, maximize your uptime and maintain the integrity of your data. Price \$99.00



**AWARD
SOFTWARE,
INC.**
236 North Santa Cruz Ave., Los Gatos, CA 95030
(408) 395-2773

CIRCLE NO. 200 ON INQUIRY CARD

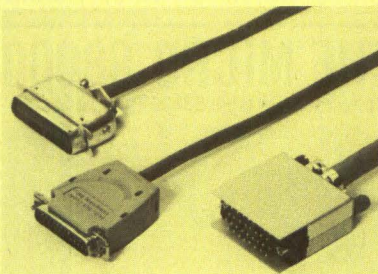

EIA AND 200 OTHER INTERFACE CABLES – Call on Data Set Cable for all types of cables and connectors, many in stock for immediate shipment . . . or order pinned to your specifications: ribbons, coax, twin-ax, TELCO, compatibles for IBM, DEC, H-P . . . to name just a few. EIA RS-232C cables – 25 conductors, all connected, \$16 plus 50¢/ft. Send for catalog. **Data Set Cable Co.**, 722 Danbury Road, Ridgefield, CT 06877 – (203) 438-9684. Also Las Vegas – (702) 382-6777.

CIRCLE NO. 201 ON INQUIRY CARD

NEW FROM OMEGA! WB-40 Interfacing Micro-Computer

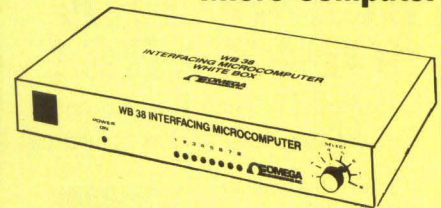

The White Box™ 40 stands alone or converts up to 8 analog signals to RS-232C format for full two-way communications with any compatible computer.



One Omega Drive, Box 4047, Stamford, CT 06907 U.S.A.
Telex 996404 Cable OMEGA FAX (203) 359-7700

(203) 359-RUSH

CIRCLE NO. 202 ON INQUIRY CARD

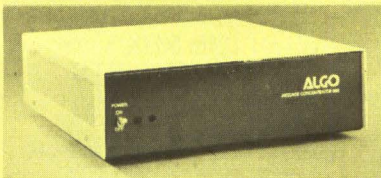

ALGO Message Concentrator 600

An easy, inexpensive way to network IBM-PCs or compatibles with existing mini/micro computers without the use of special bus cards or communications software. The 600 can save on telephone line costs.

- Local/Remote Networking for any group of computer systems using only one RS-232-C Port/system.
- Obeys simple command strings from your applications program.
- 6 Asynchronous RS-232 Ports.
- No special PC-Bus Cards or System Software Needed.
- Automatic, Easily Modified Message Routing.
- Complete Error Control.

Six Ported Message Concentrator priced at 1545.00



ALGO, INC.
9198-C Red Branch Rd.
Columbia, MD 21045
301-730-7442

CIRCLE NO. 203 ON INQUIRY CARD

DEDUCT MY
COMPUTER?



ONLY IRS
IF YOU PROVE
50% BUSINESS
USE!

DEDUCT YOUR COMPUTER?

New tax laws require proof of 50% business use. The *PYD* (Prove Your Deduction) program records and reports use on most CP/M and MS-DOS computers.

Only \$24.95

Call BCD = COMPUTERS
(800) 223-5369 EXT 242

CIRCLE NO. 204 ON INQUIRY CARD

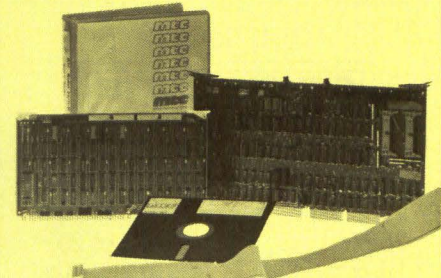

HIGH SPEED BUS COUPLER

MTC's Bus Couplers provide high speed DMA Data Transfers between Multibus and Unibus, Q-Bus or other Multibus based computers. Transfer rates from one to four MB/SEC are possible depending on the busses connected. Double buffered operations, 64K word block transfers and a parity mode are also possible. The link to DEC Systems is DR11W compatible and fully supports interprocessor link mode.

A coupler kit includes two boards, cables, user manual, and an iRMX 86 Driver. OEM configurations available.

MESA TECHNOLOGY CORPORATION

16021 Industrial Drive, Gaithersburg, MD 20877
Tel.: 800-638-2039. Inside MD 800-492-3198

CIRCLE NO. 205 ON INQUIRY CARD

**ZX-5000™
EXTENDED RANGE™
SURGE SUPPRESSORS**



SUTTON DESIGNS INC

111 S. Cayuga, Suite 200 - Ithaca, NY 14850 - 607/277/4301

CIRCLE NO. 206 ON INQUIRY CARD

Like-new products



For free catalog,
phone toll-free (800) 225-1008
In Massachusetts (617) 938-0900
Genstar REI Sales Company

CIRCLE NO. 207 ON INQUIRY CARD

The Little Board™ ...\$199*
The world's simplest and least expensive CP/M computer

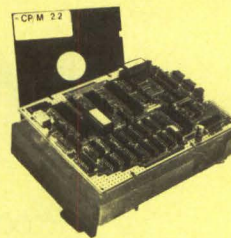

- 4 MHz Z80A CPU, 64K RAM, Z80A CTC, 5730 Boot ROM
- Mini/Micro Floppy controller (1-4 Drives, Single/Double Density, 1-8 sided, 40/80 track)
- Only 5.75 x 7.75 inches, mounts directly to a 5 1/4" floppy drive
- 2 RS232C Serial Ports (75-9600 baud & 75-38,400 baud), 1 Centronics Printer Port
- Power Requirement: -5VDC at .75A; +12VDC at .05A/On-board -18V converter
- CP/M 8.3 BIOS • ZCR33 CCP • Enhanced AMPRO BIOS
- AMPRO Utilities Included:
 - read/write to more than 8 dozen other formats (Kaypro, Televideo, IBM CP/M86....)
 - format disks for more than a dozen other computers
 - format/copy/verify all in one
 - menu-based system customization
- SCSI OPTION • BIOS and Utilities Source Code Available
- Custom Versions: Contact Factory • OEM enclosure available

AMPRO
COMPUTERS, INCORPORATED

67 East Evelyn Ave. • Mountain View, CA 94041 • (415) 968-0930 • TELEX 4940302

CIRCLE NO. 208 ON INQUIRY CARD

**DON'T
BLAME THE
SOFTWARE!**

Complete Hi-Tech Equipment
Protection: Write for Free Catalog!

- Power line isolators
- Spike/surge suppressors
- Power line filter/suppressors
- Twist type socket protection
- Line voltage regulators
- Line conditioners
- Modem protectors

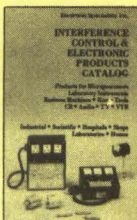

Electronic Specialists

171 S. Main, Natick, MA 01760 (617) 855-1532
Toll Free Order Desk 1-800-225-4876

CIRCLE NO. 209 ON INQUIRY CARD

THE MICRO 68000
Completely Portable 68000 Training System

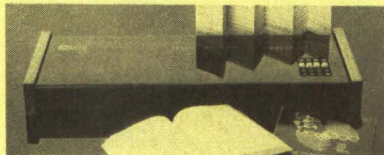

Designed for Engineer and Technician training, demonstrating logic analyzer, and prototyping, the MICRO 68000 comes complete with: 6 amp switching power supply • Keyboard • Display-Hex & Binary • Pete Bug keyboard monitor • Optional Macs Bug CRT monitor • Attractive cabinet • Dual RS232 interface • 32 bit parallel I/O • Versibus compatibility • The only system that provides for direct entry of 68000 machine code • An optional padded carrying case is also available.
Perfect for the classroom as well as the lab or self study. The MICRO 68000 comes complete with Lance Leventhal's "68000 Assembly Language Programming" text, Motorola's "68000 Users Manual," a complete Laboratory Manual, and CSA's "MICRO 68000 Users Manual."

CSA Computer System Associates
7564 Trade St., San Diego, CA 92121 (619) 566-3911

CIRCLE NO. 210 ON INQUIRY CARD

Simple Genius in Multibus®
• Intel Trademark

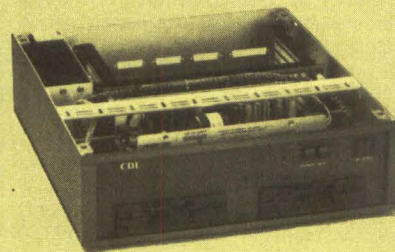

Relax! Now you can just hook up the terminal plug in the system boards, turn on power, and you're off and running.
Series VI system chassis from CDL is the key to turn your design into reality.

CHEN DIGITAL LABORATORIES Contact (206) 881-5031
*Intel Trademark
16718 NE 41st Street, Redmond, WA 98052

CIRCLE NO. 211 ON INQUIRY CARD

*IBM® Compatible



E-PROMS — Call! Lowest Prices Anywhere

- *4164-150/200 480
- 2764-250 675
- 6116-LP3 499
- 256K as low as 2995
- TTL & HCT Parts — now avail... Call
- XIDEX DS DD Box of 10. 2650
- *TM-100-2 16995
- *Teac Half-Heights. 16995
- *10 mb Microscience w/cable & controller 95999

Add \$3.95 shipping to all orders • Prices subject to change • P.O.'s on approval • C.O.D. OK • All new, no surplus, no seconds, QUANTITY DISCOUNTS.
4920 Cypress St., Ste. 100, Tampa, FL 33607
In FL and for info, call 813-875-0299

FOR ORDERS ONLY, 800-237-8910



TELEX 330690

CIRCLE NO. 212 ON INQUIRY CARD

**PIN GRID ARRAY
& DIP SOCKETS**



Leadless Chip Carrier Adapters
Test Accessories
In-Line Socket Strips

10 Mupac Drive, Brockton, MA 02401
Tel (617) 588-6110 TWX (710) 345-8458

CIRCLE NO. 213 ON INQUIRY CARD

THE RSX/VMS SPECIALISTS



THE LSI-11/73 BASED
CM-300/Q22 COMPUTER
SYSTEMS WITH RSX-11M+
SUPPORTING SUPERIOR-
MODE LIBRARIES AND
SEPARATE I AND D SPACE

THE MICRO-VAX I BRINGS
VAX POWER AND HIGH
PERFORMANCE TO THE
Q-BUS

CM-300/Q22 computer systems are configured with DEC's NEW LSI-11/73 CPU, giving these systems 11/70 PERFORMANCE AT LSI-11 PRICES. CM-300/Q22 systems can be configured with up to 1200MB of fixed Winchester disk, up to 4MB of main memory and up to 64 terminals. System back-up is provided by an industry standard 9 track 1/2" 1600 BPI tape drive. Optional software packages include accounting software, mailing list, FORTRAN 77, PMS-11, BASIC *2 and DATARETRIEVE. An LSI-11/73 based 300MB system including RSX-11M+ license, media and documentation, with a VT220 terminal may be purchased for under \$23,000.

MICRO/VAX I computer systems can be configured with up to 4MB of main memory, up to 31MB of fixed disk and up to 5 terminals. Prices start at \$13,730.

Call A.C.S. and let us configure a hardware/software solution for your specific problems.



250 Prospect Street
Waltham, Massachusetts 02154
617-894-3278

CIRCLE NO. 214 ON INQUIRY CARD

EPSON QUALITY PRODUCTS FOR THE OEM.

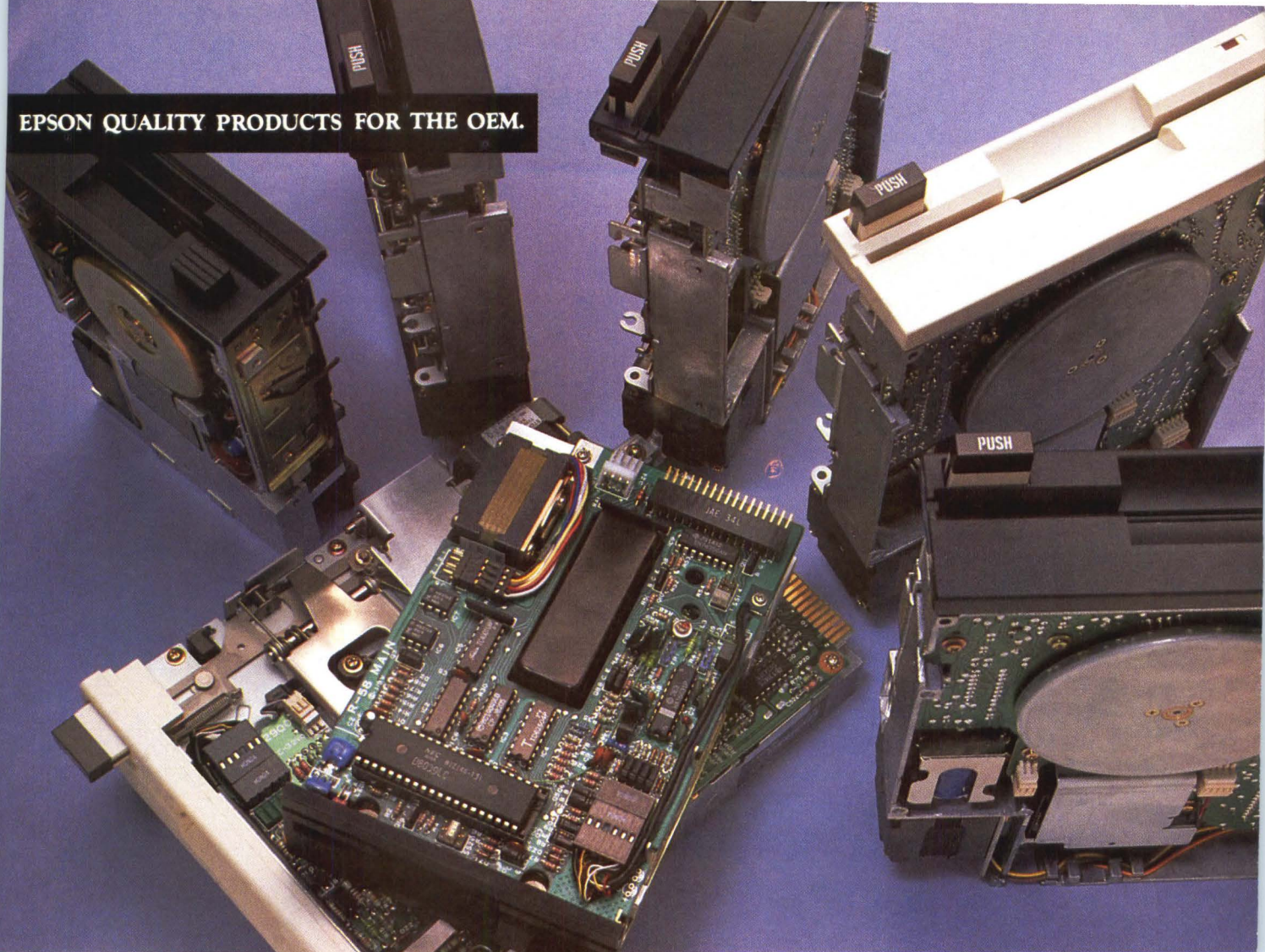

INTRODUCING THE EXTRAORDINARY EPSON OEM FAMILY OF FLOPPY DRIVES

SERIES	SMD 100		SD 500			SD 300
MEDIA SIZE	3 1/2"		5 1/4" (1/2 High)			5 1/4" (1/3 High)
	4" x 1.57" x 5.98"		5.75" x 1.6" x 7.68"			5.75" x 1.1" x 9.27"
Max. Capacity (2 Sides) (Unformatted)	500 KB	1000 KB	500 KB	1000 KB	1604 KB	500 KB
Drive Motor Speed	300 RPM	300 RPM	300 RPM	300 RPM	360 RPM	300 RPM
Track Density	67.5 TPI	135 TPI	48 TPI	96 TPI	96 TPI	48 TPI
Access Time	6 msec	3 msec	6 msec	3 msec	3 msec	15 msec

Extraordinary is the best word we could find to describe the new Epson family of 3 1/2" and 5 1/4" floppy disk drives. Because there is nothing ordinary about them.

The 3 1/2" drives, for instance, feature two-sided capacities up to 1MB. And some draw so little power they can operate on batteries.

The half-height 5 1/4" drives offer capacities from 500KB to 1.6MB and access times down to 3 msec. And the one-third height 5 1/4" drive is the industry's slimmest.

But that's only part of the story. What really makes them extraordinary is the fact that they're Epson drives. Designed and built by the people who have made "quality in quantity" their trademark around the world.

That means they're designed and engineered with such state-of-the-art features as noise and RF shielding, ultra-high precision head positioning and loading, perfect disk centering, reduced power consumption and heat generation. But, even more importantly, it means they're manufactured by the people who have established the lowest rejection rate in the industry. When you buy Epson, you buy confidence.

If you'd like more information about the extraordinary Epson family of floppy drives and how they can solve your storage problems, write or call us today.

SW Region (714) 250-0111 • NW Region (408) 985-8828
SE Region (404) 458-9666 • NE Region (617) 345-8007
CENTRAL Region (815) 338-5810

CIRCLE NO. 2 ON INQUIRY CARD

EPSON

EPSON AMERICA, INC.

OEM Products Division
Peripherals Group

3415 Kashiwa Street, Torrance,
CA 90505 (213) 533-8277
Telex: 664277

All your favorite dial modem flavors

You don't have to settle for plain old vanilla modems any more. Treat yourself to something special from MICOM's new DialNet3000 and DialNet3000+ families. They include all your favorite modem flavors. And speeds up to 2400bps. And synchronous/asynchronous support in all models at no extra cost. And full diagnostics. And more.

2-WAY & 3-WAY COMPATIBILITY

All DialNet3000s can automatically match the transmitting mode and speed of earlier modems, too—selecting Bell 103/212, or Bell 103/212/Vadic 3400, or even V.22 bis/Bell 212.

"PLUS" LEAST-COST ROUTING

Going beyond conventional auto dial, 3000+ Series models offer directory dialing, using pulse or Touch-Tone® signalling or both, either under terminal or computer

control. Plus they can link stored numbers in priority order, as when trying the least expensive routing first.

16-MODEM RACK MOUNTS

Especially important to central sites, the single-board design used in both families allows for mixing up to 16 of any of the modems in a rack space only 8¾ inches high.

2400BPS FOR ONLY \$795

All DialNet modems are inexpensive, but the 2400bps models are forcing the whole industry to rethink its pricing. And they'll force you to reconsider your current 1200bps dial-up transmissions, too: for only a few hundred dollars more, you can double your speed, saving time and money. In fact, our 2400bps models really can pay for themselves in what they save you in telephone charges.

There's no reason to resist temptation. **Call today for a color brochure and a price list.**

Whatever your favorite flavor of dial network modem...



MICOM makes it better.

MICOM®

MICOM Systems, Inc. • 2015 Nordhoff Street • Chatsworth, CA 91311 • Telephone (805) 583-8600 • TWX 910/494-4910
Regional Sales/Service • Atlanta, GA • (404) 435-2999 • Boston, MA • (617) 527-4010 • Chicago, IL • (312) 789-2430
Dallas, TX • (214) 258-0774 • San Francisco • (415) 327-0890 • St. Louis, MO • (314) 576-7626 • Teaneck, NJ • (201) 836-4000
MICOM-Borer Ltd. • Bel Court • 15 Cradock Road • Reading, Berkshire RG20JT, England • (0734) 866801 • Telex 847135

For literature please call: (800) "MICOM U.S."

AVAILABLE NOW FROM THESE STOCKING REPS... AK: Anchorage (907) 561-1776 / Juneau (907) 789-4101 • AL: (800) 327-6600 • AR: (214) 620-1551 • AZ: (602) 994-5400
CA: Anaheim (714) 635-7600 / Lodi (209) 334-1961 / San Diego (619) 565-1557 / San Jose (408) 298-7290 • CO: Colorado Springs (303) 594-0880 / Denver (303) 777-8070
CT: (617) 235-5520 • DE: (609) 779-0200 • FL: (800) 432-4480 • GA: (800) 327-6600 • HI: (808) 537-9758 • IA: (402) 895-5850 • ID: (801) 466-6522 • IL: (312) 255-4820
IN: (317) 846-2591 • KS: (816) 252-3700 • KY: (502) 228-5401 • LA: (800) 327-6600 • MA: (617) 235-5520 • MD: (301) 340-0600 • ME: (617) 235-5520 • MI: (313) 588-2300
MN: (612) 425-4455 • MO: Independence (816) 252-3700 / St. Louis (314) 721-0401 • MS: (800) 327-6600 • MT: (801) 466-6522 • NC: (800) 327-6600 • ND: (612) 425-4455
NE: (402) 895-5850 • NH: (617) 235-5520 • NJ: North (201) 569-2353 / South (609) 779-0200 • NM: Albuquerque (505) 292-1212 / Las Cruces (505) 524-9693
NV: (714) 635-7600 • NY: Albany (518) 459-5891 / Buffalo (716) 662-4568 / New York City (212) 569-2353 / Rochester (716) 424-7492 / Syracuse (315) 455-5841 • OH: Cleveland (216) 524-5930 / Dayton (513) 434-7500 • OK: (405) 478-5000 • OR: (503) 224-3145 • PA: East (609) 779-0200 / West (412) 892-2953 • RI: (617) 235-5520 • SC: (800) 327-6600
SD: (612) 425-4455 • TN: (800) 327-6600 • TX: Dallas (214) 620-1551 / Austin (512) 327-8600 / El Paso (915) 542-1762 / Houston (713) 353-7728 • UT: (801) 466-6522
VA: North (301) 340-0600 / South (800) 327-6600 • VT: (617) 235-5520 • WA: (206) 454-2383 • WI: (414) 784-9379 • WV: East (301) 340-0600 / West (412) 892-2953
WY: (303) 777-8070 • Washington, DC: (301) 340-0600 • Puerto Rico: (809) 753-1771 MD002

CIRCLE NO. 3 ON INQUIRY CARD