

EDN[®]

PROCESSOR UPDATES
PG 65

A CAHNERS PUBLICATION
AUGUST 6, 1992

ELECTRONIC TECHNOLOGY FOR ENGINEERS AND ENGINEERING MANAGERS WORLDWIDE

SPECIAL REPORT

How C++ works
pg 78

ARTICLE INDEX

**Technical-Article
Database Index**

Includes articles
published in EDN
Magazine, EDN News
Edition, and four
other electronics
magazines
pg 115

DESIGN FEATURES

**Three-step method
evaluates neural
networks for your
application**
pg 93

**BTL transceivers
enable high-speed
bus designs**
pg 107

TECHNOLOGY UPDATE

**Speed-resolution
tradeoff key to
choosing ADCs**
pg 39

Product Updates
pg 59

Design Ideas
pg 129

Special Report:

pg 78

- * if the desired page is not the last page in the handle's memory space map in it and the page following this will take care of array elements that cross page boundaries.

```
*/  
if( page (  
GetEMSAAllocdPageCount( Handle) - 1)  
MapEMSPage( Handle, page + 1,  
FRAME - 1);
```

ion information

HP scopes make digital designs easier to understand.

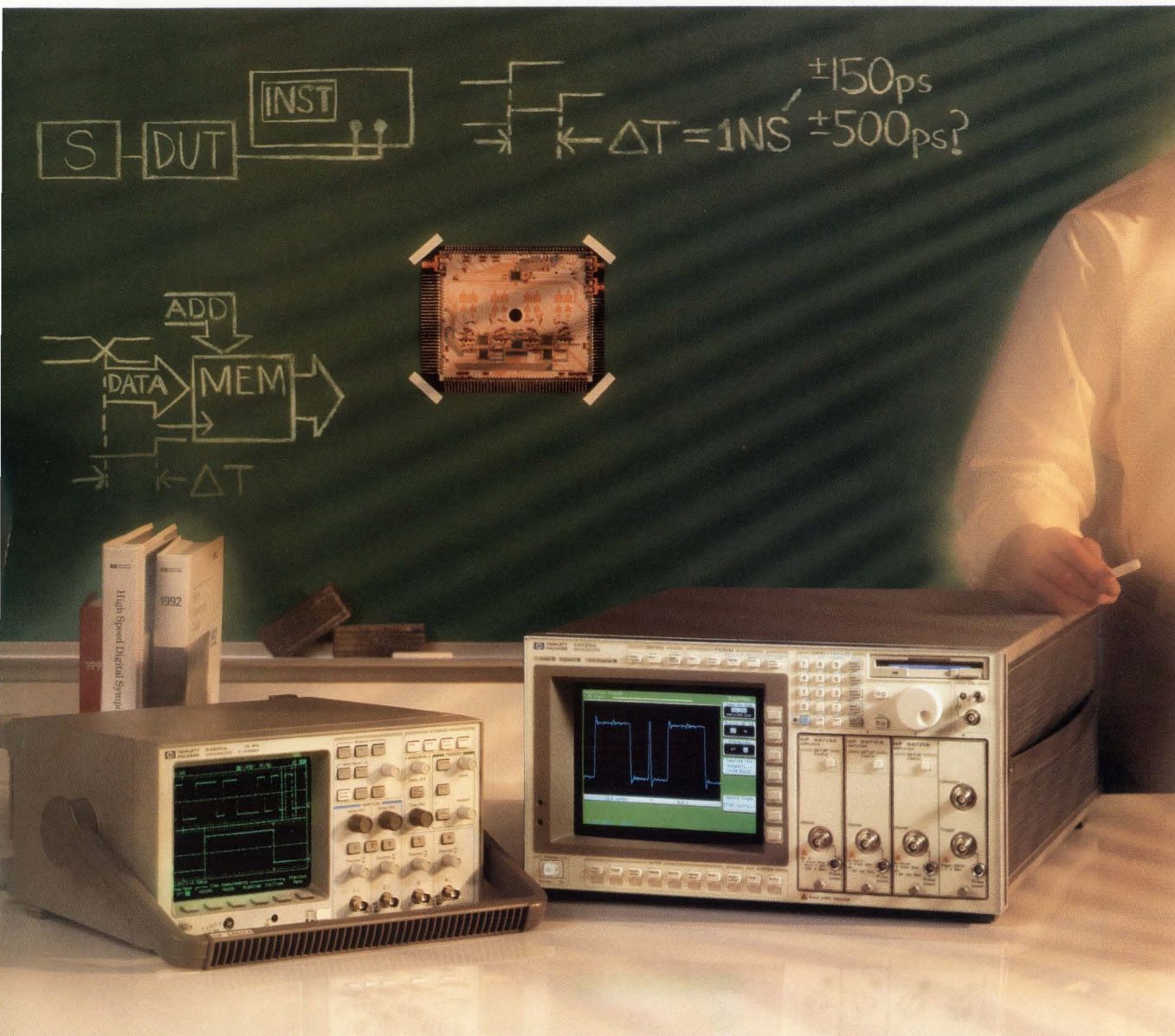

© 1992 Hewlett-Packard Co. TMCOL133C/EDN

Now there's a way to get the information you need.

Experience is the best teacher. And since 1980, HP has developed digitizing scope technology to help you understand how well digital designs are working. Or why they aren't.

When high-speed signal integrity issues are problems, use either the 50 GHz HP 54124 or HP's new 4GSa/s 54720A to learn why. If you need to make precision single-shot measurements, you can't go wrong with the 1 GSa/s, 4 channel

HP 54512. And for general-purpose use, the HP 54600 offers the look and feel of analog with the power of digital.

And scopes are only part of the picture. HP's unique high-speed digital symposium sheds light on leading-edge digital design issues. In-depth information on techniques and methods is available through seminars, application notes, and HP's worldwide network of field engineers and product specialists.

So, if you want a better understanding of digital designs, call

1-800-452-4844. Ask for Ext. 2890,* and we'll send an information packet that explains how HP can help you find the answers.

There is a better way.



* In Canada call 1-800-387-3867, Dept. 430.



The Key Building Block in High-Frequency EDA Applications

From cellular and satellite communications to radar and electronic defense, EEsof's electronic design automation (EDA) software suite is the key building block in today's rapidly growing RF and microwave applications. In fact, EEsof is the world leader in EDA software tools for high-frequency analog circuit and system design.

Top electronic engineering firms use EEsof's powerful design-for-manufacturing software to increase design efficiency, reliability and yields while reducing time-to-market.

Our easy-to-use tools provide engineers with a complete hierarchical suite to support

advanced circuit design... from top-down design of high-frequency systems, to bottom-up development of detailed electrical models. EEsof provides the most complete line of high-frequency simulators, along with libraries of circuit and system models. We support industry manufacturing standards like Gerber,TM GDSII,TM and IGES,TM and interfaces to Cadence, Mentor Graphics

and other top EDA vendors.

Make EEsof the key building block in your applications. Call, FAX or write EEsof for more information on the complete

suite of integrated high-frequency analog simulation software.

5601 Lindero Canyon Road
Westlake Village, CA 91362 USA
Phone: 1-800-34-EESOF
FAX: 1-818-879-6467.

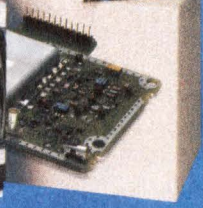
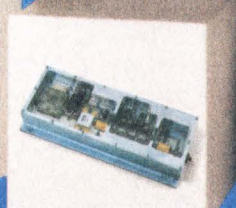
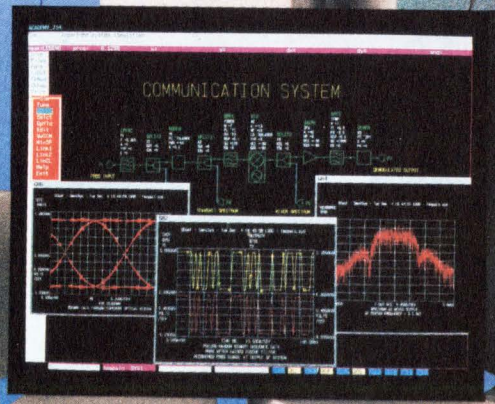
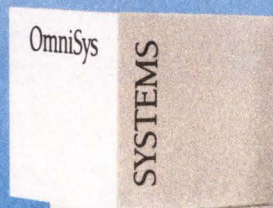
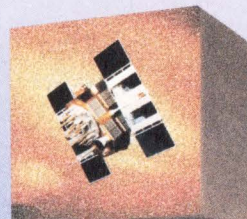

©1992, EEsof Incorporated

Circle No. 1



Take a Look at LabWindows[®]

LabWindows brings a new look to data acquisition and instrument control. The new look is graphical—a graphical user interface for your acquisition and control system.

Graphical User Interface

With LabWindows, you can easily create custom graphics panels to interface with your DOS-based system. Using the graphical editor and standard development tools, you can build a system that combines data acquisition, data analysis, and data presentation.

Program with C or BASIC

When you develop with LabWindows, you have the benefit of standard programming languages and development tools designed specifically for data acquisition and instrument control.

Data Acquisition Hardware

LabWindows has libraries of functions to control data acquisition hardware ranging from plug-in boards to industry-standard GPIB, VXI, and RS-232 instruments. You can develop a system with LabWindows to meet all of your measurement and control needs.

Take a look at LabWindows. Call for your **free** demo disk (800) 433-3488 or (512) 794-0100.

NATIONAL INSTRUMENTS[®]
The Software is the Instrument[®]

6504 Bridge Point Parkway
 Austin, TX 78730-5039
 Fax: (512) 794-8411

Branch Offices: Australia 03 879 9422, Belgium 02 757 00 20, Canada 519 622 9310, Denmark 45 76 73 22, France 1 48 65 33 70, Germany 089 714 50 93, Italy 02 48301892, Japan 03 3788 1921, Netherlands 01720 45761, Norway 03 846866, Spain 91 896 0675, Sweden 08 98 49 70, Switzerland 056 45 58 80, U.K. 0635 523545. Product names listed are trademarks of their respective manufacturers. Company names listed are trademarks or trade names of their respective companies. © Copyright 1992 National Instruments Corporation. All rights reserved.

SEE US AT AUTOTESTCON, BOOTH 605
 Circle No. 2

ITT CANNON'S COMMERCIAL D SUBMINIATURE CONNECTORS GIVE YOU OPTI-

It's kinda

MUM POWER AND EFFICIENCY WITH MINIMUM REAL ESTATE. WE OFFER

like a

THE INDUSTRY'S BROADEST LINE, FEATURING SURFACE MOUNT

hamster

AND COMBO D® CONNECTORS, PLUS ACCESSORIES. AND

that can

WITH HIGH-DENSITY CONFIGURATIONS YIELDING 30-40%

bench

SIZE REDUCTION, YOU CAN MEET THE DEMANDS

250.

OF TOMORROW'S TECHNOLOGY TODAY.

ITT Cannon

COMMERCIAL/INDUSTRIAL
1851 E. DEERE AVE.
SANTA ANA, CA 92705
(714) 261-5300



LITTLE FOOT

"SIZE IS POWER" DEBUNKING THE MYTH

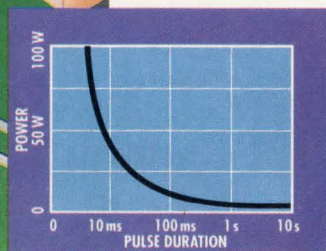
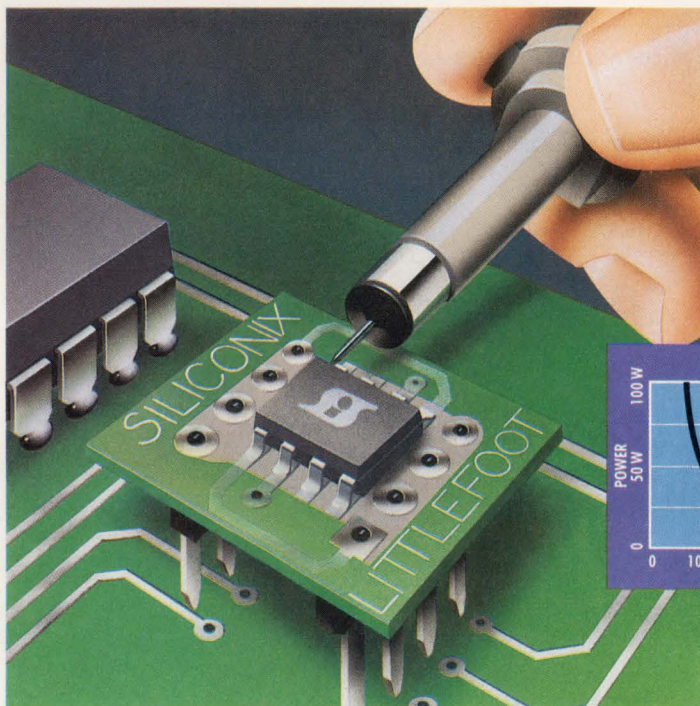

The myth of mass.

Many say, "Size is power." We say different. Sometimes it's just hard to believe a device so small can dissipate so much power. A full 2 watts. But LITTLE FOOT™ does.

It also delivers the highest current rating available, up to 6 amps, in a tiny SOIC-8 package. Just what you need for motor control, load switching, and DC/DC conversion in applications where

space and heat are critical constraints.

How else can you design one or two powerful MOSFETs into your system in less than five one-hundredths (0.05) of a single square inch?

Use the world's smallest evaluation board...and see for yourself.

Siliconix simplifies circuit testing by providing you with a mini-evaluation board. It's only 1/2" x 1/2". Just solder LITTLE FOOT to the mini-board and drop it into your socket.

LITTLE FOOT is designed for manufacturability.

LITTLE FOOT simplifies your assembly process because Siliconix's SOIC packaging is compatible with the digital

devices on your board. And its two-MOSFET capability means you use fewer components

and get higher system reliability.

LITTLE FOOT cuts your costs and reduces set-up time. And there are no solder voids, no lead trimming, and no tube jamming.

Get the LITTLE FOOT big advantage.

Call our toll-free hot line now! **1-800-554-5565, ext. 969.** Ask for your LITTLE FOOT design kit and evaluation board. And remember, at Siliconix we're bringing a seamless power interface to the digital world.

Siliconix

2201 Laurelwood Road, Santa Clara, CA 95056

© Copyright 1992 Siliconix, Inc.

Part Number & Type	$V_{(BR)DSS}$	I_D	$R_{DS(on)}$
Si9400DY (Single P-Ch)	-20	-2.3	0.25
Si9405DY (Single P-Ch)	-20	-3.8	0.10
Si9410DY (Single N-Ch)	30	6.3	0.03
Si9420DY (Single N-Ch)	200	1.0	1.00
Si9942DY (N- & P-Ch)	20	3.0	0.125
	-20	-2.5	0.20
Si9952DY (N- & P-Ch)	25	3.5	0.10
	-25	-2.3	0.25
Si9953DY (Dual P-Ch)	-20	-2.3	0.25
Si9955DY (Dual N-Ch)	50	3.0	0.13
Si9956DY (Dual N-Ch)	20	3.5	0.10
Si9959DY (Dual N-Ch)	50	2.0	0.30

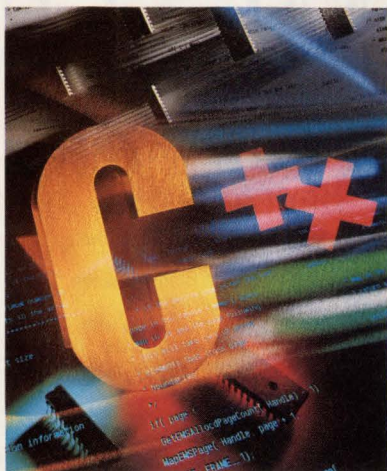

On the cover: With a few exceptions, C++ is a superset of our old and familiar friend, C. And like an old friend, C++ is comfortable, friendly, and has its little idiosyncrasies. (Photo courtesy Borland International; art direction by Ilene Rosenberg; photography by Dave Casteel) **PAGE 78**

Foldout Contents

Turn to the last information-retrieval service card in the back of this magazine and you'll find a foldout table of contents. Now, instead of flipping back and forth from this table of contents to the articles you want to read, you can have the convenient foldout open at all times while you're reading EDN. Use the foldout contents to mark off articles you'd like your colleagues to read or to remind yourself to copy stories for your files.



How C++ works

SPECIAL REPORT

Despite the many similarities between C and C++, at run time, a C++ program can take some unexpected twists and turns.—*Charles H Small, Senior Technical Editor*

78

DESIGN FEATURES

Three-step method evaluates neural networks for your application

Characterizing your problem and assessing the available data may lead you to formulating a neural-network implementation. If the problem type fits and the data is sufficient, a neural network can do the thinking for you.—*Jeannette Lawrence and Peter Andriola, California Scientific Software*

93

BTL transceivers enable high-speed bus designs

As bus transfer rates extend into warp speeds, large capacitive loads can behave like anchors. Low-capacitance backplane-transceiver-logic devices offer advantages over their TTL counterparts when you're trying to maximize throughput.—*Joel Martinez, National Semiconductor Corp*

107

EDN's Technical-Article Database Index

115

Continued on page 7

EDN® (ISSN 0012-7515, GST Reg. #123397457) is published 48 times a year (twice monthly with 2 additional issues a month, except for March and October, which have 3 additional issues and July and December which have 1 additional issue) by Cahners Publishing Company, A Division of Reed Publishing USA, 275 Washington Street, Newton, MA 02158-1630. Terrence M McDermott, President/Chief Operating Officer; Frank Sibley, Executive Vice President; Jerry D Neth, Senior Vice President/Publishing Operations; J J Walsh, Senior Vice President/Finance; Thomas J Dellamaria, Senior Vice President/Production and Manufacturing; Ralph Knupp, Vice President/Human Resources. EDN® is a registered trademark of Reed Properties Inc., used under license. Circulation records are maintained at Cahners Publishing Company, 44 Cook Street, Denver, CO 80206-5800. Telephone: (303) 388-4511. Second-class postage paid at Denver, CO 80206-5800 and additional mailing offices. **POSTMASTER: Send address changes to EDN®, PO Box 173377, Denver, CO 80217-3377.** EDN® copyright 1992 by Reed Publishing USA; Robert L Krakoff, President and Chief Executive Officer. Rates for nonqualified subscriptions: EDN Magazine and EDN News combined (48 issues) U.S. \$154.95/year; EDN Magazine only (26 issues) U.S. \$119.95 year; EDN News only (22 issues) U.S. \$74.95/year. Subscription rates higher outside U.S. Please inquire at Denver office for rates. Telephone (303) 388-4511. Except for special issues where price changes are indicated, single copies are available for \$20 U.S. and \$25 foreign. Please address all subscription mail to Ellen Porter, 44 Cook Street, Denver, CO 80206-5800.

FLUKE®



PHILIPS

Introducing SCOPEMETER.™

There's More Than One Reason to Reach for It.

In fact, there's *every* reason to reach for ScopeMeter.™ Because only ScopeMeter combines the expertise of Fluke and Philips to bring you a dual-channel digital scope along with everything you've come to expect from Fluke digital multimeters.

The result: an integrated scope-and-multimeter that lets you see a waveform and digital meter display at the same time from the same input. Or switch between dedicated high-performance Scope and Meter functions with the touch of a key. That makes it faster and easier than ever to capture, store and analyze precisely what you're looking for. At a price that looks good, too.

To get your hands on a ScopeMeter, contact your Fluke sales office or your nearest Fluke distributor. For more product information, call **1-800-44-FLUKE**.

SCOPEMETER. Now there's only one to reach for.



Built to Take It.

- Completely sealed against water, dust and contaminants.
- EMI protected and measures up to 600 volts rms.
- Rugged construction with shock-resistant holster.
- Three-year warranty from Fluke.

Simply Easy.

- Intuitive front panel layout for simple, straightforward operation.
- Pop-up menus and five function keys for easy control.
- Autoset automatically sets voltage, time and trigger functions.
- Safety-designed BNC connectors and probes simplify floating measurements.

Double Duty.

- 50 MHz digital storage scope and 3000-count digital multimeter in one handheld package.
- Precision Min Max Record and 40 ns Glitch Capture make it easy to troubleshoot intermittent failures.
- Simultaneous waveform and digital display on a backlit screen you can read across the room.

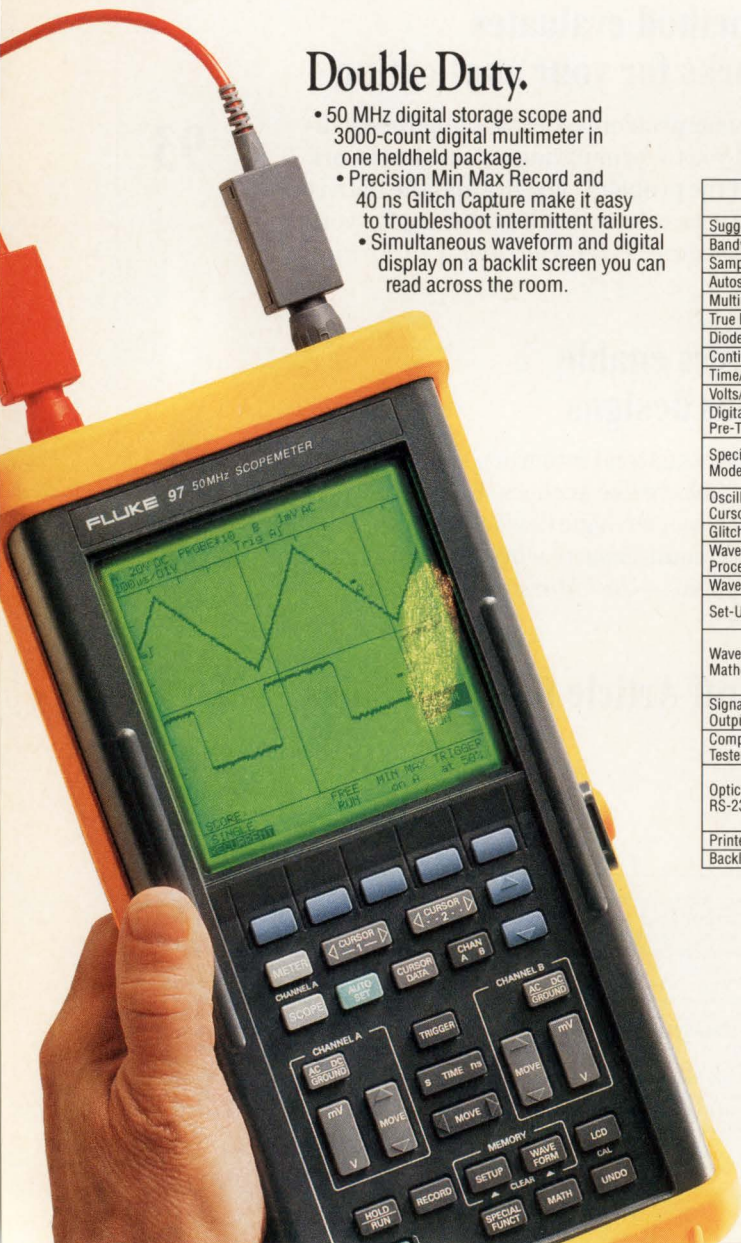

FLUKE 90 SERIES SCOPEMETER SELECTION GUIDE			
	FLUKE 97	FLUKE 95	FLUKE 93
Suggested List Price	\$1795	\$1495	\$1195
Bandwidth	50 MHz Dual Channel		
Sample Rate	25 Megasamples/second		
Autoset	Automatically sets Voltage, Time and Trigger		
Multimeter Display	3 ¹ / ₃ digits (>3000 Counts)		
True RMS Volts	AC or AC+DC up to 600V (1700V Pk-Pk)		
Diode Test	Up to 2.8V		
Continuity Beeper	Yes		
Time/Division	10 ns/div to 60 sec/div		
Volts/Division	1 mV/div to 100V/div		5 mV/div to 100V/div
Digital Delay or Pre-Trigger	By Number of Cycles, Events, Time, or Zoom Mode		By Time
Special Multimeter Modes	Min Max Average Record, Relative (zero), dBm, dBV, dBW, Audio Watts, % Scale, Frequency, Smoothing™ Change Alert™		Frequency, Smoothing™ Change Alert™
Oscilloscope Cursors	12 Measurements, Display 5 Simultaneously		
Glitch Capture	≥40 ns		
Waveform Processing	Average, Variable Persistence, Min Max Record		
Waveform Memory	Store and Recall 8 Waveforms		
Set-Up Memory	Store and Recall 10 Front Panel Set-Ups		
Waveform Mathematics	Add, Subtract, Multiply, Invert, Filter or Integrate Waveforms		
Signal Generator Output	Sinewave or Squarewave		
Component Tester Output	Voltage or Current Ramp		
Optically Isolated RS-232-C Interface	Full Operation by Remote Control via optional PM 9080 cable		
Printer Output	Serial		
Backlit Display	Electroluminescent		



Goes Wherever You Go.

- Runs on rechargeable NiCad Batteries, standard C-cells or the included line voltage adapter/battery charger.
- Adjustable tilt-stand/hanger.
- Compatible with a wide range of Fluke multimeter accessories.

©1992 John Fluke Mfg. Co., Inc. Ad No. 00224.

FLUKE®

CIRCLE NO. 5

Home Office
275 Washington St, Newton, MA 02158
EDN Bulletin Board: (617) 558-4241
MCI: EDNBOS
(617) 558-extension

VP/Publishing Director
Peter D Coley -4673

VP/Publisher
Roy Forsberg -4367

VP/Editor/Editorial Director
Jonathan Titus -4573

Executive Editor
Steven H Leibson -4214

Managing Editor
Joan Morrow Lynch -4215

Assistant Managing Editor
Anne Gallagher -4653

Gary Legg, *Senior Technical Editor* -4404
Tom Ormond, *Senior Technical Editor* -4414
Charles Small, *Senior Technical Editor* -4556
MCI: EDNSMALL; Compuserve: 70324, 3270

John A Gallant, *Technical Editor* -4666
John C Napier, *Technical Editor* -4690
Dan Strassberg, *Technical Editor* -4205
Julie Schofield, *Senior Associate Editor* -4619
Jay Fraser, *Associate Editor* -4561
Carl Quesnel, *Associate Editor* -4484
Susan Rose, *Associate Editor* -4738
Helen McElwee, *Senior Copy Editor* -4311
James P Leonard, *Copy Editor* -4324
Gillian A Caulfield, *Production Editor* -4263
Erin Heffernan, *Production Editor* -4333
Chuck Harper, *BPEF Intern*

Editorial Field Offices
Doug Conner, *Technical Editor*
Atascadero, CA: (805) 461-9669
MCI: EDNDCONNER

J D Mosley, *Technical Editor*
Arlington, TX: (817) 465-4961
MCI: EDNMOSLEY

Richard A Quinnell, *Technical Editor*
Aptos, CA: (408) 685-8028
MCI: EDNQUINNELL

Anne Watson Swager, *Technical Editor*
Wynnewood, PA: (215) 645-0544
MCI: EDNSWAGER

Ray Weiss, *Technical Editor*
Woodland Hills, CA: (818) 704-9454
MCI: EDNWEISS

Maury Wright, *Technical Editor*
San Diego, CA: (619) 748-6785
MCI: EDNWRIGHT

Brian Kerridge, *Technical Editor*
22 Mill Rd, Loddon
Norwich, NR14 6DR, UK
(508) 28435
MCI: EDNKERRIDGE

Contributing Editors
Robert Pease, Don Powers, Dave Pryce,
David Shear, Bill Travis

Editorial Coordinator
Kathy Leonard -4405

Editorial Services
Helen Benedict -4681

Art Staff
Robert L Fernandez, *Art Department Director*
Ken Racicot, *Senior Art Director* -4708
Chinsoo Chung, *Associate Art Director* -4446
Cathy Madigan, *Associate Art Director* -4599

Marketing & Business Director
Deborah Virtue -4779

Marketing Communications
Kathy Calderini, *Manager* -4526
Pam Winch, *Promotion Specialist* -4660

ADC architectures: Speed-resolution tradeoff key to choosing ADCs

TECHNOLOGY UPDATE

The diverse applications for A/D converters demand that you understand the basic differences in the available architectures.—*Dave Pryce, Contributing Editor*

39

PRODUCT UPDATES

Graphical-user-interface accelerator chip	59
Filtered power amplifier	60
Analog peripheral IC	62

PROCESSOR UPDATES

SPARC chip sets for MBus modules	65
16-MHz embedded SPARClite μ P	68

NEW PRODUCTS

Components & Power Supplies.	138
Test & Measurement Instruments.	141
Computers & Peripherals.	144
Integrated Circuits.	147
CAE & Software Development Tools.	152

DEPARTMENTS

Inside EDN.	9
News Breaks.	17
Signals & Noise.	27
Editorial.	37
Design Ideas.	129
Career Opportunities.	158
EDN's International Advertisers Index.	163

Cahners Publishing Company, A Division of Reed Publishing USA Specialized Business Magazines for Building & Construction Research Technology Electronics Computing Printing Publishing Health Care Foodservice Packaging Environmental Engineering Manufacturing Entertainment Media Home Furnishings Interior Design and Lodging. Specialized Consumer Magazines for Child Care Boating and Wedding Planning.

The Next World Standard for Embedded Systems

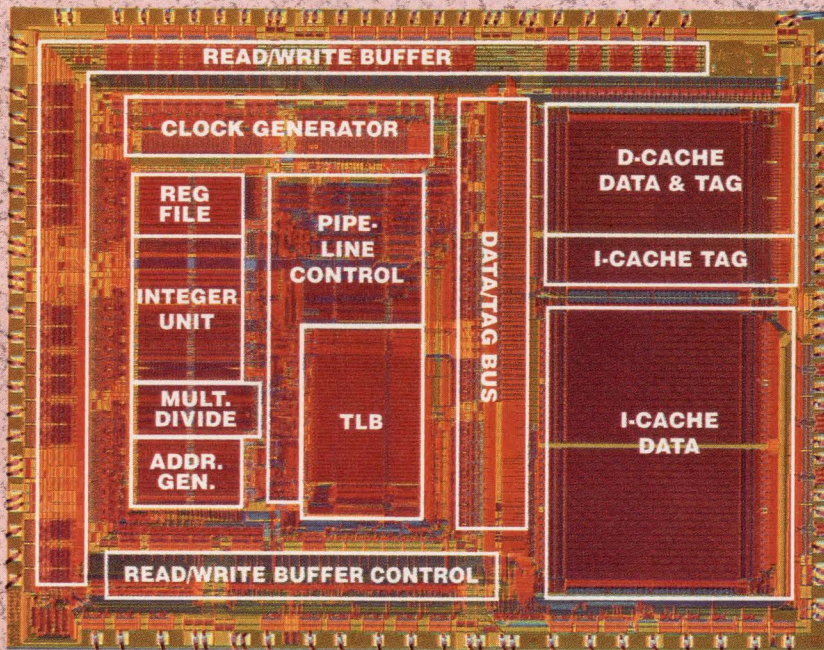

IDT's R3051 RISCController™

MIPS® RISC for \$30

The 32-bit R3051™ outperforms the i960 and AMD29K, and has everything you need in a high-performance, low-cost CPU:

- **Larger Cache**—up to 10KBytes of I and D cache on-chip for PostScript®, networking, or X protocols.
- **4-Deep Read and Write Buffers**—allow the CPU to run at full speed, even in low-cost DRAM designs.
- **Multi-Sourcing**—provides form, fit, and function interchangeable products at competitive prices.
- **Development Support**—100% software compatible with low-cost MIPS and IDT development tools on PC, SPARC, MIPS, and Macintosh® host platforms.
- **In Production Now!**



"I could never have imagined that RISC would become so inexpensive, powerful, and pervasive, and IDT's R3051 has made that happen."

Steve Blank
Vice President of Marketing
SuperMAC, Leader in high-end graphics

Evaluate the R3051 Today

For a limited time, we're offering a complete R3051 Evaluation Kit, including an evaluation board and software, for \$595 (an \$895 value).

Call our toll-free hotline to get an IDT RISC Product Roadmap and complete information on the R3051 Evaluation Kit, so you can evaluate the next μ P standard for embedded systems today.

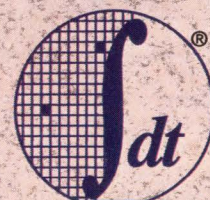
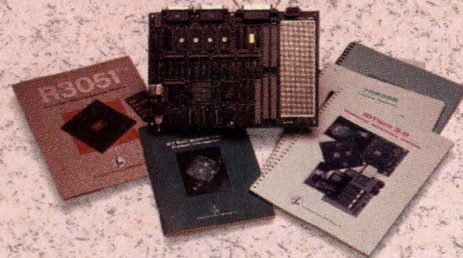

Integrated Device
Technology, Inc.

(800) 345-7015 • FAX: 408-492-8674
ASK FOR KIT CODE 5071

CIRCLE NO. 6

If the confusing and sometimes nonsensical terminology of **object-oriented programming (OOP)** articles has left you reeling, turn to this issue's Special Report. Senior Technical Editor Charles H Small uses concrete examples and diagrams to show how C++ works in the world of OOP. He's used this same nuts-and-bolts approach in his previous articles describing the inner workings of embedded DOS, Unix, diagrammatic compilers, and Windows.

Charles begins by comparing the arrays and array-defining constructs of C to the objects and classes of C++. He asserts that if you have ever programmed in any high-level language, you've been using a class to generate objects all along. He continues the analogy by comparing manipulating C++ objects to manipulating C constants, variables, strings, arrays, and structures. Even if the computer languages you know don't include C, you'll be able to follow along. If you want to learn still more about C++, try browsing through EDN's bulletin-board system (BBS), which has a variety of C++ software including compilers, preprocessors, libraries, and computerized tutorials.

Leaving the software world of OOP, we enter the analog realm of the real world. But much real-world information processing occurs in the digital realm. To get from one realm to the next, you'll need an A/D converter. If your current design needs an ADC—and especially if you're choosing a converter for the first time—you'll want to check out Contributing Editor Dave Pryce's Technology Update on **ADC architectures**. He says that looking at the converters' architectures will help you understand the advantages and disadvantages of each type. The architectures he examines are successive-approximation, flash, subranging, integrating, and sigma-delta.



In this issue, Contributing Editor Dave Pryce's Technology Update focuses on ADC architectures.

Dave concentrates on resolution and speed, which a converter's architecture determines to a great extent. Not only are there speed and resolution tradeoffs among converter types, but also among converters of the same type. You can't usually obtain both the highest possible speed and the highest possible resolution with the same device. For example, successive-approximation converters have speeds of 10 ksamples/sec to 1 Msample/sec and resolutions of 8 to 18 bits. However, their resolution is limited to about 12 bits at the higher speeds. To get you started choosing an ADC, Dave includes a graph that gives you an at-a-glance view of the speed and resolution limits of the five A/D converter types.

Finally, we've heard all your clamoring and at long last we're printing our **technical-article database**. The database indexes by subject matter articles that appeared from November 1991 to April 1992 in *EDN Magazine* and *EDN News Edition*, *Electronic Design*, *Electronic Products*, *Computer Design*, and *Electronics*. A database for articles published from November 1989 to October 1991 is on the EDN BBS, so you've got one more reason to phone (617) 558-4241 with modem settings 300/1200/2400/9600 8,N,1.

Julie Anne Schofield
Senior Associate Editor

Technical calculations made easy!

ALL NEW VERSION 3.0!



Mathcad - [mathcad.mcd] Window Help

Edit Text Math Graphics Symbolic Window Help

The dimensions of the aluminum block will be 3.5 feet by 4.5 feet by 1.4 inches.

$$4.5 \text{ ft} \times 14 \text{ in} \times 185.264 \frac{\text{lb}}{\text{ft}^3} = 3.037 \text{ lb} \quad (\text{density of Al from the Mathcad Electronic Handbook...})$$

Mathcad supports calculator section radius 2 inches) this work is out to

$$\frac{(1.9817 \text{ lb})}{(4 \pi (2 \text{ in})^2)} = 60.419 \frac{\text{lb}}{\text{m}^2} \quad (\text{is this load going to be OK?})$$

How about the coating - the sketch of the right shows the kind of profile we want at the edges. The rate of loss depends on temperature, roughly like this:

The worst case is around 140 degrees so for a 6 month lifetime we need

$$6 \text{ month} \times (140) = 9.342 \text{ in}$$

This will add quite a lot to the cost (this stuff is expensive!) At \$165 per gallon

$$165 \times 7.33 = 1209.45 \text{ dollars}$$

Now it's easier than ever to perform faster, more reliable engineering and scientific calculations.

- **Windows graphics features make Mathcad 3.0 the simple solution to complex analytic needs.** Dialogs, pull-down menus, and mouse point-and-click capabilities make it easy to combine equations, text, and graphics right on your screen and print it all in a presentation-quality document.
- **New Electronic Handbook Help facility serves as an on-line reference library.** Paste standard formulas, constants, and diagrams from searchable, hypertext Electronic Handbooks for instant use in your Mathcad worksheet.
- **Symbolic calculations with a simple menu pick.** Use expressions resulting from symbolic derivations in your numeric calculations or for further symbolic manipulation.
- **Mathcad works on PC DOS, PC Windows, Macintosh, or UNIX.** More than 120,000 engineers, scientists, and educators already use Mathcad for a variety of technical applications. Applications packs are also available to customize Mathcad for particular disciplines, including electrical, mechanical, and civil engineering and advanced math.

Call 800-MATHCAD or use this coupon to request a free 3.0 demo disk!

In Massachusetts, call 617-577-1017. Please specify diskette size:

3 1/2" 5 1/4"

For a free Mathcad 3.0 Introductory kit, clip this coupon and mail it back to us, or fax it to 617-577-8829. Or circle your reader service card.

Yes! Tell me more about Mathcad 3.0!

Name _____
Title _____
Company or Institution _____
Address _____
City _____ State _____ Zip _____
Phone(_____) _____

Mail this coupon to:
MathSoft, Inc.
201 Broadway
Cambridge, MA 02139
USA

EDN 13

TECH 3.0

CIRCLE NO. 26

An Object Less For Absolutely Pr



The MACH™ Family From AMD: The Fastest, Most Predictable High Density PLDs Available Today.

Oops! You're a couple of nanoseconds shy this time, and it's going to hurt. Perhaps next time you'll choose a more predictable vehicle. And the most predictable high speed, high-density PLDs available are the MACH family from AMD.

Only the MACH Family offers you worst case delays of 15ns* or

less. Because MACH parts are essentially PAL® devices, just like the kind you already know. Not some hybrid

PLD/FPGA, where you don't know how it performs — until it's too late. So you don't have to guess your delays or clock speeds, you just read them right off our datasheet.

But they're not just ordinary

Model Number	Equiv. Gates	Macro Cells	Max. Delay	System Speed	I/O Pins	Hard-Wired Option
MACH 110	900	32	12ns	66.7 MHz	44	MASC 110
MACH 210	1800	64	12ns	66.7 MHz	44	MASC 210
MACH 120	1200	48	15ns	50 MHz	68	MASC 120
MACH 220	2400	96	15ns	50 MHz	68	MASC 220
MACH 130	1800	64	15ns	50 MHz	84	MASC 130
MACH 230	3600	128	15ns	50 MHz	84	MASC 230

*In applications with a full 16 product terms. Every MACH part is specified using real-life conditions with all outputs switching.

on In The Need edictable Speed.



PAL devices. They're bigger and better, with densities ranging from 900 to 3600 gates, all in our submicron CMOS technology.

Nor will you face unpredictable delays when you order. Because the entire MACH family is now shipping in volume.

Working with them is equally predictable. You don't have to learn any new techniques, just use the software and test equipment you already know. Like ABEL, CUPL, OrCad, and others. Not to mention the software and support from over 20 FusionPLD vendors — all prepared to bring your products to market on time.

And each MACH part can migrate easily to a pin-

compatible, hard-wired MASC™ counterpart for high volume. So you can get the volume you need, without redesign, NRE, or unforeseen delays.

So call AMD today at **1-800-222-9323**. And let the MACH family make your design cycle a whole heck of a lot safer.



Advanced Micro Devices

© 1992 Advanced Micro Devices, Inc. 901 Thompson Place, P.O. Box 3453, Sunnyvale, CA 94088. PAL is a registered trademark, and MACH and MASC are trademarks of Advanced Micro Devices, Inc. All brand or product names mentioned are trademarks or registered trademarks of their respective holders.

CIRCLE NO. 7

Compare Us To The F And You'll Have Second

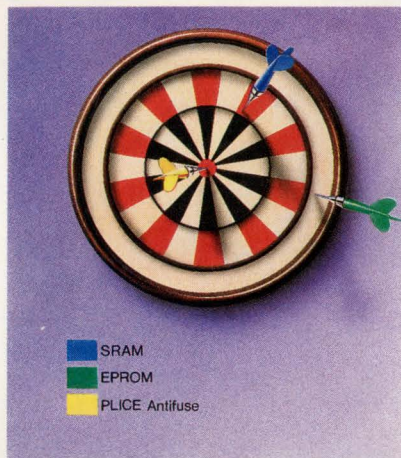

Optimal Programming Element.

PLICE® antifuse elements combine small size and high reliability, giving you FPGAs with higher speed, lower cost, greater ease-of-design, and more capacity than any other.



Superior Performance.

The antifuse-based ACT 2, the most predictable FPGA available, incurs short delays in interconnecting logic functions, which means higher speeds to keep pace with your latest microprocessor.

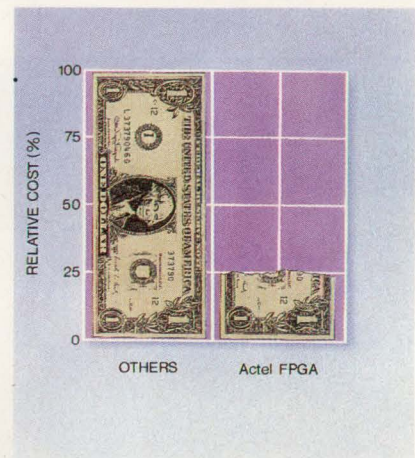

Lower Cost.

PLICE antifuse technology results in smaller die sizes, saving you as much as 75% off the cost of the alternative solution.

Once You Witness The Performance Of Our ACT™ 2 FPGAs, You'll Know The Real Leader Is Actel.

If you plan to move to the superior capacity, flexibility and cost of FPGAs, you should know the facts. Compare us against the industry "leader." You'll find our ACT 2 FPGAs turn in some very impressive numbers indeed.

#1 in architecture. The ACT 2 family's innovative PLICE antifuse technology provides the ideal programming and intercon-

nect elements for high-density FPGAs. Our FPGAs offer superior reliability and design flexibility, and give you the most predictable FPGA performance available. And with more than 1 million FPGAs shipped, Actel has more experience manufacturing antifuse-based FPGAs than anyone. That's experience you can count on.

#1 in speed. The fastest ACT 2 family member—the A1225—offers 2,500 gates of pure speed. With a 4 ns logic delay and system-level speeds up to 66MHz, ACT 2 helps you make the most of your design.

#1 in ease-of-use. With ACT 2, designs are easily captured with standard PLD tools like ABEL™ and PLDesigner-XL™, as well as with your favorite sche-

matic capture program from Mentor Graphics, OrCAD, Valid Logic Systems and Viewlogic. And Actel's Action Logic® System rapidly converts captured designs into programmed Actel devices. For years, our 100% automatic placement and routing has simplified the design process. And it's still faster and easier than any other solution.

#1 in affordability. Our FPGAs also provide the best price/performance available. Actel offers

PGA Market Leader, Thoughts About Who's #1.

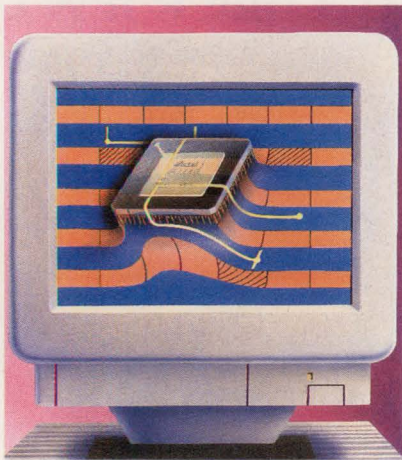

Designing Made Simple.

Actel devices' plentiful routing resources give you 85% gate utilization using 100% automatic placement and routing, letting you place and route a 4,000-gate design in our A1240 chip in only 30 minutes.

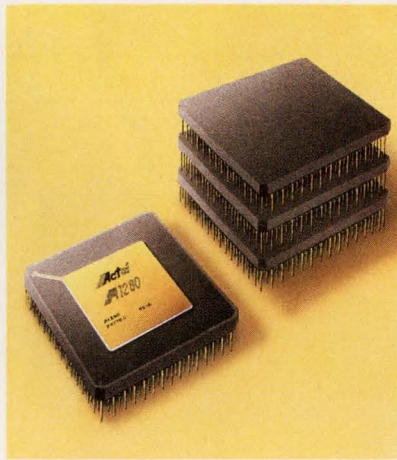

Greater Capacity.

With 8,000 gate-array equivalent gates, the A1280 has led the industry in capacity for over 2 years. And it's still the only high-density, high-performance FPGA available in volume production.



Catch Our Next Act.

We're building on this FPGA technology to set new performance levels with our upcoming ACT 3 FPGAs. Whichever ACT you catch, you'll get a long-term partner and the best performance in town.

much quicker time-to-market and complete control of the design process, as well as competitive FPGA prices. Which saves you both money and time.



The FPGA Design Guide

answers to their application questions.

We're building on our experience to bring you the most advanced products for any application, and we're committed to establishing a quality, long-term partnership with you for your future success.

Call 1-800-228-3532

for more information on our powerful family of FPGAs. And discover how far the real industry leader can take you.

And #1 in service and support. Customers can call our technical hotline and talk to a real person—not voicemail. Or customers can use our automatic Action FACTS system to fax themselves quick

Broad Family With High Capacity

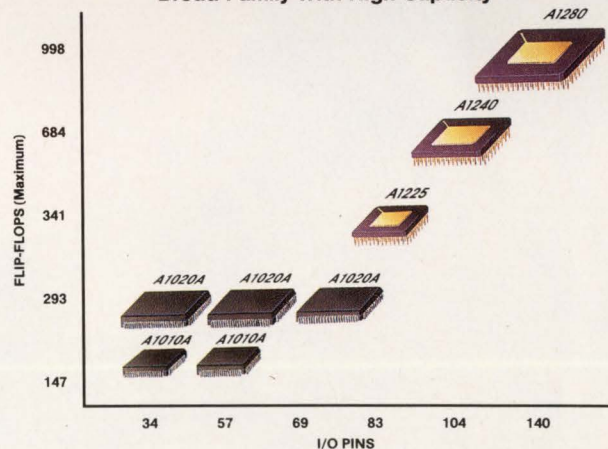

Actel
Risk-Free Logic Integration

We provide more
to a place few co

©1992 FORCE Computers, Inc.

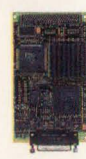
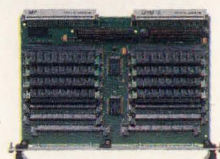
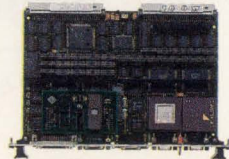
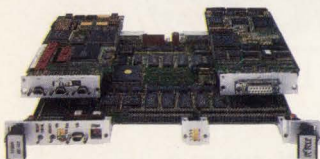

e solutions because we've been
companies have dared to venture.

When it comes to embedded systems design, nobody offers better solutions than FORCE.

But, we have to admit, we had a little help. From you.

At FORCE, we get inside the heads of our customers to learn about their requirements.

The result is the world's most advanced CISC and SPARC™ based VME single board computers, including the latest SPARC CPU-2E boards.

What else did you have in mind? How about bus extensions – like SBus and our own FLXibus™ Plus SunOS™ and the widest variety of real-time operating systems and kernels.

And when your designs need to evolve to the next generation, count on FORCE for the best in VME64/Plus™ or Futurebus/Plus™. Because better products come from better knowledge.

For a partner that can get your application up and running fast, call 800-237-8863, ext. 10. In Europe, call 49.89.608-14-0.

And thanks for keeping an open mind.

FLXibus, VME64/Plus and Futurebus/Plus are trademarks of FORCE Computers, Inc. All other brands or products are trademarks of their respective holders.

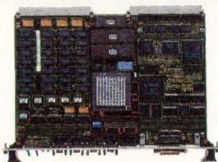
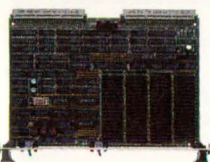

3165 Winchester Blvd., Campbell, CA 95008-6557
Prof.-Messerschmitt-Str. 1 W-8014 Neubiberg/München

CIRCLE NO. 9

Last year several hundred Pulse Generator users dumped the one line display and the High Price.

Here's why.



Sophisticated Signal Sources from LeCroy

To receive a complete package of
technical information:

1-800-4-LeCroy

(1-800-453-2769)

LeCroy 9210 300 MHz Programmable Pulse Generator

	with 9211 Module	with 9212 Module	with 9213 Module
TRANSITION SPEED	1 ns - 10 ns	300 ps - 1 ns	6.5 ns - 95 ns
MAX. REP RATE	250 MHz	300 MHz	50 MHz
OUTPUT LEVEL	5V p-p (50Ω)	5V p-p (50Ω)	16V p-p (50Ω)
VARIABLE EDGES	Yes	Yes	Yes
TIMING ACCURACY	±(0.5% + 0.2 ns)	±(0.5% + 0.2 ns)	±(0.5% + 0.2 ns)

LeCroy

Innovators in Instrumentation

Logic analyzers maximize performance vs price

Hewlett-Packard's 1660A family of portable analyzers suits users who want to maximize performance vs price and do so without a modular analyzer's configurability and expandability. The family includes four members with channel counts ranging from 34 to 136. All units provide 100-MHz state analysis with six clocks, a 3.5-nsec setup-and-hold window that is adjustable in 500-psec increments, 250-MHz timing analysis (500 MHz when you reduce the number of active channels by half), transitional timing at half the maximum timing-analysis speeds, and memory of 4 kbits/channel (8 kbits/channel with half the channels active). The firm has also enhanced the user interface; for example, besides a hexadecimal keypad, the front panel includes a "QWERTY" pad for entering alphabetic labels. Moreover, you can attach a separate keyboard and a mouse. The 102-channel unit costs \$10,900; the 136-channel unit costs \$13,500; the 34- and 68-channel units cost \$5900 and \$8500, respectively. Hewlett-Packard Co, Colorado Springs, CO, (800) 452-4844.

PC kit teaches and runs VHDL

For \$795 you can buy a full VHDL (VHSIC-Hardware-Description-Language) development system with a step-by-step tutorial that runs on a PC. The VHDL SelfStart_Kit from Topdown Design Solutions bundles the Model Technology DOS-based VHDL development system with a hands-on tutorial. The development system includes a VHDL compiler, simulator, and debugger. With it, engineers can compile and run VHDL models and designs on 286, 386, or 486 PCs. A Windows version, SelfStart_Kit/Windows-B, is available for \$2490. On a 25-MHz 486, the Windows version compiles VHDL code at a rate of 1500 lines per minute. For a few hundred VHDL lines, compile and simula-

tion times run 1 to 2 minutes. The system supports the full IEEE-1076 VHDL language, not a subset of the language.

The system's tutorial consists of a core text and a set of lab experiments. It gives users a fast, hands-on start, using VHDL basic structures to build and simulate actual logic designs. Users build a bit-slice processor complete with a 3-port register RAM, input multiplexers, ALU, and shifter. With the tutorial, engineers can get a feel for VHDL basics, as well as familiarity with what it takes to do VHDL compilation and simulation. This is not a high-level, complex course, but rather a nuts-and-bolts tutorial for experienced logic designers who want to get into VHDL. Topdown Design Solutions, Nashua, NH, (603) 888-8811, FAX (603) 888-4258, contact Art Pisani.

Laser system excels on fine-pitch pc boards

LPKF CAD/CAM Systems' multifunction laser system lets you manufacture prototype and production pc boards with the high resolution needed for fine-pitch technology. The system exceeds the capability of chemical etch systems, allowing as many as seven conductor paths between a 0.1-in. grid spacing and three conductor paths between a 0.05-in. grid. System prices start at \$160,000. LPKF CAD/CAM Systems, Beaverton, OR, (503) 645-0240, FAX (503) 645-0403.

0.8- μ m ASICs operate from 2.7 to 5.5V

The TGC1000 and TGC-1000LV family gate arrays from Texas Instruments feature a sea-of-gates architecture consisting of a new CMOS base cell for low-voltage operation and efficient implementation of memory functions. The cell meets the requirements of systems that adhere to voltage standards from 2.7 to 5V. The two families include 12 base arrays that range in complexity from 16k to 455k gates. Gate utilization is approximately 70%. The LV version dissipates 0.8 μ W per MHz per gate. For each base array, the company offers double-level-metal interconnect for I/O-limited applications or triple-level-

metal interconnect for core-limited applications. The gate arrays come in a range of packages, including plastic leaded chip carriers, plastic quad flatpacks, and metal quad flatpacks. I/Os range from as many as 558 for conventional packaging to 696 in tape-automated-bonding carriers. NRE costs start at \$20,000. Texas Instruments Inc, Semiconductor Group, Dallas, TX, (214) 995-6611, ext 3990.

Pulse generator handles TTL, ECL, and CMOS

Pulse Research Lab's PRL-150 is a 100-MHz time-mark pulse generator that fits in a hand. You can use it to test and calibrate oscilloscopes or as a precision high-frequency signal source for test applications that don't require continuously variable frequency and pulse-width signals.

The \$597 generator handles TTL, CMOS, and ECL signal levels. The device generates 151 distinct time markers—from 10 nsec at 100 MHz to 160 nsec at 0.0065 Hz—by dividing the internal crystal-controlled 100-MHz time-base frequency through a counter chain. You use a 10-position decade period switch and a multiplier switch ($1 \times$ to $16 \times$) to select a time period. The output pulse width is constant, approximately half the output frequency period, and multiplied by the period switch setting. The generator provides 0.2%, 5V dc or 5V p-p, and 1-kHz square wave for amplifier gain check or probe alignment. The generator fits into

a 6.3 × 3.5 × 1.2-in. high-impact plastic enclosure with two BNC connectors. For TTL levels only, you can buy the \$385 PRL-155. Pulse Research Lab, San Pedro, CA, (310) 514-1478. FAX (310) 514-0115.

Integrate VHDL into ASIC designs

At this year's Design Automation Conference, Cadence Design Systems demonstrated a VHDL (VHSIC-Hardware-Description-Language)-based design tool set with mixed-level design composition, 1076-language simulation, and VHDL synthesis. Composer (\$14,500) with mixed-level design capture and VHDL-XL (\$35,000), with support for 135 certified libraries, are available now. The Synergy VHDL Synthesizer (\$15,000) and Optimizer (\$45,000) will be available in the fourth quarter of 1992. All the tools share the same VHDL intermediate formats, libraries, timing information, delay calculator, and user interface. They work with the company's Design Framework II and with its ICs and ASICs. The tools exchange timing information in the company's public-domain standard delay format (SDF). The software couples a proprietary gate-level simulation algorithm with behavioral algorithms, letting users simulate at different levels with one tool. Cadence Design Systems Inc, San Jose, CA, (408) 944-7339.

Universities receive software

Cadence Design Systems Inc donated more than \$12 million worth of electronic-design-automation software to the California Institute of Technology (Pasadena, CA) and the University of Dayton (Dayton, OH). Through the Cadence University Program, the company supports leading educational institutions with real-world commercial software-design applications. More than 270 institutions worldwide have benefited from the program with software donated and supported by the company in excess of \$100 million. Cadence Design Systems Inc, San Jose, CA, (408) 944-7339.

Parallel-processing award finalists announced

Finalists for the 1992 Gordon Bell Prize competition will present their projects at Supercomputing 92, November 16 to 20, 1992, in Minneapolis, MN. The competition recognizes the application of parallel processing in practical scientific and engineering problems. The IEEE Computer Society and the Association for Computing Machinery sponsor the conference. Prizes go to spur the transition of parallel processing from computer-science research to useful applications.

The two \$1000-prize winners will be chosen from entries submitted in

Unit combines curve tracer and parameter analyzer

Some of the most important information that designers and users of ICs and discrete semiconductor devices need to learn about these parts has nothing to do with high-frequency or switching properties. The information is contained in the devices' dc parameters and quasistatic characteristics. Traditionally, measuring these dc and low-frequency values has required two types of instruments: a parameter analyzer and a curve tracer. Tektronix's \$24,950 372 Semiconductor Workbench combines the functions of these old standbys into a single unit. The system incorporates two source/measure units. Each unit supplies 200V and 400 mA (10W max) and measures current with 25-fA resolution. These capabilities suit bipolar, CMOS, BiCMOS, and GaAs devices. The user interface, which resembles that of a curve tracer, makes the effects of operating-condition changes immediately visible. According to the vendor, the system's ability to perform pass/fail testing is not shared by any parameter analyzer or curve tracer. Moreover, a TTL parallel port lets the system control a device handler. An MS-DOS-compatible floppy-disk drive lets you export files containing the graphical information the system displays on its CRT in any of three industry-standard formats. Tektronix Inc, Beaverton, OR, (800) 426-2200.

three categories: performance; price/performance; and compiler parallelization. The finalists are:

- Tom Cwik, Jean Patterson (Jet Propulsion Laboratory) and David Scott (Intel Corp)—Electromagnetic Scattering Calculations on the Intel Touchstone Delta
- Anton Gunzinger, Urs Müller, Walter Scott, Bernhard Bäuml, Peter Kohler, Florian Müller-Plathe, Wilfred F van Gunsteren, and Walter Gugenbühl (Swiss Federal Institute of Technology)—The Multisignal Processor System with Intelligent Communication
- Mark T Jones and Paul E Plassman (Argonne National Laboratory)—Solution of Large, Sparse Systems of Linear Equations in Massively Parallel Applications
- Hisao Nakanishi, Vernon Rego (Perdue University) and Vaidy Sunderam (Emory University)—Super-concurrent Simulation of Polymer Chains on Heterogeneous Networks
- Michael S Warren (Los Alamos National Laboratory) and John K Salmon (California Institute of Technology)—Astrophysical N-Body Simulations at 5.4 Gflops.

For more information, contact Marilyn Potes at the IEEE Computer Society, Los Alamitos, CA, (714) 821-8380.

Get the Jump on Windowed Environments for Circuit Design!

We did! Now you can too!!
All you need is the
Design Center™ running
under Microsoft Windows.

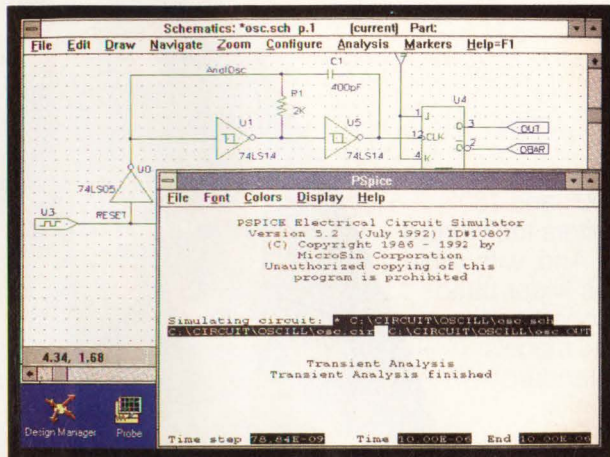

Schematic capture and PSpice simulation of a mixed analog/digital oscillator

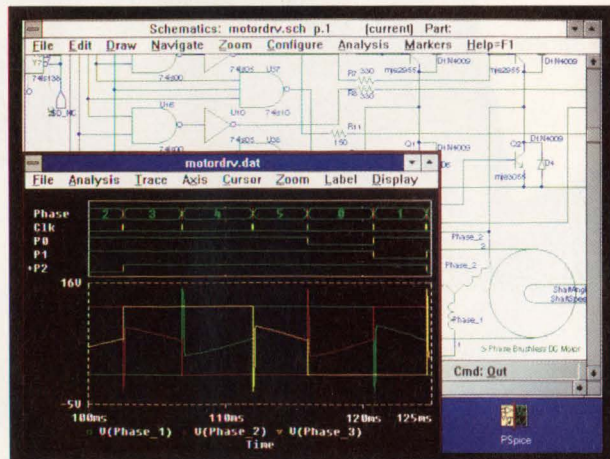

Graphical analysis of the analog and digital signals produced by a DC brushless motor simulation

Native Microsoft Windows Applications — Available Today

The **Design Center** provides you with the analog and digital circuit design software you need, running as fully integrated Microsoft Windows applications on the PC. Whether you are capturing schematics, simulating circuits with PSpice, or graphically analyzing waveforms, you have all of the convenience of windowed environments at your fingertips: relocatable and scalable windows, pull-down menus, dialog boxes, on-line help, and the ability to freely move between different windowed applications.

At the Forefront of User Interface Technology

We're proud to be the first to offer an integrated environment for circuit design under Microsoft Windows. In one window, graphically define your circuit with our schematic editor. Then, after simulating your circuit's behavior with PSpice, automatically view the waveform results in another window by marking pins, wires, and devices on the circuit drawing. If you like, save the schematic or graphical waveform display to the Windows Clipboard for use in a document. All phases of the circuit design process are simple and direct under Microsoft Windows.

Stick with the Leader in Desktop CAE...

Discover for yourself the ease with which your circuits can be generated, simulated, and analyzed with our **Design Center** system running under Microsoft Windows. For more information on the **Design Center** under Microsoft Windows, or to find out about the **Design Center** on our Sun OpenWindows platform, call MicroSim Corporation toll free at (800) 245-3022 or FAX at (714) 455-0554.



MicroSim Corporation

The Standard for Circuit Design
20 Fairbanks • Irvine, CA 92718

THE MAKERS OF PSpICE

POWER SPLITTERS/ COMBINERS

the world's largest selection
2KHz to 10GHz from \$2⁹⁵

With over 300 standard models, from 2-way to 48-way, 0°, 90° and 180°, 50- and 75-ohms, covering 2KHz to 10GHz, Mini-Circuits offers the world's largest selection of off-the-shelf power splitter/combiners. And, with rapid turnaround time, we'll also supply "special" needs, such as wider bandwidth, higher isolation, lower insertion loss and phase matched ports.

Available for use in military and commercial requirements, models include plug-in, flat-pack, surface-mount, connectorized standard and custom designs. New ultra-miniature surface mount units provide excellent solutions in cellular communications, GPS receivers, Satcom receivers, wireless communications, and cable systems.

All units come with a one-year guarantee and unprecedented "skinny" sigma unit-to-unit and production run-to-production run repeatability. All catalog models guaranteed to ship in one week. Mini-Circuits... dedicated to exceed our customers' expectations.

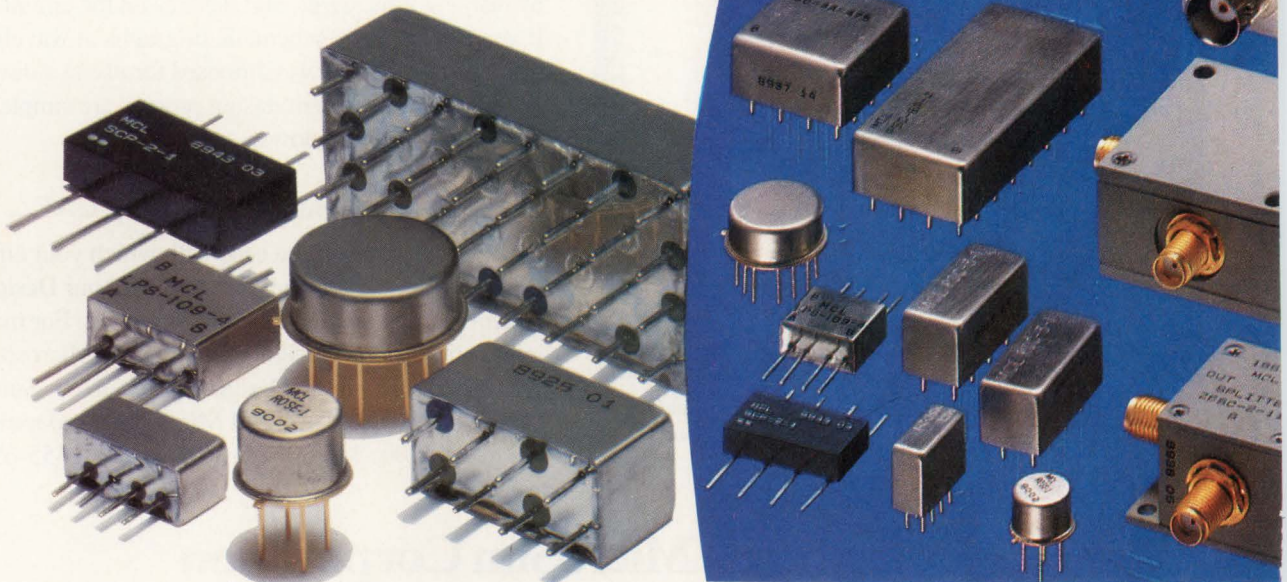

finding new ways ...
setting higher standards

 **Mini-Circuits**™

WE ACCEPT AMERICAN EXPRESS AND VISA

P.O. Box 350166, Brooklyn, New York 11235-0003 (718) 934-4500 Fax (718) 332-4661

Distribution Centers / NORTH AMERICA 800-654-7949 • 417-335-5935 Fax 417-335-5945 EUROPE 44-252-835094 Fax 44-252-837010

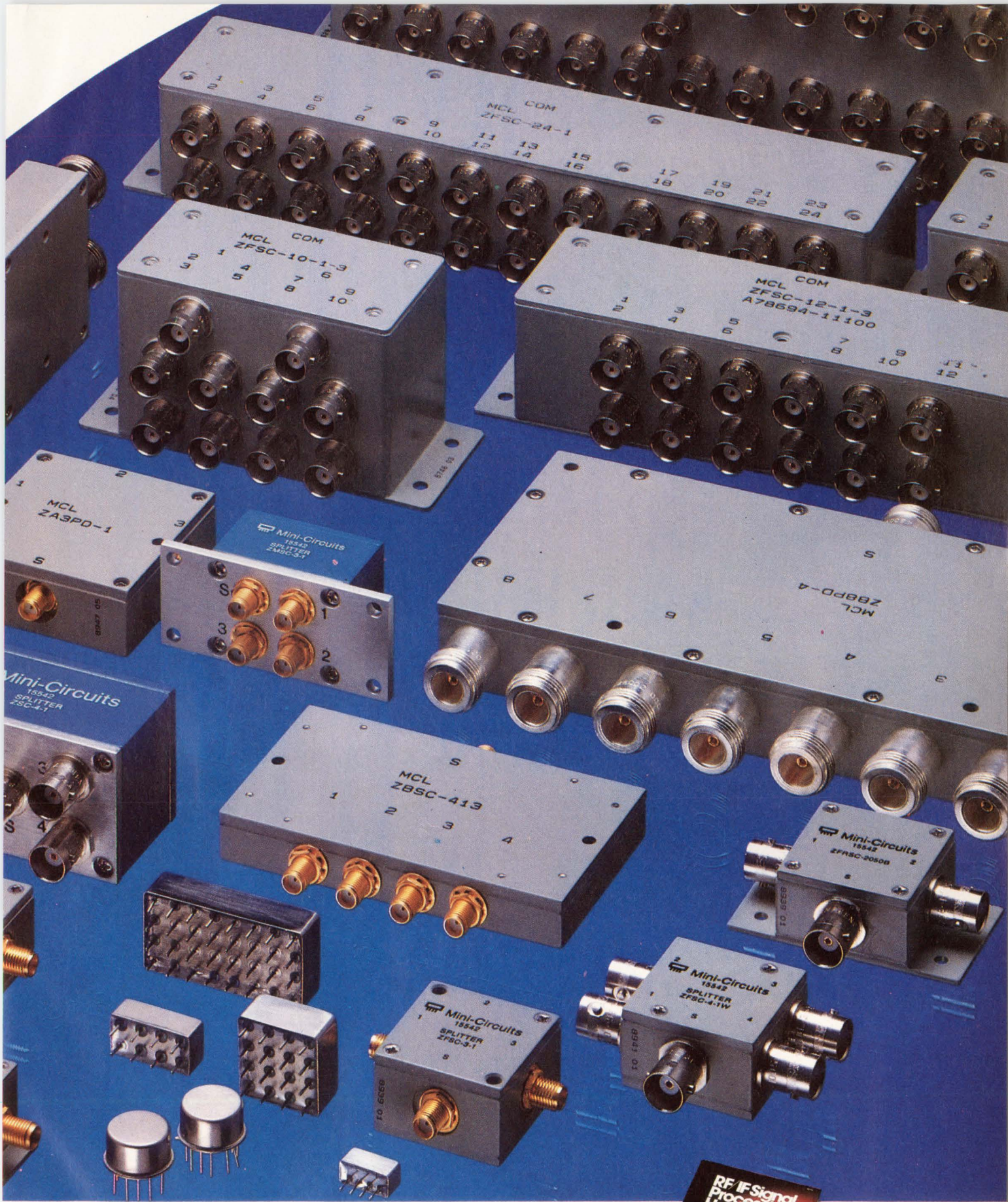

For detailed specs on all Mini-Circuits products refer to
 • THOMAS REGISTER Vol. 23 • MICROWAVES PRODUCT DIRECTORY
 • EEM • MINI-CIRCUITS' 740-pg HANDBOOK.

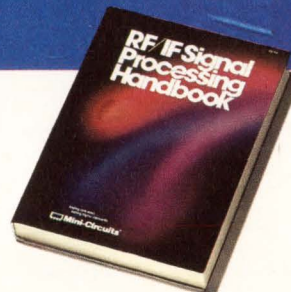

CIRCLE NO. 18

F134 REV. C

*Ours is also engineered
to terminate the competition.*

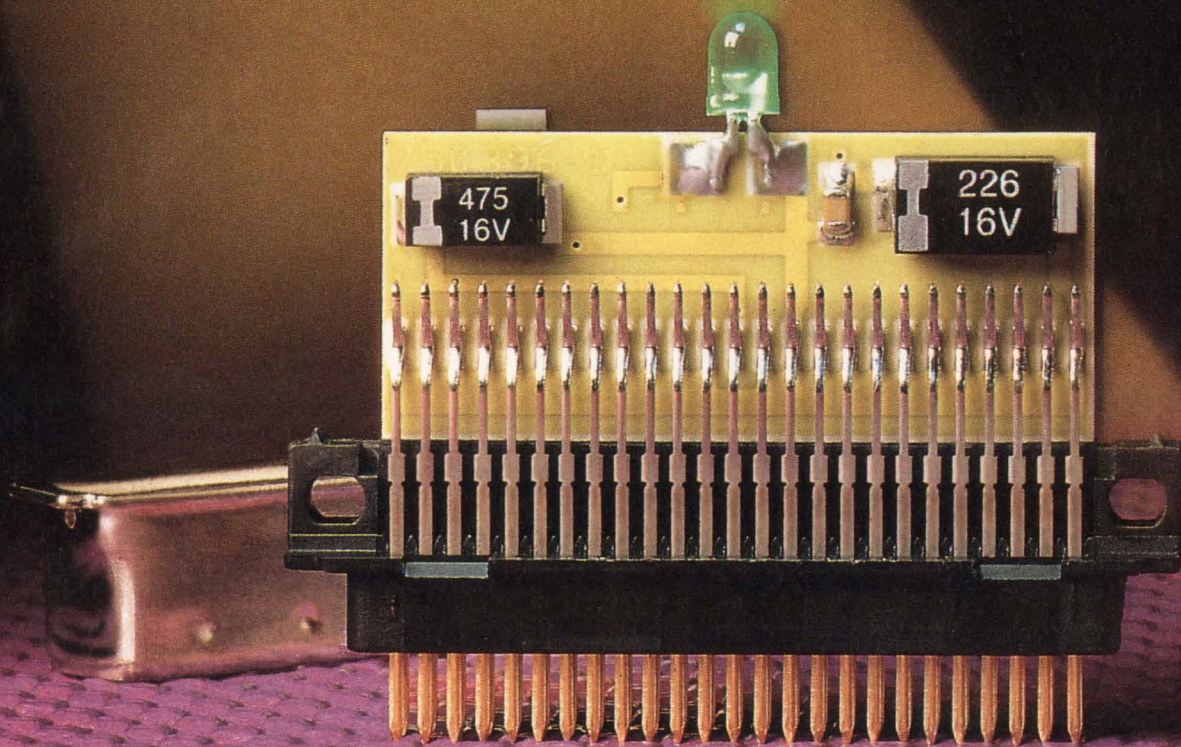

THIS IS AMP TODAY.



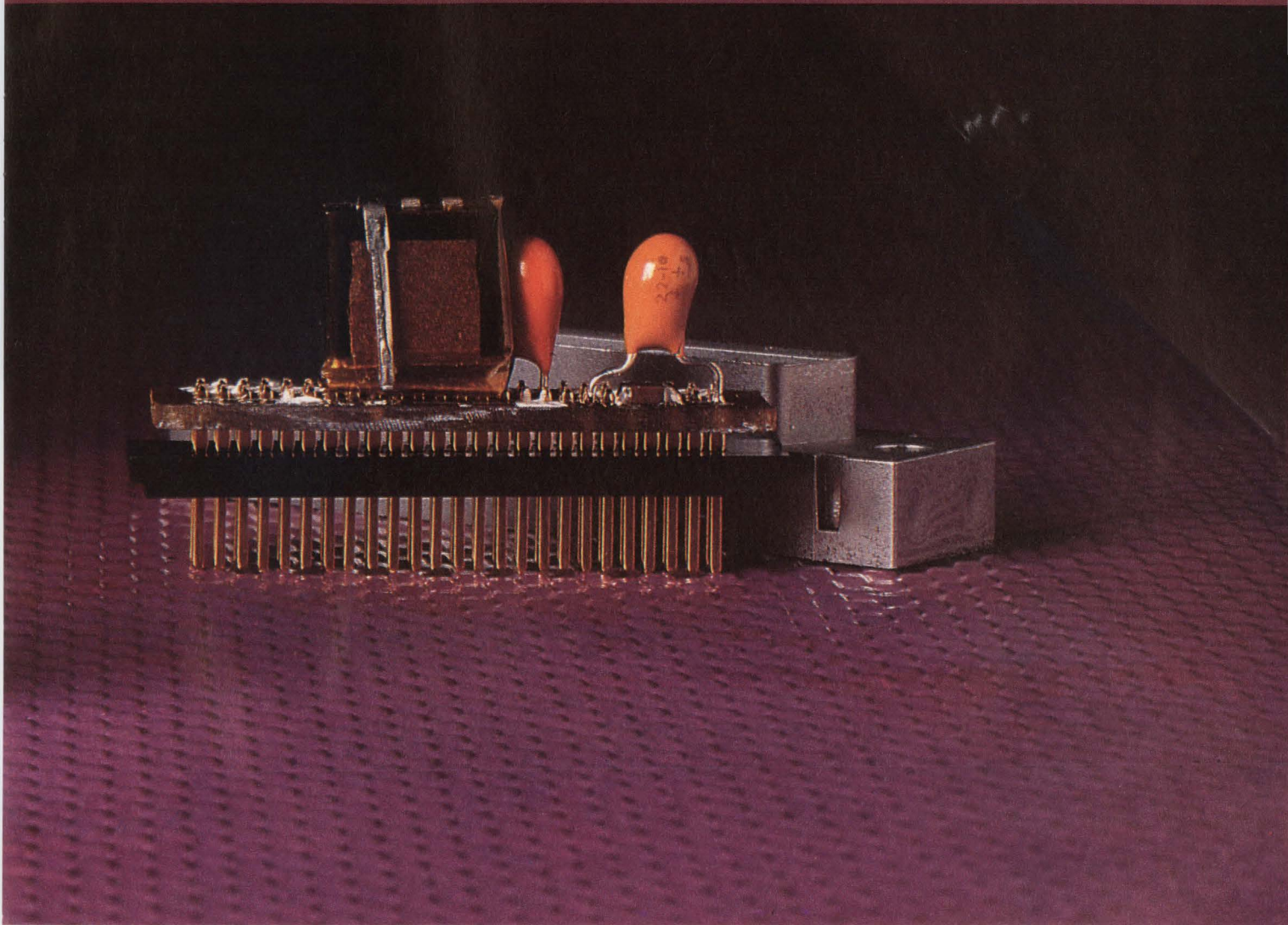

It isn't hard to see why our terminators are catching on with both manufacturers and installers of network systems. The engineering differences are obvious: ours are simply better.

Take the AMPLIMITE .050 Series Terminator, above left. All components are surface mounted (greater inherent reliability). We use a ceramic substrate (better heat dissipation), a front metal shell (more effective shielding), and a variety of shielded and unshielded backshells. Better engineering gives us a major performance advantage while keeping production simple—which is

why we're able to offer custom configurations, and optional LEDs. And why we can keep our prices very competitive.

We offer the styles and types you want, too. Choose from single-ended passive or active, differential, bus and tag, even the latest FPT (forced perfect termination) types. Standard versions conform to SCSI-1, SCSI-2, SCSI-3, IPI-1, and IPI-2.

We also have the engineering know-how to offer all the options and specials you need, including loopbacks and feed-throughs, shielding, post molding, and your choice of mounting hardware.

Naturally, you can't compare all those variations with what our competitors offer, but you can compare what matters. Do a one-on-one with your specific application, and see for yourself the difference in engineering. And who knows? That other terminator might become a collector's item.

For more information on AMP terminators and the name of your nearby AMP distributor, call our Product Information Center at 1-800-522-6752 (fax 717-986-7575). AMP Incorporated, Harrisburg, PA 17105-3608. In Canada, call 416-475-6222.

We've just tested the performance of our new i960 CF processor.

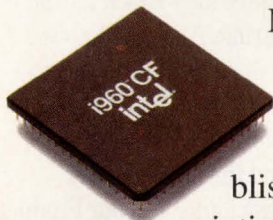

Make no mistake. This is no middle-of-the-road processor.

It's our new superscalar i960™ CF chip. And it delivers blistering speed to your high-end printing, imaging, communications and networking applications. Simply put, it outruns every 32-bit embedded processor on

the market—and we have over 25 benchmarks to prove it.

You see, only our i960 RISC architecture brings superscalar processing with multiple operations per clock to embedded applications. Our new i960 CF processor is highly integrated with optimized data and instruction caches for throughput up to

© 1992 Intel Corporation. i960 is a trademark of Intel Corporation.



twice that of our i960 CA chip. Which makes it the most advanced technology available for embedded applications.

If you're already using our i960 CA processor, you can quickly shift up to higher performance with full code and pin compatibility. And, of course, we offer a comprehensive array of Solutions960 development tools to

further speed up your design process.

So step on it. Call 800-548-4725 and ask for literature packet A9A51 for complete benchmarks. And learn what your applications can do with a faster engine.

intel[®]

The Race for Quality . . .

They say in the race for quality there's no finish line. But there are milestones, and we passed some long ago:

1985 PTS introduces a 2-year warranty, among the first in the industry.

1986 PTS introduces an 8 year flat rate \$350 service charge for any out-of-warranty repair (covers years 3 through 10 of ownership).

From all the recent press, you might think the concept of quality was invented in the last few years. Well, at PTS we've been building quality frequency synthesizers for well over a decade, and backing that up with our warranty and service plan. And with more than 30,000 years of instrument service in the field, we have a proven failure rate of less than 3% per year.

High Reliability Frequency Synthesizers

PTS manufactures a complete line of frequency synthesizers covering the 100 KHz to 1 GHz band with switching time as fast as $1\mu\text{s}$ for our Direct Digital (DDS) models. And plenty of other options as well, such as resolution down to 0.1 Hz, GPIB and digital phase rotation.

Whether it's ATE, SATCOM, EW or MRI/NMR imaging, PTS has a frequency synthesizer to fit your needs. PTS synthesizers carry one or more of these approvals:



Call (508) 486-3008 FAX (508) 486-4495

PTS

PROGRAMMED TEST SOURCES, INC.

9 Beaver Brook Road, P.O. Box 517, Littleton, MA 01460

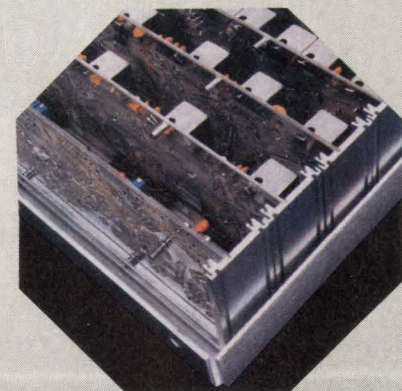
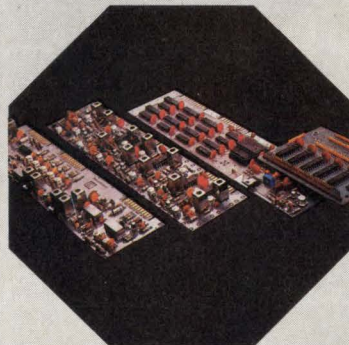
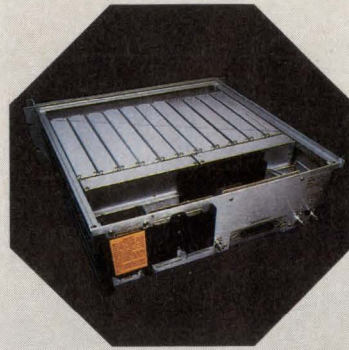

Distinguish between multi-tasking and task switching

In J D Mosley's article, "Multimedia" (EDN, March 16, 1992, pg 100), she did not distinguish between multitasking and task switching. A simple test for distinguishing them is to place a clock with a second hand on the screen and go to another task. If the clock stops, the operation is task switching. Many big company programs that claim to be multitasking fail this test.

Of course, a single-processor computer cannot really multitask because all it can do is switch from one task to another. But the present convention seems to be that the computer is multitasking if there is no noticeable delay in any task execution. And in the sense of multimedia, the second task must be a different media form from the first.

In the larger sense, a true multimedia, multitasking machine uses several different types of processors, each designed for a particular medium. Mosley chose to concentrate on attaining this by board and program additions. In the process, she ignored the computer, which handles multiple tasks and multiple media right out of the box. I refer, of course, to the Amiga, called by *Byte* "the most capable multimedia platform you can get in a single box." And this is true even for the bottom of the line, at prices below the median level of the boards she lists. The top of the line, expanded, will compete in performance with the top combination of the computer, board, and program she lists—and be much lower in price.

*R P Haviland, PE, Retired
Daytona Beach, FL*

Reader spots error in Hands-On FPGA Project

In Part 1 of the Hands-On FPGA Project (EDN, April 9, 1992, pg 101), I made an error where I stated that the ALS software automati-

cally combines 2-input gates with flip-flops and latches wherever possible. The software apparently makes the combinations for the Act 2 family, but not for the Act 1 family. You have to make the combinations in the schematic on Act 1 designs. I'd like to thank John Conners at Marquette Electronics, Milwaukee, WI, for bringing the error to my attention.

*Doug Conner
EDN Technical Editor*

Add it to your Mips list

In our Special Report, Third-generation RISC processors (EDN, March 30, 1992), we inadvertently omitted a vendor from the manufacturers list on pg 103. To the list of companies that produce the Mips R4000, add Toshiba America Electronic Components. The company is located at 9775 Toledo Way, Irvine, CA 92718; contact them by phone at (714) 455-2000.

Address correction

Following is the correct address and phone number for Northern Telecom Inc (EDN, March 2, 1992, pg 62):

Northern Telecom Inc
105 Laurentian Blvd
St Laurent, Quebec H4N 2M3,
Canada
(514) 744-8755
Contact: Demetri Elias.

WHAT'S COMING IN EDN

In the August 13 issue of EDN News Edition, look for an article on DSP ICs. In the Careers section of the tabloid you'll find an article on jobs in the video-conferencing area. EDN News Edition's Management Series continues with a story on how to motivate employees.

PICO DC-DC INDUSTRIAL CONVERTERS

**Economical
Wide Input Voltage
36-170V DC
Hi Reliability**

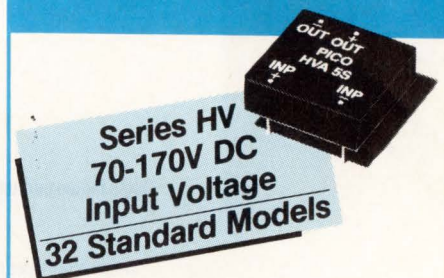

- Single and Dual Isolated Outputs
- Low Profile, .500" max. ht.
- Up to 15 Watts
- No External Components Required
- Fully Regulated
- Short Circuit Protection
- No Heat Sink or Electrical Derating Required
- -20°C to +70°C Operating Temp. Ambient

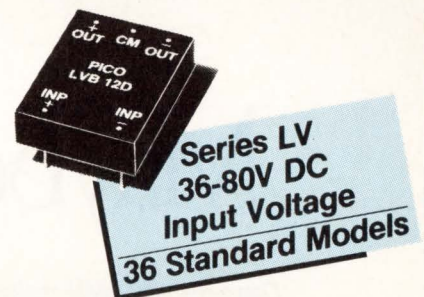

Delivery—
stock to one week

See EEM
or send direct for
FREE PICO Catalog

PICO
Electronics, Inc.

453 N. MacQuesten Pkwy. Mt. Vernon, N.Y. 10552
Call Toll Free **800-431-1064**
IN NEW YORK CALL **914-699-5514**
FAX **914-699-5565**

CIRCLE NO. 23



PHILIPS



All ranges and functions specified

Closed-case software calibration

User-selectable reading rates

M is actually a 5½ digit DMM.

interfere with your measurements? Will input impedance load your circuits? Not with a Fluke 8842A. It beats HP's 34401 hands down.

If isolation is an issue — say you're making null measurements — Fluke's 8842A provides the 1000V dc you need, unlike HP's 34401 which has just 500V dc.

Since their introduction, the 8842A and its companion the 8840A have become the most popular bench

DMMs in the business because they deliver what you're looking for: accuracy, stability and ease of use. Simple as that.

So if you're looking for a tough, dependable tool, look beyond the data sheets and the footnotes.

You'll choose the Fluke 8842A. For more information, contact your local Fluke representative. Or give us a call toll-free at 1-800-44-FLUKE (1-800-443-5853).

John Fluke Mfg., Inc., P.O. Box 9090, M/S 250E, Everett, WA 98206-9090. U.S. (206) 356-5400. Canada (416) 890-7600. Other countries: (206) 356-5500. ©1992 John Fluke Mfg. Co., Inc. All rights reserved. Ad no. 00212. HP® is a registered trademark of Hewlett-Packard Co. Information subject to change without notice.

CIRCLE NO. 24

FLUKE®

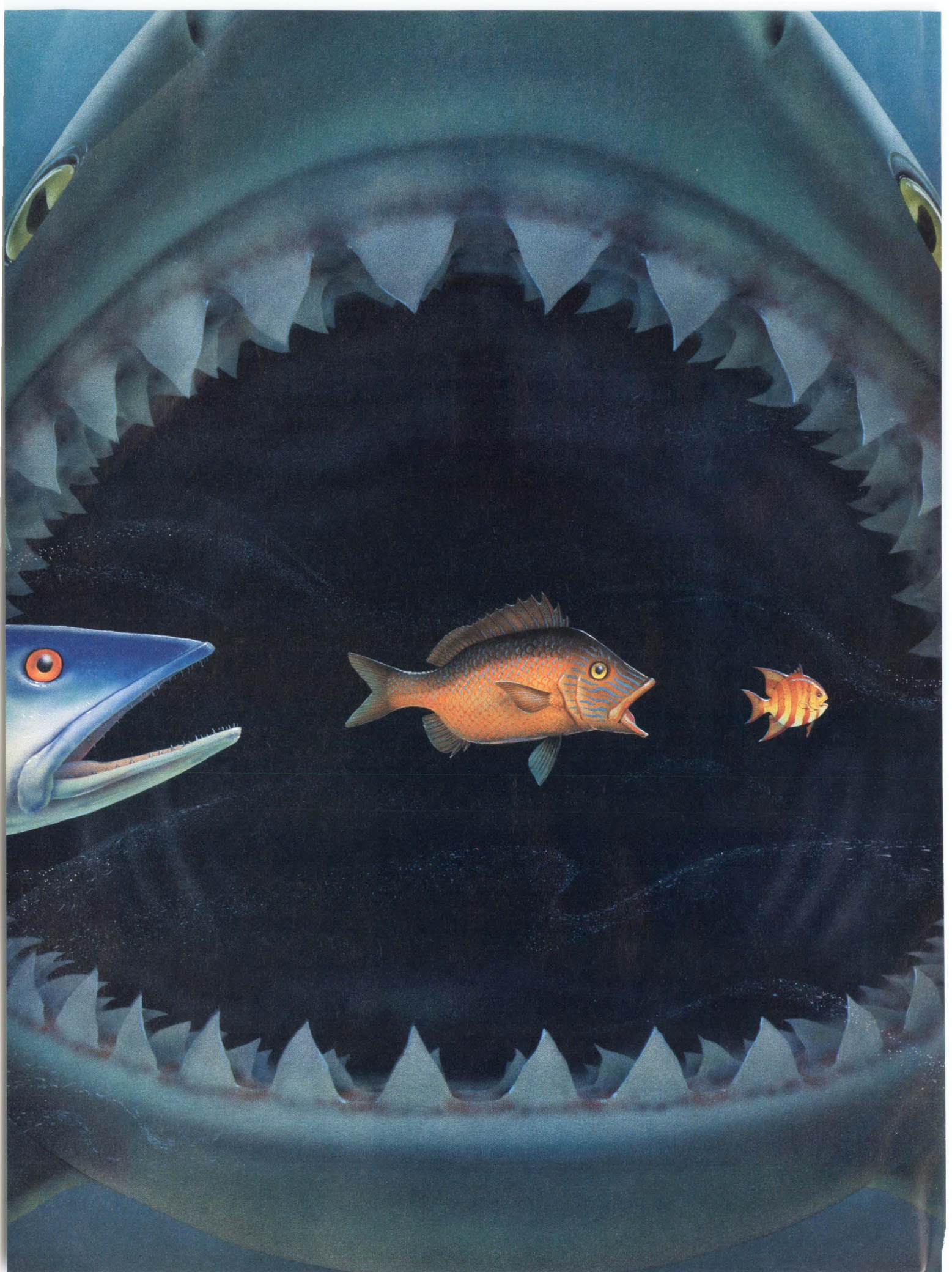

The Max It drives a h

Go ahead, search all you want. But we don't think you'll find a lower cost or higher quality 200 MB class disk drive than our new 7213.

The reason is simple. We made it with very few parts. Far fewer than any other drive in its class. So it's not only easier to

manufacture, it assures exceptional reliability. And that's critical.

Because it's that level of reliability that keeps your customers sold.

Now you might be thinking, "How could Maxtor possibly produce a quality 200 MB drive at such a low cost?" Well, after produc-



tor 7213. ard bargain.

ing more than 3 million 7000 series drives, you get real good at it.

The 7213 is just one more example of the New Drive at Maxtor. A very serious commitment to customer satisfaction. Unmatched service and support. And visionary product design.

For more information, please call 1-800-4-MAXTOR. Quite frankly, you won't find a better bargain than this.

Maxtor[®]

There's a new drive at Maxtor.

Maxtor Corporation, 211 River Oaks Parkway, San Jose, CA 95134

CIRCLE NO. 25

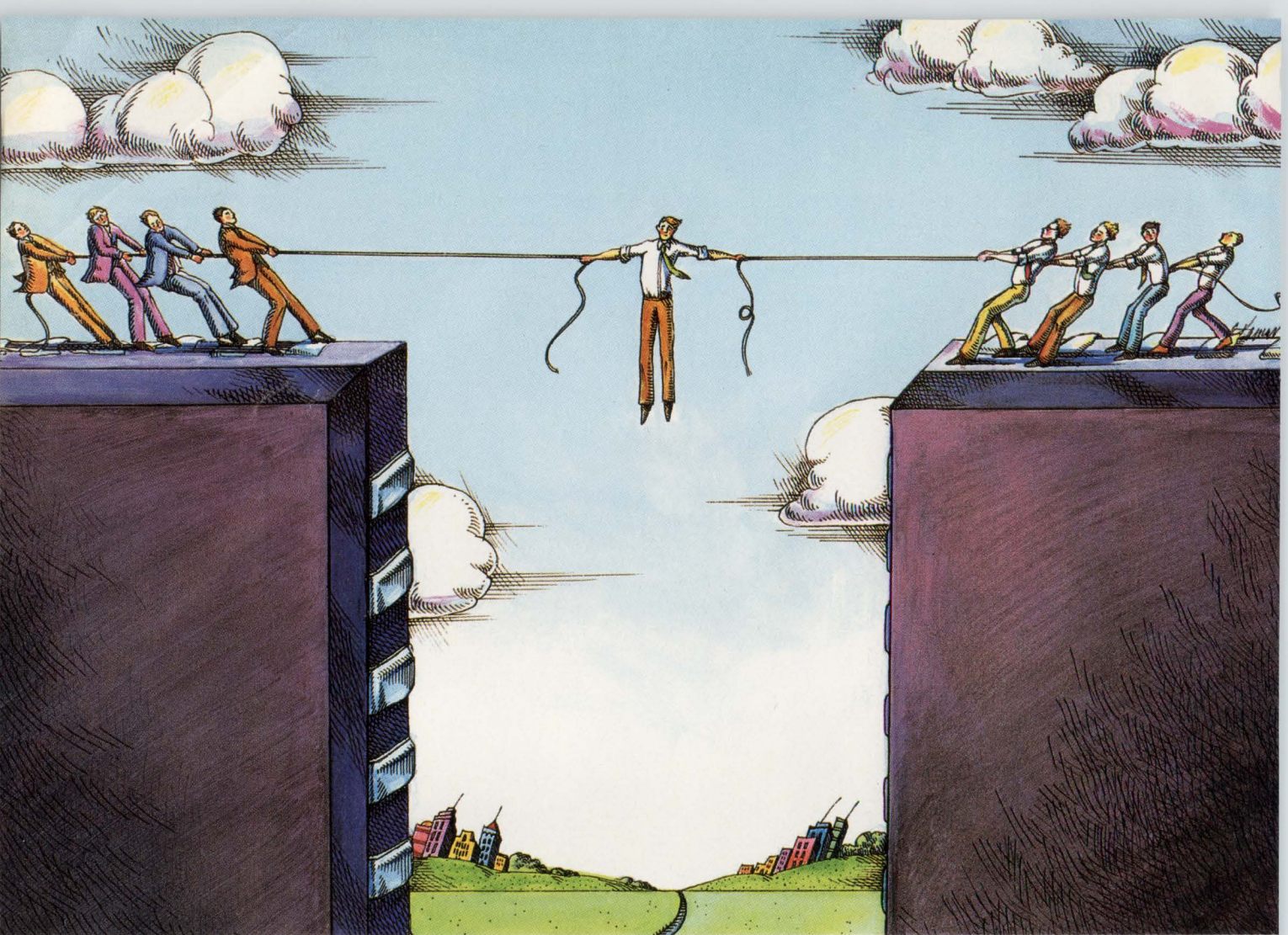

TI's 7.5-ns '22V10. For those times you're torn between profit and performance.

Trying to get the best performance on a tight budget can create a few hang-ups. Texas Instruments has a simple solution. Introducing the TIBPAL22V10-7. TI's newest high-performance programmable logic device that's designed to fit the bottom line as easily as it meets your design specs.

High performance, low price
While competitive pricing is one of our '22V10's most outstanding features (less than \$17 when you purchase 5,000 or more), you'll be even more impressed by its performance.

At an incredibly fast 7.5 ns, our '22V10 supports system speeds up to 50 MHz with a variable term distribution that gives you more design freedom with complex functions. It's an excellent choice for high-end systems

using the latest microprocessors. And since all this is achieved using our proven bipolar process, the '22V10 provides a universal architecture that's easy to work with using familiar design tools.

Accurate, dependable and available today

Speed and ease of use mean nothing if difficult programming keeps your product from getting to market on time. That's why our '22V10 is designed for quick, dependable programming with your present tools. In fact, we're running at a 99.4% first-time programming success rate.

Best of all, our 7.5-ns '22V10 is available in volume *today* with just-in-time and ship-to-stock delivery programs tailored to meet your needs. You'll also have the backing of our

global support network to help keep things running smoothly.

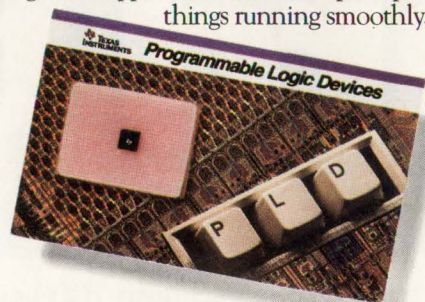

Hang in there —
a free sample is on the way
Simply return the attached reply card or call 214-995-6611, ext. 3717, for one free TIBPAL22V10-7.

 **TEXAS
INSTRUMENTS**

Science by mail



I remember as a teenager the excitement of getting a package of electronic parts from Lafayette Radio, or a new kit to assemble from Heathkit. It seemed that there was always something interesting in the mail. Today, young people can also participate in "science by mail" through a program sponsored by the Museum of Science in Boston. The program also lets many of us who are young at heart and mind enjoy science and creative thinking right along with the kids. The science program provides a way to help youngsters get interested in science and keep them interested. It can be a lot of fun—and a challenge—for adults, too.

The museum's Science-by-Mail program is an international program meant for young people between about 9 and 14 years of age. Last year, about 24,000 children took part. Three times during the year, the kids in the program receive a science-experiment package by mail. Past packages include one on communications and another on ecology and natural resources. Not only can the kids do science experiments with the simple materials and apparatus that come in each kit, but the kits ask them to think about solving problems. For example, how would you dispose of trash accumulated during a trip to Mars? Or, how would you invent a time-keeping device?

The kids' projects, experiments, and solutions are only part of the program, which encourages participation by parents and teachers. Most of the experimenting takes place during science classes and under teacher supervision. The kids can experiment on their own, too. In addition, a very important part of the program involves scientists and engineers who act as pen-pal mentors for the kids. Typically, four young people work as a team on each experiment

kit. During and after their work, they correspond with their mentor, who critiques their work, offers suggestions, and may stimulate more experiments and problem solving.

So, how do you get involved? First, you can sponsor a Science-by-Mail team. If you know three or four young people who would like to try the science kits as a team, sponsoring a group costs \$44 for a year. The fee includes a scientist or engineer pen pal. If your company would like to get involved further, consider sponsoring an entire science class. Most important of all, seriously consider being one of the scientist or engineer pen pals. Working with the kids can be an enjoyable—and challenging—experience. It requires a commitment to communicate with as many as five teams of kids for each of the three annual science kits. You can get as involved as you want, even communicating as the projects unfold and continuing your correspondence after the kids finish their formal work. There are 2500 volunteer mentors in the program today.

Many museums throughout the USA have Science-by-Mail chapters, and there are international chapters as well. For information about a chapter nearby, or for more information about becoming a mentor, write to Science-by-Mail, Museum of Science, Science Park, Boston, MA 02114. Phone numbers are (617) 589-0437, or (800) 729-3300; fax requests to (617) 589-0454. The entire program is nonprofit and is underwritten by individuals, corporations, and the National Science Foundation.

When you sign up as a mentor, drop me a note and let me know what your experiences are like. I'll put together some of the brief reports and tell the rest of the readers about the fun and excitement they're missing.



Jesse H. Neal
Editorial Achievement Awards
1990 Certificate, Best Editorial
1990 Certificate, Best Series
1987, 1981 (2), 1978 (2),
1977, 1976, 1975

American Society of
Business Press Editors Award
1991, 1990, 1988, 1983, 1981

Jon Titus
Jon Titus
Editor

Send me your comments via fax at (617) 558-4470, or on the EDN Bulletin Board System at (617) 558-4241 300/1200/2400, 8,N,1; on 9600-bps modems, try (617) 558-4580, 4582, or 4398.



TO BREAK SPEED RECORDS, TURN TO THE SRAM LEADER.

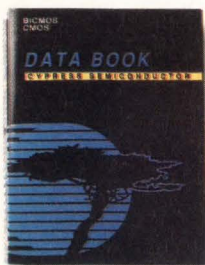

To break performance records, you need extraordinarily fast SRAM solutions. According to In-Stat, Inc., no U.S. company sells more SRAM parts worldwide than Cypress. Period.

If you need high-performance SRAMs, this broad range of fast memories is at your service. CMOS or BiCMOS, TTL or ECL, from 64-bit to multi-megabit, multichip modules, from standard SRAM pinouts to specialty dual-ports, FIFOs, or Cache SRAMs, we've got your high-speed SRAM solution. Our Data Book will show you. It's a hit. And it's free.

FREE 1992 DATA BOOK HOTLINE: 1-800-852-1810*
Ask for dept C45.

*In Europe, fax your request to the above dept. at 1 (415) 961-4201 or call (32) 2-652-0270. In Asia, fax to the above dept. at 1 (415) 961-4201. © 1992 Cypress Semiconductor, 3901 North First Street, San Jose, CA 95134. Phone 1 (408) 943-2600. Telex: 821032 CYPRESS SNJ UD, TWX: 910-997-0753. Statistic from In-Stat, Incorporated's 1991 Worldwide Merchant Market Dollar Shipments data.



ADC ARCHITECTURES

Speed-resolution tradeoff key to choosing ADCs

DAVE PRYCE, Contributing Editor



The diverse applications for A/D converters demand that you understand the basic differences in the available architectures.

Many factors influence the choice of an A/D converter for a given application, and among the most important are resolution and speed. To a great extent, the converter's architecture determines the values for these two key parameters and, to a lesser extent, influences other critical parameters. In selecting an A/D converter, designers need to understand the advantages and disadvantages of the various converter types and the tradeoffs associated with their respective architectures. Converter types include successive approximation, flash, subranging, integrating, and sigma-delta.

Regardless of the type of converter you select, the speed and resolution parameters often tend to conflict. For example, flash converters offer blazing speeds—as fast as 500 Msamples/sec at the extreme limit—but their resolution is limited to a maximum of 8 to 10 bits. Conversely, sigma-delta converters have a maximum-speed limitation of about 100 ksamples/sec but their typical resolution is 16 to 18 bits. Satisfying a wide range of applications, successive-approximation converters exhibit speeds from 10 ksamples/sec to about 1 Msample/sec and resolutions from 8 to 18 bits. However, the resolution is limited to about 12 bits at the higher speeds.

As the successive-approximation example implies, the speed-resolution tradeoff tends to exist even among converters of

the same type. Although a converter's architecture determines its overall speed and resolution limits, you can't usually obtain both the highest possible speed and the highest possible resolution with the same device.

For example, constructing a flash converter having a speed of 300 Msamples/sec and a resolution of 12 bits may be theoretically possible, but the overwhelming burden of the required 4095 comparators makes such a converter a practical impossibility either in monolithic or hybrid form. Flash converters having 12-bit resolution do not exist, and you're not likely to ever see one. To more completely understand the speed-resolution conundrum and the advantages and disadvantages of each type of converter, it is instructive to look at

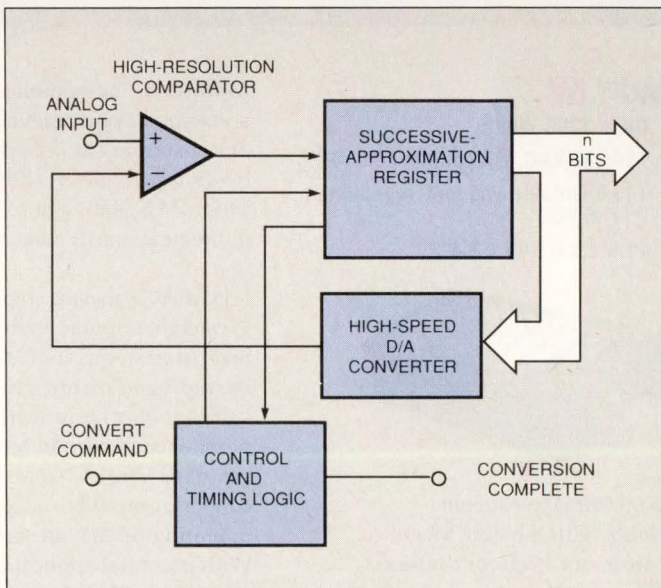
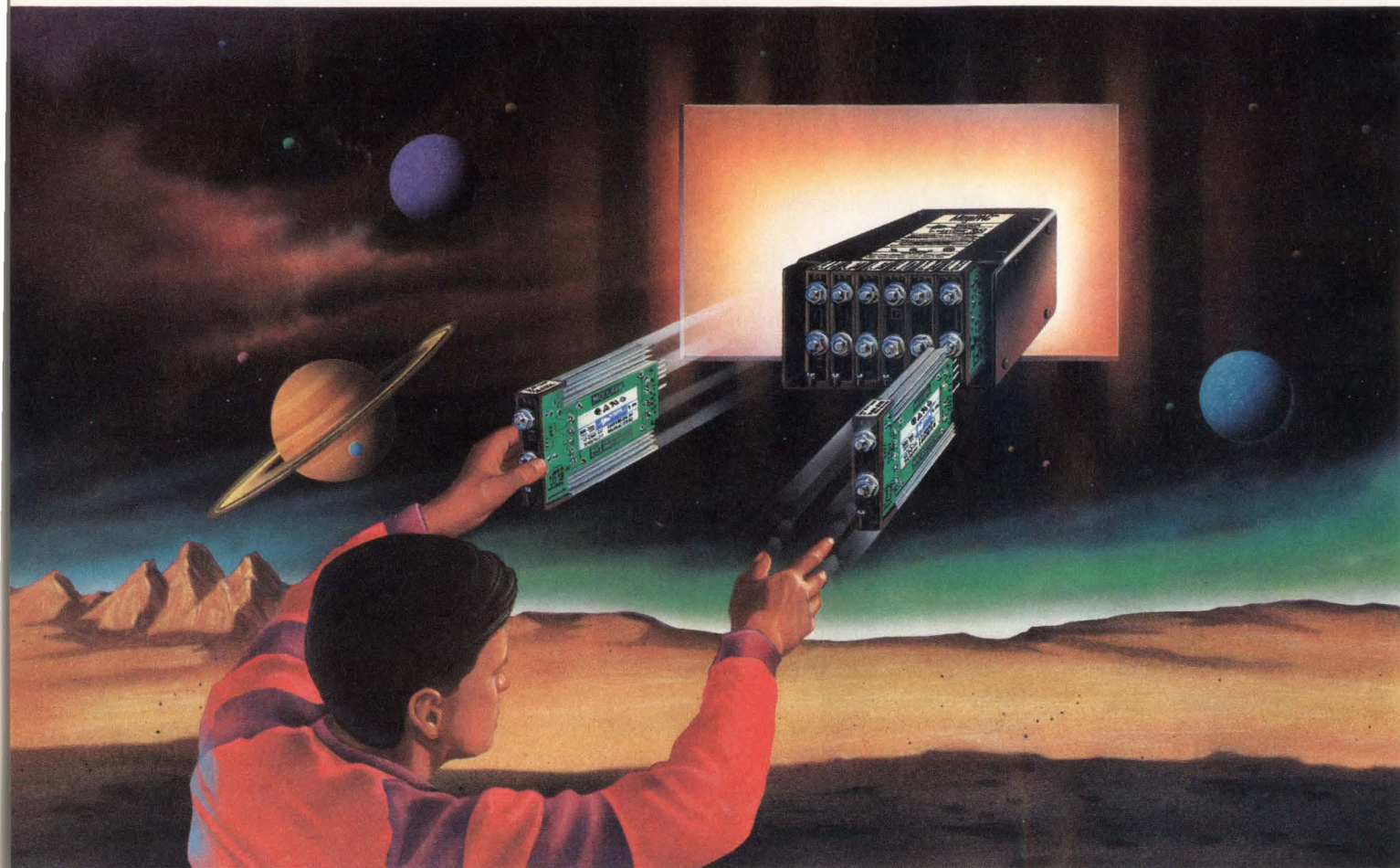

Fig 1—A successive-approximation converter compares an analog input with the output of an n-bit DAC in a series of successive approximations. At the end of the conversion, the contents of the register output a binary word. This type of converter has a speed-resolution limit of about 1 Msample/sec and 12 bits.

POWER To Configure



MegaPAC™

Power: Up to 1200 Watts

Input: 110/220 VAC, strappable; 300 VDC

Outputs: 1 to 8 isolated and fully regulated,
2 to 95 VDC

Size: 11.8"L x 6.0"W x 3.4"H



Plug into *instant power supply configurability* with the new MegaPAC switcher from our Westcor division. MegaPAC outputs can be configured in virtually an infinite number of voltage and power combinations using up to 8 slide-in

ModuPAC™ assemblies. Want to change a voltage or power level at your factory or at a customer site? No problem. . . shut down input power, slide out the ModuPAC you want to replace and slide in the new one. It's that simple.

MegaPAC's instant configurability takes Westcor's popular StakPAC to the next level of customization and flexibility. And its improved manufacturability means a substantial price reduction too! At the heart of each plug-in ModuPAC is a standard Vicor VI-26X series DC-DC converter module. . . over 1 million are operating reliably in systems world-wide. With potential applications around the globe, MegaPAC is designed to meet stringent UL, CSA, and IEC safety standards (approvals in process).

So take the risk out of specifying your system power supply. Contact us today and request ordering information. . . then sit back and relax. . . your custom-tailored MegaPAC will be delivered within four weeks.

Call VICOR EXPRESS (800) 735-6200 for information and be sure to ask for a MegaPAC data sheet. Or call WESTCOR (division of Vicor) at (408) 395-7050. Fax us at (508) 475-6715 or (408) 395-1518.



VICOR Corporation
23 Frontage Road, Andover, MA 01810

Component Solutions For Your Power System

CIRCLE NO. 28

ADC ARCHITECTURES

the basic characteristics of the individual architectures.

By far the most universally popular converter is the successive-approximation type, which can satisfy a wide range of applications. Used in everything from modems to missiles, this type of converter owes its popularity to its ability to combine relatively high resolution and speed with low cost.

As Fig 1 shows, the successive-approximation converter uses a comparator, a successive-approximation register, a reference DAC, and control and timing logic to perform n single-bit conversions. The ADC compares the analog input with the output of an n -bit DAC in a series of successive approximations. The approximations start with the most significant bit (MSB) and continue through the least significant bit (LSB) until the output of the DAC is within 0.5 LSB of the input and all bits are latched into the corresponding states. At the end of the conversion, the contents of the register form an n -bit binary word corresponding to the magnitude of the input signal.

During the conversion, each of the bit decisions takes a clock period. As a result, the allowable clock frequency and the number of bits determine the maximum conversion time of a successive-approximation converter. The maximum clock frequency is limited by the DAC settling time, the successive-approximation register's setup time, and the clock-to-data output delay. Depending on the nature of the analog input signal, the converter sometimes needs a sample-and-hold (S/H) or track-and-hold (T/H) circuit. The determining factor is whether the input signal is stable during the conversion period. Many of the newer successive-approximation converters include an on-chip T/H circuit.

The successive-approximation converter has a speed-resolution

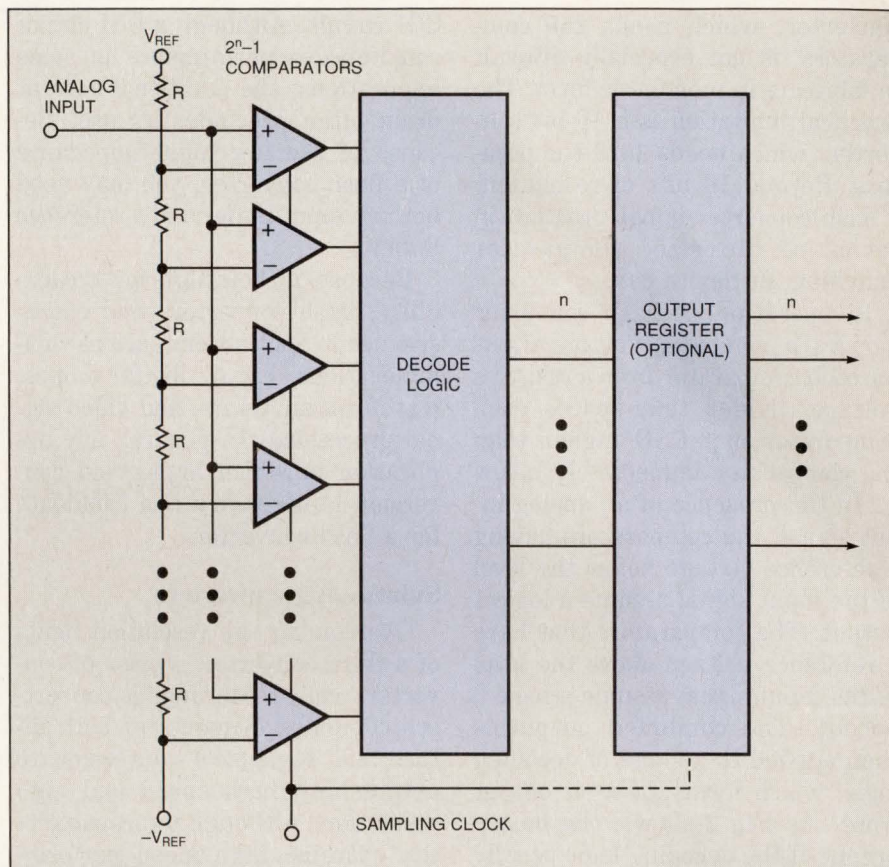

Fig 2—A flash converter processes all bits at essentially the same time rather than through a series of individual steps. Sampling rates of 75 to 100 Msamples/sec are common, and some converters can go as high as 500 Msamples/sec. The main disadvantage of the flash converter is its 10-bit resolution limit, which is due to the large numbers of comparators needed.

limit of approximately 1 Msample/sec and 12 bits. Resolutions of 16 bits and higher are possible at slower speeds. The architectural simplicity of the converter makes manufacturing the device in monolithic form easy. Thus, successive-approximation converters are lower in cost than similarly performing hybrid versions as well as most other monolithic converters that have a different architecture. Many industry-standard types having a wide range of speed and resolution combinations are available from several manufacturers.

Flash converters

The successive-approximation converter uses sequential conversion; a flash converter provides di-

rect conversion. That is, it processes all bits at essentially the same time rather than through a series of individual steps. The parallel nature of the conversion cycle makes the flash converter capable of very high speeds. The speed range extends from about 1 Msample/sec to as high as 500 Msamples/sec for some devices. Sampling rates of 75 to 100 Msamples/sec are common. The main disadvantage of the flash converter is its 10-bit resolution limit.

This limitation is inherent in the flash converter's architecture (Fig 2). The flash converter needs $2^n - 1$ comparators, where n is the number of bits. A 4-bit flash converter, which needs only 15 comparators, is easy to construct. Even an 8-bit

ADC ARCHITECTURES

converter, which needs 255 comparators, is not especially difficult to fabricate in monolithic form. The practical limitation is a 10-bit converter, which needs 1023 comparators. Beyond 10 bits of resolution, a flash converter is not practical in terms of die size, comparator matching, or device cost.

In operation, a flash converter derives a reference-voltage input for each comparator from a resistive voltage divider that spaces each comparator one LSB higher than the comparator immediately below it. In the presence of an analog input signal, the comparators having a reference voltage below the level of the input signal assume a logic 1 output. The comparators that have a reference voltage above the level of the input signal assume a logic 0 output. The combined output is then applied to a stage of decoding logic, which forms an n -bit output word. As Fig 2 shows, the binary output of the decoding logic usually drives an on-chip output register, or latch.

Flash converters are sampling devices and do not usually need a

S/H circuit. Although a S/H circuit can improve performance in some applications, the additional current drain often precludes its use. Because of the low input impedance of a flash converter, you may need both an input buffer and a reference buffer.

Because of their high-speed capability, flash converters find extensive use in applications such as communications, radar, digital scopes, waveform analyzers, and video signal processing. In general, any application in which high-speed conversion is necessary is a candidate for a flash converter.

Subranging converters

Overcoming the resolution limits of a flash converter, a class of converters called subranging converters combines elements of both direct and sequential conversion to obtain both high speed and high resolution. Although not capable of the extreme high-speed performance of a flash converter or the absolute resolution limits of other types of converters, the subranging converter offers an excellent com-

promise. The converters offer resolutions as high as 16 bits and speeds as fast as 40 Msamples/sec. In general, subranging converters provide remarkable speed-resolution characteristics, particularly at higher speeds.

Subranging converters typically use two or more steps of flash conversion but have an architecture that has a singular advantage over flash converters—a great reduction in the number of comparators. In the simplified 8-bit example of Fig 3, the two 4-bit flash converters need only 30 to 32 comparators. By contrast, a single 8-bit flash converter would need 255 comparators. The reduced number of comparators a subranging converter needs greatly reduces chip size and power consumption. Although the 8-bit flash converter and the 8-bit subranging converter have the same resolution, to equal the overall speed of a single 8-bit flash converter, the two 4-bit converters in the subranging converter must be twice as fast.

In Fig 3's 2-step subranging circuit, the first flash converter digitizes the first four bits and applies the binary output to the 4-bit DAC. The summing amplifier then subtracts the DAC's analog output from the held analog input; amplifies the resulting signal, or residue; and applies it to the second 4-bit flash converter. The subranging converter then combines the outputs of the two 4-bit flash converters into a single 8-bit binary word. If the amplified residue signal doesn't fill the range of the second flash converter, the converter can exhibit nonlinearities and missing codes.

Most subranging converters are more complex than this basic example and include digital error-correction logic to minimize nonlinearities and the possibility of missing codes. The error-correction logic, which is usually just an adder circuit, works

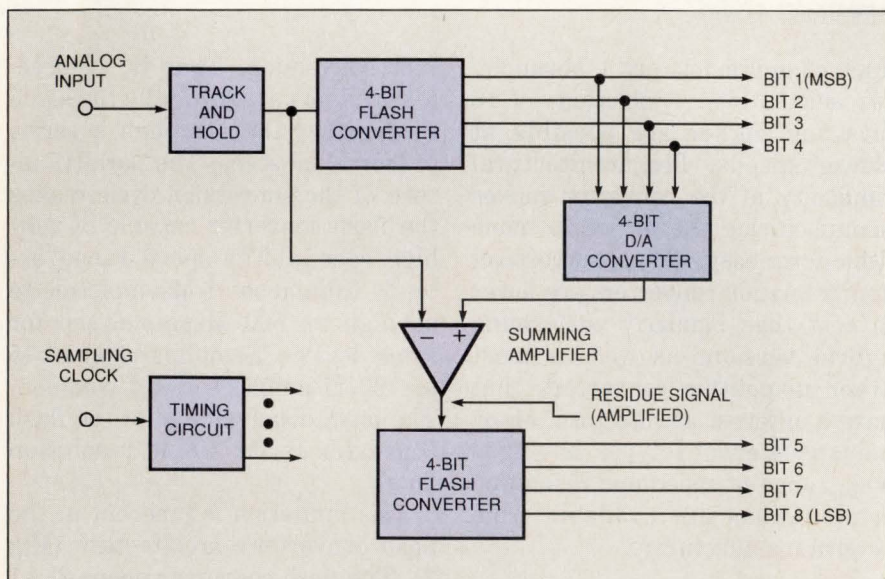
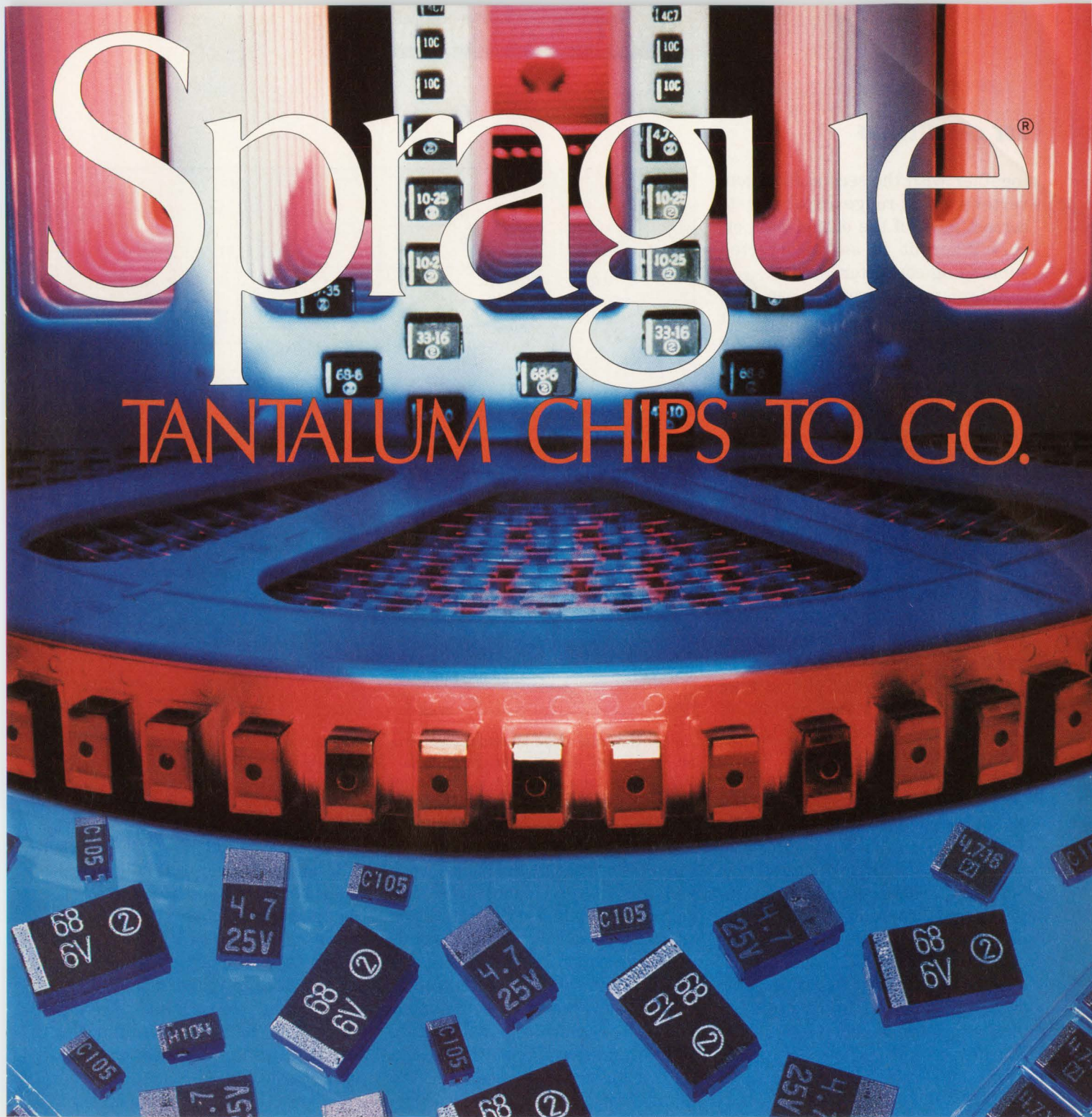

Fig 3—In this simplified example of an 8-bit subranging converter, the two 4-bit flash converters need only 30 to 32 comparators. By contrast, a single 8-bit flash converter would need 255 comparators. Subranging converters permit resolutions as high as 16 bits and speeds as fast as 40 Msamples/sec.



Sprague® delivers tantalum chips off-the-shelf.

Need tantalum chip capacitors in a hurry? Need ten thousand? Or hundreds of thousands? Sprague® can deliver Type 293D TANTAMOUNT® tantalum chip capacitors factory direct or from our Industrial Distributors. Featuring rugged, fully molded construction, they conform to EIA 535BAAC. Depending on size, they are supplied taped on 8mm or 12mm reels per EIA 481 for automatic

placement. Available in four package sizes covering 4 to 50 WVDC ratings. Capacitance values: 0.10 to 150 μ F. When it comes to machine-friendly tantalum chips, we're ready NOW!

For technical information contact Sprague®, 678 Lower Main Street, Sanford, ME 04073. Phone (207) 324-4140. FAX (207) 324-7223. For literature call (402) 563-6363.



ADC ARCHITECTURES

together with the second flash converter's extra-range capability to correct most of the output-data errors inherent in an uncorrected subranging converter.

Subranging converters can take several forms, including those that use more than two flash converters and those that use only one flash converter. In the latter type, which is called a recursive subranging converter, a single flash converter makes multiple passes until the device obtains the desired resolution. The final result appears at the digital output. To some extent, the multiple passes made by a recursive subranging converter resemble the action of the successive-approximation converter.

All subranging converters require a S/H circuit—some types use several. The accuracy of this type of converter is limited by that of the internal DAC or DACs. Subranging converters are available that have resolutions of 8 to 16 bits and speed ratings of 100 ksamples/sec to 40 Msamples/sec. Although not as fast as a true flash converter, subranging converters offer an effective compromise in applications that require high-speed operation at resolutions greater than 8 or 10 bits. With the addition of image capturing, applications for subranging converters are generally the same as those for a flash converter.

Integrating converters

The converters discussed thus far can all digitize analog inputs at speeds of at least 10 ksamples/sec, typically at much faster rates. In stark contrast with these relative speed demons, the typical 10-sample/sec integrating converter is as slow as the proverbial turtle. Useful for precisely measuring slowly varying signals, the integrating converter finds application in digital voltmeters and processing the output of some transducers. The two

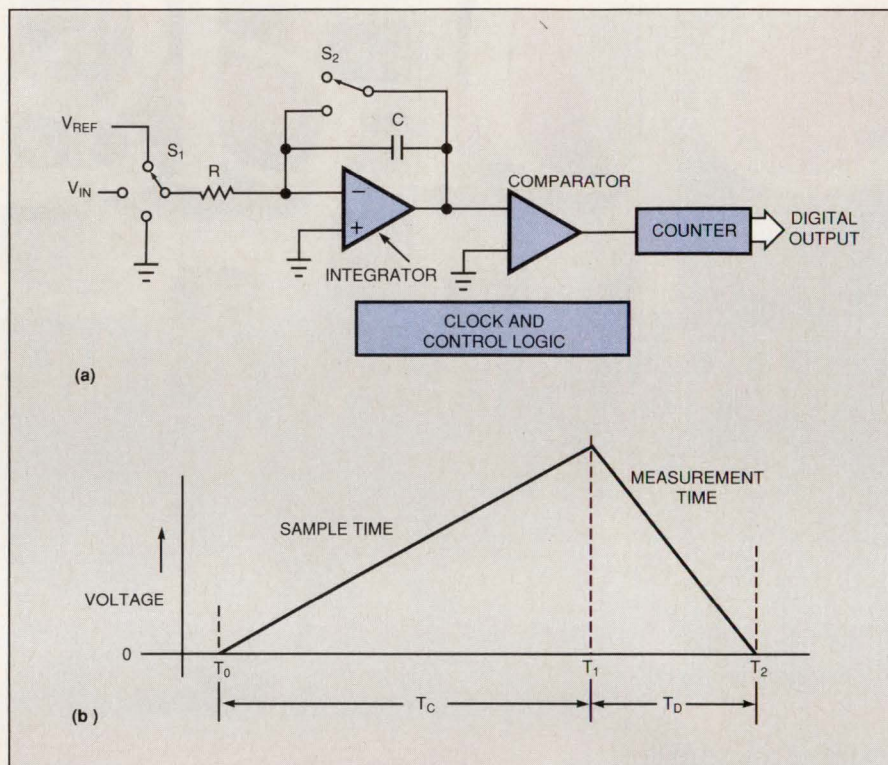

Fig 4—This dual-slope integrating converter (a) contains an analog integrator, a comparator, a counter, a clock, and control logic. The converter's characteristic charge-discharge (T_C/T_D) waveform is shown in (b). As the name implies, the output of an integrating converter represents the average value of an input voltage over a fixed time period.

common variations of the integrating converter are the dual-slope type and the charge-balance type. Designers typically use the latter type as a voltage-to-frequency converter.

As the name implies, the output of an integrating converter represents the average value of an input voltage over a fixed period of time. This integration eliminates the need for a S/H circuit to "capture" the input signal during the measurement period. The dual-slope converter contains an analog integrator, a comparator, a counter, a clock, and control logic (Fig 4a). Fig 4b shows the circuit's characteristic charge/discharge (T_C/T_D) waveform.

To hold the integrator in the discharged state, switch S₁ initially connects resistor R to ground, and S₂ shorts out capacitor C. To start the conversion, S₁ connects R to the unknown input voltage, and S₂

opens to let C charge. The clock and the counter control the integration time. At the end of the integration period, S₁ connects a known reference voltage to R, and the capacitor discharges until the comparator detects that the integrator has reached the original starting point. The counter measures the amount of time the capacitor takes to discharge.

Because the values of the resistor and integrating capacitor and the frequency of the clock remain the same for both the charge and discharge cycles, the ratio of the charge time to the discharge time is equal to the ratio of the reference voltage to the unknown input voltage. The absolute values of R, C, and the clock frequency do not affect the conversion accuracy. Moreover, any noise on the input signal is integrated over the entire sampling period, which imparts a high

Introducing the only linears approved to meet IEC 950 and Level B EMI.

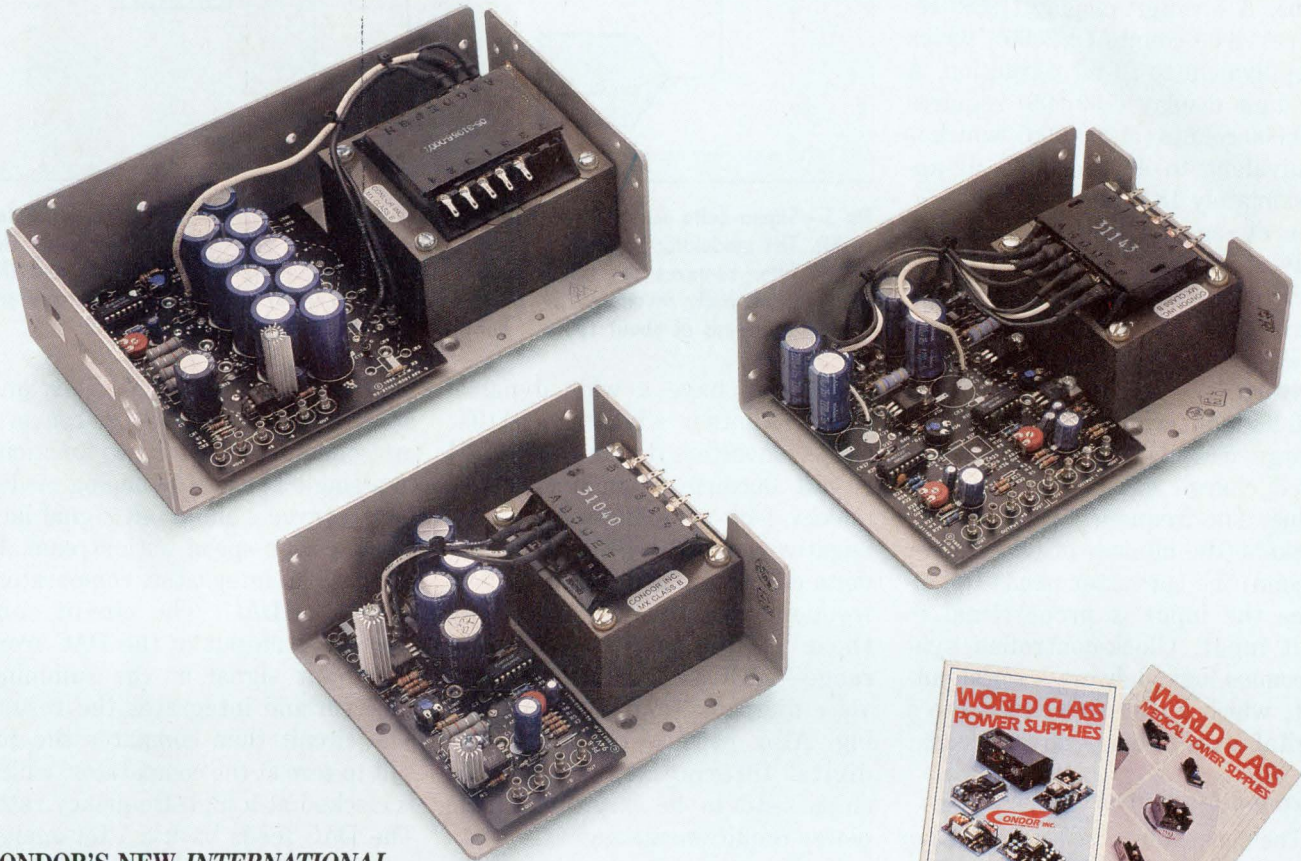

CONDOR'S NEW *INTERNATIONAL PLUS* LINEAR D.C. POWER SUPPLIES MEET TOMORROW'S TOUGH STANDARDS TODAY!

Our International Plus linears offer you performance, price and one more important feature: the agency approvals you need for the 90's, including IEC 950 and VDE 0871 level B EMI. And Condor has more approved linears in stock than anyone in the industry (including more than 30 models in IEC 601 medical versions).

International Plus linears have what you're looking for:

- 115 models (single and multi-output)
- 7 power levels — 3 to 288W
- Worldwide AC input ranges
- OVP on all 5V outputs

- Hermetically sealed power transistors
- MTBF 200,000+ hours per Mil Hndbk 217E
- 2-hour burn-in with cycling (8 hours on medicals)
- Computerized testing (data sheets furnished)
- 3-year warranty — longest in the industry
- 30-day FREE evaluation (call us for samples)

If you need world class performance, quick turnaround, competitive pricing *and* full agency approvals, call Condor — the leader in linear D.C. power supplies.



Call for our
FREE catalogs!

- 300+ power supplies
- Standard and medical
- Switchers and linears
- Open frame and enclosed
- Custom capability

CONDOR

Condor Inc. D.C. Power Supplies
2311 Statham Parkway
Oxnard, CA 93033 • (805) 486-4565
CALL TOLL-FREE:
1-800-235-5929 (outside CA)
FAX: (805) 487-8911

ADC ARCHITECTURES

level of noise rejection to the converter. By making the signal-integration period an integral multiple of the line-frequency period, you can obtain excellent 60-Hz noise rejection.

Typically used in digital voltmeters to provide a display of $3\frac{1}{2}$ to $5\frac{1}{2}$ digits, a dual-slope integrating converter can attain high resolutions. A $3\frac{1}{2}$ -digit display (1999) requires 4000 counts (± 2000), which is equivalent to 12-bit resolution. A $5\frac{1}{2}$ -digit display (199,999) requires 400,000 counts ($\pm 200,000$), which is equivalent to a resolution of approximately 18.6 bits.

A charge-balance integrating converter incorporates many of the same elements as the dual-slope converter but uses a free-running integrator in a feedback loop. The converter continually attempts to null its input by subtracting precise charge packets when the accumulated charge exceeds a reference value. The frequency of the charge packets (the number of packets per second) the converter needs to balance the input is proportional to that input. Clock-controlled synchronous logic delivers a serial output, which a counter converts to a digital word in many applications.

Sigma-delta converters

The converters discussed thus far offer a choice of architectures to satisfy nearly any conceivable need, but a relatively new type—the sigma-delta converter—is making its presence known in digital audio and digital signal-processing applications. A close relative of integrating converters, a sigma-delta converter—sometimes called a bit-stream converter—is a 1-bit converter that uses oversampling and noise shaping as the key elements to its operation. Inherently linear because of the 1-bit conversion process, these converters typically have resolutions of 16 to 20 bits.

Because of their high resolution and a good S/N ratio, sigma-delta

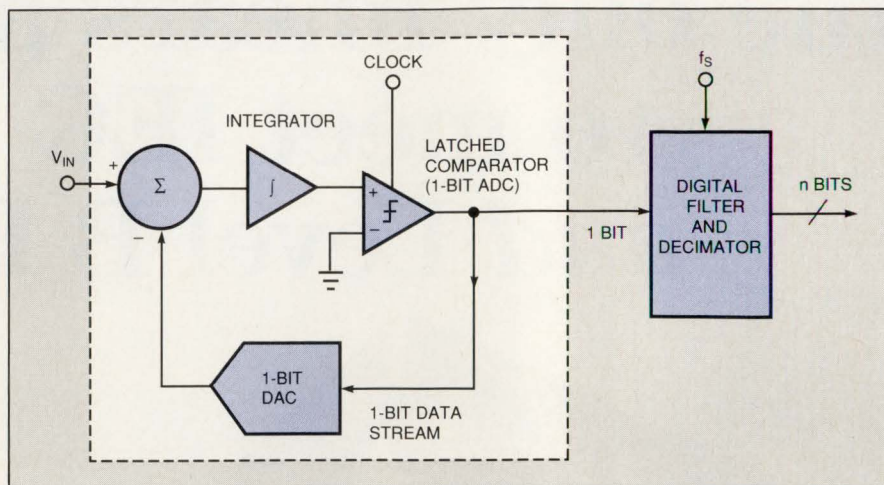

Fig 5—Sigma-delta converters include an analog modulator and a digital-filter/decimator circuit. The modulator converts the input signal to a 1-bit, high-speed data stream. The digital filter removes the high-frequency noise generated by the modulator, and the decimator digitally resamples the filtered output at a lower rate. These converters are limited to speeds of about 100 kHz but have resolutions as high as 20 bits.

converters have a wide dynamic range. Another advantage is that these converters do not need a S/H circuit because of their high-frequency 1-bit sampling rate. On the negative side of the ledger, sigma-delta converters are limited to low-frequency applications—typically those in the 10-Hz to 100-kHz range—such as industrial control, voice digitizing, and audio processing. Also, because of the complex digital filtering, the monolithic chips tend to be large and their power requirements high.

Unlike other converters, sigma-delta converters handle conversion, or quantization, noise by moving most of it outside the frequency band of the input signal via oversampling and digital filtering. This technique allows accurate conversion in the desired frequency band but provides no useful information for frequencies outside the specified bandwidth. Sigma-delta converters have bandwidths that are narrower than those of a successive-approximation converter but much wider than those of a dual-slope integrating converter.

The basic sigma-delta converter has three functional blocks: an ana-

log modulator, a digital filter, and a decimator (Fig 5). Most converters combine the latter two functions in a single block. The analog modulator converts the input signal into a 1-bit, high-speed data stream. It contains an integrator, comparator, and 1-bit DAC. The circuit subtracts the output of the DAC from the input signal at the summing junction and integrates the result. The circuit then compares the result to zero at the comparator, which is clocked at a high-frequency rate. The DAC feeds back a 1-bit analog representation of the comparator's output—a serial stream of bits.

The comparator generates a single bit containing the quantization noise associated with the input signal. Because the oversampling action of the clocked comparator converts the signal to a high frequency that varies around the average value of the input, the quantization noise increases with frequency. In effect, the analog modulator acts like a lowpass filter for the signal and a highpass filter for the noise. This noise-shaping action moves the noise outside the range of the sampled signal.

The digital-filter/decimator block

BUY A TEKTRONIX SCOPE FROM ONE OF THESE GUYS.

Allied Electronics, TEXAS, (800) 433-5700
Brownell Electro, NEW JERSEY, (800) 828-1552
Carlton-Bates, ARKANSAS, (800) 482-9313
Contact East, MASSACHUSETTS, (508) 682-2000
Dow Electronics, GEORGIA, (404) 448-4004
Electronic Parts, NEW MEXICO, (505) 293-6164
Electronics Supply, KANSAS, (800) 669-3752
EMSCO Division/Hammond Electronics, FLORIDA, (800) 275-3554
EnTest, TEXAS, (800) 955-0077
Frigid North, ALASKA, (907) 561-4633
HARCO Electronics, MARYLAND, (800) 638-7616
ITC Electronics, CALIFORNIA, (800) 225-5482
Inotek Technologies, TEXAS, (800) 492-6767
Instrument Engineers, CALIFORNIA, (800) 444-6106
Jensen Tools, ARIZONA, (800) 426-1194
Joseph Electronics, ILLINOIS, (800) 323-5925
Kendall/Great Lakes Electronics, MICHIGAN, (800) 321-8434
Klaus Radio Supply, ILLINOIS, (800) 545-5287
Marshall Industries, CALIFORNIA, (800) 522-0084
Metermaster, ARIZONA, (602) 431-9304
R.A.G. Electronics, CALIFORNIA, (800) 732-3457
R.S. Electronics, MICHIGAN, (800) 366-7750
Resource Electronics/Dixie Division, SOUTH CAROLINA, (800) 854-1002
NW Test & Measurement, OREGON, (503) 645-9000
Olive Electronics, MISSOURI, (314) 997-7709
Radar Electric, WASHINGTON, (206) 282-2511
Stark Electronics, MINNESOTA, (800) 752-4215
Sunshine Instruments, PENNSYLVANIA, (800) 343-1199
TESSCO, MARYLAND, (800) 638-7666
Transcat, NEW YORK, (800) 828-1470
Zack Electronics, CALIFORNIA, (408) 942-5432
Zorn Industries, MASSACHUSETTS, (603) 894-4950

AND WE'LL KNOCK 1/2 OFF ONE OF THESE GUYS.

OFFER GOOD! (on selected Tektronix oscilloscopes purchased between July 6 and December 31, 1992.) OFFER GOOD!
(only on scopes purchased through an authorized Tek distributor.) OFFER GOOD! (in U.S. only.) OFFER GOOD! (trust us.)



Tektronix

Test and Measurement

VIW-283134 Copyright © 1992, Tektronix, Inc.

CIRCLE NO. 31

ADC ARCHITECTURES

performs three functions. The digital filter removes the high-frequency noise the modulator generates and also acts as an antialiasing filter with respect to the final sampling rate. The decimator then performs the final data reduction by digitally resampling the filtered output at a lower rate. This process reduces the oversampled bit stream to the converter's low-frequency output rate but at high resolution.

The sigma-delta converter of Fig 5 is the simplest form possible. Most practical converters contain second-order modulators having two integrators, and some use a multibit DAC in the feedback path. For an in-depth treatment of oversampling converters, see Refs 1 and 2.

For an at-a-glance view of the speed-resolution limits of the various A/D converters, see Fig 6. Prepared by Doug Grant of Analog Devices, this graph depicts the typical speed and resolution characteristics

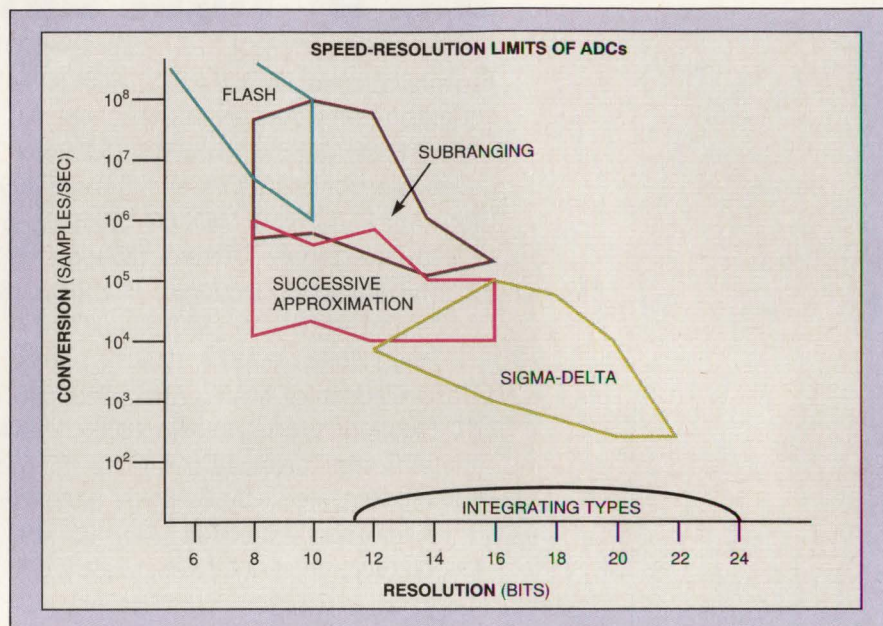

Fig 6—This graph shows the speed-resolution limits of successive-approximation, flash, subranging, integrating, and sigma-delta converters. (Figure courtesy Analog Devices Inc)

for successive-approximation, flash, subranging, integrating, and sigma-delta converters. By referring to

this graph, you can quickly determine what type or types of converters are likely to satisfy the de-

For more information . . .

For more information on the A/D converters discussed in this article, circle the appropriate numbers on the Information Retrieval Service card or use EDN's Express Request service. When you contact any of the following manufacturers directly, please let them know you read about their products in EDN.

Analog Devices Inc
1 Technology Way
Norwood, MA 02062
(617) 329-4700
Circle No. 700

Burr-Brown
Box 11400
Tucson, AZ 85734
(602) 746-1111
Circle No. 701

Comlinear Corp
4800 Wheaton Dr
Fort Collins, CO 80525
(303) 226-0500
Circle No. 702

Crystal Semiconductor
4210 S Industrial Dr
Austin, TX 78744
(512) 445-7222
Circle No. 703

Datel Inc
11 Cabot Blvd
Mansfield, MA 02040
(508) 339-3000
Circle No. 704

Elantec
1996 Tarob Ct
Milpitas, CA 95035
(408) 945-1323
Circle No. 705

Fujitsu Microelectronics
Integrated Circuit Div
3545 N First St
San Jose, CA 95134
(800) 642-7616
Circle No. 706

Harris Semiconductor
Box 883
Melbourne, FL 32902
(800) 442-7747, ext 1131
Circle No. 707

ILC Data Device Corp
105 Wilbur Pl
Bohemia, NY 11716
(516) 567-5600
Circle No. 708

Linear Technology Corp
1630 McCarthy Blvd
Milpitas, CA 95035
(408) 432-1900
Circle No. 709

Maxim Integrated Products
120 San Gabriel Dr
Sunnyvale, CA 94086
(408) 737-7600
Circle No. 710

Micro Linear Corp
2092 Concourse Dr
San Jose, CA 95131
(408) 433-5200
Circle No. 711

Micro Networks
324 Clark St
Worcester, MA 01606
(508) 852-5400
Circle No. 712

Motorola Inc
6501 William Cannon Dr W
Austin, TX 78735
(512) 891-2030
Circle No. 713

National Semiconductor Corp
Box 58090
Santa Clara, CA 95052
(408) 721-5000
Circle No. 714

Precision Monolithics
1500 Space Park Dr
Santa Clara, CA 95052
(408) 727-9222
Circle No. 715

SGS-Thomson Microelectronics
1000 E Bell Rd
Phoenix, AZ 85022
(602) 867-6340
Circle No. 716

Siemens Components
2191 Laurelwood Rd
Santa Clara, CA 95054
(408) 980-4547
Circle No. 717

Philips Components—Signetics
811 E Arques Ave
Sunnyvale, CA 94088
(408) 991-3600
Circle No. 718

Sipex Corp
22 Linnel Circle
Billerica, MA 01821
(508) 667-8700
Circle No. 719

Sony Corp
10833 Valley View St
Cypress, CA 90630
(714) 220-9100
Circle No. 720

Texas Instruments
Box 809066
Dallas, TX 74380
(800) 232-3200
Circle No. 721

UltraAnalog Inc
47747 Warm Springs Blvd
Fremont, CA 94539
(415) 657-2227
Circle No. 722

VOTE . . .

Please also use the Information Retrieval Service card to rate this article (circle one):

High Interest 476
Medium Interest 477
Low Interest 478

POWER-ONE D.C. POWER SUPPLIES

Not Only The Best...The Best Selection, Too

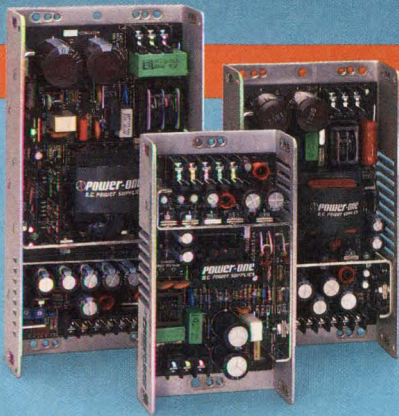

SWITCHERS

POWER-ONE'S International Switcher Series incorporates the latest state-of-the-art switching technology while providing POWER-ONE's traditional high quality at low prices. With certification to the world's toughest safety agency requirements, the series is especially suited for products sold not only domestically, but internationally as well. • 85 models... 40 watts to 400 watts • Efficient... reliable... economical • VDE construction • Up to 5 fully regulated outputs • Full international safety and EMI approvals

LINEARS

POWER-ONE'S International Linear Series is the world's undisputed leader in versatile, cost-effective linear power supply products. A long-time favorite of designers and engineers worldwide, the series is the most widely purchased power supply line through distribution in the industry. The most popular voltage and current combinations are available in a wide variety of off-the-shelf standard models. • Popular industry standard packages • 77 models... 6 watts to 280 watts • $\pm 0.05\%$ regulation • Up to 4 fully regulated outputs • Worldwide safety approvals

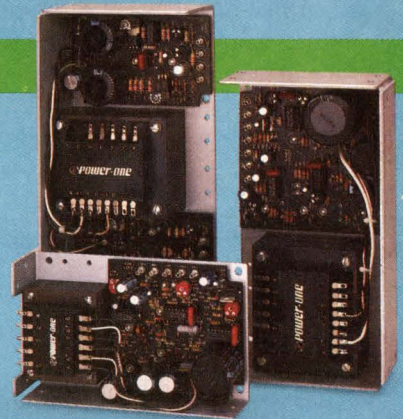

HIGH POWER

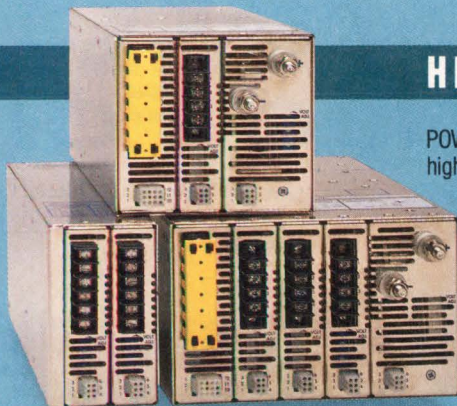

POWER-ONE'S International High Power Series is a true fully-modular high power product line. Specify a power system that meets your exact requirements from a wide selection of single, dual and triple output plug-in power modules. Virtually any combination of output voltage and current rating can be delivered from stock. • 500 watts to 2,000 watts • Fully modular construction • Up to 15 fully regulated outputs • UPS battery backup option • Parallelable outputs with current sharing • Power Factor Correction optional

**TOLL FREE
LITERATURE
HOT-LINE:
(800) 678-9445**



POWER-ONE offers one of the largest selections of switcher, linear, and high power standard models in the world. Most models available off the shelf from authorized distributors. So, whatever your D.C. power supply requirement, make POWER-ONE your first choice and be sure you're getting the best—quality, selection, value and quick delivery. Call today for our new Reference Guide and the location of our closest authorized distributor.

"Innovators in Power Supply Technology"
POWER-ONE
D.C. POWER SUPPLIES

POWER-ONE, INC.
740 Calle Plano • Camarillo, CA 93012-8583
Phone: (805) 987-8741 • FAX: (805) 388-0476



ADC ARCHITECTURES

sign goals of a particular application.

In addition to the five basic converter types in Fig 6, you should be aware of another class of converters, the self-calibrating type. These converters are available in several basic architectures, including successive-approximation, sub-ranging, and sigma-delta types.

Self-calibrating converters use a switched-capacitor DAC and on-chip RAM to compensate for linearity and accuracy errors, which are particularly troublesome in many high-resolution converters. Among other advantages, self calibration eliminates the need for laser-trimmed resistors, which are difficult to trim to sufficient accuracy at resolutions higher than 12 bits. For further information on self-calibrating A/D converters, see Ref 3.

No single article, particularly one this short, can possibly cover all of

the nuances of ADC architectures. In addition to resolution and speed—the distinguishing characteristics covered here—there are a host of other considerations important to designers. These include S/N ratio, harmonic distortion, spurious-free dynamic range, and reference accuracy. All of these factors influence the end application to various degrees.

For detailed information on A/D and D/A converters and their application, you should examine any good textbook on the subject. One example is the *Analog-Digital Conversion Handbook*, written by the engineering staff of Analog Devices and available from Prentice-Hall, Englewood Cliffs, NJ. For an excellent treatise on sub-ranging converters, Datel Inc's application note AN-5, which EDN originally published as a 3-part series, provides a wealth of information. **EDN**

References

1. *Mixed-Signal Design Seminar Handbook*, 1991. Analog Devices, Box 9106, Norwood, MA 02062.
2. Swager, Anne Watson, "Oversampling data conversion: Technique bolsters dc-to-audio converters," *EDN*, September 2, 1991, pg 77.
3. Pryce, Dave, "Self-calibrating A/D converters: Monolithic devices enhance accuracy and linearity," *EDN*, January 20, 1992, pg 53.

Acknowledgments

Thanks to Doug Grant of Analog Devices for his comments on the characteristics of various ADCs and their applications. Thanks also to George Hill of Burr-Brown, particularly for the information on sigma-delta and integrating converters.

Article Interest Quotient
(Circle One)

High 476 Medium 477 Low 478

Also,
486 SX/DX and DX2,
Up to 66MHz
Landmark 2.0 of 220MHz

386SX FULLY Re-Designed For

Up to 16Mb
RAM On-board

IDE
Interface

Floppy
Interface

Parallel
Port

Design Enhancement
For FCC/UL Approval

Slotpro™
SERIES

Now Shipping
33MHz

High Performance
80386SX

Optional 80387SX
Coprocessor

Optional
PROM/FLASH Disk

A Totally Integrated Solution with Powerful Features at an Attractive Price!

PADS-Logic
Schematic
Capture System

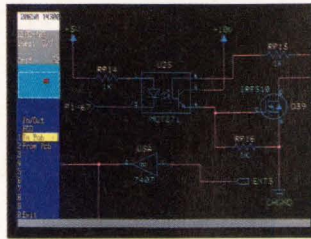

- Multi-sheet, design oriented database
- Fast, graphical library browsing
- Top-down hierarchy with back-annotation
- Automatic gate and pin assignment
- Automatic ref. designator assignment
- Search and query functions across all sheets
- Context sensitive cursor for copy, move, delete
- On-line Logic checking across entire database
- User definable Bill of Materials



PADS-PCB
PCB Design &
Layout System

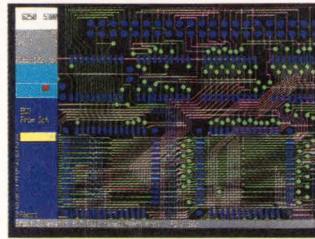

- ▲ Simple, easy-to-use graphical user interface
- ▲ Fast, graphical library browsing
- ▲ 16 bit database, 1 mil database resolution
- ▲ 400 IC design capability
- ▲ Blind and buried via support
- ▲ Automatic gate and pin swapping
- ▲ Autoplace and route
- ▲ Design ruleschecking to 1 mil accuracy
- ▲ Fully integrated to schematic capture

PADS PADS PADS PADS PADS PADS PADS

119 Russell Street, Littleton, MA 01460 Tel: (508) 486-9521 Fax: (508) 486-8217 Toll Free: 1-800-255-7814

CIRCLE NO. 33

Software, Inc.

INTEGRATED Lower Cost!

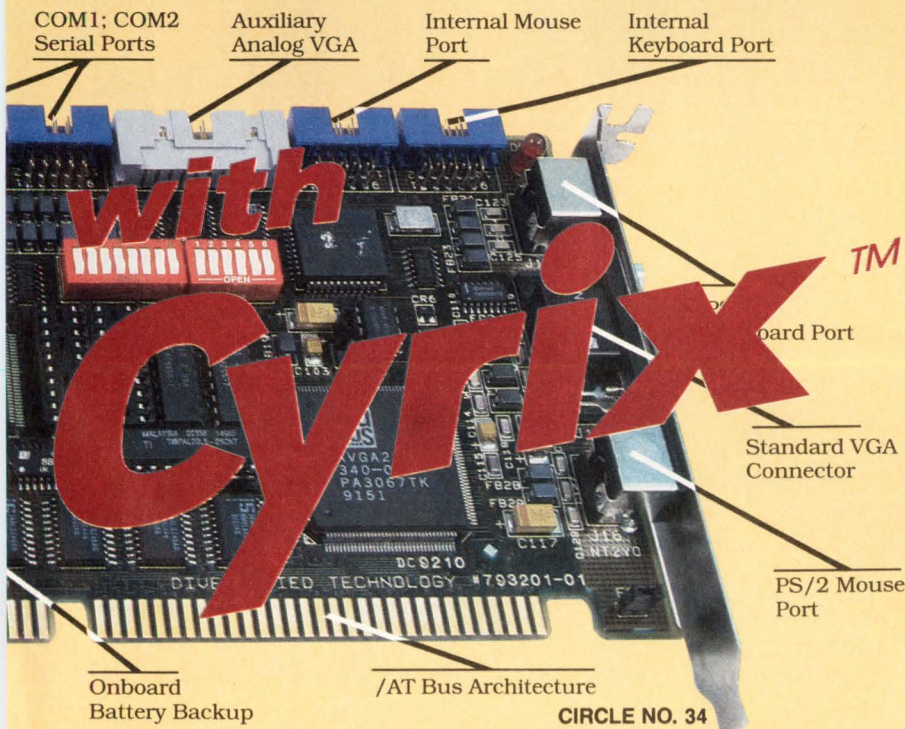

386SX FUNCTIONS	CAT 975	CAT 970
16, 20 or 25 MHz CPU	✓	
16, 20, 25 or 33MHz CPU		✓
Up to 16Mb RAM Onboard	✓	✓
Up to 1Mb Flash or PROM Disk	✓	
Optional 80387SX Coprocessor	✓	✓
Future Domain SCSI		✓
Watch Dog Timer	✓	
VGA Interface		✓
VGA Interface with Analog/ Digital/ EGA/ VGA	✓	✓
IDE Hard Drive interface	✓	✓
Floppy Interfaces	✓	✓
Two 16/232 Serial Ports	✓	✓
Bi-directional Centronics	✓	✓
/AT-PS/2 Keyboard Support	✓	✓
PS/2 Mouse Port	✓	✓
Onboard Battery Backup	✓	✓
Real Time Clock	✓	✓
Noise Reduction Capability For FCC Class B	✓	✓
Double Sided Surface Mount Technology	✓	✓
Manufactured In-House (U.S.A.)	✓	✓
One Year Limited Warranty	✓	✓
Landmark 2.0 Speed at 25MHz	31	32

Enhanced Landmark v2.0 with Cyrix 33MHz increased to 107MHz

Diversified Technology
An Ergon Co.

Call us toll free for orders and information

1-800-443-2667

Outside USA PH.-(201)891-8718 • FAX-(201)891-9629 **51**

CIRCLE NO. 34

Making your 24 bits better.



PC display

That's AT&T "Customerizing."

"Customerizing" means being ready today with a total 24-bit graphics solution—a complete package to enhance your multimedia PC applications.

It's an industry first from AT&T Microelectronics. A true-color graphics chip set with complete driver support, including 24-bit window drivers. Today!

Developed to give you one-stop, hassle-free, true-color shopping. And priced to take a surprisingly small bite out of a PC design budget.

16 million colors

Offering quick and easy implementation, our chip set includes a True-Color VGA Controller and highly-integrated RAMDACs.

This high-performance system, capable of generating over 16 million colors, makes possible a virtually unlimited range of shading possibilities.

The system also delivers photographic-quality graphics

display, provided by an AT&T True-Color VGA Graphics Controller that supports resolutions as high as 1024 by 768.

Integrated Solution

AT&T's chip set is designed for a 5-chip motherboard that consumes only 30 square centimeters, and incorporates two memory devices.

Flexibility? AT&T's chip set offers three RAMDAC options—24, 16/18 and 8/6 bit—so you can differentiate your application with various price/performance points.

Development time? Our complete manufacturing kit helps you sharply reduce design-in time and cost.

For more on how you can give your product a 24-bit edge at the lowest possible system cost, just give AT&T Microelectronics a call at 1 800 372-2447, ext. 903. FAX: 215 778-4106.

(In Canada:
1 800 553-2448, ext. 903)



AT&T
Microelectronics

Put These G And Take So



Think of it as peer pressure at its finest. All these companies want you to take some time off: Time off your design cycle, and your time to market. They're the Fusion29KSM Partners, and their support helps make the 29KTM Family of embedded RISC processors so fast and easy to use.

Fusion29K Partners include over 100 reputable companies with more than 200 different support products. Together,

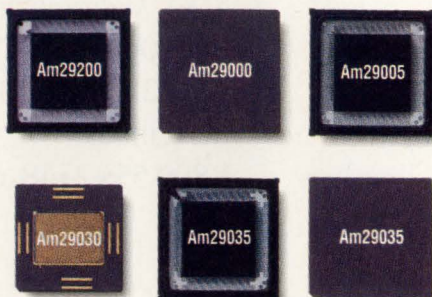

The 29K Family includes parts for every conceivable application—from the brand new low cost, easy-to-use Am29200TM to the top-of-the-line Am29050TM with on-chip floating point coprocessor.

they provide everything you need to speed up the design process, every step of the way. From evaluation, to system and hardware design, software development, hardware and software integration, system debug—all the way to production.

The Fusion29K Partners have a whole arsenal of time and labor saving devices. You'll find emulators, simu-

Ways To Work me Time Off.



5M Consulting



TeleSoft International, Inc.

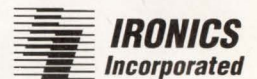

MICRO-PROCESSOR SERVICES, INC.

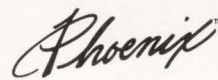

Schneider & Koch



Research



Graphics Resource Group



FLUKE®

MetaWare®
INCORPORATED



cygnus



Epsilon Industries

telenetworks
SOFTWARE FOR DATA AND TELECOMMUNICATIONS A LHM COMPANY



Capricorn Systems
International



Augat



Custom Applications Inc.

PEERLESS

GSI Techsi



Gibbons & Associates



EDI

LOGIC
MODELING

FUJITSU



Information &
Communications Mgmt.



XDI

Tektronix®
COMMITTED TO EXCELLENCE

IBM



lators, CASE and CAE tools, C compilers, machine and source level debuggers, logic analyzers, and manufacturing support of all kinds. All of the highest quality and performance standards.

And it won't take a lot of time to get acquainted with these development tools, since they include most of the hardware and software products you already know.

For more information on the 29K Family of embedded RISC processors and Fusion29K support, call AMD today: **1-800-292-9263 Ext. 3.**

With this much support, you may be able to take some time off for yourself.



Advanced Micro Devices

901 Thompson Place, P.O. Box 3453, Sunnyvale, CA 94088. © 1992 Advanced Micro Devices, Inc.
29K is a trademark and Fusion29K is a servicemark of Advanced Micro Devices. All other brand or product names are trademarks or registered trademarks of their respective holders.

With 546 different standard product configurations, our *Piezoresistive Silicon Pressure Sensors* meet almost anyone's spec. DIP and surface mount packages help cut your assembly costs, too. Which makes you more competitive—and more profitable. Find out why so many engineers are designing these sensors into their OEM applications. Circle the number below.



We'll send you product literature and data sheets.
Or call **800-767-1888**.

SENSORS

1701 McCarthy Blvd. Milpitas, CA 95035-7416

546 Different Silicon Pressure Sensors. One Phone Call.

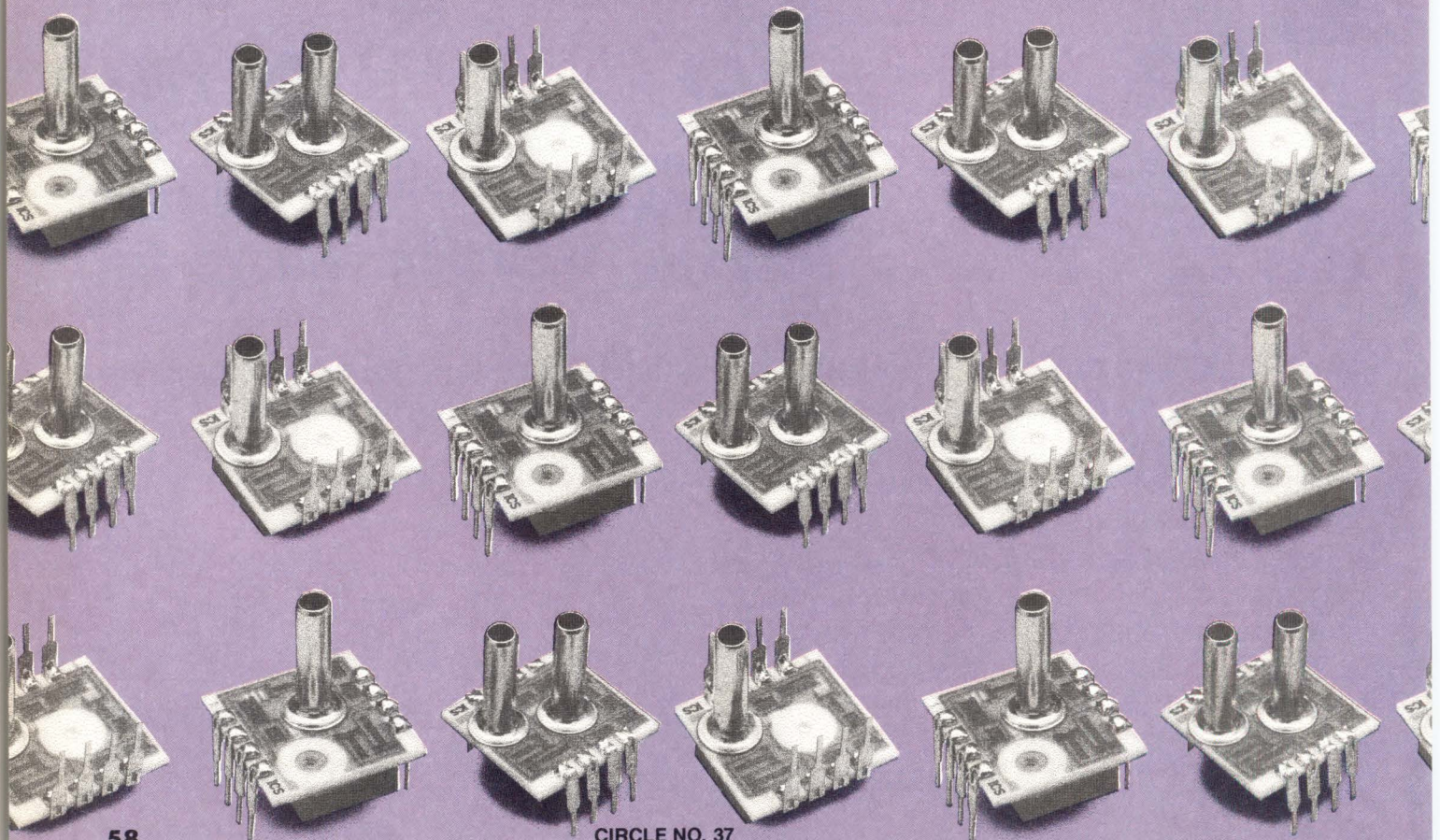

58

CIRCLE NO. 37

Let a GUI accelerator chip make your graphics whiz

The 86C911 is a graphical-user-interface (GUI) accelerator chip that speeds up Windows or Presentation Manager applications. The accelerator performs essential graphics operations such as moving and resizing windows, operating the cursor, manipulating icons, and generating pull-down menus. In systems that have only a VGA or SVGA (super VGA) display controller, the host CPU must perform these operations in software.

The chip also performs bitblt (bit-block transfer) operations, image transfers, line drawing, and cut-and-paste operations. Because the chip is a dedicated hardware processor, it can execute these functions faster than a general-purpose CPU. For example, the company claims that the chip can perform bitblt

transfers four times faster than a 50-MHz 486 μ P and can draw lines eight times faster.

The chip contains a bus interface that features multiple FIFO buffers and directly communicates with an ISA or Micro Channel Architecture bus. It also interfaces with 512-kbyte and 1-Mbyte video RAMs. You can design a 512-kbyte 86C911-based accelerator card using 11 ICs, including the display memory. In addition, the chip can interface to the local bus of an 80386 or 80486 μ P, which eliminates the system-bus bottleneck when transferring data to display memory.

The chip drives 1024 \times 768-pixel noninterlaced displays having 72-Hz refresh rates as well as 1280 \times 1024- or 1280 \times 960-pixel interlaced displays having 43-Hz re-

fresh rates. A direct-color mode produces 65,536 colors for 640 \times 480-pixel displays. The chip is also 100% register-level compatible with VGA, MDA/Hercules, and CGA graphics standards.

A package of 14 software drivers allows applications using Windows 3.0, AutoCAD, PCAD, VersaCAD, Microsoft Word 5.0, Lotus 1-2-3, and Wordperfect. An enhanced VGA BIOS, called BOC911, is compatible with the industry-standard VGA BIOS and optimizes the use of the chip's extended VGA text and enhanced modes. \$75 (1000).

—John Gallant

S3 Inc, 2933 Bunker Hill Lane, Santa Clara, CA 95054. Phone (408) 986-8144. FAX (408) 986-1457.

Circle No. 731

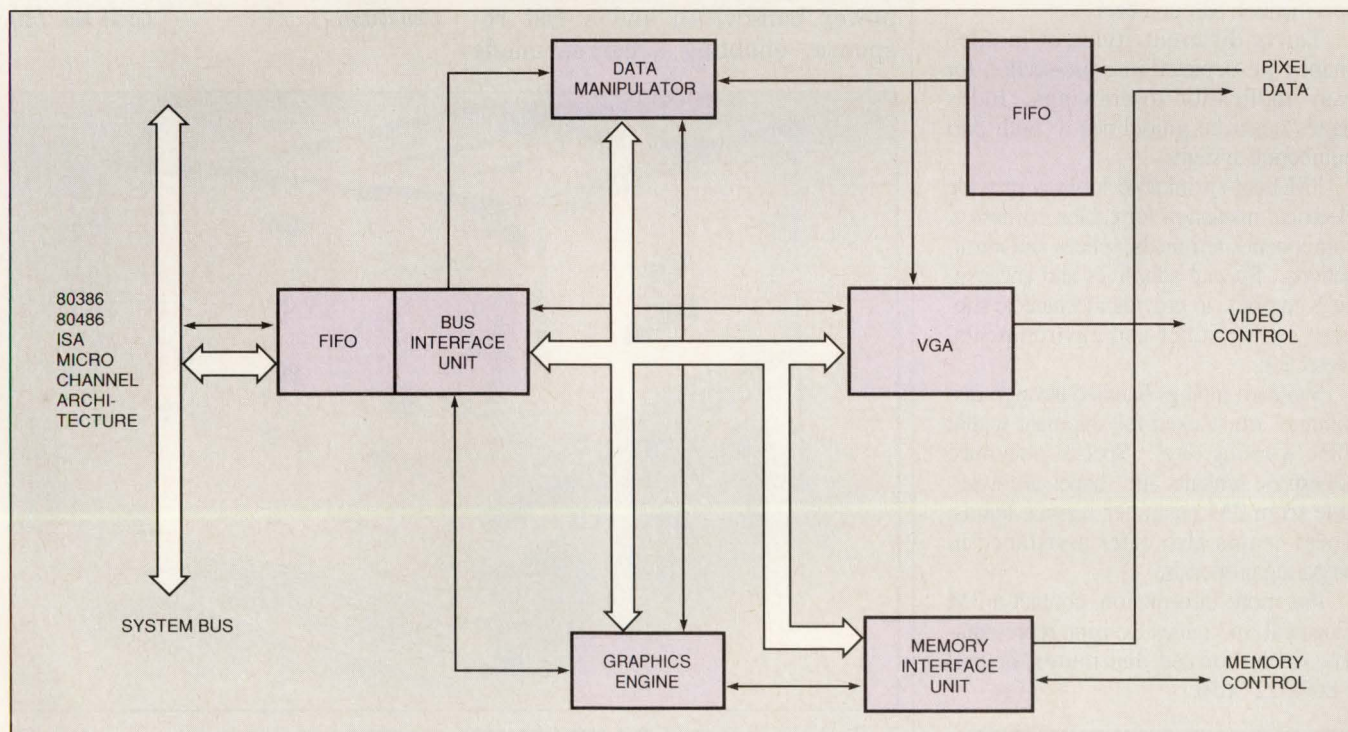

The integrated functions on the 86C911 GUI accelerator chip include a bus-interface block that communicates directly with an ISA, Micro Channel Architecture, or CPU Local Bus to speed up graphics operations.

3M Publishes Heat-Shrink Cross Reference Chart

Helps OEM designers find best fit for standard tubings, molded shapes and shield terminators.

AUSTIN, Tex. — Finding the best heat-shrink tubing fast is the purpose behind 3M's new heat-shrink tubing cross reference chart.

It includes hundreds of descriptions and drawings, all cross referenced with part numbers for quick ordering.

Products include single and dual-wall polyolefins, and special purpose tubings of modified fluoropolymer, polychloroprene and polyester elastomer.

Comparisons are made with 3M shield terminators that include NAS and MIL specification part numbers.

Thirty different styles of molded shapes are depicted in cross-section for easy application to drawings. Index pages describe guidelines to both part numbering systems.

3M heat-shrinkable tubings provide electrical insulation for cables, harnesses, components, terminals, splices and terminations. Special adhesives and encapsulants combine to provide mechanical supports, strain relief and environmental protection.

Standard tubings handled through distributors are stocked for shipment within three working days. Special materials, adhesives, sealants and shapes are available from 3M customer service teams. These teams also offer assistance in preparing proposals.

For more information, contact a 3M Electrical Specialties Division representative or authorized distributor, or call 1-800-322-3636.



Hundreds of listings include applicable UL, CSA, AMS and MIL specs.

Filtered power amplifier can develop a 980-kW output

The Model 265 wideband high-voltage PWM dc amplifier includes internal filtering that yields output like that of a linear amplifier. A single module can develop a $\pm 150A$ at $\pm 330V$ dc (49 kW), or a 226V ac, continuous output. Peak output equals $\pm 312A$. You can parallel as many as 20 modules to develop a $\pm 3000A$ at $\pm 330V$ output—980 kW.

By providing smart power at low cost, the Model 265 can enhance existing programmable power applications. The unit also paves the way for entirely new technologies—variable-frequency power for ac drives, active friction-free magnetic bearings, active magnetic suspension systems, active neutralization of ac power-line harmonics, and active neutralization of ripple on high-voltage dc transmission lines.

The Model 265 can function as either a current source or a voltage source. The 81-kHz switching frequency yields a dc-to-4-kHz full-power bandwidth and a fast response, enabling a current-mode

output to settle within 0.2% of its final value in 400 μ sec. Maximum harmonic distortion at $\pm 150A$ rms and 200 kHz equals 0.2%, and input voltage-offset drift is only 3 $\mu V/^\circ C$. The unit's 3000W dissipation at a 150A output equates to an amplifier full-load efficiency of 94%.

The rack-mountable Model 265 measures 19 \times 10.4 \times 23.4 in. and weighs 88 lbs. The amplifier is protected against short circuits, overload, overvoltage, undervoltage, and excessive operating temperature. The amplifier also provides a current-monitoring analog-output signal, which is calibrated to represent load current in terms of 1V per 25A. A current-limit circuit enables you to set the amplifier's maximum output current between $\pm 19A$ and $\pm 312A$. \$15,500.

—Tom Ormond

Copley Controls Corp, 410 University Ave, Westwood, MA 02090. Phone (617) 329-8200. FAX (617) 329-4055.

Circle No. 730

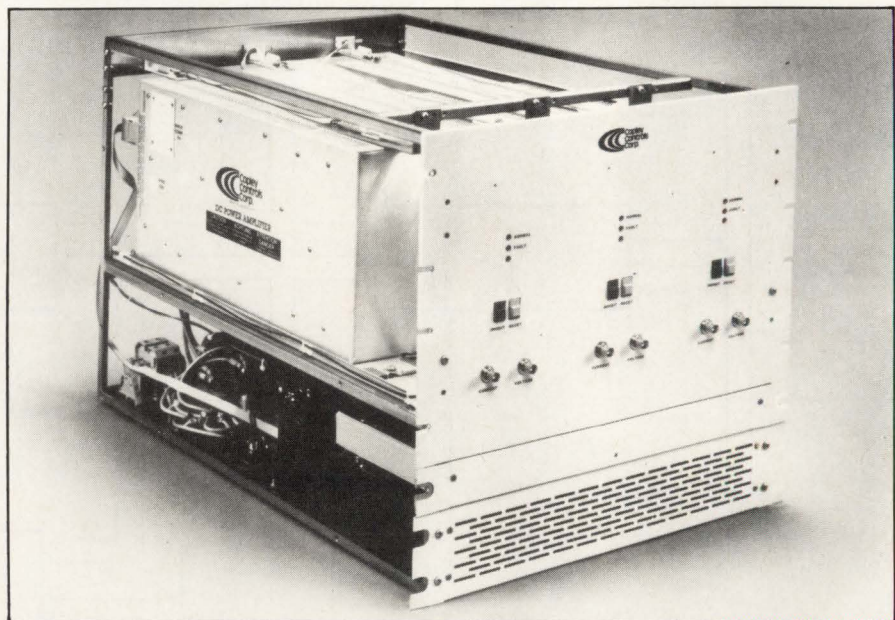

To develop an output of 980 kW ($\pm 3000A$ at $\pm 330V$), you can parallel as many as 20 Model 265 PWM amplifier modules. Individual modules can operate as either a dc supply, a wideband ac supply, or a high-power function generator.

3M Electrical Specialties Division
6801 River Place Boulevard
Austin, Texas 78726-9000

CIRCLE NO. 38

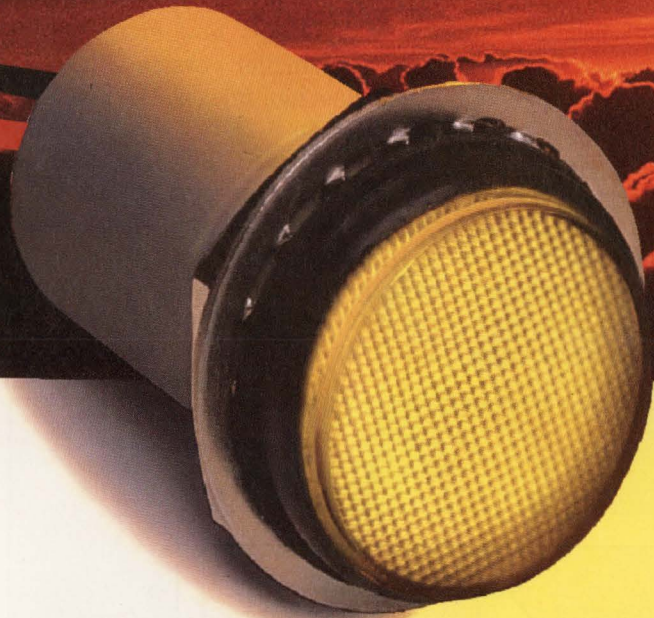
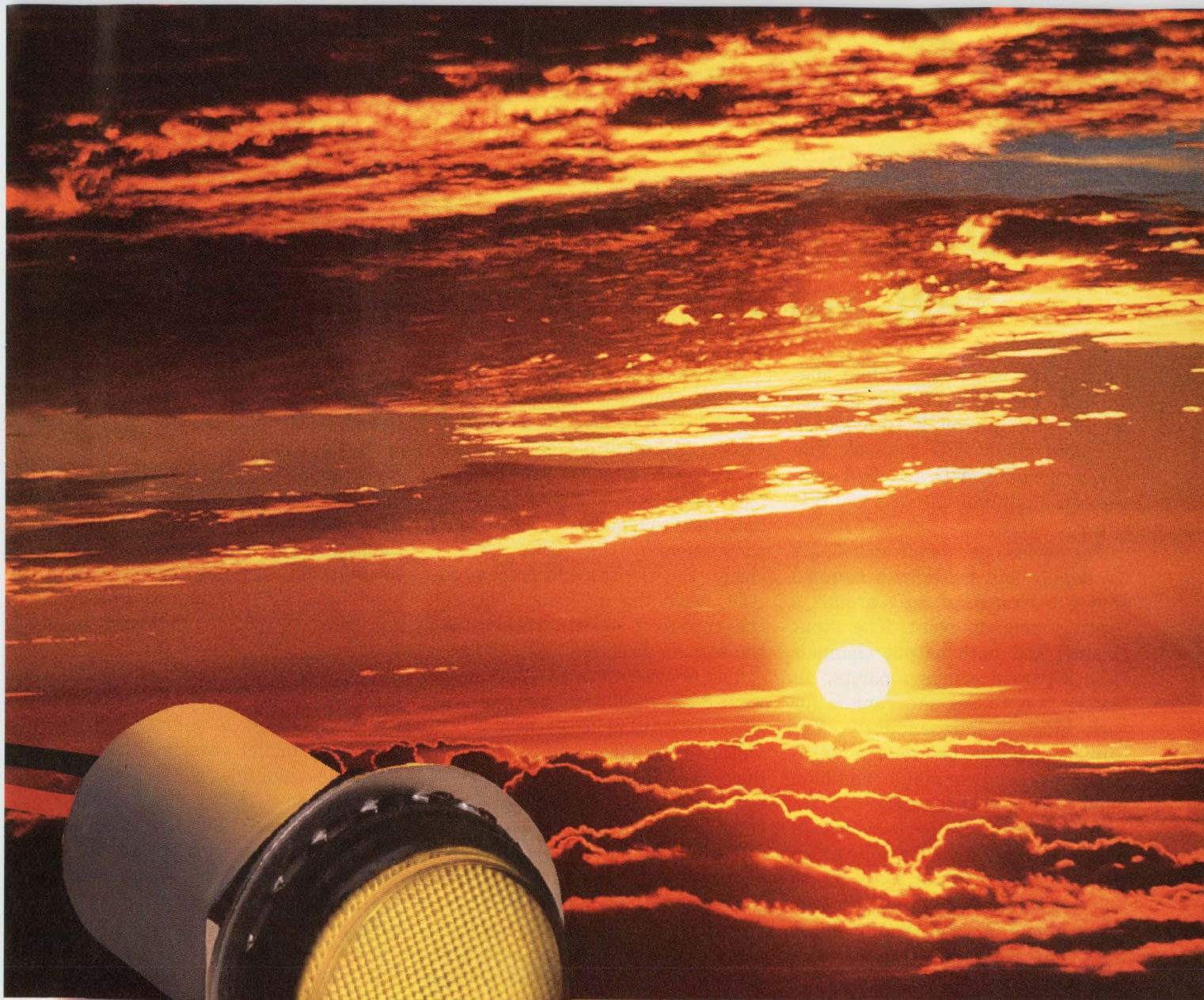

Few things shine brighter or last longer.

Dialight presents the best of both worlds in $\frac{1}{16}$ " panel mount indication: The 557 Series.

Incorporating unique multiple LED construction and proprietary lens design featuring wide-viewing angle, Dialight's new super-bright array produces the kind of light you thought you could only get from incandescent indicators.

And, as good as that sounds, consider the reliability and long life (100,000 hours) of LEDs. The result is a virtual replacement-free front panel mount indicator.

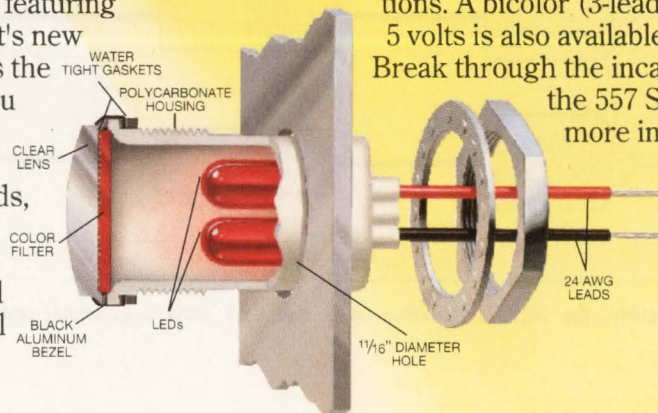

Watertight, tamperproof and complete with 6" wire leads, the 557 Series comes in single colors (red, green and yellow) in 4.3, 5, 12 and 28 volt configurations. A bicolor (3-leaded red/green) version in 5 volts is also available.

Break through the incandescent light barrier with the 557 Series from Dialight. For more information, contact: Dialight

Corp., Dept. PL7, 1913 Atlantic Ave., Manasquan, NJ 08736; Tel.: (908) 223-9400; Fax: (908) 223-8788.

CIRCLE NO. 39
ALL INDICATIONS ARE

DIALIGHT



Now You Can See True Colors Without Getting Soaked.

New full-featured RAMDACs from Brooktree deliver 24-bit true color for cost-conscious PC designers. Introducing four new RAMDACs that span the spectrum of PC applications, from 640x480 VGA systems to 1280x1024 workstation-quality graphics. They've got the right features, the right prices and are available right now.

True Color in a VGA Environment

Unplug Sierra. Plug in our totally compatible Bt481 or Bt482. You'll get 24-bit performance at 16-bit prices.

These new RAMDACs support 15-bit TARGA, 16-bit 5:6:5 and 24-bit true-color formats. They even allow you to switch between VGA and true color on a pixel-by-pixel basis.

Choose the Bt481 if you prefer an external

hardware cursor. Or pick the Bt482 for its on-board 32x32x2 cursor — ideal for faster windowing environments.

Workstation Graphics at PC Prices

Introducing the Bt484 and Bt485, our newest mouth-watering RAMDACs. They combine true color with higher resolutions for higher performance graphics subsystems. And they're economical, too.

Bt485 operates at up to 135 MHz to drive pseudo color to 1280x1024 resolutions and gamma correct true color to 1024x768. It has a 64x64x2 cursor and all the serialization and timing to directly interface to a VRAM frame buffer.

Bt484 provides maximum flexibility with its programmable pixel port to provide 256

to 16.8 million colors, on-board 32x32x2 cursor and supports both interlaced and non-interlaced monitors.

Bt		Resolution			
		640x480	800x600	1024x768	1280x1024
Colors	16.8M 64K 256	Bt481/Bt482			Bt485
	16.8M 64K 256	Bt484/Bt485			Workstation RAMDACs

Call Brooktree at **1-800-VIDEO-IC** for technical details and pricing today.

Brooktree Corp., 9950 Barnes Canyon Road, San Diego, CA 92121, (619) 452-7580, FAX (619) 597-0673.

Brooktree®

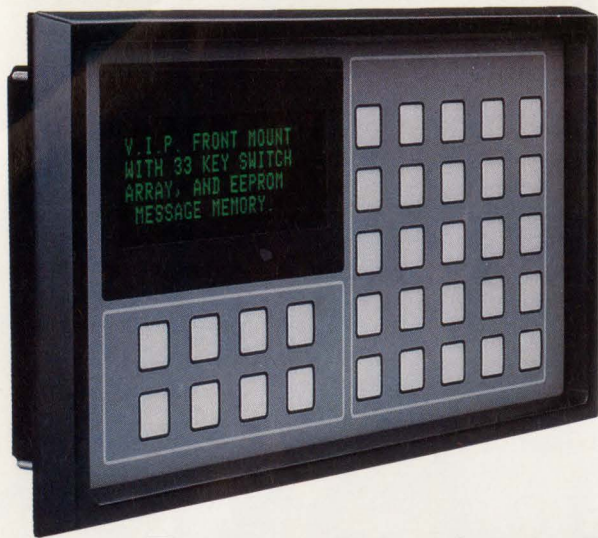

Meet The V.I.P.™ That Will Save You Months Of...

- ✓ Hardware/software design frustration.
- ✓ Material sourcing headaches.
- ✓ Mechanical design trials.
- ✓ Vendor delays.
- ✓ Tooling problems—not to mention costs!
- ✓ Overtime.
- ✓ Phone calls to numerous vendors.
- ✓ Distractions from your basic business.

Introducing The 4×20 V.I.P. Operator Workstation/Mini-Terminal

Product development delays are difficult to avoid—even for professionals. Our new, self-contained, front mount 3902-04 4×20 V.I.P. eliminates your frustration before it begins! For starters—it uses a bright, clear, vacuum fluorescent display featuring **5mm dot matrix characters** arranged in four twenty-character rows.

Sealed Front Panel

The 33-key, rim embossed switch array uses reliable stainless steel metal-dome actuators behind a completely **sealed** membrane overlay.

Slide-In Switch Legends

Slide-in switch legends make it easy for you to quickly generate professional-looking prototypes.

Programmable Through Serial Port

We've gone one step further—you can now program canned messages **directly through the serial port to EEPROM**. Removing PROMs for external programming is a thing of the past!

Only 1" Deep

Our 4×20 V.I.P. is only 1" deep behind the front panel—making it ideal solution for door-mounted displays and other tight installations where depth presents a problem.

Applications

The 4×20 V.I.P. is tailored for process control, security, machine tool, and test equipment applications.

Operates On Low Power

This workstation/mini-terminal operates on 5 VDC and dissipates only 3 watts.

Additional Features:

- Programmable switch outputs
- Horizontal scroll
- Blinking characters
- 5 sets of 6 custom (user-programmable) characters
- 3 software-controlled display brightness levels
- NEMA-12 rated
- Both RS-232-C (with CTS & DTR) and RS-422 protocol I/O at 1200, 2400, 9600, and 19,200 baud
- ESD shielding standard
- Operating temperature range: 0 to +70°C
- Up to 127 **canned** messages can be stored in the 7k bytes of onboard EEPROM memory
- Choose from several display viewing filter color options
- Built-in comprehensive self-test function
- Overall dimensions: 11.40×6.00×1.73" (W×H×D)

Also available as a 3902-9904 "Stripped" V.I.P. without the front panel, keyboard and rear cover. Use your own external keyboard (up to 8×8) and panel mount.

The Finishing Touches

We can add custom overlay graphics, multi-colored key legends, and your company logo to give the 4×20 V.I.P. your personal touch.

Meet The Entire IEE Industrial Products Division Family—

Call or write for our free, 4-color Product Selector Guide.

Circle #44 Reference

Circle #45 Immediate



IEE is a sustaining member of **SID**.

INDUSTRIAL ELECTRONIC ENGINEERS, INC. 7740 Lemona Avenue, Van Nuys, California 91409-9234 (818) 787-0311 FAX: (818) 901-9046

SPARC chip sets provide MBus expandability for high-performance SPARCstations

Cypress Semiconductor's SPARCset is the first MBus-module-based SPARC chip set and board design. The set accepts interchangeable SPARC MBus modules, such as those used in the Sun SPARCstation 10 or Sun Galaxy multiprocessor server. The chip set does not include the modules. The board design uses the 64-bit, 40-MHz MBus as a system bus and the 25-MHz SBus as a mezzanine or peripheral bus. The design is also available from Nimbus Technology. Cypress sells the chips and the board design; Nimbus sells the SPARC Board Set, which comprises the same chips and a board ready for component insertion.

The most successful system paradigm of the 1980s was the PC. For the 1990s, SPARC chip vendors are out to repeat that success using the SPARC RISC (reduced-instruction-

set-computer) microprocessor as the base for SPARCstation clones. These vendors' chip sets include SPARC-based support chips and board-level designs, and some sets come with a pc board ready for components. Chip sets from Cypress Semiconductor, LSI Logic, and Fujitsu let engineers quickly turn out clones in much the same way clone vendors spin out PCs.

The chip sets free engineers from having to design cache and memory controllers. Vendors have structured the board designs so that each company can add its own peripheral set and expansion boards. The chip sets let you implement clones ranging from an MBus-module design that accepts Sun/Texas Instruments or Cypress SPARC processor modules to a SPARCstation 2 design having a 40-MHz SPARC CPU.

The SPARCset has two SBus

slots and a Sun-compatible graphics controller that works with monitors having resolutions as great as 1152 x 900 pixels with 8 bits color. The graphics controller runs directly off the MBus, unlike most other SPARC implementations, which tie the graphics controller to the slower SBus. Low-level peripherals such as keyboards, mice, and floppy-disk drives have a separate I/O bus. The chip set's main memory uses up to 128 Mbytes of DRAM having 60-, 70-, or 80-nsec access times. The MBus modules may or may not include a cache memory.

Nimbus Technology's NIM6000M SPARC MBus Board Set includes the seven Cypress chips, which were developed by Nimbus, and a mother board. The board takes one MBus module, such as the single- or double-CPU Sun/TI SuperSPARC

Text continued on pg 68

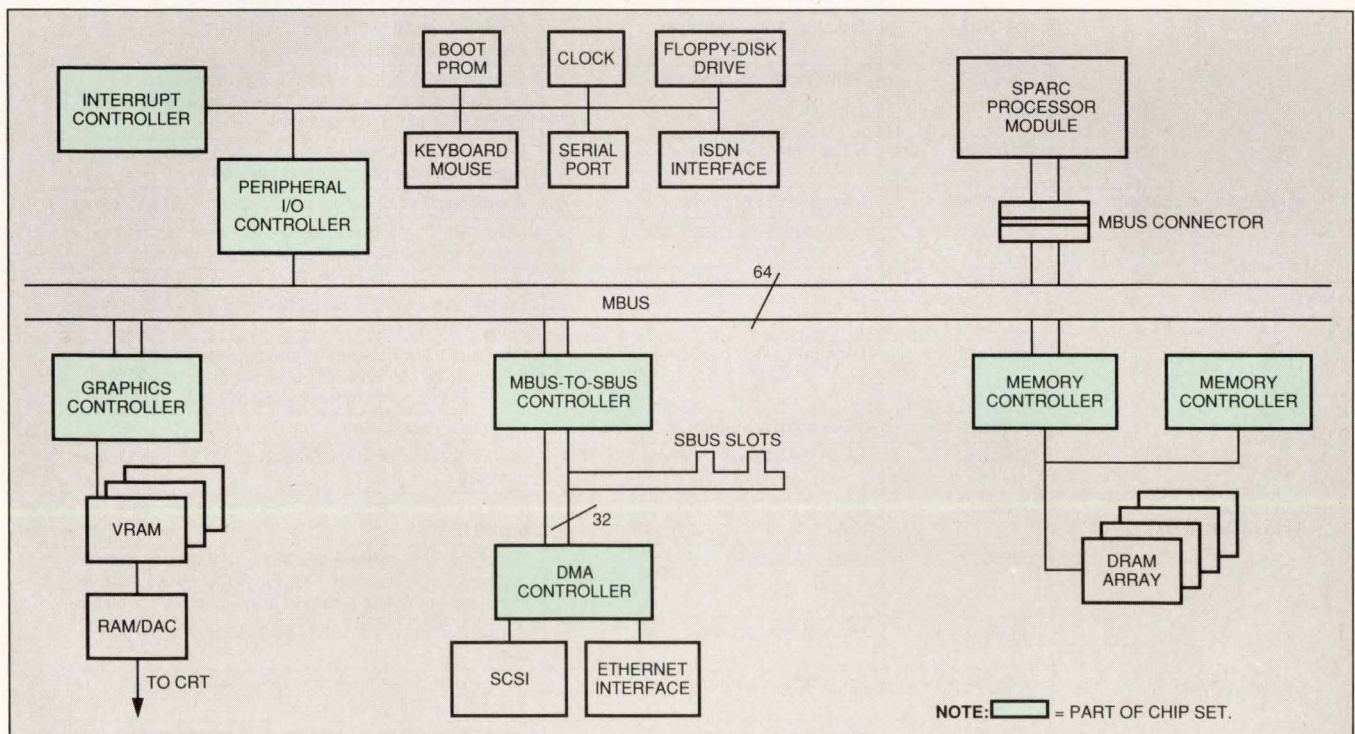

The Cypress SPARCset implements a SPARCstation using the 64-bit MBus for memory and the 32-bit SBus for peripherals. The chip set accepts MBus processor modules, including the superscalar SuperSPARC-based modules that have one or two CPUs.

SPARC chip-set features

	Cypress SPARCset (Nimbus Board Set)	Fujitsu SBus chip set	LSI Logic SparKit-40/MBus
SPARCstation design	SPARCstation 10	SPARCstation 2	SPARCstation 2/IPX
Number of chips	7 chips, 6 different types	6, including CPU	7, including CPU
Clock rate	40 MHz for MBus. CPU can run faster on its own module.	33-, 40-MHz CPU	40 MHz
Performance	52.6 SPECint; 64.6 SPECfp* with 40-MHz TI SuperSPARC	29 SPECmarks at 40 MHz	24 SPECmarks
System bus	MBus	MBus (level 1)	MBus
Memory	8 to 96 Mbytes	As much as 512 kbytes of DRAM and 256 kbytes of cache memory.	8 to 96 Mbytes
Comments	MBus links SPARC module, system chips (except DMA controller, which interfaces to the MBus-to-SBus controller). Chip set works with MBus and CPU modules, which can have cache memory.	32-bit integer-unit bus links CPU, cache controller, and caches. Implements MBus level II and cache coherency for multiprocessing.	32-bit integer-unit bus links CPU, cache controller, and caches. Set can use Super VGA and run Solaris 1.x software.
Price	\$250** (100); license to manufacture SPARCset board, \$50,000. Nimbus: chip set and board, \$350 (10,000).	33 MHz, \$660; 40 MHz, \$838 (1000).	\$629 (100)

*SPECint and SPECfp have replaced SPECmarks.

**Price does not include CPU. CPU supplied in MBus module.

SPARC chip-set chips

Vendor, chip set	Chip	Description	Comments
Cypress SPARCset	CY7C613	MBus interface memory controller	Translates 32-bit virtual address to 36-bit physical address. Includes a 64-kbyte direct-mapped cache controller and SRAM tag bits. Cache data held in cache RAMs.
	CY7C614	MBus peripheral I/O controller	Links MBus to 386SX address and data formats. Can address as many as eight 386-addressed peripherals.
	CY7C615	Interrupt controller	Provides SPARC system interrupts with 15 request levels (14 masked, nonmaskable). Has two 32-bit counters.
	CY7C616	MBus-to-SBus controller	Interfaces 25-MHz SBus to 40-MHz MBus. Controls as many as 4 SBus master/slaves.
	CY7C617	MBus graphics controller	Compatible with Sun's 1152x900-pixel 8-bit color or monochrome display. Has 256-word palette and programmable CRT timing signals.
	CY7C618	SBus DMA controller	Can control Ethernet and SCSI channels. Handles eight 16-bit data paths to and from SBus
Fujitsu SBus chip set	MB86903	Integer unit/FPU	Combines SPARC integer and floating-point processors.
	MB86921	Cache controller, MMU, and cache-tag RAM	Links CPU to MBus and serves as MMU cache controller. Handles as many as 256 kbytes of cache.
	MB86980	Memory and peripheral controller	Controls as many as 512 Mbytes of DRAM. Provides interleaving, parity, error-correction code, and an 8-bit peripheral interface.
	MB86981	DMA and video controller	Provides 3 DMA channels. Interfaces to SCSI, Ethernet, VRAM, and CRT controllers. Implements Sun CG4 color and monochrome frame buffer.
	MB86985	MBus-to-SBus interface controller	Links SBus and MBus.
	MB86986	MBus-to-VMEbus interface controller	Lets chip set work in VMEbus systems. Links VMEbus to MBus.
LSI Logic Sparkit-40/MBus	L64831	SPARC CPU with FPU and integer unit	4-stage pipeline, 32-bit RISC microprocessor with on-chip FPU.
	L64844	Cache controller	Direct-mapped cache with a write-through and buffer strategy. Can handle a 64-kbyte unified cache (32-byte line size). Implements path to main memory via SBus.
	L64841	Memory-management unit	Converts integer-unit virtual addresses to physical ones.
	L64853A	SBus DRAM controller	Hooks to SBus as main bus. Drives as many as 4 banks of SIMMs.
	L64846	SBus DRAM controller	Hooks up to SBus as main bus. Drives as many as 4 banks of SIMMs.



Pick up the number one real-time operating system.



And run with it.

In today's competitive market, it's important to run with the best. And when it comes to real time, the iRMX® operating system is the clear favorite.

You see, iRMX has a 13-year track record for proven reliability. In fact, only DOS runs on more X86 systems. Now, iRMX for Windows provides the first real-time operating system with guaranteed response time that runs DOS and standard-mode Windows on the i386™ and i486™ architecture. That's right, true real time on a PC.†

iRMX for Windows brings more than just

affordable hardware to real time. It also gives you a head start on development with access to the huge installed base of DOS applications and tools. In fact, you even have the option to run Windows†† (including Windows 3.1).

So take the first step, call (800) GET-iRMX (800-438-4769)* and ask for Lit. Pack. #2D. And start running real time with your favorite DOS and Windows software.

*Outside the U.S.A and Canada, FAX (503) 696-4633. © 1992 Intel Corporation. iRMX is a registered trademark and i386 and i486 are trademarks of Intel Corporation.

†iRMX runs on IBM and Compaq compatible i386 and i486 based PCs. ††All other products shown or mentioned are trademarks or registered trademarks of their respective owners.

modules that feature the TI super-scalar SPARC processor.

LSI Logic offered the first SPARC chip sets, which let designers implement a 20-MHz, and later a 25-MHz, Sun SPARCstation 1. The company followed with a SPARCstation 2 version. The SparKit-40/MBus is an MBus-based upgrade that can handle CPU rates as fast as 40 MHz. The kit lets engineers implement a SPARCstation 2/IPX system.

The LSI SparKit-40/MBus uses the MBus as the system bus and the SBus as both a mezzanine or high-end-peripheral bus and a low-end I/O bus. The kit includes the 40-MHz L64831, a SPARC CPU that has an on-chip FPU (floating-point-unit) coprocessor. The CPU uses an integer-unit bus, which serves as a memory bus for the processors, the cache, and the cache controller. The cache controller, in turn, links to the system MBus, which handles the main memory

and links to the SBus and I/O bus. The main difference between the LSI and Cypress chip sets is that the LSI set includes the CPU, and the Cypress set interfaces to an MBus processor module, which has its own SPARC processor or processors.

Fujitsu introduced its 33- and 40-MHz SPARC chip sets last year. A hardware-design kit lets you use the chip sets to build a busless, SBus or VMEbus SPARC workstation. Fujitsu is the only SPARC chip set vendor to provide a mechanism to build a VMEbus-based system; the VMEbus is the standard base for larger Sun workstations and servers.

The chip set is based on Fujitsu's MB86903 single-chip SPARC processor, which integrates an integer unit and FPU. The processor runs at clock rates as fast as 40 MHz. The set includes a memory-management-unit/tag-RAM chip, which

manages cache memory and links the cache and processor to level one of the MBus; a memory and peripheral controller, which can handle as much as 512 kbytes of DRAM; an MBus-to-SBus interface controller; and a VMEbus-to-SBus interface controller.—Ray Weiss

Cypress Semiconductor, 3901 N First St, San Jose, CA 95134.

Phone (408) 943-2653. FAX (408) 370-8092.

Circle No. 733

Fujitsu Microelectronics Inc, Advanced Products Div, 77 Rio Robles, San Jose, CA 95134. Phone (408) 922-9000. FAX (408) 943-9293.

Circle No. 734

LSI Logic Corp, 1551 McCarthy Blvd, Milpitas, CA 95035. Phone (408) 433-8000. FAX (408) 433-6802.

Circle No. 735

Nimbus Technology Inc, 2900 Lakeside Dr, Suite 205, Santa Clara, CA 95054. Phone (408) 727-5445. FAX (408) 727-5447.

Circle No. 736

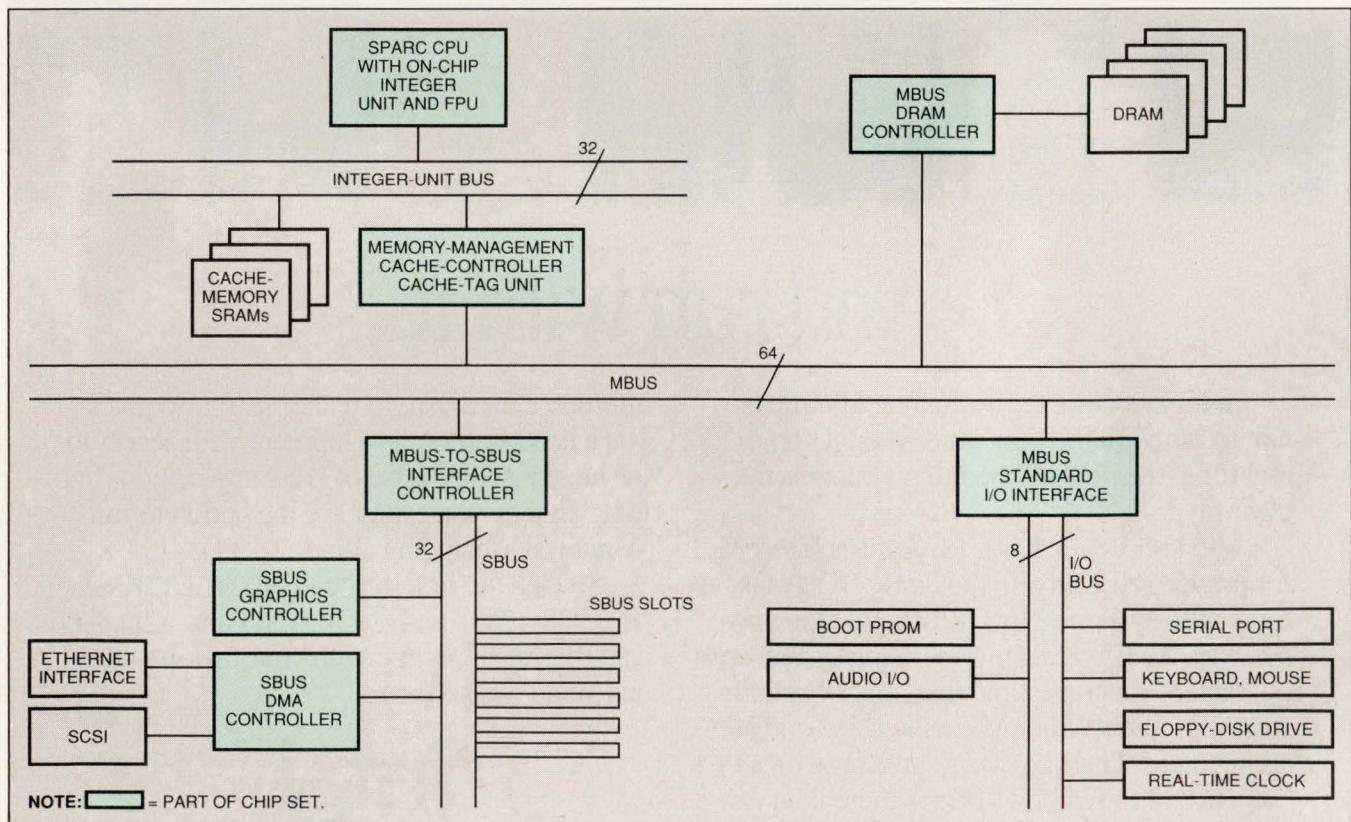

LSI Logic's SparKit-40/MBus includes a 40-MHz SPARC CPU that has an on-chip FPU coprocessor. The kit's design uses the MBus as a main system bus and the SBus for peripherals.



With Motorola's fuzzy logic educational kit, you can learn how to design systems using Motorola's standard 8-bit microcontrollers that perform better, get to market sooner, at far less cost. And if you're one of the 10 people to score the highest on the fuzzy logic test and project, we'll send you to Hawaii to learn more.

For only \$195, our kit* will provide computer-based training materials that will take you step-by-step through fuzzy logic fundamentals, practical application considerations, and a detailed example. You will receive a demonstration version of Apronix's Fuzzy Inference Development Environment (FIDE) software, an easy-to-follow PC-based tutorial, and other support software. Or if you need real-time evaluation, (not required for successful completion of the course) a limited



quantity of board-level evaluation modules (EVM) for Motorola's 8-bit microcontroller plus the

* The kit requires a minimum of a PC-AT™ class or compatible, with one floppy drive, a 40MB hard-drive, a VGA monitor, DOS™ 3.30 with Windows™ 3.0 (DOS 5.0 is recommended)

educational kit will be available for \$600.

Qualify to win your place at Motorola's 3-day Fuzzy Logic Seminar in Hawaii.

Simply complete and return the test and the fuzzy logic software

project included in the educational kit. The 10 people who score the highest on the test and the project will win a trip to Hawaii this winter for a 3-day seminar on Fuzzy Logic led by the experts in the field. Tests and projects must be postmarked by October 17, 1992.



Order your entry materials today.

To order Motorola's Fuzzy Logic Kit and the details on the Hawaii Fuzzy Logic Seminar Contest, fill out the coupon and mail it and your payment - payable to Motorola (company checks, money orders and cashier's checks accepted) to: Fuzzy Logic Kit, Motorola, Inc, PO Box 1466, Austin, TX 78767. Kits are also available through your local Motorola Sales Office or a participating Motorola authorized distributor.



Offer expires August 31, 1992

— Please send me the microcontroller version of Motorola's new fuzzy logic education kit that I checked below:

— FLEDKT05* (Educational Kit with M68HC05EVM that emulates 68HC05 C-Series, B-Series & L6) - Price \$600

— FLEDKT11* (Educational Kit with M68HC11EVM that emulates 68HC11 A-Series, D-Series & E-Series) - Price \$600

— FLEDKT00 (Educational Kit without EVM) - Price \$195 (\$295 after August 31, 1992)

— Send me more information about the special introductory version of the Motorola fuzzy logic development kit.

*Limited Quantity

Name _____

Title _____

Company _____

Address _____

City _____ State _____ Zip _____

Telephone _____ Fax _____

Offer expires August 31, 1992.

Official information on rules, regulations and contest deadlines is included with each fuzzy logic kit. Government employees and Motorola employees and their families are not eligible for the fuzzy logic contest. If a winner is not permitted to accept this prize by his or her employer's policies or practices, Motorola will donate an equivalent cash amount to an appropriate charity designated by the winner. Void where prohibited or restricted by law. ® and Motorola are registered trademarks of Motorola, Inc. ©1992 Motorola, Inc.



\$27 buys a 16-MHz embedded SPARClite microprocessor

SPARC RISC has made the grade for embedded systems. Engineers can now easily design in embedded versions of the desktop standard. These variants include stripped-down versions with specialized interfaces that minimize expensive glue logic. The MB86933, Fujitsu's low-end, 32-bit SPARClite, delivers SPARC performance at embedded-system prices. A 16-MHz version costs \$27.

The original SPARC RISC (reduced-instruction-set-computer) microprocessor (μ P) was not easy to design in; it required special, fairly tricky glue logic and lacked on-chip caches. In contrast, SPARClite carries a complement of special controllers to minimize design costs. The chip integrates a dynamic-RAM (DRAM) controller (with page-mode support), a 16-bit timer, and two DMA channels. In addition, the CPU provides a programmable address decoder and a wait-state gen-

erator for adapting to slower memories; it handles booting up from 8- or 16-bit memories.

Fujitsu engineers also upgraded the SPARC core processor. SPARClite runs with a static core, where clocks can be dropped to minimize power. A multiply instruction was added, and loads and stores were accelerated, typically taking one instruction cycle (pipelined).

To speed up embedded applications and provide a low-cost memory hierarchy, SPARClite integrates 2 kbytes each of instruction and data cache with the CPU core. The caches are 2-way set associative, with 16-byte, lockable cache lines (the cache block unit). These caches are big enough to hold key algorithms and their temporary data. Moreover, the cache locking feature enables programmers to flag critical code and data as cache resident, minimizing cache trashing and consequent indeterminate time behavior.

The low-end MB86933 has a 104-word register file comprising six overlapping windows. Each window provides the local environment for

Fujitsu SPARClite MB86933

- 16-, 20-MHz external clock
- RISC CPU with 4-stage pipeline; 73 instructions
- 17-native-MIPS sustained performance at 20 MHz
- Multiply (MPY) instruction, step divide (DIV); unsigned MPY takes 5 clocks
- 2-kbyte instruction cache; 2-kbyte data cache—both 2-way set-associative with 16-byte line size, with cache lock per line
- Memory support: page-mode dynamic-RAM controls, wait-state generator, refresh controller, programmable address decoder
- 32-bit external address and data buses and 8 bits for chip selects and control
- 16-bit autoreload timer
- 15 interrupts; 2 USARTs
- 160-pin quad flatpack
- 16-MHz, \$27 (10,000)

a function or subroutine. Control can move from function to function without having to save the former context by switching to the next function's register window. This feature minimizes context switching time, but it must be used care-

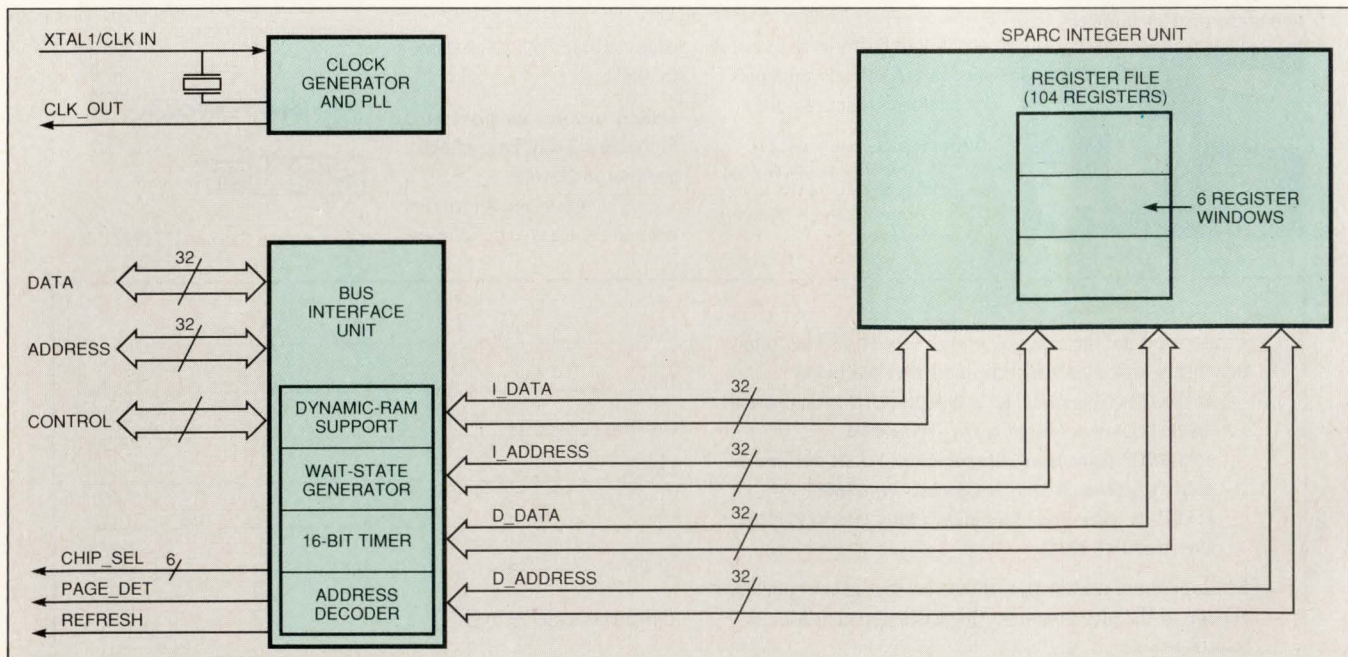

The Fujitsu MB86933 is a low-cost SPARC μ P designed for embedded applications. It includes 2-kbyte instruction and data caches and memory controllers to minimize glue logic.

If you're looking for easier embedded debugging, try our new environment.

Real-time software performance analyzer profiles your code and speeds optimization.

User-configurable tools offer intuitive operation and share common look and feel.

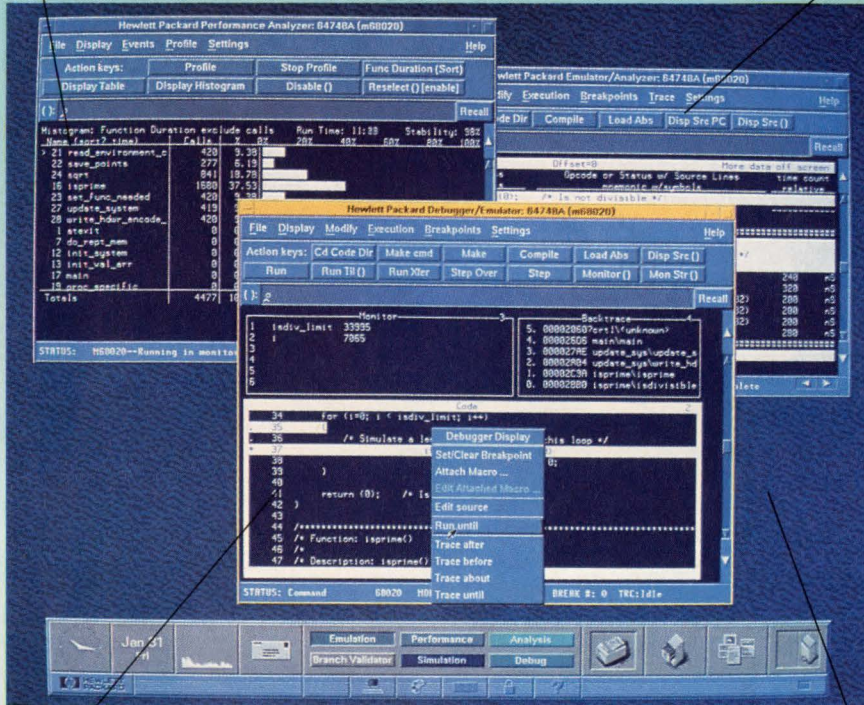

Full-featured C debugger runs in-circuit with our emulator.

Concurrent real-time analyzers and debuggers provide simultaneous, linked views of target.

The new HP 64000 embedded debugging environment makes it easy.

If easier embedded debugging is what you're looking for, the HP 64000 can point you in the right direction, with a new graphical user interface that has pull down menus for workstation hosted products. Point and click measurements. And rapid action keys to speed up routine tasks.

For most popular processors, the interface is always the same. So you don't have to learn new commands for different jobs.

And the interface is completely integrated. Emulators, debuggers,

and the software performance analyzer all operate consistently and interactively. Which means you can share data between tools, and enjoy all the productivity benefits of synchronized measurements operating in a multiple window, high-performance environment.

So, if you're looking for a simpler way to develop embedded systems, call 1-800-452-4844. Ask for Ext. 3036, and we'll send you a free video that shows you how the HP 64000 embedded debugging environment makes it easy.

© 1992 Hewlett-Packard Co. TMCOL205/EDN

EMULATORS ⁽¹⁾		
MOTOROLA		
68000/EC000	68331/332	68030/EC030
68HC000/001	68340	68040/EC040
68302	68020/EC020	68LC040
INTEL		
80960SA/SB	80C186EA/EB/EC	8086/88
80960KA/KB	80C186XL	80C186/188 80286/C286
PLATFORM SUPPORT		
HP 9000 Series 300, 400 & 700		
Sun Microsystems SPARCstations		
IBM PC Compatibles		
<small>(1)Also support for AMD, Texas Instruments, Zilog, National Semiconductor, ATT, NEC, Hitachi and Mitsubishi; call for more information.</small>		

There is a better way.



EDN-PROCESSOR UPDATE

fully, because of the limited number of register windows. A register window overflow can eat up a large block of time as the filled register windows are saved or restored.

Other SPARClite family members run to 40 MHz and include peripherals such as additional counter/timers, USARTs, a debug support interface, and a 36-entry TLB (translation look-aside buffer). Software and hardware tools include ICEs, logic analyzers, real-time kernels, and complete software-development tool chains.

An MB86933 evaluation board comes with 4 Mbytes of DRAM, 128 kbytes of static RAM, and 2 Mbytes of EPROM. The board has 4 counter/timers, two USARTs, an Ethernet port, and an AT bus interface.

—Ray Weiss

Fujitsu Microelectronics Inc, Advanced Products Div, 77 Rio Robles, San Jose, CA 95134. Phone (408) 922-9000. FAX (408) 943-9293.

Circle No. 737

THREE THINGS TO THINK ABOUT

When You Select I/O Cards For Your PC-Based Data Acquisition System...

COST: Don't just **THINK** purchase price. **CONSIDER** the time and effort it takes to get your system up and running.

PERFORMANCE: **PONDER** hardware performance, but don't forget software, too!

AVAILABILITY: **THINK** off-the-shelf and then call **ACCES**. We've got a whole catalog full of PC-based I/O Boards.

Don't just sit there! Call us today!

ACCES
I/O Products, Inc.

TOLL FREE (800) 326-1649

9400 Activity Rd.
San Diego, CA 92126
(619) 693-9005
Fax: 619-578-9711

CIRCLE NO. 41

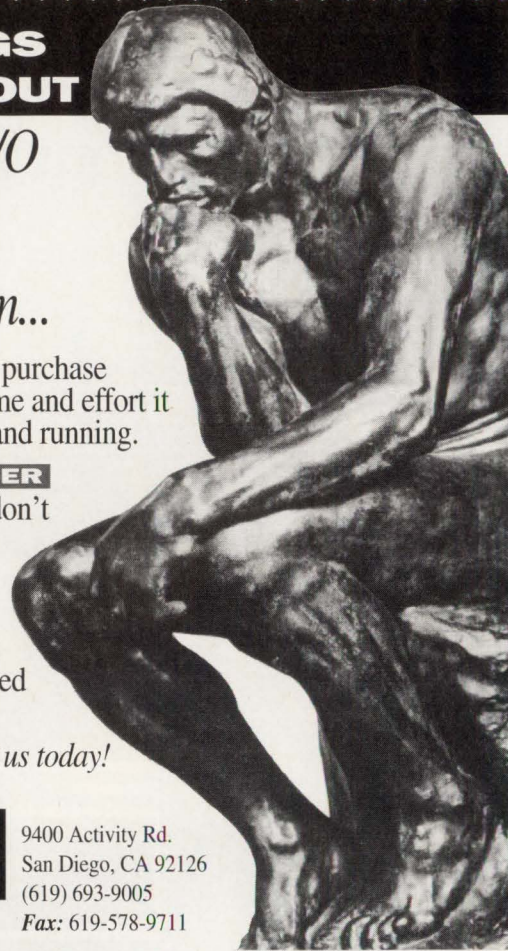

THERMOSTATS

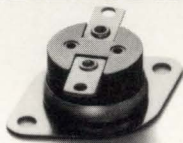

Reliable, surface mounted, snap-action thermostats make or break current to temperature-critical devices. Some models open on temperature rise, others close, at fixed set points between 35°F and 550°F. Average delta is 30°F. Various mounting and terminal options. Some units feature manual reset. Broad selection from stock. Attractive discounts in OEM quantities. Four-color catalog, free samples, and quotations on request.

SELCO ▲ ▼ SELCO

DREAM METER



FRONT



BACK

**80% SMALLER MOVEMENT,
66% FEWER PARTS.**

- Core magnet design ■ Dramatically reduced total volume ■ Taut band suspension
- Accuracy to ± 1.5% of full scale
 - Four sizes ■ AC and DC versions
 - Standards conformance
 - Custom Marking Services

selco PRODUCTS CO.
7580 Stage Road, Buena Park, CA 90621
(213) 921-0681, (714) 521-8673, or (800) 229-2332.
FAX (714) 739-1507

CIRCLE NO. 42

IEEE-488

You can control any IEEE-488 (HP-IB, GP-IB, 488.2) device with our cards, cables and software for the PC/AT/386, EISA, Micro Channel and Macintosh II. You get fast hardware and software support for all the popular languages, plus a software library of time saving utilities. Instrument control has never been easier.

FREE
Informative Catalog 800-234-4CEC
Applications help 617-273-1818

Capital Equipment Corp.
Burlington, MA. 01803

Micro Channel is a trademark of IBM

CIRCLE NO. 43

Looking for a way to reduce shorting potential
in a modular jack?

We've got it covered.

Because contacts are exposed in most modular jacks, the chance of a thousand volts jumping from the jack to the nearest conductor is very real.

Molex's 41314 series of modular jacks greatly reduce the risk of shorting because their top is covered by the jack's plastic housing. This cover not only protects, but adds an extra margin of design flexibility by allowing PCBs to be stacked together more closely.

Each Molex Modjack must pass three functional tests, including on-line hi-pot testing. Jack contacts are plated after stamping, eliminating bare edges in critical areas. Molex Modjacks also meet all FCC 68.5 and UL 1863 requirements.

Assembly to board, both robotic and manual, is more efficient because contact tails lock securely into housing, assuring precise location.

For the widest selection of modular jack sizes, types and configurations, contact Molex.

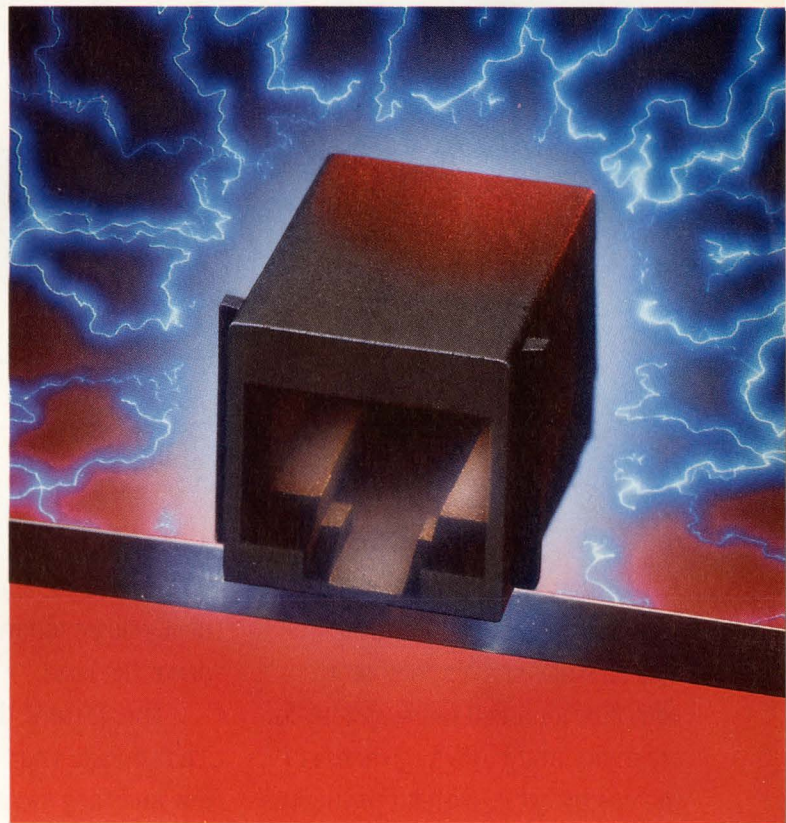

Bringing People & Technology Together, WorldwideSM

Corporate Headquarters: 2222 Wellington Ct., Lisle, IL 60532 U.S.A., Tel: (708) 969-4550 • European Headquarters: Munich, Germany, Tel: 49-89-413092-0
Far East North Headquarters: Tokyo, Japan, Tel: 81-427-21-5539 • Far East South Headquarters: Jurong Town, Singapore, Tel: 65-660-8555

CIRCLE NO. 46

© 1991, Molex Incorporated



Design and production schedules have never been tighter. Systems have never been more complex. You need more options for creativity, and more forgiveness in the design cycle, without paying the usual time or cost penalties.

Time has become so compressed, hardware and software are being engineered concurrently. Often, there isn't even time for a prototype.

So what do you do now? Above all, just keep reading.

LOGIC FOR THE 90'S. AND BEYOND.

The programmable logic solutions from Xilinx

were made for the way you have to design logic today. Not to mention down the road.

For starters, there's no NRE. That means your costs going in are low, and they are going to get lower every day.

Our devices are infinitely re-programmable, even while they're

in the system, so you can refine your design until it hums.

Later on, adding new capabilities is just as easy.

And with our short development cycle (at least 15 weeks shorter than a gate array), you're not waiting for production quantities. You can get them as fast as you like.

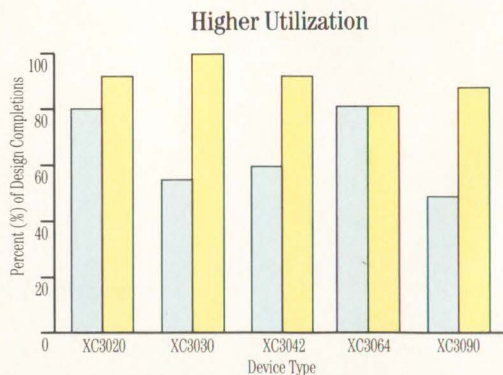
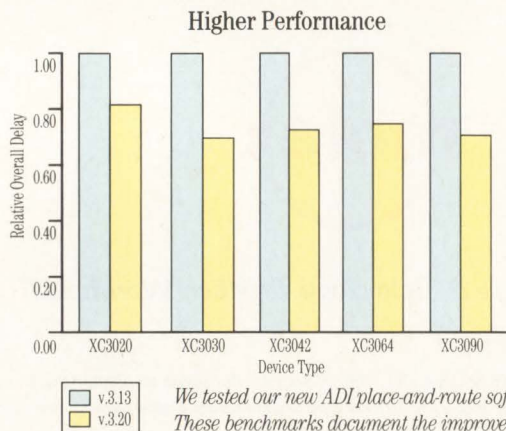

We tested our new ADI place-and-route software, v.3.2, on 153 of our customers' toughest designs. These benchmarks document the improvements you can look forward to, automatically, with Xilinx.

WHICH LOGIC COMPANY IS GOING TO GET YOU WHERE YOU WANT TO GO?

Don't worry about your inventory, either. Our devices are fully tested standard parts, so they'll keep until you're ready.

And our pin-for-pin compatible Hardwire Gate Array can make migrating to high volumes automatic—no test vectors, no waiting, no pain, no kidding.

XILINX, THE SOFTWARE COMPANY.

Our XACT™ development system never stops getting better.

We've added more libraries, ABEL support, more user control, user-defined hard macros, more new 3rd party interfaces, more efficient place-and-route for better performance, and just plain more.

In fact, benchmarks show our new place-and-route software (v.3.2) delivers a 30 to 40% improvement in device utilization. And a 25% improvement in performance.

All of which has made our XACT development system easier than ever to live with. But we don't intend to rest on our disks. We're building more intelligence into the system every day, with powerful new

Our XACT software is so automatic, the difference between last year's model and this year's model is just one button.

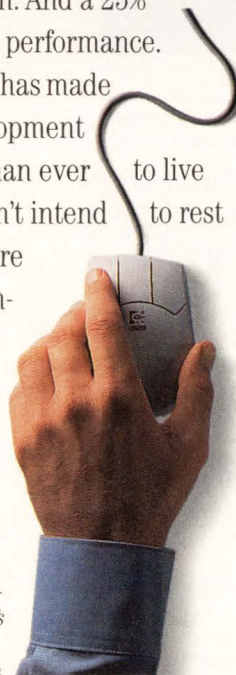

features like deadline timing, a floor planner, and a hot, very smart design manager.

You see, our goal is to build a development system that practically runs itself, and produces perfect designs in record time.

For the latest progress report, call our 24-hour literature hotline at 800-231-3386 for our product information and the Xilinx rep nearest you.

Because wherever you're going, we can get you there.



The Programmable Logic Company.™

© 1992 Xilinx, Inc., 2100 Logic Drive, San Jose, CA 95124. Europe, 44 (332) 349401; Japan, 81 (3) 297-9191; Asia, 852 (3) 721-0900. Xilinx is a trademark, and The Programmable Logic Company is a service mark of Xilinx, Inc. All other trademarks or registered trademarks are the property of their respective holders.

Transform Your World

EDN
Announces

DSP^x

Exposition & Symposium

...featuring the latest Digital Signal Processing applications and technology

San Jose Convention Center, October 14 - 16, 1992

The future of Digital Signal Processing is here. Improved technology has combined with decreasing manufacturing costs to produce a remarkably high rate of growth: DSP shipments grew a healthy 35% in 1991 versus 9% for integrated circuits.

Until now a current or prospective user could not turn to one source to learn more about DSP, its applications, and its benefits. Now there is DSP^x: Exposition & Symposium ...featuring the latest Digital Signal Processing applications and technology.

DSP^x focuses on the needs of the commercial market. It offers an applications-oriented approach to DSP, providing both an introduc-

tion for those not familiar with the technology and detailed tutorials for those exploring new avenues of implementing DSP.

DSP^x promises to bring together top vendors of DSP devices, boards, software, and systems with current and prospective end-users in the computer, communications, automotive, consumer, medical, industrial, military, and aerospace industries.

It's no longer a question of whether DSP will be part of your product. It's only a question of when.

Managed and produced by



DSP^x

Exposition & Symposium

...featuring the latest Digital Signal Processing applications and technology

Yes, I want to learn more about DSP^x: Exposition & Symposium...featuring the latest: Digital Signal Processing applications and technology

Please send me information on attending the One-Day Introductory Course

Please send me information on attending the Three-Day Conference Program

Please send me information on exhibiting

Name: _____

Title: _____

Company: _____

Address: _____

City: _____

State: _____

Zip: _____

Telephone: _____

Fax: _____

XAA

**For more information, call: (203) 964-8287, or
Fax to: (203) 964-0176 or Mail to: DSP^x, P.O. Box 3833,
999 Summer Street, Stamford, CT 06905-0833**

TWO ROOMS. TWO BUSINESS DEALS. TWICE THE PRODUCTIVITY.



EMBASSY SUITES[®]. TWICE THE HOTEL.SM



Free, cooked-to-order breakfast.

For people who travel a lot on business, there is no better partner than Embassy Suites hotels.

+Subject to state and local laws.

TWICE THE ROOM. A large private bedroom. A separate spacious living room with a well-lit work area perfect for small meetings. Each suite also has two telephones, two TVs, a wet bar with refrigerator, coffee maker and microwave. Computer modem hookup available in most suites.

TWICE THE VALUE. A free, cooked-to-order breakfast is served each morning. Two hours of complimentary

beverages+ each evening. Both sure to help keep your expense report in line.

Next time you need a hotel room, Think Twice.SM Then call your travel agent or Twice The Hotel.SM 1-800-EMBASSY.



**EMBASSY
SUITESSM**

In Mexico, call 95-800-362-2779.
Hawaii, call 1-800-GO-2-MAUI.

How

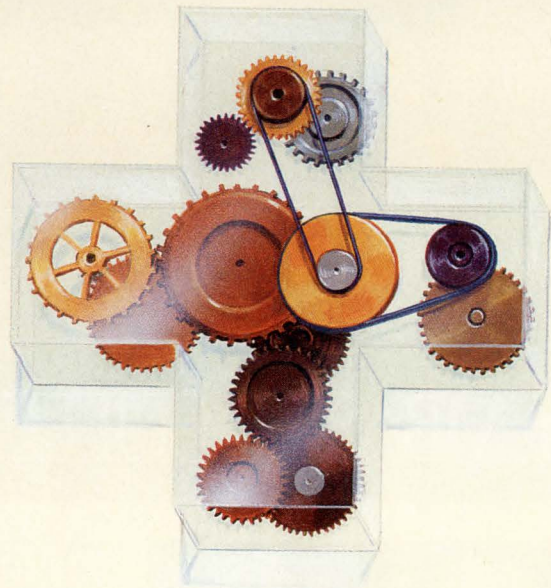
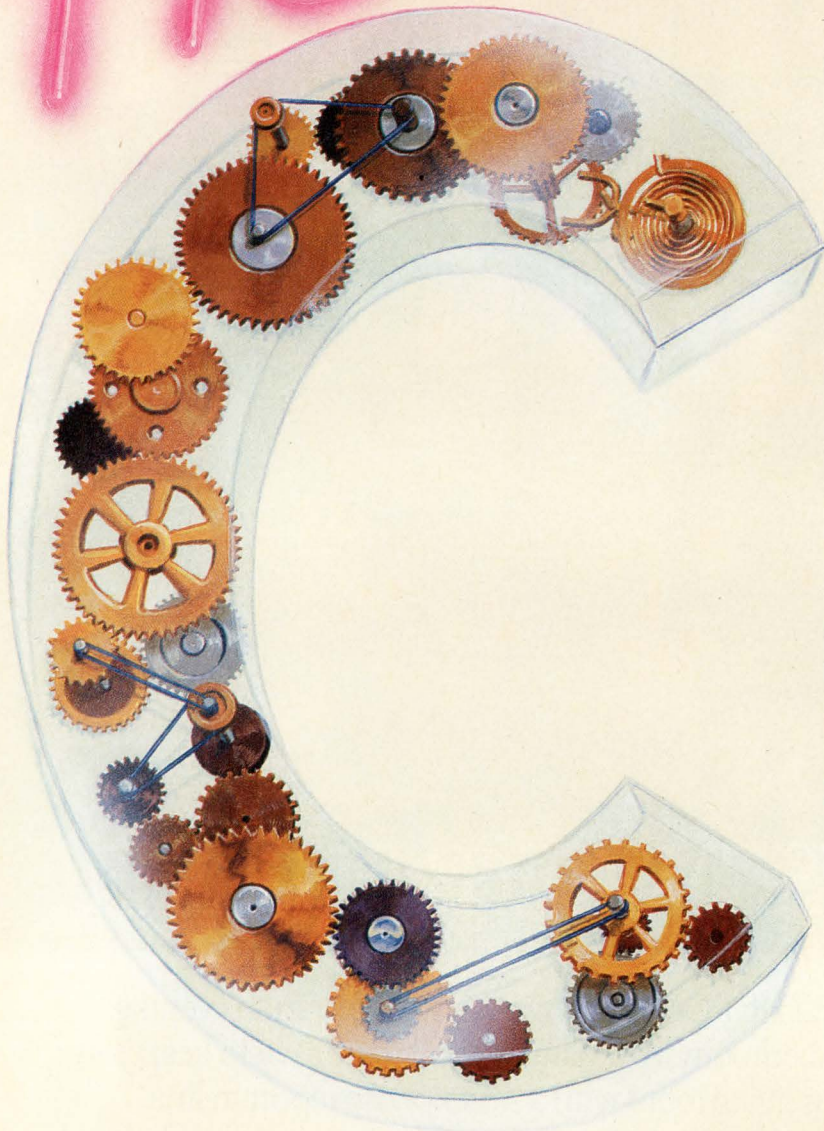

Despite the many similarities between C and C++, at run time, a C++ program can take some unexpected twists and turns.

Charles H Small, Senior Technical Editor

C++ tantalizes, proffering an easy upgrade to object-oriented programming (OOP). C++ is, with a few exceptions, a superset of C—an old and familiar friend. OOP will supposedly yield dramatic improvements in programmer productivity because objects are easy to reuse, enhance, and extend. Prophets tell us that the four essential properties of OOP (encapsulation, abstraction, inheritance, and polymorphism) make these benefits possible. Yet, all this OOPspeak can seem like so much self-referential gobbledygook.

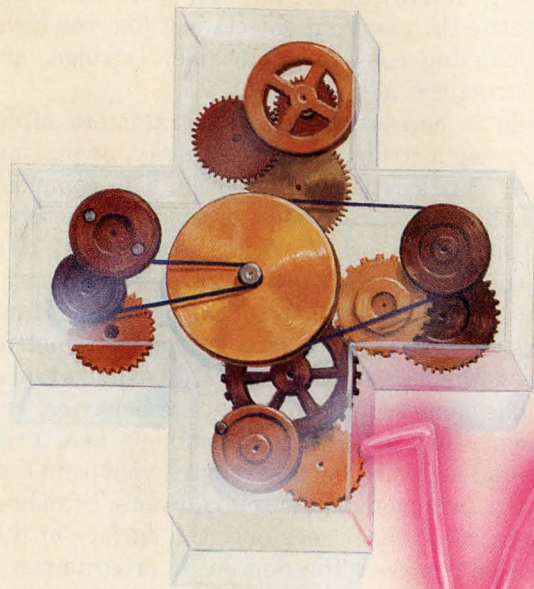

Works

Fortunately, like the man who was delighted to find out he had been speaking prose all his life, if you have ever programmed in any high-level language, you have been using a class to generate objects all along. The class is none other than the construct that defines arrays, such as DIM or []. And the objects are the arrays themselves.

The array is the archetype for objects. If you keep the properties of arrays firmly fixed in your mind, you should be able to relate OOP jargon to what you already know.

Consider the array-defining construct (class) as a little software factory that will spit out as many customized versions of its basic model as you choose to summon (**Fig 1**). At run time, the arrays (objects) that the array-defining construct has manufactured not only have defined areas of memory for data storage constructed according to your specifications, but they also have functions associated with them that you can use to manipulate the data.

In OOP terms, the arrays (objects) encapsulate both data and functions. You cannot get at the arrays' data directly; you must use the array functions to access the data. And, the compiler hides the exact details of the functions from you.

Arrays also exhibit polymorphism. What this OOP gobstopper means is that you can have arrays (objects) for different kinds of data—all of which work the same way. That is, you can define an array (object) of 8-bit characters, or 16-bit integers, or 32-bit longs and subsequently use what appears to you to be the same access functions no matter what the size of the individual datum in the array (object). Clearly the code that takes an array index as an argument must be doing different calculations to find data located every 8 bits in memory from those calculations needed to find data located every 16 or 32 bits. The array (object), in good OOP fashion, hides these messy details from you.

Now comes a key implementation detail. Obvi-

How C++ Works

ously, every time you invoke an array-defining construct (class), the compiler dedicates a separate area of memory for that array (object). But does the compiler also generate a set of array-manipulating functions for every array? Of course not; doing so would clutter the compiled code with numerous copies of the same functions. The compiler produces only one copy of the array-manipulating functions. Because compilers never forget, the compiler always knows how to connect any particular array's data area with the single copy of the appropriate functions.

Thus, in the case of C arrays, the compiler makes the link between the array-manipulating functions and the arrays at compile time. The OOP term for such linking at compile time is static binding. In some OOP languages, the compilers make no links between objects' data and data-manipulating functions. Instead, each object determines at run time, each time it is invoked, which data-manipulation function to use. The OOP term for linking at run time is late binding or dynamic binding.

For the most part, C++ statically binds objects' data and functions. Dynamic binding is more flexible, but incurs more overhead than static binding does.

Where necessary, you can use dynamic binding in C++.

With the model of the array firmly fixed in your mind, you can move on to C++. The guiding ideas for C++ are twofold: the first is to let you set up classes that generate objects; and the second is to let you manipulate the resulting objects just like you have been manipulating constants, variables, strings, arrays, and structures all along in C.

One aside is necessary here: Programmers often speak of passing a string, passing an array, or passing a structure. This locution is imprecise. The compiled code does not move entire strings, arrays, or structures from one place to another. What gets passed is a pointer to the beginning of the defined area in memory.

This article will examine some of the more important new programming constructs of C++ and attempt to explain how they actually work. The explanations, which include compile-time and run-time behavior, encompass more than a C++ programmer's ken. Programmers and software engineers have viewpoints as different as a swimmer's and a scuba diver's. Standing on the shore, a swimmer sees only the surface of the water; a diver perceives the depths. A programmer's view of a program is similarly shallow and limited to

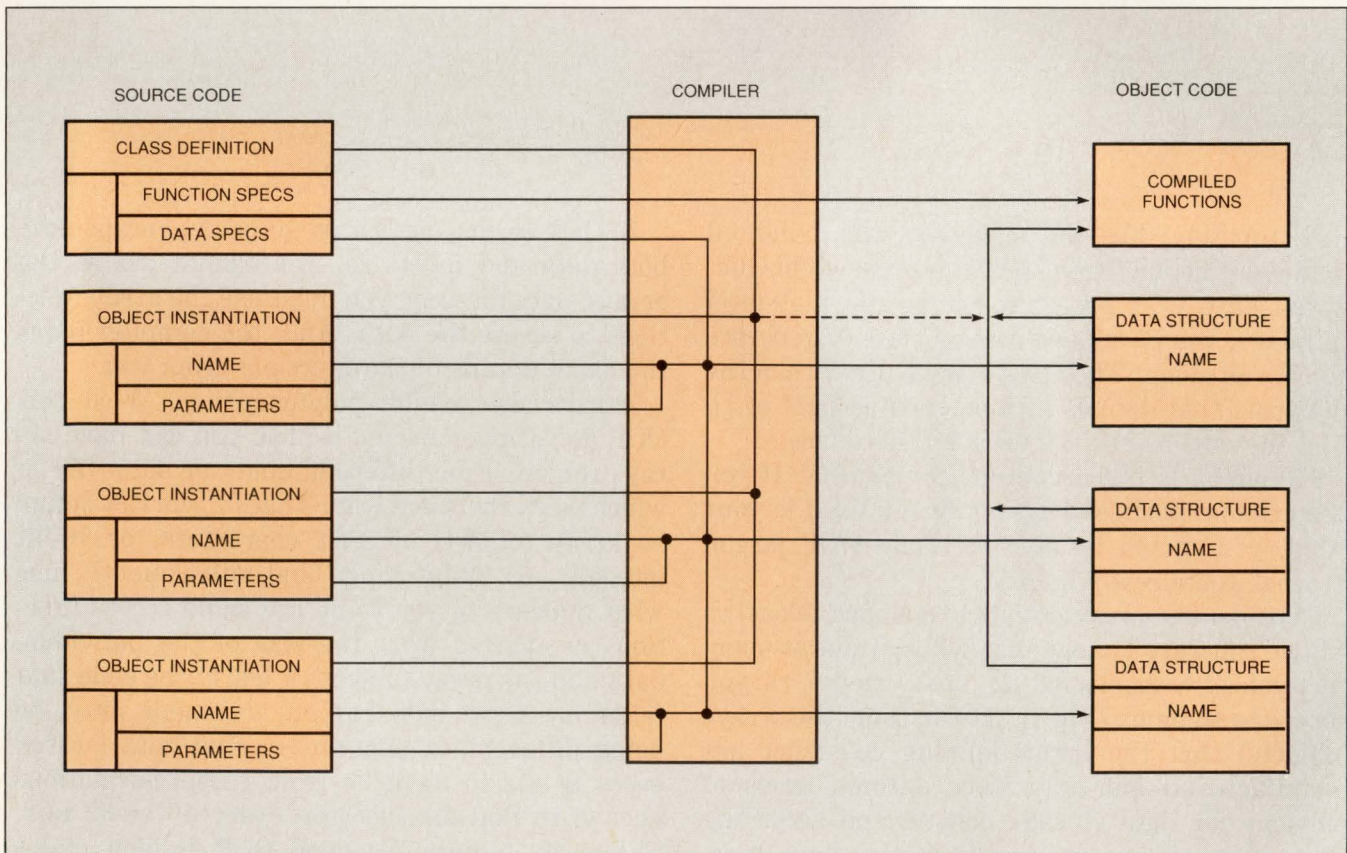

Fig 1—A class is a set of specs for data structures and functions that operate on those data. A class generates objects each of which has its own set of specified data structures and all of which share one copy of the specified functions.

the ASCII file containing the source code. A software engineer's concerns go far beyond the source code, taking in the actual object code and the hardware it interacts with.

You can divide the effects of C++ constructs into two broad categories: those that are internal to the compiler and which result in no run-time code or data structures, and those that result in object code or data structures. Further, the run-time effects of C++ break down into two subcategories: static effects and dynamic, run-time effects (Fig 2).

C++ compilers, just like C compilers (and all other compilers, for that matter), do more than simply translate the source code into object code. C++ adds hidden code to the source code. Thus, you cannot understand how a compiler works until you become aware of these hidden bits (see **box**, "Compilers slip hidden code into your programs").

The C++ format for defining a class is pretty straightforward. Suppose you are setting up a hierarchy of pc boards. First you need a "base" class from which you will "derive" other, more-specific classes. Remember that a class specification does not compile into run-time code. Using the class to make (instantiate) objects of that class generates run-time code.

```
class board {
private:
    int model_num;
    int sample_size;
    float reading;
...
public:
    void reset() {...}
    int get_model_num() {...}
    float take_reading() {...}
};
void main()
{
    board board_one;
    board board_two;
    board board_three;
    ...
}
```

This fragment declares a class called *board*. In typical OOP fashion, objects of the *board* class have private data and public functions that operate on those data. The C++ compiler is thrifty. Even though you can make (instantiate) as many *board* objects as you want (*board_one*, *board_two*, *board_three*, etc), the C++ compiler compiles the public functions only once. So Fig 3 is a simplified memory map of the result of compiling the code fragment. Each *board* object has its own data fields. But they all share the one copy of the *board* class' functions.

Just as with arrays, the compiler always knows where it put each class' functions. So when you invoke

a particular object's public function (using the typically cryptic relational operator ".")

```
board_one.reset();
```

the compiler knows which particular function the program needs to jump to and simply plugs the function into the compiled code. Recall that the term for this form of linking an object's code and data is static binding.

Derived functions

The *board* class, by itself, is not very realistic. Not all plug-in boards would be able to use a common *reset()* or *take_reading()* function. So you can derive more specific classes from the base class, *board*, adding functions and data items as necessary.

```
class board {
private:
    int model_num;
    ...
public:
    void get_model_num() {...}
    ...
};

class io_board : public board {
private:
    int io_slot;
    int sample_size;
    ...
public:
    void reset() {...}
    void take_reading {...}
    ...
};

class prom_burner : public board {
private:
    int io_slot;
    int sockets;
    ...
public:
    void reset();
    void burn_prom();
    ...
};
```

```
...//more board subclasses defined
```

Now the seemingly mysterious C++ property of inheritance becomes clear. The compiler knows that *io_board* is a subclass of *board*. So when the compiler makes (instantiates) an *io_board* object, for each object it sets up both the data areas specified in the *io_board* class's specification and the data areas specified in the *board* class' specification. Similarly, the compiler remembers that objects of the *io_board* class can use the functions defined in both the *io_board* class and the parent *board* class.

How C++ Works

Multiple inheritance, too, is just so much grist for the C++ compiler's mill. The program fragment

```
class mother {...};
class father {...};
class child : public mother, public father {...};
```

results in objects of the *child* class that have all the data structures of both the *mother* and *father* classes as well as access to all the *mother* class' and *father* class' member functions (Fig 4). After all, the compiler has complete specifications for all these data structures. Just as the compiler can concatenate dissimilar data items into a C *structure*, it can assemble any number of dissimilar data items into a derived class' object. And the compiler can easily remember where it put all the functions and who can use them. Compilers are very good at this sort of thing.

Note that in actual practice, C++ is a little more complex than the preceding discussion. Actually C++ has some modifiers for a class' own functions (member functions) that allow you finer control over just who can use which functions. For example, you can define functions that only the base class can use and which subclass objects do not inherit using the C++ keyword "private." You can also define base-class functions that subclass objects can use, but that nonrelated objects cannot use using the C++ keyword "protected." The compiler handles all these fine details at compile time. The restrictions on inheritance add nothing to your compiled code.

The objects you create have many of the properties of constants, variables, strings, arrays, and structures. As long as you inform the compiler of what classes of objects you are manipulating, you can "pass" and "re-

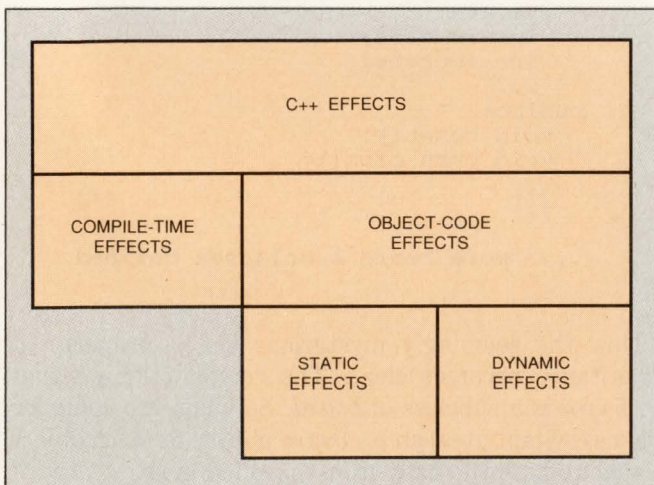

Fig 2—Not everything you type into your source file results in executable code in your object file; some of what you enter goes no further than the guts of the compiler. Conversely, compilers add hidden code that does not appear in your source file to your object file.

turn" objects to and from functions. (That is, you can specify an object as a parameter to be passed or returned and then the compiler will actually generate code that passes a pointer to your object.) You can embed objects in structures and assemble arrays of structures. You can define pointers to objects (which, confusingly, entails a new pointer operator "—>" for operation but recycles the old pointer operator "*" for definition). All these operations are possible because the compiler knows that every object is really just a defined, restricted data area—a data area which has some particular functions associated with it.

For example, the code fragment below defines an array named *backplane* of 15 of our old friends, objects of class *board*. Then it uses a combination of array notation and relational notation to call a member function of each object in the array.

```
...
board backplane[15];
for (int j = 0, j < 15, j++) {
  backplane[j].get_model_num(); }
```

Objects can even contain other objects. In this program fragment, the class *overseer* instantiates an ob-

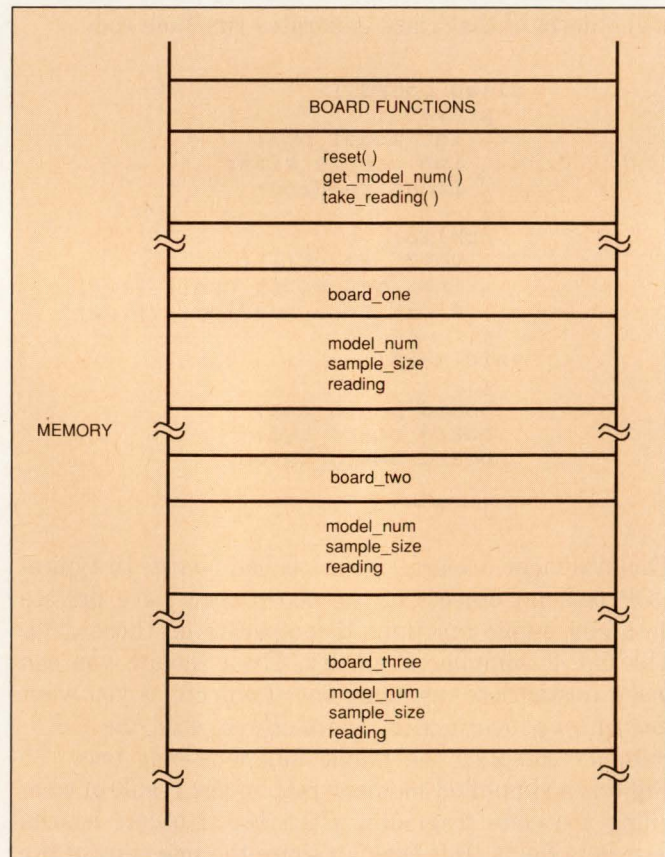

Fig 3—Three instantiations of the class *board*, *board_one*, *board_two*, and *board_three*, have their own data areas but share one compiled set of the class' member functions.

Compilers slip hidden code into your programs

The most common example of hidden code that C and C++ adds to your program specification is the overhead associated with setting up a so-called stack frame for each function call.

C's designers made good use of the general-purpose registers and the stack pointer possessed by the computers they developed C on. Noting that many variables were used only during the execution of short subroutines, the designers decided to set these variables up on the stack rather than allocate permanent areas of memory for them. Luckily, their host computers' stack pointers could perform relative and relative-indirect addressing. That is, a program could easily access data that was either at some known offset from the stack pointer or was pointed to by a pointer at some known offset from the stack pointer.

C's designers also decided to pass variables by value rather than by reference. Contrasting value and reference makes for a rather murky opposition. Examining the run-time behavior will hopefully clear things up. **Fig A** shows the stack that corresponds to the following C code fragment:

```
...
void main()
{...
  int m_one=1;
  int m_two=2;
  func_1(m_one, m_two);
  ...
}
void func_1(int one, int two){...}
```

The compiler, seeing that the integers *m_one* and *m_two* are active only within the body of the main function, will set them up as "automatic" variables on the stack. The compiler will concoct indexed-indirect stack-pointer instructions for any operation on these variables. When the *main()* function calls the function *func_1()*, the compiler inserts hidden code to set up *func_1()*'s stack frame and copies

m_one and *m_two* from *main()*'s stack frame into *func_1()*'s stack frame.

This arrangement has one big advantage: having only copies of *main()*'s variables, *func_1()* cannot corrupt *main()*'s variables. But this arrangement also has one big disadvantage: because C functions can return only one parameter, *func_1()* cannot return new values for both *m_one* and *m_two*.

Because C's designers had a mania for compactness, they limited C to returning one parameter so that C functions could stand in for variables. Only those who can remember back through the mists of time to the dawn of the computer age can appreciate why C's designers were so fanatical about making C text files as compact as possible. In those days, programmers entered their code line-by-line on electromechanical teletypes using balky line editors. These line editors let you revise a line with minimal pain; revising a paragraph was much harder.

But does the ability to embed functions in a line of code, along

with every other trick C uses to compress source code result in correspondingly compact object code? In a word, no; it's just a paper trick.

In C, the solution to this parameter-passing problem is to pass the function's pointers to variables back in the main routine. Then the functions could operate on the calling routine's local variables indirectly. C++ explicitly lets a function access the calling routine's variables by passing parameters by reference like this:

```
...
void main()
{...
  int @I(m_one)=1;
  int @I(m_two)=2;
  @I(func_1())( @I(m_one), @I(m_two) );
  ...
}
void @I(func_1())(int& one, int& two){...}
```

The ampersands (&) appended to the definitions of the parameters of *func_1()* mean that instead of obtaining copies of the calling function's variables, *func_1()* will operate, by indirection, on the calling function's variables. Without the ampersands, C++ works just like C. Here a simple change to the source code results in radically different compiled code.

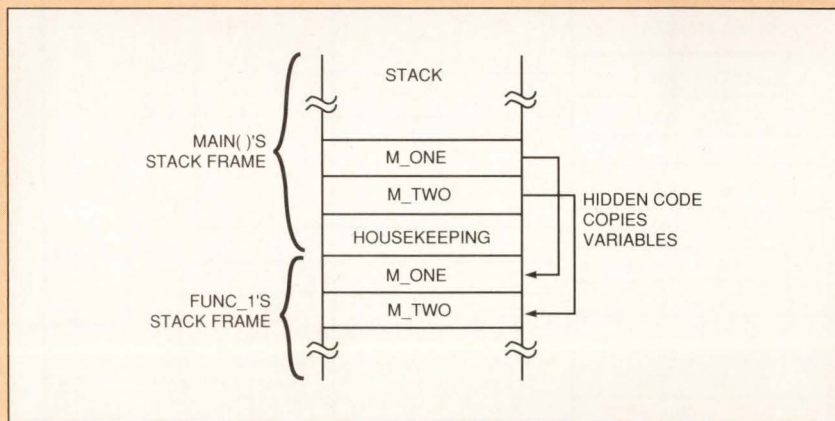

Fig A—C and C++ compilers insert hidden code at the entrance and exit of each function call to set up and tear down, respectively, a stack frame. In addition to the usual housekeeping data that calling a subroutine entails, each stack frame has places for each function's local variables. Further, if the calling routine passes parameters to the called routine, C copies the calling routine's data to the called routine's stack frame.

How **C++** Works

ject *peon* of the class *wage_slave* as a part of instantiating objects of the class *overseer*.

```
class wage_slave {...};
class overseer
{ wage_slave peon;
  ... };
```

Just like variables, objects can come alive only for the duration of a subroutine. C++ classes can optionally have a constructor that initializes an object's data structure and performs other housekeeping upon the object's creation. When your program kills an object, an optional destructor statement can do any necessary house cleaning. In fine C++ style, a `~` is the keyword that identifies a destructor.

```
class gatekeeper {
private:
  static int attendees;
public:
  gatekeeper() { attendees++; }
  ~gatekeeper() { attendees--; }
};
```

Every time you instantiate an object of the class *gatekeeper*, the constructor *gatekeeper()* increments the private variable *attendees*. Every time you kill a *gate-*

keeper object, the destructor *~gatekeeper()* decrements *attendees*.

But in some cases the compiler cannot make the link between data area and function at compile time. Suppose that after defining a workable set of *board* subclasses and creating a number of *board*-derived objects from the various subclasses, you try to manipulate them en masse. Specifically, suppose you make an array of pointers to all your *board*-derived objects and try to step through that array, resetting each pc board. Note that each subclass has its own *reset()* function. This situation certainly makes sense. You would expect different kinds of pc boards to have different reset functions. But the question here is not what do you expect, but what does the C++ compiler expect?

The answer, quite literally, is that in the case of an array of pointers to objects, the compiler doesn't know what to expect. A given pointer could point to an object of any subclass. So the compiler does not know at compile time which *reset()* function to plug in to the statement that indexes the array. So the compiler simply sets up a look-up table of *reset()* functions and jumps to the proper one dictated by the object being accessed.

The C++ term for this scheme is the unequivocal and inappropriately named virtual function. The so-

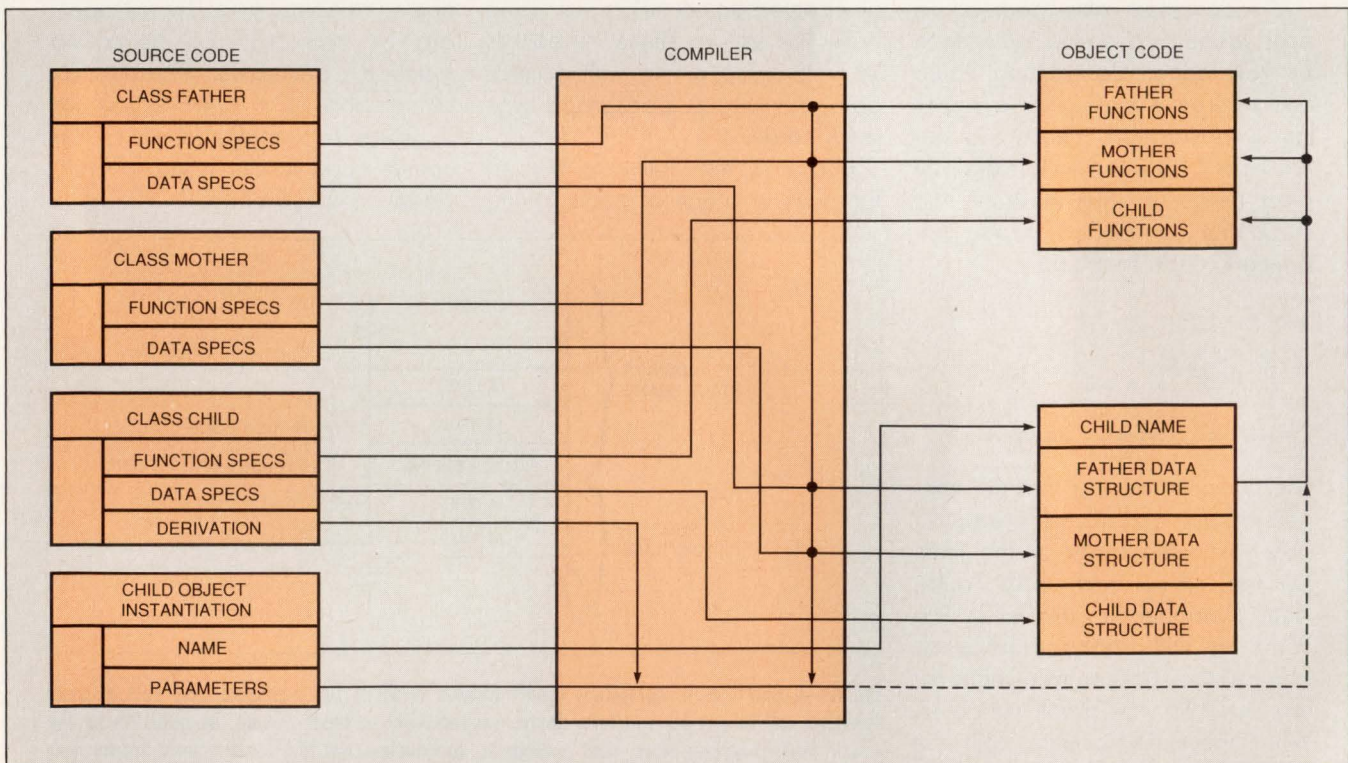
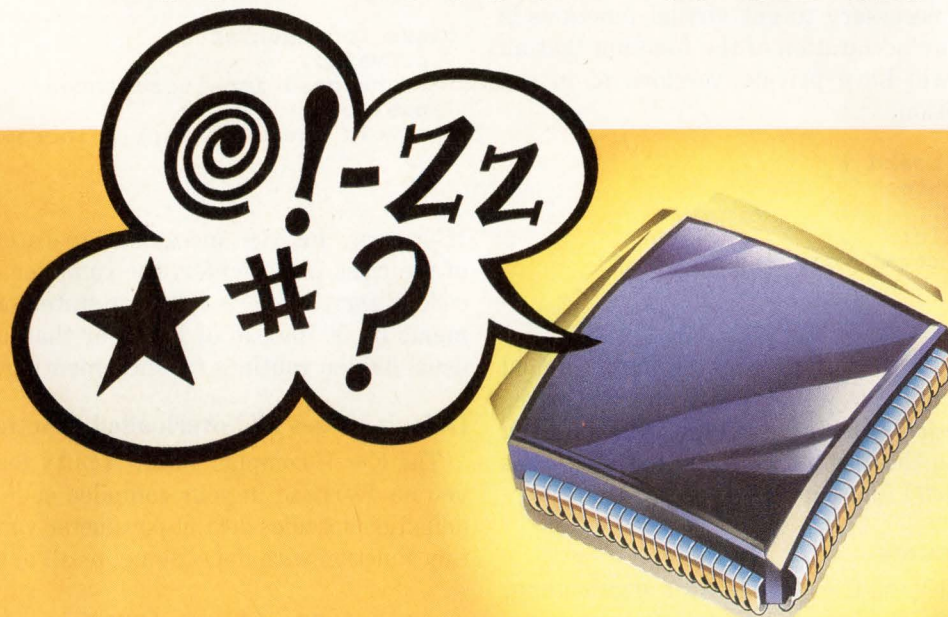

Fig 4—Derived from both the father and mother classes, an object of the child class gets private copies of father and mother data structures as well as access to father and mother member functions. Additionally, the child can have its own unique data structures and functions that the father and mother classes know nothing about.

For demanding designs, FPGA is no longer a four-letter word.



To push performance and logic density to obscene limits, you need an FPGA architecture you can fine tune. With the CLi6000 Series, you get the fastest, most symmetrical array structure available today. It's easy to understand and manipulate. With no complex cell logic puzzles to solve.

This advanced architecture takes the curse off of conventional FPGAs.

Now you can create pipelined, register-rich designs in much smaller arrays, because CLi6000 Series devices feature *thousands of registers*—many times the number of any comparable FPGA.



This architecture supports system speeds of up to 70MHz—*the fastest in-system performance* of any SRAM-based FPGA today. And it delivers *lots of I/O* too, even with low-density devices. So your high-I/O designs fit into smaller, less expensive arrays. Plus you get the *highest silicon efficiency*, with lots of small, powerful cells that pack plenty of logic into very little space.

When design talk gets tough, the tough talk to Concurrent Logic.

To order your CLi6000 Series Information Packet, call (408) 522-8703 or fax (408) 732-2765 today.

Or write Concurrent Logic, Inc.

1290 Oakmead Parkway, Sunnyvale, CA 94086.



Concurrent Logic, Inc.

All product and company names are trademarks of their respective holders.

CIRCLE NO. 50

EDN August 6, 1992 • 85

How C++ Works

called virtual functions are quite real and not the least bit virtual. You define them in your source code and the compiler compiles them into the object code. At run time, they really and truly execute.

The only trick necessary to get virtual functions is to include a dummy declaration of the function that all your subclasses will have private versions of in the base class's definition.

```
class board {
private:
    ...
public:
    virtual void reset() { }
    ...
};
```

Without this opaque subterfuge of the dummy virtual declaration, the compiler would woodenheadedly use the base class' *reset()* function for each subclass even if you had gone to the trouble to equip each subclass with a custom *reset()* function.

Overloading operators

Another key idea of C++, operator overloading, is nothing new either. Many existing C operators are quite overloaded already. Consider the C keyword ***. First of all, in some contexts *** means multiply. The same *** keyword can multiply different types of numbers, sometimes also automatically promoting one member of a mixed-type multiplication. In those other contexts where *** defines pointers, the same operator can define pointers to a host of different kinds of data. Think about it: Just like the index operators for arrays, the compiler must be selecting the appropriate hidden code to make the multiplications come out right and the pointers point properly.

C++ does not let you concoct your own operators as some OOP languages do. But C++ does let you make up custom definitions for any of the regular C

operators. C++ compilers will use these customized operators only for objects of classes you specify. The syntax for overloading an operator is straightforward.

```
class incremter {
private:
    unsigned int incrementee;
public:
    void operator ++() { incrementee + 50; }
};
```

If you use the *++* increment operator on any object of the class *incremter*, the compiler will plug in the code in *incremter*'s operator statement (which increments by 50 instead of 1) rather than using one of the usual hidden routines for incrementing.

Default values and overloaded functions

The C++ compiler offers a nifty feature that costs you no overhead in your compiled code. If a function's definition specifies default parameter values, you can call that function with none, some, or all of the parameters.

```
void func_2(float fnum=2.3, int inum=6)

void main()
{
    ...
    func_2();
    func_2(4.4);
    func_2(4.3, 3);
    ...
}
```

The compiler will plug in your specified default values for any missing parameters. This feature is another example of overloading.

Inline functions

C++'s inline functions hardly merit any justification at all after you realize how much overhead a function

Embedded C++ has single source

C++ compiler vendors obviously don't think that engineers will be using C++ for embedded systems. All the commercial C++ compilers are native-code compilers that run on, and produce compiled code for, a handful of common host computers.

Luckily, the ever fascinating, non-profit Free Software Foundation's

GNU C++ compiler runs on dozens of hosts, compiles code for over 40 processors, and handles any number of obscure file formats. The compiler, complete with source code no less, is available for only a media charge. If you have access to Internet, you can skip the media charge (**Ref 3**).

Free Software Foundation

675 Massachusetts Ave
Cambridge, MA 02139
Phone (617) 876-3296
Internet opus@gnu.al.mit.edu
Circle No. 650



Why our chip inductors are more attractive for your high frequency applications

Theirs.

Ours.

The point of this little demonstration is that Coilcraft surface mount inductors are made of ceramic. A decidedly non-magnetic material.

Most other chip inductors are made of ferrite. Which is great for demonstrating the principles of magnetism, but not so hot for high frequency magnetics.

Take self resonance, for example. SRFs on our coils are up to 3 times higher than equivalent ferrite chips. And located a safe distance away from your operating frequency.

The actual inductance you'll get with Coilcraft chips at higher

frequencies is very predictable and consistent. Not so with ferrites. Beyond the test frequency, their inductance curves rise steeply and vary significantly from part to part.

Coilcraft ceramic chips also have a low temperature coefficient of inductance: +25 to +125 ppm/°C, depending on inductance. TCLs on ferrite chips are often two to four times higher!

And if you need close tolerance parts, we offer even more advantages. Thanks to our computer - controlled manufacturing and ceramic's neutral properties, it's easier for us to make 5% or 2%

parts. We can even production-test at your operating frequency! Other chip makers have to cope with ferrite's permeability variations, so their yields are lower. Which means delivery can be unpredictable.

So next time you're selecting surface mount inductors, forget the ferrite and stick with Coilcraft ceramic chips.

For complete specifications and information on our handy Designer's Kits of sample parts, circle the reader service number. Or call 800/322-COIL.

Coilcraft

See our catalog in Vol. A, Section 1800
ECM/electronic engineers master

1102 Silver Lake Rd., Cary IL 60013 800/322-COIL Fax 708/639-1469

CIRCLE NO. 51

EDN August 6, 1992 • 87

How C++ Works

call entails. An inline function works just like a macro definition in an assembly program.

```
inline float func_3(float temp)
{
    return 3.414 * temp;
}
```

A short function such as *func_3* is a good candidate for being an inline function. The compiler will simply plug in *func_3*'s code every place in your program where you invoke *func_3*. Just as for a macro, you must trade off program size for program speed when deciding whether to use an inline function or not.

The OOP precepts of encapsulation and data hiding mean that one object's functions should not be able to access another object's private or protected data. Of course C++ wouldn't be an extension of C if it didn't offer you a way to kluge things up. By declaring a function to be a *friend* function in the definition of two classes, the *friend* function can then operate on data from both classes of objects in one function call.

```
...
class laurel {
private: int joke;
public:
    friend int kluge(laurel x, hardy y);
};
class hardy {
private: int joke;
public:
    friend int kluge(laurel x, hardy y);
};
int kluge(laurel x, hardy y)
{ return ( laurel.joke + hardy.joke; ) }
void main() {
    int joke_total;
    laurel stan; hardy ollie;
    joke_total = kluge(stan, ollie);
}
```

The *friend* declaration is just so much more busy work for the computer. Certainly, the compiler has enough clues about what you intend. The *friend* function *kluge* has a function "prototype" in both the *laurel* and *hardy* classes as well as its own function definition. In *main()*, *kluge* takes objects of the *laurel* and *hardy* classes as arguments, accessing data of two different classes of objects in the same function call. This construction has no particular effect on your compiled code because the compiler is just doing what it does anyway: matching data structures to allowed functions.

What the *friend* construct can do to your program's design is a matter of raging debate. *Friend* functions outrage OOP purists. They predict that *friend* functions will lead to spaghetti code.

OOP is not a panacea. Small's second law of software, "You can write a bad program in any language," applies equally well to C++. A fanatical OOP programmer can compress and condense his source code wonderfully. But at compile time the compact source code could expand into a cumbersome plodder of a program. OOP deliberately emphasizes the relationships between things while suppressing the processes that operate on these things. Thus, you could lose sight of how things work.

Learning the new syntax of C++ is not difficult if you are already familiar with C (Ref 1). But changing your mindset from procedural to object-oriented programming takes time; six months is a common estimate. Breaking a problem down into a hierarchy of objects is far from an exact science. And no method exists to test how optimal a given breakdown is.

Proponents fervently hope that C++ will lead to more code sharing and reuse. While a given programmer may be able to reuse his own code more easily, code sharing within and among companies depends on

Editor's analysis

Programmers have a long history of semiliterate, inappropriate, muddled, or just plain silly neologisms. No one knows why programmers feel the need to have many different words for the same thing (function, procedure, subroutine, and method) or use the same word for a multitude of different things (virtual, environment). Programmers put unrelated words in opposition (logical vs real) or confound them (using argument and parameter interchangeably).

This tendency to use real words and nonsense words Alice-in-Wonderland fashion leads to puzzling, unevocative terminology. A classic example from C is dereference. To reference (that is, refer to) a memory location is to get its contents. But some locations are pointers whose contents are the addresses of something else. So far so good. Programmers refer to getting the contents of the memory location pointed to by the pointer as dereferencing the pointer, perhaps by

conflating derive with reference. A quick trip to the dictionary reveals that dereference does not accord with any other use of the prefix "de-" in the English language.

C++ continues this tendency with the inappropriately named virtual function. Something that is virtual is present in essence or effect, but not in fact. As demonstrated in the main body of this article, virtual functions are quite real and not the least bit ethereal.

Clean, dependable power.

AMPLIFIED

When you're powering high-current or sensitive industrial equipment, that power had better be clean and constant. But most important, strong.

Techron power amplifiers. They're the industry's heavy hitters when it comes to clean dependable high-current power. Techron power amplifiers reduce filtering requirements and give you a true power supply you can count on.

- ◆ Super-clean power from DC to 50 kHz.
- ◆ Total Harmonic Distortion: At 0.4% or better, one of the most distortion-free power sources in the industry.
- ◆ Inner Modulation Distortion: .001%
- ◆ Limiting: instantaneous with no flyback pulses, thumps or cutouts.
- ◆ Amplifier Output: Short-, mismatch- and open-circuit protected in voltage mode.
- ◆ Phase shift between input and output: from DC to 20 kHz less than -20 degrees.

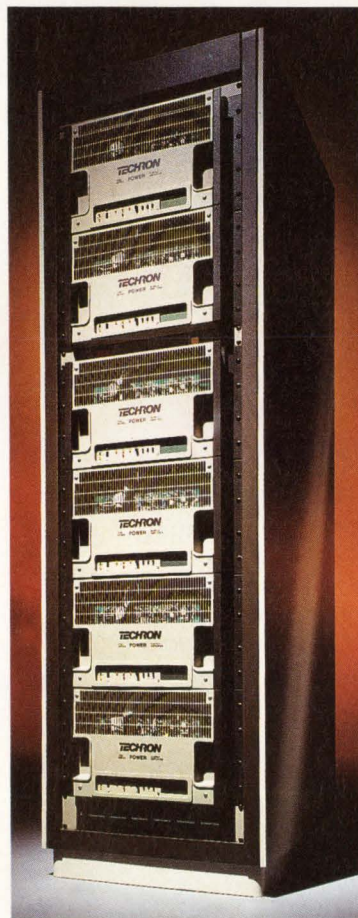

The right power

Different applications require specific solutions. That's how Techron came to be the power of choice for the gradient subsystem of one of modern medicine's most important diagnostic tools, the Magnetic Resonance Imaging systems. MRI manufacturers choose our power amplifiers which utilize advanced bi-level power supplies with clean, low-noise and linearity.

Tell us your application requirement. During development or in final application, Techron will back you up. With standard product or custom-configured amps. As a line voltage regulator and/or line voltage generator system. Working with you to solve power supply problems is what we do best.

That's what we mean by clean, dependable power. Amplified all the way down the line. Call Techron for more power than you've ever had before. **1-800-933-7956**

TECHRON

1718 W. Mishawaka Road, Elkhart, Indiana 46517

How C++ Works

more than a good language. A host of organizational, territorial, legal, financial, and archival problems overshadow the problems of grafting a foreign bit of code into a program. While **Ref 2** is ostensibly about reusing Ada code, the article actually describes the tough, real-world problems of code reuse that have little, if anything, to do with computer languages.

C++'s objects and operator overloading particularly suit the language to scientific computing. Who knows? C++ might slay the ancient Fortran dragon. But despite past reports of Fortran's impending death, it is still with us, alive and kicking. **EDN**



The EDN Readers' Electronic Bulletin Board System (BBS) has considerable C++ material. Call (617) 558-4241 (300/1200/2400,8,N,1). Access the /compiler, /util, and /tutorial Special Interest Groups (SIG) and do a keyword search for C++ by entering "rkC++" after you have gotten to each SIG's menu. The EDN BBS has C++ compilers, preprocessors, libraries, and computerized tutorials.

References

1. Ellis, George, "C++ has C's familiarity and OOP capability," *EDN*, January 2, 1992, pg 97.
2. Small, Charles H, "Adopting Ada is first step to code reuse," *EDN*, August 20, 1990, pg 71.
3. Fraser, Jay, "Keeper of the faith: Richard Stallman is leading a crusade to preserve your programming freedom," *EDN*, October 1, 1990, pg 174.

You can reach Senior Editor Charles Small at (617) 558-4556; FAX (617) 558-4470.



Acknowledgments

The author wishes to thank Pat Arcand and Kech Holt of Intermetrics Microsystems Software Inc, Cambridge, MA, for their invaluable assistance with this story.

Article Interest Quotient (Circle One)
High 473 Medium 474 Low 475

At half the price, our current limiting diodes have few limitations.



Designing in our high reliability current limiting diodes makes a lot of sense.

They offer superior circuit performance, superior lot-to-lot consistency, and superior thermal characteristics . . . in a space-saving, hermetically sealed glass case. Motorola-equivalent leaded or SMD versions are available at about half the price. Special selections also available.

Available Types:

1N5283 THRU 1N5314 (leaded).
CCL0035 THRU CCL5750 (leaded).
CMCL1300 THRU CMCL 1304 (leaded).
CCLM0035 THRU CCLM5750 (SMD).

Pencil in Central. For more information, write or call.

Central 
Semiconductor Corp.

Central: We make the difference.

145 Adams Avenue, Hauppauge, NY 11788
Phone (516) 435-1110 FAX (516) 435-1824



Aren't you a little old to be putting batteries in your toys?



Nonvolatile random access memory is a grown-up problem. But now, you can design in nonvolatility without batteries and without sacrificing performance, reliability, density, or anything else. With the nvSRAM from Simtek.

It's truly a one-chip solution. At 64K, Simtek's nvSRAM has four to sixteen times the capacity of competing products. With access speeds from 30ns-55ns, it's fast too.

Of course, since there's no battery to fail, you can forget about reliability worries.

Skeptical? That's why we'll send you a Simtek design kit. Free. And we guarantee you'll have it within 48 hours. So call

Simtek at 1-800-637-1667 right now

for your free design kit or call us for details on where to buy production quantities. And see just how well your toys can run without batteries.



SIMTEK

719-531-9444 Fax 719-531-9481

CIRCLE NO. 54



If You're Not Using DuPont Berg Stik II, You Should Have Your Headers Examined.

If you haven't made the switch to DuPont Berg Stik II headers, take a good, hard look at the headers you're using now – including Berg Stik I. Because DuPont Berg Stik II delivers all the quality and performance features you need – even for your toughest applications.

You can get Berg Stik II headers with a wide range of today's most advanced features. High temperature plastic. Surface mount configurations. And DuPont's

patented retentive leg that keeps the header secure during assembly.

You can even specify Berg Stik II headers with customized polarization, a variety of pin lengths, single or double row vertical versions, "Better Than Gold" GXT™ plating, and DUFLO® Solder Preforms.

Best of all, Berg Stik II headers are competitively priced, and available for immediate delivery.

For more information about the

flexible, low-cost Berg Stik II header line from DuPont, call 1-800-237-4357. And get a header above the rest.

Available in high-temperature plastic.

GXT™ plating outwears and outperforms hard gold plating.



Retentive leg keeps header secure during assembly.

U.S.: (800) 237-4357 • Canada: (416) 821-3300 • Argentina: 54-1-312-2011 • Brazil: 55-11-421-8122 • Mexico: 525-250-90-33 • Venezuela: 58-2-92-6022 • Europe: 41-(22) 717-5111
Japan: 81-3-3585-5511 • Australia: 61-2-923-6111 • Hong Kong/China: 852-734-5345 • Korea: 82-2-721-5114 • Singapore: 65-273-2244 • Taiwan: 886-2-719-1999

DuPont Electronics



Three-step method evaluates neural networks for your application

Jeannette Lawrence and Peter Andriola, California Scientific Software

Characterizing your problem and assessing the available data may lead you to formulating a neural-network implementation. If the problem type fits and the data is sufficient, a neural network can do the thinking for you.

Neural networks are the core of many well-known applications, including sonar that can recognize submarines, robots that learn how to avoid obstacles, and computers that read words aloud on the fly. But odds are that you're working on yet another application and you need to determine whether a neural network would be effective for you. Just being familiar with many neural-network applications doesn't give you an answer. You need an organized approach to assessing new problems and evaluating possible ways this technology can solve them. Armed with such a methodology, you can quickly determine the effectiveness of a neural network for any particular project without wasting development time and money.

A good methodology would explain why and when neural networks could be useful and would help you determine when another design approach might be better. The methodology discussed in this article provides you with a general-purpose evaluation broken down into three steps: characterizing the problem, assessing the available data, and formulating a plan for fitting the neural network into the total design. After presenting this methodology, we'll use it to evaluate three ways that you can use neural networks in an automated assembly and test system.

Neural networks perform a unique type of comput-

ing, requiring you to look at data and problems differently from when you use traditional techniques. You can forget logic, memorized formulas, and compilers, because neural networks don't read Boolean, calculate well, or understand rules. Neural networks are non-linear associating devices able to solve complex relationships that are often difficult to express with rules or math. If you give a neural network a set of example situations and results, it will "learn" to generalize for similar cases.

In our experience, only one neural-network algorithm—back propagation—has proven to be widely effective, though many exist. To save time and space, we'll limit our scope to neural networks of this type (see the **box**, "Seven design steps," for a summary of neural-network design). For an in-depth explanation of neural networks' operation, see Maury Wright's Technology Update, "Neural networks tackle real-world problems," in the November 8, 1990, *EDN*, as well as the references at the end of this article.

Defining the problem

Because you define neural networks without math, rules, or programming, problem definition often involves looking for new types of solutions. Neural networks handle certain types of problems well, and often you can redefine an old problem as one of these types. If you can think of a problem as pattern recognition, classification, evaluation, modeling, prediction, or control, a neural network is a good tool to use. Any problem that a system can solve by associating some input pattern with another output pattern offers good potential for solution by neural-network technology.

For example, consider a process-control problem in

NEURAL NETWORKS

which an expert system determines the appropriate control law depending on the state of the process. You can redefine this problem as associating the neural-network input pattern (the state variables) with the output (the control law), as shown in Fig 1. This approach allows you to use a neural network to model and control the plant (Ref 1). When a process model must include the effects of time (such as the progress of a chemical reaction), the input data would include recent-past data for the previous states.

You can express many such problems as a kind of pattern recognition that identifies the input, perhaps by a set of characteristics, such as round or square, or perhaps by a unique name, such as "capacitor." Signal processing and filtering are examples of pattern-recognition problems that neural networks handle well (Ref 2). When filtering a noisy data channel, the receiver must determine which of the noisy signals is the original one. You can train a neural network to do this using samples of noisy inputs and uncorrupted signal output. Classification and evaluation are closely related tasks in which the neural network sorts through lots of data and categorizes the data by such features as quality, physical position, noise level, etc.

You can often redefine a sequential "if-then" problem as a pattern-recognition task. Suppose, for example, that you have collected some results from testing a bad electrical assembly (the input pattern). You can set up a neural network to recognize which pc board to swap out, or which component to replace on a board (Ref 3). Rather than program the conditions under which each pc board or component might exhibit various kinds of failures, you can train a neural network on examples collected from failures that repair technicians have diagnosed. When examples are readily available, such a network is often easier to use, cheaper, and more accurate than automatic test equipment or diagnostic software.

If the problem involves modeling some behavior, particularly nonlinear behavior, then a neural network is an excellent tool. You can use a neural network to model any process with an input/output relationship, including production processes and human, mechanical, financial, or chemical behaviors. Neural networks can grasp very complex nonlinear behavior without specific formulas or rules.

Assessing the data

It is critical that you assess the available data before committing to a neural network. If you don't assess data properly, you may waste a lot of time training, redesigning, and retraining a neural network that will not learn to solve the problem because the data set you're feeding it is poor. You must have an ample,

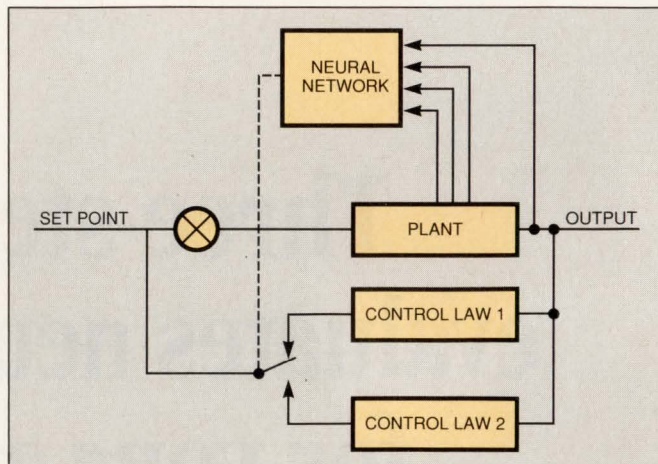

Fig 1—A neural network can choose the appropriate control law, given the current control law and the current state of the plant.

truly representative collection of example data and known inputs and outputs to train and test with. If no examples are available, and you can't generate any, then a neural network is not the tool to use. You're better off with a traditional technique such as a program, an expert system, or digital logic.

The example data can be a historical collection, such as records of production-line failures and the corrective action taken, or experimental results. Alternatively, you can create a training set. For example, a filter's training set could consist of many examples of both data or signals mixed with added noise (network input) and clean data or signals (network output). You can also generate data using simulation software, or by creating random examples (inputs) and having human experts classify them (to identify outputs). In any case, you don't need to define underlying principles, rules, or math. You don't even have to understand how to solve the problem. Knowing which data are relevant is the key.

The most difficult aspect of assessing data is judging its quality. Good data is relatively clean and contains the important variables needed to make associations. The data must include enough examples of sufficient variety for the network to generalize. You should include a good distribution of possible inputs and outputs; if 90% of the examples depict one outcome and 10% of the examples depict another, the neural network may have difficulty learning the latter outcome. The data doesn't have to be perfect or exact; neural networks can tolerate noisy data and will learn to generalize regardless, if given enough examples. However, if two examples contradict each other, the neural network cannot learn that both are true. The best data contains no direct contradictions and very few ambiguous cases. Contradictions and ambiguities often occur

when human experts rate the examples, such as for a quality-assessing application.

Generally speaking, the more examples you can collect for training and testing, the better. Having enough data is even more important than having good data. Unfortunately, no rules or formulas exist for calculating the appropriate quantity, because that depends on the complexity of the problem to be solved. Most applications having 30 or fewer inputs and a few outputs need at least 100 examples, and 1000 is a safer guess. If the data typically falls into categories or tends to cluster around certain examples, then fewer are needed. If the input set could include almost any combination of input values, then you must add more examples for training.

One approach that can save some design time is to identify the border cases, if they are apparent in your data. In a border case, a small change in input causes a notably different output. If you supplement a set of border cases with examples created using randomly generated input patterns, you should have sufficient data to train the network. Be sure to have the corresponding outputs for the random inputs properly rated by experts or generated by a reliable simulator.

Certain problems are too big for neural networks to learn in a reasonable amount of time. If the system has thousands of different continuous-valued input

variables and thousands of example input/output sets, then the problem may be too large. The largest, most successful network we know of has 1440 inputs and 20 outputs and was trained with 200 Mbytes of data. This particular network reads a line of text from a medical journal, paper, or book and classifies the material as author, title, publisher, table of contents, abstract, etc. After roughly 100 training runs (which took many weeks on a 80386 machine), the neural network learned all training examples with 96% accuracy. In three months of use with 400 Mbytes of new data, the neural network made no errors. Though a network this size is not out of the question, a design with over 1000 inputs and this much data is very unusual.

If you are unsure about the quality or quantity of data available, you might consider a quick training session to see if the neural network can solve the problem. A good test may take only a few days of effort (if you already have some data) using software you can find for a few hundred dollars.

Designing an implementation

You can train most neural networks using software simulation. Once trained, a neural network can operate in software, hardware (specialized chips), or a combination of the two. You can use neural networks as complete solutions or include them within a larger design

Seven design steps for back-propagation neural networks

Step 1. Decide what you want your neural network to predict, generalize, or recognize. Examples include noise reduction of an ultrasound signal, recognition of a submarine from sonar, and diagnosis of production-line failures.

Step 2. Decide what information you want your neural network to use as inputs for generating its predictions, generalizations, or recognitions. For example, pressure readings, temperature, quantities of chemicals, and material-combining processes may predict the outcome of a chemical experiment.

Step 3. Get some data. To train your neural network, you must have examples of input data (ie, what you know when the network is implemented) matched with output results (what you will be asking the

network to tell you). The sample training data is like a set of flash cards that the neural network will learn to generalize from. The data may come from historical databases, tests, simulations, expert opinions, etc.

Step 4. Build a network. The two things you need to create a working neural network are a definition of the network and a collection of data. The definition includes number of inputs and outputs, number of hidden neurons, and possibly other specifications such as the neuron transfer function.

Step 5. Train your network. The neural-network simulation software does this for you. You don't need to train the neural network to 100% accuracy for all training examples. You specify the level of accuracy desired.

Step 6. Test your network. In order to be sure that you have a good network, you must show it data it has never seen before and check the results. If the results are correct, you're ready to use your network. If not, you'll have to get more or better data, or redesign your network. Often, adjusting the number of hidden neurons or connections will improve the ability of the network to generalize for new data.

Step 7. Run your network. Running a network consists of presenting it with new input data and gathering the usable result. You can run a neural network from within the simulation software, from another program, or on a chip (for high-speed operation without the overhead of an operating system).

NEURAL NETWORKS

that is controlled under another scheme, such as an expert system. The trained neural network exists as a matrix of connection values (weights), which you can put on a computer disk, in program memory, or onto a chip. Running the trained neural network involves presenting current data at the inputs and observing the results at the outputs. Many neural-network programs offer compilable code for calling the neural network as a routine.

Speed is one advantage of neural networks over traditional programming techniques, even when the neural network is implemented in software. The output comes as an immediate response to many highly interconnected "neurons" operating in parallel, rather than from a sequence of logical or mathematical operations that define some input/output behavior. For truly fast operation, you can implement a neural network on a specialized chip. The fastest neural-network chip, Intel's ETANN 80170, can cycle through a complete network with up to 128 inputs and 64 outputs in about 3 μ sec. It interfaces to either analog or digital signals.

Time and size considerations can make or break a neural-network implementation. **Table 1** offers some guidelines for the response time of various-sized networks running on different chips, boards, and computers.

The following application demonstrates several ways neural networks can be useful. Suppose you want to automate the assembly and test of a 5V dc/dc-converter circuit board. Although conventional board-stuffing equipment is adequate for handling common resistors and capacitors, power supplies have nonstandard parts, such as transformers and inductors, that usually require hand installation. You'll need a more flexible robotic system to handle such parts. Because parts like these can't be lead-taped, the insertion machine will have to handle them in loose form. This kind of handling will require a machine-vision system to identify the part's orientation so that the robot can pick it up.

Because you would want this system to operate unattended most of the time, you should have it perform self-diagnostic testing. The system should also help reduce board-testing costs not only by automatically identifying a nonfunctional unit but also by diagnosing the probable cause of the failure. You can use a neural network to solve these three problems:

- 1) determining the orientation of parts for robotic insertion
- 2) performing diagnostics on the robotic equipment
- 3) testing the completed circuit board and diagnosing component failures.

You should apply the three evaluation steps discussed earlier to determine whether to use a neural network to solve these three problems.

You have two parts, a transformer and an inductor, which you want the robot to insert. Both parts are

encapsulated in rectangular potting forms with radial leads on a 0.250-in. pitch. The robot fingers need to align within 20° of the sides of the part for the fingers to properly pick it up. A vibratory feeder delivers parts to a table where they land with random orientation. A camera forms an image of each part delivered by the feeder. The system must process the picture data and assign one of the eighteen ($360^\circ/20^\circ = 18$) possible orientations to the part. It also must be able to determine the orientation regardless of the location of the part within the camera's field of view.

You can set up the system to determine the orientation of the part in two steps. First, locate the part in the camera's field of view. You can do this by training a neural network to output the location of the center of the part. Another way to do this is to use traditional methods such as calculating the centroid of the part. Once the system has located the center, it can determine the part's angular orientation. You can use a neural network to classify the part's orientation into 1 of 18 categories.

The camera image is 1024 pixels on a side, but you cannot train a network with that many inputs (over a million) in a reasonable amount of time. So you'll have to do some preprocessing of the raw camera data to reduce the problem size, first by locating the center of the part, and second by focusing in on the area around the part. Then the system can determine the orientation. Simply tiling the picture will provide you with data that you can apply to the neural network.

Table 1—Running speed of representative neural-network implementations¹

Computer or chip	Number of inputs/outputs			
	20/2	100/10	1000/10	4000/20
80286 8-MHz PC	0.0039	0.0975	8.221	130.26
80386 25-MHz PC	0.00086	0.02150	1.8129	28.724
80486 33-MHz PC	0.00041	0.01018	0.86428	13.694
Brainmaker Professional Accelerator Board ²	0.000081	0.00204	NA ³	NA
Micro Devices MD 1220 chip	0.000024	0.000611	0.0506	0.8016 ⁴
Brainmaker Accelerator Board	0.000006	0.000153	0.01265	0.20206
Intel 80170 ETANN chip	0.00000012	0.000003	NA	NA

Notes: 1. The number of hidden neurons is estimated at half the number of inputs plus outputs. The speed, in seconds, is the response time of the trained neural network while running. Training times will be greater. Software speed estimates are for the Brainmaker software package; speeds for other packages may differ. Relative speed differences among computers should be similar for other neural-network software packages.

2. 512 inputs max

3. Not applicable

4. Estimated

NEURAL NETWORKS

Tiling means grouping some adjacent pixels (a 16×16 square in this case) into a single value. The first neural network outputs the location of the center of the part, and this data restricts inputs to the second network to just the pixel information from the area local to the part. Fig 2 depicts the two networks. You train the first network simply by providing it with sample pictures of the part in various locations along with the center X and Y coordinates.

The area surrounding the part takes up $\frac{1}{4}$ of the full field of view or 512×512 pixels. But a network with this many inputs may take weeks to train, so you can tile the 512×512 area down to 64×64 . In a case like this, all the system has to do is identify the orientation of the part's edge that has the leads on it, so losing some granularity is not important.

The second orienting network will need at least a few hundred training examples. You can easily generate these by rotating the part in 0.1° steps. At each step, save the camera's output along with the orientation of the part. The input to the neural network is a layer of 4096 neurons, one for each pixel. The output is a layer of 18 neurons, one for each of the 20° orientation ranges. For each of the training examples, you set the output neuron for the correct range to fully on and the other 17 to fully off.

Path control is another, more-complex application from assembly robotics that neural networks can solve. Once the network has determined the initial orientation of the part and the final orientation required for insertion, another neural network can control the X-, Y-, or Z-axis motion of the insertion device as it picks and places the part (Refs 4 and 5). Rather than use tensor math (which is slow and hard to calculate), you could input starting coordinates and desired end coordinates to a neural network and train it to output a path.

For this assembly system, you can afford to wait until the robot has finished handling a part to have the neural network assess the orientation of the next one. Therefore, the system only needs to process a view of one part at a time. An 80486 PC runs the neural network fast enough that it has time to perform frame grabbing and still maintain adequate throughput. So you can implement the network in software on the same PC that hosts the frame-grabber board for the camera. Where you need faster results, the network can run on accelerator boards, which give 10 to 100 times greater throughput. For truly demanding applications, the trained network can run on a special-purpose neural-network chip like Intel's 80170 for performance several thousand times faster than a '486.

Frequently, problems on automated assembly lines do not appear until a defective finished product reaches the inspection and test stations. By the time the first

bad product turns up, the pipeline may be full of several hours' worth of defective goods that need rework or have become scrap. Diagnosing the assembly equipment's problem as soon as it occurs is much more efficient. In the case of a power-supply circuit board, rework is feasible but very expensive, because the machine-installed parts must be removed by hand. To diagnose equipment failures, you need access to some signals that reliably describe the system's behavior.

Servos control both the positioning of the head and the gripping force of the fingers on the robotic insertion machine. The commands that control the actuator and the sensor-feedback signals are available for you to

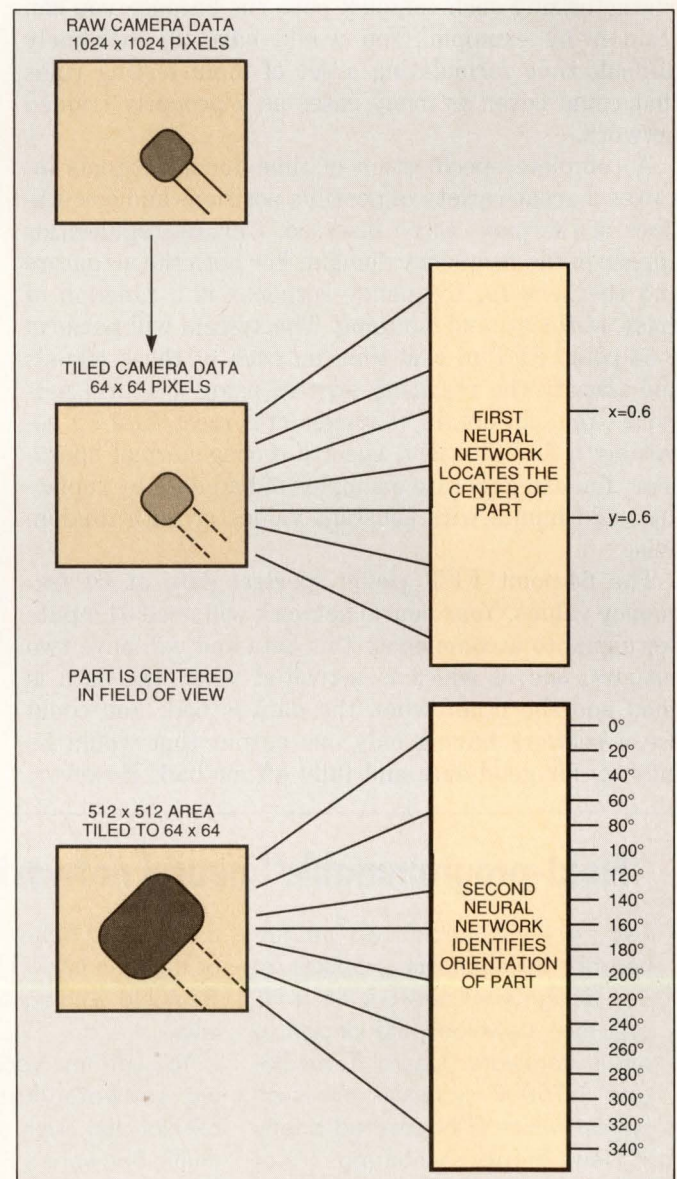

Fig 2—Two neural networks operate together on input from a frame grabber. First, one locates the center of a part. Then the other identifies the part's angular orientation.

NEURAL NETWORKS

observe. What you need is a method of deducing the state of the equipment from the behavior of these signals. As one simple test, you could check that the signals are all within range. Many problems would not be detected by such a scheme, however. For example, the servo amplifier driving the brushless dc motor that rotates the robot's wrist could oscillate because of a failed compensating capacitor. In this case, the wrist could be within legal range but still fail to place parts.

You need some method to look at all the signals in relationship to each other and determine if the pattern is valid or not. A neural network is an ideal tool for characterizing such complex patterns because you can train it by example. You would have an extremely difficult time formulating a set of input-testing rules that could cover as many cases as a properly trained network.

A complete specification of time-domain signals involves a great variety of possible positions and orientations of the parts to be inserted. Certain regularities appear in the frequency domain. For both the actuators and the sensors, frequency response is a function of mass, stiffness, and damping. The system will perform a 64-point FFT in real time on each of these signals and classify the resulting spectra using a neural network. You can obtain examples of correct data by recording a few thousand spectra during normal operation. You can generate examples of bad data by replacing valid inputs with constant values or with random noise.

The 64-point FFT yields spectral data at 64 frequency values. Your neural network will need 64 inputs per signal to accommodate this data and will have two outputs, one of which is activated when the data is good and the other when the data is bad. You could use a network having only one output that would be fully on for good data and fully off for bad. However,

using two outputs with complementary values often results in a network that is easier to train because it doubles the number of internal network node weights that you can adjust.

Two linear and four rotary motors control the assembly robot. Each motor has an optical position encoder. One of the linear motors controls the part-gripping fingers, which also have a force sensor. As a result, the system has to analyze 13 signals. The system has 64 inputs per sensor (resulting from the 64-point FFT), so you need a network with $13 \times 64 = 832$ inputs. The system components have bandwidths of approximately 10 Hz, requiring samples to be taken 20 times a second. So the neural network must process inputs in 50 msec to make use of all the data generated. For this network size, 50 msec is about ten times faster than a '486 performs, so you would need to implement this network on a dedicated PC that has an accelerator card.

Diagnosing circuit-board faults

The power supply has three functional blocks: the switching circuit, which controls the transfer of energy from the input to the output; the control circuit, which determines how the switching circuit operates; and the feedback circuit, which measures the output voltage and current and provides error signals to the control circuit. In this case, the power supply is an off-line forward converter with fixed-frequency PWM control. A test fixture automatically varies the line and load. The problem consists of gathering and analyzing data that will tell you whether the circuit is operating correctly. If it is not, you would also want to know which component is at fault. Your methods of analyzing the data should tolerate the effects of normal component variation.

The network should identify four common component

"Field-programmable" neural networks

Two recently introduced neural-network development products let you design your network on a PC and then download the design to run in hardware. Neural Technologies' NT5000 system is one such system, which EDN covered briefly in News Breaks section (pg 24) of the May 7, 1992, issue. Another is the Intel 80170 development system. This board works in PCs having

a 80286 or better CPU to program or train the Intel ETANN (Electrically Trainable Analog Neural Network) chip.

You can test your pattern set using software that simulates the ETANN chip, such as California Scientific Software's Brainmaker Back-Propagation simulation software, then download your trained-network file and pattern file to the chip.

Alternately, you can perform "chip-in-the-loop" training; that is, use the development system to apply your patterns directly to the chip. If you use direct training, the chip can learn around variations and defects in its own processing elements. Because the chip uses EEPROM technology, both programming approaches allow you to change the weights many times.

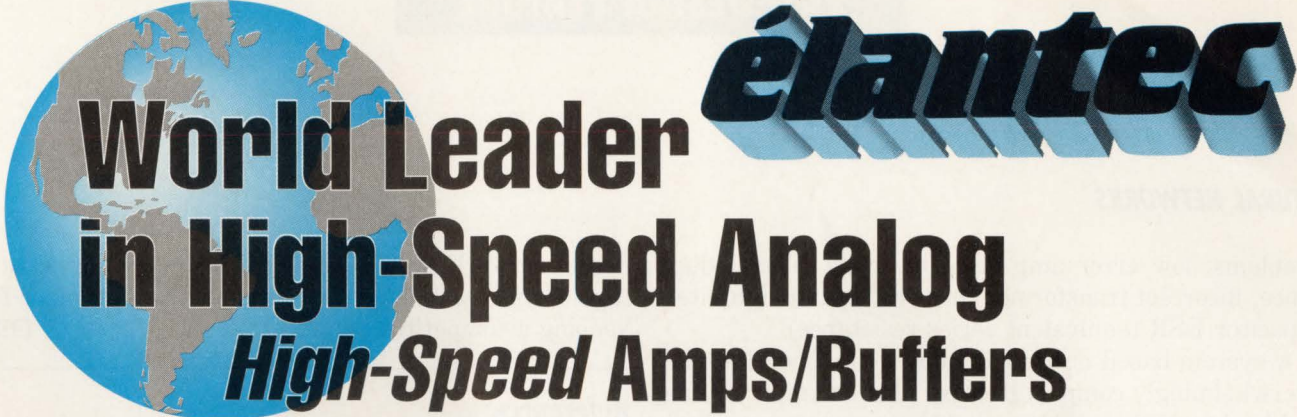

World Leader in High-Speed Analog High-Speed Amps/Buffers

MONOCHROME & COLOR VIDEO AMPLIFIERS

- Cable Drivers
- Distribution Amps
- Gain Blocks

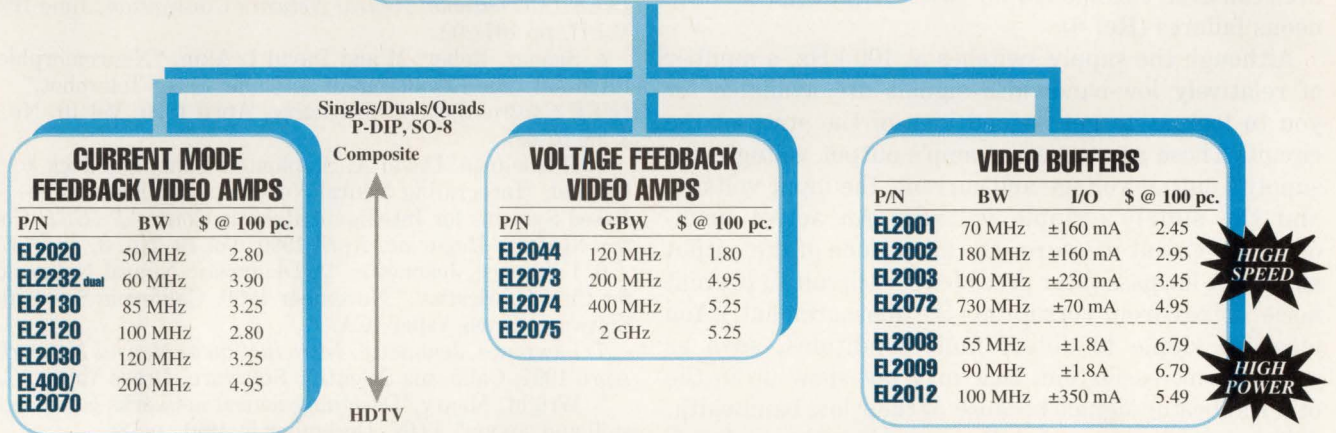

GENERAL PURPOSE HIGH-SPEED AMPS/BUFFERS

- High-Speed Signal Processing
- Instrumentation
- Medical Instruments

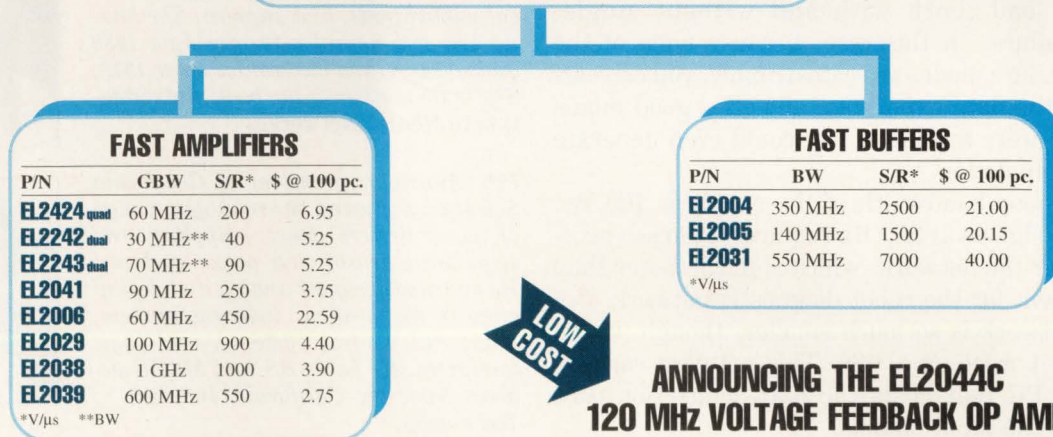

LOW COST

ANNOUNCING THE EL2044C 120 MHz VOLTAGE FEEDBACK OP AMP

- ONLY 1.5¢/MHz
- 325 V/μs Slew Rate
- 120 MHz (-3 dB) BW @ Gain = 1
- Drives Unlimited Load Capacitance
- Single or Split Supplies as Low as 2.5V
- \$1.80 @ 100 pc. - P-DIP (\$1.90 - SO-8)

FOR SAMPLES CALL OUR APPLICATIONS HOTLINE - (800) 333-6314 ext 311, Literature Only - ext 234

ELANTEC, INC. ■ 1996 Tarob Court ■ Milpitas, CA 95035 ■ (408) 945-1323 ■ (800) 333-6314 ■ FAX (408) 945-9305

NEURAL NETWORKS

problems: low error amp gain, incorrect filter inductance, incorrect transformer turns ratio, and high filter capacitor ESR (equivalent series resistance).

A system based on formal rules would soon become overwhelmingly complex because of the number of line and load conditions that it would have to test to ensure that the circuit functioned properly. A neural network, on the other hand, can much more easily learn complex relationships among data and recognize patterns that are similar (but not identical) to those it was trained on. It also can generalize between example data points. A neural network trained with examples of single failures can even extrapolate for cases of multiple simultaneous failures (Ref 6).

Although the supply switches at 100 kHz, a number of relatively low-bandwidth signals are available for you to look at to get a good idea of the state of the circuit. These are the error amp's output voltage, the supply's output voltage and current, the input voltage, and the supply's ripple voltage. An active peak-detection circuit measures the magnitude of the output ripple. (A lowpass filter precedes this circuit to prevent noise spikes from corrupting the measurement.) You measure ripple to detect fault conditions, such as subharmonic oscillation, that may not show up in the other indicator signals because of their low bandwidth. After multiplexing and A/D conversion, these signals become inputs to your neural network.

This network is relatively small (five inputs and four outputs), so you can train it adequately on a few hundred examples. You can generate five hundred examples by taking all combinations of 10 different values of line and load, both with and without single-component failure. In this case, because none of the categorized failure modes are catastrophic, you can easily generate the data experimentally. If a good model of the supply were available, you could even generate the data by simulation.

The closed-loop bandwidth of the supply is 100 Hz. Sampling the signals at 250 Hz requires a 4-msec processing time for the network, which is much faster than the requirement for the robot diagnostic network. Because this network is so much smaller, though, it can run in under 1 msec on a '486. This network can run on the same PC that hosts the data-acquisition card that converts the input signals.

Engineers use neural networks in signal processing, data analysis, robotics, modeling, production control, assembly, and thousands of other areas. You can expect many more applications in coming years, and being able to creatively use this technology will give you an advantage in many designs. As faster and larger

neural-network chips become available, taking advantage of this technology may become a requirement for keeping a competitive edge. **EDN**

References

1. Nguyen, Derrick and Bernard Widrow, "Neural Networks for Self-Learning Control Systems," *IEEE Control Systems Magazine*, April 1990, Vol 10, No. 3, pp 18-23.
2. Widrow, B and R Winter, "Neural Nets for Adaptive Filtering and Adaptive Pattern Recognition," *IEEE Computer*, March 1988, Vol 21, No. 3, pp 25-39.
3. Kagle, B, et al, "Multi-fault Diagnosis of Electronic Circuit Boards Using Neural Networks," *Proceedings of IEEE International Neural Network Convention*, June 1990, Vol II, pp 197-202.
4. Sanner, Robert M and David L Akin, "Neuromorphic Pitch Attitude Regulation of an Underwater Telerobot," *IEEE Control Systems Magazine*, April 1990, Vol 10, No. 3, pp 62-68.
5. Handelman, David A, Stephen H Lane, and Jack J Gelfand, "Integrating Neural Networks and Knowledge-Based Systems for Intelligent Robotic Control," *IEEE Control Systems Magazine*, April 1990, Vol 10, No. 3, pp 77-87.
6. Lawrence, Jeannette, "A Diagnostic Neural Network for Chip Fabrication," November 1990, California Scientific Software, Grass Valley, CA.
7. Lawrence, Jeannette, *Introduction to Neural Networks*, April 1991, California Scientific Software, Grass Valley, CA.
8. Wright, Maury, "Designing neural networks commands skill and savvy," *EDN*, December 5, 1991, pg 86.

Authors' biographies

Jeannette "Jet" Lawrence has held positions at California Scientific Software in the areas of public relations, technical publications, and support. She has worked with neural networks since 1988 and software and electronics since 1979. She is the author of the book, Introduction to Neural Networks.



Pete Andriola, president of California Scientific Software, has managed design of motor drivers, power supplies, and spaceborne sensor and power systems. He has also designed analog and digital circuits for medical instrumentation, industrial control systems, and logic analyzers. He holds BS and MSEE degrees from the California Institute of Technology.

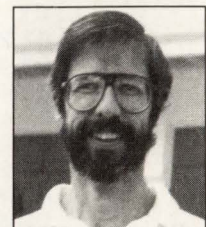

Article Interest Quotient (Circle One)

High 476 Medium 477 Low 478

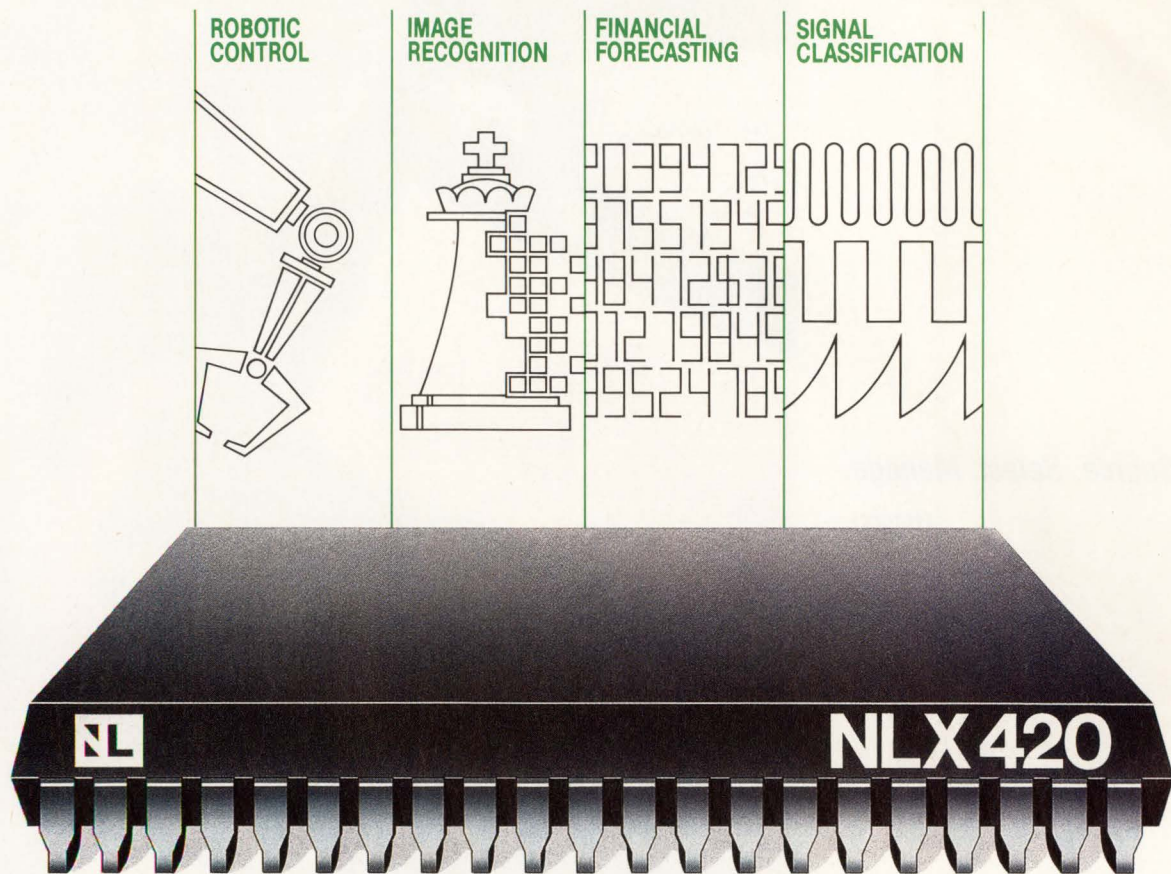

The single-chip neural building block for emerging technologies

When you're designing with neural networks, flexibility is what you need—and flexibility is what the NLX420 Neural Processor Slice™ delivers.

Flexible resolution — choose 1, 4, 8 or 16 bits.

Flexible transfer function — sigmoid, linear, step, pulse or design your own. You can implement any function you can imagine!

Flexible architecture — feed forward, feed back, totally connected, single- or multilayer.

Compatible with BrainMaker™ from California Scientific Software!

Flexible expansion — sixteen independent processors per chip perform up to 320 million connections per second for full-system support. Devices can be cascaded or multiplexed to expand system size.

Flexible interface — the NLX420 can be configured for immediate use with existing neural network software.

The NLX420 is available now from NeuraLogix, the leader in artificial intelligence devices. At only \$89 (quantity one price) you can afford to begin your neural network development now! For detailed specifications contact NeuraLogix today.



Two NLX420 development systems are available to speed your entry into neural networks. At \$595, the ADS420-1 offers a single NLX420, plus associated hardware, software and manuals for system development and neural network training on your AT. The ADS420-4 has four neural circuits on board and supports more than 1 billion connections per second for only \$1495.

NeuraLogix

American NeuraLogix, Inc.
411 Central Park Drive
Sanford, FL 32771
Telephone 407/322-5608;
FAX 407/322-5609

Source, Select, Manage.
(Hours)

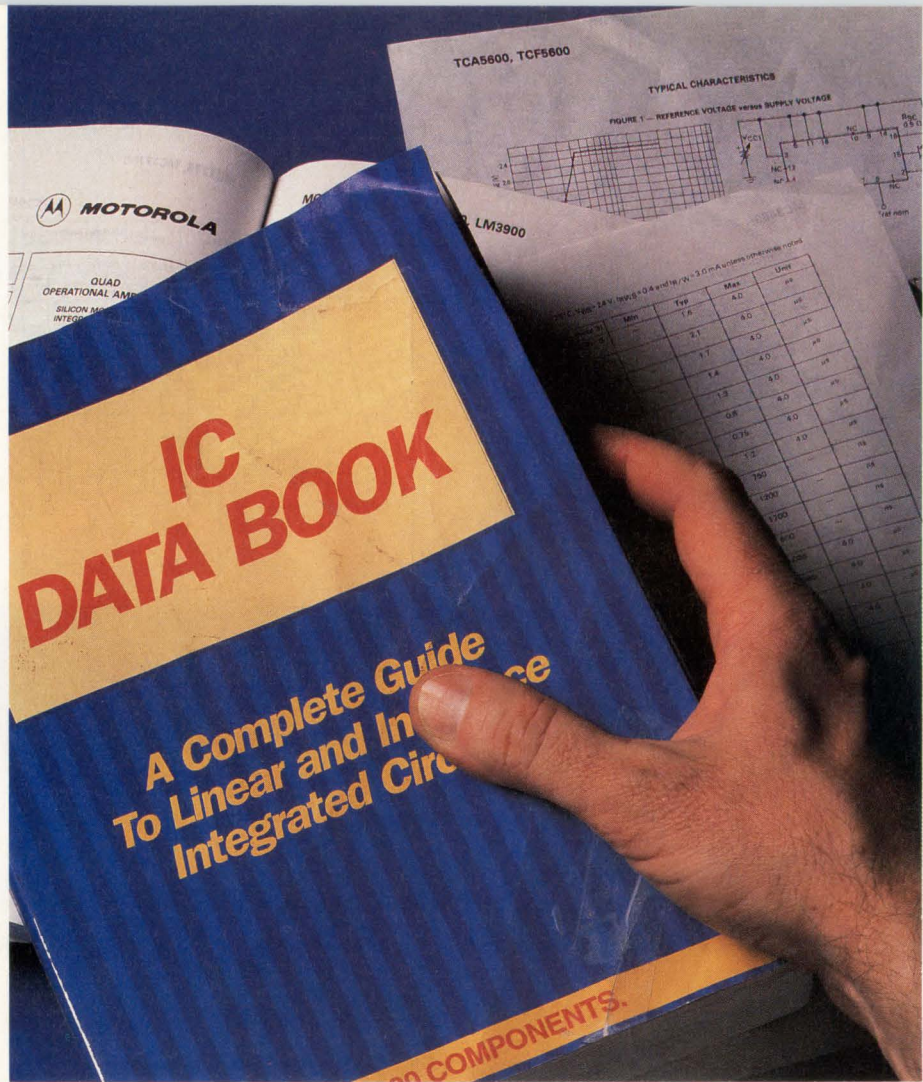

NO CON

**Maximize productivity
for all your engineers.**

**with CAPS[®] network-based
component management
systems**

How much can you save by integrating a CAPS component information system into your local area networks? Plenty if you're like most organizations.

Rockwell's Collins Air Transport Division saved hundreds of engineering hours in just a few months. Tekelec saved more than \$50,000 the first year. Welch Allen's Data Collection Division saved over \$19,000 at the demo.

In fact, five-fold productivity gains in component selection are common with benefits to design engineering, component engineering, manufacturing engineering and purchasing.

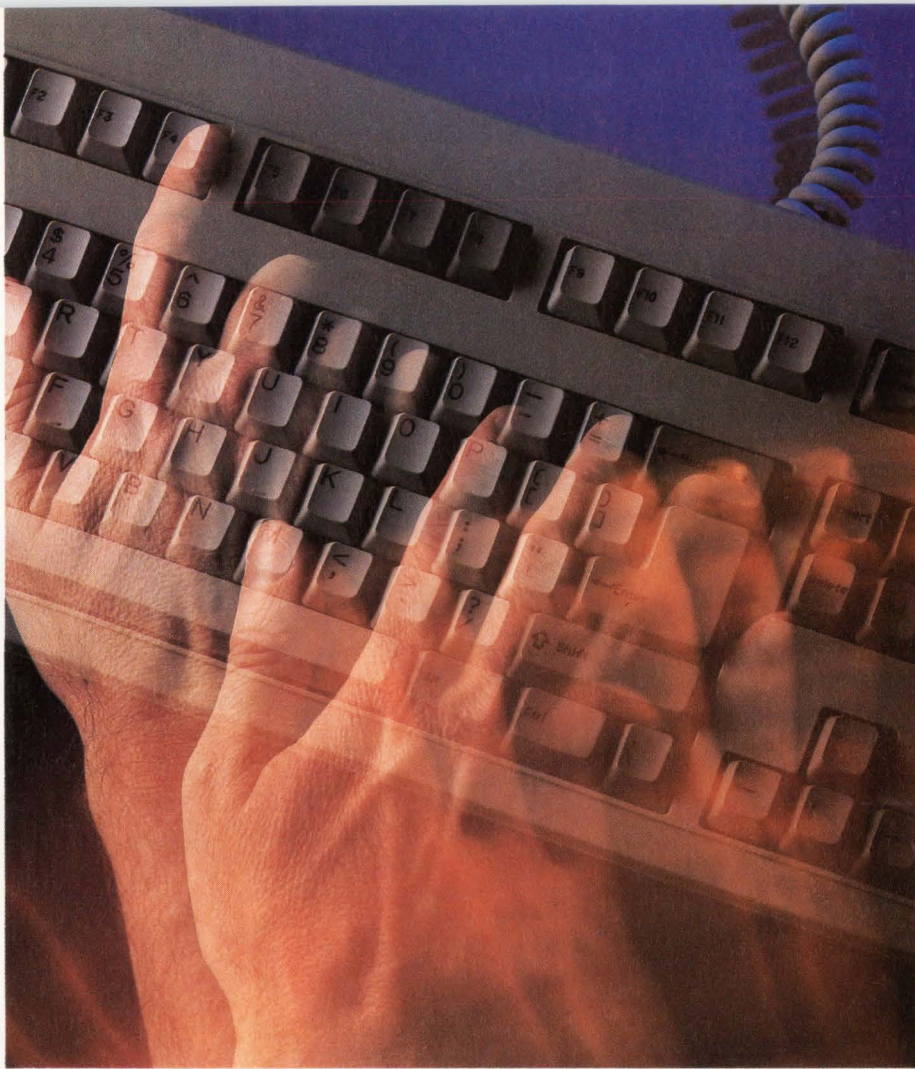

**Source, Select, Manage,
Source, Select, Manage,
Source, Select, Manage,
Source, Select, Manage,
Source, Select, Manage,
Source, Select, Manage,
Source, Select, Manage.
(Minutes)**

TEST.

CAPS is a CD-ROM based database that makes it easy to find and compare ICs, semiconductors, resistors and capacitors. A search through millions of parameters takes seconds. The complete database is updated monthly so you're always working with current information.

Plus CAPS accommodates preferred parts lists so you can implement consistent selection practices throughout your organization.

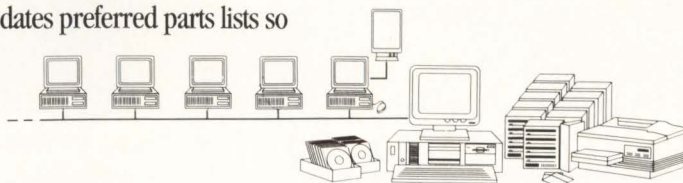

It all adds up to better quality management. And dramatically improved productivity.

See for yourself. CAPS is available for PCs, workstations, and in a variety of network configurations. Send for a free demo disk and complete details. **(800) 245-6696.**

C A H N E R S

CAPS[®]

Computer Aided Product Selection

Cahners Technical Information Service, 275 Washington Street, Newton, MA 02158, **(800) 245-6696.** (617) 558-4960. Fax: (617) 630-2168

CIRCLE NO. 60

EDN August 6, 1992 • 105



TRY AND TALK YOUR WAY OUT OF THIS ONE

Introducing HYDRITECH™ the new nickel hydride battery with 25% more power than the best nickel cadmium battery. With HYDRITECH, your cellular phones can give users additional talk time without recharging. HYDRITECH's enhanced performance allows you to add more features and design a lighter, smaller product. All with one hour charge capability. And it's environmentally preferred. Gates Energy is the only company that offers a full line of nickel hydride batteries and unparalleled assistance to apply this new technology to your designs. If you're interested in designing cellular phones with more talk time, then there's no excuse for not using HYDRITECH. So, just give Gates Energy a call at 1-800-67-POWER. HYDRITECH. It's the one power source you can't talk your way out of.

THE NEW HYDRITECH BATTERY FROM  **Energy Products**

BTL transceivers enable high-speed bus designs

Joel Martinez, National Semiconductor Corp

As bus transfer rates extend into warp speeds, large capacitive loads can behave like anchors. Low-capacitance backplane-transceiver-logic devices offer advantages over their TTL counterparts when you're trying to maximize throughput.

Speed is the most important consideration when defining a computer bus standard. In many systems the backplane often becomes a bottleneck when high-speed CPUs communicate with shared resources on the bus. The maximum data-transfer rate between two cards on a backplane largely depends on the maximum bus delay, which consists of the bus settling time and propagation delay. The bus settling time is the time required for reflections and crosstalk interference to subside before a receiver can reliably sample data on the bus. The propagation delay depends on the intrinsic inductance and capacitance of the bus media.

Improper bus terminations and inadequate bus drivers can cause the settling time to be several times longer than the propagation delay. For this reason, an IEEE committee defined the IEEE 1194.1 Standard for Electrical Characteristics of Backplane Transceiver Logic (BTL) Interface Circuits. A properly designed backplane using BTL interface circuits not only eliminates the bus settling time, but minimizes the propagation delay of a loaded backplane. BTL can produce the maximum bus throughput. To illustrate the

effectiveness of BTL, contrast the bus delay for a transmission line using high-current TTL transceivers vs BTL transceivers.

Fast logic signals, which have rise and fall times significantly shorter than the bus' round-trip propagation delay, determine when to consider the backplane as transmission lines. Transmission lines have an unloaded characteristic impedance (Z_0) and an unloaded propagation delay (tp_0) given by

$$Z_0 = \sqrt{L_0 C_0} \quad (1)$$

and

$$tp_0 = \sqrt{L_0 C_0}, \quad (2)$$

where L_0 equals the unloaded distributed inductance per unit length and C_0 equals the unloaded distributed capacitance per unit length.

High-speed backplanes often use strip lines (Fig 1) as the transmission medium. You can calculate the unloaded characteristic impedance and unloaded propagation delay of a stripline using the following formulas:

$$Z_0 = \frac{60}{\sqrt{\epsilon_r}} \ln \left[\frac{4h}{0.67p(0.8w+t)} \right] \quad (3)$$

and

$$tp_0 = 1.017 \sqrt{\epsilon_r}, \quad (4)$$

BTL Transceivers

where ϵ_r equals the relative dielectric constant of the insulation material, h equals the height between ground planes, w equals the width of the signal trace, and t equals the thickness of the signal trace.

A typical stripline backplane may have the following features:

$$\begin{aligned} h &= 52 \text{ mils} \\ w &= 12 \text{ mils} \\ t &= 1.4 \text{ mils (1 oz copper)} \\ \epsilon_r &= 3.5 \text{ (epoxy-glass).} \end{aligned}$$

Substituting these values in **Eqs 3 and 4** produces

$$Z_0 = 70 \Omega \quad (5)$$

and

$$tp_0 = 1.9 \text{ nsec ft.} \quad (6)$$

Eqs 3 and 4 let you calculate the parameters of an unloaded transmission line. In practice a backplane consists of plug-in cards having pc-board traces, vias, and connectors that capacitively load the transmission lines. The impedance of a capacitively loaded transmission line is lower than an unloaded line, and the propagation delay of the capacitively loaded transmission line is longer than an unloaded line. When the backplane has a uniformly distributed capacitive load, the loaded characteristic impedance and propagation delay are, respectively,

$$Z_L = \frac{Z_0}{\sqrt{1 + \frac{C_L}{C_0}}}$$

and

$$tp_L = tp_0 \sqrt{1 + \frac{C_L}{C_0}},$$

where C_L equals the distributed load capacitance per unit length.

You can determine the unloaded distributed capacitance (C_0) using **Eqs 1 and 2** to get

$$C_0 = \frac{tp_0}{Z_0}.$$

For the calculated stripline values given in **Eqs 5 and 6**,

$$C_0 = \frac{(1.9 \text{ nsec/ft})}{70 \Omega} = 27 \text{ pF/ft.}$$

To calculate the distributed load capacitance, you

must make some assumptions for the slot capacitance associated with a connector on the backplane, pc-board traces, vias, and the bus transceiver's input capacitance. Connectors, pc-board traces, and vias typically contribute 3- to 5-pF total capacitance. First, consider the input-capacitive load for a high-current TTL transceiver driving the backplane. High-current TTL transceivers have an input capacitance ranging between 12 and 20 pF. Under a worst-case assumption, the total slot capacitance for a card using high-current TTL transceivers can be as high as 25 pF.

The distributed load capacitance per unit length is given by

$$C_L = \frac{1}{d_{\text{SLOT}}} \left(\frac{12 \text{ in.}}{1 \text{ ft}} \right) C_{\text{SLOT}},$$

where d_{SLOT} is equal to the slot-to-slot spacing of adjacent cards on the backplane in inches and C_{SLOT} is equal to the slot capacitance. Under the assumption that the slot-to-slot spacing between adjacent cards is 0.8 in.,

$$C_L = \frac{1}{0.8 \text{ in.}} \left(12 \frac{\text{in.}}{\text{ft}} \right) (25 \text{ pF}) = 375 \text{ pF/ft.}$$

Using the above assumptions, the loaded characteristic impedance and propagation delay are, respectively,

$$Z_L = \frac{70 \Omega}{\sqrt{1 + \frac{375 \text{ pF/ft}}{27 \text{ pF/ft}}}} = 18 \Omega \quad (7)$$

and

$$tp_L = 1.9 \text{ nsec/ft.} \sqrt{1 + \frac{375 \text{ pF/ft}}{27 \text{ pF/ft}}} = 7.3 \text{ nsec/ft.} \quad (8)$$

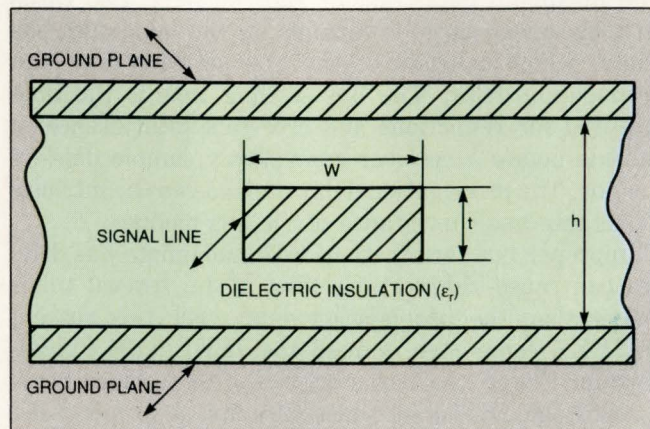

Fig 1—High-speed backplanes must rely on transmission-line characteristics. Striplining provides the advantages of two ground planes, which offer EMI shielding.

Comparing loaded transmission line calculations (Eqs 7 and 8) with the unloaded transmission line calculations (Eqs 5 and 6) reveals that the distributed-capacitive loads increase the bus delay time in two ways. The most obvious impact is the increase in propagation delay from 1.9 to 7.3 nsec/ft. Lowering the line's characteristic impedance from 70 to 18Ω also increases the bus-delay time. A low characteristic impedance makes the transmission line harder to drive, which effectively increases the settling time.

Driving a split transmission line

To illustrate the effect that the line's impedance has on the settling time, consider a TTL transceiver driving a transmission line terminated on both ends by the line's loaded characteristic impedance (Fig 2). Because the driver must supply current in both directions, the transmission line presents a load of $Z_L/2$ to the driver. A TTL driver, which produces a nominal 3V swing, must deliver a current of

$$I_D = \frac{3V}{\left(\frac{Z_L}{2}\right)} = \frac{3V}{\frac{18\Omega}{2}} = 333 \text{ mA.}$$

The required drive current is much larger than the current capacity for standard high-current TTL transceivers, which ranges from 50 to 100 mA. Fig 3 shows the bus settling time when a typical 50-mA transceiver

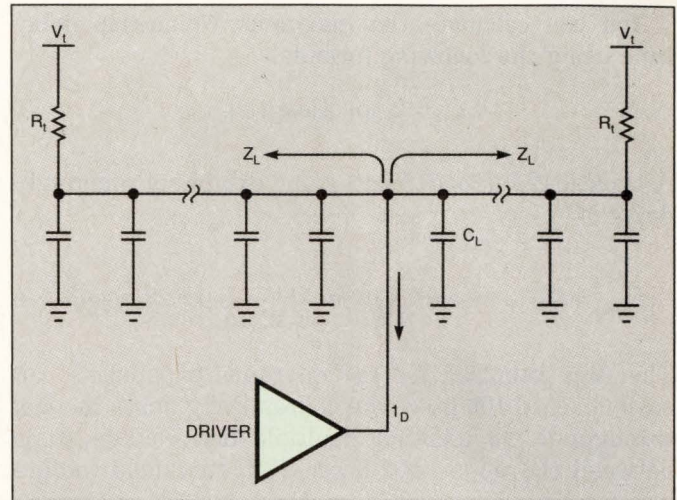

Fig 2—Bus drivers must have enough current drive to launch a voltage in two directions on the backplane. Initially, the line presents a load of $Z_L/2$ to the driver.

drives a loaded characteristic impedance of 18Ω. Initially, the voltage waveform traveling on the bus is 0.45V, which is the product of the maximum drive current (50 mA) and half of the loaded impedance ($Z_L/2$). However, a 0.45V signal swing is considerably smaller than the upper TTL-threshold voltage necessary to guarantee a logic transition on the bus. Therefore, a receiver must wait several round-trip delays on the bus before sampling the signal.

Futurebus + rides BTL transceivers into the future

Backplane-transceiver logic (BTL) is the interface circuit of choice for Futurebus+ backplanes. Chapters 6, 7, and 8 of the IEEE 896.2, "Futurebus+ Physical Layer and Profile Specifications" (Ref 3) define the electrical specifications for the Futurebus+ Profiles A, B, and F, respectively. The document specifies the unloaded backplane impedance (Z_0) without vias to be 67Ω, unloaded capacitance per unit length (C_0) of 29 pF/ft.

To determine the loaded capacitance per unit length, you must first estimate the capacitance/slot. The capacitance/slot is the sum of an estimate of the capacitance for the backplane via, the backplane connector, and the pc board. Some reasonable estimates yield

$$\begin{aligned} C_{\text{SLOT}} &= C_{\text{VIA}} + C_{\text{CONNECTOR}} + C_{\text{BOARD}} \\ C_{\text{SLOT}} &= 0.75 \text{ pF} + 0.45 \text{ pF} + 10 \text{ pF} \\ C_{\text{SLOT}} &= 11.2 \text{ pF.} \end{aligned}$$

Using the Futurebus+ slot-to-slot spacing of 30 mm (approximately 1.2 in.), the loaded capacitance per unit length is

$$\begin{aligned} C_L &= 11.2 \text{ pF} \left(\frac{1}{1.2 \text{ in.}} \right) \\ \left(\frac{12 \text{ in.}}{\text{ft}} \right) &= 112 \text{ pF/ft.} \end{aligned}$$

Under the above assumptions, this fully loaded Futurebus+ backplane has a loaded backplane impedance of

$$Z_L = \frac{67\Omega}{\sqrt{1 + \frac{112 \text{ pF/ft}}{29 \text{ pF/ft}}}} = 30\Omega. \quad (\text{A})$$

The drive current required to launch a 1V signal on this backplane is

$$I_D = \frac{1V}{\left(\frac{30\Omega}{2}\right)} = 67 \text{ mA,}$$

which is within the 80mA drive capacity of BTL transceivers.

Both the drive current and the signal swing determine the backplane-termination resistor. After extensive analysis and simulations, the Futurebus+ Electrical Task Group has determined that the optimum termination resistor should be 33Ω, ±1%. The calculated loaded impedance in Eq A is within the specified tolerance. The Task Group also specifies a termination voltage of 2.1V ±2%.

BTL Transceivers

You can calculate the maximum round-trip delay time using the following formula:

$$t_{(2d)} = 2(t_{pL})(\text{length}).$$

A typical 19-in. loaded backplane exhibits a round-trip delay of

$$t_{(2d)} = 2(7.3 \text{ nsec/ft})(19 \text{ in.})\left(\frac{1 \text{ ft}}{12 \text{ in.}}\right) = 23 \text{ nsec}.$$

The time required for several round-trip delays can easily exceed 100 nsec, which drastically limits the bus throughput. In addition, multiple line voltage steps between the upper and lower TTL threshold-voltage limits may cause multiple triggers on clock and strobe lines, leading to catastrophe.

Higher-current drivers and precision receivers that have narrow voltage region between threshold limits can alleviate multiple triggers by ensuring the first voltage transition exceeds the maximum voltage threshold. The high-current drivers and precision receivers are often used for the clock and strobe line to eliminate multiple triggers. However, wide-data and -address buses present practical limits. The significantly higher current necessary to drive 32- and 64-bit data and address buses often precludes the use of very-high-current drivers. In addition, higher current transceivers exhibit higher input capacitance, which in turn further lowers the loaded line impedance and demands larger drive currents. The situation is a Catch 22.

Diode is a capacitance buffer

Next consider the bus delay for a transmission line using BTL transceivers. The IEEE 1194.1 standard specifies that the maximum I/O capacitance for a BTL

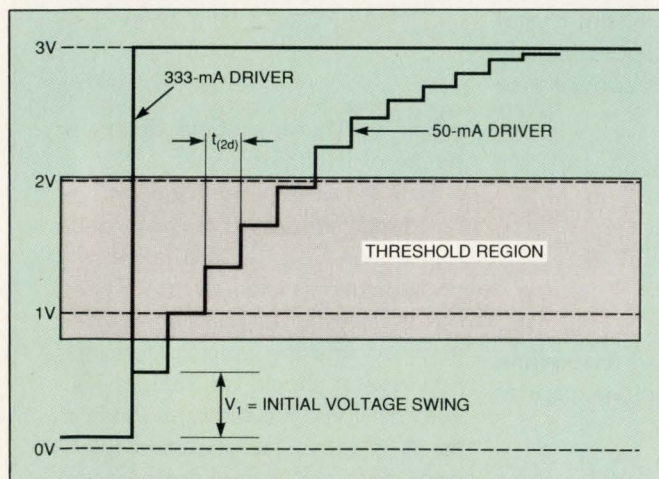

Fig 3—Insufficient current drive can result in many round-trip bus delays before a bus signal comfortably exceeds the TTL threshold region.

transceiver should be 5 pF or less. To meet this low-capacitance specification, BTL transceivers use a Schottky diode in series with an open-collector driver output (**Fig 4**). The small reverse-biased capacitance of the diode isolates the driver's open collector capacitance when the transceiver is receiving data. The Schottky-diode capacitance is typically less than 2 pF, which varies slightly with drive current. Allowing a maximum of 2 pF for the receiver's input capacitance produces a total BTL-transceiver I/O capacitance of less than 5 pF.

BTL transceivers have other features that contribute to fast, reliable bus throughput. For example, the maximum voltage swing on the bus is 1V when you use BTL transceivers, instead of 3V for TTL transceivers. The low-voltage swing not only reduces the current drive requirements, it also reduces induced crosstalk noise between bus lines. The lower voltage swing doesn't make BTL transceivers more susceptible to bus-generated noise either. The reason is that the IEEE 1194.1 standard specifies a precision receiver threshold centered between 1 and 2.1V logic levels.

The tightly controlled threshold region extends ± 75 mV about a nominal 1.55V level and is independent of power supply and temperature variations (**Fig 5**). BTL transceivers use a bandgap reference voltage to achieve the specification. Noise generated external to the bus can cause EMI problems, however. A shielded backplane, such as stripline, can eliminate EMI problems.

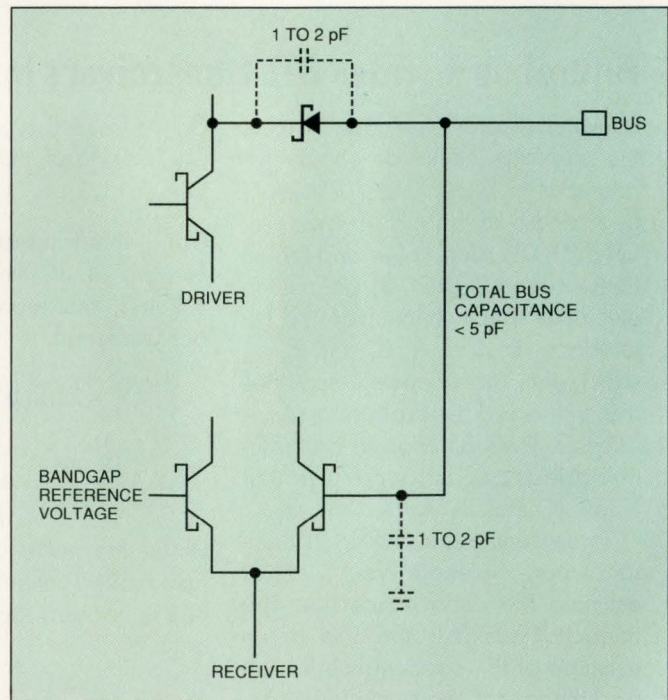

Fig 4—Typical BTL transceivers use a Schottky diode to isolate the capacitance of the driver transistor from the bus. Typical I/O capacitance of a BTL transceiver is < 5 pF.

The High Performance of Two Chips from the Lowest Cost Product!

You can't beat Harris Semiconductor's HI5812 for price/performance. It's the lowest cost, 12-bit sampling analog-to-digital converter available today. And with significantly lower power consumption than the competition, it's even more cost effective.

The HI5812 is ideal for numerous applications having input frequencies of up to 30 KHz. It's fast. The throughput rate is 50 kilosamples-per-second. Conversion time is as low as 15 milliseconds with a single 5 volt supply.

With track and hold built in, it's the equivalent of two chips needed for other manufacturers' solutions. And you can rely on the HI5812 to meet your design requirements. No missing codes over the full industrial temperature range. User-selectable outputs feature full, high-speed CMOS, three-state bus driver capability. It typically draws just 1.9 mA.

HI5812 12-Bit Sampling A/D Converter

HI5812JIP	24-Lead PDIP	(N)
HI5812KIP	24-Lead PDIP	(N)
HI5812JJI	24-Lead Cerdip	(N)
HI5812KIJ	24-Lead Cerdip	(N)
HI5812JIB	24-Lead SOIC	(W)
HI5812KIB	24-Lead SOIC	(W)

N = Narrow W = Wide



Hamilton/Avnet: Your Best Source

Hamilton/Avnet is the established leader in electronics distribution and a supplier of Harris Semiconductor's products for nearly 20 years.

Our salespersons and technical specialists have the on-line information and training to provide prompt, knowledgeable assistance. The high level of our Total Quality Management program ensures that you receive parts you can depend on. We have full capabilities for kitting and special handling. And whether you need products fast, or just-in-time, Hamilton/Avnet delivers.

**Call Hamilton/Avnet at
1 (800) 442-6458
and receive the complete
HI5812 data sheet with
application notes.**

See how low on cost and high on performance your designs can go.

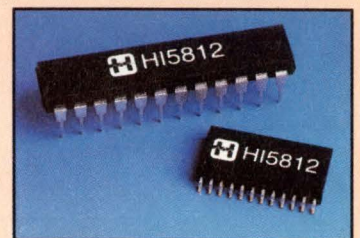

REACH THE HIGHS AND LOWS

 **HAMILTON/AVNET**

 **HARRIS**
SEMICONDUCTOR

CIRCLE NO. 62

EDN August 6, 1992 • 111

BTL Transceivers

When estimating the slot capacitance using BTL transceivers, you must add the transceiver's 5-pF I/O capacitance to the allotted 5-pF estimated capacitance for connectors, pc-board traces, and vias. The total estimated slot capacitance is 10 pF. The distributed load capacitance per unit length for the chosen transmission line is

$$C_L = \frac{1}{0.8 \text{ in.}} (12 \text{ in./ft})(10 \text{ pF}) = 150 \text{ pF/ft.}$$

The loaded impedance using BTL transceivers is

$$Z_L = \frac{70\Omega}{\sqrt{1 + \frac{150 \text{ pF/ft}}{27 \text{ pF/ft}}}} = 27\Omega.$$

Because the loaded impedance is higher when using BTL instead of high-current TTL transceivers, the transmission line is easier to drive. The current necessary to launch a 1V BTL signal on the transmission line is

$$I_D = \frac{1V}{\left(\frac{27\Omega}{2}\right)} = 74 \text{ mA.}$$

BTL transceivers are capable of delivering 80 mA when you terminate the transmission line with its loaded impedance. Because the launched signal exceeds the threshold region by a comfortable noise margin on the first transition, BTL transceivers are capable of incident-wave switching even under worst-case load conditions.

BTL's low distributed load capacitance also contributes to a shorter propagation delay. The propagation

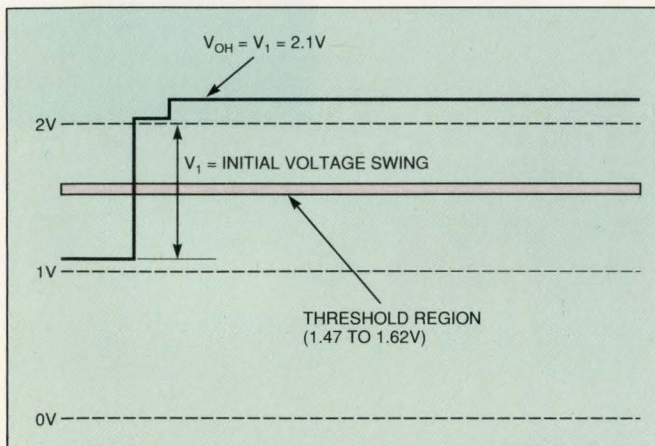

Fig 5—The combination of a tight threshold region, low-voltage swing, and high-current drive, lets a BTL signal comfortably exceed threshold on the initial voltage swing on the bus line.

delay for the chosen transmission line using BTL transceivers is

$$t_{pL} = 1.9 \text{ nsec/ftA} \sqrt{1 + \frac{150 \text{ pF/ft}}{27 \text{ pF/ft}}} = 4.9 \text{ nsec.}$$

The propagation delay is 30% shorter than the delay using high-current TTL transceivers.

Transmission-line analysis is necessary to get the most out of a high-speed backplane. The large distributed capacitive loads associated with conventional TTL transceivers produce small backplane impedances and long propagation delays. The combination can slow down the backplane's throughput considerably. In contrast, the low I/O capacitance of a BTL transceiver can actually create a high-speed backplane. In addition, the smaller 1V signal swing reduces crosstalk and current-drive requirements. EDN

Acknowledgment

Special thanks to R V Balakrishnan's "IEEE 896 Futurebus—A solution to the bus driving problem," on which much of this article is based.

References

1. Balakrishnan, R V, "IEEE 896 Futurebus—A solution to the bus driving problem," National Semiconductor Interface Data Book, 1988.
2. IEEE 1194.1, "Electrical Characteristics of Backplane Transceiver Logic BTL Interface Circuits," 1990.
3. IEEE 896.2, "Futurebus+ Physical Layer and Profile Specifications," 1992.
4. Hayward, Michael, "Backplanes for Bus Systems," Hybrid Corp, 1989.
5. Standard Logic Inc, "High-Speed Printed Circuit Backplane Electrical Design Considerations and Signal Integrity," Technical Bulletin No. 0188.

Author's biography

Joel Martinez is an application engineer for National Semiconductor Corp's interface and peripherals group. In the past five years he has helped develop BTL and Futurebus+ products for the company. He also provides customer support for bus transceivers. Joel has a BSEE degree from San Francisco State University. He was the secretary for the IEEE 1194.1 committee and the draft editor for the 1194.2 Small Computer Expandability Module (SCEM).

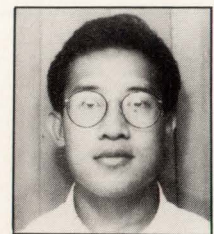

Article Interest Quotient (Circle One)
High 479 Medium 480 Low 481

Designing with Motorola's

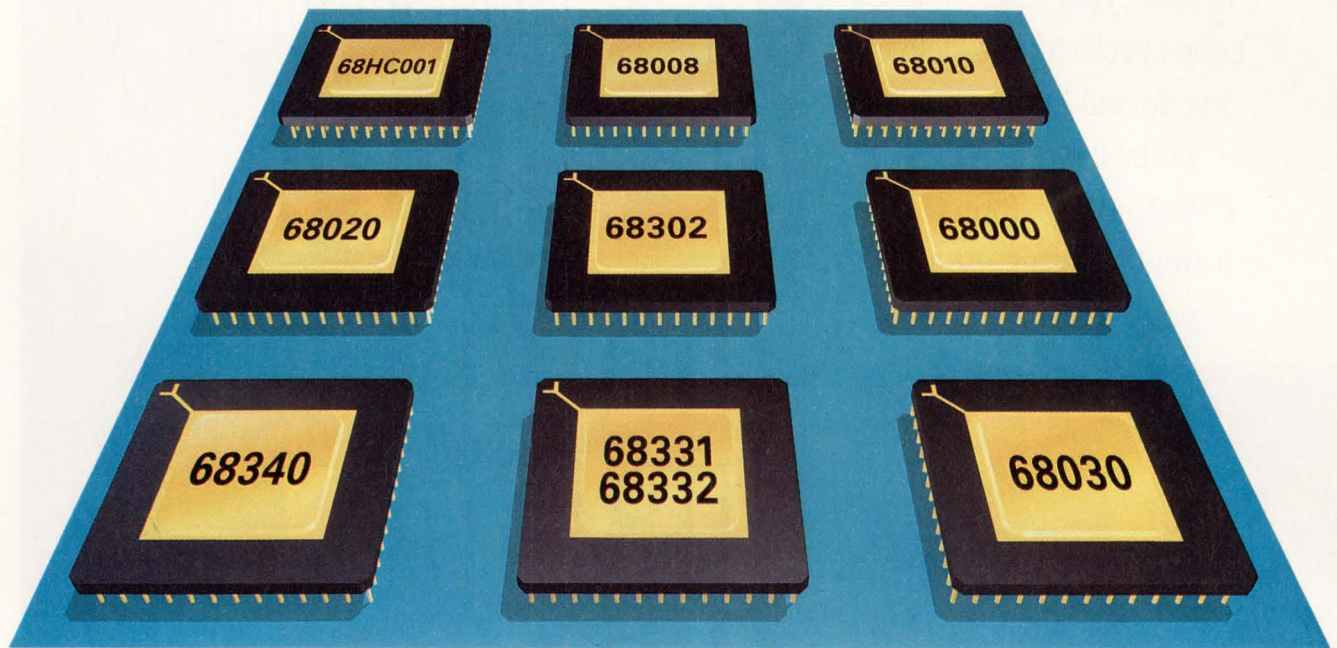

Microprocessors?

Then you need HMI's development systems. We support the entire 68000 family. As Motorola enhances and increases integration of its microprocessors, you can count on HMI to be there with

high-quality development products to support your projects. HMI believes in supporting the entire family of products for the Motorola family. Ease of use and familiarity are common in all the emulators.

Features of HMI's development systems includes:

- Run at real-time with no wait states.
- Window driven source level debugging—SourceGate.®
- C, Pascal and ADA compiler source level support for all major compiler companies.
- Real-time hardware performance analyzer.
- Works with IBM PC family and UNIX based machines including Sun and Apollo.
- RS232 Interface up to 115.2K.
- Parallel Interface for high-speed code downloading.
- Complex events and sequences for break and trigger conditions.
- Two independent 4K deep trace buffers.
- 1 μ sec resolution interval timer.
- 100 nsec resolution Time-stamp in trace buffer.
- Logic state analyzer capabilities built into the emulator.
- 16 External Trace bits.
- Overlay memory up to 4 Mbytes.

If you are looking for one emulator company that provides support for the entire Motorola family, then look to HMI for total support. Write or call for further information and *free* demo disk.

Motorola Devices Supported Include:

68000	68302	68EC020
68008	68301/303	68EC030
68010	68330/333	68HC001
68020	68331/332	68HC11 including
68030	68340	F1 and D3
6809		68HC16 Family

Now supporting 68040 Series

IBM is Reg. T.M. International Business Machines, Inc. Unix is Reg. T.M., Bell Laboratories, Inc.



Huntsville Microsystems, Inc.
3322 South Memorial Parkway
Huntsville, AL 35801
Tel.: (205) 881-6005
FAX: (205) 882-6701

Raltron manufactures its compact VC 7025 Voltage Controlled Crystal Oscillator to meet your Phase Locked Loop specifications, delivering deviation sensitivity or pullability of up to ± 100 PPM/V. Big performance in a small package. At a price you've been looking for.



VCXO WITH PULLABILITY

Raltron manufactures a complete line of the highest quality VCXO's to both standard and custom specifications. Send us your VCXO specifications today or call (305) 593-6033 for more information.

Raltron Electronics Corp.

2315 NW 107th Avenue, Miami, Florida 33172 U.S.A.
Fax (305) 594-3973 Telex 441588 RALSEN
(305) 593-6033

Telecommunications:

If you're into it... listen to this!

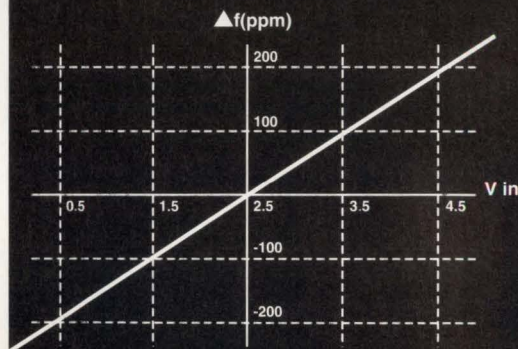

Crystals
Crystal Oscillators
Crystal Filters
Ceramic Resonators

RALTRON

Only Raltron has it all.

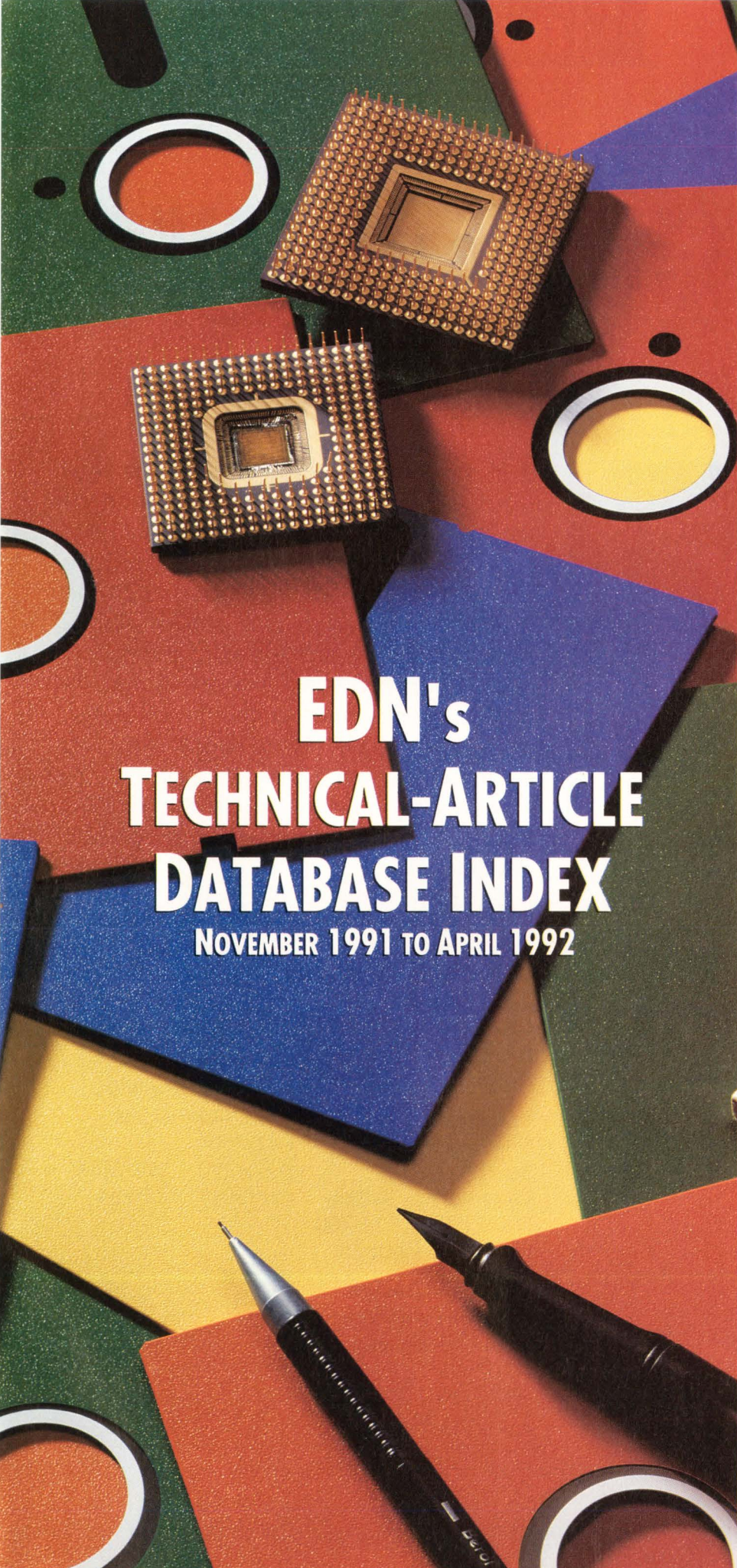

EDN's TECHNICAL-ARTICLE DATABASE INDEX

NOVEMBER 1991 TO APRIL 1992



Includes articles published in
EDN Magazine, EDN News
Edition, and four other major
electronics magazines.

How to use this article index
pg 116

Keyword index
pg 118

A bonus on EDN's BBS:

For a complete listing of
articles published from May
1990 to October 1991, log
on to EDN's Bulletin-Board
Service by dialing (617) 558-
4241 with modem settings
300/1200/2400/9600 8,N,1.
From the main system menu,
enter/TADB, then rsO.



ULTRA-MINIATURE SURFACE MOUNT



Actual Size

DC-DC Converter Transformers and Power Inductors

All PICO surface mount units utilize materials and methods to withstand extreme temperature (220°C) of vapor phase, IR, and other reflow procedures without degradation of electrical or mechanical characteristics.

These units have gull wing construction and are packaged in shipping tubes, which is compatible with tube fed automatic placement equipment or pick and place manufacturing techniques. Transformers can be used for self-saturating or linear switching applications. The Inductors are ideal for noise, spike and power filtering applications in Power Supplies, DC-DC Converters and Switching Regulators.

- Transformers have input voltages of 5V, 12V, 24V and 48V. Output voltages to 300V.
- Transformers can be used for self-saturating or linear switching applications
- Schematics and parts list provided with transformers
- Inductors to 20mH with DC currents to 23 amps
- Inductors have split windings

Delivery—
stock to one week

See EEM
or send direct for
FREE PICO Catalog

PICO
Electronics, Inc.

453 N. MacQuesten Pkwy. Mt. Vernon, N.Y. 10552

Call Toll Free 800-431-1064

IN NEW YORK CALL 914-699-5514
FAX 914-699-5565

CIRCLE NO. 23

How to use EDN's article index



Look for the topic of interest in the keyword index. If your topic isn't one of the keywords, try a related, but less specific, topic. Then go to the appropriate page in the database and scan the article titles, which are listed alphabetically within each keyword category. Information provided in each listing includes article title, author, company, magazine name, issue date, starting page number, and article length.

For more information on the articles listed, please contact each magazine directly.

EDN Magazine/ EDN News Edition

Cahners Building
275 Washington St
Newton, MA 02158
Phone (617) 964-3030
Fax (617) 558-4470

Computer Design

1 Technology Park Dr
Box 990
Westford, MA 01886
Phone (508) 692-0700
Fax (508) 692-0525

Electronic Design

611 Route #46 West
Hasbrouck Heights,
NJ 07604
Phone (201) 393-6060
Fax (201) 393-0204

Electronic Products

645 Stewart Ave
Garden City, NY 11530
Phone (516) 227-1300
Fax (516) 227-1901

Electronics

611 Route #46 West
Hasbrouck Heights,
NJ 07604
Phone (201) 393-6060
Fax (201) 393-0204

NO ONE OFFERS MORE 1 MEG SRAMS. PERIOD.

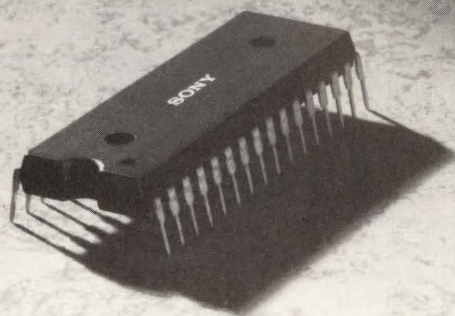

More variety. More speeds. More packages.
SRAMs built to run at extended operating temperatures, yet take only 12 μ A.

Plus fast cache and quick delivery so you can get better products to market sooner.

Sony knows low power, small spaces, high volume, quality, and reliability like no other company.

Call 1-800-288-SONY. Or FAX your current requirements to (714) 229-4333 in U.S.A., (416) 499-8290 in Canada.

We make the chips. You make the history.

The Sony 1 Megabit SRAM Family

Model	Speed (ns)	Package	Standby Current (μ A)	Special Features
CXK581000P	100/120	DIP 600 mil	12/50	-25° - +85° C
CXK581000M	100/120	SOP 525 mil	12/50	-25° - +85° C
				-40° - +85° C
CXK581100TM	100/120	TSOP	12/50	
CXK581100YM	100/120	TSOP (rev.)	12/50	
CXK581001P	70/85	DIP 600 mil	12/50	
CXK581001M	70/85	SOP 525 mil	12/50	
CXK581020SP	35/45/55	DIP 400 mil		
CXK581020J	35/45/55	SOJ 400 mil		
CXK581021J	47	SOJ 400 mil		
CXK581120J	15/17/20	SOJ 400 mil		
CXK77910J	20	SOJ 400 mil		Sync., 128K x 9

Note: All packages 5V, 32 pin, 128K x 8, unless otherwise noted.

© 1992 Sony Corporation of America
Sony is a trademark of Sony

SONY

1991

Technical-Article Database Index

(November 1991 to April 1992)

Keyword Index

Business/legal/professional	119	Board-level computers	120	Simulators/simulation	123
Conferences/conventions/shows	119	Computer user groups	121	Spectrum analyzers/analysis	123
Corporate appointments/ development/strategies	119	Graphics systems	121	Testability	123
Economics	119	Personal computers	121	Integrated circuits/semiconductor	
Employment/labor relations/ personnel/recruitment	119	Portable/laptop computers	121	devices/circuit design	123
Finance	119	Data acquisition/		Amplifiers	123
International trade	119	communications	121	Charge-coupled devices	123
Management	119	Data communications systems/ techniques	121	Circuit protection	123
Professional associations/issues	119	Local-area-network architecture/ design/design standards	121	Clock circuits	123
Research	119	Network architecture/design/ design standards (nonlocal)	121	Communications ICs	123
Standards	119	Telecommunications	121	Comparators	123
Computer software	119	Discrete components	121	Data converters	123
Computer languages/compilers/ interpreters	119	Capacitors	121	Digital signal processing (DSP)	124
Computer operating systems/ system software	119	Delay lines	121	Disk controllers	124
Computer software, analysis packages	119	Displays	121	Filter circuits	124
Computer software, CASE	120	Relays	121	Gate arrays	124
Computer software, data/ file management	120	Resistors	121	Graphics circuits	124
Computer software, design applications	120	Sensors/transducers	121	Integrated circuits/semiconductor devices/circuit design, other	124
Computer software, image processing	120	Energy storage/generation	121	Logic families and circuits	124
Computer software, other	120	Batteries	121	Low-voltage logic	125
Computer software, program development	120	Power supplies	121	Memory devices	125
Computer software, scientific/statistical	120	Uninterruptible power supplies	122	Microprocessor support chips	125
Programming	120	Voltage converters	122	Microprocessors	125
Computer subsystems/		Hardware/interconnection	122	Modem ICs	126
peripherals	120	Circuit packages	122	Motor control circuits	126
Computer buses/interfaces	120	Connectors	122	Op amps	126
Computer subsystems/ peripherals, other	120	Fiber optics	122	Oscillators	126
Digitizers	120	Interconnection systems	122	PLD/programmable-logic devices	126
Image-acquisition/ processing boards	120	Sockets	122	S/H circuits	126
Keyboards	120	Wire/cable	122	Semicustom/custom ICs	126
Memory boards/systems	120	Instrumentation/design aids		Timer ICs/circuits	127
Microprocessor buses	120	& services/measurement	122	Voltage references	127
Optical storage	120	Computer-aided design/ engineering (CAD/CAE)	122	Production/manufacturing/	
Printer controllers	120	Development systems	122	testing	127
Rigid-disk drives	120	Digital multimeters (DMMs)	122	Packaging/encapsulation/sealing	127
Terminal controllers	120	EMI/RFI testing	122	Production/manufacturing/ testing, other	127
Terminals	120	General troubleshooting	122	Technology/research	127
Computer systems/		In-circuit emulators/emulation	123	CMOS technology	127
system design	120	Instrumentation/design aids & services/measurement	123	Ergonomics/product design	127
		Logic analyzers/analysis	123	GaAs technology	127
		Modular instruments	123	Industrial electronics	127
		Oscilloscopes	123	Technology/research, other	127
		PROM/PLD programmers/ programming	123	Video	127
		Pulse generators/generation/ detection	123	Vision systems	127

Business/legal/professional

Conferences/conventions/shows

- A surge of pen-input systems at Comdex. Vaughan, Jack, EDN News Staff; EDN News Edition, 11/14/91, pg 1, .5 pg.
- Applied technology dominates conference papers at Wescon. Leonard, Milt, Senior Editor; Electronic Design, 11/21/91, pg 45, 4 pgs.
- Buscon '92 West: mezzanine buses ride a new wave of popularity. Nass, Richard, Technology Editor; Electronic Design, 02/06/92, pg 35, 5 pgs.
- Buscon beefs up technical program. Schofield, Julie Anne, Associate Editor; EDN Magazine, 01/20/92, pg 82, 2 pgs.
- EDN Innovation of the year awards. Staff; EDN Magazine, 11/21/91, pg 43, 5 pgs.
- ISSCC. Staff; Electronic Design, 02/20/92, pg 47, 1 pg.
- ISSCC analog technology. Goodenough, Frank, Senior Editor; Electronic Design, 02/20/92, pg 64, 8.5 pgs.
- ISSCC communications & special-purpose ICs. Leonard, Milt, Senior Editor; Electronic Design, 02/20/92, pg 79, 6 pgs.
- ISSCC digital technology. Bursky, Dave, Technology Editor; Electronic Design, 02/20/92, pg 48, 8 pgs.
- Wescon/91. Ormond, Tom, Senior Editor; EDN Magazine, 11/07/91, pg 157, 3.5 pgs.

Corporate appointments/development/strategies

- European manufacturing contractors encourage close relationships. Kerridge, Brian, Technical Editor; EDN Magazine, 02/17/92, pg 58, 4 pgs.
- Technology for sale: what price alliances? Shandle, Jack, Department Editor; Electronics, 11/91, pg 45, 4 pgs.

Economics

- The economic challenge of a united Europe. Fraser, Jay, Associate Editor; EDN Magazine, 11/07/91, pg 355, 3.5 pgs.

Employment/labor relations/personnel/recruitment

- After the pink slip: how to handle the job merry-go-round. Ward, Mark, EDN News Contributor; EDN News Edition, 04/30/92, pg 62, 1 pg.
- Alternate routes for finding a job. Colborn, Kate, EDN News Contributor; EDN News Edition, 02/06/92, pg S21, 2 pgs.
- ASIC vendors target hiring at systems specialists. Karon, Paul, EDN News Contributor; EDN News Edition, 04/30/92, pg 61, 1 pg.
- Don't count on contract engineering. Asbrand, Deborah; EDN News Edition, 02/06/92, pg S33, 2 pgs.
- Fear and loathing in performance reviews. Fraser, Jay, Associate Editor; EDN Magazine, 12/05/91, pg 229, 3.5 pgs.
- Mid-Atlantic states sustain scattered hiring, but not much more. Colborn, Kate, EDN News Contributor; EDN News Edition, 03/19/92, pg 24, 2 pgs.
- Pending pension reforms put the buck back in EEs' pockets. Bermar, Amy, EDN News Contributor; EDN News Edition, 01/23/92, pg 33, 1 pg.
- Salaries stagnate in tough times. Coco, Donna, EDN News Staff; EDN News Edition, 02/06/92, pg S16, 2 pgs.
- Take charge of your career. Veal, Barbara, NCR Microelectronic Products; EDN News Edition, 04/30/92, pg 64, 1 pg.
- Tough times to continue for out-of-work EEs. Handelman-Sagan, Julie, Cahners Economics; EDN News Edition, 02/06/92, pg 1, 1 pg.
- Use your resume to rebuild your career. Bermar, Amy; EDN News Edition, 02/06/92, pg S29, 1.5 pgs.

Finance

- Cellular phone designs call for mixed-signal solutions. Wilson, Dave, Senior Editor; Computer Design, 12/91, pg 57, 6 pgs.

International trade

- European manufacturing contractors encourage close relationships. Kerridge, Brian, Technical Editor; EDN Magazine, 02/17/92, pg 58, 4 pgs.

The economic challenge of a united Europe. Fraser, Jay, Associate Editor; EDN Magazine, 11/07/91, pg 355, 3.5 pgs.

Management

- Managing stress for success. Fraser, Jay, Associate Editor; EDN Magazine, 04/23/92, pg 256, 4.5 pgs.

Professional associations/issues

- Fear and loathing in performance reviews. Fraser, Jay, Associate Editor; EDN Magazine, 12/05/91, pg 229, 3.5 pgs.
- How engineering managers are tackling diversity. Bermar, Amy, EDN News Contributor; EDN News Edition, 01/09/92, pg 1, 1 pg.
- Is diversity working? Colborn, Kate, EDN News Contributor; EDN News Edition, 03/05/92, pg 21, 1.5 pgs.
- Managing stress for success. Fraser, Jay, Associate Editor; EDN Magazine, 04/23/92, pg 256, 4.5 pgs.
- Pending pension reforms put the buck back in EEs' pockets. Bermar, Amy, EDN News Contributor; EDN News Edition, 01/23/92, pg 33, 1 pg.
- Training with technology. Fraser, Jay, Associate Editor; EDN Magazine, 02/17/92, pg 212, 5.5 pgs.

Research

- Training with technology. Fraser, Jay, Associate Editor; EDN Magazine, 02/17/92, pg 212, 5.5 pgs.

Standards

- A glut of standards slows multimedia. Curran, Lawrence, Senior Editor; Electronics, 03/92, pg 34, 2 pgs.
- DMM calibration shortcuts pose question of confidence. Kerridge, Brian, Technical Editor; EDN Magazine, 12/19/91, pg 82, 5.5 pgs.
- Lack of standards impedes database management. Donlin, Mike, Senior Editor; Computer Design, 03/92, pg 71, 5 pgs.
- Lack of standards impedes design issues. Mosley, JD, Technical Editor; EDN Magazine, 01/02/92, pg 35, 4.5 pgs.
- Wrestling with multimedia standards. Wilson, Dave, Senior Editor; Computer Design, 01/92, pg 70, 11 pgs.

Computer software

Computer languages/compilers/interpreters

- Ada and generic FFT generate routines tailored to your needs. Carlin, Fred H, Consulting Engineer; EDN Magazine, 04/23/92, pg 165, 4 pgs.
- Building a case for object-oriented technology. Fleming, Read, Mazzucchelli, Lou, Cadre Technologies; Electronic Design, 11/07/91, pg 63, 4.5 pgs.
- C++ has C's familiarity and OOP capability. Ellis, George, Industrial Drives; EDN Magazine, 01/02/92, pg 97, 6 pgs.
- Check your designs with VHDL test benches. Coelho, David R, Vantage Analysis Systems; Electronic Design, 12/19/91, pg 73, 5 pgs.
- Combine C and assembler to program powerful DSP processors. Denny, Steve, Roome, Stephen J, Data Sciences; EDN Magazine, 04/23/92, pg 153, 3.5 pgs.
- Windows and engineering software. Small, Charles H, Senior Technical Editor; EDN Magazine, 04/09/92, pg 122, 9 pgs.

Computer operating systems/system software

- Real-time multiprocessing pushes software limits. Williams, Tom, Senior Editor; Computer Design, 11/91, pg 63, 6 pgs.
- Windows and engineering software. Small, Charles H, Senior Technical Editor; EDN Magazine, 04/09/92, pg 122, 9 pgs.

Computer software, analysis packages

- Software smooths complex computations. Gallant, John, Associate Editor; EDN Magazine, 11/07/91, pg 75, 6 pgs.

Computer software, CASE

CASE tools prove worth in boosting productivity. Williams, Tom, Senior Editor; Computer Design, 01/92, pg 51, 6.5 pgs.

Computer software, data/file management

Lack of standards impedes database management. Donlin, Mike, Senior Editor; Computer Design, 03/92, pg 71, 5 pgs.

Computer software, design applications

Combine C and assembler to program powerful DSP processors. Denny, Steve, Roome, Stephen J, Data Sciences; EDN Magazine, 04/23/92, pg 153, 3.5 pgs.

Innovation software stimulates engineering creativity. Small, Charles H, Senior Technical Editor; EDN Magazine, 02/03/92, pg 59, 4 pgs.

Real-time multiprocessing pushes software limits. Williams, Tom, Senior Editor; Computer Design, 11/91, pg 63, 6 pgs.

Shareware and freeware are only a phone call away. Small, Charles H, Senior Technical Editor; EDN Magazine, 03/02/92, pg 49, 2 pgs.

Computer software, image processing

Standard buses gain ground in image processing. Andrews, Warren, Senior Editor; Computer Design, 03/92, pg 83, 5.5 pgs.

Computer software, other

Human-interface rules reduce test-program operator errors. Dinan, John A; EDN Magazine, 02/03/92, pg 95, 3.5 pgs.

Innovation software stimulates engineering creativity. Small, Charles H, Senior Technical Editor; EDN Magazine, 02/03/92, pg 59, 4 pgs.

Shareware and freeware are only a phone call away. Small, Charles H, Senior Technical Editor; EDN Magazine, 03/02/92, pg 49, 2 pgs.

Computer software, program development

Human-interface rules reduce test-program operator errors. Dinan, John A; EDN Magazine, 02/03/92, pg 95, 3.5 pgs.

Computer software, scientific/statistical

Software smooths complex computations. Gallant, John, Associate Editor; EDN Magazine, 11/07/91, pg 75, 6 pgs.

Programming

Ada and generic FFT generate routines tailored to your needs. Carlin, Fred H, Consulting Engineer; EDN Magazine, 04/23/92, pg 165, 4 pgs.

Human-interface rules reduce test-program operator errors. Dinan, John A; EDN Magazine, 02/03/92, pg 95, 3.5 pgs.

Software smooths complex computations. Gallant, John, Associate Editor; EDN Magazine, 11/07/91, pg 75, 6 pgs.

Computer subsystems/peripherals

Computer buses/interfaces

8-bit μ C evaluation boards. Weiss, Ray, Technical Editor; EDN Magazine, 01/20/92, pg 104, 10.5 pgs.

Boards let you try out μ C architectures. Weiss, Ray, Technical Editor; EDN Magazine, 02/03/92, pg 41, 7.5 pgs.

Buscon '92 West: mezzanine buses ride a new wave of popularity. Nass, Richard, Technology Editor; Electronic Design, 02/06/92, pg 35, 5 pgs.

Complex functions land on the Sbus. Phillips, Barry, EDN News Contributor; EDN News Edition, 01/09/92, pg 1, 1.5 pgs.

Standard buses gain ground in image processing. Andrews, Warren, Senior Editor; Computer Design, 03/92, pg 83, 5.5 pgs.

Understanding PC-based hard-disk interfaces. Liccardo, Michael, Quezada, Sam, Cirrus Logic; Electronic Products, 01/92, pg 45, 4.5 pgs.

Computer subsystems/peripherals, other

Multimedia. Mosley, JD, Technical Editor; EDN Magazine, 03/16/92, pg 100, 10 pgs.

Digitizers

VESA XGA standard. Knapp, Bill, Cirrus Logic; Electronic Design, 02/20/92, pg 120, 1 pg.

Image-acquisition/processing boards

Multimedia. Mosley, JD, Technical Editor; EDN Magazine, 03/16/92, pg 100, 10 pgs.

Keyboards

Membrane keyboards continue to advance. DeVisser, Bruce, Fujitsu Microelectronics, Electronic Components; Electronic Products, 11/91, pg 21, 3 pgs.

Memory boards/systems

IC-card spec adapts I/O to memory-card slot. Nass, Richard, Technology Editor; Electronic Design, 01/23/92, pg 45, 6.5 pgs. Smart-card applications' hidden problems add to designers' challenges. Legg, Gary, Senior Technical Editor; EDN Magazine, 03/02/92, pg 83, 5 pgs.

Microprocessor buses

8-bit μ C evaluation boards. Weiss, Ray, Technical Editor; EDN Magazine, 01/20/92, pg 104, 10.5 pgs.

Boards let you try out μ C architectures. Weiss, Ray, Technical Editor; EDN Magazine, 02/03/92, pg 41, 7.5 pgs.

Bus-driver ICs. Quinnell, Richard A, Technical Editor; EDN Magazine, 02/03/92, pg 78, 7.5 pgs.

System cabling for the SCSI bus: past, present, and future. Blackford, Peter M, Cooper Industries, Belden Division; Electronic Design, 03/19/92, pg 91, 4 pgs.

Optical storage

Drives meet standards for removable data storage. Wright, Maury; EDN Magazine, 03/16/92, pg 47, 4.5 pgs.

Printer controllers

Laser-printer controllers get ASICs. Martin, Louis, EDN News Contributor, Vaughan, Jack, EDN News Staff; EDN News Edition, 11/14/91, pg 1, 1 pg.

Rigid-disk drives

Drives meet standards for removable data storage. Wright, Maury, Technical Editor; EDN Magazine, 03/16/92, pg 47, 4.5 pgs.

Future laser-recording techniques will boost MO drives. Helsel, Michael, Teac America, Data Storage Products; Electronic Design, 01/09/92, pg 124, 1 pg.

Understanding PC-based hard-disk interfaces. Liccardo, Michael, Quezada, Sam, Cirrus Logic; Electronic Products, 01/92, pg 45, 4.5 pgs.

Terminal controllers

X-terminals stretch price-performance boundaries. Nass, Richard, Technology Editor; Electronic Design, 03/05/92, pg 43, 5 pgs.

Terminals

X-terminals stretch price-performance boundaries. Nass, Richard, Technology Editor; Electronic Design, 03/05/92, pg 43, 5 pgs.

Computer systems/system design

Board-level computers

8-bit μ C evaluation boards. Weiss, Ray, Technical Editor; EDN Magazine, 01/20/92, pg 104, 10.5 pgs.

Add-on boards boost real-time performance. Andrews, Warren, Senior Editor; Computer Design, 12/91, pg 71, 5 pgs.
Boards let you try out μ C architectures. Weiss, Ray, Technical Editor; EDN Magazine, 02/03/92, pg 41, 7.5 pgs.

Computer user groups

Shareware and freeware are only a phone call away. Small, Charles H, Senior Technical Editor; EDN Magazine, 03/02/92, pg 49, 2 pgs.

Graphics systems

Standardized feature sets add versatility and speed. Quinnell, Richard A, Technical Editor; EDN Magazine, 03/16/92, pg 37, 3.5 pgs.

Personal computers

A glut of standards slows multimedia. Curran, Lawrence, Senior Editor; Electronics, 03/92, pg 34, 2 pgs.
A surge of pen-input systems at Comdex. Vaughan, Jack, EDN News Staff; EDN News Edition, 11/14/91, pg 1, .5 pg.
Multimedia. Mosley, JD, Technical Editor; EDN Magazine, 03/16/92, pg 100, 10 pgs.
Pen-based computing. Legg, Gary, Senior Technical Editor; EDN Magazine, 04/23/92, pg 136, 9.5 pgs.
Wrestling with multimedia standards. Wilson, Dave, Senior Editor; Computer Design, 01/92, pg 70, 11 pgs.

Portable/laptop computers

Liquid-crystal displays: High-resolution panels target laptop computers. Pryce, Dave, Technical Editor; EDN Magazine, 04/23/92, pg 61, 5.5 pgs.
Pen-based computing. Legg, Gary, Senior Technical Editor; EDN Magazine, 04/23/92, pg 136, 9.5 pgs.
Smart-card applications' hidden problems add to designers' challenges. Legg, Gary, Senior Technical Editor; EDN Magazine, 03/02/92, pg 83, 5 pgs.

Data acquisition/communications

Data communications systems/techniques

"Data-pump" chips add voice capabilities. Arnold, Bill, EDN News Staff; EDN News Edition, 11/14/91, pg 3, 1 pg.
Evaluating the communications performance of your next board design. O'Dell, Robert W, Motorola; Electronic Design, 04/16/92, pg 104, 7 pgs.
Low-cost routers can tame complex global internets. Edem, Brian, et al, National Semiconductor; Electronic Design, 03/19/92, pg 61, 8 pgs.

Local-area-network architecture/design/design standards

Arm yourself with LAN know-how. Strassberg, Dan, Technical Editor; EDN Magazine, 12/19/91, pg 130, 7.5 pgs.
Content-addressable memories: FDDI routers and bridges create niche. Gallant, John, Technical Editor; EDN Magazine, 04/09/92, pg 61, 5.5 pgs.
Low-cost routers can tame complex global internets. Edem, Brian, et al, National Semiconductor; Electronic Design, 03/19/92, pg 61, 8 pgs.
Networking advances will anchor concurrent engineering. Willett, Ken, Mentor Graphics; Electronic Design, 01/09/92, pg 107, 5.5 pgs.
Opposing groups struggle to define standards for FDDI using copper wire. Pryce, Dave, Technical Editor; EDN Magazine, 03/02/92, pg 57, 4 pgs.
The best LAN may be found off the MAP. Mosley, JD, Technical Editor; EDN Magazine, 11/07/91, pg 63, 5.5 pgs.
WAN boards bring the protocols home. Vaughan, Jack, EDN News Staff; EDN News Edition, 02/06/92, pg 1, 1 pg.
Wireless data links broaden LAN options. Leonard, Milt, Senior Editor; Electronic Design, 03/19/92, pg 51, 5 pgs.

Wireless LANs: welcome to the virtual workplace. Shandle, Jack, Department Editor; Electronics, 04/92, pg 26, 3 pgs.

Network architecture/design/design standards (nonlocal)

Can data superhighways put the U.S. in high gear? Shandle, Jack, Department Editor; Electronics, 02/92, pg 40, 3 pgs.

Telecommunications

The world of communications is moving to fiber optics. Leonard, Milt, Senior Editor; Electronic Design, 01/09/92, pg 73, 6 pgs.

Discrete components

Capacitors

Materials will drive progress in SMD tantalum capacitors. Tatebe, Mitsuhiro, NEC, Electronic Component Application Engineering; Electronic Design, 01/09/92, pg 122, 1 pg.

Delay lines

Delay lines take on timing tasks. Ormond, Tom, Senior Technical Editor; EDN Magazine, 12/19/91, pg 108, 4.5 pgs.

Displays

Flat panels proliferate and challenge the CRT. Oromaner, Jeff, Planar Systems; Electronic Products, 01/92, pg 21, 3.5 pgs.
Liquid-crystal displays: High-resolution panels target laptop computers. Pryce, Dave, Technical Editor; EDN Magazine, 04/23/92, pg 61, 5.5 pgs.
Passive- and active-matrix LCDs to dominate flat-panel displays. Tannas, Jr, Lawrence, Tannas Electronics; Electronic Design, 01/09/92, pg 116, 1 pg.

Relays

Solid-state relays meet requirements and handle demanding applications. Ormond, Tom, Senior Technical Editor; EDN Magazine, 03/16/92, pg 61, 4.5 pgs.

Resistors

Negative resistors are versatile design aids. Stitt, R Mark, Kunst, David, Burr-Brown; Electronic Design, 02/20/92, pg 93, 5 pgs.

Sensors/transducers

Inexpensive sensors provide precision. Ormond, Tom, Senior Technical Editor; EDN Magazine, 11/07/91, pg 99, 4 pgs.
Negative resistors are versatile design aids. Stitt, R Mark, Kunst, David, Burr-Brown; Electronic Design, 02/20/92, pg 93, 5 pgs.
Piezoelectric-film sensors leave niches behind. Maliniak, David, Technology; Electronic Design, 12/05/91, pg 37, 4 pgs.

Energy storage/generation

Batteries

The business of finding the best battery. Quinnell, Richard A, Technical Editor; EDN Magazine, 12/05/91, pg 162, 4.5 pgs.

Power supplies

DC/DC converters: when to build and when to buy. Hennigan, Andrew; Electronic Products, 03/92, pg 41, 1.5 pgs.
External power supplies. Duarte, Brad, Ault; Electronic Products, 03/92, pg 51, 1.5 pgs.
Practical considerations in the use of dc/dc converters. Fury, Art, Modupower; Electronic Products, 03/92, pg 45, 2 pgs.

Selecting switching power supplies for medical applications. Miller, Steve, Hemphill, David, Condor DC Power Supplies; Electronic Products, 03/92, pg 35, 2 pgs.

Solve switcher problems with power-factor correction. Hunter, Patrick L, Unipower; Electronic Design, 02/06/92, pg 67, 6.5 pgs.

Switching power supplies will become system-level component. Todd, Paul, Todd Products; Electronic Design, 01/09/92, pg 123, 1 pg.

Uninterruptible power supplies

Uninterruptible power supplies today. Mock, John, Exide Electronics; Electronic Products, 03/92, pg 55, 2.5 pgs.

Voltage converters

DC/DC converters: when to build and when to buy. Hennigan, Andrew; Electronic Products, 03/92, pg 41, 1.5 pgs.

Practical considerations in the use of dc/dc converters. Fury, Art, Modupower; Electronic Products, 03/92, pg 45, 2 pgs.

Hardware/interconnection

Circuit packages

Designers look beyond DIPs to meet application needs. Gabay, Jon; Computer Design, 11/91, pg 73, 6 pgs.

Future packaging depends heavily on materials. Maliniak, David, Technology Editor; Electronic Design, 01/09/92, pg 83, 9 pgs.

High-performance packaging increases system speed and density. Bogatin, Eric, nChip; Electronic Design, 11/21/91, pg 97, 6.5 pgs.

Lack of standards impedes design issues. Mosley, JD, Technical Editor; EDN Magazine, 01/02/92, pg 35, 4.5 pgs.

Multichip-module technology will drive EDA evolution. Khanna, Sandeep, Valid Logic; Electronic Design, 01/09/92, pg 99, 4.5 pgs.

Connectors

Surface-mount sockets expand design options. Ormond, Tom, Senior Technical Editor; EDN Magazine, 01/20/92, pg 71, 5 pgs.

Fiber optics

The world of communications is moving to fiber optics. Leonard, Milt, Senior Editor; Electronic Design, 01/09/92, pg 73, 6 pgs.

Interconnection systems

Level-3 pc-board connectors edge toward high-speed applications. Sucheski, Matt, AMP; Electronic Design, 03/19/92, pg 97, 2.5 pgs.

System cabling for the SCSI bus: past, present, and future. Blackford, Peter M, Cooper Industries, Belden Division; Electronic Design, 03/19/92, pg 91, 4 pgs.

Sockets

Surface-mount sockets expand design options. Ormond, Tom, Senior Technical Editor; EDN Magazine, 01/20/92, pg 71, 5 pgs.

Wire/cable

Ribbon cable ties it all together. Pryce, Dave, Technical Editor; EDN Magazine, 12/05/91, pg 56, 5 pgs.

Instrumentation/design aids & services/measurement

Computer-aided design/engineering (CAD/CAE)

ASIC designers turn to VHDL tools despite obstacles. Tuck Eden, Barbara, Senior Editor; Computer Design, 02/92, pg 55, 6 pgs.

Behavioral models expedite simulation. Watson Swager, Anne, Technical Editor; EDN Magazine, 11/21/91, pg 67, 6 pgs.

Check your designs with VHDL test benches. Coelho, David R, Vantage Analysis Systems; Electronic Design, 12/19/91, pg 73, 5 pgs.

Control-system simulation: Simulation software gains sophistication. Gallant, John, Technical Editor; EDN Magazine, 04/23/92, pg 79, 5 pgs.

Design software links active-filter performance with real devices. Watson Swager, Anne, Technical Editor; EDN Magazine, 04/09/92, pg 45, 5 pgs.

Design tools can ease the transition to a VHDL environment. Kassardjian, Vahan, Valid Logic Systems; Electronic Design, 12/05/91, pg 61, 1 pg.

Dynamic timing can cause snags in VHDL models. Milligan, Mark, Teradyne; Electronic Design, 12/05/91, pg 68, 1 pg.

EDN's hands-on FPGA project. Conner, Doug, Technical Editor; EDN Magazine, 04/09/92, pg 98, 15 pgs.

EDN's hands-on FPGA project. Conner, Doug, Technical Editor; EDN Magazine, 04/23/92, pg 120, 11.5 pgs.

Evolving VHDL into a more useful standard. Shahdad, Moe, Viewlogic Systems; Electronic Design, 12/05/91, pg 62, 1 pg.

Gate-level simulation in VHDL does not have to be slow. Wiley, John, Vantage Analysis Systems; Electronic Design, 12/05/91, pg 65, 1 pg.

Is the industry ready for VHDL-based synthesis? Carlson, Steve, Synopsys; Electronic Design, 12/05/91, pg 66, 1 pg.

Limited VHDL library support can hinder ASIC design. Goel, Prabhu, Cadence Design Systems; Electronic Design, 12/05/91, pg 64, 1 pg.

Mixed-signal board designers resist the siren call of simulation. Donlin, Mike, Senior Editor; Computer Design, 11/91, pg 84, 11 pgs.

Networking advances will anchor concurrent engineering. Willett, Ken, Mentor Graphics; Electronic Design, 01/09/92, pg 107, 5.5 pgs.

One-touch board designs: fantasy or reality? Gipper, Jerry, Motorola, Technical Systems; Electronic Design, 01/09/92, pg 126, 1 pg.

Schematics battle equations for design representation. Weiss, Ray, Technical Editor; EDN Magazine, 12/19/91, pg 62, 6 pgs.

System simulation still holds promise. Maliniak, Lisa, Technology Editor; Electronic Design, 02/06/92, pg 53, 7.5 pgs.

System validation can be tricky with VHDL. Rood Goldman, Steven, Protocol, a Div of Zycad; Electronic Design, 12/05/91, pg 70, 1 pg.

Teaching engineers a new design paradigm. Mendes da Costa, Robert, Mentor Graphics; Electronic Design, 12/05/91, pg 60, 1 pg.

Top-down methodologies infiltrate system designs. Donlin, Mike, Senior Editor; Computer Design, 01/92, pg 61, 5.5 pgs.

Development systems

Designers can now take their pick of 32-bit debugging tools. Child, Jeffrey, Associate Editor; Computer Design, 03/92, pg 92, 10 pgs.

Digital multimeters (DMMs)

DMM calibration shortcuts pose question of confidence. Kerridge, Brian, Technical Editor; EDN Magazine, 12/19/91, pg 82, 5.5 pgs.

EMI/RFI testing

Designers will be paying more attention to EMC testing. Linkwitz, Siegfried, Hewlett-Packard, Signal Analysis; Electronic Design, 01/09/92, pg 117, 1 pg.

General troubleshooting

Analyzers fine-tune high-performance buses. Andrews, Warren, Senior Editor; Computer Design, 04/92, pg 75, 5.5 pgs.

Versatile units find more use than you might expect. Strassberg, Dan, Technical Editor; EDN Magazine, 03/30/92, pg 65, 7 pgs.

In-circuit emulators/emulation

Designers can now take their pick of 32-bit debugging tools. Child, Jeffrey, Associate Editor; Computer Design, 03/92, pg 92, 10 pgs.

Instrumentation/design aids & services/measurement

Accelerate RF mixer measurements. Jerse, Tom, Cramer, Will, Hewlett-Packard, Signal Analysis; Electronic Design, 03/05/92, pg 101, 3.5 pgs.

Active probes will help designers test faster circuits. Applebee, Phil, Tektronix, Test and Measurement Group; Electronic Design, 01/09/92, pg 121, 1 pg.

Choosing instrument accuracy becomes more complicated. Jones, Kris, John Fluke Mfg; Electronic Design, 01/09/92, pg 120, 1 pg.

Design for test (without really trying). Markowitz, Michael C, Technical Editor; EDN Magazine, 02/17/92, pg 114, 9.5 pgs.

Designers adapting to new test techniques. Novellino, John, Senior Editor; Electronic Design, 12/05/91, pg 85, 2 pgs.

Designers can now take their pick of 32-bit debugging tools. Child, Jeffrey, Associate Editor; Computer Design, 03/92, pg 92, 10 pgs.

DMM calibration shortcuts pose question of confidence. Kerridge, Brian; EDN Magazine, 12/19/91, pg 82, 5.5 pgs.

New communication standards require specialized test. Prasannan, V, Smith, Kevin, Tektronix, Telecommunications Product Lines; Electronic Design, 12/05/91, pg 89, 5 pgs.

New measurement techniques. Strassberg, Dan, Technical Editor; EDN Magazine, 03/02/92, pg 118, 9 pgs.

Parameter analyzers give you a closer look at dc-circuit performance. Conner, Doug, Technical Editor; EDN Magazine, 02/17/92, pg 65, 4 pgs.

Use the analytic approach to avoid errors when probing CMOS circuits. Porter, Art, Hewlett-Packard; EDN Magazine, 03/30/92, pg 123, 6 pgs.

Logic analyzers/analysis

Analyzers fine-tune high-performance buses. Andrews, Warren, Senior Editor; Computer Design, 04/92, pg 75, 5.5 pgs.

Modular instruments

Modular systems give freedom of choice. Conner, Doug, Technical Editor; EDN Magazine, 11/21/91, pg 53, 6 pgs.

Oscilloscopes

Versatile units find more use than you might expect. Strassberg, Dan, Technical Editor; EDN Magazine, 03/30/92, pg 65, 7 pgs.

PROM/PLD programmers/programming

Improve reliability by rigging pc boards for in-circuit programming. Clark, Barry M, Stag Microsystems; EDN Magazine, 04/09/92, pg 135, 6 pgs.

Time-domain techniques enhance testing of high-speed ADCs. Demler, Michael J, Micro Networks; EDN Magazine, 03/30/92, pg 115, 5.5 pgs.

Pulse generators/generation/detection

Modular systems give freedom of choice. Conner, Doug, Technical Editor; EDN Magazine, 11/21/91, pg 53, 6 pgs.

Simulators/simulation

Behavioral models expedite simulation. Watson Swager, Anne, Technical Editor; EDN Magazine, 11/21/91, pg 67, 6 pgs.

Control-system simulation: Simulation software gains sophistication. Gallant, John, Technical Editor; EDN Magazine, 04/23/92, pg 79, 5 pgs.

Design software links active-filter performance with real devices. Watson Swager, Anne, Technical Editor; EDN Magazine, 04/09/92, pg 45, 5 pgs.

EDN's hands-on FPGA project. Conner, Doug, Technical Editor; EDN Magazine, 04/09/92, pg 98, 15 pgs.

EDN's hands-on FPGA project. Conner, Doug, Technical Editor; EDN Magazine, 04/23/92, pg 120, 11.5 pgs.

Gate-level simulation in VHDL does not have to be slow. Wiley, John, Vantage Analysis Systems; Electronic Design, 12/05/91, pg 65, 1 pg.

Improve noise analysis with op-amp macromodel. Buxton, Joe, Analog Devices, Precision Monolithics Div; Electronic Design, 04/02/92, pg 73, 6.5 pgs.

Macromodels aid in use of current-mode feedback amps. Tabor, Joe, Siegel, Barry, Elantec; Electronic Products, 04/92, pg 25, 5.5 pgs.

Mixed-signal board designers resist the siren call of simulation. Donlin, Mike, Senior Editor; Computer Design, 11/91, pg 84, 11 pgs.

Simulating audio transducers with Spice. Agnew, Jeremy; Electronic Design, 11/07/91, pg 45, 6.5 pgs.

System simulation still holds promise. Maliniak, Lisa, Technology Editor; Electronic Design, 02/06/92, pg 53, 7.5 pgs.

Spectrum analyzers/analysis

Digital technology simplifies spectrum analyzer operation. Novellino, John, Senior Editor; Electronic Design, 03/05/92, pg 93, 6 pgs.

Use spectrum analyzers' selectivity to precisely measure random noise. Johnson, Kevin, Hewlett-Packard; EDN Magazine, 03/02/92, pg 131, 6 pgs.

Testability

Design for test (without really trying). Markowitz, Michael C, Technical Editor; EDN Magazine, 02/17/92, pg 114, 9.5 pgs.

Integrated circuits/semiconductor devices/circuit design

Amplifiers

Filters and oscillators. Williams, Jim, Linear Technology; EDN Magazine, 11/07/91, pg 193, 6.5 pgs.

High-speed communications circuits. Williams, Jim, Linear Technology; EDN Magazine, 11/07/91, pg 233, 8.5 pgs.

High-speed data-conversion circuits. Williams, Jim, Linear Technology; EDN Magazine, 11/07/91, pg 211, 9.5 pgs.

Charge-coupled devices

CCDs mix technologies to enhance operation. Vaughan, Jack, EDN News Staff; EDN News Edition, 12/12/91, pg 1, 2 pgs.

Circuit protection

Electrical-transient immunity: a growing imperative for system design. Clark, Melville, Neill, Donald E, General Semiconductor Industries; Electronic Design, 01/23/92, pg 83, 7.5 pgs.

Clock circuits

Goof proof your input clock circuit. Atkins, Don, Motorola; Electronic Design, 11/21/91, pg 94, 2.5 pgs.

Communications ICs

"Data-pump" chips add voice capabilities. Arnold, Bill, EDN News Staff; EDN News Edition, 11/14/91, pg 3, 1 pg.

Evaluating the communications performance of your next board design. O'Dell, Robert W, Motorola; Electronic Design, 04/16/92, pg 104, 7 pgs.

High-speed communications circuits. Williams, Jim, Linear Technology; EDN Magazine, 11/07/91, pg 233, 8.5 pgs.

Comparators

Digital audio drives 14-to-20-bit DAC designs. Goodenough, Frank; Electronic Design, 04/16/92, pg 55, 8.5 pgs.

Data converters

Get F-V converters to settle fast without ripple. Stitt, Mark, Burt, Rod; Electronic Design, 12/05/91, pg 73, 6 pgs.

EDN-ARTICLE INDEX

High-speed data-conversion circuits. Williams, Jim, Linear Technology; EDN Magazine, 11/07/91, pg 211, 9.5 pgs.
 Monolithic devices enhance accuracy and linearity. Pryce, Dave, Technical Editor; EDN Magazine, 01/20/92, pg 53, 7.5 pgs.
 Time-domain techniques enhance testing of high-speed ADCs. Demler, Michael J, Micro Networks; EDN Magazine, 03/30/92, pg 115, 5.5 pgs.
 Try single-slope A-D conversion for a low-cost 12-bit solution. Daugherty, Kevin, National Semiconductor; Electronic Design, 01/23/92, pg 59, 5.5 pgs.

Digital signal processing (DSP)

32-bit floating-point DSP processors. Weiss, Ray, Regional Editor; EDN Magazine, 11/07/91, pg 126, 16 pgs.
 Combine C and assembler to program powerful DSP processors. Denny, Steve, Roome, Stephen J, Data Sciences; EDN Magazine, 04/23/92, pg 153, 3.5 pgs.
 Digital-filter synthesis serves DSP applications. Betts, Richard F, Eldec; Electronic Design, 03/05/92, pg 65, 5.5 pgs.
 DSP houses address software. Vaughan, Jack, EDN News Staff; EDN News Edition, 03/19/92, pg 1, 1 pg.
 Is RISC or DSP best for your application? Wilson, Dave, Senior Editor; Computer Design, 04/92, pg 65, 6 pgs.

Disk controllers

Drive ICs: ASICs or off-the-shelf? Arnold, Bill, EDN News Staff; EDN News Edition, 11/28/91, pg 1, 1.5 pgs.

Filter circuits

Design software links active-filter performance with real devices. Watson Swager, Anne, Technical Editor; EDN Magazine, 04/09/92, pg 45, 5 pgs.
 Digital-filter synthesis serves DSP applications. Betts, Richard F, Eldec; Electronic Design, 03/05/92, pg 65, 5.5 pgs.

Filters and oscillators. Williams, Jim, Linear Technology; EDN Magazine, 11/07/91, pg 193, 6.5 pgs.

Gate arrays

FPGAs race for the gold in product development. Tuck, Barbara, Senior Editor; Computer Design, 04/92, pg 88, 10 pgs.
 Revisiting ECL gate arrays. Kemps, John, Griesbach, Bill, AT&T Microelectronics; Electronic Products, 04/92, pg 37, 3.5 pgs.

Graphics circuits

Local bus speeds video. McCabe, Ron, Tseng Labs; Electronic Design, 04/16/92, pg 103, 1 pg.

Integrated circuits/semiconductor devices/circuit design, other

Bus-driver ICs. Quinnell, Richard A, Technical Editor; EDN Magazine, 02/03/92, pg 78, 7.5 pgs.
 Expect MPEG ICs to support audio. Martin, S Louis, EDN News Contributor; EDN News Edition, 04/02/92, pg 1, 1 pg.
 New processes to spawn next-generation analog, mixed-signal power ICs. Goodenough, Frank, Senior Editor; Electronic Design, 01/09/92, pg 59, 8.5 pgs.
 Process advancements fuel IC developments. Bursky, Dave, Technology Editor; Electronic Design, 01/09/92, pg 37, 8.5 pgs.
 Silicon microstructures. Petersen, Kurt, Lucas NovaSensor; Electronic Design, 01/09/92, pg 118, 1 pg.

Logic families and circuits

Chip makers unleash 3V ICs. Arnold, Bill, EDN News Staff; EDN News Edition, 02/20/92, pg 1, 1.5 pgs.
 Fuzzy logic is anything but fuzzy. Williams, Tom, Senior Editor; Computer Design, 04/92, pg 113, 13 pgs.

PURE PERFORMANCE

	HSP45116	HSP45106	HSP45102
Phase accumulator size	32 bits	32 bits	32 bits
Phase control	16 bits	16 bits	2 bits
Frequency control	32 bits	32 bits	32 bits
Tuning resolution at maximum speed	0.008 Hz	0.008 Hz	0.009 Hz
Interface	Standard μ P	Standard μ P	Serial
Speed	33 MHz	33 MHz	40 MHz
Output	16 parallel	16 parallel or serial	12 parallel

DIGITAL MODULATION MADE EASY

QAM Implement nearly infinite levels of Quadrature Amplitude Modulation

PSK Implement all forms of Phase Shift Keying from DPSK to BPSK

FM/FSK/FHOP Real time frequency control; change frequency in a single clock cycle

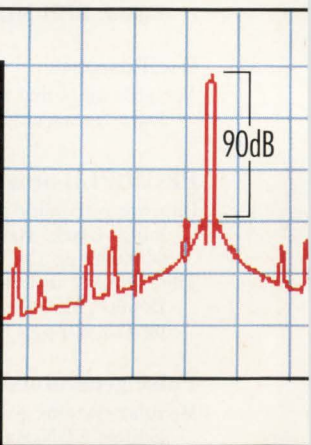

HSP45102
Shown Actual Size

For pure performance in frequency synthesis, catch the new wave in DSP. The new wave is Harris. Our Numerically Controlled Oscillators (NCOs) offer spectral purity of better than 90 dB. Tuning resolution of 0.008 Hertz. 32-bit-wide

EDN-ARTICLE INDEX

Piecewise analysis and accurate emulation yield precise power estimates. Hall, William, Mentzer, Ray, National Semiconductor; EDN Magazine, 03/16/92, pg 113, 12.5 pgs.

Timing techniques help signals stay in sync. Swager, Anne, Technical Editor; EDN Magazine, 02/17/92, pg 81, 6.5 pgs.

Low-voltage logic

Advanced techniques tackle advanced op amps' extremely low distortion. Graeme, Jerald, Burr-Brown; EDN Magazine, 02/17/92, pg 139, 7 pgs.

Memory devices

Caches and low voltage steer memory development. Myrvaagnes, Rodney, Associate Editor; Electronic Products, 04/92, pg 49, 4.5 pgs.

Content-addressable memories: FDDI routers and bridges create niche for memories. Gallant, John, Technical Editor; EDN Magazine, 04/09/92, pg 61, 5.5 pgs.

Cut I/O transfer delays by adding an I/O cache. Hsieh, Michael M, Sun Microsystems; Electronic Design, 11/21/91, pg 75, 8.5 pgs.

Enhanced SRAMs propel systems performance. Bursky, Dave, Technology Editor; Electronic Design, 04/02/92, pg 57, 6.5 pgs.

Expect more μ P-specific cache SRAMs. Arnold, Bill, EDN News Staff; EDN News Edition, 03/05/92, pg 1, 1.5 pgs.

Improve reliability by rigging pc boards for in-circuit programming. Clark, Barry M, Stag Microsystems; EDN Magazine, 04/09/92, pg 135, 6 pgs.

Processor-specific static RAMs begin to proliferate. Myrvaagnes, Rodney, Associate Editor; Electronic Products, 11/91, pg 25, 2 pgs.

Standardized feature sets add versatility and speed. Quinnell, Richard A; EDN Magazine, 03/16/92, pg 37, 3.5 pgs.

Microprocessor support chips

Chip makers take aim at multimedia market. Shandle, Jack, Department Editor; Electronics, 03/92, pg 36, 1 pg.

Expect more μ P-specific cache SRAMs. Arnold, Bill, EDN News Staff; EDN News Edition, 03/05/92, pg 1, 1.5 pgs.

ICs see mainstream duty as μ P glue logic. Wright, Maury, Technical Editor; EDN Magazine, 03/02/92, pg 97, 4.5 pgs.

Improve reliability by rigging pc boards for in-circuit programming. Clark, Barry M, Stag Microsystems; EDN Magazine, 04/09/92, pg 135, 6 pgs.

Smart peripherals make or break microcontrollers. Small, Charles H, Senior Editor; EDN Magazine, 12/05/91, pg 124, 5.5 pgs.

Standardized feature sets add versatility and speed. Quinnell, Richard A, Technical Editor; EDN Magazine, 03/16/92, pg 37, 3.5 pgs.

Microprocessors

16-bit μ Cs gather memory, functions. Arnold, Bill, EDN News Staff; EDN News Edition, 01/23/92, pg 1, 1.5 pgs.

32-bit floating-point DSP processors. Weiss, Ray, Regional Editor; EDN Magazine, 11/07/91, pg 126, 16 pgs.

40-MHz CMOS circuits send designers back to school. Gallant, John, Technical Editor; EDN Magazine, 03/02/92, pg 67, 5.5 pgs.

Dual processors boost computer power. Atkins, Mark, Intel; Electronic Design, 02/20/92, pg 122, 5.5 pgs.

EDN's 18th annual μ P/ μ C chip directory. Markowitz, Michael, Technical Editor; EDN Magazine, 11/21/91, pg 82, 49 pgs.

Integration rises for RISC chips. Arnold, Bill, EDN News Staff; EDN News Edition, 11/14/91, pg 1, 1 pg.

Is RISC or DSP best for your application? Wilson, Dave, Senior Editor; Computer Design, 04/92, pg 65, 6 pgs.

Microprocessor architectures will evolve in the 90s. Slater, Michael, Microprocessor Report; Electronic Design, 01/09/92, pg 115, 1 pg.

SPECTRAL PURITY OF THE HARRIS NCO FAMILY

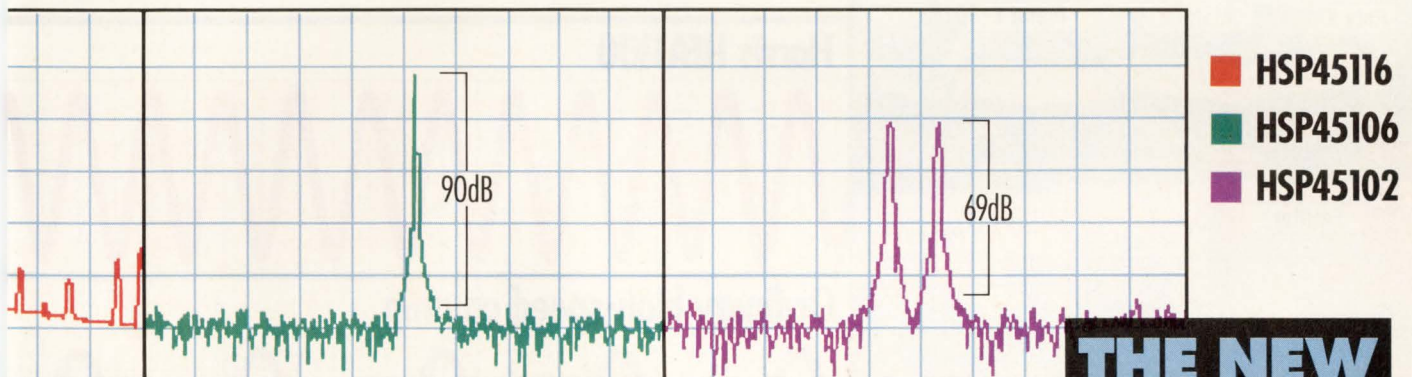

Typical spectral purity as measured by 2048 point FFT with Blackman window. The Harris family of NCOs will always have a spurious-free dynamic range better than shown.

phase accumulation. No one else offers NCOs that generate signals so pure with so much precision.

No one else offers NCOs with so many features, either. Our HSP45116 also implements Direct Digital Down Conversion on the same chip. And

our HSP45102 12-bit NCO has a footprint of just 0.28 square inches.

So get in tune with Harris. With our broad line of DSP products — including NCOs, digital filters and image processing — we're the new wave in DSP. Catch it. Call 1-800-4-HARRIS, ext. 1171.

**THE NEW
WAVE
IN DSP**

HARRIS
SEMICONDUCTOR

Multiprocessing to bring the next jump in performance. Andrews, Warren; Computer Design, 02/92, pg 78, 11 pgs.
 RISC is simple, but benchmarking isn't. Williams, Tom, Senior Editor; Computer Design, 02/92, pg 67, 6 pgs.
 Smart peripherals make or break microcontrollers. Small, Charles H, Senior Editor; EDN Magazine, 12/05/91, pg 124, 5.5 pgs.
 Smart-card applications' hidden problems add to designers' challenges. Legg, Gary; EDN Magazine, 03/02/92, pg 83, 5 pgs.
 Third-generation RISC processors. Weiss, Ray, Technical Editor; EDN Magazine, 03/30/92, pg 96, 10.5 pgs.

Modem ICs

How to specify modem chipsets. Sorensen, Jeff, Silicon Systems; Electronic Products, 11/91, pg 65, 4.5 pgs.
 Now hear this: modem ICs add voice. Martin, S Louis, EDN News Contributor; EDN News, 12/12/91, pg 1, 1.5 pgs.

Motor control circuits

Sensorless motor-control ICs: Spin chips whirl into nondrive applications. Mosley, JD; EDN Magazine, 04/23/92, pg 43, 4.5 pgs.

Op amps

High-speed communications circuits. Williams, Jim, Linear Technology; EDN Magazine, 11/07/91, pg 233, 8.5 pgs.
 High-speed data-conversion circuits. Williams, Jim, Linear Technology; EDN Magazine, 11/07/91, pg 211, 9.5 pgs.
 Improve noise analysis with op-amp macromodel. Buxton, Joe, Analog Devices; Electronic Design, 04/02/92, pg 73, 6.5 pgs.
 Low-cost op amps break speed barriers. Watson Swager, Anne, Technical Editor; EDN Magazine, 01/02/92, pg 53, 8.5 pgs.
 Macromodels aid in use of current-mode feedback amps. Tabor, Joe, Siegel, Barry; Electronic Products, 04/92, pg 25, 5.5 pgs.
 Op amps expand voltage reference options. Graeme, Jerald, Burr-Brown; Electronic Design, 04/16/92, pg 75, 9.5 pgs.

Op-amp distortion measurement bypasses test-equipment limit. Graeme, Jerald; EDN Magazine, 02/17/92, pg 133, 4 pgs.

Oscillators

Filters and oscillators. Williams, Jim, Linear Technology; EDN Magazine, 11/07/91, pg 193, 6.5 pgs.

PLD/programmable-logic devices

Avoid pitfalls in selecting the right programmable-logic design. Schulze, Bill; Electronic Design, 11/07/91, pg 71, 4.5 pgs.
 Converting PLD and FPGA designs to ASICs. Myrvaagnes, Rodney; Electronic Products, 02/92, pg 21, 4.5 pgs.
 Designers split over FPGAs. Arnold, Bill, EDN News Staff; EDN News Edition, 04/30/92, pg 1, 1 pg.
 EDN's hands-on FPGA project. Conner, Doug, Technical Editor; EDN Magazine, 04/09/92, pg 98, 15 pgs.
 EDN's hands-on FPGA project. Conner, Doug, Technical Editor; EDN Magazine, 04/23/92, pg 120, 11.5 pgs.
 FPGAs race for the gold in product development. Tuck, Barbara, Senior Editor; Computer Design, 04/92, pg 88, 10 pgs.
 High-density PLDs. Conner, Doug; EDN Magazine, 01/02/92, pg 76.
 Programmable device masters the art of high-speed data transfers. Singhal, Vinita; EDN Magazine, 01/20/92, pg 121, 6.5 pgs.
 Streamline programmable-logic design with the proposed LPM standard. Holley, Michael, Data I/O, Kaplinsky, Cecil, Plus Logic; Electronic Design, 11/07/91, pg 89, 6.5 pgs.

S/H circuits

Choosing the right sample-and-hold amplifier. Rahim, Zahid; Electronic Products, 12/91, pg 43, 3.5 pgs.

Semicustom/custom ICs

Cellular phone designs call for mixed-signal solutions. Wilson, Dave, Senior Editor; Computer Design, 12/91, pg 57, 6 pgs.

HARRIS GENERATES INNOVATIONS WITH

This HFA1100 family's fast performance is made possible by Harris' unique UHF-1 process. The shallow structure of UHF-1 transistors is the result of bonded wafer technology.

Harris HFA1100

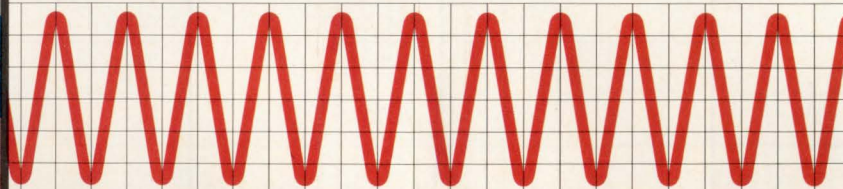

Ordinary high-speed op amp

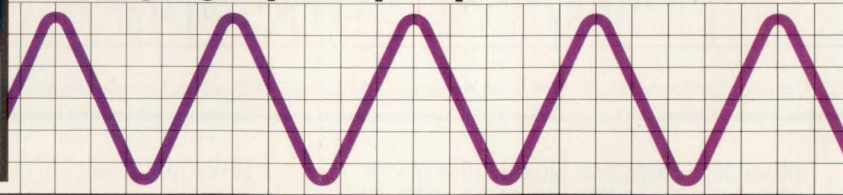

Once again, the latest breakthrough in ultra-high-speed op amps comes to you from Harris. This time, it's the HFA1100. Three times as fast as the old record holder. And just what

fast-thinking engineers like you have been waiting for. Quickly imagine what you can do with a bandwidth so huge. Providing excellent phase linearity and a remarkable gain

flatness of 0.14 dB to 100 MHz. And your creativity needn't stop with standard products. Because the HFA-1 process is available in semicustom, as part of Harris' industry-leading

Converting PLD and FPGA designs to ASICs. Myrvaagnes, Rodney; Electronic Products, 02/92, pg 21, 4.5 pgs.
 Cut product size and cost with mixed-signal ASICs. Goodenough, Frank; Electronic Design, 11/21/91, pg 37, 5 pgs.
 Designers search for the secret to ease ASIC migration. Tuck Eden, Barbara; Computer Design, 12/91, pg 78, 11 pgs.
 Drive ICs: ASICs or off-the-shelf? Arnold, Bill, EDN News Staff; EDN News Edition, 11/28/91, pg 1, 1.5 pgs.
 Laser-printer controllers get ASICs. Martin, Louis, and Jack Vaughan; EDN News Edition, 11/14/91, pg 1, 1 pg.
 Mixed-signal ASICs: migrating to a true semicustom methodology. English, Nick, Palumbo, Mike, Harris Semiconductor; Electronic Products, 12/91, pg 25, 5.5 pgs.

Timer ICs/circuits

Timing techniques help signals stay in sync. Swager, Anne, Technical Editor; EDN Magazine, 02/17/92, pg 81, 6.5 pgs.

Voltage references

Microamps sustain stable sources. Kerridge, Brian, Technical Editor; EDN Magazine, 03/30/92, pg 53, 4.5 pgs.

Production/manufacturing/testing

Packaging/encapsulation/sealing

Lack of standards impedes design issues. Mosley, JD, Technical Editor; EDN Magazine, 01/02/92, pg 35, 4.5 pgs.

Production/manufacturing/testing, other

European manufacturing contractors encourage close relationships. Kerridge, Brian; EDN Magazine, 02/17/92, pg 58, 4 pgs.

Technology/research

CMOS technology

40-MHz CMOS circuits send designers back to school. Gallant, John; EDN Magazine, 03/02/92, pg 67, 5.5 pgs.
 Use the analytic approach to avoid errors when probing CMOS circuits. Porter, Art; EDN Magazine, 03/30/92, pg 123, 6 pgs.

Ergonomics/product design

Designing neural networks commands skill and savvy. Wright, Maury; EDN Magazine, 12/05/91, pg 86, 8 pgs.

GaAs technology

ICs see mainstream duty as μ P glue logic. Wright, Maury, Technical Editor; EDN Magazine, 03/02/92, pg 97, 4.5 pgs.

Industrial electronics

The best LAN may be found off the MAP. Mosley, JD, Technical Editor; EDN Magazine, 11/07/91, pg 63, 5.5 pgs.

Technology/research, other

10 technologies to watch in 1992. EDN News, 02/06/92, pg 3, 2 pgs.
 Fuzzy logic is anything but fuzzy. Williams, Tom, Senior Editor; Computer Design, 04/92, pg 113, 13 pgs.

Video

Ring in the new: HDTV becomes a reality. Gosch, John, Bureau Manager; Electronics, 04/92, pg 36, 3 pgs.

Vision systems

Standard buses gain ground in image processing. Andrews, Warren, Senior Editor; Computer Design, 03/92, pg 83, 5.5 pgs.

ASTOUNDING FREQUENCY

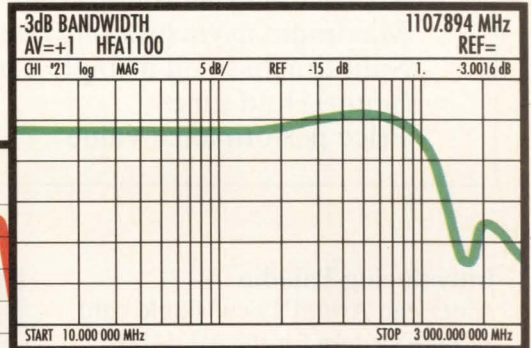

APPLICATIONS

- High-Resolution Displays
- RF Transmitters/Receivers
- Medical Imaging Systems
- Radar Systems
- Flash A/D Drivers
- Video Switching and Routing/Line Drivers
- Fiber Optics

PRODUCT

HFA1100 op amp
 HFA1120 op amp
 HFA1130 clamped op amp
 HFA1110 buffer
 HFA1112 buffer

CONFIGURATION

Standard pinout
 Output offset adjust
 User-defined output clamp
 Standard buffer pinout
 Standard op amp pinout

	HFA1100/20/30	HFA1110/12
-3dB Bandwidth	870 MHz	700 MHz
Slew Rate	2500V/ μ sec	2500V/ μ sec
Settling Time (0.1%)	11 ns	7 ns
High Current Output	60 mA	60 mA
Temperature Range	-40°C to 85°C	-40°C to 85°C
Packages	8-pin PDIP, CerDIP, SOIC	8-pin PDIP, CerDIP, SOIC
Price (100s)	\$9.95	\$5.95

FASTRACK™ design system.
 So rev up your oscilloscopes.
 And get your hands on some
 HFA1100s today. Just call
 1-800-4-HARRIS, ext. 1173.
 Today.



NEW RISC/CISC
DEVELOPMENT TOOLS

BEWARE!

Are you buying a Logic Analyzer for RISC or high-speed CISC* Development? Compare...

Features	American Arium	Tektronix ¹	Hewlett Packard ²
100 channels, 100 MHz sync	YES	YES	YES
Dynamic cache control	YES	NO	NO
Data cycles fully labeled in disassembly	YES	NO	NO
Maximum trace depth across all channels	128K	128K	4K
Maximum synchronous rate	200 MHz	100 MHz	100 MHz
Maximum asynchronous rate	1GHz	400 MHz	500 MHz
Split timebase on a single card	YES	NO	YES
Setup+Hold time	3.0 nsec	5.0 nsec	3.5 nsec
Price performance value	High	Low	Moderate

(1) 92A96XD (2) 16550A

Introducing Paladin™ —

American Arium's new single card capture system for the ML4400 Logic Analyzer featuring 100 and 200 MHz synchronous and 1 GHz asynchronous data capture. With 100 channels of 100 MHz synchronous capability per capture card, plus the powerful features of the ML4400, Paladin delivers the maximum capability available today for state and timing measurements on high-performance μ P-based designs.

Fully Labeled Disassembly

The ML4400 boasts fully automatic synchronizing disassemblers for all major families of μ Ps, including RISC, CISC, DSP and GSP. These are the *only* disassemblers available that completely identify and label all data cycles including task switches, exception processing, page translation and other complex CISC instructions.

*Such as 80486 or beyond, or 68040 or beyond.



Dynamic Cache Control

The ML4400 provides dynamic control of cache fill on many processors, allowing complete disassembly of some program segments while the majority of the program runs fully cached.

Total Versatility

Paladin cards may be paralleled to form analyzers with up to 200 channels per timebase. You can configure the ML4400 to fit your needs, with the flexibility of 5 different types of capture cards.

Compare First

Paladin delivers the speed and power you'd expect from the leader in Logic Analyzer technology. And you can save thousands of dollars. For a demo, call (714) 731-1661.

American Arium

Formerly American Automation and Arium Corporation
14281 Chambers Road, Tustin, California 92680

Circle #57 for Logic Analyzer Information

Circle #58 for Development Systems Information

SEE US AT EMBEDDED SYSTEMS CONFERENCE BOOTH 638-640

Table-look-up scheme speeds software correlation

Domingo G Garcia, Texas Instruments, Dallas, TX



In digital-communications systems, a sync-frame code or preamble often delineates the start of a message transmission. Maximum-length sequences, Gold codes, and Barker codes are useful for this purpose because of their good autocorrelation properties. The correlation function of a specific bit sequence is as follows:

$$(1) R(n) = \sum_{i=1}^{N-n} (r_i s_{i+n})$$

At a particular sample instant, the correlation function compares the received sequence with a reference sequence and counts the number of matches. When the number of matches is greater than a specified threshold, frame synchronization is established. Assuming that the data rate is slow enough, software can perform the correlation function by replacing the multiplication operations with EXCLUSIVE-OR operations. For long sequences, performing the EXCLUSIVE-OR and sum operations on a bit-by-bit basis is impractical. Fortunately, most μ Ps can perform the EXCLUSIVE-OR operation on a word basis. Exploiting the word-wide EXCLUSIVE-OR operation and using a table-look-up scheme speeds up the correlation process by approximately a factor of three.

In this example, a TMS320C25 DSP μ P implements a 1024-bit digital correlator. The TMS320C25 can perform a 16-bit by 16-bit EXCLUSIVE-OR operation in a single clock cycle. You can exploit this feature to reduce the number of multiply operations from 1024 to 64. However, for such a long sequence, the sum operation presents a problem. The problem is to determine the number of matches (zeros) in the resultant EXCLUSIVE-OR operations. Counting the matches normally involves testing each bit and accumulating the number of matches.

However, you can count the matches in blocks using a table-look-up scheme. Listing 1's scheme (which you can also download from the EDN bulletin board) breaks up the result of the EXCLUSIVE-OR operation into 8-bit bytes and then uses these bytes as an offset into a table of length 256. Each table entry holds the number of zeros in the offset byte. The software retrieves the table entry and adds it to the ongoing sum.

EDN BBS /DL_SIG #1164

EDN

Listing 1—Digital correlator using table-look-up scheme

```
*****
* FUNCTION: Performs a L=1024, 1-bit wide, Digital Correlation
* and shifts the input sequence by one.
*****
TEMP1 EQU 1 ; Block B0 variable storage.
TEMP2 EQU 2 ; "
SUM EQU 3 ; "
BYTEMSK EQU 4 ; "
MSBIT EQU 5 ; "
NEWBIT EQU 6 ; "
CORBUF EQU 300 ; Starting address of input
* sequence to be correlated.
CORREF EQU 340 ; Starting address of previously
* loaded reference sequence.
THRESHLD EQU 1000 ; Threshold value.
*
CORREL EQU $ ; INITIALIZATION.
RSXM EQU 4 ; Use Block B0.
LDPK LACK 00FFh ; Mask to extract lower byte.
SACL SACL BYTEMSK ; Mask to extract lower byte.
ZAC ZAC ; Clear ongoing sum.
LARK LARK AR2,63 ; Counter for loop.
LRLK LRLK AR1,CORREF ; Load start of reference table.
LRLK LRLK AR0,CORBUF ; Load start of buffer.
LARP LARP AR0 ; Point to buffer.
*
IN NEWBIT,PA0 ; New bit is in LSB.
LAC NEWBIT ; Place in accumulator.
ANDK ANDK 0001h ; Isolate the LSB.
*
LOOP0 EQU $ ; Shift in new bit.
ADD *,1 ; Store MSBit.
SACH SACH MSBIT ; Save shifted data word.
SACL **+,AR1 ; Compare with Reference word.
XOR **+,AR2 ; Store temporarily.
SACL TEMP1 ; Extract lower byte.
AND BYTEMSK ; Add table offset.
ADLK ZEROTBL ; Get number of zeros in the byte.
TBLR TEMP2 ; Compute ongoing sum.
LAC SUM ; Extract upper byte.
ADD TEMP2 ; Extract upper byte.
SACL SUM ; Add table offset.
LAC TEMP1,8 ; Get number of zeros in the byte.
SACH TEMP1 ; Compute ongoing sum.
LAC TEMP1 ; Compute ongoing sum.
ADLK ZEROTBL ; Do for 64 times
TBLR TEMP2 ; Check for threshold exceedance.
LAC SUM ; Set threshold flag in acc.
SACL THRESHLD ; 0 : (< threshold).
LAC CORFND ; 1 : (> or = threshold).
BANZ LOOP0,*-,AR0 ; Done
*
CORFND LACK DONE ; Done
DONE RET 1 ; Done
```

Table 1—Example look-up table

```
*****
* Table contains number of zeroes in offset location.
* Example: location offset 00 Hex has eight zeroes.
* location offset FF Hex has no zeroes.
*****
ZEROTBL EQU $
.word 8, 7, 7, 6, 7, 6, 6, 5, 7, 6, 6, 5, 6, 5, 5, 4
.word 7, 6, 6, 5, 6, 5, 5, 4, 6, 5, 5, 4, 5, 4, 4, 3
.word 7, 6, 6, 5, 6, 5, 5, 4, 6, 5, 5, 4, 5, 4, 4, 3
.word 6, 5, 5, 4, 5, 4, 4, 3, 5, 4, 4, 3, 4, 3, 3, 2
.word 7, 6, 6, 5, 6, 5, 5, 4, 6, 5, 5, 4, 5, 4, 4, 3
.word 6, 5, 5, 4, 5, 4, 4, 3, 5, 4, 4, 3, 4, 3, 3, 2
.word 6, 5, 5, 4, 5, 4, 4, 3, 5, 4, 4, 3, 4, 3, 3, 2
.word 5, 4, 4, 3, 4, 3, 2, 4, 3, 3, 2, 4, 3, 2, 2, 1
.word 7, 6, 6, 5, 6, 5, 5, 4, 6, 5, 5, 4, 5, 4, 4, 3
.word 6, 5, 5, 4, 5, 4, 4, 3, 5, 4, 4, 3, 4, 3, 3, 2
.word 6, 5, 5, 4, 5, 4, 4, 3, 5, 4, 4, 3, 4, 3, 3, 2
.word 5, 4, 4, 3, 4, 3, 3, 2, 4, 3, 3, 2, 4, 3, 2, 1
.word 6, 5, 5, 4, 5, 4, 4, 3, 5, 4, 4, 3, 4, 3, 3, 2
.word 5, 4, 4, 3, 4, 3, 3, 2, 4, 3, 3, 2, 4, 3, 2, 1
.word 5, 4, 4, 3, 4, 3, 3, 2, 4, 3, 3, 2, 4, 3, 2, 1
.word 4, 3, 3, 2, 3, 2, 2, 1, 3, 2, 2, 1, 2, 1, 1, 0
```

To Vote For This Design, Circle No. 746

Current loop transmits ac measurements

Mark Fazio, David Scott, and Bob Clarke, Analog Devices, Wilmington, MA

Process-control applications use current loops to send information as an analog signal over long distances with high noise immunity. Using the 3-chip circuit in Fig 1, you can measure alternating current or voltage and transmit the results on a 4- to 20-mA current loop. The circuit accepts a 0- to 10-mV ac rms input and provides a 4- to 20-mA output.

The input signal creates a floating voltage across sensing resistor R_{SENSE} , whose size produces 0- to 10-mV rms from the expected sensed current. This floating voltage is the input to a differential-input, single-ended AD22050 sensor interface (IC_1). IC_1 operates at a gain of approximately 20 and drives the low-impedance (8-k Ω) input (pin 1) of the AD736 rms-to-dc converter (IC_2). This converter's full-scale range is 200 mV rms. IC_2 's output drives IC_3 , an AD694 voltage to 4- to 20-mA current-loop interface.

Because of their low power consumption, both IC_1 and IC_2 can operate from the 10V supplied by IC_3 's reference output at pin 7. IC_3 , and hence the entire

circuit, operates from the standard 24V loop supply. Because this circuit operates from a single supply, you must bias IC_2 's common input at $\frac{1}{2}$ of IC_3 's 10V output, or 5V. The voltage divider comprising R_1 and R_2 divides the 10V to 5V. R_2 is in parallel with a 10-k Ω resistor inside IC_3 .

IC_3 's internal buffer amplifies the difference between IC_2 's output at pin 6 and the 5V rail. This difference ranges from 0- to 200-mV dc for a 0- to 10-mV rms input and produces a 4- to 20-mA current output from IC_3 . R_3 allows you to adjust the circuit's gain. R_4 and R_5 set the gain of IC_3 's internal amplifier to 10. R_5 matches R_4 to prevent offsets due to the internal amplifier's input-bias current. This circuit's accuracy is 1.2% of readings from 20 Hz to 40 Hz and 1% of readings from 40 Hz to 1 kHz. The -3-dB bandwidth is 33 kHz. EDN BBS /DL SIG #1167

EDN

To Vote For This Design, Circle No. 747

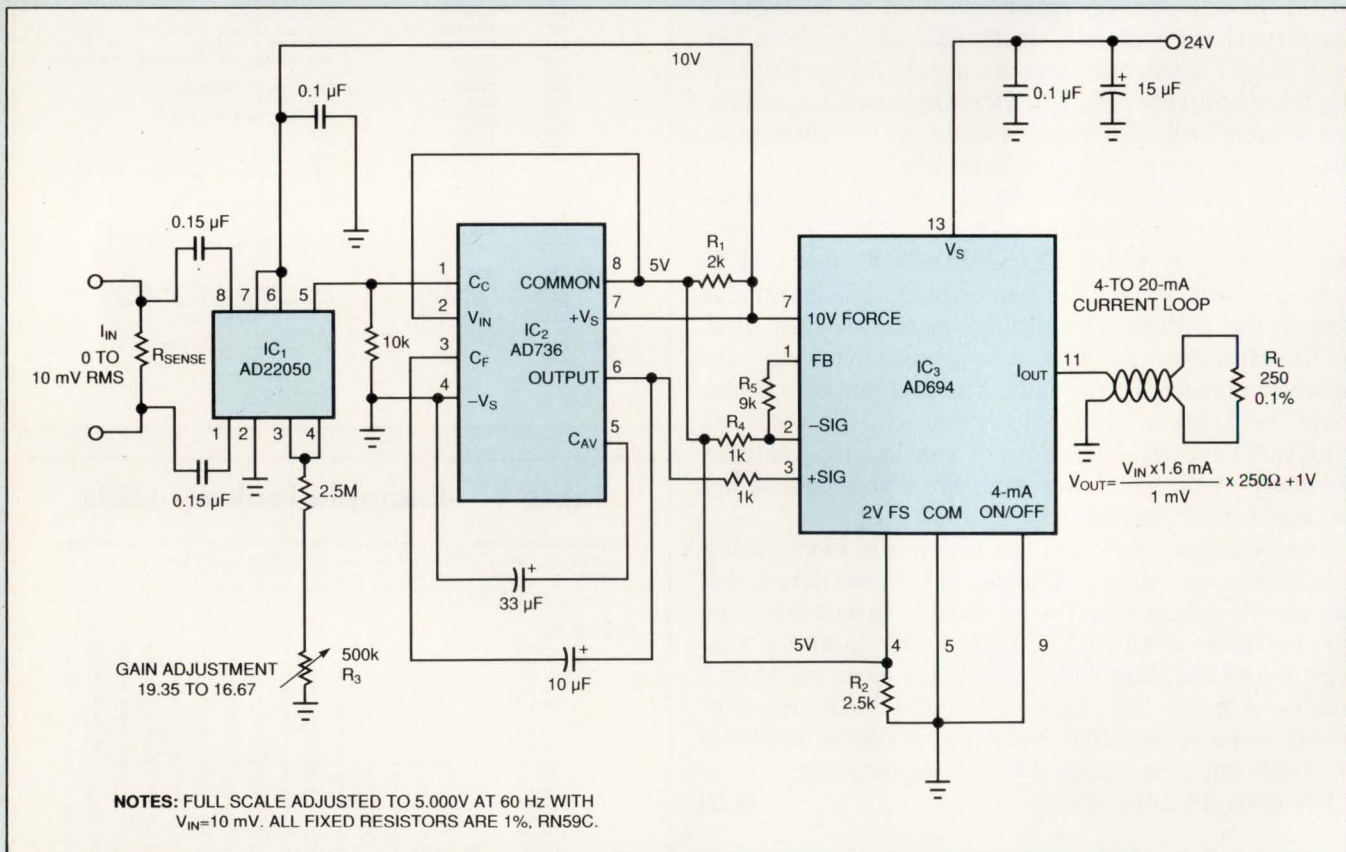
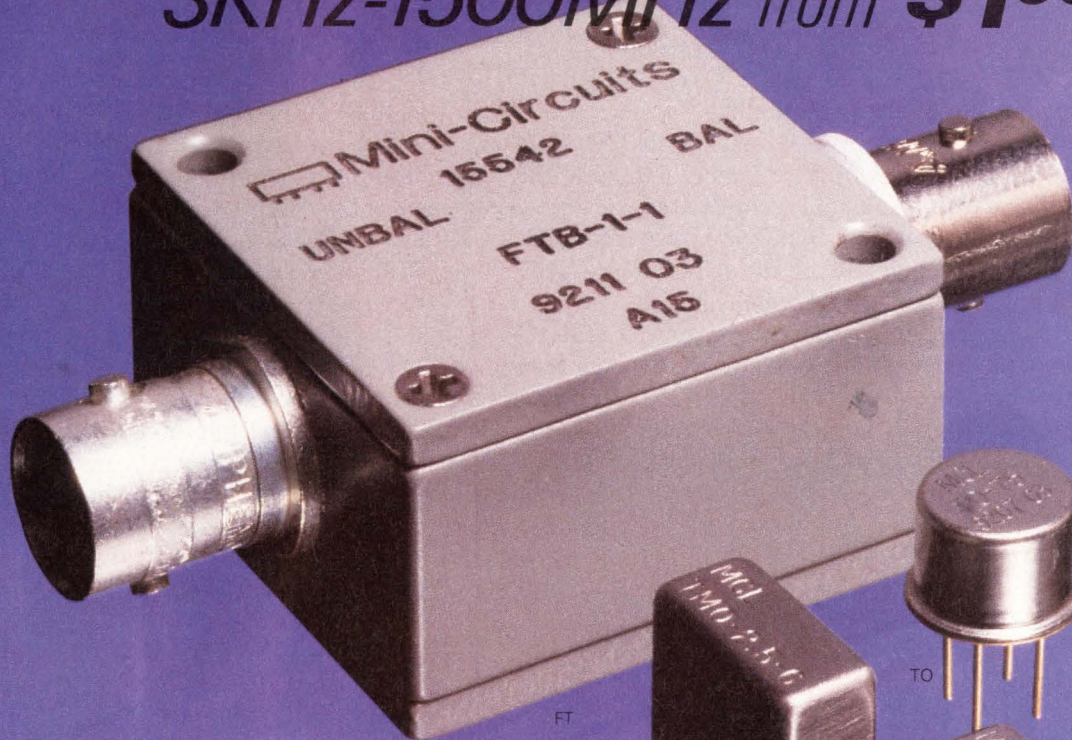

Fig 1—This circuit measures alternating current or voltage and transmits the results on a 4- to 20-mA current loop.

RF TRANSFORMERS

Over 80 off-the-shelf models...
3KHz-1500MHz from \$1⁹⁵



Having difficulty locating RF or pulse transformers with low droop, fast risetime or a particular impedance ratio over a specified frequency range?... Mini-Circuits offers a solution.

Choose impedance ratios from 1:1 to 36:1, in connector, TO-, flatpack, surface-mount, or pin versions (plastic or metal case built to meet MIL-T-21038 and MIL-T-55831 requirements*). Coaxial connector models are offered with 50 and 75 ohm impedance; BNC standard, other types on request.

Ultra-wideband response achieves low droop and fast risetime for pulse applications. Ratings up to 1000M ohms insulation resistance and up to 1000V dielectric voltage. For wide dynamic range applications involving up to 100mA primary current, use the T-H series. Fully detailed data appear in our 740-pg RF/IF Designer's Handbook.

Need units in a hurry?... all models are covered by our exclusive one-week shipment guarantee. Only from Mini-Circuits.

*units are not OPL listed.

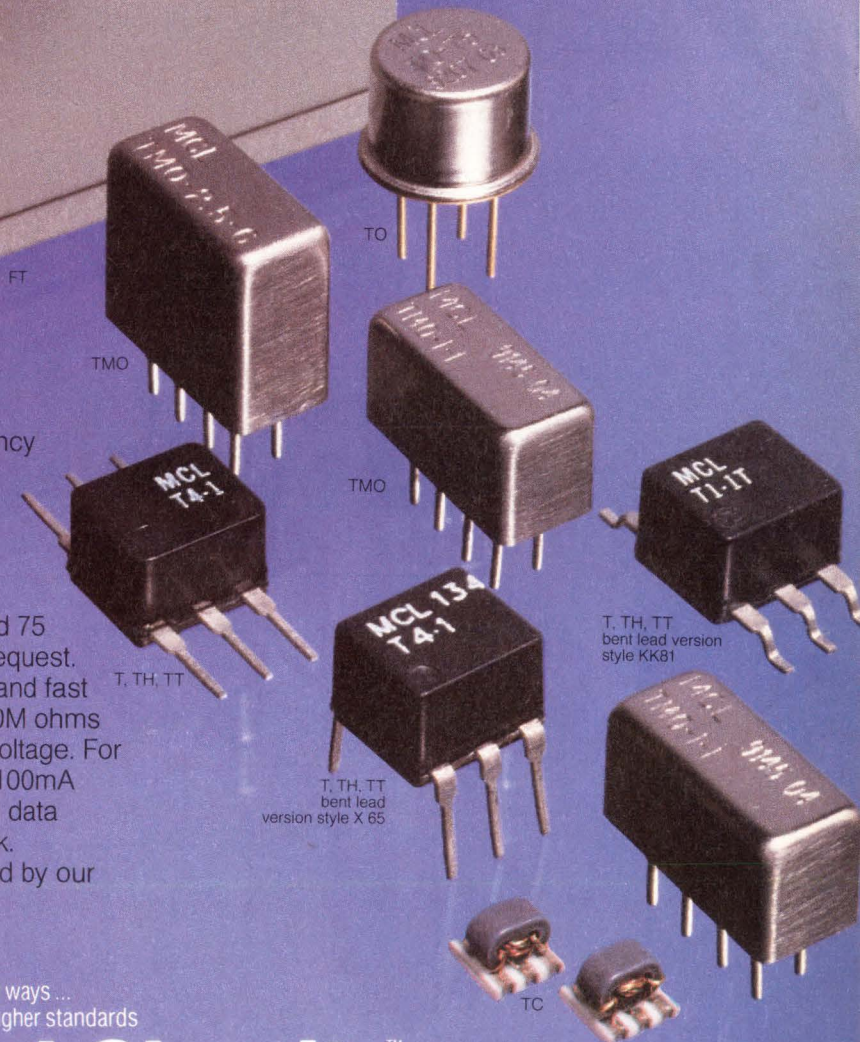

finding new ways ...
setting higher standards

Mini-CircuitsTM

WE ACCEPT AMERICAN EXPRESS AND VISA

P.O. Box 350166, Brooklyn, New York 11235-0003 (718) 934-4500 Fax (718) 332-4661

Distribution Centers/NORTH AMERICA 800-654-7949 • 417-335-5935 Fax 417-335-5945 EUROPE 44-252-835094 Fax 44-252-837010

For detailed specs on all Mini-Circuits products refer to • THOMAS REGISTER Vol. 23 • MICROWAVES PRODUCT DIRECTORY • EEM • MINI-CIRCUITS' 740-pg HANDBOOK.

Dual op amp takes absolute difference

Lindo St Angel, Motorola General Systems Sector, Arlington Heights, IL

A traditional implementation of an absolute-difference function comprises a difference circuit followed by an absolute-value circuit; the entire circuit requires at least three op amps. The design problem is complicated in single-supply-only systems, which usually require an artificial ground, typically one-half of the supply. The circuit in Fig 1 takes the absolute value of the difference of two voltages using only two single-supply, ground-referenced op amps. The circuit is designed for dc or low-speed operation.

For the case where $V_1 > V_2$, IC_{1A} is disabled because diode D_1 is off. IC_{1B} and its associated resistors form a classic difference circuit where

$$V_{OUT} = (R_2/R_1)(V_1 - V_2).$$

For the case where $V_2 > V_1$, diode D_1 conducts, producing the composite amplifier system made up of both IC_{1A} and IC_{1B} , where

$$V_{OUT} = (R_2/R_1)(V_2 - V_1).$$

Using these two equations, the overall function of the circuit for V_1 and V_2 greater than zero is as follows:

$$V_{OUT} = (R_2/R_1) | (V_1 - V_2) |.$$

The circuit was built and tested with $R_1 = 10 \text{ k}\Omega$ and $R_2 = 220 \text{ k}\Omega$. For $V_2 > V_1$, the composite amplifier system has poor phase margin and is unstable. Thus, the circuit compensates the loop with the dominant pole formed by R_3 and C_1 . At a gain of 22 and a desired response time of about $300 \mu\text{sec}$ (the 10 to 90% rise time when V_2 becomes $0.1V$ greater than V_1), values of $R_3 = 56 \text{ k}\Omega$ and $C_1 = 850 \text{ pF}$ produced the best empirical results. R_3 and C_1 will vary, depending on the required speed of the response and the closed-loop gain.

Also, when $V_2 > V_1$, the output of IC_{1A} becomes a function of the factor $2V_2 - V_1$. Thus, IC_{1A} may saturate for large values of V_2 . The factor's upper limit is as follows, where V_{SAT} is the saturation voltage for IC_{1A} :

$$(2V_2 - V_1) < V_{SAT}(R_1 + R_2)/R_2.$$

For the LM2902 operating from 5V, V_{SAT} is approximately 3.5V. This last equation also implicitly sets a common-mode voltage (V_{CM}) limitation. You can see this limitation by setting $V_1 = V_2 = V_{CM}$ and allowing the factor $(2V_2 - V_1)$ to reduce to V_{CM} .

EDN BBS /DL SIG #1168

EDN

To Vote For This Design, Circle No. 748

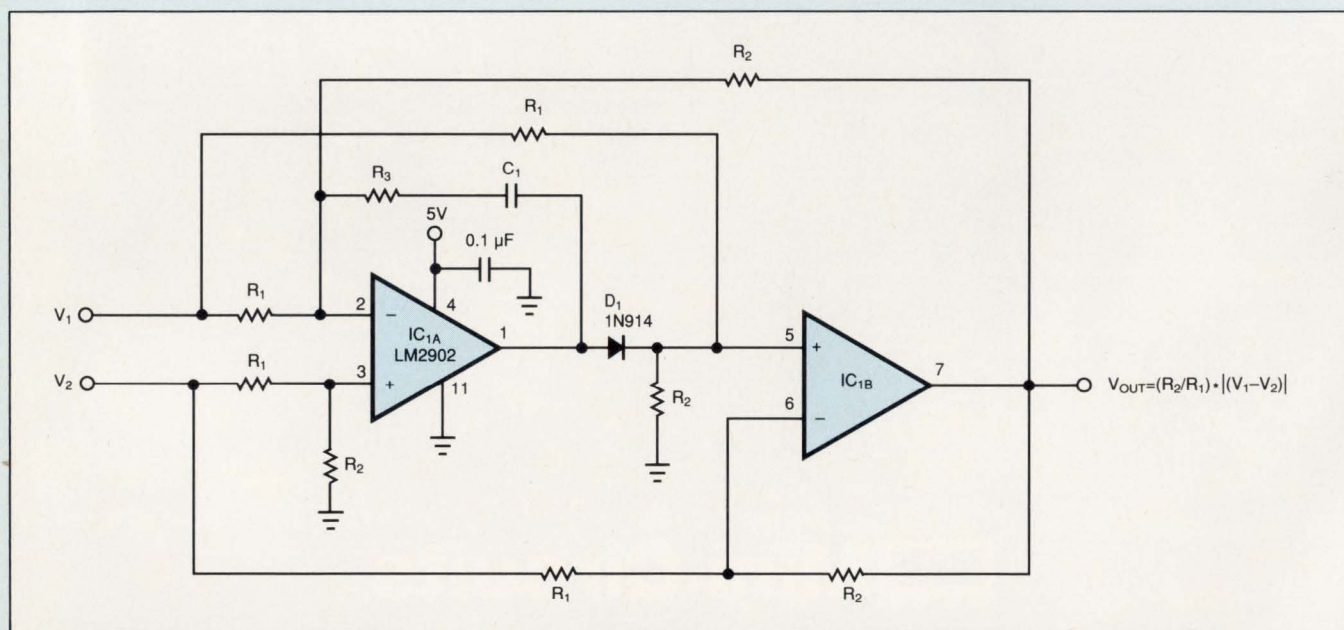
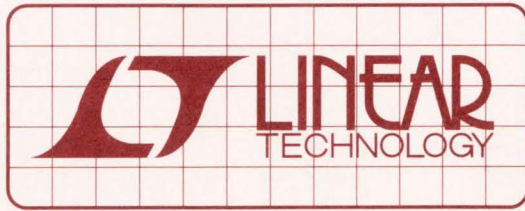

Fig 1—Using single-supply, ground-referenced op amps, this circuit accomplishes an absolute difference function.



DESIGN NOTES

Peak Detectors Gain in Speed and Performance – Design Note 61

John Wright

Introduction

Fast peak detectors place unusual demands on amplifiers. High slew rate is needed to keep the amplifier internal nodes from overracing the output stage. This condition causes either a long overload, or DC accuracy errors. To support the high slew rate at the output, the amplifier must deliver large currents into the capacitive load of the detector. Compounding these problems are issues of amplifier instability with a large capacitive load, as well as the accuracy of the output voltage.

Detecting Sinewaves

The LT1190 is the ideal candidate for this application, with a high $400\text{V}/\mu\text{s}$ slew rate, large 50mA output current, and a wide 70 degree phase margin. The closed-loop peak detector circuit of Figure 1 uses a Schottky diode inside the feedback loop to obtain good accuracy. The 20Ω resistor R_O isolates the $0.01\mu\text{F}$ load and prevents oscillation. The DC error with a sinewave input is plotted in Figure 2 for various input amplitudes. The DC value is read with a DVM. At low frequency, the error is small and dominated by decay of the detector capacitor between cycles. As frequency rises the error increases because capacitor charging time decreases. Finally at approximately 4MHz the error rises rapidly due to the slew rate limitation of the op amp. For comparison purposes the error of an LM118 is also plotted for $V_{IN} = 2\text{V}_{P-P}$.

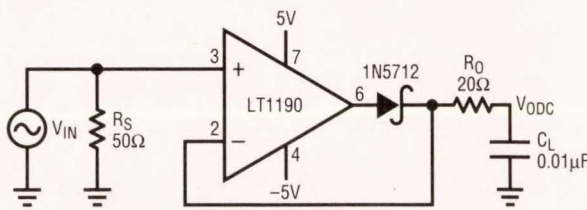

Figure 1. Closed-Loop Peak Detector

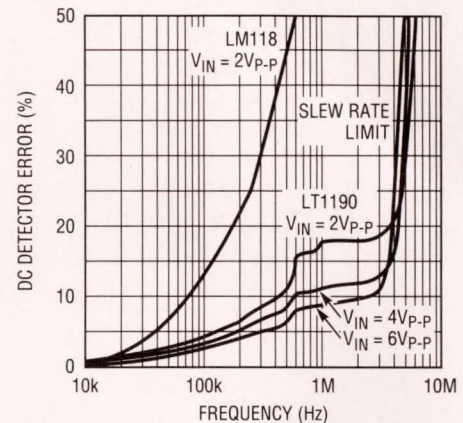

Figure 2. Closed-Loop Peak Detector Error vs Frequency

A fast Schottky diode peak detector can be built with a 1000pF capacitor, and 10k pull down. Although this simple circuit is very fast, it has limited usefulness due to the error of the diode threshold, and its low input impedance. The accuracy of this simple circuit can be improved with the LT1190 circuit of Figure 3. In this open-loop design, the detector diode is $D1$, and a level shifting or compensating diode is $D2$. A load resistor R_L is connected to -5V , and an identical bias resistor R_B is used to bias the compensating diode. Equal value resistors ensure that the diode drops are equal. Low values of R_L and R_B (1k to 10k) provide fast response, but at the expense of poor low frequency accu-

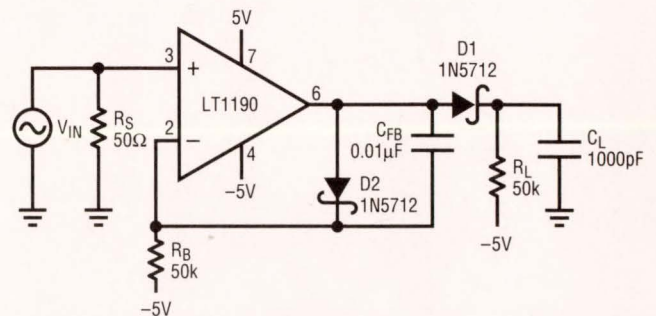

Figure 3. Open-Loop High Speed Peak Detector

racy. High values of R_L and R_B provide good low frequency accuracy, but cause the amplifier to slew rate limit, resulting in poor high frequency accuracy. A good compromise can be made by adding a feedback capacitor C_{FB} which enhances the negative slew rate on the (-) input. The DC error with a sine wave input is plotted in Figure 4 and is read with a DVM. For comparison purposes the LM118 error is plotted as well as the error of the simple Schottky detector.

Detecting Pulses

A fast pulse detector can be made with the circuit of Figure 5. A very fast input pulse will exceed the amplifier slew rate and cause a long overload recovery time.

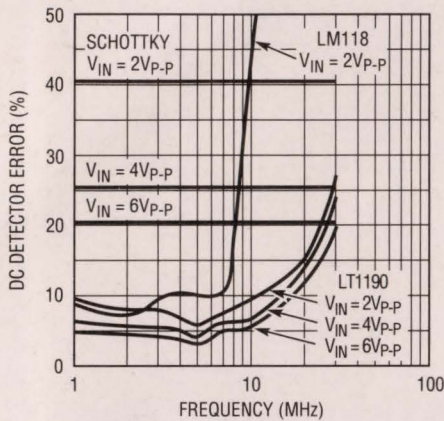

Figure 4. Open-Loop Peak Detector Error vs Frequency

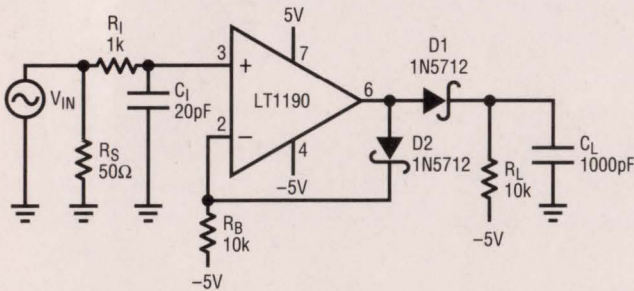

Figure 5. Fast Pulse Detector

Some amount of dv/dt limiting on the input can help this overload condition, however this will delay the response. Figure 6 shows the detector error vs pulse width. Figure 7 is the response to a $4V_{P-P}$ input that is 80ns wide. The maximum output slew rate in the photo is $70V/\mu s$. This rate is set by the 70mA current limit driving 1000pF. As a performance benchmark, the LM118 takes $1.2\mu s$ to peak detect and settle the same amplitude input. This slower response is due in part to the much lower slew rate and lower phase margin of the LM118.

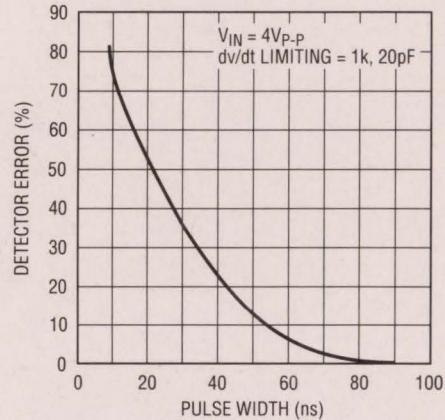

Figure 6. Detector Error vs Pulse Width

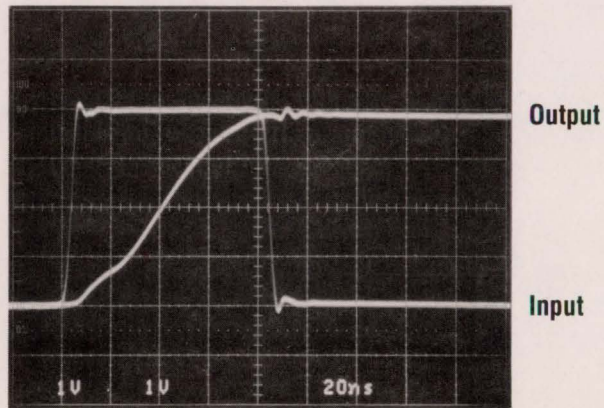
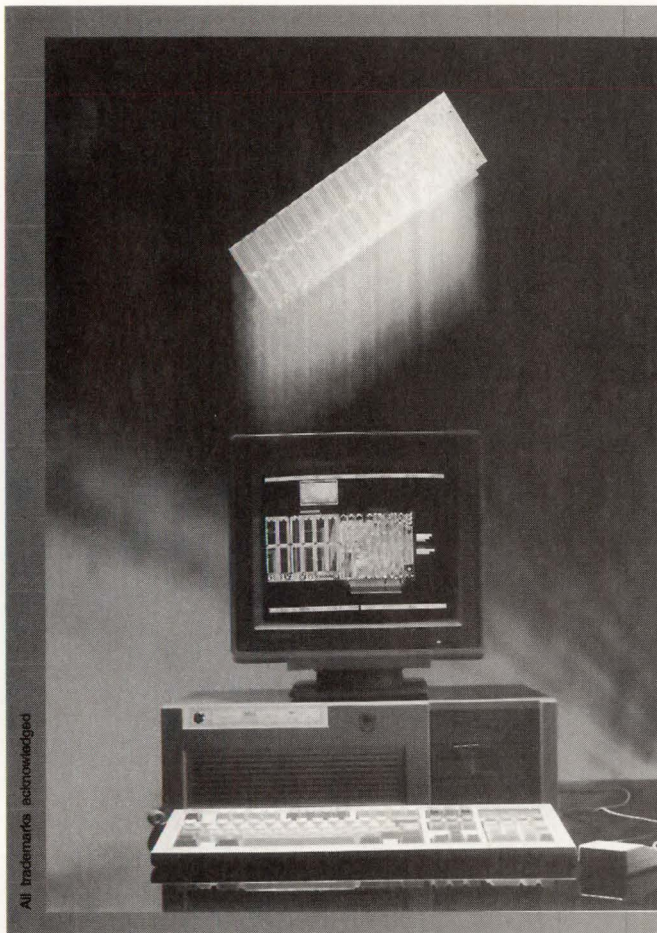

Figure 7. Open-Loop Peak Detector Response

For literature on our High Speed Amplifiers, call (800) 637-5545. For applications help, call (408) 432-1900, Ext. 456



All trademarks acknowledged

BoardMaker

Finally... an upgradeable PCB CAD system to suit any budget

BoardMaker1 - Entry level

- PCB and schematic drafting
- Easy and intuitive to use
- Surface mount support
- 90°, 45° and curved track corners
- Ground plane fill
- Copper highlight and clearance checking

\$95

BoardMaker2 - Advanced level

- All the features of BoardMaker1 plus
- Full netlist support - OrCad, Schema, Tango, CadStar
- Full Design Rule Checking - mechanical & electrical
- Top down modification from the schematic
- Component renumber with back annotation
- Report generator - Database ASCII, BOM
- Thermal power plane support with full DRC

\$295

NEW

BoardRouter - Gridless autorouter

- Simultaneous multi-layer routing
- SMD and analogue support
- Full interrupt, resume, pan and zoom while routing

\$200

Output drivers - Included as standard

- Printers - 9 & 24 pin Dot matrix, HPLaserjet and PostScript
- Penplotters - HP, Roland, Houston & Graphtec
- Photoplotters - All Gerber 3X00 and 4X00
- NC Drill plus annotated drill drawings to HPGL, Gerber and DXF (BM2)



Call for info or FREE evaluation kit:
 US Phone : (800) 626-4460
 US Fax : (603) 635-3918
 UK Phone : (+44) 223 277-777
 UK Fax : (+44) 223 277-747

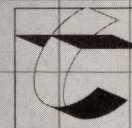

tsien

CIRCLE NO. 69

EDN INFO CARDS

THE 2¢ SOLUTION

to your marketing budget blues — the EDN Info Card Pack. At 2¢ per name, the EDN Info Card Pack can reach over 123,000 engineering specifiers affordably.

Call **Melissa Bachman** at (617) 558-4282 for details.

EDN Magazine
Edition
News
Edition

A Partnership in Power and Prestige Worldwide

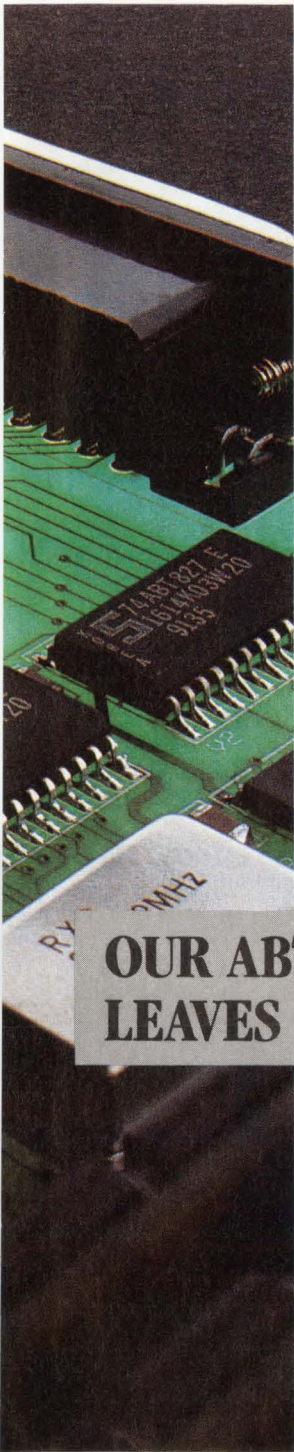

When you need extra room for improved functionality and smaller designs, simply replace your old bus interface logic with the new SSOP version of our popular ABT devices.

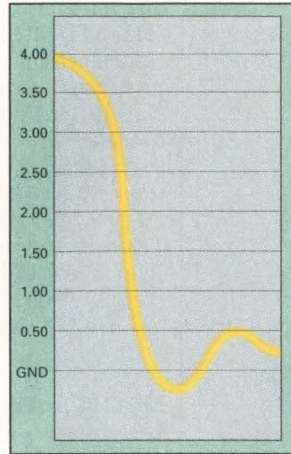

ABT in SSOP offers the highest performance while improving noise characteristics.

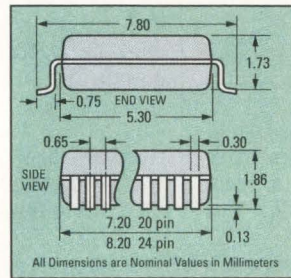

As well as offering you the significant space savings of an SSOP package, each also delivers all the performance you've come to expect from ABT.

Like the highest usable speed available. The lowest possible noise. And 64mA output drive. All of which let you design products that run faster and sell faster.

Also, thanks to our QUBiC BiCMOS process, you dissipate the lowest power. That's perfect for today's power-critical applications. Plus it simplifies thermal management.

And with more than 40 ABT products — and a contracted second source — you're always assured of the right devices at the right time.

OUR ABT LOGIC IN THE NEW SSOP PACKAGE LEAVES YOU PLENTY OF ROOM FOR IMPROVEMENT.

To learn more, or to receive your ABT BiCMOS bus interface logic SSOP sample package, call us today at 800-227-1817, ext. 755D.

See how things improve when you apply a little logic.

Signetics

Extending the Dimensions of Performance



PHILIPS

EDN-NEW PRODUCTS

Components & Power Supplies

Redundant power supplies. MPS Series n+1 350W, 3- and 4-output, redundant power supplies feature a zero-wire power-sharing system. This paralleling technique uses a nondissipative droop regulator, which automatically shares output power and ensures glitch-free operation. Main outputs deliver 5V at 50A. The second output delivers 12V at 8A, and the third output provides 12V at 4A; the fourth output provides -5.2 or 12V at 2A, and 24V at 1.5A. \$366 (100). Delivery, four to six weeks ARO. **Todd Products Corp.**, 50 Emjay Blvd, Brentwood, NY 11717. Phone (516) 231-3366. FAX (516) 231-3473.

Circle No. 351

Monolithic backplanes. The units in this family of monolithic J1/J2 backplanes meet the 80-Mbps transfer-rate requirement of VME64. Available in versions with 3 to 21 slots, the units feature an 8-layer stripline design that minimizes crosstalk and reflections. The design features onboard terminations and decoupling capacitors at every slot. Electrolytic capacitors distributed throughout the board cause the V_{CC} lay-

ers to act as virtual ground planes. \$895 for a 21-slot version. **Bustronic Corp.**, 44350 Grimmer Blvd, Fremont, CA 94538. Phone (510) 490-7388. FAX (510) 490-1853.

Circle No. 352

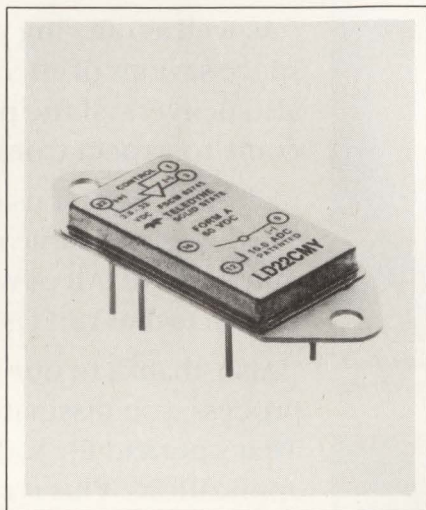

Solid-state relays. LD Series solid-state relays combine short-circuit protection with status information for military applications. The power FET out-

put has a 10A-60V dc rating and a 75-m Ω max on-resistance. The relay suits MIL-STD-704 28V dc systems, and the control circuit is optically isolated for protection against output transients. Options include short-circuit/current-overload protection and switch status to monitor the output circuit for load power and continuity. \$94 (OEM qty). Delivery, stock to eight weeks ARO. **Teledyne Solid State**, 12525 Daphne Ave, Hawthorne, CA 90250. Phone (213) 777-0077. FAX (213) 779-9161. TWX 910-321-4610.

Circle No. 353

Crystal oscillators. VC-7000 Series voltage-controlled oscillators operate to 150 MHz. Stability equals ± 25 ppm, and output drive measures 10 TTL loads or 15 pF for HCMOS. Control voltage level ranges from 0.5 to 4.5V and output rise and fall times are 10 nsec or better. Supply requirement equals 5V at 35 mA, and operating range spans 0 to 70°C. \$15 (1000). Delivery, 8 to 12 weeks ARO. **Raltron Electronics Corp.**, 2315 NW 107th Ave, Miami, FL 33172. Phone (305) 593-6033. FAX (305) 594-3973.

Circle No. 354

SAFETY.

It's this simple.

Maxell offers an incredibly wide range of long life Lithium Thionyl Chloride and Lithium Manganese Dioxide Batteries, covering more of your industrial/engineering applications than most others.

Every Maxell Lithium Battery is built with our unique manufacturing process and rigorous chemical purity and process control to assure maximum battery safety and performance.

Every one is engineered with controlled internal resistance for slower discharge and longer shelf life. Some are even available with built-in resistors and diodes to safeguard memory backup.

So when you're looking for the ultimate in Lithium Battery selection, performance and safety, look to Maxell.

It's that simple.

maxell[®]

Maxell Corporation of America, 22-08 Route 208,
Fair Lawn, NJ 07410, 1-800-533-2836.

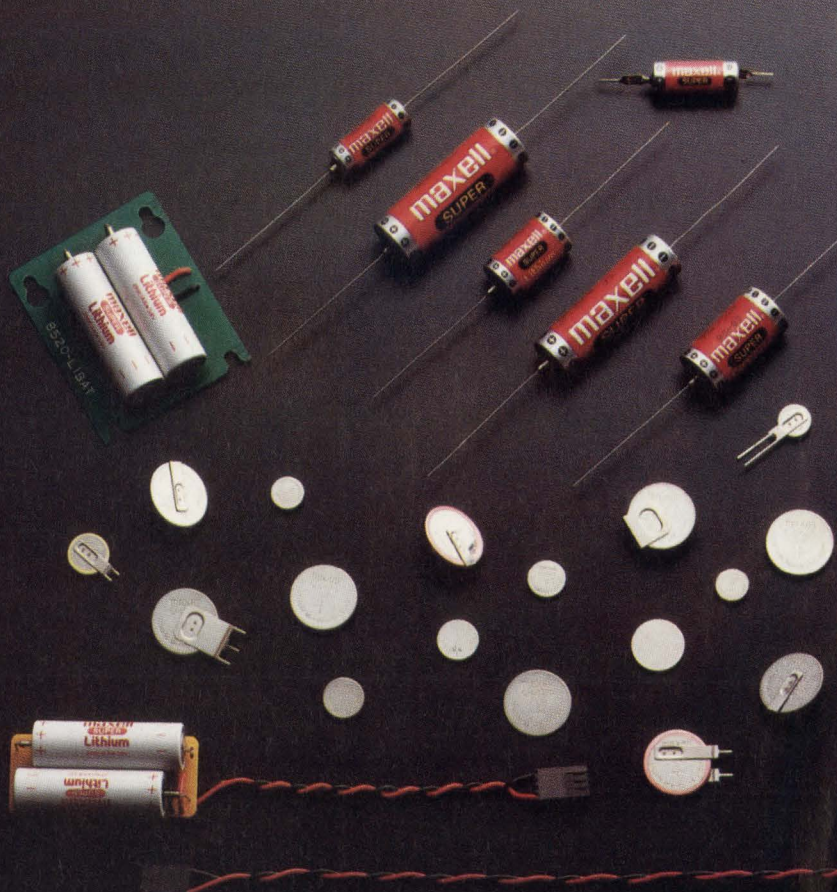

Portable VME towers. PT Series VME towers come as a 4-slot system that measures 4 × 15.25 × 13.75 in. The system includes an integral carrying handle, a 150W power supply, a 4-slot J1-J2 backplane-card-cage combination, and a fan for system cooling. From \$1150. **Hybricon Corp.**, 12 Willow Rd, Ayer, MA 01432. Phone (508) 772-5422. FAX (508) 772-2963. **Circle No. 355**

Magnetic pickup. The 54Z operates over a 0- to 20,000-target/sec range. The unit uses solid-state Hall-effect technology. Voltage range equals 5 to 18V, and air-gap requirement measures 0.005 to 0.03 in. Operating range spans -40 to +105°C. A mounting clamp simplifies installation. \$43. **Danaher Controls**, 1675 Delany Rd, Gurnee, IL 60031. Phone (708) 662-2666. FAX (708) 662-6633. **Circle No. 356**

Power amplifiers. Model 265 amplifiers develop ±300V at ±150A continuous and ±312A peak. The 81-kHz switching frequency provides a dc to 4-kHz full-power bandwidth and a 400-

μsec current-mode settling time to 0.2% of final output. Efficiency at full load equals 94%. \$15,500. Delivery, stock to six weeks ARO. **Copley Controls Corp.**, 410 University Ave, Westwood, MA 02090. Phone (617) 329-8200. FAX (617) 329-4055. **Circle No. 357**



Piezo-effect switches. Based on piezo-effect principles, KP Series NO switches require no moving parts. The switching circuit and the piezo crystal are protected by a hermetically sealed housing. The switches interface with all logic circuitry and switch both ac and dc loads. Load rating equals 250 mA at 50V. A 500-mA load capability is op-

tional. \$6.75 to \$12 (1000). Delivery, four to six weeks ARO. **C&K Components Inc.**, 15 Riverdale Ave, Newton, MA 01258. Phone (617) 964-6400, ext 246. FAX (617) 332-2379. **Circle No. 358**

DMOS transistors. BSN10, BSN10A, and BSN20 n-channel enhancement mode transistors have maximum currents of 175, 175, and 100 mA, respectively. On and off switching times equal 2 and 5 nsec, respectively, for the BSN10 and BSN10A, and 5 and 10 nsec, respectively, for the BSN20. Power dissipation ranges to 830 mW for the BSN10 and BSN10A, and 250 mW for the BSN20. BSN10 and BSN10A, \$0.13; BSN20, \$0.15 (100,000). Delivery, 8 to 10 weeks ARO. **Philips Components**, 2001 W Blue Heron Blvd, Riviera Beach, FL 33404. Phone (800) 447-3762; (407) 881-3308. **Circle No. 359**

Industrial enclosures. The ZT 250 and ZT 300 are designed for 0 to 70°C operation. Both card cages come with a power supply and a low-noise STD-32 backplane. The enclosures feature a hinged

IN NUMBERS.



CIRCLE NO. 71

EDN-NEW PRODUCTS

Components & Power Supplies

front panel that contains removable plates for I/O connectors. The 250 comes with an 80W supply and can hold 9-, 12-, or 15-slot backplanes. The 300 has a 150W supply and accommodates a 24-slot backplane. ZT 250, from \$880; ZT 300, from \$1300. **Ziatech Corp.**, 3433 Roberto Ct, San Luis Obispo, CA 93401. Phone (805) 541-0488. FAX (805) 541-5088. **Circle No. 360**

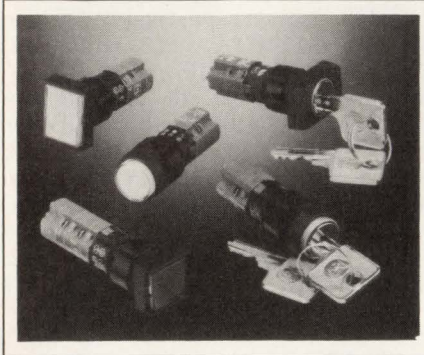

Lighted switches. Series 75 pushbutton switches come in red, yellow, green, black, or clear. Available in commercial (IP40) and industrial-grade, water-tight (IP65) versions, the units feature snap-action contacts in NO and NC configurations. Silver contacts are self-cleaning and are rated for 4A at 250V ac. Gold plating is an option. The units use standard T-4.5 telephone lamps. Engraved legends are optional. \$9.25 (100). **Unimax**, Box 152, Wallingford, CT 06492. Phone (800) 624-4308; (203) 269-8701. FAX (203) 265-5398. **Circle No. 361**

Servo amplifiers. The 25A family of PWM servo dc amplifiers includes three members. Model 12A8 develops a 12A pk output from a 20 to 80V dc bus. Model 25A8 develops 25A pk from the same bus levels, and the 20A14 develops 20A pk from bus voltages of 30 to 140V dc. All units are protected against power-supply overvoltage, excessive temperature, and short circuits. Model 12A8, \$275; Model 25A8, \$295; Model 20A14, \$335. **Advanced Motion Controls**, 3211 Corte Malpaso #407, Camarillo, CA 93012. Phone (805) 389-1935. FAX (805) 389-1165. **Circle No. 362**

Outdoor LEDs. TLYA series amber LEDs achieve luminosity levels that satisfy the needs of many outdoor applications. The four units in the line have half-viewing angles of 4° (190P), 8° (180AP), 30° (156P), and 70° (256); the units' luminosities equal 6, 2.5, 0.35,

and 0.25 cd, respectively, and have lens diameters of either 10 or 5 mm. \$0.90 to \$1.70. **Toshiba America Electronic Components Inc.**, 9775 Toledo Way, Irvine, CA 92718. Phone (714) 455-2000, or contact local sales office.

Circle No. 363

Dual-gate MOSFET. The BF998 MOSFET combines a transfer admittance of 24 msec with a 2.1-pF input

capacitance. The depletion-type tetrode works as a gain-controlled amplifier at frequencies to 1 GHz. The transistor operates from 12V, has a 1-dB noise figure at 800 MHz, dissipates 200 mW, and comes in a 4-lead SOT-143 plastic surface-mount package. \$0.15 (100,000). Delivery four to six weeks ARO. **Philips Components**, 2001 W Blue Heron Blvd, Riviera Beach, FL 33404. Phone (800) 447-3762; (407) 881-3308.

Circle No. 364

Programmable Anti-Alias Filters for Critical A/D Prefiltering

848P8E Series are Elliptic lowpass filters providing extremely sharp roll-off for A/D prefiltering.

Features:

- 8 pole, 6 zero elliptic lowpass filters
- Digitally programmable corner frequency
- Shape factor of 1.77 at 80db
- 8 bit (256:1) tuning ratio
- Internally latched control lines to store frequency selection data
- Ideal for single or multi-channel applications
- Plug in, ready to use, fully finished filter modules
- Five frequency ranges to 51.2kHz

Other Filter Products Available:

- Linear phase • Programmable
- Fixed frequency • Instrumentation
- Custom designs

For more information about how Frequency Devices can meet your most critical filtering requirements, call our applications engineers at **(508) 374-0761.**

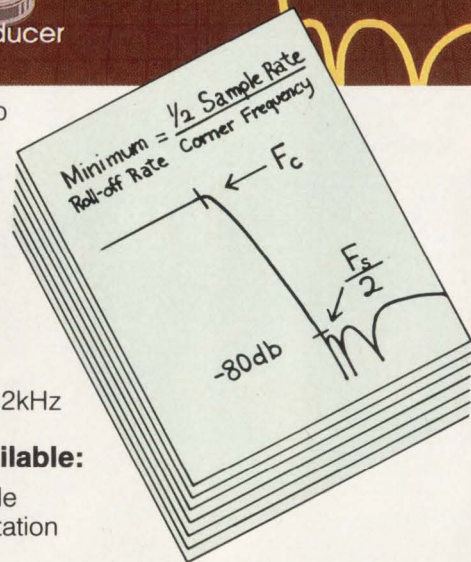
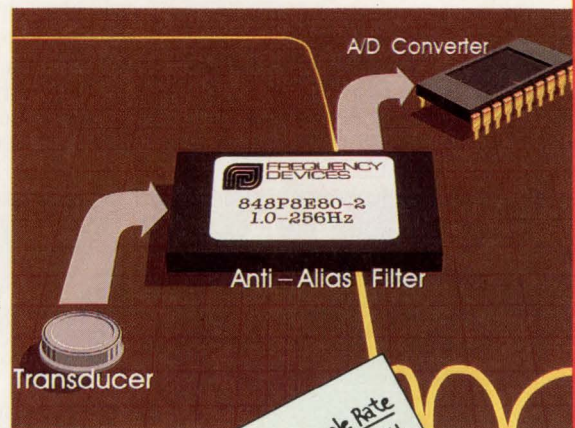

FREQUENCY DEVICES™

25 Locust Street
Haverhill, MA 01830
(508) 374-0761

EDN-NEW PRODUCTS

Test & Measurement Instruments

Enhanced data-acquisition-and-analysis software. V4.0 of the Asyst MS-DOS-based high-level programming language for developing scientific and engineering applications includes memory enhancements, more than 30 new commands, additional analysis tools, and counter/timer support. The language works with A/D and D/A converters and with instruments that interface to the host PC via IEEE-488 and RS-232C ports. By using expanded

memory for tables and dictionaries, the new version frees more than 300 kbytes of conventional memory. Among the added analysis tools are finite-impulse-response digital filters that you can design using windowing or the Parks-McClellan algorithm. \$2295; upgrades for current users, \$195 to \$795, depending on version upgraded. **Keithley Asyst**, 440 Myles Standish Blvd, Taunton, MA 02780. Phone (800) 348-0033; (508) 880-3000. **Circle No. 365**



Nonintrusive, ROM-based emulator for 68000 and 68302. The 8800 emulator/analyzer can connect to target systems by clipping onto surface-mount μ P chips. This method of connection is unlike that of most in-circuit emulators, which plug into the target μ P socket. This difference alone makes the emulator usable where other ICEs don't work. The vendor claims to have refined its ROM-based emulation technology to make it completely nonintrusive; that is, the emulators do not usurp any target resources. Moreover, the analyzer, whose bus cycle time is just 30 nsec, can include 2 Mbytes of emulation memory that has a <40-nsec cycle time under all conditions. From \$9250 for 68302. **Orion Instruments Inc**, 180 Independence Dr, Menlo Park, CA 94025. Phone (800) 729-7700; (415) 327-8800. FAX (415) 327-9881. **Circle No. 366**

HIGH BETA DARLINGTON LOW COST DESIGN

- 15-20% More Rugged Than Std. Darlington
- New R&D Processing Techniques Advance Bipolar Technology
- Best Cost Performance Trade-Off
- 600A/1200V
- Fits Existing Design Layout
- Reduce Drive Power By 90%
- (BETA) Performance Increased HFE By 10 Times
- Best SOA
- Faster Switching

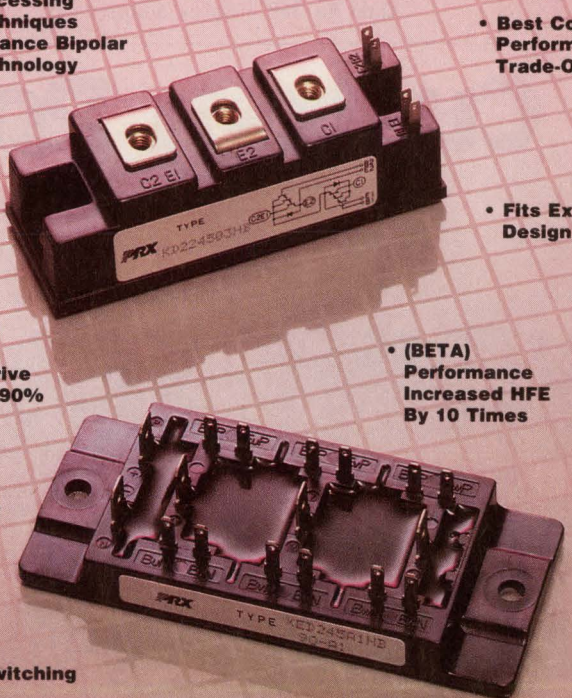

A continuing investment for the advanced products of tomorrow.

POWEREX

Joint Venture Corporation of Westinghouse, General Electric, and Mitsubishi Electric

CIRCLE NO. 73

5½-digit DVM virtual instrument for PCs. The Model 70 is a 5½-digit ADC that resides in a small box outside your PC. You can daisy-chain as many as 32 of the units and connect them all to a single RS-232C port. For PCs that use MS-DOS, the vendor provides virtual-instrument software that lets you control the ADCs and display their readings. The software lets you increase the reading rate to 60 samples/sec by truncating the ADC word length to 4½ digits. The normal input range is $\pm 2V$. \$239 with software, \$199 without. **Prairie Digital Inc**, 846 17th St, Prairie du Sac, WI 53578. Phone (608) 643-8599. FAX (608) 643-6754. **Circle No. 367**

Portable spectrum analyzers. HP 8590E-series units accept test setup and measurement instructions from credit-card-size ROMs. The units store these instructions in battery-backed static RAM, which contains between 32 and 128 kbytes. Applications include tests for CT2-CAI (second-generation cordless telephone, common-air interface),

EDN-NEW PRODUCTS

Test & Measurement Instruments

GSM (Group Speciale Mobile cellular system), EMC (electromagnetic compatibility), and several cable-TV system tests; the vendor will develop additional applications on a contract basis. Five models, which range in price from \$11,500 to \$26,250, collectively cover the RF and microwave frequency range to 22 GHz. An optional card (\$2000) boosts the range of the top-of-the-line model to 26.5 GHz. Another optional card (\$995) provides narrow-resolution bandwidths of 30, 100, 200, and 300 Hz. Delivery, eight weeks ARO. **Hewlett-Packard Co.**, Box 58059, MS 51L-SJ, Santa Clara, CA 95051. Phone (800) 452-4844. **Circle No. 368**

Handheld power meter with waveform display. Like a number of other handheld instruments, the Analyst 2000-P clips onto power lines to measure ac currents; the maximum is 2 kA. The unit measures dc current, too. The device measures dc voltage (to 1 kV), ac voltage (to 750V), ac power (to 2 kW), apparent power (to 2 kVA), power factor (to 0.3 leading or lagging), frequency (5 Hz to 1 kHz), and resistance



(to 400 k Ω). AC measurements can be average, true-rms, or peak. Unlike other meters, the unit incorporates a graphics LCD that lets you view the waveform of the measured quantity. \$995. **LEM USA**, 6643 W Mill Rd, Milwaukee, WI 53218. Phone (800) 236-5366; (414) 353-0711. FAX (414) 353-0733. **Circle No. 369**

Stereo, telephone, and digital-audio interfaces. The SAIB (stereo audio/telephone interface box) is a 16-bit stereo A/D and D/A converter whose dynamic range exceeds 80 dB. It includes input antialiasing and output-smoothing filters. Software controls the gain, word size, and conversion rate (8 to 48 ksamples/sec). The digital-audio interface (DAI) is an interface to compact-disk players and digital-audio tape decks that use either the Sony/Philips Digital Interface Format (SPDIF) or Audio Engineering Society/European Broadcast Union (AES/EBU) connections. Input and output data rates are 32, 44.1, and 48 ksamples/sec. The unit handles 16- and 24-bit words. Both units connect directly to the vendor's TMS320C30-based boards for the ISA bus, SBus, and VMEbus. SAIB from \$595; DAI from \$795. **Sonitech International Inc.**, 14 Mica Lane, Wellesley, MA 02181. Phone (617) 235-6824. FAX (617) 235-2531. **Circle No. 370**

Automated production IC programmer. The Autosite programmer eliminates adapters by providing test sites

Hungry for Custom Power



And, we'll serve it up in one tasty little package.

At E/M, we can serve-up custom rack mountable assemblies that will make your mouth water. Sandwiched between your specific requirements are Electronic Measurements' standard power supply ingredients.



EDN-NEW PRODUCTS

Test & Measurement Instruments

grouped by package style. (Nine styles are supported.) The programmer also uses universal pin drivers and performs functional device testing. From \$9995 (44 pins) and \$14,995 (88 pins). **Data I/O Corp**, Box 97046, Redmond, WA 98073. Phone (206) 881-6444. FAX (206) 881-6856. **Circle No. 371**

VMEbus 6-channel synchro-to-resolver converters. You can specify each channel of the Model 5410-61 for synchro or resolver input; 12-, 14-, or 16-bit resolution; any frequency from 50 Hz to 10 kHz, and any one standard input voltage from 3.5 to 90V. The boards require no external supplies and have no user adjustments. A self-test feature, accessible via the bus, disconnects all inputs and applies an internally generated fixed angle. The board transmits an alert on loss of the reference or the signal. The 180°-step inputs do not cause the system to hang up. From \$2400. Delivery, 8 to 10 weeks ARO. **Transmagnetics Inc**, 210 Adams Blvd, Farmingdale, NY 11735. Phone (516) 293-3100. FAX (516) 293-3793.

Circle No. 372

AC wattmeter/rms voltmeter/rms ammeter. The 3½-digit WD-768 accepts voltage inputs to 150V and current inputs to 20A. It reads to 1999W. It can display voltage, current, or power, and it can simultaneously provide analog outputs corresponding to all three. \$550. **Vector Group Inc**, 189 Horsham Rd, Horsham, PA 19044. Phone (800) 523-3696; (215) 672-6702. FAX (215) 672-3411. **Circle No. 373**

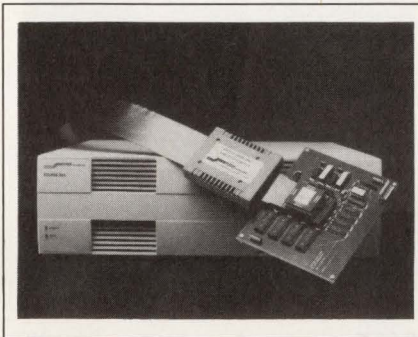

Low-cost development tools for Am29000 series. Eclipse 29K/LCD is a set of development tools for the Am29000, 29030, and 29050 RISC μ Ps.

The tools include a source-level debugger, a compiler, an assembler, a linker/loader, and an in-circuit emulator (ICE). The ICE operates nonintrusively at speeds to 25 MHz. The tools work with several host systems, including the Sun-4. The MS-DOS version runs under MS Windows 3.x. Less than \$15,000. The vendor also offers a higher performance version in which the ICE supports μ P clocks as fast as 40 MHz. **Step Engineering**, Box 3166, Sunnyvale, CA 94088. Phone (800) 538-1750; (408) 733-7837. FAX (408) 773-1073. TWX 910-339-9506. **Circle No. 374**

Insulated tuning tool. The JFD-7104-8A has a molded plastic body and a plated-steel screwdriver tip. It is intended for adjusting slotted tuning mechanisms in deep cavities that have small-diameter access holes. The 5-in.-long handle is 7/16 in. in diameter. The tip measures 0.082 x 0.117 x 0.015 in. \$11.20 (25). Delivery, stock to eight weeks ARO. **Sprague-Goodman Electronics Inc**, 134 Fulton Ave, Garden City Park, NY 11040. Phone (516) 746-1385. FAX (516) 746-1396. **Circle No. 375**

Assemblies?

We deliver!

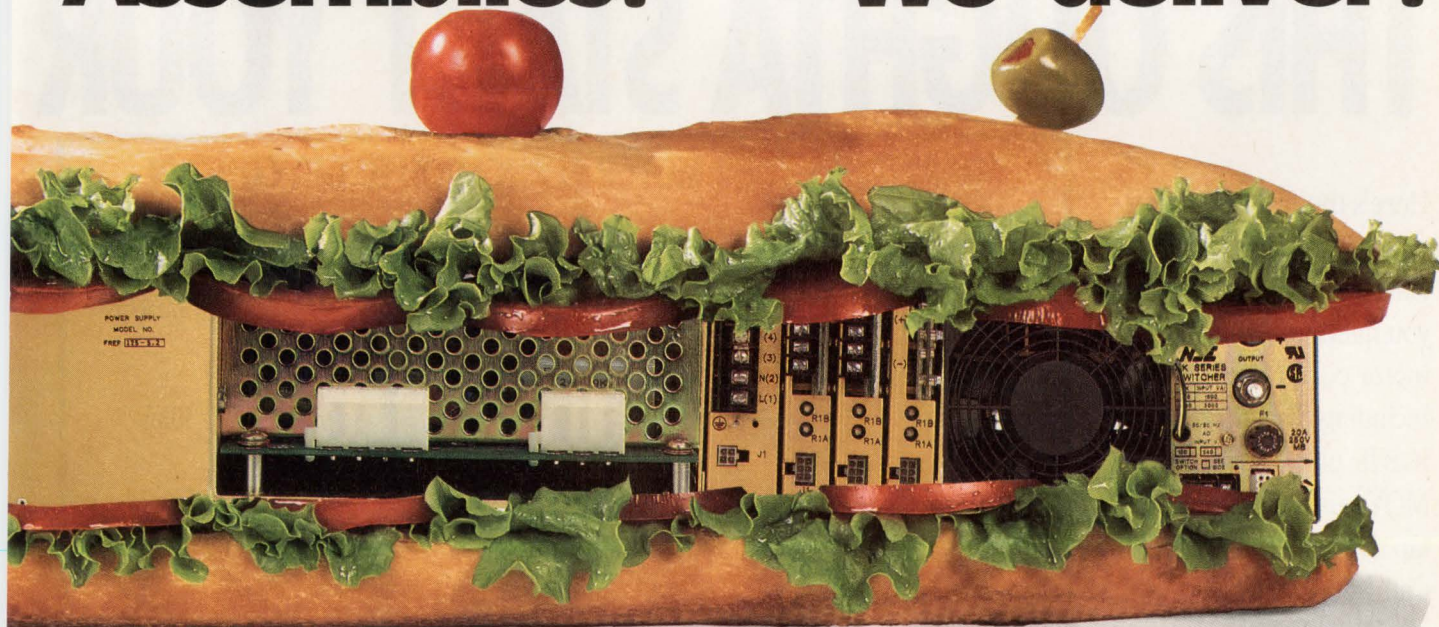

Best of all, you'll love choosing from our menu of regulated switching power supplies for the highest output wattage, all the way to linear power supplies for low noise. We'll even add in features like N+1 redundancy, live replacement of modules, sequential start-up, and special logic control or fault shut-down circuitry.

So call in your order today, and see how fast it shows up at your door. For details, contact:



ELECTRONIC MEASUREMENTS, INC.

405 Essex Road, Neptune, New Jersey 07753
Telephone: 908-922-9300 • FAX: 908-922-9334

CIRCLE NO. 74

EDN-NEW PRODUCTS

Computers & Peripherals

STD Bus DSP card. The DSP-30 is a DSP board for the STD Bus, containing a TI 33-MHz TMS320C30 chip. It operates as a slave on an STD-80 or STD 32 Bus. A development package called Debug30 lets you develop code on an MS-DOS computer and download programs, set breakpoints, run, and perform single-step operations. Other features include two 8-Mbps serial ports and a 32-bit, 1-Mbps parallel port. \$2895. **Kinetic Computer Corp.**, 82 Grandview Rd, Arlington, MA 02174. Phone (617) 547-2424. FAX (617) 547-7266. **Circle No. 376**

Terminal server. Available in 8- or 16-port configurations, the Micro Annex ELS connects terminals, modems, printers, and other serial devices to an Ethernet. It can access any network using TCP/IP or LAT protocols and provides full modem controls for high-speed modems on selected ports. Network management is via the Simple Network Management Protocol (SNMP). Other features include rotaries and modem pools, port password security, and macros for customizing user interfaces.

The 8-port server, \$1895; 16-port server, \$2495. **Xylogics Inc.**, 53 Third Ave, Burlington, MA 01803. Phone (617) 272-8140. FAX (617) 273-5392. **Circle No. 377**



386SX personal computer. The ME 386-SX/33 comes standard with 2 Mbytes of RAM (expandable to 16 Mbytes). The base configuration also includes a 120-Mbyte hard-disk drive, a 1.2-

Mbyte, 5-1/4-in.- and a 1.44-Mbyte, 3-1/2-in.-floppy drive, one parallel and two serial ports, a 200W power supply, a mouse, a super-VGA color-graphics card and monitor, DOS 5.0, and a choice of keyboards. \$1399. **Micro Express**, 1801 Carnegie Ave, Santa Ana, CA 92705. Phone (714) 852-1400. FAX (714) 852-1225. **Circle No. 378**

Short-haul modem. Model 420 accommodates any synchronous network configuration supporting bit rates of 32 to 128 kbps. Data streams are handled on a full-duplex basis over distances as great as 8 miles. The unit can pass a control signal end to end or use a multidrop network configuration. The device also includes a selectable RTS/CTS delay. Six LED indicators provide modem-status information. \$575. **Telebyte Technology Inc.**, 270 E Pulaski Rd, Greenlawn, NY 11740. Phone (516) 423-3232. FAX (516) 385-8184. **Circle No. 379**

Controllers. Personal488/IUX and 488/SCX IEE 488.2 controllers function with PCs running Interactive Unix or

THIS OUGHTA START YOUR

Here's the fast way to get your motor started. Call Harris. We've got everything you need for every kind of motor control application. Including power MOSFETs, IGBTs, ultra-fast rectifiers, MOVs and IC drivers. So tap the power of Harris. Call 1-800-4-HARRIS, ext. 7009. Today.



HARRIS HAS YOUR MOTOR APPLICATION UNDER CONTROL

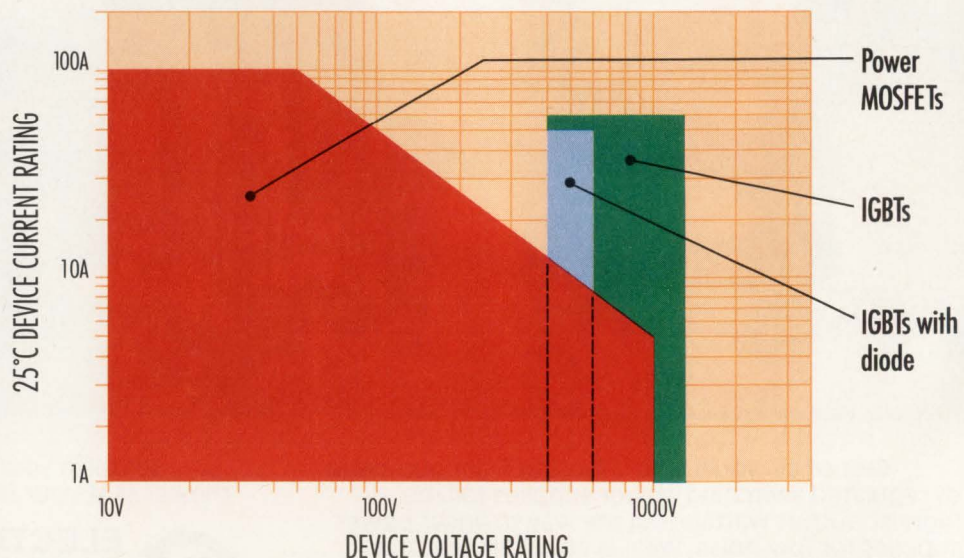

SCO Unix/386, respectively. Each unit is available with either an 8-bit GP488B board that works with 330-kbyte/sec DMA, seven interrupt lines, and three DMA channels, or with a 16-bit AT488 board that works with 1-Mbyte/sec DMA, 11 interrupt lines, and six DMA channels. The software drivers on both controllers offer familiar bus commands. The 8- and 16-bit units, \$595 and \$695, respectively. **Iotech Inc.**, 25971 Cannon Rd, Cleveland, OH 44146. Phone (216) 439-4091. FAX (216) 439-4093. **Circle No. 380**

Development platform. The DSP-1 revision C development platform for the SBus provides standard-bus interface logic, a high-speed DMA controller, and a basic software package. The unit includes the hardware interface, driver software, firmware PROM, prototyping boards, connectors, brackets, and jumpers. A user guide includes source code and schematics. The software comes on a disk. \$1095. **Dawn VME Products Inc.**, 47073 Warm Springs Blvd, Fremont, CA 94539. Phone (510) 657-4444. FAX (510) 657-3274. **Circle No. 381**

Print server. The Five Printer is an entry-level version of Print Server. It offers a variety of network-management facilities including font, job, printer, and forms management, as well as print resource accounting. The unit reduces the system-administrator's workload and allows management to track network printing usage. \$495. **Insight Development Corp.**, 2200 Powell St, Suite 500, Emeryville, CA 94608. Phone (510) 652-4115. **Circle No. 382**

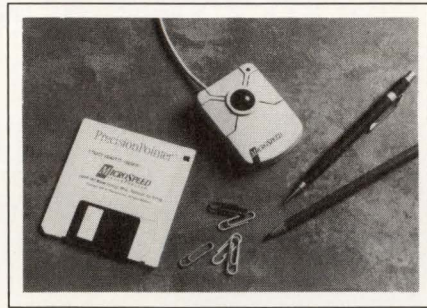

Trackball. The Microtrac stand-alone trackball connects to a serial or PS/2 mouse port. Measuring only 2.8x2 in., the unit offers 400-dpi resolution and

comes in versions that are compatible with the Microsoft mouse, the PS/2 mouse, and Microsoft Windows. The trackball works in combination with the CQ19M, a trackball module that occupies the same space as the cursor keys. **Microtrac**, \$29; **CQ19M**, \$18 (1000). **Microspeed Inc.**, 44000 Old Warm Springs Blvd, Fremont, CA 94538. Phone (510) 490-1403. FAX (510) 490-1665.

Circle No. 383

Communications adapters. The MPA 100/200/300 adapter cards are capable of synchronous data communications in bit-synchronous SDLC/HDLC modes, as well as byte synchronous in mono-sync and IBM bisync modes. All are standard with the Intel 82530 and are compatible with the Zilog 85230 and 8530 Serial Communications Controller (SCC) ICs. Onboard hardware allows the units to meet all SCC access-timing requirements, allowing host software to run correctly, independent of the host-computer clock speed. \$365. **Quatech Inc.**, 662 Wolf Ledges Pkwy, Akron, OH 44311. Phone (216) 434-3154. FAX (216) 434-1409. **Circle No. 384**

MOTOR RUNNING

PURE POWER IN MOSFETS

- Lowest $R_{DS(on)}$ available

	N-CHANNEL	P-CHANNEL
TO-220		65mΩ
TO-247	10mΩ	26mΩ

- Only SPICE model that operates over temperatures from -55°C to 150°C
- Only Harris provides UIS/SOA curves
- ESD rated and protected devices

RECTIFY WITHOUT DELAY

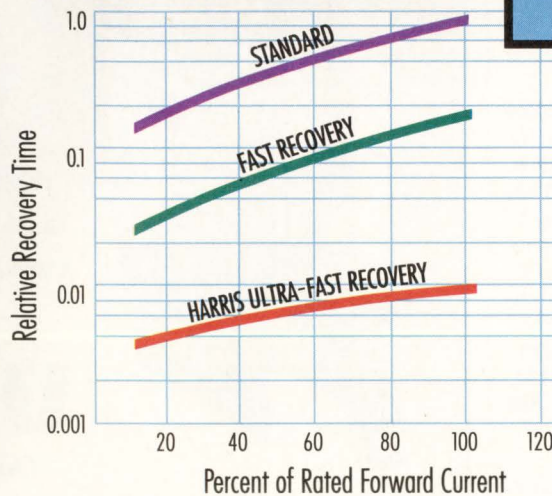

Harris can rectify your speed problems. Our ultra-fast rectifiers offer recovery speed that's 10 times better than the competitors. Plus they feature low V_F , high V_R , and low I_{RM} .

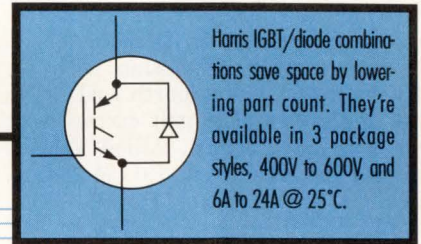

Harris IGBT/diode combinations save space by lowering part count. They're available in 3 package styles, 400V to 600V, and 6A to 24A @ 25°C.

TRANSIENT PROTECTION

INDUSTRY'S WIDEST VOLTAGE RANGE
3.5 V dc to 6000 V ac

INDUSTRY'S WIDEST RANGE OF PACKAGES
Radials
Surface Mount
Industrial high-energy MOVs

EDN-NEW PRODUCTS

Computers & Peripherals

Touchscreen monitor. This Touchmonitor consists of a Mitsubishi 3925 19-in. monitor and a touchscreen that employs resistive technology. The monitor has resolutions to 1024×768 pixels, is UL listed, FCC Class A approved, and has CSA approval pending. The unit will accommodate mouse-emulation software for MS-DOS, Microsoft Windows, OS/2, Apple Macintosh, and other operating systems. \$2935. **Elographics Inc.**, 105 Randolph Rd, Oak Ridge, TN 37830. Phone (615) 482-4100. FAX (615) 482-4943. **Circle No. 385**

S/D converter. STB/SDC Series single-slot STB-bus converters accept any synchro- or resolver-input voltage from 50 Hz to 5 kHz and convert it to 10, 12, 14, or 16 bits of binary data. The binary data is addressable in a 2-byte format over the backplane. Power requirements are ±15 and 5V, and operating range spans 0 to 70°C or -55 to +105°C. \$995 (OEM qty). **Computer Conversions Corp.**, 6 Dunton Ct, East Northport, NY 11731. Phone (516) 261-3300. FAX (516) 261-3308. **Circle No. 386**

Transceiver. The AT-210TS 10Base-T microtransceiver measures 2.8×1.7×0.9 in. The unit features a switch-selectable SQE/Heartbeat test with an LED indicator, polarity detection and correction with an LED indicator, a link-integrity test function with an LED indicator, and a fourth LED indicator for power. The unit carries a 2-year warranty. \$59.95. **Allied Telesis Inc.**, 575 E Middlefield Rd, Mountain View, CA 94043. Phone (415) 964-2994, ext 122. **Circle No. 387**

Color interface. The Precisioncolor 24Xp is a color graphics interface for the Macintosh II and Quadra families. A NuBus-based design, it has 24-bit color and incorporates onboard Quickdraw acceleration, support for an array of displays, a resolution of 832×624 bits, and on-the-fly resolution switching. The device is specifically designed for 16-in. displays. \$599. **Radius Inc.**, 1710 Fortune Dr, San Jose, CA 95131. Phone (408) 434-1010. **Circle No. 388**

Computer module. Despite its 1.7×5.2-in. size, the ESP 8680 module handles a range of computing functions. The module has a fully integrated 8086XT with a nonvolatile-memory-card (PCMCIA) socket, CGA graphics,

1-Mbit-max dynamic RAM, a keyboard interface, one serial port, and connectors for expansion. \$995. **Dover Electronics Manufacturing West**, Box 1532, Longmont, CO 80502. Phone (303) 772-5933. **Circle No. 389**

Color printer. The HP Paintjet XL300 uses four 50-color print cartridges to create virtually any color. The unit prints on a variety of media—including

plain paper. The unit prints color graphics at approximately 1.5 to 6 minutes per page and prints monochrome text at 1 to 2 minutes per page. The printer comes standard with 2 Mbytes of memory. The printer comes standard with a 200-sheet input tray that can handle letter- and legal-size paper and letter-size transparencies. From \$3495. **Hewlett-Packard Co.**, Box 58059, MS511L-SJ, Santa Clara, CA 95051. Phone (800) 752-0900. **Circle No. 390**

VMEbus Test & Debug

Nothing can boost your VMEbus test and debugging productivity like Bus Analyzers from **VMETRO**

The VME-P2 Tool-kit:

Simultaneous, integrated dual bus VME and VSB (or other P2 bus, like SCSI) State/Timing Analysis in a one-slot solution.

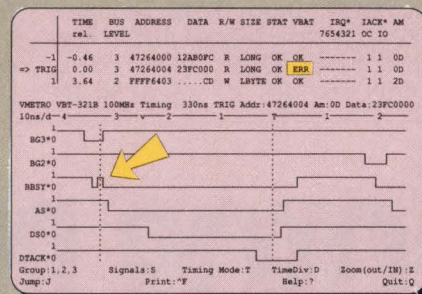
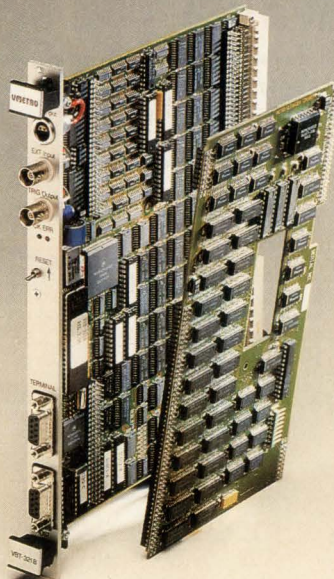

The VME-STA Tool-kit:

True VME STATE Analysis with simultaneous, time-correlated 100MHz/100ch TIMING Analysis with cursors and zooming. Integrated VMEbus ANOMALY trigger for automatic detection of rule violations. A two-slot integrated solution, only from

VMETRO

The Bus Analyzer Specialist

VMETRO A/S
Prof. Birkelandsvei 24,
P.O. box 213 Leirdal, N-1011 Oslo, Norway
Tel: 47 2 322 580 Fax: 47 2 322 880

VMETRO, Inc.
16010 Barker's Point Ln. #575
Houston, TX 77079, USA
Tel: 713 584 0728 Fax: 713 584 9034

EDN-NEW PRODUCTS

Integrated Circuits

Graphics chip set. The 68800 chip set is a second-generation graphics controller that employs features found on the company's Ultra and VGAWonder boards. It drives 1280×1024-pixel non-interlaced displays and has as much as 4 Mbytes of video RAM. The chip set is compatible with the 16- and 32-bit Micro Channel Architecture bus, EISA, ISA, and Local Bus architectures. The controller displays 16.7 million colors and supports the 8514/A, Super VGA, and VGA standards. \$79 (1000). **ATI Technologies Inc.**, 3761 Victoria Park Ave, Scarborough, ON M1W 3S2, Canada. Phone (416) 756-0718. FAX (416) 756-0720. TLX 06966640. **Circle No. 391**

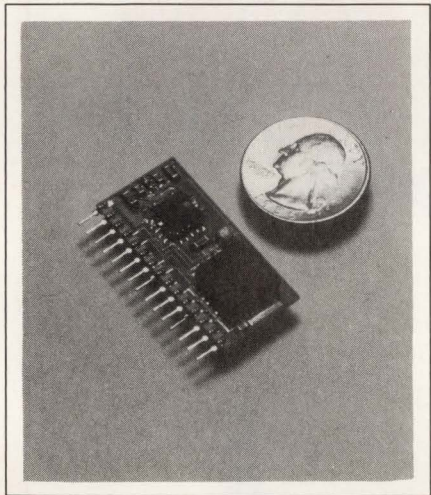

Digital frequency synthesizer. The STEL-1479 is a complete direct digital frequency synthesizer in a single in-line package measuring 1.3×0.8×0.35 in. The thick-film hybrid unit employs the company's STEL-1179 modulated numerically controlled oscillator chip driving an 8-bit DAC. The device operates at clock frequencies as fast as 25 MHz, producing an output frequency range to 10 MHz and having a resolution of 1.49 Hz. You can modulate the carrier using 8-PSK (phase-shift keying), binary PSK, or quadrature PSK modulation. \$20 (1000). **Stanford Telecommunications Inc.**, 2421 Mission College Blvd, San Jose, CA 95056. Phone (408) 980-5684. FAX (408) 727-1482. **Circle No. 392**

Cellular-telephone ICs. Four lines of IC products receive and transmit voice and data signals for cellular phones. Different models in the five FM-amplifier line contain an FM demodulator, receive-signal strength indicator, second mixer, and gain-adjustable IF amplifier. Two modem ICs provide modula-

Supporting Motorola's 68HC11, 68HC16 and many others ... Call for the complete list!

PENTICA SYSTEMS INC IN-CIRCUIT EMULATORS

We love to solve puzzles!

Tracy L. Kangas
Administrative/Sales Support

Pentica Systems, Inc.
19A Crosby Drive
Bedford, MA 01730
Tel: (617) 275-4419
Fax: (617) 275-6514

#1. We stand by you.

"Many admire perfection; we pursue it.

Join the Pentica team--where customers become friends!"

--Tracy L. Kangas
Administrative/Sales Support

CIRCLE NO. 77

Performing in Perfect Time. SYNDAC™

- Flexible Clock Synthesizer & Palette
- VGA/SVGA, 8514/A
- Pixel Replicate™
- Loop Filters
- Sense

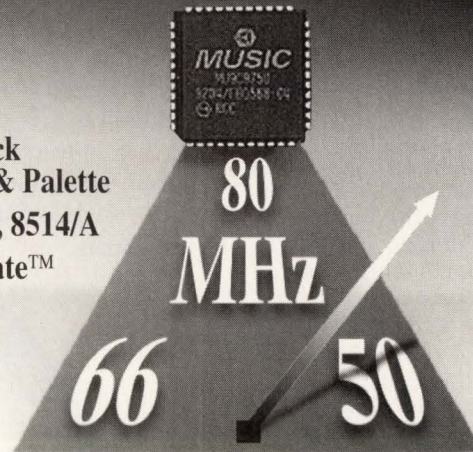

The SYNDAC combines a color lookup table, triple video DAC, and dual clock synthesizers in a single chip. Programmable clock frequencies eliminate multiple crystals and retain compatibility with any controller. Features include, on-chip reference, monitor sensing, and 50, 66, or 80 MHz pixel rates. Keep in sync with SYNDAC; contact MUSIC™ Semiconductors, The Specialty Memory Company.

For your FREE design kit call:

USA 1-800-788-MUSIC (6874),

Europe +31-45-467878, Asia 63-2-816-2477

MUSIC
SEMICONDUCTORS

CIRCLE NO. 78

EDN-NEW PRODUCTS

Integrated Circuits

at 70 MHz. Memory macrocells include a 64-kbit static RAM and a 256-kbit ROM. NRE prices, from \$53,600; each gate, \$0.07 (50,000). Delivery, five to seven weeks ARO. **Oki Semiconductor**, 785 N Mary Ave, Sunnyvale, CA 94086. Phone (800) 654-6388; (408) 720-1900. FAX (408) 720-1918. **Circle No. 397**

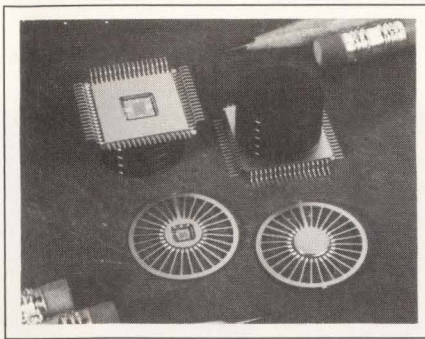

High-frequency ECL ASICs. The E500H and E128VH are ECL ASICs that operate at 3- and 5-Gbps data rates, respectively. The E500H has 504 gates having internal gate speeds of 60 psec and 0.35-mA emitter current. The E128VH has 128 gates having internal gate speeds of 40 psec and 1-mA emitter current. The ASICs employ a 0.3- μ m Si-Bipolar process. E500H, \$175; E128VH, \$140. **Fujitsu Microelectronics Inc.**, 3545 N First St, San Jose, CA 95134. Phone (800) 642-7616; (408) 922-9000. FAX (408) 432-9044. **Circle No. 398**

Disk controller. The SX1615 24-Mbps disk-controller chip features internal ECC generation, a 32-bit DMA channel, and DMA transfer rates as high as 50 Mbps. The chip is designed for IPI-2 disk-control service. \$172 (1000). **Simulex Corp.**, 2832-C Walnut Ave, Tustin, CA 92680. Phone (714) 730-1500. **Circle No. 399**

Mixer-IF FM circuits. The NE/SA625 and SA627 FM circuits have an on-chip mixer/oscillator that accommodates RF and IF signals as fast as 500 MHz and 25 MHz, respectively. Sensitivity is 0.22 μ V for an RF input at 45 MHz. The NE/SA624 contains two limiting IF amplifiers, a quadrature detector, and a 90-dB logarithmic received-signal strength indicator (RSSI). The RSSI has rise and fall times of 0.9 and 1.4 μ sec for an input-frequency signal at 10.7 MHz. NE624N, \$2.84; NE625/7N, \$3.55 (100). **Signetics Co.**, Box 3409, Sunnyvale, CA 94088. Phone (408) 991-4520. **Circle No. 400**



With transfer rates up to 36 megabytes per minute and access times faster than 30 seconds, 3M 1/4-inch data cartridges give you a fast, practical, proven reliable choice for data backup. When you need to save the day in minutes, look to the fastest growing backup media—one that's growing to 10 gigabytes and beyond. Find out more. Call 1-800-888-1889, ext. 54.

Save the day.

In minutes.

A 3M Magnus 1.35 data cartridge is shown inserted into a drive, set against a background of a city skyline at night with lights reflecting on water.

Innovation working for you™

3M Magnus 1.0 and 1.35 data cartridges require a compatible drive. Archive, Maynard, Sankyo, Tandberg, Tecmar and Wangtek have introduced gigabyte 1/4-inch drives. Magnus is a trademark of 3M. © 1992 3M

CIRCLE NO. 80

262,144 Colors Perform Here

- Pixel Replicate™
- Nibble Mode
- VGA/SVGA
- 8514/A
- XGA™



MUSIC's graphics color palettes are fine-tuned for your graphics subsystem applications. MUSIC gives you the sharpest graphics and truest colors available at the lowest cost. So whether you're designing desk-top computers, graphics add-in cards, low-power laptops or multi-media systems, contact MUSIC Semiconductors, The Specialty Memory Company. For your Free design kit call: USA 1-800-788-MUSIC (6874), Europe +31-45-467878, Asia 63-2-816-2477



CIRCLE NO. 81

EDN-NEW PRODUCTS

Integrated Circuits

Cache RAMs. These cache RAMs are available in 16k-word \times 10-bit \times 2-way (μ PD46710) and 8k-word \times 20-bit \times 2-way (μ PD46741) configurations. The units come in 12- and 15-nsec versions and maintain 40- and 33-MHz R3000-based systems. Both the instruction- and data-cache core include on-chip address and chip-enable latches, on-chip instruction and data cache, and 10 I/Os. The 15- and 12-nsec versions, \$33 and \$65 (10,000), respectively. **NEC Electronics Inc.**, 401 Ellis St, Mountain View, CA 94039. Phone (415) 960-6000. FAX (415) 965-6130. **Circle No. 401**

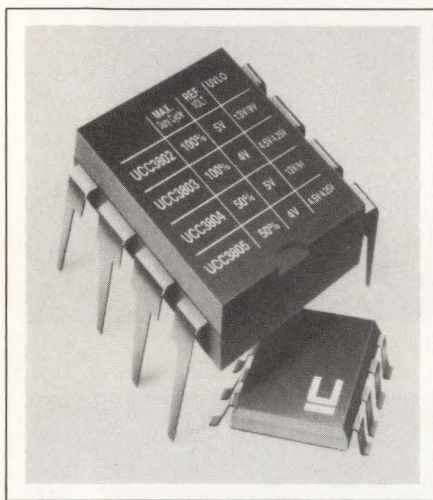

PWM current-mode controllers. The UCC380x family of BiCMOS PWM, current-mode controller ICs features a current-sensing to gate-drive delay of 70 nsec typ. The family contains the circuitry to implement de-to-de switching power supplies using a few external components. Typical operating current is 500 μ A, and the start-up current is less than 100 μ A. The units operate as fast as 1 MHz and deliver 1A output current. Commercial version, \$2.08 (1000). **Unitrode Integrated Circuits Corp.**, Box 399, Merrimack, NH 03054. Phone (603) 424-2410. FAX (603) 424-3460. **Circle No. 402**

ASIC family. The LCA300K compacted-array series of 0.6- μ m ASICs offers as many as 600,000 gates and more than 800 I/O pins. They consist of 14 master slices ranging from 10,000 to 500,000 usable gates. The LCB300K cell-based ASICs implement as many as 200,000 gates, a 512-kbit RAM, and a 1-Mbit ROM on a single chip. The LEA300K embedded-array ASICs embed the LCB300K cell-based memory and complex logic functions in the chip's

core to provide fast turnaround. NRE charges, from \$30,000. **LSI Logic Corp.**, M/S D102, 1551 McCarthy Blvd, Milpitas, CA 95035. Phone (408) 433-7871; (408) 433-7146. **Circle No. 403**

Communications chip set. The HDMP-1000 Gigabit-Link (G-Link) chip set and transmitter and receiver chips provide serial data communications as fast as 1.5 Gbps. The bipolar transmitter and

receiver transfer data through a single fiber-optic cable for distances as long as 10 km. The chip set incorporates the circuitry to encode and multiplex parallel input data for serial data rates from 100 to 1500 Mbps. The chip set also decodes and demultiplexes received data. Chip set, \$710; transmitter, \$355; receiver, \$355 (1 to 9). **Hewlett-Packard**, 19310 Pruneridge Ave, Cupertino, CA 95014. Phone (800) 752-0900.

Circle No. 404



Prime Real Estate Available in a Great Location.

Locate your next product on a VME MXbus™ SideCard™ adjacent to a Mizar CPU card and you get your product to market faster because you start with an off-the-shelf CPU that comes up with the debugger the first time you power it on. And if you want to use a commercially available real-time OS, it is probably already ported to the board.

By building your custom design on a proven hardware and software foundation you also minimize your design risk. But you need not sacrifice any design flexibility because Mizar supplies a variety of configurations based on Motorola processors, including the 040. And the VME MXbus™ accommodates single high 3U, conventional double height 6U, as well as unconventional 9U and custom configurations.

Call us today to take advantage of this opportunity to put your next design in a great location. It's a unique solution from Mizar that you can build on.

MIZAR

1419 Dunn Drive • Carrollton, TX 75006

1-800-635-0200 FAX 214-242-5997

©1992 Mizar Digital Systems, Inc.

Mizar is a registered trademark of Mizar Digital Systems, Inc. Other names are trademarks of their respective manufacturers.

Drive your DSP design all the way home.

Why complicate your travel plans? Zip along the entire DSP design route with SPW™ — the Signal Processing WorkSystem® from Comdisco.

SPW is the only DSP and communications design software tool that's complete and integrated. The only one that can take you all the way from idea to implementation. No matter where you're headed. No matter which road you take. And it's fast. It has all the horsepower you need to cut design time by as much as 90 percent.

First, SPW helps you choose your destination. You can quickly draw from its extensive libraries of reusable function blocks. And you can take advantage of SPW's open architecture to incorporate your own models.

After this, SPW automatically transforms your design into an

error-free simulation program. One that lets you perform accurate design, prototyping and analysis. One that confirms that you're headed in the right direction.

And, to assure that your way is free from bumps, potholes, and those awful "dead end" signs, SPW comes with the industry's widest range of implementation options. Options that generate code for floating- and fixed-point DSP chips as well as DSP systems with multiple processors. Options for bit-true fixed-point simulation that automatically generate VHDL and provide seamless links to the leading logic synthesis tools. Options that pave the way to fast FPGA and ASIC production.

So, how about a test drive? Call us at 415-574-5800. And learn how SPW can put you in the fast lane to market.



COMDISCO[®]
SYSTEMS, INC

U.S.: Telephone 1-415-574-5800, Fax 1-415-358-3601 Europe: Telephone 44-454-614256, Fax 44-454-614700

CIRCLE NO. 83

EDN August 6, 1992 • 151

CAE & Software Development Tools

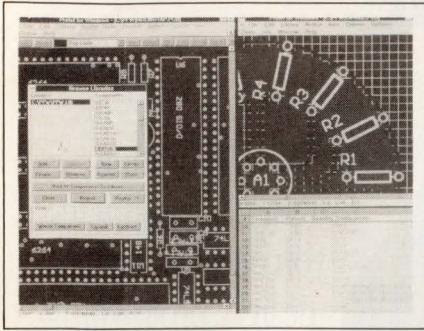

Updated pc-board-design software. Protel for Windows pc-board-design system version 1.1 works with MS-Windows 3.0 or 3.1 and autoplaces component footprints with netlists from other capture packages. It reads PADS-PCB and Tango-PCB files; provides pen plotting down to 0.0025 mm wide; and has a 300-pattern footprint library. The system's binary file size has been reduced an average of 60%. Other features include an arc resolution of 0.001° and placement to a resolution of 0.001 mil. Version 1.1 update supplied at no charge to previous version owners. \$3480 for new users. **Protel Technology Inc.**, 151 Bernal Rd, San Jose, CA 95119. Phone (800) 544-4186; (408) 281-5858. FAX (408) 225-1863. **Circle No. 405**

Thermal analysis for PC boards. Thermax Designer has a forms-driven user interface and a thermal library of 15,000 components and 700 packages. It requires minimal user knowledge of thermal analysis and operates automatically. As a board layout or circuit designer, you use this product to satisfy thermal constraints during physical design. Heat-transfer specialists use a related product, Thermax Expert, to precisely model all heat-transfer mechanisms for ICs, multichip models, and pc boards. Thermax Designer, \$21,000. **Cadence Design Systems Inc.**, 555 River Oaks Pkwy, San Jose, CA 95134. Phone (408) 943-1234. FAX (408) 943-0513. **Circle No. 406**

Ada-language system and tool set. The Sun Ada Development Environment version 1.1 enhances user applications by as much as 30 percent over previous versions, according to benchmarks from the Performance Issues Working Group of IEEE SIGAda. In addition, the product is compatible with the Vadsross family of cross-development products from Verdex Corp, giving a common tool set and user interface for both host- and target-system devel-

opment. The product also comes with network licensing. It includes a compiler, debugger, on-line language reference manual, an X11 tool kit, and an interactive build-and-test tool kit for GUIs. US single-use license, \$10,000. **Sunpro Inc.**, 2550 Garcia Ave, Mountain View, CA 94043. Phone (415) 960-1300. FAX (415) 969-9131. **Circle No. 407**

Block-oriented network simulator. Bones Designer 2.0 simulates networks and networking devices including protocols, LANs, WANs, circuit- and packet-switched networks, Integrated Services Digital Network, Switched Multimegabit Data Service, packet radio networks, computer buses and architectures, and satellite-based systems. You use a library of 300 primitives as building blocks for creating modules and models. The user interface is a graphical user interface with mouse-based selection and copy-and-paste functions for building new modules from previously defined blocks. An animation mode displays the flow of data through the model, and you can place probes anywhere to collect data that documents network performance. Available on Sun-4 SPARCstations, DECstations, and HP9000/700 workstations, \$12,000. **Comdisco Systems Inc.**, 919 E Hillsdale Blvd, Foster City, CA 94404. Phone (415) 574-5800. FAX (415) 358-3601. **Circle No. 408**

Spice simulator. The Analog Interface Kit provides users of proprietary Spice simulators and third-party Spice vendors with an interactive, graphical front end for Spice and Spice-like simulators. It also provides a link to the Design Architect schematic-capture tool, the Simview simulation user interface, and the Falcon framework for concurrent design. The software includes a suite of postprocessing and analysis tools for viewing results of analog simulations interactively or in real time. For Sun and HP workstations, from \$13,900. **Mentor Graphics Corp.**, 8005 SW Boeckman Rd, Wilsonville, OR 97070. Phone (408) 436-1500. **Circle No. 409**

Top-down ASIC design tool. The ASIC Navigator design system performs behavioral VHDL (VHSIC Hardware Description Language) simulation, design partitioning, and logic and test synthesis. You can use any combination of graphical- and HDL-based specifications to create single- or mul-

tichip ASIC systems. Also available with the software are eight ASIC and FPGA libraries that work with all logic-design tools in the design system. Libraries are available from Fujitsu, LSI Logic, Motorola, NCR, SMOS Systems, Toshiba-Siemens, VLSI Technology, and Xilinx. \$95,000. **Compass Design Automation**, 1865 Lundy Ave, San Jose, CA 95131. Phone (408) 433-4880. FAX (408) 434-7820. **Circle No. 410**

Virtual instrument library. Using the Anaview virtual instrument library for Labview 2, you can control, monitor, and configure Anafaze 8LS and 12LS PID (proportional integral derivative) loop controllers. The controllers regulate temperature, pressure, and other process variables using PID algorithms. \$795. **Software Engineering Group**, 1 Dana St, Cambridge, MA 02138. Phone (617) 492-6664. FAX (617) 661-6483. **Circle No. 411**

R&M software for workstations. SoftPC, a DOS emulator, lets you run the manufacturer's reliability and maintainability software on workstations. SoftPC emulates DOS 3.3 and PC/AT performance. \$695. **Powertronic Systems Inc.**, Box 29109, New Orleans, LA 70189. Phone (504) 254-0383. FAX (504) 254-0393. **Circle No. 412**

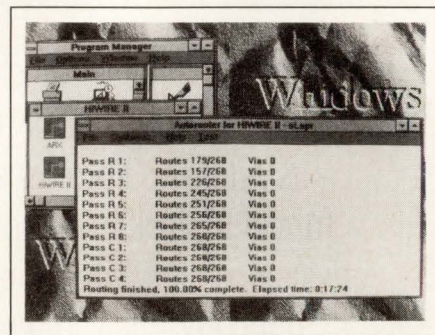

Extended-memory autorouter for PC. The ARX autorouter for Hiwire II pc design software can use as much as 15 Mbytes of extended memory under MS-Windows 3.0. The software, which runs in native 286 or 386 modes, can autoroute boards at least 10 times larger than the maker's standard autorouter. The product is a multipass, 100% completion, gridless router featuring rip-up-and-reroute capability, through minimization and flexible design rules. \$1695. **Wintek Corp.**, 1801 South St, Lafayette, IN 47904. Phone (800) 742-6809. FAX (317) 448-4823. **Circle No. 413**

EDN PRODUCT MART

This advertising is for new and current products.

Please circle Reader Service number
for additional information from manufacturers.

EXPRESS

Best Value in the World
for
5
DAY TURN
PRINTED CIRCUIT PROTOTYPES

2 PIECE PRICES

LAYERS	1	2	3&4	5&6	7&8
15	\$212	\$265	\$581	\$715	\$850
30	240	300	658	815	983
60	283	354	775	954	1034
90	325	407	891	1097	1304
120	350	442	949	1092	1417

■ 5 PIECES x 1.34
■ 10 PIECES x 1.67

EXTRAS

- Photo Plotting
- Testing
- Gold Contacts - \$50
- 25% - Below 8 Mil

DISCOUNTS

10% **NET 10**
5% **CREDIT CARD SALES**

FOR MORE INFORMATION CALL OR FAX

Ken Bahl
Sierra Circuits, Inc.
Phone (408) 735-7137 FAX (408) 735-1408 Modem (408) 735-9842

CIRCLE NO. 325

☆☆☆☆
"The Best 8051 Emulator"

FULL 8XC51 FA/FB/FC SUPPORT

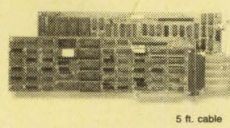

5 ft. cable

8051

SEE EEM 91/92
Pages D 1300-1303

PC based emulators for the 8051 family

8031, 8032, 8051, 8052, 80C152/154/321/451/452/51FA/51GB/515/517/535/537/552/562/652/851, 80C451/552/652/751/752/851, 8344, 87C451/552/751/752, 8751, 8752, D95000 + CMOS ... more.

- PC plug-in boards or RS-232 box.
- Up to 33 MHz real-time emulation.
- Full Source-level Debugger w/complete C-variable support.
- 64 bit wide, 256K deep trace, with time stamp.
- Bond-out/hooks pods for 8051, 83C552, 83C451, 83C652, 83C751, 80C515/80C517, 83C752, 8XC51FA/FB/FC, and more.

CALL OR WRITE FOR FREE DEMO DISK!
Ask about our demo VIDEO

NOHAU CORPORATION 51 E. Campbell Avenue
Campbell, CA 95008
FAX (408) 378-7869
(408) 866-1820

Call 408-378-2912
Nohau's 24-hour
information center to
receive info via your FAX

CIRCLE NO. 326

MICROTIME Set up at 1984 for Development tools

Bice 8051 (Add-on Card ICE)

- 8051 adapter to emulate 8051/52, 8751/52
- 8031 adapter to emulate 8031/32
- Real-time breakpoint and Non real time trace
- Symbolic Debugger
- The others: 8048, Z8, 6805, T17000

MEMPET-256 (Memory emulator)

- To emulate EP (ROM) from 2K to 256K
- Bytes and SRAM from 8K to 128K Bytes
- To emulate byte, word, long word, expand up to 8 modules or 1 EPROM writer (4MBIT)
- Support Break, Range Break and external trigger function
- Support Line Assembler/Disassembler for each cpu (option)

AP-511 (Programmer)

- Can program 8751/52, 8748/49/50 family and 27xxx up to 27020
- Support Line Assembler/Disassembler for each CPU

Stand-alone ICE and programmer

- ICEPET 8048, 8051, Z80, 6502, 8086, 88, Z8, 68000/10
- ICEPET V (universal ICE) 80186/88, 80196 (8096), 87C751/752, 64180 (Z180) (Z80, 68000/10, 68020, 80286, 80386, 68HC11 will come out on 1992)

Distributor Welcome

MICROTIME COMPUTER INC.
10F, 196, SEC. 4, CHENG-TEH RD. TAIPEI, TAIWAN
R.O.C. TEL: 886-2-8811791 FAX: 886-2-8820836

CIRCLE NO. 327

Instant Microcontroller

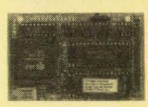

Instant C Programming

Don't use a microprocessor, use a **SmartBlock™** microcontroller module to build your custom controller. Our \$195 interactive **Dynamic C™** development system makes programming easy. 3.5 x 2.5 inch module includes microprocessor, memory, time/date clock, eeprom, watchdog, serial ports and more. As low as \$59 in quantity. The efficiency of a custom design without the headaches.

Z-World Engineering
1724 Picasso Ave., Davis, CA 95616 USA
Tel (916) 757-3737
Regular Fax: (916) 753-5141
Automatic Fax: (916) 753-0618
(Call from your fax, request data sheet #14.)

CIRCLE NO. 328

UNIVERSAL PROGRAMMER, EMULATOR & TESTER

TUP-400 \$745.00
TUP-300 \$575.00 **NEW**



- New improved hardware and software.
- The most complete PC-based Universal Programmer. Programs PLD (PAL, GAL, FPL, EPLD, PEEL, MAX, MACH...), E(E) PROM (up to 16 Mbit), Flash EPROM, B-PROM, Special PROM, MPU (87XX, 68XX, Z8, PSD301, PIC16XX, TMS320CXX, UPD75PXXX, HD637XXX...).
- Covers DIP, PLCC, OFF, SOP, and PGA with 8 to 84 pins. Gang Programming adapters available also.
- EPROM EMULATION capability.
- Tests digital ICs and DRAMs (SIMM/SIP adapter available).
- Free software updates and new devices added upon request.
- IC Manufacturers' approval.
- 1 year warranty, 30 day money back guarantee.

Supports Motorola and PIC MICROS, WSI PSD 3XX, MAX and MACH.

CALL TODAY FOR MORE INFORMATION. Distributors are welcome!

Tribal Microsystems Inc.
44388 S. GRIMMER BLVD. FREMONT, CA 94538
TEL: (510) 623-8859
FAX: (510) 623-9925

DEVELOPER'S TOOLS

CIRCLE NO. 329

ROM-IT™

EPROM EMULATION SYSTEM



The Most Flexible EPROM Emulator You Can Get Today!

- Emulates up to 8 4-Megabit EPROMs through one standard serial port.
- Downloads 2-Megabit programs in less than 23 seconds.
- Allows you to examine and modify individual bytes or blocks.
- Accepts Intel Hex, Motorola S-Record and Binary files.
- Software available for IBM PC and compatibles.
- Base 27256 EPROM System \$395.00. Other configurations available.

ORDER TODAY--IT'S EASY
CALL OR FAX FOR MORE INFORMATION

Incredible Technologies, Inc.
(708) 437-2433
(708) 437-2473 Fax
Visa and MasterCard accepted.

CIRCLE NO. 330

To advertise in Product Mart, call Joanne Dorian, 212/463-6415

FREE DEMO DISKS

See why over 20,000 engineers rely on SCHEMA for their design needs.

- ✓ Schematic Capture
- ✓ PCB layout & routing
- ✓ Simulation
- ✓ PLD design

Call 800-553-9119



801 Presidential • Richardson, TX 75081
(214) 231-5167 • FAX (214) 783-9072

CIRCLE NO. 331

DR. "CHIP" MUNK SAYS



6805/68HC05/68HC11
DEVELOPMENT TOOLS
QUALITY + SERVICE
AFFORDABILITY
TECI

"Chip" experts agree with Dr. Munk. TECI'S PC based microcontroller development tools are the most cost effective for veterans or beginners.

6805 PRIMER FOR BEGINNERS...\$195.00
6805/68HC05/68HC11 CROSS ASSEMBLERS...\$99.00
6805/68HC05 SIMULATOR / DEBUGGERS...\$99.00
68705 P3,P5,U3,U5,R3,R5 PROGRAMMERS FROM \$349.00
68HC705/68HC805 PROGRAMMERS FROM \$395.00
COMPLETE PC BASED DEV. SYSTEMS FROM \$449.00
68HC05/68HC11 REAL TIME EMULATORS FROM \$895.00

TECI TEL: (802) 525-3458
FAX: (802) 525-3451

The Engineers Collaborative, Inc.
RR# 3 Box 8C Barton, VT. 05822 USA
CALL TOLL FREE 1-800-336-8321

CIRCLE NO. 332

Consistency is key

to the power of EDN Product Mart

Analog Circuit Simulation

- Schematic Entry
 - SPICE Simulation
 - Model Libraries
 - Waveform Processing
- only \$990

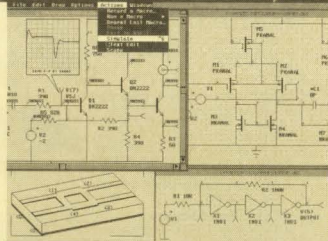

Powerful - Affordable

FULLY INTEGRATED, EASY TO USE, ANALOG CIRCUIT SIMULATION ENVIRONMENT, FROM ONE VENDOR, FEATURING:
A powerful SPICE simulator performing AC, DC, and Transient, analyses, extensive model libraries, schematic entry, graphical waveform processing, and report quality printouts.

Call Or Write For
Your Free Demo and
Information Kit!
Tel. 310-833-0710



P.O. Box 710 San Pedro,
CA 90733-0710
Fax 310-833-9658

CIRCLE NO. 334

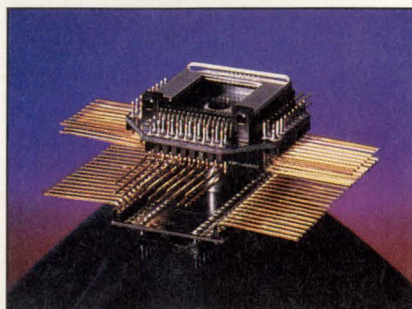

Quick, Fast Socket Conversion

- Convert-A-Socket™ makes it a snap to convert a production socket to a test socket and vice-versa.
- Complete line of male/female sockets for LCC, PLCC, PGA, PQFP, and DIP circuits.
- A must if you're inserting circuits repeatedly in low insertion force sockets.
- Quick turnaround on custom engineering services, if needed. For a free catalog, contact:

Emulation Technology, Inc.
2344 Walsh Ave. Santa Clara, CA 95051
Phone: 408-982-0660 FAX: 408-982-0664



CIRCLE NO. 335

Now
Networkable!

Facts about

750,000

ICs and Semiconductors at Your Fingertips

Cahners CAPS is the newest component search and selection tool for electronic design engineers:

- PC-driven, CD-ROM-based
- Includes unabridged manufacturers' technical documentation
- Represents more than 600 manufacturers worldwide

Call toll-free: 1-800-245-6696



275 Washington Street
Newton, MA 02158-1630
Telephone: 508-692-4148
Facsimile: 508-392-0603

CIRCLE NO. 336

Schematic Capture for the Macintosh

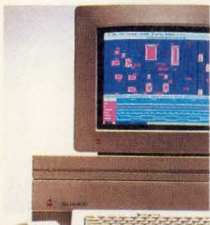

NEW DesignWorks™ 3.0!

Introducing a new generation of design tools for the Apple Macintosh. **DesignWorks 3.0 Schematic Features** Unlimited hierarchy • multi-level Undo/Redo • auto-packaging • spreadsheet-style attribute browser and much more. **Optional Digital Simulation Module** 13-state event driven simulation, fully interactive even on hierarchical designs • New interactive test vector panel **Schematic Libraries** New expanded libraries with over 13,000 parts, including all 74xx families, 75xx, 4000, ECL, processors, memories, etc. **Interfaces** Netlist outputs for SPICE, Douglas, McCAD, Cadnetix, OrCad, Tango, Racal-Redac, etc. • Fully customizable reports

CALL (800) 444-9064 TODAY FOR YOUR
FREE DEMONSTRATION KIT!

CAPILANO COMPUTING
(604) 522-6200 Fax (604) 522-3972

CIRCLE NO. 337

MICROPROCESSOR EMULATORS

Zax provides a comprehensive series of real-time emulation support for Motorola, Intel, NEC, Zilog, and Hitachi microprocessors. Some of the highlighted features include source-level debug, real-time trace, and performance analysis.

Call now for more information:

(800) 421-0982
(714) 474-1170 (Inside CA)
(714) 474-0159 (Fax)

ZAXTEK

42 Corporate Park Irvine, CA 92714

CIRCLE NO. 338

CHIP PAIR CORRECTS RANDOM AND BURST ERRORS

EASILY ADD FORWARD ERROR CORRECTION
(FEC) TO ANY DATA CHANNEL.

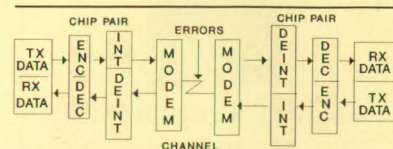

- Separate FEC and Interleaver chips.
- 1/2-rate FEC code chip alone corrects any 3-errors per 24-bit block.
- Programmable to correct error bursts from 9 to 12,285 bits!
- Completely transparent to user's data.
- Patented auto-sync scheme.
- Easy to use, low power CMOS.
- Only requires data and clock from user.



4950 FM 1960 WEST, SUITE C3190
HOUSTON, TX 77069
713-782-2244 713-875-1756 (FAX)

CIRCLE NO. 339

To advertise in Product Mart, call Joanne Dorian, 212/463-6415

Advin

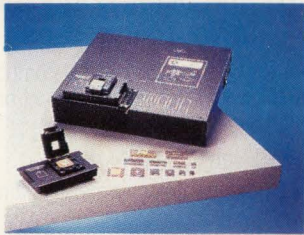

ADVIN versus DATA I/O

- **Data I/O and Model 2900:** reputable company, dependable equipment, supports 40-pins. Software updates: fair amount.
- **Advin and PILOT-U40:** reputable company, dependable equipment, supports 40-pins. Software updates: free via electronic BBS.

ADVIN SYSTEMS INC.

Smaller Company, Better Service.

800-627-2456, 408-243-7000, Fax 408-736-2503

CIRCLE NO. 340

UNIVERSAL PROGRAMMER

SUPERPRO[®]

- PLD (PAL, GAL, FPL, EPDL, PEEL, MAX, MACH....) E(E)PROM up to 8Mbit, Flash EPROM, BPROM, Micro-controllers (MOT, NS, MICROchip, Intel....) and 1700 other parts
- Tests TTL/CMOS logic ICs & Dynamic/Static Memory.
- New parts added upon customer request and free updates on BBS (24 hrs)
- Online technical support and hardware warranty for 1 year.

ROM MASTER™: \$149

Universal E(E)PROM programmer to 4Mbit

ROM MASTER/4: \$239

Universal E(E)PROM programmer 4 Gang Version

XELTEK

757 N. Pastoria Avenue
Sunnyvale, CA 94086
TEL (408) 524-1929
FAX (408) 245-7084 BBS (408) 245-7082

CIRCLE NO. 341

Embedded Industrial AT

- 40° to + 85° C

Tiny industrial AT fits in any new design or upgrade. "Instant DOS" in ROM operation. Just three steps to download your .EXE file to the flash memory on the 5016A. Use any PC language.

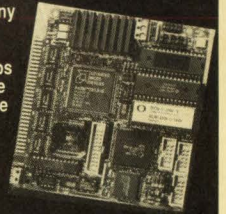

Operates stand-alone or in ISA passive backplane with other cards. Three solid-state disks mean no floppy/hard disks. Only 4.5 x 4.9 in.

80C286
16 MHz CPU

- | | |
|--------------------------|----------------------|
| ▶ COM1, COM2, LPT1 ports | ▶ DOS 3.31 in ROM |
| ▶ 4 MB DRAM | ▶ Calendar/clock |
| ▶ 2 MB solid-state disks | ▶ Coprocessor socket |
| ▶ Keyboard/speaker port | ▶ Autorun capability |
| ▶ Watchdog timer | ▶ 5V only operation |

THE MICROCOMP COMPANY

OCTAGON SYSTEMS® Tel: 303-430-1500, Fax: 303-426-8126

CIRCLE NO. 342

FREE CATALOG



Affordable tools for programmable devices are just a phone call away.

- Unbeatable values on Data I/O® device programmers, software, updates, and accessories
- 30-day, money-back guarantee

- Access to Data I/O's toll-free technical hotline and on-line bulletin board

To order your FREE catalog, call Data I/O Direct today.

1-800-3-DatalO
(1-800-332-8246)

DATA I/O

CIRCLE NO. 343

Save 50%
on our
memory
programming system.



- Includes the 212 Multi Programmer with EPROM module, and PROMlink™ Ltd. PC Interface Software
- Supports more than 400 EPROMs up to 40 pins

- Full-hex keypad for extensive editing
- Optional logic and microcontroller modules
- Manufacturer-specified algorithms ensure accuracy

1-800-3-DatalO
(1-800-332-8246)

*U.S. list price only.

Call Data I/O® Direct today to order the 212 Memory System.

DATA I/O

CIRCLE NO. 344

320C25 DSP ASAP \$1,995

Drive your embedded 320C25 design to market as fast as possible with our 320C25 in-circuit emulator. The MACROCHIP® C25 emulator features real time emulation to 50 MHz with no wait states, 64K words of program overlay memory, simple software breakpoint, single step trace, disassembler, and RS-232 communications for fast downloading of programs from your PC COM port.

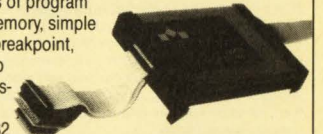

Call, write or fax for literature:



1301 N. Denton Drive
Carrollton, TX 75006
Tel 1-800-783-9546
Fax 214-245-1005

CIRCLE NO. 345

DC/CAD

introducing...

THE TERMINATOR

Super High Density Router
(Complete with Schematic & PCB EDITOR)

Features the following powerful algorithm & capability:

- Rip-up and Retry
- Pre-routing of SMT components
- Real-Time via minimization
- Real-Time clean up passes
- User defined strategies
- Window 3.0 capability as DOS Task
- 1-mil Autoplacer and Autoplaning
- Two-way Gerber and DXF
- Automatic Ground Plane w/ Cross Hatching
- Complete w/ Schematic & Dolly Libraries
- Optional simulation capability & protected mode for 386 users

Call for
FREE DEMO DISK
price range:
\$295 - \$1495

* PCB LAYOUT SERVICE AT LOW COST *
LEASE PROGRAM & SITE LICENSE AVAILABLE

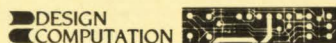

1771 State Highway 34, Farmingdale, NJ 07727
(908) 681-7700 • (908) 681-8733 (FAX)

"DC/CAD...The focal point of future CAD market"

CIRCLE NO. 346

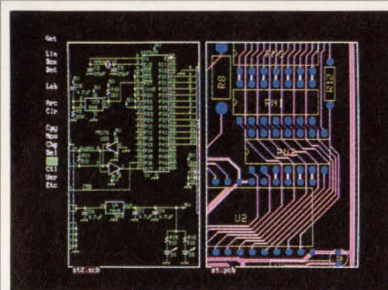

New Schematic and PCB Software

With support for extended and expanded memory, HiWIRE II can handle your most demanding schematic and PCB designs quickly and easily. The unique HiWIRE editor allows you to display and edit schematics and PCBs simultaneously, using the same commands for each. HiWIRE II is \$995, and is guaranteed.

Wintek Corporation

1801 South St., Lafayette, IN 47904
(800) 742-6809 or (317) 448-1903

CIRCLE NO. 347

Telecom Solutions from Teltone

R1/R2 MF Transceivers

M-986 transceivers transmit and receive CCITT R1 or R2 forward and backward



NOW AVAILABLE
IN PLASTIC

multi-frequency signals. For trunk adapters, test equipment, paging terminals, traffic recorders, PBX circuitry, etc.

- Single or dual channel versions available
- Binary or 2 of 6 input/output format
- Complete microprocessor interface
- 40-pin thru-hole/44-pin PLCC packages
- 5-volt power, crystal time base

1-800-426-3926

Or: 206-487-1515 Fax: 206-487-2288

TELTONE®

INNOVATING SOLUTIONS

In Telecom Interface Components

Teltone Corporation, 22121-20th Avenue SE, Bothell, WA 98021

CIRCLE NO. 348

To advertise in Product Mart, call Joanne Dorian, 212/463-6415

PCB and SCHEMATIC C.A.D.

EASY-PC **\$195** EASY-PC

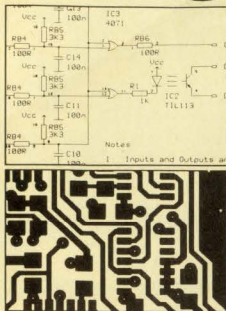

- Runs on PC/XT/AT/286/386 with Herc, CGA, EGA, VGA.
- Design Single sided, Double sided and Multilayer boards.
- Provides Surface Mount support.
- Standard output includes Dot Matrix / Laser / Inkjet Printer, Pen Plotter, Photo-plotter and N.C. Drill.
- Award Winning EASY-PC is now in use in over 12,000 Installations in 70 Countries World-wide.
- SUPERBLY EASY TO LEARN AND USE.
- Not Copy Protected.

Options:- 1000 piece symbol library \$75.00,
Surface Mount library \$112, Gerber Import facility \$195.00

For full info, write, fax, call or use inquiry #

Number One Systems Ltd. 1

REF: EDN, HARDING WAY, ST.IVES, HUNTINGDON,
CAMBS, ENGLAND, PE17 4WR.

Telephone: USA: 011-44-480-61778
Intnl: +44-480-61778
UK :- 0480 61778

Fax: USA: 011-44-480-494042
Intnl: +44-480-494042
UK :- 0480 494042

AMEX,VISA,
MasterCard
Welcome



CIRCLE NO. 349

CIRCLE NO. 350

CIRCLE NO. 751



PROGRAMMABLE HAND HELD

Introducing the PDS:

- Powerful 8051 Based Microprocessor
- Flash EPROM
- Battery Backed RAM
- Programmable Using Your PC
- RS-232, RS-422, RS-485 Or IR Interface
- 4 line by 20 Character LC Display
- Choice of 20, 30, or 45 Key Keypad
- Low Cost
- Full 24 Month Warranty



Two Technologies, Inc.
419 Sargon Way
Horsham, PA 19044
Phone: (215)441-5305
Fax: (215)441-0423

Now Networkable!

Facts about
750,000

ICs and Semiconductors at Your Fingertips

Cahners CAPS is the newest component search and selection tool for electronic design engineers:

- PC-driven, CD-ROM-based
- Includes unabridged manufacturers' technical documentation
- Represents more than 600 manufacturers worldwide

Call toll-free: 1-800-245-6696



275 Washington Street
Newton, MA 02158-1630
Telephone: 508-692-4148
Facsimile: 508-392-0603

Natural Voice Playback

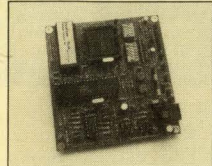

DataVoice - DV-64

Add a high quality *Recorded Natural Voice* to your product. Recorded Voice vocabularies consisting of over 100 words or multiple phrases up to 1 minute in a *Natural Voice* is saved in Non-Volatile E-Prom memory. We'll record your message(s) in a male or female voice - or - you can record the library of words and phrases by using the optional SDS-1000 development system with an IBM or compatible computer. OEM designs are available.

Parallel input word select 500 ma. keyline output 32 Kb sampling rate Multiple modes Selectable timing

8 ohm Audio output 600 ohm Audio output +9v to +14v Supply Size: 4.00" x 4.25" Under \$ 100 - OEM qty

Several different models available - Call for a demonstration

Palomar Telecom, Inc.

300 Enterprise St. Suite E - Escondido, Ca. 92029
(619) 746-7998 Fax (619) 746-1610

CIRCLE NO. 752

FINALLY

One tool to satisfy all your firmware development needs

PROMICE is a universal system.

- Develops code for any microprocessor
- Complete, real time, source level debugging
- Host software for DOS, Unix, Mac, VMS
- Non intrusive on your target system
- Simply plugs into any ROM socket

PROMICE also supports Turbo Debugger, C_thru_ROM, FreeForm, GDB, and more.

PROMICE

...the affordable solution.



TEL: (614) 899-7878
West: (415) 750-0219
FAX: (614) 899-7888

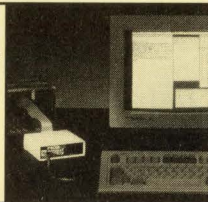

CIRCLE NO. 753

Communicate Weekly

to the electronics OEM through EDN's Magazine and News Editions Product Mart

LASER DIODE DRIVERS

HIGH SPEED HIGH POWER

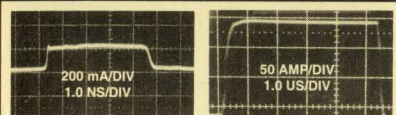

Avtech offers over 80 different fast laser diode drivers. See our free 113-page general catalog for:

- Peak currents from 100 mA to 500 Amps
- Pulse widths from 200 ps to 1 ms
- Rise times as low as 100 ps
- Plug-in diode bias insertion units
- Lab instrument or miniature module format
- 250 other fast pulse generators, amplifiers, samplers, transformers and fast pulse accessories

AVTECH ELECTROSYSTEMS

P.O. Box 265, Ogdensburg New York 13669 (315) 472-5270
P.O. Box 5120, Station F Ottawa, Canada K2C 3H4 (613) 226-5772 Fax: (613) 226-2802

CIRCLE NO. 755

ICE FOR THE 2105 DSP

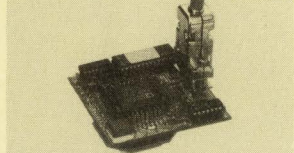

- Low cost in circuit emulator for the 2105 DSP comes with DOS user software.
- VGA color display allows viewing and editing target memory and registers.
- Pull-downs, menus, and soft keys are used in the mouse driven user interface.
- Your assembled files may be loaded, emulated, debugged, and printed with optional symbolic displays.
- Software breakpoints, step, trace, move, fill, and other functions are available.
- Designed for use in booth page mode.

Independent Digital Consulting, Inc.
Box 1868, Akron, Ohio 44309
Phone 216-753-0777 Fax 216-753-0772

CIRCLE NO. 756

Imagine if **YOUR product could talk!**

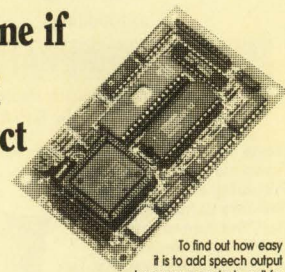

To find out how easy it is to add speech output to your own products, call for your free V6600 data book today!

- Converts plain ASCII text into high quality speech
- Unlimited vocabulary-no custom recording necessary
- Requires only a single 5V supply and speaker
- Built in µP, serial and printer interfaces
- Less than \$100 in OEM quantities
- Customization services available

RC SYSTEMS
121 W Winesap Rd - Bethel, WA 98012

USA/Canada Phone/Fax: (206) 672-6909
UK/Europe 81 539 0285 Fax: 81 558 8110

CIRCLE NO. 757

PORT•FOLIO

13 PORTS IN ONE CARD

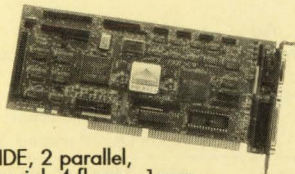

- 2 IDE, 2 parallel,
- 4 serial, 4 floppy, 1 game
- Serial ports configurable as com 1-4
- 16 bit, 3/4 size card, SMT circuit design
- Saves ISA bus slots on your PC
- Cables for 9 ports included
- Made in the USA

\$79

TO ORDER CALL
 800-324-TREK (in USA)
 512-338-2127 (fax)
 512-338-2125 (outside USA)

VISA/MASTERCARD ACCEPTED

QUADTREK CORPORATION 6034 W COURTYARD DR
 STE 305-74
 AUSTIN TX 78730

CIRCLE NO. 758

8051 68HC11 COP8 68HC05

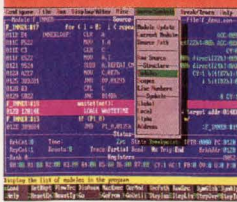

iceMASTER Improved User Interface Features

- Easy to learn & use
- Windowed interface -- user configurable
- FAST! Download -- < 3 sec. typ. at 115Kb
- Source level debug

- A 4K frame trace buffer with advanced searching capabilities.
- iceMASTER connects easily to your PC, requires no disassembly or expansion slots. Works on any PC (DOS or OS/2), MicroChannel or EISA. Even laptops!
- Broad support of derivative devices.
- Rental and 10-day trials available.
- Now quick-breaks, virtual memory and mouse support.
- Call today for free demo disk and ask about a free 8051 Macro Assembler! (800) 638-2423

MetaLink
Corporation

MetaLink Corporation P.O. Box 1329 Chandler, AZ 85244-1329
 Phone: (602) 926-0797 FAX: (602) 926-1198 TELEX: 4998050MILINK



CIRCLE NO. 759

8051, 8096, 68HC11, 68332 SINGLE BOARD COMPUTERS

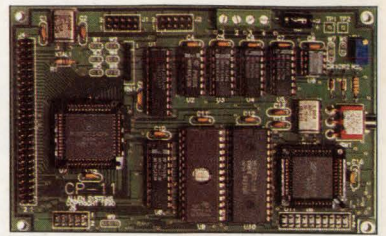

We feature a series of single board computers for process control applications. Each is available as a bare printed circuit board, or fully assembled and tested. Optional development software is also available. Please contact us to discuss your requirements and receive a literature package covering technical specs and pricing.

ALLEN SYSTEMS
 2346 Brandon Road, Columbus, OH 43221
 614-488-7122

CIRCLE NO. 760

48 Channel 50MHz Logic Analyzer

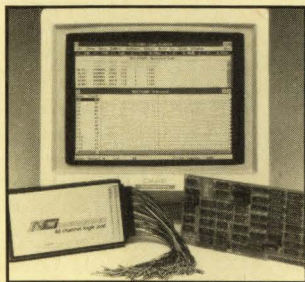

Complete System \$1895.00

New Windows 3.0 Compatible Software

- 48 Channels @ 50 MHz x 4K words deep
- 16 Trigger Words/16 Level Trigger Sequence
- Storage and recall of traces/setups to disk
- Disassemblers available for: 68000, 8088, 8086, 6801, 6811, Z80, 8085, 6502, 6809, 6303, 8031

NCI 6438 UNIVERSITY DRIVE,
 HUNTSVILLE, AL 35806
 (205) 837-6667 FAX (205) 837-5221

CIRCLE NO. 761

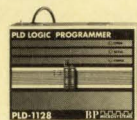

PLD-1128 LOGIC DEVICE PROGRAMMER \$995.00

Program over 1100 different PLDs including the latest architectures from AMD, Cypress, NS
 Qualified by **AMD, Lattice, National Semiconductor, Signetics** and others

Supports all MACH and MAPL devices, **all versions of 22V10, including the /4 from AMD, -5 & -7 PLDs** from NS, and Altera 900 & 1800 series EPLDs

Only uses the **manufacturer approved** programming algorithms to ensure accuracy
LIFETIME FREE SOFTWARE UPDATES VIA BBS AND US MAIL

Risk free 30-day money-back guarantee
MADE IN THE USA

BP MICROSYSTEMS
1-800-225-2102

Houston, Texas 77043-3239 • (713) 461-9430 • (713) 461-7413

CIRCLE NO. 762

Analog Four Play

X9241 Quad E²POT™
 Digitally Controlled IC Potentiometers

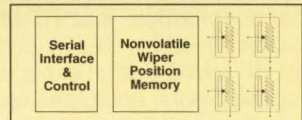

- Automated System Adjustments
- Faster System Calibration
- No Special Adjustment Tools Needed
- No Knobs, Shafts or Screws Required
- Will Not Wear Out
- Vibration, Dust And Water Proof
- Nonvolatile Wiper Position Storage

Xicor Xicor, Inc., 1511 Buckeye Drive, Milpitas, California 95035-7493
 (408) 432-8888 X3549 FAX 408-432-0640

CIRCLE NO. 763

Combine Your Product Mart Ads

In EDN's Magazine
and
News Editions for
higher impact and a
lower rate.

PC KEYBOARD DESIGN

This book will tell you how to use the keyboard port as an input for your embedded system. It defines the protocol between the keyboard and computer for both the XT and the AT, and describes methods for the detection, debounce, and buffering of keyswitches. Schematics cover the hardware design, and the accompanying diskette contains source code for the keyboard's internal controller. The hardware and firmware design example is for an automatic teller application. PC Keyboard Design, by Gary Konzak, is \$249.

FREE We'll include a free copy of the pocket-sized XT-AT Handbook by Chissoer and Foster with each PC Keyboard Design book if you tell us where you saw this ad. Of course, this \$9.95 value is also available by itself. Or buy five or more for only \$5.00 each.

VISA 800-462-1042 MasterCard
 619-673-0870

Annabooks 15010 Avenue of Science, Suite 101 San Diego, CA 92128
 FAX 619-673-1432
 Money-back guarantee

CIRCLE NO. 765

Tango

The Complete Electronic Design Solution.

For **FREE** evaluation software and product specs, call **800 488-0680**

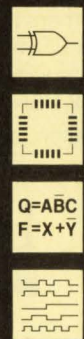

Tango, the leader in PC-based tools for:

- Schematic entry
- PCB layout and autorouting
- PLD design
- Simulation, timing verification and thermal reliability

ACCEL Technologies, Inc.
 6825 Flanders Drive
 San Diego, CA 92121-2986
 Service 619 554-1000
 Fax 619 554-1019

CIRCLE NO. 766

To advertise in Product Mart, call Joanne Dorian, 212/463-6415

WE DO BUSINESS JUST ONE WAY — SUCCESSFULLY

At Hughes Network Systems, we are securing a future of continued success by making a long-term commitment to product development and maintaining our high-level of energy, drive, and excellence. If you share in our dedication, consider one of these opportunities available now at our headquarters in Germantown, Maryland:

VLSI TECHNOLOGY

RF LSI DESIGNER

Working with product designers, you will identify RF LSI opportunities, interface to MMIC foundries to define circuit libraries and strategic functions needed for our products, lead RF MMIC design efforts, and teach others the design techniques. Requires 2+ years of RF MMIC design experience, knowledge of high-speed bipolar and GaAs technologies, and familiarity with the packaging challenges of RF design. (Dept. 914N564)

PACKAGING SPECIALIST

We will count on you to evaluate design proposals for performance, price and MTBF of the proposed package; evaluate and recommend alternative VLSI and board packaging solutions from suppliers; and assist in the development and manufacturing decisions regarding component packaging and capital equipment investments. Requires five years experience in VLSI packaging technologies and applications, and knowledge of price performance and reliability of industry standard VLSI packaging (PFP, TAB, MCM, etc.) (Dept. 914563)

FIELD ENGINEERING

FIELD ENGINEER

You will provide hardware/software support for packet switching networks, including installation, configuration, and troubleshooting of X.25 networks and LANs. You will also engage in extensive travel to support worldwide customers in their network operations. Position requires a BS in Electrical Engineering or Computer Science, four years related experience, and knowledge of X.25 or LAN 802. (Dept. 761R495)

For immediate consideration, send your resume indicating the department code for the position of interest, to: Hughes Network Systems, Inc., 11717 Exploration Lane, Germantown, MD 20876. An equal opportunity employer.

HUGHES
NETWORK SYSTEMS

Subsidiary of
Hughes Aircraft Company

EDN-CAREER OPPORTUNITIES

1992 Recruitment Editorial Calendar

Issue	Issue Date	Ad Deadline	Editorial Emphasis
News Edition	Aug. 27	Aug. 13	Embedded Software • Software • Regional Profile: Washington DC, Maryland, Virginia
Magazine Edition	Sept. 3	Aug. 13	ASICs SPECIAL ISSUE CAE Tools & Techniques Computer Peripherals • Computer Buses • Sensors & Transducers • Buscon Show Coverage
News Edition	Sept. 10	Aug. 27	CAE • Test & Measurement Diversity Special Series
Magazine Edition	Sept. 17	Aug. 27	Field-Programmable Gate Arrays DSP Directory • Embedded Computers • CAE
SOFTWARE ISSUE	Sept. 17	Aug. 27	SOFTWARE ENGINEERING SPECIAL ISSUE (To be polybagged with the Sept. 17th Magazine Edition issue)
News Edition	Sept. 24	Sept. 10	Automotive Electronics Sensors • Computers & Peripherals • Regional Profile: Oregon, Washington
Magazine Edition	Oct. 1	Sept. 10	TEST & MEASUREMENT SPECIAL ISSUE • European Technology Update • Data Acquisition Software • Superconductors • How to Design it Right the 1st Time Series—Part I PLD/FPGA Directory
News Edition	Oct. 8	Sept. 24	CAE • PC/Workstation Design • Engineering Management Special Series
Magazine Edition	Oct. 15	Sept. 24	Disk Drives • Portable-Computer Design • Switching Power Supplies • Design it Right Series—Part II
News Edition	Oct. 22	Oct. 8	Data Storage Technology Communications Technology Regional Profile: Michigan, Illinois, Missouri
Magazine Edition	Oct. 29	Oct. 8	ELECTRONICA SHOW ISSUE • Object-oriented Programming • Chipsets for PCs Design it Right Series—Part III Wescon Preview Issue
News Edition	Nov. 5	Oct. 22	COMDEX/WESCON SPECIAL ISSUE • Special Supplement: Design for Portability • Microprocessors • Wescon/Comdex Hot Products • CAE Software • Diversity Special Series
Magazine Edition	Nov. 12	Oct. 22	COMDEX/WESCON SPECIAL ISSUE • Integrated Circuits • Test & Measurement • Design it Right Series—Part IV

Call today for information
on Recruitment Advertising:

East Coast: Janet O. Penn (201) 228-8610

National: Roberta Renard (201) 228-8602



The capacity to show the way by taking the lead. To influence or direct the activities of others.

Some appear to be the leader. But actions speak much louder than muscle. We believe in the personal power of the individual. Which is why, at Motorola Semiconductor Products Sector (SPS), we encourage our people to be champions. To establish goals. To influence by example. As a result, we're an international innovator in the semiconductor industry.

The microelectronics technology leader. Naturally, it's the Microprocessor and Memory Technologies Group, Motorola SPS. **Opportunities now exist in our Texas facility for professionals with expertise in the following areas.**

SENIOR DESIGN ENGINEER Participate in specification, design and implementation of next generation RISC/68000 microprocessors. Requires BS/MSEE and 5 years experience with a strong background in new product specification, behavioral modeling, VLSI and microprocessor design.

CUSTOM SRAM DESIGN ENGINEERS Design, verification and test of CMOS and BiCMOS fast static RAMS. Requires a BS/MSEE and 1-5 years in design of fast statics. Experience in design of BiCMOS SRAMS desirable.

IC DESIGN ENGINEER Design logic and CMOS control circuitry for a RISC-based microprocessor cache. Involves circuitry definition, modeling, and verification, plus integration of custom SRAM cache and MMU arrays. Requires BS/MSEE with emphasis on computer engineering and 3+ years VLSI CMOS design experience. Cache/MMU control design expertise is a must.

SYSTEM VERIFICATION ENGINEER Develop verification programs/behaviorals to verify RISC/68000 microprocessor families' functions and perform failure analysis at system and chip levels. Requires BS/MSEE and 3-5 years experience with proficiency in C/UNIX.

PRODUCT/TEST ENGINEERS From wafer probe and assembly through final test, will ensure effective product yield/cost management. Involves customer interface and characterization of products to support design, manufacturing and quality improvements for RISC/68000 microprocessor families. BSEE and 2+ years related experience required.

SOFTWARE ENGINEER Develop, port and support RISC architecture debuggers. Includes UNIX X Window graphics HW/SW tools and porting of cross-tools to various development platforms. Requires BSCS and 4+ years C/UNIX experience with a minimum of 2 years in UNIX X Window graphics. C++ skills preferred.

CAD SOFTWARE ENGINEERS Will develop and support leading edge electronic design automation tools and methodologies for IC design. Requires a minimum of 7 years experience in CAD tool development and extensive C or C++ programming. Cadence experience a plus.

MECHANICAL ENGINEER Requires BSME with a minimum of 2 years Class 10 or cleaner wafer fab experience with a large semiconductor manufacturer. Working knowledge of HVAC, tool fit-up, specialty piping and controls is essential, as well as proficiency with AUTOCAD 10 or 11. Ideal candidates will have P.E. registration or ability to become registered as soon as possible.

GRAPHICS/EMBEDDED CONTROL MARKETING MANAGER Develop/implement marketing strategies for 88000 and PowerPC graphics embedded control products with an emphasis on facilitating design wins in targeted areas. Requires BSEE and 4+ years experience marketing embedded control microprocessors. Knowledge of HW/SW development tools and key operating system software is essential.

There's no company — or opportunity — in the world like this one. Be a part of it. For consideration, call or send your resume to: **Motorola SPS, Dept. ATX-9214, 505 Barton Springs Rd., One Texas Center, Suite 400, Austin, TX 78704. (800) 531-5183. (512) 322-8811 FAX.** An Equal Opportunity/Affirmative Action Employer.



MOTOROLA

Microprocessor and Memory Technologies Group

**CMOS LOGIC AND CIRCUIT DESIGN
SYNTHESIS • BUS INTERFACE • SIMULATION
RISC ARCHITECTURE • MICROPROCESSOR DESIGN
MICROPROCESSOR ARCHITECTURE**

MEMORY SYSTEMS • DEVELOPMENT TOOLS

THE QUALITY OF THE PRODUCT DEPENDS ON THE QUALITY OF THE RESOURCES

Pulse Communications has been creating advanced voice and data transmission products for almost 30 years. Today, as we develop the industry's most advanced digital loop carrier systems, we seek goal-oriented, resourceful professionals to join our dynamic technical staff.

Qualified applicants will have a BSEE or BSCS along with 2+ years experience in a telecommunications environment. An advanced degree is preferred, as is knowledge of Bellcore standards and demonstrated ability in the design of advanced voice and data transmission products. Specific opportunities are available for:

SOFTWARE ENGINEERS

- Embedded real-time systems
- C programming on a UNIX platform
- Intel 5081 and Motorola 68XXX processors

LINE CARD DESIGNERS

- Analog and digital
- Voice and data transmission
- Microprocessor control
- High speed backplanes
- X.25, LAN

ASIC DESIGNERS

- HDL design
- Valid running on Sun Workstations
- SONET, ADM, TSI
- EPLD, ASIC, FPOA
- ISDN, T1

COMMON CONTROL DESIGNERS

- ASIC or FPOA
- Remote test
- Motorola 68XXX microprocessors

In addition to highly competitive salaries and top benefits, you'll enjoy the variety of cultural, recreational and residential attractions available in our Fairfax County, Virginia location—only 30 minutes from Washington, D.C.

Learn more about these promising career opportunities. Forward your resume and salary history to: Pulsecom, Human Resources, 2900 Towerview Road, Herndon, VA 22071. An Equal Opportunity Employer M/F/D/V.



pulsecom

INFINITE CHALLENGES

E-Systems ECI Division is in need of engineers with military satellite communication experience (ground, manpack/manportable, airborne, or spaceborne); a BSEE/BSCE; and at least 2 years' experience in one of the following areas:

SOFTWARE

- ADA, C
- 1750A, of 68020 Microprocessors
- VAX VMS, Sun UNIX
- Real-time, Embedded Microprocessor
- DOD-STD-2167A, CASE Tool

DIGITAL HARDWARE

- ACTEL FPGAs
- Microprocessor based systems
- 1553 bus interface

DIGITAL SIGNAL PROCESSING

- Discrete Fourier Transforms
- Control Loops
- PSK Demodulation

EMBEDDED CRYPTO

- Security Fault Analysis
- TEMPEST, Red/Black Isolation
- Related interface hardware

RF and MICROWAVE

- Synthesizer Design, Direct Digital
- Power amp and filter design
- MMIC design

ANTENNA DESIGN

- Parabolic Antenna Design
- Gimbal, Positioner
- 10 TO 60 GHz

SYSTEMS

- BSEE/MSEE, minimum 4 years' experience
- Strong communication background
- Requirements Analysis, Functional Analysis
- System Synthesis, System Analysis
- RF Link Budget Analysis
- System Integration/Test
- Customer Interface

Background: Hardware, Software Architecture Cryptographic; BIT/BITE; Antenna Pointing, Tracking, and Platform Stabilization; MIL-STD-1582; SI-1135, SI-2035, LL1005.

MILSTAR or other military satellite design experience a plus.

E-Systems offers very competitive salaries and an excellent benefits package which includes an Employee Stock Ownership Plan, 401(k), and major medical and dental insurance. Qualified candidates should forward a resume and salary history to: Manager of Staffing, E-Systems, Inc., ECI Division, Post Office Box 12248, St. Petersburg, Florida 33733-2248.

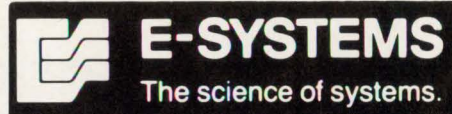

U.S. Citizenship Required.
An Equal Opportunity Employer, M/F, D/V.

Quality design and advanced technology. Because lives depend on it.

Siemens Pacesetter, Inc. makes implantable cardiac devices. Tiny enough to fit in your fist. Powerful enough to sustain life. Innovative enough to have made history. Incredible enough to last a decade or more. Perceptive enough to know when patients are exercising and when they're resting.

But at Siemens Pacesetter, Inc., together with our multi-billion dollar parent company Siemens, we are looking toward the future. We are developing implantable devices that can start a stopped heart. Pacemakers tiny enough to be implanted in premature babies with heart defects. Implantable technology that mimic the human heart down to the subtlest nuances.

The field of cardiac device therapy has come so far so fast, there's no telling where technology will take us in twenty years. If you need incredible challenges in a high-tech environment and the opportunity to do work that literally saves and changes lives, you'll find your opportunity to make a difference at Siemens Pacesetter, Inc. Future opportunities include:

AUTOMATIC TEST ENGINEER

To perform analog and digital circuit design, SW development and test system integration. Requires BSEE and 3+ years ATE experience in the design/development of computer-based automatic production test equipment. **Respond to Dept. EDN/ATE.**

IC LAYOUT DESIGNER

Utilizing Sun SPARC workstations, will layout CMOS analog/digital circuits with standard cell and fully customized methodologies. Requires 2+ years layout experience and working knowledge of UNIX. **Respond to Dept. EDN/ICDE.**

PROCESS ENGINEER

Will handle machine design projects utilizing electro-pneumatic mechanisms/processes involving YAG laser welding. Requires BSME/EE with 5 years experience in CNC machine control, diagnostics, mechanical fixture design and repair of digital/analog circuits. **Respond to Dept. EDN/PE.**

SR. PROCESS ENGINEER

Will develop/implement new processes, equipment, components and manufacturing methods to support hybrid test and manufacturing. Emphasis will be on improving manufacturing yields, designing SPC systems and conducting hybrid material R&D. Requires BSEE/ME; 5 years hybrid experience preferred. **Respond to Dept. EDN/SPE.**

SOFTWARE QUALITY ENGINEER

Will develop/implement software test designs for validation/verification of product and manufacturing. Requires experience in software development for microprocessor-based products and software test design procedures. A BSCS or equivalent is desirable. **Respond to Dept. EDN/SQE.**

SR. COMPONENT RELIABILITY ENGINEER

Requires BSEE with 5 years experience in reliability engineering, failure analysis techniques and rate predictions. Knowledge of IC and hybrid design/evaluation/qualification techniques and CMOS is essential. **Respond to Dept. EDN/CRE.**

SR. ANALOG ELECTRONICS DESIGN ENGINEER

Duties include designing low power CMOS op amps and switched capacitor circuits and overseeing layout. Will also perform some system design, integration and scheduling. Requires BS/MS in Electronics, 10+ years analog design experience and 5+ years IC design experience. Thorough knowledge of SPICE and FET models a must. **Respond to Dept. EDN/AEDE.**

SR. ELECTRONIC PRODUCT ENGINEER

BSEE and 3-5 years experience in analog/digital design, CMOS/TTL devices and microprocessor-based systems essential. Ideal candidate will have knowledge of hybrid microelectronics involved in the manufacture of high-reliability electronic devices. **Respond to Dept. EDN/EPE.**

SOFTWARE ENGINEER

Utilizing Assembly and C languages, will design/develop system and application SW for real-time embedded microprocessor-based device support products. Requires BSEE/CE or equivalent and 3+

years experience in embedded microprocessor and system-level SW design/development. **Respond to Dept. EDN/SE.**

In addition to our desirable Southern California location, we offer competitive compensation, paid relocation and an excellent benefits package, including employer-contributed pension plan, 401(k), tuition reimbursement, vision care and a choice of dental/health plans. Send resume (NO PHONE CALLS, PLEASE!) to the appropriate department: **Greer A. Brooks, Employment Representative, Siemens Pacesetter, Inc., 15900 Valley View Court, P.O. Box 9221, Sylmar, CA 91392-9221. AA/EOE**

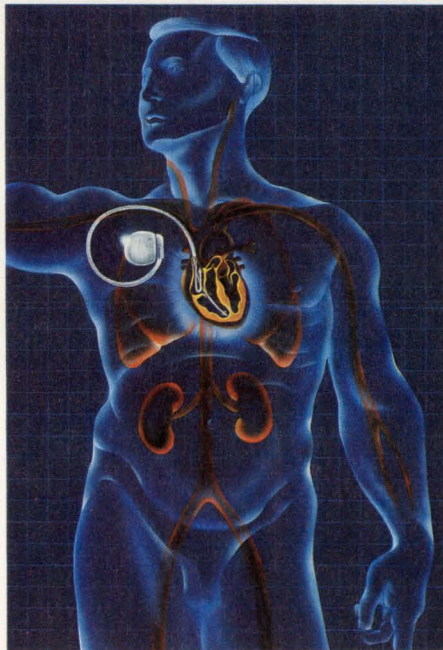

Siemens Pacesetter®



Excellence in Cardiac Pacing

Vr4000PC (64-bit)

- 50MHz: 179-pin PGA
- 66MHz: 179-pin PGA

Vr4000SC (64-bit)

- 50MHz: 447-pin PGA/LGA
- 66MHz: 447-pin PGA/LGA

Vr4000MC (64-bit)

- 50MHz: 447-pin PGA/LGA
- 66MHz: 447-pin PGA/LGA

VR series

Vr3010A (32-bit FPU)

- 25MHz: 160-pin QFP
84-pin Plastic PGA
- 33MHz: 84-pin PGA/Plastic PGA
- 40MHz: 84-pin PGA

Vr3000A (32-bit CPU)

- 25MHz: 160-pin QFP
175-pin Plastic PGA
- 33MHz: 175-pin PGA/Plastic PGA
- 40MHz: 175-pin PGA

Vr3600A (32-bit CPU + FPU)

- 25MHz: 175-pin PGA
175-pin Plastic PGA
- 33MHz: 175-pin PGA
175-pin Plastic PGA
- 40MHz: 175-pin PGA

NEC offers the Industry's broadest choice of RISC processors.

RISC microprocessors will soon be driving the next generation of workstations, servers, PCs, and embedded applications.

To meet your expanding needs, NEC offers the industry's broadest selection of RISC microprocessors.

Whether you're designing for the 32- or 64-bit world, our lineup includes RISC microprocessors that match your type, speed and package requirements.

64-bit RISC

NEC's 64-bit RISC family offers excellent price/performance and future upgrade paths. Vr4000PC gives you a completely integrated set of functions for 64-bit computing. The floating point unit, as well as 8K-byte instruction cache, and 8K-byte data cache are all included on chip. Vr4000SC also supports a large secondary cache of up to 4M bytes. Vr4000MC features a multiprocessor interface for parallel processing.

32-bit RISC

We offer three device types for 32-bit RISC computing: Vr3000A CPU, Vr3010A FPU, and Vr3600A which integrates both CPU and FPU on a single chip. For cost-sensitive applications, try our plastic PGA and QFP versions.

For the right type, the right speed, the right package and the right price, come to NEC. You'll find what you need in the industry's broadest line of RISC microprocessors.

For fast answers, call us at:

USA Tel:1-800-632-3531. Fax:1-800-729-9288. Germany Tel:0211-650302. Fax:0211-6503490. The Netherlands Tel:040-445-845. Fax:040-444-580. Sweden Tel:08-753-6020. Fax:08-755-3506. France Tel:1-3067-5800. Fax:1-3946-3663. Spain Tel:1-504-2787. Fax:1-504-2860. Italy Tel:02-6709108. Fax:02-66981329. UK Tel:0908-691133. Fax:0908-670290. Ireland Tel:01-6794200. Fax:01-6794081. Hong Kong Tel:755-9008. Fax:796-2404. Taiwan Tel:02-719-2377. Fax:02-719-5951. Korea Tel:02-551-0450. Fax:02-551-0451. Singapore Tel:253-8311. Fax:250-3583. Australia Tel:03-8878012. Fax:03-8878014. Japan Tel:03-3454-1111. Fax:03-3798-6059.



EDN-INTERNATIONAL ADVERTISERS INDEX

ACCEL Technologies Inc	157
Access	72
Actel	12-13
Advanced Micro Devices	10-11, 56-57
Advin Systems Inc	155
Allen Systems	157
American Arium	128
American Neurologix	101
AMP	22-23
Annabooks	157
AT&T Microelectronics	52-55
Avtech ElectroSystems Ltd	156
BP Microsystems	157
Brooktree Corp	63
Cahners CAPS	102-105, 154, 156
Capilano Computer Systems Inc	154
Capital Equipment Corp	72
Central Semiconductor	90

Coilcraft	87
Comdisco	151
Concurrent Logic	85
Condor	45
Cypress Semiconductor	38
Dale Electronics Inc	43
Data I/O Corp	155, C4
Datel	166C
Design Computation Inc	155
Dialight Corp	61
Diversified Technology	50-51
DSP Development	76
Du Pont Co	92
EEsof	1
Elantec	99
Electronic Measurements Inc	142-143
Embassy Suites	77
Emulation Technology Inc	154

FDK Electronics	164
Force Computers Inc	14-15
Frequency Devices	148
Gates Energy Products Inc	106
Grammar Engine Inc	156
Hamilton Avnet Electronics	111
Harris Semiconductor	124-125, 126-127, 144-145
Hewlett-Packard Co	C2, 71
Huntsville Microsystems Inc	113
IC Sensors	58
IDT	8
IEE	64
Incredible Tech	153
Independent Digital Consulting Inc	156
Intel	24-25, 67
International Rectifier	C3
Intusoft	154
Ironwood Electronics Inc	164
ITT Cannon	3
ITT Pomona Electronics	164
John Fluke Manufacturing Co Inc	6, 28-29
LeCroy Corp	16
Linear Technology Corp	133-134
Macrochip Research	155
MathSoft Inc	9
Maxell	138-139
Maxtor	32-33
Metalink Corp	157
MicroSim Corp	19
Microtime Computer Inc	153
Mini-Circuits Laboratories	20-21, 131, 166
Mizar Inc	150
Molex Inc	73
Motorola Semiconductor Products Inc	30-31, 69
Music Semiconductor	147, 149
National Instruments	2
NEC Corp	162
NCI	157
Nohau Corp	153
Number One Systems Ltd	156
Octagon Systems	155
Ohmite Mfg Co	163
Omaton Inc	154
PADS Software Inc	51
Palomar Telecom Inc	156
Pentica Systems	147
Philips Semiconductor*	135-137
Pico	27, 116
Powerex Inc	141
Power-One Inc	49
Programmed Test Services	26
Quadtek	157
Raltron	114
RC Systems	156
Selco Products Inc	72
Sierra Circuits	153
Signetics Corp	136-137
Siliconix Inc	4
Simtek	91
Sony Semiconductor Div	117
Space Research Technology Inc	154
Stockholm International Fairs	150A, B
TECI	154
Techron	89
Tektronix Inc	47
Teltone Corp	155
Texas Instruments Inc	34-36
3M Data Recording Products Div	149
3M Electrical Specialties Div	60
Toyocom	140
Tribal Microsystems	153
Tsien	135
Two Technologies	156
VMETRO Inc	146
Westcor	40
Wintek Corp	155
Xeltek	155
Xicor Inc	157
Xilinx	74-75
Zaxtek	154
Z-World	153

When space is tight... Ohmite has the resistor that fits. The POWER-CHIP®

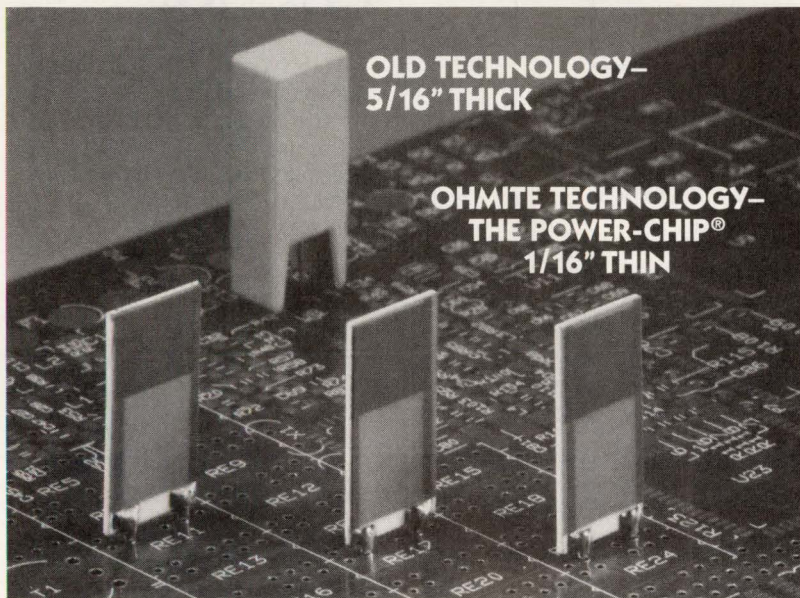

New technology handles the power in 1/5 the space.

Ohmite has revolutionized power resistors with the innovative POWER-CHIP®, a non-inductive resistor which dissipates up to 10 watts in a body thickness of 1/16". Using thick film technology, the POWER-CHIP® offers a resistance range of 1.0 ohm to 250k ohm in 1% and 5% tolerances. Three power ratings are offered: 5, 7.5, and 10 watts. 5 watt units are 1/2" wide x 1" high, 7.5 watt units are 3/4" wide x 1" high, and the 10 watt units are 1" wide x 1" high. Designed for plug-in boards with .1" centers.

Get fit with Ohmite.
Tel 708-675-2600 Fax 708-675-1505

OHMITE® CIRCLE NO. 85

Since 1925, Ohmite Manufacturing Co. has been in the forefront of innovative electronic component technology. Progressive and competitive, Ohmite maintains a tradition of quality and service.

Ohmite Manufacturing Co., 3601 Howard St., Skokie, IL 60076 Tel 708-675-2600 Fax 708-675-1505

Recruitment Advertising 158-161

*Advertiser in European edition

HIGH POWER FACTOR

Custom Switching Power Supplies for

- Engineering work stations
- Computer main frames
- Computer peripheral equipment
- Business equipment
- Telecommunications
- etc.



- High power factor 0.99
- Design, manufacturing in Japan
- Repair center in U.S.A.

FDK also specializes in DC-DC converters, hybrid ICs, memory cards, ferrite cores, lithium batteries, stepper motors, optical isolators, etc.

FDK Your Best Strategic Partner
FDK AMERICA, INC.

A Division of Fuji Electrochemical Co., Ltd.
2880 Zanker Road, #102 San Jose, California 95134, U.S.A.
TEL: 408-432-8331 FAX: 408-435-7478

Dallas TEL: 214-650-7742 FAX: 214-650-7792
Boston TEL: 617-487-3198 FAX: 617-487-3199

CIRCLE NO. 86

TEST QUAD FLATPACK

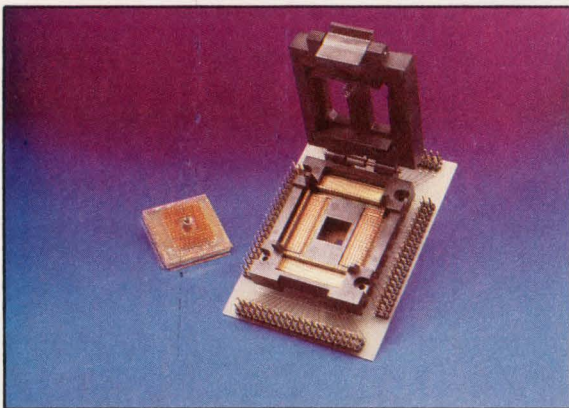

SURFACE MOUNT
OR IN SOCKET

With Quad Flat Pack Carrier Adaptors

- Two piece assembly consisting of:
 - Quad Flat Pack Emulator.
 - Foot and Socket/Test Probe Assembly.
- Simply solder or socket the Emulator Foot.
- Excellent lead coplanarity for reliable solder connection.
- Plug the two assemblies together with .050" center gold pins.
- Socket Test Probe assembly has overlay for easy pin probing.
- Recessed screw and nut provide extra mechanical strength.
- Custom overlays and configurations available upon request.
- Available in many sizes.

IRONWOOD ELECTRONICS
P.O. BOX 21151, ST. PAUL, MN 55121
(612) 431-7025; FAX (612) 432-8616

CIRCLE NO. 87

Test Fine-Pitch Devices to
208 Pins

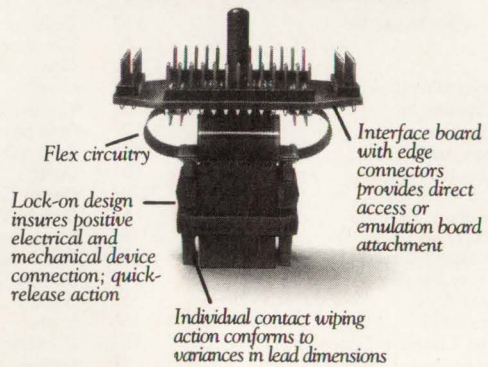

Logic Analyzer's Friend.



Pomona's new FIN™ (Flexible Interface Network) QFP test clips give you direct access to today's newest 100-, 132- and 196-pin JEDEC devices. Set-up time is drastically reduced, and you can rely on repeatable contact with every pin, every time. And, you can choose among three styles in each pin count to suit your interface needs.

Of course, you'll be able to select from Pomona's complete family of SMD and IC test accessories including IC clip kits and PGA adapters. You can also choose from 18 EIAJ QFP test adapter models.

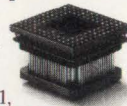

Italy: (2) 8358351, U.K.: (081) 9989061,
France: (1) 43027606, Germany: (089) 3887210

We're Making Technology
Easier To Live With.

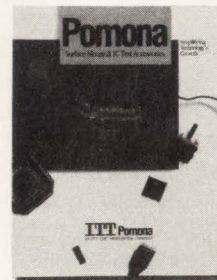

Call, FAX or write today for your free copy of Pomona's full-color *Surface Mount & IC Test Accessories* brochure.

ITT Pomona
The World Leader In Test Accessories

1500 E. Ninth Street, Pomona, California 91769 U.S.A.
(714) 469-2900 FAX (714) 629-3317.

CIRCLE NO. 88

Why didn't I think of that?

That's what you'll say when you read the details about the Innovation and Innovator of the Year finalists and their products in EDN's Special August 20th Innovation Ballot Supplement.

Each innovation finalist will be the subject of a short feature article that will provide you with

interesting information on what's new in the world of electronics. You'll read about innovative products that exhibit high levels of performance and innovative people who display technical leadership in the electronics industry. You'll learn

about products that solve problems more effectively, and products or new technologies that allow engineers to design better products at a significant reduction in cost. Most of all, you'll notice that the people behind the nominated products are engineering professionals like you.

Each and every finalist's product is the cream of the crop. But, only a select few will be voted the Grand Winner of EDN's 1992 Innovation/Innovator of the Year in each category. It's up to you to decide which of these products is the most innovative. The best of the best.

So . . . keep your eyes open for the August Innovation Ballot Supplement which will be mailed to you with your August 20th issue. Your peers are counting on you to make the final judgement on their product and their innovative skills. Be sure to cast your vote on the ballot that's inside the supplement.

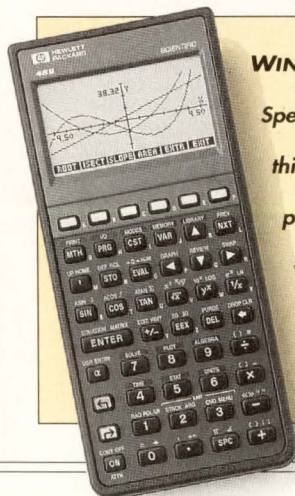

WIN A FREE CALCULATOR!!! By simply filling out the innovation ballot inside EDN's August 20th Special Innovation Supplement you can qualify to win a HP 48S Scientific Calculator. Valued at \$250, this Hewlett-Packard calculator is the first calculator that enters equations in textbook style and provides interactive calculator graphics. But — just like the innovation finalists — only a select few will win so make sure to send in your ballot! By sending in your ballot, you are automatically entered in a random drawing to be held on September 30th. You will be notified by mail if you are a winner.

EDN MAGAZINE
EDITION
NEWS
EDITION

incredible!

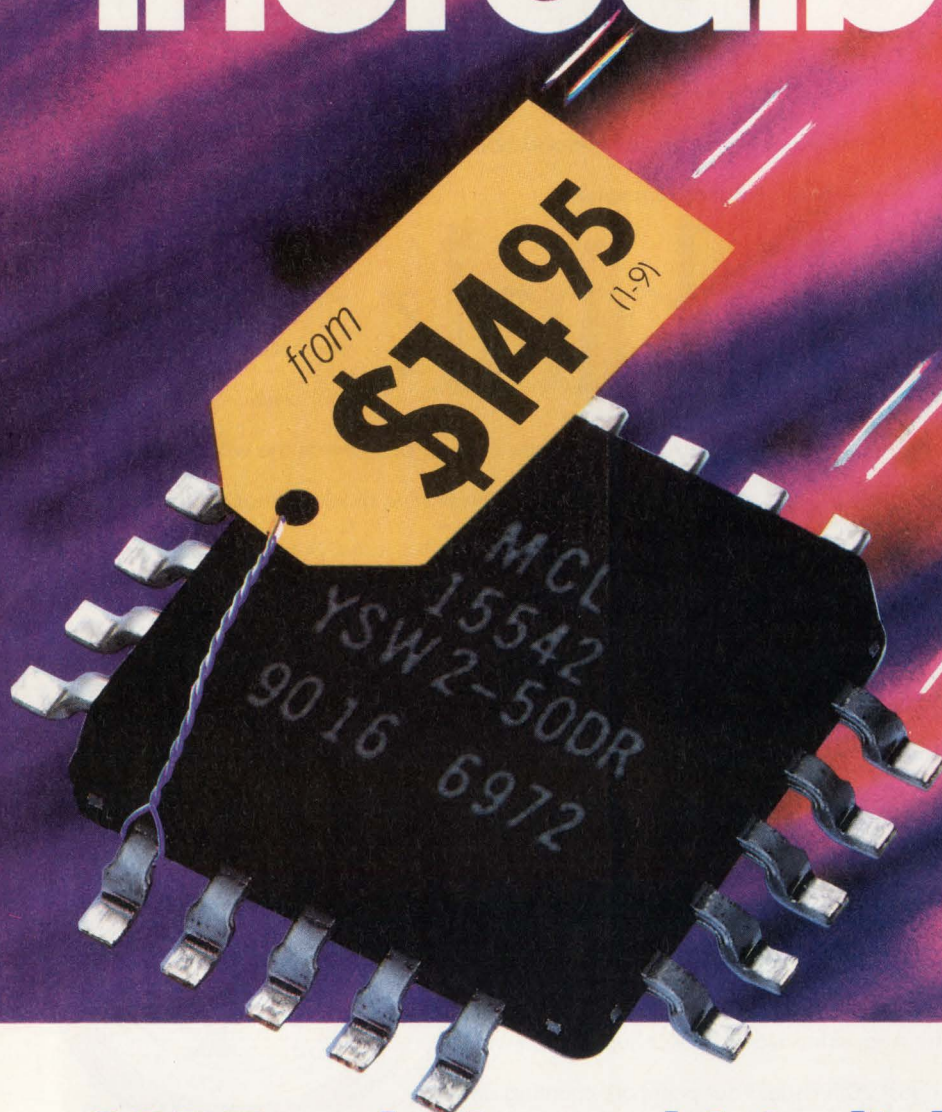

SPDT switches with built-in driver

ABSORPTIVE or REFLECTIVE dc to 5GHz

Truly incredible...superfast 3nsec GaAs SPDT reflective or absorptive switches with built-in driver, available in pc plug-in or SMA connector models, from only \$14.95. So why bother designing and building a driver interface to further complicate your subsystem and take added space when you can specify Mini-Circuits' latest innovative integrated components?

Check the outstanding performance of these units...high isolation, excellent return loss (even in the "off" state for absorptive models) and 3-sigma guaranteed unit-to-unit repeatability for insertion loss. These rugged devices operate over a -55° to +100°C span. Plug-in models are housed in a tiny plastic case and are available in tape-and-reel format (1500 units max, 24mm). All models are available for immediate delivery with a one-year guarantee.



finding new ways...
setting higher standards

SPECIFICATIONS (typ)

SPECIFICATIONS (typ)	Absorptive SPDT			Reflective SPDT		
	YSWA-2-50DR	ZYSWA-2-50DR		YSW-2-50DR	ZYSW-2-50DR	
Frequency (MHz)	dc- 500	500- 2000	2000- 5000	dc- 500	500- 2000	2000- 5000
Ins. Loss (dB)	1.1	1.4	1.9	0.9	1.3	1.4
Isolation (dB)	42	31	20	50	40	28
1dB Comp. (dBm)	18	20	22.5	20	20	24
RF Input (max dBm)	20			22	22	26
VSWR "on"	1.25	1.35	1.5	1.4	1.4	1.4
Video Bkthru (mV,p/p)	30	30	30	30	30	30
Sw. Spd. (nsec)	3	3	3	3	3	3
Price, \$ (1-9 qty)	YSWA-2-50DR (pin) 23.95 ZYSWA-2-50DR (SMA) 69.95			YSW-2-50DR (pin) \$14.95 ZYSW-2-50DR (SMA) 59.95		

Mini-Circuits™

P.O. Box 350166, Brooklyn, New York 11235-0003 (718) 934-4500 Fax (718) 332-4661

Distribution Centers / NORTH AMERICA 800-654-7949 • 417-335-5935 Fax 417-335-5945 EUROPE 44-252-835094 Fax 44-252-837010

For detailed specs on all Mini-Circuits products refer to • THOMAS REGISTER Vol. 23 • MICROWAVES PRODUCT DIRECTORY • EEM • MINI-CIRCUITS' 740-pg HANDBOOK

THE NEXTFETS.™

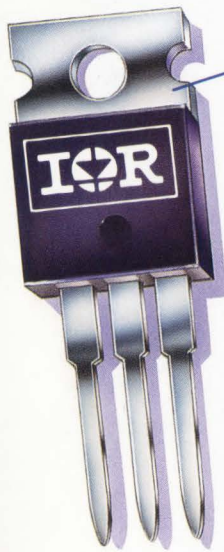

IRFZ48
60V, 0.018 Ω ,
50A TO-220

It's our proven IR HEXFET® technology, taken to new heights in efficiency.

Introducing low on-resistance HEXFET power MOSFETs in two popular plastic packages, including the 9m Ω TO-247, with the lowest $R_{DS(ON)}$ rating of any discrete power MOSFET on the market.

We call them NEXTFETs because they'll take your design to the next level of performance and efficiency.

They're high-performance components for your most demanding power switching, motor control and power management applications. All with the HEXFET technology, quality and reliability you expect from IR.

This is the first in a series of new MOSFETs for leading-edge designs. Watch for the next. And the next. And the next.

NEXTFETs only from IR. Anything else is next best.

IRFP064
60V, 0.009 Ω ,
70A TO-247



IR International Rectifier

WORLD HEADQUARTERS: 233 KANSAS ST., EL SEGUNDO, CA 90245, U.S.A. (310) 322-3331. FAX (310) 322-3332. TELEX 66-4464. EUROPEAN HEADQUARTERS: HURST GREEN, OXTED, SURREY RH8 9BB, ENGLAND TELEPHONE (0883) 713215, TELEX 95219

NEW
2900/3900
Programming Series starts at \$2995!



The new 3900 takes you wherever technology goes.

At the speed technology is advancing, you need to be ready for anything. On a limited budget.

The NEW 3900 Programming System keeps up with your most advanced designs while keeping device-programming costs down. It offers leading-edge support for FPGAs, PLDs, memory devices, and microcontrollers up to 88 pins, with future device and package capabilities built in. Yet this support is



offered in device libraries so you pay for only what you need, when you need it. And you can get into the 2900/3900 Programming Series for as little as \$2995.* Move up to 88-pin support and beyond with a simple upgrade.

Find out how the 3900 can make

your future affordable.

Call today for more information and we'll also send you a FREE copy of Data I/O's all-new, and expanded Wall Chart of Programmable Devices (a \$24.95 value).

To qualify, just call us with the brand name and serial number of any programmer you are currently using.



1-800-3-DataIO
(1-800-332-8246)

*U.S. list price only.

Data I/O Corporation 10525 Willows Road N.E., P.O. Box 97046, Redmond, WA 98073-9746, U.S.A. (206) 881-6444
1-800-3-DataIO (1-800-332-8246)

Data I/O Canada 6725 Airport Road, Suite 302, Mississauga, Ontario L4V 1V2 (416) 678-0761

Data I/O Europe 660 Eskdale Road, Winnersh, Wokingham, Berkshire, United Kingdom RG11 5TS, 0734 448899

Data I/O GmbH Lochhamer Schlag 5A, 80332 Graefelfing, Germany, +49 (0)89-856580

Data I/O Japan Sumitomoseimei Higashishinbashi Bldg., 8F, 2-1-7, Higashi-Shinbashi, Minato-Ku, Tokyo 105, Japan
011-81-3-3432-6991

Data I/O Limited 660 Eskdale Road, Winnersh, Wokingham, Berkshire, United Kingdom RG11 5TS, 0734 440011

©1992 Data I/O Corporation

CIRCLE NO. 92

DATA I/O